

EDN[®]

Electro/89 preview:
sessions and products

Designer's guide to
dynamic RAMs—Part 1

Logic-synthesis tools

RISC CPU boards

ELECTRONIC TECHNOLOGY FOR ENGINEERS AND ENGINEERING MANAGERS

Processors let PCs construct realistic 3-D graphics



Z I L O G



The next standard. A new generation of high performance SCCs.

Zilog's universal serial communication controller, the USC (Z16C30™), provides higher throughput than any general purpose SCC. And it does it while reducing the CPU workload 60%.

More speed.

The USC is four times faster than any general purpose SCC. You get guaranteed data rates of 10 Mbits/sec. But speed is not the only USC advantage.

More CPU power.

The USC requires less attention from the system CPU. That means more power for the system. The USC's lower overhead is due to easy initialization, auto-sequencing word transfers from deep FIFOs, fly-by DMA control, and reduced latency from an efficient, chained interrupt structure.

More flexibility.

You've got two completely independent channels, as well as multi-protocol capability. Because the USC has two BRGs per channel you can transmit and receive at two different bit rates. And the USC's universal bus interface means you can cut the cost of GLU logic and expensive board real estate.

More performance.

CMOS and Superintegration™ bring more CPU power and higher data throughput. The USC carries a 12.5 MByte/sec bus bandwidth punch. Straight DMA connect and 32-byte FIFOs make the USC's systems simple, elegant and fast. Very fast.

More reliability.

With the USC you get Zilog's proven quality and reliability. Unique built-in testability features allow access to nodes and registers for testing program functionality in real time. Find out more about the USC or any of Zilog's growing family of Superintegration products. Contact your local Zilog sales office or your authorized distributor today. Zilog, Inc., 210 Hacienda Ave., Campbell, CA 95008, (408) 370-8000.

Superintegration™ and the Communications Market.

Developed as an answer to the demand for more integration than ASICs could provide, Zilog's Superintegration™ technology has resulted in a rapidly growing family of application specific standard products (ASSPs), also known as cell-based integrated circuits, or CBICs. Working CPU and Peripheral cores and cells have been combined and enhanced for specific applications, yet they use the same proven architectures and instruction sets you're already working with.

Systems designers for the communications market needed SCCs with more speed. But that meant taking performance away from the CPU. A trade-off that was not acceptable. The USC, first of a family of Superintegration SCCs, is a solution that provides enhanced performance and reliability. Consider the far-reaching benefits. Now the way is clear for even more highly integrated systems to be developed.

And consider this. Nobody has a more complete library of proven, generic cores, system cells, or I/O bolts than Zilog. Nobody is better qualified to develop and deliver Superintegration parts.

Right product. Right price. Right away. **Zilog**

ZILOG SALES OFFICES: CA (408) 370-8120, (714) 838-7800, (818) 707-2160, CO (303) 494-2905, FL (813) 585-2533, GA (404) 923-8500, IL (312) 517-8080, MA (617) 273-4222, MN (612) 831-7611, NJ (201) 288-3737, OH (216) 447-1480, PA (215) 653-0230, TX (214) 987-9987, CANADA Toronto (416) 673-0634, ENGLAND Maidenhead (+44) (628) 39200, W. GERMANY Munich (+49) (89) 612-6046, JAPAN Tokyo (81) (3) 587-0528, HONG KONG Kowloon (852) (3) 723-8979, TAIWAN (886) (2) 741-3125, SINGAPORE 65-235 7155, DISTRIBUTORS: U.S. Anthem Electric, Bell Indus., Hall-Mark Elec., JAN Devices, Inc., Lionex Corp., Schweber Elec., Western Microtech, CANADA Future Elec., SEMAD, LATIN AMERICA Argentina—Yel.-(1) 46-2211, Brazil—Digibyte (011) 241-3611, Mexico—Semiconductores Profesionales (5) 536-1312.

CIRCLE NO 50

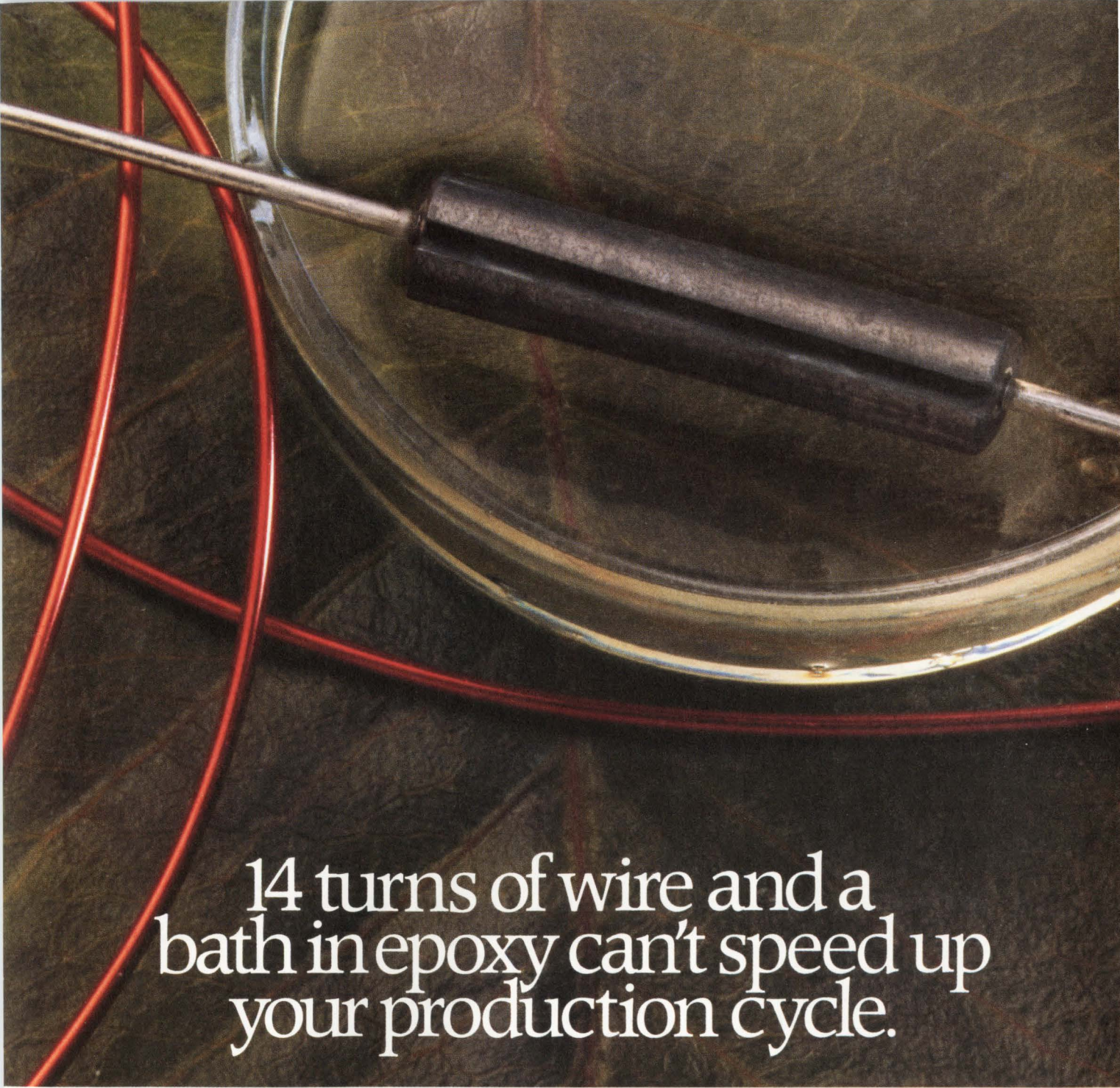

14 turns of wire and a
bath in epoxy can't speed up
your production cycle.

The phone book is full of magnetics suppliers. But one call — to Dale® Electronics — can add more than just a supplier to your next project.

We have the breadth of line, the staff and the facilities to deliver the exact part you need, exactly on time. We can document this in many ways — including a customer list full of firms who've proven it's more efficient to turn in-house magnetics production over to us.

So tell us your needs: A molded, shielded inductor, a MIL-C-15305

Dale® Can.

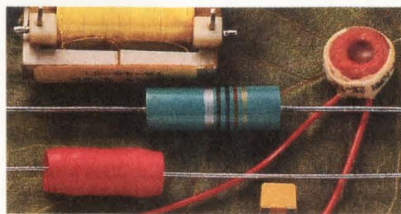

model, a high-volume, roll-coated choke, a custom switch model design. Off-the-shelf or one of a kind, Dale can be the partner you need to provide time-saving,

cost-efficient magnetic components.

Call today or write for a copy of our expanded Magnetic Components Catalog. Dale Electronics, Inc., East Highway 50, Yankton, South Dakota 57078. Phone: 605-665-9301.



Dale Makes Your Basics Better

CIRCLE NO. 1

WANT TO TALK SCSI? CALL CIPRICO AT 1-800-SCSI-NOW.

Why talk SCSI with Ciprico? To start with, we're the only vendor with a complete line of high-performance SCSI host bus adapters for Multibus* I, VMEbus, and Multibus II. Each board was designed to optimize performance with its system bus. And consider our experience. Ciprico has over 50,000 boards installed worldwide. Our design expertise provides you with the highest possible performance at the lowest possible price.

But that's not all. Ciprico has *responsibility*. We have the largest staff of customer support engineers in the industry to help you resolve any integration problems. Plus software drivers for all major operating systems.

Our SCSI adapters are all based on an 80186 microprocessor, providing a command queuing, pass-through SCSI command software interface. Each board supports SCSI disconnect/reconnect and asynchronous and synchronous transfer rates of 2MB/s and 5MB/s respectively. And a floppy port is optional for cost effective system design.

So if you're currently designing a system based on Multibus I, VMEbus, or Multibus II, give us a call to talk SCSI.



CIPRICO LISTENS. AND RESPONDS.

RIMFIRE 1500
SCSI Adapter for
Multibus* I

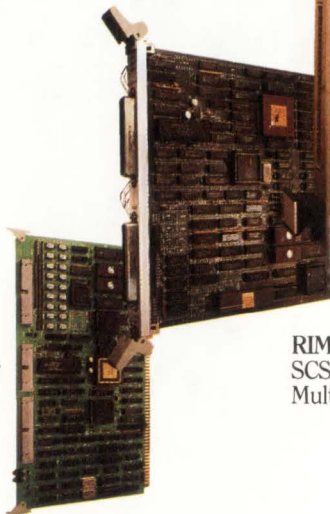

RIMFIRE 3510
SCSI Adapter for
VMEbus

RIMFIRE 2500
SCSI Adapter for
Multibus* II

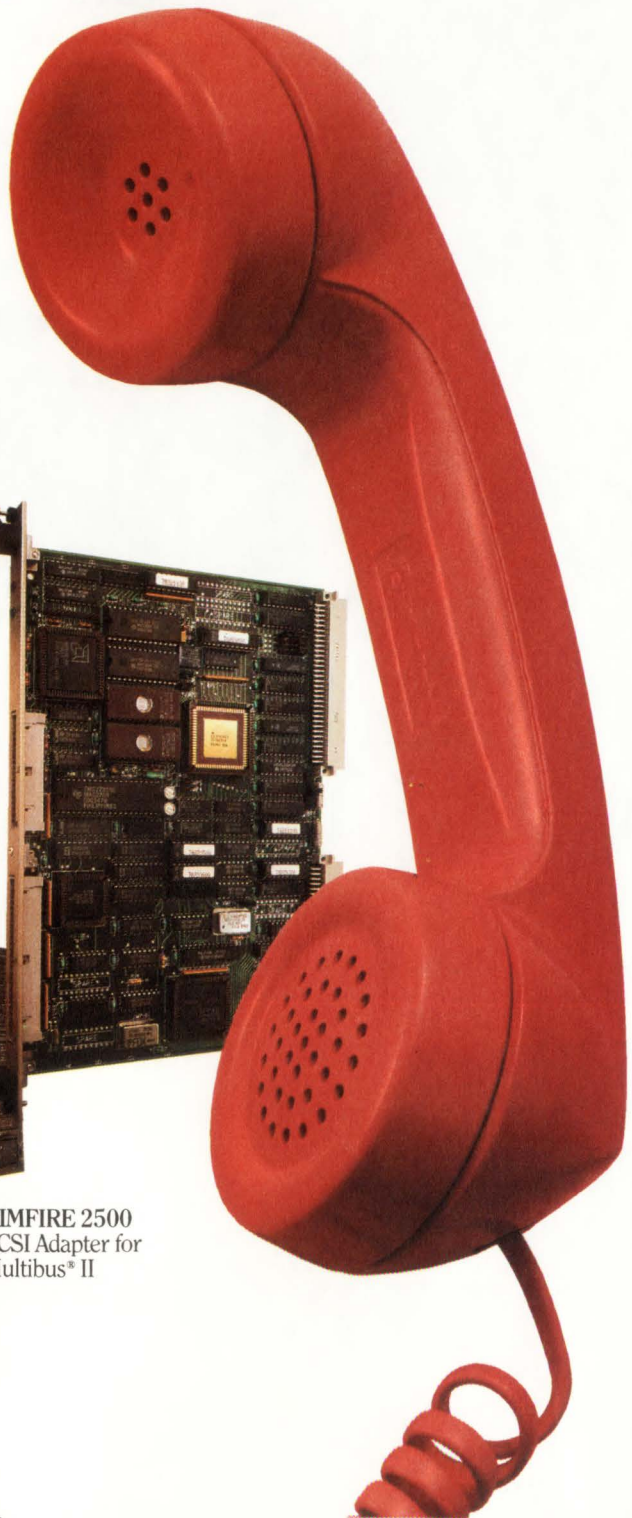

Multibus is a registered trademark of Intel Corporation.



Super Amplifier

2.5KHz to 500MHz 250mW only \$199

- POWERFUL** up to +23dBm undistorted output
- FLAT** within 1dB over the entire band. 2.5KHz to 500MHz
- UNCONDITIONALLY STABLE** regardless of load
- DAMAGE-RESISTANT** built-in voltage regulator; supply voltage 24V, 0.35A
- RUGGED** operates from -55 to +85° C, withstands shock and vibration, ground equipment
- COMPACT** only 3.75 by 1.8 by 2.6 in.

Packed with these super performance features, 22dB flat gain and a typical VSWR of 1.3 to 1, the ZHL-6A amplifier is ideally suited for your latest broadband systems designs. And where space is critical, its height can be cut in half, to only 0.9 in., by removing the heat sink and attaching the unit to your chassis.

Running tests in your lab or on the production line covering all or segments of the 2.5KHz to 500MHz range and need more output from sweep or signal generators? It's not necessary to purchase and connect/disconnect an assortment of amplifiers when the ZHL-6A does it all...at an attractive price of only \$199.

For a super price/performance amplifier, order a ZHL-6A, available for immediate delivery with a one-year guarantee.

finding new ways ...
setting higher standards

Mini-Circuits

A Division of Scientific Components Corporation
P.O. Box 350166, Brooklyn, New York 11235-0003 (718) 934-4500
Fax (718) 332-4661 Domestic and International Telexes: 6852844 or 620156



F127 REV. ORIG.

tiny SPDT switches

absorptive... reflective

dc to 4.6 GHz from \$32⁹⁵₍₁₀₋₂₄₎

Tough enough to pass stringent MIL-STD-883 tests, useable from dc to 6GHz and smaller than most RF switches, Mini-Circuits' hermetically-sealed (reflective) KSW-2-46 and (absorptive) KSWA-2-46 offer a new, unexplored horizon of applications. Unlike pin diode switches that become ineffective below 1MHz, these GaAs switches can operate down to dc with control voltage as low as -5V, at a blinding 2ns switching speed.

Despite its extremely tiny size, only 0.185 by 0.185 by 0.06 in., these switches provide 50dB isolation (considerably higher than many larger units) and insertion loss of only 1dB. The absorptive model KSWA-2-46 exhibits a typical VSWR of 1.5 in its "OFF" state over the entire frequency range. These surface-mount units can be soldered to pc boards using conventional assembly techniques. The KSW-2-46, priced at only \$32.95, and the KSWA-2-46, at \$48.95, are the latest examples of components from Mini-Circuits with unbeatable price/performance.

Connector versions, packaged in a 1.25 x 1.25 x 0.75 in. metal case, contain five SMA connectors, including one at each control port to maintain 3ns switching speed.

Switch fast... to Mini-Circuits' GaAs switches.

SPECIFICATIONS

Pin Model	KSW-2-46	KSWA-2-46
Connector Version	ZFSW-2-46	ZFSWA-2-46
FREQ. RANGE	dc-4.6 GHz	dc-4.6 GHz
INSERT. LOSS (dB)	typ max	typ max
dc-200MHz	0.9 1.1	0.8 1.1
200-1000MHz	1.0 1.3	0.9 1.3
1-4.6GHz	1.3 1.7	1.5 2.6
ISOLATION (dB)	typ min	typ min
dc-200MHz	60 50	60 50
200-1000MHz	45 40	50 40
1-4.6GHz	30 23	30 25
VSWR (typ)	ON 1.3:1 OFF —	1.3 1.4
SW. SPEED (nsec) rise or fall time	2(typ)	3(typ)
MAX RF INPUT (bBm)		
up to 500MHz	+17	+17
above 500MHz	+27	+27
CONTROL VOLT.	-8V on, OV off	-8V on, OV off
OPER./STOR TEMP.	-55° to +125°C	-55° to +125°C
PRICE (10-24)	\$32.95 \$69.95	\$48.95 \$79.95

finding new ways...
setting higher standards

Mini-Circuits

A Division of Scientific Components Corporation

P.O. Box 350166, Brooklyn, New York 11235-0003 (718) 934-4500
Fax (718) 332-4661 Domestic and International Telexes: 6852844 or 620156

C 117 REV. E

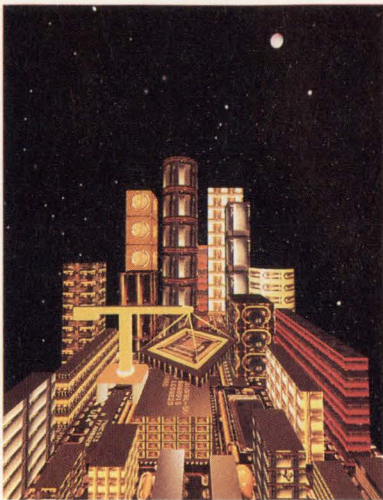

On the cover: With any one of three recently introduced processors, you can give your PC's graphics an added dimension. See pg 96.

This cover art was produced by Diane Molina and Ben Deiman of Bendi Photographic Design on equipment from Austin Business Computers Inc. The image was created on an IBM PC/AT-compatible computer containing a 34010-based Truevision ATVista video-graphics card. The image started with 35-mm color slides of the ATVista card and the TI34020 graphics processor. It was then digitized with a Howtek slide scanner. Extrusions of the chips were made to look like buildings with TOPAS software from AT&T Graphics Software Labs. The designer used Truevision Vista TIPS to create the textures. This photograph was provided courtesy Texas Instruments.

SPECIAL REPORT

Processors for 3-D graphics

96

Because of their enormous appetite for floating-point operations, 3-D graphics displays were previously limited to high-end workstations. With some powerful new processors, however, you can now bring workstation-quality 3-D graphics to such applications as PC add-in boards and embedded-graphics systems.—*Margery S Conner, Regional Editor*

DESIGN FEATURES

Electro/89

110

For three days in April, New York City will offer the electronics-engineering community much of interest in the form of Electro/89—eastern US's largest design-electronics trade show and convention.—*Richard A Quinnell, Regional Editor*

Electro/89 Products

127

Designer's guide to dynamic RAMs—Part 1

155

Although designers often prefer dynamic RAMs (DRAMs) to their static counterparts, they sometimes shy away from using DRAMs because of the devices' added complexity. This article, part 1 of a 4-part DRAM series, sheds light on some of the complex issues surrounding DRAMs and describes the different DRAM architectures. The succeeding articles will cover memory-system architectures, DRAM controllers, and DRAM-board design.

—*Steve Gumm and Carl T Dreher, Texas Instruments*

Antialiasing filters reduce errors in A/D converters

171

The need for effective antialiasing filters closely matches the growing number of applications for A/D converters. These filters reduce converter errors by limiting the input signal bandwidth. To correctly specify the filter, you need to consider the appropriate frequency band and the filter's characteristics.—*Robert W Steer Jr, Frequency Devices Inc*

Continued on page 7

EDN®(ISSN 0012-7515) is published 49 times a year (biweekly with 2 additional issues a month, except for February, which has 3 additional issues and July and December which have 1 additional issue) by Cahners Publishing Company, A Division of Reed Publishing USA, 275 Washington Street, Newton, MA 02158-1630. Terrence M McDermott, President; Frank Sibley, Senior Vice President/General Manager, Boston Division; Jerry D Neth, Vice President/Publishing Operations; J J Walsh, Financial Vice President/Magazine Division; Thomas J Dellamaria, Vice President/Production and Manufacturing. Circulation records are maintained at Cahners Publishing Company, 44 Cook Street, Denver, CO 80206-5800. Telephone: (303) 388-4511. Second-class postage paid at Denver, CO 80206-5800 and additional mailing offices. POSTMASTER: Send address corrections to EDN® at the Denver address. EDN® copyright 1989 by Reed Publishing USA; Saul Goldweitz, Chairman; Ronald G Segel, President and Chief Executive Officer; Robert L Krakoff, Executive Vice President; William M Platt, Senior Vice President. Annual subscription rates for nonqualified people: USA, \$105/year; Canada/Mexico, \$125/year; Europe air mail, \$150/year; all other nations, \$150/year for surface mail and \$230/year for air mail. Single copies are available for \$10. Please address all subscription mail to Eric Schmierer, 44 Cook Street, Denver, CO 80206-5800.

THE POWER SUPPLY

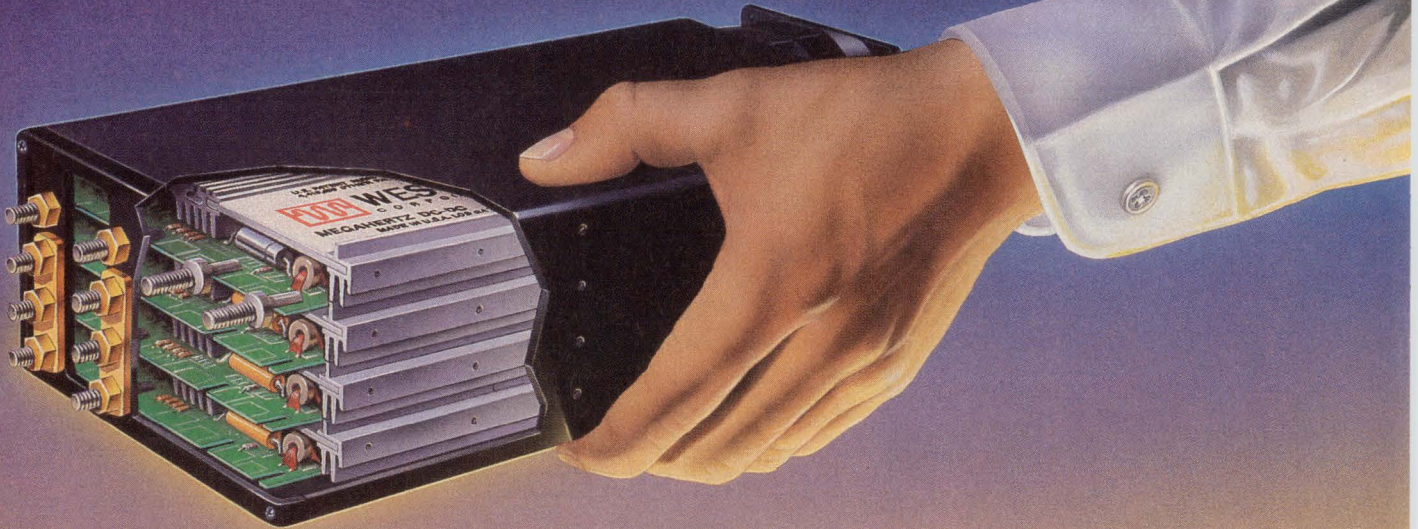

REDEFINED

THE WESTCOR STAKPAK™. NEW GENERATION 250 TO 1200 WATT SINGLE OR MULTIPLE OUTPUT OFF-LINE SWITCHER. 3.2 X 5.5 X 11.4 INCH CASE. FAN-COOLED.

Stack the odds in your favor by designing-in Westcor's 6 watt/cubic inch high power megahertz switcher. Capitalizing on patented and proven megahertz module technology and innovative thermal management techniques, the StakPak provides up to 1200 watts of power at 50°C with 1 to 8 isolated and fully regulated outputs.

For existing designs the StakPak's small size and low profile allow system enhancement without mechanical redesign. Simply replace your open frame switcher with up to 1200 watts of StakPak power or replace your "box switcher" with 2 StakPaks and realize up to twice the power without losing additional space. StakPak power factor correction provides 850 watts of output power from a standard 115 VAC wall outlet. In new designs, more space can be devoted to functionality or the system can be downsized.

The StakPak's 8 module output section can be factory configured in virtually an infinite number of voltage, current and power combinations. Special models providing between 250 to 1200 watts and outputs from 2 to 95 VDC are available.

Other features include outstanding electrical performance; UL, CSA, VDE safety agency approval (in process); variable speed fan option for low ambient noise environments and 3 phase or DC input options. Indeed, with unprecedented power density, versatility and new features, the StakPak redefines power packaging. Please contact Westcor for a data sheet, pricing and additional information.

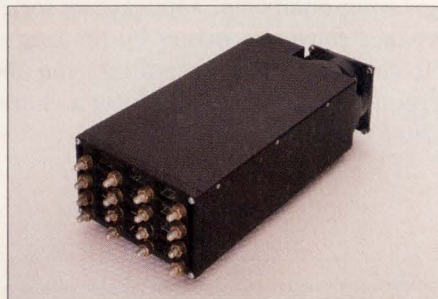

STANDARD 1200 WATT STAKPAK MODELS (110/220 VAC input)

Model Output Voltage (VDC) and Maximum Current (amperes) per Channel

Model	#1	#2	#3	#4	#5
Single Output					
SP1-1801	2 @ 240				
SP1-1802	5 @ 240				
SP1-1803	12 @ 100				
SP1-1804	15 @ 80				
SP1-1805	24 @ 50				
SP1-1806	28 @ 42				
SP1-1807	48 @ 25				

Total output power may not exceed 1200 watts for any model, single or multiple output. Lower power StakPak models are available. Please contact the factory.

Model	#1	#2	#3	#4	#5
Dual Output					
SP2-1801	2 @ 120	5 @ 120			
SP2-1802	5 @ 120	5 @ 120			
SP2-1803	5 @ 120	12 @ 66			
SP2-1804	12 @ 66	12 @ 66			
SP2-1805	15 @ 53	15 @ 53			

Model	#1	#2	#3	#4	#5
Triple Output					
SP3-1801	5 @ 180	12 @ 16	12 @ 16		
SP3-1802	5 @ 150	12 @ 33	12 @ 16		
SP3-1803	5 @ 180	15 @ 13	15 @ 13		
SP3-1804	5 @ 150	15 @ 26	15 @ 13		

Model	#1	#2	#3	#4	#5
Quad Output					
SP4-1801	5 @ 150	12 @ 16	12 @ 16	5 @ 30	
SP4-1802	5 @ 150	15 @ 13	15 @ 13	5 @ 30	
SP4-1803	5 @ 150	12 @ 16	12 @ 16	24 @ 8	
SP4-1804	5 @ 150	15 @ 13	15 @ 13	24 @ 8	

Model	#1	#2	#3	#4	#5
Five Output					
SP5-1801	5 @ 120	12 @ 16	12 @ 16	5 @ 30	24 @ 8
SP5-1802	5 @ 120	15 @ 13	15 @ 13	5 @ 30	24 @ 8



WESTCOR CORPORATION • 485-100 Alberto Way • Los Gatos, CA 95032 • (408) 395-7050 • FAX (408) 395-1518

Westcor is a subsidiary of  VICOR CORPORATION

CIRCLE NO 137

EDN March 30, 1989

VP/Publisher
Peter D Coley

Editor/Editorial Director
Jonathan Titus

Managing Editor
John S Haystead

Assistant Managing Editor
Joan Morrow

Special Projects
Gary Legg

Home Office Editorial Staff
275 Washington St, Newton, MA 02158
(617) 964-3030

Tom Ormond, *Senior Editor*
Joanne De Oliveira, *Associate Editor*
John A Gallant, *Associate Editor*
Michael C Markowitz, *Associate Editor*
Christine McElvenny, *Associate Editor*
Dave Pryce, *Associate Editor*
Cynthia B Rettig, *Associate Editor*
Julie Anne Schofield, *Associate Editor*
Charles Small, *Associate Editor*
Dan Strassberg, *Associate Editor*
Anne Watson Swager, *Associate Editor*
Chris Terry, *Associate Editor*
Helen McElwee, *Staff Editor*
James P Scanlan, *Staff Editor*
Kathleen M Vejvoda, *Staff Editor*
Steven Paul, *Senior Production Editor*
Flo E Evans, *Production Editor*

Editorial Field Offices

Margery S Conner, *Regional Editor*
Los Osos, CA: (805) 528-0833

Doug Conner, *Regional Editor*
Los Osos, CA: (805) 528-0865

Steven H Leibson, *Regional Editor*
Boulder, CO: (303) 494-2233

J D Mosley, *Regional Editor*
Arlington, TX: (817) 465-4961

Richard A Quinnell, *Regional Editor*
San Jose, CA: (408) 296-0868

David Shear, *Regional Editor*
San Jose, CA: (408) 997-5452

Maury Wright, *Regional Editor*
San Diego, CA: (619) 748-6785

Peter Harold, *European Editor*
0603-630782
(St Francis House, Queens Rd,
Norwich, Norfolk NR1 3PN, UK)

Contributing Editors
Robert Pease, Bob Peterson,
Don Powers, Bill Travis

Editorial Services
Kathy Leonard, *Office Manager*
Nancy Weiland, Helen Benedict

Art Staff
Ken Racicot, *Senior Art Director*
Chinsoo Chung, *Associate Art Director*
Cathy Filipski, *Staff Artist*
Martha Crowell, *Staff Artist*

Production/Manufacturing Staff
William Tomaselli, *Production Supervisor*
Danielle M Biviano, *Production Assistant*
Deborah Hodin, *Production Assistant*
Diane Malone, *Composition*

Director of Art Department
Joan Kelly
Norman Graf, *Associate*

VP/Production/Manufacturing
Wayne Hulitzky

Director of Production/Manufacturing
John R Sanders

Business Director
Deborah Virtue

Marketing Communications
Anne Foley, *Promotion Manager*
Sara Morris, *Marketing Services Administrator*
Gordon Keegan, *Promotion Specialist*

TECHNOLOGY UPDATE

Logic synthesis prepares for VHDL 51

Logic synthesis tools are the latest in a long line of CAE tools that are destined to shrink the product development cycle for ICs and ultimately convert gate-level designers to systems engineers.—*Michael C Markowitz, Associate Editor*

RISC boards target real-time applications 69

Several manufacturers of CPU boards for real-time applications now offer powerful models based on RISC (reduced-instruction-set computer) μ Ps. You'll have to make the usual price/performance judgment before choosing a RISC-based board for a real-time application.—*Maury Wright, Regional Editor*

PRODUCT UPDATE

1M-transistor microprocessor	87
Hardware modeling system	88
PC-based precision counter	90
Logic verifier	92

NEW PRODUCTS

Computers & Peripherals	207
Integrated Circuits	215
Components & Power Supplies	221
Test & Measurement Instruments	226
CAE & Software Development Tools	234

DEPARTMENTS

News Breaks	21
News Breaks International	24
Signals & Noise	33
Editorial	45
Career Opportunities	251
Business/Corporate Staff	258
Advertisers Index	260

April 1st Special Supplement 193

Cahners Publishing Company, A Division of Reed Publishing USA Specialized Business Magazines for Building & Construction Manufacturing Foodservice & Lodging Electronics & Computers Interior Design Printing Publishing Industrial Research & Technology Health Care and Entertainment. Specialized Consumer Magazines: American Baby and Modern Bride.

HOW MUCH COLOR CONTROL CAN BE SQUEEZED ON TO A SINGLE CHIP?

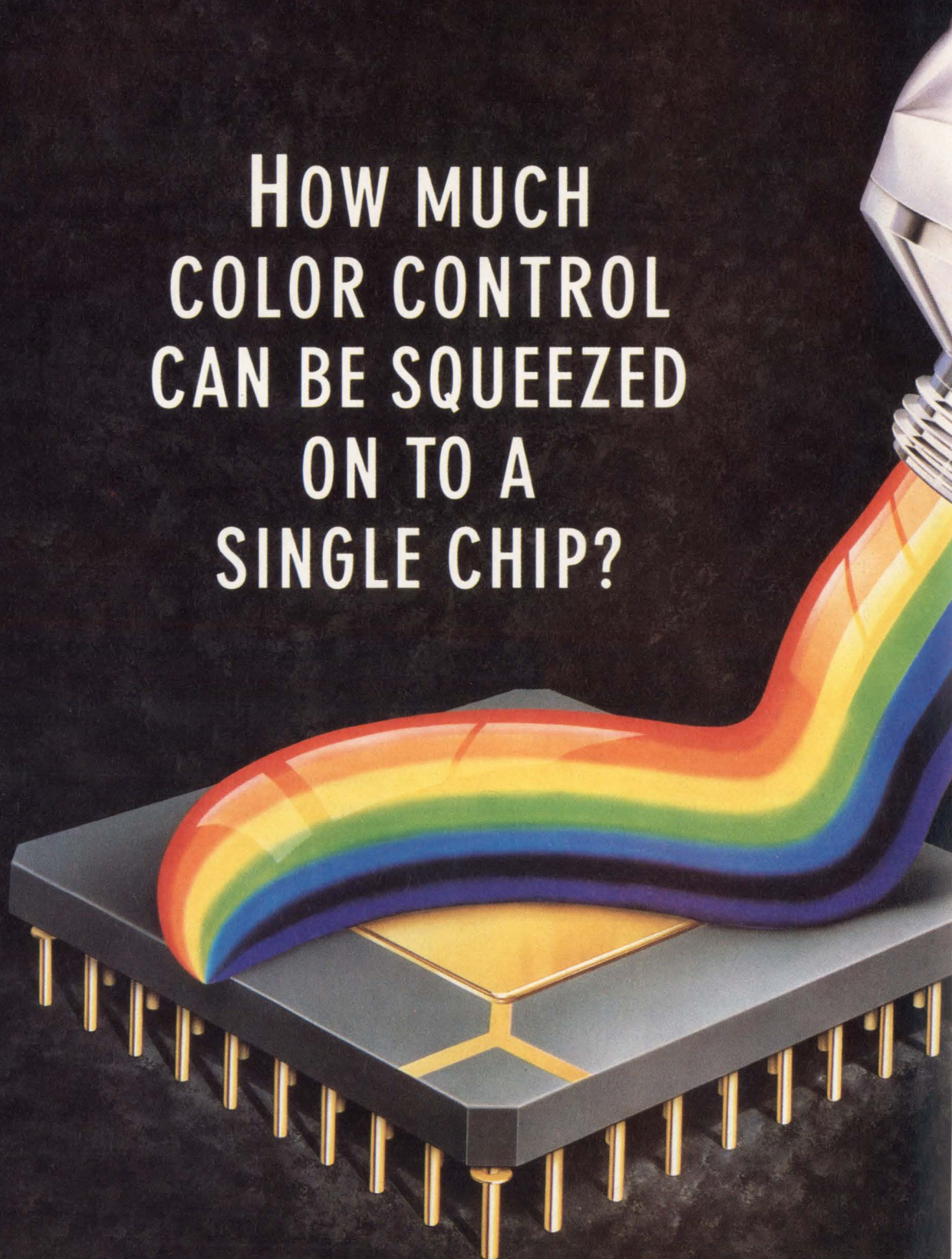

INMOS and IMS are trademarks of the INMOS Group of Companies.

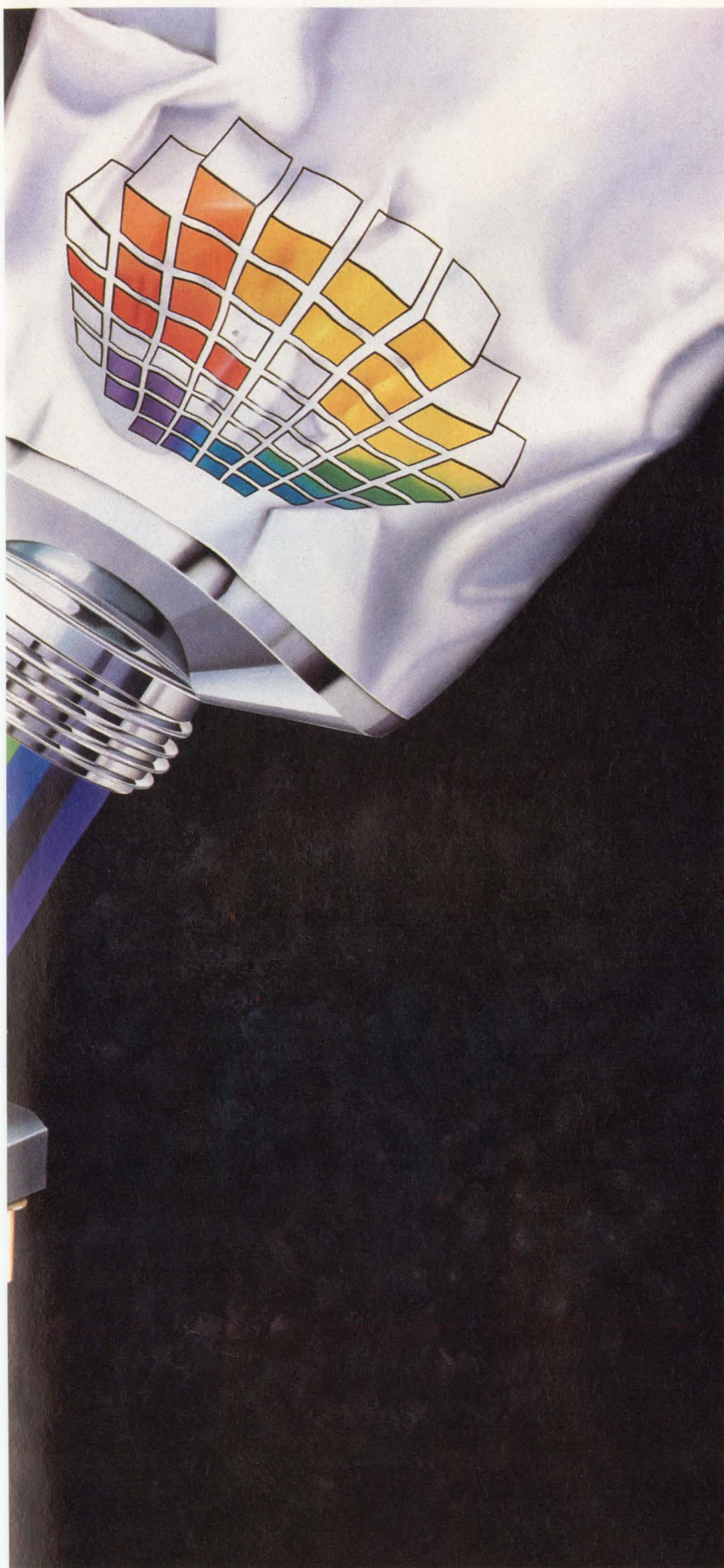

If the chip in question is the new IMMSG300 Color Video Controller (CVC) from INMOS, the answer is quite simply, "all of it".

Through high integration, INMOS has combined total graphics control and data conversion onto a single 84 pin device. This includes a color look-up table, programmable video timing generator, full bitmap management, triple 8-bit video DACs and a phase-locked loop.

Because the IMMSG300 is programmable, it is easily interfaced to any processor or monitor that may be used in your system. The G300 promotes the technique of using software drawing algorithms as opposed to designing them in hardware. This dramatically reduces design-in time and allows for easy upgradability.

The IMMSG300 also provides an optional 24-bit pixel mode for full color as well as pseudo color, an on-chip phase-locked loop for generating all high frequency clocks, and a 32-bit multiplexed pixel port for achieving pixel rates up to 110MHz.

Only the INMOS G300 CVC gives you all the options you need to tailor  your systems exactly the way you want them – both now and in the future.

The INMOS G300 CVC single chip solution. Find out more today.

INMOS, PO Box 16000, Colorado Springs, Colorado 80935. Tel: (719) 630 4000

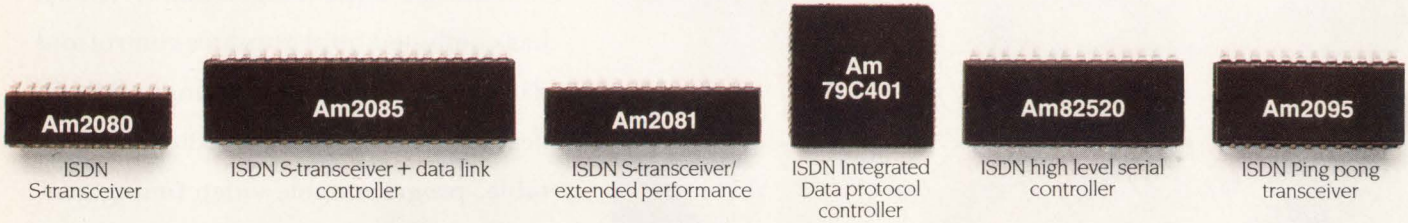

It takes to make a

Am2090

ISDN U-transceiver
(4B/3T + 2B/1Q)

Am2091

ISDN U-transceiver (4B/3T + 2B/1Q)

Am2075

ISDN Quad data link
controller

**Am
82525**

ISDN high
level serial
controller/
extended
performance

Am2055

ISDN Line card controller

guts switch.

We have all the guts you need. In one complete ISDN chip set.

It's flexible and integrated. You can meet the future without tearing up the past. Start with any transceiver, then come back later and replace it to meet new requirements.

Not only will you avoid major redesigns, you'll avoid the wrath of your programmers because there'll be just minimal changes in software.

These parts were designed to meet the IOM™-2

standard so they're guaranteed to work with any other IOM-2 based devices. No acrobatics, no patching things together.

We've even got your analog loop needs covered with a new IOM-2 DSLAC.™

Plus, all these ISDN devices are part of a common chip set available from both Siemens and AMD. So you'll never feel like you're on hold.

Call (800) 222-9323 and find everything you need to make a switch.

Advanced Micro Devices 

901 Thompson Place, P.O. Box 3453, Sunnyvale, CA 94088.

CIRCLE NO 139

**“The VME world
doesn't just need
RISC performance.**

**It needs a total
RISC computing
environment.”**

Andreas Schreyer,
RISC Product Marketing Manager



The Motorola 88000 RISC architecture offers tremendous performance. But to serve a complex and well-established market like VME, it takes more. A total environment of hardware and software for both system development and applications. Software compatibility between RISC platforms from many suppliers. And a painless growth path from 68000-based systems to 88000 and beyond.

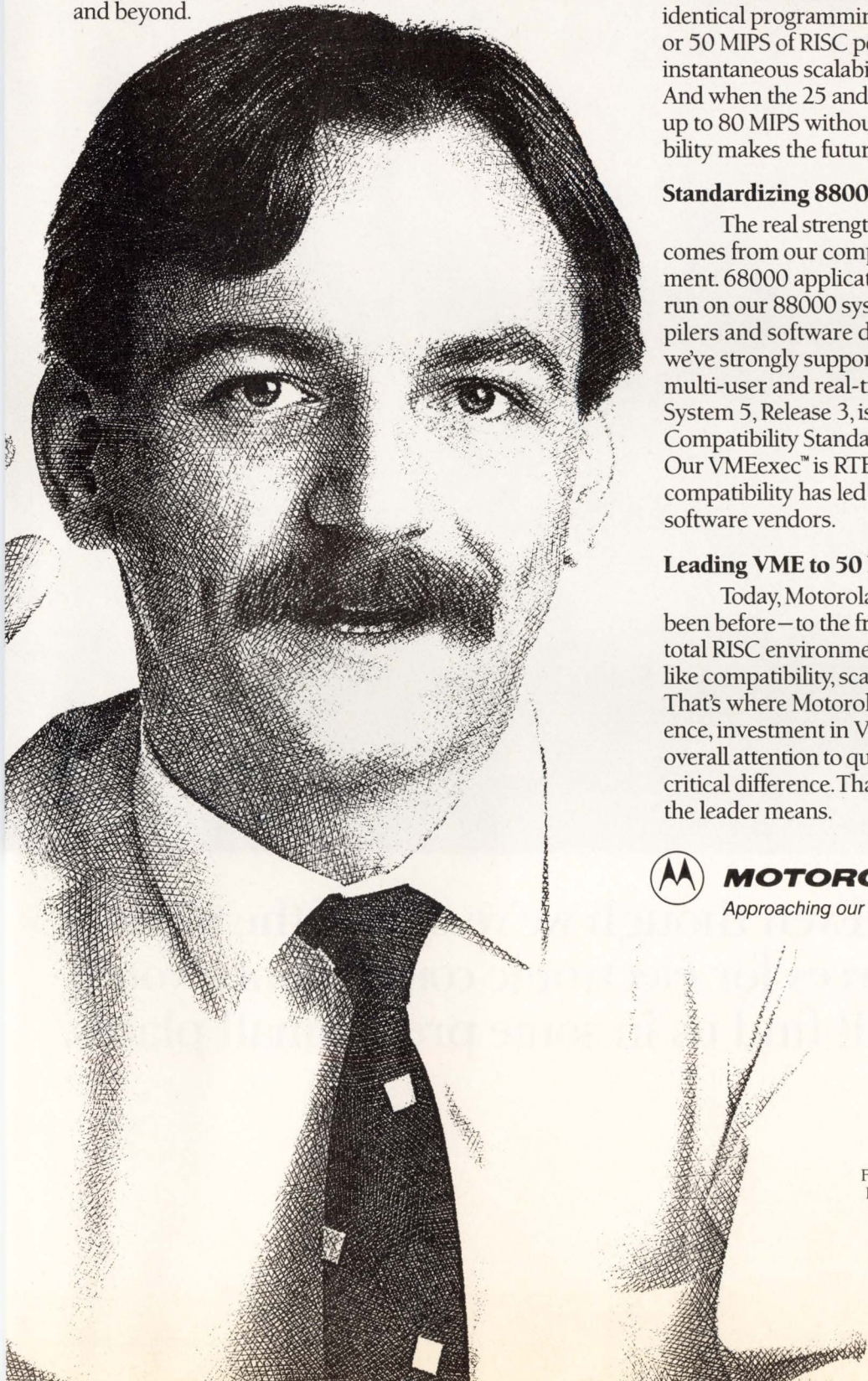

Creating VME hyper-performance.

To help people integrate the 88000 into their VME systems easily, we invented the HYPERmodule™—a miniaturized subsystem with one, two or four closely-coupled 88000s, cache memories, memory management and high-speed internal buses. Because all HYPER-modules have identical interfaces to the CPU board and identical programming models, you can plug in 17, 30 or 50 MIPS of RISC performance interchangeably. That's instantaneous scalability, with today's 20 MHz 88000. And when the 25 and 33 MHz versions arrive, you'll have up to 80 MIPS without rewriting a line of code. Scalability makes the future safe and sane for developers.

Standardizing 88000 software.

The real strength of our 88000 boards and systems comes from our compatibility in the software environment. 68000 applications can simply be recompiled to run on our 88000 systems. We have the optimizing compilers and software development tools in place. And we've strongly supported the industry standards for both multi-user and real-time 88000 software. Our UNIX™ System 5, Release 3, is compliant with BCS (Binary Compatibility Standard), as well as SVID and POSIX. Our VMEexec™ is RTEID compatible. This industry-wide compatibility has led to massive porting activity by software vendors.

Leading VME to 50 MIPS and beyond.

Today, Motorola has taken VME where it's never been before—to the frontier of 80 MIPS. We've provided a total RISC environment. And we've addressed issues like compatibility, scalability and long-term growth path. That's where Motorola's system experience, investment in VME software and overall attention to quality make a critical difference. That's what being the leader means.



MOTOROLA Microcomputer Division
Approaching our technology from your point of view.

For reprints of this series, call 1-800-556-1234, Ext. 230; in California, 1-800-441-2345, Ext. 230. Or write: Motorola Microcomputer Division, 2900 South Diablo Way, Tempe, AZ 85282. HYPERmodule and VMEexec are trademarks of Motorola, Inc. UNIX is a trademark of AT&T.

CIRCLE NO 140

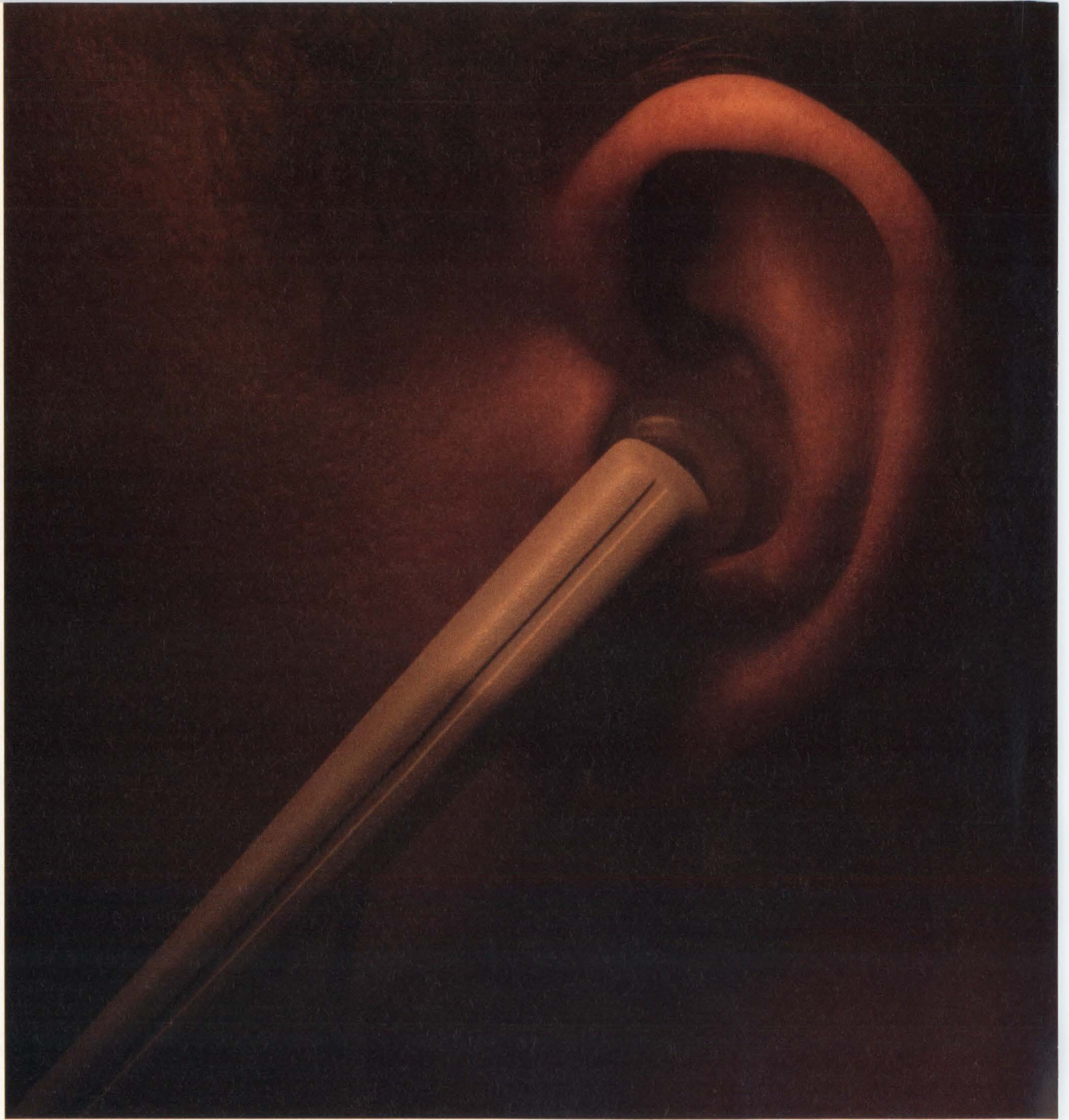

Even though we're one of the world's largest sources for electronic components, you'll still find us in some pretty small places.

ITT ElectroMechanical Components Worldwide. Our name not only describes what we do, but it also says we're an international company, with worldwide presence. So, it should really come as no surprise that you'll find our products in everything from the rotary dial in a telephone headset, to places like Willow Springs.

Fact is, you can find our switches, relays, connectors, cable assemblies and test accessories in virtually every part of the world. In almost every application.

Whether it's in telecommu-

nications, instrumentation, medical electronics, automotive, military, aerospace, computers or consumer electronics, ITT EMC Worldwide has the experience and technical expertise to help you build a quality product, every time.

For seventy-five years, our engineering strength and customer support have been second to none. That's why many of the world's leading companies select us for their ship-to-stock programs.

When you do business with the companies of ITT EMC Worldwide,

you can always expect quality, service and on-time delivery. And no matter where you are in the world, chances are we've got a representative nearby.

So, drop us a line today. And see how small a one billion dollar company can be.

*1851 East Deere Avenue
Post Office Box 35000
Santa Ana, CA 92705-6500
Or call (714) 261-5300*

ITT ElectroMechanical
Components Worldwide
Discover our strengths.

Who do the Best

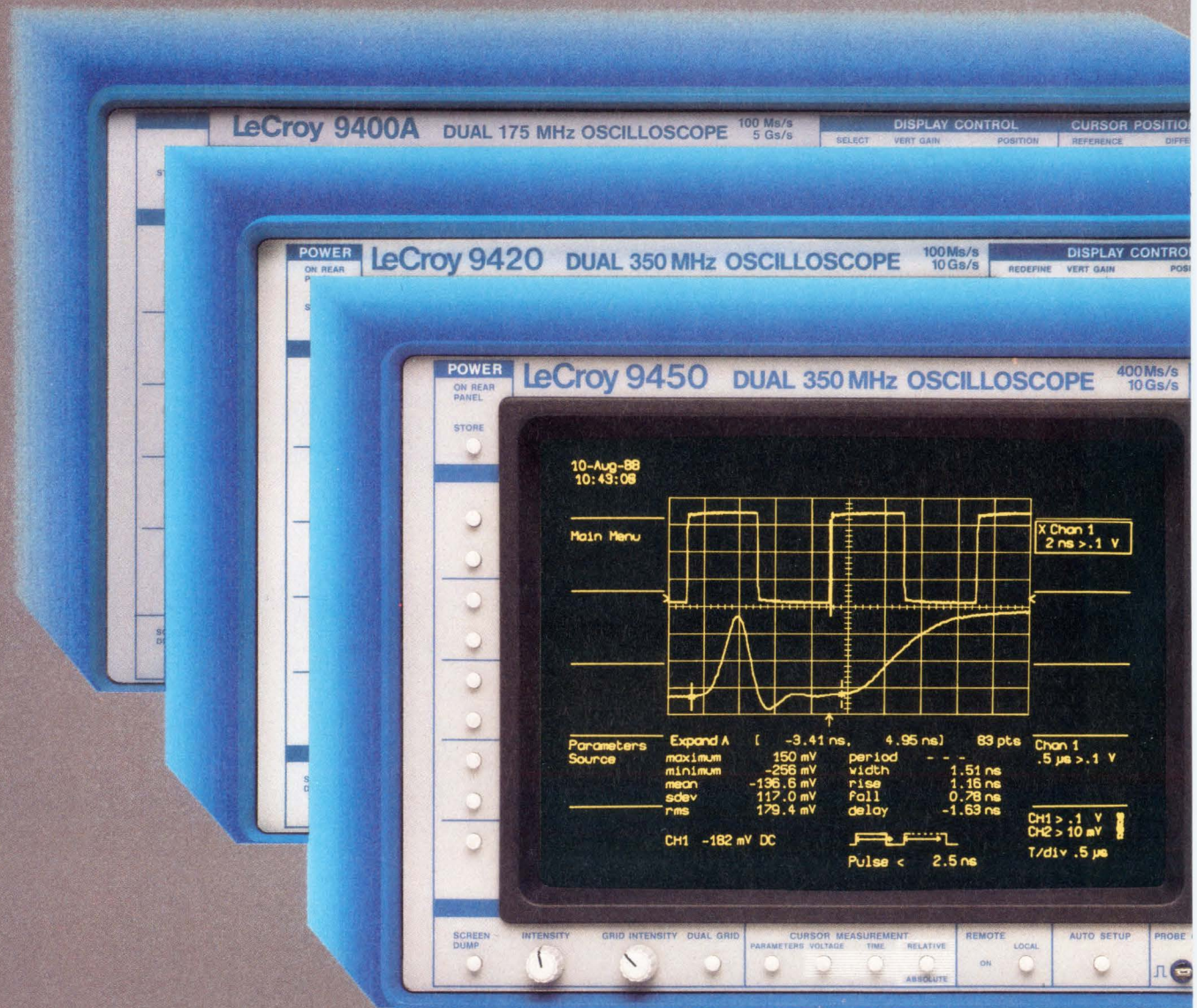

Model	Bandwidth (MHz)	Sampling Rate S.S. (Ms/s)	RIS (Gs/s)	Memory per Channel (kwords)	Vertical Resolution (bits)	FFT Spectral Analysis
9450	350	400	10	50	8 [†]	yes
9420	350	100	10	50	8 [†]	yes
9400A	175	100	5	32	8 [†]	yes

[†] up to 12 bits with averaging

choose...

...for their High-frequency Applications

Demanding engineers and scientists choose the best because they need better measurements.

They Choose LeCroy.

From the very first moment you see a LeCroy oscilloscope you'll find it offers you more. Our low-noise 8-bit ADCs and high resolution displays present signals with a finer trace and more precision than wide-band analog or other digital oscilloscopes.

Only LeCroy oscilloscopes combine fast sampling rates (up to 400 megasamples/sec for transients and 10 gigasamples/sec for repetitive signals) and **long acquisition memories** to allow high bandwidth and outstanding timing resolution on all time-base settings*. Powerful waveform expansion (up to 1000 times) reveals signal details that other scopes simply fail to digitize. And versatile trigger modes, like **Fastglitch**, **Sequence** and **Logic**, meet your most exacting requirements.

Take a look at our "analog style" front panels with rotary knobs and large crisp displays. In contrast to instruments with menu/pushbutton layouts, they're easier to use. And only LeCroy's unique **FFT spectral analysis**, **waveform processing** and **parameter measurement** capabilities deliver the answers you need instantly, in both time and frequency domains.

**Choose LeCroy...
If You Value Performance !**

LeCroy Corporate Headquarters
700 Chestnut Ridge Road
Chestnut Ridge, NY 10977-6499
Tel.: **800-5-LeCroy**
(914) 578 6097

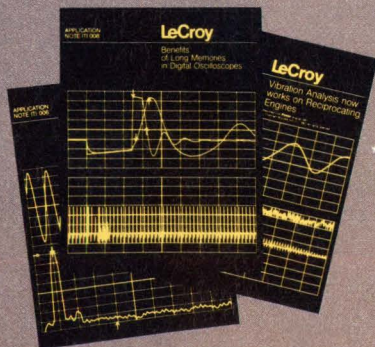

*Call us today to receive a copy of our application note "The Benefits of Long Memories in Digital Oscilloscopes"

Request your free
Video Demo now!
Circle No. 142

LeCroy

Innovators in Instrumentation

Enter the Knowledge-based

NCR

Cross the threshold into the Knowledge-based Engineering Environment (KE²), a world created by NCR specially for ASIC designers.

Here, the normal conventions of ASIC design are superseded.

Previously unthinkable deadlines are now routine.

Increased levels of quality are matched by decreased cost per gate.

Yesterday's integration impossibilities are mere keystrokes away.

And your control is absolute.

In ASICs, knowledge is power and with KE² tools and libraries, you command the knowledge amassed by hundreds of top ASIC designers over the past decade.

For example, our Design SynthesisTM tool lets you design entire blocks without getting bogged down in implementation details. The system automatically generates correct and efficient logic specifications from your high-level language descriptions.

Design AdvisorTM is an expert system that puts you in charge of a "team" of top ASIC design, test and pro-

duction professionals that we "captured" in software. At your request, this "team" analyzes the design and reports back to you with comments and suggestions for your review.

ViTatTM, NCR's Static Timing Analysis Tool, compresses the time needed to analyze high performance designs by up to two months over pattern-driven simulations.

And there's much more, including function compilers, extensive libraries of digital/analog cells, MPU cores and supercells and the complete NCR ViSysTM tool set.

Leave behind the ASIC design systems that restrain your capabilities and tether your imagination. Enter a world where there is more time, more power, more options. Where all your capabilities are multiplied.

A world all the more incredible because it's not an illusion, it's real.

For additional information on the Knowledge-based Engineering Environment, call the NCR Hotline 1-800-334-5454. Or write, NCR Microelectronics, 2001 Danfield Court, Ft. Collins, CO 80525.



Knowledge-based Engineering Environment, KE², Design Synthesis, Design Advisor, ViTat and ViSys are trademarks of NCR Corporation.

Engineering Environment.™

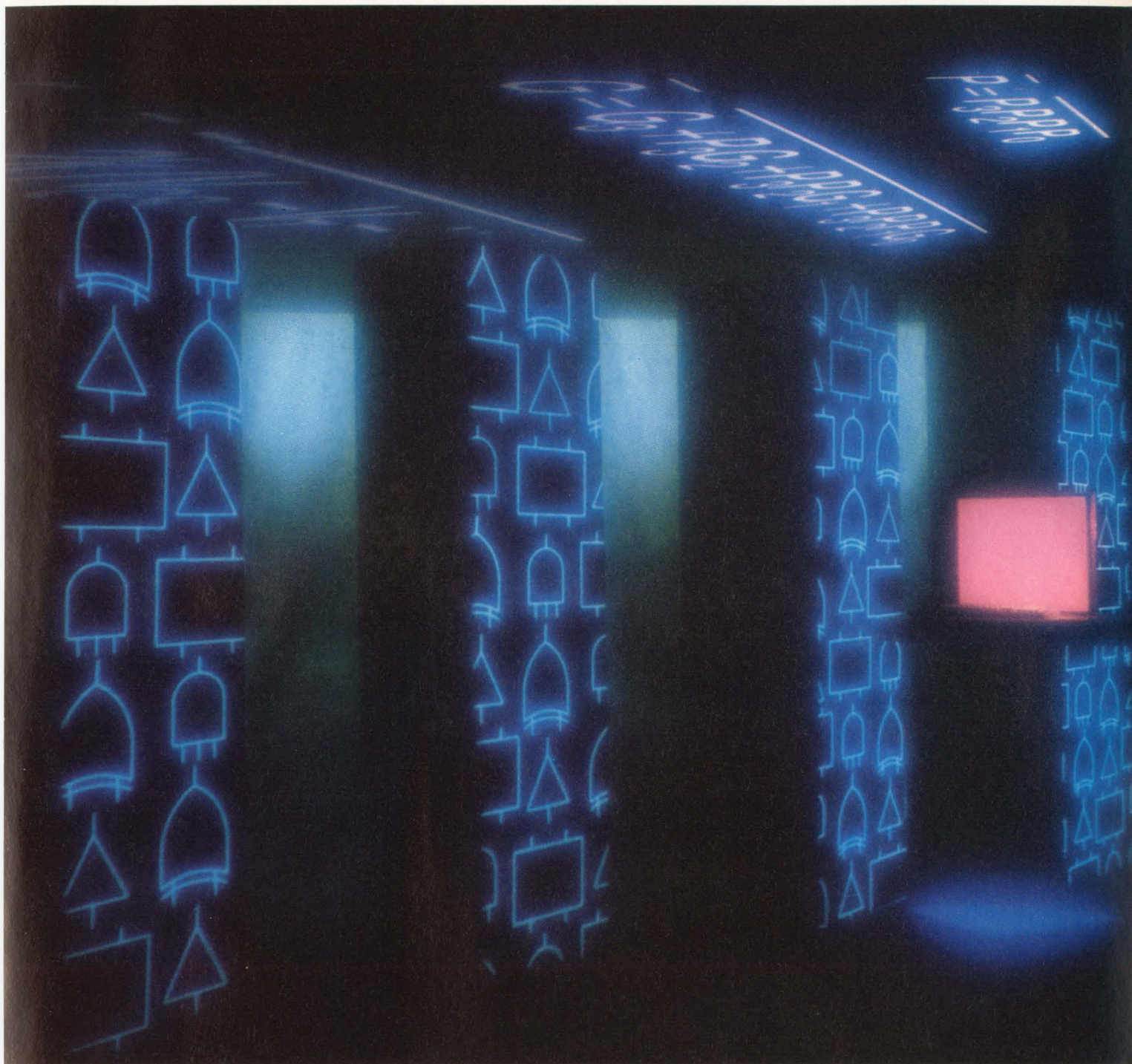

Creating value

Thanks to Elantec, video design engineers are no longer worried about going in the red.

With its true color accuracy, Elantec has the video industry seeing red.

Bright red. Like never before possible with an IC.

Just like we're extending possibilities in a variety of applications. From disk drives and LANs, to ATE, instrumentation and more.

One of the products that makes Elantec red-hot for video equipment is our 50MHz EL2020 video amplifier. It cuts differential phase error below 0.02° . And reduces differential gain error to 0.02% or less.

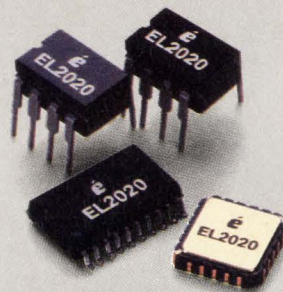

That means truly superior video characteristics.

Plus you get powerful cable-driving capability. All with less cost and less space than previous broadcast-quality solutions.

For all high-performance applications, look to the full family of Elantec high-speed analog products. Including everything from amplifiers and buffers, to pin drivers, comparators and transistor arrays. Each backed by the industry's only two-for-one guarantee. Elantec, analog that's ahead of the times.

Free Selection Guide. For a copy of Elantec's Selection Guide, circle the bingo number or write Elantec.

Make it a red letter day for your designs.

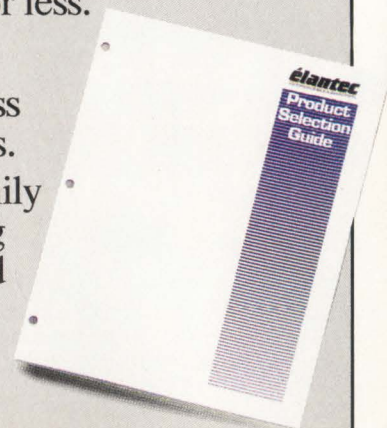

élantec
HIGH PERFORMANCE ANALOG INTEGRATED CIRCUITS

Elantec: 1996 Tarob Court, Milpitas, CA 95035. Telephone: (408) 945-1323, Fax: (408) 945-9305 © 1989 Elantec
European Sales: 87 Jermyn Street, London, SW1Y6JD, England. Tel: 44-1-839-3841, Telex: 917835, Fax: 44-1-930-0751

NEWS BREAKS

EDITED BY JOANNE DE OLIVEIRA

DEVELOPMENT TOOL SIMPLIFIES CREATION OF USER INTERFACES

The Microware Systems Corp (Des Moines, IA, (515) 224-1929) Rave (Real-time Audio/Video Environment) software-development tool simplifies the design of human interfaces for real-time applications such as process-control systems. The development tool, an extension to the OS-9 real-time operating system, allows you to combine audio and video signals, computer-generated graphics, and customizable menus to create a user interface. Rave consists of three software packages. The File Manager (\$300) and the Graphics Support Library (\$175) handle run-time chores and include drivers that interact with system hardware. You use the Presentation Editor (\$995) to create a user interface. All of the products will be available in May.—Maury Wright

INTERFACE UNIT LINKS SCSI AND IEEE-488 BUSES

If your computer or workstation provides a SCSI port, you may have thought that only peripherals such as disk and tape drives could take advantage of it. Now, however, you can use a SCSI port to control external data-acquisition systems, measuring instruments, and other devices that operate on the IEEE-488 bus. The SCSI488 interface unit from IOtech Inc (Cleveland, OH, (216) 439-4091) lets a SCSI port control as many as 14 IEEE-488 devices. Keep in mind that many computers and workstations provide only SCSI and RS-232C ports for communication with peripheral devices.

Because the interface is bidirectional, you can also use one IEEE-488 port to control as many as seven SCSI-based devices. Although the device's internal microprocessor controls the flow of information, it doesn't interfere with block-transfer operations, which can reach a speed of 800k bytes/sec. You can buy the SCSI488 for \$795; it's available from stock.—Jon Titus

PROTOTYPING BOARD KITS INCLUDE A RISC-LIKE 32-BIT μ P

Intel Corp (Dept 9P01, Santa Clara, CA, (800) 548-4725) now offers two kits that provide designers with a low-cost way to evaluate or prototype products based on the 20-MHz, 32-bit, 80960KB RISC-like processor from Intel. The kits include working CPU boards, schematics, programmable logic equations, and a software debug monitor. You can choose from kits with slightly different 80960KB-based boards. The EVQT960F20 kit costs \$1960 and includes 128k bytes of zero-wait-state static RAM and 128k bytes of flash EPROM, which are installed on the CPU board. The board included in the \$960 EVQT960E20 kit hosts 128k bytes of 2-wait-state static RAM and sockets for 128k bytes of EPROM. The CPU boards include an onboard prototyping area and a connector that you can use to add external circuits. Shipments will start by midyear.—Maury Wright

FAMILY OF 1- TO 10-MHz 12-BIT ADCs FEATURES LOW DISTORTION

Datel Inc (Mansfield, MA, (508) 339-3000) has announced a complete family of sampling A/D converters that operate at sampling rates of 1, 2, 5, and 10 MHz. The ADS-112 (1-MHz), ADS-132 (2-MHz), ADS-131 (5-MHz), and ADS-130 (10-MHz) converters offer excellent dynamic performance. At the Nyquist frequency, the total harmonic distortion is -73 dB for the 1-MHz and 2-MHz devices and -69 dB for the 5-MHz and 10-MHz devices. The number of effective bits at the Nyquist frequency is 11.0 for the two lower-frequency devices and 10.6 for the two higher-frequency devices.

NEWS BREAKS

The ADCs, which also feature low noise and low nonlinearity specs, use a digitally corrected subranging architecture to achieve 12-bit resolution. The design of these converters includes an internal sample/hold circuit, on-chip references, a clock, 3-state outputs, and user-selectable output coding. Power dissipation ranges from 1.3W for the 1-MHz part to 4.9W for the 10-MHz device. Pricing for commercial units is \$259 (24-pin ADS-112), \$346 (32-pin ADS-132), \$465 (40-pin ADS-131), and \$549 (40-pin ADS-130). Delivery, from stock to four weeks.—Dave Pryce

FULL-HEIGHT 5¼-IN. WINCHESTER STORES 764M BYTES

The MK-358 Winchester disk drive from Toshiba (Irvine, CA, (714) 380-3000) offers an unformatted capacity of 764M bytes. The 8-platter drive dedicates one surface to servo control, but also relies on servo information embedded in each sector to ensure accurate tracking. The SCSI version of the drive costs \$2645 (1000); the ESDI version is \$2495 (1000). The SCSI version includes support for SCSI-2 features. Furthermore, the SCSI drive features an extensive command set that is stored on the drive and downloaded to RAM on power up. You can update the command set by downloading from a floppy disk. The company can easily implement custom command sets.—Maury Wright

EVALUATION BOARDS AID IN RISC-μP DEVELOPMENT

Two boards from Step Engineering (Sunnyvale, CA, (408) 733-7837) can assist you in developing systems based on the AMD (Sunnyvale, CA) 29000 RISC (reduced-instruction-set computer) processor. The \$3445 Step PCEV (personal-computer evaluation vehicle) incorporates the μP along with 512k bytes of dual-ported video RAM, and plugs into the IBM PC/AT bus. The \$1750 Step STEB (stand-alone target evaluation board) includes a 29000 μP, 512k bytes of RAM, two serial ports, and sockets for as much as 512k bytes of ROM. The company ships the board with a ROM-based debugging monitor called MON29K. Step also offers a line of software-development products for the 29000 μP; the PCEV and STEB boards give you a ready target for code developed with those tools.—Steven H Leibson

RETARGETABLE CROSS-MACROASSEMBLER REDUCES TOOL PURCHASES

If you're tired of buying yet another assembler every time you incorporate a new μP in one of your designs, or if you've been avoiding using a new μP because you don't have the software tools necessary to program it, the CASM retargetable cross-assembler from AnyWare Engineering (Boulder, CO, (303) 442-0556) can solve your problem. The \$195 software package includes the cross-macroassembler, a linker, and a definition-file compiler. Definition files describe a particular μP's instruction set and assembly-language syntax by using a proprietary, procedural programming language. The language eases the task of molding the assembler to complex, pipelined architectures, such as those in RISC processors, and to wide instruction words, such as those used in digital signal processors. CASM also includes definition files for the 8085, Z80, 8041, 8048, 8051, 8096, 6805, 68HC11, 6502, and R2000 μPs and the NEC 7720 digital signal processor.—Steven H Leibson

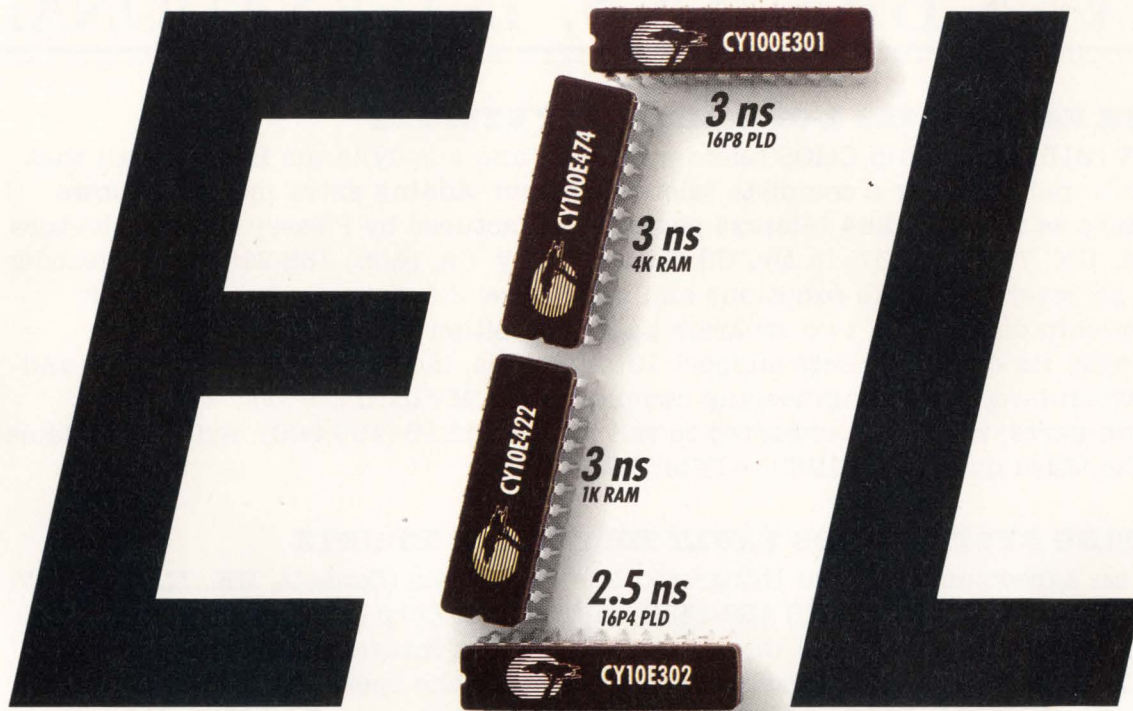

How to say speed in 3 ns—or less.

Our customers design the world's fastest systems.

Today, that means clock rates of 50 MHz, and more. In system-critical memory and logic, TTL just can't keep up.

ECL can. Here is the speed you need, to design desktop supercomputers, fast networks, advanced graphics, and more.

New, ECL RAM and PLD parts, fabricated in our new 0.8 micron bipolar and BiCMOS technologies.

RAMs and PLDs with speeds up to 40% faster than the fastest components previously available. The new parts are available in 10K/10KH-compatible, 100K-compatible, and low power versions, too.

Our data book has the full ECL story. As well as the entire Cypress Semiconductor high-performance, low-power product line.

Say you want one, and it's yours, free, fast.



**CYPRESS
SEMICONDUCTOR**

**Data Book Hotline
1-800-952-6300*
Ask for Dept. C48.**



*1-800-387-7599 In Canada, (32) 2-672-2220 In Europe. Cypress Semiconductor, 3901 North First Street, San Jose, CA 95134 Phone: (408) 943-2666, Telex 821032 CYPRESS SNJUD, TWX 910-997-0753. ©1989, Cypress Semiconductor.

NEWS BREAKS: INTERNATIONAL

DECODER FACILITATES 2-CHIP TELETEXT SYSTEMS

The MV1815 single-chip CMOS teletext decoder and one dynamic RAM are all that you need to put together a complete teletext system. Adding extra memory allows you to store as many as 254 teletext pages. Manufactured by Plessey Semiconductors (Swindon, UK, TLX 449637; in the US: Scotts Valley, CA, (408) 438-2900), the decoder includes all level 1 teletext functions and many level 2 functions. In addition, it has an on-chip data slicer, two separate page-acquisition circuits, and RGB color-display logic. Its character sets support 13 languages, including most European and Scandinavian languages. Engineering samples of the MV1815 are available now. Production parts, which are expected to sell for around £5 (100,000), will be available during the third quarter of 1989.—Peter Harold

OPERATING SYSTEM ADDS FAULT TOLERANCE TO UNIX

Under an agreement between Integrated Micro Products (Consett, UK, TLX 537747; in the US: Santa Cruz, CA, (408) 429-1338) and Unisoft Corp (Emeryville, CA, (415) 420-6400), both companies will internationally market Integrated Micro Products' new FT-Unix fault-tolerant operating system. Because the operating system's fault tolerance is completely transparent, the system provides a standard Unix V.3 software environment in which you can run unmodified application programs. Together with suitable hardware, FT-Unix supports the synchronization of two CPUs, mirroring of data on separate disks, redundant I/O and communications operations, and isolation and reintegration of hardware modules to support diagnostic and servicing operations. It also supports the use of uninterruptible power supplies. FT-Unix licenses will be less than twice the price of standard Unix V.3, and both companies will promote its adoption as an open standard.—Peter Harold

SYSTEM TRANSLATES SPOKEN JAPANESE TO SPOKEN ENGLISH

Matsushita has reportedly developed a translation system that can convert spoken Japanese sentences to the corresponding English sentences in approximately 5 to 10 sec. Unlike conventional voice-translation systems, which recognize only registered voices and require the speakers to divide sentences into clauses, this machine accepts natural speech from arbitrary speakers. Conventional machines are also fairly large; this system is the size of a typical workstation. It comprises a sound-recognition device, a general-purpose (Sun-3) workstation, and a sound-composition device.

The system performs its translation by converting spoken Japanese to a series of alphabetical phoneme symbols and transmitting them to the workstation, where a translating program analyzes and comprehends the sentence, translates it into English, and formulates the English verbalization. To do so, the system uses the translation program developed by Professor Masaru Tomita of Carnegie-Mellon University. The system can translate about 3000 short Japanese sentences (of two to four clauses) after 50 words have been entered in the dictionary. In testing the system, the firm has achieved an 80% recognition figure; the company plans to improve the accuracy of recognition to the 85% to 90% level. It also expects to offer high-speed performance and eventually to offer translation from English to Japanese. In addition, Matsushita reportedly aims to produce the world's first portable translation machine.—Joanne De Oliveira

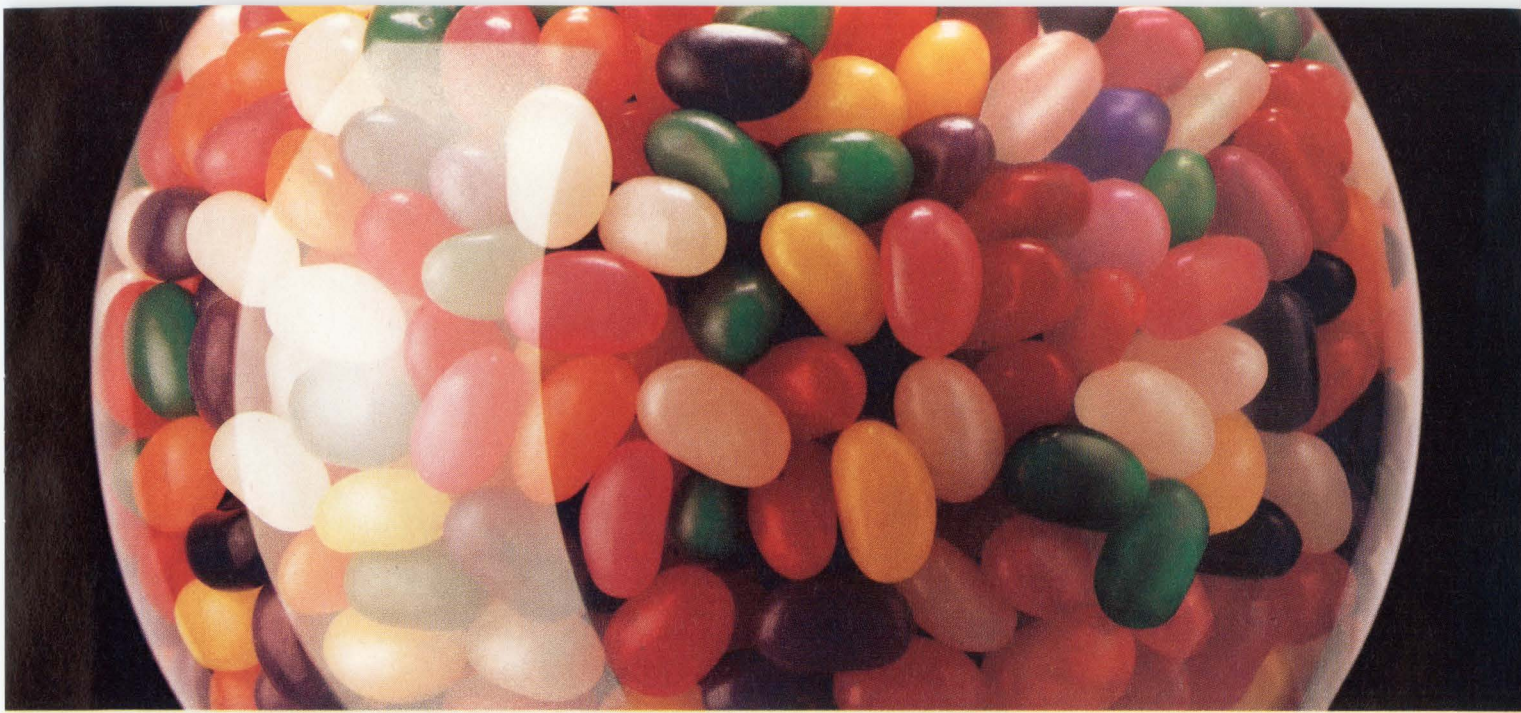

If this is how you see LEDs, the ad is over.

The popular myth goes something like this: "An LED, is an LED, is an LED." Or: "If you've seen one, you've seen them all." And of course: "LEDs? They're commodity products." Notions we at Dialight, steadfastly reject. And once you're familiar with our products, you'll know why.

Take our Circuit Board Indicators. Single or multiple discretes aligned in a sturdy plastic housing, complete with their own current limiting resistor. The entire assembly polarity-keyed to guarantee correct insertion.

Each unit is 100% tested—ready to insert for wave soldering. No leads to bend, trim, or break. No time wasted fumbling with discretes.

Dialight pioneered the concept more than fifteen years ago to satisfy the OEM need for fast and reliable circuit board installation of LEDs. And we've been perfecting it ever since. Developing hundreds of standard and custom designs. A heritage of technological advance you can see in our new super-bright gallium aluminum arsenide units.

All meticulously engineered with the understanding that the failure of a "jelly bean product" can cost thousands in end-user downtime, and who-knows-what in customer loyalty.

The same understanding might bring you to call 201-223-9400, or write Dialight Corporation, 1913 Atlantic Ave., Manasquan, NJ 08736, and ask for our catalog or a product sample. At the very least, it's brought you to the real end of our ad.



DIALIGHT CORPORATION
A Cambridge Electronic Industries Company

Engineering is the only commodity we sell.



value-packed
filters from **\$11.45**

dc to 3GHz

- less than 1dB insertion loss over entire passband
- greater than 40dB stopband rejection
- 5 section, 30dB per octave roll-off
- VSWR less than 1.7 (typ)
- over 100 models, immediate delivery
- meets MIL-STD-202
- rugged hermetically sealed package (0.4 x 0.8 x 0.4 in.)
- BNC, Type N, SMA available

finding new ways ...
 setting higher standards

Mini-Circuits

A Division of Scientific Components Corporation
 P.O. Box 350166, Brooklyn, New York 11235-0003 (718) 934-4500
 Fax (718) 332-4661 Domestic and International Telexes: 6852844 or 620156

LOW PASS	Model	*LP-	10.7	21.4	30	50	70	100	150	200	300	450	550	600	750	850	1000
Min. Pass Band (MHz) DC to			10.7	22	32	48	60	98	140	190	270	400	520	580	700	780	900
Max. 20dB Stop Frequency (MHz)			19	32	47	70	90	147	210	290	410	580	750	840	1000	1100	1340
Prices (ea.): Qty. (1-9) P \$11.45, B \$32.95, N \$35.95, S \$34.95																	

HIGH PASS	Model	*HP-	50	100	150	200	250	300	400	500	600	700	800	900	1000
Pass Band (MHz)	start, max.		41	90	133	185	225	290	395	500	600	700	780	910	1000
	end, min.		200	400	600	800	1200	1200	1600	1600	1600	1800	2000	2100	2200
Min. 20dB Stop Frequency (MHz)			26	55	95	116	150	190	290	365	460	520	570	660	720
Prices (ea.): Qty. (1-9) P \$14.95, B \$36.95, N \$39.95, S \$38.95															

*Prefix P for pins, B for BNC, N for Type N, S for SMA example: PLP-10.7

C105 REV. E

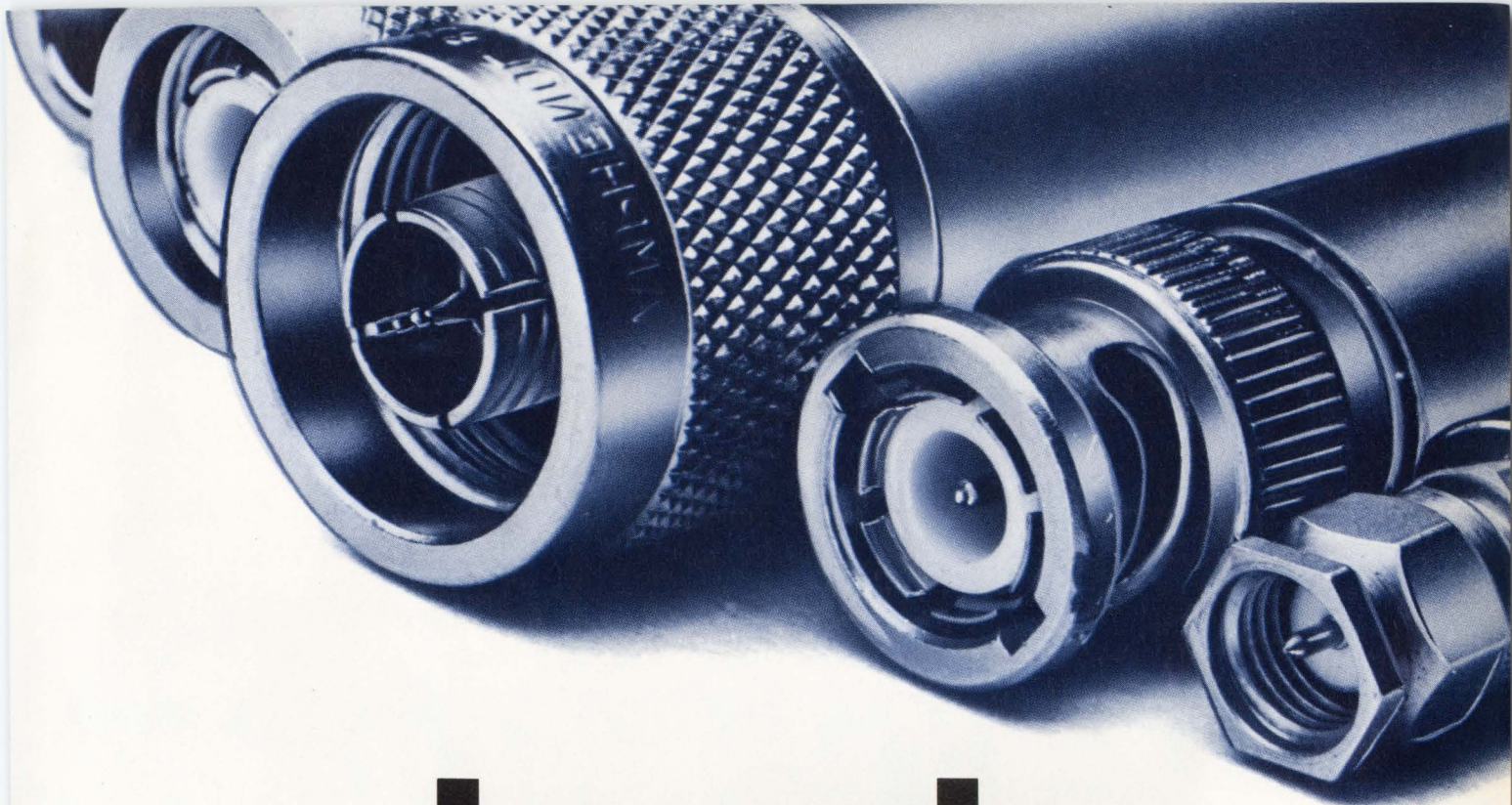

tough attenuators

one-piece design defies rough handling from **\$16⁹⁵** (1-9)

- Each unit undergoes high-impact shock test
- Unexcelled temperature stability, .002 dB/°C
- 2W max. input power (SMA is 0.5W)
- BNC, SMA and N models (TNC, consult factory)
- Immediate delivery, one-year guarantee
- **50 ohms, dB values,** 1, 2, 3, 4, 5, 6, 7, 8, 9, 10, 12, 15, 20, 30, and 40
- **75 ohms dB values,** 3, 6, 10, 15, 20 BNC only
- **Price** (1-9 qty.)
 CAT (BNC) \$16.95 SAT (SMA) \$20.95
 NAT (N) \$23.95

*Freq. (MHz)	Atten. Tol. (Typ.)	Atten. Change. (Typ.) over Freq. Range		VSWR (Max.)	
		DC-1000	1000-1500	DC-1000 MHz	1000-1500 MHz
DC-1500 MHz	±0.3	0.6	0.8	1.3	1.5

*DC-1000 MHz (all 75 ohm or 30 dB models) DC-500 MHz (all 40 dB models)

Model Availability

SAT (SMA) CAT (BNC) NAT (N)

Model no. = a series suffix and dash number of attenuation.

Example: CAT-3 is CAT series, 3 dB attenuation.

Precision 50 ohm terminations \$8.25 (1-9)
 DC to 2 GHz, 0.25W power rating, VSWR less than 1.1
 BNC (model BTRM-50), TNC (consult factory)
 SMA (model STRM-50), N (model NTRM-50)

finding new ways...
 setting higher standards

Mini-Circuits

A Division of Scientific Components Corporation

P.O. Box 350166, Brooklyn, New York 11235-0003 (718) 934-4500

Fax (718) 332-4661 Domestic and International Telexes: 6852844 or 620156

EDN March 30, 1989

CIRCLE NO 147

C 92 REV. E

27

We Supply Solutions Every Step of the Way



From single ICs to board-level development, Oki's systems approach gives you a competitive edge

Oki Semiconductor offers you a unique array of products, leading-edge technologies, and comprehensive support services. But what really sets us apart is our unique way of applying them. We call it *System Technologies for Customer Solutions*.

Oki systems thinking

Rather than just taking your order as other suppliers might do, we join with you as a partner and work to understand your product concept as a whole, before determining its component technologies. Then to meet your goals, we draw on a tremendous range of expertise and worldwide resources others simply cannot match.

Expertise at every level

As the only company that can deliver standard IC, ASIC, packaging, and value-added capabilities *from a single source*, we can uncover options and alternatives at many levels of system development and fabrication—opportunities others would not perceive. So we can assist you with everything from single ICs to value-added products, at any stage you require.

The result of this integrated, single-source approach is a solution that's precisely tailored to your needs. A solution that can help you achieve real competitive advantages—by speeding product development, getting you to market faster, lowering costs substantially, enhancing your product with new features, or making production more efficient.

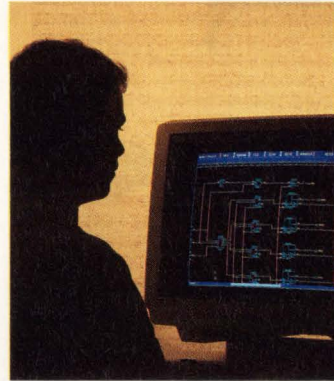

Partnerships that work

Unlike many companies, Oki is willing to share resources to co-develop products and technologies. We back this commitment with comprehensive design and support tools, as well as highly capable people who help you make the most of our resources. If you'd like to gain the kind of competitive edge Oki customers already enjoy, call us today or complete and mail the coupon below. And find out how Oki's unique blend of partnership and systems thinking can make a real difference for you.

Oki. Solutions from start to finish.

Please send detailed technical information on Oki products and capabilities:

- | | |
|---|---|
| <input type="checkbox"/> Memory | <input type="checkbox"/> ASICs |
| <input type="checkbox"/> DSP | <input type="checkbox"/> Board-level solutions |
| <input type="checkbox"/> Microcontrollers & microprocessors | <input type="checkbox"/> Packaging capabilities |

() _____

Business Phone _____

Name _____

Title _____

Company _____

EDN 033089

Attach coupon to business card or letterhead and mail to:
Corporate Customer Service, Oki Semiconductor, 785 N. Mary Avenue, Sunnyvale, CA 94086. Phone: (408) 720-1900.



OKI
SEMICONDUCTOR

FLUKE

Truth.

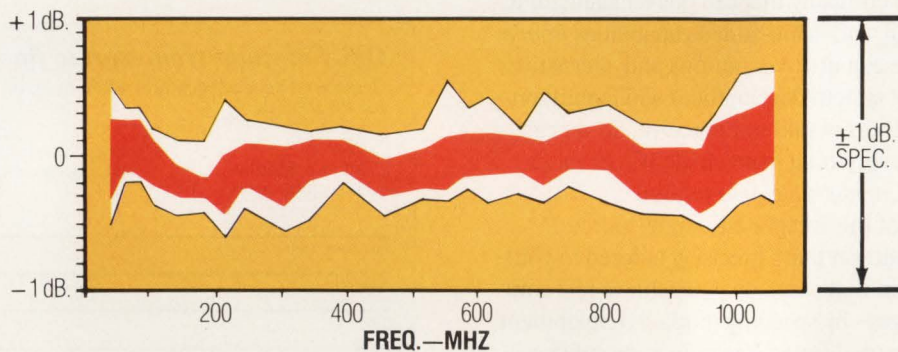

6060B typical level accuracy vs. frequency at -127 dBm.

Sample: 38 units. Solid line: worst case. Shaded: Typical (75%).

Getting the performance you expect from your instruments can sometimes be a pain. But not when it comes to the Fluke 6060B RF signal generator. It delivers more performance than you thought you paid for, even at the extremes.

On paper, most general purpose RF signal generators look pretty much the same.

But how they perform in your real-world test environment is another matter.

Take the Fluke 6060B. Its specified amplitude level accuracy in a typical working environment is ± 1 dB. Nothing surprising there. Except that this performance is available over the entire dynamic range of -127 dBm to +13 dBm. What's more, as the chart above shows, typical performance is much better: 2:1 or more. Even at -127 dBm. And in the over range areas to +16 dBm and -140 dBm, the 6060B typically stays within its ± 1 dB specification. That means the devices you test can

be specified and measured more precisely with increased confidence. Your test yields go up. And you can process more workload with a single signal generator.

What is the key to this extra margin of performance? Attention to the details. Software compensation techniques. And outstanding linearity and repeatability over the 6060B's amplitude and frequency range.

Which means you can be sure of your measurements. From instrument to instrument. Test to test.



PHILIPS

Hertz.



The 1.05 GHz Fluke 6060B.

The 6060B also offers a number of amenities that make it easy to use. Uncluttered front panel layout. Bright digit editing. Stored front panel set-ups. Increment stepping. And relative amplitude and frequency. To name a few.

The 6060B is just one member of a family of general purpose RF signal generators from Fluke, each designed to deliver more performance than you thought you paid for.

Test the true performance of the

6060B for yourself. Because what you don't know might hurt you. Call Fluke toll-free at **1-800-44-FLUKE** and arrange for a demonstration.

Fluke 6060B

- 10 kHz — 1.05 GHz
- +13 dBm maximum output level
- ±1 dB level accuracy
- 60 dBc spurious

John Fluke Mfg. Co., Inc., P.O. Box C9090, M/S 250C, Everett, WA 98206. U.S. (206) 356-5400. Canada (416) 890-7600. Other countries: (206) 356-5500. Specifications subject to change without notice. ©1988 John Fluke Mfg. Co., Inc. All rights reserved. Ad no. 0881-F6060.

FLUKE

One company offers 1, 2, 5, & 10MHz 12-bit sampling A/D converters. DATEL.

Superior dynamic performance brings both harmonic distortion and signal-to-noise ratios to new lows.

We're working hard at DATEL to bring you new lows - to create new highs in performance. The *lowest* harmonic distortion. The *lowest* non-linearity. The *lowest* absolute accuracy errors. The *lowest* power consumption. The *lowest* physical size. And the *lowest* price. All to produce the highest dynamic and static performance in sampling A/D converters available anywhere.

Features unavailable anywhere else in all models include an internal sample hold with full power input bandwidth higher than Nyquist frequency, together with a functionally complete architecture. DATEL has truly produced the First complete Family of 12-bit ADCs.

With DATEL, you now have four new reasons guaranteed to shorten your ADC selection cycle. Bottom-line, compare these converters with our competition and you'll see that there is no reason to look anywhere else. Call us at (508) 339-3000.

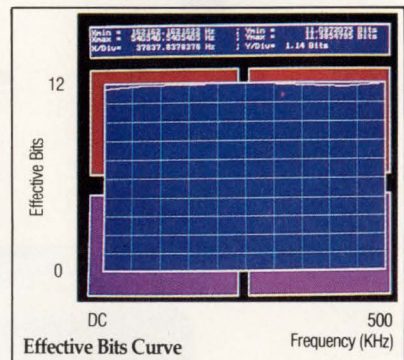
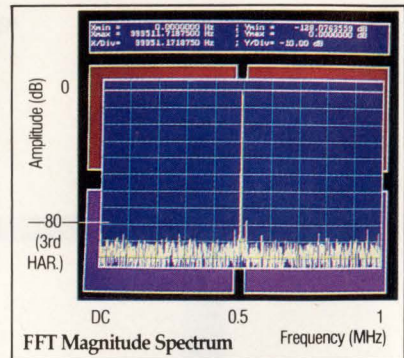

Model	Sampling Rate	Effective Bits at Nyquist Frequency	THD* at Nyquist Frequency	Power Dissipation	Package	Price (1-9)
ADS-112	1MHz	11.0	-73 dB	1.3 watts	24-pin DDIP	\$259
ADS-132	2MHz	11.0	-73 dB	2.9 watts	32-pin TDIP	\$346
ADS-131	5MHz	10.6	-69 dB	4.2 watts	40-pin TDIP	\$549
ADS-130	10MHz	10.6	-69 dB	4.5 watts	40-pin TDIP	\$775

* THD (Total Harmonic Distortion)

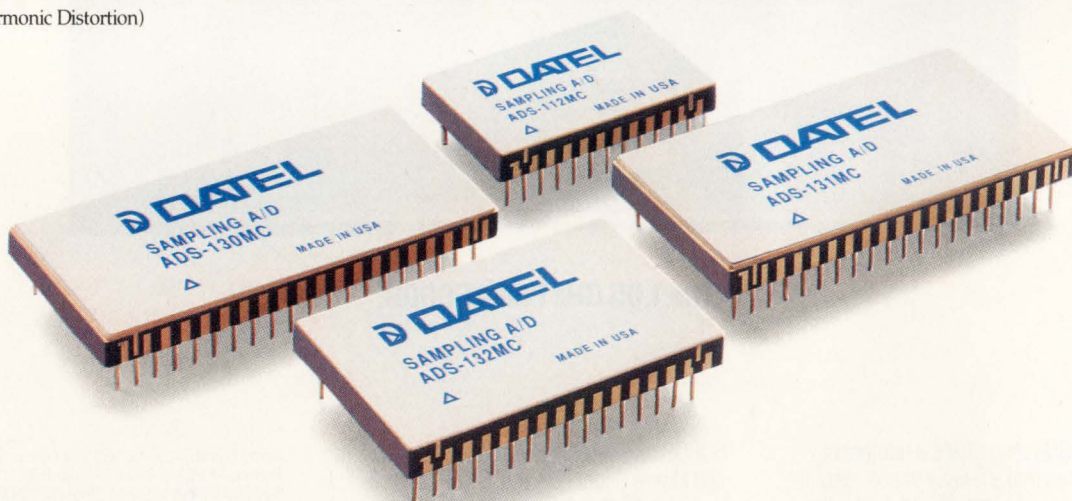

DATEL

INNOVATION AND EXCELLENCE IN PRECISION DATA ACQUISITION.

Datel, Inc., 11 Cabot Boulevard, Mansfield, MA 02048 (508) 339-3000



See us at ELECTRO/89 Booth 1704

EDN March 30, 1989

SIGNALS & NOISE

Don't confuse the DFT with the FFT

I found Tom Springer's article "Sliding FFT computes frequency spectra in real time" (September 29, 1988, pg 161) to be interesting and informative. The concept of a recursive algorithm for calculating a discrete Fourier transform (DFT) became particularly important to our research group about a year ago, and I published an internal technical note whose results were identical (and whose title was nearly identical) to Tom Springer's. There were, however, a few inaccuracies in Tom's article that may tend to confuse any reader working through the algorithm derivations.

In particular, the term "FFT" was used throughout the article as a generic label for the discrete Fourier transform. Although the FFT label could be used to describe any fast Fourier transform (that is, any transform algorithm using fewer calculations than the canonical DFT implementation), it has generally been associated with the fast algorithm produced by eliminating redundant calculations through a binary factoring principle. The recursive algorithm described in the article is nowhere derived or related to the FFT, but is a direct derivation from the definition of the DFT.

The derivation in the colored box at the bottom of pg 164 begins with the definition of the DFT, and not the FFT, as it states. In addition, the derivation makes no distinction between the time-series function $x(n)$ and the frequency-domain function $X(m)$. This problem is particularly confusing in the last and most important expression, where the frequency- and time-domain functions are mixed in the right-hand side of the equation.

Also, Fig 3 on pg 164 illustrates the $X^{k+1}(m)$ frequency spectrum as being computed from an $N + 1$ point time series beginning at k and end-

ing with $k + N$. The sequence should, of course, begin with $k + 1$.

In addition to the caveats Tom mentioned, there are two others worth mentioning. First, because the computation is recursive, errors due to floating-point approximations will accumulate, the severity increasing with the size of the transform. Also, as with all DFT calculations, there is an implicitly applied windowing function. In the case of the sliding DFT, the windowing function is rectangular, with unity magnitude. The sliding DFT, as presented, will not accommodate other windowing functions.

Randall Johnson,
Research and Technology
Development
De La Rue Printrak
Anaheim, CA

Some thoughts on American education

Richard Simonelli and Jorgen Vinding raise valid points [about engineering education] in their letters (Signals & Noise, EDN, September 29, 1988, pg 31). In his references to Hirsch and Ravitch and Finn, Jorgen Vinding shows more deep thought on the subject than the average engineer. The reference to Bloom will be appreciated by a large sample of educated Americans, who have read (at least in excerpts or interviews) about what the educational system has done to miseducate or de-educate students. Jorgen's recommendation that only 10 to 12% of a student's credits be in the humanities seems to me a bit low.

Ronald Khol makes the point (in *Machine Design*, October 20, 1988) that in Europe and Japan a degree from an American university is considered to be almost meaningless. He recommends that all students, regardless of their eventual fields of specialization, should have two

BRADFORD

RLR — "S" level in
05, 07, 20, 32C.
Tol.: 4, 2, 5%.
TC.: 400 PPM/°C.,
40 ohms to 1 Meg.

RNC/RNR —
"S" level in
50, 55, 60, 65
(Char: "H", "J").
Tol.: 4, 5, 4%,
49.9 ohms to 1 Meg.

CUSTOM SERVICE includes special burn-in, marking test summaries, serialization, X-ray, noise screen, ESD packaging and hot solder dipped leads.

OUR BOTTOM LINE

Cost-Effective Metal Film Resistors

Bradford E-Rel metal film resistors give you broad qualification, short delivery times, competitive pricing and excellent capabilities for meeting special requirements. Our strong E-Rel credentials also give us an edge in matching your standard MIL and commercial needs including low value, flameproof and pulse withstanding protective styles plus thick film networks and chips. Phone today for complete details.



550 High Street, Bradford, PA 16701
Phone (814) 362-5700

EZ-PRO Emulation Plus...

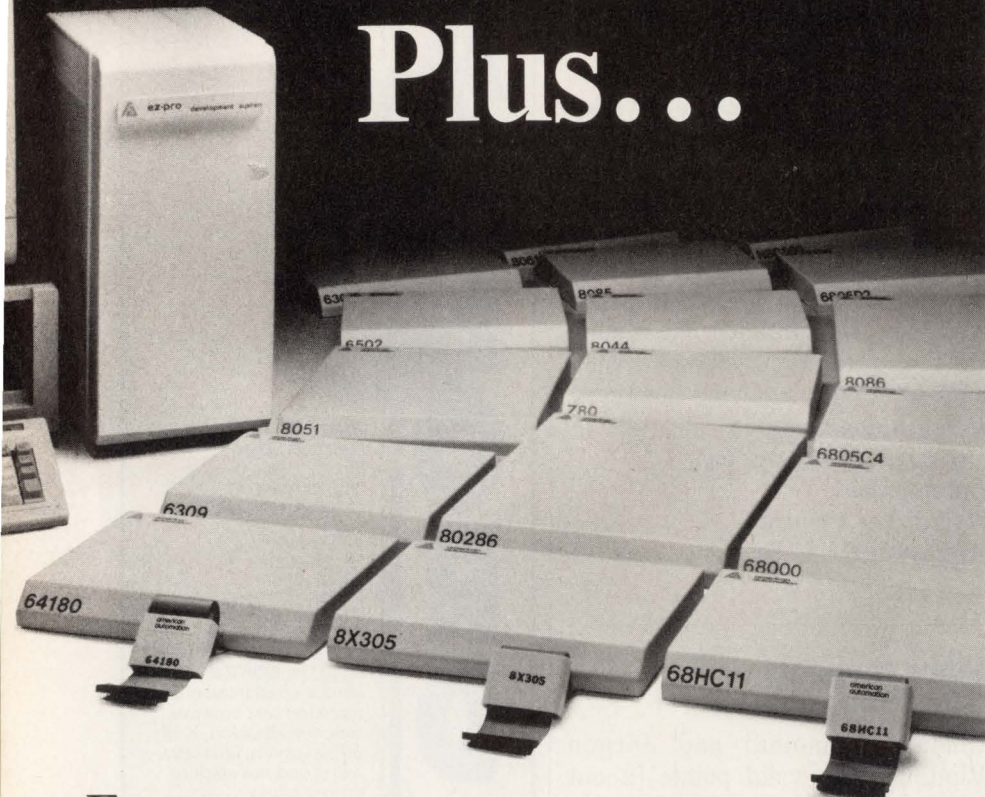

From the experience leader in emulation, the widest selection of microprocessor development support, hosted on IBM® PC-XT/AT, PS/2™, Macintosh II™, VAX™, and Sun Workstation®.

+ *C-Thru™* integrated C source-level debugging, including setting breakpoints and stepping by source line, tracking variables in native format, stack-frame trace-back.

+ *Show-Tyme™* performance analysis by software activity distribution and interaction frequencies, with detailed timing histograms and advanced breakpointing.

EZ-PRO Supports...

1802, 1805, 1806AC, 6303R, 6301V1, 63701V0, 6301X0, 6303Y0, 6303X, 6303Y, 6309, 6309E, 64180R0, 64180R1, (10 MHz), 647180, 6502, 6503, 6504, 6505, 6506, 6507, 6512, 6513, 6514, 6515, 6800, 6802, 6808, 6801, 6803, 68HC05C4, 68HC05C8, 68HC05D2, 68HC05E2, 68HC05E3, 6809, 6809E, 68HC11A2, 68HC11A8, 68000, 68008, 68010, 8031, 8051, 8032, 8052, 8344, 80C515, 8035, 8039, 8040, 8048, 8049, 8050, 8085, 8086, 80C86, 8088, 80C88, 8096, 8097, 80C196, 80186, 80C186, 80188, 80C188, 80286, 8X300, 8X305, NSC800, Z80H, Z180

...and more

 **american automation**

2651 Dow Avenue • Tustin, CA • 92680 • Tel: (714) 731-1661 • FAX: (714) 731-6344

IBM is a registered trademark of International Business Machines, VAX and MicroVAX are registered trademarks of Digital Equipment Corporation, Macintosh is a registered trademark of Apple Computer, Inc., Sun Workstation is a registered trademark of Sun Microsystems, Inc.

CIRCLE NO 154

SIGNALS & NOISE

years of intensive science and math. Such a requirement would be very good for journalism majors. It might reduce such ridiculous things as the wire-service science article that stated repeatedly that fluorocarbons release chlorine. Or the *Time* magazine article about Sprague, which stated that Sprague makes "capacitors," or the one about Gillette that claimed the company applies "silicon" (instead of *silicone*) to razor blades. Freshman chemistry these reporters obviously have not had.

Richard Simonelli is quite right that a formal, conventional liberal arts curriculum is not the only answer. In a large number of faculties, that is merely multiple exposure to socialist propaganda. My late wife had, in essence, a fine liberal education, though she had never had a college course. She read deeply of biography, history, and constitutional law, as well as news and business magazines, and she could discourse intelligently in these fields.

*Walter B Jones
Clear Lake City, TX*

PC-resident analog-I/O cards

This is a short note to compliment your publication for including the excellent article "PC-resident analog-I/O cards," by contributing editor Bill Travis, in the September 15, 1988, issue of EDN (pg 150).

In addition to being very well written, the article was the most complete examination of the present status of this technology that I've seen anywhere in the past couple of years.

Bill should, in my opinion, receive some special recognition for doing such an exceptional job on this complex and timely subject. Thanks to all, and keep up the good work.

*James Bischof
Advertising, Marketing, and
Public Relations
Newport Beach, CA*



THE ANALOG IC SEARCH STARTS...

AND STOPS HERE

PMI's free **Precision Decisions selector guide disk** eliminates the search of your entire library for the analog or data conversion IC essential to your design.

All you need is the disk, an IBM®-compatible PC, and DOS. With PMI's unique program, input your IC design specs or current part number and the disk does the searching. **Once the optimum device has been identified for you**, (operational amplifier, data converter, matched transistor, voltage reference, voltage comparator, sample-and-hold amplifier, analog switch, or multiplexer) refer directly to the appropriate data sheet in PMI's 1300 page full line catalog for complete design curves and specifications on the part.

Precision Decisions also features pricing, Mil/Aero and SSM Audio product listings, new product guide, sales office listing, and part numbering system. **Free quarterly updates** ensure you have current information available.

EDN March 30, 1989

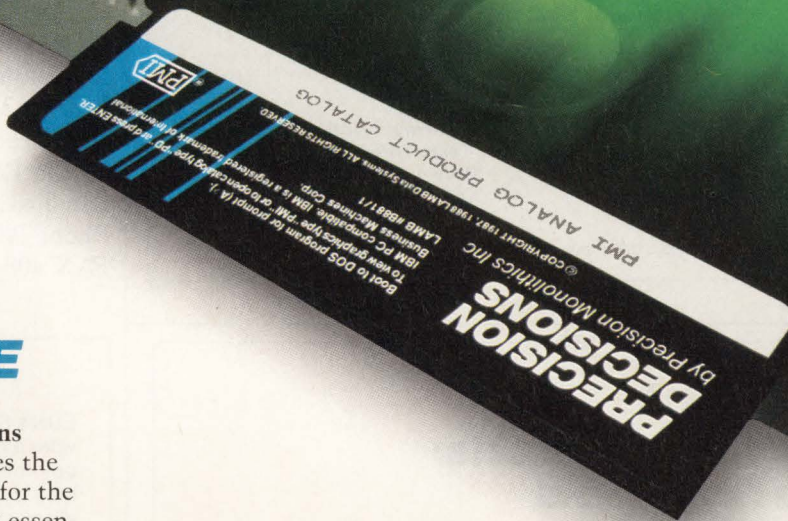

PMI offers the latest design tools to make your job easier. Call us and find out the other ways we can help you.

To receive your free copy of Precision Decisions, call **800-843-1515** or complete and mail the coupon below. **Your next search for an analog IC will start and stop with PMI.**



Precision Monolithics, Inc.
A Bourns Company

1500 Space Park Drive
P.O. Box 58020
Santa Clara, California 95052-8020

Please send me a free copy of Precision Decisions

Name: _____
Title: _____
Company: _____
Address: _____
Phone Number: _____

Check boxes that apply:

- I would like to receive free quarterly updates of Precision Decisions
- Also send me PMI's full line catalog

EDN 033089



ALTAMONTE SPRINGS: (407) 260-9780, ATLANTA: (404) 263-7995, BOSTON: (508) 794-0026, CHICAGO: (312) 250-0808, DALLAS: (214) 690-3495, DENVER: (303) 792-9595, DETROIT: (313) 227-2190, LOS ANGELES: (818) 886-6881, MILPITAS: (408) 942-8060, ORANGE COUNTY: (714) 637-9602, PHILADELPHIA: (215) 953-1070

CIRCLE NO 118

ONE WEEK TURN AROUND ON OUR PCB DESIGN SERVICE OR IT'S FREE!

National Design, Inc. is the only PCB designer you'll see that can make this incredible offer. How can they do it? Simple. NDI has:

- Senior level designers and electrical engineers on staff
- State-of-the-art Cadnetix's workstations and routing engine on site
- Gerber photoplotter
- Custom designs of up to 1400 IC's on a single circuit board.

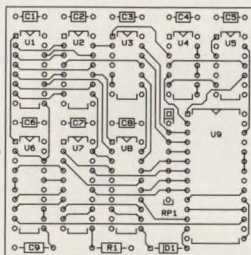

— Fortune 100 references available on request —

National Design

"Specializing in high speed printed circuit board design"

National Design, Inc. • 9171 Capital of Texas Hwy. North
Houston Building, Suite 230 • Austin, Texas 78759
Phone (512) 343-5055 • FAX (512) 343-5053 • Modem (512) 343-5054

* Applies to digital circuits only. NET LIST input must also be provided.

CIRCLE NO 119

New TO-5 snap-action thermostats: PC board mountable and very affordable.

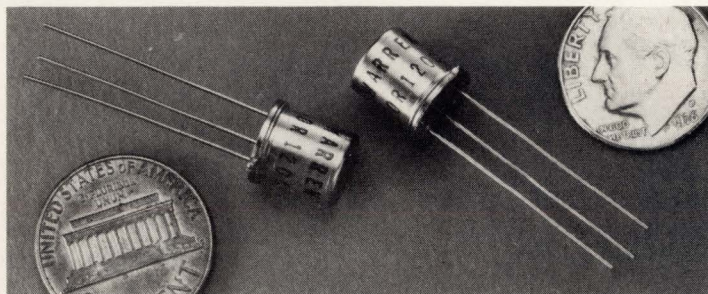

Hermetically sealed SD Series thermostats from Warren G-V offer proven calibration stability...withstand wave soldering and all washing methods...and require no power for operation.

Available in competitively-priced quantity lots. We will deliver to you in 4-5 weeks—guaranteed. For more details, call us today.



1 Apollo Drive
Whippany, NJ 07981
Phone: (201) 386-1200

CIRCLE NO 120

SIGNALS & NOISE

Oops

The Special Report on power MOSFETs and IGBTs appearing in EDN's January 5, 1989, issue (pg 128) incorrectly listed Powertec Inc (Chatsworth, CA) as a supplier of those products. The company does not make MOSFETs or IGBTs; it manufactures power supplies only.

Address update

"EDN's 15th Annual μ P/ μ C Chip Directory," which appeared in the October 27, 1988, issue (pg 164) included an incorrect address for Fujitsu Microelectronics Inc. The correct address, phone number, and FAX number are:

Fujitsu Microelectronics Inc
Advanced Products Div
50 Rio Robles, Bldg 3
San Jose, CA 95134
Phone (408) 922-9000
FAX 408-432-9070

YOUR TURN

EDN's Signals and Noise column provides a forum for readers to express their opinions on issues raised in the magazine's articles or on any topic that affects the engineering industry. Send your letters to the Signals and Noise Editor, 275 Washington St, Newton, MA 02158. We welcome all comments, pro or con. All letters must be signed, but we will withhold your name upon request. We reserve the right to edit letters for space and clarity.

21st Century CMOS Technology, NOW

0.4 micron/6ns SCRAMs

First of a New Generation of 3.3V Center-Pin Power and Ground Products.

Performance now offers two 6ns SCRAMs: P3C3148 1Kx4 and P3C3147 4Kx1. These SCRAMs are superfast Static CMOS Random Access Memories. Future superfast products, using center-pin power and ground with a 3.3 volt power supply, will include SCRAMs with 4Kbit to 256Kbit densities and popular logic parts such as buffers, transceivers, latches, flip-flops, comparators, registers and gate arrays.

"It has been clear for some time that the primary consideration which could limit the use of future generations of CMOS technology in the highest speed applications were issues associated with constraints that have been hangovers from bipolar TTL circuit implementations. If those constraints are not removed, then either performance will be compromised or serious application problems will result. It is easy to see the value of the changes that are needed to take maximum advantage of the attributes of the fine line CMOS technology in the sub half-micron regime (PACE III). Therefore, we have decided to invest a significant part of our Company's technical and marketing resources to help make the transition from a TTL environment to an optimized CMOS environment. As the 3.3 volt supply, low lead inductance product line emerges with 0.4 micron PACE III Technology, the uncompromised performance will overcome resistance to change and we will have a 'kinder & gentler' speed."

Tom Longo

4K Bit Density Static RAM Speeds

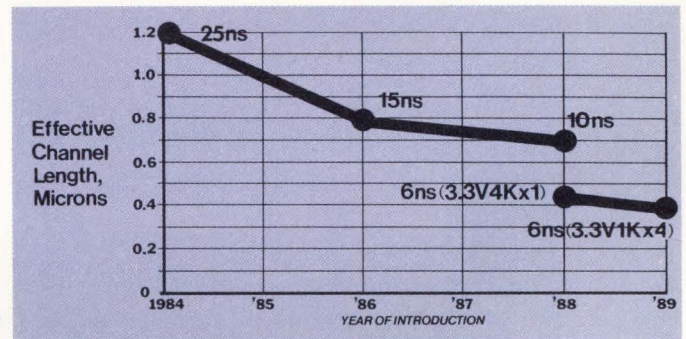

Performance's PACE III Technology, which features 0.4 micron effective gate length, 0.75 micron line widths and 250ps gate delay, offers a 40 percent speed improvement even with a 35 percent voltage reduction. Superfast 6ns SCRAM performance is available now with significantly lower power dissipation.

Typical Address to Dataout Delay: 4Kx1 SCRAM

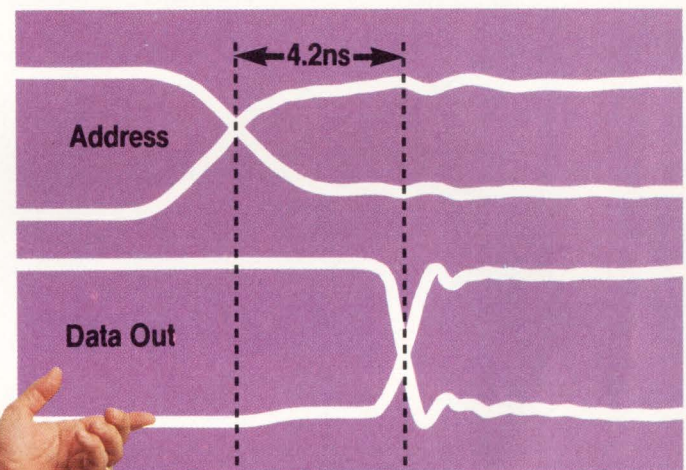

Performance's superfast 3.3 volt products incorporate multiple center power and ground pins as well as reduced signal swings to dramatically reduce ground bounce and simplify signal interconnection issues such as reflections, cross talk and ringing.

For further information or to order SCRAMs call or write:

PERFORMANCE
SEMICONDUCTOR CORPORATION

610 E. Weddell Drive, Sunnyvale, CA 94089 (408)734-9000

CIRCLE NO 75

PERF0001/S

Tek's New ASIC Verification System.

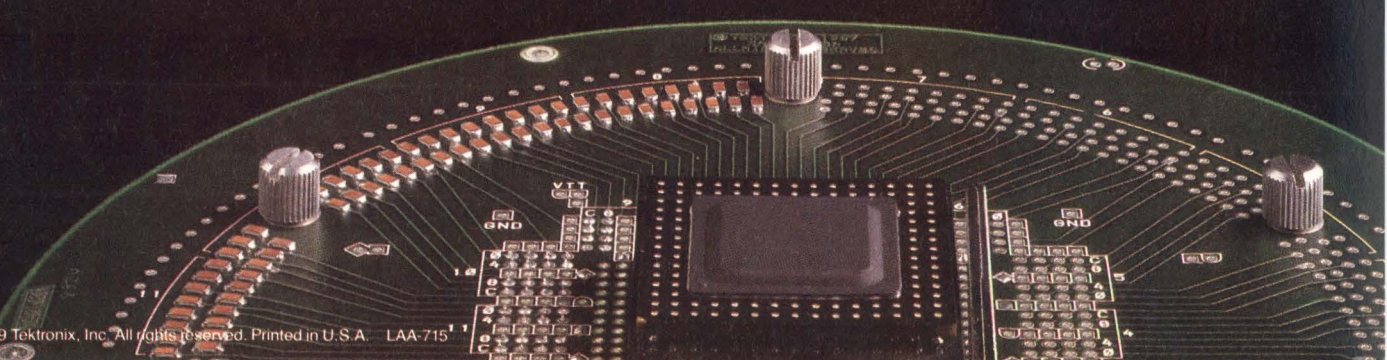
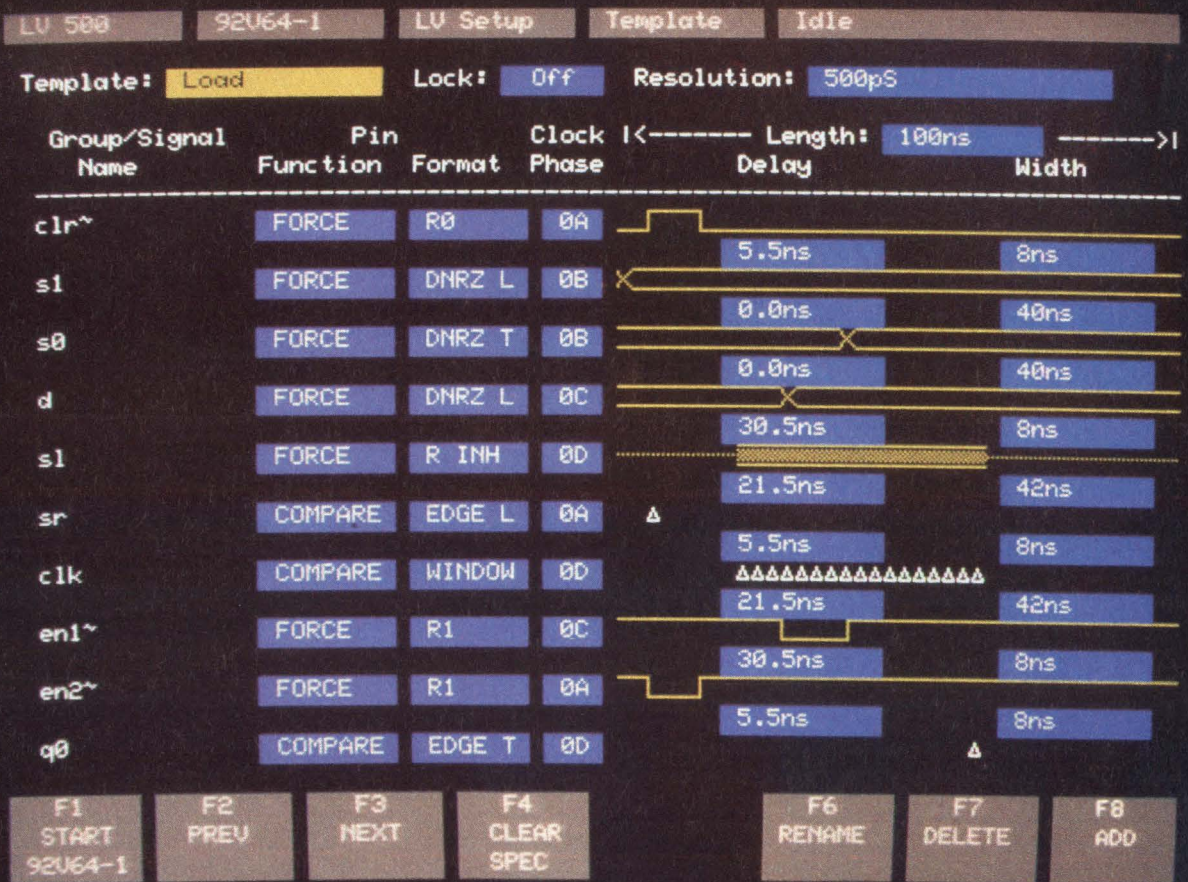

Big Tester Performance At A Benchtop Price.

For a fraction of the price of large production testers, designers can now easily perform timing verification and margin analysis on their own ASICs, using a turnkey system with the critical timing of the million-dollar machines.

Tek's new LV 500 ASIC Verification System is a true *designer's* solution, integrated into a 50 MHz, 256-channel, 64K deep benchtop system with a test head just 17 inches square.

Using a simple menu structure and concepts familiar to the designer, the LV 500 combines elementary operation with astonishing performance, made possible by integrating all 256 bidirectional channels onto a single PCB. Results include:

■ **More accurate simulation,** even for complex synchronous devices. The LV 500 lets you vary cycle length and timing for each of 16 clock generators on a cycle-by-cycle basis.

■ **Familiar operation** for example, template-based test cycles replicate the everyday timing diagrams of your IC book.

■ **Graphic displays.** See clearly when devices are operating too close to parametric boundaries.

Thanks to its high degree of integration, the LV 500 rarely needs calibration. DUT fixturing is simplified. And capacitance loading is reduced to about 25 pF, further contributing to the system's accurate results. And it is compatible with virtually all logic simulators.

Don't wait for chips to fail in production — or worse, for products to fail in the field. Start putting ASIC verification where it does the most good: in the hands of the designers themselves. For more information or a demonstration, contact your Tek sales representative. Or call 1-800-245-2036.



Tektronix
COMMITTED TO EXCELLENCE

"What if I told you there's a 15ns 64K SRAM available"

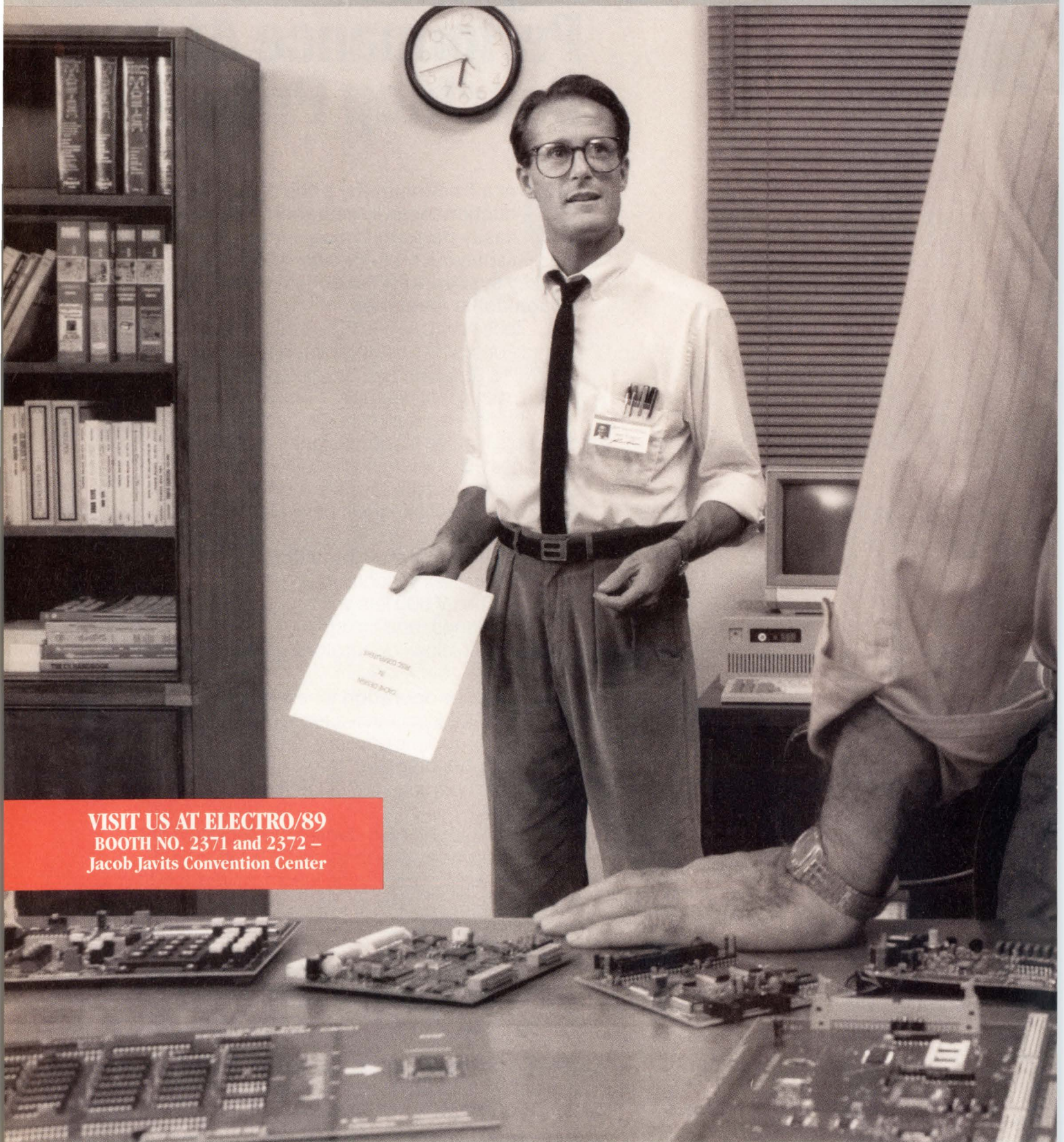

**VISIT US AT ELECTRO/89
BOOTH NO. 2371 and 2372 –
Jacob Javits Convention Center**

ALABAMA, Marshall Electronics Group, (205) 881-9235, Milgray Electronics, Inc., (404) 393-9666, Repron Electronics, (404) 446-1300 **ARKANSAS**, Marshall Electronics Group, (214) 233-5200, Milgray Electronics, Inc., (214) 248-1603, Sterling Electronics-Dallas, (214) 243-1600, **ARIZONA**, Marshall Electronics Group, (602) 496-0290, Sterling Electronics-Phoenix, (602) 268-2121 **CALIFORNIA**, Image Electronics, (714) 259-0900, (818) 407-8850, Marshall Electronics Group, (818) 407-0101, (714) 458-5395, (408) 942-4600, (916) 635-9700, (619) 578-9600, Merit Electronics, Inc., (408) 434-0800, Western Microtechnology, (619) 453-8430, (714) 637-0200, (408) 725-1660, (818) 707-0377 **COLORADO**, Marshall Electronics Group, (303) 451-8383, Sterling Electronics-Denver, (303) 792-3939 **CONNECTICUT**, Cronm Electronics, Inc., (203) 265-3134, Marshall Electronics Group, (203) 265-3822, Sterling Electronics-Wallingford, (203) 265-9535 **DELAWARE**, General Components, Inc., (609) 768-6767, Marshall Electronics Group, (301) 840-9450, Milgray Delaware Valley, Inc., (609) 983-5040, (800) 257-7808, (800) 257-7111, Sterling Electronics-Sterling, (703) 450-2373 **DISTRICT OF COLUMBIA**, Marshall Electronics Group, (301) 840-9450, Milgray Washington, Inc., (301) 621-8169, (800) 638-6656, Sterling Electronics-Sterling, (703) 450-2373 **FLORIDA**, Marshall Electronics Group, (305) 767-8585, (813) 576-1399, (305) 977-4880, Repron Electronics, (813) 855-4656, (305) 735-1112 **GEORGIA**, Marshall Electronics Group, (404) 923-5750, Milgray Electronics, Inc., (404) 393-9666, Repron, (404) 446-1300 **IDAHO**, Marshall Electronics Group, (801) 485-1551, Western Microtechnology, (503) 629-2082, Milgray Electronics, Inc., (801) 272-4999 **ILLINOIS**, Gold Electronics, (312) 593-3220, Marshall Electronics Group, (312) 490-0155, (314) 291-8554, Milgray Electronics, Inc., (913) 236-8800, (312) 350-0490 **INDIANA**, Gold Electronics, (312) 593-3220, Marshall Electronics Group, (317) 297-0483, Milgray-Chicago, Inc., (312) 350-0490 **IOWA**, Marshall Electronics Group, (612) 559-2211, Milgray Electronics, Inc., (913) 236-8800 **KANSAS**, Marshall Electronics Group, (913) 492-3121, Milgray Electronics, Inc., (913) 236-8800, Sterling Electronics-Kansas, (913) 236-5589 **KENTUCKY**, Marshall Electronics Group, (513) 898-4480, Milgray-Cleveland, Inc., (216) 447-1520, (800) 321-0006 **LOUISIANA**, Marshall Electronics Group, (214) 233-5200, Milgray Electronics, Inc., (214) 248-1603, Sterling Electronics-Dallas, (214) 243-1600 **MAINE**, Cronm Electronics, Inc., (617) 449-5000, Marshall Electronics Group, (617) 658-0810, Sterling Electronics-Boston, (617) 938-6200, Western Microtechnology, (617) 273-2800 **MARYLAND**, Marshall Electronics Group, (301) 840-9450, Milgray Washington, Inc., (301) 621-8169, (800) 638-6656, Sterling Electronics-Sterling, (703) 450-2373 **MASSACHUSETTS**, Cronm Electronics, Inc., (617) 449-5000, Marshall Electronics Group, (508) 658-0810, Sterling Electronics-Boston, (617) 938-6200, Western Microtechnology, (617) 273-2800 **MICHIGAN**, Marshall Electronics Group, (313) 525-5859 **MINNESOTA**, Marshall Electronics Group, (612) 559-2211, Repron Electronics, (612) 938-0000, Sterling Electronics, (612) 831-2666 **MISSISSIPPI**, Marshall Electronics Group, (205) 881-9235, Milgray Electronics, Inc., (404) 393-9666 **MISSOURI**, Marshall Electronics Group, (913) 492-3121, (314) 291-8554, Milgray Electronics, Inc., (913) 236-8800, Sterling Electronics-Kansas, (913) 236-5589 **NEBRASKA**, Marshall Electronics Group, (913) 492-3121, Milgray Electronics, Inc.,

now?"

"I'd say you've been reading too many supermarket tabloids"

"Seriously! You get high speed and quantity delivery, plus the ability to drastically cut your qual costs!"

"OK, I'll bite. Who's got 'em?"

"Toshiba"

"Why didn't you just say that in the first place?"

While others continue to talk speed, Toshiba now delivers 15ns Static RAMs. The exceptional access speed of the new 15ns 64K SRAM family is the result of a little technological wizardry and lots of 1.0µ CMOS know-how. The bottom line is a 15ns 64K SRAM that dissipates less power and requires a smaller-sized die than more costly BiCMOS devices.

And, if you've been looking for ways to cut qualification costs on your 64K SRAMs, look no further than Toshiba's 64K SRAM family. By using an aluminum master slice common to all configurations within the 64K family, the cost of qualifying individual parts is reduced by as much as 75%!

Toshiba builds a full line of SRAMs that offer high speed and fully static operation. A line whose depth and breadth provides higher system performance and lower system costs when designing high-speed cache memories, high-speed main memories, high-speed buffers and writeable control stores for minis, superminis, workstations, RISC-based systems, real-time processors,

high-speed storage and high-end graphics applications.

When it comes to SRAMs, Toshiba's got all the

Toshiba High-Speed SRAMs						
Configuration	Density	Speed (ns)			Availability	
64K x 1	64K	35	45	55	Now	
16K x 4	64K	15	20	25	35	
16K x 4 (OE)	64K	15	20	25	35	
8K x 8	64K	15	20	25	Now	
8K x 9	72K	15	20	25	Now	
64K x 4	256K	20	25	35	Early '89	
64K x 4 (OE)	256K	20	25	35	Early '89	
32K x 8	256K	20	25	35	Early '89	
32K x 9	288K	20	25	35	Early '89	
16K x 12	192K module	25	35		Now	
16K x 16	256K module	25	35		Now	

speeds, configurations and densities you need. Including 256K, coming soon.

And plenty of packaging options, too. From JEDEC standard Skinny DIPs and SOJs to ZIP Modules.

Not to mention the kind of service and deliverability others can only talk about.

Call today for complete data sheets and applications notes at 1-800-888-0848 ext. 517.



TOSHIBA

TOSHIBA AMERICA, INC.

ELECTRONIC COMPONENTS BUSINESS SECTOR

Service is our key component.

CIRCLE NO 122

© 1989 Toshiba America, Inc.

MST-88-012

(913) 236-8800. Sterling Electronics-Kansas. (913) 236-5589. **NEVADA**, Marshall Electronics Group. (916) 635-9700. (602) 496-0290. Sterling Electronics. (602) 268-2121. Western Microtechnology. (408) 725-1660. **NEW HAMPSHIRE**, Cronin Electronics, Inc. (617) 449-5000. Marshall Electronics Group. (617) 658-0810. Sterling Electronics-Boston. (617) 938-6200. Western Microtechnology. (617) 273-2800. **NEW JERSEY**, General Components, Inc. (609) 768-6767. Marshall Electronics Group. (201) 882-0320. (609) 234-9100. Milgray Electronics, Inc. (516) 420-9800. (609) 983-5010. (800) 257-7808. (800) 257-7111. Sterling Electronics-So. Plainfield. (201) 769-7000. **NEW MEXICO**, Marshall Electronics Group. (602) 496-0290. Sterling Electronics-Albuquerque. (505) 884-1900. **NEW YORK**, Marshall Electronics Group. (516) 273-2424. (607) 798-1611. (716) 235-7620. Milgray Electronics, Inc. (516) 420-9800. (716) 235-0630. Rome Electronics. (315) 337-5400. **NORTH-SOUTH CAROLINA**, Marshall Electronics Group. (919) 878-9882. Milgray Electronics, Inc. (404) 393-9666. Resco Raleigh. (919) 781-5700. (704) 588-1530. **NORTH-SOUTH DAKOTA**, Marshall Electronics Group. (612) 559-2211. Repron Electronics. (612) 938-0000. **OHIO**, Marshall Electronics Group. (513) 898-4480. (216) 248-1788. (614) 891-7580. Milgray-Cleveland, Inc. (216) 447-1520. (800) 321-0006. Repron Electronics. (614) 436-6675. (216) 349-1415. **OKLAHOMA**, Marshall Electronics Group. (214) 233-5200. Milgray Electronics, Inc. (214) 248-1603. Sterling Electronics-Tulsa. (918) 963-2410. **OREGON**, Marshall Electronics Group. (503) 644-5050. Western Microtechnology. (503) 629-2082. **PENNSYLVANIA**, General Components, Inc. (609) 768-6767. Marshall Electronics Group. (609) 234-9100. (412) 963-0441. Milgray-Cleveland, Inc. (216) 447-1520. (800) 321-0006. Milgray-Delaware Valley, Inc. (609) 983-5010. (800) 257-7808. (800) 257-7111. **RHODE ISLAND**, Cronin Electronics, Inc. (617) 449-5000. Marshall Electronics Group. (617) 658-0810. Sterling Electronics-Boston. (617) 938-6200. Western Microtechnology. (617) 273-2800. **TENNESSEE**, Marshall Electronics Group. (205) 881-9235. Milgray Electronics, Inc. (404) 393-9666. Resco Raleigh. (919) 781-5700. **TEXAS**, Marshall Electronics Group. (214) 233-5200. (915) 593-0706. (713) 895-9200. (512) 837-9991. Milgray Electronics, Inc. (214) 248-1603. Sterling Electronics. (713) 623-6600. (512) 836-1341. (214) 243-1600. **UTAH**, Marshall Electronics Group. (801) 485-1551. Sterling Electronics-Denver. (303) 792-3939. Milgray Electronics. (801) 272-4999. **VERMONT**, Cronin Electronics, Inc. (617) 449-5000. Marshall Electronics Group. (617) 658-0810. Sterling Electronics-Boston. (617) 938-6200. Western Microtechnology. (617) 273-2800. **VIRGINIA**, Marshall Electronics Group. (301) 840-9450. Milgray-Washington, Inc. (301) 621-8169. (800) 638-9656. Resco Raleigh. (919) 781-5700. Sterling Electronics. (703) 742-8400. (804) 226-2190. **WASHINGTON**, Marshall Electronics Group. (206) 486-5747. Western Microtechnology. (206) 881-6737. **WISCONSIN**, Good Electronics. (312) 593-3220. Marshall Electronics Group. (414) 797-8400. Milgray-Chicago, Inc. (312) 350-0490. Repron Electronics. (612) 938-0000. **CANADA**, Marshall Electronics Group. (416) 674-2161. IIT Multi-components. (604) 291-8866. (403) 451-4001. (403) 253-8575. (306) 933-2888. (204) 786-8401. (416) 736-1144. (613) 226-7406. (514) 335-7697. (506) 857-8011. Space Electronics Sales Corp. (514) 697-8676. (416) 636-8814. (613) 596-5340. (604) 294-1166.

CHOICE
LA SELECCION
LE CHOIX
LA SCELTA
DIE AUSWAHL
選択

For circuit breaker choice that's recognized throughout the world, Airpax has the answer. Our SNAPAK® circuit breakers are available with rocker, toggle, paddle, baton, push-, pull or push-to-reset actuation. They offer you a wide choice of reliable, magnetic circuit protection to provide precisely the right style, configuration and rating for your designs.

For enhanced aesthetics in front-panel applications, the SNAPAK family includes paddle, rocker, and baton handles in seven attractive colors. Also available are illuminated rocker handles in LED or neon.

Compact SNAPAK circuit breakers are offered in single- and double-pole designs, in ratings and delays from 0.10 to 15 amperes, in either DC, 50/60 Hz or 400 Hz versions. In addition, a variety of mounting hardware and indicator plates allow vertical or horizontal mounting, with standard "on-off" or "I-O" imprinting for international

designs. Reach out to world markets. Contact Airpax Company, Woods Road, Box 520, Cambridge, MD 21613. (301) 228-4600. A division of North American Philips Corporation. In Europe, contact N.V. Airpax S.A., Rue de la Bienvenue, 7-9, B-1070 Bruxelles. Phone: +32-2-526.29.11.

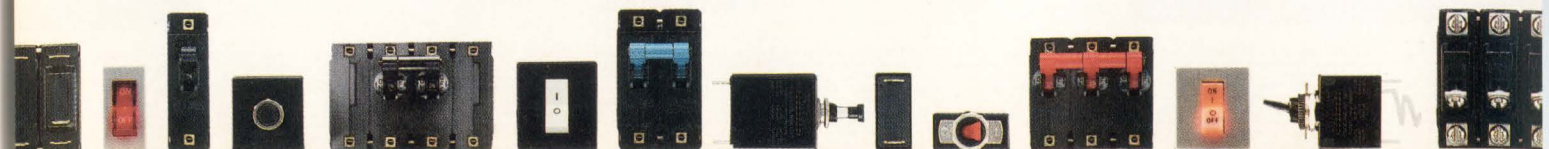
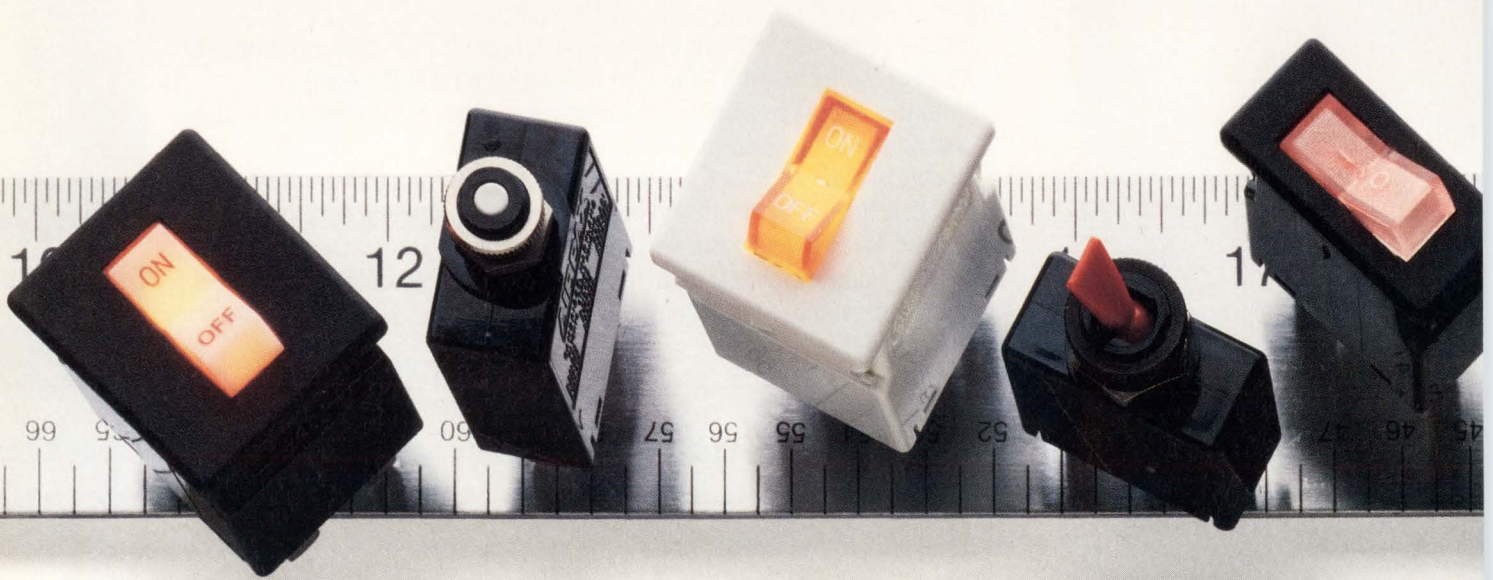

**PROTECTION
LA PROTECCIÓN
LA PROTECTION
LA PROTEZIONE
DIE SICHERUNG**

For circuit breaker protection that's recognized throughout the world, Airpax has the answer. Our SNAPAK® circuit breakers are UL recognized and CSA certified, and include many versions that are SEV approved, VDE approved, and meet IEC spacing requirements. They offer reliable, magnetic circuit protection in the most compact breaker design worldwide. SNAPAK snap-action ensures greater lifespan, withstanding shock, vibration and temperature fluctuations from -40°C to +85°C. SNAPAK circuit breakers are also trip free, protecting against overload even when forcibly held in the "on" position.

Reach out to world markets. Contact Airpax Company, Woods Road, Box 520, Cambridge, MD 21613. (301) 228-4600. A division of North American Philips Corporation. In Europe, contact N.V. Airpax S.A., Rue de la Bienvenue, 7-9, B-1070 Bruxelles. Phone: +32-2-526.29.11.

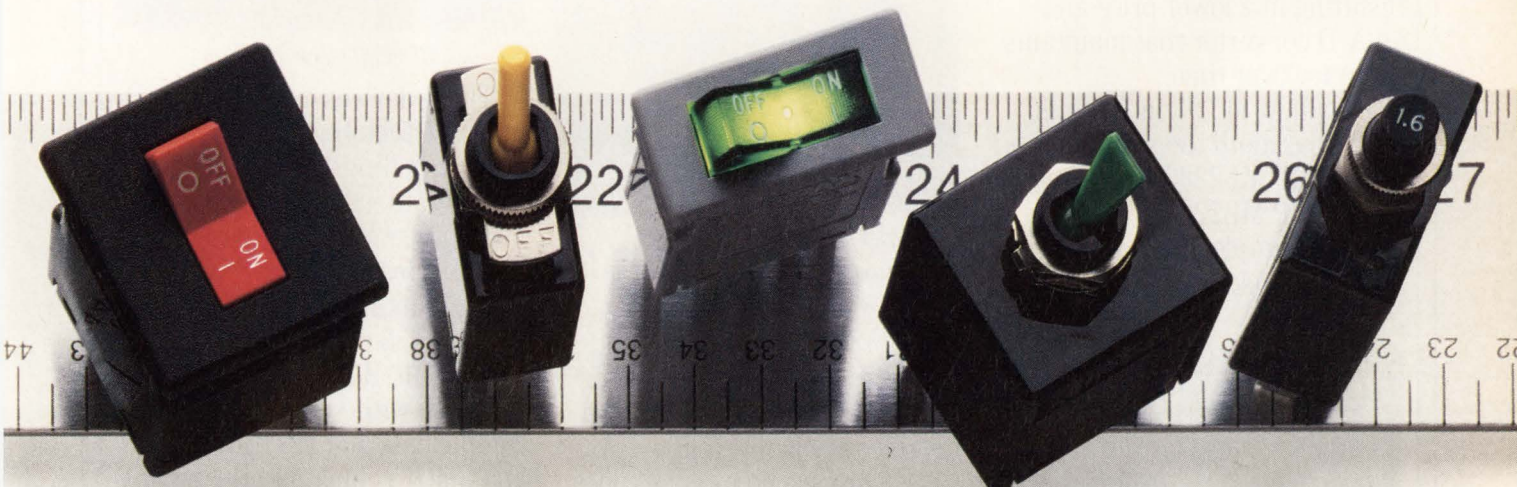

See us at ELECTRO '89 Booth number 2039



AIRPAX®
CAMBRIDGE DIVISION

New price performance level attained with algorithmic 12-bit + sign A/D converters.

Micro Linear now has two 12-bit + sign A/D algorithmic converters that incorporate auto-zeroing circuitry and self-calibration; the ML2230, and the ML2233. This approach has no trimming and less circuitry, resulting in a lower price and an A/D converter that maintains accuracy over time.

Priced at \$15.95 in 100 unit quantities, both the standard 24-pin DIP ML2230, and the 28-pin DIP ML2233, include an internal sample-and-hold and an easy to use microprocessor interface.

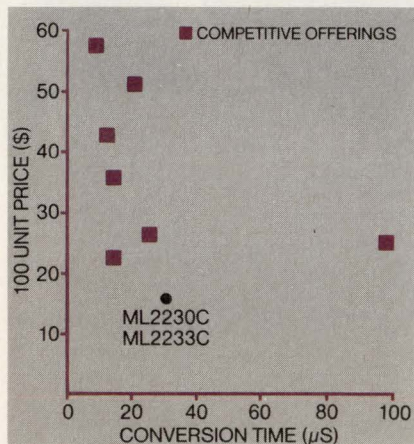

12-bit A/D price/performance comparison including sample-and-hold cost.

Accuracy and Speed

Total conversion time is 31 microseconds, including the on-chip sample-and-hold acqui-

sition time. Both devices can digitize a $-2.5V$ to $+2.5V$ sine wave at 12 kHz with a 73 db signal-to-noise ratio. Harmonic distortion is just 0.01%.

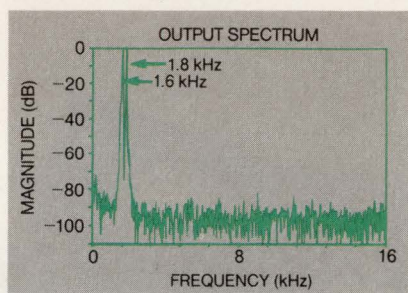

The FFT plot of the ML2233. A two tone, $-2.5V$ to $+2.5V$, low distortion sine wave input.

All errors of the sample-and-hold are accounted for in the accuracy specification. Integral nonlinearity is $\pm\frac{1}{2}$ LSB or ± 1 LSB, there are no missing codes, and full scale and zero errors are less than ± 1 LSB. This is over the temperature range, and with $\pm 5\%$ tolerance on $+5V$ and $-5V$ power supplies.

Versatility and Ease of Use

These 12-bit + sign A/D converters are designed for ease of use. The analog inputs can withstand 7V beyond the supplies. The high impedance analog input is differential for noise immunity and power supply rejection.

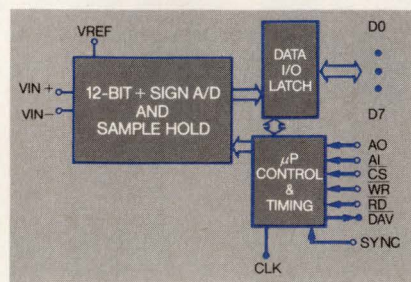

ML2230 block diagram

These devices support several interface techniques: interrupt, DMA or polling. The ML2230 is designed to interface to an 8-bit microprocessor bus by outputting the data result in two 8-bit bytes. To interface to a 16-bit bus, the ML2233 provides a 13-bit data result. Both are designed to interface without additional components and are fully TTL and CMOS compatible. Bus timing parameters are compatible with the fastest microprocessors currently available.

Call or Write for More Information

If your application calls for a 12-bit A/D converter or if you would like more information on Micro Linear's complete range of linear devices, please call (408) 433-5200 ext. 900 or write:

Micro Linear, Dept. TB,
2092 Concourse Drive,
San Jose, CA 95131.

© 1988 Micro Linear

EDITORIAL

Farewell...



It never once occurred to me in the last 20 years that I would someday write a farewell letter to you, the good and loyal readers of EDN. I never considered working for another publication because I always thought EDN was the best, even in earlier years, when it wasn't. Now, it truly is the best publication in the electronics industry. It has the most professional and the most knowledgeable editorial staff, serves the most exciting industry in the world, and has the most loyal readers of all.

But there comes a time when we must move on to new opportunities and challenges, which is what I'm doing. Though I feel bitter-sweet at the thought of leaving EDN, I'm pleased to become publisher of Test & Measurement World—a magazine that serves the same exciting industry. I'm also pleased to continue my affiliation with Cahners Publishing. And making the transition that much easier is the fact that many of you are readers of Test & Measurement World. I am most fortunate indeed.

Together we've faced many changes these past 20 years, the most significant being the microprocessor. That single development revolutionized not only every aspect of the electronics industry (and your job), but also every industry worldwide.

We positioned EDN to help you understand how to use and exploit the benefits of that and every other significant technical development. I believe that we've served you well—and you tell me I'm right in readership survey after readership survey.

EDN will continue to serve you well under the leadership of both Peter Coley, a good friend and supportive publisher, and my successor, Jon Titus, who is an outstanding editor.

I thank my entire editorial staff for their loyalty, support, and professionalism. And I thank you for all the same reasons. I wish for all of you, staff and reader alike, the sentiments of an old Navy saying, "May you have fair winds and a following sea."

Roy W. Forsberg

Roy Forsberg
Vice President/Editorial Director



Jesse H Neal
Editorial Achievement Awards
1987, 1981 (2), 1978 (2),
1977, 1976, 1975
American Society of
Business Press Editors Award
1988, 1983, 1981

**If you believe EPLDs are
constrained by their architecture,
this should open your mind.**



Introducing MAX.

A totally new architecture that will change your thinking about EPLDs.

Still think that EPLDs can't be fast and dense?

Then prepare to erase and reprogram your thinking.

The new MAX family from Altera has a radically different EPLD architecture that can make your fastest, densest designs fly out the door in no time.

With twice the speed and three times the density of conventional EPLDs.

At the heart of the MAX architecture are Logic Array Blocks incorporating three major innovations:

First, streamlined, totally programmable macrocells with multiple control product terms.

Secondly, Logic Expanders that let you assign additional product terms to any macrocell.

Finally, decoupled I/O that lets you use all your pins and flip-flops independently.

Tying it all together, a Programmable Interconnect Array (PIA) links MAX's multiple LABs efficiently.

When you combine the MAX architecture with a high speed, 0.8 micron CMOS process, you get high density devices with extraordinary performance.

And to get those devices to market faster, there's MAX+PLUS™ Logic synthesis makes it the

most powerful, easy to use software ever developed for EPLDs.

That's why the MAX family is destined to become the new standard for logic design.

For more information, call Altera today: 1-800-545-3377.

And see how easy it is to change your thinking about EPLDs.

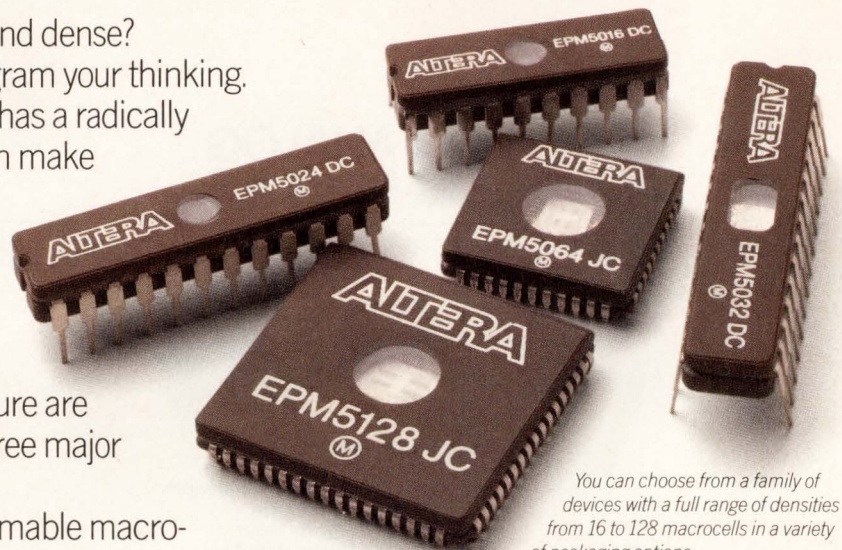

You can choose from a family of devices with a full range of densities from 16 to 128 macrocells in a variety of packaging options.

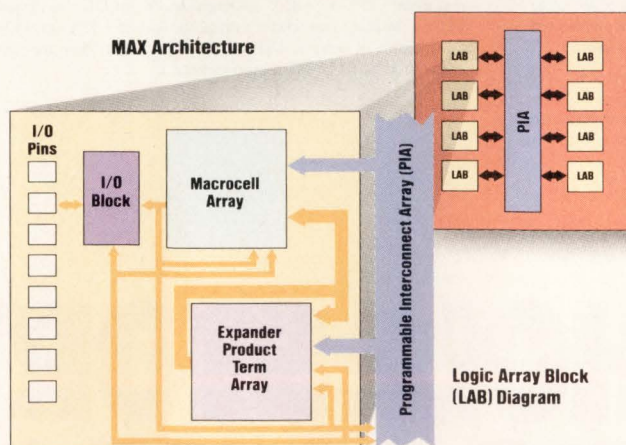

At the highest densities, MAX incorporates a Programmable Interconnect Array that gives you the high performance of small arrays with large array density.

MAX+PLUS is a trademark of Altera Corp.
© 1988, Altera Corporation.

ALTERA

3525 Monroe Street, P.O. Box 58163
Santa Clara, CA 95052-8163 (408) 984-2800

Whether it's a question of speed, bandwidth, power consumption or cost, our family of 8-bit A/D flash converters has the answer.

For example, if you need a monolithic high speed, ECL-compatible converter, there's our AD770 or AD9002.

The AD770 is our fastest ECL-compatible 8-bit converter, with a guaranteed sample rate of 200MSPS. And its 250MHz full power bandwidth and SNR performance with high frequency input signals can't be beaten. The AD770 is available in commercial and extended temperature range versions.

The AD9002 has a guaranteed sample rate of 125MSPS – yet its nominal power dissipation is a mere 750mW – and it operates from a single –5.2V power supply. The AD9002 is also available with MIL-STD-883 processing, making it ideal for a wide range of applications.

On the other hand, if it's a TTL-compatible 8-bit flash converter you need, there's our AD9012 or AD9048.

The AD9012 is the industry's fastest TTL-compatible converter, with a guaranteed sampling rate nearly twice that of its



ECL COMPATIBLE

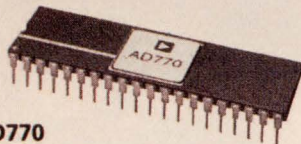

AD770

- High Bandwidth,
ECL Compatible, 200MSPS**
- 400MHz Small-Signal Bandwidth
 - 19pF Input Capacitance
 - Bipolar or Unipolar Input
 - +5V/–5.2V Power Supplies

The AD770 200MSPS A/D Converter uses an advanced VLSI bipolar process and a proprietary design to achieve new levels of performance in sampling rates and signal bandwidths for flash converters. Full power bandwidth is 250MHz.

The AD770 is ideal for high performance digital oscilloscope, radar, communications and electronic warfare systems. High input bandwidth permits undersampling of high frequency band-limited signals.

Multistage comparator design reduces the probability of errors due to metastable states or insufficient gain; decoding logic further reduces errors with a two-stage error-correcting architecture.

All inputs and outputs are ECL compatible, and analog inputs can be either bipolar or unipolar signals with up to 4V range. High accuracy and minimum temperature drift are preserved with end point reference Force and Sense connections.

There are three grades available. JD and KD grades are specified over a 0 to +70°C range; the SD grade is specified for temperatures from –55°C to +125°C. All standard grades are packaged in 40-pin ceramic DIPs; contact the factory for other package options.

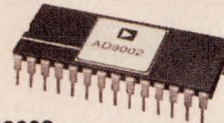

AD9002

- Low Power,
ECL Compatible, 125MSPS**
- 160MHz Analog Input Bandwidth
 - 17pF Input Capacitance
 - 750mW Power Dissipation
 - Single –5.2V Power Supply

Designs for radar, digital oscilloscopes, ATE systems, electronic warfare, communications/signal intelligence systems and a wide variety of other applications can be made easier with the AD9002 High Speed Monolithic A/D Converter.

An overflow bit indicating overrange signals can also be used to "stack" two AD9002 units to get 9-bit resolution of the digitized signal.

Input capacitance is typically 17pF and only 22pF maximum, simplifying the choice of a driving amplifier. Cooling requirements and power supply problems are also eased because of the low 750mW dissipation of the AD9002.

Two grades are available; one has 0.5LSB linearity, and the other has 0.75LSB linearity. Both versions are offered for operation from –25°C to +85°C packaged as 28-pin DIPs or 28-pin PLCCs. Military temperature range devices of –55°C to +125°C are available as ceramic DIP and LCC packages; they are compliant to MIL-STD-883 requirements.

FOR THE WHOLE STORY DO SOME SP

nearest competitor. Plus the AD9012 offers excellent ac performance, low power operation and low input capacitance.

The AD9048 is an improved version of an industry-standard 8-bit TTL-compatible A/D converter, with the highest sampling rate, widest bandwidth, lowest input capacitance and lowest power. And the AD9048, as well as the AD9012, is available to MIL-STD-883.

There's no question about it – high performance characteristics are traits in our family of 8-bit A/D flash converters. So no matter what your requirement is for 8-bit analog-to-digital conversion, we have the solution.

If you want more information in a flash on our 8-bit flash converters, call your nearest Analog Devices sales office or our applications engineers. Answers for the AD770 are at (617) 935-5565. For the AD9002, AD9012 and AD9048, call (919) 668-9511.



Analog Devices, Inc., One Technology Way, P.O. Box 9106, Norwood, MA 02062-9106; Headquarters: (617) 329-4700; California: (714) 641-9391, (619) 268-4621, (408) 559-2037; Colorado: (719) 590-9952; Maryland: (301) 992-1994; Ohio: (614) 764-8795; Pennsylvania: (215) 643-7790; Texas: (214) 231-5094; Washington: (206) 575-6344; Austria: (222) 885504; Belgium: (3) 237 1672; Denmark: (2) 845800; France (1) 4687-34-11; Holland: (1620) 81500; Israel: (052) 911415; Italy: (2) 6883831; Japan: (3) 263-6826; Sweden: (8) 282740; Switzerland: (22) 31 57 60; United Kingdom: (932) 232222; West Germany: (89) 570050.

8-Bit Flash Converters

TTL COMPATIBLE



AD9012

- Low Power, Wide Bandwidth, TTL Compatible, 75MSPS
- 160MHz Input Bandwidth
- 16pF Typical Input Capacitance
- Power Dissipation < 1W
- Minimum 46dB SNR

The AD9012 is a TTL compatible A/D converter fabricated in an advanced bipolar process which makes it possible to operate at typical conversion speeds up to 100MSPS.

For commercial and industrial applications, the AD9012 is an excellent choice for professional video, instrumentation, digital radio and PC-based video digitizing equipment.

In military applications, the requirement for mil-qualified devices can be met with MIL-STD-883 units in electronic countermeasures, missile guidance, radar, radar warning and other military systems equipment.

The AD9012 is available in two grades: one has 0.5LSB linearity, and the other has 0.75LSB linearity. Both operate from -25°C to +85°C and are packaged as 28-pin DIPs or 28-pin PLCCs. Military temperature range devices of -55°C to +125°C are available as ceramic DIP and LCC packages.

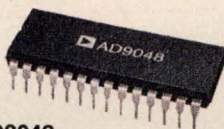

AD9048

- Low Power, Low Cost, TTL Compatible, 35MSPS
- 15MHz Typical Bandwidth
- Input Capacitance Typically 16pF
- 550mW Power Dissipation
- Industry-Standard Pinouts

As its name implies, the monolithic AD9048 Video A/D Converter is an ideal choice for real-time conversion of video signals.

Its full power bandwidth is typically 15MHz, with no missing codes, and is a guaranteed minimum of 10MHz.

Low power dissipation of 550mW typical makes the AD9048 adaptable and attractive for a broad range of applications. In addition to professional video systems and video imaging, it is an excellent choice for electro-optics, digital radio and electronic warfare systems, among others.

The AD9048 has industry-standard pinouts and is available over two temperature ranges, with two grades of linearity. Linearities of either 0.5LSB or 0.75LSB can be ordered for 0 to +70°C commercial ranges, or -55°C to +125°C military temperatures. Commercial versions are in 28-pin DIPs and PLCCs; military versions are in ceramic DIP and LCC packages. Both commercial units and MIL-STD-883-compliant devices are standard products.

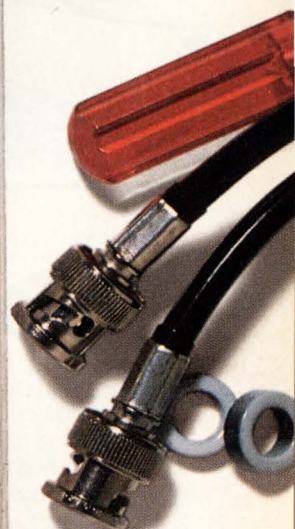

ON FLASH CONVERTERS EED READING.

Need 50 watts of power or less?

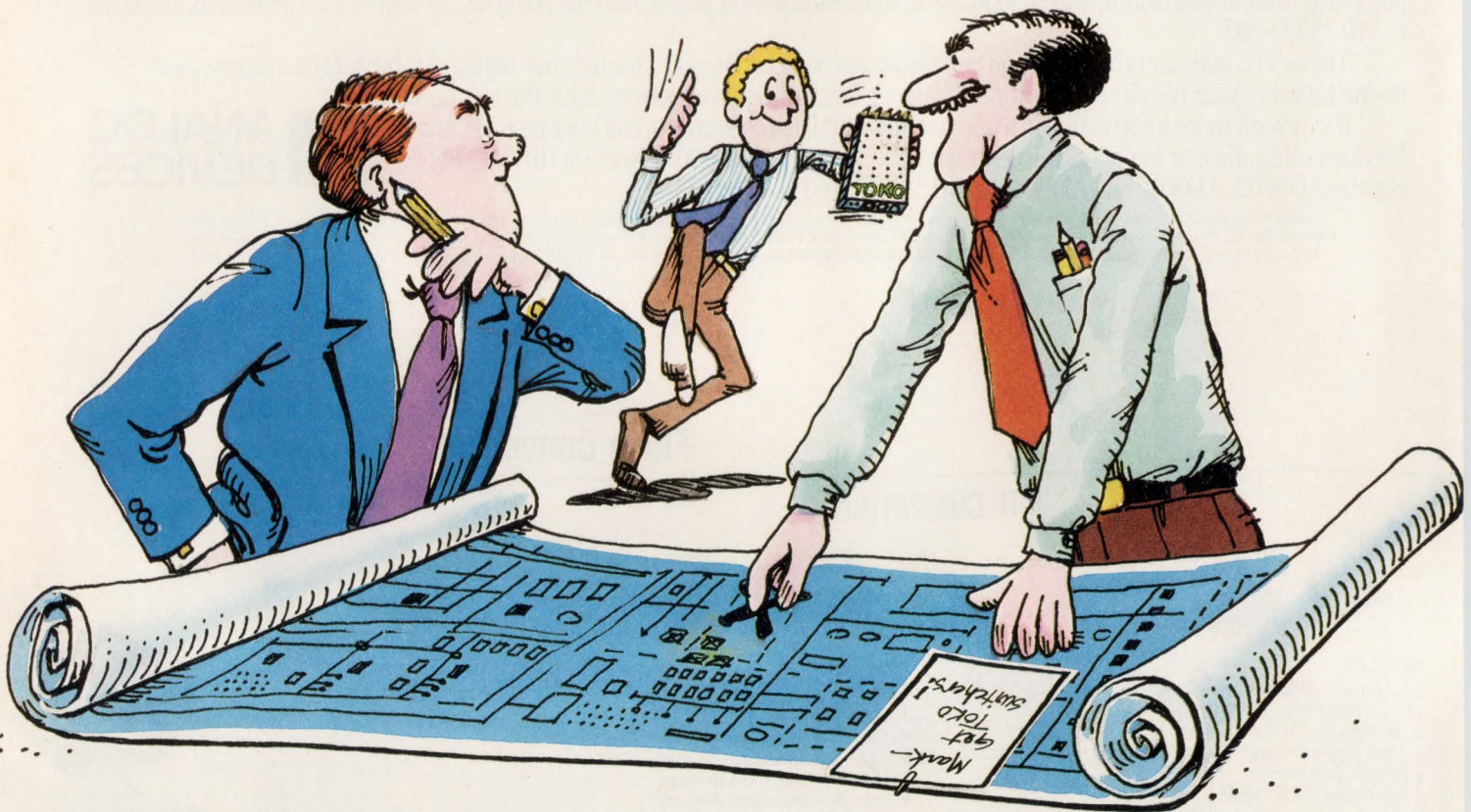

Toko switchers have what you need.

There's no need to overbuy or add extra bulk and heat when you're specifying a low-wattage power supply. Toko has the output power you need in leading-edge switchers.

With over 250 models in the under 50-watt category, Toko offers you the right switcher at a price that will also make the controller happy. Whether you're powering computer peripherals, portable devices or other systems where space is at a premium, Toko is the name to know.

More high-tech features.

Because Toko is a low-power specialist, we're at the forefront of technology. For example, our new MW series offers 85-264 VAC universal input and very high power densities. All Toko switchers offer high-switching frequencies and excellent EMI/RFI protection.

Low power is different.

The design requirements for a low-power compact switcher are as unique as your own product needs. Toko's 30+ years of experience in magnetics and filtering technology have

SERIES	VAC INPUT VOLTAGE	RATED POWER	NO. OF OUTPUTS	NO. OF STANDARD MODELS
ET	85-132	10W	3	6
		15W		
EM	170-264	10W	3	6
		15W		
PU & PS	85-132/ 110-175/ 170-264	10W	1	192
		15W		
		30W		
		50W		
PE&PT	85-132/ 170-264	15W	3 (PT)	60
		30W	1 (PE)	
		50W		
MW	85-264*	15W	3	7
		30W		
		50W		

*Automatic (no jumpers required)

led to development of switchers that pack the most clean reliable power into your available space.

Toko stays on the job.

With MTBF over 200,000 hours, 105°C electrolytic capacitors, 100% 8-hour burn-in, and 20% derating of all components, you may never need our 2-year guarantee. Toko dependability and commitment to servicing your needs give you the lowest cost of ownership in the long run. Our prices and no-charge options save you money now.

Ask about our Free Sample Evaluation Program. For a free power supply guide and to discuss your own low-power needs, contact Toko America, Headquarters and Midwest Branch (312) 297-0070; East Coast Branch (203) 748-6871; Southeast Branch (205) 830-0952; West Coast Branch (408) 432-8281.

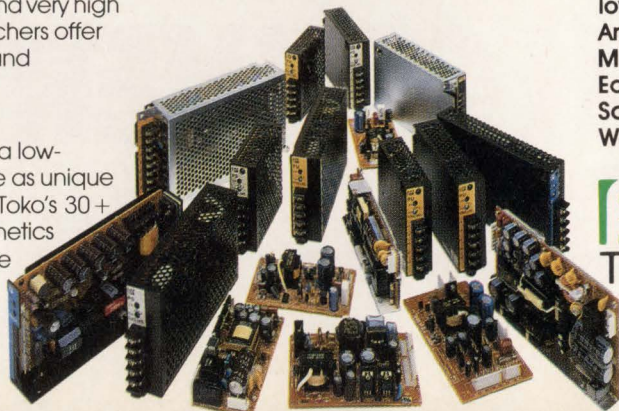

TOKO
TOKO AMERICA, INC.

Your strategic partner...
for all the right reasons.

Logic synthesis prepares for VHDL



Although logic-synthesis tools offer greater efficiency to system designers, the current generation still suffers from a lack of compatibility with other CAE packages.

*Michael C. Markowitz,
Associate Editor*

Logic synthesis tools are the latest in a long line of CAE tools that are destined to shrink the product development cycle for ICs and ultimately convert gate-level designers to systems engineers. These tools have the ability to increase your design productivity while minimizing the risks of introducing design faults. But despite the efficiency gains, danger still lurks: Logic-synthesis software is still new, and the CAE industry is undergoing a radical transformation—thanks to the Very-high-speed-integrated-circuit (VHSIC) Hardware Description Language (VHDL).

The increasing complexity of the current generation of PLD and IC designs has stretched the capabilities of the engineers who create them. The difficulty of effectively trading-off such considerations as performance and packaging while still trying to meet delivery deadlines prompted the development of logic-synthesis software. The software translates and optimizes a design far faster than you could manually.

One way you can utilize this time savings is to simulate and test the design more extensively. If you had more time you could run system simulations that would let you improve on the oft-quoted statistic that 50% of ASICs fail to perform in their target system. You

might also play “what if . . .” games to evaluate performance-area tradeoffs; most of the synthesis packages have options that let you limit parameters like gate count and critical-path speed.

There are two major obstacles to the widespread acceptance of logic synthesis. One hurdle is the confusion over what logic synthesis is and what it can do; the second is a lack of standardization.

At the most basic level, logic synthesis maps Boolean equations to a gate-level representation of your design. A broader definition stretches the input medium to include high-level circuit descriptions, like register-transfer-level (RTL) descriptions and hardware-description language (HDL) implementations. Further, the broader definition of synthesis encompasses two separate operations—translation of the behavioral circuit description to a structural implementation and, subsequently, optimi-

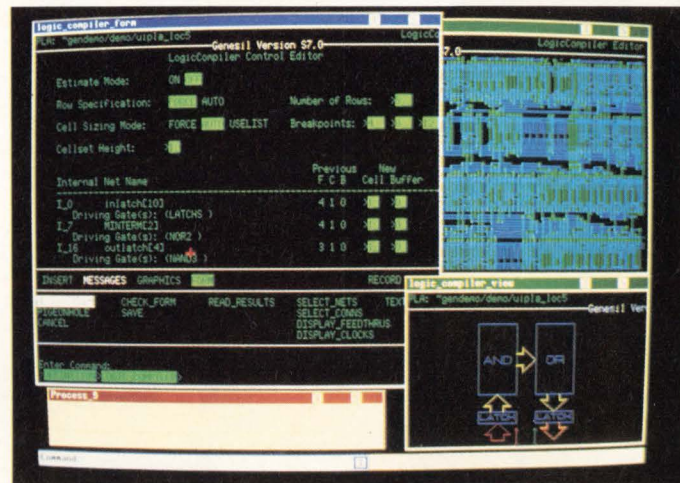

You can specify a PLA with state equations, logically optimize it, and then implement it in compiled standard cells with the Genesis Logic Compiler.

LEADER

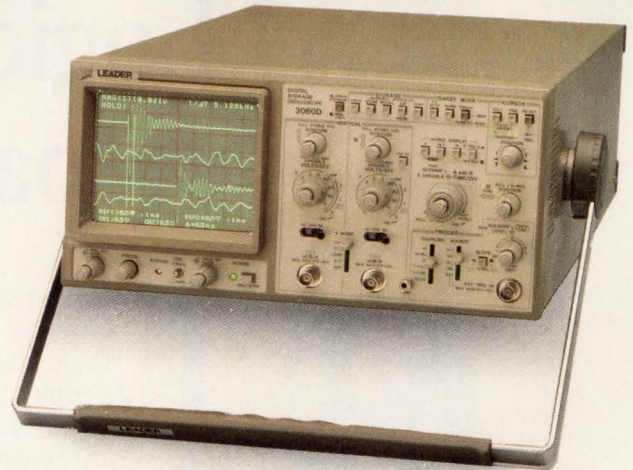

New full-time digital storage oscilloscope grabs fast events!

Perfect for freezing fast and slow events, the Model 3060D performs as a 40MS/s digital storage oscilloscope and 60-MHz real-time scope.

With high-speed digitizing and CRT readout with cursors, you can capture and easily analyze single-shot events, fast transients and slowly occurring phenomena.

Expand captured waveforms up to 100 times and interpolate them; store four waveforms in the 2k word/2-channel memory for immediate or later evaluation, and send fully documented waveforms to a plotter.

Plus, calibrated delay sweep, pre-trigger functions, p-p auto triggering, sine and pulse interpolation, autoranging time base... etc. And for computer control, GPIB is standard.

The 3060D is backed by a TWO-YEAR WARRANTY, and factory service depots on both coasts.

Look at Leader and see the difference. Phone now for our catalog, an evaluation unit, and the name of your nearest "Select" Leader Distributor.

Call toll-free
1 800 645-5104
 In NY State
516 231-6900

Leader Instruments Corporation
 380 Oser Avenue, Hauppauge, New York 11788
 Regional Offices:
 Chicago, Dallas, Los Angeles, Boston, Atlanta
 In Canada call Omnitrax Ltd. 416 828-6221

LEADER
 FOR PROFESSIONALS WHO KNOW
 THE DIFFERENCE

Captured waveforms can be magnified up to 100 times at trigger point

Time measurements between cursors

Type of Interpolation

Indicates captured waveforms

Reference memory 1, voltage range and time base settings

CH-1, voltage range setting

CH-2, voltage range setting

Reference memory 2, voltage range and time base settings

Main time base setting

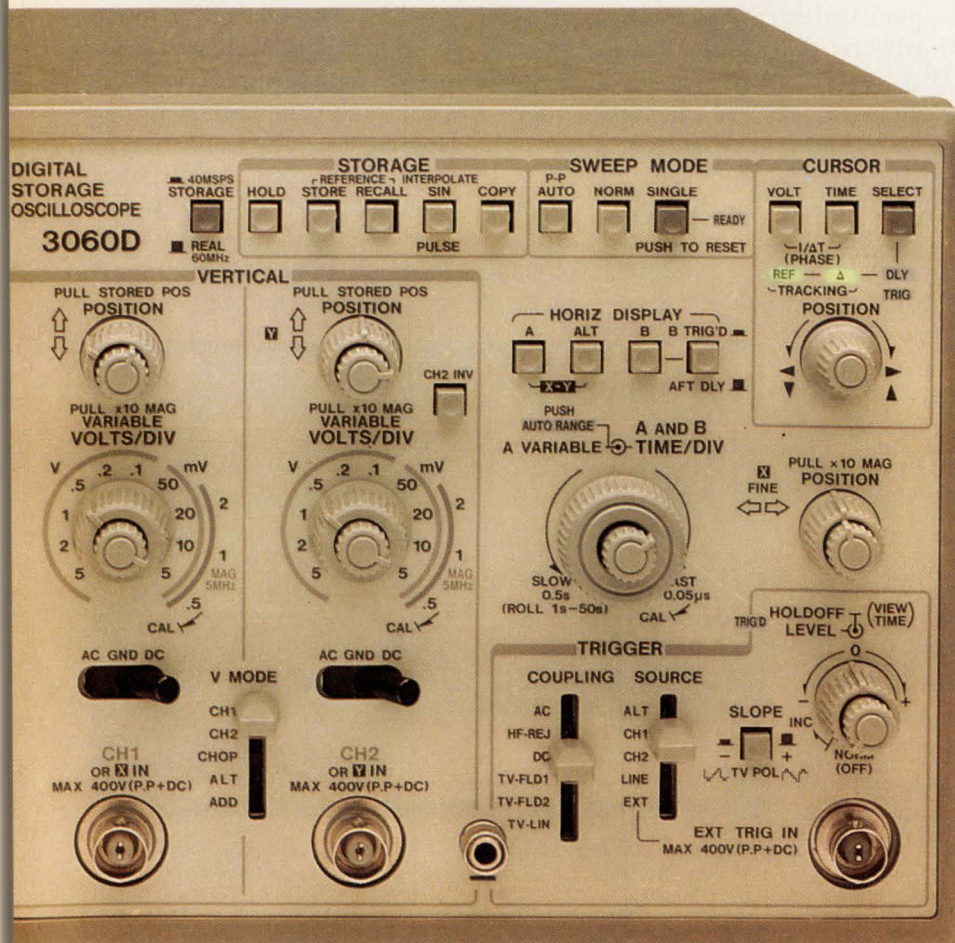
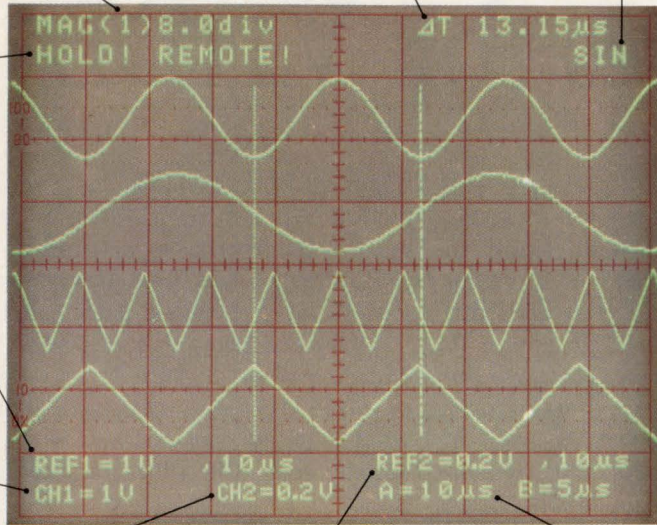

TECHNOLOGY UPDATE

Logic synthesis

zation of the structure to eliminate redundancy and inefficiency. Optimization is where you can design for high speed, low real-estate utilization, or some combination of the two. Trading off these considerations is the part of logic synthesis where engineers can obtain their highest level of productivity enhancement today.

To help visualize the design process and where logic synthesis fits into it, refer to the "Y" chart model (Fig 1) adapted from the original suggested by Gajski and Kuhn (Ref 1). This model proposes three ways to represent a design. More complex designs can use all three representations at various times in their development. But you might design exclusively at the gate level for smaller integrated circuits or at the polygon level for discrete transistors.

The behavioral domain is the highest and most theoretical level at which you can represent a design. At this level, you are solely concerned with the function of the circuit from input to output. At the most abstract level, you can specify a design as a behavioral system. Refinement makes this specification more detailed as an algorithm; an RTL description; a set of Boolean equations; and, ultimately, as a set of differential equations. All of these representations define outputs as some function of the inputs and, possibly, time.

The structural domain specifies what elements you use to convert inputs into outputs and how you connect these elements to work toward their goal. Paralleling the refinement of the behavioral domain, the structural domain can be as abstract as a structural system. Providing more detail lets you define your circuit as a group of subsystems, which can include CPUs and memories. You could then refine your subsystems as modules, such

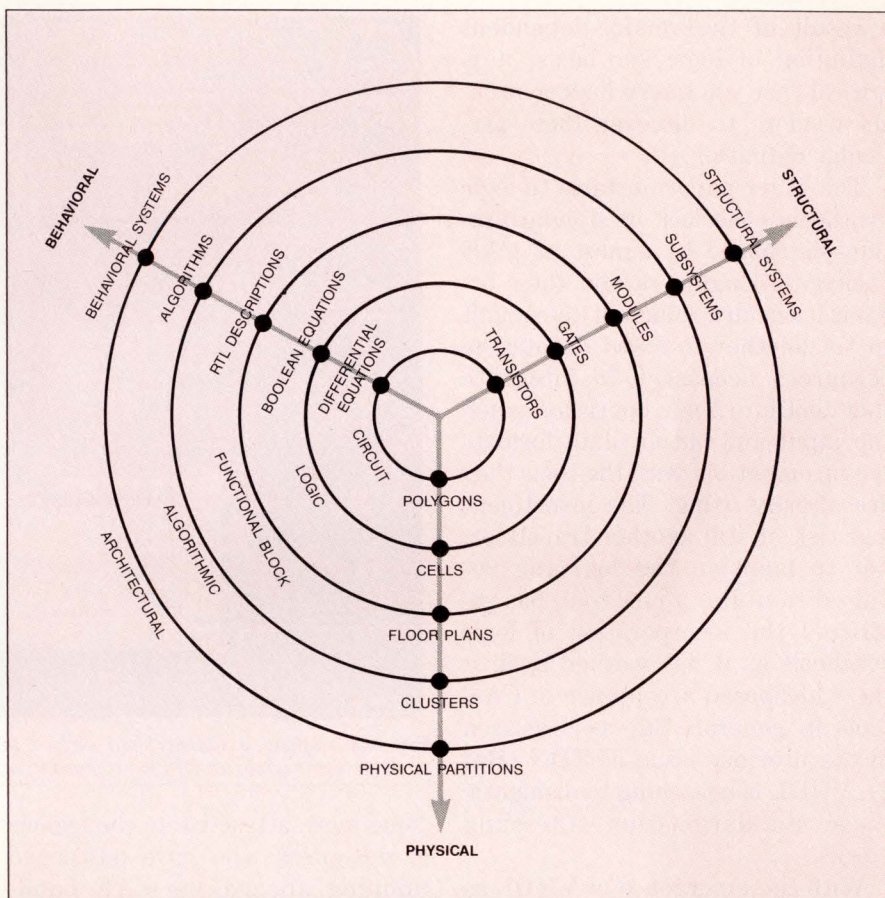

Fig 1—The Y chart is a three-part representation of a design that can help you understand the design process and how you can use CAE tools to achieve your design goals.

as ALUs and registers. The modules can be further specified as gates and flip-flops; the gates and flip-flops can then be specified as transistors.

Finally, the physical domain describes the actual geometric implementation of the circuit. You can, at the most general level, represent a design as a collection of physical partitions. By refining the description and providing more detail, you can describe the physical circuit as a cluster; a floor plan; a group of cells; and, most basically, as an assortment of polygons.

A series of concentric circles connect each of the levels of detail. The circles represent, at the most philosophical level, an architectural description of the design. Refining the design produces the algorithmic,

functional-block, logic, and circuit descriptions.

In the jargon of the industry, logic synthesis at its simplest is strictly the translation from one level of detail in the behavioral domain to the same level of detail in the structural domain. Broadening the view a little, some vendors of synthesis tools include optimization in their definition of logic synthesis. These routines eliminate redundancies and inefficiencies that the synthesis software creates. At the most extreme end, some vendors insist that true logic synthesis encompasses translation, optimization, and refinement. Thus—independent of what you put in—you ultimately finish logic synthesis with either a transistor- or gate-level representation of your circuit. As

TECHNOLOGY UPDATE

Logic synthesis

a result of the vendor-dependent definition of logic synthesis, it is critical that you query logic-synthesis vendors to discover their particular definition.

The other major obstacle to logic synthesis—the lack of standardization—is shared by almost all CAE packages. Engineers and their organizations are reluctant to commit to yet another tool and devote the resources necessary to integrate that tool into their operation when the input and output data formats are incompatible with the tools they are already using. The investment and risk of still another translator, not to mention the learning required to utilize a new tool, has restricted the incorporation of logic synthesis as it has worked against the widespread acceptance of CAE tools in general. But as discussed in the previous issue of EDN (Ref 2), VHDL is beginning to dismantle these standardization stumbling blocks.

With the emergence of VHDL as a standard for the documentation and design of integrated circuits and systems, CAE tools will be-

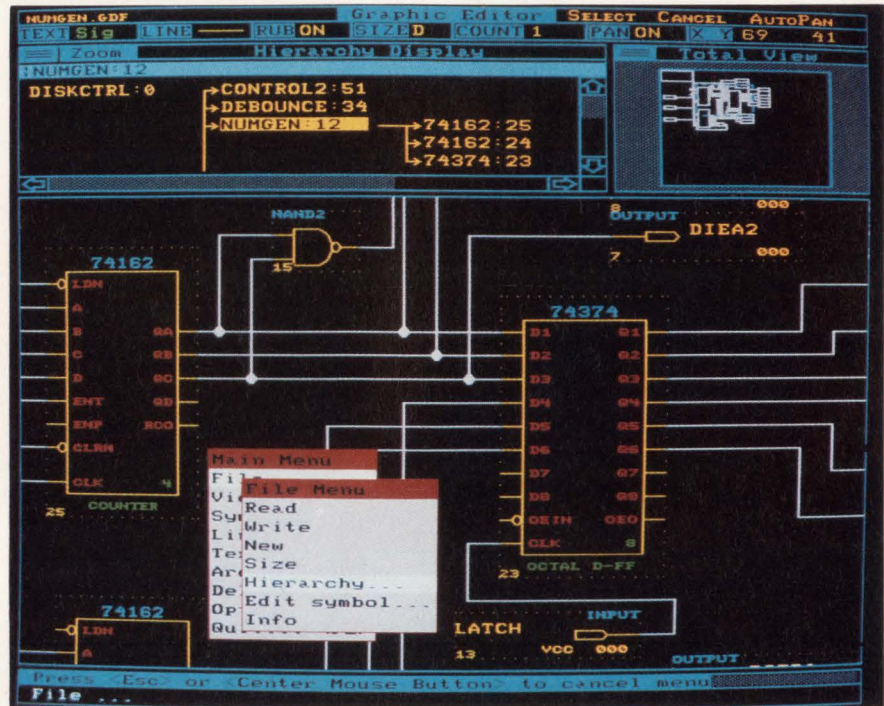

You can capture a hierarchical circuit using TTL logic from which the PLDS-MAX package synthesizes an EPLD programming file.

come more attractive to the legions of designers who have postponed jumping aboard the CAE bandwagon for fear of either being left with a dinosaur or committing to the wrong standard. Most logic syn-

thesis vendors and, indeed, most CAE vendors are coming to the realization that VHDL is the biggest game in town and are making major efforts to enable their software to accept VHDL input and generate VHDL output.

Initially, VHDL will be primarily a documentation and transfer language, hence the necessity for front-end design tools that can create and output VHDL code from some other input format. The reluctance of designers to embrace new techniques over their well-worn, time-proven methods will impede VHDL's rate of acceptance. Additionally, if you are immersed in a design project, you have little time to spend learning a new way to design—essentially by writing code—and if you are between designs and have more time, you might not have the motivation to learn a new design technique. Call it a Catch-22. But once the benefits become clearer and the reluctance to write code rather than draw or capture

PLDesigner 1.0 - Partitioning Solution Menu

System Name : CPU EXIT

Possible Solutions: Attempted : 2431 Found : 66

==> 1	P20R6, P16R6, 7 x P16R4	1650na	60ns	\$25.13
2	P20R6, P16R8, 7 x P16R4	1650na	60ns	\$25.13
3	P20R8, P16R8, 7 x P16R4	1650na	60ns	\$25.13
4	P20V8R, P16R6, 7 x P16R4	1530na	60ns	\$25.92
5	P20RP6, P16R8, 7 x P16R4	1530na	60ns	\$25.92
6	P20RP8, P16R8, 7 x P16R4	1530na	60ns	\$25.92
7	P20RP6, P16R6, 7 x P16R4	1530na	60ns	\$25.92
8	P20V8R, P16R8, 7 x P16R4	1530na	60ns	\$25.92
9	P20V8R, 8 x P16R4	1530na	60ns	\$25.92
10	P16R8, 2 x P16R6, 7 x P16R4	1800na	60ns	\$26.00

Possible Devices:

P16R4 P16R6 P16R8 P16RP4 P16RP6 P16RP8 P16V8R P20R4 P20R6 P20R8 P320 P20X8 P20X4 P20X10 P20V8R P20RP8 P20RP6 P20RP4 E9R8 PR19R4 PR19R6 PR19R8 PT19R4 PT19R6 PT19R8 P900 P600 P32R16 P22V10R P20XRP8 P20XRP6 P20XRP4 P20XRP10 P20RS8 P20RS4 P20RS10 P20RP10

The PLDesigner software partitions the circuit and chooses the most cost-effective solutions within the performance constraints that you set.

Experience makes the difference



Raytheon's experience gives you the winning ECL combination

Raytheon's ECL array family performs at a fraction of the power of competing ECL technologies. Proven ECL logic arrays are denser than 1.5 micron CMOS arrays.

Here now: ECL arrays with a proven track record. Raytheon's extensive experience in design, prototype and production devices gives you the highest level of confidence.

Highest density: CGA 70E18: 12,800 equivalent gates
CGA 40E12: 7,752 equivalent gates

CGA 1ME12: 4,584 equivalent gates and 1280 bits of RAM.

Performance: Superior speed/power performance— <0.1 pJ; 300 ps delay; 300 μ W power dissipation (typical gate).

Ease of design: Raytheon's contiguous row array topology provides a superior design approach when compared to fixed position cell-based technologies. This topology offers greater flexibility and ease in macrocell design, placement and routing.

Interface capability: I/Os compatible with ECL (10 KH or 100 K), TTL, CMOS, ETL (mixed ECL and TTL), and ETC (mixed ECL, TTL and CMOS).

The extensive experience and support provided by Raytheon mean easy, error-free, and cost-effective ECL design for you.

Raytheon Company
Semiconductor Division
350 Ellis Street
Mountain View, CA 94039-7016
(415) 966-7611

Raytheon

Where quality starts with fundamentals.

TECHNOLOGY UPDATE

Logic synthesis

a design dissipates, VHDL will gather steam as a design language.

In the meantime, the decision to use logic-synthesis tools depends largely on your circumstances. If you design a large number of complex circuits, then the productivity enhancements offered by the current generation of logic-synthesis packages would probably outweigh the instability of the CAE marketplace and future enhancements to logic-synthesis tools. If you don't design circuits that could ultimately make their way into Department of Defense (DoD) systems, many of these logic-synthesis tools would probably serve your purposes quite well. On the other hand, if you only do a few designs, or are under DoD mandate to use VHDL either for

design or documentation, then you might want to wait for the VHDL dust to settle before jumping into logic synthesis.

If you decide that you must have logic-synthesis capability or just want to know what's available, you should know that some vendors target their logic-synthesis software to either PLDs or ASICs because of the different requirements of each technology. Some of the PLD-specific synthesis vendors have made a commitment to VHDL; others are still waiting to see how the dust settles. MinC's PLDesigner will have a provision for VHDL input in the third quarter of this year.

Altera is targeting a fourth-quarter introduction of VHDL capability for its PLDS-MAX soft-

ware. The company is planning to add some extensions that its software will accept to the VHDL-language inputs to give you greater flexibility in creating your design. PLDS-MAX will output your circuit in standard VHDL format without the extensions, so you can exchange data with other VHDL-compatible tools. OrCAD is developing a VHDL compiler for its OrCAD/PLD that will let you program PLDs from a VHDL behavioral circuit description.

PLDesigner, PLDS-MAX, and OrCAD/PLD create JEDEC (Joint Electron Devices Engineering Committee) standard file outputs for programming PLDs. PLDS-MAX generates Altera's ADF format netlist as well as a PLD pro-

TABLE 1—LOGIC-SYNTHESIS PACKAGES

COMPANY	PRODUCT	VHDL	PLDs/ASICs	CAPABILITY	OPTIMIZATION	WORKSTATIONS	PRICE
ALGORITHMIC SYSTEMS	ASCYN LOGIC SYNTHESIZER	IN DEVELOPMENT	P, A	1, 2, 3, 4	LOCAL/GLOBAL	PC/XT, PC/AT, VAX, APOLLO, MAC	\$3000 TO START
ALTERA	PLDS-MAX	Q4 '89	P	1, 2, 3, 4	GLOBAL	PC/AT, PS/2	\$4995 INCLUDING PROGRAMMING HARDWARE
DATA I/O	GATES	—	P, A	1, 2, 3, 4	LOCAL/GLOBAL	PC/XT, PC/AT, PS/2, /386, SUN-3	\$4440
MENTOR	PLDSYNTHESIS	Q3 '89	P	1, 2, 3, 4	LOCAL/GLOBAL	APOLLO	\$14,900
MINC	PLDESIGNER	Q3 '89 INPUT	P	1, 2, 3, 4	LOCAL/GLOBAL	PC/XT, PC/AT	\$4500
NCR	DESIGN SYNTHESIS	H2 '89	A	1, 2, 3, 4	LOCAL/GLOBAL	APOLLO (MENTOR GRAPHICS)	\$51,500 INCLUDING NCR LIBRARIES
ORCAD	ORCAD/PLD	INPUT IN DEVELOPMENT	P	1, 2, 3, 4	GLOBAL	PC	\$495
SEATTLE SILICON	FINESSE	IN DEVELOPMENT	A	1, 2, 3	GLOBAL	APOLLO (MENTOR GRAPHICS)	\$59,000 WITH CHIPCRAFTER
SILC	SILCSYN	OUTPUT NOW INPUT SEPT '89	A	1, 2, 3, 4	LOCAL/GLOBAL	SUN, APOLLO, DEC	\$50,000 TEST OPTION \$28,000
SILICON COMPILER SYSTEMS	LOGIC COMPILER	IN DEVELOPMENT	A	1, 2, 3	LOCAL	SUN, APOLLO, DEC (MENTOR/DAISY)	\$24,500
SYNOPSISYS	DESIGN COMPILER	IN DEVELOPMENT	P, A	1, 2, 3, 4	LOCAL/GLOBAL	SUN, APOLLO, DEC (MENTOR)	\$35,000
TRIMETER	DESIGN CONSULTANT	JUNE '89	A	1, 2, 3, 4	LOCAL/GLOBAL	SUN, APOLLO, DEC (MENTOR/DAISY)	\$49,500
VLSI TECH	LOGIC SYNTHESIZER	INPUT Q3 '89 OUTPUT IN DEVELOPMENT	P, A	1, 2, 3	LOCAL/GLOBAL	SUN, APOLLO, DEC, HP, ELIXI, RIDGE	\$30,000
XILINX	DS-23	N/A	P	1, 2, 3	LOCAL/GLOBAL	PC/AT, SUN, APOLLO	\$1500 \$3000

NOTES:
 1=COMBINATORIAL LOGIC 3=SYNCHRONOUS CIRCUITS
 2=SEQUENTIAL LOGIC 4=ASYNCHRONOUS CIRCUITS

LOGIC SYNTHESIS

AVAILABLE
NOW
ON THE
Sun Workstation

PALS LCAS FPLAS
EPLDS Gate Arrays

LOGIC SYNTHESIS GIVES YOU MORE DESIGN CHOICES.

FutureNet® FutureDesigner™ gives you more choices than any other design entry software—choices in how you enter your design, in target technologies, and in design output. And only FutureDesigner uses logic synthesis to automatically turn your input choices into your output choices, optimizing and streamlining your design for the technology you select.

CHOOSE THE DESIGN ENTRY METHOD.

Only FutureDesigner lets you describe your design in the easiest, fastest, most natural way. You can enter some functions structurally, using DASH schematics. Others can be described behaviorally with any combination of truth tables, state diagrams, or high-level logic equations. Interactive verification and design rule checking help you catch errors up front, as you design.

CHOOSE THE TARGET TECHNOLOGY.

FutureDesigner is technology inde-



Choose the platform: FutureDesigner runs on 80386 and 80286 machines, IBM® personal computers, and the Sun-3 Series.

pendent. After you've described your design, you can choose any mix of TTLs, PLDs, LCAs, gate arrays, or other ASIC devices for implementation. It's also easy to migrate designs from one technology to another—for example, from TTL to PLD, PLD to LCA, or PLD to gate array.

CHOOSE THE OUTPUT FORMAT. With more than 100 DASH-Partners providing a broad range of comple-

mentary products and services, FutureDesigner's industry-standard format is accepted virtually everywhere. When you design with FutureDesigner, you'll have more choices in technologies, CAE systems, foundries, and service bureaus.

CHOOSE FUTUREDESIGNER WITH LOGIC SYNTHESIS.

With its unique logic synthesis capabilities, FutureDesigner reduces and factors your design, eliminating redundancy and improving efficiency. It optimizes for the particular technology you've selected, making the necessary speed/size trade-offs. Then it generates the schematics, net lists, or JEDEC files for programming PLDs. Automatically.

Call us today for more information. Find out why FutureDesigner is the design entry software of choice.

1-800-247-5700
Ext. 153

DATA I/O
Corporation

Data I/O Corporation 10525 Willows Road N.E., P.O. Box 97046, Redmond, WA 98073-9746, U.S.A. (206) 867-6899/Telex 15-2167
Data I/O Canada 6725 Airport Road, Suite 302, Mississauga, Ontario L4V 1V2 (416) 678-0761
Data I/O Europe World Trade Center, Strawinskylaan 633, 1077 XX Amsterdam, The Netherlands +31 (0)20-6622866/Telex 16616 DATIO NL
Data I/O Japan Sumitomoseimei Higashishinbashi Bldg., 8F, 2-1-7, Higashi-Shinbashi, Minato-ku, Tokyo 105, Japan
(03) 432-6991/Telex 2522685 DATAIO J

©1988 Data I/O Corporation

CIRCLE NO 131

TECHNOLOGY UPDATE

Logic synthesis

programming file for use with its hardware and PLDs. The PLDesigner provides its output in several useful formats, although Minc currently has no immediate plans for providing VHDL output. Minc's output formats include EDIF (electronic design interchange format) standard netlists, and schematics that are compatible with Mentor Graphics, Daisy/Cadnetix, OrCAD, PCAD, Futurenet-Data I/O, Teradyne, and Intergraph CAE systems. As with other front-end tools, until PLDesigner provides its own facility for generating VHDL descriptions, you'll need to use an indirect approach to generate a VHDL description. An example of such an approach would be importing your schematics to a schematics package that does have VHDL generation capability.

PLD-specific tools can begin the logic-synthesis process with Boolean equations, truth tables, or state-machine descriptions. Additionally, the PLDesigner can utilize RTL descriptions as well as synchronous-waveform entry, a method that lets you enter as many as 64 input and output waveforms. A waveform compiler then builds state-machine equations; and, if the waveforms do not provide sufficient information, the software provides you with the location of the problem and suggests solutions. Finally, if your design is too large, the PLDesigner can automatically partition your design among multiple PLDs, which it selects from its own library of more than 2500 devices, based on constraints like cost, pin count, and which devices your company stocks.

Logic cell arrays (LCA) are a cross between PLDs and ASICs. Xilinx's DS-23 Automated Design Implementation Program is an adaptation of Exemplar Logic's synthesis tools optimized for LCAs. It accepts either schematics that

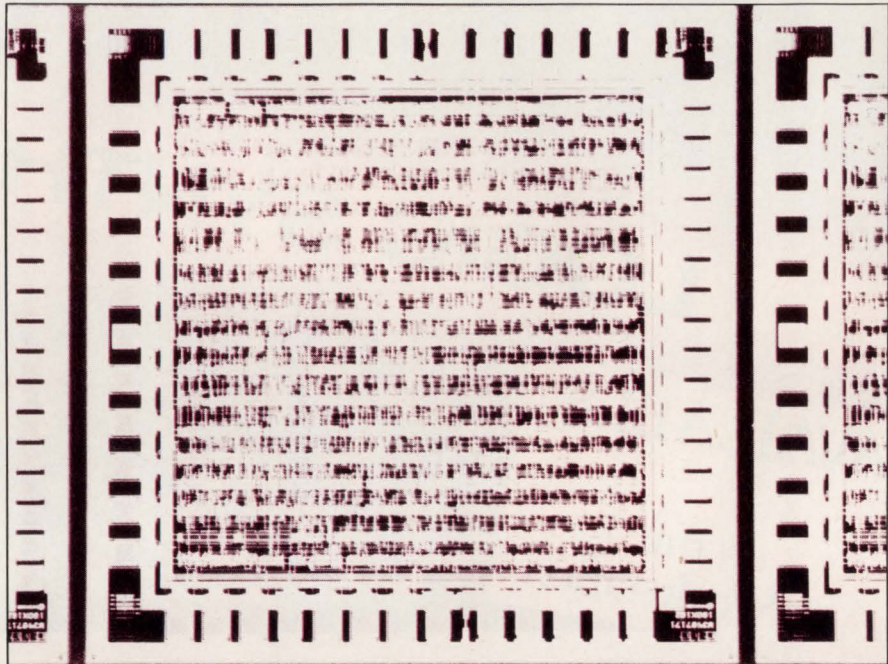

Logic synthesis tools have the capability to synthesize chips more complex than those they could generate even a year ago. This SCSI core is functionally equivalent to the NCR 53C80 SCSI chip but is fully synchronous. It has roughly 1000 gates, took six weeks to design rather than six months, and is 9% smaller than the core of its asynchronous cousin.

you've created with your favorite schematic-capture tool or Boolean equations. The DS-23 requires another front-end tool to create the circuit description from which the Xilinx software synthesizes and optimizes an LCA-compatible circuit. Thus, the company is relying on the capabilities of other front-end tools for VHDL compatibility.

Other vendors of logic-synthesis tools target the ASIC market. Most of these vendors recognize the importance of VHDL to their customers and are making progress toward providing their tools with the capability to both accept and generate VHDL descriptions. Logic-synthesis tools that accept circuit descriptions in other HDLs have an easier conversion path to VHDL than others. These HDLs include Gateway Design Automation's Verilog; Praxis' Ella, which was developed by the British Royal Signals and Radar Establishment (RSRE), adopted by the British Standards Institution (BSI), and licensed to

Praxis; and other proprietary languages,

Silc Technologies SilcSyn ASIC Design System already provides VHDL output, and the company is committed to releasing a revision with VHDL-input support in September. The company wrote the original logic-synthesis software to accept their SilcSyn HDL and is modifying the tool for VHDL compatibility. As is common with all of the ASIC logic-synthesis tools, you can create your specification using either Boolean equations or truth tables.

SilcSyn has an optional \$28,000 test-synthesis package that incorporates partial scan test into the design to implement testable ASICs. The software synthesizes the partial scan function after the circuit translation process but before the optimization routine is run, so that the software minimizes the scan logic with the rest of the design. The cost of the increased testability is four I/O pins and about 10% addi-

Demanding Designers Need the Best

OrCAD/SDT III Schematic Design Tools for the PC

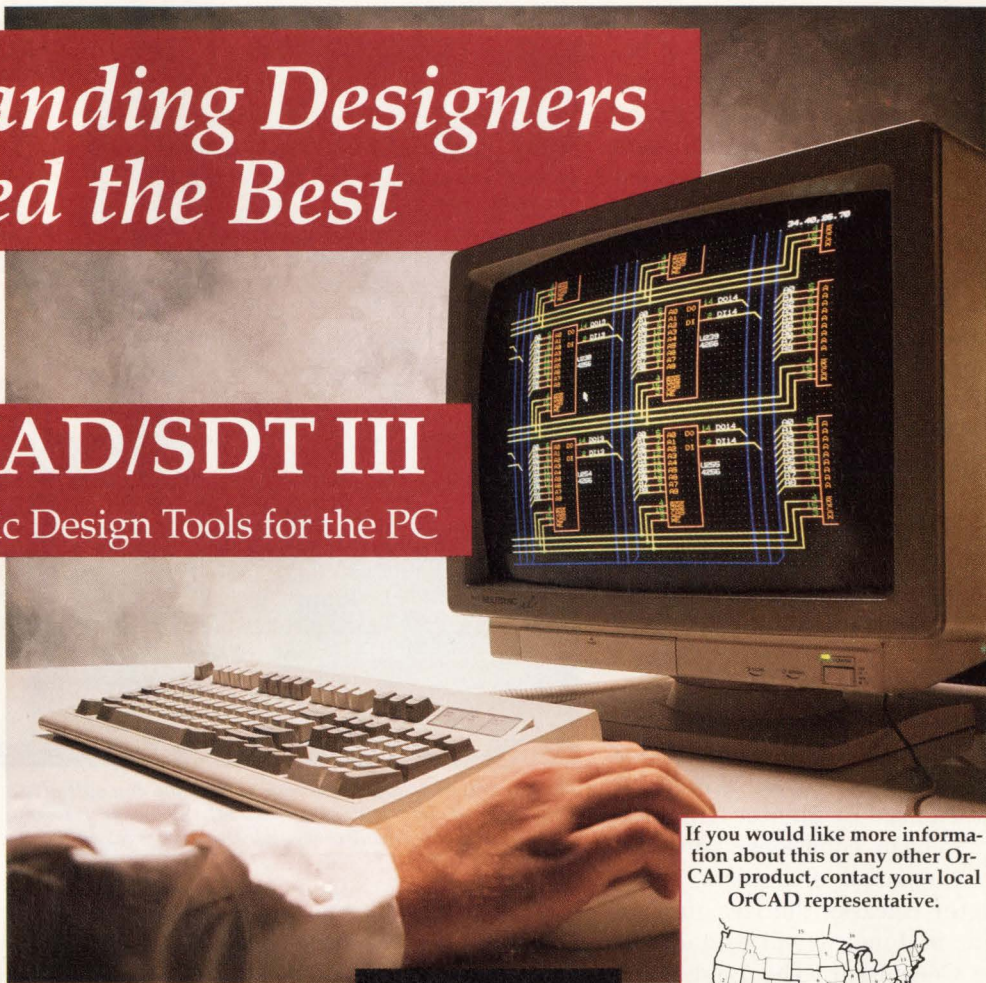

Ease-of-use + Power = Productivity

In today's tough design environment, good engineering tools aren't good enough. You need the best to get the job done.

OrCAD/SDT III offers the power

SDT III comes with the options you'd expect to pay extra for.

- **Completeness:** A library of over 6100 unique parts that you can browse through in a breeze. Utilities to generate Bill of Materials, Electrical rules check, create custom library parts
- **Compatibility:** Over thirty netlist formats, over 50 supported display adapters, over 50 printer drivers, a dozen plotter drivers. We conform to your system better than anyone.

- **Complexity:** 4000+ sheet design capacity for single designs. 200 levels of hierarchy. Great support for small, simple designs to large, complex hierarchical systems.
- **Control:** SDT III gives you the ability to customize your work environment to make you more productive. This includes user definable macros, text/object sizes, sheet sizes, graphical object editor, even the colors on the screen.

OrCAD/SDT III makes it easy

The lightning fast operation saves time. The intuitive, pop-up menu displays your most likely next action. This means a short learning curve and immediate productivity.

Only \$
495

Get our No-risk, Demo Disk

Try before you buy. Get our free demonstration disk and see for yourself the solid performance SDT III has to offer.

Once you've given our demo disk a spin, you'll know one of the reasons why OrCAD is the world's leading supplier of PC based CAE tools.

All OrCAD products come complete with one full year of technical telephone support, free product updates and access to our 24 hour BBS.

OrCAD 
Systems Corporation

1049 S.W. Baseline Street Suite 500
Hillsboro, Oregon 97123
(503) 640-9488

If you would like more information about this or any other OrCAD product, contact your local OrCAD representative.



- | | |
|---|--|
| 1. WA, OR, MT, ID, AK
Seltech, Inc.
(206) 746-7970 | 9. IN, OH, KY, WV, W. PA
Frank J. Campisano
(513) 574-7111 |
| 2. N. CA, Reno NV
Elcor Associates Inc.
(408) 980-8868 | 10. VA, TN, NC, SC
Tingen Technical Sales
(919) 870-6670 |
| 3. So. CA
A D G
(714) 897-0319 | 11. FL
High Tech Support
(813) 920-7564 |
| 4. Las Vegas, UT, AZ, NM, CO
Tusar Corporation
(602) 998-3688 | 12. MS, AL, GA
Electro-Cadd
(404) 446-7523 |
| 5. ND, SD, MN, W. WI
Comstrand, Inc.
(612)788-9234 | 13. DE, MD, DC, E. PA.
Beta Lambda, Inc.
(201) 446-1100 |
| 6. NE, KS, IA, MO
Walker Engineering
(913)888-0089 | 14. CT, RI, MA, VT, NH, ME
DGA Associates
(617) 935-3001 |
| 7. TX, OK, AR, LA
Abcor, Inc.
(713)486-9251 | 15. BC, AB, SK, MB
Interworld Electronics, Ltd.
(604) 984-4171 |
| 8. MI, E. WI, IL
MacKellar Associates
(313) 335-4440 | 16. ON, PQ & Maritimes
Electralert, LTD.
(416) 475-6730 |

Call or write today for our FREE DEMO DISK

CIRCLE NO 132

TECHNOLOGY UPDATE

Logic synthesis

tional real estate—a savings of between one-half and two-thirds that of full scan-path designs. After implementing the logic, the software creates Mentor's logfile-format test patterns.

NCR Microelectronics has integrated SilcSyn into their KE² (Knowledge-based Engineering Environment) package. The company expects to offer both VHDL support and the test synthesis feature in the second half of this year. If NCR is your ASIC supplier, its Design Synthesis package maps your circuit description directly to NCR library elements. Silc Technologies has additional cell libraries from Toshiba, LSI Logic, Fujitsu, and Standard Microsystems, and has a proprietary library from GTE.

You can drive the Logic Consultant from Trimeter Technologies (which has reached an agreement to be acquired by Mentor Graphics) with Boolean equations, truth tables, schematics, or netlists. When Trimeter releases the Design Consultant in June, it will contain the Logic Consultant. The Logic Consultant will have the capability to utilize and generate VHDL descriptions as well as Verilog HDL descriptions. The software lets you exchange netlists and schematics with either Daisy or Mentor workstations or with other CAE toolsets utilizing EDIF. Another enhancement to the Design Consultant will be a graphic state-machine-diagram editor that lets you draw a state machine to use as the input to the logic-synthesis software.

Seattle Silicon and Silicon Compiler Systems have leveraged their experience in silicon compilers to present an approach that could ultimately fulfill the original promise of silicon compilation. That promise was to enable you to plug a high-level circuit specification into a black box and receive a fully fabricated, tested, and ready-to-use piece of silicon.

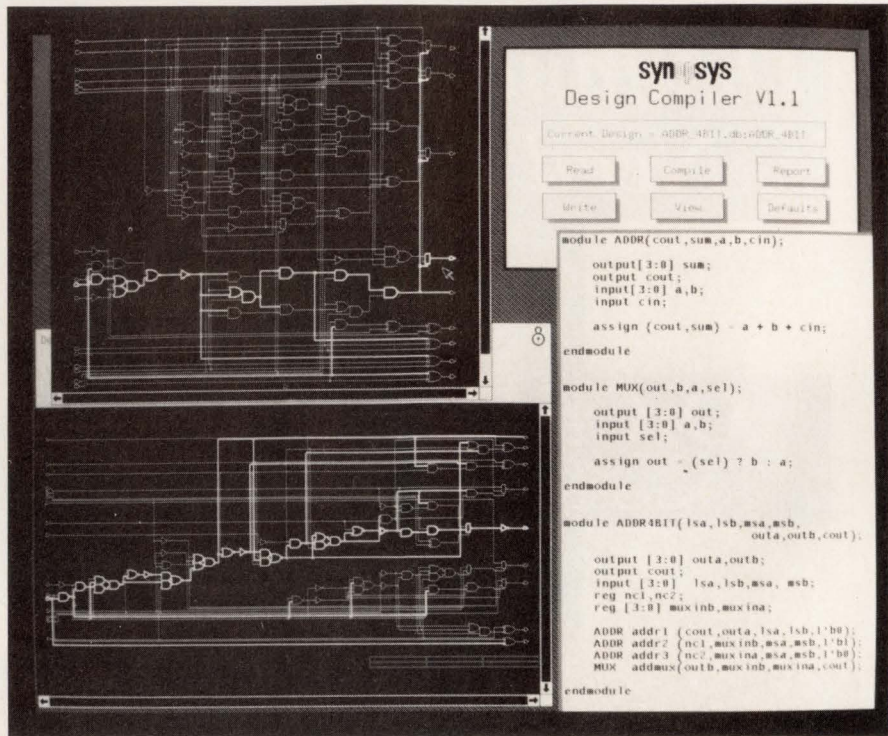

The advantage to logic synthesis is that you can optimize a design for either high performance (top) or area efficiency (bottom). Synopsys' Design Compiler highlights the critical path, so you can visualize possible problem areas in the circuit.

Neither Seattle Silicon's Finesse nor Silicon Compiler Systems' Logic Compiler currently support VHDL. However, both companies are committed to supporting the language and are developing enhancements that will bring VHDL capabilities to their tools. Finesse offers the ability to incorporate scan as a test strategy at the description level—currently you can use Boolean equations, truth tables, and state-machine descriptions to drive both Finesse and the Logic Compiler. The ability of these silicon compilers to size drive transistors automatically according to loading is a feature that provides more flexibility, better matching between circuit stages, and more efficient real-estate utilization than the typical standard-cell or gate-array alternatives.

Other vendors target their logic-synthesis tools to work with both PLDs and ASICs. Synopsys' Design Compiler and HDL Compiler

accept descriptions in many formats. In addition to Boolean equations and truth tables, you can use netlists in EDIF, LSI Logic's NDL, Mentor's MIF, Tegas format, or Cadence format as well as EDIF schematics or Verilog HDL to drive the Synopsys tools. The only HDL Synopsys currently supports is Verilog, but the company is committed to VHDL and plans to include VHDL support in a future release.

VLSI Technology's Logic Synthesizer accepts input from Boolean equations and a state-machine high-level language. VLSI Technology is working to enable you to use truth tables, state diagrams, and PLA code files to drive its synthesis tools. The next release of the Logic Synthesizer will support the Ella HDL; the company's goal is to offer VHDL-input support in the synthesizer's third-quarter 1989 release. VLSI is planning VHDL output support, although it is unsure when that support will be available. The

New Precision Pulse Generator



Four Channels, 5 ps Resolution, and GPIB Interface... Price: \$3350

TIMING IS EVERYTHING

Your critical timing problems are over. No more worries about drift, jitter, or control. The DG535 Precision Pulse Generator has four delay channels (two pulse outputs), each with a 1000 second range and 5 ps resolution. The four independent delays specify two variable-width pulse outputs. With only 50 ps jitter and accuracy down to 1 ppm (option O3), the instrument can handle the most demanding applications. The internal trigger may be programmed from 0.001 Hz to 1.000 MHz, or operated in single-shot or burst modes. Output levels are continuously adjustable or may be set to TTL, NIM, or ECL levels. High impedance or 50 Ohm loads can be driven with a slew rate of 1 V/ns. Optional rear panel outputs generate pulses to 35 volts.

EASY TO USE

The delay and output levels for each channel may be entered numerically or modified by cursor keys on the backlit LCD display. Delays may be linked together so that as one moves, the other follows. Up to nine instrument settings may be stored in nonvolatile RAM for later recall, and, of course, all of the instrument's functions may be controlled via the GPIB interface.

A GENERATION AHEAD

The DG535's precision, accuracy, range, and versatility make it the solution to all your timing needs, at a price that will meet your budget. Call us today for more information.

FEATURES AND PERFORMANCE

- Four Delay Outputs
- Two Variable-Width Outputs
- Times from 0 to 1000 sec.
- 5 ps Resolution
- 50 ps rms Jitter
- 1 ppm Accuracy (Option O3)
- Internal or External Timebase
- Internal, External, Single-Shot, or Burst Mode Triggers
- Frequency Synthesized Rate Generator
- Variable, TTL, NIM, and ECL Outputs
- Optional ± 35 Volt Outputs
- GPIB Computer Interface

FRANCE

Optilas
c.e. 1422
91019 Evry Cedex
607740.63, TLX 600019

GERMANY

Spectroscopy Instruments
Carl Benz Strasse 11
D-8031 Garching
0 8105/5011, TLX 523862

Tokyo Instruments
Koizumi Building
6-8-10 Nishikasai
Edogawa-ku, Tokyo 134
03 (686) 4711, TLX 6860831

JAPAN

Seki and Company
1-2-6, Nihonbashi Ningyocho
Chuo-ku, Tokyo 103
03 (669) 4121, TLX J24419

UNITED KINGDOM

Lambda Photometrics
Lambda House, Barford Mill
Harpenden, Herts AL5 5BZ
05827/64334, TLX 825889

Speirs Robertson
Moliver House,
Oakley Road
Bromham, Bedford
02302/3410, TLX 825633

Stanford Research Systems

1290 D Reamwood Avenue, Sunnyvale, CA 94089

FAX 4087449049, TEL (408) 744-9040

TECHNOLOGY UPDATE

Logic synthesis

Logic Synthesizer is part of VLSI's multichip ASIC system-design package, which helps you partition your circuit according to size, power, and packaging requirements.

The Ascyn logic synthesizer, from Algorithmic Systems, has VHDL compatibility in development. The program supports Xilinx LCAs, gate arrays, and standard cells. Ascyn and Gates are the only two packages targeted for ASICs that run on the IBM PC/AT and compatibles, and Ascyn is the only package that runs on Apple's Macintosh family of personal computers.

Ikos Systems uses a simple logic-synthesis capability in its hardware-based Simulation System. Typically, if you find an error while you are simulating, you must exit the simulator, correct the circuit, recompile, re-enter the simulator, and resimulate. Because you must repeat this procedure every time you find a design error, simulation

is often the bottleneck in design. With the Simulation System, you can enter Boolean equations, or netlist corrections interactively within the simulator shell. The Simulation System can perform local optimization; but, because it is strictly a simulator, it does not back annotate your logic changes to the original netlist. The simulator creates a file that documents your changes so you can update your netlist or schematic after you've finished simulating.

There is little question that logic synthesis is a powerful addition to the repertoire of system-design engineers. It can save you from entering schematics or netlists on a gate-by-gate basis. Many tools let you design using techniques that you're familiar with, like Boolean equations, truth tables, and state diagrams. Although you may not be comfortable working at the behavioral level, that's where the technology seems to be ultimately headed. Logic-synthesis tools are leading the way.

Standing in the way, however, are all the classic arguments against CAE tools: the lack of compatibility among hardware, software, and user interface. The cavalry, VHDL, is about to ride over the hill. **EDN**

References

1. Gajski, Daniel D, and Robert H Kuhn, "Guest Editors' Introduction: New VLSI Tools," *IEEE Computer*, December 1983, pgs 11-14.
2. Leibson, Steven H, "VHDL," *EDN*, March 16, 1989, pgs 110-124.
3. Trevillyan, Louise, "An Overview of Logic Synthesis Systems," Twenty-fourth Design Automation Conference, 1987, pgs 166-172.
4. Smith, David, "What is Logic Synthesis?" *VLSI Systems Design*, October 1988, pgs 18-26.
5. "An Introduction to Logic Synthesis," October 1988, Data I/O Corp.

Article Interest Quotient (Circle One)

High 518 Medium 519 Low 520

For more information . . .

For more information on the logic-synthesis products discussed in this article, contact the following manufacturers directly, circle the appropriate numbers on the Information Retrieval Service card, or use EDN's Express Request service.

Algorithmic Systems
399 Pond St
Number C5
Braintree, MA 02184
(617) 849-0580
Circle No 700

Altera Corp
3525 Monroe St
Box 58163
Santa Clara, CA 95052-8163
(408) 984-2800
Circle No 701

Exemplar Logic Inc
2550 Ninth St
Suite 102 Berkeley, CA 94710
(415) 849-0937
Circle No 702

FutureNet-Data I/O Corp
10525 Willows Rd NE
Box 97046
Redmond, WA 98073
(206) 881-6444
Circle No 703

Ikos Systems Inc
145 N Wolfe Rd
Sunnyvale, CA 94086
(408) 245-1900
Circle No 704

Mentor Graphics
8500 SW Creekside Pl
Beaverton, OR 97005
(503) 626-7000
Circle No 705

Minc Inc
1575 York Rd
Colorado Springs, CO 80918
(719) 590-1155
Circle No 706

NCR Corp Microelectronics Div
2001 Danfield Ct
Fort Collins, CO 80525
(303) 226-9530
Circle No 707

OrCAD Systems Corp
1049 SW Baseline St
Suite 500
Hillsboro, OR 97123
(503) 640-9488
Circle No 708

Seattle Silicon
3075 112th Ave NE
Bellevue, WA 98004
(206) 828-4422
Circle No 709

Silc Technologies Inc
34 3rd Ave
Burlington, MA 01803
(617) 273-1144
Circle No 710

Silicon Compiler Systems
2045 Hamilton Ave
San Jose, CA 95125-6199
(408) 371-2900
Circle No 711

Synopsys Inc
1500 Salado Dr
Mountain View, CA 94043
(415) 962-5000
Circle No 712

Trimeter Technologies Inc
200 Hightower Blvd
Suite 100
Pittsburgh, PA 15205
(412) 787-8630
Circle No 713

VLSI Technology Inc
1109 McKay Dr
San Jose, CA 95131
(408) 434-3000
Circle No 714

Xilinx Inc
2069 Hamilton Ave
San Jose, CA 95125
(408) 559-7778
Circle No 715

SMT Solutions

Technical Information On Surface Mountable Voltage Suppressors.



Figure 1 • Energy Dissipation for Zener Diodes and Transguards

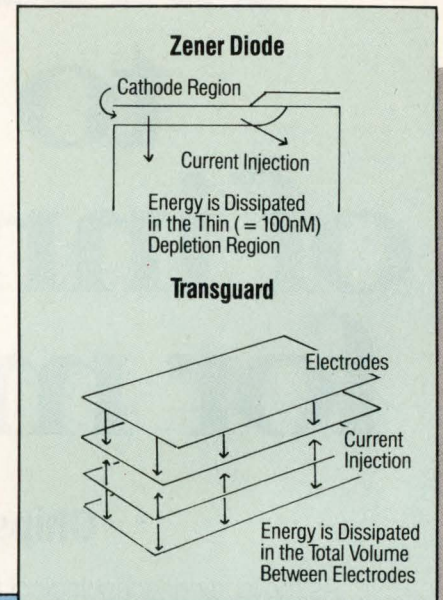

A Multilayer Approach to Transient Voltage Suppression

Electrical overstress, especially due to electrostatic discharge (ESD), has been a growing concern to designers and the trend toward surface mount technology (SMT) has placed severe size constraints on the components that provide this protection.

Low voltage transient suppressor applications have been dominated by specially designed zener diodes because of their clamping characteristics and smaller size. However, continuing advances in ceramic technology have made the AVX TransGuard possible—a high performance, low voltage surface mountable varistor that, unlike single plane devices, uses a multilayer structure. This structure offers significant improvement in electrical performance as well as in size and usability in SMT assemblies. (Table I)

Clamping Characteristics

Multilayer construction and improved grain structure of TransGuards result in excellent transient clamping characteristics (in excess of 150 amps peak current) while maintaining very low leakage currents under DC operating conditions.

Suppressor Type	5.6V DC		14V DC	
	TransGuard	Zener	TransGuard	Zener
Dimensions	L x W .126" x .063"	.250" x .140"	.126" x .063"	.250" x .140"
Clamping Voltage	V_C	15.5V	30V	25.8V
8 x 20 μ S, 10 Amp Peak				
10 x 1000 μ S, 62.5 Amp Peak		9.6V		
10 x 1000 μ S, 23.3 Amp Peak				
Peak Current @ 85°C	I_{PEAK}	150A	200A	150A
8 x 20 μ S Pulse			150A	90A
Transient Energy	E_{TRAN}	.4J	.5J	.4J
10 x 1000 μ S Pulse			.4J	.5J

Table I. Comparison of Surface Mount Transient Suppressors

Energy Dissipation

Varistors or semiconducting ceramics are in reality series/parallel combinations of Schottky diodes that support most energy dissipation in thin depletion regions at each Schottky barrier. Zener diodes have only a single thin depletion region at the surface, while varistors have many in series/parallel combination distributed throughout the whole ceramic volume (as seen in Figure 1). This results in superior energy dissipation per unit volume.



— Please send me the AVX Technical paper "A Multilayer Approach to Transient Voltage Suppressors."

— Please send me more information describing AVX MLC's.

Name _____
 Title _____
 Company _____
 Address _____
 City _____
 State _____ Zip _____
 Phone _____

AVX Corporation, P.O. Box 867
 Myrtle Beach, SC 29577
 Tel: (803) 448-9411, FAX: (803) 448-1373

There's no end to our line of innovative ICs for mass storage.

Chips For Every Disk Drive Function

As the leading technological partner with disk drive designers since the beginning—Silicon Systems offers the industry the most extensive line of innovative IC solutions for disk drive electronics. Whether it's standard or custom ICs—you can rely on Silicon Systems to help enhance the performance of your new disk drive products while reducing board space, power dissipation, and cost.

Our cornucopia of standard product ICs includes the industry's most highly integrated and comprehensive families of read/write, pulse detection, data separation, head positioning, motor speed control, and controller devices. These families of standard chips offer a powerful mix-and-match approach and include a variety of companion chip-set solutions. Our chip sets significantly reduce interconnect, external passives, and design time.

If your design requires a custom solution, then Silicon Systems supports you with a full

range of custom and semicustom capabilities and a spectrum of Bipolar and CMOS process technologies. We can put the art of mixed signal analog and digital to work for you. And, whether you require a totally unique custom chip or use existing standard product blocks, we can build the right device for you.

Call Now!
(714) 731-7110, Ext. 3575

For more information on our Disk Drive IC Product Families or our custom capabilities, contact Silicon Systems, your local representative, or local distributor today.

Silicon Systems, Inc.,
14351 Myford Road, Tustin, CA 92680.
Phone: (714) 731-7110, Ext. 3575.
European Hdq. U.K. Ph: (44) 7983-2331.

silicon systems[®]

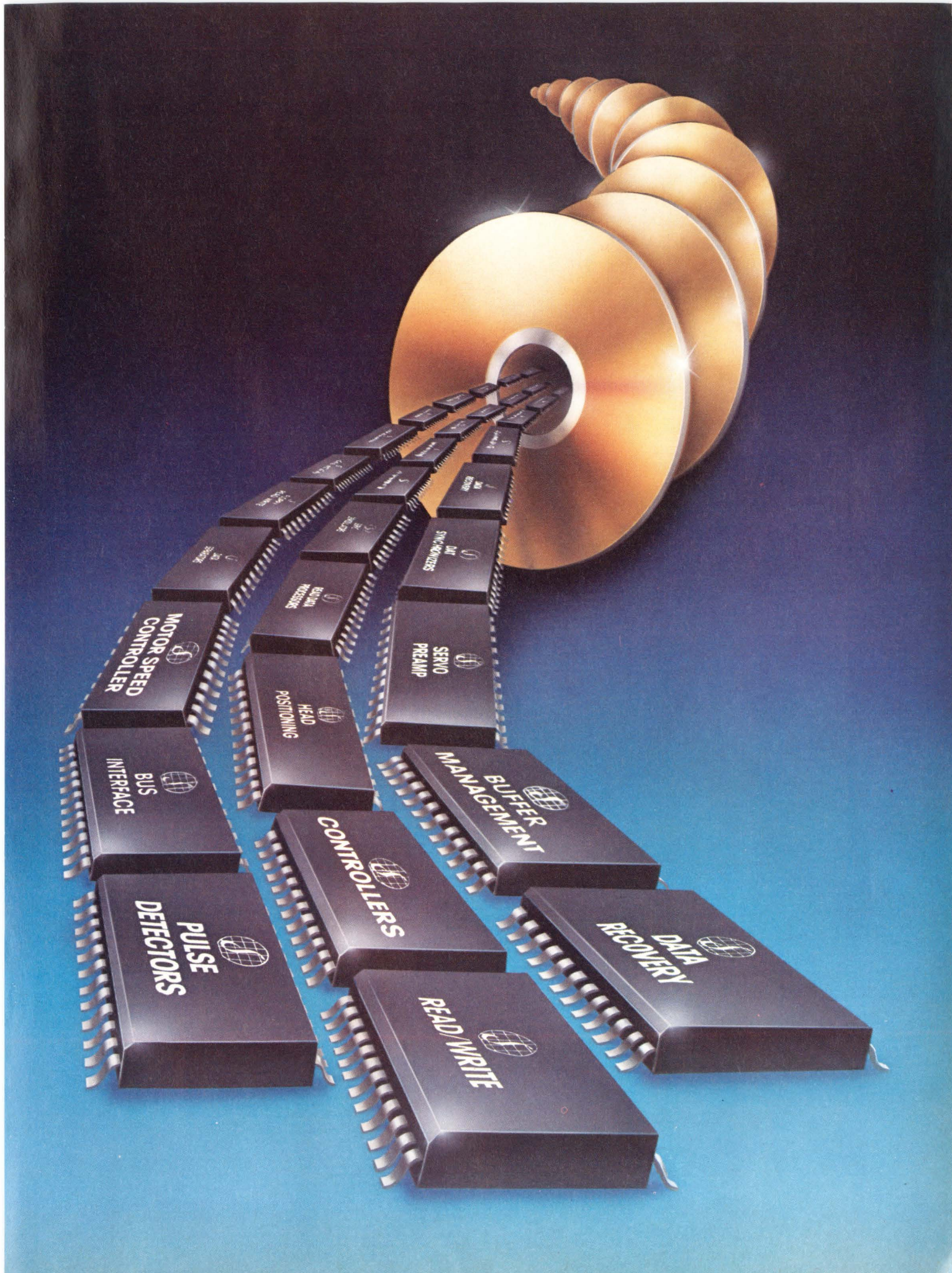

**MOTOR SPEED
CONTROLLER**

**BUS
INTERFACE**

**PULSE
DETECTORS**

**HEAD
POSITIONING**

CONTROLLERS

READ/WRITE

**SERVO
PREAMP**

**BUFFER
MANAGEMENT**

**DATA
RECOVERY**

**DATA
SYNCHRONIZERS**

Fujitsu's new RISC chip-computer development.

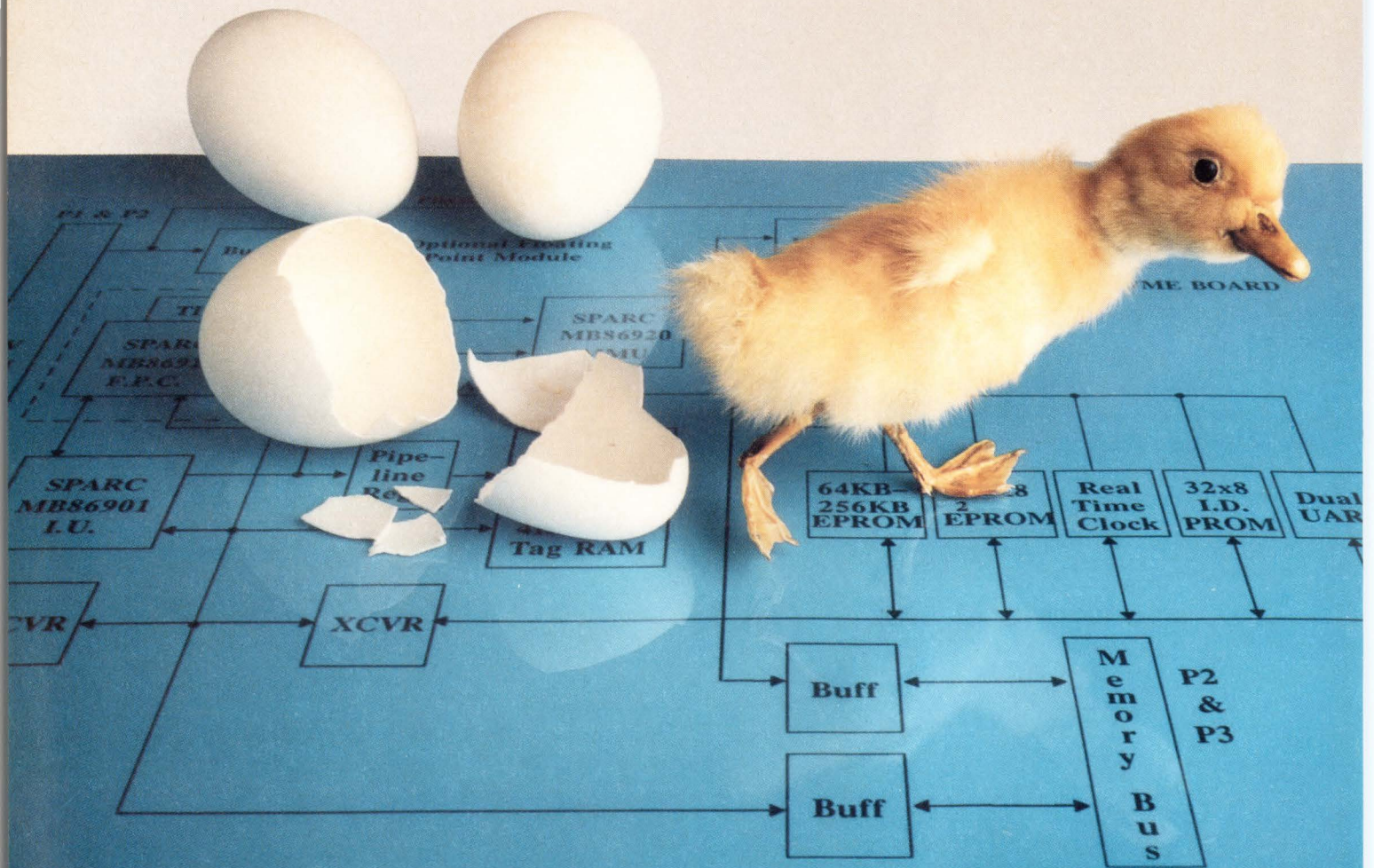

set speeds up your

Break out!

Get your computer to market before your competitors.

When you need to be first, nothing helps more than getting a head start. And nothing will get you started faster than these new SPARC™ devices from Fujitsu.

Not just a speedy microprocessor—but a complete high performance RISC chip-set. One that accelerates the development cycle of powerful minis, PCs and workstations. And eliminates many components plus the time it takes to integrate them. Yet, offers a high degree of design flexibility.

A complete chip-set to speed up your product development.

Fujitsu's new S-25™ chip-set includes a 25 MHz, 32-bit Integer Unit (IU) for high-speed processing. A Memory Management Unit (MMU) ideal for the UNIX® environment and tailored for SPARC processors. And a Floating Point Controller (FPC) that allows interface to the IU and supports IEEE single and double precision arithmetic.

In addition, these devices are fully supported by a

wide range of hardware and software development tools.

A proven architecture from a proven supplier.

SPARC is multi-sourced and proven over time. We first implemented it for the Sun 4/200 workstation over two years ago and have been producing it in volume ever since. Using the same Fujitsu manufacturing know-how that has made us a world leader in gate array and memory production.

The S-25 chip-set is a third-generation product designed at our Advanced Products Division in Silicon Valley. Where our engineering teams continue to advance the state-of-the-RISC-art—supported by the resources of a multi-billion dollar worldwide organization.



MB86901 (IU)

- 25 MHz
- 40 ns / cycle
- 15 MIPS

MB86911 (FPC)

- Single & double precision floating point arith.
- ANSI / IEEE 754-1985 std.
- 64-bit int. data paths

MB86920 (MMU)

- 64-entry TLB
- Fully associative
- 64-Gbyte physical address

Break outs—without breakdowns!

Enjoy the competitive advantage of getting to market first! Rely on an architecture and supplier who can get you there. On time. On spec. On budget.

When you want to be first, we're the first ones to call.

(800) 523-0034

FUJITSU

FUJITSU MICROELECTRONICS, INC.

Advanced Products Division

50 Rio Robles, Bldg. 3, San Jose, CA 95134-1804

MICE®

FORETELLS YOUR DEVELOPMENT NEEDS...



MICROTEK offers a complete line of MICE (Micro-In-Circuit-Emulator) for most popular 8, 16 and 32-bit microprocessors. These series of MICE are capable of debugging high speed targets without accumulating wait state, e.g. 25 MHz for 68020, 16 MHz for 68000/80C186. Protected Mode in 80386, coprocessor emulation in 16/32 bit series and bus/execution breakpoints in all series, are few examples of MICE powerful emulation features designed to meet advanced development needs.

All MICE series could work well with IBM PC/XT/AT*, IBM PS/2*, VAX*, μ VAX*, Apollo*, Sun* and NEC* 98 series. Cross assembler/compiler, symbolic debugger and high level language debugger are also available to offer optimized software tool supports to an advanced development environment.

MICE SERIES AVAILABLE MODELS

μ C	8048 Family, 8052 Family, Z8, Z8S, 68HC11, 80515, 535, V25
8-BIT	8085, 6809E, Z80, NSC800, 6502F, 64180
16-BIT	80C86/88, 80C186/188, 80286, 68000/010, 68008, V20/30
32-BIT	80386, 68020 (25 MHz)

MICROTEK

MICROTEK INTERNATIONAL INC.

HEADQUARTERS

Tel: 886-35-772155 Fax: 886-35-772598
Telex: 32169 MICROTEK

U.S.A. OFFICE

Tel: (213)321-2121 Fax: (213)538-1193
Telex: 797880 MICR0

EUROPE OFFICE

Tel: 49(211)556181 Fax: 49-211-572362
Telex: 8584020

See us at Electro '89, New York.
Booth No. #475.

• AUSTRIA ALLMOS ELECTRONIC (222)6271954 • BELGIUM SIMAC ELECTRONICS B.V. (2)2523690 • DENMARK SC METRIC A/S (2)804200 • ENGLAND ARS MICROSYSTEMS (276)685005 • FINLAND OY COMDAX AB (0)670277 • FRANCE M.T.E. (1)39618228 • ITALY PRATICA SRL (11)503427 • NETHERLANDS SIMAC ELECTRONICS B.V. (40)582911 • NORWAY MORGENSTIERNE & CO A/S (2)358110 • SPAIN NOVATRONIC, S.A. (4)4520811 • SWEDEN NORDISK ARRAYTEKNIK AB (8)7349935 • SWITZERLAND TRACO ELECTRONIC AG (1)2010711 • W. GERMANY ALLMOS ELECTRONIC (89)8570000 • AUSTRALIA MACRO DYNAMICS (3)7202399 • HONG KONG IDEALAND ELEC. (3)7443516 • INDONESIA PT. ASCII (21)6002305 • ISRAEL ARITMOR (3)5447475 • JAPAN CORE DIGITAL CORP. (3)7955171 • KOREA DAESANG INC. (2)7196438 • NEW ZEALAND NORTHROP INSTRUMENTS (4)856658 • PAKISTAN EAST WEST SYSTEMS (21)529827 • SINGAPORE EPE COMPUTRONICS 7468182 • THAILAND ANA-DIGIT COMPANY (2)2217040 • THAILAND SANYA PHANICH (2)225223 • U.S.A. MicroCASE INC. (503)6901252 • ARGENTINA MICROTEC INGENIERIA S.R.L. (1)469518 • BRAZIL DIGIBYTE SISTEMAS DIGITAIS (11)2413611 • CHILE EQUIPOS INDUSTRIALES S.A.C.I. (2)716882 • SOUTH AFRICA PROTEA TEST & MEASUREMENT (011)7883710

* Registered Trademarks: PC/XT/AT, PS/2: International Business Machines; VAX, μ VAX: Digital Equipment Corporation; Apollo: Apollo Computer Inc; Sun: Sun Microsystems, Inc; NEC: NEC Corporation.

RISC boards target real-time applications



A RISC board can turbocharge your real-time system design, but it may also drain your budget.

*Maury Wright,
Regional Editor*

Several manufacturers of CPU boards for real-time applications now offer powerful models based on RISC (reduced-instruction-set computer) μ Ps. You'll have to make the usual price/performance judgment before choosing a RISC-based board for a real-time application. But you also need to consider the relative performance merits of RISC technology and the effect that a RISC architecture will have on your software-development tasks and the auxiliary hardware that surrounds the CPU. Furthermore, all of the available RISC processors are relatively new and expensive, and you currently have few choices of real-time operating systems and software-development tools for these processors.

The RISC boards available for real-time applications are primarily based on the VME Bus. RISC-board manufacturers claim that their products offer a way to build more-powerful real-time systems than you can build with CISC (complex-instruction-set computer) boards. For one thing, the board vendors suggest that you can use a single-processor RISC board in a real-time application that might previously have required a tightly coupled multiprocessor design. Furthermore, the manufacturers assert that the real-time

RISC offerings can also be used in multiprocessor configurations.

And finally, the board manufacturers spec their RISC boards' performance at 12 MIPS and higher, comparing that figure with CISC boards' performance of around 1 to 12 MIPS. Such a comparison isn't as straightforward as it may look, however: To implement a given task, you don't need to write as many instructions for a CISC as you do for a RISC.

Architectures seek an AIT of 1

RISC proponents, in general, claim that the technology offers a greater potential for performance than can be achieved with CISC architectures. RISC processors employ a relatively simple instruction set implemented without microcode. On average, available RISC processors can execute one

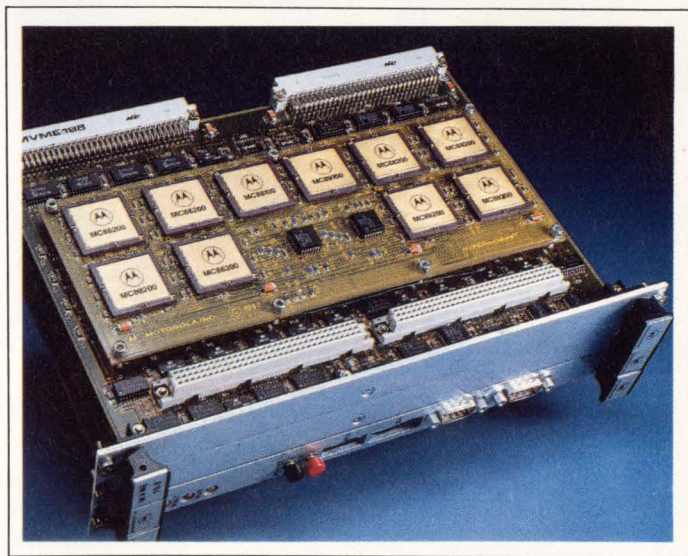

The 3-board VME Bus module from Motorola, Model MVME188, hosts eight 88200 cache/MMU ICs and as many as four 25-MHz 88100 processors. One board hosts the 88000-family chips, one is the system controller, and one carries 16M bytes of RAM.

*You can't afford to buy cheap!
But inexpensive is
another story.*

Introducing the new Bud Economizer™

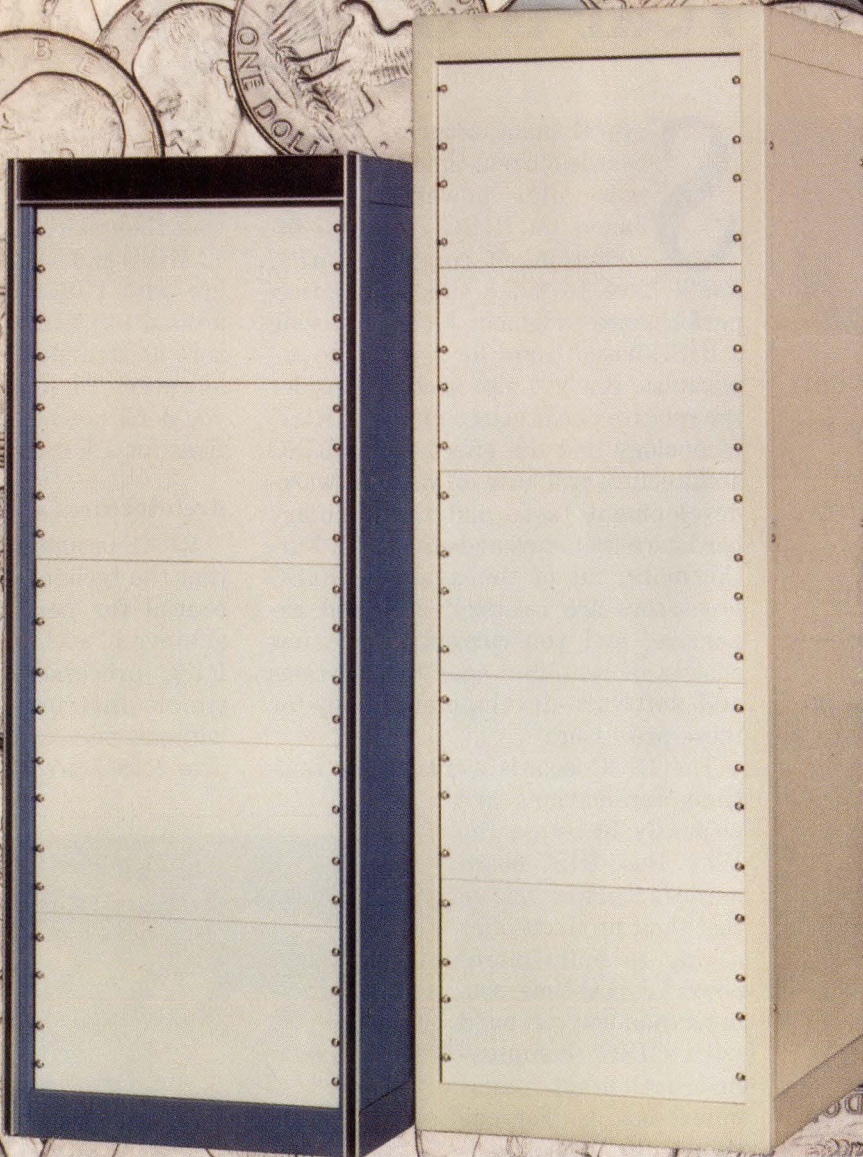

Check these features, then count your savings when you buy the new Economizer.™

- The stiffest welded frame in the Bud line at an incredible low price.
- Removable sides for easy access.
- Fully adjustable, top of the line mounting rails for fast accessory installation.
- 19" equipment can also be mounted from rear.
- Optional Trim Kit as shown above on blue unit.
- Accepts the complete line of Bud standard accessory items.
- Stocked in all 5 heights and 3 depths.
- Available today from your local Bud Authorized Distributor.

BUD

Bud Industries, Inc.

BUD EAST, INC.
4605 East 355th Street
P.O. Box 431
Willoughby, Ohio 44094
(216) 946-3200
FAX 216-951-4015

BUD WEST, INC.
7733 West Olive Avenue
P.O. Box 1029
Peoria, Arizona 85345-0350
(602) 979-0300
FAX 602-878-5371

CIRCLE NO 101

TECHNOLOGY UPDATE

RISC boards for real time

instruction per clock cycle—an AIT (average instruction time) of 1. System-dependent latencies, however, typically make it impossible to realize an AIT of 1 in a system. (For more information on RISC technology, see **Ref 1**).

When they compare RISC and CISC processors implemented at the same clock speed and in the same silicon technology, CISC advocates concede that CISC processors can't match the AIT performance of RISCs. But CISC proponents argue that a RISC processor must execute more instructions than a CISC processor must to accomplish the same task. The RISC side counters that compilers primarily use simple instructions and therefore closely match RISC-processor instruction sets.

In fact, a comparison of RISC and CISC performance is significant only in relation to a specific application. Despite all the industry chatter about RISC technology, it's not automatically your best choice. The right choice for your application will be based on your analysis of the available hardware and software products for both technologies, and not on marketing hype.

The RISC-vs-CISC debate will probably continue into the next decade. But one fact stands clear: The available RISC chips and boards are members of today's highest-performance class of 32-bit μ Ps and μ P-based boards (some CISC chips and boards are also members of that class). The available RISC boards are also members of the highest-cost class—their prices range from \$7000 to more than \$35,000.

RISC requires fast memory

To use a RISC μ P or board for a real-time application and to exploit the performance potential that RISC technology offers, you must accept and work with two characteristics of RISC technology. First,

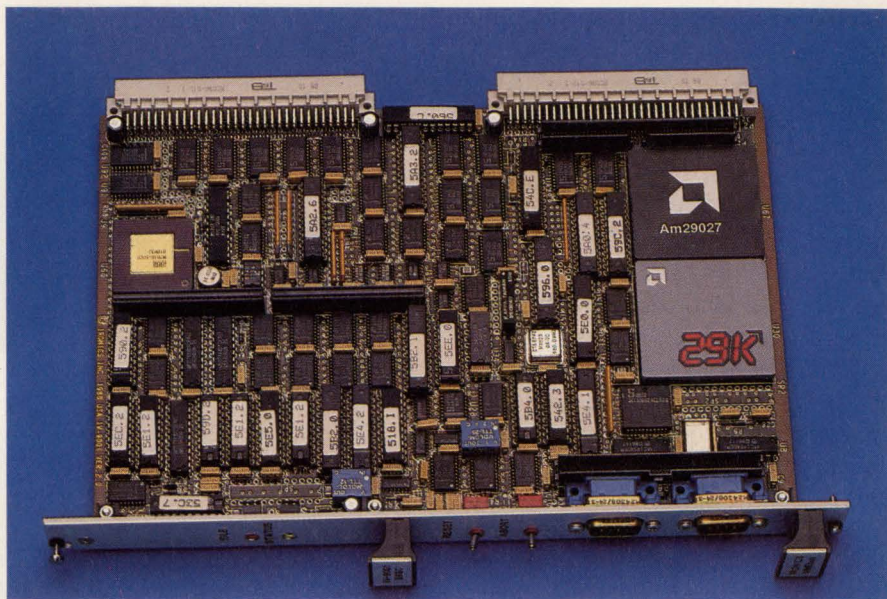

Burst-mode memory-read operations allow the 29000-based Ironics IV-9001 board to operate at 17 MIPS with a cost-effective dynamic-RAM array.

to develop software for RISC processors, you must employ high-level languages. Second, RISC processors require fast access to fairly large memory arrays.

The requirement to program in a high-level language derives from the nature of RISC architectures. Because of the instruction set and large register file, it's not feasible for you to write your own assembly-language code (as you could for CISC processors), even for small routines for which execution speed is critical.

Furthermore, RISC architectures enhance performance by implementing such features as delayed branch execution. By delaying the execution of branch instructions, a processor can avoid waiting for the next instruction to be loaded into the execution pipeline. Compilers take advantage of such architectural features by changing the sequence in which instructions execute.

Using a high-level language isn't always a drawback, as you might be tempted to think. Languages such as C and Ada have become in-

creasingly popular for any (RISC or CISC) 32-bit real-time application. High-level languages simplify the software-development task and make it easier to manage the large amounts of code generated in 32-bit real-time applications.

Optimizers complicate debugging

High-level languages do complicate the debugging process, however. Today's RISC and CISC compilers can optionally generate code that's optimized for run-time efficiency. In optimizing the code, the compilers often shuffle the machine-code instructions, changing their sequence. Optimization is necessary to make any code run efficiently, whether on a RISC or a CISC processor, but it's more important for RISCs, because only optimized code will take full advantage of the unique architectural features of RISCs, such as delayed branch execution.

The source-code-level debugging packages available from most compiler vendors, however, operate only on unoptimized code. Therefore, you can't debug your code

TECHNOLOGY UPDATE

RISC boards for real time

when it's running at full speed (optimized) at the source-code level.

Unix-type programmers (programmers who create software for non-real-time applications) probably don't need to debug software after optimization. But in real-time applications, the code interacts directly with the real world via robots, instrumentation, motors, and other asynchronous I/O devices. If you used a source-level debugger on the unoptimized code, and then optimized the code, you might run into a problem. For example, a robot might perform actions in the wrong sequence because the compiler had shuffled the instructions. In such a situation, you may need to debug the actual optimized code.

You can debug optimized code for CISC processors at the assembly-language level. However, because of the architectural features of RISC processors (such as delayed branching and large register sets) and the level of optimization that RISC compilers perform, it's virtually impossible to debug assembly code for RISC processors. You simply can't correlate the assembly code with the source code. (For more information on RISC compilers, see **Ref 2**.)

Source tools should improve

It's a good bet that vendors of compilers and real-time operating systems will soon offer improved debugging tools. For now, however, if you must fix software glitches in real-time RISC applications, you may have to resort to the trial-and-error method.

Memory architecture holds the other key to exploiting the performance potential that RISC chips offer. The clock speeds of available RISC μ P's currently range from 20 to 25 MHz, but in the next couple of years you can expect to see RISC μ P's with clock rates approaching 50 MHz. To attain an AIT ap-

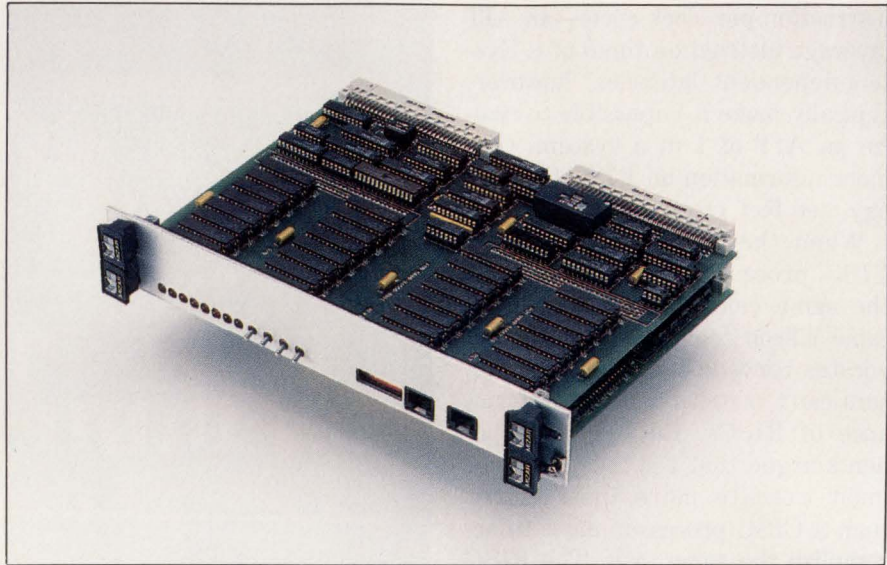

A 1M-byte static-RAM array provides the SPARC-based Mizar MZ7170 with the deterministic response capability required in strict real-time applications.

proaching 1, a RISC μ P needs to fetch a new instruction, and perhaps even new data, every clock cycle. Architectural features such as delayed branch execution serve no purpose unless the memory can supply instructions and data to the processor without latency.

A dynamic-RAM (DRAM) system can't accommodate a 20-MHz RISC μ P with the required memory-access speed (at 1 instruction per clock cycle, that speed would be 50 nsec). Even schemes—such as interleaved memory—that satisfy pipelined CISC architectures fall short of the every-cycle-access needs of RISC processors. Fast CISC μ P's also need faster access than DRAMs can provide, but memory latency has more of an impact on RISC performance than on CISC performance.

Cache latency varies

In general-purpose computer systems, designers implement static-RAM (SRAM) caches to provide the processors with fast memory access much of the time; the percentage of time is called the "hit rate." However, when cache misses (instances

when the required instruction or data is not present in the cache) occur, the processor suffers a latency period while a new line of data is added to the cache. The latency varies according to the μ P and cache architecture, but it typically ranges from 5 to 20 clock cycles.

Real-time systems require what's termed a "deterministic" response to asynchronous real-world events. Typically, a system responds to an event by generating an interrupt to a μ P. The processor then invokes a routine to service the interrupt. Part of the system designer's task is to ensure that the processor can respond to and service such an interrupt in a certain maximum amount of time: the worst-case response time. Historically, designers of real-time systems have avoided cache-based architectures because of the latency caused by cache misses. The latency would raise the worst-case response time significantly.

Before choosing a RISC architecture for a real-time application, you must consider the RISC board's memory-system design. The available RISC processors each include

ALUMINUM CITY.

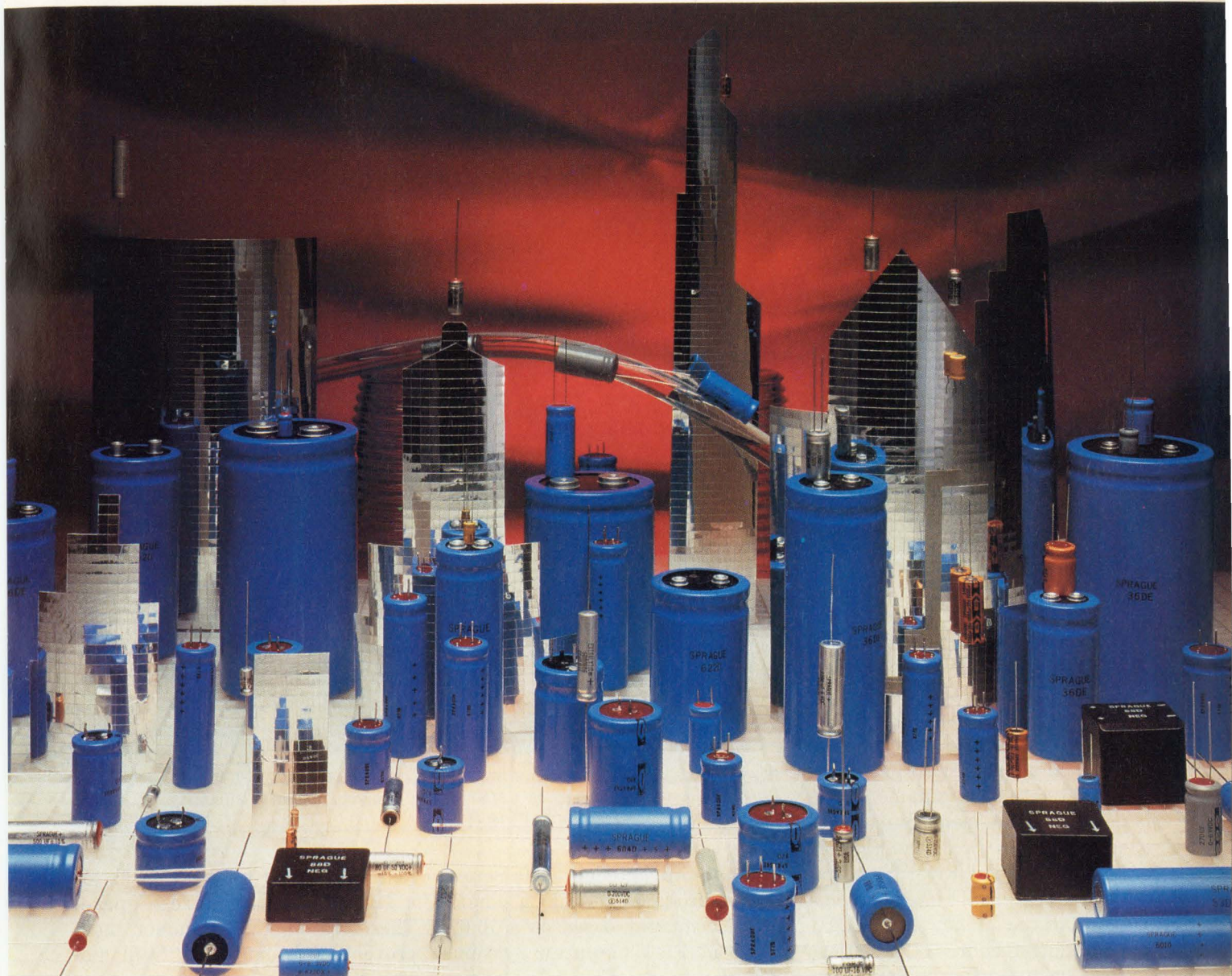

4SE-8101

SPRAGUE...A FULL LINE OF ALUMINUM CAPS FROM A U.S. SOURCE.

You can get any type of aluminum electrolytic capacitor that you need for *all* your applications from Sprague, the only U.S. based manufacturer of a complete line of high-performance aluminums. Whether it's axial-lead or single-ended miniature tubulars or large cans packed with capacitance, Sprague has the aluminum cap that'll meet your requirements. If you need radial or axial-lead miniatures for general purpose, power supply, special applications, or high-reliability military applications,

we've got the capacitor you need. We offer all types of large cans for high-voltage SMPS input applications and low-voltage SMPS output use. And the best news of all... we can deliver fast because our aluminum cap line is available from Sprague plants in Lansing, NC and Hillsville, VA. For technical information, write for our new "Quick Guide To Aluminum Electrolytic Capacitors", ASP-502E, to Technical Literature Service, Sprague Electric Company, P.O. Box 9102, Mansfield, MA 02048-9102.



CIRCLE NO 102

TECHNOLOGY UPDATE

RISC boards for real time

architectural features that may fit one memory scheme better than another. Each of the available boards uses a specific memory implementation, so when you buy a board, you're choosing a memory system. The board's memory architecture will play a large part in determining your system's worst-case response time.

Static RAM minimizes latency

For example, Mizar chose to employ static RAM for the entire RAM array on its SPARC-based MZ7170 board set. The 2-board VME Bus product includes 1M byte of static RAM and 4M bytes of EPROM. A 20-MHz version of the board costs \$6995, and a 25-MHz version adds \$500. You can also add a 20-MHz Texas Instruments 8847 FPU (floating-point unit) for \$995.

Mizar currently offers the Wind River Systems (Emeryville, CA) VxWorks real-time operating system and software-development tools for the MZ7170, and plans to have other real-time packages available late this summer. The MZ7170 has no memory-management unit (MMU). Jerry Fiddler, president of Wind River Systems, believes that real-time systems can't afford the latency that a MMU can add during address translation. In fact, when porting its operating system to a board that includes an MMU, Wind River bypasses the MMU.

Software bypasses MMU

Harvey Goldman, vice president of marketing at Integrated Solutions, agrees with the no-MMU, no-cache philosophy for real-time applications. According to Goldman, the company has ported its UniWorks real-time operating system to boards that have caches or MMUs, but has bypassed the cache or MMU features.

Integrated Solutions currently of-

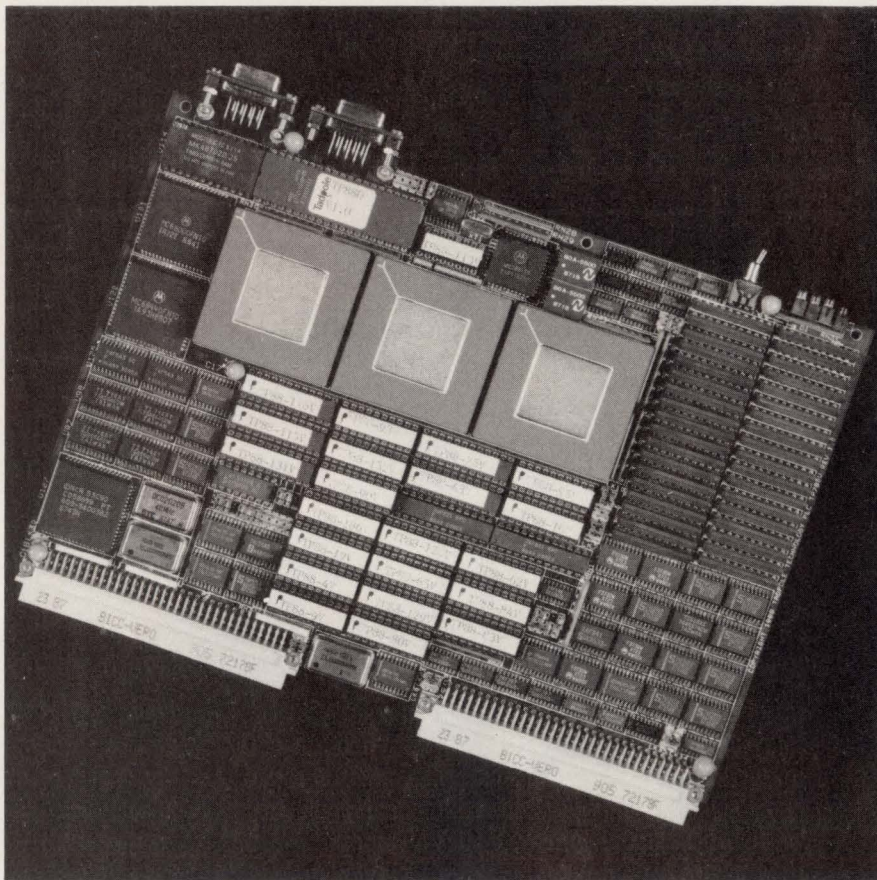

The VME Bus-based RISC board from Tadpole Technology, Model TP880V, includes an 88100 processor and two 88200 CMMUs. The company makes a similar product, the TP880M, that's based on the Multibus II.

fers the Advantedge 2000 Series. These products include a single-board computer based on a 16.67-MHz MIPS Computer Systems R2000 chip set. The board, which costs \$10,000, does not support a bus such as the VME Bus. It's truly suited for applications such as workstations. The company does plan to make the UniWorks real-time operating system available for the board during the first half of the year, however. You can also expect the firm to introduce a follow-up VME Bus-based product that's more suitable for real-time applications.

In general, real-time systems employ multitasking operating systems and application software. A CPU board that doesn't contain an MMU requires you to develop each

task of a set of software tasks for a single physical-address space. Therefore, the programmer must prevent different tasks from manipulating the same memory locations improperly. An MMU simplifies the programming tasks, but it may add latency in the form of address-translation time.

Burst mode speeds memory read

The Ironics IV-9001 board employs the AMD 29000 RISC processor, and the 29000 includes an on-chip MMU. The MMU performs translations in the instruction pipeline and eliminates latency concerns. Ironics also implemented a hybrid-cache-based memory architecture on the board. The 29000 μ P employs a Harvard architecture

CμBIT FOR V40 ON STD BUS.

V40 PROCESSOR RUNS AT 7.4 MHz
8088 CODE COMPATIBLE
ALL CMOS
64K BATTERY-BACKED RAM
128K EPROM
TWO RS-232/RS-485 LINES
THREE 8-BIT PARALLEL PORTS
BATTERY-BACKED CLOCK CALENDAR
SBX CONNECTOR
8-BIT, 8-CHANNEL A/D CONVERTER
DEBUG FIRMWARE LINKS TO PC

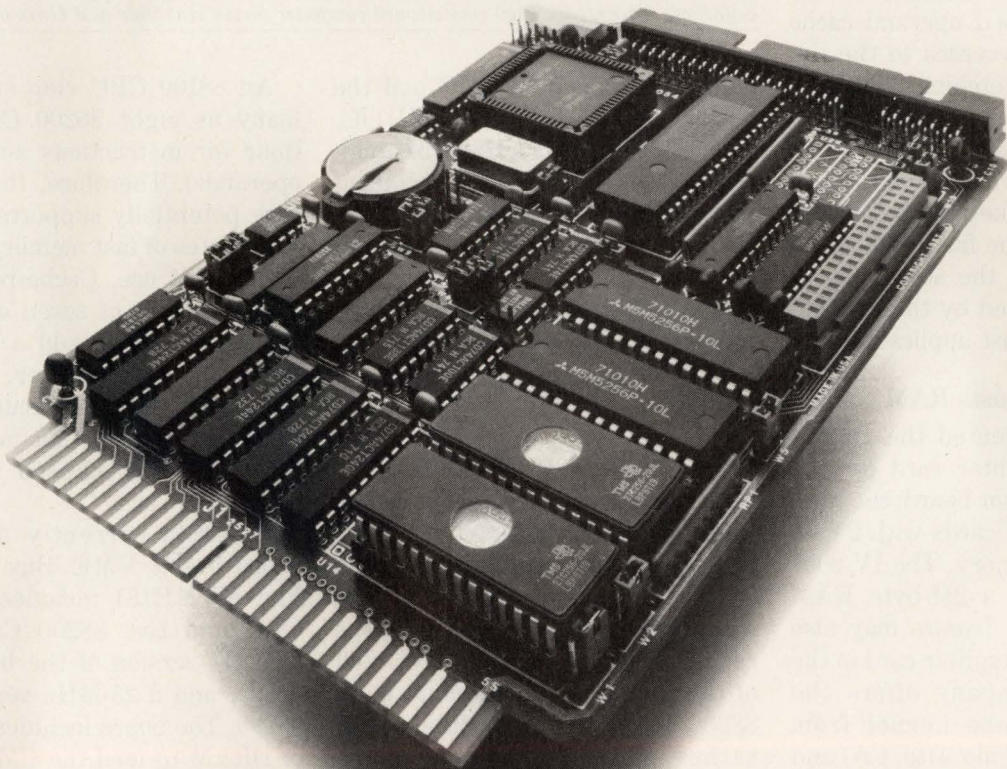

CμBIT DIVISION
OF
PROTEUS
INDUSTRIES

340 Pioneer Way
Mountain View, CA 94041-1577
Telephone: (415) 962-8237
FAX: (415) 965-9355

CIRCLE NO 103

TECHNOLOGY UPDATE

RISC boards for real time

with separate operand and instruction buses. The chip also includes circuitry to improve the performance of DRAM arrays. The μ P can fetch operands and instructions in burst mode without issuing an address for each word fetched.

On the IV-9001, Ironics employs the burst-mode fetch feature and an interleaved array of static-column DRAMs to feed both the instruction and the operand buses of the 29000, each at speeds as high as 100M bytes/sec. In fact, the DRAM array can supply instructions to the CPU at a rate of one instruction per cycle; memory latencies are caused only by memory-refresh operations and dual-port conflicts with operand accesses.

The board also includes a 16k-byte direct-mapped operand cache that minimizes accesses to the dynamic RAM for fetching operands. A cache miss to the operand cache causes a worst-case latency of seven cycles. Ed Schulman, Ironics' vice president of marketing, points out that because of the fast clock speed of the 29000 μ P, the actual worst-case latency caused by the cache is acceptable for most applications.

Daughter card hosts RAM

Ironics implemented the DRAM array on a daughter card for the VME Bus processor board; the company offers RAM cards with 2M to 16M bytes of memory. The IV-9001 costs \$7995, and a 2M-byte RAM card adds \$1995. Ironics may also offer an SRAM daughter card in the future. The company offers the VRTX32 real-time kernel from Ready Systems (Palo Alto, CA) and the pSOS real-time kernel from Software Components Group (San Jose, CA) for the RISC board.

If you consider using a board based on the Motorola 88000 RISC processor, you may have to deal with an even more complex memory architecture. This RISC chip set in-

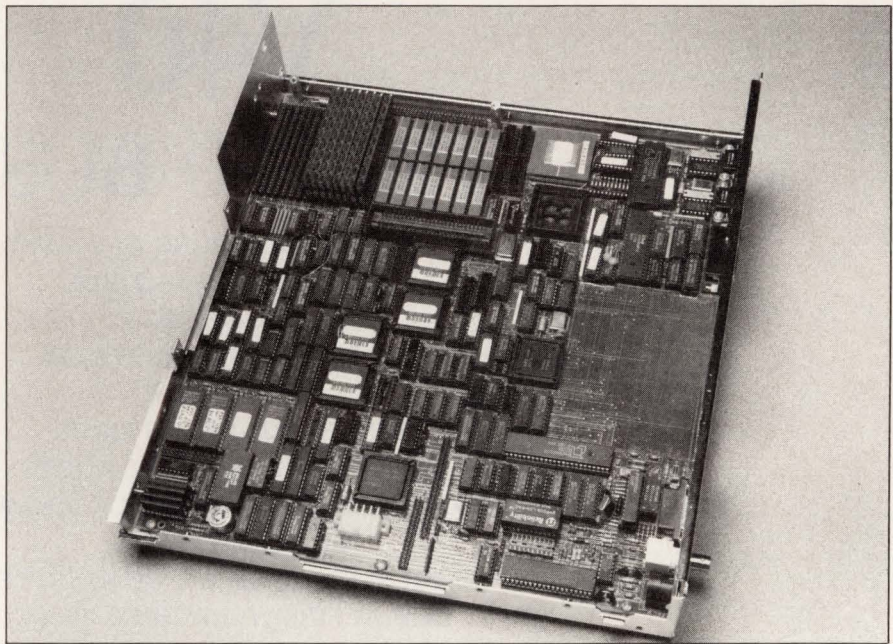

Based on the 16.67-MHz R2000 chip set from MIPS Computer Systems, the Integrated Solutions Advantedge 2000 single-board computer serves real-time and Unix applications.

cludes the 88100 CPU IC and the 88200 CMMU (cache and MMU) IC. The 88100 employs a Harvard architecture, and it's typically accompanied by one to four 88200 CMMUs for both instruction and operand buses. According to Motorola, the 88100 can be used without any 88200 CMMUs, but no vendors currently offer such a board-level product.

Cache IC emulates static RAM

Motorola did, however, make some provisions in the CMMU IC for real-time applications. The 88200 includes a 4-way, set-associative, 16k-byte physical-address cache. You can program any or all of the four 4k-byte segments in an 88200 to act as fast static RAM rather than as cache memory. Therefore, you can permanently load speed-critical sections of code into the memory segments that are set up as static RAM. The MMU portion of the IC performs address translations and adds no latency during accesses to the on-chip memory locations.

An 88100 CPU chip supports as many as eight 88200 CMMU ICs (four for instructions and four for operands). Therefore, the architecture potentially supports a total of 128k bytes of fast memory for cache and SRAM use. Cache-read misses add a latency of seven cycles, and misses on writes add a 4-cycle latency. Misses, however, cause the transfer of four consecutive words of data (16 bytes), not just the single word that caused the cache miss.

Motorola currently offers two 88000-based VME Bus products. The MVME181 includes an 88100 CPU and two 88200 CMMUs. A 20M-Hz version of the board costs \$8995, and a 25-MHz version costs \$9995. The board includes 8M bytes of DRAM to feed the CMMUs.

Motorola also offers the MVME188 3-board set, which comes in three versions. You can specify the board set with one, two, or four 88100 processors, and each of the versions includes eight 88200 CMMUs. The versions cost \$22,950, \$27,200, and \$33,500 (100), respec-

CuBIT FOR 64180 ON STD BUS.

TWO 8 BIT PARALLEL PORTS

TWO SERIAL LINES

SOFTWARE LINKS TO PC

UP TO 256K DRAM

UP TO 128K EPROM

ALL CMOS VERSION AVAILABLE

64180 CPU RUNS 280 CODE

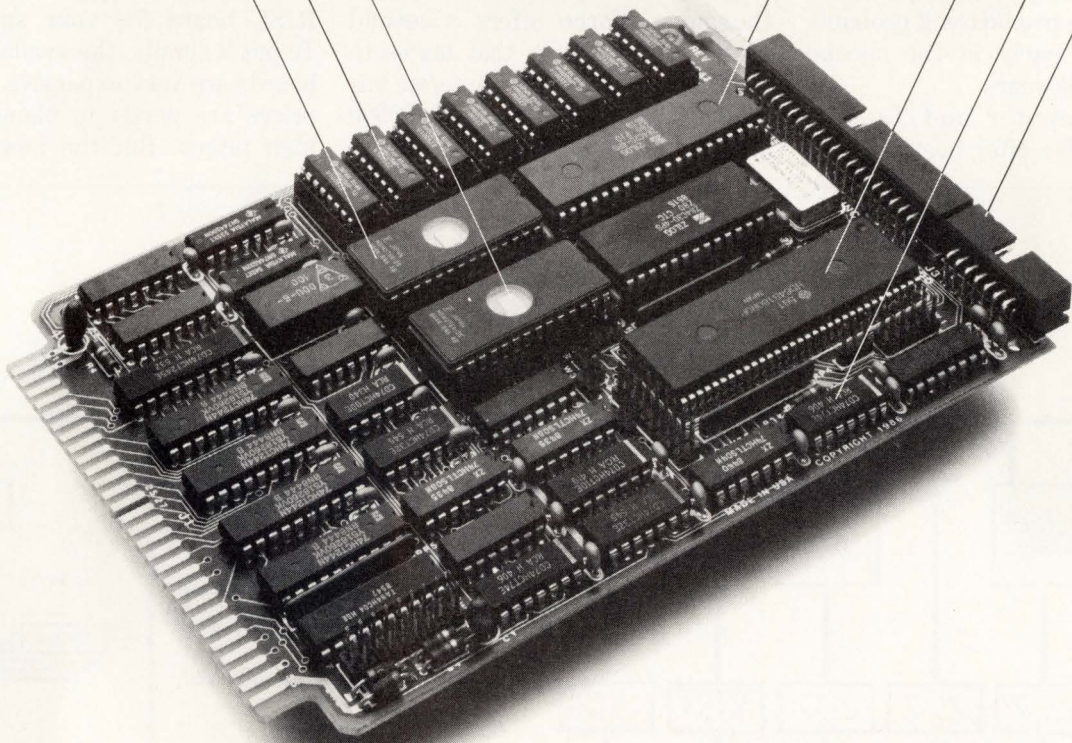

CuBIT DIVISION
OF
PROTEUS
INDUSTRIES

340 Pioneer Way
Mountain View, CA 94041-1577
Telephone: (415) 962-8237
FAX: (415) 965-9355

TECHNOLOGY UPDATE

RISC boards for real time

tively. One board of the set hosts the 88000-family chips, a second board serves as a system controller, and the third board carries 16M bytes of DRAM. A proprietary memory bus connects the boards.

ICs support multiprocessing

The 88000 architecture inherently supports multiprocessing. In fact, the CMMU IC includes a bus-watching feature, and the ICs maintain cache integrity in a multiprocessor configuration. Motorola offers its VMEexec real-time operating system with the boards. The operating system supports multiprocessing. Software Components Group also plans to offer pSOS for the 88000; the product will probably be available early in the second quarter of this year.

Force Computer and Tadpole Technology also offer boards based

on the 88000 family. Tadpole's VME Bus-based TP880V costs \$10,995, and its Multibus-II-based TP880M costs \$11,495. The Tadpole boards feature similar architectures, and they each include an 88100 processor and two 88200 CMMUs. The boards come with 4M bytes of DRAM and a 64k-byte SRAM array that the 88100 can access without latency. In addition, pSOS will be available for both boards in the second quarter.

The Force offering, the CPU-81, also includes a single 88100 and two 88200 CMMUs (Fig 1). The board costs \$8900, has 4M bytes of DRAM, and includes sockets for as much as 4M bytes of ROM. Furthermore, Force offers a second board, the CPU-82, that mates to the CPU-81 via a 100M-byte/sec bus (Fig 2). The CPU-82 costs \$9900 and carries an 88100, three 88200s,

and 12M bytes of dynamic RAM.

Force labels the board set a "dynamic processor" and claims that the architecture eliminates all latency in computation-intensive applications. One of the three 88200 CMMUs on the CPU-82 is dedicated as an SRAM to store speed-critical sections of code. The CPU-81 and CPU-82 will be available around the middle of the year. The company plans to offer pSOS, VRTX32, and OS-9 from Microware (Des Moines, IA) as real-time operating-system options.

RISC prices are sky high

At present, cost may prove to be the ultimate key to how well a RISC board fits your application. To put it simply, the available RISC boards are very expensive. Memory prices are partly to blame for the high prices. But the newness and

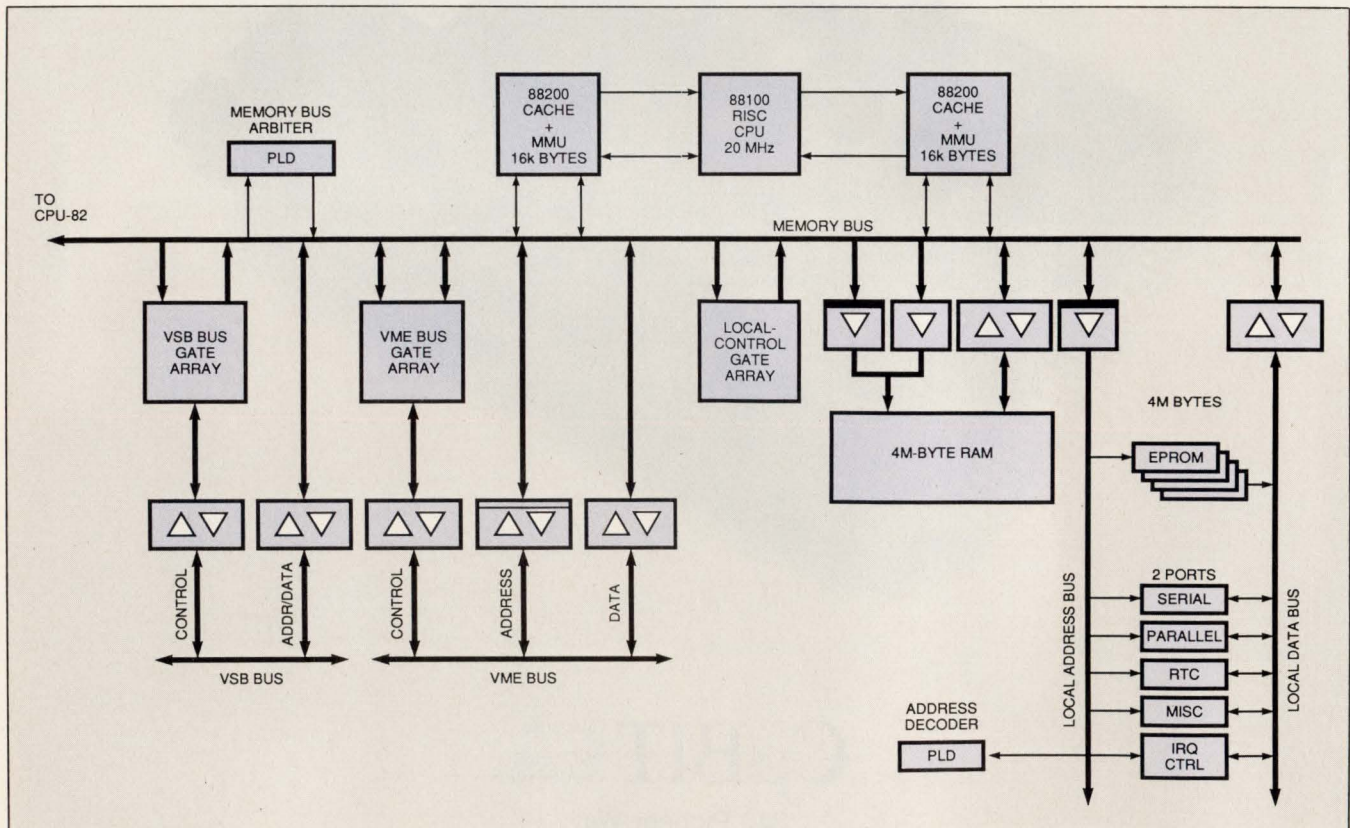

Fig 1—A 4M-byte dynamic-RAM array and the 88000 chip set make up the CPU-81 board from Force Computers. The board also includes a 100M-byte/sec bus that can connect to a second processor and memory board (the CPU-82).

CuBIT FOR 80186 ON STD BUS.

80186 16 BIT MICROPROCESSOR

SERIAL AND PARALLEL I/O

SOFTWARE LINKS TO PC

128K BYTES EPROM

512K BYTES RAM

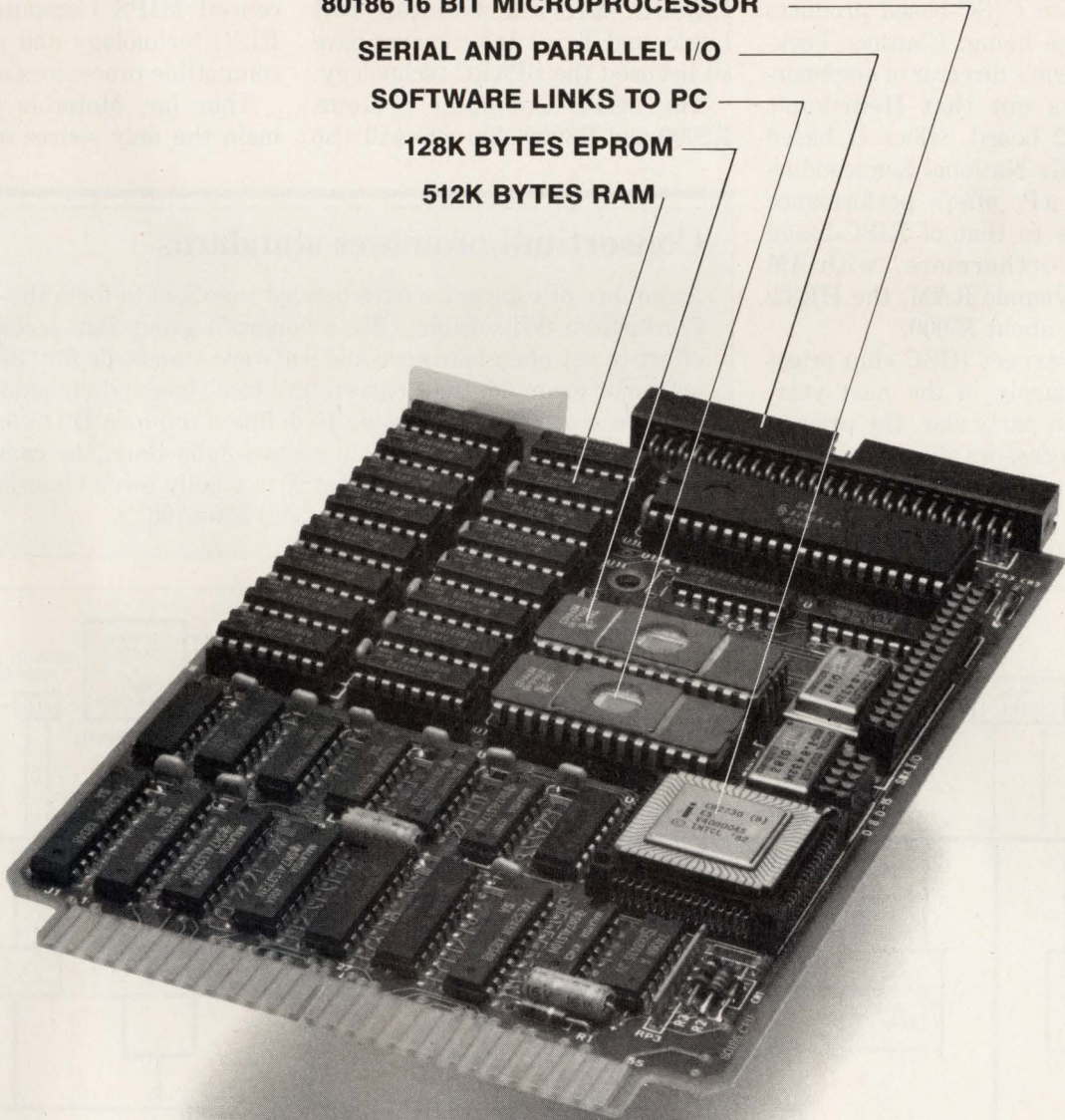

CuBIT DIVISION
OF
PROTEUS
INDUSTRIES

340 Pioneer Way
Mountain View, CA 94041-1577
Telephone: (415) 962-8237
FAX: (415) 965-9355

TECHNOLOGY UPDATE

RISC boards for real time

sparse availability of the chips has also driven RISC-board prices up.

In fact, the price/performance ratio has kept some CPU-board vendors out of the RISC market. Heurikon Corp, for example, plans to stick with CISC-based products for the time being. Clarence Peckham, the firm's director of engineering, points out that Heurikon's HK32/V532 board, which is based on a 20-MHz National Semiconductor 32532 μ P, offers performance comparable to that of RISC-based boards. Furthermore, with 4M bytes of dynamic RAM, the HK32/V532 costs about \$5000.

You can expect RISC chip prices to drop sharply in the next year, however. In particular, the price of SPARC processors should drop, because manufacturers are already producing the chips in volume for Sun workstations. Customers for

SPARC chips are also likely to benefit because of the large number of semiconductor companies that manufacture or plan to manufacture the chips. Bipolar Integrated Technology, Cypress Semiconductor, Fujitsu Microelectronics, LSI Logic, and Texas Instruments have all licensed the SPARC technology.

The MIPS Computer Systems R2000 and R3000 chip sets will also

be available from several vendors. Integrated Device Technology, LSI Logic, and Performance Semiconductor currently offer these chips. NEC Corp (Japan) and Siemens (West Germany) have recently licensed MIPS Computer Systems' RISC technology and plan to offer compatible processors in the future.

Thus far, Motorola plans to remain the only source of the 88000.

Consortium promotes standards

A number of companies have banded together to form the 88open Consortium (Wilsonville, OR), a nonprofit group that is leading the effort to set open hardware and software standards for 88000 products. For example, the Consortium's real-time and embedded-systems committee is working to define a common BIOS for real-time systems. For information, contact John Barr, the committee chairman, at Motorola Computer X (a wholly owned subsidiary of Motorola). His phone number is (312) 576-8706.

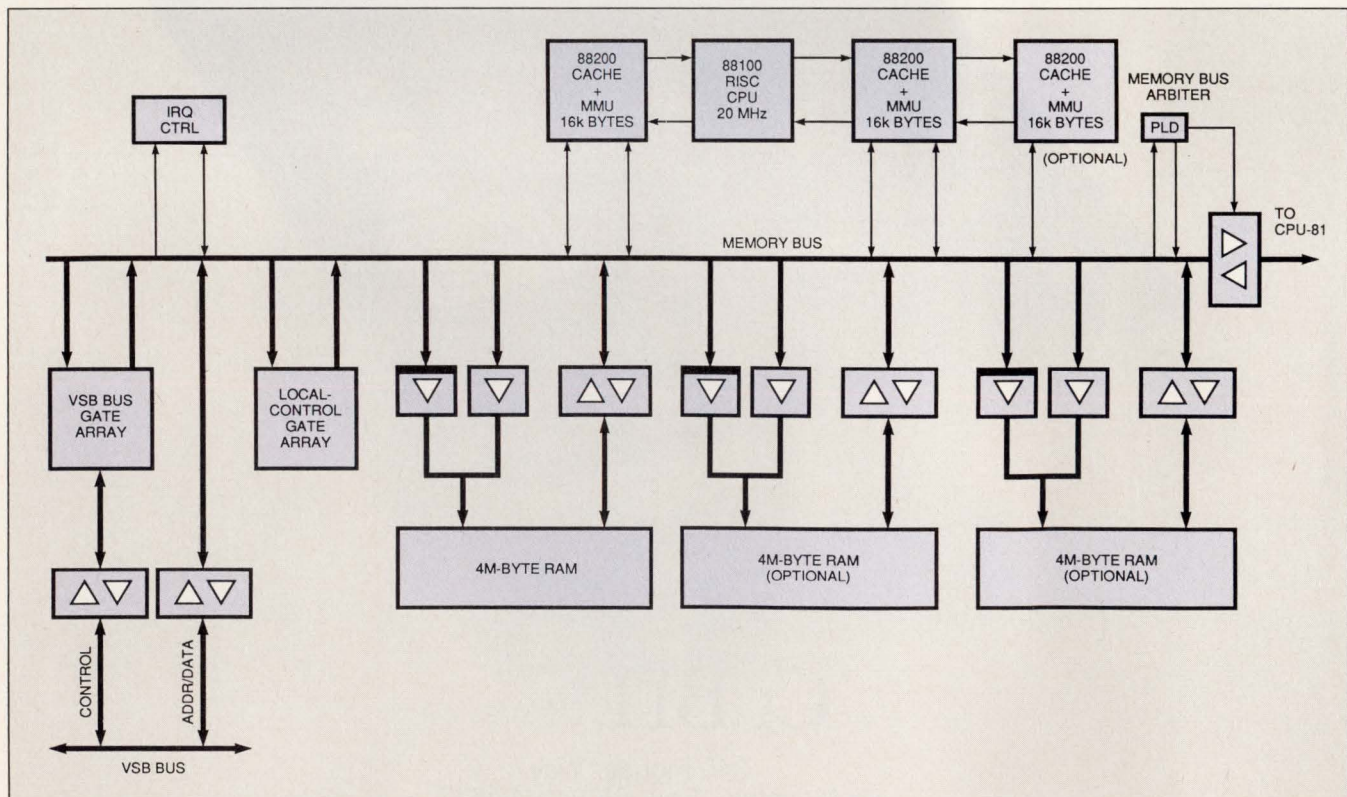
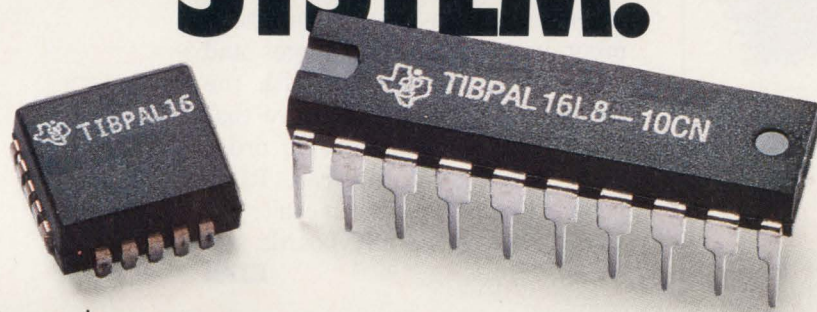

Fig 2—The three 88200 CMMU ICs and the 88100 processor on the CPU-82 board from Force Computer can ensure deterministic processor response when the board is paired (in a dyad) with the CPU-81 board. The CPU-82 board also includes 12M bytes of dynamic RAM.

TEXAS INSTRUMENTS PAL[®] DEVICES CAN IMPROVE ONE MORE SYSTEM THAN YOU THINK. YOUR NERVOUS SYSTEM.



Sure, IMPACT[™] technology from Texas Instruments can improve all your Programmed Array Logic systems. From Zero standby power CMOS to high-speed bipolar PALS, including 6ns ECL devices, Texas Instruments' PAL family can meet your system performance needs.

Now, thanks to Marshall Industries, buying Texas Instruments PAL devices will improve your nervous system, as well. Because Marshall will program your orders at one of their industry-leading programming centers. In fact, Marshall co-designed the very first IMPACT center with Texas Instruments. So your orders

are programmed, tested and marked quickly and accurately.

So accurately you don't have to worry about testing incoming devices.

Then they're shipped to you on time. No matter how tight your delivery schedule. Which should all take a big load off your mind. And your nerves.

Call Marshall today for PAL devices from Texas Instruments.

It'll keep all your systems in top shape.



[®] PAL is a registered trademark of Monolithic Memories, Inc.
[™] IMPACT is a trademark of Texas Instruments

TEXAS INSTRUMENTS AUTHORIZED DISTRIBUTOR

(*Authorized Locations)
AL Huntsville (205) 881-9235*
AZ Phoenix (602) 496-0290*
Tucson (602) 790-5687*
CA Irvine (714) 859-5050*
Los Angeles (818) 407-4100*
Sacramento (916) 635-9700*
San Diego (619) 578-9600*

San Francisco (408) 942-4600*
CO Denver (303) 451-8383*
CT Connecticut (203) 265-3822*
FL Ft. Lauderdale (305) 977-4880*
Orlando (407) 767-8585*
Tampa (813) 573-1399*
GA Atlanta (404) 923-5750*

IL Chicago (312) 490-0155*
IN Indianapolis (317) 297-0483*
KS Kansas City (913) 492-3121*
Wichita (316) 264-6333*
MA Boston (508) 658-0810*
MD Maryland (301) 840-9450*
MI Michigan (313) 525-5850*

MN Minneapolis (612) 559-2211*
MO St. Louis (314) 291-4650*
NC Raleigh (919) 878-9882*
NJ N. New Jersey (201) 882-0320*
Philadelphia (609) 234-9100*
NY Binghamton (607) 798-1611*
Long Island (516) 273-2424*

Rochester (716) 235-7620*
OH Cleveland (216) 248-1788*
Dayton (513) 896-4480*
Westerville (614) 891-7580*
OR Portland (503) 644-5050*
PA Pittsburgh (412) 963-0441*
TX Austin (512) 837-1991*

Brownsville (512) 542-4589*
Dallas (214) 233-5200*
El Paso (915) 593-0706*
Houston (713) 895-9200*
San Antonio (512) 734-5100*
UT Salt Lake City (801) 485-1551*
WA Seattle (206) 486-5747*
WI Wisconsin (414) 797-8400*

Marshall

BOARD LEVEL TIMING PRODUCTS

- Synchronize Multiple Processors
- Time Tag Data

Bancomm's line of board level timing products generate and/or decode standard time code formats (IRIG, XR3, 2137, NASA36, etc.).

PC AT/XT:

- Millisecond Resolution

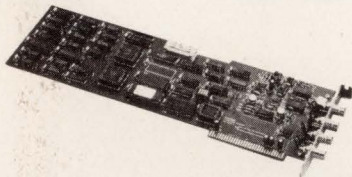

PC03XT Time Code Reader
PC05XT Time Code Generator
PC09XT SLOCODE/DC Level Shift
PC11XT Parallel Output
PC16XT Transport Control

VMEbus:

- Microsecond Resolution

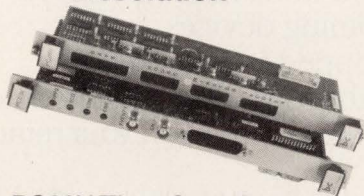

PC03V Time Code Processor
PC05V Time Code Generator
PC26V Time Code Display

Call or contact:

BC BANCOMM

Division of Datum Inc.
6541 Via del Oro
San Jose, CA 95119
TEL (408) 578-4161
FAX (408) 578-4165

TECHNOLOGY UPDATE

RISC boards for real time

The company has taken great pains, however, to encourage all sections of the computer industry to use the 88000 family (see **box**, "Consortium promotes standards").

Your determination of whether to use RISC boards in your system application, as well as your choice of a particular RISC board, might well hinge on unquantifiable factors. Sure, you'll study the hardware and software available for RISC processors in making your decision, but you'll also be influenced by such factors as the industry momentum gathering behind a certain chip.

Ultimately, however, your decision between RISC and CISC boards will be reduced to two technical issues: You must decide whether you can tolerate programming in high-level languages and whether you can work with the complex memory architecture that RISC boards must have in order to be efficient. If you can, RISC boards are for you, if you can't, you should stick with CISC boards.

EDN

References

1. Leibson, Steven H, "RISC design woos 32-bit- μ P architects," *EDN*, November 24, 1988, pg 122.
2. Small, Charles H, "RISCs force move to compilers," *EDN*, January 5, 1989, pg 73.

Article Interest Quotient (Circle One)

High 512 Medium 513 Low 514

For more information . . .

For more information on the RISC boards discussed in this article, contact the following manufacturers directly, circle the appropriate numbers on the Information Retrieval Service card, or use EDN's Express Request service.

Force Computers Inc
3165 Winchester Blvd
Campbell, CA 95008
(408) 370-6300
FAX 408-374-1146
Circle No 720

Mizar Inc
1419 Dunn Dr
Carrollton, TX 75006
(214) 446-2664
FAX 214-242-5997
Circle No 723

Integrated Solutions Inc
1140 Ringwood Ct
San Jose, CA 95131
(408) 943-1902
FAX 408-943-0626
Circle No 721

Motorola Microcomputer Div
Marcom Dept DW283
2900 S Diablo Way
Tempe, AZ 85282
(800) 556-1234
In CA, (800) 441-2345
Circle No 724

Ironics Inc
798 Cascadilla St
Ithaca, NY 14850
(607) 277-4060
FAX 607-272-5787
TLX 705742
Circle No 722

Tadpole Technology Inc
1601 Trapelo Rd
Waltham, MA 02154
(617) 890-8898
FAX 617-890-7573
Circle No 725

SRAMs

Our New SRAMs Haul Access.

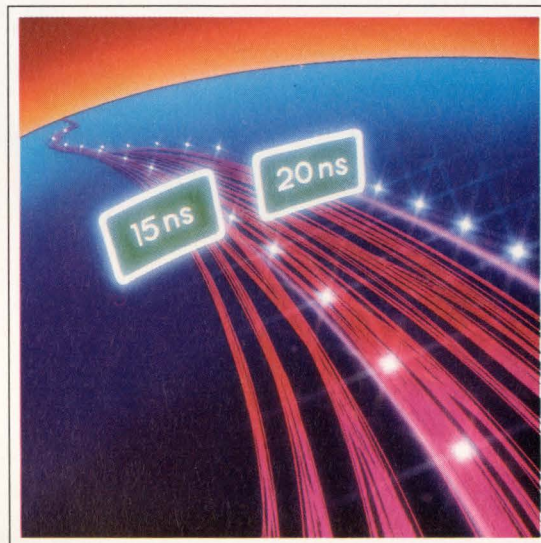

At 15 nsec, Our SRAMs Really Tear Up The Track.

If you've been wondering where to find fast SRAMs lately, we have good news for you. Now you can look to Logic Devices—the logical choice.

Our new family of CMOS SRAMs gives you more options for high-end applications, where you have to match fast CPU speeds. They're available in speed categories from 15 to 45 nsec. So even your high-performance RISC and 32-bit micro designs can forget about wait states.

Because these parts just plain haul access. But without making

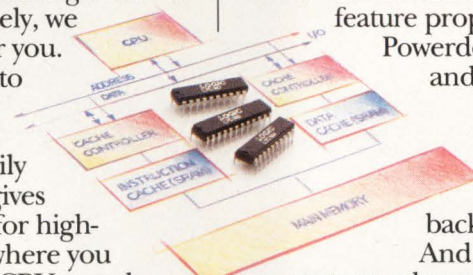

you pay a power penalty. Their advanced CMOS technology runs as low as 340 mW in active mode, and 25 mW in standby. Plus they feature proprietary Auto

Powerdown™ circuitry and 2 volt data retention, making them ideal for battery backup operation. And since these

parts are plug-compatible with industry-standard SRAMs, you have a clear upgrade path to higher performance. We've reved up production for delivery today, on all popular organizations, including 64K x 1, 16K x 4 and 8K x 8—in a variety of package types.

For full details, call us today toll free at (800) 851-0767; in California, (800) 233-2518.

ORGAN.	SPECIAL FEATURES	MAX t _{AA} ns
16K x 1*	SEP I/O	12
4K x 4*	COM I/O	15
4K x 4*	COM I/O W/OE	15
4K x 4*	SEP I/O TRANSP/WRITE	15
4K x 4*	SEP I/O HI IMP/WRITE	15
2K x 8*	COM I/O W/OE	20
64K x 1	SEP I/O	15
16K x 4	COM I/O 1 CHIP ENABLE	20
16K x 4	COM I/O 2 CHIP ENABLES + OE	20
16K x 4	COM I/O 1 CHIP ENABLE + OE	20
16K x 4	SEP I/O TRANSP/WRITE	20
16K x 4	SEP I/O HI IMP/WRITE	20
8K x 8	COM I/O 2 CHIP ENABLES + OE	25

* PRELIMINARY

Or write: Logic Devices, Inc., 628 East Evelyn Avenue, Sunnyvale, CA 94086; Telex 172387.





The New Harris Semiconductor. Expanding your horizons in signal processing and control.



Today, signal processing and control means much more to you than it did just a few years ago. Increasingly sophisticated applications are blurring the boundary between signal processing—both analog and digital—and data processing. And your future designs are certain to require further integration of these functions. ■ For The New Harris Semiconductor—a company combining the strengths of Harris, GE, RCA and Intersil—signal processing and control is both our heritage and our future. ■ We understand the myriad requirements of designing products for the real world. That's why we specialize in providing both performance and application oriented solutions to your design problems. At many levels of integration from discrete semiconductors to systems on a chip. ■ No matter what your signal processing and control requirements—from DC to microwave frequencies, from low power consumption to high speed operation, from precision input to high power/high voltage output—The New Harris Semiconductor has what you need. With a full range of amplifiers, switches, opto-isolators, discrete power, smart power, data acquisition, logic, digital signal processing, microprocessors and microcontrollers. And our expertise in analog *and* digital lets us put them both together to meet your most complex system requirements. ■ In signal processing and control, The New Harris Semiconductor is what your vision of the future demands. Today. ■ For more information and a free 1989 calendar call, toll-free, 1-800-4-HARRIS, Ext. 1989. (In Canada, 1-800-344-2444, Ext. 1989.)



What your vision of the future demands. Today.

CIRCLE NO 110

THE \$64 ANSWER

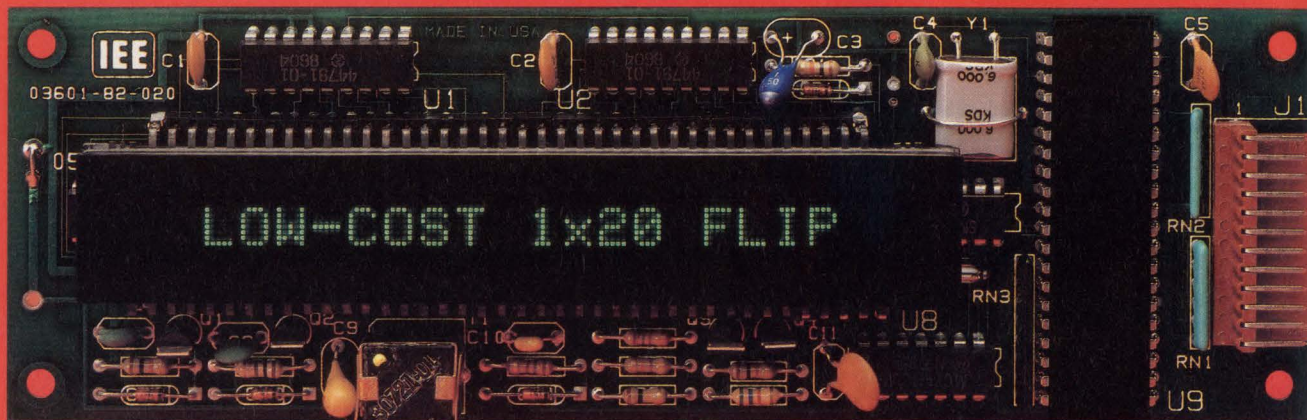

3601-82-020
ACTUAL SIZE

Now you can have a good-looking VF display at an **affordable price** with IEE's new line of "NO-FRILLS" FLIP™ vacuum fluorescent display modules.

These compact, economical displays share many of the most convenient features of the standard IEE FLIP display line, but at a much lower cost. The 1 x 20 model shown above is priced at only **\$64 each in quantities of 100**. Production-quantity pricing is even lower.

"NO-FRILLS" FLIPs are ideal for high-volume OEM applications such as copiers, point-of-sale terminals, pay telephones, and security systems.

And, just look at all of the features:

- Bright, easy-to-read 5 x 7 dot matrix characters
- On-board microprocessor that accepts parallel ASCII data
- Operation from a single +5VDC power supply
- Optional low-cost serial data converter module available

Choose from the following formats:

1 x 16	1 x 20	1 x 24	1 x 40
2 x 16	2 x 20	1 x 32	2 x 40

So, if you want a low-cost, high-quality, front-panel performer, just call IEE and ask the \$64 question.



3601-95-040



3600-83-032



3601-88-016



3600-89-024



3601-87-032



3601-84-040

Circle 5 for Immediate Application

See us at ELECTRO booth #s 2160/2162

Circle 6 for Reference Material



INDUSTRIAL ELECTRONIC ENGINEERS, INC.
Industrial Products Division
7740 Lemona Ave., Van Nuys, CA 91409-9234
Tel.: (818) 787-0311, Ext. 418 • Telex: 4720693 IEE IPD
FAX (818) 901-9046 (G2/G3)

μ P packs workstation power and graphics ability in 1 M-transistor chip

The 80860 microprocessor, with more than 1,000,000 transistors, integrates a RISC core, a floating-point unit (FPU), a hardware shading unit, and an instruction and data cache. At 40 MHz, the chip achieves 80M flops and can sustain 500,000 4×4 matrix transformations/sec. In addition, the shading hardware can Gouraud-shade 50,000 100-pixel triangles/sec.

The chip comprises six basic units: the integer RISC core, the FPU, the graphics memory-management unit, the data and instruction caches, and the bus-control unit. The RISC core has a 32×32 -bit integer register file. It decodes and executes load, store, integer, bit, and control-transfer instructions. It fetches floating-point as well as integer instructions and can operate in parallel with the FPU.

The FPU has a separate register file that you can configure as 8×128 , 16×64 , or 32×32 bits. Its separate adder and multiplier units both conform to IEEE STD 754. Both the adder and multiplier units can provide one result for every clock cycle. When pipelined, they operate at 2 results/clock cycle, yielding the 80M flops rate. The graphics unit, which provides Gouraud shading and z-buffering as well as clipping capability, is discussed in more detail in the Special Report on pg 96.

The memory-management unit can translate addresses from linear logical space to linear physical space for both instructions and data, although this translation is optional. The processor stores translated address information in a table and caches the table in a 64-entry, 4-way associative memory. The page tables are compatible with those of

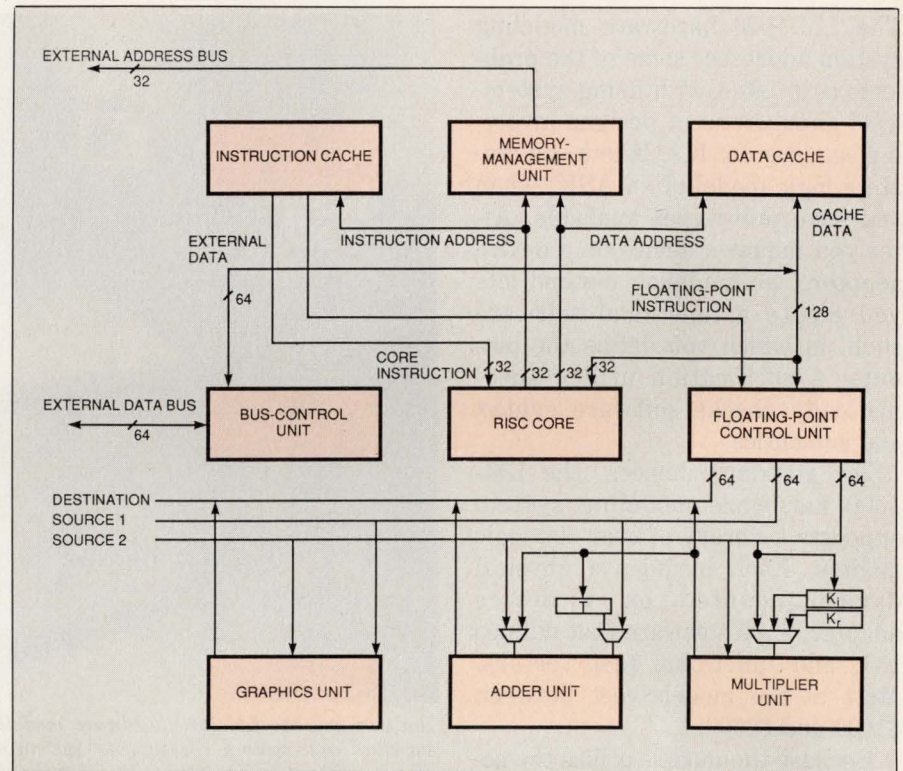

Combining a floating-point control unit and wide on-chip data and instruction caches, the 80860 can sustain an 80M-flops rate. The destination and source buses carry the operands used in pipelining the results of the FPU. K_i and K_r are constants; T is a temporary register.

the 80386. These tables enable you to design a paged, virtual memory with user/supervisor protection, which is important in multitasking systems.

One-third of the chip's area is dedicated to data and instruction caches. The caches' aggregate bandwidth is 1G byte/sec, a speed not possible with off-chip caching. The instruction cache is a 2-way set-associative memory of 4k bytes, divided into 32-bit blocks. The 8k-byte data cache, which is a write-back cache, is also 2-way set-associative and divided into 32-bit blocks.

The bus-control unit works with conventional static-column dynamic

RAM. A pin indicates whether the next address takes place using the same page. The unit supports both pipelined and nonpipelined operation. Pipelining allows a new 64-bit word to transfer every two cycles when the pipeline is full, even though the total number of cycles required for the transfer can number as many as six. Note that overall chip performance is often limited by the data-bus width. The 80860's 64-bit external and 128-bit internal buses lessen this possibility. \$750.—**Margery Conner**

Intel Corp, 3065 Bowers Ave, Santa Clara, CA 95051. Phone (408) 987-8080.

Circle No 734

Hardware modeling system creates simulation models of your ASICs

The LM-1000 hardware modeling system addresses some of the problems associated with doing system-level simulations of designs involving semicustom ICs. It lets you create a logic model of an ASIC when you have prototypes available. After you mount a device on a device adapter, the modeling method lets you create a functional software shell, in which you define the pin-outs; a verification utility automatically checks software syntax and semantics.

For standard devices, the LM-1000 hardware modeling system supports a library of over 600 logic models. Each includes a physical device mounted on a device adapter, shell software that defines I/O, and functional test vectors. Most of the models cost between \$1000 and \$2000.

Because the models utilize the actual physical device, they are by definition correct; as long as the shell software is correct, the model will perform as the actual device—because it is, essentially, the actual device. The shell also lets you control worst-case timing, including minimum, typical, and maximum delays. The pattern clock of the LM-1000 is continuously variable between 150 kHz to 25 MHz with a resolution of 1% and accuracy of $\pm 0.5\%$. Timing resolution varies from 500 psec at 25 MHz to 50 nsec at 150 kHz; accuracy is ± 3 nsec or $\pm 1\%$ of the pattern clock period, whichever is larger.

The LM-1000 currently supports, under OEM agreements, Verilog from Gateway, Hilo from GenRad, Validsim from Valid, the Vantage Spreadsheet from Vantage Analysis Systems, and Viewsim from Viewlogic, although the vendor

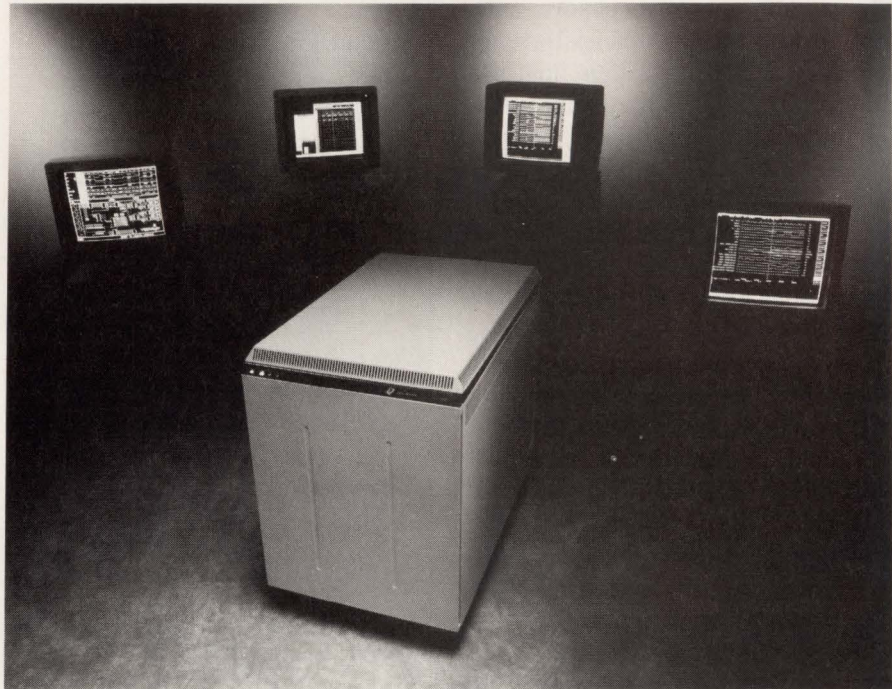

You can use the LM-1000 hardware modeling system to simulate the behavior of both standard and custom ICs in your system design—as long as silicon exists for all the pieces—without having to change either the simulator or the host you are already familiar with.

claims the LM-1000 is simulator independent and can easily adapt the hardware modeling system for any simulator. Because only a simulator function interface and some user utilities reside on the host computer, you can drive the LM-1000 from a variety of computers, including the Sun-3 and Sun-4; Apollo Series 3000, 3500, 4000, and 4500; DEC VAXstation, MicroVAX and VAX; and IBM PC/386 and compatibles.

The base configuration for the hardware modeler allows for one 80-pin device. Through expansion, you can build the pin capacity to 2560 total pins organized as eight slots by four lanes. This organization gives you as many as 32 80-pin devices, 16 160-pin devices, 8 320-pin devices, or some combination

thereof. The LM-1000 supports pattern memory from 128k patterns \times 80 pins to 2M patterns \times 320 pins—you can expand memory with 128k \times 80- or 512k \times 80-pin modules.

The LM-1000 starts at \$50,000 for the minimum unit and is available through Gateway Design Automation, GenRad, Valid Logic Systems, Vantage Analysis, or Viewlogic.

—**Michael C Markowitz**

*Logic Modeling Systems Inc,
1520 McCandless Dr, Milpitas, CA
95035. Phone (408) 954-5200.*

Circle No 731

SONY CORP. UNVEILS FIRST THREE SRAMS.

WTHORNE - Sony's recent Product Division unveils three SRAMs. The SRAM models will follow shortly as Sony engineers complete final testing. Sony Component Product

1985

SONY EXPANDS SRAM LINE.

CYPRESS, CA - Sony announces a major expansion in its SRAM line.

Now, OEMs have a wider choice in Sony SRAMs than ever before.

Many package densities are available including 16K.

Packages are available in 600 mil DIP and 300 mil DIP, depending on application chosen.

Sony reports market share in SRAMs is growing. Sony Component Product

1986-1988

SONY SRAMS: HIGH-SPEED, HIGH-DENSITY.

CYPRESS, CA - Sony makes a major commitment to the high-speed, high-density SRAM market. A range of models are available in various speeds and densities, in SOP, DIP and SOJ packages.

only the beginning of Sony's high-speed, high-density SRAM thrust.

Sony engineers report higher speed, higher density models available soon. Sony Component Product

HIGH-SPEED, HIGH-DENSITY SRAMS EVEN FASTER.

CYPRESS, CA - Sony Component Product Division continues dramatic rise in high-speed, high-density SRAMs.

OEMs are benefiting more than ever before. Sony Component Product Division plans to continue to lead the industry.

Tomorrow

Not Bad For A Five Year Old.

Today

We're showing you our rapid rise into high-speed, high-density SRAMs to dramatize one singular point: *Sony's serious commitment to your SRAM needs.*

Major SRAM investment. Answering your demands for higher speeds, we've beefed-up our SRAM engineering, design and production capabilities. Dramatically.

Already, we're producing 16K x 4-bit models at 25, 30 and 35 ns. 32K x 8-bit models at 25, 30 and 35 ns. 64K x 4-bit models at 35, 45 and 55 ns. And 256K x 1-bit models at 35, 45 and 55 ns.

In a range of DIP, SOP and SOJ packages.

0.8-micron CMOS technology: The best is yet to come.

Soon we'll debut all new SRAMs based on our 0.8-micron CMOS technology. With even higher speeds and densities. *In combinations never before available.*

Sony SRAMs are shipping now. And they're available at very competitive prices. Backed by the reliability and responsive service you expect from any Sony product.

Be a part of our success story. When you're considering high-speed, high-density SRAMs, first consider this: Sony's SRAM success story has only just begun.

For full details, call (714) 229-4197 today. Or write Sony Corporation of America, Component Products Division, 10833 Valley View St., Cypress, California 90630, Attn: Semiconductor sales. FAX (714) 229-4271.

SONY®

Sony is a registered trademark of Sony Corporation.

SONY HIGH-SPEED, HIGH-DENSITY SRAMS.

MODEL	CONFIGURATION	SPEED (ns)	PACKAGE
CXX5863P	8K x 8	25/30/35	DIP 300 mil
CXX5863M	8K x 8	25/30/35	SOP 450 mil
CXX5863J	8K x 8	25/30/35	SOJ 300 mil
CXX5464AP	16K x 4	25/30/35	DIP 300 mil
CXX5464AJ	16K x 4	25/30/35	SOJ 300 mil
CXX5465P*	16K x 4	25/30/35	DIP 300 mil
CXX5465J*	16K x 4	25/30/35	SOJ 300 mil
CXX5164P	64K x 1	25/30/35	DIP 300 mil
CXX5164J	64K x 1	25/30/35	SOJ 300 mil
CXX5971P	8K x 9	25/30/35	DIP 300 mil
CXX5971J	8K x 9	25/30/35	SOJ 300 mil
CXX58255AP	32K x 8	25/30	DIP 300 mil
CXX58255AJ	32K x 8	25/30	SOJ 300 mil
CXX58258P	32K x 8	35/45	DIP 600 mil
CXX58258SP	32K x 8	35/45	DIP 300 mil
CXX54256P	64K x 4	35/45/55	DIP 300 mil
CXX51256P	256K x 1	35/45/55	DIP 300 mil
*0/E			

PC-based precision counter offers high performance and low cost

At \$1495, the GT200 is possibly the lowest-priced precision universal counter available. Its performance, however, is far from the lowest for IBM PC/XT-, PC/AT-based, or stand-alone counter/timers. This counter can measure frequencies with 10-digit resolution/sec of gate time, and you can make timing measurements to 100-psec resolution without averaging. If this is more resolution than you need, you can trade it for speed measuring 7 digits of frequency resolution in 1 msec. For example, you can resolve a 10-kHz signal to .001 Hz in 1 msec.

The instrument performs frequency, period, time-interval, delay-time-interval, ratio, totalize, gated-totalize, and pulse-width measurements; it can sustain operation at 2000 measurements/sec. This speed not only gives you the potential for higher system throughput, but also allows you to characterize dynamic signals.

For example, using this throughput you can quickly compute the drift rate and peak-to-peak jitter of a signal. Indeed, you can make multiple measurements and look at measurement statistics in the same amount of time you might need for single measurements on slower units. Because the counter's statistics software displays a running mean and standard deviation, and minimum and maximum count, you can see the sample results as they occur. This means that you don't need to wait for the instrument to finish taking all samples to see results.

The counter's two dc-coupled input channels are specified for input frequencies of dc to 75 MHz and accept signals from -5 to +5V. To be sure you trigger on the correct

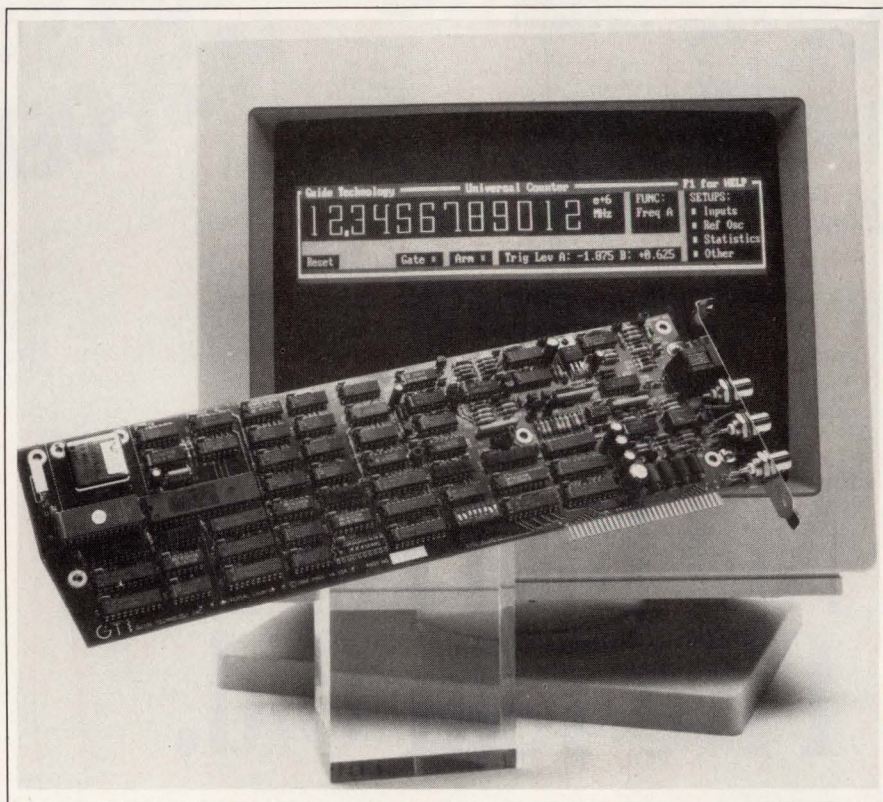

The IBM PC-based GT200 universal counter can simulate benchtop operation with its 12-digit display. You can also use the GT200 under program control for fully automated testing.

signal, you can use auxiliary inputs to arm the trigger. The auxiliary inputs also let you perform gated counting.

Input impedance and trigger threshold levels are programmable. You can select an input impedance of 50 Ω or 1 k Ω in parallel with 30 pF. The trigger threshold is programmable from -4.375 to 5V in 0.625V steps. You can also use an automatic trigger mode to automatically set optimum input threshold levels.

If you need better stability than the standard 5-ppm crystal oscillator provides within the range of 0 to 40°C, you can select either the temperature-compensated or the

ovenized crystal oscillator. You can also use an external 10-MHz reference.

The instrument's software supports two user interfaces. A virtual front panel simulates benchtop operation with mouse control of pull-down menus, including built-in statistics. You can also operate the counter under program control with simple English-like commands compatible with any programming language.—**Doug Conner**

Guide Technology Inc, 1940 Fallenleaf Lane, Los Altos, CA 94022. Phone (415) 961-9259.

Circle No 732

Get accurate and reliable small signal switching from HP's first solid state relay.

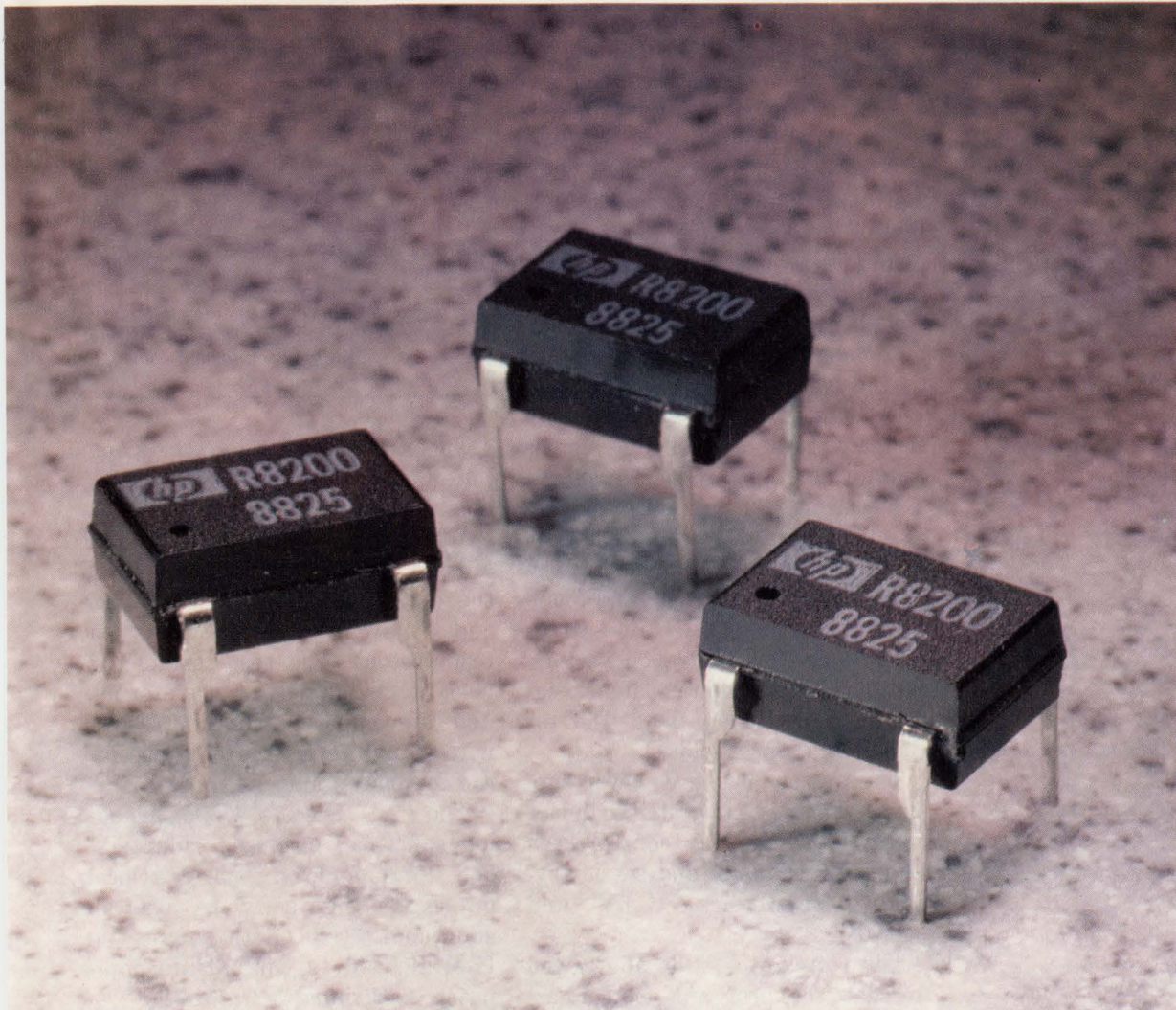

Introducing the first of a series of solid state relays for small signal switching.

HP's HSSR-8200 delivers the reliability and long operating life you need for process control and test and measurement instrumentation applications.

It eliminates the mechanical or electrical limits associated with electromechanical relays. And its low offset voltage of less than $0.5 \mu\text{V}$ and low leakage current

of 0.02 nA insure greater measurement accuracy.

You also get lower power dissipation and its associated costs, thanks to a control current as low as 1 mA . Which makes our new relay CMOS-compatible.

The HSSR-8200 also provides high-speed switching, typically $50 \mu\text{s}$, a high transient immunity of greater than $2000 \text{ V}/\mu\text{s}$ and standard DIP packaging.

Best of all, you're always assured of worldwide field service and application support.

If you'd like to know more about our innovative solution in small signal switching, circle the reader service number.

CG08804

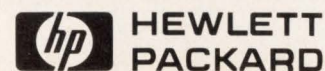

IEEE 488

for PC/AT/386 & PS/2

Compare the features!

IOtech Personal488

National Instruments PCIIA

\$395	\$395	IEEE 488 board with Quick BASIC & BASICA driver for PCs and compatibles
✓	✓	BASIC ON SRQ GOSUB capability
✓	✓	IEEE printer/plotter redirection utilities
✓	✓	Compatible with Windows 286 & 386
✓	✓	Compatible with IBM GPIB board
✓	N/A	DMA beyond 64K segment boundaries
✓	N/A	BASIC ON ERROR GOSUB capability
✓	N/A	Instrument control directly from DOS
✓	N/A	Borland Quattro spreadsheet support
✓	N/A	DADiSP waveform spreadsheet support
✓	+\$495	Lotus 1-2-3 spreadsheet support
✓	+\$495	Lotus Symphony spreadsheet support
✓	+\$100	On-board crystal oscillator
✓	+\$50	Turbo BASIC support
✓	+\$50	True BASIC support
✓	+\$50	Microsoft C support
✓	+\$50	Microsoft Quick C support
✓	+\$50	Aztec C support
✓	+\$50	TURBO C support
✓	+\$50	Microsoft FORTRAN 4.0 support
✓	+\$50	TURBO Pascal support
✓	+\$50	8086 assembler support

\$395 \$1,935 Total

Add \$100 to each for IBM Micro Channel PS/2 support.

If you already own a National Instruments PCII or PCIIA, IBM GPIB, or any NEC 7210-based IEEE board, Driver488 from IOtech provides the software features above for only \$195. Also, our GP488B IEEE board at \$295 is an economical replacement for any of the IEEE boards listed above.

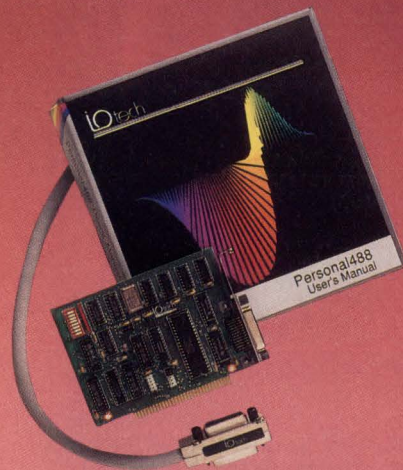

Call or send for your
FREE Technical Guide

IOtech

(216) 439-4091

Telex 6502820864 • Fax (216) 439-4093
IOtech, Inc. • 25971 Cannon Road • Cleveland, Ohio 44146
London (0734861287) • Paris (134810178) • Milan (024120360) • Brussels (02)3848062
Zurich (01)8219444 • Vienna (0222)253626 • Gorinchem (01)8303533
Linköping (0331)10140 • Helsinki (035211) • Munich (089) 710020 • Oslo (02)849070
Copenhagen (02)804200 • Madrid (91)4027000 • Lisbon (01)4103420 • Seoul (02) 678 7457
Tel Aviv (03) 491 922 • Melbourne (03)5793622 • Toronto (416)6740444
Products listed are trademarks of the respective manufacturers.
Comparison based on product information available January 1, 1989.

CIRCLE NO 114

PRODUCT UPDATE

Logic verifier handles ASICs and PLDs

The Personal Logic Design Verification System (PLDVS) allows you to perform functional tests and develop test programs for your ASIC- and PLD-based designs. The system comprises hardware and software that combine with your IBM PC/AT or compatible computer to form a test workstation.

The hardware portion of PLDVS includes plug-in cards for the computer and a generic socket adapter to receive the device under test. The adapter accepts devices with as many as 128 signal pins and is configurable to any device pinout and package style. You can program the system to simultaneously stimulate and read the signal pins, check for pin continuity, and monitor signal-drive current—all at rates as great as 200,000 vectors/sec. The system double-latches signal readings using fixed TTL or CMOS logic thresholds.

The system has five power supplies available to operate the device under test. You can control each supply individually and set it anywhere between -12.5V and +12.5V.

The software portion allows you to create test programs using a Pascal-like language. You can enter test vectors in tabular form or generate them with algorithms. By using algorithms, you can quickly generate large numbers of test vectors, allowing you to exercise your design thoroughly. A 25-line program, for example, generates 65,000 test vectors for a counter design.

The system software also includes a variety of utilities that allow you to design custom test-result displays. One utility, for example, automatically places pin readings at



This logic design verification system handles both ASICs and PLDs, allowing you to develop test programs and perform functional tests on your design.

a specified location on the computer's screen whenever the readings change.

When used with the company's Max + Plus logic design software, the design verification system accepts waveform descriptions for test vectors. The test results can also be displayed as waveforms. You can compare simulation results with actual device performance for the company's Max EPLDs.

The PLDVS costs \$6595, including software, interface, adapters, and documentation. The graphical interface design software costs an additional \$3400. Both require an IBM PC/AT or compatible computer. —Richard A Quinnell

Altera Corp, 3525 Monroe St, Santa Clara, CA 95051. Phone (408) 984-2800.

Circle No 730

16-Bit CMOS Microcontrollers. More Functions and More Memory On-Chip. Now. From Mitsubishi.

32K bytes EPROM or ROM. 2K bytes RAM. Two UARTs, with on-board baud rate generator. 8-bit, 8-channel A-D converter. Eight multi-function 16-bit timers that operate in five modes (timer, event-counter, one-shot, pulse-period and pulse-width), and pulse-width modulation. 12-bit watchdog timer. Interrupt controller. 68 independently programmable I/O ports. All on-chip.

Plus, linear access for 16 mega-

bytes external memory. Powerful instruction set optimized for high-performance operation. High efficiency hardware multiply and divide instructions. And, configurable for 8- or 16-bit external operation. All in low power, 1.3 μm silicon-gate CMOS technology. All part of a broad 16-bit MCU product line.

IBM[®]-PC based development and software support tools. Plus, masked ROM, ROM-less and OTP ROM

versions and prototyping adapters.

All available now from Mitsubishi. Driven by your applications, we put more on-chip and give you more choices, so you can reduce system component count, save board space, lower overall design costs and get products to market fast. For more information call now. (408) 730-5900 Ext. 2106. 1050 E. Arques Avenue, Sunnyvale, CA 94086.

IBM is a registered trademark of International Business Machines Corporation.



Applications-Driven Microcontrollers

Hitachi's HMCS400 Series of CMOS Microcontrollers

The intelligent answer for small system control problems

The raccoon has a remarkable ability to thrive in any type of environment. His sheer intelligence and ingenuity let him adapt to whatever circumstances he may find, and prosper with only minimal resources at hand.

Resourcefulness also characterizes Hitachi's HMCS400 series of CMOS microcontrollers. These sophisticated devices are optimized for real-time control tasks and include a great number of peripheral functions on-chip.

This new generation of 4-bit micros is a far cry from the old 4- or 8-bit designs you're used to. They execute efficient 10-bit instructions in as little as 0.89 μ s, and include powerful on-chip peripherals such as large EPROMs, LCD and vacuum fluorescent drives, and multiple serial interfaces.

For example, our new HD4074408 has an 8K one-time-programmable EPROM, a 512 x 4 bit RAM, 58 I/O lines, comparator inputs, PWM timer outputs and serial interfaces—all in a plastic package. Future devices will include A/D converters, phase locked-loop circuitry, DTMF generators, and much more.

Most importantly, Hitachi's ZTAT™ technology gives you Zero Turn-Around Time. The on-board one-time user-programmable EPROM eliminates the need to wait three or four months for mask ROM devices. The very day you finish development, ZTAT gets you into production. And, you can implement software changes immediately, to stay one step ahead of everyone else.

Put all of Hitachi's HMCS400 series resources to work for you: Ceramic windowed devices for deve-



Resourceful

lopment, ZTAT devices for pilot and small-scale production, and mask ROM devices for large-scale production. And, a full complement of development support tools is available for use with IBM-PC*, DEC VAX*, and Hitachi systems.

Plus, when you consider all the on-chip integration, you also get the lowest-cost solution for your design. The packaging is one of the reasons why ZTAT only costs slightly more than mask ROM microcontrollers, and is *a lot* cheaper than ceramic reprogrammable devices.

Clearly, Hitachi's HMCS400 series is right for a broad range of today's small systems applications in automotive, consumer, handheld instrumentation, telecom, and industrial products.

There's no need to wait. Hitachi is delivering the 4-bit all-CMOS HMCS400 series *right now*—

including EPROM-on-chip ZTAT devices. For more information, call your local Hitachi Sales Representative or Distributor Sales Office today.

Literature Fast Action: For product literature only, CALL TOLL FREE, 1-800-842-9000, Ext. 6809. Ask for literature number #SB-106.

*IBM-PC and DEC VAX are trademarks of International Business Machines Corporation and Digital Equipment Corporation, respectively.

Hitachi America, Ltd.

Semiconductor & I.C. Division

Hitachi Plaza

2000 Sierra Point Parkway, Brisbane, CA 94005

Telephone 415/589-8300



HITACHI®

We make things possible



SPECIAL REPORT

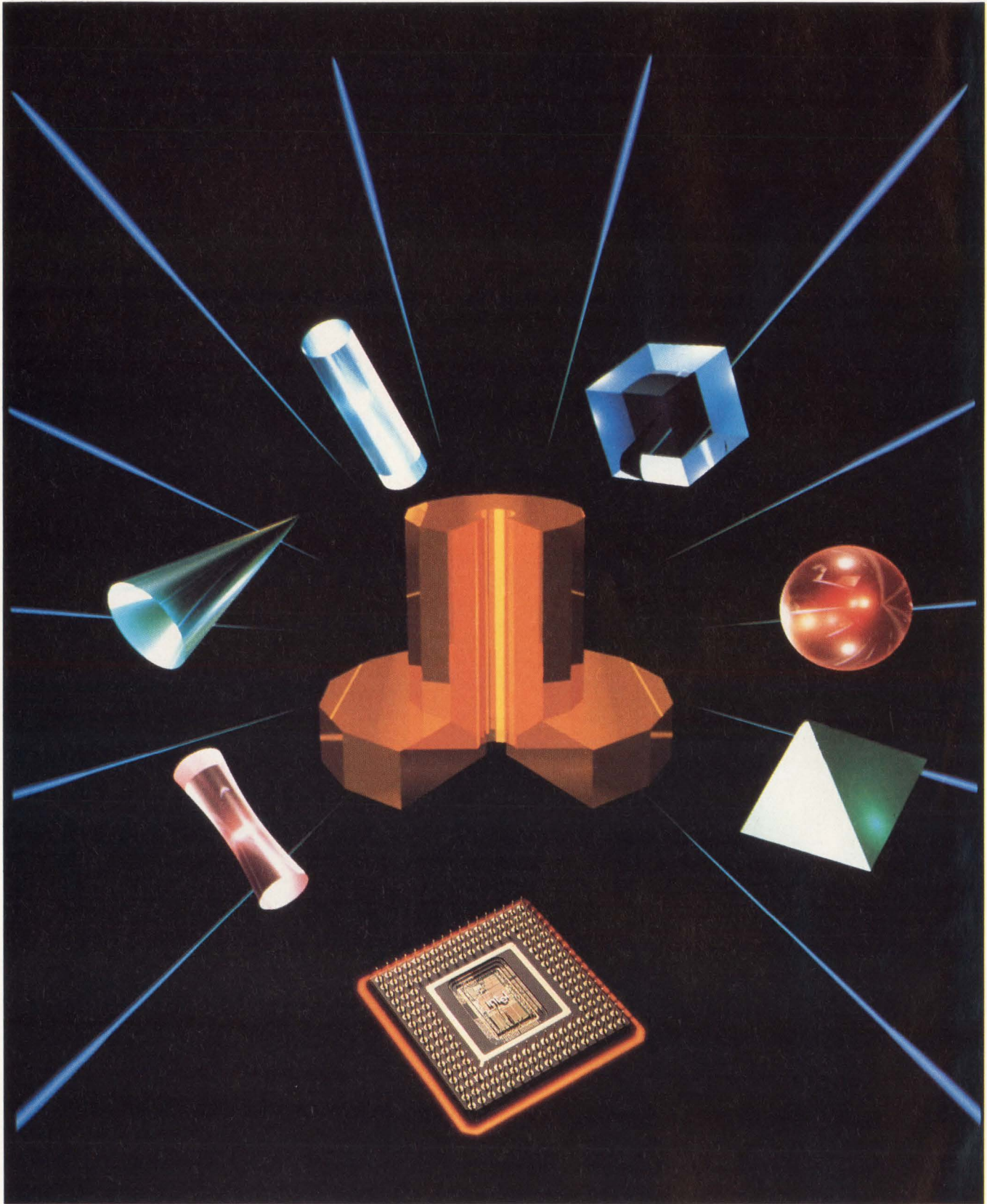

The shapes of things to come—realistic 3-D graphics images—will soon be showing up on personal-computer screens. One of three new processing products can give a PC add-in board or embedded graphics system the power to produce high-quality graphics. (Photo courtesy Intel Corp)

Processors for 3-D graphics

Because of their enormous appetite for floating-point operations, 3-D graphics displays were previously limited to high-end workstations. With some powerful new processors, however, you can now bring workstation-quality 3-D graphics to such applications as PC add-in boards and embedded-graphics systems.

Margery S Conner, Regional Editor

Three-dimensional color graphics displays, which are capable of manipulating an image in real time and shading it realistically, require a processor to perform a great number of floating-point and integer calculations. Two recently introduced processors, the 80860 from Intel and the TMS34020 from Texas Instruments, are specifically tailored to produce 3-D graphics. A third chip, the G300 parallel processor from Inmos, makes it easier for you to design the company's fast Transputer (T800) into 3-D displays. With any of these three products, you can design workstation-quality graphics into a personal computer or other graphics application.

Beyond their ability to perform fast floating-point calculations, the three products have little in common. For example, unlike the 80860 and T800/G300, the 34020 requires a coprocessor (TI's 34082) to perform fast floating-point calculations. Both the 80860 and the T800/G300 combination have on-chip floating-point hardware, but the 80860 includes hard-wired shading algorithms; the T800/G300 does not. However, because 3-D graphics suits diverse applications, ranging from workstation displays to PC add-in boards to embedded military displays, there's no one correct design approach. The application determines the cost and size of the system you can build as well as which chip you'll choose. To decide which chip is best for your applica-

tion, you must first understand how graphics chips perform 3-D manipulations and shading.

In a 3-D color graphics display, the graphics application software stores graphical shapes in world coordinates, which are dimensionless Cartesian coordinates. The scale of a world-coordinate system depends on the application: 3-D applications can require thousands of units of resolution.

The graphics system processor must be able to rotate or tilt any graphical shape to conform to the viewing angle. These manipulations require the processor to perform a matrix transformation. To get an idea of the number of floating-point multiplications and additions the processor must perform, consider the following example. To move a point (x, y, z) to a new position (x', y', z'), you must multiply it by a 4x4 transformation matrix:

$$[x' \ y' \ z' \ w'] = [xyzw]^* \begin{bmatrix} abcd \\ efgh \\ ijkl \\ mnop \end{bmatrix}$$

$$\begin{aligned} x' &= ax + ey + iz + mw \\ y' &= bx + fy + jz + nw \\ z' &= cx + gy + kz + ow. \end{aligned}$$

A useful guideline for measuring an FPU's performance is the time it takes to do a 4×4 matrix transformation, a basic 3-D operation.

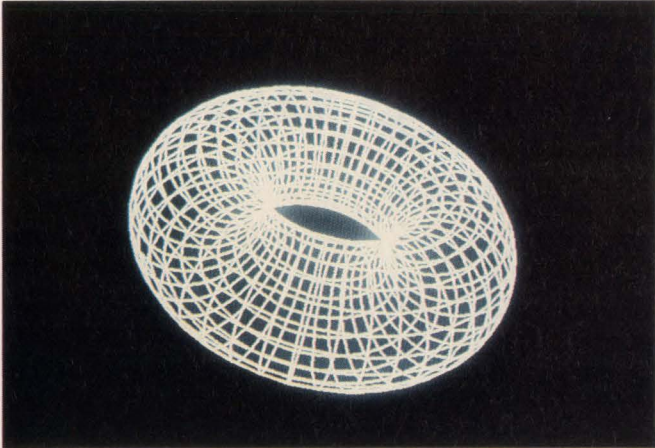

Fig 1—This rendering of a torus shows how a graphics-display system would draw the shape before applying a hidden-surface removal algorithm. At this stage, all the polygons that the application software uses to represent the shape are visible. (Photo courtesy Weitek Corp, Sunnyvale, CA)

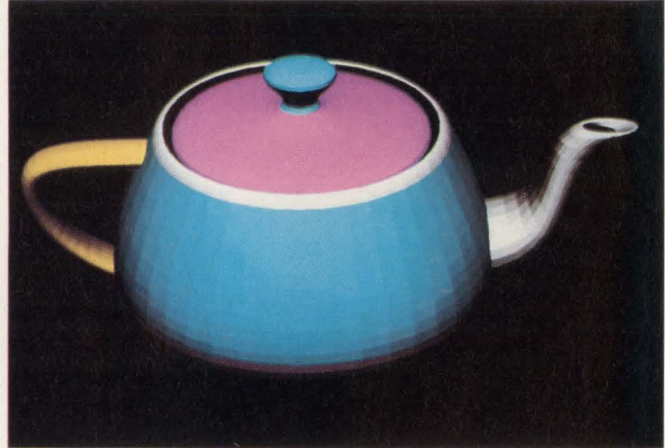

Fig 2—When no shading algorithms are applied to this graphical rendering of a teapot, each polygon has only one color assigned to it, so the teapot appears to have a nonsmooth surface.

To multiply the vector representing the pixel position by the transformation matrix, the processor must perform 28 floating-point operations: 16 multiplications and 12 additions. The 4×4 matrix transformation is basic to all 3-D manipulations, so it's a useful guideline for comparing different processors' floating-point capabilities. For example, a representative workstation, the Sun-4, transforms 150,000 vectors/sec.

The graphics application software doesn't store all of a graphical shape's pixels in memory; instead, it divides the shape into a series of polygons and stores only the vertices of the polygons. To transform a graphical shape, therefore, the system must transform the vertices of all the shape's polygons (**Fig 1**).

After the graphics system processor transforms all of the shape's polygons to the correct viewing angle, the processor performs a clipping test to ensure that the system will display only those pixels that fit into the viewing window. The viewing window can be any size you care to make it.

To display the graphical shapes created by the application program, the processor must convert, or transform, the world coordinates to screen coordinates. Screen coordinates are relatively small, and their size is determined by the physical display. The screen-coordinate system for the IBM PC's VGA display, for example, is 640×480 pixels. The processor converts the coordinates by using a matrix transformation similar to those used for rotation and scaling. Up to this point, all the manipulations performed by the processor consist of floating-point operations.

The next step is for the system to move the graphical entities from 3-D memory to the 2-D screen display. To move the images, the system must use a hidden-surface-removal algorithm, which is necessary to make an image look realistic. When you look at a real object, the visible surfaces obscure surfaces behind them from view. When you move an image stored in three dimensions to the 2-dimensional screen, therefore, you must remove the surfaces that would be hidden from view in a real 3-dimensional object. The hidden-surface-removal algorithm checks each pixel in a scene and determines whether it would be visible from that particular view, and thus should be displayed in the scene, or whether it would be obscured by another pixel, and so should not be displayed.

The hidden-surface-removal algorithm can be performed in integer arithmetic. However, even though the graphics processor doesn't have to use floating-point arithmetic, its calculations are no fewer or less time consuming.

But first, scan convert

Before the graphics-system processor can apply a hidden-surface-removal algorithm, it must scan-convert the polygons to determine where their edges lie. Scan-conversion techniques rely on the fact that the color and visibility of adjacent pixels is usually very similar. The program calculates the horizontal limits of the polygon. Each pixel within the polygon must have its z value and color determined and placed in the z buffer and frame buffer, respectively. As a result of scan conversion, the system knows the color

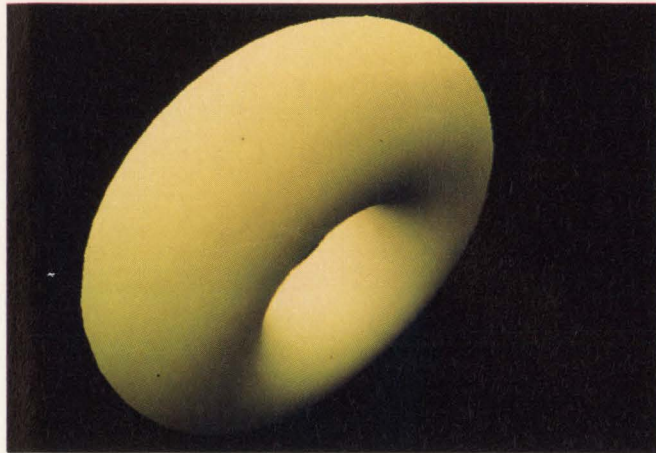

Fig 3—This version of the torus shows how the wireframe version can look after hidden-surface-removal and shading algorithms have been applied. (Photo courtesy Weitek Corp)

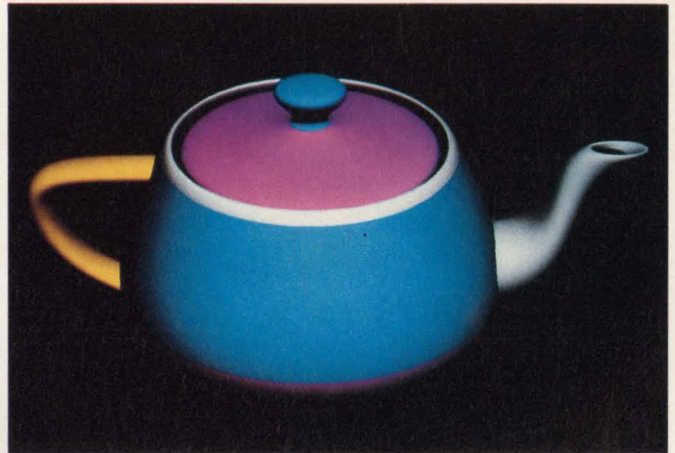

Fig 4—With the application of a Phong shading algorithm, which simulates the effects of a single light source, the teapot takes on a much more realistic look.

on the edges of the polygon and the z coordinate of each pixel and its color. The graphics-display system needs to know a pixel's z coordinate in order to remove hidden surfaces by using the z-buffer algorithm, and it must be able to identify the polygon's edges and their colors to perform the shading algorithms.

The z-buffer algorithm is the most popular hidden-surface-removal algorithm. It compares the depth of each pixel under examination (that is, its z coordinate) with the value currently in the z buffer. If the current pixel's z coordinate is smaller than the previous one in that position, the processor updates the z buffer with the new pixel's z value, and updates the frame buffer with the new pixel's color.

After performing hidden-surface removal, the graphics system can display a wire-frame representation of the graphical shape. However, to color each polygon with just one color gives a rough, unrealistic rendering of the object (Fig 2).

The next step, therefore, is to use a shading algorithm. In Gouraud shading, the simplest shading scheme, the algorithm uses linear interpolation to determine what the colors on each line should be (Fig 3). That is, if one edge is dark red, and the horizontally opposite edge is light red, fairly realistic shading would go linearly from dark to light red. At the halfway point, a Gouraud-shaded line has gone through half of the total color change.

Gouraud shading doesn't allow for the effect of a light source, however, a technique that produces an even more realistic image. The Phong shading technique creates the effect of a single light source. Rather than

linearly interpolating across a line of pixels, Phong shading determines the normal vector for each pixel, and calculates the angle of incidence for the light source (Fig 4). The processor still performs a linear interpolation, but it recalculates each pixel's color on the basis of the pixel's normal vector.

There are several different ways to implement the shading algorithms in your graphics system. Only one of the three processors suitable for 3-D graphics display—Intel's 80860—provides the shading algorithms on chip. The others require you to implement the shading algorithms in software or to create an ASIC that can perform shading.

With over one million transistors on a single chip, Intel's 80860 integrates a RISC core, a floating-point unit (FPU), and a hardware shading unit. (For more information on the 80860's general processing capabilities, as well as a block diagram, see the Product Update on pg 87.) The on-chip FPU is capable of peak speeds of 80M flops. Its Linpack number is 10M flops (by comparison, a VAX 8650 has a Linpack rating of 0.7M flops). Keep in mind that Linpack ratings are always considerably lower than peak speed ratings, because the numbers generated in the Linpack benchmark can't fit into most on-chip caches. However, the 80860's cache is big enough to hold an entire 4×4 matrix transformation. Therefore, it can perform the transformation at close to its peak speed of 80M flops, which allows for 500,000 transformations/sec.

One of the most time-consuming parts of the process of rendering the image is the z-buffer check in the hidden-surface-removal algorithm. Even a flat shading

Even a simple shading technique such as the Gouraud scheme can run over 100 times more slowly than the 3-D matrix transformations.

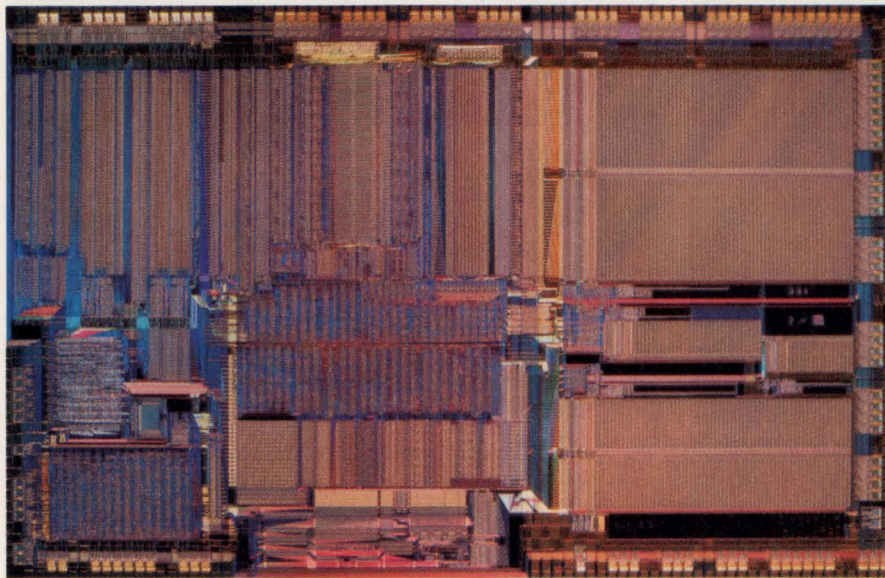

Because it has more than 1,000,000 transistors, the Intel 8086 processor has the density to pack a RISC core, an 80M-flops floating-point unit, and shading hardware all onto one chip.

of a 3-D surface is much slower than a simple 2-D fill because the processor must check the buffer for each pixel. When the buffer check is combined with Gouraud shading, the shading process can run about 100 times slower than the transform rate. The 80860 has dedicated hardware that performs the z-buffer comparisons and computes the shading interpolation on all pixels in a 64-bit word simultaneously. (A pixel may be 8, 16, or 32 bits long, so each 64-bit word may have 8, 4, or 2 pixels.) The shading hardware gives you a choice between Gouraud or Phong shading. Its Gouraud-shading speed is 50,000 polygons/sec. By comparison, the Sun-4 workstation's Gouraud-shading speed is 20,000 polygons/sec.

Although the shading algorithms are implemented in hardware on the 80860, they still don't approach the speed of the FPU. If you can't stand letting the FPU idle while the shading hardware completes its tasks, you can put the FPU to work performing application-software tasks such as simulation calculations. In this scenario, the 80860 functions as a workstation on a board. **Fig 5** illustrates the architecture for a PC plug-in board that incorporates the 80860.

Note that the 80860 can operate as a stand-alone microprocessor; it does not require you to use another processor as a host. However, the software for the 80860 is totally incompatible with that for previous Intel processors, so if you wanted to run MS-DOS, you'd need an Intel host processor. Samples of the 80860 are available now. The chip will be in production

in the third quarter of this year; it will cost \$750 in OEM quantities.

Although the 80860 has 3-D graphics capability, it lacks the display-control hardware that a graphics processor has, and thus shouldn't be considered a true graphics processor. Texas Instruments' 34020, however, is a true graphics processor: It has built-in signals that support direct control of the display. It doesn't have floating-point capability, however; for that function, you need to use TI's recently introduced 34082 floating-point unit. The 34082 has a 50-nsec clock cycle; multiplication and addition occur in parallel, giving the chip a sustained floating-point speed of 40M flops, and a Linpack figure of 5.2M flops. It requires only 130 cycles for a full 4×4 matrix transformation, so it can perform more than 150,000 vector transformations/sec.

The 34082 has its own C compiler and assembler, and it can address as much as 256k bytes of memory over a local bus. These capabilities allow you to write your own routines (such as a rotation algorithm) for the 34082 and store them in the 34082's local memory. As host, the 34020 could command the 34082 to run its own routines from local memory, thus freeing the 34020 from having to oversee the operation of the 34082.

Because the 34020's object code is compatible with that of the chip's precursor, the 34010, a wealth of supporting graphics software already exists for the 34020. An example of such software is the Texas Instruments Graphics Interface (TIGA). The interface runs on 34010/34020 graphics plug-in boards in MS-

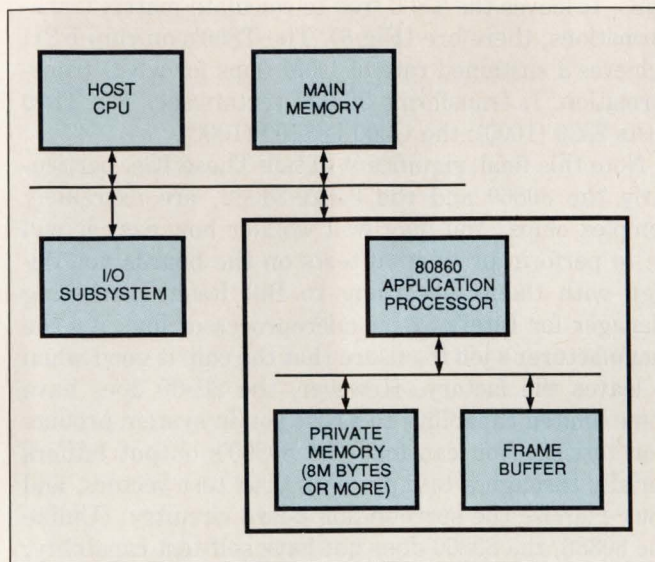
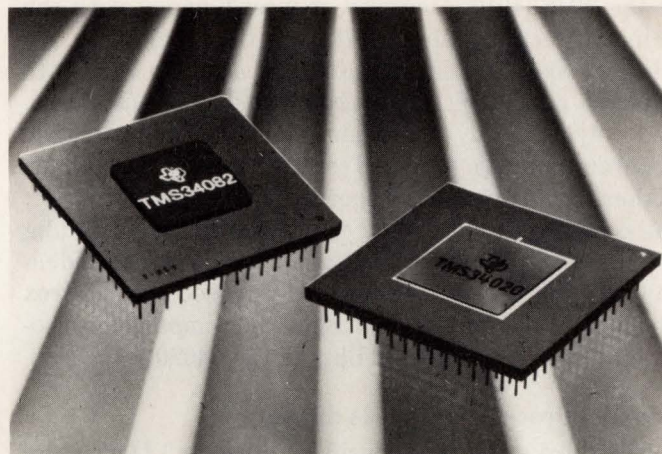

Fig 5—To exploit the power of many of today's PCs, whose capabilities now approach those of workstations, the PC's graphics displays will have to be able to support workstation-quality graphics. One way to design a PC-based system with workstation-quality graphics is to plug in an 80860-based 3-D graphics add-in board that runs application software while the host processor runs the PC's operating system.

DOS systems; it standardizes the way that application software and the host processor communicate with the 34010/34020 graphics processor.

According to Karl Gutttag, TI graphic-strategy manager and designer of the 34010/34020 family architecture, you must be careful to balance the workloads between the host processor and the graphics processor. Because of the difference in power between the 34010 and the 80286, which is often the host in PC workstations, the 34010 often had to wait for the host processor, an inefficient scheme. In 80386-based systems, the 34010 no longer has to wait for the host. To use the processors most efficiently in such systems, you must give more thought to which tasks you assign to which processor. According to TI, 80386/34010 systems are demonstrating speed increases beyond those you'd expect to obtain by simply adding the faster host processor. The speed increases result from the redistribution of processing tasks.

The 34020 makes no provisions for 3-D color shading. If your application requires shading, you have two choices: You can either implement the algorithm in software, or you can develop your own shading ASIC. In the past, only vendors of high-end workstations could justify the time and expense of developing a



When teamed with the TMS34082 floating-point unit, the TMS34020 32-bit graphics processor from Texas Instruments can perform more than 150,000 vector transformations/sec.

shading ASIC, but this situation will soon change. National Semiconductor (Santa Clara, CA), for example, plans to introduce hardware shading chips into its standard-cell ASIC library this year.

Samples of the 34020 will be available this quarter; full production of the chip will start in the fourth quarter of the year. Samples cost \$500; in production quantities, the chip will cost \$100. The 34082's volume price will be \$150. You can expect the quantity pricing for the 34020 to fall below \$50 in two years.

Make your graphics system stand out in a crowd

You may be concerned that designs based on single-chip processors such as the Intel and TI ICs will make your system or board too generic. This has indeed been the case with low-resolution graphics boards. There's little to distinguish one VGA-compatible personal-computer board from another, for example, so price has become the determining factor in a customer's decision to buy. That's a nice situation for the customer, but the board manufacturer will want to avoid it.

One way to distinguish your design from others is to develop your own chips to accelerate one part of the graphics pipeline. For example, you could develop hardware-shading ASICs. An add-in graphics-board company with experience in this technique is Matrox (Dorval, Quebec, Canada). According to Ray Snow, graphics-board marketing manager at Matrox, when the company evaluated the various graphics chips two years ago, it particularly liked the programmability

If the shading portion of your graphics display is too slow,
consider using a shading-accelerator ASIC.

of the TMS34010. However, it wasn't happy with the chip's relatively slow software bit-block transfer (BitBlit) speeds. Matrox developed its own ASICs to perform all BitBlit operations, windowing functions, and polygon fills. This scheme gave the company the programmability it found so attractive, as well as higher hardware BitBlit speeds. As you might expect, the company is looking for ways to accelerate shading for its next-generation 3-D graphics board. (Incidentally, Texas Instruments obviously agreed with Matrox about the need for faster BitBlits; the company incorporated faster hardware BitBlits in the 34020.)

Parallel processing speeds displays

The third product to consider for use in 3-D graphics systems is a 2-chip set comprising the Inmos T800 Transputer and the G300 color video controller. Inmos's T800 Transputer chip is aimed at parallel-processing applications. Parallel-processing applications are any applications that can be broken down into subtasks and performed by several different processors at the same time, accelerating the system speed. Graphics is a prime candidate for parallel processing. For one thing, the matrix manipulations necessary in graphics processing are very repetitive in nature. Further, parallel processing lets you develop several elements of a picture independently and bring them together just before displaying them on the screen.

The G300, which Inmos recently introduced, includes all CRT control signals and performs interface to the display; it also has a color look-up table and a video

DAC. It leaves the T800 free to calculate matrix transformations, therefore (Fig 6). The T800's on-chip FPU achieves a sustained rate of 1.5M flops for a 3-D transformation. It transforms 50,000 vectors/sec. The T800 costs \$330 (1000); the G300 is \$100 (1000).

Note this final, significant detail: These ICs, particularly the 80860 and the 34020/34082, are extremely complex chips. You may well wonder how easy it will be to perform production tests on the boards you design with them. According to Bill Rash, marketing manager for Intel's 32-bit microprocessor line, it's the manufacturer's job to ensure that the chip is good when it leaves the factory. However, the 80860 does have some limited capability to assist you in system production testing. You can load the 80860's output buffers serially through a test pin with your test vectors, and thus exercise the surrounding board circuitry. (Unlike the 80386, the 80860 does not have self-test capability. The 80386's self-test capability relies on the fact that the chip is microcoded; the 80860 is not.)

As you might expect from TI, which has taken a leadership position in developing scan-path test methods, the initial version of the 34020 does incorporate a scan-path test method for emulation support. At present, the test capabilities of the 34082 are limited to forcing all pins to high, low, or 3-state, but the next version of the chip, due in 1990, will incorporate TI's full JTAG scan-path test method.

When you first see the prices of these processors, you may be taken aback. Consider, however, that these chips can give a graphics board or system the graphics

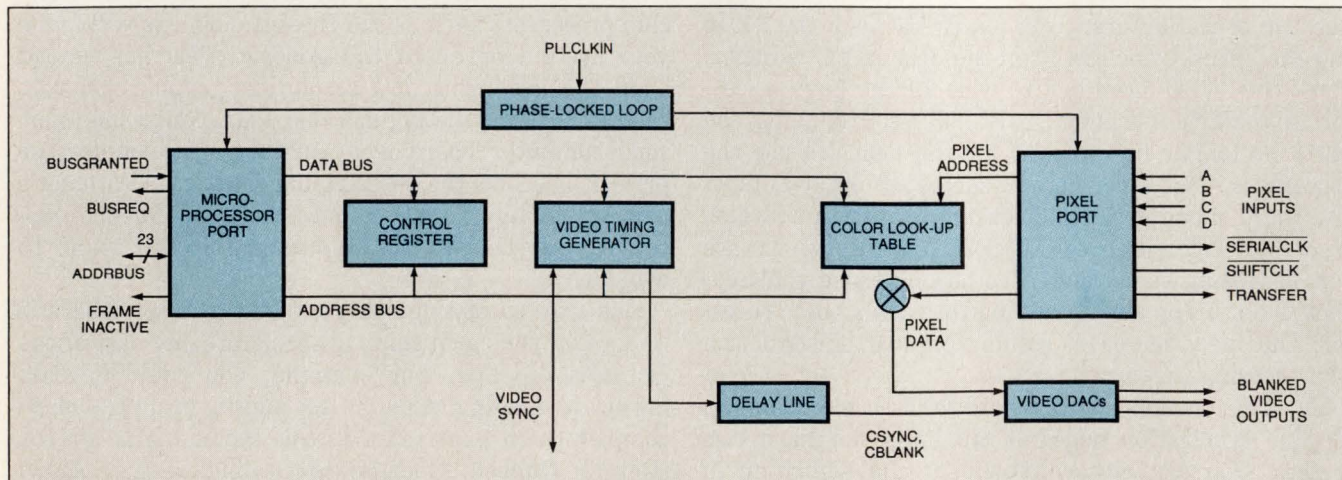
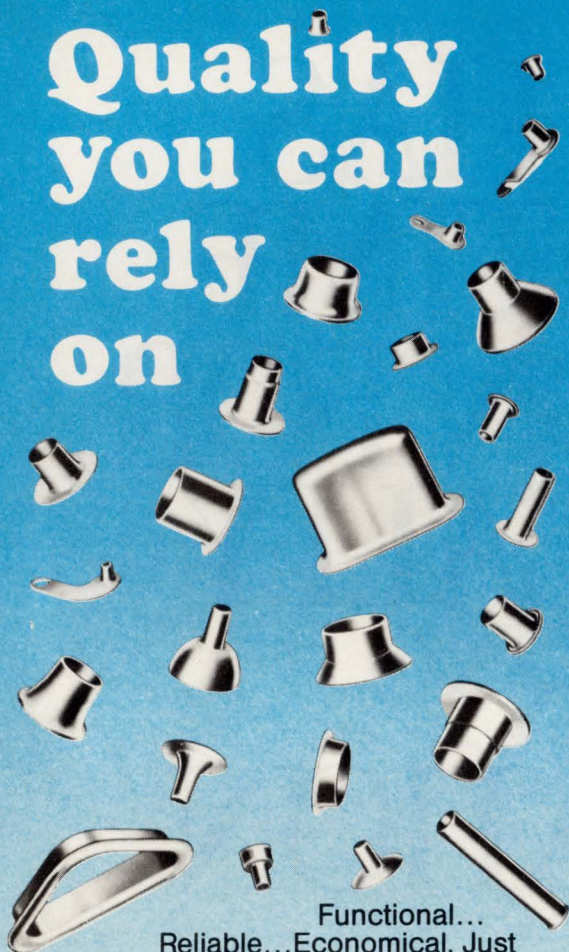

Fig 6—Because graphics is a natural application for parallel processing, the Inmos T800 Transputer, which is eminently suitable for parallel processing, is a good candidate for a node processor in a 3-D graphics subsystem. The company's IMG300 chip takes care of video control, including video D/A conversion.

**INTEL HAS
A REAL-TIME
SOLUTION FOR
PRACTICALLY
EVERY
APPLICATION.**

**HOW COULD
WE POSSIBLY
IMPROVE?**

Quality you can rely on



Functional...
Reliable...Economical. Just
a few qualities that make
STIMPSON Eyelets the leading
choice when securing your
fastening needs.

At STIMPSON, we realize that each eyeleting application presents its own problems and requirements. That's why we maintain the largest stock in the world, producing over 3,000 different sizes and styles, each furnished in a variety of metals, finishes and colors.

You can also rely on our Assembly Service Experts to recommend the right combination of eyelets and machinery to meet your design specifications.

Send for your free copy of STIMPSON'S latest Eyelet Catalog, which illustrates over 2,300 standard and specialty eyelets and our full line of precision-built automatic eyeleting machines.



Stimpson

Co Inc.



900 SYLVAN AVE. BAYPORT, N.Y. 11705-1097
(516) 472-2000

CIRCLE NO 80

Manufacturers of processors for 3-D graphics

For more information on processors that implement 3-D graphics, such as the processors described in this article, contact the following manufacturers directly, circle the appropriate numbers on the Information Retrieval Service card, or use EDN's Express Request service.

Inmos Ltd
1000 Aztec West
Almondsbury
Bristol, UK BS12 4SQ
(0454) 616616
FAX (0454) 617910
Circle No 650

Texas Instruments Inc
Semiconductor Group SC-879
Box 809066
Dallas, TX 75380
(800) 232-3200 ext 700
Circle No 652

Intel Corp
3065 Bowers Ave
Santa Clara, CA 95051
(408) 987-8080
Circle No 651

capability of a Sun-4 workstation. In light of their capabilities, the chips are actually quite cost-effective.

What's more, although people tend to think that a PC's number-crunching capability is used mostly to run application software, it's actually the graphics display that causes most of the processing overhead. Similarly, as far as the user is concerned, it's the graphics-display subsystem that determines how fast the computer runs. No matter how quickly a PC performs a function internally, it's the speed with which the results show up on the screen that makes the difference. Fast processors that can handle 3-D graphics, therefore, are not just luxury options anymore; they're going to become necessary parts of graphics systems for many PCs in the near future. **EDN**

References

1. Foley, J D and A Van Dam, "Fundamentals of Interactive Computer Graphics," Addison-Wesley, 1984.
2. Conner, Margery, "Graphics engines," *EDN*, March 4, 1987, pg 112.

Article Interest Quotient (Circle One)
High 491 Medium 492 Low 493

SIMPLE.



System 120. The first integrated real-time system based on the AT-bus with iRMX® software.

With the addition of the System 120, Intel now offers the widest range of dedicated real-time products.

The System 120 brings the power of iRMX and the 386™ microprocessor to a cost-effective AT-bus system.

Because of iRMX, the System 120 gives you the same optimized real-time response and unique programming features already used in over half a million CPUs.

What's more, System 120 applications can migrate to the world's most popular single board computer family, Multibus® I.

Without recompiling.

Or move distributed real-time applications to Multibus II for a quantum improvement in performance and functionality. So, one development effort lets you span two orders of magnitude in performance.

To learn more about the System 120, call Intel at 800-548-4725, Dept. AA02.

It's that simple.

intel®

The World's Most Advanced Power Supply Control IC.

Programmable Current-Mode Control.

The CS-320 from Cherry Semiconductor Corporation

The CS-320. A power supply control IC so advanced it is the first to provide for unconditionally stable Hysteretic control.

The CS-320. A power supply control IC so advanced it is the world's first to offer power supply designers the option of working in any one of three modes of control: Hysteretic, Constant-Off-Time or Conventional (constant frequency).

The CS-320. A power supply control IC so advanced it offers better short circuit protection than any other control chip in the world.

Load Current Demand and Inductor Current Responses

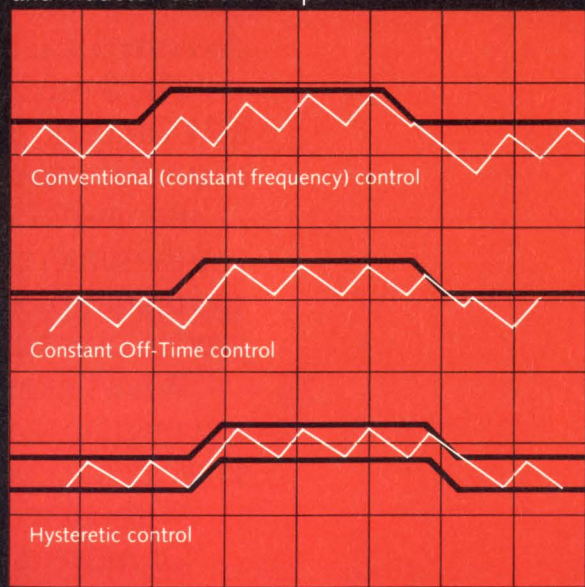

Three Types of Control

The CS-320 offers power supply designers greater range and flexibility. While conventional control can be used, Hysteretic and Constant-Off-Time are both superior. Conventional control does **not** instantaneously respond to load current demand. Hysteretic and Constant-Off-Time control, by comparison, **do** provide instantaneous response, which guarantees that the power supply will remain well-controlled and stable.

CSC™ **CHERRY SEMICONDUCTOR**

Cherry Semiconductor Corp., 2000 South County Trail, East Greenwich, RI 02818
(401) 885-3600 FAX (401) 885-5786 Telex: WUI6817157

Output Voltage Response to a 5:1 Load Change.

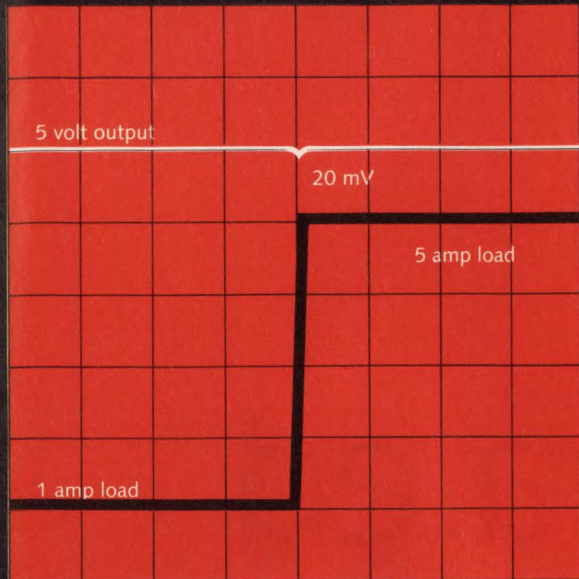

Unconditional Stability.

Hysteretic control directly controls both the peak and valley inductor current. Additionally, slope compensation is not required. A power supply using Hysteretic control is free from subharmonic oscillation and is unconditionally stable. Figure 2 shows the response of a CS-320 controlled Hysteretic DC-DC converter to a 5:1 variation in load current.

Current Runaway Prevented

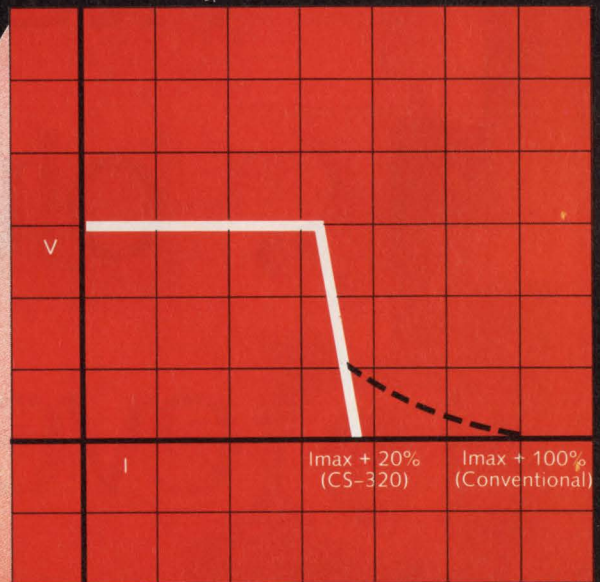

Unconventional Control of Short Circuits

The unique (patent pending) circuitry of the CS-320 prevents current runaway at or near short circuit conditions during high frequency operation.

All of these advances can be working for you, plus operation at up to 1MHz, flexible current sensing, use in parallel operation of converters without master/slave designation, and Under Voltage Lockout with a choice of start/stop thresholds.

Excellent Application Support

Cherry Semiconductor is a leading producer of power supply control ICs. In addition to product innovation, CSC is recognized for helping customers to anticipate problems, arriving at workable solutions, and effectively integrating CSC ICs into end product designs.

Call or write for more information.



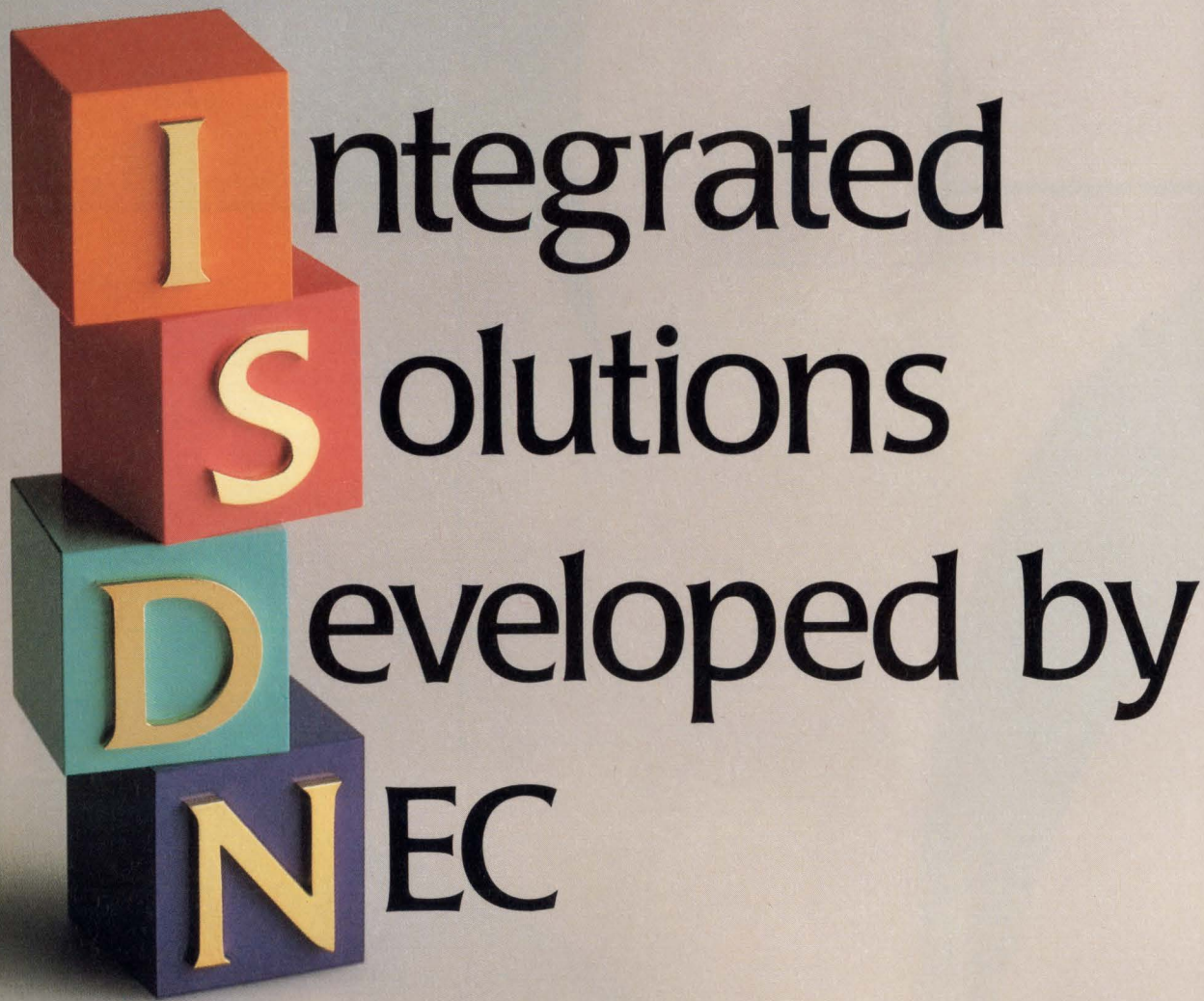

Integrated
Solutions
Developed by
NEC

For fast answers, call us at:

USA Tel:1-800-632-3531. TWX:910-379-6985.

W. Germany Tel:0211-650302. Telex:8589960.

The Netherlands Tel:040-445-845. Telex:51923.

Sweden Tel:08-753-6020. Telex:13839.

France Tel:1-3946-9617. Telex:699499.

Italy Tel:02-6709108. Telex:315355.

ISDN no longer means "I Still Don't Know". The Integrated Services Digital Network is rapidly taking shape. It's opening vast new markets. And NEC has the technology to help you exploit them.

Integrating voice, image and data into a total digital network is NEC's special area of expertise. We offer a basic set of building blocks for your ISDN system.

Five high-performance ISDN devices.

Start building your share of the ISDN future now by designing NEC's high-quality ISDN devices into your terminals or switching equipment.



Digital line interface controller: μ PD98001

- 2B + D support; Layer 1.
- 2-wire, full-duplex operation (ping-pong method).
- Communication distance: 2.5Km.
- Master/slave operation mode.

S-interface controller: μ PD98201

- Fully implements CCITT I.430; Layer 1.
- 4-wire, full-duplex operation.
- Multi-framing capability.
- Communication distance: 1Km (point to point).
- Master (NT)/slave (TE) operation mode.

LAP-D controller: μ PD72305

- Fully implements CCITT I.440/I.441; Layer 2.
- Memory-based host interface.
- On-chip DMAC.
- Basic (16Kbps)/primary (64Kbps) interface.

LAP-B controller: μ PD72107

- Fully implements CCITT X.25/X.75; Layer 2.
- Memory-based host interface.
- On-chip DMAC.
- Baud rate: 4Mbps (max).

SS No. 7 controller: μ PD72307

- Fully implements CCITT Q.703; Layer 2.
- Memory-based host interface.
- On-chip DMAC.
- Baud rate: 4.8K – 64Kbps.

Now you know.

NEC has the resources, the experience and the commitment to help you succeed in the ISDN era. If you still don't know where to find outstanding ISDN devices, call today and ask about the Integrated Solutions Developed by NEC.

Electro/89

Addressing the present and future needs of design engineers, Electro/89 features information on design, new technologies, and professional career issues.

Richard A Quinnell, *Regional Editor*

New York City is noted for offering something for every interest—at any hour of the day or night. For three days in April, the city will offer the electronics-engineering community much of interest in the form of Electro/89—eastern US's largest design-electronics trade show and convention.

An estimated 45,000 electronics engineers will converge on the Jacob Javits Convention Center, Tuesday, April 11 through Thursday, April 13, to see and hear about the latest developments in electronics technology. The show will feature more than 900 companies exhibiting their products and will offer 25 technical sessions and eight tutorials devoted to the present and future needs of electronics engineers and managers. New to the show this year will be a special exhibit area on design-automation tools.

In keeping with this year's theme, "Building a world class economy," the keynote speaker will be Dr John G Stoessinger, noted political analyst and professor of



international affairs at Trinity University in San Antonio, TX. Dr Stoessinger is a member of the Council on Foreign Relations and author of 10 books on world politics, including the Bancroft Prize-winning *The Might of Nations: World Politics in Our Time*. His topic will be "Toward new horizons in the world's economy" at the keynote breakfast to be held on Tuesday, April 11 at 9:00 AM in the Marriott Marquis. Tickets for the breakfast cost \$20.

Tracks to professional enhancement

The conference's economic theme continues in one of the six tracks along which conference organizers have arranged the professional program activities. The economic track, Entrepreneurial Activities, comprises two professional sessions. **Session 14** discusses venture capital, which is characterized as an ingredient of, but "only part of the success equation," and **session 18**



Jacob Javits Convention Center

discusses hiring consultants to attain profitability.

The Automated Design/Semiconductor/Systems track (sessions 1, 4, 5, 16, 17, 20, and 21) will bring you up to date on a variety of circuit technologies, including PLDs, RISCs, and ASICs. If you're seeking timely practical advice, you might want to attend **session 1** for a discussion of system-design techniques using ASICs, or **session 4**, which discusses high-density PLDs and their design tools. You also might consider **session 20**, which deals with in-circuit board programming. Those contemplating their next design may be interested in **session 16**, which deals with the second generation of RISC.

Microwaves, optics, and video

If your interests lie outside the digital world, you may want to follow the tracks on communications, (sessions 3, 7, and 10) or video technology, (sessions 11,

15, and 24). They will lead you to "Microwave technology," (session 3), "Fiber optics networks," (session 7), and two sessions, (11 and 15) on aspects of high-definition television.

The New Technologies track (sessions 6, 8, 13, 19, and 22) heads in the direction of tomorrow's engineering solutions. In **session 6**, you can learn the status and possible implications of high-temperature superconductors in electronics. **Session 8** introduces you to the quantum world of "Nanoelectronics," where dimensions are small enough to allow adjacent circuits to interact because their electron wave functions overlap. You may come away from **session 22** with new

Electro shuttle bus stops

The Electro shuttle bus will operate on show days from 8:00 AM to 7:00 PM. Here is a list of the shuttle stops:

- Lexington Ave at 42nd St, Grand Central Station
- 7th Ave between 51st and 52nd Sts
- 45th St, just west of Broadway
- 7th Ave at 31st St, Pennsylvania Station
- 41st St between 8th and 9th Sts (Port Authority Bus Terminal)
- 49th St and 8th Ave, northeast corner

ELECTRO PROFESSIONAL-PROGRAM SCHEDULE

TUESDAY APRIL 11, 1989 10 AM TO NOON	SESSION 1 SUCCESSFUL SYSTEM DESIGN TECHNIQUES USING ASICs	SESSION 2 CHALLENGES FOR THE ENGINEER IN THE NEXT DECADE	SESSION 3 MICROWAVE TECHNOLOGY	ELECTRONIC THEATER* DIGITAL VIDEO INTERACTIVE SYSTEMS	SESSION 4 HIGH DENSITY PROGRAMMABLE LOGIC DEVICES AND THEIR DESIGN TOOLS	TUTORIAL SUPERCONDUCTORS IN INSTRUMENTATION AND STANDARDS 9 AM TO NOON
1:30 PM TO 3:30 PM	SESSION 5 16/32 BIT MICROCONTROLLERS—SOFTWARE AND HARDWARE FEATURES	SESSION 6 SUPERCONDUCTIVITY: TECHNOLOGY/ APPLICATIONS	SESSION 7 FIBER OPTICS NETWORKS	ELECTRONIC THEATER ACM/SIGGRAPH REVIEW	SESSION 8 NANOELECTRONICS	TUTORIAL LEGAL CHALLENGES TO MANAGING THE WORKPLACE 1 PM TO 4:30 PM
WEDNESDAY APRIL 12, 1989 10 AM TO NOON	SESSION 9 OPPORTUNITIES FOR EXPERIENCED ENGINEERS	SESSION 10 NEW TRENDS IN MICROWAVE, MILLIMETER-WAVE AND PHOTONIC DEVICE TECHNOLOGY	SESSION 11 PROGRAM PRODUCTION IN HIGH DEFINITION TELEVISION	ELECTRONIC THEATER* HIGH TECH VIDEOS	SESSION 12 WOMEN IN ENGINEERING	TUTORIAL INTELLECTUAL PROPERTY FOR ENGINEERS AND MANAGERS 9 AM TO 12:30 PM
1:30 PM TO 3:30 PM	SESSION 13 NEW APPLICATIONS FOR ELECTRO-OPTICAL COMPONENTS	SESSION 14 VENTURE CAPITAL—AN INGREDIENT BUT ONLY PART OF THE SUCCESS EQUATION	SESSION 15 TRANSMISSION SYSTEMS FOR HIGH DEFINITION TELEVISION	ELECTRONIC THEATER ACM/SIGGRAPH REVIEW	SESSION 16 RISC: THE SECOND GENERATION	TUTORIAL FUNDING TECHNOLOGY DEVELOPMENT IN SMALL FIRMS 1 PM TO 4:30 PM
THURSDAY APRIL 13, 1989 10 AM TO NOON	SESSION 17 WHAT SHOULD YOU KNOW ABOUT VHDL, EDIF AND IGES?	SESSION 18 MANAGING FOR PROFITABILITY—THE SMART USE OF CONSULTANTS	SESSION 19 ELECTROMAGNETIC INTERFERENCE—PROBLEMS AND SOLUTIONS	ELECTRONIC THEATER* ACM/SIGGRAPH REVIEW	SESSION 20 IN-CIRCUIT BOARD PROGRAMMING	TUTORIAL HIGH-DEFINITION TELEVISION 9 AM TO 12:30 PM
1:30 PM TO 3:30 PM	SESSION 21 ADVANCED LOGIC—MEETING DESIGNER NEEDS	SESSION 22 PERSONAL COMPUTER FOR AUTOMATIC TEST AND MEASUREMENT	SESSION 23 MEETING THE NEEDS OF THE EE PROFESSION	SESSION 24 SPACE PHOTOGRAPHY	SESSION 25 OFF CAMPUS EDUCATION FOR THE WORKING ENGINEER	TUTORIAL NEURAL NETWORKS 1 PM TO 4:30 PM
						TUTORIAL TRANSFER IMPEDANCE METHOD OF MEASURING QUALITY OF EMI GASKETED JOINTS AND SHIELDING EFFECTIVENESS OF JOINTS 1 PM TO 4:30 PM

*NOON-1:30 PM EACH DAY: MISCELLANEOUS VIDEOS

Worming your way into the Big Apple

Whether you're staying in the city or just coming in for the day, the Jacob Javits Convention Center—located on 11th Ave between W 34th and W 39th Sts—is easily accessible. Both public transportation and a free Electro shuttle have stops at the center. The shuttle also has stops near hotels and transit terminals.

If you're coming in by plane, take Carey Bus from Kennedy (\$8) or from LaGuardia (\$6) Airports, or NJ Transit from Newark Airport (\$6) to the Port Authority Bus Terminal. There you can catch either a crosstown bus or the Electro shuttle to the Javits Center. If you're coming by rail to Pennsylvania Station or Grand Central Terminal, you

can catch either a crosstown bus or an Electro shuttle near the station.

The Center is served by two crosstown buses, the M-34, which runs along 34th St, and the M-42, which runs along 42nd St. Both buses stop at every block from river to river and are identified with Javits Center signs. The M-34 stops across the street from the center at 11th Ave. The M-42 stops at the north end of the center's internal roadway. The fare is \$1 in either coins or tokens and transfers to north/south bus routes are free.

If you're trying to get to Electro by car, you have a challenge ahead of you. There is no parking available at the Jacob Javits Con-

vention Center. Your best bet is to park at either the Manhattan Plaza Garage (on 42nd Street between 9th and 10th Avenues) or at the Port Authority Bus Terminal garage—accessible directly from the Lincoln Tunnel or from 40th Street. Once parked, catch either the Electro shuttle in the Port Authority terminal complex or the M-42 crosstown bus. Otherwise, it's a 10-minute walk.

An alternative to downtown parking is available if there are no afternoon baseball games scheduled. Park at either Yankee Stadium or Shea Stadium, and take the subway to 8th Ave at either 34th or 42nd. The fare is \$1.

Smart Drivers for Industrial and Automotive applications.

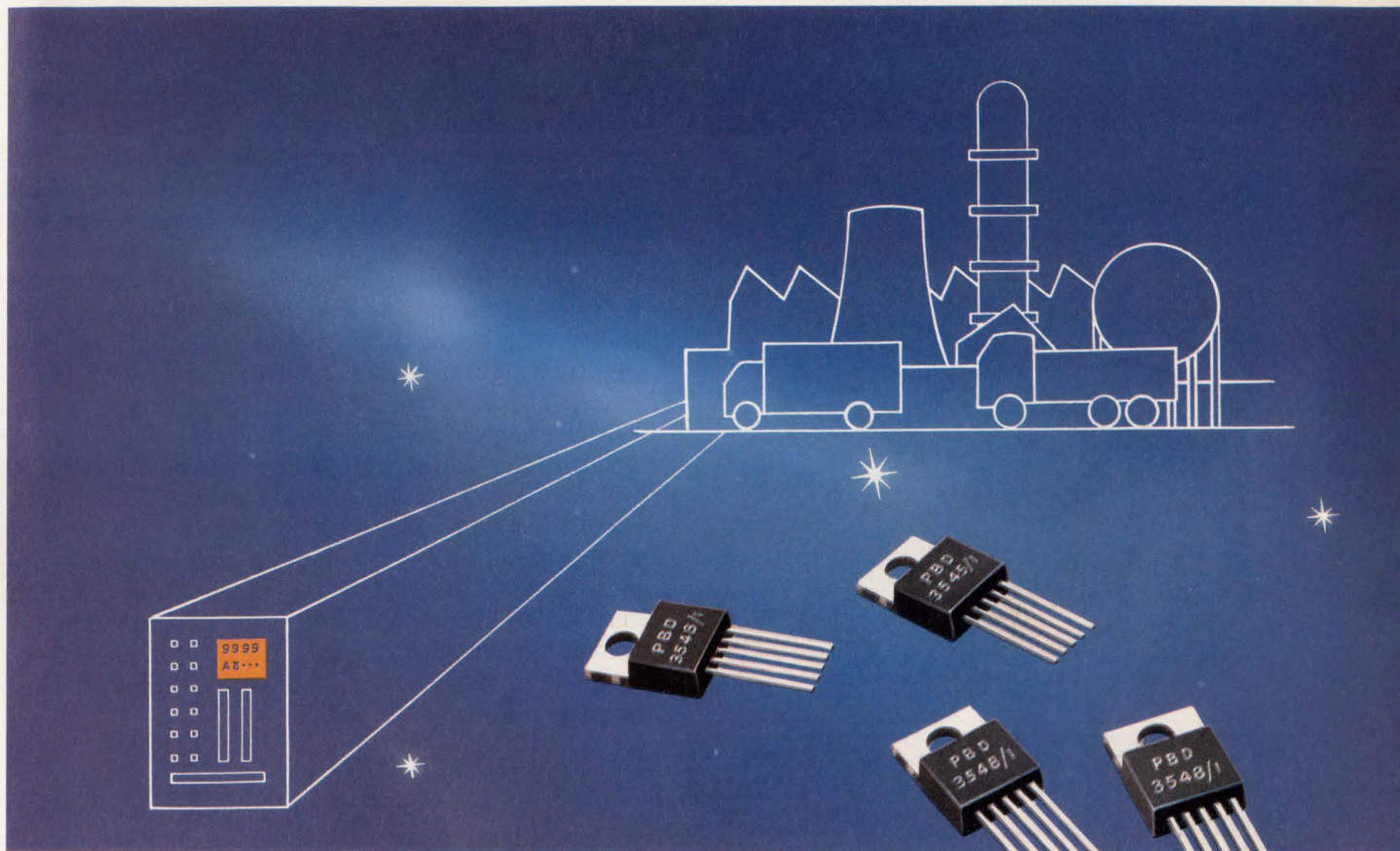

The intelligent interface for micro-controllers.

To manufacturers of automotive electronics and industrial controllers, Ericsson Components offers this latest range of compact, cost-effective, rugged Smart Drivers.

Full protection against short circuits and over-temperatures, plus open-circuit detection and error reporting in microprocessor language. Ideal for driving Solenoids, Valves, Actuators and inductive loads of all kinds.

Ericsson's experience, plus high-quality design and manufacturing, gives you intelligent, hard-working devices, built to operate in the most severe industrial and automotive environments. Don't let your controllers leave home without one. Contact us for more information.

Ericsson PBD 3545/1 (Low-side switch)
& PBD 3548/1 (High-side switch)

- ★ Efficient short-circuit protection.
- ★ Up to 2A continuous drive current.
- ★ Up to 45V supply voltage.
- ★ Built-in situation-monitoring/ERROR-reporting.
- ★ Built-in protection diodes for inductive loads.
- ★ TTL/CMOS compatible logic input.
- ★ Operating range -40°C to $+85^{\circ}\text{C}$.
- ★ Reliable, cost-effective Bipolar Design.

ERICSSON 

Ericsson Components Inc.
403 International Pkwy
Richardson, TX 75085-3904
Telephone (214) 480-8300
Telefax (214) 680-1059

We're in the lead

CIRCLE NO 83

Sampling A/Ds

DATEL's video speed sampling A/D converters give superior dynamic performance, to bring both harmonic distortion and signal-to-noise ratios to new lows.

For complete information call (508) 339-3000

Model	Sampling Rate	Effective Bits at Nyquist Frequency	THD* at Nyquist Frequency	Power Dissipation	Package	Price (1-9)
ADS-112	1MHz	11.0	-73 dB	1.3 watts	24-pin DDIP	\$259
ADS-132	2MHz	11.0	-73 dB	2.9 watts	32-pin TDIP	\$346
ADS-131	5MHz	10.6	-69 dB	4.2 watts	40-pin TDIP	\$549
ADS-130	10MHz	10.6	-69 dB	4.5 watts	40-pin TDIP	\$775

*THD (Total Harmonic Distortion)

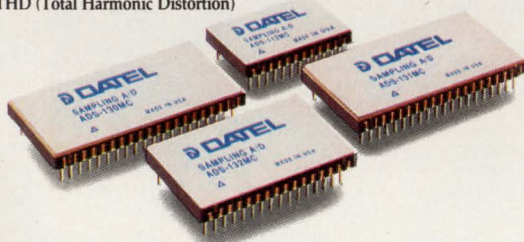

DATEL

INNOVATION AND EXCELLENCE IN PRECISION DATA ACQUISITION
DATEL, Inc., 11 Cabot Boulevard, Mansfield, MA 02048 (508) 339-3000
See us at ELECTRO/89 Booth 1704
CIRCLE NO 84

Featuring the newest line of Instrument Cases from Hammond

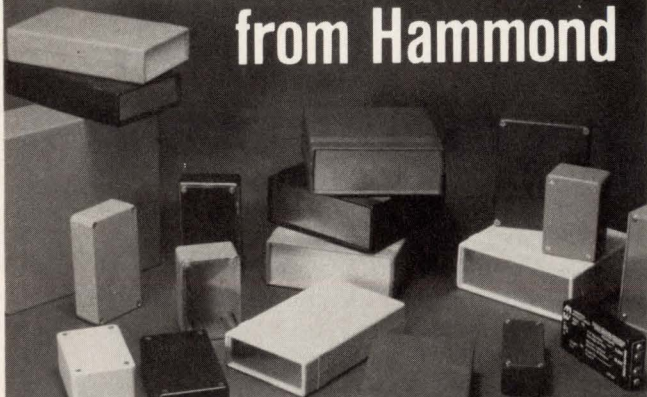

New 1598 plastic instrument cases are the latest in our line of plastic and diecast boxes. Don't pay for expensive tooling, we have the lowest prices on volume under 20,000 pieces. We'll also do your custom punching and screening. Send for FREE brochure or contact us for volume pricing.



HAMMOND
MANUFACTURING™

1690 Walden Ave.
Buffalo, N.Y. 14225

Tel: (716) 894-5710
Fax: (716) 894-1156

Electro/89

ideas for using a "personal computer for automatic test and measurement."

Because an engineer's career is not based on technology alone, you may wish to follow the Professional and Personal Concerns track (**sessions 2, 9, 12, and 25**). **Session 2** focuses on personal career development and management. **Session 9** explores "Opportunities for experienced engineers," and **session 12** examines the special concerns of "Women in engineering." You may also want to hear EDN's Jon Titus, along with IEEE officers and the editors of other publications at **session 23**, "Meeting the needs of the EE profession."

In addition to the professional sessions, Electro/89 will offer eight tutorials, covering a variety of subjects. Some tutorials of particular interest to EDN readers are "Neural networks—Models and hardware implementation," held Thursday, April 13 at 1:00 PM, and "Fiber optic communications," scheduled for Wednesday, April 12 at 9:00 AM. Tutorials are not covered by the show's registration fee, however. They range in price from \$70 to \$285.

Don't forget the exhibits

When you are done with the professional program, you'll still have time to explore the exhibitors' booths on the convention center's main floor. The exhibits are open from 9:30 AM to 6 PM on Tuesday and Wednesday, and 9:30 AM to 4 PM on Thursday. Included in the exhibits are products in a category new to Electro—design-automation tools. A cluster of more than 50 exhibitors will provide an automated design center where you can try out new developments in this growing field.

Whatever your interests, Electro/89 in New York offers something to make your day. What New York has to offer at night is yours to discover. **EDN**

Article Interest Quotient (Circle One)
High 494 Medium 495 Low 496

The comfort of analog... the power of digital.

Full 100MHz performance in a compact 15-lb scope.

The new Hitachi Real-time Storage Oscilloscopes (R.S.O.s) store signals, provide bright, flicker-free displays, deliver hard copy from a digital plotter, and capture elusive transient events with pre- or post-triggering.

And Hitachi's R.S.O.s act and feel like real-time scopes. Providing full 50 or 100MHz analog capability, the R.S.O.s can also present two saved waveforms from battery-backed memory for comparison with two waveforms of current data.

All three storage modes are automatically selected for maximum waveform fidelity with options to:

- Extract signals from noise with averaging.
- Smooth waveforms with dot-joining.
- Provide waveform insight with sine or pulse interpolation.

And these compact (the 6" CRT front panel fits on this page) ... lightweight (15.5 lbs.) high performance ... popular R.S.O.s are priced right: VC6045-100MHz, 40Ms/s, 2KW/channel @ \$3,295, VC6025-50MHz, 20Ms/s, 2KW/channel @ \$2,195.

Find out more about the R.S.O. benefits by calling or writing **Hitachi Denshi, America, Ltd.**, 175 Crossways Park West, Woodbury, NY 11797. 516-921-7200. LA area 213-328-6116. Dallas area 214-233-7623.



Hitachi Denshi, Ltd.
Tokyo, Japan.

DIMENSIONS: 5.1" H x 10.8" W x 14.2" D

CIRCLE NO 87

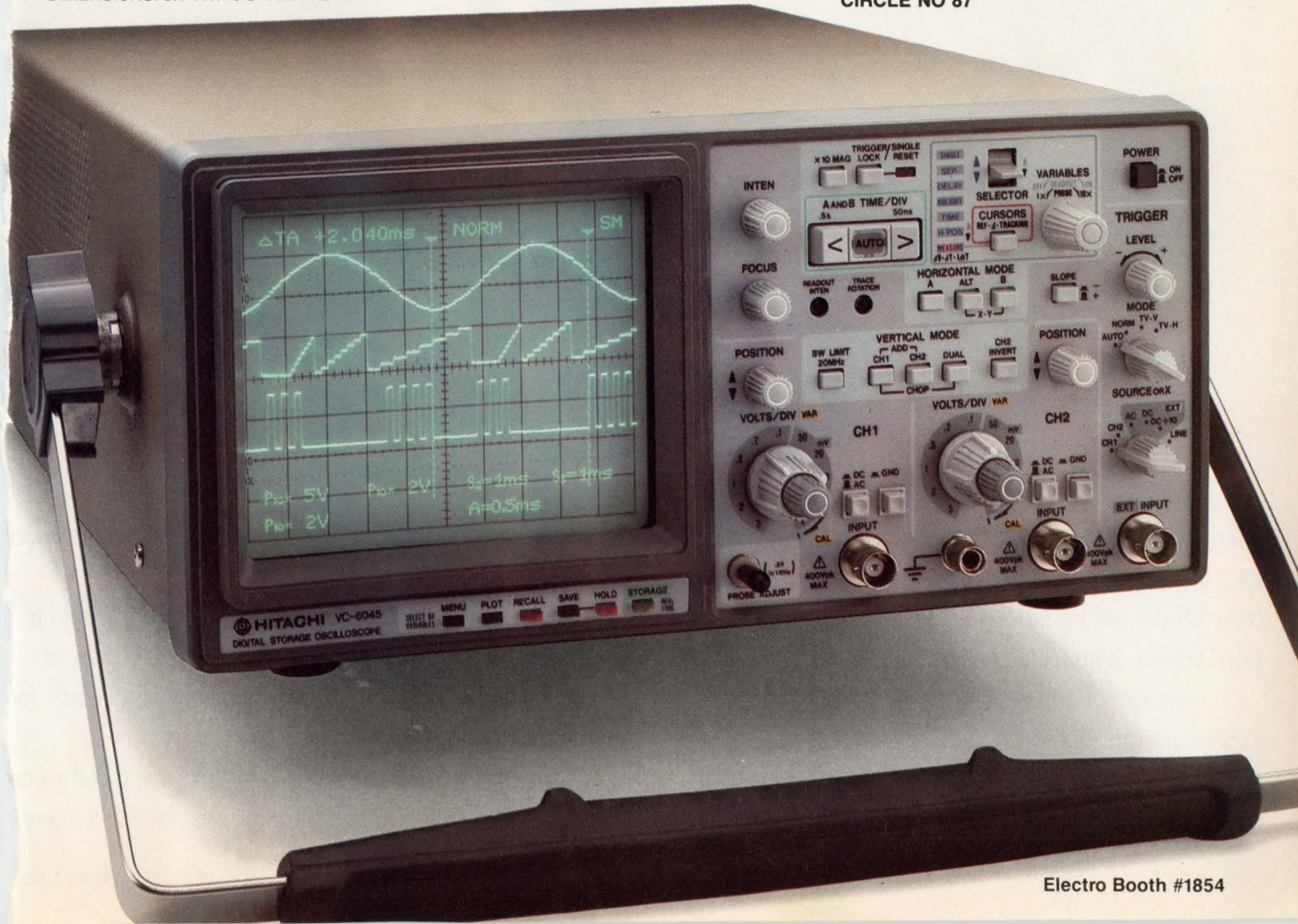

The most uninhibited vacuum in history.



Four and a half years ago, Freedom™ was nothing more than a great idea. Today it's a great product. The world's only full-size vacuum that operates totally cord-free. Only from Eureka. With a little help from Gates Energy Products.

Freedom offers everything you'd ever expect from a Eureka upright—durability, quality and cleaning effectiveness. And, thanks to its revolutionary design, the convenience of cordlessness. Made possible by a rechargeable

Gates battery. A 12-volt, 5-amp hour sealed-lead monobattery mounted in a portable snap-in battery pack.

Of course, it wasn't easy. And some people said it couldn't be done. How, they asked, could a battery be powerful enough without being too heavy and costly for the market to bear?

But at Gates we believed in Freedom and committed our resources to making it happen. That involved many

The power that set it free.



people and years of close cooperation and hard work. The result was a battery that surpassed all others in run time and shelf life, with the light weight and affordability consumers demand.

Sure, it took time. But that's because we like being a part of your project from the beginning. With a full range of technical and applications engineering support, backed by a broad line of standard and custom-designed rechargeable

cells and batteries in both sealed-lead and nickel-cadmium. All intended to help you develop a product that really works.

At Gates we believe that great ideas deserve to become great products. Maybe that's why we're the company the idea people turn to most. So, give us a call at 1-800-627-1700. And experience the power of your great idea.



CIRCLE NO 88

The power of great ideas.



TWISTITE™

MAGNET WIRE

For superior performance and tighter control over twisted wire construction.

Developed for use in the production of custom toroid, ferrite or recording head coils, specialty audio and R.F. transformers, TWISTITE offers a number of distinct advantages.

TWISTITE is custom produced to offer a wider range of twisting construction. Manufacturing capabilities include:

- Up to 33 Twists Per Inch on fine wire.
- Twisting tolerance as tight as $\pm 1\%$.
- Tightly controlled capacitance, inductance and impedance characteristics.
- Up to 10 colors in some sizes for conductor identification.
- Huge selection of insulations: NEMA MW 1000, JW1177, 105–220°C (single through quadruple film builds).
- Wide range of sizes: 24 AWG and finer.
- Wide variety of conductor materials: copper, silver, plated conductors, and special alloys.

Call or write for your free copy of our Technical Data Booklet and Capabilities Brochure. Both contain valuable information on all wire produced and inventoried by MWS Wire Industries. Samples of TWISTITE are available upon request.



MWS

Wire Industries

31200 Cedar Valley Drive, Westlake Village, CA 91362

CALL TOLL FREE 800 423-5097

In California 800 992-8553. In L.A., 818 991-8553

TWISTITE is a trademark of MWS Wire Industries

CIRCLE NO 89

Electro/89 Products

Programmable device combines features of PLDs and programmable gate arrays

The PA7024 is the first member of a CMOS programmable-device family, PEEL (programmable electrically erasable logic) ARRAYS, which combines elements of both PLDs and programmable gate arrays. The foundation of the PA7024 is its logic-control cell (LCC).

Each LCC has four primary input lines and produces two independent output signals. LCCs contain registers that can operate as synchronous or asynchronous D, T, or JK flip-flops. The input signals for each LCC are four of 80 possible sum-of-product terms, selected by programming.

The four input signals can be used as data for the register or to clock and control the register. An LCC's two output signals are selectable from three of its input signals or the register's output signal. One

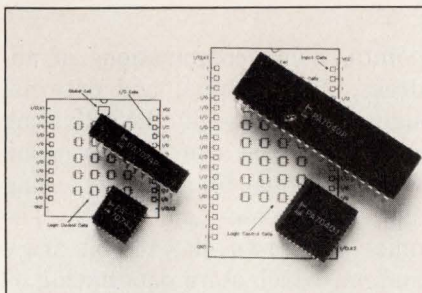

output of each LCC connects to an I/O cell, and the other is available for creating the sum-of-product terms.

The PA7024 has 20 I/O pins and two dedicated clock-input pins. Internal to the device are 20 LCCs, 20 I/O cells, and a global cell interconnected through a programmable logic matrix. The device allows you to define signals in PLD-like sum-of-product terms but, as with gate arrays, creating internally used sig-

nals does not force you to sacrifice an I/O pin.

The global cell controls selection and routing of clock signals to both the I/O cells and the LCCs. This cell can treat all cells as a single group with a common set of clocks or divide them into two independent groups. The internal clocks can operate as fast as 50 MHz. The propagation delay from one I/O pin through an LCC to another I/O pin is 23 nsec. \$22.50 (100). Samples will be available in the second quarter of 1989.

International CMOS Technology Inc, 2125 Lundy Ave, San Jose, CA 95131. Phone (408) 434-0678. TWX 910-997-1531. No booth. Product to be reviewed at session 4.

Circle No 658

100-MHz digital-storage oscilloscope travels to the field

The PM 3308 looks like a portable typewriter, but it's actually a full-featured digital-storage oscilloscope. It features a maximum single-channel sampling rate of 40M samples/sec and a sample memory of 8k bytes. The scope also has a battery-backed 180k-byte RAM-disk, allowing storage of as many as 100 setup menus and waveforms.

The oscilloscope has a 100-MHz bandwidth and two input channels. It can display as many as four traces, however, allowing simultaneous display of input signals and computed traces. The computed traces can be based on addition, subtraction, multiplication, division, integration, and differentiation of signals.



In addition to displaying waveforms, the oscilloscope allows you to make a variety of waveform measurements. These include time between reference points, voltage differences, p-p and rms voltages,

mean and average voltages across a trace, rise time, frequency, period, and phase. A glitch-capture capability registers the occurrence of transient signals that are as fast as 10 nsec. You can make all measurements either relative to a reference or as absolute values.

The unit features an electroluminescent display screen that folds down for transporting. It weighs 14.5 lbs and comes with a shoulder strap to make carrying it to field sites easier. The PM 3308 costs \$7500. Delivery, eight weeks ARO.

John Fluke Mfg Co Inc, Box C9090, Everett, WA 98206. Phone (800) 443-5853; in OR, (206) 356-6433. TLX 185102. Booth No 1559.

Circle No 657

Electro/89 Products

Emulator series supports 68020 processor with clock rates as fast as 25 MHz

The HMI-200 Series in-circuit emulators now include units that support 16- and 25-MHz 68020 microprocessors. Both units are functionally identical, differing only in operating speed. Like other members in the series, each unit operates with either a terminal or host computer controlling the unit through an RS-232C data link. The emulators have two RS-232C ports; one attaches to the controller, and the other allows data transfers such as downloading data files from a second source or printing the trace buffer's contents. The ports support data rates to 19.2k baud.

The units allow both single-step and real-time emulation of the processor. You can program as many as four complex break and trigger

points, using combinations of address, data, status, and external signal lines to specify the activating condition. You can also program four additional break points, using simple addresses and ranges. The units offer two 4k×136-bit trace buffers, which store data having 32 bits of time-tag information.

The emulators offer a number of built-in functions. For example, you can use the break points singly or in a conditional sequence to stop emulation, to trigger acquisition of data to the trace buffer, to generate an output signal for external triggering, or to measure time between break points. You can also examine and modify memory and registers, search memory for data strings, test memory, and read and write

hex files in a variety of formats.

When connected to an IBM PC- or Unix-based system, the emulators allow symbolic and source-level debugging, using the optional SourceGate software. The software supports C, PL/M, and Pascal compilers from several manufacturers. You can display source code only, source and assembly, or assembly only when reading the trace buffer.

The 16-MHz version of the HMI-200 base unit costs \$10,500, and the price of the 25-MHz version is \$16,000. Delivery, six to eight weeks ARO.

Huntsville Microsystems Inc,
Box 12415, Huntsville, AL 35802.
Phone (205) 881-6005. TWX 510-600-8258. Booth No 971.

Circle No 654

Data-acquisition mainframe communicates over IEEE-488 bus

The Model 556 data-acquisition mainframe allows you to connect a variety of digital and analog signals and controls to any computer that supports IEEE-488 communications. The mainframe can accept as many as 10 plug-in cards and present them to a host computer as a single remote instrument.

The device comprises a 10-slot card cage, a power supply, and IEEE-488 interface control logic. The unit communicates on the IEEE-488 bus as a single instrument, regardless of the number of plug-in cards inserted. To control individual cards, you must send device-dependent commands to the unit; that is, commands that include the card's location. The unit's control logic can read card identifiers,



allowing you to query the unit to determine your setup. The control logic is also compatible with test-instrument software such as LabView and Labtech Notebook.

The unit is self-contained, requiring no special controller cards in the

host computer. It supplies all needed power to the plug-in cards, providing as much as 800 mA at ±15V and 3A at 5V.

The manufacturer offers a choice of 28 boards for use in the mainframe. These boards have a variety of signal input and output characteristics and provide functions such as strain-gauge signal conditioning, thermocouple sensing, and data acquisition. You can also use boards for the Model 556 with other mainframes from the same manufacturer. The Model 556 costs \$1395.

Keithley Instruments Inc, 28775
Aurora Rd, Cleveland, OH 44139.
Phone (800) 552-1115; in OH, (216)
248-0400. TLX 985469. Booth No
2826.

Circle No 653

**YOU CAN SEE HOW
CLEAR AND BRIGHT THE PICTURE IS.**

**WHAT YOU CAN'T SEE IS
HOW FAST IT RESPONDS.**

Fast response time, less than 5 ms, gives Finlux Electroluminescent displays video capability. In laptop PCs, the cursor is visible during all rapid movements or data changes.

As for picture quality, you can see for yourself: it's worth a thousand words. Here are just a few: Crisp. Stable. Bright. Wide-angle viewing. Finlux EL is easy on the eyes, even during a long workday.

The big little EL display

The display above is shown as large as life. Just 18 mm thin and weighing less than 500 grammes, this Finlux EL shows as much text as an 11" CRT: 25 lines of 80 characters, or full graphics. Finlux EL displays are available in a range of 320x256 to 640x400 pixels.

Wherever your customers need compact clarity

Finlux EL displays are easily interfaced for high-resolution graphics, word processing, medical and industrial applications. The fully solid-state flat EL panel and electronics are assembled into a sturdy, compact package ready for mounting in even the most demanding environments.

Lohja Finlux is the only European manufacturer of flat panel Electroluminescent displays.

To see more, get in touch with:



LOHJA CORPORATION
FINLUX Display Electronics
Box 46
SF-02201 ESPOO 20, FINLAND
Telephone (+358-0) 420 01
Telecopy (+358-0) 422 143
Telex 125023 ldis sf

In the USA:
FINLUX INC.
20395 Pacifica Drive
Suite 109
Cupertino, CA 95014, USA
Telephone (408) 725-1972
Telecopy (408) 996-7547

Electro/89 Products

Universal device programmer handles all available technologies

The System 3000 simplifies your device-programming operation by giving you a single set of hardware for all your programming needs. The system can handle more than 1600 device types, including PLDs, PROMs, EEPROMs, and microcomputers. The unit has 2M bits of onboard RAM as standard and is expandable to 64M bits, allowing it to handle high-density devices.

The programming section accepts DIPs with pin counts from 16 to 40 and widths from 0.3 to 0.6 in. An optional SMD chip station handles PLCC and LCC surface-mount devices with 20- to 68-pin packages. Each pin location in the programming section has programmable voltage, current, and rise-time out-



put characteristics as well as the ability to sense conditions such as open and short circuits.

System 3000 handles all available programmable device technologies, including NMOS, CMOS, bipolar, and fuse-link memories. It reads electronic identifier bytes, when available, and retains its configura-

tion on power-down, thereby making setup and use easier. A user-inserted IC memory card contains all the device libraries and programming algorithms needed by the unit.

The unit features a built-in keyboard and CRT display that allow you to use it as a stand-alone programmer. Offering four interface ports—two RS-232C, an IEEE-488, and a handler port, the unit lets you communicate with a host computer or peripheral equipment. \$9495.

Stag Microsystems Inc, 1600 Wyatt Dr, Santa Clara, CA 95054. Phone (408) 988-1118. Booth No 2827.

Circle No 656

IBM PC-based software supports PLD design and modeling

The OrCAD/PLD and OrCAD/MOD software tools allow you to design and simulate PLD functions on an IBM PC, PC/XT, PC/AT, PS/2, or a compatible computer. The OrCAD/PLD design package is either integrated with schematic capture and simulation software or can function as a stand-alone design aid. It allows you a choice of methods for describing your design. You can use schematics, Boolean equations, truth tables, or procedural state-machine programs to define your circuit's operation. The program also supports indexed equations; as a result, counters, Gray code converters, addressable latches, and other structured designs are definable with a single equation.

The PLD package generates

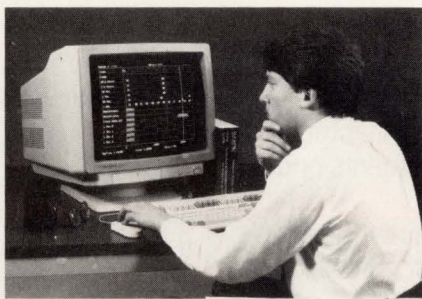

standard JEDEC files for programming a device. It also features a logic simulator, allowing you to create test-vector files for later design verification. When used as part of an integrated design package, the software allows you to back-annotate your schematic with text files that describe the PLD's function; it also automatically updates the schematic files whenever programming changes are made.

The modeling program, OrCAD/MOD, serves as an extension to the OrCAD/VST verification and simulation software. MOD allows you to create simulation models based on the PLD's definition and the JEDEC file. The program combines the design information with the structure and timing characteristics of specific PLD devices. The characteristics are stored in a library file that comes with MOD. The file contains more than 300 entries and offers utility programs for creating additional models. The software packages cost \$495 each.

OrCad Systems Corp, 1049 SW Baseline St, Suite 500, Hillsboro, OR 97123. Phone (503) 640-9488. TWX 910-240-2090. Booth No 360.

Circle No 655

Mepcopal Is Your Worry-Free Source For Surface Mount Trimmers And Switches.

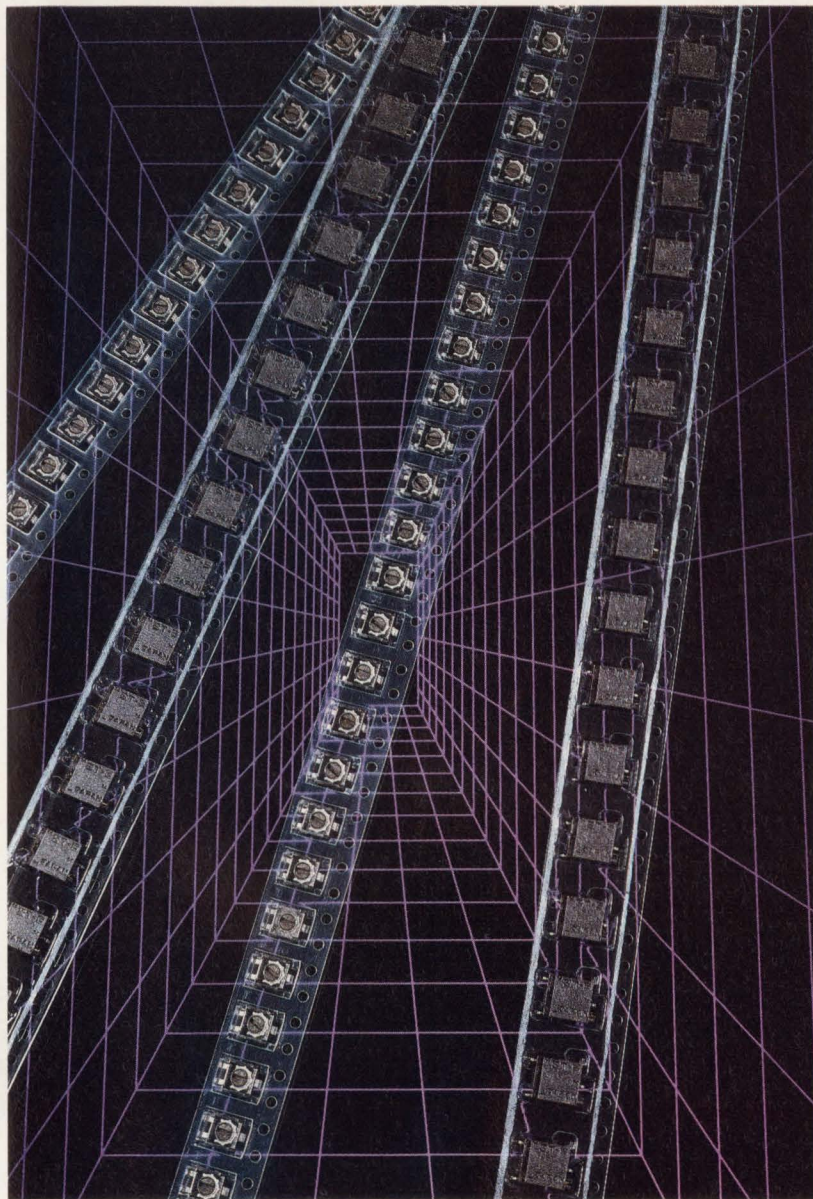

We hold the record for SMD® firsts. We were the first U.S. manufacturer to introduce SMD rotary switches and cermet trimmers. All O-ring sealed for trouble-free processing through soldering and cleaning.

No one can match our SMD expertise. Our experienced SMD product development team and state-of-the-art manufacturing techniques deliver the most reliable SMD products you can buy.

And, we've proven our reputation for SMD product innovation and quality. Formed as a joint venture between Mepco/Centralab and Copal Electronics, Mepcopal represents years of SMD experience. And we're proud to be a part of the North American Philips growing family of products.

So the next time you need quality trimmers and switches, call Mepcopal. And if you want a FREE copy of our newest catalog, call now.

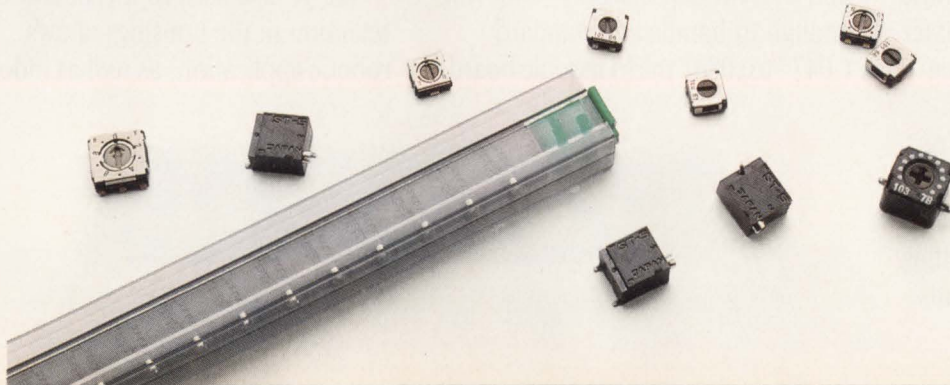

MEPCOPAL
Trimmers and Switches.

Mepcopal Company
11468 Sorrento Valley Road
San Diego, CA 92121

(619) 453-0332

FAX (619) 481-1123

Electro Booth No. 2926

SMD® is a service mark of North American Philips Corporation.

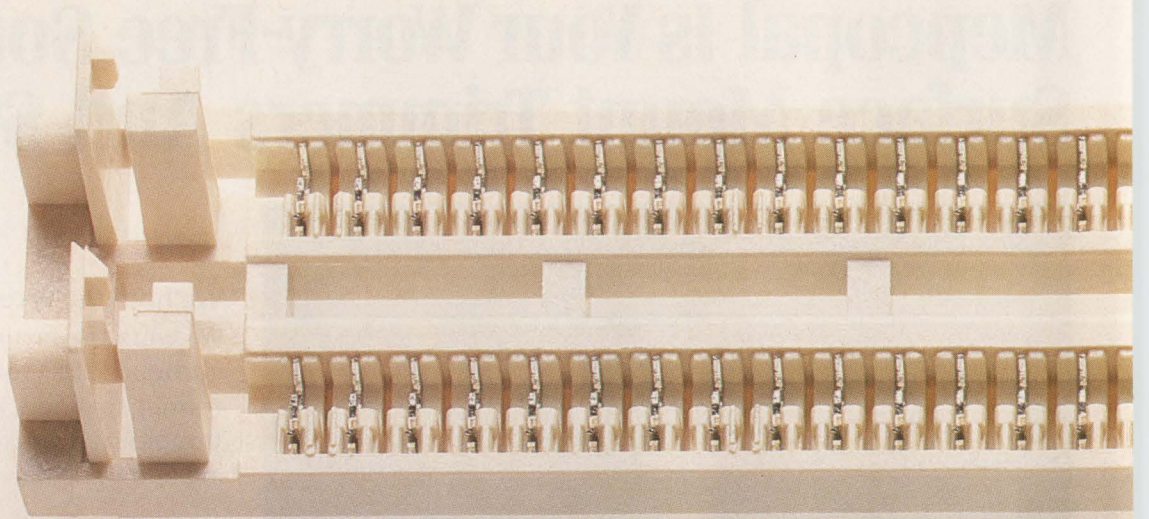

High sec

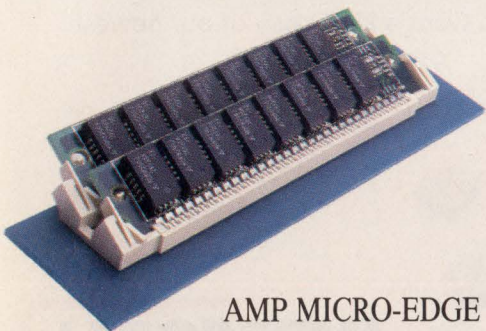

AMP MICRO-EDGE
SIMM sockets provide the highest security your memory or logic module could ask for: Each contact produces 200 grams normal force on each module pad. Minimum.

And the contacts float. They're free to move laterally, so uneven thermal expansion can't separate contacts from pads. Goodbye, fretting corrosion, opens and intermittents.

Hello, reliable performance on 100 mil and 50 mil center modules.

We've also thought about the effects of use on long-run reliability. So our MICRO-EDGE SIMM sockets provide positive wiping action during insertion. And contacts are designed to deflect up to .017", with full anti-overstress protection—forgiving enough to handle any standard (.047" to .054" thick) module board.

Over the life of your product, the socket housing can take a real beating. We've thought that through, too. Our liquid crystal polymer housings, rated for continual use at 200°C, give ramps and latches the strength and dimensional stability that promise a long, useful life.

We've also seen to it that contact retention in the housings allows robotic application, as well as inde-

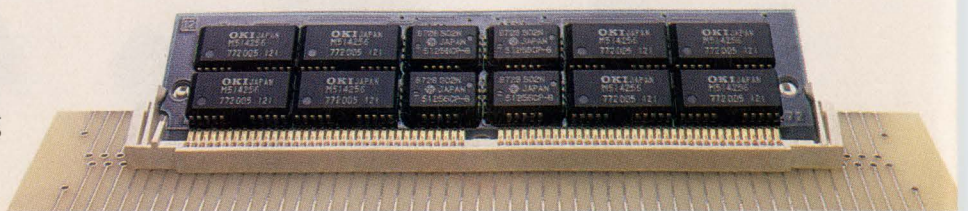

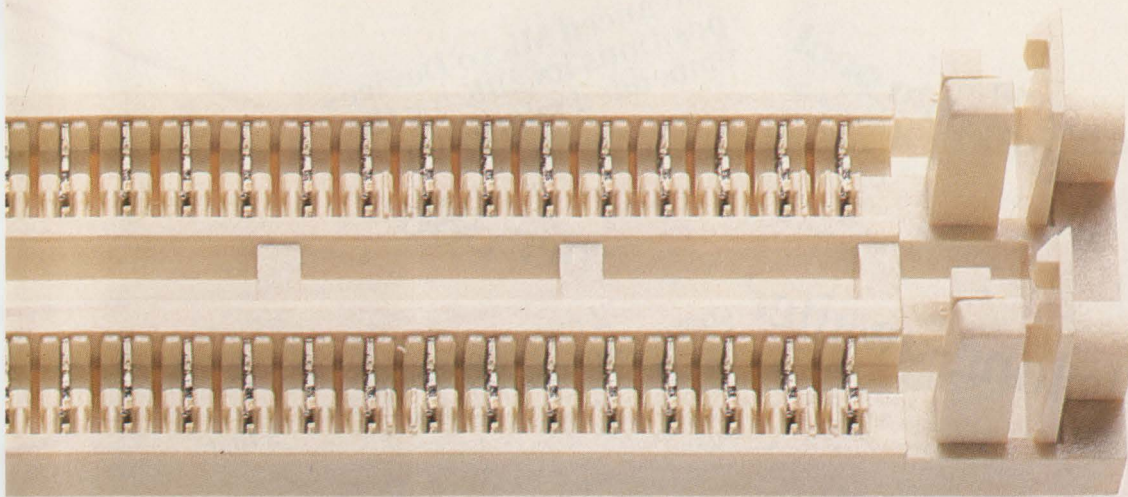

urity area.

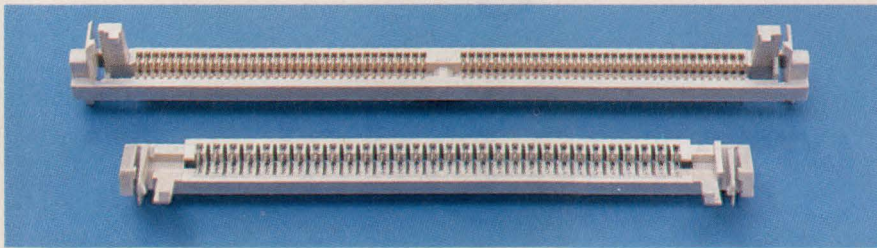

pendent repair or replacement. Closed bottom design prevents solder wicking and bridging. And, naturally, latching ears are protected against overstress, and module polarization is designed in.

Now the best part: MICRO-EDGE SIMM sockets are available in the style you need. We have .100" or .050" centerlines in a wide selection of singles and duals, vertical and slanted. Plus options, including a

choice of gold or tin on contact mating surfaces.

Our very-low-insertion-force design and high-reliability contacts make

the 50 mil versions especially attractive. *Every* version comes with the quality and support you expect from AMP.

For literature and product information, contact the AMP Information Center, toll-free, at 1-800-522-6752. AMP Incorporated, Harrisburg, PA 17105-3608.

AMP Interconnecting ideas

Signetics 68070
Moto dives into RISC chip pool

NEW YORK—Motorola finally takes its plunge into the RISC pool today as it announces its long-awaited 68070 chip set. More

chip from a semiconductor manufacturer to find a place in the computer and workstation world. Major system companies are pushing the RISC theme with own architectures, shutting the door on standard products

Advanced Micro Devices positions its 29K for the embedded micro market

AMD, with its new 29000 microprocessor, probably the most recent addition to its line of embedded microprocessors.

Intel 386

to replace the 80286 chip in many systems, they also expect the huge market for machines, particularly lower-end PCs, to be directly upgradeable to the 386 chip. But

Intel unveils long-awaited 386 micro now supported by fast coprocessor control chip

Intel Corp. of Santa Clara unveiled on Thursday its long-anticipated 'P-9' computer chip, which will create less expensive personal computer systems that run more sophisticated software.

Introduction of the new 80386SX chip, which analysts say eventually will supplant Intel's widely used 80286 chip as the "brain" of certain IBM PC and compatible computers, essentially is a marketing move that allows computer makers to offer lower-cost alternatives in their high-powered 80386-based product line.

For example, prices of computers—like the IBM 80286—range from \$4,500. Systems based like the IBM Model 486 chip—start at about \$1,500. The 80386SX chip—although more slow—the new chip also will support 8086 software, Intel said. While analysts said they expect

Although National Semiconductor's NS32532 microprocessor has a dedicated math coprocessor (the NS32381), its 1-MFLOPS floating-point calculation speed is deemed too slow for many tasks. To meet speed demands, National came up with the NS32580,

a dedicated coprocessor-control chip that ties Weitek's WTL3164 fast floating-point data path in the 32-bit 32532 microprocessor. The combination yields a peak floating-point performance of 15 MFLOPS for single- and double-precision tasks.

**Now, what about
the other 95%
of your design?**

We've got the guts!

Make us prove it. Call (800) 227-1817, ext. 982 and ask for our new capabilities brochure.

One standard. **0** defects.

Signetics

a division of North American Philips Corporation



PHILIPS

CIRCLE NO 94

© Copyright 1988 North American Philips Corporation.

Electro/89 Products

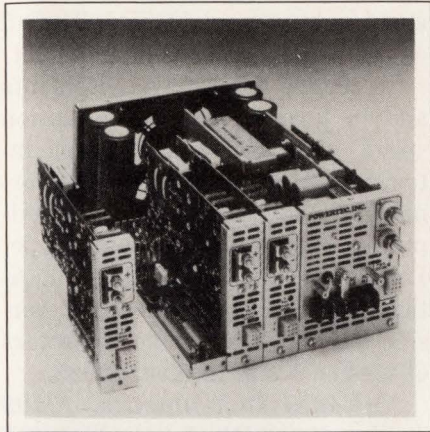

POWER SUPPLIES

Series 6A, 6B, and 6C power supplies feature a mainframe enclosure that provides the main output. The mainframe accommodates and powers as many as three auxiliary modules with 2 to 48V outputs; the overall power ratings are 600W for the 6A series, 800W for the 6B series, and 1000W for the 6C series. The main output values range from 2 to 24V; a 5V main output provides currents of 90 to 150 mA.

You can connect outputs with identical voltages in parallel, regardless of current ratings. When so configured, outputs automatically current-share in proportion to their current ratings. Standard supply features include overvoltage protection, remote sense, automatic thermal shutdown, and soft start. The units feature an EMI filter and also include reverse-voltage protection. \$939 to \$1079. Delivery, stock to eight weeks ARO.

Powertec, 20550 Nordhoff St, Chatsworth, CA 91311. Phone (818) 882-0004. TLX 277483. Booth No 313.

Circle No 659

CONNECTORS

L Series low-insertion-force (LIF) connectors provide the combination of small size and low contact resistance required for plug-in power supplies. These rugged rack-and-panel connectors are available with contacts rated for 8, 15, 25, 50, and

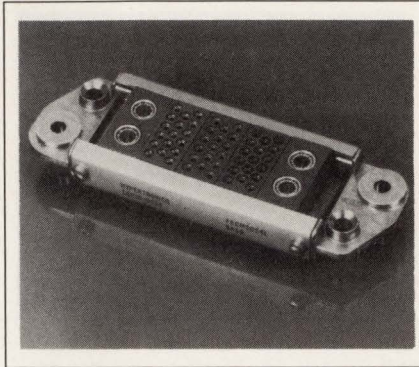

200A. The L Series product line utilizes a hyperboloid-type LIF socket. In addition to LIF, the socket design provides inherent immunity to shock and vibration. Socket contact resistance ranges from 0.25 to 2.5 m Ω . The float-mounting socket design accommodates as much as 0.049 in. of radial misalignment in blind-mating situations. The connectors are available with solder cup, crimp, and flow-solder terminations, depending on the contacts selected. The L Series units meet the performance requirements of MIL-C-28748A. \$40 to \$100 (1000). Delivery, 14 to 16 weeks ARO.

Hypertronics Corp, 16 Brent Dr, Hudson, MA 01749. Phone (800) 568-9228; in MA, (508) 568-0451. FAX 508-568-0680. Booth No 503.

Circle No 660

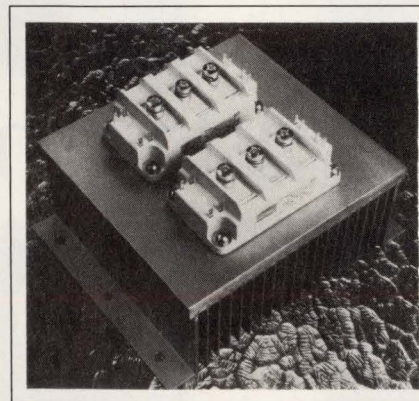

HEAT SINKS

Series 6760 heat sinks provide low thermal resistance in both natural-convection and forced-air applications. The units feature aluminum

fins that are bonded to the mounting surface with epoxy. The nine standard units in the line have hole patterns that accommodate all standard power modules.

Forced-air models will accept muffin fans that have a 4.12-in.-square mounting-hole pattern. Mounting surfaces range from 7 \times 4.78 to 16 \times 10.78 in., and thermal-resistance values range from 0.024 to 0.08 $^{\circ}$ C/W. Natural-convection models are 3.13 in. high and are available in 7- and 12-in. lengths. The heat sinks have a 7.375-in.-wide mounting surface and are available with or without mounting flanges. Thermal resistance ranges from 0.22 to 0.3 $^{\circ}$ C/W. The 7-in. natural-convection model, \$39.37 (100). Delivery, eight to 12 weeks ARO.

Aavid Engineering Inc, Box 400, Laconia, NH 03247. Phone (603) 528-3400. Booth Nos 2660 and 2662.

Circle No 661



SIGNAL GENERATORS

Models 2040 and 2045 arbitrary waveform generators convert data from 8-bit bytes to analog voltages at the rate of 800M points/sec. You can describe the desired waveforms as mathematical equations, graphics sketches, or line segments, or you can download them from a host computer. The generators feature 512,000 points of memory that you can divide into multiple segments and 78k bytes of battery-backed RAM that stores files containing polynomial waveform definitions. You can trigger the output wave-

Electro/89 Products

forms or you can synchronize them to an external source.

Both generators provide a pair of analog outputs. The 2040's outputs, which are in phase opposition, have internal impedances of 50Ω and supply a 1V p-p signal to a 50Ω load. One output of the 2045 is obtained directly from the main D/A converter, and the other passes through a programmable 64-dB attenuator and Bessel filter. Model 2040, \$13,500; Model 2045, \$14,500. Delivery, 90 days ARO.

Analogic Corp, 8 Centennial Dr, Peabody, MA 01961. Phone (508) 977-3000. FAX 508 531-1266. TLX 949307. Booth No 2812.

Circle No 663

PROGRAMMING SYSTEM

LabView version 2, an upgrade of version 1.2, has a compiler that significantly reduces the execution

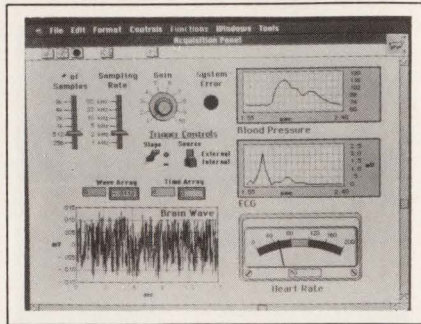

time, provides editing capabilities like rubberbanding, and offers graphics controls such as panning and zooming. This color, icon-based programming system simplifies engineering and scientific programming on Apple Macintosh computers by permitting you to design software-generated virtual instruments. You produce these instruments by drawing block diagrams that represent test and measurement functions. You then control the instruments via pictorial renditions of the types of switches, dials,

and levers you might actually find on 3-D versions of such equipment.

To reduce memory requirements and to further increase execution speed, LabView 2 adds multiple integer and floating-point data formats to 1.2 version's extended-precision floating-point data type. LabView 2 can run all the applications you've developed under version 1.2 and is available to owners of version 1.2 at no cost. \$1995.

National Instruments, 12109 Technology Blvd, Austin, TX 78727. Phone (800) 531-4742; in TX, (800) 433-3488. TLX 756737. Booth No 524.

Circle No 662

IBM PC-BOARD ROUTER

The HiWire-Plus Autorouter is a gridless, via-minimizing, multi-layer, IBM PC-based autorouter. It lets you make trace-specific design

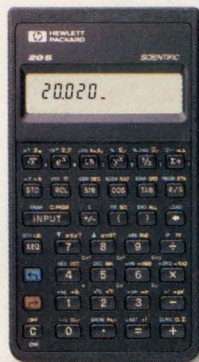

HP-20S
Scientific with program library. Algebraic. \$49.95.

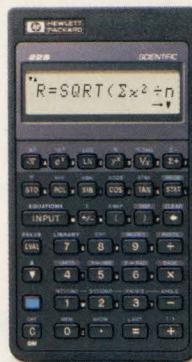

HP-22S
For science students. Algebraic. \$59.95.

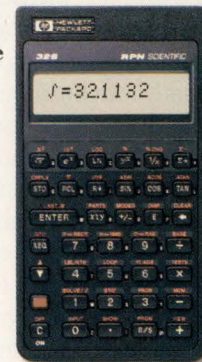

HP-32S
Integration, solver, programming. RPN. \$69.95.

In this ad is the answer to

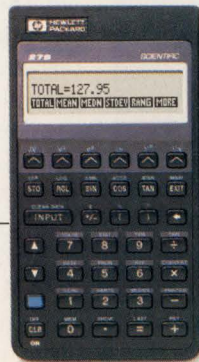

HP-27S
Scientific plus business. HP Solve. Algebraic. \$110.00.

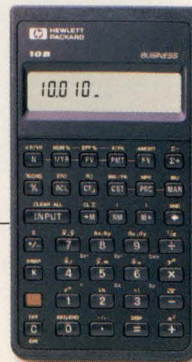

HP-10B
Business essentials. Algebraic. \$49.95.

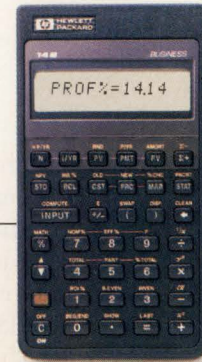

HP-14B
Specialized business analyses. Algebraic. \$79.95.

©1989 Hewlett-Packard Company PG12903

All prices suggested retail. Sweepstakes void where prohibited by law.

Electro/89 Products



rules; for example, you can tell the autorouter to route power networks with 21-mil width and 11-mil spacing, some signal traces with 12-mil width and 8-mil spacing, and other signal traces with 5-mil width and 5-mil spacing. The HiWire Plus Autorouter completes board routing; it lets traces cross each other and violate other design rules during the early stages of routing.

In subsequent phases of routing, the Autorouter optimizes, rips up, and reroutes vias for each network.

During the final passes, the router centers traces in the routing channels and further optimizes vias. For critical traces, you can prewire before starting the autorouter. To operate the HiWire Plus Autorouter, you need the HiWire Plus CAD package and an IBM PC, PC/XT, PC/AT, or PS/2 with 640k bytes of RAM. A utility program can translate FutureNet, OrCAD, Schema, and Tango netlists. \$895.

Wintex Corp, 1801 South St, Lafayette, IN 47904. Phone (800) 742-6809; in IN, (317) 742-8428. TLX 709079. Booth No 760.

Circle No 665

PROCESS METER

The model 205-P digital process meter features 0.56-in. characters and includes a power supply. It provides a 3½-digit display span. Potentiometers allow you to achieve

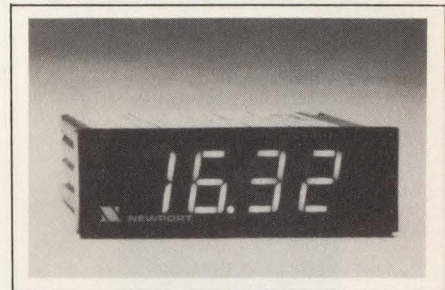

2000-count zero and span adjustments from the front of the meter's panel. The full-scale signal ranges of 4 to 20 mA, 0 to 199.9 mV, 1 to 5V, 0 to 10V, and 0 to 100V are jumper selectable. The input is true differential and features 56 dB of normal-mode noise rejection. The meter operates either from 24, 100, 115, or 230V ac or from 5 or 7 to 32V dc power sources. All power options feature EMI filtering, which prevents power-line noise from disrupting the meter reading. The meters are housed in a polycarbonate plastic case that carries a



HP-28S
Symbolic math capabilities. \$235.00.

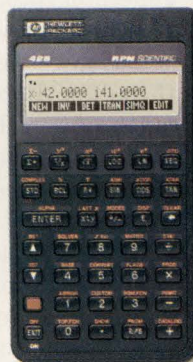

HP-42S
Superior matrix functions. RPN. \$120.00.

all your problems.

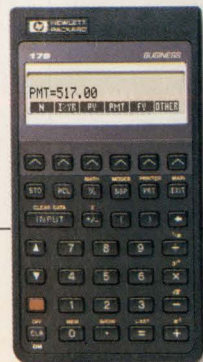

HP-17B
Broad business solutions. HP Solve. Algebraic. \$110.00.

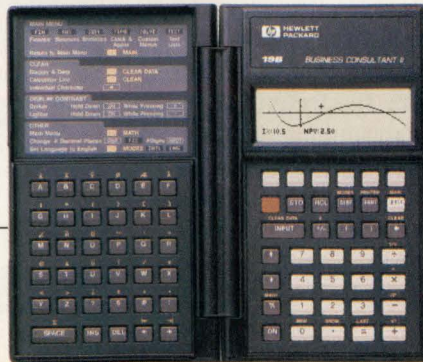

HP Business Consultant II
The Ultimate. HP Solve. \$175.00.

Whether you're an up-and-coming engineer or a recent Nobel prize winner, a business student or the CEO of a Fortune 100 company, HP offers you an entirely new series of calculators designed for your specific needs.

The most advanced scientific capabilities. Everything from numeric integration to superior matrix functions and symbolic math. HP Solve which lets you create custom menus. And the widest range of built-in business functions. Easy screen guides that lead you clearly to your solutions.

Visit our proud new family of quality HP calculators at your local retailer. Ask about our exciting Celebration Sweepstakes. But hurry, the Sweepstakes end April 30th, 1989. For the HP retailer nearest you, call 1-800-752-0900, Ext. 216T.

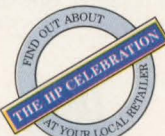

CIRCLE NO 95

DADiSP..

/EX/EX/EX/EX/EX

Now Available!!! - DADiSP/EX -
Runs 80286 and 80386-based PCs
in protected mode.
Up to 16MB addressability.

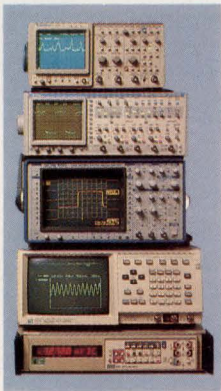

Talk to your instruments with **DADiSP-488**. Use over 150 functions to display and analyze your waveforms, as easy as typing a name. Run external data acquisition software, or *your own analysis programs*. Create new functions with DADiSP Macros.



the First Spreadsheet
designed exclusively for
Scientists and Engineers.

(617) 577-1133

Order our \$20 Interactive Demo Disk. Ask about DADiSP for IBM-PC/XT/AT, DEC MicroVAX, HP9000, Masscomp 5000, and Sun Workstations. For further information write DSP Development Corporation, One Kendall Square, Cambridge, MA 02139, (617) 577-1133



CIRCLE NO 96

Electro/89

94V-0 UL rating. Removable screw-clamp cable connectors for signal and power terminations comply with VDE and UL requirements. From \$139.

Newport Electronics Inc, 630 E Young St, Santa Ana, CA 92705. Phone (714) 540-4914. FAX 714-546-3022. TWX 910-595-1787. Booth No 2113.

Circle No 664

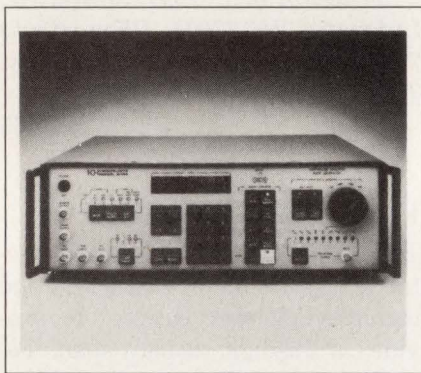

SIGNAL GENERATOR

The Model 2100A-7 synthesized function/pulse generator produces sine, square, and triangular waves as well as positive and negative programmable-width pulses. It covers the frequency range of 0.01 Hz to 31.16 MHz (to 10 MHz for pulses) with 7-digit resolution and accuracy of 0.5 ppm. The main output provides open-circuit voltages that you can set from 10 μ V to 30V p-p. You can also obtain outputs whose amplitude accuracy is 0.05 dB, as an option.

An auxiliary output supplies TTL levels. The pulse rise and fall times are <11 nsec. The unit sweeps the output frequency linearly or logarithmically between start and stop frequencies that you program. You can also vary the frequency by supplying a programming voltage. Below 30 kHz, the unit can produce bursts of 1 to 255 waveforms with start and stop points programmable in 1° increments from -90 to +267°. \$4750. Delivery, six weeks ARO.

Krohn-Hite Corp, Avon Indus-

Text continued on pg 146

TAPE MEMORY SYSTEMS



Braemar continues to refine and define the mini-cassette, standard cassette and cartridge tape market. Our latest offerings include...

MINI-CASSETTE DRIVES-

Utilizing low cost mini-cassette media, 136K memory and unbeatable pricing. These are the most reliable, cost-effective drives you can buy.

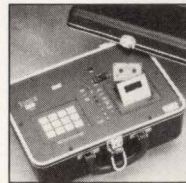
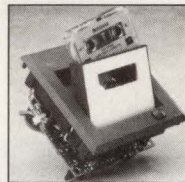

PRO-LOADER PORTABLE CASSETTE DRIVES-

Economical, self-contained, stand-alone RS 232 based

systems capable of reliable data acquisition, storage, and program loading.

CARTRIDGE TAPE DRIVES-

High speeds and high storage capacities in a 3.5" or 5.25" half height form factor. Designed for the DC 2000 cartridge media. These drives represent a breakthrough in performance, ease of integration, and user convenience.

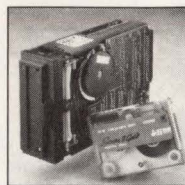

Braemar Div. of Carlisle Corp.
11400 Rupp Drive
Burnsville, MN 55337
CARLISLE (612)890-5135
TELEX 882169

For more information call:
1-800-328-2719

CIRCLE NO 155

Fluke
signals the
end of the
generation
gap.

That was then.



The Fluke 6011A Signal Generator. This innovative product featured a crystal reference oscillator, and could output frequencies from 10 Hz to 11 MHz. It signalled Fluke's major entrance into the generator market, and continued the tradition of excellence Fluke had established with their multimeter and calibration product lines for years. Introduced in the 1970's, the 6011A was Fluke's first microprocessor-based signal generator, and had an incredible 0.15 dB amplitude accuracy specification (0.07 dB typical). Even today, for certain applications, the 6011A remains to be the best signal generator available.

FLUKE



PHILIPS

This is now.

The Fluke and Philips alliance closes the gaps Fluke once had in its signal generator line. Today, you can choose from three times as many signal sources, generating a wider range of frequencies, and offering



more functions. The entire range covers frequencies from 0.0001 Hz (almost DC) to 2 GHz, and includes synthesized RF, LF and MF signal generators, function and pulse generators, and video and audio pattern generators.

6062A Synthesized RF Signal Generator. 100 kHz to 2100 MHz frequency output range, with ± 1 dB amplitude accuracy to 1 GHz, ± 1.5 dB to 2.1 GHz. Includes amplitude, frequency, phase and pulse modulation. Featured is a fast-rise 15 ns pulse modulator using gallium arsenide technology. IEEE-488 is standard.



6060B Synthesized RF Signal Generator. 10 kHz to 1050 MHz; ± 1 dB amplitude accuracy; -60 dBc spurious. IEEE-488 optional.



6061A Synthesized RF Signal Generator. 10 kHz to 1050 MHz; ± 1 dB amplitude accuracy; low SSB phase noise (-123 dBc/Hz). IEEE-488 standard.

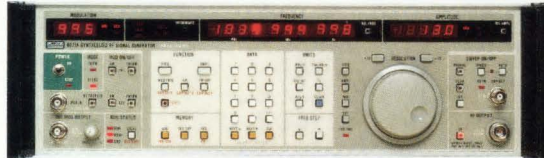

6071A Synthesized RF Signal Generator. 200 kHz to 1040 MHz; high spectral purity; AM, FM, QM modulation; precision digital sweep.



PM 5193 Programmable Synthesizer/Function Generator. 0.1 mHz to 50 MHz; full 8 digit resolution, and eight standard waveform outputs. FM, AM, GATE, SWEEP, and BURST modulation. Full IEEE-488 control.



PM 5190X Synthesized Function Generator. 1 mHz to 2.147 MHz; sine, triangle, square waveforms; TTL output.



PM 5134 Function/Sweep Generator. 1 mHz to 20 MHz; five waveforms; sweep, burst, single modes; 20Vp-p output.



PM 5132 Function Generator. 0.1 Hz to 2 MHz; five waveforms; sweep, VCO modes; variable duty cycle.



PM 5110 Low-Distortion LF Generator. 10 Hz to 100 kHz; 0.02% distortion; sine, square waveforms.

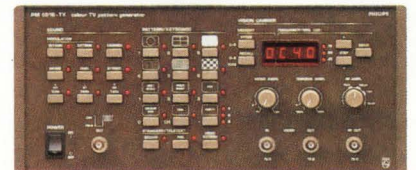

PM 5518 Color TV Pattern Generator. Covers every RF band from IF to IV/V, and cable TV. 70 patterns.



PM 5705 Pulse Generator. 0.1 Hz to 10 MHz; 15V output amplitude; 10 ns rise time; external triggering.



PM 5786 Pulse Generator. 1 Hz to 125 MHz; rise and fall times to 2 ns; external triggering.



PM 5718 Pulse Generator. 1 Hz to 50 MHz; 6 ns to 500 ms rise/fall times, 10V amplitude.

And here's the ultimate challenge: Try to find a company that gives you better service and support than Fluke.

When you buy Fluke or Philips products, you can count on getting more than the hardware you order.

Because we also deliver Fluke service and support. We stand behind every Fluke or Philips instrument we sell, and we challenge you to find anyone in the industry who consistently backs up their gear better than us.

PRODUCT SUPPORT:

- **The Best Service Warranty in the Industry.*** We warrant the entire instrument after we service it—not just the repaired portion.

- **Repair and Calibration Services.** Complete certification and reporting is standard with Fluke Service. Services meeting MIL-STD-45662 and NRC standards are also available.

- **Standard Price Service.** Select the service you need and pay a fixed price for a one-time repair or calibration.

- **Extended Warranty Service.** Provides routine calibration at regular intervals, repairs whenever they are needed, or both.

- **On-Site Service.** For those customers with large systems or special service needs.

- **Emergency 48-hour Service.** A priority service when downtime is critical.

- **Module Exchange Program.** For customers who wish to do their own board level repairs.

- **Blanket Service Agreements.** A volume discount program for customers with large numbers of different products.

- **Replacement Parts for Service.** A complete inventory of Fluke and Philips replacement parts, sub-assemblies and modules for customers who do their own repair.

- **Update Kits** to upgrade your existing instruments to newer performance specifications.

- **Pick-up and Delivery** (at selected Fluke Technical Service Centers).

- **Product Reliability Data, Manuals, and Product Change Notices** are available on Fluke and Philips products. Base sets of product change notices on Fluke products are also available on microfiche, as is an annual subscription service.

*Certain Limitations.

APPLICATION SUPPORT:

- **System Consulting and Integration** assistance on any Fluke and Philips product you are considering.

- **Applications Software Programming** with a complete factory staff of seasoned programmers.

- **Third Party Support.** More than 20 authorized, trained companies to assist in programming and integration for specialized industries and disciplines.

TRAINING SUPPORT:

- **Product Application and Maintenance Courses and Technology Principles Seminars.** Choose from 28 specialized courses on Fluke and Philips products, conducted regularly around the U.S. and Canada.

- **Customized and On-Site Training** when and where you need it.

TECHNICAL SERVICE CENTER LOCATIONS:

Burbank, CA
(213) 747-5935

Fremont, CA
(415) 651-5112

Irvine, CA
(714) 863-9031

Denver, CO (Aurora)
(303) 659-1171

Orlando, FL
(305) 896-4881

Palatine, IL
(312) 705-0500

Boston, MA (Billerica)
(508) 663-2400

Rockville, MD
(301) 770-1576

Paramus, NJ
(201) 599-9500

Dallas, TX
(214) 869-2848

Everett, WA
(206) 356-5560

Ontario, Canada
(416) 890-7600

In fact, we've invested millions in facilities, people, training and replacement parts. To provide you with the support you need in over 60 Technical Service Centers worldwide.

Here's a quick rundown of all the extras you can depend on when you buy from Fluke.

SALES OFFICE AREAS:

AL, Huntsville
(205) 837-0581

AZ, Phoenix
(602) 438-8314

*AZ, Tucson
(602) 790-9881

*CA, San Diego
(619) 292-7656

*CA, Irvine
(714) 863-9031

*CA, Burbank
(213) 849-7181

CA, Fremont
(415) 651-5112

*CA, Los Angeles
(213) 747-5935

CO, Denver
(303) 695-1000

CT, Hartford
(203) 659-3541

DC, Washington
(301) 770-1570

*FL, Clearwater
(813) 799-0087

FL, Miami
(305) 462-1380

FL, Orlando
(407) 896-4881

*FL, Tampa
(813) 251-9211

GA, Atlanta
(404) 953-4747

IL, Chicago
(312) 705-0500

IN, Indianapolis
(317) 875-7870

*LA, New Orleans
(504) 455-0814

MA, Boston
(508) 663-2400

*MD, Baltimore
(301) 792-7060

MD, Rockville
(301) 770-1570

MI, Detroit
(313) 453-3373

MN, Minneapolis
(612) 452-4264

MO, St. Louis
(314) 993-3805

NC, Greensboro
(919) 273-1918

NJ, Paramus
(201) 262-9550

*NM, Albuquerque
(505) 881-3550

NY, Rochester
(716) 323-1400

OH, Cleveland
(216) 234-4540

*OR, Portland
(503) 227-2042

*OK, Oklahoma City
(405) 236-2977

*OK, Tulsa
(918) 665-3530

PA, Philadelphia
(215) 647-9550

*PA, Pittsburgh
(412) 261-5171

*TX, Austin
(512) 459-3344

TX, Dallas
(214) 869-0311

*TX, El Paso
(915) 533-3508

*TX, Houston
(713) 240-5995

TX, San Antonio
(512) 340-0498

*UT, Salt Lake City
(801) 268-9331

WA, Seattle
(206) 881-6966

Canada (Ontario)
(416) 890-7600

Canada (Quebec)
(514) 685-0022

Canada (Alberta)
(403) 291-5215

*Tie line to another area.

**FACTORY HOTLINE:
1-800-44-FLUKE**

FLUKE

John Fluke Mfg. Co., Inc., P.O. Box C9090, M/S 250C
Everett, WA 98206
U.S.: 206-356-5400 Canada: 416-890-7600
Other Countries: 206-356-5500

© Copyright 1988 John Fluke Mfg. Co., Inc. All rights reserved. Ad no. 0191-CORP

99.9992% pure sine waves. Within 0.001 Hz.

High speed at high purity makes this easy-to-use high precision Brüel & Kjær 1051 sine generator the instrument of choice for ADC characterization, product or system calibration requiring many frequencies/levels.

With distortion less than 0.0008% (–102 dB) in the 20 Hz to 20 kHz range, and frequency accuracy +180/–0 μ Hz throughout its 1 mHz to 200 kHz operating range, the 1051 combines production-line speed with laboratory-instrument accuracy to give you the best of both in a single integrated package.

You get plenty of convenience features, too. Like easy external control (English language commands) via IEEE-488 interface, a 1024-point amplitude memory, storage of up to 9 user-defined test setups, calibrated output from 100 μ V to 5 V, accuracy within 0.05 dB from 20 Hz to 20 kHz, and six-decade log or linear frequency sweep in one continuous range with selectable upper and lower limits.

For ADC characterization, Automated Test Systems, or any kind of product or system calibration application, our 1051 gives you precisely what you've always needed in a sine wave generator — precision. Coupled with what you've always wanted and never had — speed.

For complete information on the 1051 sine generator that's both pure and fast, call Brüel and Kjær today or circle reader service number.

CIRCLE NO 64

Brüel & Kjær

Sine Generator Type 1051

175.00kHz

102.3dBuV



Brüel & Kjær 
Brüel & Kjær Instruments, Inc.

185 Forest Street, Marlborough, MA 01752 USA • Telephone 508/481-7000
WORLD HQ: DK-2850 Naerum • Denmark • Tel: + 452800500 • Telex: 37316 bruka dk

Australia (02) 450-2006 • Austria 02235/7550*0 • Belgium 02-242-9745 • Brazil 11-246-8166 • Canada (514) 695-8225
• Finland (90) 8017044 • France (1) 64572010 • Federal Republic of Germany (04106) 4055 • Holland 03402-39994 • Hong Kong
5-487486 • Italy (02) 5244141 • Japan 03-438-0761 • Republic of Korea 02-554-0605 • Norway 02-787096 • Singapore 2258533 •
Spain (91) 2681000 • Sweden (08) 7112730 • Switzerland (042) 651161 • Taiwan (02) 7139303 • United Kingdom (01) 954-2366
• USA (508) 481-7000 • Local representatives and service organizations world-wide.

WORKS GREAT



LESS FILLING

Small but Tough

The STD Bus is designed for industrial applications. The small 4.5" by 6.5" format doesn't fill up too much application space and is extremely rugged.

Fills Your Order

The STD Bus offers the widest range of processors, industrial interfaces, peripherals, software and networking options of any industrial bus. These choices have made the STD Bus one of the most widely used industrial busses in the world.

A Nice Price

The STD Bus offers economy too. Its price/performance ratio is unbeatable, a real benefit for volume OEM projects.

Learn More

For more detailed product information, call the STD Manufacturers' Group at 312/255-3003 or circle the reader service number listed below.

STD
The Cost Effective
Industrial Computer

CIRCLE NO 65

Electro/89

trial Park, Bodwell St, Avon, MA 02322. Phone (508) 580-1660. TWX 710-345-0831. Booth No 1436.

Circle No 666

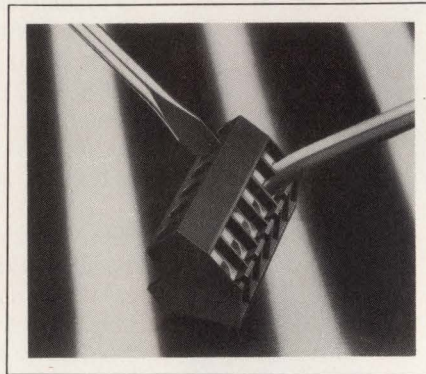

TERMINAL STRIPS

Featuring a 45° entry, Eurostyle terminal strips save space and provide easy, safe access for wiring on crowded pc boards. The 0.197-in. contact spacing provides five terminations in less than an inch. The strips have touch-proof terminals and wire-ready captive screws that won't fall out and cause shorts. The terminals have UL ratings of 15A and 300V max. Other features include wire entries that accept wires as large as #14 AWG, a closed side that acts as a wire stop, and thermoplastic insulator material that has a UL flame-retardant rating of 94V-0 and a UL temperature index of 130°C. \$0.18 (500).

Vernitron Corp, Beau Products Div, Box 10, Laconia, NH 03247. Phone (603) 524-5101. FAX 603-524-1627. TWX 710-364-1843. Booth Nos 645 and 649.

Circle No 667

8-BIT FLASH ADC

Fabricated in low-power CMOS, the ADC-208 flash A/D converter provides an 8-bit sampling rate of 20 MHz and effective bit rates to 30 MHz in the burst mode. The video flash converter operates from a 5V supply and consumes 500 mW of power. Other features include a

NEW...

A 10ns DELAY LINE FOR HIGH FREQUENCY APPLICATIONS.

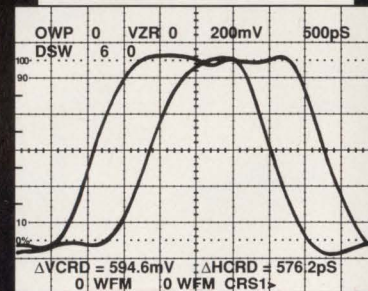
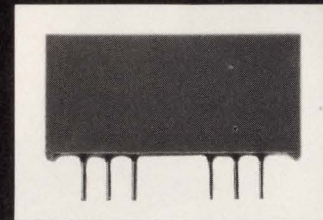

Introducing Our New Expanded Family of Delay Lines...

With...

- Controlled Impedance
- Low Attenuation
- Tight Time Delay Tolerance
- SIP & SMT Packaging

Contact Thin Film Technology
for product specifications!

TFT

Thin Film Technology Corp.
1980 Commerce Drive
N. Mankato, MN. 56001
(507) 625-8445
FAX (507) 625-3523

CIRCLE NO 66

EDN March 30, 1989

ADC574A and ADC674A A/D Converters - Lower Power, Lower Prices

New, improved 12-bit microprocessor-compatible A/D converters run cooler, last longer, cost less than ever before.

Burr-Brown's new ADC574A/674A A/D converters have been redesigned for greater economy and reliability. They are complete devices, with +10V buried-zener reference, internal current-controlled clock; 8-, 12-, or 16-bit μ processor interface; and three-state output buffers.

Key ADC574A/674A Features

- 12-bit resolution
- $\pm 1/2$ LSB max linearity error
- 450mW max, typ power dissipation
- 150ns max bus access time
- 28-pin ceramic or plastic DIP packaging
- no missing codes guaranteed for 0/+75°C and -55/+125°C specified temp ranges
- from \$15.75 in 1000s (U.S. List Price)

Ask your Burr-Brown sales representative for complete details and evaluation samples, or call Applications Engineering, 1-800-548-6132. Burr-Brown Corp., P.O. Box 11400, Tucson, AZ 85734.

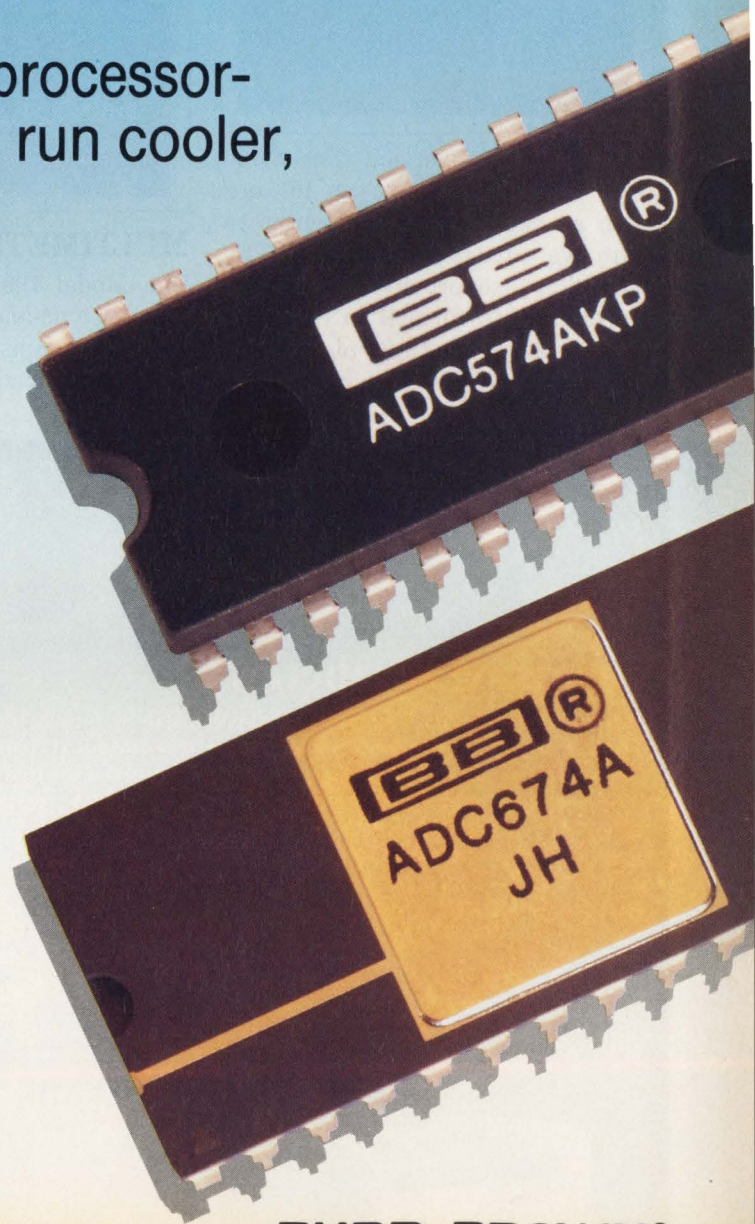

BURR-BROWN®
BB

Electro/89 Products

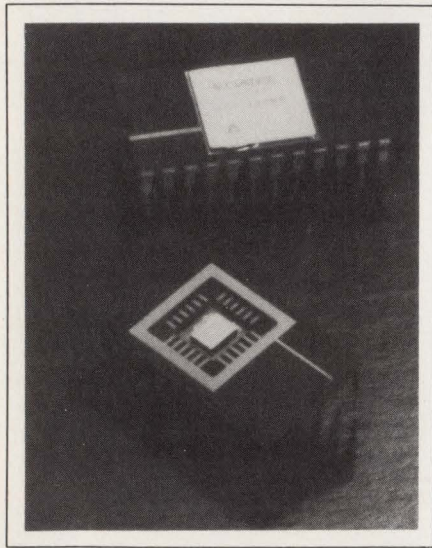

1-shot-mode conversion time of 35 nsec and a mid-point tap for use with an external voltage source to improve integral linearity. The ADC-208 also provides latched 3-state outputs for μ P interfacing. Housed in a hermetic 24-pin ceramic DIP, the device is available in both

commercial and military temperature-range versions. \$50 to \$158 (100).

Datel Inc, 11 Cabot Blvd, Mansfield, MA 02048. Phone (508) 339-3000. TWX 710-346-1953. Booth No 1704.

Circle No 668



MULTIMETER

The Model 199 digital multimeter measures dc and ac voltage, dc and ac amps, ohms, and decibels. By adding an 8-channel scanner option,

you can transform the instrument into a complete multichannel measurement system. The instrument's sensitivity specs are 1 μ V, 1 m Ω , and 100 nA, and its best 1-year dc-voltage accuracy is 0.007% of reading. You can take 150 readings/sec at a resolution of 4½ digits and store them in an internal buffer. You can trigger the readings externally.

The optional scanner, which you can install at your site, offers a switching speed of 400 channels/sec, including measurement time, 2-pole and 4-pole switching, and <1 μ V thermal offset in switch contacts. The low thermal offset lets the Model 199 accurately switch and measure low signal levels. Further, the scanner's 4-pole switching mode provides Kelvin-type (4-wire) resistance measurements. The unit can switch and take measurements across 40 channels/sec. With scanner, \$1395; without scanner, \$995.

Keithley Instruments Inc, 28775 Aurora Rd, Cleveland, OH 44139. Phone (216) 248-0400. TLX 985469. Booth No 2826.

Circle No 669

NORYL

FOAMABLE

MODIFIED PPO® RESIN

Processing Aesthetics

enhancing productivity. The new KODAK Minilab System 20 film and paper processor—reliable performance at economical cost.

All exterior panels and tank supports foam-molded. Optimal wall thickness for material savings. Outstanding strength, rigidity, UV resistance. Application-specific properties and process development—only from GE. For more information, call: **(800) 845-0600**



GE Plastics

© Trademark of GE

CIRCLE NO 68

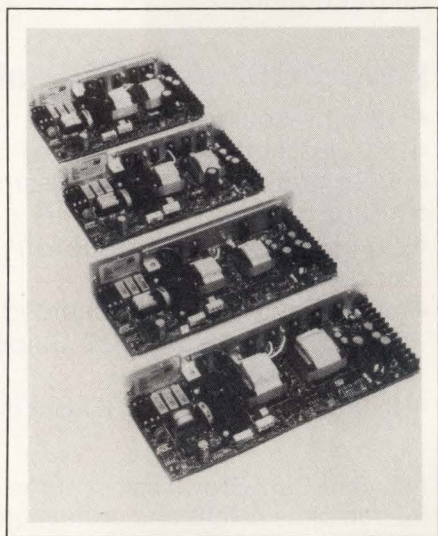

POWER SUPPLIES

The SQM International Series switchers offer a 150 to 350W continuous-output capability. All units feature peak-power capabilities to accommodate the initial turn-up/

Electro/89 Products

spin-up loads required by peripherals such as disk or tape drives and printers. The switchers feature main 5V outputs with current capabilities of 20 to 50A. Auxiliary 5, 12, 15, and 24V outputs are available with as much as 16A of peak current. All units are available with as many as four outputs.

The supplies feature built-in line filtering, 3750V ac safety isolation, shielded power transformers, built-in overload and overvoltage protection, overtemperature shutdown, remote-sensing capability, vacuum-impregnated magnetics, and fixed-frequency pulse-width modulation. You can also opt for a power-valid indicator and for TTL-high or TTL-low power-fail detection circuitry. All units meet VDE, IEC, UL, CSA, FCC, and British Telecon specifications for safety isolation and EMI/RFI emissions. \$266 to \$358. Delivery, six to 10 weeks ARO.

Switching Systems International, Box 1599, Placentia, CA 92670. Phone (714) 996-0909. FAX 714-996-2753. Booth No 2324.

Circle No 670

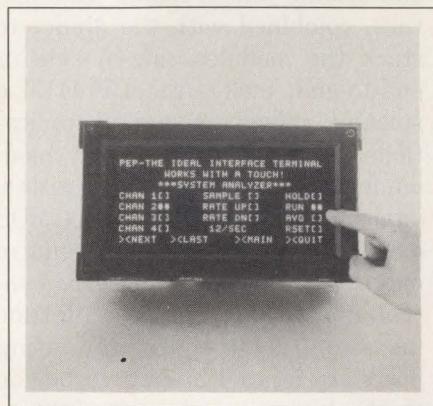

DISPLAY MODULE

The Model 4285-XX canned-message module combines an 8-line x 32-character dc gas-plasma display with an infrared touch-screen. The module provides 16k bytes of RAM, which can store as many as 127 canned messages; the memory is backed by an onboard

battery. The touch-screen IR switch matrix provides 128 switch locations. The alphanumeric display provides a 64-character ASCII character set as well as several European character sets in a 5 x 7 dot-matrix format.

The software can adjust the green or neon-orange characters to three brightness levels. The module accepts RS-232C or RS422 data at 1200 or 9600 baud. The unit supports CTS (clear to send) and DTR (data terminal ready) signals and can detect parity and rate errors in transmission. Options include mounting subpanels, drip-proofing, and EMI/RFI shielding. Neon-orange or red display, \$1089; green display, \$1242 (100).

IEE Inc, 7740 Lemona Ave, Van Nuys, CA 91409. Phone (818) 787-0311. FAX 818-902-3723. TLX 4720556. Booth Nos 2160 and 2162.

Circle No 671

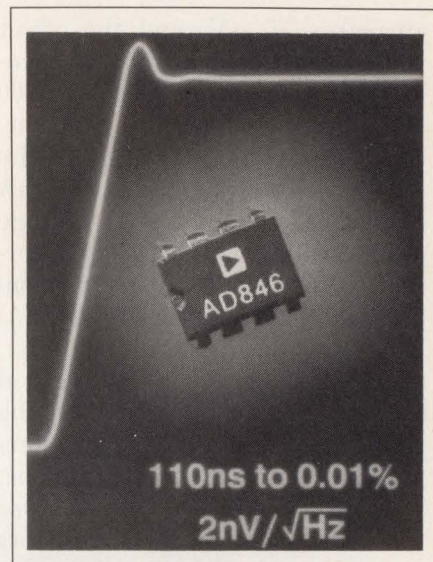

OP AMP

The AD846 op amp uses current feedback to provide a 46-MHz gain-bandwidth product at a gain of -1 and 31 MHz at a gain of -10. Settling time to 0.01% equals 110 nsec for a 10V step. The offset voltage

LEXAN

POLYCARBONATE RESIN

Processing Performance

driving end-user profitability. The economical new film and paper processor, KODAK Minilab System 20.

Interior paper rollers with extruded polycarbonate strength and durability. Unmatched impact resistance. Close point-to-point tolerances. Long-term resistance to distortion and warpage. Diverse resin technologies, unmatched creative support—only from GE. For more information, call:

(800) 845-0600

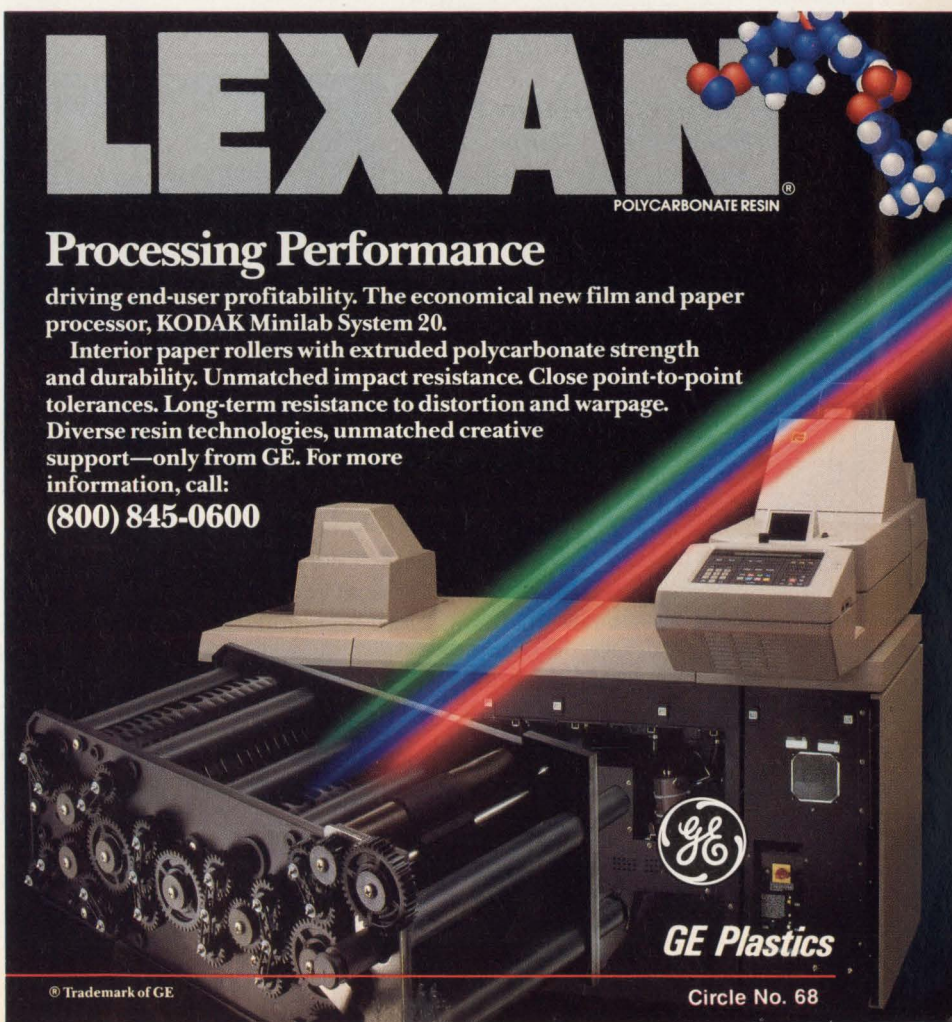

© Trademark of GE

Circle No. 68

Electro/89 Products

measures 75 μV , and the offset voltage drift is 3.5 $\mu\text{V}/^\circ\text{C}$; the open-loop transimpedance measures 200 MHz. Although the quiescent current measures only 6 mA, the AD846 delivers as much as 65 mA of output current. Input voltage noise equals 2 nV/ $\sqrt{\text{Hz}}$; input current noise for the inverting and non-inverting inputs measures 20 pA/ $\sqrt{\text{Hz}}$ and 6 pA/ $\sqrt{\text{Hz}}$, respectively.

The total harmonic distortion of 0.0005% at 100 kHz makes the AD648 well suited for high-performance audio-circuit applications. To implement the AD648, you use the source and feedback resistors to set the dc transfer function. However, the feedback resistor alone determines the closed-loop ac response. This eliminates the usual design tradeoffs between required gain and achievable bandwidth. The device is available in plastic mini-DIPs, hermetic ceramic DIPs, and hermetic metal cans. Two operating ranges are available: -40 to +85°C and -55 to +125°C. From \$7.45 (100).

Analog Devices, Literature Center, 70 Shawmut Rd, Canton, MA 02121. Phone (617) 935-5565. Booth No 2518.

Circle No 673

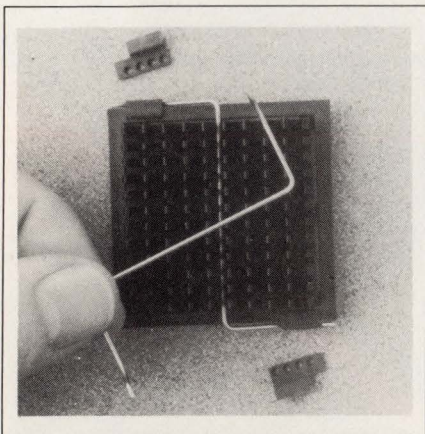

HEAT-SINK MOUNT

The E-Z Mount assembly provides a mechanical means of attaching a heat sink to a pin-grid array (PGA). Thus, it eliminates the mess and the

thermal expansion problems associated with adhesive bonding. The assembly consists of a spring clip and either a plastic frame or shoes for the PGA. You start the assembly procedure by inserting the PGA into the frame. The spring fits into the heat sink and over the ridges of the frame, securely attaching the heat sink to the PGA.

The shoes are useful when board space is tight. The two shoes slip under the four outer pins of the PGA and the spring snaps onto the shoes rather than the frame. You then wave-solder the entire assembly to the board. Mounts are available for 11x11-, 14x14-, 15x15-, and 21x21-pin PGA packages. You can use this assembly for extruded-pin or radial-machined heat sinks. 15x15-pin mount, \$0.40 (1000).

Thermalloy Inc, Box 810839, Dallas, TX 75381. Phone (214) 243-4321. TLX 203965. Booth No 3029.

Circle No 672



BOARD TESTER

Without any programming, the Model 900 Troubleshooter captures timing and intermittent faults as well as static device failures. It dynamically tests each digital IC on the unit under test (UUT) while in circuit and provides 10-nsec fault detection at data rates as high as 20 MHz. The board tester tests each IC on the UUT by comparing its performance with that of a known-good reference chip. It automati-

cally synchronizes the test device and the reference chip before beginning the test. This procedure eliminates the need to define test vectors or even to describe the devices. You simply plug in the reference chip and clip the Model 900 to the chip under test in the UUT. The unit can test standard chips from SSI to VLSI, RAM and ROM, and custom PALs, ASICs, and gate arrays. The tester is equipped with an RS-232C port and data-logging software that allows you to upload data to an IBM PC. \$7990.

John Fluke Mfg Co Inc, Box C9090, Everett, WA 98206. Phone (800) 443-5853, ext 88; in WA, (206) 347-6100. TWX 910-445-2943. Booth No 1559.

Circle No 675

DISPLAY MODULE

The Model LT1441M, a multicolor display module, uses high-luminosity LEDs to improve visibility in outdoor applications. Completely prepackaged, the module is ready to plug in, program, and play. The LEDs used in the 16x16 array are dichromatic, producing red, green, and orange-yellow colors. This feature, combined with the ability to stack the modules side-by-side or end-to-end, makes the LT1441M a suitable choice for many applications. Each LT1441M display module features a built-in shift register, latch circuits, and low-power CMOS driver ICs. The modules require only 5V of power and a serial control input. The device's lifetime measures 2000 hours. Mounting posts are located in each corner on the back of the module. \$545.20.

Sharp Electronics Corp, Microelectronics Div, Sharp Plaza, Mahwah, NJ 07430. Phone (201) 529-8757. FAX 201-529-8759. Booth No 2859.

Circle No 674

DEVELOPING CHANGE

Capture Dynamic Design, Material And Processing Creativity With GE

Solutions in total from a single source. Diverse material technologies. Copolymers, alloys, composites. Leading-edge process development. In-depth, worldwide market expertise. The exclusive Engineering Design Database—unique design and analysis tools in a total system for plastics engineering.

The innovative KODAK Minilab System 20. Blow-molded developer tanks, injection-molded racks, foam-molded panels and tank supports of NORYL[®] resin. Rollers of extruded LEXAN[®] resin.

Unmatched customer commitment, unlimited creative resources—only from GE.

For more information, call:
(800) 845-0600

CIRCLE NO 68





ESCAPE UNHARMED

With NEC Code approved cable from Manhattan.*

The heat is on! The NEC ruled that by July 1, 1988, all electronic cable installed through walls, floors or ceilings must be UL listed and meet the new fire safety requirements.

We're cable ready to meet your NEC Code needs from the industry's largest inventory. Our twelve regional sales centers are ready to ship cables that meet the requirements of installers, electrical contractors and OEM's, within 24 hours.

Call today for technical literature and ordering information on the 1987 NEC Code Cable. Escape Unharmed!



Manhattan

ELECTRIC CABLE CORPORATION

Station Plaza, Rye, New York 10580

Toll Free 1-800-228-MECC

*NEC is a registered trademark of the National Fire Protection Association, Inc., Quincy, MA.

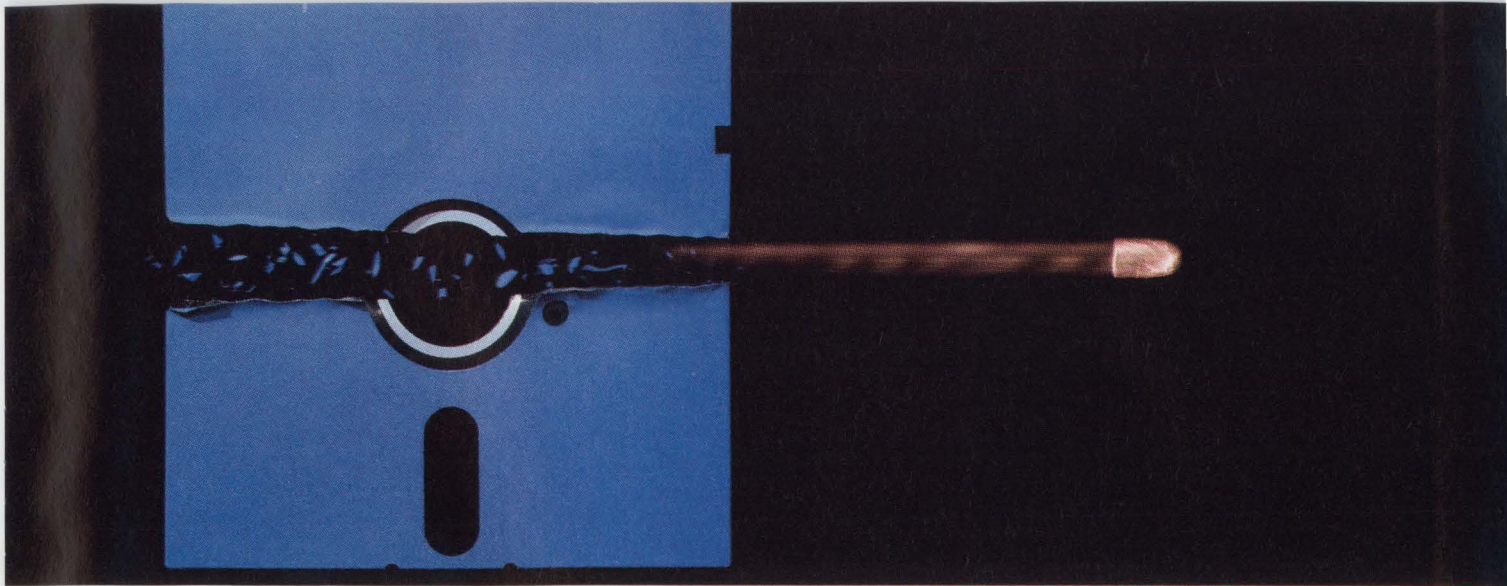

NEW AVOCET C™ FOR MICROCONTROLLERS— A BREAKTHROUGH IN SPEED AND QUALITY.

Introducing Avocet C™ Fast, *optimizing* cross-compilers that can cut microcontroller development time in half—without sacrificing code quality.

From concept to code in a fraction of the time.

Programming in C lets you concentrate on end results, not annoying details—so you get more done, faster. And rapid compilation takes the frustration out. But for microcontrollers, you need more than speed. You need tight, high-quality code.

That's why we spent two years field-testing and perfecting Avocet C for both speed and quality. We built in three separate phases of optimization—for object code tight enough for real applications. And we integrated Avocet C with an assembler package that's mature in its own right—not an afterthought. So you can still work magic at the bits-and-bytes level.

Avocet C saves you time in all phases of development. Our run-time library is extensive—no need to write the routines yourself. You'll arrive at bug-free code faster, thanks to LINT-like type checking. And your program's useful life is extended, because you can recompile for other target chips.

Testing is easier, too. Avocet C is ANSI-standard—so you can test generic parts of your program with host-resident systems like Microsoft Quick-C™ and Codeview™. And when you're ready for hardware-specific testing, Avocet's AVSIM Simulator/Debugger tests microcontroller code right on your PC.

An excellent value.

Just \$895 buys Avocet C for your favorite chip: Intel 8051 or 8096, Hitachi 64180, or Zilog Z80—with more to follow. And Avocet C includes the latest version of AVMAC—Avocet's superfast, professional assembly-language development package. *(If you're already a registered AVMAC owner, you can upgrade to Avocet C for only \$595.)*



The AVSIM Full-Screen Display

AVOCET

SYSTEMS, INC.®

THE SOURCE FOR QUALITY PERSONAL μ P DEVELOPMENT TOOLS.

Free Catalog

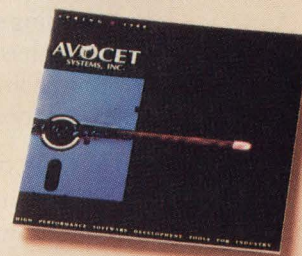

Call Toll-Free 800-448-8500*

For your free Avocet catalog—to order—for more information about Avocet C and other Avocet products.

The best technology— responsive, personal service.

Avocet offers a powerful, comprehensive approach to microcontroller development.

Avocet development tools put the most advanced technology at your fingertips. The Avocet staff stands ready to give you complete support—including technical assistance—on a moment's notice. And we'll ship your order in 48 hours or less.

Call 800-448-8500. Discover how Avocet can speed up your next project.

Avocet Systems, Inc., 120 Union Street
P.O. Box 490BP, Rockport, Maine 04855
*In Maine, or outside U.S., call (207) 236-9055
TLX: 467210 Avocet CI, FAX: (207) 236-6713

© 1988 Avocet Systems, Inc. All rights reserved. Quick-C and Codeview are trademarks of Microsoft Corp. Logo and name Avocet are registered trademarks of Avocet Systems, Inc.

MORE ADC FLASH, ie:

MP0820, MP7682, MP7683, MP7684, MP7685, MP7688, MP7690, MP7783, MP0820, MP7682, MP7

Micro Power Systems—the USA's leading supplier of CMOS flash converters—has extended its ADC flash product line to now offer you a broader selection than ever before.

Our 6 to 11 bit converters offer:

- CMOS Technology for low power consumption and high reliability
- More Surface Mount Package Options (SO, PLCC and LCC) than anyone
- Lowest differential non-linearity for accurate conversions
- High Speed Processing to 11 bits with no offset or drift

The Industry's Broadest Line of Flash ADC's

Device	Resolution (Bits)	Sampling Rate (MHz) (Typical)	DNL (+/- LSB)	Clock (MHz)	Power Dissipation (mW) (Typical)
MP7682	6	20.0	1/2 at	15.0	160
*MP7686	6	45.0	1/4 at	30.0	200
MP0820	8	0.5	1 at	2.0	80
*MP7783	8	2.5	1/4 at	2.5	75
MP7683	8	3.0	1/2 at	3.0	75
MP7690	8	20.0	1/2 at	10.0	250
MP7684	8	20.0	1/2 at	10.0	250
*MP7688	8	35.0	1/2 at	20.0	350
MP7685	11	2.0	2 at	1.0	100

*New product

Micro Power Systems' flash ADC's accommodate any board design and are TTL compatible. Their single supply operation simplifies design. Our flash converters can also provide pin compatibility, bit resolution, no missing codes, sampling rates to 30 MHz and full power bandwidths.

Micro Power offers more flash ADC's to fit your application needs:

Broadcast

- Time base correction and rebroadcast
- Video digitizing

Data Acquisition

- Environmental control
- Process control

Computer

Computer Peripherals

- FAX
- Scanner
- Disk drive
- Tape drive

Medical

- Ultrasound imaging

Micro Power Systems is the company that pioneered CMOS flash converters. We support our products with technical seminars, application assistance and an application engineering hotline. To find out more about the broadest line of CMOS flash converters available, phone (408) 562-3615 or circle the reader service card number below. Or write us at 3151 Jay St., Santa Clara, CA 95054.

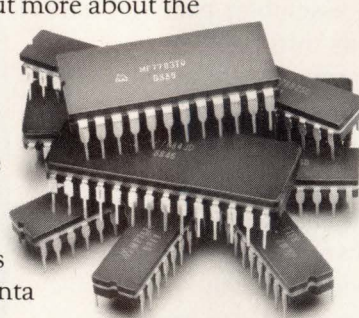
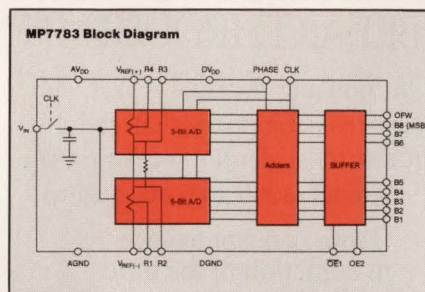

MICRO POWER SYSTEMS

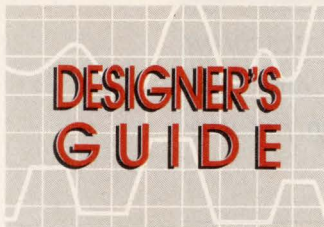

dynamic RAMs
Part 1

Unraveling the intricacies of dynamic RAMs

Although designers often prefer dynamic RAMs (DRAMs) to their static counterparts, they sometimes shy away from using DRAMs because of the devices' added complexity. This article, part 1 of a 4-part DRAM series, sheds light on some of the complex issues surrounding DRAMs and describes the different DRAM architectures. The succeeding articles will cover memory-system architectures, DRAM controllers, and DRAM-board design.

Steve Gumm and Carl T Dreher,
Texas Instruments

When constructing a memory system, designers most commonly choose the dynamic RAM (DRAM) as the basic building block. The DRAM owes its popularity to the fact that it costs less than the static RAM (SRAM), yet has a higher bit density, an advantage that stems from the DRAM's simple, tiny memory cells. It's true that DRAMs require more housekeeping than SRAMs do: The term "dynamic" implies that the data in the memory cells must continually be accessed or refreshed to ensure that the stored data is valid. Nevertheless, DRAMs' lower cost and smaller size more than make up for any deficiencies.

A designer's first encounter with DRAMs can often be intimidating. The uninitiated engineer must confront such terms as "page-mode access," "static-column

mode access," and "nibble-mode access," as well as "refresh rate," and "precharge period." The designer also faces a host of timing parameters, which can be perplexing. Even after you understand these bewildering terms, you must choose from among a vast number of options the DRAM architecture that best suits your needs.

The most common type of DRAM, which is classified as $N \times 1$, stores 1 bit of data in N addressable locations. Each device has a 1-bit input and a 1-bit output data bus. Current single-package bit densities for this family range from 16k bits to 1M bits; 256k bits is the most popular. Other less-common types include the $N \times 4$ and $N \times 8$ DRAMs, which have 4- and 8-bit data buses, respectively. Although this discussion is restricted to $N \times 1$ DRAMs, you can easily apply the information presented here to DRAMs with wider buses.

The difference between SRAMs and DRAMs

Accessing data in a DRAM is different from accessing data in an SRAM. The DRAM has a multiplexed-address arrangement, which conserves package space. To access data, a 256k-byte DRAM requires 18 addresses ($2^{18} = 256k$). To accommodate these addresses on separate pins—along with the normal complement of pins for power, control, and I/O data—would require a 24-pin package. The DRAM has nine address lines (A_0 through A_8) and two strobe lines for accessing data. Essentially, the DRAM accesses a row and a column of an array by internally latching a row address with

Even though they require more housekeeping than SRAMs do, DRAMs' lower cost and component size more than make up for any deficiencies.

the Row Address Strobe (RAS) and a column address with the Column Address Strobe (CAS). Because both addresses are multiplexed onto the same pins, 256k-bit DRAMs come in 16-pin packages and 1M-bit DRAMs come in 18-pin packages.

Besides multiplexed addressing, the most significant differences between SRAMs and DRAMs are their refresh and precharge requirements. A DRAM's memory cell consists of a storage capacitor. When a charge is placed on this capacitor for data storage, the charge must be periodically refreshed; otherwise, the capacitor will discharge, invalidating the stored data. Some of the older 16k-bit DRAMs must be refreshed every 2 msec; newer 1M-bit DRAMs specify a 10-msec refresh rate.

The DRAM's architecture simultaneously refreshes all of the column cells for a selected row every time the row is accessed. Furthermore, some DRAMs reserve the most significant bit (MSB) as a select bit for an internal multiplexer that selects data in two banks of arrays. In these DRAMs, the lower address bits access the memory cells in both banks simultaneously. This arrangement cuts the required number of refresh cycles in half. For example, a 64k-bit DRAM, which has eight row- and column-address lines, requires a

refresh cycle for only 128 rows instead of 256. Similarly, a 256k-bit DRAM requires only 256 cycles, and a 1M-bit DRAM requires only 512 cycles.

Another peculiarity of the DRAM is precharge. Performing a memory-read operation from a DRAM cell causes its capacitor to discharge slightly. Therefore, data must be written back into the cell after each read operation. This write-back operation is called "precharge" and is automatically handled by the DRAM. The time it takes to perform this operation is called the precharge period, and you must account for it when you determine the read-cycle time for the DRAM.

An $N \times 1$ DRAM has two pins, D and Q, for handling the input and output (I/O) data. In most of these DRAMs, the data-out line (Q) goes to the high-impedance state when inactive, so you can tie it to the data-input line (D) in order to handle bidirectional data. Other DRAMs require external 3-state buffers to handle bidirectional data. In order to conserve package size, $N \times 4$ and $N \times 8$ DRAMs share a set of bidirectional pins.

Perhaps the most intimidating features of DRAMs are their timing diagrams. Most of the turmoil centers on the sheer number of timing specifications and the combination of abbreviations used to describe them.

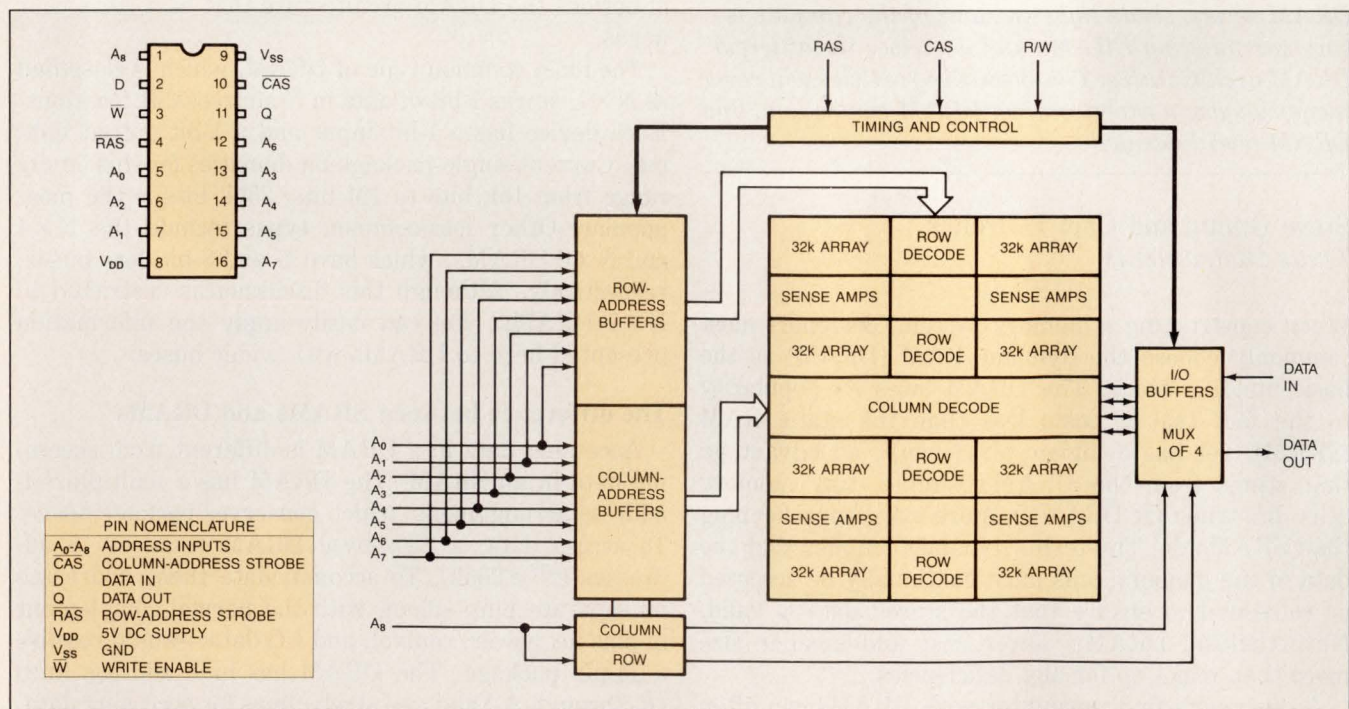

Fig 1—A DRAM's internal architecture determines which of the variety of DRAM modes it can support. The TMS4256-12 DRAM, for example, has a 4-to-1 multiplexer that can access four memory arrays to support nibble-mode access.

TABLE 1—PARAMETER ABBREVIATIONS

PARAMETER	ABBREVIATION
COLUMN OR CAS	C
ROW OR RAS	R
LOW SIGNAL	L
HIGH SIGNAL	H
ACCESS TIMES	a
HOLD TIMES	h
SETUP TIMES	su
PULSE WIDTH	w
READ OPERATION	rd
WRITE OPERATION	W
CYCLE	c
ADDRESSES	A
DATA	D

The abbreviations listed in **Table 1** will help you decipher the timing specifications. For example, the minimum pulse width during which the $\overline{\text{CAS}}$ line is low is abbreviated as "tw(CL)." The w indicates pulse width, the C indicates $\overline{\text{CAS}}$, and the L means "low." Similarly, the setup time for a row address is abbreviated as "tsu(RA)."

To accommodate a DRAM's timing requirements, the memory system requires a DRAM controller, which generates the control signals and interfaces the DRAM to the system's CPU. Some CPUs, such as the Z80, include a DRAM controller on chip. Most CPUs, however, require an external circuit that functions as the DRAM controller. The controller must coordinate the system access while guaranteeing that the DRAM is refreshed within its specified period. Ideally, the DRAM controller fools the system CPU into believing that it's communicating with an SRAM.

To use a DRAM effectively, you must pay attention to a number of timing parameters. The read cycle is probably the easiest of these parameters to understand, and it also demonstrates many of the DRAM's timing principles. **Fig 1** shows the timing parameters for a 256k-bit DRAM (the TMS4256-12).

Reading and writing

A read cycle begins when the controller issues a row address and drives the $\overline{\text{RAS}}$ line low, thus strobing the address into the DRAM. The address must be stable for tsu(RA) seconds (row-address setup time) before the falling edge of the $\overline{\text{RAS}}$ line, and it must remain stable for a minimum of th(RA) seconds (row-address hold time) after the falling edge (**Fig 2a**). The $\overline{\text{RAS}}$ line must remain low during the entire read cycle. Because the $\overline{\text{CAS}}$ line not only strobes in the column

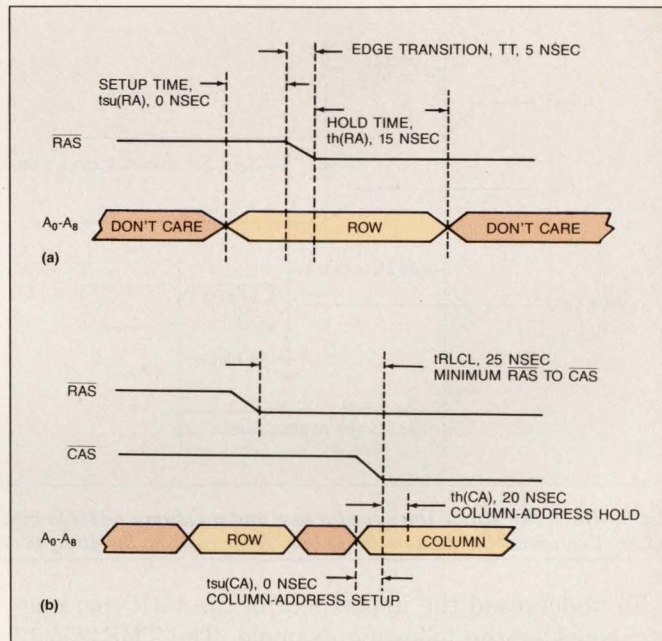

Fig 2—The timing diagrams for a DRAM's read cycle illustrate many of the device's timing constraints. The timing parameters shown here are for the TMS4256-12 DRAM's $\overline{\text{RAS}}$ (a) and $\overline{\text{CAS}}$ (b) lines, which strobe a row and a column address, respectively, into the DRAM.

address but also enables the output buffer, it should be high when strobing the row address into the DRAM. Keeping the $\overline{\text{CAS}}$ line high ensures that the Q output is in a high-impedance state.

Next, the controller must issue a column address to the DRAM. Once the column address is stable for the minimum setup time of tsu(CA) seconds, the controller drives the $\overline{\text{CAS}}$ line low to strobe the address into the DRAM. The falling edge of the $\overline{\text{CAS}}$ line should not occur any sooner than tRLCL (RAS-low to CAS-low time) seconds after the falling edge of the $\overline{\text{RAS}}$ line (**Fig 2b**). Because the $\overline{\text{CAS}}$ line also enables the output buffer, the $\overline{\text{WRITE}}$ line should be high in order to activate the read cycle when $\overline{\text{CAS}}$ is low. After the falling edge of the $\overline{\text{CAS}}$ line, there is an access delay of ta(C) seconds before the output buffer is enabled.

To ensure that the output data is valid, you must observe one more critical timing parameter, ta(R). This parameter specifies the minimum time that must elapse after the falling edge of the $\overline{\text{RAS}}$ line before the output data is valid. Even though the controller satisfies the requirements for the other delays, such as ta(C), the output data is not valid until ta(R) seconds. For this reason, manufacturers quote ta(R) when specifying a DRAM's speed.

The DRAM's multiplexed-address arrangement conserves package size.

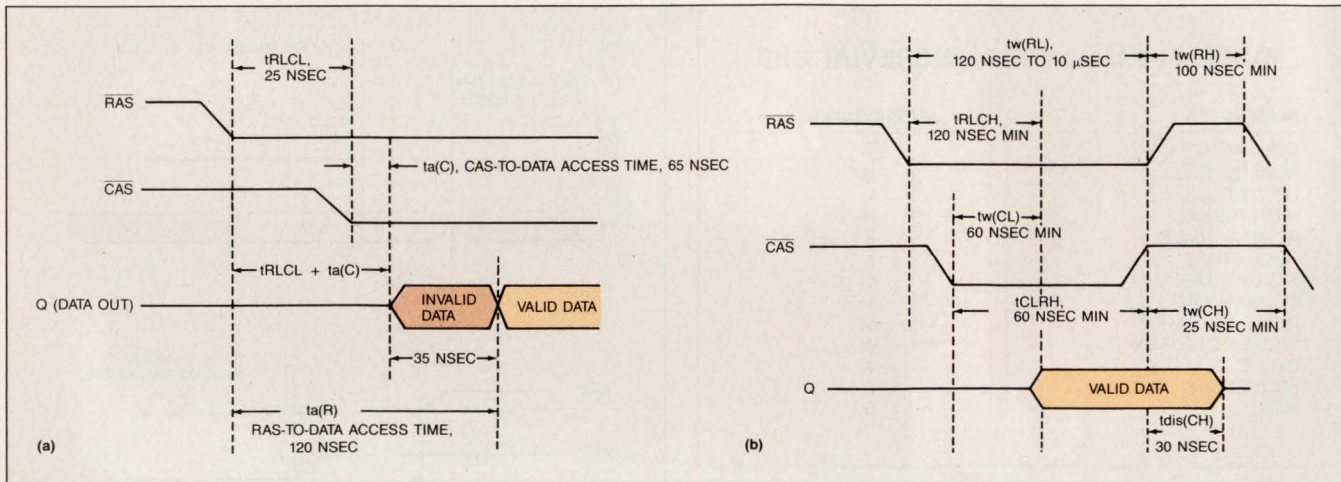

Fig 3—Once the strobe lines load a row and a column address into the DRAM, the controller must wait until the data becomes valid (a) before it can read the data on the Q bus. After reading the data, the controller resets the strobe lines high (b).

To understand the importance of the $t_a(R)$ parameter, consider the following example. The TMS4256-12 DRAM specifies a minimum time of 25 nsec for the t_{RLCL} parameter, and it specifies $t_a(C)$ as 60 nsec. Therefore, data appears at the output 85 nsec after the falling edge of the \overline{RAS} line. However, the DRAM's $t_a(R)$ specification is 120 nsec. Even though data is available at the output 85 nsec after the falling edge of the \overline{RAS} line, it is not valid until 120 nsec after the falling edge—an additional 35 nsec (Fig 3a).

To terminate the read operation, the controller must bring the \overline{RAS} and \overline{CAS} lines high. Each line, however, must remain low for a minimum pulse width ($t_w(RL)$ and $t_w(CL)$, respectively) before returning to the high state. For the TMS4256-12 DRAM, $t_w(RL)$ and $t_w(CL)$ are specified as 120 nsec and 60 nsec, respectively. In addition, the \overline{RAS} line should not return high until t_{CLRCH} seconds (CAS-low to RAS-high time) after the falling edge of the \overline{CAS} line. Similarly, the \overline{CAS} line should not return high until t_{RLCH} seconds (RAS-low to CAS-high time) after the falling edge of the \overline{RAS} line. For the TMS4256-12, t_{CLRCH} and t_{RLCH} are 60 nsec and 120 nsec, respectively (Fig 3b).

Returning the \overline{CAS} line high disables the DRAM's output buffer. However, the output line is not in a high-impedance state until $t_{dis(CH)}$ seconds (disable time after CAS-high) after the rising edge of the \overline{CAS} line. A typical value for $t_{dis(CH)}$ is 30 nsec.

Driving the \overline{RAS} and \overline{CAS} lines high does not completely terminate the read cycle. The next cycle can't begin until the DRAM automatically writes data back into the previously accessed location during the pre-

charge period. The precharge period occurs while both the strobe lines are held high for a minimum specified pulse width, $t_w(RH)$ and $t_w(CH)$. For the TMS4256-12 DRAM, $t_w(RH)$ is 100 nsec and $t_w(CH)$ is 25 nsec. Because $t_w(RH)$ is longer, you must observe it when calculating the read-cycle time.

The only restrictions placed on the \overline{WRITE} line during the read cycle are that it must be high for $t_{su}(rd)$ seconds before the falling edge of the \overline{CAS} line, and that it must remain high for $t_h(CHrd)$ seconds after the rising edge of the \overline{CAS} line. Because the TMS4256-12 specifies these times as 0 nsec, the \overline{WRITE} line must simply be high during the time that \overline{CAS} is low.

You can now piece together the timing parameters for determining the DRAM's minimum read-cycle time. Because $t_a(R)$ is longer than the sum of t_{RLCL} and $t_a(C)$ for the TMS4256-12, it dominates this portion of the cycle. The remainder of the cycle consists of the 25-nsec $t_w(CH)$, the 100-nsec $t_w(RH)$, the 60-nsec t_{CLRCH} , and 30-nsec $t_{dis(CH)}$ minimum time periods. Because all of these time periods occur simultaneously, and $t_w(RH)$ is the longest period that must be maintained, the read cycle consists of the sum of $t_a(R)$ and $t_w(RH)$, or $120 + 100 = 220$ nsec. Strictly speaking, you should add the maximum time allotted for the \overline{RAS} to make a transition between logic levels; this maximum time is specified as 5 nsec. Adding 5 nsec for each of the cycle's two transitions produces a minimum read-cycle time of 230 nsec (Fig 4).

Writing to a DRAM involves most of the same timing parameters that a read operation does. The primary difference between the read and write operations lies

in the timing parameters associated with the $\overline{\text{WRITE}}$ line. Essentially, you can use one of two methods to write to a DRAM—the early-write cycle or the delayed-write cycle. Your choice of write cycle will depend on your application (see box, “Weigh early- vs delayed-write cycles”).

The early-write and delayed-write cycles are distinguished by whether the $\overline{\text{WRITE}}$ line is asserted before or after the $\overline{\text{CAS}}$ line is asserted. During an early-write cycle, the controller drives $\overline{\text{WRITE}}$ low prior to driving $\overline{\text{CAS}}$ low. Fundamentally, the falling edge of the $\overline{\text{CAS}}$ line strobes the input data into the DRAM and acts as a reference for the address setup and hold times. During a delayed-write cycle, $\overline{\text{WRITE}}$ strobes the data into the DRAM after the controller asserts the $\overline{\text{CAS}}$ line low. The address setup and hold times are referenced to the falling edge of the $\overline{\text{WRITE}}$ line.

During a delayed-write cycle, $\overline{\text{CAS}}$ is low for a certain time while $\overline{\text{WRITE}}$ is high, so the output drivers are briefly enabled as if the DRAM were executing a read operation. Therefore, unless the memory array has separate input and output buses, the delayed-write operation can cause bus conflicts (Fig 5). In the early-write cycle, the output drivers are not enabled, because the controller asserts the $\overline{\text{WRITE}}$ line low before setting the $\overline{\text{CAS}}$ low. Therefore, you can tie the D input line directly to the Q output line in order to accommodate a bidirectional bus.

The $\overline{\text{WRITE}}$ line must remain low for at least the period specified by $t_w(W)$. (For the TMS4256-12,

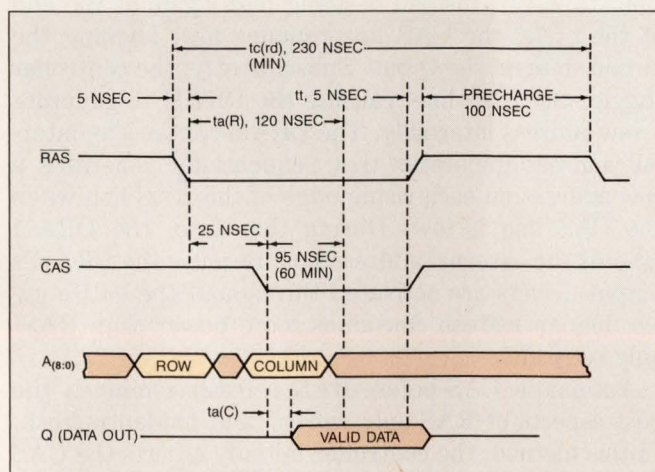

Fig 4—Before the controller can execute two successive reads, it must wait for the DRAM to refresh the previously accessed cell during the precharge period. The minimum read-cycle time for the TMS4256-12 DRAM—230 nsec—includes a 100-nsec minimum precharge period.

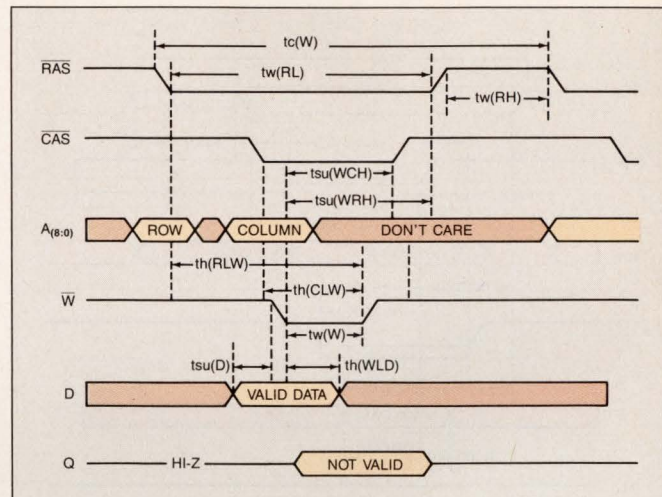

Fig 5—The timing parameters for the delayed-write cycle are appealing for many applications. However, asserting $\overline{\text{CAS}}$ while the $\overline{\text{WRITE}}$ line is high causes the DRAM's output buffers to turn on, which, in turn, causes a potential bus conflict.

$t_w(W)$ is specified as 40 nsec.) During a delayed-write cycle, the $\overline{\text{WRITE}}$ pulse must also remain low for $t_w(CLW)$ and $t_w(RLW)$ seconds after the falling edges of the $\overline{\text{CAS}}$ and $\overline{\text{RAS}}$ lines, respectively. (For the TMS4256-12, $t_w(CLW)$ is 35 nsec, and $t_w(RLW)$ is 95 nsec.) Further, the falling edge of the $\overline{\text{WRITE}}$ line must occur at least $t_{su}(WCH)$ and $t_{su}(WRH)$ seconds, respectively, before the $\overline{\text{CAS}}$ and $\overline{\text{RAS}}$ lines return to their high states. Both these setup times are specified as 40 nsec for the TMS4256-12 DRAM.

In a delayed-write cycle, the data must be stable for at least $t_{su}(D)$ seconds before the falling edge of the $\overline{\text{WRITE}}$ pulse, and it must remain stable for at least $t_w(WLD)$ seconds after the same falling edge. The TMS4256-12 specifies $t_{su}(D)$ as 0 nsec and $t_w(WLD)$ as 35 nsec. Because there is no time limit on the $\overline{\text{WRITE}}$ pulse after the $\overline{\text{CAS}}$ line is driven low, the write operation can be delayed for as long as the refresh period demands.

Don't forget to write

The difference between the early-write cycle and the delayed-write cycle lies mainly in the data setup and hold requirements. In the early-write cycle, the data must be stable for at least $t_{su}(D)$ seconds before the falling edge of the $\overline{\text{CAS}}$ line. In addition, the data must remain stable for at least $t_w(CLW)$ seconds after this falling edge and also for $t_w(RLW)$ seconds after the falling edge of the $\overline{\text{RAS}}$ line. The $t_h(CLW)$ and $t_h(RLW)$ specifications for the TMS4256-12 are 35 nsec

Besides multiplexed addressing, the most significant differences between SRAMs and DRAMs lie in the devices' refresh and precharge requirements.

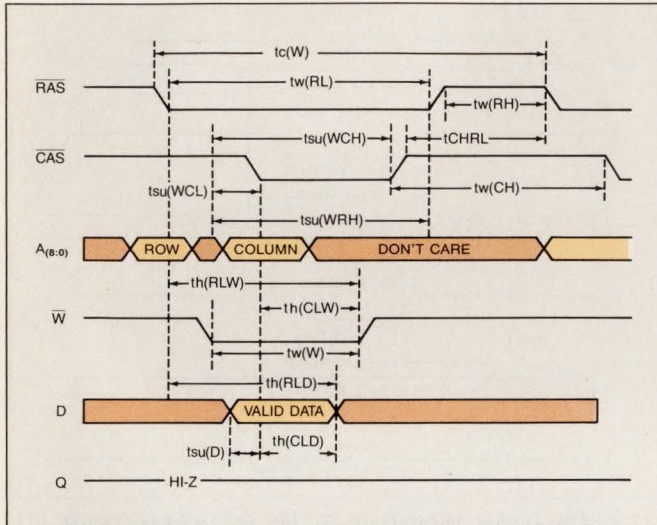

Fig 6—In the early-write cycle, the DRAM controller drives the $\overline{\text{CAS}}$ line low after it sets the $\overline{\text{WRITE}}$ line low. Therefore, the DRAM's Q-output buffers remain in the high-impedance state.

and 95 nsec, respectively. Fig 6 shows a complete early-write cycle.

Like the read-cycle time, the minimum $t_w(\text{RL})$ time exceeds the sum of the other overlapping timing parameters once the controller drives the $\overline{\text{RAS}}$ line low. Therefore, you calculate the minimum write-cycle time ($t_w(\text{W})$), by simply adding $t_w(\text{RL})$, $t_w(\text{RH})$, and the edge-transition times. The minimum write-cycle time for the TMS4256-12 is 230 nsec ($120 + 100 + 2 \times 5 = 230$). Because $t_w(\text{RL})$ is the dominant write-cycle timing parameter, the minimum write-cycle time is the same for both the early- and the delayed-write cycles.

Before you can read or write to a DRAM, the DRAM controller must execute a power-up sequence that initializes the data in the DRAM. The sequence consists of a short delay followed by a number of write cycles, which charge the memory-cell capacitors. The TMS4256 specifies the delay as 200 μsec plus eight initialization cycles. If you don't include the power-up sequence in the design, a diagnostic test will erroneously detect failures in a perfectly good memory system.

The pause that refreshes

The DRAM controller's highest priority task is to ensure that the DRAM experiences a complete refresh cycle during the specified refresh period. A refresh can occur through a read or write operation or through a specific refresh operation. The TMS4256-12 specifies a refresh period of 4 msec. Because the DRAM's inter-

nal architecture has two simultaneously addressed memory banks, the controller needs to refresh only 256 rows during the 4-msec period.

When the controller accesses a row during the refresh cycle, it must adhere to the same timing constraints that it observes for the read and write cycles. Therefore, refreshing all the rows in the TMS4256-12 DRAM takes $256 \times 230 \text{ nsec} = 58.8 \mu\text{sec}$. This worst-case refresh-cycle time (58.8 μsec) occupies 1.5% of the allotted 4-msec refresh period. Slower versions of the same DRAM have the same 4-msec refresh-period specification, but occupy a greater bandwidth because of the longer access times.

RAS-only refresh is one of a variety of methods for refreshing DRAMs. In this method, the controller holds the $\overline{\text{CAS}}$ line high while using the $\overline{\text{RAS}}$ line to strobe a row address into the DRAM. The controller remembers which rows have been accessed during a refresh period to ensure that it services all the rows (Fig 7a). The DRAM's output drivers are never enabled during a refresh, because the $\overline{\text{CAS}}$ strobe is always high. The minimum time it takes to refresh an entire row is the same as the minimum read-cycle time.

The hidden-refresh method attempts to make refreshing transparent by inserting a refresh cycle when the CPU is decoding an op code after a memory read (Fig 7b). For many of today's high-speed μPs , this method is too slow to be practical. The controller initiates the refresh by strobing a row and a column address into the DRAM during a standard memory-read operation. However, instead of going high again at the end of the cycle, the $\overline{\text{CAS}}$ line remains low, latching the output data on the Q bus. Subsequently, the controller toggles the $\overline{\text{RAS}}$ line, causing the DRAM to generate a row address internally. The DRAM contains an internal address generator that sequentially generates a row address on each rising edge of the $\overline{\text{RAS}}$ line when the $\overline{\text{CAS}}$ line is low. During this time, the DRAM ignores the external address bus. Because the DRAM's output drivers are activated throughout the entire cycle, hidden refresh consumes more power than RAS-only refresh.

Automatic CAS-before-RAS refresh combines the best aspects of RAS-only refresh and hidden refresh. In this method, the controller initially asserts the $\overline{\text{CAS}}$ line low before asserting the $\overline{\text{RAS}}$ line low. The DRAM's internal address generator then sequentially generates the row addresses after the controller has toggled the $\overline{\text{RAS}}$ line. Because this method asserts the $\overline{\text{CAS}}$ line low when the $\overline{\text{RAS}}$ line is high, the DRAM's

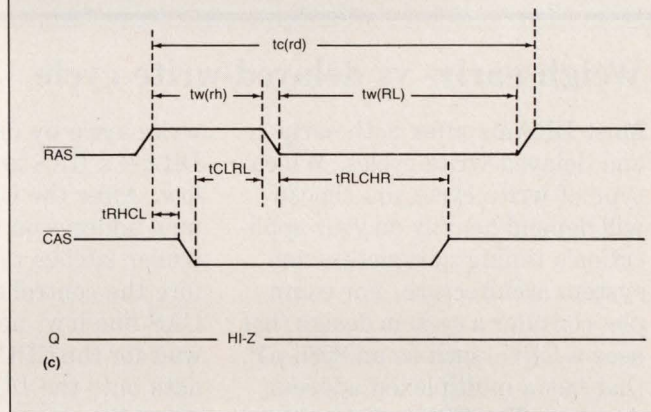
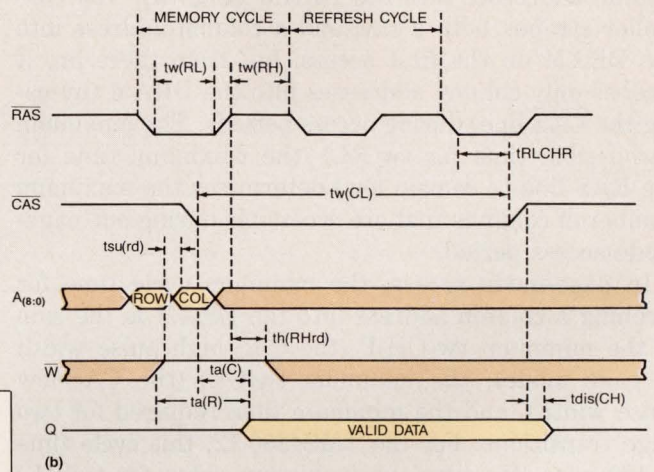
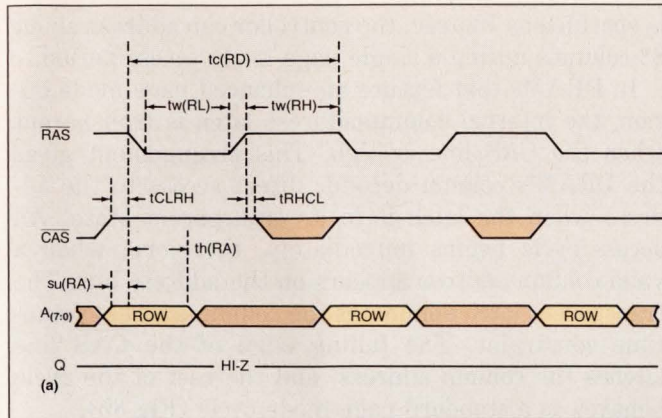

output drivers are not enabled, and the DRAM maintains low power consumption (Fig 7c).

Tradeoffs, tradeoffs, tradeoffs

The previous refresh methods access the rows in the DRAM at selected intervals within the refresh period. For example, a controller can refresh a TMS4256-12 by using RAS-only refresh every $4 \text{ msec}/256 = 15.6 \mu\text{sec}$. The controller must contain a row sequencer in order to implement RAS-only refresh. At selected intervals, it must multiplex the row sequence to the address bus. Hidden-refresh and automatic CAS-before-RAS refresh rely on the DRAM's having an internal row sequencer; the controller design is therefore less complicated.

Instead of refreshing the DRAM at selected intervals, burst refresh rejuvenates all the rows in one burst. Although this method furnishes the CPU with a longer period of uninterrupted access time, it produces a very long latency period if the CPU desires access to the DRAM during the refresh burst. Therefore, burst refresh is used only in applications in which the long uninterrupted access time is a must.

Some refresh methods even scrub the data in the DRAM, occasionally removing any soft errors incurred over time. DRAMs are more susceptible to soft errors than are SRAMs. Soft errors are often caused by alpha particles that are emitted by radioactive impurities in a DRAM's package. Although the probability of an individual soft error is small, the cumulative probability of an error increases as the memory size increases. During a scrubbing refresh cycle, the controller reads the accessed data and provides error detection and correction (EDC). The controller then rewrites any corrected data back into the DRAM.

Besides offering various refresh methods, modern

Fig 7—Three common methods for refreshing DRAMs include RAS-only refresh (a), hidden refresh (b), and automatic CAS-before-RAS refresh (c). The controller accesses the DRAM at selected intervals to implement these refresh schemes.

DRAMs provide an assortment of modes for accessing data in the storage cells. (Table 2 summarizes many of the advantages and disadvantages of the available DRAM access modes.) To enhance the access speed, all of these modes rely on the principle that it's not necessary to strobe both the row and the column addresses into the DRAM when you access small portions of consecutive memory space. By eliminating some of the address strobes, these access modes shorten the overall access time and reduce the overall precharge time. Because most DRAMs support only one option, the DRAM controllers for a particular design are often unique, preventing you from mixing DRAMs that have different access modes.

Page-mode memory access establishes a constant row address, while the controller strobes a series of

Performing a read operation from a DRAM cell causes the capacitor to discharge slightly.

column addresses into the DRAM (Fig 8a). The controller strobes both a row and a column address into the DRAM on the first access, but from there on, it strobes only column addresses into the DRAM (by using the CAS line) during access periods. The maximum permissible time for $t_w(\text{RL})$ (the maximum time for the RAS line to remain low) determines the maximum number of columns that are accessible during one page-mode access period.

In page-mode access, the minimum cycle time for strobing a column address into the DRAM is the sum of the minimum $t_w(\text{CH})P$ (the CAS-high pulse width in page mode), the minimum $t_w(\text{CL})$ (the CAS-low pulse width), and the minimum time required for two edge transitions. For the TMS4256-12, this cycle time is 120 nsec. Because the maximum value for $t_w(\text{RL})$

is specified as 10 μsec , the controller can address about 83 columns during a single page-mode access period.

In DRAMs that feature an enhanced page-mode option, the internal column-address latch is transparent when the CAS line is high. This arrangement gives the DRAM's column decoder direct access to the address when the latch is in its transparent state. An access cycle begins immediately, therefore, when a valid column address appears on the address bus. The transparent latch eliminates the column-address setup-time constraint. The falling edge of the CAS line latches the column address, and the rest of the cycle behaves as a standard page-mode cycle (Fig 8b).

Some DRAMs feature a static-column mode for high-speed read and write access. These DRAMs have a 3-state input column-address buffer instead of a col-

Weigh early- vs delayed-write cycle

Most DRAMs offer both early- and delayed-write cycles. Which type of write cycle you choose will depend heavily on your application's timing parameters and system architecture. For example, consider a system design that uses a CPU, such as an 8086 μP , that has a multiplexed address/data bus. The CPU communicates with external memory by placing a destination address on its I/O pins. After a suitable delay, it transfers data to or from memory by using the same I/O pins. An early-write cycle seems well suited for this application because it doesn't need 3-state buffers for eliminating bus conflicts. In either case, you need a DRAM controller to coordinate the action between the two devices.

In the early-write cycle, the CPU initiates a write cycle by placing a row address on its I/O pins. The DRAM controller, which is located between the CPU and the memory, latches the address and begins an early-

write cycle by driving the DRAM's RAS and WRITE lines low. After the CPU places a column address on the bus, the controller latches the address. Before the controller can drive the CAS line low, however, it must wait for the CPU to multiplex the data onto the I/O pins. Once the controller determines that the data is stable, it can then drive the CAS line low for the minimum $t_w(\text{CL})$ seconds. After this procedure, the controller can return the CAS, RAS, and WRITE lines to their high state.

Now consider using a delayed-write cycle under the same circumstances. Once again, the CPU initiates a write cycle by placing a row address on its I/O pins. The controller latches the address and begins a delayed-write cycle by driving the RAS line low. Because the controller holds the WRITE line high, it can issue a low on the CAS line while it's waiting for the data to stabilize. By driving the CAS line low, the

controller enables the DRAM's output buffers. Therefore, your system requires additional 3-state buffers in order to prevent bus conflicts. When the controller detects that the data from the CPU is stable, it writes the data into the DRAM by driving the WRITE line low for a minimum of $t_w(\text{WL})$ seconds during the remainder of the cycle.

In this sample application, the difference between an early-write cycle and a delayed-write cycle is the difference between the DRAM's minimum $t_w(\text{CL})$ and $t_w(\text{WL})$ specifications. The TMS4256-12 DRAM specifies the minimum $t_w(\text{CL})$ time as 60 nsec and the minimum $t_w(\text{WL})$ time as 40 nsec. For this application, therefore, the delayed-write cycle is the cycle of choice, even though it will force you to use additional hardware, because it's 20 nsec faster than the early-write cycle. For slower DRAMs, the difference can be even more pronounced.

TABLE 2—COMPARISON OF DRAM MODES

	MODE	ADVANTAGES	DISADVANTAGES
WRITE MODES	EARLY-WRITE	CAN TIE DRAM INPUT TO OUTPUT; NO 3-STATE BUFFER NEEDED	SLOWER THAN DELAYED-WRITE
	DELAYED-WRITE	FASTEST ACCESS	REQUIRES 3-STATE BUFFER
REFRESH MODES	RAS-ONLY	LOW POWER; ALL Q BUFFERS ARE IN HIGH-IMPEDANCE STATE	EXTERNAL CIRCUIT MUST GENERATE ROW ADDRESS
	HIDDEN	DRAM GENERATES ROW ADDRESS INTERNALLY, SIMPLIFYING DRAM-CONTROLLER DESIGN; REFRESH IS HIDDEN DURING SLOW CPU CYCLES	Q BUFFER IS ON DURING REFRESH; HIGHER POWER THAN RAS-ONLY; USEFUL ONLY FOR SLOW CPUs
	CAS-BEFORE-RAS	DRAM GENERATES ROW ADDRESS INTERNALLY, SIMPLIFYING DRAM-CONTROLLER DESIGN; LOW POWER	REQUIRES DRAMs THAT SUPPORT THIS MODE
	BURST	AFTER REFRESH BURST, MEMORY IS AVAILABLE FOR MAXIMUM REFRESH PERIOD (4 TO 15 mSEC)	DURING REFRESH BURST, MEMORY IS UNAVAILABLE; REQUIRES SPECIAL DRAM CONTROLLER
	SCRUBBING	PREVENTS SOFT ERRORS IN HIGH-RELIABILITY AND LARGE-MEMORY SYSTEMS	REQUIRES EXTERNAL EDC CIRCUITS; MEMORY ACCESS USUALLY SLOWER DUE TO EXTRA BUFFERS IN DATA PATH
	PAGE	LOW POWER; ALLOWS RANDOM ACCESS WITHIN ANY ROW; DOES NOT REQUIRE SPECIAL DRAMs	NEEDS SOPHISTICATED DRAM CONTROLLER; ACCESS USUALLY SLOWER WHEN CONTROLLER ACCESSES RANDOM ROWS
ACCESS MODES	ENHANCED PAGE	FASTER THAN PAGE-MODE SINCE COLUMN DECODE OCCURS BEFORE CAS; LOW POWER; ALLOWS RANDOM ACCESS WITHIN ANY ROW; DOES NOT REQUIRE SPECIAL DRAMs	NEEDS SOPHISTICATED DRAM CONTROLLER; ACCESS USUALLY SLOWER WHEN CONTROLLER ACCESSES RANDOM ROWS
	STATIC-COLUMN	VERY FAST ACCESS; ALLOWS RANDOM ACCESS WITHIN ANY ROW	HIGH POWER BECAUSE Q BUFFERS ARE ON BETWEEN ACCESSES; REQUIRES 3-STATE BUFFERS; NEEDS SOPHISTICATED DRAM CONTROLLER, SPECIAL DRAMs; ACCESS IS USUALLY SLOWER WHEN CONTROLLER ACCESSES RANDOM ROWS
	CYCLIC	FASTEST ACCESS FOR SYSTEMS DOING CACHE BURST FILL	NEEDS SPECIAL DRAMs, SOPHISTICATED DRAM CONTROLLER; IS SLOW IF ADDRESSES ARE NOT SEQUENTIAL

umn-address latch. When the $\overline{\text{CAS}}$ line is high, this input buffer is in the high-impedance state. The controller initiates the first static-column access by asserting the $\overline{\text{RAS}}$ line and then the $\overline{\text{CAS}}$ line. Holding both lines low throughout the access period, the controller accesses the subsequent columns by altering the column address. This method eliminates the setup, hold, transition, and precharge times associated with toggling the $\overline{\text{CAS}}$ line (Fig 8c).

Because DRAMs inherently can't support both page-mode and static-column-mode access, you must choose the mode that best suits your system. Essentially, both modes provide the CPU with a low-cost cache memory by virtue of their fast access to a small block of the system's memory (there are many columns within a

single row). One factor in your choice is access-mode speed. Although static-column mode is faster than page mode (because static-column mode eliminates some timing restrictions), the controller must alter the column address quickly enough to realize the speed advantage.

Power consumption is another consideration. Because the output buffers are continually enabled during static-column access, a DRAM that uses static-column mode consumes more power than does a DRAM that uses page-mode access. In either case, when there are frequent row changes, both modes can often be slower than direct read and write cycles because of the extra overhead in the DRAM controller.

The TMS4256 DRAM's architecture offers the use

Ideally, the DRAM controller fools the system CPU into believing that it's communicating with an SRAM.

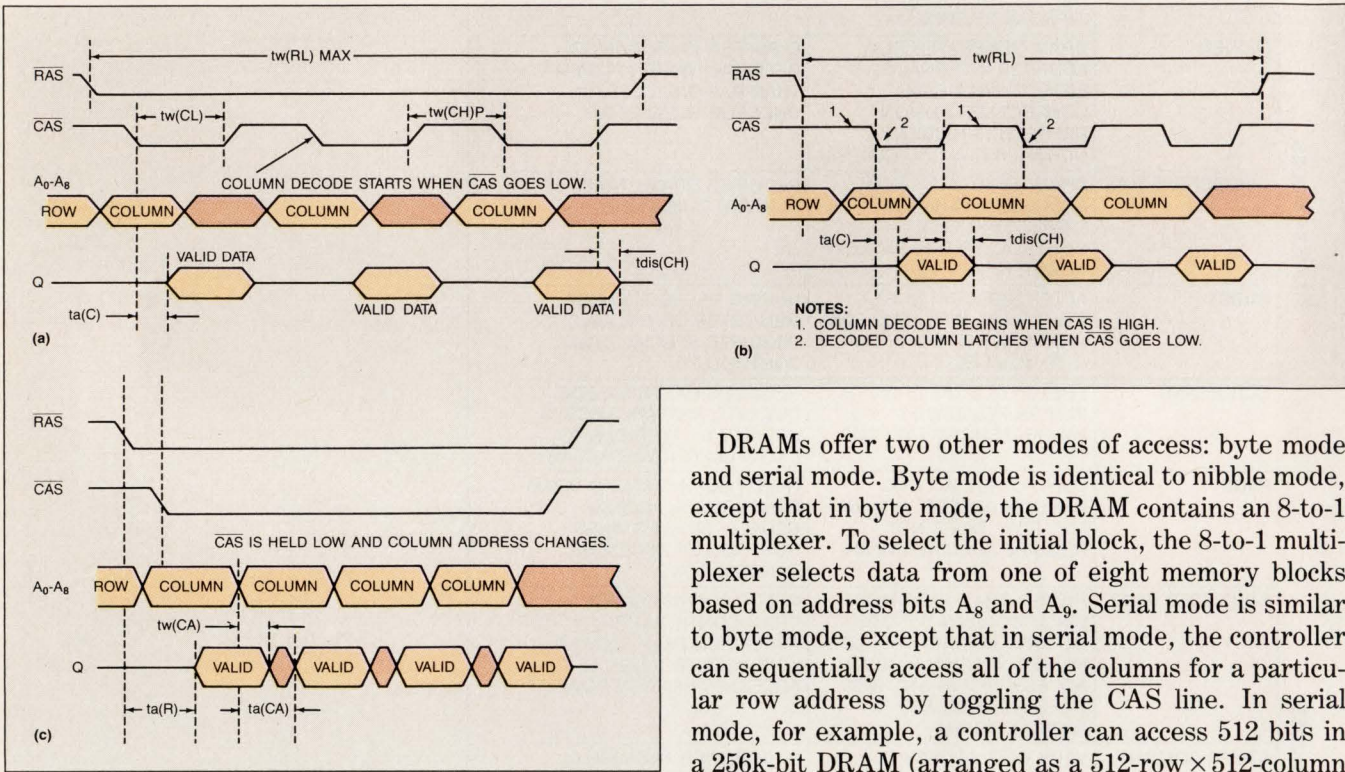
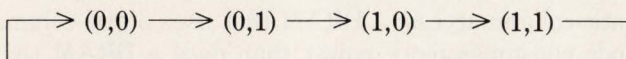

Fig 8—When designing a memory system, you must choose from a number of access-mode options before selecting a DRAM for a particular application. To implement page-mode (a), enhanced page-mode (b), or static-column mode (c) access, for example, you require a controller that's customized to support the mode you choose.

of nibble mode for reading and writing data. As shown in Fig 1, each of the DRAM's dual memory banks are further subdivided into dual 64k-bit blocks. Furthermore, the DRAM contains a 4-to-1 multiplexer, which selectively enables one of the four 64k-bit blocks. Bit A₈ for the row and column addresses determines which block is initially selected. After accessing an initial block, the controller indexes the other three blocks by toggling the \overline{CAS} line three times while maintaining a low on the \overline{RAS} line. Each falling edge of the \overline{CAS} line exercises the multiplexer-select lines circularly through the following sequence:



In this way, the controller can access 4 bits (a nibble) of data with one set of row and column addresses. Typically, the access time for the final 3 bits is 60 nsec/bit.

DRAMs offer two other modes of access: byte mode and serial mode. Byte mode is identical to nibble mode, except that in byte mode, the DRAM contains an 8-to-1 multiplexer. To select the initial block, the 8-to-1 multiplexer selects data from one of eight memory blocks based on address bits A₈ and A₉. Serial mode is similar to byte mode, except that in serial mode, the controller can sequentially access all of the columns for a particular row address by toggling the \overline{CAS} line. In serial mode, for example, a controller can access 512 bits in a 256k-bit DRAM (arranged as a 512-row × 512-column array) by simply establishing a row address and toggling the \overline{CAS} line 511 times (after the initial access).

Some access-mode comparisons

In sum, your application will ultimately determine the access mode you choose. All the modes have advantages and disadvantages, and the tradeoffs they present are the familiar ones: performance vs cost and complexity. Page-mode access, for example, requires one row and a separate column address for each location in the DRAM, whereas nibble mode requires only one address and four \overline{CAS} strobes to access data. Therefore, nibble mode is faster than page mode for short, sequential read operations such as fetching 4 bytes of data for a 32-bit CPU via an 8-bit port. However, nibble mode requires a precharge period when the \overline{RAS} line returns high after four successive reads.

Because page mode holds the \overline{RAS} line low throughout the access period, it's well suited to long, uninterrupted data transfers. Although nibble mode may be faster than page mode for long data transfers, when the DRAM controller employs nibble mode it must supply a new set of addresses on every fourth transfer. In addition, page mode can randomly access the columns within a row, whereas nibble-mode access is sequential.

RASCO® PLUS Oscillator Drives CMOS up to 50 MHz



From 1.25 to 50 MHz, drives high speed microprocessors (68020, 68030, 80386, etc.), with $\pm 0.01\%$ stability from 0°C to $+70^\circ\text{C}$. TTL compatible (up to 5 gates), or CMOS compatible (50 pF load). Optional $\pm 0.005\%$ stability, enable/disable. Optional tight symmetry to 50 MHz TTL, or to 20 MHz in CMOS.

John Keilman, 312-451-1000

MSO Surface Mount Data Clocks from 1.25 to 35 MHz



Hermetically sealed ceramic package only 0.560" by 0.360" with 0.160" seated height. "C" lead configuration. Tape-and-reel or anti-static tubes for standard pick-and-place. Vapor phase or wave solder reflowable. $\pm 0.01\%$ stability, CMOS or TTL compatible; 5,000g shock rating. Optional tight symmetry, enable/disable.

John Keilman, 312-451-1000

Voltage Controlled Oscillator for Phase Locked Loop

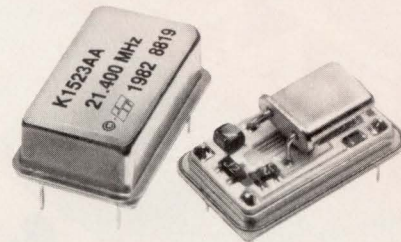

The K1523AA Voltage Controlled Crystal Oscillator allows system designer to phase lock to a reference standard. For LANs, computer shared management systems, communications, A/D interface. 3 MHz to 35 MHz, ± 50 ppm per volt sensitivity. ± 25 ppm stability. TTL or CMOS compatible.

John Keilman, 312-451-1000

Crystal Controlled MSO Surface Mount Oscillators

pick & place from anti-static tube or 24mm tape & reel

- 1.25 to 35 MHz Frequency Range
- 0.560" by 0.360" (14,22 by 9,14 mm) footprint
- Compatible with high speed CMOS or TTL logic
- 5,000g Shock Rating
- Custom IC Chip - Fewer Components, Fewer Interconnects
- Optional Enable/Disable With CMOS or TTL

Automatic Placement - Ideal for use with the latest pick-and-place automated assembly equipment. Available with either tape and reel or anti-static tube packaging, MSO oscillators are vapor phase/wave solder reflowable.

Product Features - Available over a frequency range of 1.25 to 35 MHz, with stability of $\pm 0.01\%$ over the temperature range of 0°C to $+70^\circ\text{C}$. Symmetry is 40/60% standard, 45/55% optional. Compatible with either CMOS or TTL logic.

Total Ceramic Package - For better long term stability; provides more complete hermetic seal than available with most plastic packages.

5,000g Shock Rating - Uses AT strip crystal with mechanical shock performance greatly superior to that of conventional crystals - made by a proprietary process that avoids the edge faults, fractures, and weaknesses inherent to conventional processes.

Second Sourcing Available

Custom IC Chip - patented custom IC chip replaces hybrid components, allows fewer processing operations and fewer circuit interconnects. Class 100 clean room, completely automatic processing, statistical process control, and 100% computer-automated testing provide uniform high quality and reliability.

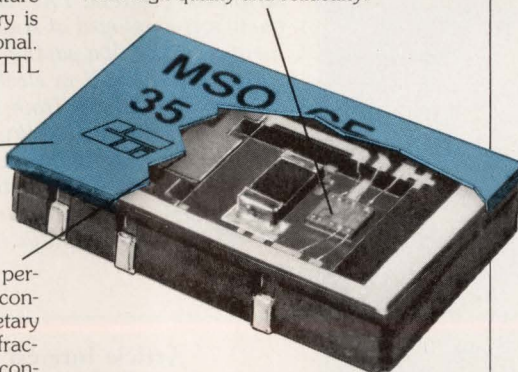

© 1989 by Champion Technologies, Inc.
And Champion Technologies are trademarks of Champion Technologies, Inc.

 **Champion
Technologies, Inc.**

2553 N. Edgington Street, Franklin Park, IL 60131 (312) 451-1000
FAX: 312-451-7585 EasyLink: 62931824 TELEX: 499-0104 CTI UD

ECL-Compatible Oscillator 40 to 150 MHz



MECL 10KH-based design for improved rise and fall times, duty cycle, noise margin, and power supply rejection. Open emitter output for user selection of load. Complementary outputs available, various pinouts also available.

John Keilman, 312-451-1000

Miniature Memory Backup Battery



Rechargeable NiCd batteries use less area than a dime on a pc board, deliver 35 mAh of memory backup power. MMB "C" series batteries are available in 2.4, 3.6, or 4.8V EMF, with seated heights of .280", .450" and .650"; slightly larger "B" series batteries offer 110 mAh capacity. Can be wave soldered, no tie-downs needed.

John Keilman, 312-451-1000



Manufacturing

CMS has the manufacturing flexibility to meet your low or high volume production requirements for quality custom Molded-On® cable assemblies. CMS order processing is designed to deliver 100% on time shipments. Our 40 years of experience help you meet the challenges of today's dock to stock and JIT requirements. Call or write Component Manufacturing Service, Inc.; One Component Park, West Bridgewater, MA 02379. Tel. (508) 580-0111.

CMS is the Molded-On® connector company.

CIRCLE NO 73



Quality Sockets and Plugs

Standard, Customized and New Designs

Prototype through Production

CONNECTOR CORPORATION

6025 N. Keystone Ave. • Chicago, IL 60646-5290
 Phone: 312/539-3108 • TWX 910-221-6059 • FAX: 312/539-3825
 NEPCON Booth #2421 S.I.D. Baltimore Booth #904

Static-column mode offers all of the speed advantages of nibble mode and also provides the random-access capability of page mode. Although static-column mode is more difficult to implement, it's rapidly becoming the mode of choice for high-speed memory systems.

Of course, a DRAM's cost, availability, packaging, and alternate sources will also weigh heavily in your choice of a memory unit for a particular application. Remember, however, that once you select a DRAM, your system's access mode is fixed. A page-mode DRAM, for example, can't operate in a system designed for static-column or nibble-mode DRAMs. You must customize the DRAM controller and the system architecture for your chosen access mode. **EDN**

Authors' biographies

Steve L Gumm is a senior member of the technical staff at Texas Instruments' Information Systems & Services Div (Dallas, TX). He has been with the company for five years. Steve, who earned a BSEE in 1974 from the Tennessee Technological University, has also worked at General Dynamics and the Tennessee Valley Authority. He's currently a member of the IEEE Computer Society. Steve devotes some of his leisure hours to bicycling, scuba diving, and camping.

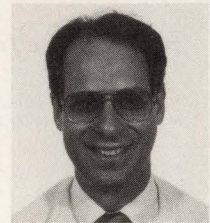

Carl T Dreher is a technical writer in the ASIC Marketing Div of Texas Instruments (Dallas, TX). He was previously self-employed at Analytic Instruments and is still a partner in that firm. Carl received a BS in electrical engineering and physics from Rose-Hulman Institute of Technology, and MS and PhD degrees from the University of Virginia. He holds three patents. In his spare time he teaches English ritual dancing and plays the concertina.

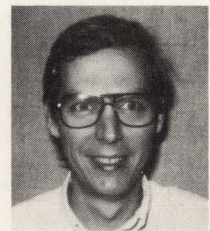

Article Interest Quotient (Circle One)
 High 482 Medium 483 Low 484

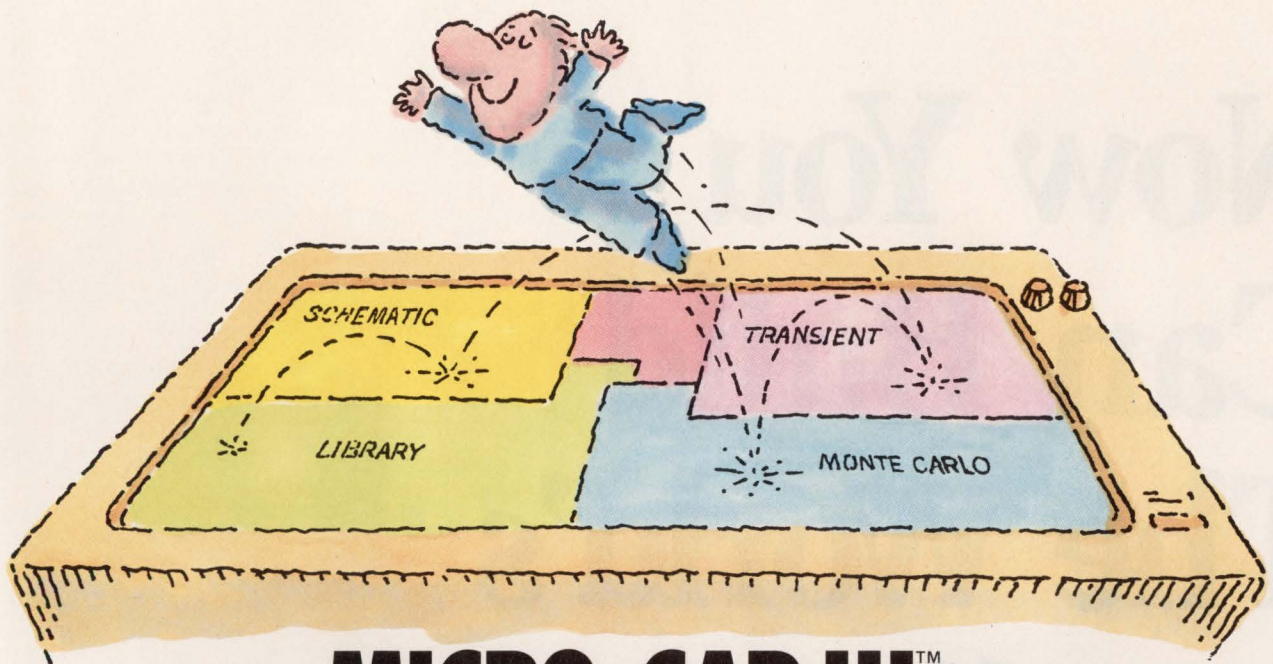

MICRO-CAP III.™

THIRD-GENERATION INTERACTIVE CIRCUIT ANALYSIS. MORE POWER. MORE SPEED. LESS WORK.

MICRO-CAP III,™ the third generation of the top selling IBM® PC-based interactive CAE tool, adds even more accuracy, speed, and simplicity to circuit design and simulation.

The program's window-based operation and schematic editor make circuit creation a breeze. And super-fast SPICE-like routines mean quick AC, DC, Fourier and transient analysis — right from schematics. You can combine simulations of digital and analog circuits via integrated switch models and macros. And, using stepped component values, rapidly generate multiple plots to fine-tune your circuits.

We've added routines for noise, impedance and conductance — even Monte Carlo routines for statistical analysis of production yield. Plus algebraic formula parsers for plotting almost any desired function.

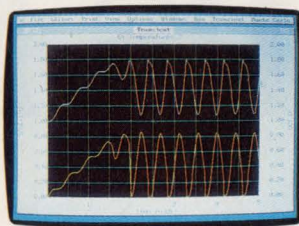

Transient analysis

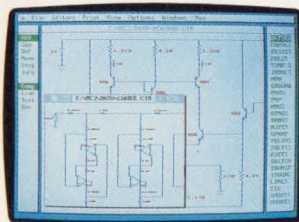

Schematic editor

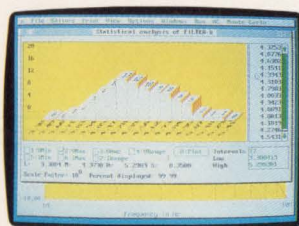

Monte Carlo analysis

Modeling power leaps upward as well, to Gummel-Poon BJT and Level 3 MOS — supported, of course, by a built-in Parameter Estimation Program and extended standard parts library.

There's support for Hercules® CGA, MCGA, EGA and VGA displays. Output for laser plotters and printers. And a lot more.

The cost? Just \$1495. Evaluation versions are only \$150.

Naturally, you'll want to call or write for a free brochure and demo disk.

Spectrum

1021 S. Wolfe Road,
Sunnyvale, CA 94086
(408) 738-4387

MICRO-CAP III is a registered trademark of Spectrum Software.
Hercules is a registered trademark of Hercules Computer Technology.
IBM is a registered trademark of International Business Machines, Inc.

**Now You
Can Build
The World's
Smallest,
Lowest Power
2400 BPS Modem
Using...**

...Only Two Chips



(Actual Size)



(Actual Size)

Great for battery operated, portable applications — especially lap tops. This remarkable 5.0 V chip set includes all the features you need in a 2400 BPS Hayes compatible modem.

This powerful pair consumes only 300mW when operating and less than 100mW in Auto Power Down.

The SC11019 controller's 16K bytes of ROM contains all code for DSP, Call Establishment and Command with plenty of space left over for customization. An on-board UART allows direct PC BUS interface.

The SC11024 modem's built-in Hybrid provides interface directly to the

DAA. However, it can be disabled to allow for use of an external Hybrid. And there's an external port for EEPROM default memory.

This pair isn't all we have — Sierra's Data Communications Products span the data rate range of 300 BPS to 14,400 BPS and conform to CCITT and Bell Standards. And we offer MNP solutions for error free communications.

FAX, Write or Call today for more information. Data Communications Marketing, Sierra Semiconductor, 2075 N. Capitol Avenue, San Jose, CA 95132. (408) 263-9300 FAX (408) 263-3337

Triple Technology™ In CMOS



SIERRA SEMICONDUCTOR

Now run on micropower without cutting corners

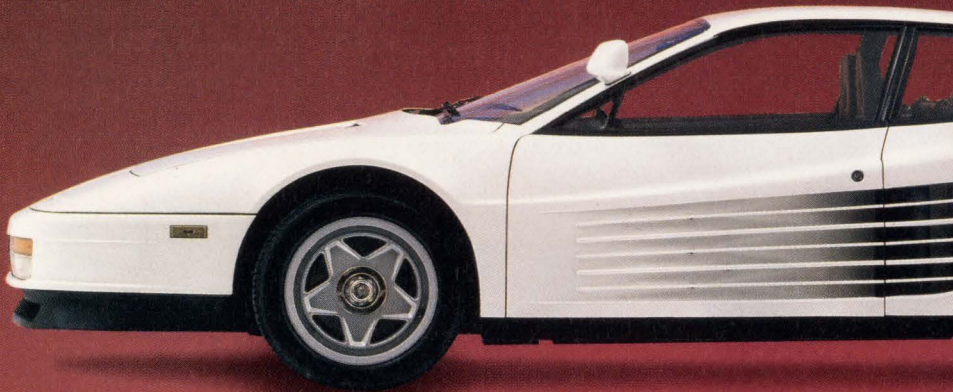

You wouldn't want compromises if you bought the classiest car in the world. So, we think you expect that same quality in your micropower op amp.

Our LT1078 dual and LT1079 quad micropower op amps are optimized for micropower operation. This means no sacrificing precision, noise, speed and output drive specifications in your 5V single supply or $\pm 15V$ applications.

We've concentrated on reducing supply current ($50\mu A$ max.) without affecting other parameters. Our $70\mu V$ max. offset voltage is the lowest for any non-chopper-stabilized dual or quad op amp, regardless of power consumption. The 1/f corner of the voltage noise spectrum is set at 0.7Hz—three times lower than any other monolithic op amp. You achieve a 0.1Hz to 10Hz noise performance of $0.6\mu V$ p-p found only on devices with an order of magnitude higher supply current.

Other features include: offset current of $250pA$ max., $0.4\mu V/^\circ C$ drift, current noise of $3pA$ p-p, a slew rate of $0.07V/\mu s$, gain bandwidth of 200kHz and guaranteed output drive of 5mA.

These op amps operate from low supply voltage—as low as

Single Battery, Micropower, Gain = 100, Instrumentation Amplifier

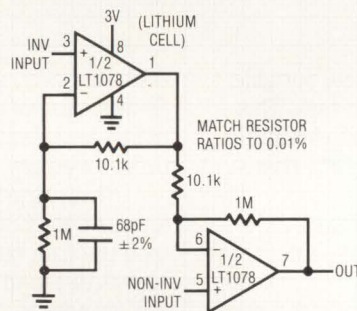

TYPICAL PERFORMANCE

INPUT OFFSET VOLTAGE = $40\mu V$
 INPUT OFFSET CURRENT = $0.2nA$
 TOTAL POWER DISSIPATION = $240\mu W$
 COMMON MODE REJECTION = 110 dB AT DC
 = 80 dB AT 500Hz
 GAIN BANDWIDTH PRODUCT = 200kHz
 OUTPUT NOISE = $85\mu V$ p-p 0.1Hz TO 10Hz
 = $300\mu V_{RMS}$ OVER FULL BANDWIDTH
 INPUT RANGE = 0.03V TO 1.8V
 OUTPUT RANGE = 0.03V TO 2.3V ($0.3mV \leq V_{IN} \leq 23mV$)
 OUTPUTS SINK CURRENT — NO PULL DOWN RESISTORS ARE NEEDED

one lithium cell or two Ni-cad batteries. The input common-mode range goes below ground. The all-NPN output stage swings to within a few millivolts of ground while sinking current. This means you don't need pull-down resistors to pull the output to ground. In competitive micropower op amps, the required pull-down resistors sometimes draw significantly more battery current than the entire amplifier.

Applications include battery-powered portable instruments, remote sensor amplifiers, micropower sample-and-holds and thermocouple amplifiers. The LT1078/79 also offer performance advantages in non-micropower applications.

LT1078 comes in 8-pin DIP or metal can versions, and LT1079 in a 14-pin DIP. Both military and commercial versions are available. In lots of 100, LT1078CN8 and LT1079CN op amps are priced at \$2.80 and \$3.50 each.

Stop cutting corners. Ask for the world class op amps with no tradeoffs. For details on our LT1078/79 series, contact Linear Technology Corporation, 1630 McCarthy Blvd., Milpitas, CA 95035. Or call 800-637-5545.



TOUGH PRODUCTS
FOR TOUGH APPLICATIONS.

Antialiasing filters reduce errors in A/D converters

The need for effective antialiasing filters closely matches the growing number of applications for A/D converters. These filters reduce converter errors by limiting the input signal bandwidth. To correctly specify the filter, you need to consider the appropriate frequency band and the filter's characteristics.

Robert W Steer Jr, *Frequency Devices Inc*

The growing number of applications for analog-to-digital converters (ADCs) in data-acquisition systems, image processing, and industrial controls is driving the need for antialiasing filters that reduce errors in many converter-based systems. By limiting the bandwidth of a converter's input signal, antialiasing filters inhibit the generation of false (aliased), low-frequency signals caused by too low a sampling rate (f_s).

Limiting the converter's input-signal bandwidth reduces the highest frequency (f_m) whose amplitude is greater than or equal to the weight of an LSB (least significant bit). Lowering f_m reduces the rate at which the ADC must sample the input signal to avoid aliasing errors or at least to limit them to an acceptable level. Putting a value on the term "acceptable" requires a

knowledge of the specific application and of sampling theory. (See **box**, "Sampling theory sets inviolable limits.") A converter whose sampling rate is finite may be capable of error-free conversions, but if you present such an ADC with an improperly band-limited input signal, the output will contain aliasing errors.

Prefiltering lets a slower ADC do the job

At first glance, a faster A/D converter might appear to provide an obvious and immediate answer to the aliasing problem. However, if you can't accept lower resolution, you'll have to pay more for a faster ADC. Furthermore, regardless of how much you are willing to pay for a converter, you can't get one with unlimited speed or resolution. In addition, noise frequencies extend well beyond the sampling rate of present-day ADCs. The sampling-rate requirements imposed by broadband noise are important because aliased high-frequency noise components can "fold back" and appear as lower frequencies that you can't distinguish from valid sampled data. Moreover, the system itself can generate "spurs"—spurious high-frequency signals, which will introduce errors if aliased.

By precisely limiting the bandwidth at the input of the ADC, active lowpass filters can reduce the need for brute-force increases in conversion speed. The restricted bandwidth lowers the maximum frequency of signals and noise that reach the ADC's input, and hence reduces the sampling (conversion) rate needed to avoid aliasing. Lowpass filters can exhibit a virtually flat, non-attenuating passband response that extends from

An obvious solution to aliasing is the use of a faster ADC, but prefiltering the ADC's input can let a slower converter do the job.

dc to the cutoff frequency f_r . Beyond f_r , the gain can roll off steeply at rates that exceed -90 dB per octave. However, for technical as well as economic reasons, a filter with a flat passband response and the steepest available stopband roll-off characteristic isn't necessarily the best choice for a particular application.

By band limiting the ADC input, a prefilter (**Fig 1**), prevents the ADC from digitizing alias-producing signals. A properly chosen filter attenuates signal components at frequencies greater than f_m to levels well below the quantizing threshold of the ADC. (Here $f_m \leq f_{sr}/2$.) A binary-coded n -bit A/D converter digitizes

Sampling theory sets inviolable limits

Signal sampling, such as that occurring during A/D conversion, can generate lower frequency, in-band error signals when the sampled signal contains higher frequency components at or above half the sampling frequency, that is, above $f_{sr}/2$. **Fig A** illustrates the alias that would result from a single-frequency sine wave sampled at too low a rate.

The sampling theorem, which deals with sampling at a theoretical, mathematical level, states that a signal sampled at a rate, f_{sr} , equal to or greater than twice the maximum signal-frequency component, f_m , can be exactly reconstructed from the data samples. If frequency components greater than $f_{sr}/2$ are present, they "fold back" into the 0-to- f_m frequency band. **Fig B** illustrates a simple graphical derivation of the folding frequency ($f_f = f_{sr}/2$). Above f_f , aliasing commences as

the first harmonic spectrum begins folding over into the original spectrum.

Conversely, sampling rates less than $2f_m$ introduce aliases in the sampled signal that begin at $f_{sr} - f_m$ and range about each harmonic of f_{sr} , extending to $nf_{sr} \pm f_m$. (Here, n equals the harmonic number.) Because you can't distinguish the aliases from the valid data sharing the dc-to- f_m passband, accurate retrieval of the original signal is impossible. In real-world situations, the input signals are usually nonsinusoidal, are often random, and always contain noise. The noise, randomness, and high-frequency components of such signals are all potential sources of aliasing.

The elimination of frequency components above $f_{sr} - f_m$ requires a lowpass filter—usually one with sharp cutoff characteristics. With zero attenuation in its

passband and infinitely sharp and deep attenuation beyond, the ideal filter of **Fig Ca** completely eliminates aliasing and passes all desired signals unattenuated. However, this ideal filter is not attainable. Fortunately, various filter designs approach this ideal closely enough to achieve control of aliasing.

The response of the real-world filter in **Fig Cb** more nearly represents the response of an actual, realizable antialiasing filter. The finite roll-off and attenuation floor allow higher frequency signal and noise components to arrive at the sampler input. In some cases, these components can cause aliasing. The quantizing threshold of the sampler—an A/D converter for purposes of this discussion—determines whether these signals will be digitized.

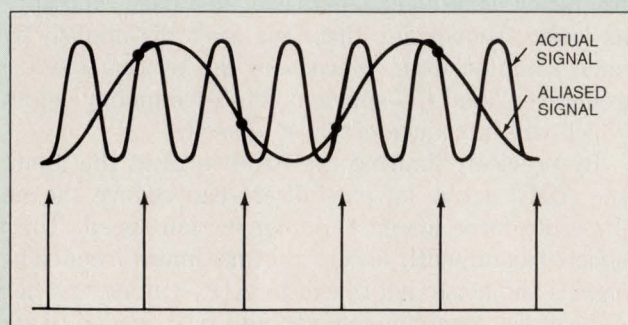

Fig A—Insufficient sampling can produce a false lower frequency, in-band signal (an alias).

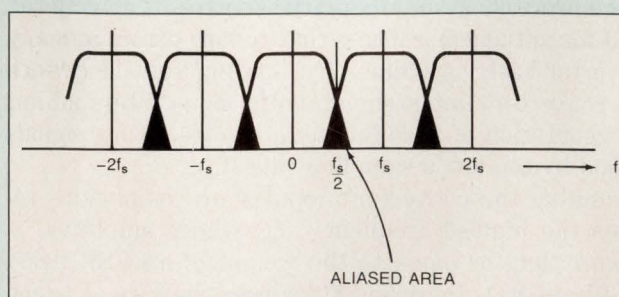

Fig B—Frequency folding (aliasing) sets in when too low a sampling rate causes fundamental frequencies and harmonic spectra to overlap.

its analog input into 2^n discrete levels, with the n th or least-significant bit being the smallest resolvable level. The LSB has a weight of $1/2^n$ of the full-scale input voltage range and each higher order bit carries twice the weight of its lower order neighbor.

An ADC with a unipolar input range generates 2^n

output codes as you vary the input from 0V to the full-scale voltage, V_{fs} . Ideally, the midpoint of each input increment occurs at an exact integer multiple of $V_{fs}/2^n$, and each output transition occurs at the exact midpoint of a given analog increment, or at a multiple of $V_{fs}/2^{n+1}$. **Table 1** shows that the LSB threshold of a

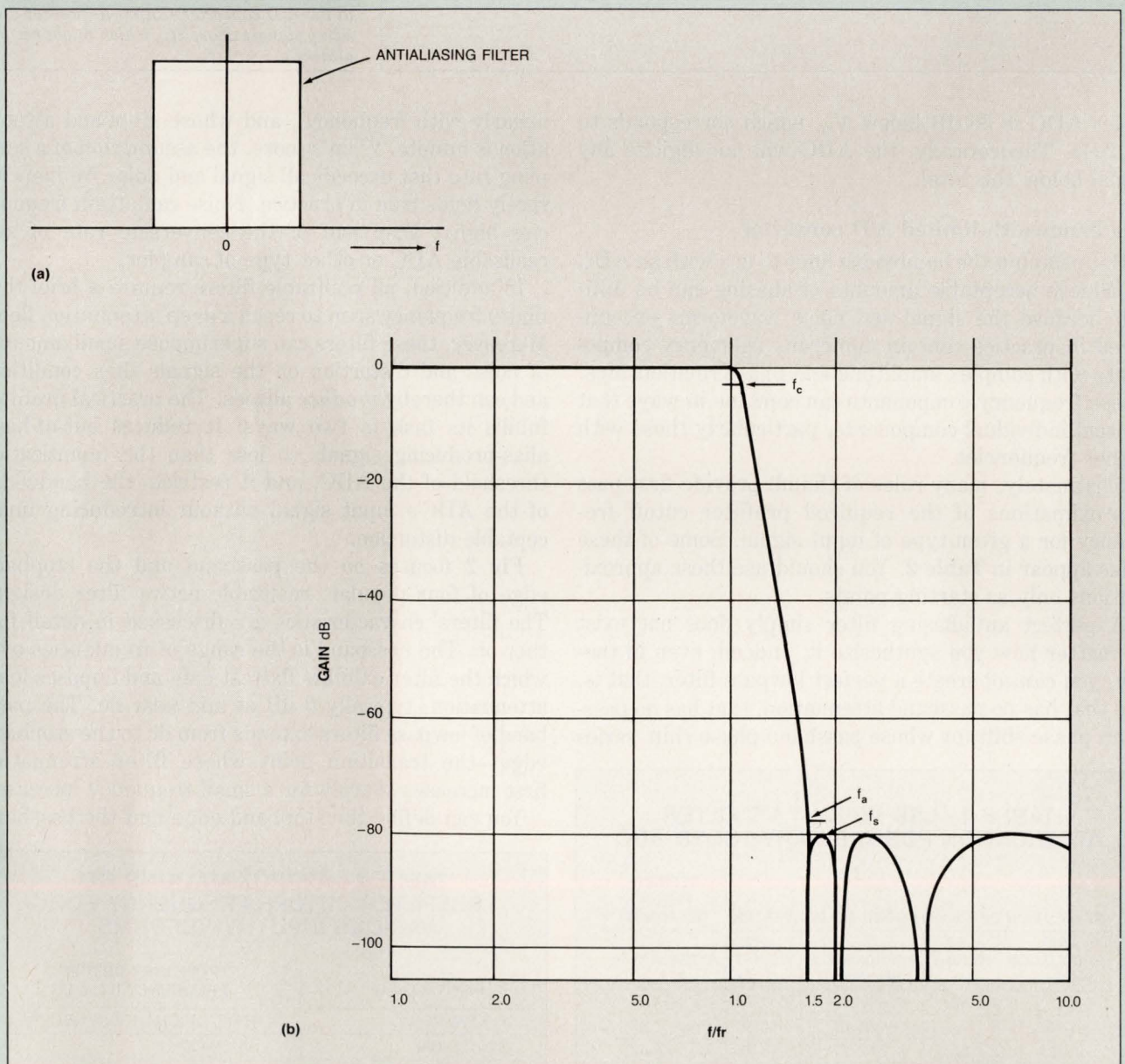

Fig C—An ideal filter (a) removes all frequencies beyond its stopband edge. A real-world filter (b) can approach this ideal of infinitely sharp cutoff.

The role of an antialiasing prefilter is to minimize ADC errors by attenuating high-frequency signals before they reach the ADC.

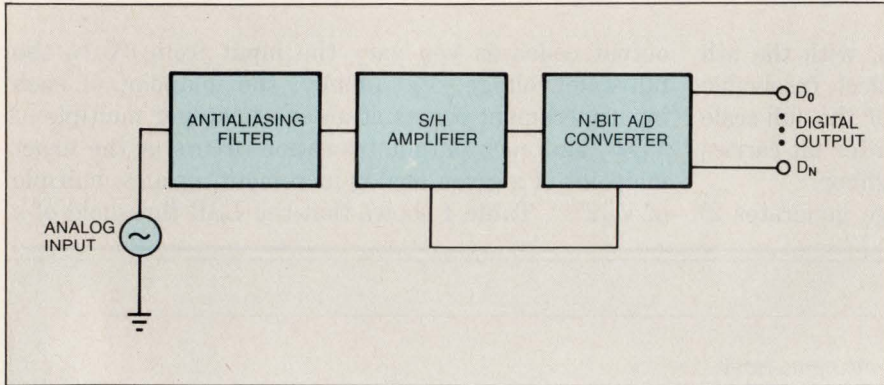

Fig 1—The prefilter limits the bandwidth to the A/D converter's input to prevent digitizing signals above $2f_{sr}$, which might become aliases.

10-bit ADC is 66 dB below V_{fs} , which corresponds to $V_{fs}/2048$. Theoretically, the ADC will not digitize any signal below this level.

The bandwidth-limited A/D converter

Determining the bandwidth limit to use with an ADC to achieve acceptable amounts of aliasing can be difficult because the signal and noise waveforms encountered in practice contain numerous frequency components with complex amplitude and phase relationships. These frequency components can combine in ways that conceal individual components, particularly those with higher frequencies.

Fortunately, many rules of thumb provide first-pass approximations of the required prefilter cutoff frequency for a given type of input signal. Some of these rules appear in Table 2. You should use these approximations only as starting points.

A perfect antialiasing filter simply does not exist no matter how you synthesize it. Indeed, even in theory, you cannot create a perfect lowpass filter; that is, one that has no passband attenuation, that has no passband phase shift (or whose passband phase shift varies

linearly with frequency), and whose stopband attenuation is infinite. What's more, the assumption of a sampling rate that exceeds all signal and noise frequencies rarely holds true in practice. Noise can attain frequencies higher than half of the conversion rate of any realizable ADC or other type of sampler.

In addition, all realizable filters require a brief (but finite) frequency span to reach a deep attenuation floor. Moreover, these filters can superimpose small amounts of noise and distortion on the signals they condition, and can thereby produce aliases. The practical prefilter fulfills its task in two ways: It reduces out-of-band alias-producing signals to less than the quantization threshold of the ADC, and it restricts the bandwidth of the ADC's input signal without introducing unacceptable distortion.

Fig 2 focuses on the passband and the stopband edge of four popular, realizable active filter designs. The filters' characteristics are discussed in detail further on. The passband is the range of frequencies over which the filter exhibits flattest gain and imposes least attenuation, typically 0 dB at and near dc. The passband of lowpass filters extends from dc to the stopband edge—the transition point where filter attenuation first increases sharply for a small frequency increase.

You can define the stopband edge and the passband

TABLE 1—LSB WEIGHT VS FILTER ATTENUATION FOR A BINARY-CODED ADC

RESOLUTION OF BINARY-CODED A/D CONVERTER				DESIRED FILTER RESPONSE
A/D RESOLUTION (BITS)	LSB WEIGHT $\frac{1}{2^n}$	APPROXIMATE LSB WEIGHT	$\frac{1}{2}$ LSB WEIGHT $(\frac{1}{2} \cdot 2^{n-1})$	ATTENUATION AT f_m
8	$\frac{1}{256}$	-48 dB	-54 dB	≥ -54 dB
10	$\frac{1}{1024}$	-60 dB	-66 dB	≥ -66 dB
12	$\frac{1}{4096}$	-72 dB	-78 dB	≥ -78 dB
14	$\frac{1}{16,384}$	-84 dB	-90 dB	≥ -90 dB

TABLE 2—APPROXIMATIONS OF PREFILTER CUTOFF FREQUENCY FOR VARIOUS INPUT WAVEFORMS

INPUT SIGNAL	PREFILTER CUTOFF FREQUENCY ($f_c \leq f_m$)
PULSATING DC	RATE OF CHANGE (V/SEC)/1V
SINUSOIDAL	1/PERIOD
COMPLEX PERIODIC	20/FUNDAMENTAL PERIOD
SINGLE EVENTS	1/PULSE WIDTH

ripple to comply with system accuracy requirements. (Passband ripple is the peak-to-peak variation in a filter's passband frequency response.) One popular method locates the stopband edge at the break (corner) frequency, f_c , where attenuation first becomes 3 dB—that is, where, for a constant input amplitude, the filter's output amplitude is 70.7% of its amplitude at very low frequencies. In commercial filters, passband ripple usually exhibits typical values of 0.2, 0.5, or 1 dB. To allow comparison of filter types, Fig 2 normalizes the four filter responses to coincide at f_c .

An alternative method locates the filter's stopband edge at the passband ripple frequency f_r , the highest frequency at which the passband ripple remains within

the filter's passband-ripple (passband response flatness) specification. Applicable to curves 3 and 4 of Fig 2, this approach yields a narrower—but much flatter—passband than does the 3-dB method. To repeat, you can locate the stopband-edge frequency at an attenuation level dictated by system tolerances.

Fig 3 views the responses of Fig 2 over a wider bandwidth to allow a comparison of filter roll-off characteristics and the definition of two key frequencies for curve 4. For antialiasing applications, f_a , the frequency at which attenuation first becomes $6(n+1)$ dB, is the next highest frequency of interest; n is the ADC resolution in bits. The final and highest frequency, f_s , the attenuation-floor frequency, locates the lowest fre-

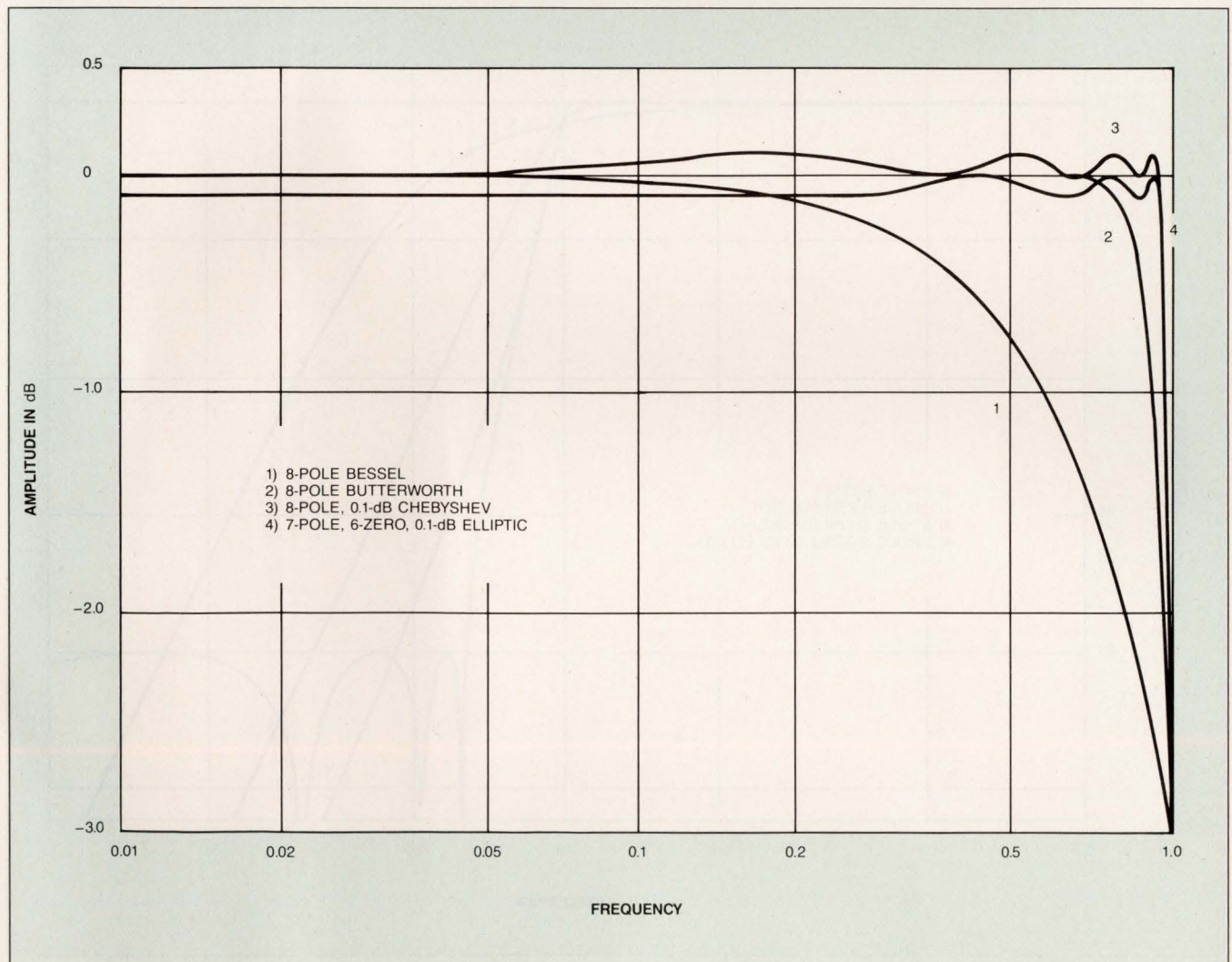

Fig 2—The passband and stopband-edge characteristics of the four filter types differ greatly. The curves are normalized to -3 dB and are shown in an expanded view of the passband region.

In theory, you can exactly reconstruct a signal sampled at twice its maximum signal frequency.

quency at which the stopband response drops below a specified attenuation floor and remains there. The floor defines the minimum attenuation a filter imposes at and beyond f_s .

Three additional parameters can simplify filter selection. Bounded by stopband edge-frequency f_r or f_c and by f_s , the transition band, β_t , is, depending on the application, the range from f_s to f_r or from f_s to f_c . This parameter measures the frequency span required to reach the attenuation floor. A narrower transition band provides faster roll-off and sharper, better-defined frequency discrimination.

The shape factor, Ω_s , is the ratio of the attenuation-floor frequency, f_s , to either f_r or f_c (In equation form,

$\Omega_s = f_s/f_r$ or $\Omega_s = f_s/f_c$.) Shape factor, which provides the designer with a scale factor, is a useful figure of merit for comparing filters and is another measure of a filter's attenuation steepness or roll-off rate.

A lowpass filter is said to be monotonic within a specified frequency band when its attenuation beyond the stopband edge increases with increasing frequency. Curves 1, 2, and 3 of **Fig 3** illustrate monotonic responses. Curve 4 shows a nonmonotonic response. Illustrating this relationship, **Table 3** tabulates the shape factor of each filter, based on the ratio of the frequencies occurring at -80 and -3 dB ($\Omega_s = f_{-80}/f_{-3dB}$). The table includes comments about comparative behavior beyond the stopband edge.

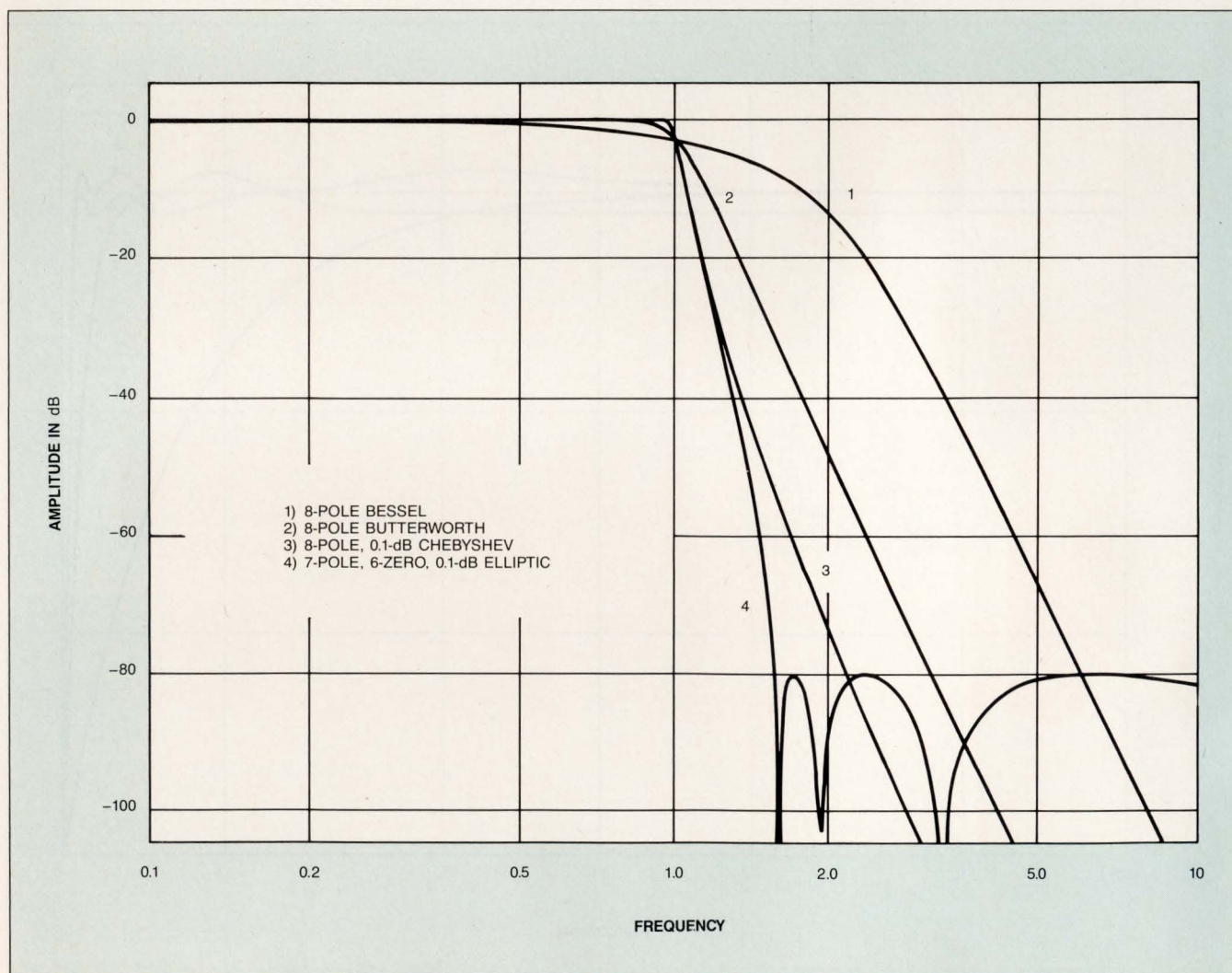

Fig 3—The unique roll-off characteristics of each filter type determine the transition bandwidth as well as the shape and depth of the attenuation floor. Normalized to -3 dB, the curves are shown in a broadband view.

Table 3 shows that the Cauer elliptic filter (curve 4) rolls off fastest, the Chebyshev filter (curve 3) second fastest, the Butterworth filter (curve 2) third fastest, and the Bessel filter (curve 1) slowest. However, the attenuation of the Cauer elliptic filter is not monotonic because it varies in a cusp-like manner at frequencies above f_s . Note, however, that the 7-pole, 6-zero, elliptic filter rolls off faster than its 8-pole monotonic companions.

In theory, the attenuation shown in the first three curves increases without limit as frequency increases, but the Cauer elliptic filter exhibits a finite attenuation floor. As shown later, the Bessel filter fills an important need, and the Cauer elliptic filter's exchange of

attenuation depth for faster roll-off is a worthwhile tradeoff for certain applications. Playing a key role in determining system bandwidth, transient response, and accuracy, the width and flatness of the A/D converter's prefilter passband warrants a closer look. **Fig 4** displays the same four curves normalized to their -80 -dB frequencies.

With all filters normalized to -80 dB at the attenuation-floor frequency, f_s , **Table 4** lists the passband of each filter and compares the ratio of the Cauer elliptic filter's passband to that of each of the remaining filters at both the -0.1 -dB and the -3 -dB corner frequencies. The choice of these corner frequencies was arbitrary, based on the assumed requirement for passband

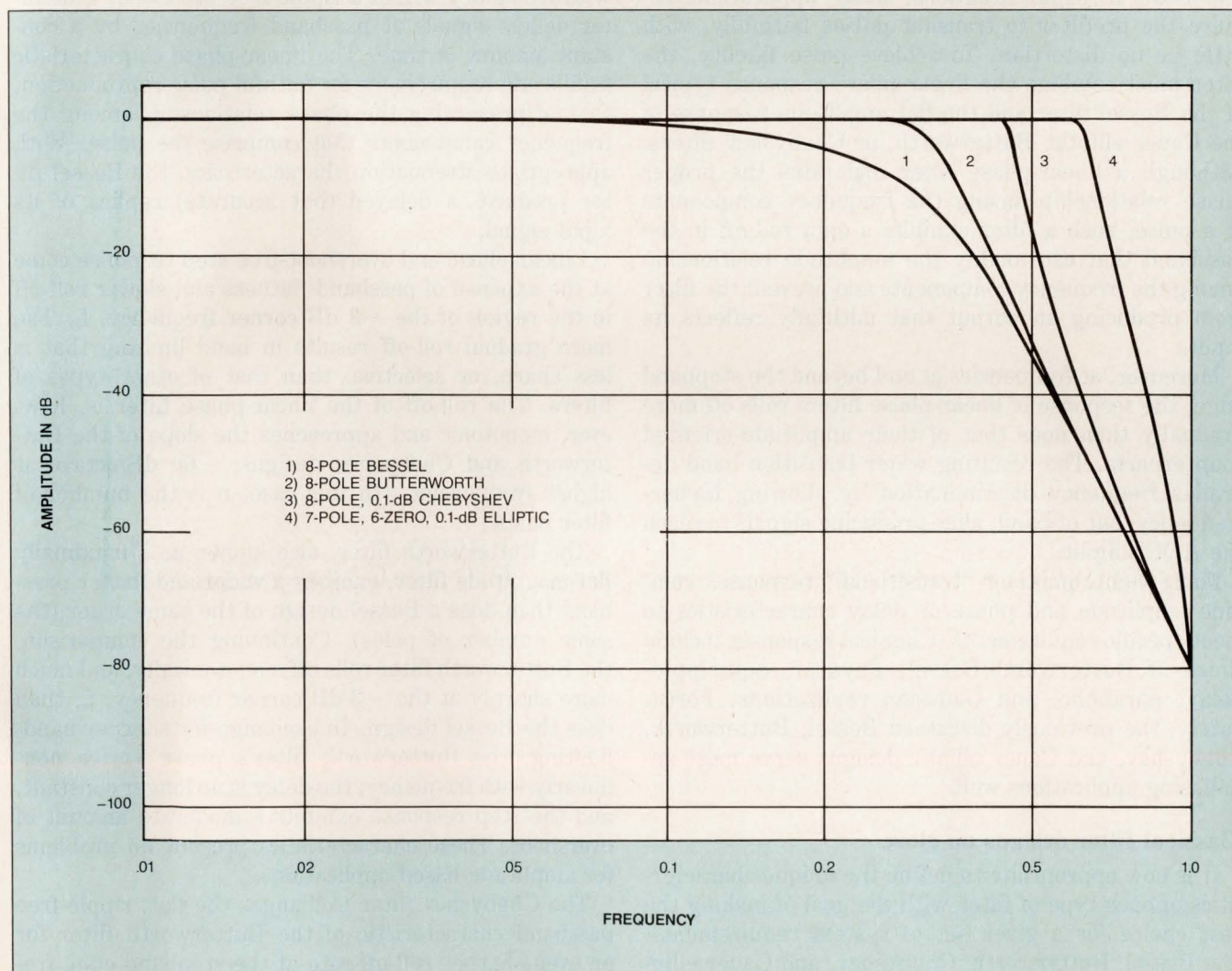

Fig 4—A broadband view normalized to a common -80 dB attenuation floor more clearly illustrates the transition-band behavior of the four filter types.

The phase of a Bessel filter varies linearly with frequency within a ripple-free passband and delays passband frequencies by a constant amount of time.

amplitude ripple of 0.1 dB and 3 dB.

This table shows that the Cauer elliptic filter provides a 0.1-dB passband approximately 12 times as wide as the Bessel filter's, five times as wide as the Butterworth filter's, and 1.5 times as wide as the Chebyshev filter's.

For a -3 -dB corner, **Table 4** shows that the width of the Cauer elliptic filter's passband is approximately four times that of the Bessel's, twice that of the Butterworth's, and 1.5 times that of the Chebyshev's. These ratios lead to the obvious conclusion that the Cauer elliptic filter surpasses the other designs for amplitude-critical applications.

Though carefully controlled frequency response is important in some situations, many applications require the prefilter to transmit pulses faithfully, with little or no distortion. To achieve pulse fidelity, the filter must combine the linear phase response typical of the Bessel filter and the flat amplitude response of the Cauer elliptic, Butterworth, or Chebyshev filters. Although a linear-phase filter maintains the proper phase relationship among the frequency components of a pulse, such a filter exhibits a gain roll-off in the passband that can modify the amplitude relationship among the frequency components and prevent the filter from producing an output that faithfully reflects its input.

Moreover, at frequencies at and beyond the stopband edge, the response of linear-phase filters rolls off more gradually than does that of their amplitude-oriented counterparts. The resulting wider transition band degrades frequency discrimination by allowing higher-frequency, out-of-band, alias-producing signals to reach the ADC's input.

Many compromise or "transitional" responses combine amplitude and phase or delay characteristics to meet specific requirements. Classical responses include those of Butterworth/Bessel, Paynter, equiripple-delay, parabolic, and Gaussian realizations. Fortunately, the previously discussed Bessel, Butterworth, Chebyshev, and Cauer elliptic designs serve most antialiasing applications well.

Classical filter designs up close

It is now appropriate to define the unique characteristics of each type of filter with the goal of making the best choice for a given set of system requirements. The Bessel, Butterworth, Chebyshev, and Cauer elliptic responses of **Figs 2** through **4** are so-called classical responses that meet the needs of most antialiasing ap-

TABLE 3—COMPARISON OF TRANSITION BAND AND STOPBAND PERFORMANCE

CURVE	FILTER TYPE	SHAPE FACTOR Ω_s ($f=80$ dB/ $f=3$ dB)	ROLL-OFF	
			RATE	MONOTONIC
1	8-POLE BESSEL	6.068	SLOWEST	YES
2	8-POLE BUTTERWORTH	3.162	FASTER	YES
3	8-POLE, 0.1-dB CHEBYSHEV	2.183	NEXT TO FASTEST	YES
4	7-POLE, 6-ZERO, 0.1-dB CAUER	1.661	FASTEST	NO

plications. The phase of the Bessel filter varies linearly with frequency within a ripple-free passband. This filter delays signals at passband frequencies by a constant amount of time. The linear-phase characteristic fulfills one requirement for faithful pulse reproduction, that of preserving the phase relationship among the frequency components that comprise the pulse. With appropriate attenuation characteristics, the Bessel filter produces a delayed (but accurate) replica of its input signal.

Linear phase and overshoot-free step response come at the expense of passband flatness and slower roll-off in the region of the -3 dB corner frequency, f_c . The more gradual roll-off results in band limiting that is less sharp, or selective, than that of other types of filters. The roll-off of the linear-phase filter is, however, monotonic and approaches the slope of the Butterworth and Chebyshev designs: $-6n$ dB/octave at higher frequencies. (In this case, n is the number of filter poles.)

The Butterworth filter, also known as a maximally flat-magnitude filter, exhibits a wider and flatter passband than does a Bessel design of the same order (the same number of poles). Continuing the comparison, the Butterworth filter rolls off monotonically, and much more sharply at the -3 -dB corner frequency, f_c , than does the Bessel design. In exchange for sharper band-limiting, the Butterworth filter's phase varies nonlinearly with frequency; the delay is no longer constant, and the step response exhibits a moderate amount of overshoot. These characteristics present no problems for amplitude-based applications.

The Chebyshev filter exchanges the flat, ripple-free passband characteristic of the Butterworth filter for an even sharper roll-off rate at the stopband-edge frequency, f_r . This design exhibits equal-amplitude ripple across the passband and a step response with even

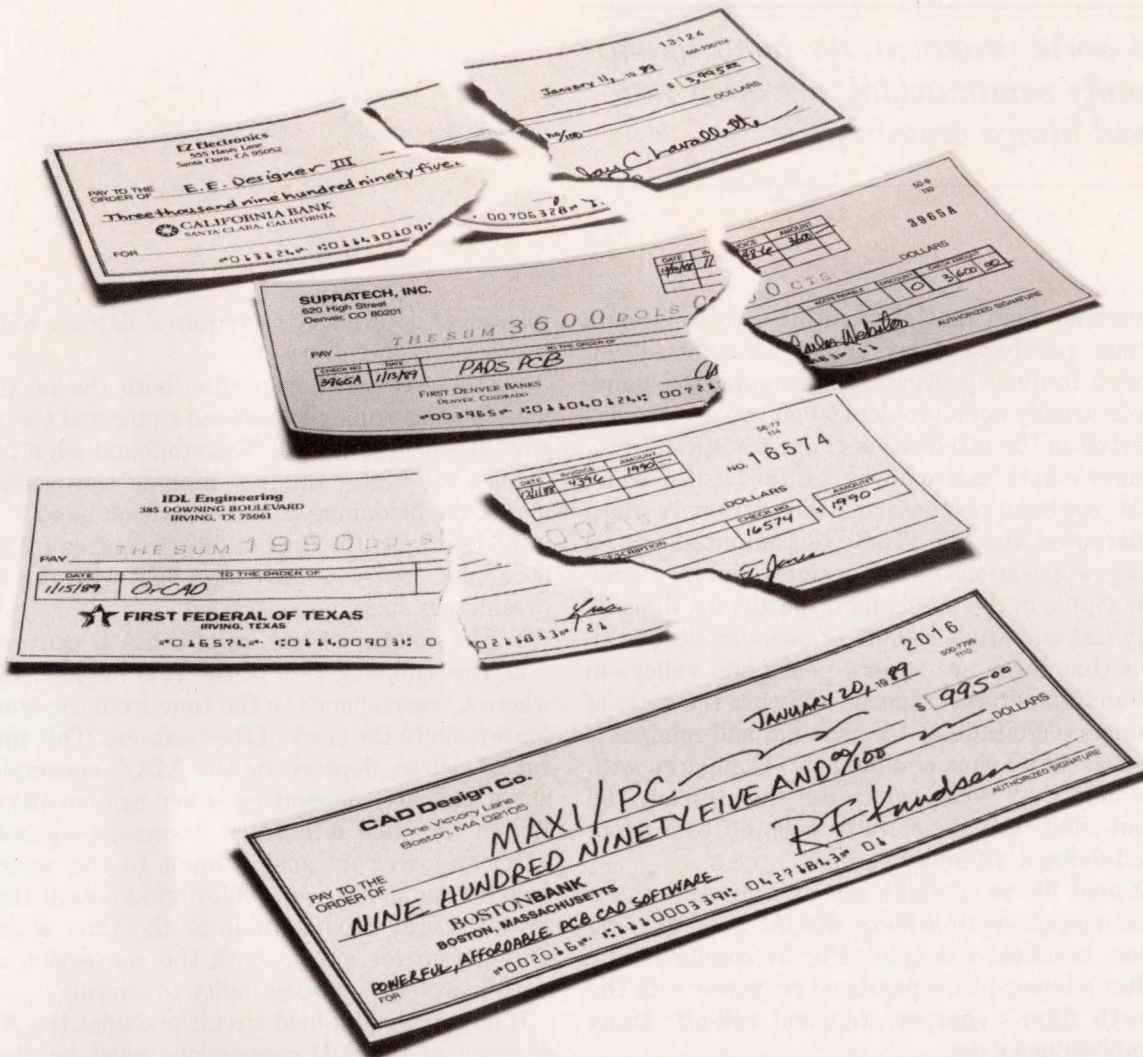

ARE YOU ABOUT TO WRITE A BAD CHECK?

TEAR IT UP AND CHECK OUT MAXI/PC INSTEAD...JUST \$995!

"We almost wrote a \$3,500 check for PCB CAD software that couldn't compare with MAXI/PC."

BOB TILDEN, SENIOR ELECTRONIC DESIGNER
PHYSICS RESEARCH GROUP,
NORTHWESTERN UNIVERSITY

Capabilities	EE Designer III*	PADS-PCB*	OrCAD*	MAXI/PC
Hierarchical Design			✓	✓
Back Annotation	✓	✓		✓
Automatic Placement	✓	✓		✓
Automatic Gate & Pin Swap		✓		✓
Automatic Component Rename				✓
Data Migration				✓
Price	\$3,995	\$3,600	\$1,990	\$995

Prices and features are those available at time of publication, 1/89.
*Trademark

How can the world's largest PCB CAD vendor offer you so many advanced capabilities for such an affordable price... MAXI/PC \$995? It's simple. We took proven software from our high-end workstation systems and designed it to run on the PC.

MAXI/PC is schematic capture/PCB layout software offering interactive and automatic capabilities such as automatic gate and pin swapping, automatic component rename, and back annotation to name a few. With features like these, you'll be able to tackle the toughest boards... dual in-line and multilayer designs, as well as double-sided and surface-mount designs.

And MAXI/PC is software you can grow with. Data can be migrated upward to our mid-

range PC-based CADSTAR™ system and from there to our engineering workstation-based Visula™ system.

So, before you make out a bad check, check out MAXI/PC's impressive features and unbelievable price. We don't offer demo disks. We do one better. Order MAXI/PC today and you get a full 30-day money-back guarantee if you're not satisfied.

1-508-692-4900

MAXI/PC
PCB CAD SOFTWARE

RACAL-REDAC

238 Littleton Road, P.O. Box 365
Westford, MA 01886-9984

We accept check/money order, Visa and MasterCard.

CADSTAR and Visula are trademarks of Racal-Redac, Inc.
©Copyright 1989 Racal-Redac, Inc.

In real-world situations, the input signals are usually nonsinusoidal, are often random, and always contain noise.

more overshoot than that of the Butterworth design. In addition, passband delay is not constant—it increases with frequency. Again, the frequency-dependent delay is usually not a problem when you are primarily interested in the attenuation characteristics.

The Cauer elliptic active lowpass filter has the wide, nearly flat passband response and the extremely sharp roll-off characteristics that ideally suit amplitude-based antialiasing applications. This design exhibits equal-amplitude ripple in the passband (typically 0.1 dB) and extremely fast amplitude roll-off. (Equal-amplitude ripple means that there are several peaks and valleys in the passband amplitude response and that the ratio of the response magnitude at the maxima and minima is constant over all maxima and minima.) Compared with the preceding filter types, which can theoretically roll off without limit, the Cauer filter rolls off to a deep, finite, well-defined attenuation floor.

Transitional filters combine selected characteristics of classical responses to achieve specific band-shaping tasks. One practical example (Fig 5) combines the Bessel filter's linear-phase passband response with the Butterworth filter's sharper stopband roll-off. Many other combinations exist.

Without violating other system performance criteria, the correct antialiasing filter provides the passband, transition-band, and attenuation-floor characteristics required to adequately prefilter the signals supplied to an n-bit ADC. Alias prevention defines the transition-band and attenuation-floor requirements; system

tolerances determine the required flatness of the passband.

System specifications define both the maximum allowable magnitude of passband ripple and the stopband edge frequency, f_c or f_r . The stopband edge frequency defines the high-frequency limit of the passband and marks the beginning of the transition band.

To determine the type of filter required by a particular application, you must next deal with the following parameters simultaneously:

1. The number of bits, n , of the A/D converter.

2. The sampling rate of the A/D system, $f_{sr} = (1/t_{sr})$, where t_{sr} corresponds to the time from the start of one conversion to the start of the next one. This time interval, of course, depends on the ADC's conversion time, but it can also depend on other system parameters. Within the time interval, a successive-approximation ADC compares its analog input to the weighting of each bit and delivers an n-bit digital output that corresponds to the input's value at the time of sampling. This parameter affects both the conversion accuracy and the system's susceptibility to aliasing.

If no sample-and-hold circuit precedes the ADC, the duration of the A/D conversions must be short compared with the time required for the input signal to change by $1/2$ LSB. In essence, when there is no S/H circuit, the sampling "window" of a successive-approximation converter is the same as the duration of a conversion. With a given value of f_{sr} , an S/H circuit at the ADC input dramatically shortens the sampling

TABLE 4—COMPARISON OF THE PASSBAND AND ATTENUATION-FLOOR SHAPE OF THE FILTERS

RESPONSE CURVES		STOPBAND EDGE (SE)		PASSBAND/ ATTENUATION FLOOR
		AT -0.1 AND -3 dB	RATIO CAUER SE TO OTHER CURVES	
CURVE	RESPONSE TYPE	$f_r (=f_s/\Omega_s)$ AT -0.1 dB, $f_s=1$	CAUER/CURVES 1, 2, 3 (f_r/f_{rn})	COMMENTS
		$f_c (=f_s/\Omega_s)$ AT -3 dB, $f_s=1$	CAUER/CURVES 1, 2, 3 (f_c/f_{cn})	
1	BESSEL 8-POLE	$f_{r1} = 0.0506$	11.9 AT -0.1 dB	NARROWEST/ THEORETICALLY UNLIMITED
		$f_{c1} = 0.1648$	3.9 AT -3 dB	
2	BUTTERWORTH 8-POLE	$f_{r2} = 0.1283$	4.7 AT -0.1 dB	WIDER/ THEORETICALLY UNLIMITED
		$f_{c2} = 0.3163$	2.0 AT -3 dB	
3	0.1-dB RIPPLE CHEBYSHEV 8-POLE	$f_{r3} = 0.430$	1.4 AT -0.1 dB	NEXT WIDEST/ THEORETICALLY UNLIMITED
		$f_{c3} = 0.4581$	1.4 AT -3 dB	
4	0.1-dB RIPPLE CAUER ELLIPTIC 7-POLE, 6-ZERO	$f_{r4} = 0.6020$	1.0 AT -0.1 dB	WIDEST/CUSP-LIKE WITH FIXED MINIMUM VALUE
		$f_{c4} = 0.6339$	1.0 AT -3 dB	



Brooktree

Image Capture is out there.

CIRCLE NO 158

The Butterworth filter exhibits a sharp, monotonic roll-off at the -3 dB corner frequency, but its phase varies nonlinearly with frequency.

window and allows conversion of signals having much higher rates of change and much higher frequency content.

For alias-free conversion, the sampling rate, f_{sr} , must exceed the highest in-band (passband) frequency, f_m , by no less than a factor of two: $f_{sr} \geq 2f_m$. This equation relates the ADC's sampling rate to the maximum frequency present in the ADC's input signal at an amplitude greater than or equal to $\frac{1}{2}$ LSB.

3. A frequency span closely related to the transition band described earlier. The frequency band of interest in this case is that required for the filter's attenuation to increase from the value at the stopband edge to a value that attenuates signals above f_m to less than $\frac{1}{2}$

LSB. Signals at frequencies above this band cannot produce aliases because, when they arrive at the ADC input, their amplitudes are too small.

Table 1 furnishes the values of the first parameter, the fractional and decibel (dB) weighting of $\frac{1}{2}$ LSB of an n-bit ADC. The right-hand column lists the attenuation required to reduce a signal at f_m to below the ADC's threshold and, at the same time, defines the high-frequency bound of the transition band.

The value of the maximum frequency of interest, f_m , influences the value of the second parameter, t_{sr} and its frequency equivalent, f_{sr} . When selecting f_{sr} , you may discover that you must choose between using a faster ADC and a prefilter—and you may actually need

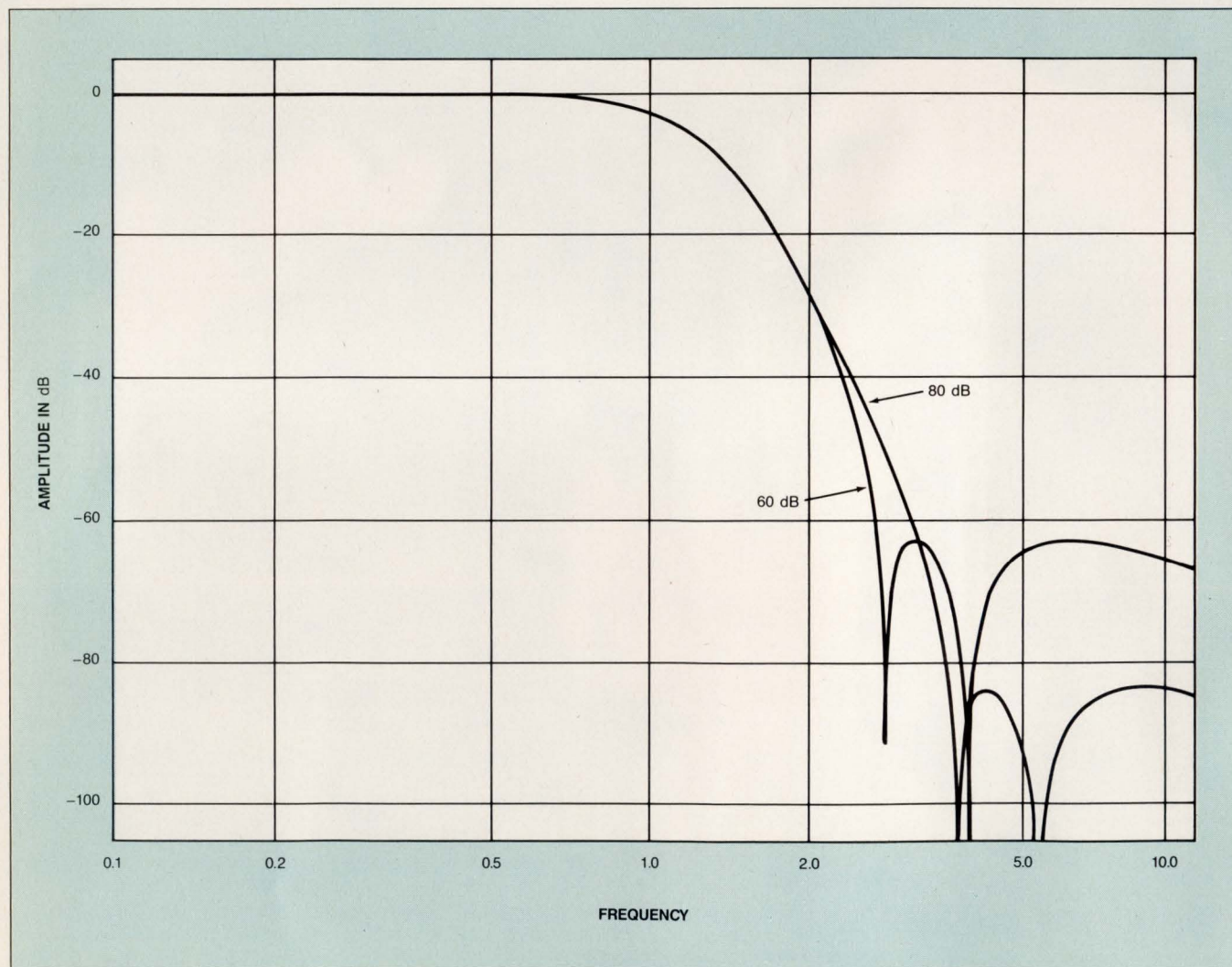
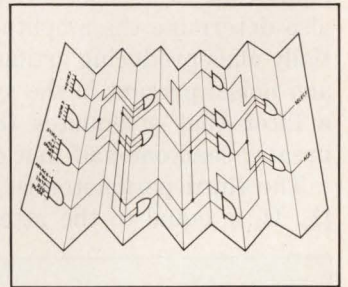

Fig 5—This transitional filter approximates the linear phase (constant delay) of the Bessel response in the passband, combined with the sharper roll-off of the Butterworth filter beyond the passband.

“Thwap!”

When you're tired of hitting the wall—Signetics Programmable Logic Arrays offer those additional product terms you're aching for.

Thwap! The 12ns Signetics PLUS173D (24-pin) and PLUS153D (20-pin) have a proven architecture with programmable AND and OR arrays that eliminate “product term depletion.” In fact, when you require more than eight product terms per output these devices will outperform the fastest PAL® parts available in a fraction of the board space.



Design flexibility and efficiency with shared product terms.

Thwap! More design flexibility and efficiency. All product terms (up to 48) can be shared among all individually controlled outputs. The result—no speed penalty, improved design flexibility (active high or active low), no redundancy and enough product terms to keep you from hitting the wall. And that's not all! These PLAs, like all Signetics PLDs, are supported by ABEL, CUPL or our powerful AMAZE design software that makes designing easy.

Thwap! We've got the guts! That's right, we have those essential PLDs you need to improve total system performance. Programmable Macro Logic, Logic Sequencers, PAL-type devices and our new PLAs that reduce part count and improve system reliability.

Get the product terms you need! Call Signetics at (800) 227-1817, ext. 986D, for a PLD Data Manual. For surface mount and military product availability, contact your local Signetics sales office.

One standard. *0* defects.

Signetics

a division of North American Philips Corporation



The Cauer elliptic filter has a flat passband and extremely sharp roll-off characteristics that suit amplitude-based, antialiasing applications.

both. If you add a prefilter, you may find that it slows the system response significantly; the system's response can become essentially the same as that of the prefilter. To make an intelligent selection of a conversion rate and a prefilter response, you must determine the highest signal frequency that's important to the system's operation. The ADC must sample at a rate equivalent to at least twice this frequency. You must also determine the amplitude of unwanted and potentially alias-producing artifacts (both signal components and noise) present in the system, and you must select a filter that attenuates the artifacts to a value no greater than one-half that of the ADC's LSB.

The third parameter is, in effect, the shape factor Ω_s . Ω_s is equal to the attenuation-floor frequency di-

vided by the stopband-edge frequency. For the curves of Fig 3, the equation you use to obtain the shape factor is: $\Omega_s = f_{-80}/f_{-3}$. Table 3 lists Ω_s for the actual filter realizations discussed.

You can now select a filter type. Selection begins by comparing your requirements with the transition-band response of the devices listed in this table. Obviously, the linear-phase, 8-pole Bessel filter exhibits the slowest roll-off rate and is best suited to applications requiring faithful pulse reproduction. Knowing the transition band and the tolerance on passband flatness, you can now select the filter type that best meets the system requirements.

Note that the 7-pole, 6-zero Cauer elliptic filter rolls off faster than its 8-pole cousins and yields the widest

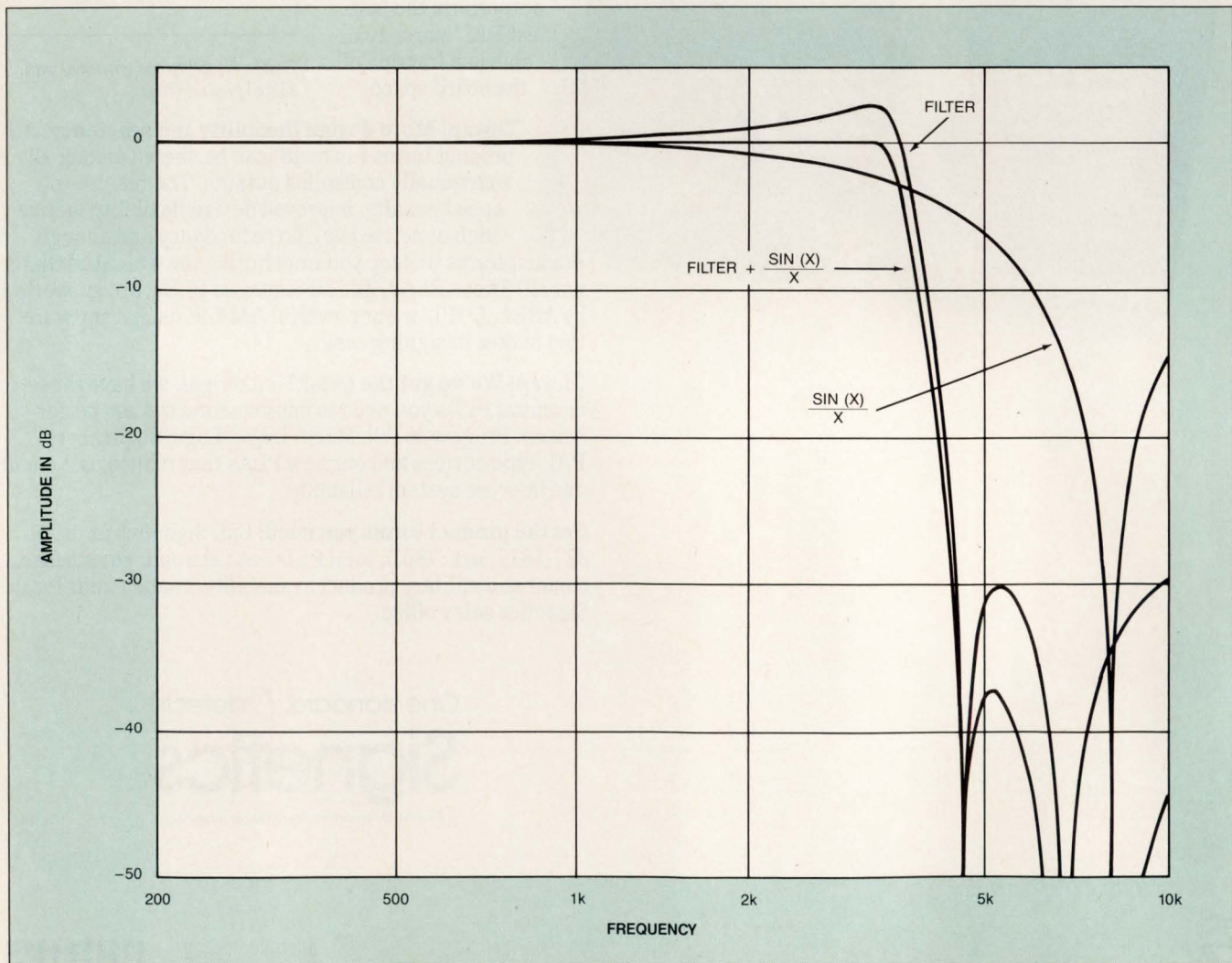
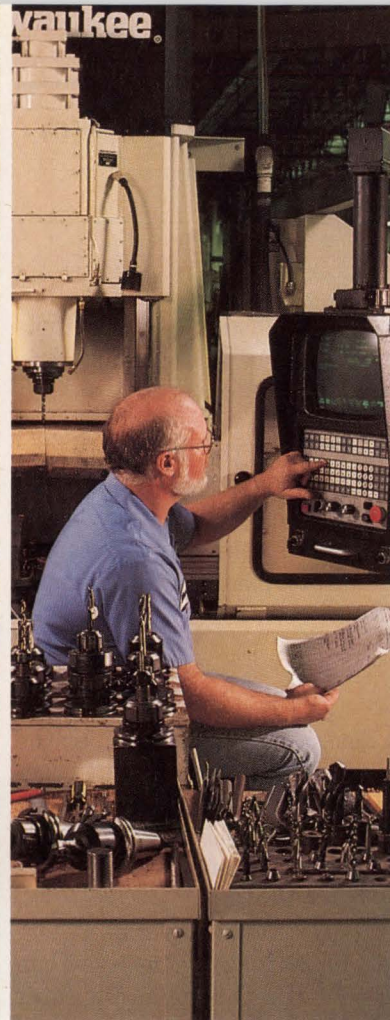

Fig 6—Sampling imposes a $\sin(x)/x$ response on the sampled signal. Accurate reconstruction requires compensation for this effect.



There's no one bigger in aluminum electrolytic caps...or smaller!

Mepco/Centralab makes the broadest range of aluminum electrolytic capacitors in the industry, from the smallest to the largest, with capacitance ratings from 0.1 μF to 1 million μF !

You can select true chip-size SMD[®] units that give your hybrids higher density. Or large, high-voltage units to 450 vdc.

We make a lot of sizes and ratings in between for your heavy-duty capacitor requirements — such as mainframe and uninterruptible power supplies, telecommunications switchgear, industrial motor control or robotic welding equipment.

Unique manufacturing...customizing, too!

Our expanding R&D operations are continually uncovering new ways to put our technological expertise to work for you. So if you don't find the exact aluminum electrolytic cap you need, we'll make it for you — with prompt turnaround on custom prototypes.

Since we're the nation's largest manufacturer of formed and etched electrical-grade aluminum foil, our aluminum electrolytic caps are readily available, with assured delivery to meet your JIT and dock-to-stock programs. And, because our total production is vertically integrated under strict quality control, our high-yield caps are bound to be more cost-effective.

For standard or custom solutions to your aluminum electrolytic capacitor needs, start with our catalogs. Just write to Mepco/Centralab — the active leader in passive components.

Mail to: Mepco/Centralab
Attn: Corp. Advertising
2001 W. Blue Heron Blvd.
P.O. Box 10330
Riviera Beach, FL 33404

Please send me the following:

- Surface Mount Device Catalog
- Leaded Resistor/Capacitor Data Book
- Please have a sales representative call

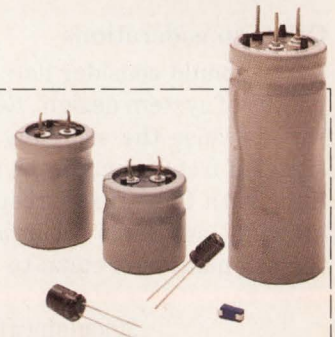

Name/Title _____
Firm/Dept./Div. _____
Address/MS _____
City/State/Zip _____ Phone () _____

EDN 03/30/89

MEPCO/CENTRALAB
A DIVISION OF NORTH AMERICAN PHILIPS CORPORATION



CIRCLE NO 53

*SMD is a service mark of North American Philips Corporation.

The Causer filter rolls off to a deep, finite, well-defined attenuation floor.

passband. The Causer filter's response suits applications requiring fast roll-off and the widest possible alias-free passband. The need for this type of filter grows as f_{sr}/f_m approaches two.

Table 4 compares the passband of the four responses, normalized to -80 dB, and provides a figure of merit for amplitude response. With reference to the 0.1- and 3-dB stopband-edge frequencies, this table lists the ratio of the Causer elliptic filter's passband to the passbands of the Bessel, Butterworth, and Chebyshev filters.

An example is useful

To illustrate a typical design approach, consider the definition of a prefilter for use with a 12-bit A/D conversion system that must digitize signals to 20 kHz without aliasing. The passband must extend from dc to 10 kHz and must exhibit no more than 0.1 dB of ripple.

Alias-free operation requires the attenuation of signals at and above the f_m of 20 kHz by no less than $6(n+1)$ dB = $6(12+1)$ dB = 78 dB. The applicable filter parameters include a stopband-edge frequency, f_r , of 10 kHz, a passband ripple of 0.1 dB max, and a minimum attenuation floor of 78 dB at $f_s=20$ kHz. The resulting shape factor is $\Omega_s=f_{-78}/f_{-0.1}=20$ kHz/10 kHz=2. The 7-pole, 6-zero Causer filter easily meets these requirements.

The A/D converter must be able to sample at a minimum rate of $2f_m$, or 40 kHz. This rate corresponds to a maximum A/D conversion time of 25 μ sec, and a sampling window on the order of 10 nsec for 12-bit accuracy.

Other considerations

You should consider data reconstruction in the early phases of system design. Reconstruction is often necessary because the sampling rate and window modify a signal of frequency f in the same way as does a lowpass filter with the $\sin(x)/x$ response shown in **Fig 6**. With $x=\pi f/f_{sr}$, and nulls occurring at f_{sr} and its harmonics, the attenuation is equal to

$$20\log(\sin(\pi f/f_{sr})/(\pi f/f_{sr})).$$

Thus, at $f_{sr}=4f$, the attenuation is

$$20\log(\sin(\pi/4)/(\pi/4))=0.9 \text{ dB.}$$

Accurate reconstruction requires compensation for the losses caused by this effect. There are many recovery mechanisms, including the zero-order hold (a

clocked digital-to-analog converter) and lowpass filters of various orders and complexity. All of these filters have the task of filling in the steps of the sampled waveform to smoothly replicate the original.

Certain filter parameters warrant attention. First, you must take care to ensure that the prefilter exhibits low distortion. The harmonics generated by a filter suffering from amplitude or rate limiting are likely sources of alias errors. You must therefore observe all of your chosen filter's specified restrictions on output loading and such signal characteristics as peak voltage and slew rate.

Then, because noise contributes to aliasing and also degrades system sensitivity and dynamic range, you need to know how much noise your filter can produce. Fortunately, present-day lowpass active filters exhibit noise performance suitable for most applications.

Next, you should consider such filter parameters as input impedance, output impedance, and the initial value and temperature coefficient of the filter's and ADC's input offset voltages. Changes in the first two quantities can produce system gain variations. The others can cause dc baseline shifts.

A final consideration concerns the reproducibility of your product. You should know or determine how closely you or the filter vendor can match the characteristics of supposedly identical filters. With this knowledge, you can ensure compliance with system specifications in both single and multichannel configurations.

EDN

Reference

Vandoren, A, *Data Acquisition Systems*, 1982, Prentice-Hall, Englewood Cliffs, NJ, pgs 27 and 29. Figs A, B, and C(a) reprinted with permission of Prentice-Hall.

Author's biography

Bob Steer is president and treasurer of Frequency Devices Inc in Haverhill MA—but those are only his official titles. In his 20 years at the company, he has always been active as a design engineer. He holds a BSEE from Merrimac College and MS and ScD degrees from MIT. Prior to founding Frequency Devices, he held positions in academia as an associate professor and as chairman of an EE department. Bob's hobbies include boating and cycling.

Article Interest Quotient (Circle One)
High 485 Medium 486 Low 487



SAFT BATTERIES. ONE FOR ALL. ALL FROM ONE.

Powering the portable electronics of the 80's has been a major problem for product design engineers. And the 90's will be even more challenging. But there is a one source supplier who can meet almost any portable power design challenge. With the industry's broadest line of Nicad® batteries and a variety of lithium chemistries, SAFT allows today's design engineer to design portability into a broad spectrum of electronics, from simple toys to sophisticated computers. And, best of all, this full range of portable power is available from a single source—one order, one shipment, one invoice.

For more information on our complete line of Nicad batteries, contact SAFT America Inc., Portable Battery Division, 711 Industrial Boulevard, Valdosta, Georgia 31601, or call (912) 247-2331. For information on our variety of lithium chemistries, contact SAFT America Inc., Advanced Battery Systems Division, 107 Beaver Court, Cockeysville, Maryland 21030, or call (301) 771-3200.



SAFT

CIRCLE NO 55



UNION
CGE

To Brighten-up Your Display Innovations

...turn onto itron VFD super-smart modules.

- HIGH VISIBILITY LOW POWER
- SURFACE-MOUNT TECHNOLOGY
- LONG-TERM RELIABILITY
- 5Vdc POWER SUPPLY OPERATION

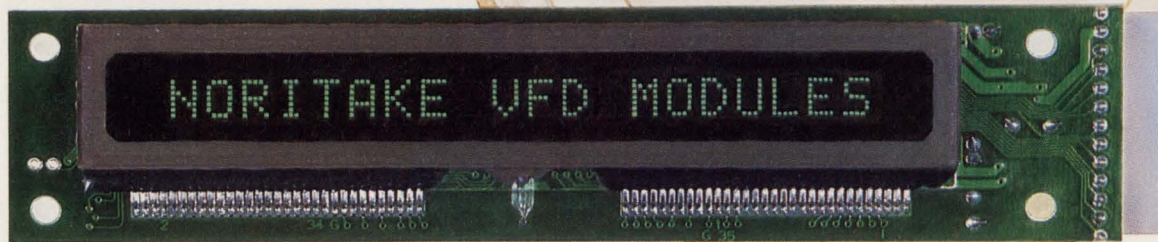
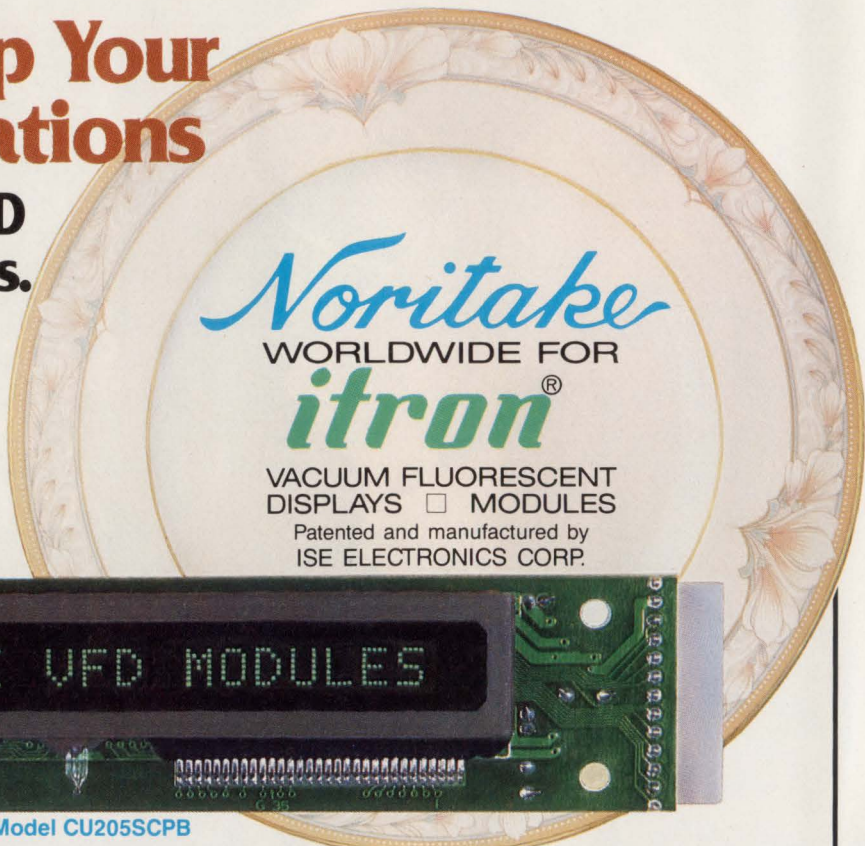

Model CU205SCPB

DOT CHARACTER DISPLAY MODULES

CHARACTER FORMAT	MODEL NUMBER	NUMBER OF CHARACTERS	CHARACTER HEIGHT (MM)	INPUT (SERIAL/PARALLEL)	BI-DIRECT BUS
5 x 7 DOT MATRIX	CU165SCPB-S	1 x 16	5.0	S/P	
	CU169SCPB-L	1 x 16	9.0	P	X
	CU205SCPB-S	1 x 20	5.0	S/P	
	CU209SCPB-L	1 x 20	9.2	P	X
	CU2015SCPB-L	1 x 20	15.1	P	X
5 x 7 DOT MATRIX PLUS CURSOR	CU406SCPB-S	1 x 40	5.0	P	X
	CU20026SCPB-S	2 x 20	5.1	P	X
	CU40026SCPB-S	2 x 40	5.0	P	X
	CU40046SCPB-S	4 x 40	5.0	S/P	X
	CU40066SCPB-S	6 x 40	5.0	S/P	X
	CU40086SCPB-S	8 x 40	5.0	P	X

DOT MATRIX DISPLAY MODULES

DOT MATRIX FORMAT (DOTS/LINE x NO. OF LINES)	MODEL NUMBER	NO. OF LINES AND CHARACTERS/LINE (5 x 7 DOT CONFIGURATION)	GRAPHICS CAPABILITY
192 x 16 (3072 DOTS TOTAL)	GU192X16	2 x 32	YES
256 x 16 (4096 DOTS TOTAL)	GU256X16	2 x 42	YES
256 x 64 (16,384 DOTS TOTAL)	GU256X64	8 x 42	YES

Model GU192X16



The models shown are typical examples of the broad selection available for immediate delivery. Contact our nearest Sales Office or Representative to help select the right Noritake VFD for your application as well as for details on costs, custom designs, etc.

NORITAKE SALES OFFICES

NORITAKE CO., INC. Electronics Division
 LA: 23820 Hawthorne Blvd. Suite 100 Torrance, CA 90505
 Phone: (213) 373-6704 FAX: (213) 772-3918
 CHICAGO: 415 E. Golf Rd. Suite 109 Arlington Hts., IL 60005
 Phone: (312) 439-9020 FAX: (312) 593-2285
 BOSTON: 263 Winn Street Suite 1D Burlington, MA 01803
 Phone: (617) 270-0360 FAX: (617) 273-2892 TLX: 4973468
 DALLAS: 2454 Trade Mart Dallas, TX 75207
 Phone: (214) 742-9389 FAX: (214) 747-5065
 NORITAKE EUROPA GmbH Electronics Division
 EUROPE: Frankfurter Strasse 97-99, D-6096 Raunheim, F.R. Germany
 Phone: 06142-43095/96/97 FAX: 06142-22799 TLX: 4182982dnd
 NORITAKE CO., LTD. Electronics Division
 JAPAN: 1-36 Noritake Shinmachi, 3 Chome, Nishi-Ku, Nagoya
 Phone: (052) 562-0336 FAX: (052) 581-1679 (GIII) TLX: 59738

REPRESENTATIVES

WA, OR: (503) 684-1671 Components West, Inc.
 No. CA, NV: (415) 961-1422 Westech Sales
 So. CA: SD (619) 292-1771 / OC (714) 891-4621 ELSCO
 TX, OK, AR, LA: (214) 386-4888 Norcom, Inc.
 CO, UT: (303) 794-4684 MRC
 OH, WV, W. PA, KY: (216) 461-6161 Arthur H. Baier
 No. IL, So. WI: (312) 439-9810 Coombs Associates, Inc.
 AL, GA, MS, TN: (205) 533-1730 Interep Associates
 IN: (317) 844-4842 Fred A. Dorsey & Associates, Inc.
 No. WI, MN, No. IA, ND, SD: (612) 536-9512 Tech. Components
 N.E.: (508) 788-0316 International Mktg. Group
 PA, MD, DE: (215) 233-0333 C.H. Newson & Associates
 FL, PUERTO RICO: (407) 831-8233 Semtronic Asso., Inc.
 NY, NJ: (201) 376-3324 F.F. Sylvester Associates
 VA: (804) 740-0063 Glasscock Associates
 NC, SC: (919) 782-8100 C-Tech Sales Co.
 CANADA: (416) 671-8111 Gidden Morton Associates

EPSON IC MEMORY CARDS

2.4 mm thin + Epson quality

BUILT TO LAST

Epson IC Memory Cards are engineered like no others . . . they are the fastest, thinnest, toughest, most reliable cards made, and have the highest industry ratings for suppression of EMI plus protection from ESD and contaminants.

Durable stainless steel outer panels cover a high-impact resistant core. Unique package provides 25,000 volts ESD protection and EMI noise suppression. The card connector's grounding system adds to the cards ESD and EMI noise protection for overall system isolation.

Epson offers IC Memory Cards from stock, plus Mask ROM and other customs made to your order. All Epson IC-Memory Cards of the same pin type are interchangeable . . . ideal wherever small, rugged and portable memories are required.



User replaceable battery for SRAM cards . . . plus write protect switch.

2.4 mm thin cards fit standard connectors for 8-bit (34/40-pin) or 16-bit (50-pin) bus applications.

EEPROM Card Series
8K to 32K Bytes

EPROM Card Series
32K to 1024K Bytes

Mask ROM Card Series
32K to 2048K Bytes

SRAM Series
8K to 512K Bytes

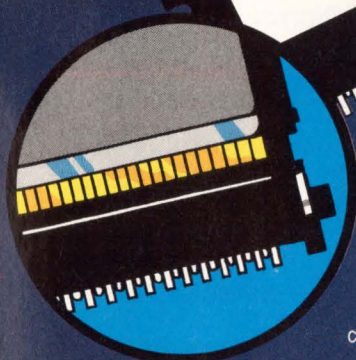

Contacts are covered by a unique protective shutter that slides open as card is inserted into the connector. Long-life contacts permit cards to be inserted and removed a minimum of 10,000 times. Inquire about Z.I.F. type connector for 100,000 cycle applications.

Call or write for complete information

EPSON
Epson America, Inc.

Component Sales Department
3415 Kashiwa Street, Torrance, CA 90505

Telephone (213) 534-4500 • Telex 664277 • FAX (213) 539-6423

CIRCLE NO 17

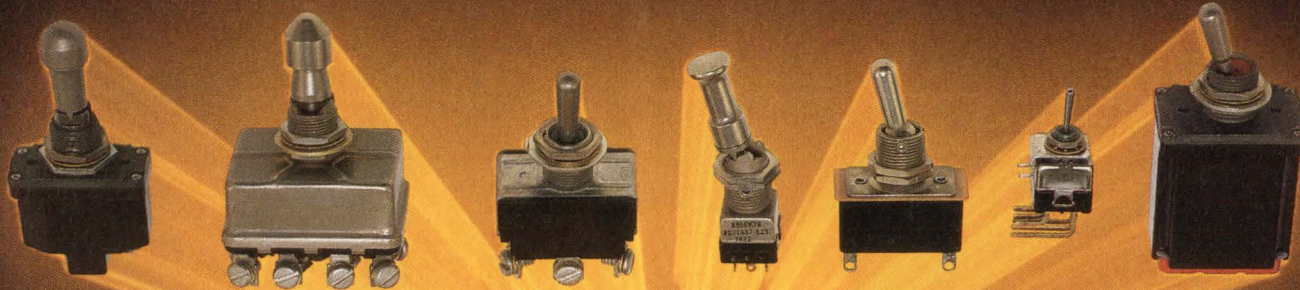

Aerospace Switches



Cutler-Hammer® aerospace switches thrive on punishment.

Pick an application—your toughest application. That's where you'll want to use one of these remarkably rugged Mil-Spec switches.

From applications on business/commercial aircraft, heavy-duty vehicles and construction equipment, to a wide variety of military applications—these switches survive the harshest environments.

Choose from a broad line of sealed and unsealed switch

types. Each backed by extensive R&D and supported by a solid, service-oriented sales and distributor network.

For more information contact your Cutler-Hammer Sales Office or Distributor. Or send for our complete catalog. Eaton Corporation, Aerospace & Commercial Controls Division, 4201 N. 27th St., Milwaukee, WI 53216. Or call 414-449-7487.



VISIT US AT THE ELECTRO SHOW BOOTH 1960

EATON

Aerospace, Commercial, Miniature, Illuminated Switches and Relays.

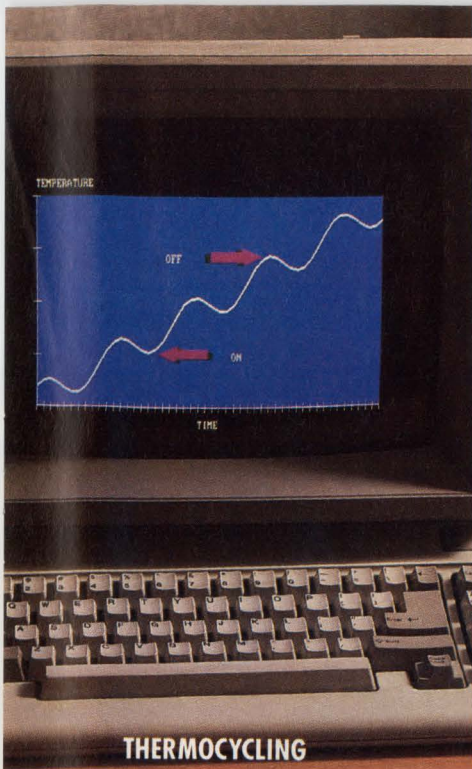

THERMOCYCLING

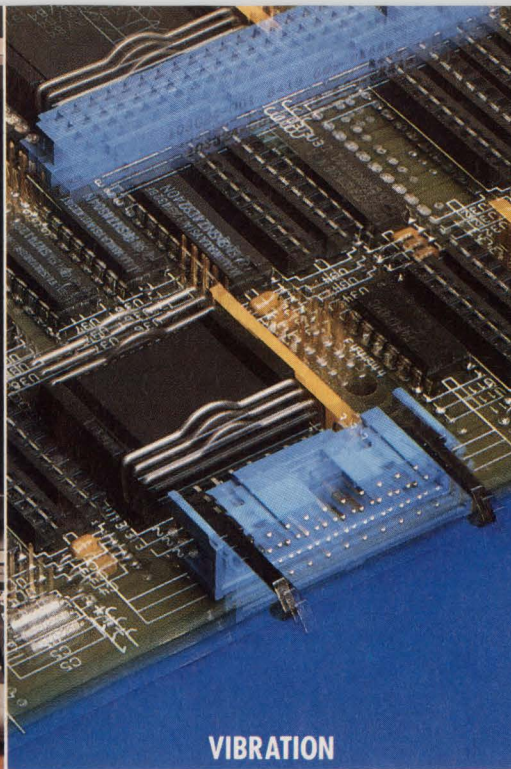

VIBRATION

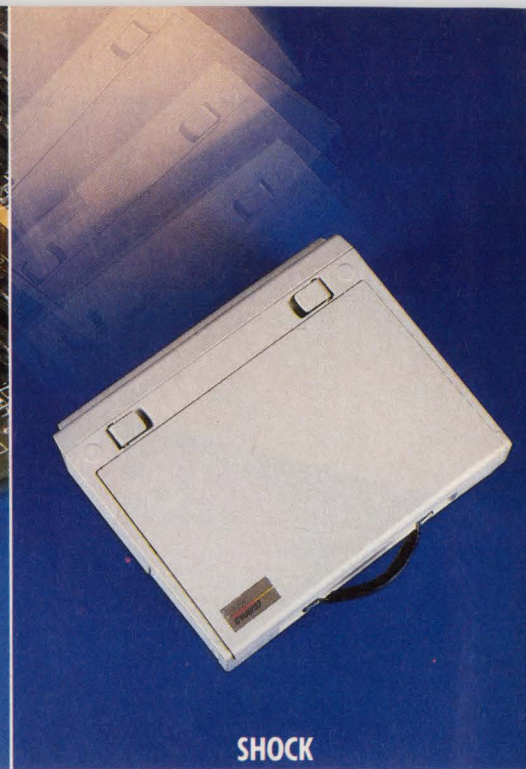

SHOCK

OUR PCC SOCKET WON'T "WALK-OUT" WHEN CONDITIONS GET ROUGH.

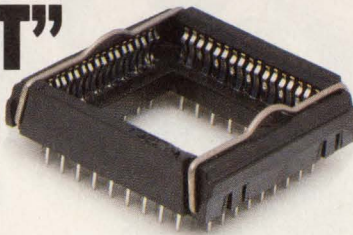

The Ansley® Plastic Chip Carrier (PCC) Socket is the only one that's tough enough to withstand the punishment of thermocycling, vibration and mechanical shock, and still stay on the job. Our unique cam-actuated socket contact design provides a positive gas-tight connection, producing 200g's normal force.

The contacts are cammed both inward and downward against the knee of the "J" lead, by means of a cam profile in the cover. This cam action assures that the IC won't

walk out of the socket no matter how rough the environment. So when your designs call for durability and high reliability, Thomas & Betts is the way to go.

High retention force is just one of the benefits you get with the new Ansley® PCC Socket. Our cam-actuated design also provides a low insertion/extraction force —50g/contact maximum—perfect for VLSI and high density applications. A polarizing feature assures positive chip carrier orientation, and the socket

installs on the board without special tooling. The device is available in four sizes: 44, 52, 68 and 84 positions. Trouble-free removal of the IC package is accomplished with a simple extraction tool.

All these Thomas & Betts benefits add up to one thing—a better PCC socket. *For more information, write or call* Thomas & Betts Corporation, Electronics Division, 1001 Frontier Road, Bridgewater, NJ 08807, (201) 685-1600.

Other quality Electronics Division products include: IDC Cable and Connector Systems, DIP and VLSI Sockets, Fiber Optic Systems, Flexible Interconnects, and Two-Piece Connectors.

To get literature immediately call:
1-800-344-4744

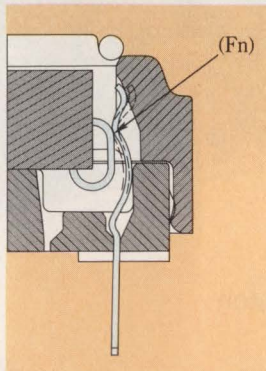

Components of the normal force drive IC into the socket.

We Wrote The Book On Switches!



Update your switch source file with C&K's new free catalogs. The Newton Division Products Catalog #8709 includes miniature instrument grade toggle, rocker, slide, DIP, pushbutton, rotary and thumbwheel switches. The Clayton Division Products Catalog #C8803 includes switchlocks and low cost slide, rotary, rocker and pushbutton switches.

Send for our new free catalogs and see how we wrote the book! To receive a free sample, call (617) 964-6400. FAX (617) 527-3062

C&K[®] C&K Components, Inc.
15 Riverdale Avenue
Newton, MA 02158-1082

The Primary Source Worldwide[®]

SEE US AT NEPCON WEST, BOOTH #2148 & SOUTHCON BOOTH #1536-1538

END

INSIDE THIS ISSUE
Blurry scope photos
Proper EE etiquette
Designer's guide to boring applications
Gausser/degausser causes cancer

ELECTRONIC NONSENSE FOR ENGINEERS AND ENGINEERING MANAGERS



Computer-aided production makes EEs smaller, faster



*Etiquette
for
Engineers*

It's a sad fact that engineering schools give short shrift to the social graces. Yet, in your career, you're faced with the necessity of dealing with people, many of them highfalutin. This column, therefore, will give you the rudiments of etiquette, both to spare you embarrassment and to increase the likelihood of your keeping your job. This month, we'll explore how to act in a fancy restaurant.

1. Upon entering, show no signs of being impressed. Statements like, "Gosh, this is a beautiful, fancy place" are a no-no. Just raise your eyelids slightly and say something like, "Hmm—looks as though my decorator's been here."

2. Always carry a flashlight and a pair of scissors with you. Americans think dark restaurants are classy, so it's likely you won't be able to read the menu by the light of the small candle on the table. Using the scissors, cut out the price column from the menu. That way, the person you're with won't think you're price conscious. And never ask for a translation of items printed in French. Nod your head knowingly and order at random.

3. When you taste the wine the sommelier (wine steward)

brings, chew it a while, then spit it on the floor. Then, even though you have no idea how good or bad the wine is, say something like, "Hmm—an impish little wine" or "Hmm—it has an imposing character that stops just short of ostentation."

4. When you eat your meal, be ambidextrous. Switching the fork from hand to hand after cutting your meat reveals your roots.

5. Finally, if your waiter's name is Jacques or Pierre, impress him and your dining companion by using a little French. Here are three phrases that are sure to go over big.

★ *Cette nourriture est abominable.*
(set new-ree-tyur ett ah-bow-me-nah-bluh)
This food is delicious.

★ *Je pense que je vais vomir.*
(zhe ponss kuh zhe vay voh-meer)
I think that I will return.

★ *Votre chef est un sacré imbécile.*
(voe-truh chef ett unh sah-cray em-bay-seal)
Your chef is a real genius.

ENGINEERS

YOU HAVE DEFINITELY WON A FREE GIFT!!!

Gift Category A	Gift Category B	Gift Category C
The Taj Mahal	19" Color TV	Tooth Brush
Yankee Stadium	Food Processor	HB Pencil
Fort Knox	Pasta Machine	Pocket Protector
47k, 1% Resistor	47k, 5% Resistor	47k, 20% Resistor

Inspect the three numbers below. If no numbers match, you've won a gift from Category C! If two numbers match, your gift is in Category B! If all three numbers match, you'll definitely receive one of the gifts in Category A!!!

6347

6347

6347

To claim your gift, all you have to do is visit our engineers' vacation resort in beautiful Sleazonia, West Virginia! You'll receive a presentation (whether you want it or not) on the benefits of purchasing a lifetime privilege to spend your vacations in our luxurious 4x6-ft mobile dwellings, which feature convenient outdoor toilet facilities and a test lab nearby.

Before setting up an appointment, simply find the gold star somewhere in this magazine and paste it on the entry certificate found somewhere else in the magazine. Then find the blue dot somewhere, and paste it on the gold star. To be eligible for the grand prizes, find the symbols of the Taj Mahal, Yankee Stadium, and Fort Knox somewhere in the magazine, and paste the symbol of your choice on the Grand Prize form found somewhere else. Then, stand on your head for 30 seconds while reciting "Beautiful Sleazonia." Finally, send proof that you're married with a combined income exceeding \$80,000 and a copy of your mortgage, including all liens attached thereto, to

Sleazonia Vacation Resorts Inc
1500 Sucker Lane
Sleazonia, WV 55555

Drawing for Grand Prizes will take place June 6, 1989. Drawing will be supervised by Joe. Odds of winning: Taj Mahal, Yankee Stadium, Fort Knox: 1 in 1 googolplex. 19" Color TV, Food Processor, Pasta Machine: 1 in 1 googol. Tooth Brush, HB Pencil, Vinyl Pocket Protector: who cares?

EDITORIAL

Tax the watt guzzlers and bit polluters

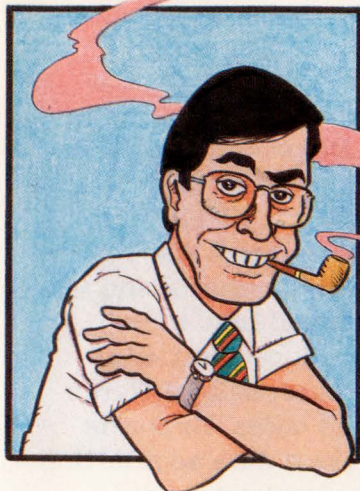

Gorde/David B Gordon

President Bush has inherited the excruciatingly difficult task of reducing our country's \$17 zillion deficit. His "1000 points of light" can only increase the debt—how much depends on the wattage of the lights. A plausible way to cut the deficit is to tax electronics end users who use circuits and systems that consume too much power, operate too fast, or use too many bits.

It's inarguable that our deficit is linked closely to our consumption of energy. Because we have 432 ready-to-go nuclear plants whose startups are blocked by picketers who yearn for a return to kerosene lamps, we must use fossil fuels to produce electricity, Ovshinsky notwithstanding. And because OPEC is poised to inflict another '70s-type punishment on us, we simply must reduce the power we consume. Some will say, "What's the problem? Now we have CMOS, so power consumption is going down." True. But what most people don't realize is that our supply of C is dwindling rapidly. There's still plenty of N in the hills, but NMOS has fallen out of favor. So we must import a high percentage of the C we use in making CMOS ICs—hardly a way to reduce the deficit.

The ever-increasing speed of modern systems is inextricably tied to the rising consumption of power. What's needed, then, is a tax system that penalizes excessive power consumption and its bosom buddy, high speed. I propose that President Bush issue guidelines on IC speed. For example, he could impose a limit on A/D-converter speed in the form of a maximum resolution-frequency product. In my opinion, 315 CM (codes \times MHz) is a reasonable figure. A 12-bit A/D converter, for instance, has 4096 codes. The 315-CM limit would restrict the converter's speed to 0.077 MHz, corresponding to a conversion time of 13 μ sec.

Another factor tied to power consumption is bit count. The evolution of computer systems from 8 to 16 to 32 bits has been accompanied by significant increases in power consumption. The same is true for the ever-increasing RAM capacities in modern computers. A side effect of this insatiable demand for more and more bits is bit pollution. A large portion of these zillions of bits goes unused, and so we have the problem of bit disposal and its resulting pollution. Land bitfills are becoming exhausted; bit incinerators use fossil fuels and pollute the atmosphere.

A presidential commission could determine a reasonable progressive tax on the number of bits in a system. Another source of revenue would be a tax on bit disposal. This disincentive would provide an impetus for developing trinary (base-3), quadrary (base-4) and quinary (Schweppes) computers, which use fewer bits to process a given amount of data. Some other ways to reduce the deficit:

- Sell Silicon Valley to the highest bidder
- Raise engineers' income taxes to 90% of gross income
- Eliminate all taxes on management personnel. Management deserves the credit for the healthy state of American electronics, despite engineers' blunders; eliminating taxes on these business geniuses will provide incentive for making companies healthier yet.
- Impose an application fee of \$1,000,000 per patent
- Restrict defense contractors' illegal overcharging to 20% of a contract's face value (unless the illegal overcharging is proven to be justified).

Bill Travis

Bill Travis
Contributing Editor

NEWS BREAKS

COMPANY MARKETS DATA-DEGRADATION SYSTEM

A new data-acquisition board, dubbed "BarfData," is available from Data Distortion Inc (Chesterfield, MA), a company that specializes in PC-based analog-signal degradation. The board features 16 poorly multiplexed analog-input channels, a signal-degrading instrumentation amplifier, a track-and-hold distorting amplifier, and a 12-bit, nonlinear A/D converter. The input multiplexers are from the bottom of the barrel, and offer only 20-dB channel-to-channel isolation and 1 M Ω each of on- and off-resistance. By the time a signal reaches the instrumentation amp, it's tainted by pollution from adjacent channels and severely attenuated by the multiplexers' high on-resistance. The instrumentation amp's specs are as repugnant as the multiplexers'; for example, gain accuracy is $\pm 48\%$ and total harmonic distortion is -15 dB. The almost unrecognizable signal then goes to the track-and-hold amp, whose abominable pedestal, accuracy, and droop parameters introduce additional errors in the signal. Finally, the output A/D converter features nauseating differential and integral nonlinearity and misses at least 2011 of its 4096 codes. Explains Joe Signalicide, president of Data Distortion, "Any wimp can make a data-acquisition system whose output accurately represents the input codes; it's a real art form to take a perfectly pure input and turn it into a stench in the nostrils of the signal-processing community."—Bill Travis

EVERYBODY ACQUIRES EVERYBODY

In a startling press conference on April 1, a spokesman from Insiders Inc, a Wall Street illegal-insider-information trader, announced that every electronics firm in the US has concluded a leveraged buyout of every other firm. According to Insiders' Boesan Ivesky, top-secret negotiations for the buyouts have been going on for the past three years. The ramifications of the buyouts are unclear at this moment; what's certain, however, is that every firm plans to fire every other firm's management team. The implications for design engineers in the acquir(ed)(ing) companies are equally unclear. Ivesky revealed, however, that the industry plans to adopt a free-agent system similar to the one used in professional sports.—Bill Travis

IBM ANNOUNCES PS/1,000,000 SERIES

Big Blue set the computer industry on its ear on April 1, when the firm announced its new, PS/1,000,000 Series of personal computers. Designed to prevent cloning, the family uses a bus architecture called TeraChannel—a 128-bit bus structure that's covered by 967 patents, 401 copyrights, and two Emmy awards. Additional clone-thwarting measures include explosive cabinet bolts, an automatic videotape record of users, and a 1-time user oath (with Bible) administered by the firm's authorized value-depleted resellers (VDRs). According to Mr Large Blue of IBM, Microhard is developing a PS/1,000,000-compatible operating system called OS/1,000,000. Immediately after IBM announced the series, a consortium of personal-computer manufacturers (led by Compaq) revealed plans for a counterattack. The firms plan to introduce a 256-bit, open-architecture system that uses Intel's new 8,000,986 microprocessor, a 250-GHz IC that addresses 9,999,999,999,999,999 Tbytes of memory.

—Bill Travis

DEAR ABBOTT

Avoid burned-out ICs . . . also, how much for trade secrets?

Dear Abbott:

I have this problem with CMOS logic ICs. Every time I wire up a breadboard, I end up with one or more burned-out ICs. I've tried fusing the power supply and bringing the voltage up gradually, but nothing seems to help. Do you have any idea what I'm doing wrong?

Worried, Santa Clara, CA

Dear Santa:

Sure—you're not seasoning the CMOS ICs properly. It's a little-known fact that these circuits require some "stroking" before you can use them in an application. The procedure is simple: Wear shoes with leather soles and scuff them about 20 times on a nylon rug. Then run a nylon comb through your hair about 10 times. Now you're ready to season the ICs. Just hold one row of pins against a ground plane and touch the other row (the row with the input pins) with your index finger. You should have no more problems.

Dear Abbott:

I'm bewildered. First, we had the 150V supplies for powering vacuum-tube circuits. Then $\pm 15V$ came along, and it seemed to be the ultimate solution. Now we have ICs that are powered from single 5V supplies, and some say the voltage will drop even further, say to 3.3V. What's your opinion about all these changes? Concerned in New Jersey

Dear New:

Well, let's look at it from the standpoint of numerology. Consider the ratios of the successive power-supply voltage-span reductions—150V to 30V, a ratio of 5; 30V to 5V, a ratio of 6. Now hold on to

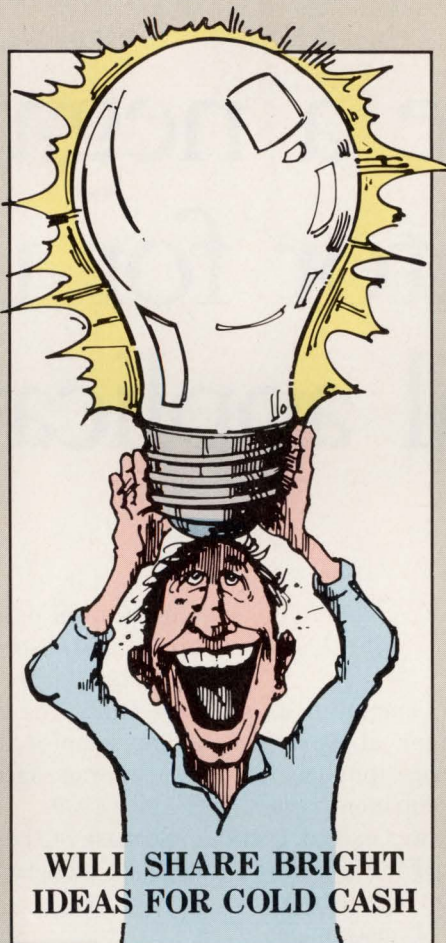

WILL SHARE BRIGHT
IDEAS FOR COLD CASH

your hat. What's startling is that the ratio of 5V to 3.3V is 1.5151515 . . . , a never-ending number. Are you sitting down? There's more—it so happens that Ramus II, the father of astrological proctology, was born on May 6, 1515. If I were you, I'd run right out and play 5615 in the daily-numbers lottery.

Dear Abbott:

My boss and I have this argument going. We have an application for a large number of extremely fast flip-flops. I want to use an ECL gate array, and my boss is set on using a GaAs array. Who do you

think is right? ECL Advocate, High Power, CA

Dear ECL:

You're both wrong. The 6SN7 dual triode makes the best flip-flop in the world. You and your boss have the same problem: You're hung up on the latest, trendiest technology, and you've lost sight of tried-and-proven techniques. Get off the fad bandwagon and take some time to smell the filaments.

Dear Abbott:

I'm a circuit-design engineer in a defense-electronics firm, and I don't make enough money to make ends meet. The problem is, my wife likes Porsches, Perrier water, and expensive yuppie restaurants. So, I've begun selling some of our company's schematics to a bearded man named Boris. My question is, how do I determine how much to charge? Entrepreneur, Profit Motive, CA

Dear Entrepreneur:

First, let's determine my share for not turning you in. I think 40% is equitable. The best way to set a price for stolen trade secrets is to charge by the IC count. That way, you'll have an incentive to maximize the number of ICs in the circuits you design. I feel \$1000 per IC package (\$10,000 for gate arrays) is fair. You'll receive the number for my Swiss bank account in the mail.

Dear Abbott is pleased to answer questions from engineers who are either too dumb or too lazy to solve their own problems. Send self-addressed stamped envelope and a blank, signed check.

Use a negative capacitor for useful, banal applications

Bill Travis, *Contributing Editor*

It's been 21 years since this editor, employed as a bizarre-product development engineer at Sprague Electric Co (North Adams, MA), serendipitously invented the MinusCap (Ref 1). This component resembles an ordinary capacitor in every way, except that its value is negative (for example, $-1 \mu\text{F}$). Fig 1 shows the startling results of applying a step signal to a series-RC integrator incorporating the MinusCap. Note that the output waveform has a negative time constant. This phenomenon is easy to explain—to preserve the negative exponent of e in the expression $V_{\text{out}} = V_{\text{in}}(1 - e^{-t/RC})$, the time t assumes a negative value.

An interesting aspect of the output waveform in Fig 1 is the fact that two output voltages exist simultaneously. A useful, albeit banal, application comes to mind. If you connect a lowpass and highpass dc-voltage filter to the output and buffer the outputs of the filters, you obtain a dual-voltage power supply. For example, assume the lower output voltage in Fig 1 is 5V and the upper one is 15V. A 5V lowpass dc filter with reasonably steep skirts will, for all intents and purposes, completely attenuate the 15V signal and pass the 5V level. And vice-versa for the 15V highpass dc filter.

Some applications suggested in Ref 1 include predictions of future noise spikes, scope probes with zero shunt capacitance (made by connecting an equal-value

MinusCap in parallel with the probe's positive capacitance), and observations of future failures. The promise of a rosy future for the component, however, never bore fruit. The Department of Defense (DoD) seized all lab samples and notes, and put the material in the same storage facility that's housed the Lost Ark (Ref 2) since 1939.

Because of the USSR's development this year of the negative inductor and the imaginary resistor, the DoD

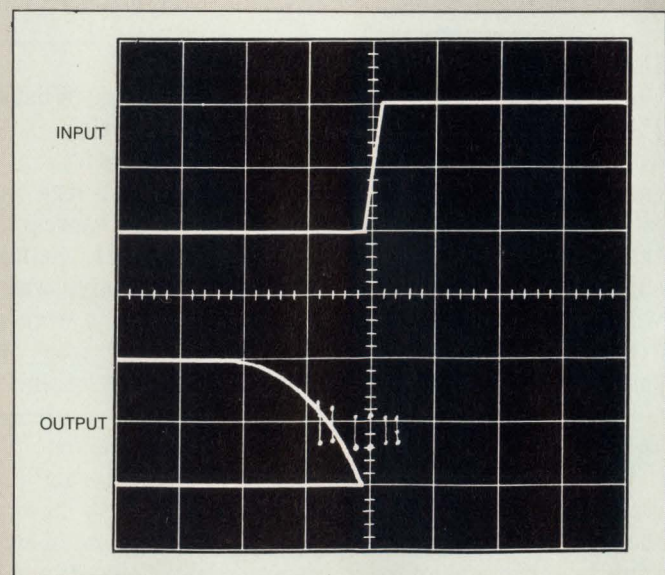

Fig 1—This scope photo depicts the input and output waveforms of the $-1 \mu\text{F}$ MinusCap; pay no attention to the phosphor burn marks.

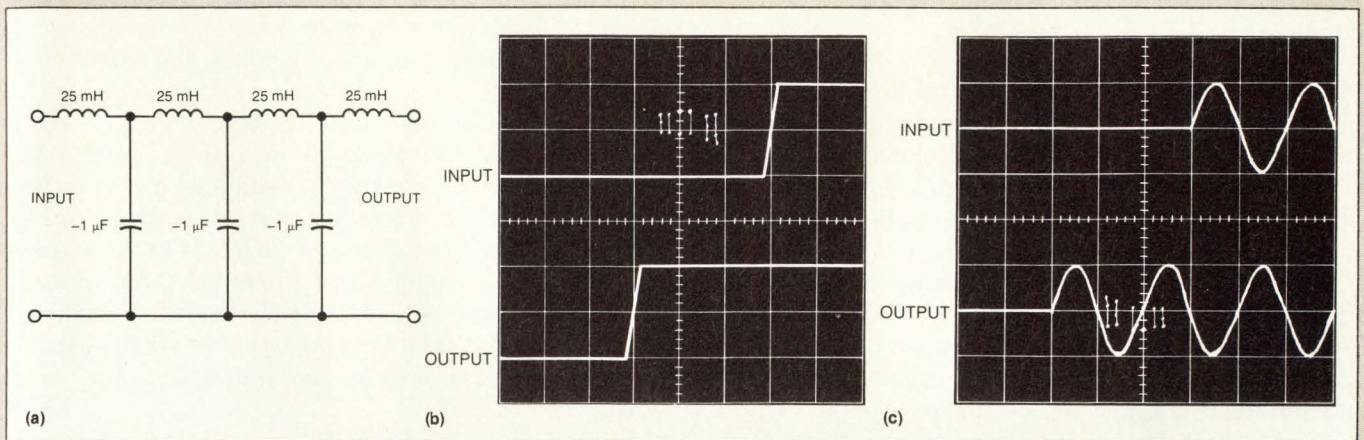

Fig 2—It's up to you to figure out any useful applications for the MinusCap.

no longer considers the MinusCap to be a threat to national security. Development of paper, ceramic, and electrolytic negative capacitors is now underway at several manufacturers' facilities. At the mammoth EDN test lab, for example, this editor recently constructed some units that exhibit a $-1\text{-}\mu\text{F}$ value and effective series resistance of -0.1Ω .

Fig 2a shows a delay line constructed with 25-mH positive inductors and the $-1\text{-}\mu\text{F}$ MinusCaps. In Fig 2b, you see the results of applying a 10V step to the input of the line. The output step appears 3 msec before the application of the input. As seen in Fig 2c, the same results accrue when you apply a sinusoidal input to the input of the delay line (actually, the anticipation line)—the sinusoidal output appears at the output 3 msec before the application of the input. It's up to you to determine useful applications for such anticipation lines. One possibility is to detect changes in system logic states before they occur.

One final application possibility, one the DoD is studying very carefully, is in imaginary-frequency transmitters. The expression

$$f = \frac{1}{2\pi\sqrt{LC}}$$

gives the frequency determined by an LC tank in an oscillator. If the value of C in the expression is negative, then the resulting frequency is, naturally,

$$f = -j \frac{1}{2\pi\sqrt{L|C|}}$$

The reason for the DoD's interest in such imaginary-frequency transmitters is the fact that their signals are detectable only by imaginary receivers, such as those the DoD often receives under defense contracts.

EDN

References

1. Travis, W J, "The negative capacitor: A challenging new component," *EEE*, September 1968.
2. Jones, Indiana, "Discovery of the Lost Ark of the Covenant," *Journal of Mythical Artifacts*, July 1939.

CAREER OPPORTUNITY: ENGINEERING PROFESSORS NEEDED

If you're experienced in electronic engineering but you feel you're at a dead end in your job, consider making a career change. At Real-World Engineering Institute, we have openings for professors who can teach practical courses not offered at most engineering schools. Some examples:

- **Buck-Passing I and II.** The fundamentals of how to avoid taking the blame for project catastrophes. Includes such categories as The Power-Outage Ploy, Copy-Protection Crash, and Joe Did It.
- **Advanced Rationalization.** The course material gives students hundreds of ways to explain away undesirable results in their designs. Some topics: We Need a Class-(1000/100/10/1) Clean Room, We're Getting Lousy Wafers from Our Supplier, and The Coprocessor Made a Math Error.
- **Climbing the Ladder.** How designers can stab their bosses in the back and get ahead. Examples: Anonymous Notes to the President, Anonymous Notes to the Boss's Wife, and The Perfect Murder.

Back-stabbing, scapegoating, and buck-passing experience is preferred. Send your resume in complete confidence to:

Real-World Engineering Institute
Opportunism, CA

An equal-opportunity employer.

ABERRANT DESIGN IDEAS

Gausser/degausser brightens color monitors

Ted Burton
Signetics

A small permanent magnet (the gausser), held in close proximity to the face of an operating color monitor, will produce a striking display of colorful patterns (Fig 1). Much to the chagrin of the gausser user, though, the colorful patterns turn into permanent color clouds when the gausser is removed.

Luckily for the gausser user, whose job might now be in jeopardy, it's easy to build a degausser from a 1000-ft roll of 30-gauge wire-wrapped wire. This degausser is not UL approved, it erases any magnetic medium within a foot or two, it uses potentially lethal

voltages, it interferes with pacemaker operation, and it probably causes cancer or hair loss in laboratory rodents. However, it also removes the cited color clouds.

Fig 2 shows how to build the degausser and turn it on by sticking its two leads into an ac outlet. You should sweep the powered-up degausser past the face of the monitor for several seconds, then turn it off by pulling the leads out of the ac outlet. If the degausser is left running longer than a minute, the degausser and its operator will most likely start to smoke or burn. (*Ed Note: The thought occurred to this editor: Why use the gausser in the first place? But that's pica-yune.*)

EDN

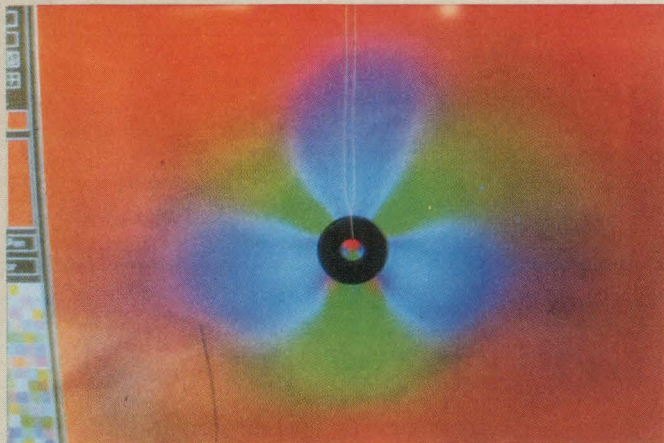

Fig 1—A simple magnet can really liven up your color monitor.

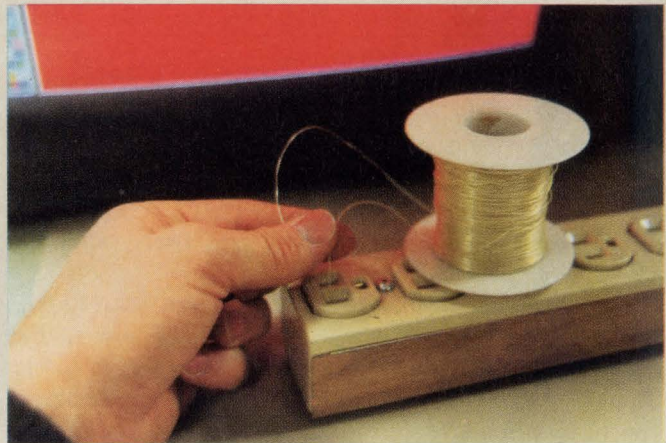

Fig 2—In addition to killing innocent lab animals, this degausser gets rid of the colorful patterns on your monitor.

Exploit Z80's hidden logarithmic mode

Jim Williams
Linear Technology Corp

The popular Z80 microprocessor contains a very powerful embedded routine dedicated to high-speed logarithmic functions. Because it operates in real time, it is significantly faster than lookup tables or computational approaches. Furthermore, it's directly addressable in analog format. All Z80 chips have this capability, although manufacturers do not supply the necessary data to exploit it.

The circuit in Fig 1 is a complete, real-time logarithmic ratio computer that uses fully parallel, coprocessing Z80s in the embedded logarithmic mode. Connecting an analyzer between the Z80's ground pin (pin

29) and the D₁ data bus (pin 15) reveals the internal logarithmic instruction set. Figs 2a, 2b, 2c, and 2d show that the best performance occurs in the 300-nA to 750- μ A range.

This designer (*Ed Note: We must avoid writing in the first person at all costs*), discoverer of the Z80's logarithmic mode, is ebullient. Everyone always told this designer that analog circuits were nowhere. Now this designer believes it. Microcomputers are great. You can do anything with them. Can you imagine what's possible with one of those 32-bit babies? This designer will bet that you can get another decade with

SIEMENS

World standard plus know-how

The quality of components is what makes boards, units of equipment and whole systems reliable.

When you are offering components of very high standards of quality, you need know-how in many areas, particularly in manufacturing technology. This is the kind of knowledge that Siemens has accumulated and consistently applies, in continuous optimization of the entire manufacturing process. Thus the whole spectrum of our SOT 23 components is produced on fully mechanized lines with CECC approval. €

However, to make full use of these benefits the application must also be optimal. And here too Siemens has the kind of know-how you need. Like in surface-mount technology, from board layout through automatic placement to sure mastery of the different soldering techniques.

To find out more about our discrete semiconductors, just write Siemens AG, Infoservice B-Z016, Postfach 2348, D-8510 Fürth, West Germany quoting "SOT 23".

TopTech Components –
Siemens



CIRCLE NO 54

A 19100-B-Z016-X-7600



ABERRANT DESIGN IDEAS

that 386 thing. After lunch, this designer is going to go over to Intel and apply for a job. This designer is also going to trade in his Tektronix 547 and 556 for a

development system. But it's going to be tough to find one with those funny little dots on the CRT.

EDN

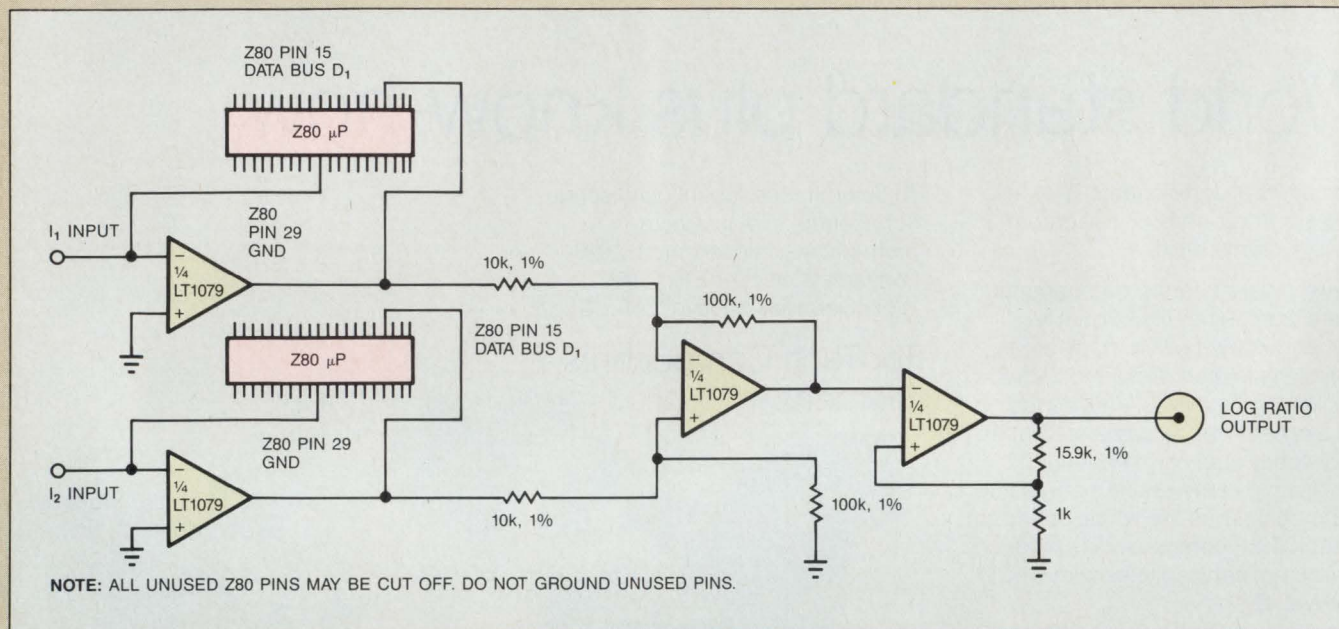

Fig 1—A couple of Z80s, configured as full parallel coprocessors, perform real-time logarithmic ratio computations.

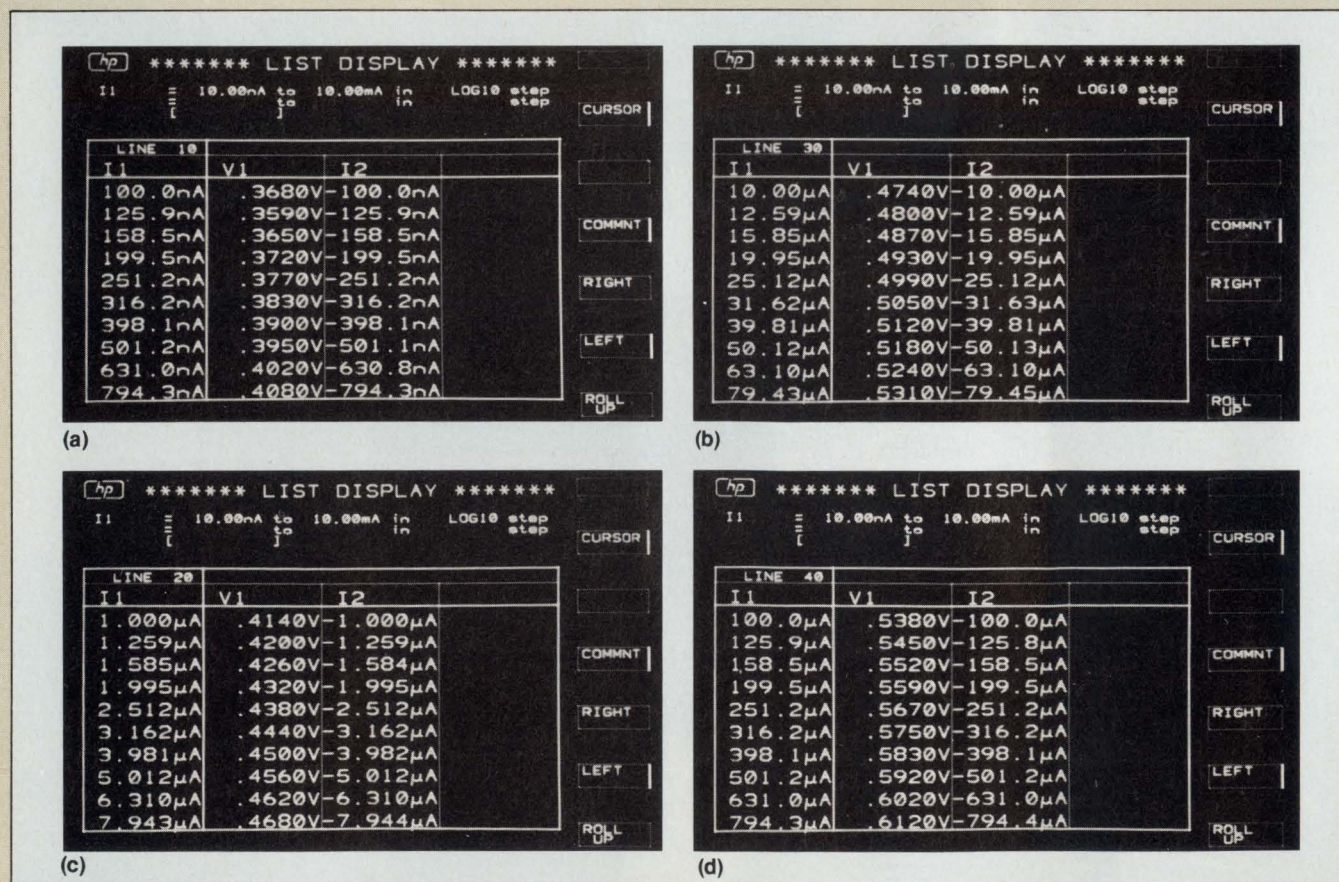
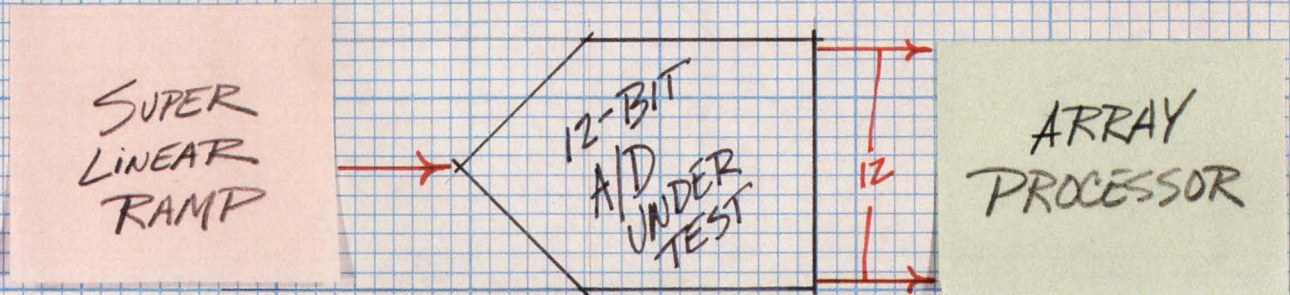

Fig 2—After viewing these displays, this author now believes "microcomputers are great."

1 is impossible. 2 is undesirable. 3 is...



TEST TIME
 $4096 \text{ CODES} \times 100 \text{ POINTS/CODE} \times 20 \mu\text{SEC/POINT} = 8.192 \text{ SECONDS}$

PROBLEM:
SPEED UP
THE 8-SECOND
LINEARITY TEST

OPTIONS:

- 1: SPEED UP THE DEVICE
- 2: COMPROMISE TEST QUALITY
- 3: SPEED UP THE TESTER

The choices don't appear to be very attractive, but the problem must be solved. An eight-second test time for all-code differential and integral non-linearity testing is out of the question for production testing. And it gets worse geometrically for higher-order converters: A 16-bit device would take 128 seconds.

What about your options? The A/D already spits out numbers ten times as fast as most testers can process them — especially with the single, general-purpose array processor typically used for this test. Testing less codes or reducing the amount of averaging would seriously diminish test quality.

Which leaves you with speeding up the tester. An option LTX has considered...

SUPER
LINEAR
RAMP

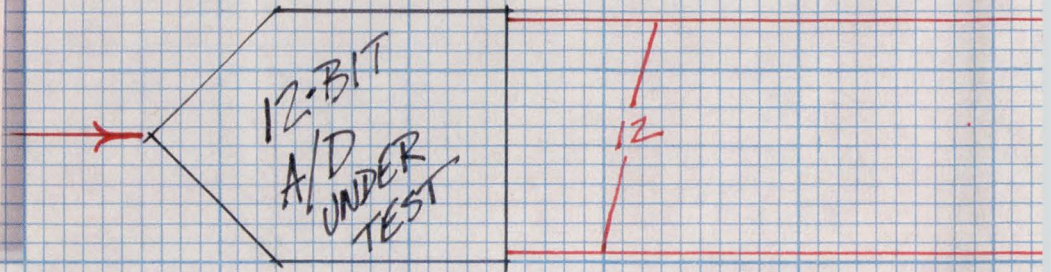

✓ PROBLEM
SOLVED

HIGH THROUGHPUT TEST TIME

$$4096 \text{ CODES} \times 100 \text{ POINTS/CODE} \div 10 \times 20 \text{ N/SEC} = 819 \text{ MS}$$

Hi.T, the high-throughput tester from LTX, gets a tenfold speed boost through a new technique: a local Digital Signal Accelerator that reads the A/D's output directly and does the bulk of the calculation on the fly. Which leaves the downstream array processor to compute results on one tenth the original data — in one tenth the time of other testers.

...unbeatable. As long as it's Hi.T.

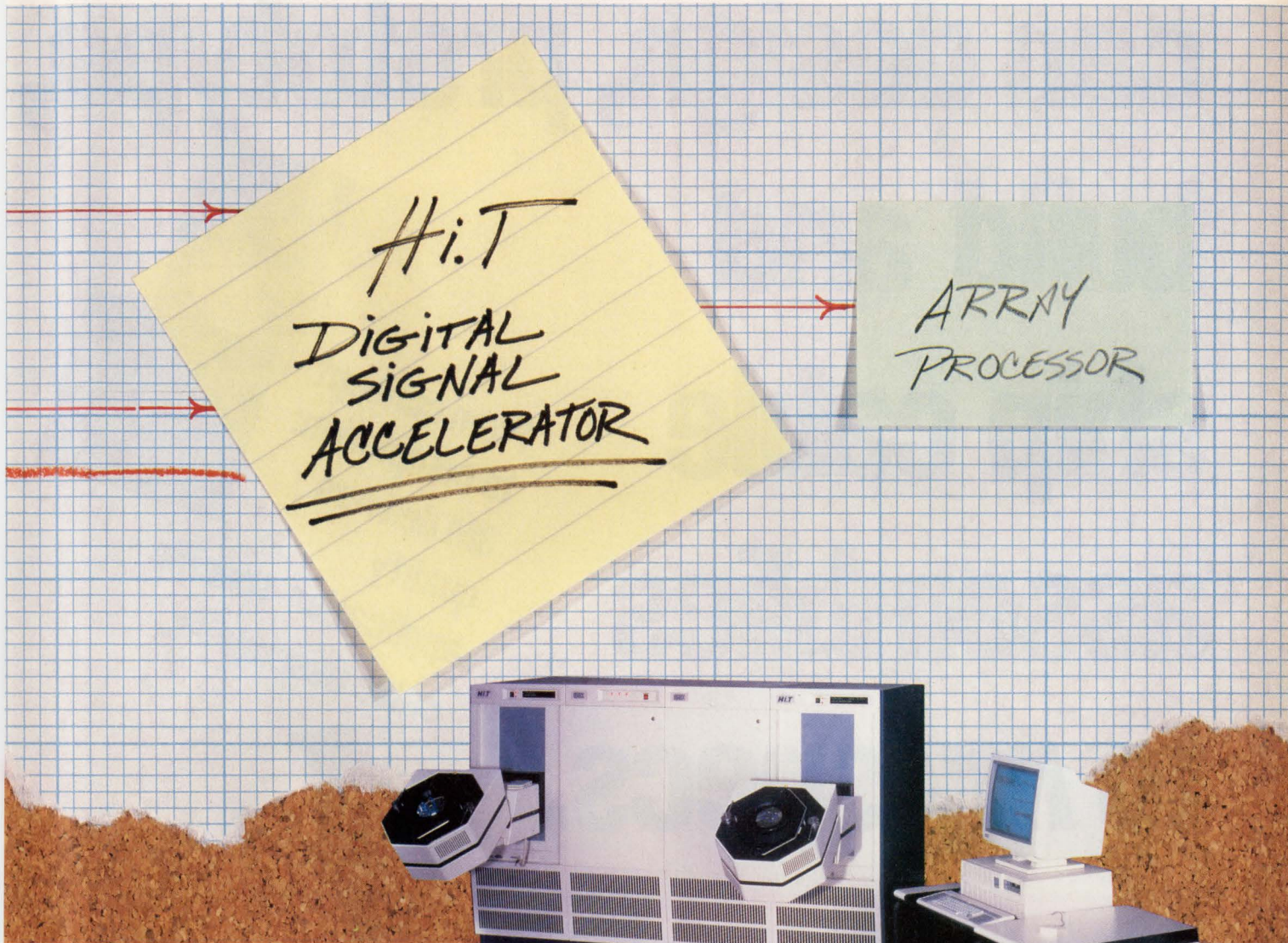

As a result, the Hi.T system brings all-code test time down to just 800 milliseconds. So you no longer have to compromise full testing to meet production demands on A/Ds and other sophisticated mixed-technology devices.

The Digital Signal Accelerator system is just one of the many local computers Hi.T uses to remove testing bottlenecks. Local processing helps Hi.T's parallel analog resources perform instant DC measurements. And local processing throughout the

Hi.T. High-throughput linear testing from LTX.

system cuts down the time it takes instruments to set up between tests.

The result: Hi.T, as you would expect, approaches testing speed limited only by the response time of the device itself. When you're looking for speed — in multiples — Hi.T is the obvious choice.

Get "Beat the Clock," our White Paper with the details on Hi.T's Digital Signal Accelerator. Circle the number or call Carol Everett at (617) 461-1000.

LTX Responds.

“I need a supplier who can design, prototype, build and ship cable assemblies to my specs.”

**Tough customers
turn to 3M.**

Turn to 3M for cable assemblies created for your specific application.

We'll help you right up front with design assistance to quickly turn your interconnect idea into a prototype. Manufacture as many finished assemblies as you need, to your most demanding specs. Then deliver everything you need—from pressed and molded to high-speed transmission line and fiber optic cable assemblies—to

meet your most ambitious production schedule.

You get all the well-known 3M quality in assemblies that meet your demanding criteria. Without having to cope with rejects or in-house modifications. You get the reliability you need to help eliminate wasted time or field failures. And the just-in-time delivery programs that reduce inventory and materials handling costs.

There's only one place tough customers turn to no matter what their specs. 3M. For information, dial 1-800-CALL-EPD. Or call from your modem 1-800-444-8080 (300-2400 baud, 8 bit, no parity 1 stop bit) and enter the access code **3MEPD4** when prompted. Or write 3M Electronic Products Division, Department F, P.O. Box 2963, Austin, TX 78769-2963.

**From concept
to completion:
3M delivers
quality
application-specific
cable assemblies.**

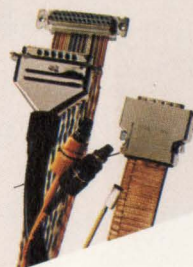

3M

NEW PRODUCTS

COMPUTERS & PERIPHERALS

THERMAL PRINTER

- Contains NiCd battery pack for handheld applications
- Unit measures 4.5 × 2.6 × 6.2-in. and weighs 2.25 lbs

The SP-400B is a battery-powered handheld thermal printer useful in field applications requiring a portable data logger. The unit has a 40-column thermal printhead, an enclosed paper supply, and a replaceable NiCd battery pack. It can print as many as 3000 lines of text between battery charges and contains a multinational character set with graphics capability. The unit provides three input interfaces: an RS232C serial port, a 20-mA current loop, and a Centronics parallel port. The printer comes in an aluminum case measuring 4.5 × 2.6 × 6.2-in. and weighs only 2.25 lbs. A flip-

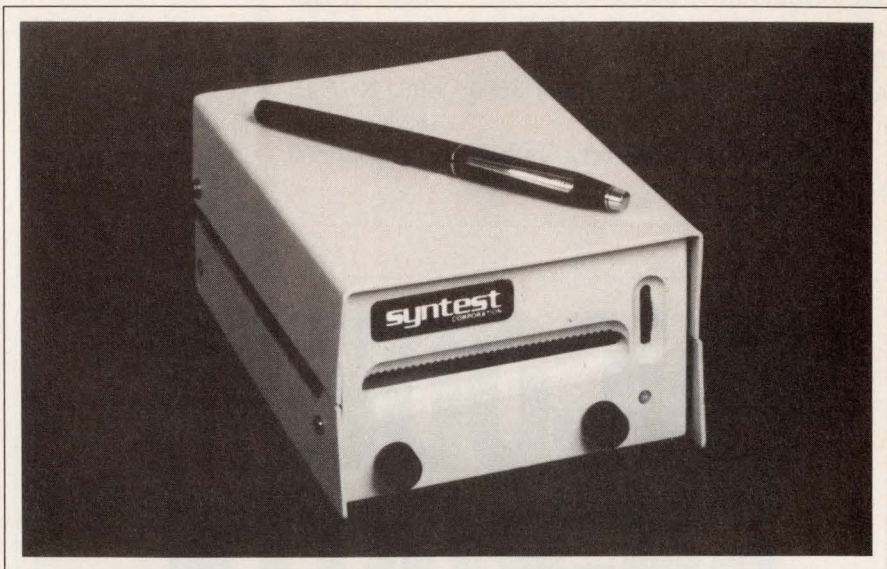

open cover permits easy access to the paper supply and battery pack. \$435. Delivery, four to six weeks ARO.

Syntest Corp, 40 Locke Dr, Marlboro, MA 01752. Phone (617) 481-7827. FAX 617-481-5769.

Circle No 370

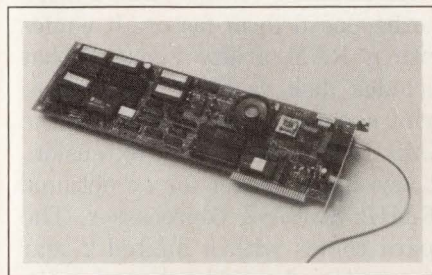

SNA COMM BOARD

- Conforms to CCITT V.32
- Combines three communications protocols on one plug-in board

The AdaptModem V.32 is a multi-protocol communications board for the IBM PC, PC/XT, PC/AT, PS/2 models 25 and 30, and compatible computers. Because the board is designed for IBM's Systems Network Architecture (SNA), it implements three communications protocols on one plug-in board: a full-duplex asynchronous modem and a synchronous modem, which conform to the CCITT V.32 standard, and a Synchronous Data-Link Control adapter. The board also supports 9600-bps communications for a vari-

ety of available AdaptSNA software packages for SNA communications protocols, including interactive 3270, batch 3770/RJE, cooperative processing LU6.2/APPC, and program-to-program LU0. Plug-in board, \$1295; AdaptSNA software packages, \$245 to \$785.

Network Software Associates Inc, 22982 Mill Creek, Laguna Hills, CA 92653. Phone (714) 768-4013.

Circle No 371

BOARD COMPUTER

- Has a CMOS μ P and peripheral devices
- Is housed on a single-height VME bus board

Implemented with CMOS devices, the VSBC-1 single-board computer for VME bus systems consumes only 3W of power. The single-height board has a 68HC000 μ P that runs at a clock speed of 12.5 or 16.7 MHz, and a memory capacity of 1M bytes of zero-wait-state

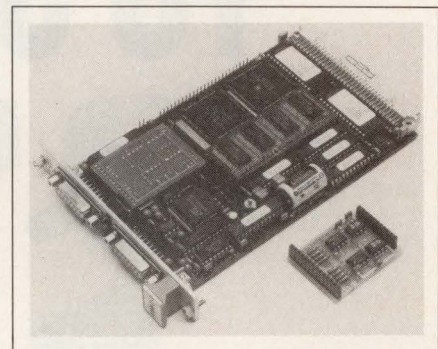

CMOS static RAM and as much as 512k bytes of 1-wait-state EPROM. I/O facilities include two serial ports that you can configure with piggy-back modules to operate at RS-232C, -422, -485 levels or in a 20-mA current loop mode, and a 16-bit parallel port with additional handshaking lines. You can optionally have a SCSI bus interface that is controlled by an NCR53C90 SCSI bus controller. Other onboard peripherals include 16- and 24-bit timer/counters, a real-time clock, and a watchdog timer. An onboard lithium cell provides battery backup for the real-time clock and static RAM.

The board's VME bus interface includes a 7-level interrupt handler and a single-level bus arbiter. Software support includes the OS-9 and PDOS operating systems, and debug monitor firmware. From \$590 in OEM quantities.

Pep Modular Computers GmbH,
Am Klosterwald 4, 8950

Kaufbeuren, West Germany. Phone (08341) 81001. TLX 541233. FAX 08341-40422.

Circle No 372

Pep Modular Computers Inc,
600 N Bell Ave, Carnegie, PA 15106. Phone (412) 279-6661. FAX 412-279-6860.

Circle No 373

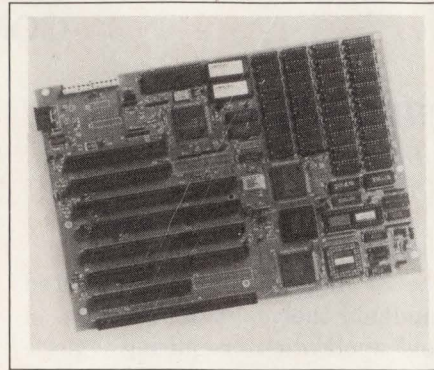

386SX MOTHERBOARD

- Contains as much as 4M bytes of zero-wait-state RAM
- Comes with RAM utilities that include disk caching

The Bullet-386SX motherboard features a 16-MHz 80386SX μ P and is available with 512k, 1024k, or 4096k bytes of dynamic RAM running with zero-wait-states. It also contains five IBM PC/AT compatible expansion slots as well as three IBM PC/XT compatible expansion slots. The motherboard's dimensions conform to the IBM PC/XT motherboard form factor. It comes with a RAM utility package that includes disk caching, RAM disk, print spooling, and support for the EMS LIM 4.0 memory extension. It also has a socket for an optional 16-MHz 80387SX coprocessor. The board comes with a limited 2-year warranty. A motherboard with 512k bytes of DRAM and a 4-utility package costs \$823, which includes a 50% discount for resellers on the first unit.

Wave Mate Inc, 2341 205th St, Suite 110, Torrance, CA 90501. Phone (213) 533-8190. FAX 213-533-5940.

Circle No 374

**ENCODERS
EN-ROUTE
TO SUIT.**

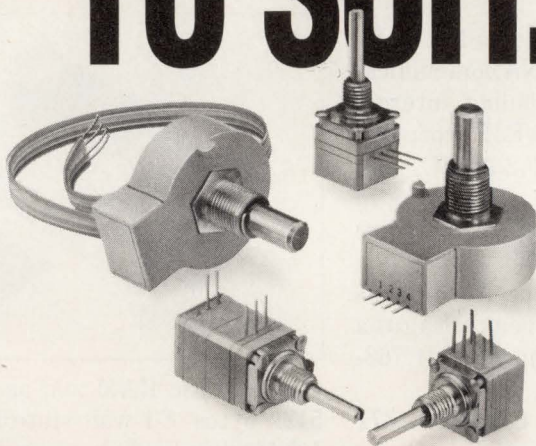

CLAROSTAT's competitively-priced mechanical and optical encoders are compact, sturdy and reliable. They're ideal for limited-space, panel-mount applications.

The industry's smallest mechanical encoder is our 0.5 inch square model that outputs 2 bit gray code and can be combined with other modular switches with push-push, push-pull, or momentary actions.

Our optical encoders include 1.0 inch and 0.5 inch sizes, output two square waves and have rotational lives in the millions.

We have the encoders that best suit your needs in stock and ready to ship. For complete details call or write Brian Ward, Product Manager at CLAROSTAT, One Washington Street, P.O. Box 1507, Dover, NH 03820-1507. Telephone (603) 742-1120. TLX VIA MCI 671 3344. Fax (603) 742-0481. To Order Call **Toll-Free 1-800-872-0042.**

WHY WAIT?



See us at **ELECTRO SHOW** — Booth #2161

CIRCLE NO 62

PGA VERIFIER

- Tests LCA designs for the IBM PC/AT
- Consists of a plug-in card, a pod, and a target-system probe

The Mesa I in-circuit PGA development tool for Xilinx's Logic Cell Arrays (LCA) consists of an IBM PC/

Text continued on pg 212
EDN March 30, 1989



WE LOOK AT MONITORS FROM YOUR POINT OF VIEW.

Cost/Performance/Reliability...

That's how most engineers look at monitors. Whether you're buying high resolution, medium resolution or standard TV resolution, custom or off-the-shelf, with whatever pallet of colors, pixel triads, or scanning rates, you want the best... at the best possible price.

And that's what the Dotronix/VMI team can deliver. Our years of combined OEM experience, and worldwide manufacturing facilities each specializing in a specific monitor technology, mean you always get the best possible monitor at the best possible price.

Video Monitors Inc. ...for your high resolution needs. Our Video Monitors Inc. facility is well recognized for continually defining "state of the art" monitor technology in high performance broadcast and video displays for Medical Diagnostics, CAD/CAM, Desktop Publishing and other high resolution applications.

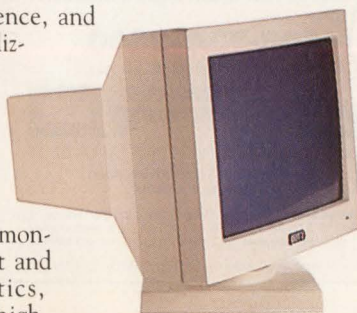

Dotronix--Mpls./St.Paul... specializing in monitor design and manufacture for Financial, Transportation, Medical Instrumentation and S-VHS applications.

Dotronix--Boulder... when it comes to monitors for Instrumentation and Process Control applications.

Dotronix--Taiwan... providing high volume production for cost advantages in VGA and OEM displays.

Talk to an Applications Specialist Today.
Phone 612/633-1742 FAX 612/633-7025

DOTRONIX

DOTRONIX INC.

160 First Street S.E. New Brighton, MN. 55112

Service Locations:

Los Angeles, CA ♦ San Jose, CA ♦ Boulder, CO
Mpls./St.Paul, MN ♦ Eau Claire, WI ♦ New Jersey

AT-compatible plug-in card, a pod with 12 LCAs, and a probe with an LCA connector and socket for the target system. The tool lets you verify host-downloaded data, observe the register states in the target LCA, isolate signals from the target system and create states to isolate problems, and alter real-

time designs. In addition, the unit serves as a breadboard for developing LCA designs. A shadow LCA acts as a mirror for the states in the target LCA. The company and Tektronix jointly developed a flex-circuit cable that connects the pod to the probe. The probe connector plugs into a PLCC socket on the

target system. The Mesa I software, which runs under Windows, is compatible with Xilinx's design software, allowing it to extract symbolic information from XACT files. \$9390. Delivery, eight weeks ARO.

Data I/O Corp., Box 97046, Redmond, WA 98073. Phone (206) 881-6444. TLX 152167. FAX 206-882-1043.

Circle No 375

WHY DESIGN YOUR PRODUCT AROUND A COMPUTER?

Design the computer in.

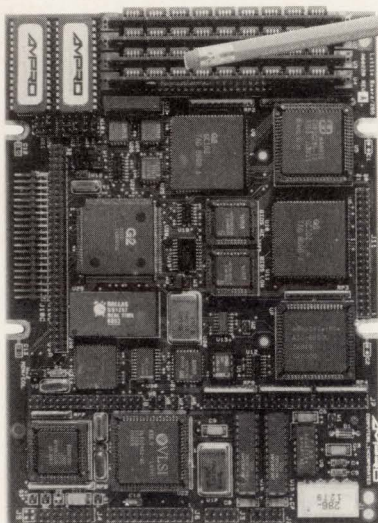

Little Board™/286

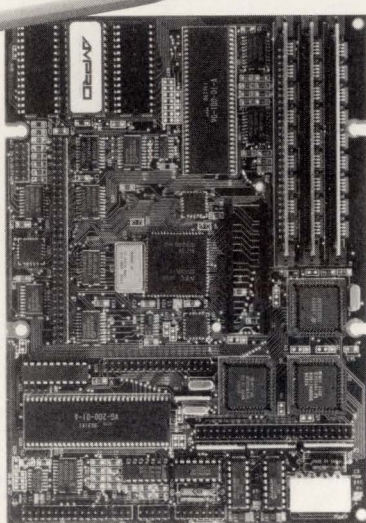

Little Board/PC

Built-in vs. built-around. External systems mean boxes, boards, backplanes, cables, and reliability problems. Ampro's Little Boards give you a complete system on a single board you can build right into your product.

Small size. Big power. Eliminate the bulk and constraints of multi-board, backplane-based systems. Embed a Little Board that requires just 2/3rds the power and volume of a 5 1/4" floppy drive. But with the full power of a PC or AT®.

Fully compatible. Little Board/286 and Little Board/PC are functionally identical to multi-board PCs and ATs. They run PC-DOS™ 2.0 to 3.X. They run DOS languages, compilers and applications. You'll be standing on a proven foundation of hardware and software.

Ampro's Single Board Systems. It's all there. Up to a Megabyte of RAM. RS-232C and Parallel ports. AT/PC-compatible controllers and bus expansion. EGA/CGA/MDA and Hercules™.

compatible video options. Even optional solid-state disk. Plus SCSI support for hard disk, tape, optical drives, bubble drives... you name it. And, low power consumption (+5VDC, less than 8W) and a wide operating temperature range (0 to 60°C). Perfect for standalone operation and harsh environments. Anywhere that reliability is a critical consideration.

Available worldwide. For information and the name of your nearest U.S. or international Ampro representative, call us at the number below. Or write for Little Board Product information.



408-734-2800

Fax: 408-734-2939 TLX: 4940302

AMPRO
COMPUTERS, INCORPORATED
1130 Mountain View/Alviso Road
Sunnyvale, CA 94089

Reps: Australia—61 3 720-3298; Austria—43-222/45 45 01; Canada—(604) 438-0028; Denmark—45 3 66 20 20; Finland—358 0 585-322; France—331 4502-1800; Germany, West—49 89 611-6151; Israel—972 3 49-16-95; Italy—39 6 811-9406; Japan—81 3 257-2630; Netherlands—010-411 85 20; Spain—M34 3 204-2099; Sweden—46 8 55-00-65; Switzerland—41 1 740-41-05; United Kingdom—44 2 964-35511; USA—contact AMPRO

Trademarks: IBM, AT—IBM Corp.; Hercules—Hercules Computer Technology, Inc.; Little Board—Ampro Computers, Inc.; DR-DOS—Digital Research, Inc.

STD I/O CARDS

- Provide 16 optoisolated inputs and outputs
- Each output can switch 50V with 400-mA max load current

The 242-1 and the 342C-1 dual-port optoisolated I/O cards for the STD Bus provide 16 input and 16 output circuits arranged as two 8-bit ports. The 242-1 is compatible with the STD TTL Bus, and the 342C-1 is compatible with the STD CMOS Bus. You can configure the inputs to handle standard TTL inputs by setting an input threshold voltage to 1.4V. In addition, the inputs can handle industrial voltage swings by setting the threshold to 6.4V above industrial ground. The input circuits can withstand input voltages between -50 to +50V. The output circuits have Darlington open-collector arrangements with provisions to install pullup resistors. Each output can switch 50V at 400 mA max. Each of the two input and two output ports has its own power supply on board, which requires only a 5V signal from the bus. 242-1, \$438; 342C-1, \$486 (10).

Enlode Inc., 1726 Kingsley Ave, Orange Park, FL 32073. Phone (800) 874-7729; in FL, (904) 264-4405. FAX 904-264-0765. TLX 466036.

Circle No 376

NEED SUPER-FAST DESIGN THRUPTUT?

Giving you the ability to complete an electronic design ahead of time, and with a level of performance you might expect from an expensive Engineering Workstation, the PADS-PCB design system does it all.

From product concept and design, through implementation, PADS-PCB



shortens long design cycles by allowing the engineer to complete a job at one station with features such as:

- LOGIC CAPTURE
- PRINTED CIRCUIT BOARD DESIGN
- AUTOPLACEMENT
- 100% RIP-UP & RE-ROUTE AUTOROUTING
- AUTO CHECKING
- AUTOCAD INTERFACE

Utilizing a design-oriented database, **PADS-CAE** accesses all the sheets of a schematic simultaneously. Auto REF DES, Auto Gate Assignment and Data Checking across all sheets are also provided.

PADS-PCB is the most popular Printed Circuit Board Design System on the market and offers:

- *Inputs from PADS-CAE, Futurenet, Orcad, Schema, and others
- *1 mil database-32" x 32" board size, 30 layers
- *400 IC Circuit Size capability

- *Automatic and Interactive Component Placement Aids, Track Routing, Design Rule Checking
- *Complete SMD Capability
- *1,2,3 Tracks between IC Pins
- *Superb Analog Design Capability

PADS-SUPERROUTER is the only PC-based Ripup and Retry to 100% Completion Autorouter on the market today, and makes the tedious and time-consuming task of Board Design simple.

PADS-DXF integrates Autocad, PADS-PCB, and the PADS-SUPERROUTER into the most powerful Electro-Mechanical PC-based CAD system available for Mechanical Design/Drafting, Logic Capture and Board Design.

The best news is that PADS-PCB design system is **PRICED LOW!** The system is affordable enough to allow every designer to have his/her own personal PADS station.

EVALUATION PACKAGE! Call for a NO-COST evaluation package, so that you can see for yourself how PADS-PCB gives you SUPER-FAST DESIGN THRUPTUT!

INSIDE MA: (508) 486-8929 or (800) 255-7814.

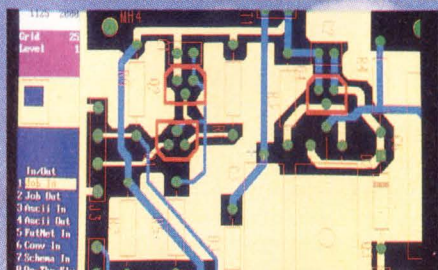
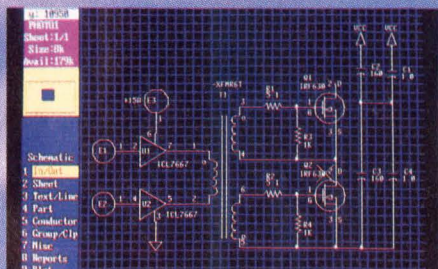
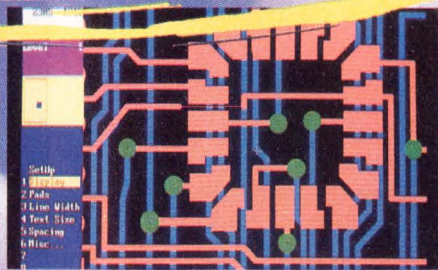

CAD

Software, Inc.

119 Russell Street

Suite #6

Littleton, MA 01460

CIRCLE NO 46

SEE US AT ELECTRO/89 BOOTH#'s 164a, 168, 267, & 265!

HVCMOS[®] IMAGING



Supertex inc.
Leadership in CMOS/DMOS Technologies

Pushing the leading edge of display technologies, the Supertex family of HVCMOS* drivers permit major breakthroughs in electroluminescent, gas plasma, LCD & vacuum fluorescent displays. This advanced smart power technology also opens up a wide range of applications in medical ultrasound imaging, robotics, telecommunications, test systems, high performance printers, power supplies, motor controls and solid-state relays.

The Supertex high density HVCMOS drivers, listed below, feature high speed with low power consumption to produce bright, high-resolution images. Investigate HVCMOS . . . a most attractive alternative to cumbersome boards or hybrids.

For more information or custom designs, write or call: Supertex, Inc., 1225 Bordeaux Drive, Sunnyvale, CA 94088; Tel. (408) 744-0100; Telex 6839143 SUPTX and FAX (408) 734-5247.

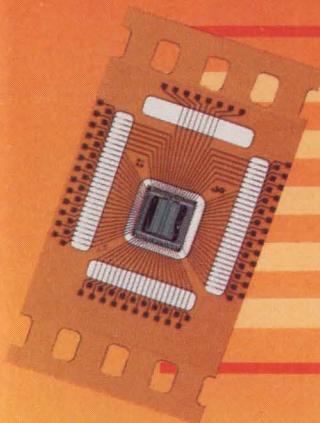

HV03 & 05	220 & 300V	64 Channel, Serial to Parallel Converters with N-Channel Open Drain Outputs
HV04 & 06	60 & 80V	64 Channel, Serial to Parallel Converters with Push-Pull Outputs
HV08**	60V	24 Channel, 16 Gray Shade Level Driver with Source Follower Outputs
HV10 - 18	140 & 160V	4 & 8 Channel Bilateral Analog Switches
HV30	180V	7 Segment Decoder with Open Drain Outputs
HV41 & 42, HV45 & 46	-220 & -300V	32 Channel, Serial to Parallel Converters with P-Channel Open Drain Outputs
HV51 & 52, HV55 & 56	220 & 300V	32 Channel, Serial to Parallel Converters with N-Channel Open Drain Outputs
HV53 & 54, HV57 & 58	60 & 80V	32 Channel, Serial to Parallel Converters with Push-Pull Outputs
HV500 & 501	100V	32 Channel, AC Plasma Driver with Push-Pull Outputs
HV6810**	80V	10 Channel, Vacuum-Fluorescent Driver with Push-Pull Outputs
AN01, AP01, HT01	160 to 400V	3 Chip Set for 8 Channel Level Translation with Low Leakage Push-Pull Outputs

CIRCLE NO 45

*HVCMOS is a registered trademark of Supertex, Inc.
**Available 2nd Quarter, 1988

NEW PRODUCTS

INTEGRATED CIRCUITS

QUAD S/H AMPLIFIER

- Has 12-bit accuracy
- Acquisition time is 600 nsec

The AD684 quad S/H amplifier features 12-bit accuracy and a sampling rate to 100k samples/sec. Each channel of the AD684 has a guaranteed maximum acquisition time of 600 nsec to within 0.1%, and 1 μ sec to within 0.01% for a 10V step. For simultaneous sampling, the AD684's entire error budget is completely encompassed in a 300-psec max aperture offset between channels. A proprietary error-correcting architecture compensates for hold-mode errors and ensures 12-bit accuracy and repeatability. The AD684 has a maximum full-scale nonlinearity of 0.005%, and its hold characteristics include a 500-nsec maximum settling time, 200-

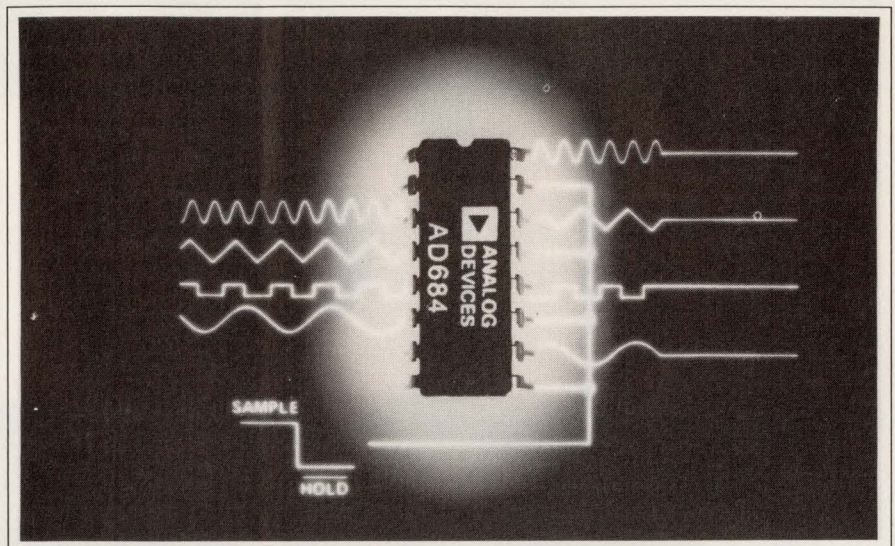

psec aperture uncertainty, and a 10-nsec aperture delay. The IC operates from ± 12 V supplies and dissipates 530 mW max. Three temperature grades are available. From

\$23.50 (100).

Analog Devices, Literature Center, 70 Shawmut Rd, Canton, MA 02021. Phone (508) 935-5565

Circle No 351

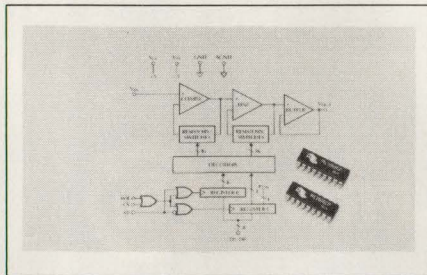

LOG GAIN/ATTENUATORS

- Provide control from -24 to 24 dB
- Interface with 8- and 16-bit buses

The ML2008 and ML2009 amplify or attenuate analog signals to ± 3 V under μ P control and are noise-rated at 900 nV/ $\sqrt{\text{Hz}}$ at 1 kHz. The devices provide automatic signal-level control from -24 to 24 dB in 0.1 dB steps. The ML2008 interfaces to an 8-bit μ P bus, using two write operations to store nine gain-setting bits and a power-down bit. The ML2009 has a single 9-bit data register, which you can program with one write operation when using a 16-bit data bus. Both devices operate from ± 5 V supplies. 18-pin

DIP or 20-pin plastic chip carrier, \$5.50 (100).

Micro Linear Corp, 2092 Concourse Dr, San Jose, CA 95131. Phone (408) 433-5200.

Circle No 352

VIDEO CONTROLLER

- Features video rates to 120 MHz
- Supports high-resolution graphics

The IMS-G300 video controller supports high-resolution color graphics applications with resolutions of 640 \times 480 (VGA), 1024 \times 768, and 1280 \times 1024 pixels. The highly integrated chip contains a 256 \times 24-bit color look-up table, a programmable video-timing generator, a 32-bit multiplexed pixel port, a triple video DAC with 8-bit resolution, and an on-chip, phase-locked loop. The -G300 can handle video rates to 120 MHz and interlaced or noninterlaced video. The chip has four 8-bit pixel ports, which accept data

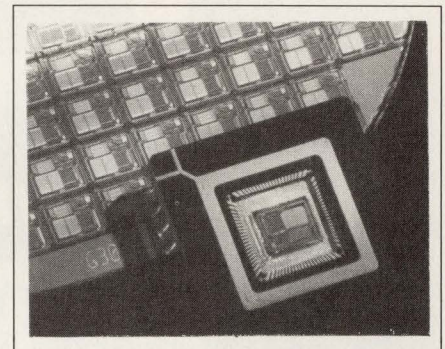

directly from the video RAM array at 25% of the video rate. The pixel port has two software-selectable operating modes. Mode 1 sends the data via the 24-bit color look-up table, permitting the selection of 256 colors from a choice of over 16 million. Mode 2 sends the 24-bit data directly to the 8-bit video DACs, allowing the display of 16 million colors at any one time. The devices come in 84-pin PGA or LCCC packages. An 85-MHz part, \$100 (1000).

Inmos Corp, Box 16000, Colorado Springs, CO 80935. Phone (719) 630-4215.

Circle No 353

THE
SMALL
AND THE
MIGHTY

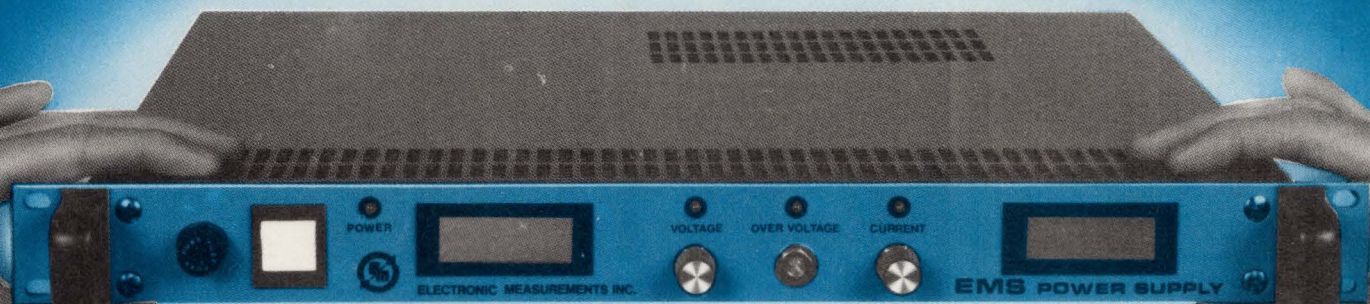

HIGH POWER SWITCHERS...FROM



Lighter...Smaller...More Powerful...

for single and three phase applications where high efficiency, precise regulation and a high degree of packaging density are required.

The EMS Series incorporates the best of customer tested and application proven features:

- 1kW, 1Ø; 2.5kW, 1Ø and 3Ø in one unit; 5kW, 3Ø
- Highest power per cubic inch for wide range, rack mount, CV/CC power supplies in the industry

- Common programming with TCR, EMHP, ATR and HCR Series
- 650 microsecond transient response time
- Built in OVP and thermal protections ...and much, much more

Want all the details on the small and the mighty? Write or call for the latest Tech Bulletin on the EMS Series of DC Power Supplies.

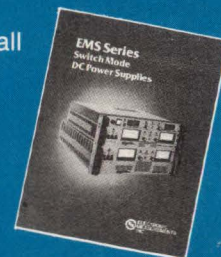

 **ELECTRONIC
MEASUREMENTS
INC.**

405 Essex Road, Neptune, NJ 07753

CALL TOLL FREE 800-631-4298* • Telex: 132-424 • Fax (201) 922-9334

*Except in New Jersey, Alaska, Hawaii and Canada call (201) 922-9300.

CIRCLE NO 43

See Us at ELECTRO Booth #1810

SCR REGULATED DC POWER SUPPLIES



SINGLE PHASE TCR

- 4 power levels 600 W – 1,000 W – 1,800 W – 2,800 W

- DC outputs variable over full range of 0 to 7.5 V DC through 0 to 2,500 V DC
- Regulated and metered (V and A)
- CV/CC with automatic crossover
- Fully programmable and remote sense
- Complies with VDE 875-N and VDE 871-A
- 5-year warranty



THREE PHASE TCR

- 3 power ranges 2,500 W – 5,000 W – 10,000 W
- DC outputs variable over range

- from 0 to 6 V DC through 0 to 600 V DC
- Regulated and metered (V and A)
- CV/CC with automatic crossover
- Complies with VDE 875-N and VDE 871-A
- 5-year warranty

EMS HIGH FREQUENCY SWITCHING DC POWER SUPPLY



- 48 models 600 W to 1,000 W to 2,500 W to 10,000 W
- Voltages from 7.5 V DC through 1,000 V DC
- High density packaging — up to 3.1 W/cubic inches at 5 kW
- Regulated and metered (V and A)
- Fully programmable and remote sense
- CV/CC with automatic crossover
- 5-year warranty
- U/L recognized

ELECTRONIC MEASUREMENTS, INC.
405 Essex Rd., Neptune, NJ 07753, Dept. EM
TOLL FREE: 800-631-4298

CIRCLE NO 44

INTEGRATED CIRCUITS

DUAL AUDIO DAC

- Features 20-bit resolution
 - Has two independent channels
- The D20200 is a complete, dual, 20-bit, D/A-converter subsystem. The module includes two 20-bit DACs, a stable bipolar reference, a serial CMOS/TTL-compatible digital interface, and two distortion-suppressing output deglitchers/amplifiers. It needs no external components or trimming to meet its specifications; you only need to connect ± 15 and 5V power supplies, a serial data source, and appropriate timing signals. The D20200 handles output signal amplitudes from 0 to -60 dB. Total harmonic distortion and noise is typically -90 dB at -20 -dB output and -52 dB at -60 -dB output. Differential nonlinearity is typically $\pm 0.0002\%$ of FSR. The D20200's serial interface accepts digital word lengths from 16 to 32 bits, and it accepts simultaneous or multiplexed data at a 15-MHz maximum clock rate. It converts at rates from dc to 200 kHz per channel and accepts digital coding formats of two's-complement, offset binary, or complementary offset binary. \$199 (100).

UltraAnalog Inc, Box 14164, Fremont, CA 94539. Phone (415) 657-2227.

Circle No 354

STATIC RAM

- Features access time as low as 55 nsec
- Operates over the military temperature range

Targeted for use in military and aerospace applications, the MS-8128SC 128k \times 8-bit high-speed static RAM has an operating temperature range of -55 to $+125^\circ\text{C}$ and can be screened to MIL-STD-883C requirements. It is available with access times of 55, 70, 85, 100, 120, or 150 nsec and has TTL-compatible inputs and outputs. The device is manufactured from four 32k \times 8-bit RAMs packaged in ce-

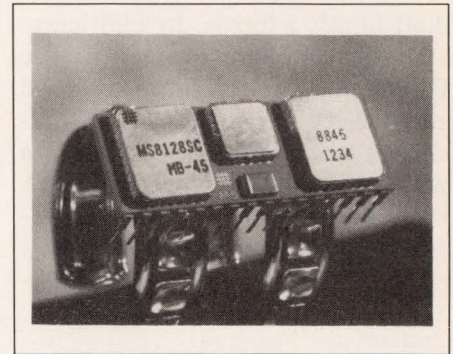

ramic leadless chip carriers that are bonded to a single 32-pin ceramic DIP substrate that also carries chip-select decoding logic and power-supply decoupling capacitors. Operating at a clock frequency of 1 MHz it consumes 150 mW of power from one 5V supply; in standby mode, it consumes 2 mW. A low-power version, which consumes only 40 μW in standby mode, is available for applications that use battery backup. From £145 to £290 (100).

Hybrid Memory Products Ltd, Elm Rd, W Chirton Industrial Estate, N Shields, Tyne and Wear NE29 8SE, UK. Phone 091-258-0690. TLX 53206. FAX 091-259-0997.

Circle No 355

Mosaic Semiconductor Inc, 7420 Carroll Rd, Suite 200, San Diego, CA 92121. Phone (619) 271-4565. FAX 619-271-6058.

Circle No 356

ANALOG MULTIPLEXERS

- 100 Ω on-resistance
- 250 nsec switching times

Pin compatible with the industry-standard DG508A and DG509A, the DG408 and DG409 analog multiplexers offer improved specifications compared to earlier types. The on-resistance of the DG408/409 is only 100 Ω , leakage current is less than 0.5 nA, switching time is 250 nsec, and power dissipation is only 2.5 mW. The DG408 is an 8-channel, single-ended device with a 3-bit binary address. The DG409 is a 4-channel, differential device with a

INTEGRATED CIRCUITS

2-bit binary address. In addition to specification improvements, the DG408 and DG409 feature reduced sensitivity to electrostatic discharge (ESD) and the ability to withstand $\pm 400V$ on all pins (with respect to ground). Both TTL-compatible multiplexers conduct current equally well in both direc-

tions and allow operation with supply voltages to $\pm 15V$ or with 12 and 0V unipolar supplies, \$4.68 to \$15.92 (100).

Siliconix Inc, 2201 Laurelwood Rd, Santa Clara, CA 95054. Phone (408) 988-8000.

Circle No 357

Electro/89
Booth 0367

Hannover Fair Industry/89
Hall 13, Booth C23

KILL 8051 BUGS FAST.

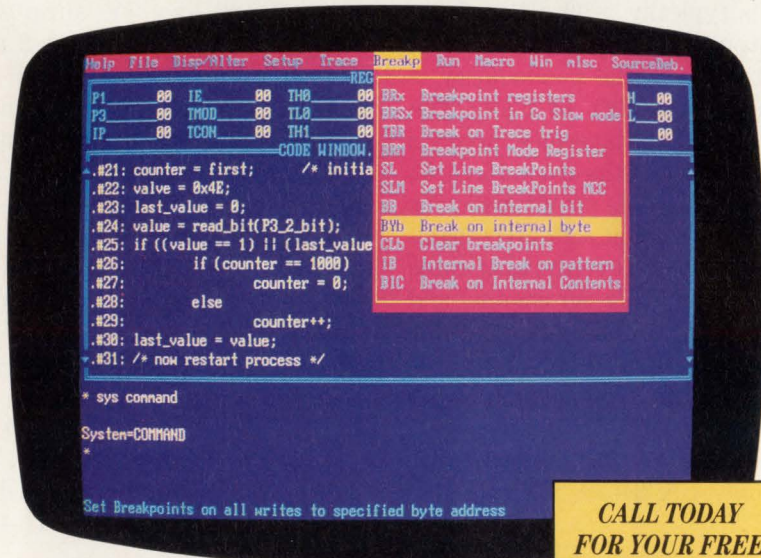

**CALL TODAY
FOR YOUR FREE
VIDEO AND
SOFTWARE DEMO.
(408) 866-1820**

Nohau's EMUL51-PC emulator and trace board make a sophisticated bug-hunting pair for your 8031/8051 projects. Plug the EMUL51-PC into your PC, XT, AT or compatible and find bugs that other emulators can't. Our powerful software makes it a snap to use.

- Source Level Debugging for PL/M-51 and C-51
- 48 bits wide 16K deep trace buffer
- 20 MHz real-time emulation
- Supports 80535, 80C451, 80C152, 80C452, 80C552/652, 80C51FA, DS5000 and more.
- Available in either "Plug-in" or "Box" configurations

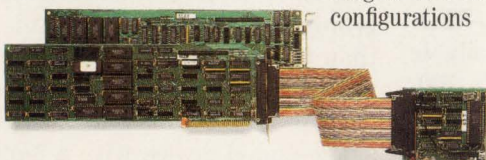

The EMUL51-PC comes with a 5-ft. cable, software and 1 year hardware warranty with free software updates. Trace board optional.

CIRCLE NO 42

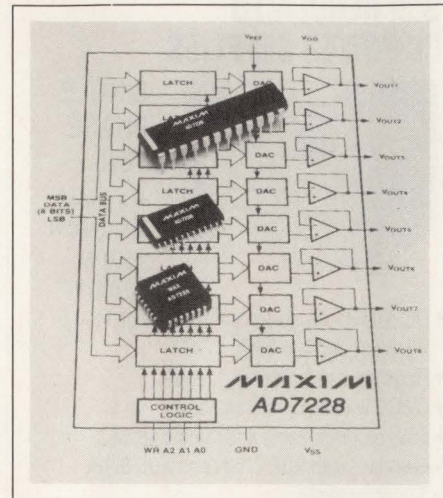

OCTAL 8-BIT DAC

- Includes output buffers
- Has μP interface logic

The AD7228 CMOS IC features eight fully independent 8-bit, voltage-output D/A converters with output buffer amplifiers in a 24-pin DIP, SO package, or plastic leaded-chip carrier. The AD7228 requires no external trims or components to achieve full specified performance and guaranteed monotonicity with any of the standard 5, 12, or 15V supplies. Each of the eight DACs has an individual latch that accepts and holds data written by the system μP , similar to an address in system memory. Because the AD7228 works with a write-pulse width of 95 nsec, it is compatible with most μP s. Each DAC can provide an output to 10V for a 2-k Ω and 100-pF load at a slew rate of 2 V/ μ sec and a settling time of 5 μ sec. The AD7228 is available in grades of ± 1 LSB and ± 2 LSB, and in three temperature ranges. \$32 to \$37.50 (100).

Maxim Integrated Products, 120 San Gabriel Dr, Sunnyvale, CA 94086. Phone (408) 737-7600.

Circle No 358

WORLDWIDE CALL:
Austria 0222-387638
Australia 02 654 1873
Benelux +31-1858-16133
Denmark 02 65 81 11
France 01 69 412 801
Great Britain 01 464 2586
Israel 03 484832
Italy 011 771 0010
Korea 02 784 7841
New Zealand 09 392 464
Portugal 01 83 56 70
Scandinavia +46 40 922425
Spain 93 217 2340
Switzerland 01 740 41 05
West Germany 08 131-1687

NOHAU
CORPORATION

51 E. Campbell Ave.
Campbell CA 95008
(408) 866-1820

SUPER FAST SRAM

**Available Now
256K 25ns / 64K 15ns**

Micron just broke the SRAM speed barrier with our family of leading edge, super high speed CMOS SRAMs.

We've applied the same state-of-the-art design and process technology used for our high quality DRAMs in development of our fast static RAMs — with some amazing results.

At an incredible 25ns for 256K and 15ns for 64K, our SRAMs are breaking speed records. And we're not just sampling product, we're shipping production volumes.

Choose from a wide variety of components in DIP, SOJ and LCC packages, with densities from 16K to 256K and organizations of x1, x4 and x8.

And like all Micron memory products, our SRAMs are backed by the type of strong sales, customer service and technical support that keeps you on the leading edge.

For additional information on how you can break the SRAM speed barrier, call 208-386-3900.

Micron, it's a name worth remembering.

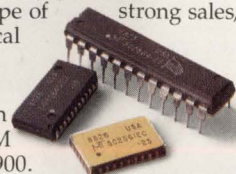

Part #	Organization	Speed*	Packages
MT5C2561	256K X 1	25ns	PDIP, CDIP, SOJ, LCC
MT5C2564	64K X 4	25ns	PDIP, CDIP, SOJ, LCC
MT5C2565	64K X 4 \overline{OE}	25ns	PDIP, CDIP, SOJ, LCC
MT5C2568	32K X 8	25ns	PDIP, CDIP, SOJ, LCC
MT5C6401	64K X 1	15ns	PDIP, CDIP, SOJ
MT5C6404	16K X 4	15ns	PDIP, CDIP, SOJ
MT5C6405	16K X 4 \overline{OE}	15ns	PDIP, CDIP, SOJ
MT5C6406/7	16K X 4 s.I/O	15ns	PDIP, CDIP, SOJ
MT5C6408	8K X 8	15ns	PDIP, CDIP, SOJ, LCC
MT5C1601	16K X 1	15ns	PDIP, CDIP, SOJ
MT5C1604	4K X 4	15ns	PDIP, CDIP, SOJ
MT5C1605	4K X 4 \overline{OE}	15ns	PDIP, CDIP, SOJ
MT5C1606/7	4K X 4 s.I/O	15ns	PDIP, CDIP, SOJ
MT5C1608	2K X 8	15ns	PDIP, CDIP, SOJ

*Slower speeds also available.

MICRON

TECHNOLOGY, INC.

European Office: Trafalgar House, Grenville Place, Mill Hill, London W7 3SA Phone: 01-959-3611, FAX: 01-959-6168

UNITED KINGDOM
Micro Call Ltd.
Phone: (084 421) 5405

FRANCE
Rep' Tronic SA
Phone: (1) 69288700

BELGIUM
MCA-Tronix SPRL
Phone: (041) 674208

DENMARK
Henckel Elektronik
Phone: (03) 906333

FINLAND
Turion Oy
Phone: (0) 372144

NETHERLANDS
AKAM
Phone: (079) 443200

ITALY
Moxel S.r.L.
Phone: (02) 61290521

SPAIN
ATD Electronica, S.A.
Phone: (1) 2344000
(1) 2344009

ISRAEL
Rapac Electronic, Ltd.
Phone: (3) 477115

NORWAY
BIT Elektronikk A.S.
Phone: (03) 847099

SWEDEN
IEK AB
Phone: (08) 804685

Abacus Electronics PLC
Phone: (0635) 30680

A2M
Phone: (1) 39549113

RTF Diffusion
Phone: (1) 47460113

**ONCE YOU'VE
SEEN FUJITSU'S AC
PLASMA DISPLAY,
YOU'LL TAKE A
DIM VIEW OF
ANYTHING ELSE.**

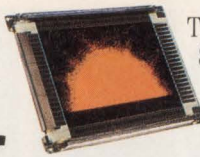

The only way our bright new 8050 display looks anything like the others is through a pair of sunglasses.

That's because the 8050 is without a doubt the brightest, most readable display in its class.

It's the first 10-inch, AC-memory, flat panel display to deliver 640 x 400 resolution with an extraordinary 44 foot-lamberts of brightness. Along with a contrast ratio of greater than 20:1. All in a package just over one inch thick.

In fact, the only thing more impressive than these numbers is looking at the display yourself. Then you'll really appreciate its exclusive solid black background. And the brightness and flicker-free clarity of text and graphics.

And what's truly amazing is that you'll get this remarkable performance under some of the worst possible conditions. Like bright sunlight. And viewing angles up to 120 degrees.

So if your application calls for the clearest images with maximum contrast, call us today at **1-800-556-1234, Ext. 238**. Inside California call, **1-800-441-2345, Ext. 238**. Or write Fujitsu Component of America, Inc., 3330 Scott Boulevard, Santa Clara, CA 95054-3197.

We'll brighten your day.

CIRCLE NO 40



FUJITSU

COMPONENT OF AMERICA, INC.

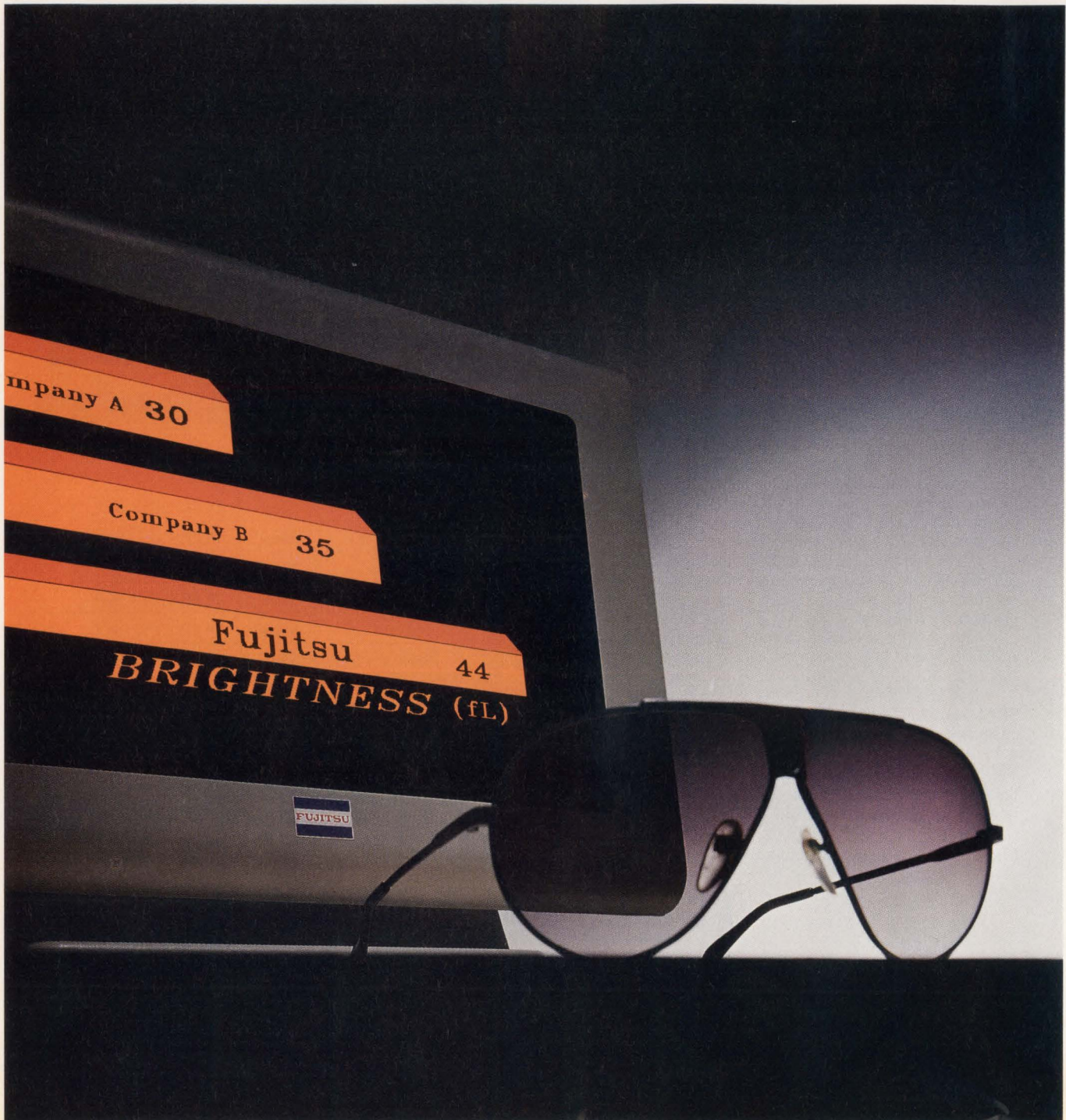

© 1988 Fujitsu Component of America, Inc.

NEW PRODUCTS

COMPONENTS & POWER SUPPLIES

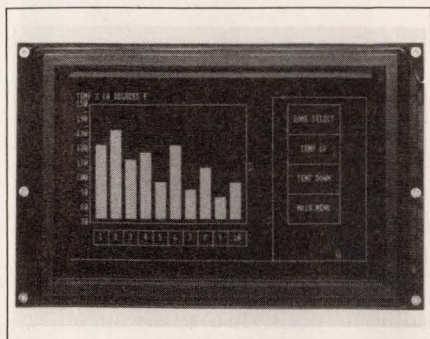

DISPLAY MODULE

- Features VT320 emulation
- Includes touch-input system

The M320ST electroluminescent display module provides graphics capability and VT320 emulation with standard 80-character \times 25-line text. It also features an infrared touch-input system, SealTouch, that provides a resolution of 2000

touch points. SealTouch firmware allows you to program button sizes, positions, and response. You can have as many as 120 pages with a maximum of 120 buttons/pg. You can define buttons as pop-up menus, multistate responses, or program them for touch sensitivity for applications requiring fail-safe operation. Complete terminal setup parameters are accessible on screen. The module includes an RS-232C, RS-422, or RS-485 serial communications port (or optional 4- to 20-mA operation), a serial printer port, and an ASCII keyboard port. \$3195.

Digital Electronics Corp., 31047 Genstar Rd, Hayward, CA 94544. Phone (415) 471-4700. TLX 172073.

Circle No 360

FIBER-OPTIC LINK

- Operates over 2 km
- Offers user-selectable inputs

This fiber-optic link provides an RFI/EMI-secure circuit for Electrospace Systems' MLP-1 phone and its associated PBX. The link consists of the F9765 and the F9766 and has a transmission capability of 2 km min. The F9765 is designed for use at the PBX end of the circuit and includes a male 25-pin connector. The F9766 is located at the phone and features a female 25-position connector. The link has a 0.3- to 3.5-kHz bandwidth and outputs 0 dBm into a balanced 600 Ω load. Each unit consists of two pc boards. The first board holds the power supply and the digitizing and multiplexing circuitry, and the sec-

Digital filters

Manufactured by **NPC**
NIPPON PRECISION CIRCUITS LTD.

DEVICE	PACKAGE		COMPOSITION	SAMPLING FREQ. OVER SAMPLING	TAPS	FILTER CHARACTERISTICS (dB)		DATA FORMAT		FEATURES
	TYPE	PIN				PASSBAND RIPPLE	STOPBAND ATTENUATION	INPUT	OUTPUT	
SM5803AP/APT	DIP	28	2 channels	8/4 times	153+29+17	± 0.00005	110	Serial	Serial	For digital audio system
SM5813AP/APT	DIP	28	2 channels	8 times	153+29+17	± 0.00005	110	Serial	Serial	For digital audio system
SM5802 A/B	FPP	60	2 channels	2 times	80	$\pm 0.09/\pm 0.01$	90	Serial Parallel	Serial Parallel	High stopband attenuation Small passband ripple
SM5804 A/B/C/D	FPP	60	2 channels	4 times	80 + 15	$\pm 0.09/\pm 0.015$	90	Serial Parallel	Serial Parallel	High stopband attenuation Small passband ripple
SM5805	DIP	28	2 channels	2 times	121	± 0.001	90	Serial	Serial	For recording and playing
SM5806	DIP SOP	28	2 channels	2 times	70	± 0.05	60	Serial	Parallel	For compact disk
SM5807 D/E/F	DIP SOP	16	2 channels	4 times	61 + 13	± 0.05	50/45	Serial	Serial	For compact disk
SM5814 A/B	DIP SOP	22 24	2 channels	4 times	105 + 21	$\pm 0.001/\pm 0.01$	70/52	Serial	Serial	64 steps digital attenuation sharp cut-off characteristics
SM5820	DIP	40	1 channel	52kHz (max)	60 (max)	Mask Option		Parallel	Parallel	Semi custom
SM5831	FPP	64	4 on-chip multipliers	15MHz	4, 7, 8 cascadable	On-chip coefficient register		Parallel	Parallel	For video signal
	PGA	68		25MHz						High speed digital filter

U.S. and Canada Sales Office

NPC
NIPPON PRECISION CIRCUITS LTD.
2151 O'TOOLE AVENUE, SUITE L,
O'TOOLE BUSINESS CENTER,
SAN JOSE, CALIFORNIA 95131

TEL: 408-922-0133
1-800-237-4590
FAX: 408-922-0137



For complete product information and order, contact Jim Chang, Director of Customer Service/Developments or, Greg Branch, Sales Director

CIRCLE NO 39

COMPONENTS & POWER SUPPLIES

ond holds the interface circuitry. A slide switch allows you to select link inputs of 115 or 230V ac, 47 to 63 Hz. The link operates over 0 to 50°C and consumes 6W. \$1960 per pair.

Versitron, 9005-8 Junction Dr, Annapolis Junction, MD 20701. Phone (301) 497-8600.

Circle No 361

COOLING SWITCH

- Operates on logic-level inputs
- Can operate to 70°C

The Series 305 cooling-failure switch operates on 5V dc input signals and responds to any change in temperature in 1 to 3 sec. The switch can generate a false signal when its own temperature exceeds



a factory preset limit. Operating over a 5 to 70°C range, the switch features a self-heated glass-bead thermister, which compensates for ambient temperature, air speed, altitude, and relative humidity, and can sense a reversal in air flow. The switch is cooled by the same air stream that cools the host equipment, and measures 3 × 0.5 in. From \$15.

Cambridge Aeroflo Inc, 900 Mt Laurel Circle, Shirley, MA 01464. Phone (508) 425-2346.

Circle No 362

Volgen
QUALITY NO. 1
HIGH SPEED
NEW!

THREE NEW LINES
HIGH-QUALITY
COMPETITIVELY PRICED

Switching Power Supplies

ERK Series

- Switches at 200 KHz
- MAG-AMP Regulation
- AC 115/220V (selectable)
- 100, 150, 200W Triple and Quad
- Safety: UL, CSA, TUV
- EMI: FCC/VDE 0871 Class "B"

PRK Series

- (Pictured Above)
- Switches at 60 to 300 KHz
- Input Range AC 85-132V
- 30, 50, 70W Triple Output
- Safety: UL, CSA
- EMI: FCC Class "B"

MRE Series

- Switches at 300 KHz
- Universal Input AC85-264V
- Miniature size
- 15 and 30W Single Output
- Safety: UL, CSA, TUV
- EMI: FCC/VDE 0871 Class "B"

Volgen also features top quality custom services and standard unit modifications.
Uninterruptible Power Supply — check out our new model VPS-500V!



See us at
Electro '89
Booth 1775

Volgen America Inc. 39650 Liberty Street, #325, Fremont, CA 94538
(415) 498-5950 FAX (415) 498-5954

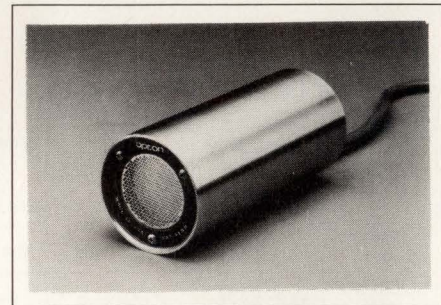

ULTRASONIC SENSORS

- Feature noncontact operation
- Withstand harsh environments

UC60 Series ultrasonic sensors offer a noncontact distance-sensing capability. The series is made up of the UC60-LN1A analog output-level sensor and the UC60-ZD1A switched-output zone-detection sensor. Both include adjustable sensing-zone features, built-in temperature compensation, short-circuit/transient-protected outputs, and 10 to 30V dc operation. The LN1A outputs distance measurements as an analog voltage or current. The ZD1A produces a switched output when an object enters a preset zone. Both units are built to with-

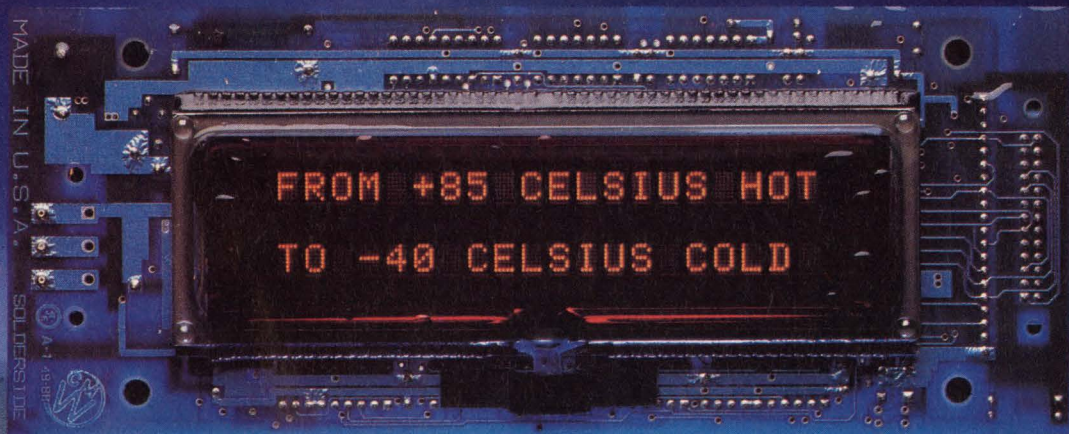
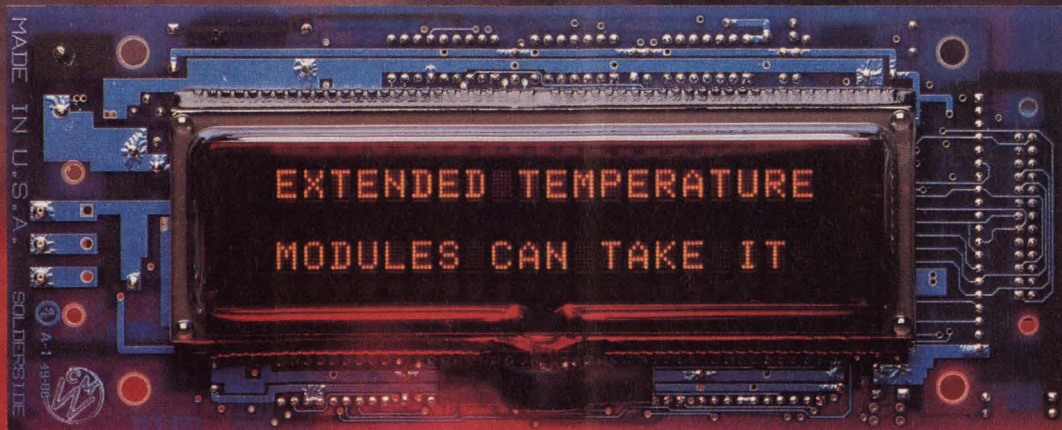

THE VF MODULES TO USE IF HELL FREEZES OVER.

If that day arrives and you need a clear readout, DeeCO's XT and XTB extended temperature display modules won't let you down.

From -40°C to $+85^{\circ}\text{C}$, through 40g shock and 2g rms vibration, XT series modules can take the heat. And the cold. And whatever else you or the forces of evil throw at them.

And when you need clear sunlight readability, our XTB1x40 high brightness extended temperature module delivers more than 600 fl of brilliant performance.

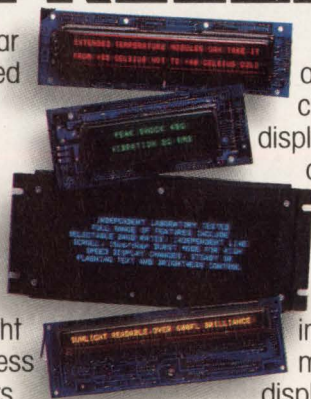

XT and XTB features include selectable baud rates, 15 microsecond-per-character burst mode for high-speed display changes, steady or flashing characters, and brightness control.

If you'd like further proof of how well we go to extremes, we'd be happy to send you test results from an independent testing lab. For more information about XT and XTB extended modules, or our full line of VF and EL display products, write or call (415) 471-4700.

DeeCO

Digital Electronics Corporation, 31047 Genstar Road, Hayward, CA 94544-7831 (415) 471-4700. DeeCO is a registered trademark of Digital Electronics Corporation © 1989.

COMPONENTS & POWER SUPPLIES

stand harsh environments and are encapsulated in stainless-steel cases that carry a NEMA 1, 2, 12, and 13 rating. UC60-LN1A, \$695; UC60ZD1A, \$595.

Opcon Inc, 720 80th St SW, Everett, WA 98203. Phone (206) 353-0900.

Circle No 363

DC/DC CONVERTERS

- Provide 1.5W single- or split-rail outputs
- Have 500V input-to-output isolation

EL1 isolated dc/dc converters have an output power rating of 1.5W and are available in single- or dual-output versions. Single-output ver-



sions have an output voltage of 5, 12, or 15V, and dual-output versions have split-rail ± 5 , ± 12 , or ± 15 V outputs. They are available with nominal input-voltage ratings of 5, 12 or 24V. Their input-to-output isolation voltage capability is 500V dc, and they have an isolation resistance of 10 G Ω . Line regulation is more than $\pm 0.3\%$ for a $\pm 10\%$ input voltage change, and zero- to full-load output regulation is more than $\pm 0.5\%$. All versions have a Pi filter on the input to minimize input and output noise. The converters are housed in standard DIP packages that measure 32x20x10.5 mm and weigh 17g. They have a -25 to +71°C operating temperature range. £18.

Gresham Powerdyne Ltd, Gresham House, Telford Rd, Salisbury, Wiltshire SP2 7PH, UK. Phone (0722) 413080. TLX 477576. FAX 0722-336263.

Circle No 364

Dowty Electronics Corp, Box 250, Prospect St, Brandon, VT 05733. Phone (802) 247-6811.

Circle No 365



REFAC KEYPADS & KEYBOARDS

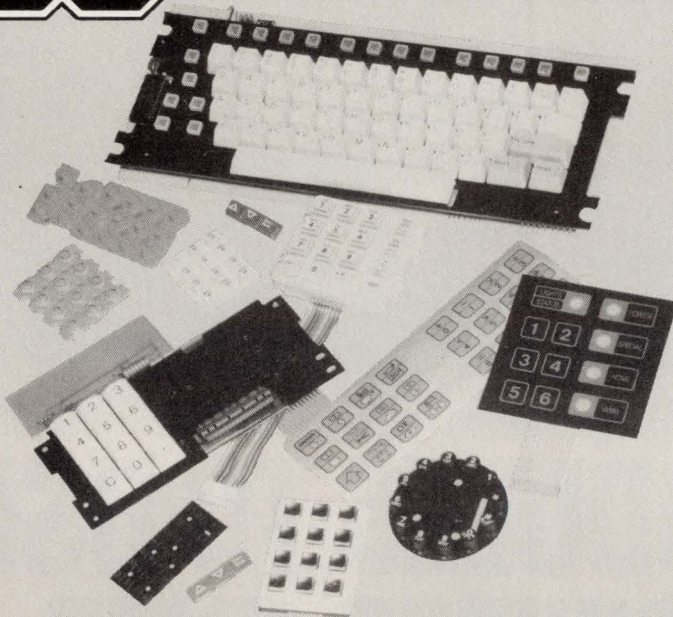

- ELASTOMERIC INTEGRATED/KEYBOARD ASSEMBLIES
- MEMBRANE FULL TRAVEL

Consultation Without Obligation

ERA/REFAC's 15 years of keyboard design and manufacturing expertise is yours for the asking. Call or write us with your inquiries. Our experienced engineers will provide the answers you need regarding applications and pricing. From keyboard components to totally integrated keyboards, ERA/REFAC has the capability to provide ideas and solutions.

Quality And Reliability

ERA/REFAC carries the highest levels of commitment to quality. Years of proven performance in high reliability aerospace, military, and tough industrial applications assure our customers that their products will achieve both design criteria and field performance. ERA/REFAC works to MIL-STD-105.

State-Of-The-Art Tooling And Assembly

You can depend on ERA/REFAC for the latest in subassemblies and turnkey products. Our manufacturing facilities in Connecticut and Taiwan are both equipped with automated assembly lines that include chip-on-board wire bonders, surface mount pick-and-place machines, wave soldering machines, and automated test equipment. Our capabilities are complemented by the ERA/REFAC Design Engineering Group, specialists in design and customer interfacing. Computer controlled tool room capabilities assure precision tooling and fast turn-arounds.

There may be a Refac keyboard in your future. Write, call, or fax your specifications to us today.



ELECTRONICS RESEARCH ASSOCIATES, INC.
REFAC ELECTRONICS
WEST HILL ROAD • WINSTED, CONNECTICUT 06098
TEL: (203) 379-2731 • FAX: (203) 379-8861

CONNECTORS

- Have 15 contacts in a 9-contact shell
 - Feature gold-plated contacts
- Sigma-D crimp-insertable D-sub-miniature connectors provide 15 contacts in a 9-contact shell. You can install the contacts by hand or with a machine. The brass contact pins and phosphor bronze sockets have gold over nickel plating as

CIRCLE NO 36

COMPONENTS & POWER SUPPLIES

standard. Other finishes are available as an option. The contacts have a 5A/500V dc rating. The connectors can accept #26 or 28 AWG wire sizes. Contacts are available in reels or in loose pieces for hand crimping. Male connectors, \$1.31 (500); 10,000-pin reel of contacts, \$70.

Vernitron Corp, Beau Products Div, Box 10, Laconia, NH 03247. Phone (603) 524-5101. FAX 603-524-1627.

Circle No 366

SELECTOR SWITCHES

- Available in top- or side-adjust versions
- Sealed to withstand assembly processes

SS-10 rotary DIP selector switches are available in top- or side-adjust versions. Single- and dual-pole models are available with four or six contacts and three contact configurations, respectively. All surfaces are permanently sealed to withstand standard soldering and washing processes. The self-cleaning, gold-plated contacts have a 5V/100 mA resistive switching rating. Contact resistance equals 100 mΩ max. The switches can carry 50V dc at 100 mA. The rotational life equals 500 cycles min and the operating range spans -10 to +60°C. \$1.70 (100).

Mepcopol Co, 11468 Sorrento Valley Rd, San Diego, CA 92121. Phone (619) 453-0332. FAX 619-481-1123.

Circle No 367

FAN SYSTEM

- Offers 12- and 15-fan capacity
- Design isolates vibration

The Airmatic 300 Fan Tray system features models with either a 12- or 15-fan capacity. The tray is configured from two structural foam halves, which include individual fan compartments to isolate noise and vibration. Rubber standoffs mounted to 8 points on the fan fur-

ther isolate noise and vibration. Each fan compartment is prewired, and each fan is terminated with a plug to ease fan replacement or additions in the field. Empty fan positions come with foam and a metal insert. All trays feature a brushed and anodized front panel, which includes easy-access handles. You can

order the trays with any number of fans from one to each tray's maximum capacity. 12-position tray with one fan, \$302.47.

Dacobas Inc, 1890 N Voyager Ave, Simi Valley, CA 93063. Phone (805) 526-7733. FAX 805-584-8371.

Circle No 368

Thoroughbred

Mizar's SPARC CPU keeps you ahead from start to finish.



You'll be favored to win with Mizar's MZ 7170, the VME processor with triple crown features. With the power of SPARC™ and the speed of zero wait-state SRAM, the MZ 7170 lets you run your application in record time. All for a price that keeps you on track.

The MZ 7170 was bred for demanding applications: a SPARC CPU at up to 25 MHz (15 MIPS), one MB of fast SRAM, up to four MB of EPROM, two RS-232 serial ports, mailbox interrupts, real-time clock, and optional T.I. 8847 FPU. And, the MZ 7170 is supported by a complete real-time operating system and UNIX®-based development tools.

Race into the homestretch with Mizar's thoroughbred, the MZ 7170. Call today. **1-800-635-0200**.

Mizar. The shortest distance between concept and reality.

MIZAR

1419 Dunn Drive • Carrollton, TX 75006 • (214) 446-2664

SPARC is a trademark of Sun Microsystems, Inc. UNIX is a registered trademark of AT&T.

©1989, Mizar, Inc.

NEW PRODUCTS

TEST & MEASUREMENT INSTRUMENTS

CALCULATOR

- Performs 254 functions
- Works with simultaneous equations and complex numbers

The TI-68 advanced scientific calculator performs 254 functions and handles complex numbers as easily as it handles real ones. It can simultaneously display the real and imaginary parts of a complex quantity. The 6×3×0.6-in. unit sports a 12-character alphanumeric LCD that scrolls horizontally to display equations having as many as 80 characters. The calculator can solve five simultaneous equations; a plain-English prompting scheme guides you through equation entry. You can recall and replay the last equation entered, and you can edit equations after you've entered them. The calculator allows you ac-

cess to as many as 36 registers and lets you assign names to the registers. You can enter as many as 12 formulas; the formulas remain in memory even when the calculator is off. The unit also determines the real and complex roots of quadratic, cubic, and quartic equations. \$65.

Texas Instruments Inc, Box 53, Lubbock, TX 79408. Phone (806) 747-1882.

Circle No 380

AUDIO TEST SET

- Generates 8-ppm distortion sine waves from 1 Hz to 102.39 kHz
- Provides 0.03%-inaccurate crystal-controlled frequencies

The 3100B generator and 3200B autoranging analyzer form an audio test set that measures amplitude

and phase vs frequency and intermodulation (IM) and total harmonic distortion (THD) vs frequency or amplitude. The analyzer measures phase from -180 to +180° with 0.1° resolution to 40 kHz and ac voltages from 4 μV to 100V with residual THD and IM of 20 ppm. The generator stores 91 front-panel setups and can produce sine waves from 1 Hz to 102.39 kHz with 8-ppm distortion and square waves from 1 Hz to 50 kHz with a rise time of <1 μsec. As the frequency is crystal controlled, errors are less than 0.03% at fixed frequencies and on some sweeps. Generator, \$4250; analyzer, \$5495.

Sound Technology, 1400 Dell Ave, Campbell, CA 95008. Phone (408) 378-6540. TLX 357445.

Circle No 381

Text continued on pg 230

We want to power your next field test.

Let us show you how much a dryfit® sealed lead-acid battery can improve your product credibility! Just give us your application specs and we'll match them with the dependable dryfit battery you need.

Whether primary power or standby, dryfit is the right battery for the job. Because dryfit is the original gelled electrolyte, recombination sealed lead-acid battery.

The only one of its kind with patent protected advantages for extended cycle life. The one with longer float life. And the one with the easiest charging techniques and the proven leak-proof construction!

Just look at the broad range of critical applications where dryfit outperforms ordinary batteries:

Backup power — UPS, Computers, Electronic scanners/Point of sale equipment, Security/Fire alarm systems, Telecommunications.

Primary Power — Portable medical equipment, Robots, Wheelchairs, Photographic equipment.

If you have a need for customized batteries, let's talk. We can design and

manufacture battery packs of any size and configuration to meet your exact specs.

Putting us to the test begins with one quick, free call to **1-800-4dryfit**

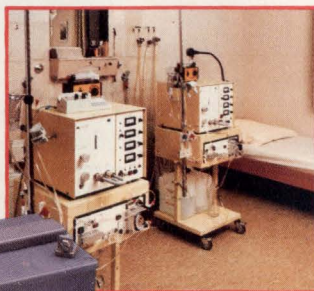

SONNENSCHNEIN BATTERIES, INC.
P.O. Box 339, Cheshire, CT 06410
(203) 271-0091

Exclusive Canadian Agent:
Advanced Battery Systems
Mississauga (416) 670-7159

dryfit® is a registered trademark of Sonnenschein Batteries, Inc.

260°C FOR 20 SECONDS True Surface Mount Crystals & Oscillators

Now, for the first time, you can surface mount crystals and CMOS crystal oscillators with complete confidence. That's because Epson has developed new materials that will withstand 260°C for 20 seconds (see curve), well above standard IR and Vapor Phase Reflow processing temperatures. And our CMOS oscillators give you high-speed 5 nsec rise and fall times, 45/55 symmetry (typ) and low power consumption.

Also ask about our Surface Mount Real Time Clocks.

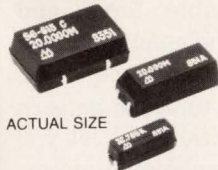

ACTUAL SIZE

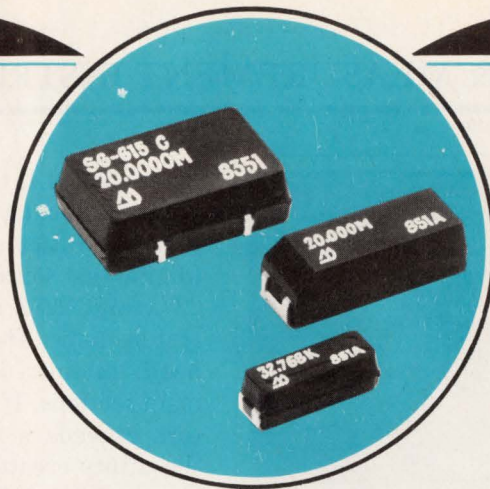

EPSON SURFACE MOUNT CRYSTAL/OSCILLATOR SPECIFICATIONS

CRYSTALS		CMOS CRYSTAL OSCILLATORS	
PART NO.	FREQUENCY	PART NO.	FREQUENCY
MC-405	32.768 KHz	SG-615	1.5000 MHz - 25 MHz (25 - 50 MHz) 1/89
MA-505	12 MHz - 25 MHz (4 MHz - 12 MHz) 9/88 (25 MHz - 60 MHz) 1/89		

Call us for detailed information.

EPSON®

EPSON AMERICA, INC. Component Sales Department
3415 Kashiwa St., Torrance, CA 90505

Telephone (213) 534-4500 • TELEX 664277 • FAX (213) 539-6423

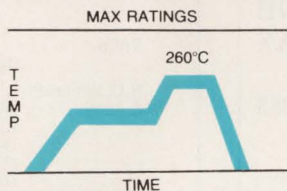

CIRCLE NO 32

"Buck Passer"

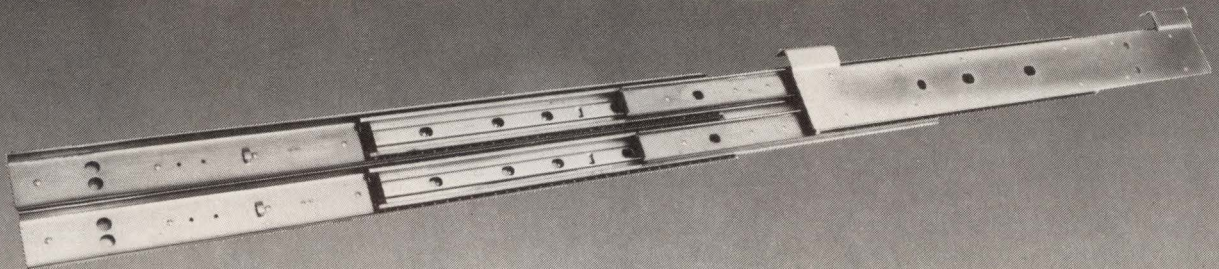

Manufacturers of Automatic Teller Machines have found they need a rugged, reliable slide mechanism for their cash dispenser — one that can stand up to the rigors of daily use and abuse. Jonathan has responded with a specially designed slide of exceptional strength, reliability and longevity. This steel, 4-section, ball-bearing tiered slide has a 140 lb. capacity, over its 34-inch extension. Built with a 4:1 safety factor, it has been tested to over 50,000 cycles, with outstops impacted and a 10 lb. side load applied. ■ If you have a problem involving chassis slides or other similar slide devices, talk to us at Jonathan — our Application Engineering Group probably has a reliable answer . . . at an economical price.

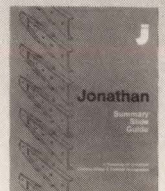
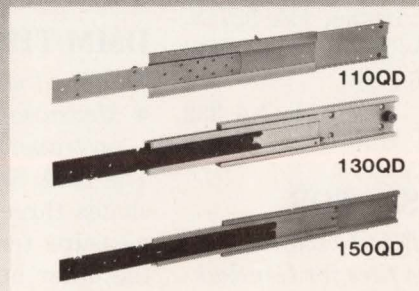

Jonathan's extensive lines of chassis slides are industry standards in industrial and aerospace applications — with load ratings to 800 lbs.



Jonathan Manufacturing Corporation • 1101 So. Acacia Ave., Fullerton, CA 92634 • (714) 526-4651 • FAX: 714-773-5582

See us at Electro/89 Booth No. 2009
CIRCLE NO 31

TEST & MEASUREMENT INSTRUMENTS



RISC DEVELOPER

- Supports 88000 RISC chips
- Traces system activity in real time to 50 MHz

The DS5000 development system provides in-circuit support for the 88100 RISC processor and the 88200 cache/memory management unit. The development system can perform 256-channel logic analysis and provides 16 levels of unrestricted triggering. It traces all target-system activity in real time to 50 MHz and captures trace data in 4k- or 16k-frame buffers. You can define trigger conditions for the cache, program memory, data memory, instruction memory, or combinations of all of them. By using a pair of buffers and filling one while routing the other's contents via DMA to the host processor's RAM, the development system can acquire data continuously. The development system works with MS-DOS-based hosts, including some Sun Microsystems units. \$28,000 to \$40,000. Delivery, six weeks ARO.

Hilevel Technology Inc., 31 Technology Dr, Irvine, CA 92718. Phone (800) 445-3835; in CA, (800) 541-2742. TLX 655316.

Circle No 382

TEST TRANSLATOR

- Translates PLD test vectors
- Creates source files for GenRad testers

The JED2DTS software utility runs on DEC VAXs under VMS and on IBM PCs, PC/XTs, PC/ATs, and compatible computers. The utility

translates PLD test vectors created with the vendor's ATG (automatic test generator) software into DTS (digital test source) files for GenRad 227x and 2282 in-circuit pc-board test systems. The DTS files include head, inhibit, disable, force, and main sections. If the number of vectors exceeds a user-defined limit, the utility creates multiple pattern bursts. PLD definition files let you customize the translation process. \$1695 including communication software for error-free file transmission to the tester.

Anvil Software Inc., 427-3 Amherst St, Suite 341, Nashua, NH 03063. Phone (603) 891-1995. FAX 603-891-1999.

Circle No 383

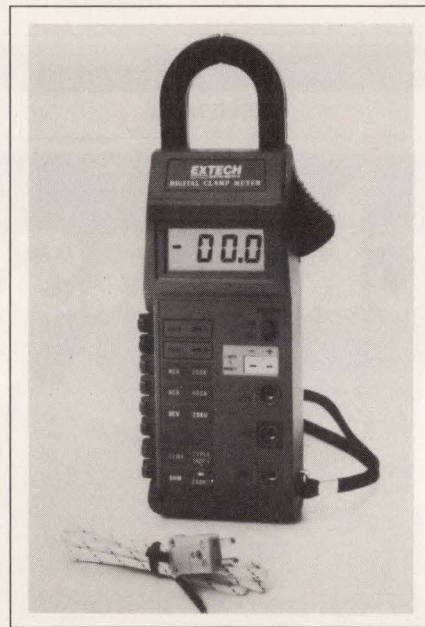

DMM/THERMOMETER

- Offered with °C and °F readouts
- Measures ac current with clamp-on transformer

The ACA Series of multimeters includes three models, two of which measure temperature—one in °F, the other in °C. All three units incorporate a peak-hold function; the two that measure temperature also include data-hold and diode-check functions. All three models measure ac current via integral clamp-on

For more information on ASC products call the Representative near you.

US and Canadian Representatives.

NORTHEAST:

BGR Associates (NJ) (609) 983-1020

EE & S, Inc. (MD) (301) 269-4234
(VA) (804) 794-8939

F & F Metro (NY) (516) 482-4080

R. O. Whitesell & Assoc. (PA) (412) 963-6161

Quality Components (NY) (315) 682-8885
(716) 837-5430

SOUTHEAST:

SACS (FL) (407) 857-3650
(407) 391-1034
(813) 577-6819

Design Marketing & Assoc. (TX) (214) 480-8151
(504) 542-1115
(512) 263-9151
(713) 550-3318

SACS (NC) (919) 859-9970

R. O. Whitesell & Assoc. (AL) (205) 883-5110
(GA) (404) 449-9190
(KY) (502) 241-1441
(TN) (615) 352-4760
(TN) (615) 694-9476

MIDWEST:

Circuit Sales, Inc. (N.IL) (312) 773-0200
(WI) (414) 784-7773

Comprehensive Technical Sales (MN) (612) 941-7181

Hill & Company (W.MO) (314) 432-1136
(KS) (816) 561-2593

C. H. Horn & Assoc. (IA) (319) 393-8703

John Macke Co. (S.IL)(E.MO) (314) 432-2830

R. O. Whitesell & Assoc. (OH) (216) 447-9020
(219) 432-5591
(MI) (313) 559-5454
(MI) (313) 695-0770
(IN) (317) 359-9283
(IN) (317) 457-9127
(OH) (513) 298-9546
(OH) (513) 521-2290
(OH) (614) 888-9396
(MI) (616) 942-5420
(MI) (616) 983-7337

WEST:

Compass Marketing & Sales (NM) (505) 888-0800
(AZ) (602) 293-1220
(602) 996-0635

J. S. Heaton Company (CA) (415) 367-9000

N. R. Schultz Company (WA) (206) 454-0300
(OR) (503) 643-1644

Waugaman Associates (CO) (303) 423-1020
(UT) (801) 261-0802

WCV/Raltech (CA) (818) 700-0933

CANADA:

Renmark Electronics Ltd. (E.CD) (416) 881-8844



CIRCLE NO 29

BEST PERFORMANCE IN A SUPPORTING ROLE.

ASC Presents First Class Film Capacitors And Technical Support, Second To None.

When you buy high technology film capacitors from ASC, you get all the support you need, absolutely free. It begins with a fully computerized sales and customer service department authorized to provide extremely competitive prices on volumes large and small. It means you get the highest level of technical support from a nationwide team of engineers prepared to help you with application specific solutions over-the-phone or at your own facility. And, when it comes to custom or "special orders," well, it's just standard procedure with us. All this, plus "just in time" deliveries that go out on time.

Since our acquisition of TRW's film capacitor division, ASC has acquired a reputation for service and support, second to none. By combining strong engineering know-how, and an even stronger commitment to technical support, ASC has emerged as the fastest growing film capacitor manufacturer in the U.S.

In fact, you'll find we offer one of the most complete lines of high quality, cost effective film capacitors in the world, including: polyester, polycarbonate, polypropylene and polystyrene dielectrics, both metallized and non-metallized, plus oil filled capacitors for lighting and motor run applications.

So, when you want an award winning performance in both product and personnel, call ASC. We'll show you why business is better when it's done right, at home. Call us today at **818/710-8555**.



ASC[®]

Sales & Marketing, Canoga Park, California
Engineering & Manufacturing, Ogallala, Nebraska
ASC, 21541 Blythe Street, Canoga Park, CA 91304

FAST BUCK or **LONG-TERM VALUE.**

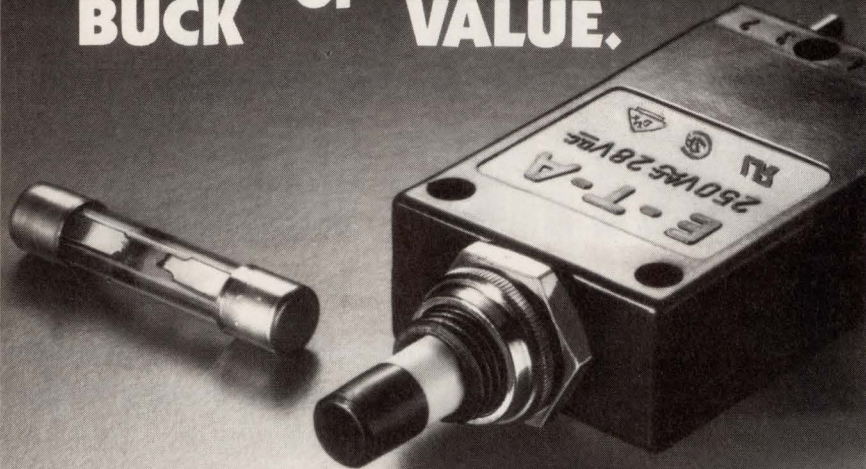

If your only concern is initial cost, then fuses cost less than E-T-A circuit breakers. But beyond initial cost, there's reality. Fuses *blow* and can drive up your cost of warranties, service, replacement, even product liability.

E-T-A circuit breakers, on the other hand, add value to your product. Yet they can lower costs while providing superior circuit protection and better performance characteristics than fuses. For example, they're trip-free, foolproof, 100% tested for quality, and approved for use, worldwide.

So, forget the fast buck. Instead, go for the long-term value of E-T-A circuit breakers. Call today or circle the number below for specification details.



E-T-A[®]

CIRCUIT BREAKERS GROUP
setting the pace for circuit protection

7400 N. CRONAME RD., CHICAGO, IL 60648 Tel. (312) 647-8303 FAX: (312) 647-7494

© 1988 E-T-A Circuit Breakers

CIRCLE NO 28

DID YOU KNOW?

Half of all EDN's
 articles are staff-written.

EDN

INSTRUMENTS

transformers on full-scale ranges of 200 and 400A. The unit that doesn't measure temperature also includes a 20A ac current range. AC-current-measuring accuracy on all units is 1% to 100A. All units measure ac and dc voltage and resistance and have four dc-voltage ranges. The unit that doesn't measure temperature has four resistance and two ac-voltage ranges. The other units have two resistance ranges and one ac-voltage range. \$119; \$109 without temperature measurement.

Extech Instruments Corp, 150 Bear Hill Rd, Waltham, MA 02154. Phone (617) 890-7440. TLX 940913.

Circle No 384

BOARD TEST SOFTWARE

- Adds enhancements to 1800-Series testers
- Automatic test-program backup prevents program loss

A software update to the vendor's 1800-Series board testers incorporates five features that expand test coverage and increase programming flexibility. These features include dual threshold measurements, which let you define both high- and low-voltage regions; HiCheck, which produces a 4-digit hexadecimal signature for all high-region measurements; digital filtering, which increases stability in a voltage measurement by averaging multiple sample readings; HiGuard, which improves guarded measurement accuracy by eliminating the thermal EMF of relay contacts; and differential measurements, which let you make voltage measurements that aren't referenced to system ground. The addition of program flow control and branching capabilities increases programming flexibility. \$500.

Zehntel Inc, 2625 Shadelands Dr, Walnut Creek, CA 94598. Phone (415) 932-6900. TWX 910-385-6300.

Circle No 385

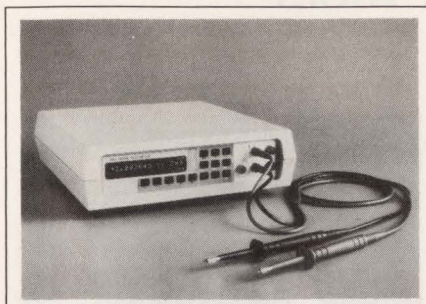

DIGITAL MULTIMETERS

- Have a 1-year dc voltage accuracy of 20 ppm
- Include an IEEE-488 interface and digital recalibration

The Model 5001 and Model 6001 are 6½-digit instruments that have a 24-hour dc voltage stability of $\pm(4$ ppm of reading + 2 ppm of full scale) and a 1-year dc voltage accuracy of ± 20 ppm. The Model 5001 provides dc and true-rms ac voltage, dc and true-rms ac current, and 2-wire resistance measurement functions. The Model 6001 has the same basic specification as the 5001, and also provides both temperature measurement using a 100- Ω platinum resistance thermometer probe, and 4-wire resistance measurement. Both instruments have dc voltage measurement ranges from 0.2 to 1000V, ac voltage measurement ranges from 2 to 700V rms, dc and ac current ranges of 2 mA and 2A, and resistance measurement ranges of 200 Ω to 12 M Ω . The instruments provide measurement periods selectable between 50 msec and 10 sec and feature math functions, an IEEE-488 interface, and digital recalibration facilities. A 10-channel input scanner option is available for both instruments. Model 5001, \$1495; Model 6001, \$1695.

Prema GmbH, Robert-Koch-Strasse 10, 6500 Mainz 42, West Germany. Phone (06131) 50620. TLX 4187666. FAX 06131-506222.

Circle No 386

Prema Precision Electronics Inc., 4650 Arrow Highway, Suite E5, Montclair, CA 91763. Phone (714) 621-7292. FAX 714-625-2098.

Circle No 387

CABLE CUTTER

- Cuts round cables
- Handles 300-pair cable

The PA 1818 portable cable cutter is 12 in. long. It cuts round multi-conductor cables containing as many as 300 signal pairs. It also cuts copper cables to 750 MCM (thousands of circular mils) and alu-

minum cables to 1000 MCM. The unit includes a folding safety latch and a release mechanism that enables you to move the tool to a different location. \$239.

Paladin Corp., 3543 Old Conejo Rd, Suite 102, Newbury Park, CA 91320. Phone (805) 499-0138.

Circle No 388

ONE OF THESE CAN CHANGE THE WAY YOU SEE LIGHTING.



WE'D LIKE TO SEND YOU ONE OF OUR EL LAMPS—

Bend and twist it. Bang it. Dunk it. Freeze it. And then watch it light up when you plug it in.

Only our electroluminescent (EL) lamps can take it. Because only our EL lamps combine solid-state technology with Loctite quality and reliability.

Besides standing-up to conditions that would virtually destroy incandescents and other ELs, our lamps also stand-out with useful life, exceeding 10,000 hours. With uniform surface illumination, so you can forget your balancing act. With no heat. With all kinds of sizes and shapes—in any color.

HERE'S HOW TO GET ONE, SO YOU CAN SEE FOR YOURSELF.

Just send this ad, along with your business card, to Mike Hartman, our Marketing Manager. Along with our DESIGN GUIDE, he'll send you a sample EL lamp—both free. After you kick it around for a while, you'll understand why we say—no other light can hold a candle to ours.



**LOCTITE
LUMINESCENT
SYSTEMS INC.**

SETTING THE STANDARD
A SUBSIDIARY OF LOCTITE CORPORATION

tel (603) 448-3444
FAX (603) 448-3452, TWX 710-366-0607
Etna Rd., Lebanon, NH 03766

CIRCLE NO 25

NEW PRODUCTS

CAE & SOFTWARE DEVELOPMENT TOOLS

REAL-TIME KERNEL

- *Runs in the 32-bit, protected mode of the 80386*
- *Allows a combination of local and global tasks*

MTOS-UX/386 is a multiprocessing, multitasking, real-time operating system for 80386-based computers. This OS normally runs in the 32-bit, protected mode of the 80386, and protects system resources such as block and memory pools, message buffers, controlled shared variables, and task resources. Also available is a version that uses the multisegmented memory model to run MS-DOS software. This model protects the kernel and the system resources by means of task privilege levels. You can increase the computing power of the system merely by adding up to 16 CPUs;

changing the number of CPUs does not require any change to the applications programs. The development kit includes test facilities, debugging tools, validation programs, configuration programs, a RAM-disk driver, a Unix interface, and a C-portable library. The symbolic debugger provides task-level debugging facilities. Because all versions of MTOS-UX have the same programmer interface, programs written in a high-level language will run under any version of MTOS-UX, regardless of the processor type. Development kit prices start at \$5000.

Industrial Programming Inc.,
100 Jericho Quadrangle, Jericho,
NY 11753. Phone (516) 938-6600.
TLX 429808. FAX (516) 938-6609.

Circle No 389

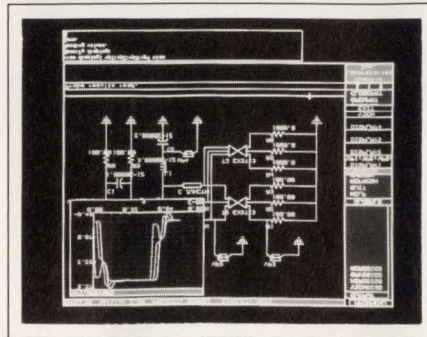

CAE TOOL

- *Handles double-sided SMT designs*
- *Handles multiple power planes and as many as 16 signal layers*

The MAXI/PC schematic-capture and pc-board layout package can execute double-sided, surface-mount designs with as many as 16 signal layers; it also handles multiple power and ground planes having

New SLO-SYN® Servo Positioners



... with real time adaptive gain control for constant, smooth, stable positioning of brush or brushless servos.

The new 800 Series SLO-SYN® Closed Loop Servo Motion Controls are single axis, stand-alone positioners that can execute stored motion profiles with a velocity programming resolution of 8,000,000:1. They are ideally suited for industrial automation applications which require demanding precise control of positioning or velocity.

800 Series units can be programmed and directed through an RS232 serial port from PC compatible software, a "dumb" terminal or a hand-held programmer. For systems configured with discrete I/Os, they can be externally interfaced through 14 defined inputs and outputs. All controls feature *real time adaptive gain control* that automatically adjusts the gain to compensate for load changes. The high velocity programming resolution ratio permits speed changes in extremely small increments.

A complete file of SLO-SYN® Motion Control literature is available on request. It is must reading for anyone involved with motion control system design.

Call 1-800-447-7171 today.



The Superior Electric Company

Bristol, CT 06010 / (203) 582-9561
TLX: 96-2446 / FAX: (203) 584-1483

CIRCLE NO 27

a resolution of $\frac{1}{1000}$ in. High-speed automatic features include placement, gate- and pin-swapping, component renaming, back-annotation, and routing. The package runs on IBM PCs and compatibles. \$995.

Racal-Redac Inc, 238 Littleton Rd, Westford, MA 01886. Phone (508) 692-4900.

Circle No 390

STABILITY ANALYZER

- *Simplifies setup and operation of a network analyzer*
- *Includes modeling and synthesis package for loop analysis*

The S350/3577 stability software package allows you to integrate your HP3577A Network Analyzer from Hewlett-Packard (Palo Alto, CA) with an IBM PC or compatible, a printer, and a plotter, to form a complete stability-analysis workstation. The menu-driven software simplifies the setup and operation of the HP3577A, so that you can quickly obtain Bode plots or Nyquist diagrams of control-loop circuits. You can store the data on disk for later analysis and circuit optimization. The software includes the vendor's proprietary K-factor modeling and synthesis package for loop optimization; the software also works with PC-MATLAB for matrix computations, and with ECA-2 for circuit modeling and analysis. From \$5995.

Venable Industries Inc, 3555 Lomita Blvd, Torrance, CA 90505. Phone (213) 539-2522. FAX 213-539-4139.

Circle No 391

SIMULATION MODELS

- *Library contains models for more than 4000 LSI/VLSI devices*
- *Models allow fault simulation at the board or system level*

SmartModels is a library of behavioral models for more than 4000 LSI/VLSI devices. Previously available for logic simulation, the

vendor has now adapted all the models for use on Mentor Graphics' (Beaverton, OR) QuickFault fault simulator. The vendor plans to support other simulators that have a behavioral interface. Behavioral models are easier to write and faster to load than gate-level models; they also run faster and allow

you to simulate larger designs without increasing the memory requirements. SmartModels allow concurrent fault simulation; that is, you can divide the design into several parts and run each part on a different node of a network, or on parallel processors of a multiprocessor system. The original subscription serv-

WE CAN GET YOU AROUND YOUR LIGHTING PROBLEMS.

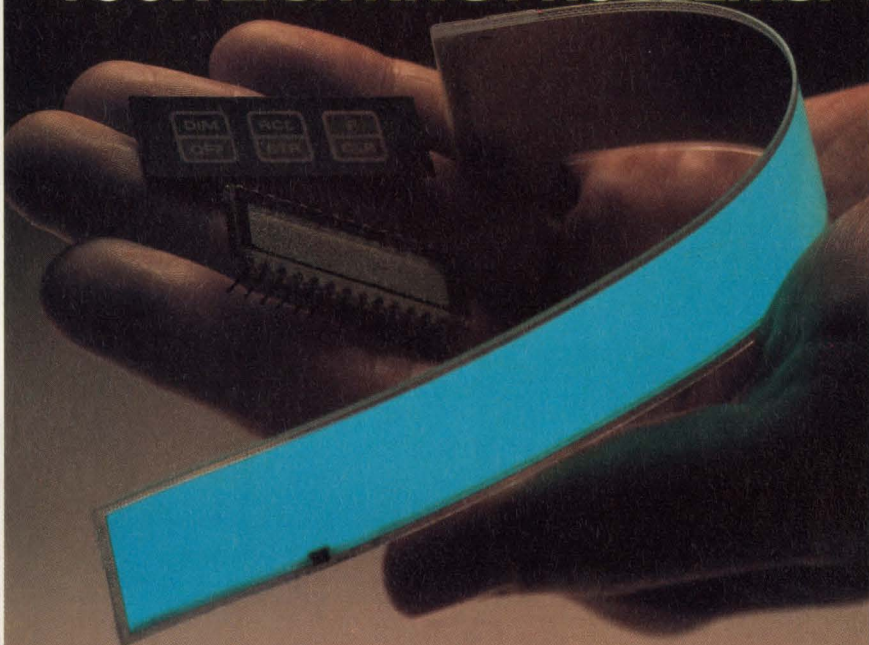

Our electroluminescent (EL) lamps give you light that's easy to work with.

Instead of juggling grains of wheat, we give you a single field of light, perfectly uniform and balanced the moment you plug it in.

Instead of bulk, we give you a lamp so thin, it's barely three-dimensional—lighted almost edge to edge. We can make our lamps in all kinds of sizes and shapes—with cutouts and holes to fit protruding knobs and switches.

Instead of resistance-based technology that's hot, we give you capacitance-based technology that's very cool. Instead of a limited color range, we can make a lamp in almost any color—even multicolor. Instead of sudden death, we give you lamps with useful lives exceeding 10,000 hours in extreme environments. We can give you a variety of connectors, including IC leads. And we can supply front or back adhesives, for easy mounting.

OUR DESIGN GUIDE CAN LIGHT YOUR WAY.

And with our lamps, we give you solid-state-of-the-art construction backed with our Loctite applications know-how. So for solutions to any problem, we're here. To learn more, send for our DESIGN GUIDE, the definitive reference on electroluminescence. Because the solution to your lighting problem may be as simple as seeing it in a new light.

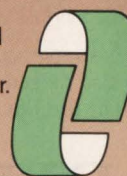

**LOCTITE
LUMINESCENT
SYSTEMS INC.**

SETTING THE STANDARD
A SUBSIDIARY OF LOCTITE CORPORATION

tel (603) 448-3444
FAX (603) 448-3452, TWX 710-366-0607
Etna Rd., Lebanon, NH 03766

CIRCLE NO 24

ice to SmartModels for fault simulation costs \$7900; the FLEX-Node service, which allows you to move licenses around a network, costs \$9900 (minimum, 3 FLEX-Node subscriptions).

Logic Automation, 19500 NW Gibbs Dr, Beaverton, OR 97006. Phone (503) 690-6900.

Circle No 392

C LIBRARY

- Lets you build resident shared libraries
- Allows you to convert existing programs to TSR versions

*/*resident_C** is a library of C routines for building terminate-and-stay-resident (TSR) programs. The C routines let you build interrupt-service routines, such as timers that schedule a program to run at a particular time. You can also build resident shared libraries that can be accessed by any number of programs. The library also allows you to convert existing C programs to TSR status by adding a few function calls. Other routines included in the library let you save screens or windows so your TSR program won't disrupt the program that it interrupts. Versions of the library are available for the Microsoft (QuickC and C 5.0), Borland (Turbo C), and Lattice C compilers that run on IBM PCs and compatibles. The distribution disk includes demonstration programs that show you how to use the library and how to build shared libraries. Binary version, \$99; binary and source code, \$198.

Essential Software Inc, 76 S Orange Ave, Suite 3, S Orange, NJ 07079. Phone (201) 762-6965.

Circle No 393

NET-LIST GENERATOR

- Allows you to reverse-engineer pc boards
- Copes with boards that contain high pin-count devices

The Net-Learn utility software for

the company's SI635 diagnostic test system lets you reverse-engineer pc boards by generating a connectivity net list for the board's components. You can then use the net list to construct a schematic diagram. The menu-driven software uses the system's in-circuit test capabilities to learn the pin-to-pin interconnec-

tions between all the devices on the pc board. Net-Learn combines as many as 128 test channels to cope with high pin-count devices. The utility employs a 2-pass test strategy to generate the net list. During the first pass, the pc board under test is powered up, and the tester locates all pins that are connected

OUR EL LAMPS WON'T LEAVE YOUR PRODUCT IN THE DARK.

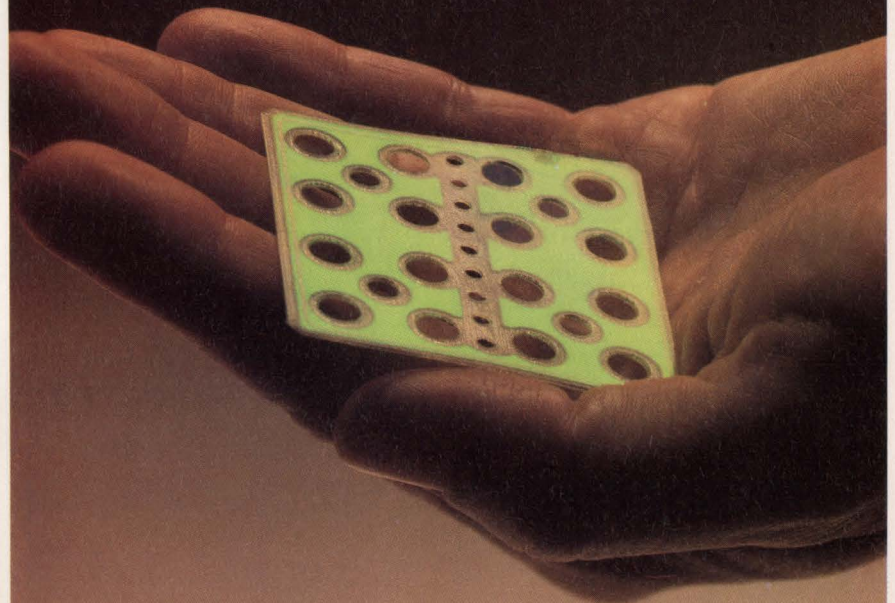

When your product needs lighting that absolutely has to work—everytime, everywhere—you need our electro-luminescent (EL) lamps.

Because in lighting, there's nothing tougher or more reliable than our solid-state-of-the-art construction. Tough Aclar packaging makes our lamps durable. Special phosphors with our unique desiccant layer make them dependable. Our lamps will survive where lesser lights—both incandescent and EL—face sure and sudden death.

So, in vibration and shock, in temperature extremes, in humidity and moisture, our EL lamps really shine...on and on. In fact, their useful lives exceed 10,000 hours.

And we can provide this reliability in almost any color. In all kinds of sizes and shapes.

SEND FOR OUR DESIGN GUIDE. IT'LL SHED MORE LIGHT.

When it comes to electroluminescence, we've quite literally written the book. And we'd like to send it to you—the DESIGN GUIDE. Because when you spend a lot of time making your product and your reputation solid, lighting shouldn't be its weakest link.



**LOCTITE
LUMINESCENT
SYSTEMS INC.**

SETTING THE STANDARD
A SUBSIDIARY OF LOCTITE CORPORATION

tel (603) 448-3444
FAX (603) 448-3452, TWX 710-366-0607
Etna Rd., Lebanon, NH 03766

CIRCLE NO 23

to power or ground lines. The pc board is turned off during the second pass, and the utility determines the interconnections between devices. The system eliminates faulty net-list generation by checking for good probe contact before the learning process begins. To cope with board modifications or updates, the

software can perform a partial learn operation. You can use the output files from Net-Learn to generate schematic diagrams for the pc under test. Around £2100.

Schlumberger Technologies, Instruments Div, Victoria Rd, Farnborough, Hampshire GU14 7PW, UK. Phone (0252) 544433. TLX

858245. FAX 0252-543854.

Circle No 394

Schlumberger Technologies, Instruments Div, 20 N Ave, Burlington, MA 01803. Phone (617) 229-4825. TLX 910-250-745. FAX 617-229-4885.

Circle No 395

The PowerTech Advantage

... our unique ability to combine high SOA with the lowest Vce (sat) in the industry for increased efficiency and highest reliability ... from 30A to 300A continuous in a single transistor and custom power blocks to 2000A and more. Plus flexible package design including isolated configurations.

*Isolated, Low Profile,
Hermetically Sealed,
Military Power
Transistor Packages*



- Mounts and connects electrically from same side for ease of installation.
- 90 mil copper core pins, 290 amps DC rated.
- Solid copper base for very low thermal resistance.
- Low profile design so it fits in crowded, low-overhead areas.
- Customized pin outs and circuitry design possible.
- Hermetically sealed package makes it ideal for military and aerospace applications.
- Passes weapons spec solderability requirements.
- Meets military environmental capabilities including temperature, shock and vibration.
- Transistor is electrically isolated from case.

PowerTech

"BIG IDEAS IN BIG POWER"

0-02 Fair Lawn Avenue • Fair Lawn, NJ 07410

201-791-5050 • FAX: 201-791-6805

Call or write today for our Design Guide Wall Chart.

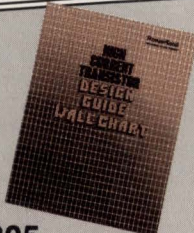

SIMULATOR

- Provides a single-screen display of analog and digital signals
- Works with the vendor's ASIC-design tool set and cell libraries

DesignSim A&D lets you simulate both analog and digital circuits concurrently, and provides a single-screen display of analog and digital signals that are synchronized in time and use the same time scale. You can run simulations of electronic devices at the system, cell, or transistor level with the accuracy of Spice. You can also model electromechanical interfaces. DesignSim A (the analog portion) is based on Analogy Inc's (Beaverton, OR) Saber simulator; DesignSim D (the digital portion) is based on HHB Systems Inc's (Mahwah, NJ) Cadat simulator. DesignSim supplements, and is accessible from, the vendor's Product Design Series I (PDS I) ASIC-design tool set, and is fully integrated into the newer PDS II tool set. When you run a mixed-signal simulation, each simulator schedules its own time steps for optimal execution speed, and both simulators analyze information simultaneously so that feedback is propagated through the analog and digital simulators as required. The simulation and analytical algorithms maintain a high level of accuracy and result in a decrease of simulation time. Pricing for PDS II with DesignSim A&D for a single user, from \$64,000.

NCR Corp, 2001 Danfield Ct, Fort Collins, CO 80525. Phone (303) 226-9500.

Circle No 396

ONE SOURCE MANY SOLUTIONS

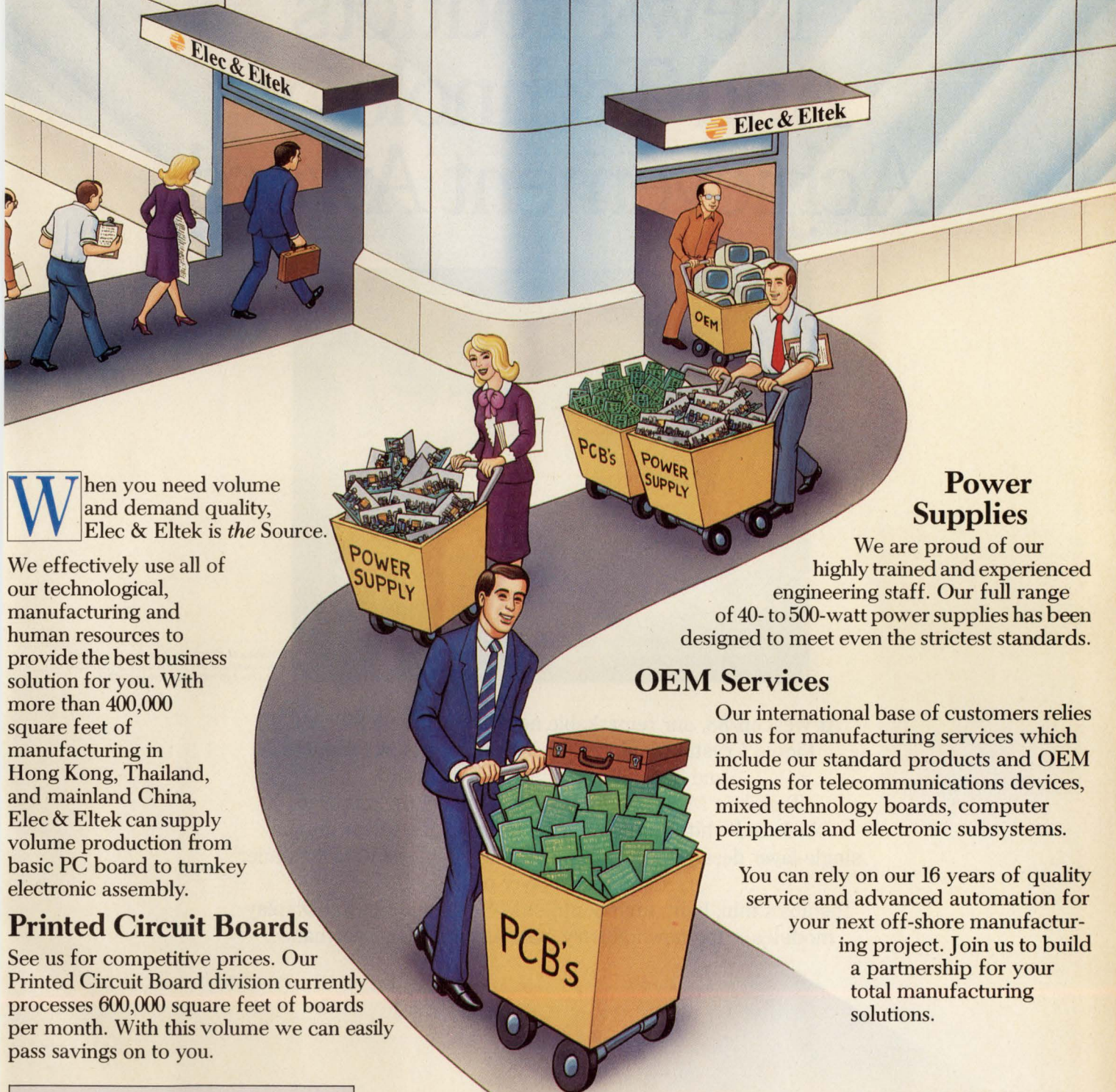

When you need volume and demand quality, Elec & Eltek is *the Source*.

We effectively use all of our technological, manufacturing and human resources to provide the best business solution for you. With more than 400,000 square feet of manufacturing in Hong Kong, Thailand, and mainland China, Elec & Eltek can supply volume production from basic PC board to turnkey electronic assembly.

Printed Circuit Boards

See us for competitive prices. Our Printed Circuit Board division currently processes 600,000 square feet of boards per month. With this volume we can easily pass savings on to you.

Power Supplies

We are proud of our highly trained and experienced engineering staff. Our full range of 40- to 500-watt power supplies has been designed to meet even the strictest standards.

OEM Services

Our international base of customers relies on us for manufacturing services which include our standard products and OEM designs for telecommunications devices, mixed technology boards, computer peripherals and electronic subsystems.

You can rely on our 16 years of quality service and advanced automation for your next off-shore manufacturing project. Join us to build a partnership for your total manufacturing solutions.

HEADQUARTERS
18/F, Luk Hop Ind. Bldg.,
8 Luk Hop Street,
San Po Kong
Hong Kong
TEL: 3-7269211, 3-7269333
FAX: (852) 3-3524625

OR CARE OF:
U.S.A. MARKETING
OFFICE
1230 Oakmead Parkway
Suite 310
Sunnyvale, California 94086
TEL: (408) 732-1181
FAX: (408) 732-8010

FOR FURTHER INQUIRIES,
PLEASE WRITE TO:



Elec & Eltek
COMPANY, LTD.

Winner Of Wescon's New Products And Technology Achievement Award.



Toshiba M-ST LCD modules are available in two sizes: the 640 x 400 dot TLX-1501-C3M and the 640 x 480 dot TLX-1551-C3M.

At Wescon/88, our remarkable new Monochrome ST (M-ST) Liquid Crystal Display modules earned a New Products and Technology Achievement Award.

Toshiba's M-ST modules offer significantly improved black-and-white contrast for better visibility, with a unique single-layer design that makes them 25% lighter and 15% thinner than double-layer panels.

Toshiba's thin, light, high-contrast M-ST Liquid Crystal Display modules — the new industry standard in LCD performance.

In Touch with Tomorrow
TOSHIBA

Toshiba America, Inc., Electronic Components Business Sector, Chicago Office: One Parkway North, Suite 500, Deerfield, IL 60015-2547 Tel: 312-945-1500 **Western Area Office:** 2021 The Alameda, Suite 220, San Jose, CA 95126 Tel: 408-244-4070 **Eastern Area Office:** 25 Mall Road, 5th Floor, Burlington, MA 01803 Tel: 617-272-4352

EDN PRODUCT MART

This advertising is for new and current products.

Please circle Reader Service number for additional information from manufacturers.

\$249. TERMINAL



- Featuring
- Standard RS-232 Serial Asynchronous ASCII Communications
 - 48 Character LCD Display (2 Lines of 24 Each)
 - 24 Key Membrane Keyboard with embossed graphics
 - Ten key numeric array plus 8 programmable function keys
 - Optional RS-422 multidrop protocol mode
 - Keyboard selectable SET-UP features—baud rates, parity, etc.
 - Size (5.625" W x 6.9" D x 1.75" H). Weight 1.25 lbs.
 - 5 x 7 Dot Matrix font with underline cursor
 - Displays 96 Character ASCII Set (upper and lower case)
 - Optional Bar Code Wand (shown)

COMPUTERWISE, INC.

302 N. Winchester • Olathe, KS 66062 • 800-255-3739 • FAX/829-0810

CIRCLE NO 325

LOW COST, RELIABLE EPROM PROGRAMMER



1 Year
Warranty
& Update

Operates stand-alone or PC based. Shooter™, an intelligent EPROM programmer, uses serial port for communications. No modules to buy. Now includes 512K buffer; \$395 price includes cable, software and manual.

**LOGICAL
DEVICES, INC.**

1201 N.W. 65th Place
Ft. Lauderdale, FL 33309
305-974-0967
1-800-331-7766

CIRCLE NO 328

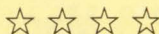

"The Best 8051 Emulator"

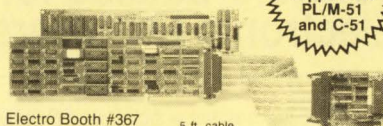

Electro Booth #367 5 ft. cable

8051

See EEM 88/89
Page D-1304

PC based emulators for the 8051 family

- (8051/51FA/52/31/32/44/152/451/452/535/552 + CMOS + more ...
- PC plug in boards or RS-232 box
- Pull-down menus combined with Command-Driven User Interface
- Context sensitive help and On-Screen Editing of data
- 20 MHz real time emulation
- 128K emulation memory
- 48 bit wide, 16K deep trace buffer with loop counter
- Program Performance analyzer
- Powerful Macros with IF-ELSE, REPEAT-WHILE structures
- Source Level debug for PL/M-51 and C-51
- Symbolic debugging with in-line assembler and disassembler
- Execution time counter
- Trace can be viewed during emulation!

PRICES: 32K Emulator for 8031 \$1790; 4K Trace \$1495*
CALL OR WRITE FOR FREE DEMO DISK!

*U.S. only

**NOHAU
CORPORATION**

51 E. Campbell Avenue
Campbell, CA 95008
FAX (408) 378-7869
(408) 866-1820

CIRCLE NO 326

25,000 STEPS/SECOND!

NEW NEAT-310

STEPPING MOTOR CONTROLLER

Complete A.C. powered indexer and drive ...With: RS-232 and Parallel communications • 8 K Byte non-volatile memory • 24 bit encoder interface • 4 Hz velocity resolution • Thumbwheel program execution • High speed 54 volt bipolar chopper drive, 3.5/7 amps • Mid-range stabilization • Multi-axis addressability • Printer port • Jog buttons • Over 60 high level ASCII commands • 16 isolated/buffered I/O lines plus relay output • Universal limit/home switch hardware and software • Powerful editor with expanded mnemonics • Nested subroutines • Automatic idle current reduction • ± 10 microstepping version (250,000 steps/sec.) • Multiple input line testing • Half step mode • And many additional features. **For further information, call:**

1-800-227-1066



new england affiliated technologies
620 Essex Street, Lawrence, MA 01841
In Mass.: (508) 685-4900

CIRCLE NO 329



CONTROL COMPUTER

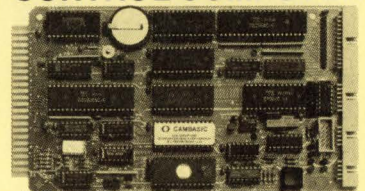

Our Multitasking Industrial BASIC runs as fast as BASICA on the IBM PC/AT. It can also handle interrupts, frequency inputs, bit manipulation, datalogging and more. The hardware includes 4 channels of analog with 12-bit resolution, 32 digital I/O lines, battery-backed calendar clock keypad and display ports. 2 RS-232C serial ports, 96K RAM, EPROM and EEPROM programmers, autorun mode, low power CMOS circuitry, 8 MHz Z80 CPU, only 4.5" x 8". Stand-alone or expandable. Low cost optional software turns your IBM PC into a program development workstation. FREE CATALOG describes other models and accessories. Call 303-426-8540 for same day response.

OCTAGON SYSTEMS CORPORATION 6510 W. 91st Ave.
Westminster, CO 80030

CIRCLE NO 327

.025" SQUARE RECEPTACLES

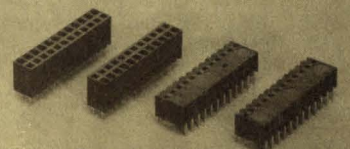

Specialty Electronics' .025" Square Receptacles are available in a variety of sizes and configurations as follows:

- Variety of housing materials for high temperature applications.
- Variety of configurations, single and dual row versions, up to 64 positions per row with vertical and horizontal pin entry.
- SMT.
- PCB retention tail.
- Dimensions are compatible with other manufacturers.

For additional information write or call:

SPECIALTY ELECTRONICS INCORPORATED
105 E. Rutherford Street, Landrum, S.C. 29356
(803) 457-3824, FAX 1-(803)457-2535

CIRCLE NO 330

To advertise in Product Mart, call Joanne Dorian, 212/463-6415

Analog Circuit Simulation

Completely Integrated CAE with ICAP/2

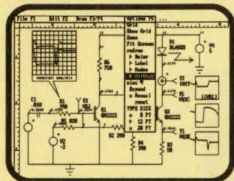

From Schematic Capture through SPICE Simulation to Post Processing

for Only **\$790[†]**

†IsSPICE \$95, the complete SPICE program that runs on all PC's. Performs AC, DC, and Transient analyses.

IsSPICE/386 \$386, enhanced SPICE for 386 PC's.

†SPICENET \$295, a schematic editor for any SPICE simulator. Generates a complete SPICE netlist.

†INTUSCOPE \$250, a graphics post processor that performs all the functions of a digital oscilloscope.

†PRESPICE \$200, extensive model libraries, Monte Carlo analysis and parameters sweeping.



P.O. Box 6607 (213) 833-0710
San Pedro, CA 30 Day Money
90734-6607 Back Guarantee

CIRCLE NO 331

PAL™ /PLD SOFTWARE

Sets The Standard

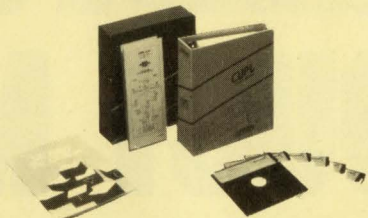

CUPL™ PLD compiler, the most powerful language for state machine logic design, now allows OrCAD™ schematic software as the front end design entry. CUPL supports all PLDs and carries the most extensive update program. Available on MS-DOS™, Apollo™, Sun™, VAX™ and most UNIX™ based platforms.

LOGICAL DEVICES, INC.

1201 N.W. 65th Place
Ft. Lauderdale, FL 33309
305-974-0967
1-800-331-7766

CIRCLE NO 332

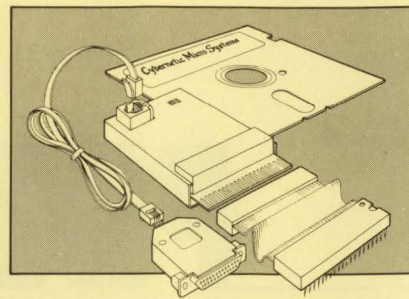

Real Time 8051 ICE

d²ICE-51 is lowest cost Full Speed 8051 ICE. Hi-level multi-window source code debugging. Powerful user interface. No Slots! Uses IBM-PC COM1/2. Portable. Fits in shirt pocket. \$995



Cybernetic Micro Systems

Box 3000 • San Gregorio, CA 94074
(415) 726-3000 • Telex: 910-350-5842

CIRCLE NO 333

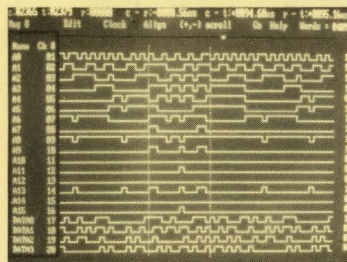

25MHz 48 CHANNEL PC-BASED LOGIC ANALYZER \$1595.⁰⁰ + POD PRICE

- 48 Channels @25MHz x 4K word deep
- 16 Trigger words/16 trigger sequence
- Automatic set-up and loading of symbol tables
- Comparison of Reference and Trace Memories
- Storage and recall of trace data to disk
- 20 Channel Waveform Display
- Disassemblers available for:
8088, 8086, 68000, Z80, 8085, 80286
6502, 6801, 6303, 8031, 6809, 6811
NCI □ 6438 UNIVERSITY DRIVE,
HUNTSVILLE, AL 35806
(205) 837-6667

CIRCLE NO 334

Free MSDOS & Mac Software Catalog for Electronic Engineers

AC/DC Circuit Analysis • Active and Passive Filter Design • Screen/Printer & Pen Plotter Graphics for Engineers • LaPlace Transfer Function/FFT Analysis • Logic Simulation • Root Locus Analysis • CAD/CAE • Digital and Analog Signal Processing • Curve Fitting • Statistics • Thermal Analysis • Math • Microstrip Design and Analysis • Data Acquisition • VISA & M/C Accepted



Engineering

Professional Software

2023 Chicago Ave., Suite B-13 • Riverside, CA 92507
Tel: (714) 781-0252 • U.S.A. • TELEX: 6503089864

CIRCLE NO 335

6809

Single Board Computer

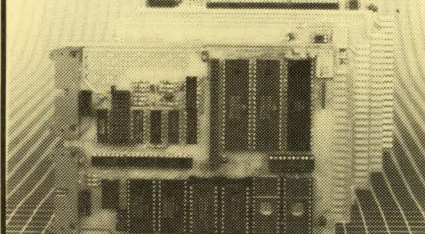

6809 MPU, 2 serial ports, 4 parallel ports, RAM, EPROM, real-time clock, watchdog timer, 44-pin 4.5" x 6.5" PCB

EXPANSION MODULES: RAM, EPROM, CMOS RAM/battery, analog I/O, serial I/O, parallel I/O, counter/timer, IEEE-488, EPROM programmer, floppy disks, cassette, breadboard, keyboard/display.

WINTEK

Wintek Corp.
1801 South Street
Lafayette, IN 47904
800-742-6909

CIRCLE NO 336

ELIMINATE DECOUPLING CAPACITORS

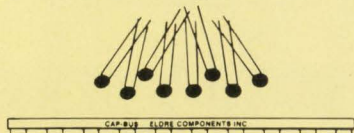

CAP-BUS® CAPACITOR/BUS BAR

Eliminate the decoupling capacitors and the power and ground traces from your PCB for more reliability. CAP-BUS® has a distributed capacitance of .05 micro-farads per lin. in., at 50 VDC with low inductance and low impedance. The capacitor and the bus bar have been joined together for CAP-BUS®; a more efficient capacitive decoupled power distribution system, increasing IC density on a two sided board.

ELDRE COMPONENTS, INC. 1500 Jefferson Rd.
Rochester, NY 14623
(716) 427-7280

CIRCLE NO 337

Fast and easy Data Acquisition

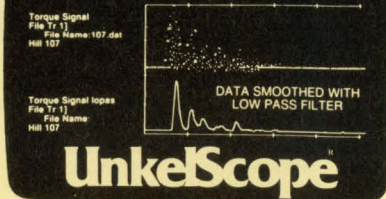

UnkelScope
Menu-driven software package for your PC

JUNIOR - \$125

Take, store, retrieve, print data - perfect for Design Engineers

LEVEL 2+ - \$549

Data acquisition plus: experiment control, data analysis. The complete package.

FREE Demo Disk. Money-back guarantee

Unkel Software Inc.

62 Bridge St. Lexington, MA 02173 (617) 861-0181

CIRCLE NO 338

CUSTOM MAGNETICS

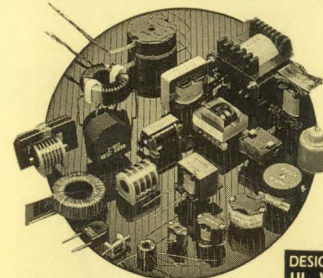

DESIGN TO MEET UL, VDE & IEEE REQUIREMENTS

1. AUDIO TRANSFORMERS
TYPES: SIGNAL, POWER
APPLICATIONS: AUDIO, TELECOM, DATACOM.
2. SWITCHING POWER TRANSFORMERS
TYPES: VOLTAGE, CURRENT, LINE FILTER, DRIVE
APPLICATIONS: COMPUTER, TELECOM, INDUSTRIAL.
3. HIGH-VOLTAGE TRANSFORMERS
TYPES: POWER, PULSED
APPLICATIONS: IGNITION, INDUSTRIAL
4. PULSE TRANSFORMERS
TYPES: MATCHING, PULSED
APPLICATIONS: DATACOM, TELECOM.

THE SOURCE YOU CAN REALLY RELY ON!



KINGATRON ELECTRONIC INDUSTRIAL CO., LTD.
380, PAI-LIN 5TH RD., PEI-TOU, TAIPEI,
TAIWAN, R.O.C. TEL: 886-2-821-3191-5
TLX: 27069 KDATRON FAX: 886-2-821-2200

CIRCLE NO 339

To advertise in Product Mart, call Joanne Dorian, 212/463-6415

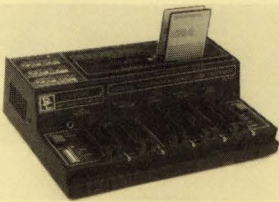

E(E)PROM, MICRO & MEMORY CARD PROGRAMMER.... \$345 - \$595

- No personality modules for E(E)Proms & Intel Micros.
- All 24/28/32 pin EProms/EEProms to 4 MBit (upgr. to 32MB).
- Flash Eproms; Micros: 8741,-2,-8,-8H,-9,-9H,-S1,-C51,-52,-55 ...
- Memory Cards: Seiko/Epson, Mitsubishi, GI. Modular design.
- ON-BOARD Programming capability. Easy F/W upgrades.
- Stand-alone E(E)Prom & Memory Card Duplication / Verify.
- User friendly menu - driven driver for IBM-PC & Macintosh.
- Autobaud RS232 to any computer. Hex/Binary/Intel/Motorola.
- Built-in Eraser/Timer option (\$50). Gang-Module ready.
- Open board units starting from \$245. (OEM discounts available)
- Direct technical support. Dedicated BBS. Full 1 year warranty. MC/VISA/AMEX Call today for datasheets!



B&C MICROSYSTEMS INC.
355 WEST OLIVE AVE. SUNNYVALE, CA 94086
TEL: (408)730-5511 FAX: (408) 730-5521

CIRCLE NO 340

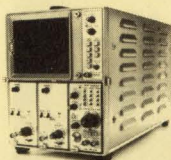

Davidyn
CORP.

13406 Saticoy Street
No. Hollywood, CA 91605-3475

TEK 7603N
(AN/USM-281C)
\$595.00

TEKTRONIX 7603N
(Mil Spec AN/USM-281C)

8 x 10 CM Display
100 MHZ Response which accepts Standard 7000 Series Plug-Ins.
Vertical Plug-In 2 ea. 7A15 (AM-6565)
Frequency BW 75 MHZ
Maximum Sensitivity 5mV/DIV
Horizontal Plug-In 1 ea. 7B53 (TD-1085)
Triggering to 100 MHZ
Minimum Sweeptime 50 NS/DIV
Has delayed sweep capacity
Includes Manual and Cover • 90 Day Unconditional Warranty
1-800-235-6222 (outside Calif.) / 1-818-787-3334
CALL FOR FREE CATALOG

CIRCLE NO 341

Sprague-Goodman
Surftrim®
Surface Mounted
Trimmer Capacitors

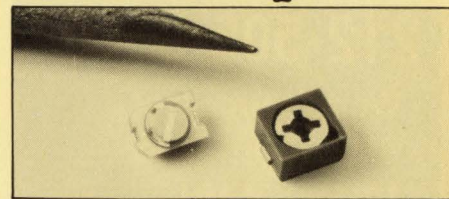

- Wide range of unsealed and sealed models.
- Designed for vapor phase reflow soldering.
- Available in carrier and reel packaging.
- Sizes: unsealed—3.2 x 4.5 x 1.6mm; sealed—4 x 4.5 x 2.8 mm.



Sprague-Goodman Electronics Inc.

The First and Last Name in Trimmer Capacitors

134 Fulton Avenue, Garden City Park, NY 11040-5395
516-746-1385/TWX: 510-600-2415/TLX: 14-4533

CIRCLE NO 342

RUGGED
JOYSTICK/KEYBOARD
FOR FACTORY FLOOR

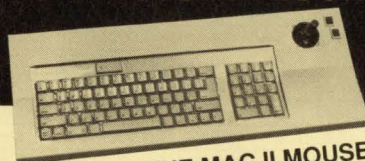

REPLACES THE MAC II MOUSE

- Noncontacting inductive joystick no moving electrical parts
- Sealed keyboard enclosure for harsh environments

PATENTS PENDING

CTI

CTI ELECTRONICS CORP.
200 Benton Street, Stratford, CT 06497
TEL: 203/386-9779 FAX: 203/378-4986
MAC II IS A REGISTERED TRADEMARK OF APPLE.

CIRCLE NO 343

DIGITAL AUDIO

The Desktop Recording™ board plugs into an AT and allows the recording and playback of professional quality digital audio. Audio data is stored to the AT's hard disk. The record channels feature 2x oversampling, digital filter, and linear-phase antialiasing filters. Playback features digital filter, 8x oversampling, and dual 18-bit DACs. Sampling rate is software selectable at 48kHz, 44.1kHz, and 32kHz. The price is \$1295, \$795 in 100's.

Digital Audio Labs

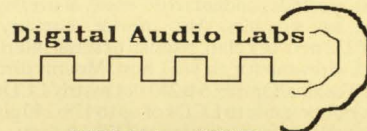

2570 Abbey Hill Dr.
Minnetonka, MN 55343
(612) 559-6104

CIRCLE NO 344

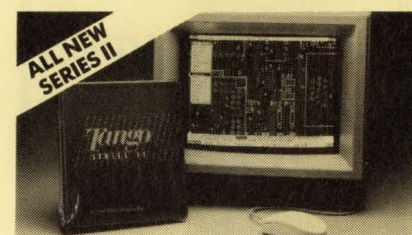

Tango. Now More Than Ever,
The Best Value in PCB Design.

Take a look at the all new Tango Series II. Our pop-up menu interface sets a new standard for ease-of-use and productivity. Lay out simple prototypes or complex, multi-layer, SMT designs with over 100 new features including user-definable tracks, pads, and grids.

For IBM-PCs and compatibles, Tango-PCB Series II, just \$595. Tango-Route Series II autorouter, just \$495. Both include one year's updates, free tech support, 30-day money-back guarantee. Call today.



FREE EVALUATION PACKAGE

800-433-7801 619-695-2000

ACCEL Technologies, 7358 Trade Street, San Diego, CA 92121

CIRCLE NO 345

E/EPROM & MICRO PROGRAMMER

\$895



- EP-1140 includes: software, cable, user's manual, 2 free software update coupons, toll-free technical support, one-year warranty & a unconditional 30-day money back guarantee
- Programs 24-, 28-, 32- & 40-pin E/EPROMs
- Supports 874X & 875X series microcontrollers
- Connects to a standard parallel port
- Hardware to support future parts to 8 Megabit
- Software updates on floppy disk
- 32-pin model, EP-1132, available for \$695

The Engineer's Programmer™

CALL TODAY 800-225-2102

BP MICROSYSTEMS

10681 Haddington, #190, Houston, TX 77043
713/461-9430 FAX 713/461-7413
Electro Booth #374

CIRCLE NO 346

FREE SCHEMATIC CAPTURE DEMO DISK

SCHEMA II+:
Capture More Than Ever

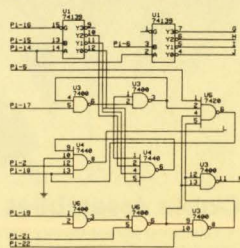

Incredible speed, ease of use and power have made SCHEMA a best-selling schematic capture program for engineering professionals the world over. Now, SCHEMA II+ sells for \$495 and

supports most common IBM PC/XT/AT/PS2 configurations.



OMATION

In Texas Call (214) 231-5167

FREE Demo Disk: 1-800-553-9119

CIRCLE NO 347

Cut the Time and Cost to
Get Agency Approval
for Your Product



A leader in product safety and regulatory compliance engineering, L-CAD provides:

- Design Review
- Construction Review
- Product Testing
- Consulting
- Agency Submittal
- Document Support
- Factory Follow-up
- Seminars



Call or write today for free estimate or catalog
508-683-6274

L-CAD, Inc.

1755 Osgood Street, N. Andover, MA. 01845

CIRCLE NO 348

To advertise in Product Mart, call Joanne Dorian, 212/463-6415

Quartz Crystals Oscillators

212-505-5340

- World's Smallest
- SMT & Thru-hole
- 10kHz–35 MHz
- Ceramic & Metal Pkgs
- Free Catalog

Micro Crystal Division/SMH

CIRCLE NO 349

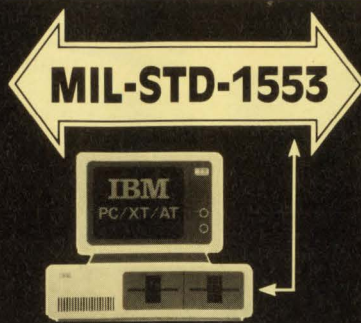

**MIL-STD-1553 Interface Board
For IBM-PC/XT/AT or Compatibles**
Dual redundant bus controller, remote terminal and monitor with powerful easy-to-use software. From only \$2095

Call now for free data & demo disc
Ballard Technology 1216 N.W. 75th St.,
Seattle, WA 98117
(206) 782-8704

CIRCLE NO 350

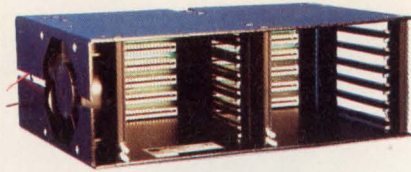

STDbus 12-SLOT CARD CAGE/BACKPLANE ASSEMBLY

- OFFERS MORE FUNCTION CAPABILITY IN LESS SPACE
- INEXPENSIVE ALTERNATIVE TO MULTIBUS I
- WITH SIMILAR FORM FACTOR
- IDEAL FOR PC BUS EMULATION APPLICATIONS
- CAN BE USED FOR 8 TO 16 BIT APPLICATIONS
- BUILT-IN COOLING SYSTEM

Hybricon

12 Willow Road, Ayer, MA 01432
Factory 508-772-5422 Western Operations 602-921-1824

CIRCLE NO 751

DATA ACQUISITION PC-BASED



MODULES:

- 12 BIT A/D and D/A
- 8 BIT A/D and D/A
- 72 Line Digital I/O
- Counter/Timer

1-800-553-1170



478 E. Exchange St., Akron, OH 44304
TEL: (216) 434-3154 FAX: (216) 434-1409
TLX: 5101012726

CIRCLE NO 752

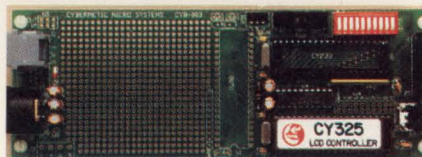

CYB-003 LCD Windows Controller Board

Quickly prototype new LCD applications. Built around CY325 LCD Windows Controller, board provides LCD with 256 built-in windows, window relative scroll/wrap/clip, plots, bargraphs, waveforms, text, etc. Independent write, erase, & overlay for text and graphics. Also provides circuitry for CY233 network chip, parallel or serial interface, and wirewrap for an 8051 host. Mounts directly on Toshiba/Optrex 64x240 dot matrix LCDs, or via ribbon cable to LCDs of up to 128x240 pixels. Several versions, starting at \$170 kit form.



Cybernetic Micro Systems
Box 3000, San Gregorio CA 94074
(415) 726-3000 Tx: 910-350-5842

CIRCLE NO 753

CDC HIGH PERFORMANCE DRIVES

LAN KITS for PC's, Work stations & DEC computers

106MB	5 1/4"	18ms	40,000MTBF	\$995
182MB	5 1/4"	16.5ms	40,000MTBF	\$1295
228MB	5 1/4"	18ms	40,000MTBF	\$1595
383MB	5 1/4"	14.5ms	40,000MTBF	\$2195
385MB	5 1/4"	10.7ms	40,000MTBF	Call
766MB	5 1/4"	14.5ms	40,000MTBF	\$3295
1.2GB	5 1/4"	16.5ms	40,000MTBF	Call
1.154GB	8"	16ms	50,000MTBF	Call
1.123GB	8"	16ms	50,000MTBF	Call

□ Complete LAN KITS, CD ROM NETS, WORM NETS, ERASABLE OPTICAL DRIVES. Custom configurations available.

□ High performance drives from Maxtor, Priam and other reputed manufacturers available

□ Let us configure and custom package storage to your specifications. Call us today for a fast quotation

□ We accept International orders (714)

EDS 938-1635

CIRCLE NO 754

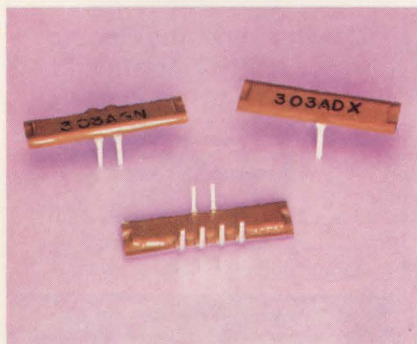

SOLVE EMI/RFI PROBLEMS

MICRO/Q 1000® capacitors with special pinout configurations give superior noise suppression, design ease. Solve special decoupling and routing problems for various microprocessors, and other devices where power and ground are not at conventional positions. **Rogers Corp.** 2400 S. Roosevelt St., Tempe, AZ. 85282. 602/967-0624

CIRCLE NO 755



Cable Assemblies

OFTI exceeds in supplying you with the very best in cable assemblies. All factory tested, our assemblies are low loss, skillfully prepared and available with a wide range of connector options.

Count on OFTI to exceed in solving your fiber optic application problem with high performance cable assemblies, connectors and termination equipment.

Pictured above are cables terminated with OFTI singlemode Biconic, SMA, NTT PC, STC and multimode Biconic connectors.



Your Fiber Optic Connection
Optical Fiber Technologies, Inc.
5 Fortune Drive Billerica, MA 01821
Tel: (617)663-6629

CIRCLE NO 756

803X/805X In Circuit Emulator For \$495

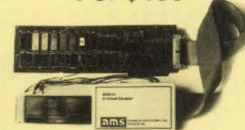

ADVANCED FEATURES:

- 64K of emulation memory
- 64K break points
- 1.5K trace buffer with 7 user test probes
- POD for emulating 8031, 8051*, 8032, 8052*, and 8053* microcontrollers
- 12 Mhz local microcontroller clock source
- Emulator to PC interface and support software on a 5 1/4" Floppy disk
- User manual
- 30 days money back guarantee

ADVANCED MICROCOMPUTER SYSTEMS, INC.
1321 N.W. 65th Place • Ft. Lauderdale, Florida 33309
Phone (305) 975-9515



**CALL TOLL FREE
1-800-9PC-FREE**

CIRCLE NO 757

To advertise in Product Mart, call Joanne Dorian, 212/463-6415

Optimize Filter Response to Fit Your Design Target with COMTRAN® - PC

- Designs filters with custom-shaped responses
- Magnitude, Phase, Zin, Zout, or combinations
- Fits any precision response using available capacitor values (by recalculating resistors)
- Derives equivalent circuit from measured data
- Cuts opamp count in half (4 poles per opamp)
- FAST — Less than 1 second per point typical

Requires AT compatible w/HP 82300B BASIC Language Processor card w/1 MB RAM, & HP 9122 floppy drive. This card adds HP Rocky Mountain BASIC, w/HP-IB interface, to your PC. Lets your PC run HP 200/300 BASIC software. COMTRAN previously ran only on HP computers.

COMTRAN® Integrated Software

A Division of Jensen Transformers, Inc.
10735 BURBANK BOULEVARD, N. HOLLYWOOD, CA 91601
FAX (818) 763-4574 • PHONE (213) 876-0059

CIRCLE NO 758

Only a Specialized Manufacturer Could Provide Versatile and Economic Products

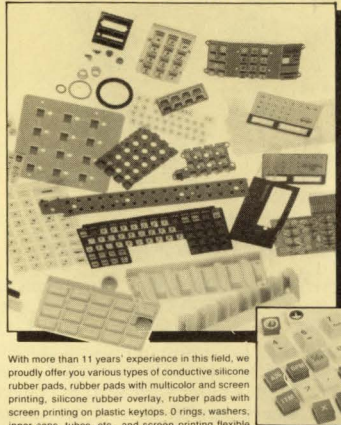

With more than 11 years' experience in this field, we proudly offer you various types of conductive silicone rubber pads, rubber pads with multicolor and screen printing, silicone rubber overlay, rubber pads with screen printing on plastic keytops, O rings, washers, inner caps, tubes, etc., and screen printing flexible circuit boards. Please contact us for more information.

GENERAL SILICONES CO., USA
650 W Duarte 305, Arcadia CA 91006, U.S.A.
Tel: (818) 445-6036. Telex: 3716189 GSCUI.
Fax: 818-4456084

CIRCLE NO 761

8051 C COMPILER SOURCE DEBUGGER

* Call today for a FREE technical bulletin *

MICRO COMPUTER CONTROL
P.O. Box 275 - Hopewell, NJ 08525 USA
Telex 9102404881 MICRO UQ

FOR IMMEDIATE ACTION CALL:
(609) 466-1751

CIRCLE NO 764

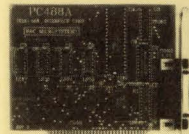

LOW COST INTERFACE CARDS FOR PC/XT/AT/PS2

RS-485/422 Card [PC485] \$95/125

- Serial Async. Communication up to 4,000ft; 2 or 4 wires; NS16450 UART;
- Can be configured as COM1-COM4; Maximum Baud Rate 56KB/115KB.
- Dual drivers/receivers; Handles 64 devices; Compatible with most comm. software.
- DB9 or phonejack. Sample communication software available - \$50/150

IEEE-488 Card [PC488A] \$145

- Includes INSTALLABLE DOS DEVICE DRIVERS and support for BASIC.
- Additional Support for ASSEMBLY, C, Pascal and FORTRAN - \$ 50.
- IRQ (1-6). DMA channel 1 or 2. Up to 4 boards per computer.
- Compatible with most IEEE-488 Software packages for IBM-PC (e.g. ASYSTANT-GPIB, Lotus Measure). Compatible with NI's GPIB-PC/IA.

IEEE-488 Card [PC488B] With Built-In Bus Analyzer \$345

- Software Support for BASIC, QuickBASIC and GWBASIC.
- Additional libraries for C, Pascal, FORTRAN, Assembly available - \$95 (all)
- Powerful menu-driven BUS ANALYZER runs in the background while 488 programs or commands are executed; Features Program Stepping, Break points, real time bus data capture (4K buffer), instant screen logging.
- Complete Controller/Talker/Listener capability. Based on TI's TMS-9914.
- NEC-7210 based card (compatible with Nat. Instruments PCII/PC/IA) - \$445.

PS2 Ser/Par Card [PS2IOA] \$95/125

- I/O card for PS2 Models 50-80. Ser. port 1-2; Par. port 1-3; IBM registered ID.

MC/VISA/AMEX

Call today for datasheets!



B&C MICROSYSTEMS INC.
355 West Olive Ave, Sunnyvale, CA 94086
TEL: (408) 730-5511 FAX: (408) 730-5521

CIRCLE NO 759

UNIVERSAL PROGRAMMER

ONLY
\$545
COMPLETE

(Menu-driven S/W,
PC Interface Card,
Cable included.)



UNIVERSAL PROGRAMMER

- programs E(E)PROMs (up to 1 Meg Bit), PAL, FPL, Bipolar PROM, 8748 & 8751 series.
- tests Static and Dynamic RAMs, TTL and CMOS logic chips.
- All of above functions are performed only on single unit without any additional module.

INDIVIDUAL PROGRAMMERS are also available.
(E)EPROM programmer (1,4,8,16 sockets), PAL programmer, BIPOLAR programmer, 8748 series programmer, 8751 series programmer, Memory IC & TTL tester.)

XELTEK

473 SAPENA COURT #24 ORDER TOLL FREE
SANTA CLARA, CA 95054 1-800-541-1975 (outside CA)
TEL: (408) 727-6995 VISA, MASTER, AMEX
FAX: (408) 727-6996 ACCEPTED

CIRCLE NO 762

THE REAL BARGAIN IN PLD PROGRAMMING



FOR
\$2495.

The 60A Logic Programmer delivers:

- Support for 350 PLDs
- Additional PLCCs and EPROMs
- Manufacturer-approved algorithms
- On-going updates and support

Call today for more information.

1-800-247-5700
Ext. 768

DATA I/O
Corporation

CIRCLE NO 765

DEBUG IN ROM

Here's a rommable debug called **SysVue** you can use in your PC-compatible systems with or without disks. **SysKit** includes the **source code** in C for SysVue so you can tailor it to your applications. SysVue includes over 30 commands, and shows you how to add more. Also includes Setup for AT CMOS. SysVue can also be used as a Terminate/Stay Resident program in your computer's Ram. **SysKit** has over 190 pages with diskette. Only \$69 complete.

FREE We'll include a free copy of the pocket-sized **XT-AT Handbook** by **Choiiser and Foster** with each SysKit if you mention this ad when you order. Of course, this \$9.95 value is also available by itself. Or buy five or more for only \$5.00 each.

Annabooks



12145 Alta Carmel Ct Suite 250-262
San Diego, California 92128
(619) 271-9526 Money-back guarantee

CIRCLE NO 760

DOT MATRIX LCD

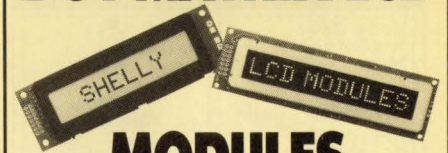

MODULES

- 1x8 to 4x80 sizes • .15" to .5"
- character heights • On-board controller
- 8-bit parallel input • Reflective, transreflective; positive or negative images
- -20°C to +70°C operating temperature
- EL and LED backlighting available
- Supertwist models in most sizes and formats

SHELLY
associates

(714) 669-9850

14281 Chambers Rd. • Tustin, CA 92680
TLX: 85-2263 • FAX: 714-669-1081

CIRCLE NO 763

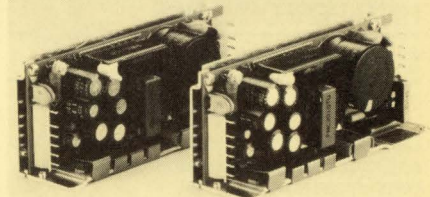

PMC & P Series power supplies Universal wide range Input Voltage

15 and 30 watts highly efficient, single or triple output power supplies in a compact size. All models are UL, CSA, TUV approved through K-Tronics and also meet FCC class "B". For information on ELCO products as well as K-Tronics services please contact K-Tronics; TEL: (408) 733-8017; FAX (408) 732-5049.

CIRCLE NO 766

To advertise in Product Mart, call Joanne Dorian, 212/463-6415

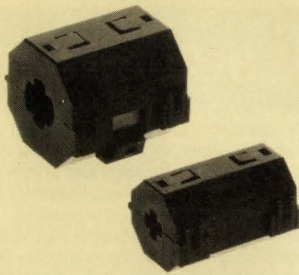

ESD-QR SERIES DATA LINE CLIP-ON FILTERS

Convenient hinged clamp construction provides high frequency filtering for existing signal or data lines. The high grade ferrite material is available with a variety of ID's to accommodate most common cable sizes. The ESD-QR series is effective over the frequency range from 10 to 1000 MHz to help reduce radiated noise emission. This product can be a life saver when your finished product fails to meet FCC regulations.

Tokin America,
155 Nicholson Lane, San Jose, CA 95134
408-432-8020

CIRCLE NO 767

AC TO DC POWER CONVERTOR

WIDE RANGE I/P 90 ~ 265V AC
O/P LOAD REGULATION 5%.
HIGH EFFICIENCY.



NEW!

PATENTED: U.S.A.
TAIWAN

FEATURES

- * WIDE AC INPUT VOLTAGE RANGE 90-265V AC
- * O/P DC VOLTAGE: 24-200V DC
- * O/P MAX. WATTES: 200W.
- * HIGH OUTPUT CURRENT TO 1A DC.
- * OUTPUT VOLTAGE REGULATED TO 5%.
- * HIGH EFFICIENCY TO 90%.
- * TURN ON SURGE CURRENT LIMITING NOT NEEDED.
- * POWER RESISTORS NOT USED.
- * MINI. EXTERNAL PART COUNT.

POWER-M

division of Mobiltron Electronics Co., Ltd.

USA: Power-M
47 Edgewood RD. Westwood, Ma. 02090
Tel: (617) 769-8795 Attn: Fred Mirow
Taiwan: Mobiltron
P.O. Box 54, Taya, Taichung Hsien, Taiwan, R.O.C.
Tel: 045-668526/668926 Fax: 045-669925 Tlx: 57568 Mobiltron

CIRCLE NO 768

NEW. TOUGHER SPECS FOR FILTER MODULES.

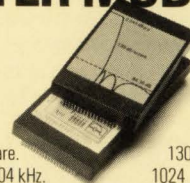

Compare. 130 or 80 dB/octave.
Up to 204 kHz. 1024 cutoff settings.
HP, LP, TD. Phase match: $\pm 1^\circ$ max., $\pm 0.25^\circ$ typical.
Amplitude match: ± 0.1 dB max., ± 0.03 dB typical.
Programmable. You get Precision filter system performance in circuit modules, 2.7" x 4.2" x 0.54". Call or write.



PRECISION FILTERS, INC.

240 Cherry Street, Ithaca, New York 14850.
607-277-3550. Fax 607-277-4466.

CIRCLE NO 769

CABLE TESTERS

Model DX50
Tests RJ11 & RJ12
cables



Model DX100A

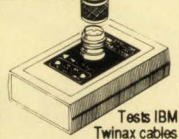

Tests IBM
Twinax cables

Model DX45



Tests MMJ cables

Model DX35A



Tests BNC, TNC
and Wang cables

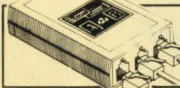

Model DSM A-B switch box
for RJ11 and RJ12 cables

Model DSM-DEC A-B switch box
for MMJ cables

Lcom

1755 Osgood St., N. Andover, MA 01845
Orders 800 343-1455 - FAX 508 689-9484
Inquiries 508 682-6936

CIRCLE NO 770



SMARTWORK® PCB Software. In a fraction of the time hand taping requires, you can create double-sided printed-circuit boards with SMARTWORK and your IBM PC. The program's features include continual design-rule checking, automatic pad shaving, a silkscreen, and text for all three layers. SMARTWORK with autorouting is \$895 (without, \$495) and comes with a 30-day money-back guarantee. Credit cards accepted. Write or call

Wintek Corporation

1801 South Street, Lafayette, IN 47904
(800) 742-6809 or (317) 742-8428

CIRCLE NO 771

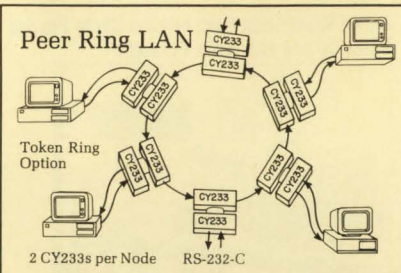

CY233-LINC Network Control

Connect computers, intelligent peripherals, or remote sites. 5v CMOS 40-pin IC. Up to 57.6K baud. Many configs such as Peer LAN shown and Host LAN with opt token; Simpler Networks allow host to control up to 255 parallel devices; UART mode with Ser/Par conversion can connect parallel devices over serial interface and save wire. \$75 ea (\$30/100). Box 3000, San Gregorio CA 94074. 415/726-3000.



Cybernetic Micro Systems

CIRCLE NO 772

Telecom Design!

HIGH-PERFORMANCE

DTMF RECEIVERS



Designed for the most demanding on-line applications (voice message systems, noisy commercial environments).

■ **M-927** is a 40-pin DIP, needs no external components except 3.579 MHz crystal. 12V.

■ **M-937** is a PCB with speech immunity 3 times that of other DTMF receivers, superior signal-to-noise, 45 dBm dynamic range. Exceeds CEPT, CCITT, and USITA CO specifications. 12V.

For more info call: **1-800-426-3926**
(In Washington State: 206-827-9626)

TELONE®

10801-120th Avenue NE, Kirkland, WA 98033

CIRCLE NO 773

CONNECTORS, CABLE ASSEMBLIES, PRECISION PARTS

"CPI" IS THE SOURCE YOU CAN TRUST

"CPI" Main Products:

- * IC SOCKETS
- * CARD EDGE CONNECTORS
- * D-SUB CONNECTORS
- * P.L.C.C.
- * RF CONNECTORS: BNC, TNC, TWIN AX, etc.
- * CABLE ASSEMBLIES:
IBM DISK DRIVER CABLE, FLOPPY DISK DRIVER CABLE, HARD DISK DRIVER CABLE, PRINTER CABLE, RS232 CABLE, 256K CABLE, COAXIAL CABLE ASS'Y, I/O CABLE (With 3R15P high density connector) etc. SIGNAL CABLE ASS'Y



NEPCON Booth No 7135

Manufacturer & Exporter:

CONNECTEK PRECISION IND. CO., LTD.

P.O. Box 12-29 Taipei, Taiwan, R.O.C.
Office: No. 104, Pao Chung Rd., Hsin Tien City, Taipei Hsien, Taiwan, R.O.C.
Tel: 886-2-918-4588 (REP) Fax: 886-2-912-8587 Tlx: 33237 CONTEK

OVERSEAS AGENTS WANTED!

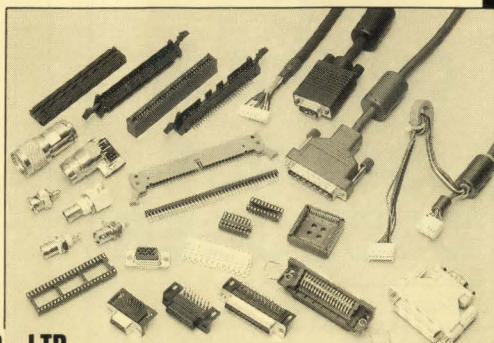

CIRCLE NO 775

To advertise in Product Mart, call Joanne Dorian, 212/463-6415

Cross-32 Meta Assembler

Table based macro cross-assembler using the manufacturer's assembly mnemonics.

Includes manual and MS-DOS assembler disk with tables for all of the following processors:

1802	64180	65C02	65816
6801	6805	6809	68HC11
680X0	80X86	COP400	COP800
8048	8051	8085	8096
TMS320	TMS370	Z8/Z80	...MORE

Users can create tables for other processors!

Generates listing, symbol table and binary, Intel, or Motorola hexcode.

Free worldwide airmail shipping & handling.

Check: US\$199.00 - VISA, MC: CN\$249.00

Universal Cross-Assemblers
POB 384, Bedford, NS
Canada B4A 2X3
(902) 864-1873

CIRCLE NO 776

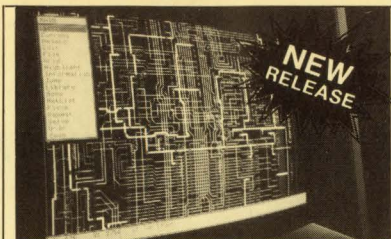

NEW
RELEASE

Top of The Line In PCB Design PROTEL-AUTOTRAX

This product has a host of new features to assist in the design of a PCB whether it is Through-Hole or SMD Technology. Features Interactive and Full Auto Routing & Component Placement with Design Rule Checking.

AUTOTRAX offers user definable tracks and pads. A multilayer program supporting CGA EGA VEGA Hercules and Hercules Video drivers. Output to plotters, printers, N/C drill and photoplotter. Hardware, IBM PC/AT/XT/PS2 or compatibles, 640K RAM, 2 floppy plus hard disk, PC or MS-DOS greater than version 2.0. Also supports 4Mb EMS.

\$995 ORDER TOLL FREE (800) 544 4186

For end-to-end design ask about **PROTEL-SCHEMATIC \$495**
If you are a licensed user of Tango™-PCB with program copyright of Protel, you qualify for one copy of AUTOTRAX at discount price \$240.
Tango™ is the registered Trade mark of Accel Technologies Inc.

PROTEL TECHNOLOGY INC.

A Member of CRITEC CORPORATION
Address: 50 Airport Parkway, San Jose, CA 95110 U.S.A.
Telephone: 408 437 7771 Telex: 510 100 7634
Facsimile: 408 437 4913 See us at Electro 89.



CIRCLE NO 777

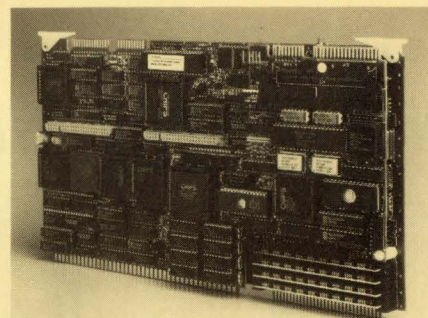

MULTIBUS™ AT-COMPATIBLE SBC

Multibus I is now IBM PC/AT™ compatible with MAT286™ our newest single board solution. MAT286 includes all of the functions of a 10 MHz AT motherboard, plus 2 serial ports, a parallel port, two SBX expansion-module interfaces, up to 512K EPROM/EEPROM/VRAM, and up to 4M of parity-checked, dual-ported DRAM. A piggy-back card, MATXSYSIO, adds EGA, floppy, and SCSI interfaces. Embed all the guts of an AT, two SBX modules, and more, into two Multibus slots!
Phone (408) 253-0250 or write for more information.

Single Board Solutions, Inc.

20045 Stevens Creek Blvd, Cupertino, CA 95014

Multibus is a registered trademark of Intel Corp.
MAT286 and MATXSYSIO are trademarks of Single Board Solutions, Inc.
IBM and PC/AT are trademarks of International Business Machines Corp.

CIRCLE NO 778

72 DIGITAL I/O FOR PS/2

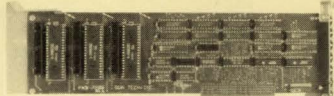

MODELS 50, 60, 80

- Parallel Expansion
- 72 I/O Lines
- Address Selectable

1-800-553-1170



478 E. Exchange St., Akron, OH 44304
TEL: (216) 434-3154 FAX: (216) 434-1409
TLX: 5101012726

CIRCLE NO 779

PL/M-51
C-51
support

8051/52

In-Circuit Emulators



- Source level debug for PL/M-51 and C-51
- IBM-PC/XT/AT/386 windowing interface with EGA 43-line, color, and mouse support
- Complex Hardware real-time breakpoints
- Hardware Trace Buffer with filtering control
- Program performance analysis
- 8 level hardware sequencer, Pass Counters
- NO PC PLUG-IN Boards

SIGNUM SYSTEMS

1820 14th St., Santa Monica, CA. 90404

(213)450-6096 telex: 362439

CIRCLE NO 780

WRITE OR CALL FOR SAMPLE
Low Cost Tempilabel® Temperature Monitor.

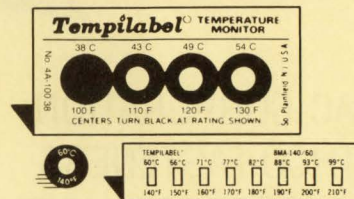

How to put a low cost temperature gauge on everything.

Label's center spot turns black when surface to which it is affixed reaches specified temperature. Single- or multi-spot labels with pre-determined increment of ratings: 100°F (33°C) to 600°F (316°C). 1% accuracy guaranteed. 1 thru 8 ratings on each monitor with various increments. Self-adhesive, removable.

TEMPIL DIVISION, Big Three Industries, Inc.
2901 Hamilton Blvd., South Plainfield, NJ 07080
Phone: (201) 757-8300 Telex: 138662

CIRCLE NO 781

BUY A DATA I/O 29B PROGRAMMING SYSTEM FOR ONLY \$159* A MONTH!

If you are budget limited, but need 29B programming reliability, call today for information on Data I/O's leasing alternative through U.S. Instrument Rentals.

Call Data I/O at **1-800-247-5700,**
Ext. 515
or U.S.I.R. at **1-800-USIR-123**

*Based on a \$5,565 system price with a 4-year lease-to-own.

DATA I/O
Corporation

CIRCLE NO 782

Redel Connectors

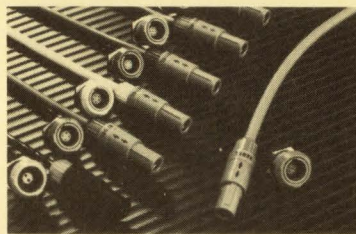

The Plastic Choice

REDEL Features:

- Quick Connect-Disconnect Design
- Autoclaveable PSU Shell Material
- Lightweight and Compact
- Temperature & Corrosion Resistant
- Color Coding and Keying Exclusivity
- Variety of Shell Styles and Configurations
- 2-9 Solder or Printed Circuit Contacts
- Precision Designed and Engineered
- Cable Assemblies

Sold and distributed by

LEMO USA, INC., P.O. Box 11488, Sanata Rosa, CA 95406
Phone (707) 578-8811, FAX 707/578-0869, Telex 340-933.

Please call for the rep nearest you.

CIRCLE NO 783

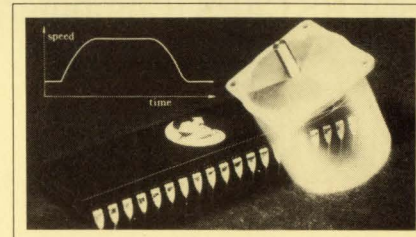

STEP MOTOR CONTROL 27K steps/sec! 16 Million steps!

New CY545. Rates up to 27K steps/sec, up to 16 million steps per single motion. Separately programmable start rate, accel/decel rate, and max rate. Pulse & direction output. External jog mode and limit switch detection. Serial or parallel interface, LED/LCD & Thumbwheel interface lines, and more. ASCII commands. Supports 64K external memory. CMOS 40-pin DIP. \$75 each (\$25/1000). Credit Cards OK.



Cybernetic Micro Systems

Box 3000, San Gregorio CA 94074
(415)726-3000 Tlx: 910-350-5842

CIRCLE NO 784

To advertise in Product Mart, call Joanne Dorian, 212/463-6415

Announcing the 1989 Western EDN Caravan

"The Electronic Show on Wheels"

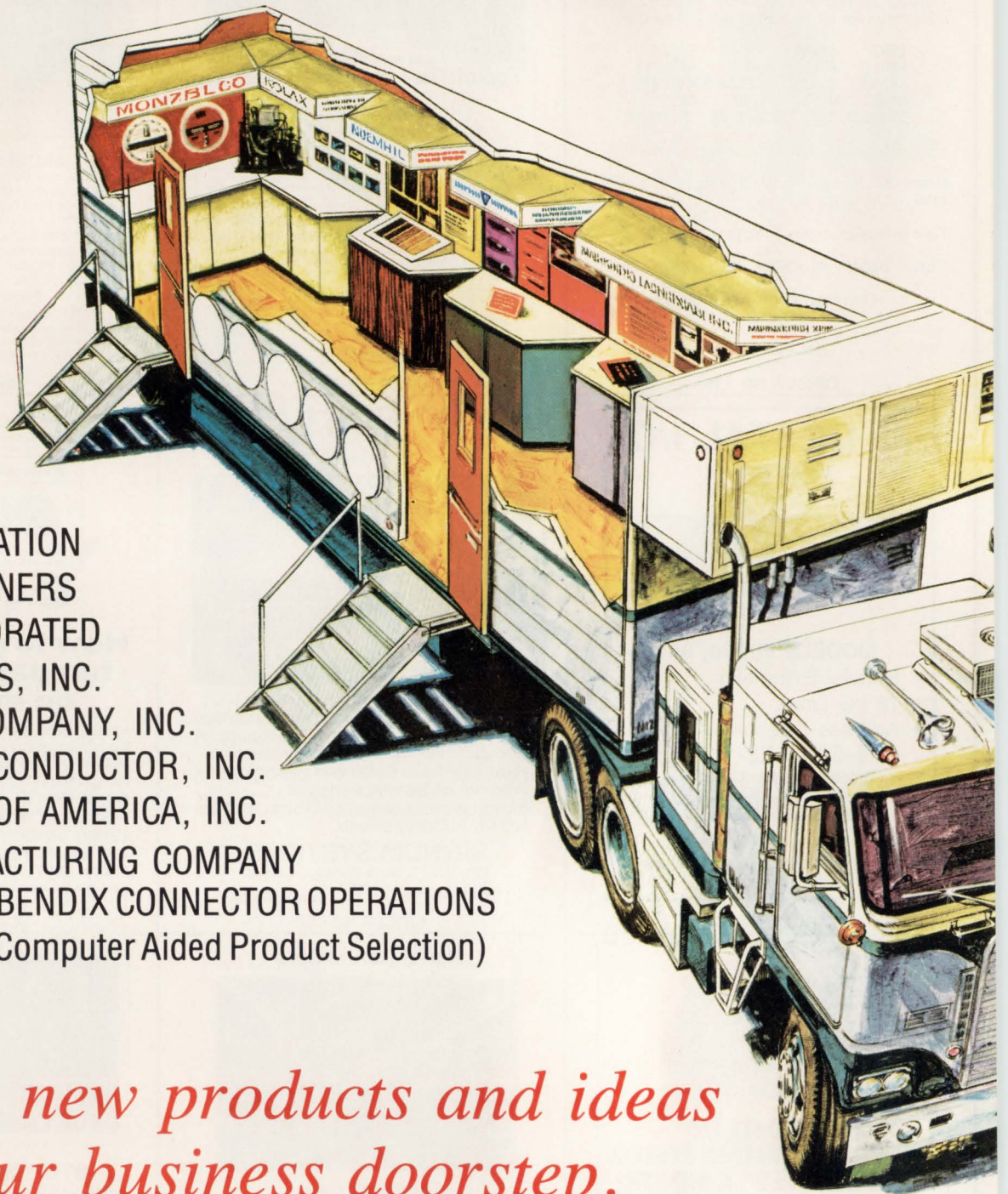

MUPAC CORPORATION
SOUTHCO FASTENERS
T-BAR, INCORPORATED
SPEEDY CIRCUITS, INC.
CAROL CABLE COMPANY, INC.
SAMSUNG SEMICONDUCTOR, INC.
NKK SWITCHES OF AMERICA, INC.
OHMITE MANUFACTURING COMPANY
Amphenol Corp., BENDIX CONNECTOR OPERATIONS
CAHNERS CAPS (Computer Aided Product Selection)

*Bringing new products and ideas
to your business doorstep.*

CHECK THE ITINERARY ON THE OPPOSITE PAGE FOR THE DATE WE VISIT YOUR COMPANY.



1989 WESTERN EDN CARAVAN TRAVELING ELECTRONIC SHOW

April 3 to May 5 (Central Edition)

DATE	TIME	SITE	DATE	TIME	SITE
April 3	9:00-12:00	LOCKHEED ENGINEERING & SCIENCES COMPANY	April 21	9:00-11:30	EMERSON ELECTRIC
Monday	AM	2400 Nasa Rd., Houston, TX	Friday	AM	Evans Ave., St. Louis, MO
April 3	1:30-4:00	COMPAQ COMPUTER CORPORATION	April 21	1:30-3:30	EMERSON ELECTRIC, Electronics & Space Div.
Monday	PM	20555 FM 149, Houston, TX	Friday	PM	8100 W. Florissant, St. Louis, MO
April 4	9:00-11:00	TEXAS INSTRUMENTS INC., Data Systems Group	April 24	9:00-11:00	MTS SYSTEM CORPORATION
Tuesday	AM	12501 Research Blvd., Austin, TX	Monday	AM	14000 Technology Dr., Eden Prairie, MN
April 4	1:00-3:30	IBM CORPORATION	April 24	11:45-2:00	IMPRIMIS TECHNOLOGY INC.
Tuesday	PM	11400 Burnet Road, Austin, TX	Monday	AM-PM	5950 Clearwater Dr., Minnetonka, MN
April 5	8:30-11:00	TRACOR, INC.	April 24	2:45-4:30	HONEYWELL, INC., Defense Systems
Wednesday	AM	6500 Tracor Lane, Austin, TX	Monday	PM	5901 So. County Road 18, Edina, MN
April 5	1:00-3:30	TEXAS INSTRUMENTS INC., Data Systems Group	April 25	8:30-10:30	HONEYWELL, INC. Military Avionics
Wednesday	PM	5701 Airport Road, Temple, TX	Tuesday	AM	6300 Olson Memorial Pkwy., Golden Valley, MN
April 6	8:30-10:30	ROCKWELL INTERNATIONAL	April 25	11:30-1:30	HONEYWELL, INC., Military Avionics
Thursday	AM	1225 N. Alma Road, Richardson, TX	Tuesday	AM-PM	1625 Zarthan Avenue, St. Louis Park, MN
April 6	11:30-1:00	ROCKWELL INTERNATIONAL	April 25	2:30-4:30	IMPRIMIS TECHNOLOGY INC.
Thursday	AM-PM	Shiloh & Renner Road, Richardson, TX	Tuesday	PM	7801 Computer Dr., Bloomington, MN
April 6	2:15-4:30	E-SYSTEMS, INC., Garland Division	April 26	8:30-11:00	CONTROL DATA CORPORATION
Thursday	PM	1200 Jupiter Road, Garland, TX	Wednesday	AM	3101 East 80th St., Minneapolis, MN
April 7	8:30-11:00	ELECTROSPACE SYSTEMS INC.	April 26	12:30-2:30	NCR COMTEN
Friday	AM	Greenville Ave. & Terrace Dr., Richardson, TX	Wednesday	PM	2700 Snelling Ave., Roseville, MN
April 7	1:30-3:30	E-SYSTEMS, INC.	April 26	3:00-4:30	UNISYS CORPORATION
Friday	PM	Farm Road 1570, Greenville, TX	Wednesday	PM	2276 Highcrest Dr., Roseville, MN
April 10	9:00-11:30	TEXAS INSTRUMENTS, INC.	April 27	8:30-11:00	UNISYS CORPORATION
Monday	AM	8505 Forest Lane, Dallas, TX	Thursday	AM	3333 Pilot Knob Rd., St. Paul, MN
April 10	1:00-3:30	TEXAS INSTRUMENTS INC.	April 27	1:00-4:00	IBM CORPORATION
Monday	PM	13500 North Central Expressway, Dallas, TX	Thursday	PM	Hwy. 52 & Northwest 37th St., Rochester, MN
April 11	9:00-11:00	LTV -Missiles & Electronics Group	April 28	8:30-11:00	ALLEN-BRADLEY COMPANY
Tuesday	AM	1902 West Freeway, Grand Prairie, TX	Friday	AM	1201 So. 2nd St., Milwaukee, WI
April 11	2:00-4:00	RELIANCE COMM/TEC	April 28	12:00-1:30	GENERAL ELECTRIC, Medical Systems
Tuesday	PM	2100 Reliance Pkwy., Bedford, TX	Friday	PM	16800 W. Ryerson Rd., New Berlin, WI
April 12	9:00-12:00	GENERAL DYNAMICS	April 28	2:30-4:30	GENERAL ELECTRIC, Medical Systems
Wednesday	AM	Grants Lane, Ft. Worth, TX	Friday	PM	3000 N. Grandview Blvd., Waukesha, WI
April 12	2:00-4:00	RECOGNITION EQUIPMENT INC.	May 1	9:00-11:30	ROCKWELL INTERNATIONAL, Collins Avionics Div.
Wednesday	PM	2701 Grauwylar Rd. Irving, TX	Monday	AM	400 Collins Road NE, Cedar Rapids, IA
April 13	8:30-11:00	TEXAS INSTRUMENTS INC. Data Systems Group	May 1	1:00-3:30	ROCKWELL INTERNATIONAL, Communications Div.
Thursday	AM	2501 S. Highway 121, Lewisville, TX	Monday	PM	855 35th St. N.E., Cedar Rapids, IA
April 13	1:30-4:00	BOEING ELECTRONICS	May 2	9:00-11:00	NORAND CORPORATION
Thursday	PM	7801 S. Stemmons, Corinth, TX	Tuesday	AM	550 Second St. S.E., Cedar Rapids, IA
April 14	9:00-11:30	TEXAS INSTRUMENTS INC.	May 2	1:00-3:00	LITTON INDUSTRIES, Clifton Precision
Friday	AM	6500 Chase Oakes Blvd., Plano, TX	Tuesday	PM	2734 Hickory Grove Rd., Davenport, IA
April 14	1:00-3:00	TEXAS INSTRUMENTS INC.	May 3	8:30-11:00	SUNDSTRAND CORPORATION, Data Control Group
Friday	PM	2501 W. University, McKinney, TX	Wednesday	AM	4747 Harrison Ave., Rockford, IL
April 17	9:00-11:00	IMPRIMIS TECHNOLOGY INC.	May 3	1:30-3:30	MOTOROLA, INC.
Monday	AM	10323 West Reno Ave., Oklahoma City, OK	Wednesday	PM	1501 W. Shure Dr., Arlington Heights, IL
April 18	9:00-11:30	NCR CORPORATION	May 4	8:30-10:30	NORTHROP CORPORATION
Tuesday	AM	3718 N. Rock Rd., Wichita, KS	Thursday	AM	600 Hicks Road, Rolling Meadows, IL
April 18	1:30-4:00	BOEING MILITARY AIRPLANE CO.	May 4	11:30-1:00	NORTHROP CORPORATION
Tuesday	PM	3801 South Oliver, Wichita, KS	Thursday	AM-PM	2525 Buffe Road, Elk Grove Village, IL
April 19	9:00-11:30	BENDIX KING	May 4	2:00-4:00	MOTOROLA, INC.
Wednesday	AM	400 N. Rogers Road, Olathe, KS	Thursday	PM	1301 E. Algonquin Rd., Schaumburg, IL
April 19	1:30-3:30	WILCOX ELECTRIC, INC.	May 5	9:00-11:30	AG COMMUNICATION SYSTEMS
Wednesday	PM	2001 NE 46th St., Kansas City, MO	Friday	AM	2500 N. Wolf Road, Northlake, IL
April 20	9:00-12:00	AT&T BELL LABORATORIES	May 5	1:00-3:30	ZENITH ELECTRONIC SYSTEMS
Thursday	AM	777 North Blue Pkwy., Lees Summit, MO	Friday	PM	1000 Milwaukee Ave., Glenview, IL

Now your CMOS backup battery can be what you've always wanted it to be.

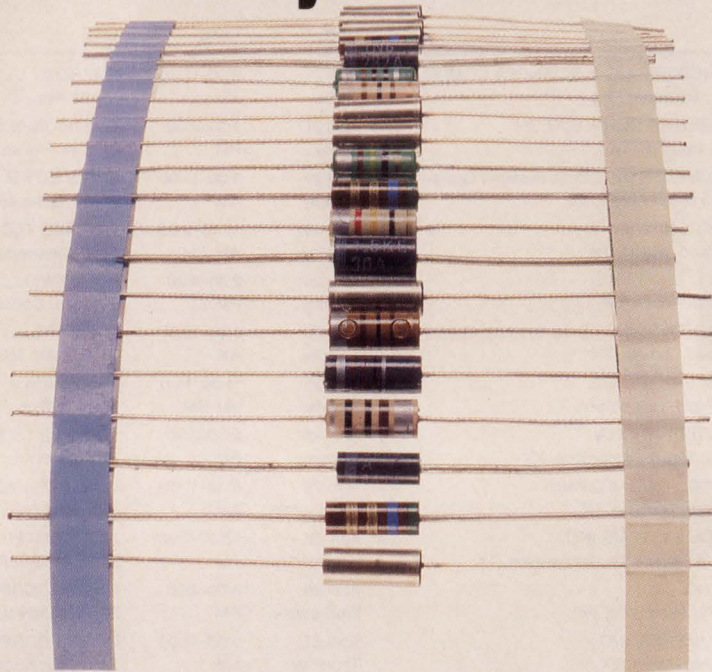

Just another component.

Forget those labor intensive methods normally required for printed circuit board mounting of batteries. Our new axial lead μ PowerCells™ (Lithium Iodine 2.8V Solid CMOS Backup Cells) look like a resistor or capacitor. They're about the same size and they don't need special handling. You can put them on a sequenced tape reel for automatic printed circuit board insertion. And like most other components, μ PowerCells™ can be wave soldered, cleaned and dried us-

ing normal procedures.

Once they're in place, μ PowerCells™ are dependable. Their Lithium Iodine chemistry is the number one choice for powering cardiac pacemakers. And a performance study of over 1 million batteries in use shows that a useful life of more than 20 years can be predicted.

At 35 milliamp-hours, the axial lead μ PowerCell™ will handle most CMOS backup problems. However, higher capacity versions to 1 amp hour are

available in a new space-saving rectilinear package. The Catalyst Research line includes modules for sensing power loss and transferring to battery backup as well as clock modules with battery built in.

Best of all, Catalyst Research μ PowerCells™ are priced like other components.



For more information, call us at 301-296-7000 ext. 304.

CATALYST RESEARCH
A DIVISION OF MINE SAFETY APPLIANCES COMPANY

1421 Clarkview Road Baltimore, MD 21209-9987, USA Telephone (301) 296-7000 ext 304 Telex 898095 CATALYST

CIRCLE NO 18

CAREER OPPORTUNITIES

1989 Editorial Calendar and Planning Guide



Issue Date	Recruitment Deadline	Editorial Emphasis	EDN News Edition
Apr. 27	Apr. 6	Communications Technology, Special Issue Communication ICs	Closing: Apr. 13 Mailing: May 4
May 11	Apr. 20	Analog Technology, Special Issue Computer Peripherals	Closing: Apr. 28 Mailing: May 18
May 25	May 4	Digital ICs, Computer Peripherals	Closing: May 25 Mailing: June 15
June 8	May 18	Components, Digital ICs	Closing: June 9 Mailing: June 29
June 22	June 1	Semicustom ICs, Computer Boards	Closing: June 22 Mailing: July 13
July 6	June 15	Product Showcase — Volume I, Power Supplies	Closing: July 21 Mailing: Aug. 10
July 20	June 29	Product Showcase — Volume II, Components	Closing: Aug. 4 Mailing: Aug. 24
Aug. 3	July 13	Integrated Circuits, Computer Boards	Closing: Aug. 18 Mailing: Sept. 7
Aug. 17	July 27	Military Electronics, Special Issue Military Software	Closing: Aug. 30 Mailing: Sept. 21
Sept. 1	Aug. 10	Test & Measurement, Integrated Circuits	Closing: Sept. 15 Mailing: Oct. 5
Sept. 14	Aug. 24	Industrial Product Showcase, Digital ICs	Closing: Sept. 28 Mailing: Oct. 19
Sept. 28	Sept. 7	Integrated Circuits, Computer Peripherals	Closing: Oct. 27 Mailing: Nov. 16
Oct. 12	Sept. 21	DSP Chip Directory, Integrated Circuits	Closing: Nov. 9 Mailing: Nov. 30
Oct. 26	Oct. 5	Test & Measurement, Special Issue, Computers & Peripherals	Closing: Nov. 22 Mailing: Dec. 14
Nov. 9	Oct. 19	CAE, Integrated Circuits	Closing: Nov. 30
Nov. 23	Nov. 2	16th Annual μ P μ C Directory, Integrated Circuits	Closing: Dec. 14
Dec. 7	Nov. 16	Product Showcase — Volume I, Power Supplies	Closing: Dec. 14
Dec. 21	Nov. 30	Product Showcase — Volume II, Components	

Call today for information:

East Coast: Janet O. Penn (201) 228-8610
 West Coast: Mary Beth West (213) 820-3887
 National: Roberta Renard (201) 228-8602

Quality in. Quality out.

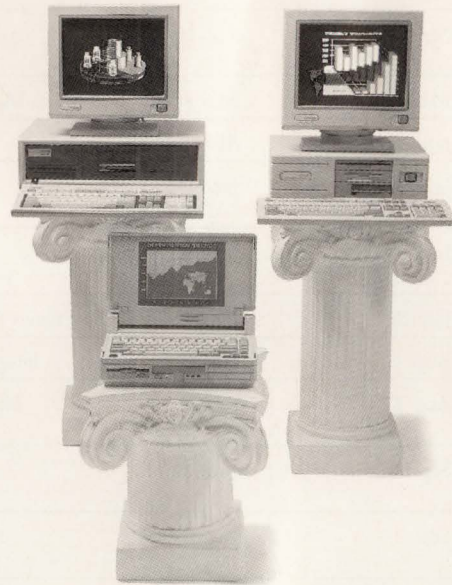

When you put your best into your products, it shows.

At Compaq, the value of our products is simply a reflection of the personal values inherent in each Compaq professional. Attributes like teamwork, mutual respect, leadership and a commitment to quality translate into some of the most advanced personal computers on the market.

Our continued success has created immediate opportunities for top Engineering professionals at our Houston headquarters. Start with a degree and relevant experience. Add to that a strong set of personal values and the desire to do what's never been done before, and you could be part of a winning team.

Microprocessor Logic and ASIC Design Engineers

Challenge your expertise in logic design and/or microprocessor system design using flow charts and timing diagrams for digital design and detailed design analysis. Your experience should include vendor libraries, test vector generation, simulation checkout and TTL emulators for gate array standard cell design. Familiarity with CAE

systems used in logic design, test vector generation, simulation checkout and documentation is also necessary. You must have five years' related experience plus a BSEE or equivalent degree. An MSEE degree is preferred.

Systems Architects

You'll design new products by investigating and evaluating system compatibility and performance of design alternatives and new technologies. You'll develop hardware compatibility tests and performance analysis tools.

Qualify with a BSEE, MSEE preferred, and three years' hardware background with a knowledge of microprocessor-based systems software. In addition, experience with CPUs/Memory/Bus architecture, numeric co-processors, file subsystems, network communications, graphic subsystems and state machines is required.

Systems Software Engineers

You'll evaluate, design and develop firmware, operating systems, device drivers and utility software for PC systems. Along with your BSEE/BSCS, you'll need four years' related experience in PC software development, 8086/286/386 Assembly/'C' language programming in MS-DOS,

OS/2 and/or UNIX/XENIX operating system environments.

Software Engineers—Audit/Test

Put your design and development talents to the test improving structural software. You'll help increase the reliability of personal computer systems and operating systems software. Five years' software quality assurance or test development experience should complement your BSEE/BSCS. Experience in 'C' and 8086/286/386 Assembly language is essential.

Make a quality career decision.

Compaq offers competitive salaries, comprehensive benefits and an unequalled work environment. If you're interested in one of these positions, please call us at 1-800-243-9003. Or simply submit your resume and the position for which you wish to be considered to:
Compaq Computer Corporation, Dept. EDN327-MW, P.O. Box 692000, Houston, Texas 77269-2000.

© 1989 Compaq Computer Corporation
© 1989 Accent Software, Inc. All rights reserved.
All Products are registered trademarks or trademarks of their respective manufacturers.
Compaq is an affirmative action employer, m/f/h/v.

COMPAQ

First, there was the vision...



Space exploration began with a vision.

The fire of imagination—fused with superior technical proficiency—leading the way to limitless possibilities. A special vision that creates the kind of breakthroughs that characterize GE Astro-Space.

Since the nation's first space communications adventure nearly 30 years ago, GE Astro-Space has been a world leader in the design and manufacture of satellites for government and commercial communications, meteorological, navigational and scientific use.

And, with over one hundred and fifty satellites currently circling the globe—and long-term, history-making projects such as the *Mars Observer*, *Space Station* and *Landsat*—we can offer Engineers the kind of rare opportunities that few are destined to realize.

If you're the Engineer we're seeking, join us as we pave the way for a new generation of emerging space technology. Our mission requires the technical proficiency of Engineers with a minimum of 3 years experience in one or more of the following:

■ Mechanical Engineers

Antenna Design
RF Packaging Design
Robotics/Mechanism Design
Spacecraft Attitude Control

■ Electrical Engineers/ Hardware

Electronic Packaging
Harness Design
ATE/AGE Design
Power Supply/Analog Design
Video Design

■ Systems Engineers

Spacecraft Power Systems
Mission Analysis

■ Integration & Test Engineers

Our New Jersey location offers all the advantages of nearby Princeton—within easy access to New York City and Philadelphia. Additionally, selected positions are open in Valley Forge, PA. In either location, you'll experience a lifestyle that complements your career, providing unlimited opportunities for personal and professional growth. As the largest employer of engineers and scientists in the world, GE provides competitive salaries and exceptional benefits including tuition refund and continuing education programs—so your expertise is always current and expanding.

Rush your resume to: Employee Relations, Dept. EDNM, GE Astro-Space, P.O. Box 800, Princeton, New Jersey 08543-0800. An equal opportunity employer.



**GE Aerospace
Astro-Space**

Cross the engineering frontier.

A Tale of Two Cities With One Mission

Shape the Future—Join GE in Syracuse or Moorestown.

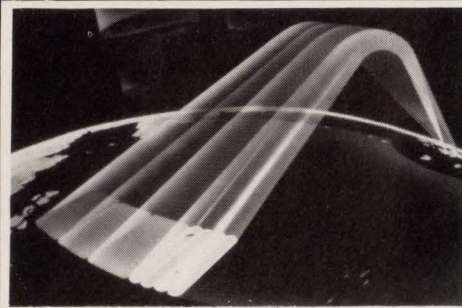

We make engineers like you part of the longest-term, most inherently dramatic "hide and seek" missions of our time.

GE Government Electronic Systems Division is prime contractor for a second generation, integrated system that will make Seawolf SSN subs effective defenders well into the 21st Century.

If your ambitions include developing big, fast signal processing capabilities and linkages to advanced ASW sensor systems and C+...or being part of more powerful, more discriminating radar, sonar and acoustical programs that enlarge ocean surveillance capabilities of surface ships...tell GE.

The more that company resources and reputation mean to you—and the more you want to accomplish in system and software architecture, hardware and circuit design, low frequency and broadband sonar, and signal and data processing—the sooner we should meet. Do what our customers do. Talk to key GE managers at our two locations.

Syracuse, NY

In an area with wide recreational, cultural and lifestyle options, you can be part of the most far-sighted signal processing programs. We have openings for engineers with at least 5 years experience as...

Systems Engineers/Managers

opportunities exist in:

- Algorithm Development
- Signal Processing
- Human Factors
- Sensor System Design
- Systems Analysis
- ASW Systems
- Combat Systems Architecture
- Reliability/Maintainability
- PIDS Through B level Specification Design

Hardware/Circuit Design Engineers/Managers

help design the future by working in:

- CMOS
- Power Design
- Gate Array Design
- Configuration Management
- Cabinet Design

Software Engineers/Programmers/Managers

opportunity to advance if you're experienced with:

- Top Down Structured Design
- MIL-STD 2167
- ADA Language Architecture and Programming
- Embedded Programmable Processors (68000 or similar)

Software Quality Assurance Engineers

with experience in:

- Metrics/Trend Analysis
- ADA/Case tools helpful
- Strong organization/personal skills
- MIL-STD 2167/2168
- Summarizing detailed data for management decisions

Choice opportunities also exist in the following areas:

- Advanced engineering design/development of future ASW systems
- Test and integration testing
- Quality assurance programs engineering
- Subcontracts management and financial analysis
- Field programs engineering (Naval systems)

Both locations provide competitive salaries, and the technical and management training and comprehensive benefits you'd expect from GE. To apply, please send your resume indicating position of interest, and salary history, to:

GE Professional Staffing, ADEDN, P.O. Box 4840, EP-1-106, Syracuse, NY 13221 or MTEDN, GESD, Bldg. 127-101, Moorestown, NJ 08057.

U.S. Citizenship Required

Moorestown, NJ

In an attractive suburb, 15 miles outside Philadelphia—near shore and mountains—engineers make exciting mental journeys. Should have BSEE or BSCS and at least 5 years experience as...

Senior Engineers, Combat Control

- BSEE
- 5+ years in Combat Control performance definition, design and test for real time Combat Control Systems.
- Knowledge of U.S. Navy systems, preferably submarine systems.

Senior Digital Design Engineers

BSEE, with 5+ years experience in the digital/firmware design of digital sub-systems. Should also have experience in the design of special purpose digital processors with strength in current custom design and simulation techniques.

Senior Software Design Engineers

BSEE or BSCS with 5+ years direct experience in the design and development of large real time Command and Control Systems which utilize sensor data input. Experience with the following:

- Fault location/fault detection with a plus for automatic configuration design experience.
- Real-time data base design experience with Ingress or Oracle.
- Motorola 68020 assembly language, and/or real time operating system experience.

Senior Engineers, Command & Decision

BSEE with 5+ years in Command and Control performance definition, design and test for real time Command and Control Systems. Should have knowledge of U.S. Navy systems, preferably submarine systems.



GE Government Electronic Systems Division

An Equal Opportunity Employer

Sun Microsystems invites you to take CIM to its limits. Then, go beyond them.

You might not expect a high technology company to put such an emphasis on CIM. But Sun Microsystems sees CIM as nothing less than a strategic advantage in the very competitive workstation market.

Sun already boasts shop floor control and automated handling and distribution, as well as complex board and system testing and decision-making support. Now we want to integrate our systems into one, functional architecture.

Our goal: the ultimate CIM system.

This architecture will combine the ease of our user interface, vivid graphics, and networking capabilities with object-oriented programming in UNIX™ and "C," and distributed RDBMS to create the ultimate CIM system.

Sun has the resources to make it happen as one of the fastest-growing companies in America, with over one billion dollars in sales last year. We have a remarkable number of CIM experts in-house. More important, we have the explicit commitment and support of top management to make Sun unsurpassed at CIM.

But we need more. More people skilled in CIM to help us accomplish our ambitious goals.

Here's your challenge.

Join the Sun Microsystems CIM effort, and you'll have the opportunity to work on any one of several challenges:

- Tools & Technologies Development
- Applications Software Development
- Systems Integration
- Engineering Services
- User Support Services

Experience in UNIX or "C" is essential to qualify for these positions. Candidates should also have manufacturing systems integration experience.

If you meet those spec's, apply now. Here are four of our current openings:

System Administrator

You will provide system administrative support to the UNIX end-user community. This will include installing and maintaining all file servers, timeshare machines, laser printers, and networks, while working with third-party vendor software. Requires a BSCS/Information Systems and 1+ years' UNIX systems administration experience. Strong communication skills and an excellent working knowledge of UNIX and UNIX utilities, software documentation, shell programming, and networking are also needed.

Software Development Engineers

Requires experience in CIM, systems integration and application software development for state-of-the-art software systems engineering in a UNIX environment. Additionally, you will need 3+ years' experience with UNIX and "C" as well as 3 years' CIM experience.

Engineers — Surface Mount Technology

Develop, maintain, support and improve Pick & Place, paste, printing and re-flow processes for internal surface mount production line. Requires a BSME and 2-5 years' related experience in SMT process development. Panasonic and/or Fuji experience desired.

Sr. CIM Systems Software Engineers

We have several positions available for individuals with experience in process control applications including factory automation and/or distribution, as well as statistical analysis in a manufacturing environment. Requires 3 years' experience as a group leader and experience with structured analysis and design techniques in an application design environment. Strong user interface and excellent communication skills required. Systems integration background and 3+ years' UNIX and "C" experience are preferred. For some positions, 4+ years' experience with relational database required.

To apply, please send your resume in confidence to Professional Employment, Sun Microsystems, Inc., M/S DAQ, 2550 Garcia Avenue, Mountain View, CA 94043. Letter-quality resumes will get to our hiring managers faster, since all resumes are electronically scanned and processed by the Resumix™ system. An equal opportunity employer. Principals only, please.

UNIX is a registered trademark of AT & T. The Sun logo and Sun Microsystems are registered trademarks of Sun Microsystems, Inc. All other products or services mentioned in this document are identified by the trademarks or service marks of their respective companies or organizations.



Systems for Open Computing.™

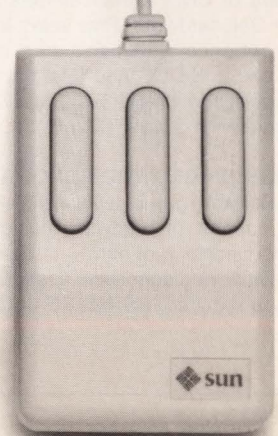
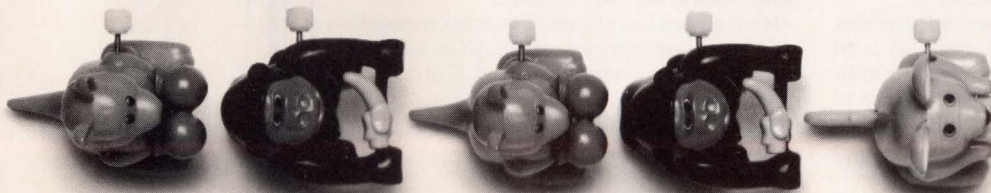

T H E O P E N C H A L L E N G E

**AMERICA'S FASTEST GROWING
PERSONAL COMPUTER COMPANY
IS LOOKING FOR A FEW GOOD PERSONS**

**DELL
COMPUTER
CORPORATION**

- Introduced the industry's first second-generation 80386-based system, using only static random access memory (SRAM).
- Current product line includes:
 - Dell System 200, our largest-selling 286 system
 - Dell System 220, the most powerful 80286-based PC available
 - Dell System 310, the fastest PC based on the Intel 80386 20 MHz microprocessor
 - Dell System 325, our 25 MHz "no compromise" PC for high-level computing
 - A wide range of peripherals, printers, accessories and software
- Dell UNIX System V/386 was recently announced for the 386-based hardware
- International subsidiaries in the United Kingdom, Canada, Germany and Japan
- Largest Austin-based publicly-held corporation, with over 1,000 employees
- Dell is located amid the beautiful hill country and lakes surrounding Austin, TX. Austin offers an affordable quality of life, unsurpassed by most major metropolitan areas

LOGIC/VLSI DESIGN ENGINEERS

Challenging responsibilities include specification, development, implementation and testing of board level and/or chip level logic design for PC applications. Requires recent high-speed logic board/card design experience, preferably with I/O BUS and CPU complex focus. BS/MS EE.

UNIX DESIGNERS

Software designers participate in team development of UNIX enhancements and customizations for Dell hardware. Five years total software design experience with two years in UNIX and C required. MS-DOS and Intel hardware and software experience preferred. Graphics and networking experience a plus. BS/MS EE.

BIOS/DIAGNOSTIC PROGRAMMERS

Software group develops low-level Intel programs in support of hardware design projects. A solid understanding of hardware design with experience in BIOS or diagnostics, assembler and C programming required. BS/MS EE or CS.

PROJECT PLANNERS

Responsible for product/project development from inception to market introduction. Requires experience in coordinating all aspects of project including design, procurement, support and administration as well as hardware/software assimilation. Prefer recent experience in PC project management with current knowledge of microprocessor-based industry. Minimum four year technical degree required.

ADVANCED TECHNOLOGY ENGINEERS

Senior Engineers work independently in researching leading edge technologies for potential products. Position requires broad-based design/project management experience with thorough knowledge of high-speed microprocessor industry. BS/MS EE.

ADDITIONAL OPPORTUNITIES

R & D groups listed below have positions requiring knowledge/experience with MS-DOS based PC hardware and software, assembler, C and UNIX.

- Systems Validation
- Systems Integration
- Mechanical Design
- Technical Publications

To explore these and other opportunities and join an organization that offers a position with an excellent salary and benefits package, send your resume to:

Professional Employment Box E283, Dell Computer Corporation,
9505 Arboretum Boulevard, Austin, Texas 78759
(EOE m/f/h)

First
in Readership
Among
Design Engineers
and
Engineering Managers
in Electronics

**EDN
EDN
EDN**

99¢

from

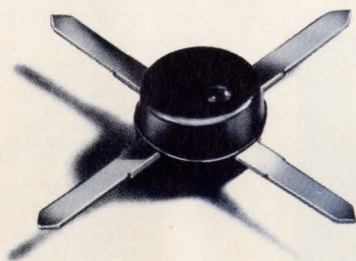

dc to 2000 MHz amplifier series

SPECIFICATIONS

MODEL	FREQ. MHz	GAIN, dB			Min. (note)	• MAX. PWR. dBm	NF dB	PRICE \$ Ea.	Qty.
		100 MHz	1000 MHz	2000 MHz					
MAR-1	DC-1000	18.5	15.5	—	13.0	0	5.0	0.99	(100)
MAR-2	DC-2000	13	12.5	11	8.5	+3	6.5	1.50	(25)
MAR-3	DC-2000	13	12.5	10.5	8.0	+8□	6.0	1.70	(25)
MAR-4	DC-1000	8.2	8.0	—	7.0	+11	7.0	1.90	(25)
MAR-6	DC-2000	20	16	11	9	0	2.8	1.29	(25)
MAR-7	DC-2000	13.5	12.5	10.5	8.5	+3	5.0	1.90	(25)
MAR-8	DC-1000	33	23	—	19	+10	3.5	2.20	(25)

NOTE: Minimum gain at highest frequency point and over full temperature range.

- 1dB Gain Compression
- +4dBm 1 to 2 GHz

designers amplifier kit, DAK-2
5 of each model, total 35 amplifiers
only **\$59.95**

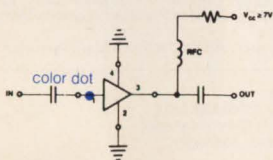

Unbelievable, until now... tiny monolithic wide-band amplifiers for as low as 99 cents. These rugged 0.085 in. diam., plastic-packaged units are 50ohm* input/output impedance, unconditionally stable regardless of load*, and easily cascable. Models in the MAR-series offer up to 33 dB gain, 0 to +11dBm output, noise figure as low as 2.8dB, and up to DC-2000MHz bandwidth.

*MAR-8, Input/Output Impedance is not 50ohms, see data sheet. Stable for source/load impedance VSWR less than 3:1

Also, for your design convenience, Mini-Circuits offers chip coupling capacitors at 12 cents each.†

Size (mils)	Tolerance	Temperature Characteristic	Value
80 x 50	5%	NPO	10, 22, 47, 68, 100, 470, 680, 100 pf
80 x 50	10%	X7R	2200, 4700, 6800, 10,000 pf
120 x 60	10%	X7R	.022, .047, .068, .1µf

† Minimum Order 50 per Value

finding new ways...
setting higher standards

Mini-Circuits

A Division of Scientific Components Corporation
P.O. Box 350166, Brooklyn, New York 11235-0003 (718) 934-4500
Fax (718) 332-4661 Domestic and International Telexes: 6852844 or 620156

C113-Rev. D

BUSINESS/CORPORATE STAFF

Peter D Coley
VP/Publisher
Newton, MA 02158
(617) 964-3030; Telex 940573
Ora Dunbar, Assistant/Sales Coordinator

Mark J Holdreith
Advertising Sales Director
Newton, MA 02158
(617) 964-3030
Heather McElkeny, Assistant

Deborah Virtue
Business Director
Newton, MA 02158
(617) 964-3030

NEW ENGLAND
John Bartlett, Regional Manager
Chris Platt, Regional Manager
199 Wells Ave
Newton, MA 02159
(617) 964-3730

STAMFORD 06904
George Isbell, Regional Manager
8 Stamford Forum, Box 10277
(203) 328-2580

NEW YORK, NY 10011
Daniel J Rowland, Regional Manager
249 West 17th St
New York, NY 10011
(212) 463-6419

PHILADELPHIA AREA
Steve Farkas, Regional Manager
487 Devon Park Dr, Suite 206
Wayne, PA 19087
(215) 293-1212

CHICAGO AREA
Clayton Ryder, Regional Manager
Greg Anastos, Regional Manager
Jack Johnson, Regional Manager
Randolph D King, Regional Manager
Maris Listello, Telemarketing
Cahners Plaza
1350 E Touhy Ave, Box 5080
Des Plaines, IL 60017
(312) 635-8800

DENVER 80206
John Huff, Regional Manager
44 Cook St
(303) 388-4511

DALLAS 75243
Don Ward, Regional Manager
9330 LBJ Freeway, Suite 1060
(214) 644-3683

SAN JOSE 95128
Walt Patstone, Regional Manager
Bill Klanke, Regional Manager
Philip J Branon, Regional Manager
James W Graham, Regional Manager
3031 Tisch Way, Suite 100
(408) 243-8838

LOS ANGELES 90064
Charles J Stillman, Jr
Regional Manager
12233 W Olympic Blvd
(213) 826-5818

ORANGE COUNTY/SAN DIEGO 92715
Jim McErlan, Regional Manager
18818 Teller Ave, Suite 170
Irvine, CA
(714) 851-9422

PORTLAND, OREGON 97221
Pat Dakin, Regional Manager
Walt Patstone, Regional Manager
1750 SW Skyline Blvd, Box 6
(503) 297-3382

UNITED KINGDOM/BENELUX
Jan Dawson, Regional Manager
27 Paul St
London EC2A 4JU UK
44 01-628 7030
Telex: 914911; FAX: 01-628 5984

SCANDINAVIA
Stuart Smith
27 Paul St
London EC2A 4JU UK
01-628 7030
Telex: 914911; FAX: 01-628 5984

FRANCE/ITALY/SPAIN
Alasdair Melville
27 Paul St
London EC2A 4JU UK
01-628 7030
Telex: 914911; FAX: 01-628 5984

WEST GERMANY/SWITZERLAND/AUSTRIA
Wolfgang Richter
Sudring 53
7240 Horb/Neckar
West Germany
49-7451-7828; Telex: 765450

EASTERN BLOC
Uwe Kretzschmar
27 Paul St
London EC2A 4JU UK
01-628 7030
Telex: 914911; FAX: 01-628 5984

FAREAST
Ed Schrader, General Manager
18818 Teller Ave, Suite 170
Irvine, CA 92715
(714) 851-9422; Telex: 183653

HONG KONG
John Byrne & Associates Ltd
1613 Hutchison House
10 HGarcourt Road
Central Hong Kong
Tel: 5-265474
Tlx: 61708 WEDIN HX
Fax: 5-8106781

JAPAN
Kaoru Hara
Dynaco International Inc
Suite 1003, Sun-Palace Shinjuku
8-12-1 Nishishinjuku, Shinjuku-ku
Tokyo 160, Japan
Tel: (03) 366-8301
Telex: J2322609 DYNACO

KOREA
Kim Kyong-Hae, BK International
Won Chang Bldg, 3rd Floor 26-3
Yoido-dong, Youngdungpo-ku
Seoul 150, Korea
Tel: 785-6665; FAX: 784-1915
Telex: K32487 BIZKOR

**SINGAPORE/MALAYSIA/INDONESIA/THAILAND/
THE PHILIPPINES/AUSTRALIA/NEW ZEALAND**
Asia Pacific Media House PTE Ltd
Peter Cheong
100 Beach Rd
#24-03 Shaw Tower
Singapore 0718
Tel: 2915354; Telex: RS 50026 MESPLY

TAIWAN
Acteam International Marketing Corp
6F, No 43, Lane 13
Kwang Fu South Rd
Mailing Box 18-91
Taipei, Taiwan ROC
760-6209 or 760-6210
Telex: 29809; FAX: (02) 7604784

PRODUCT MART
Joanne Dorian, Manager
249 West 17th St
New York, NY 10011
(212) 463-6415

INFO CARDS
Donna Pono
Newton, MA 02158
(617) 558-4282

CAREER OPPORTUNITIES/CAREER NEWS
Roberta Renard, National Sales Manager
(201) 228-8602

Janet O Penn, Eastern Sales Manager
(201) 228-8610
103 Eisenhower Parkway
Roseland, NJ 07068

Mary Beth West, Western Sales Manager
12233 West Olympic Blvd
Los Angeles, CA 90064
(213) 826-5818

Staci Comstock, Sales Assistant
(201) 228-8608
FAX: 201-228-4622

Wendy A Casella, Advertising/Contracts Coordinator
Nan E Coulter, Advertising/Contracts Coordinator
Aileen B Turner, Advertising/Contracts Coordinator
(617) 964-3030

**William Platt, Senior Vice President, Reed Publishing USA
Cahners Magazine Division**
Terry McDermott, President, Cahners Publishing Co
Frank Sibley, Senior Vice President/General Manager, Boston
Division
Tom Dellamaria, VP/Production & Manufacturing

Circulation
Denver, CO: (303) 388-4511
Sherri Gronli, Group Manager
Eric Schmierer, Manager

Reprints of EDN articles are available on a custom printing basis at reasonable prices in quantities of 500 or more. For an exact quote, contact Joanne R Westphal, Cahners Reprint Service, Cahners Plaza, 1350 E Touhy Ave, Box 5080, Des Plaines, IL 60018. Phone (312) 635-8800.

SMART MOTORS FOR SMART PRODUCTS

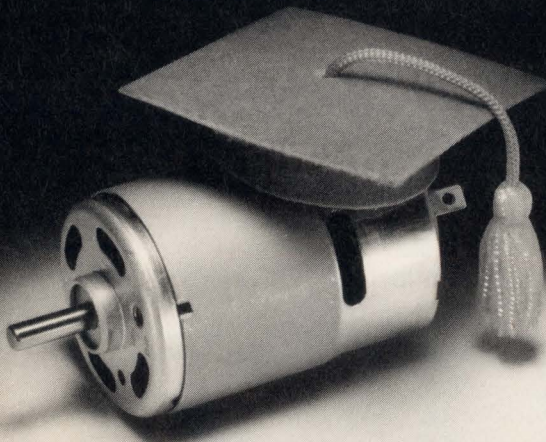

All you ever wanted in a proven resource for subfractional motors. Advanced technology, tech support, 3 million a day, 51 models, reliable, cost-effective — smart! Call/write/FAX for Engineer's catalog.

Mabuchi Motor America Corp., 475 Park Avenue South,
New York, NY 10016. Dept. EDN9. Tel.: 212/686-3622.
FAX: 212/532-4263. Telex: 23-4374 Abu.

 **MABUCHI** SUBFRACTIONAL
MOTORS

SINCE 1954

CIRCLE NO 15

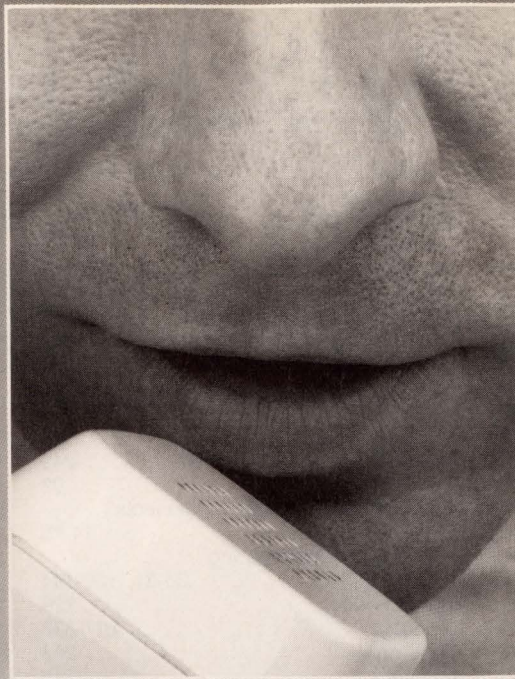

Your VME Synchro/Resolver I/O solution may be just under your nose.

It may even be just a phone call away.
To VMIC.

When it comes to VME Synchro/Resolver I/O boards and backplanes, VMIC has six high performance, board level solutions with over 100 options available to meet your needs today. Off-the-shelf.

Options include BUILT-IN-TEST which provides real time and offline fault detection and isolation to the board level. Resolutions from 10 to 16 bits. Accuracies from ± 2.3 to ± 4 arc minutes. References of 60 to 6000 Hz. Single, dual,

or quad channel configurations. And so much more.

In addition, all VMIC Products are backed by a full two year warranty; and are supported by the industry's most responsive and knowledgeable 24-hour customer service team. Our reputation for technical and applications excellence stems from a clear cut focus on leading edge, VMEbus only technology.

At VMIC, our engineering staff is continually driven toward VMEbus product refinement and innovation. The proof is evident in several VMEbus solutions

we offer for Host Computer Interfaces, VME-to-VME links and Repeaters, Digital I/O, Analog I/O and Serial I/O, Intelligent I/O controllers and more.

So, when you are searching for your Synchro/Resolver, or any other VMEbus board level solution, the answer could be just under your nose. Pick up the phone and call VMIC to find out—today.

VME Microsystems International Corp.
12090 South Memorial Parkway
Huntsville, Alabama 35803
205/880-0444 Ext. 189, Fax 205/882-0859
1-800-322-3616

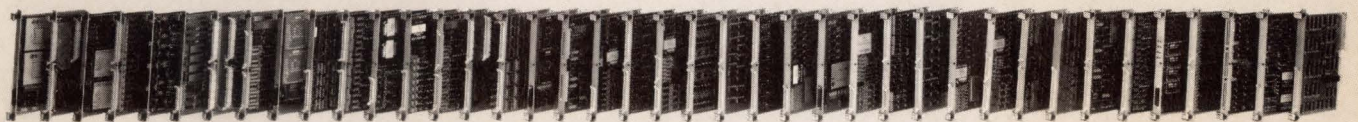

VMIC ^{VME} 
TM

CIRCLE NO 58

ADVERTISERS INDEX

ACCEL Technologies Inc	243	General Silicones	245	Protel	247
Advanced Micro Devices	10-11	Hammond Mfg Inc	114	Qua Tech Inc	244, 247
Advanced Microcomputer Systems Inc	244	Harris Semiconductor	84-85	Racal-Redac	179
Airpax Corp/Cambridge Div	42-43	Hewlett-Packard Co	91, 136-137	Raytheon	55
Altera Corp	46-47	Hitachi America Ltd*	94-95	Rogers Corp	244
American Automation	34	Hitachi Denshi, America Ltd	123	Rohde & Schwarz**	30
American Shizuki Corp	230-231	Hoffman Engineering	263	Saft	187
AMP	132-133	Hybricon Inc	244	Seponix Corp	221
Amphenol	209-210	IEE	86	Shelly Associates	245
Ampro Computers Inc	212	Inmos Corp	8-9	Siemens AG	201
Analog Devices Inc	48-49	Intel Corp	103, 105	Siemens AG**	129
Annabooks	245	Intusoft	242	Sierra Semiconductor	168-169
Avocet Systems Inc	153	IOtech Inc	92	Signetics Corp	134, 183
AVX Corp	63	ITT ElectroMechanical Components Worldwide	14-15	Signum Systems	247
Ballard Technology	244	John Fluke Manufacturing Co Inc*	30-31, 139-144	Silicon Systems Inc	64-65
B&C Microsystems	243, 245	Jonathan Mfg	229	Single Board Solutions	247
Belden Wire & Cable	C4	Kepco Inc	227-228	Sonnenschein Batteries Inc	226
BP Microsystems	243	Kingdatron	242	Sony Corp of America	89
Bradford Electronics	33	K-Tronics	245	Specialty Electronics Inc	241
Braemar Computer Corp	138	L-CAD Inc	243	Spectrum Software	37
Bruel & Kjaer Instruments	145	L-Com Inc	246	Sprague Electric Co	73
Bud Industries Inc	70	Leader Instruments Corp	52	Sprague Goodman	243
Burr-Brown Corp	147	LeCroy Corp	16-17	Stanford Research Systems Inc	61
BV Engineering	242	Lemo USA Inc	247	STD Mfg Group	146
CAD Software Inc	213	Linear Technology Corp	170	Stimpson Co Inc	104
Catalyst Research	250	Livingston Development Corp**	94	Superior Electric Co	234
Champion Tech	165	Loctite Luminescent Systems Inc	233, 235, 237	Supertex	214
Cherry Semiconductor Products Corp*	106-107	Logic Devices	83	Tektronix Inc	38-39
Ciprico Inc	2	Logical Devices Inc	241, 242	Teltone Corp	246
C&K Components Inc	192	LTX Corp	203-205	Tempil Div, Big Three	247
Clarostat	208	3M Co	206	Thin Film Technology Corp	146
Component Mfg Service Inc	166	Mabuchi Motors	260	Thomas and Betts Corp	191
Computer Consulting Assoc	244	Manhattan Electric Cable	248	Tokin America	246
Computerwise Inc	241	Marshall	81	Toko America Inc	50
Comtran® Integrated Software	245	Mepco/Centralab	185	Toshiba America Inc	40-41
Connectek Precision Inc	246	Mepcopal Co	131	Toshiba Corp	240
Connector Corp	166	Meta-Software Inc**	95	Universal Cross Assemblers	247
CTI Electronics	243	Micro Computer Control	245	Universal Data Systems	C3
Cubit/Proteus Industries Inc	75, 77, 79, 236	Micro Crystal Div/SMH	244	Unkel Software	242
Cypress Semiconductor	23	Micro Linear	44	VME Microsystems International Corp	259
Dale Electronics Inc	1	Micro Power Systems	154	Volgen America	222
Data I/O Corp	57, 245, 247	Micron Technology Inc	219	Warren	36
Datel	32, 114	Microtek Intl Inc	68	Westcor	6
Datum Inc, Bancomm Div	82	Mini-Circuits Laboratories	3, 4, 26, 27, 257	Wintek Corp	242, 246
Davilyn Corp	243	Mitsubishi Electronics America Inc	93	Xeltek	245
Dialight Corp, a Cambridge Electronic Industries Co	25	Mizar Inc	225	Zilog Inc	C2
Digital Audio Labs Inc	243	Mobiltron Electronics Co Ltd	246		
Digital Electronics Corp	223	Molex Inc	264		
Dotronix	211	Motorola Microcomputer Div	12-13		
DSP Development Corp	138	MWS Wire Industries	126		
Eaton Corp	190	National Design	36		
ECM	262	NCI	242		
EDN Caravan	248-249	NCR Microelectronics Div	18-19		
Elantek	20	NEC Corp	108-109		
Eldre Components Inc	242	New England Affiliated Technologies	241		
Elec & Eltek	239	Nohau Corp	218, 241		
Electronic Measurements Inc	216-217	Noritake Electronics Inc	188		
Electronic Research Assoc	224	Octagon Systems	241		
Emcor Products/Crenlo Inc	261	OFTI	244		
Epson America Inc	189, 229	OKI Semiconductor	28-29		
Ericsson Components	113	Omaton Inc	243		
E-T-A Circuit Breakers	232	OrCAD Systems Corp	59		
Finlux*	129	Performance Semiconductor Corp	167		
Fujitsu, APD	66-67	Powertec	82A-D		
Fujitsu Component*	220	Powertech Inc	238		
Fujitsu Limited**	31	Precision Filters Inc	246		
Gates Energy Products Inc	124-125	Precision Monolithics Inc	35		
GE Plastics	148, 149, 151				

Recruitment Advertising 251-256

Compaq Computer Corp
Dell Computer Corp
GE Aerospace, Astro—Space
GE—GESD
Sun Microsystems

*Advertiser in US edition
**Advertiser in International edition

This index is provided as an additional service. The publisher does not assume any liability for errors or omissions.



When your specs call for emission control, call for Emcor's EMI/RFI series



FCC Level

Emcor offers shielding solutions. Shown at left is an Emcor EMI/RFI enclosure —designed for commercial applications and tested to MIL STD 285. Fabricated with 14-gauge cold-rolled steel, these enclosures have the rigidity to maintain shielding continuity. They are also fully zinc-plated — both frame and external components — and come with a full complement of accessories.

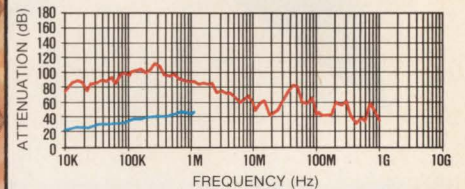

Tempest Style

To meet the most demanding levels of shielding often required by the military, Emcor offers its Tempest style line of enclosures as shown in the top photo. Also tested to MIL STD 285, this line combines high strength with modular options and attractive esthetics. Features include a rigid, 12-gauge frame plus a unique latching system and door design (patent pending). These enclosures are nickel-plated with copper finger stock gasketing.

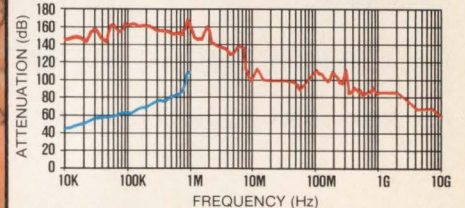

Contact Emcor to discuss your EMI/RFI needs. Our engineering staff has the knowledge and experience to help solve your shielding problems. We can also design modified and custom products.

Crenlo, Inc.

1600 - 4th Ave. N.W.
Rochester, MN 55901
Phone 507-289-3371
FAX #507-287-3405

EMCOR®

See us at the Electro Show, Booth #1835.

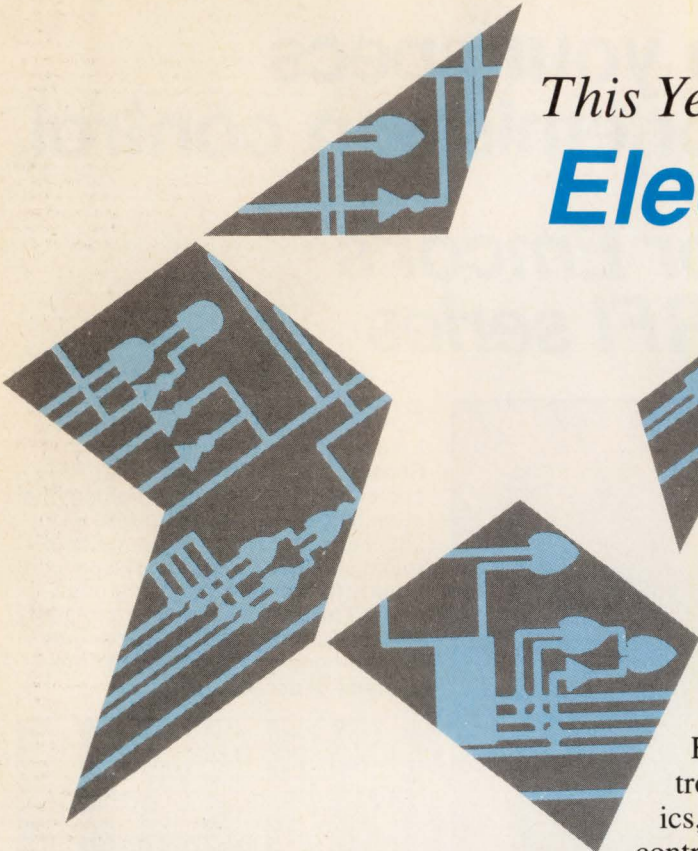

This Year in New York City:
Electro Delivers

*The People
The Products
The Technology*

Electro Delivers the newest products, the latest technology and the largest gathering of technical experts in one place at one time in the Eastern United States.

Electro Delivers the largest concentration of electronic products such as: components, microelectronics, fiber/electro-optics, computers, test equipment, control systems, production and packaging equipment, and software. Products that help you do your job better, quicker and more economically. Electro gives you an unprecedented opportunity to shop, compare and select from the finest vendors in the world.

Electro Delivers an idea-generating professional program that helps you in your professional growth and development and to become an even greater asset to your organization.

NEW AT ELECTRO this year will be the AUTOMATED DESIGN CENTER. Experience first-hand the newest developments and applications in this exciting technology! The Electro/89 Automated Design Center will feature thousands of product demonstrations of hardware, software and systems.

Electro is the most comprehensive design-oriented electronics trade show in the East. Its 14 years of established leadership assures you of a smooth, professionally run and rewarding trade show experience.

April 11-13, 1989

Jacob K. Javits Convention Center

New York City, New York

Sponsored by

Region 1, METSAC and CNEC, IEEE 

New York and New England Chapters, ERA 

Electro/89

*Building a World Class Economy...
Your Passport to the Future*

SHOW HOURS

Tuesday, April 11, 1989

9:30 a.m.-6 p.m.

Wednesday, April 12, 1989

9:30 a.m.-6 p.m.

Thursday, April 13, 1989

9:30 a.m.-4 p.m.

PLAN NOW TO ATTEND!

50% off at-the-door registration for IEEE members!

For information, call 800/421-6816.

In California, call 800/262-4208.

CIRCLE NO 12

Molex Is Making The Connection Between...

FLEXIBILITY & APPLIED COST

Get the design flexibility you want at the price you need with Molex's unique C-Grid SL™ connector system.

Molex's C-Grid SL system of connectors was designed especially for automated wire termination, modular interconnection, and robotic placement.

The SL line features fully stackable components including single piece IDT connectors, crimp contacts and housings, shrouded headers, and panel mount housings and clips. Connector styles include modular, low profile, polarized, and polarized with positive latching.

This broad line of products combined with our unique packaging and automated delivery systems make Molex's C-Grid SL line of connectors an innovative, hard-working answer for engineers looking to achieve their designs at the optimum cost.

For your free samples and our full-line catalog, contact us today.

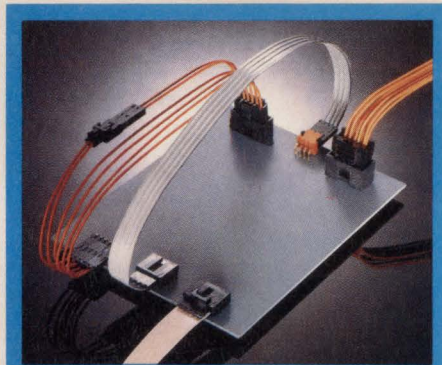

There's a C-Grid SL connector for all your wire-to-wire, board-to-board, and ribbon cable-to-board needs.

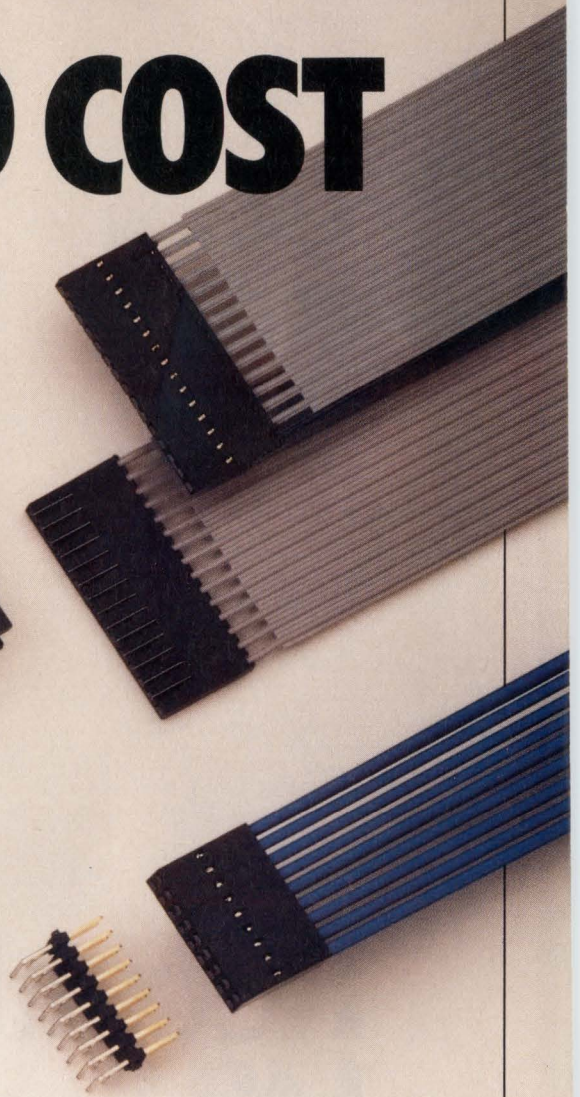

The dual row IDT connector... the only coverless dual row connector available today.



Service To The
Customer... Worldwide

Corporate Headquarters: 2222 Wellington Ct., Lisle, IL, 60532 USA, 312-969-4550 • European Headquarters: Munich, West Germany, 49-89-496093
Northern Asia Headquarters: Tokyo, Japan, 03-487-8333 • Southeast Asia Headquarters: Jurong Town, Singapore, 65-265-4755

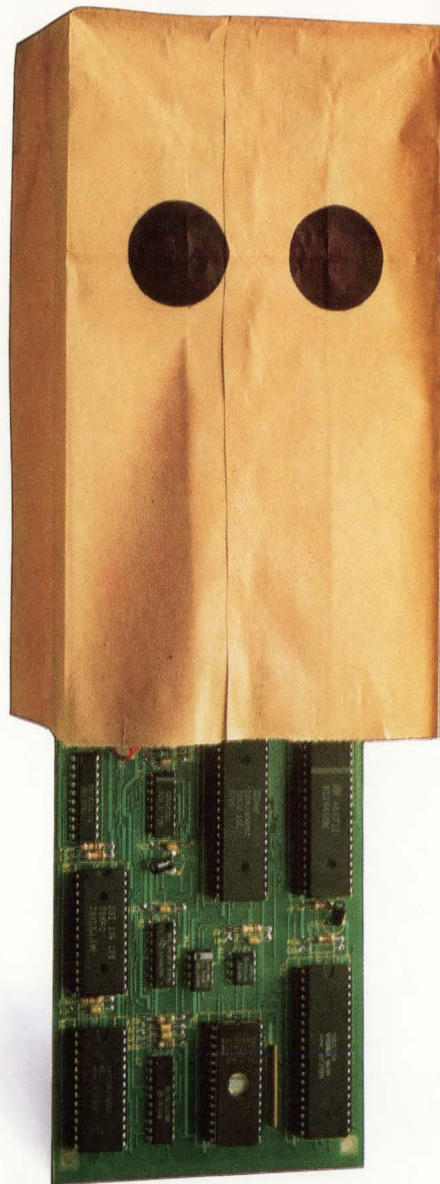

We build anonymous modems for our famous friends

Some of our best OEM customers don't want to be identified; we understand. They're among the world's leading suppliers of computers, intelligent terminals, graphics and engineering workstations and other equipment that requires built-in data communications capability.

These well-known companies have selected UDS as their modem supplier because we provide front-

running technology, superb manufacturing capability, unmatched customer support...and discretion. In a word, UDS modems give their products the kind of reliability they like to claim as their own.

UDS has a broad selection of OEM "standard" designs on file; we also offer industry-leading capability for the development of custom boards. Combined, these two approaches have already

placed more than 3,000 modem designs into active field service.

If you're one of the big boys — or if you want to solve data-comm problems the way the big boys do — find out what UDS recommends as a cost-effective solution for you. Contact Universal Data Systems, 5000 Bradford Drive, Huntsville, AL 35805. Telephone 205/721-8000; Telex 752602 UDS HTV.



Universal Data Systems



MOTOROLA INC.

Mirror Image
Cable

.025
Transmission
Line Cable

Vari-Twist™

Peelable
Ground Plane

Rainbow Cable
(PVC or FEP
Teflon*)

Ribbon Coax

Shielded
Jacketed
Ribbon Coax

Stacked Cable

Shielded
Jacketed Cable

Shielded
A & B Cable

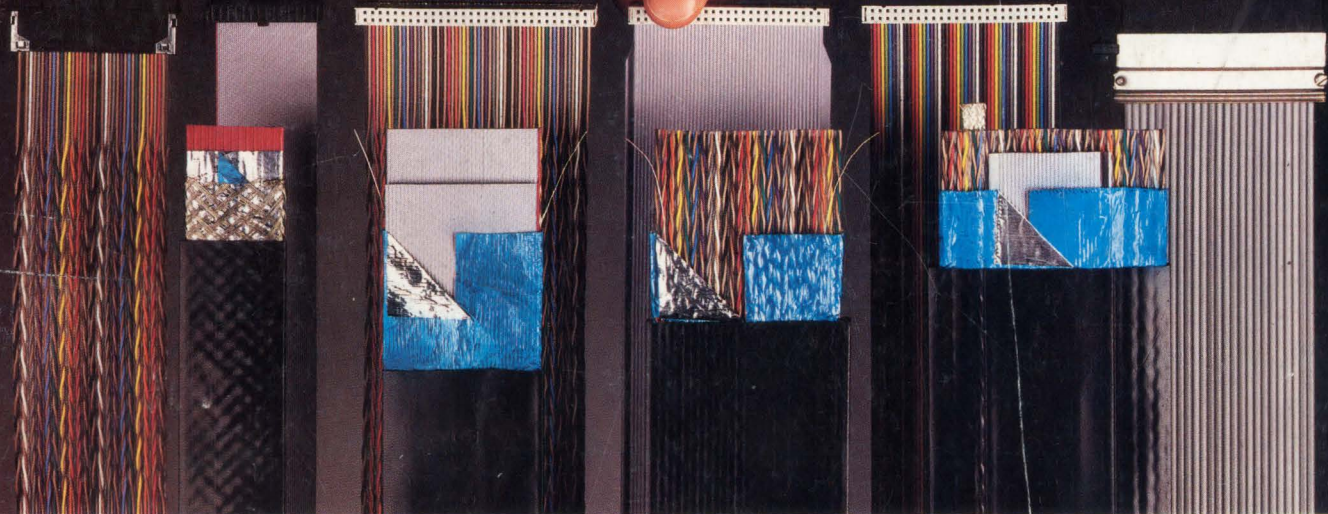

BELDEN REDEFINES FLAT CABLE TECHNOLOGY

The cost advantages of using flat cable are well known. Unfortunately, flat cable applications have been somewhat limited due to the lack of sophisticated shielding and cable design. Until now. The same advanced technology which has made Belden a leader in round cable has now been successfully integrated in flat configurations. From the simplest form of laminated cables to sophisticated designs utilizing combinations of foil and braid shielding,

Belden integrates the cost-effectiveness of flat cable with new design sophistication.

Belden offers one of the most comprehensive flat cable product lines. Shielded or unshielded, twisted or straight, jacketed or unjacketed, PVC or FEP Teflon*—all Belden® flat

cable is made to the same uncompromising level of quality.

Flat cable and connectors from Belden: we're helping you elimi-

nate traditional design conflicts with innovative solutions. That's why *There is no equal*. For more information on Belden Flat Cable and Connectors, request our Master Catalog 885. Belden Wire and Cable, P.O. Box 1980, Richmond, IN 47375.



1-800-BELDEN-4

There is no equal.™

Copyright © 1985, 1987 Cooper Industries, Inc.

See our catalog in EEM

CIRCLE NO 10



BELDEN