

EDNI[®]

ELECTRONIC TECHNOLOGY FOR ENGINEERS AND ENGINEERING MANAGERS WORLDWIDE

PROCESSOR UPDATES
PG 119

A CAHNERS PUBLICATION
May 7, 1992

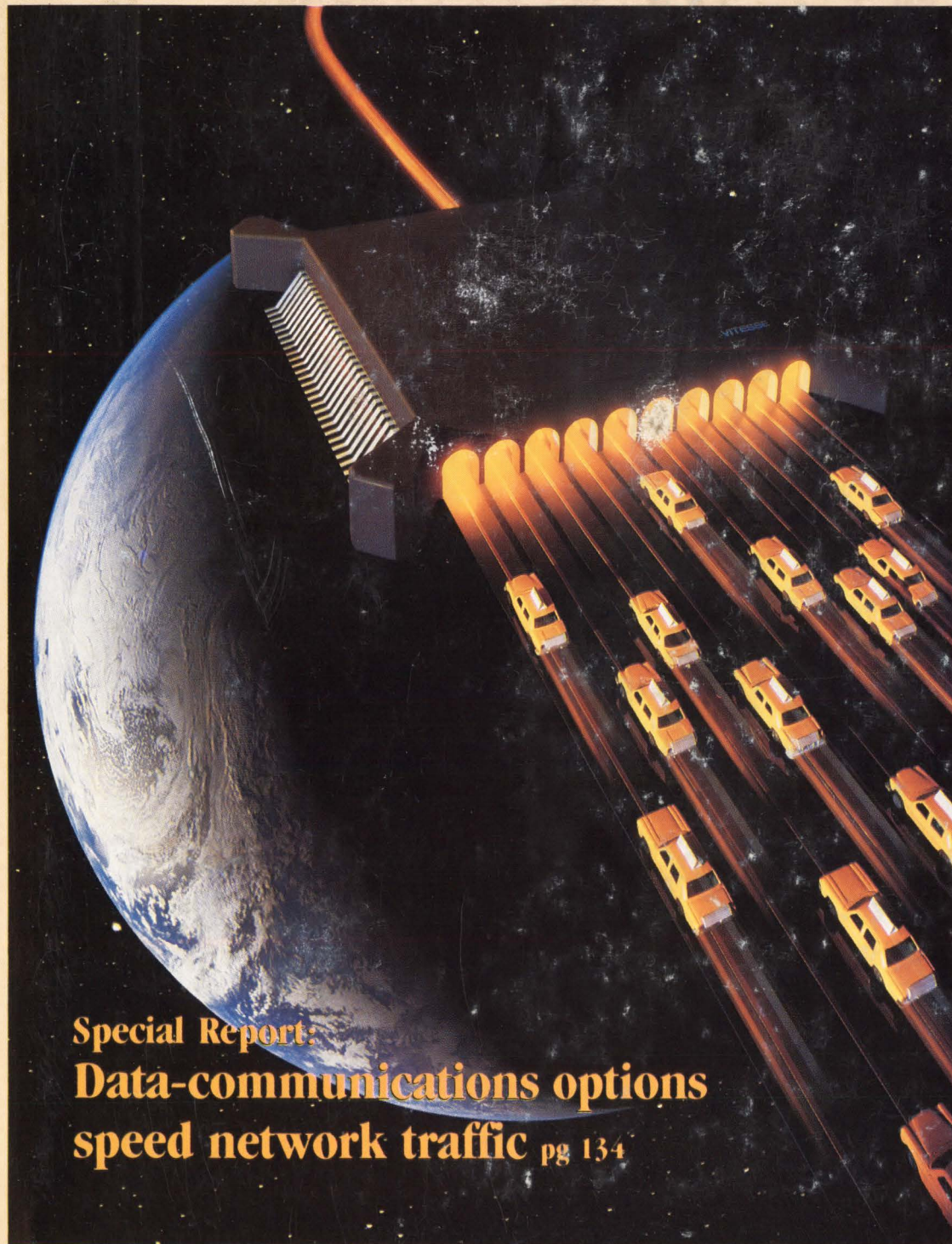

Special Report:
**Data-communications options
speed network traffic** pg 134

SPECIAL REPORT

**Data
communications**
pg 134

DESIGN FEATURES

**Electro/92
show preview
and products**
pg 153

**Concurrent
engineering**
pg 191

TECHNOLOGY UPDATES

**Generators take
the hassle out of
defining waveforms**
pg 65

**Modular
switching
power supplies**
pg 79

Crystal oscillators
pg 89

DESIGN IDEAS

**Expanded
coverage**
pg 197

PROFESSIONAL ISSUES

**Time
management**
pg 266

Within budget. Without compromise.

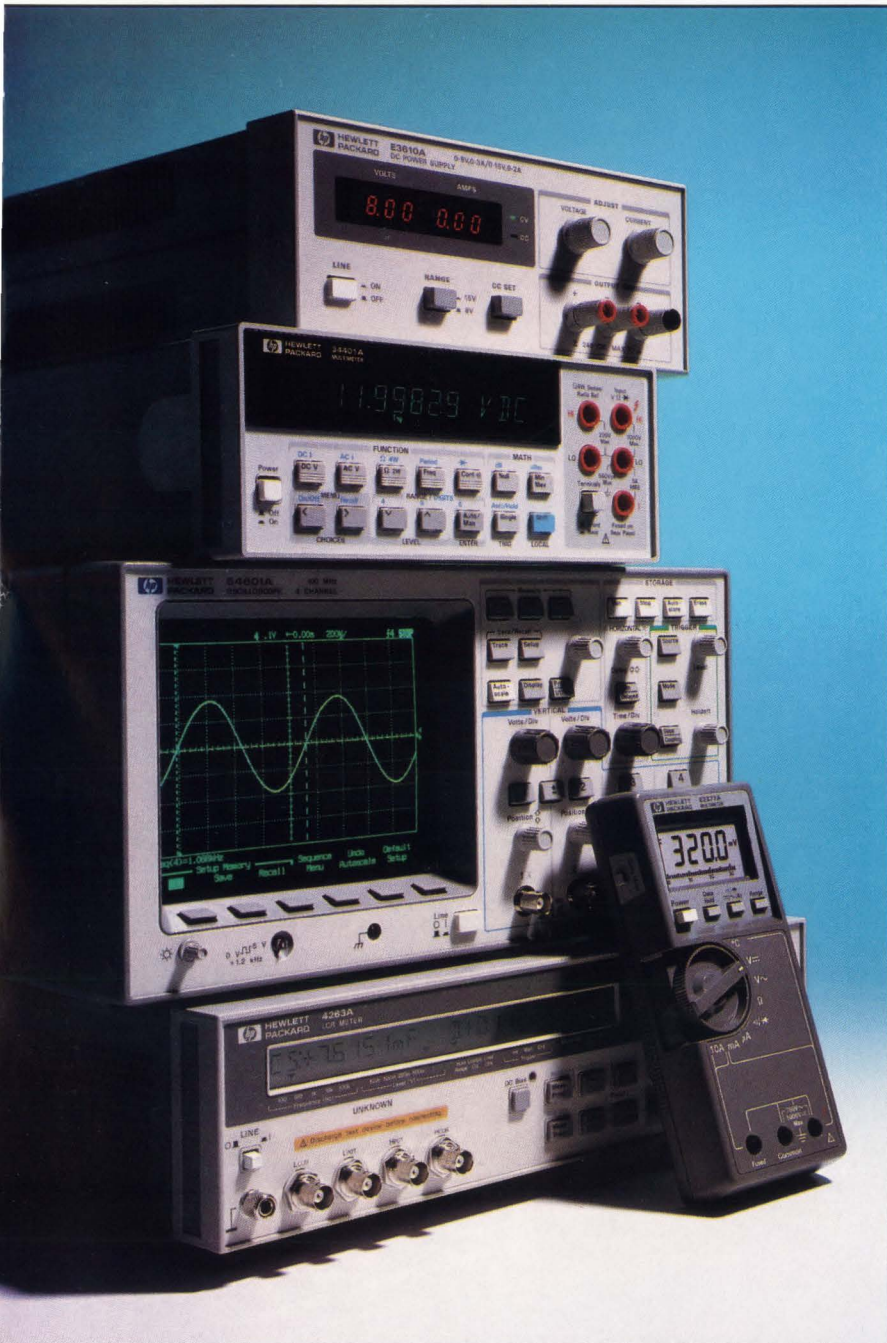

With HP basic instruments, performance costs less than you expect.

Now you don't have to accept trade-offs in a basic test instrument. Because HP offers the performance you want at prices you can afford.

Need a dual-range output power supply? The HP E3610 Series makes choosing a 30-watt dc power supply easy—especially when you consider the low noise and **\$300*** price.

What about a digital multimeter for bench or system use? The rugged 6 1/2 digit HP 34401A does both with uncompromised performance for **\$995***.

You won't find a better 100 MHz digitizing scope than the HP 54600 Series. It combines analog look and feel with digital troubleshooting power for only **\$2,395** (2-channel) or **\$2,895** (4-channel)*.

At **\$3,800***, the HP 4263A LCR Meter lowers the cost of high-precision 100 Hz to 100 kHz benchtop and system component measurements.

And the 8-function HP E2377A is just one of the HP E2300 Series 3 1/2 digit handhelds priced from **\$99** to **\$189***.

☎ For more information or same-day shipment from HP DIRECT, call 1-800-452-4844. Ask for Ext. T517 and we'll send you a data sheet that shows how affordable performance can be.**

* U.S. list price

** In Canada call 1-800-387-3867, Dept. 433

There is a better way.

 **HEWLETT
PACKARD**

2 WAYS TO COMPACT 7 PCs FOR REAL-TIME CONTROL, NETWORKING, AND DATA ACQUISITION, WITH A USER INTERFACE INTO ONE VERY SMALL BOX

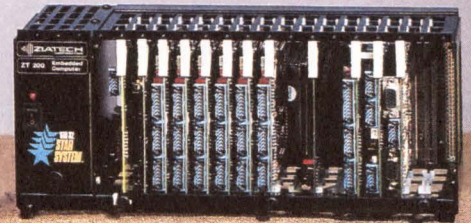

THE ALTERNATIVE TO BRUTE FORCE

Ziatech's new STD 32 STAR SYSTEM™ provides a simple-to-use, DOS-based, multiprocessing approach to automating real-time control applications. And it doesn't require a complex multitasking operating system, an expensive LAN, or the crushing of 7 PCs into a twisted bale of heavy metal.

A WINDOW INTO REAL-TIME CONTROL

Each processor in the STAR SYSTEM contains its own RAM, ROM, and DOS, while uniquely sharing disks, video, and equal access to I/O. This lets system designers segment a real-time control application into as many as seven separate computing modules. In a Microsoft Windows environment, the STAR SYSTEM becomes a Real-time Windows computer that puts real-time where it belongs, on processors separate from the user interface.

MULTIPLE COMPUTERS MEAN FAST DEVELOPMENT

The ability to run separate development tools such as Borland C++ or Microsoft QuickBASIC on each STAR SYSTEM processor helps OEM products get to market fast.

MAKE THE ONLY MULTIPLE CHOICE

Call or FAX today for a free data sheet or to arrange an on-site demonstration.



TEL 805-541-0488
FAX 805-541-5088

Circle No. 1

Product names of other companies may be trademarks of those companies.

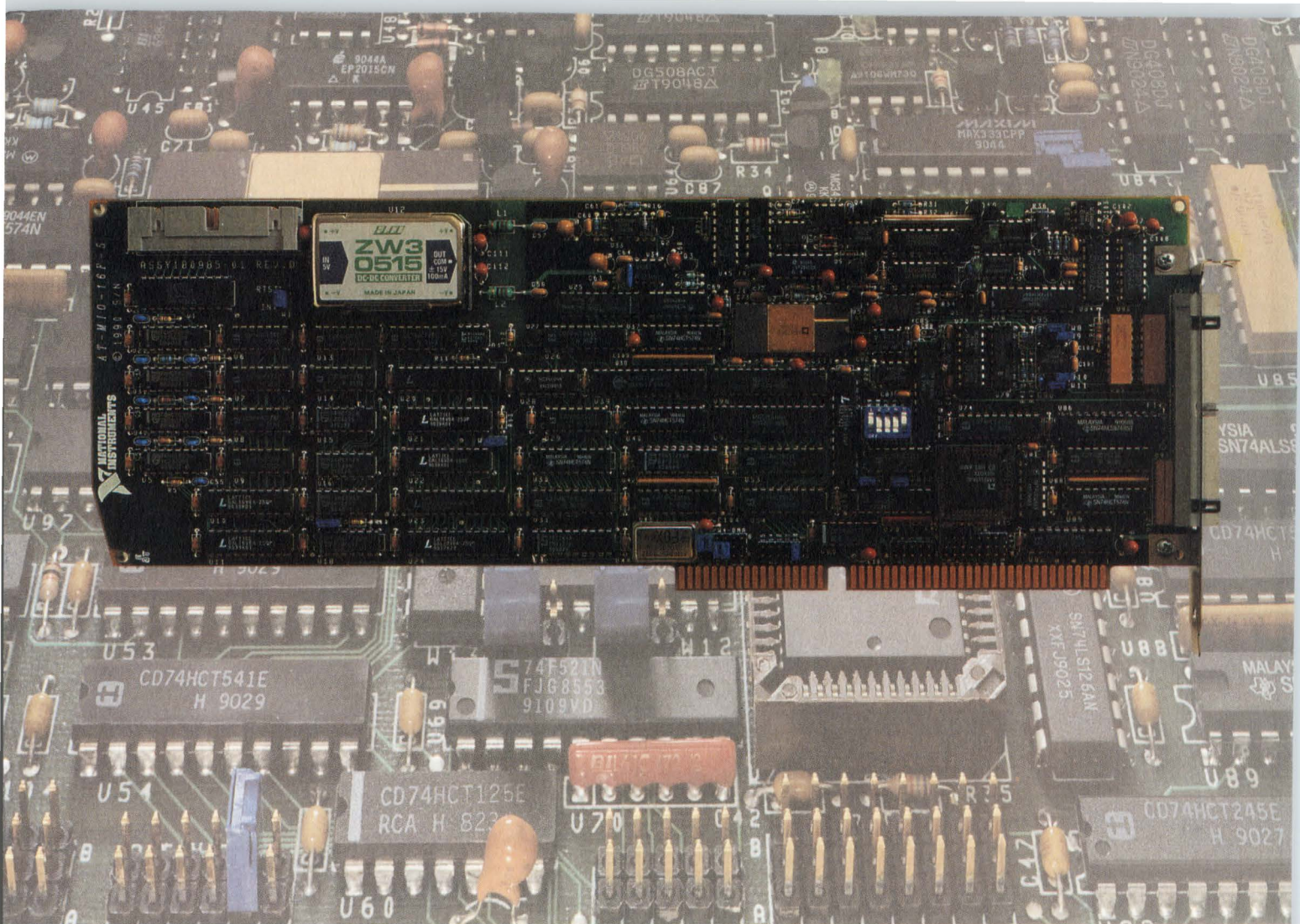

EXCELLENCE

Setting the New Standard in PC Data Acquisition

It takes a serious commitment to quality to deliver data acquisition boards that reliably meet the most demanding specifications. The National Instruments AT-MIO-16F-5 board creates a new standard in excellence with features not found on typical data acquisition boards. Most data acquisition boards have degraded accuracy at high sampling rates and high gains, due to instrumentation amplifier settling time. The AT-MIO-16F-5 does not. The AT-MIO-16F-5 is shipped with NI-DAQ™ driver software for Microsoft Windows and DOS, and DAQWare™ getting-started software.

The AT-MIO-16F-5 can also be programmed with LabWindows application software.

Other features of the AT-MIO-16F-5 include:

- 200 ksamples/sec sampling rate
- Instrumentation amplifier that settles at all gains and rates
- 12-bit resolution
- Software-configurable analog input
- True self-calibration
- Dither generator for extended resolution
- RTSI® bus for multiboard synchronization

The AT-MIO-16F-5 is one of the many plug-in data acquisition boards from National Instruments. With our **free DAQ Designer™** system configuration software tool, you can easily determine the best plug-in boards, signal conditioning products, and software for your specific application.



6504 Bridge Point Parkway
Austin, TX 78730-5039
Fax: (512) 794-8411

**For more information on the AT-MIO-16F-5 and your free copy of DAQ Designer, call us.
(512) 794-0100 or (800) 433-3488 (U.S. and Canada)**

AUSTRALIA 03 879 9422 • BELGIUM 02 757 00 20 • CANADA 519 622 9310 • DENMARK 45 76 73 22 • FRANCE 1 48 65 33 70 • GERMANY 089 714 50 93
ITALY 02 48301892 • JAPAN 03 3788 1921 • NETHERLANDS 01720 45761 • NORWAY 03 846866 • SPAIN 91 896 0675 • SWEDEN 08 984970 • SWITZERLAND 056 45 58 80 • U.K. 0635 523545
Product names listed are trademarks of their respective manufacturers. Company names listed are trademarks or trade names of their respective companies. © Copyright 1992 National Instruments Corporation. All rights reserved.

See us at Electro, booth 2201

Circle No. 2

THE TEMPUS™ CONNECTOR FROM ITT CANNON PROVIDES FASTER SIGNAL SPEED AND SPACE

Even if

SAVINGS. BOTH ARE ESSENTIAL WHEN DESIGNED FOR FUTUREBUS+. THIS INTERCONNECT

you're

SYSTEM MEETS WORLDWIDE DEMAND FOR HARD METRIC IN 2 MM PITCH. FOR DESIGN

not into

FLEXIBILITY, THE MODULES ARE STACKABLE. FOR INCREASED ELECTRICAL

Futurebus+,

PERFORMANCE, THE TEMPUS CONNECTOR HAS A SHORTER

this connector's

STUB LENGTH AND IS DESIGNED WITH A 45° CONTACT

still

ANGLE. LAPTOPS TO MAINFRAMES, IT MEETS HIGH

killer.

DATA RATE TRANSMISSION REQUIREMENTS.

CIRCLE NO. 4

ITT Cannon

1851 E. DEERE AVE., SANTA ANA, CA 92705-5720 (800) 845-7000



Where have Siliconix' industry leading analog switches been for the past twenty years?

BETWEEN A ROCK AND A HARD PLACE.



Over the years you've used our analog switches in products that have been from the rocky surface of Mars to hard places such as disk drives, oil drilling rigs, Patriot Missiles, and every application in between. We've been there for you — and been there first. Enabling you to cut your time to market and stay ahead of your competitors.

Timely technology leadership.

We were first with the DG200 Series. First with the DG400 Series of analog switches and multiplexers. And first again with the DG600 Series. That's what technology leadership is all about — being first to supply you with the industry's top performing devices.

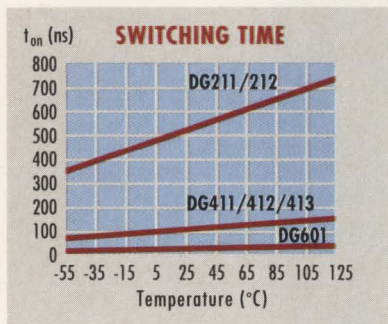

Proven process capability.

The DG400 Series is based on a high-voltage silicon-gate process technology utilizing thinner gate oxides, smaller feature sizes, and lower device thresholds. The result — faster switching, lower on-resistance, lower leakage,

less power consumption, tougher ESD tolerances, and higher reliability. And our new DG600 Series is even faster!

Where do we go from here?

To more rocks and hard places? Probably. Up in the air? Definitely — in the new video-on-demand systems coming soon to major airlines.

To learn more about our continuing commitment to technology leadership in analog switches contact your local Siliconix sales office. Or call our toll-free hot line now! **1-800-554-5565, Ext. 967.** Ask for your "Analog Switch Design Kit." And remember, when it comes to analog switches, there is only one industry leader. Siliconix.

Siliconix

2201 Laurelwood Road, Santa Clara, CA 95056

Siliconix, Inc. © Copyright 1991 Siliconix, Inc.

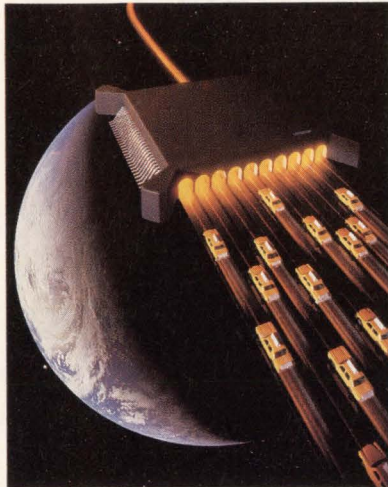

On the cover: New data-communications schemes are merging high performance and low cost to provide the data rates your high-end PCs and faster systems require. (Photo courtesy Vitesse Semiconductor) **PAGE 134**

Foldout contents

Turn to the last information-retrieval service card in the back of this magazine and you'll find a foldout table of contents. Now, instead of flipping back and forth from this table of contents to the articles you want to read, you can have the convenient foldout open at all times while you're reading EDN. Use the foldout contents to mark off articles you'd like your colleagues to read or to remind yourself to copy stories for your files.



ELECTRONIC TECHNOLOGY FOR ENGINEERS AND ENGINEERING MANAGERS WORLDWIDE

Data communications

SPECIAL REPORT

High-speed schemes, such as copper FDDI and Fiber Channel, promise to allow engineers to design systems that take advantage of LANs' utility without reducing system performance or breaking the bank.

—*Maury Wright, Technical Editor*

134

Electro/92

DESIGN FEATURES

Electro/92 will offer more than 60 technical sessions and 800 exhibits.—*Dave Pryce, Technical Editor*

153

Electro/92 products

160

Phase compensation optimizes photodiode bandwidth

There is a trick to compensating photodiode amplifiers for stable operation and maximum bandwidth. Classical analysis is more likely to confuse you than to help you, but an intuitive understanding of the circuits' operation can quickly lead to selecting the best compensation.—*Jerald Graeme, Burr-Brown Corp*

177

Concurrent engineering speeds development time, lowers costs

To be competitive in the 1990s, your company must embrace concurrent-engineering philosophies. Implementing these philosophies requires that everyone in your organization understands the basics of the product-development cycle.—*Jon Turino, Logical Solutions Technology Inc*

191

Continued on page 7

EDN® (ISSN 0012-7515, GST Reg. #123397457) is published 48 times a year (twice monthly with 2 additional issues a month, except for March and October, which have 3 additional issues and July and December which have 1 additional issue) by Cahners Publishing Company, A Division of Reed Publishing USA, 275 Washington Street, Newton, MA 02158-1630. Terrence M McDermott, President/Chief Operating Officer; Frank Sibley, Executive Vice President; Jerry D Neth, Senior Vice President/Publishing Operations; J J Walsh, Senior Vice President/Finance; Thomas J Dellamaria, Senior Vice President/Production and Manufacturing; Ralph Knupp, Vice President/Human Resources. EDN® is a registered trademark of Reed Properties Inc., used under license. Circulation records are maintained at Cahners Publishing Company, 44 Cook Street, Denver, CO 80206-5800. Telephone: (303) 388-4511. Second-class postage paid at Denver, CO 80206-5800 and additional mailing offices. **POSTMASTER: Send address changes to EDN®, PO Box 173377, Denver, CO 80217-3377.** EDN® copyright 1992 by Reed Publishing USA; Robert L Krakoff, President and Chief Executive Officer. Annual subscription rates for nonqualified people: USA, \$119.95/year; Mexico, \$169.95/year; Canada, \$181.85/year; all other nations, \$207.95/year for surface mail and \$329.95/year for air mail. Single copies are available for \$20 USA and \$25 foreign. Please address all subscription mail to Ellen Porter, 44 Cook Street, Denver, CO 80206-5800.

The Fluke 79: More Of A Good Thing

More high-performance features. More advanced measurement capabilities. More of the vital information you need to troubleshoot even the toughest problems — with both analog and digital displays.

Meet the latest, greatest member of our best selling 70 Series II family — the new Fluke 79 digital multimeter.

It picks up where the original family left off. In fact, it's a quantum leap forward — in performance, value and affordability.

It's got the features you'd expect from Fluke. Including high resolution. Fast autoranging. Patented, automatic Touch Hold®. A quick continuity beeper. Diode test. Automatic self-test. Battery-conserving sleep mode. And it's just as rugged and reliable as the rest of the 70 Series II family. Easy to operate, too — with one hand.

And thanks to the Fluke 79's proprietary new integrated circuit technology, that's only the beginning. When it comes to zeroing in on tough electrical problems, the Fluke 79 leaves the competition behind:

Hz

Frequency: The Fluke 79's built-in frequency counter lets you measure from below 1 Hz to over 20 kHz. And while you view frequency on the digital display, the analog bar graph shows you AC voltage. So you can see if potentially hazardous voltage is present.



Fast 63-segment analog bar graph: The Fluke 79's bargraph moves as fast as the eye can see, updating at a rate of 40 times per second to simulate the functionality of an analog needle. You get the high speed *and* high resolution you need to detect peaking, nulling and trending.



Capacitance: No need to carry a separate dedicated capacitance tester; the Fluke 79 measures capacitance from 10 pF to 9999 µF.

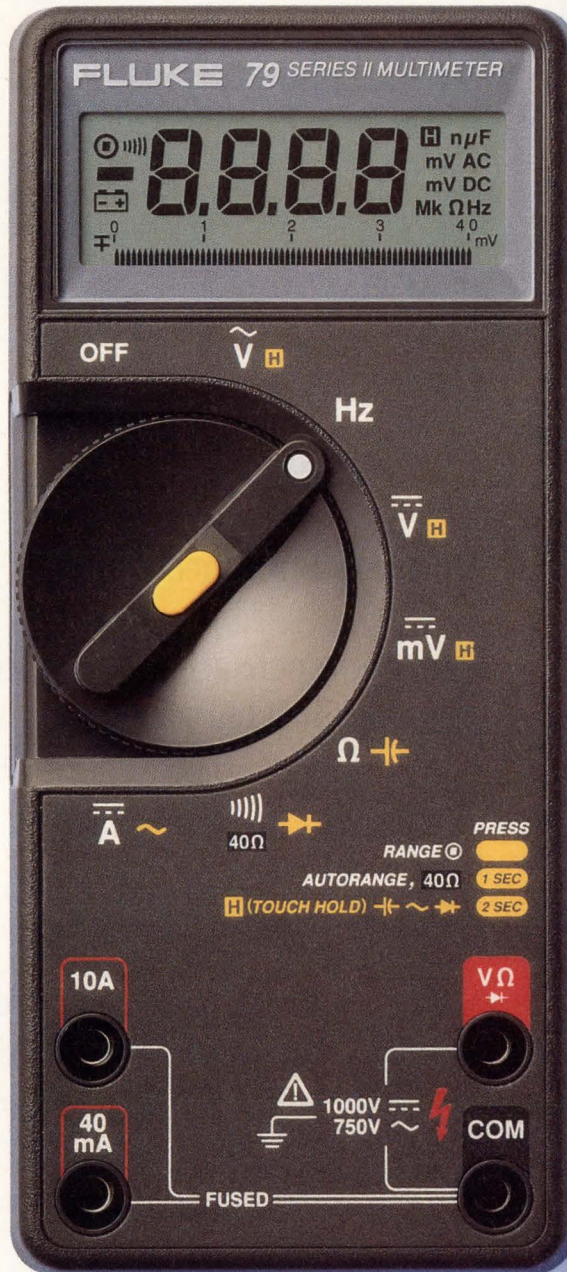

Actual Size

40Ω

Lo-Ohms range: Our proprietary Lo-Ohms function lets you measure resistance as low as 0.01 ohms. High noise rejection and a test lead Zero Calibration function make the Fluke 79 ideal for detecting small resistance changes.

SMOOTHING

Smoothing™: Our exclusive new Smoothing mode gives you a stable digital readout for unstable signals — by displaying the running average of eight readings. No more jitter or "digit rattle" due to noisy signals.

Get a good thing going: To put more meter to work for you — at a price that works for you, too — head for your nearest Fluke distributor. For the name of your nearest distributor, or for more product information, call 1-800-87-FLUKE.

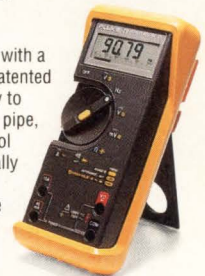

The Fluke 79 comes with a yellow holster and patented Flex-Stand™ — easy to hang from a door or pipe, clip onto a belt or tool kit, or stand at virtually any viewing angle. There's even storage space for test leads.

Fluke 79 Series II

\$185*
4000 Count Digital Display (9999 in Hz, capacitance, and Lo-Ohms)
63-segment Analog Bar Graph
0.3% Basic DC Voltage Accuracy
Automatic Touch Hold
Diode Test, Audible Continuity Beeper
Autoranging, Manual Ranging
Holster with Flex-Stand
Frequency Counter to over 20 kHz
Capacitance, 10 pF to 9999 µF
Lo-Ohms Range with Zero Calibration
Smoothing
700 Hours Battery Life (alkaline)
3-Year Warranty
* Suggested U.S. list price

FLUKE AND PHILIPS
THE T & M ALLIANCE

John Fluke Mfg. Co., Inc. P.O. Box 9090, M/S 250E Everett, WA 98206. © Copyright 1991. Prices and specifications subject to change without notice. Ad no. 00172.

FLUKE®

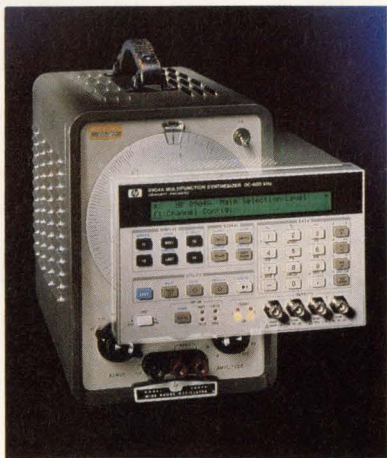

Through such techniques as using function libraries, instruments based on the technology of first-generation arbitrary-waveform generators now make obtaining basic waveforms simple. . . PAGE 65

EDN Magazine offers Express Request, a convenient way to retrieve product information by phone. See the Reader Service Card in the front for details on how to use this free service.

Express Request 

Generators take the hassle out of defining waveforms

TECHNOLOGY UPDATES

A signal source that uses digital technology and includes libraries of predefined functions can make short work of specifying waveforms.—*Dan Strassberg, Technical Editor*

65

High-power modular switching power supplies: Custom-configured supplies promote design flexibility

Power supplies made up of submodules let vendors satisfy wide-ranging power and voltage demands at lightning speed and without an engineering charge.—*Brian Kerridge, Technical Editor*

79

Crystal oscillators provide precision in high-speed systems

As system operating speeds increase, the need for high-precision clock sources gains importance. Crystal oscillators can provide the necessary precision.—*Tom Ormond, Senior Technical Editor*

89

PRODUCT UPDATES

Programmable-connection IC	105
CPU boards that use SPARC	108
Modular-instrumentation standard	110

PROCESSOR UPDATES

32-bit superscalar RISC μ P	119
68HC11 for 3.3V designs	120
μ C with 4-bit peripherals, 8-bit CPU	122
20-MHz static chip	126
Low-cost debug tool	128

Continued on page 9

Cahners Publishing Company, A Division of Reed Publishing USA Specialized Business Magazines for Building & Construction Research Technology Electronics Computing Printing Publishing Health Care Foodservice Packaging Environmental Engineering Manufacturing Entertainment Media Home Furnishings Interior Design and Lodging. Specialized Consumer Magazines for Child Care Boating and Wedding Planning.



THE CONVENIENT SOLUTION FOR HIGH SPEED CACHE.

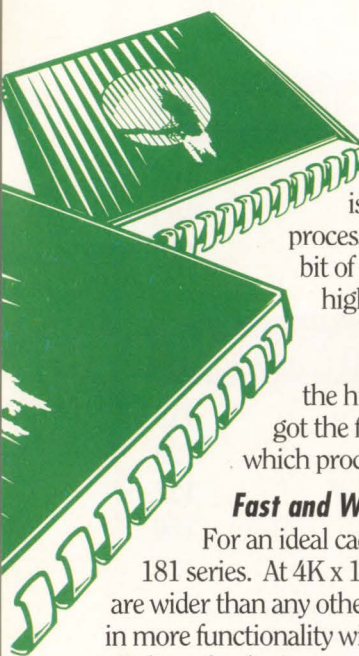

Your new RISC or CISC design is going to sport a fast, cutting-edge processor. Now, you've got to wring every bit of performance you can out of that high-revving CPU.

You need cache, and fast. Bank on Cypress Semiconductor, the high-performance specialist. We've got the fast cache you need...no matter which processor is driving your system.

Fast and Wide Cache Tags.

For an ideal cache tag solution, select the CY7B180/181 series. At 4K x 18, these high-integration, 12 ns parts are wider than any other solution at this performance. Design in more functionality with fewer tags and less performance-stealing glue logic.

*In Europe fax your request to the above dept. at (32) 2-652-1504 or call (32) 2-652-0270. In Asia fax to the above dept. at 1 (415) 961-4201. © 1992 Cypress Semiconductor, 3901 North First Street, San Jose CA 95134. Phone: 1 (408) 943-2600, Telex 821032 CYPRESS SNJ UD, TWX: 910-997-0753. SPARC is a registered trademark of SPARC International, Inc. Products bearing the SPARC trademark are based on an architecture developed by Sun Microsystems, Inc.

Fast Cache RAMs.

For cache RAM, our BiCMOS CY7B173/174 parts work hand-in-hand with popular high-performance CPUs. They've got a 14 ns max access delay and the on-chip counters you need to support either the 486 or the linear burst sequences of 68040 and 960 processors.

When you're working with the fastest CPUs around, call Cypress for your design-in needs. Call or fax your request today for your fact-filled Cache Data Pack.

**FAST CACHE HOTLINE: 1-800-858-1810*.
Ask for Dept. C43.**



CYPRESS
SEMICONDUCTOR

Home Office

275 Washington St, Newton, MA 02158
 EDN Bulletin Board: (617) 558-4241
 MCI: EDNBOS
 (617) 558-extension

VP/Publishing Director

Peter D Coley -4673

VP/Publisher

Roy Forsberg -4367

VP/Editor/Editorial Director

Jonathan Titus -4573

Executive Editor

Steven H Leibson -4214

Managing Editor

Joan Morrow Lynch -4215

Assistant Managing Editor

Christine McElvenny -4741

Gary Legg, *Senior Technical Editor* -4404
 Tom Ormond, *Senior Technical Editor* -4414
 Charles Small, *Senior Technical Editor* -4556
 MCI: EDNSMALL. Compuserve: 70324, 3270
 John A Gallant, *Technical Editor* -4666
 John C Napier, *Technical Editor* -4690
 Dave Pryce, *Technical Editor* -4326
 Dan Strassberg, *Technical Editor* -4205
 Julie Schofield, *Senior Associate Editor* -4619
 Jay Fraser, *Associate Editor* -4561
 Carl Quesnel, *Associate Editor* -4484
 Susan Rose, *Associate Editor* -4738
 Helen McElwee, *Senior Copy Editor* -4311
 James P Leonard, *Copy Editor* -4324
 Gillian A Caulfield, *Production Editor* -4263
 Brian J Tobey, *Production Editor* -4309

Editorial Field Offices

Doug Conner, *Technical Editor*
 Atascadero, CA: (805) 461-9669
 MCI: EDNDCONNER

J D Mosley, *Technical Editor*
 Arlington, TX: (817) 465-4961
 MCI: EDNMOSLEY

Richard A Quinnell, *Technical Editor*
 Aptos, CA: (408) 685-8028
 MCI: EDNQINNELL

Anne Watson Swager, *Technical Editor*
 Wynnwood, PA: (215) 645-0544
 MCI: EDNSWAGER

Ray Weiss, *Technical Editor*
 Woodland Hills, CA: (818) 704-9454
 MCI: EDNWEISS

Maury Wright, *Technical Editor*
 San Diego, CA: (619) 748-6785
 MCI: EDNWRIGHT

Brian Kerridge, *Technical Editor*
 22 Mill Rd, Loddon
 Norwich, NR14 6DR, UK
 (508) 28435
 MCI: EDNKERRIDGE

Contributing Editors

Robert Pease, Don Powers,
 David Shear, Bill Travis

Editorial Coordinator

Kathy Leonard -4405

Editorial Services

Helen Benedict -4681

Art Staff

Robert L Fernandez, *Art Department Director*
 Ken Racicot, *Senior Art Director* -4708
 Chinsoo Chung, *Associate Art Director* -4446
 Cathy Madigan, *Associate Art Director* -4599

Marketing & Business Director

Deborah Virtue -4779

Marketing Communications

Kathy Calderini, *Manager* -4526
 Pam Winch, *Promotion Specialist* -4660

DSP—Transform your world

EDITORIAL

EDN's DSP conference, scheduled for October 14 to 16, will unravel the mysteries of digital signal processing.

57

—Jon Titus, *Editor*

DESIGN IDEAS

Our special expanded Design Ideas section includes nine ideas, Software Shorts, and Feedback & Amplification.

197

Take control of your time

PROFESSIONAL ISSUES

You won't have to work long hours if you manage your time better.—Jay Fraser, *Associate Editor*

264

NEW PRODUCTS

Components & Power Supplies.	226
CAE & Software Development Tools.	234
Test & Measurement Instruments.	239
Integrated Circuits.	246
Computers & Peripherals.	250

DEPARTMENTS

Inside EDN.	11
News Breaks.	19
Signals & Noise.	31
Ask EDN.	43
Calendar.	48
Literature.	260
Career Opportunities.	278
Business Staff.	282
EDN's International Advertisers Index.	284
EDN's Acronyms & Abbreviations.	287
Hands On!.	289

0 1.0 2.0 3.0

COUNT ON IDT

When Every Nanosecond Counts

Squeeze critical nanoseconds from your high-speed logic interface with the fastest FCT logic available. IDT's FCT-CT family offers speeds that are 50% faster than standard FCT or FAST logic families — as fast as 3.4ns (typical)!

The Perfect System Solution

As a system designer, you need the perfect combination of:

1. **Fastest speed**
2. **Low ground bounce**
3. **Low power consumption**

FCT-CT logic has true TTL compatibility for ease of design. The reduced output swings and controlled output edge rate circuitry ensure low system noise generation. No other technology offers higher speeds or lower power consumption.

The FCT-CT family is completely pin- and function-compatible with FCT logic, and is available today in all standard packaging.

FUNCTION	PROPAGATION DELAY (Max)	OUTPUT ENABLE (Max)	OUTPUT DISABLE (Max)
Buffers	4.1ns	5.8ns	5.2ns
Transceivers	4.1ns	5.8ns	4.8ns
Registers	5.2ns	5.5ns	5.0ns
Latches	4.2ns	5.5ns	5.0ns

Free Logic Design Kit

Call our toll-free hotline today and ask for **Kit Code 3061** to get a **1991 High-Speed CMOS Logic Design Guide** and **free FCT-CT logic samples**.

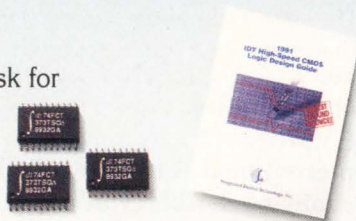

(800) 345-7015 • FAX: 408-492-8454

The IDT logo, CEMOS, BiCEMOS, and R3051 are trademarks of Integrated Device Technology, Inc.

12ns 256K SRAMS

Fastest cache solutions for RISC and CISC CPUs. 36+ ultra-high-speed sub-micron SRAMs for 33MHz processing & beyond are in the **SRAM Data Book**.



35mips RISC CHIPS AND MODULES

R3000A for the most mips at any MHz; R3051 for CPU, cache, & buffers on one chip. Modules, eval. boards & software complete the family. See them in the **RISC Data Book**.

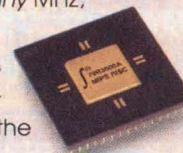

HIGHEST-PERFORMANCE MEMORIES

Fast FIFOs, dense dual-ports, BiCEMOS ECL, & memory modules. 120+ FIFOs & multi-port memories, 5ns ECL, & multi-chip modules are in the

Specialized Memories Data Book.



Call today for your new IDT data books with complete technical specifications and application information.

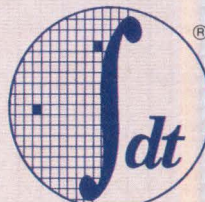

Integrated Device Technology, Inc.

INSIDE EDN

A summary and analysis of articles in this issue

We dedicate all of the articles in EDN to making your job easier, but in this issue we've gone at that task with a vengeance. Do you need a customized power supply quickly? Would you like to create complex waveforms in the lab with little effort? Perhaps you'd like help breaking through one of the last great bottlenecks of computer system design: networks. You'll find help on all of these topics in this issue.

In his Special Report, Technical Editor Maury Wright looks at the large throughput gains we're about to experience in LANs. The 100-Mbps FDDI LAN has been far too costly for conventional LANs, but Maury explains why that situation is about to end. See his sidebar on low-cost FDDI for more information. If you can't wait for the imminent drop in FDDI prices, you should look at some of the alternative proprietary LAN protocols discussed in this article.

Even if the products you design don't employ LANs, it's a good bet they incorporate power supplies. Although you've been able to order custom power supplies for many years, decreasing product design cycles make it tougher than ever to wait for a custom supply to be designed and built. Worse, decreasing product life cycles ensure that your power supply requirements will change often. Modular power supplies, the topic of Technical Editor Brian Kerridge's Technology Update, can alleviate both of these problems. Using modular components, vendors can provide built-to-order power supplies in a few days.

Brian tells you who these vendors are and what types of products you can get.

The same short product design and life cycles put real pressure on you to test your initial designs as quickly as possible. And you often need to test parts of a system before other sections are ready. Arbitrary-waveform generators (ARBs)

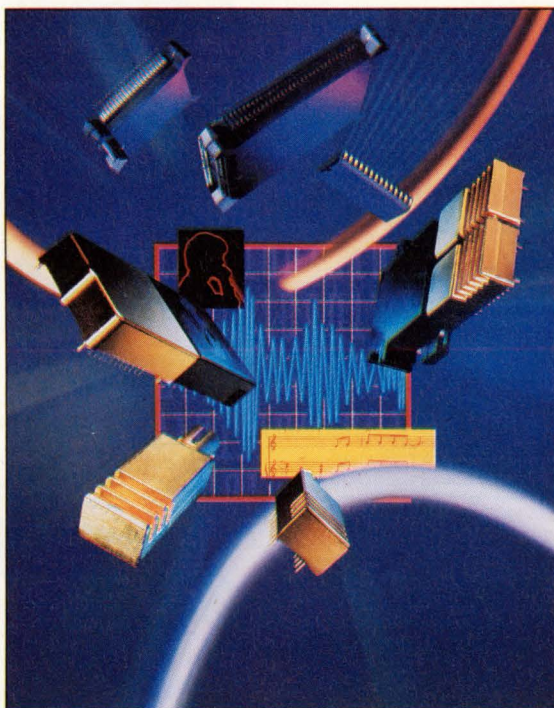

This issue's Special Report covers data communications.

can simulate parts of a system not yet built. For complex signals, it sometimes feels as though it's almost as hard to generate the waveform as it is to get the missing system components built. The latest batch of ARBs, which Technical Editor Dan Strassberg discusses in his Technology Update, makes this task much easier through the inclusion of function libraries and algorithmic waveform storage. At the same time, vendors are experimenting with several different user interfaces, which Dan summarizes.

Steven H Leibson
Executive Editor

Technical calculations made easy!

ALL NEW VERSION 3.0!



Mathcad [mathcad.mcd]
Edit Text Math Graphics Symbolic Window Help
Dimensions of the aluminum block will be 3.5 feet by 4.5 feet by 1.4 inches.
$$m = 4.5 \text{ ft} \cdot 14 \text{ in} \cdot 105 \cdot 200 \frac{\text{lb}}{\text{ft}^3} = 3.937 \cdot 10^5 \text{ lb}$$
 (Density of Al from the Mathcad Electronic Handbook)
An 4 supports (circular section radius 2 inches) this works out to
$$A = 4 \cdot (\pi \cdot (2 \text{ in})^2) = 40.419 \frac{\text{in}^2}{\text{ft}^2}$$
 is this load going to be OK?
How about the cooling, the switch at the right shows the kind of profile we want at the edges. The rate of loss depends on temperature, roughly like this:
$$f(T) = \frac{(2.3 \cdot 10^4)}{(11 - 240)^2 + 4 \cdot (11 - 120)^2)} \cdot T$$
 reaction $T = 50 \cdot 300$
The worst case is around 140 degrees so for a 6 month lifetime we need
$$6 \text{ months} \cdot (1140) = 8.342 \text{ m}$$

This will add quite a lot to the cost (this stuff is expensive) At \$165 per gallon
$$165 \cdot 7.33 = 1209.45 \text{ dollars}$$

Now it's easier than ever to perform faster, more reliable engineering and scientific calculations.

- **Windows graphics features make Mathcad 3.0 the simple solution to complex analytic needs.** Dialogs, pull-down menus, and mouse point-and-click capabilities make it easy to combine equations, text, and graphics right on your screen and print it all in a presentation-quality document.
- **New Electronic Handbook Help facility serves as an on-line reference library.** Paste standard formulas, constants, and diagrams from searchable, hypertext Electronic Handbooks for instant use in your Mathcad worksheet.
- **Symbolic calculations with a simple menu pick.** Use expressions resulting from symbolic derivations in your numeric calculations or for further symbolic manipulation.
- **Mathcad works on PC DOS, PC Windows, Macintosh, or UNIX.** More than 120,000 engineers, scientists, and educators already use Mathcad for a variety of technical applications. Applications packs are also available to customize Mathcad for particular disciplines, including electrical, mechanical, and civil engineering and advanced math.

Call 800-MATHCAD or use this coupon to request a free 3.0 demo disk!

In Massachusetts, call 617-577-1017. Please specify diskette size:

3 1/2" 5 1/4"

For a free Mathcad 3.0 Introductory kit, clip this coupon and mail it back to us, or fax it to 617-577-8829. Or circle your reader service card.

Yes! Tell me more about Mathcad 3.0!

Name _____
Title _____
Company or Institution _____
Address _____
City _____ State _____ Zip _____
Phone(_____) _____

Mail this coupon to:
MathSoft, Inc.
201 Broadway
Cambridge, MA 02139
USA
EDN 13 TECH 3.0

CIRCLE NO. 8

EDN May 7, 1992 • 11

It Takes Some Characteristics To



The Silver Surfer and The Incredible Hulk are trademarks of Marvel Entertainment Group, Inc. © 1991. All rights reserved.

Very Special Be #1 In EPROMs.



AMD EPROMs today are what other mere mortal EPROMs can only aspire to be: high density, of course. But also high speed. Able to store massive amounts of information, with lightning fast access times. All in our superior CMOS technology.

EPROMs have always been our strength—thanks to our unparalleled performance, selection, reliability, and quality.

That's why we sell more EPROMs than any other vendor.* Period. And we're ready to do the same for years to come. While other vendors have abandoned EPROMs, we're still committed—to making the fastest, highest density EPROMs.

In fact, we've got the most advanced EPROM wafer fab, assembly and test facilities in the world. Which produce the most reliable, highest quality EPROMs available. In everything from surface mount plastic to mil spec compliant packages.

So make yourself a hero. The instant you know your EPROM requirements, get them fast. Get them dense. Get them in volume. And get them right away.

Call AMD at **1-800-222-9323** for more information. Or call your local sales office to place an order.



Advanced Micro Devices

901 Thompson Place, P.O. Box 3453, Sunnyvale, CA 94088 © 1991 Advanced Micro Devices, Inc.
All brand or product names mentioned are trademarks or registered trademarks of their respective holders.
*Dataquest, March 1991, based on 1990 data.

If BYTE-WIDE DRAMS improve so many aspects of memory modules, why can't they improve

The ECONOMICS *of* MODULES? [*They can.*]

Byte-wide DRAMS in memory modules. When you compare a 4-meg byte-wide with the normal combination of 1-megs and 256K's, you find that one chip can replace six.

Now that in itself sounds pretty

good. And it gives you lots of design advantages.

Far lower use of board real estate. Greater reliability. And—what's critical for laptops—far lower power consumption.

But now byte-wides also give you an advantage in *cost*—on x36 modules like the 256Kx36 and 512Kx36.

Because the single byte-wide costs less than the six chips it replaces.

Samsung byte-wides. You name it—they improve it.

PART	ORG.	SPEEDS
KM416C256*	256KX16	70, 80, 100 ns
KM418C256	256KX18	70, 80, 100 ns
KM48C512*	512KX8	70, 80, 100 ns
KM49C512	512KX9	70, 80, 100 ns

*WPB AVAILABLE



And also because board assembly is less expensive.

So if you've been wishing you could exploit the design advantages of byte-wides but have been holding off for cost reasons, hold

off no more—the future is here.

At Samsung, byte-wide technology lets you improve even the *economics* of modules.

For more information, please call 1-800-446-2760 today.

Or write to DRAM Marketing, Samsung Semiconductor Inc., 3655 No. First St., San Jose, CA 95134.



A Generation AHEAD.

If you think DSPs are priced
Our TMS320 family starts at

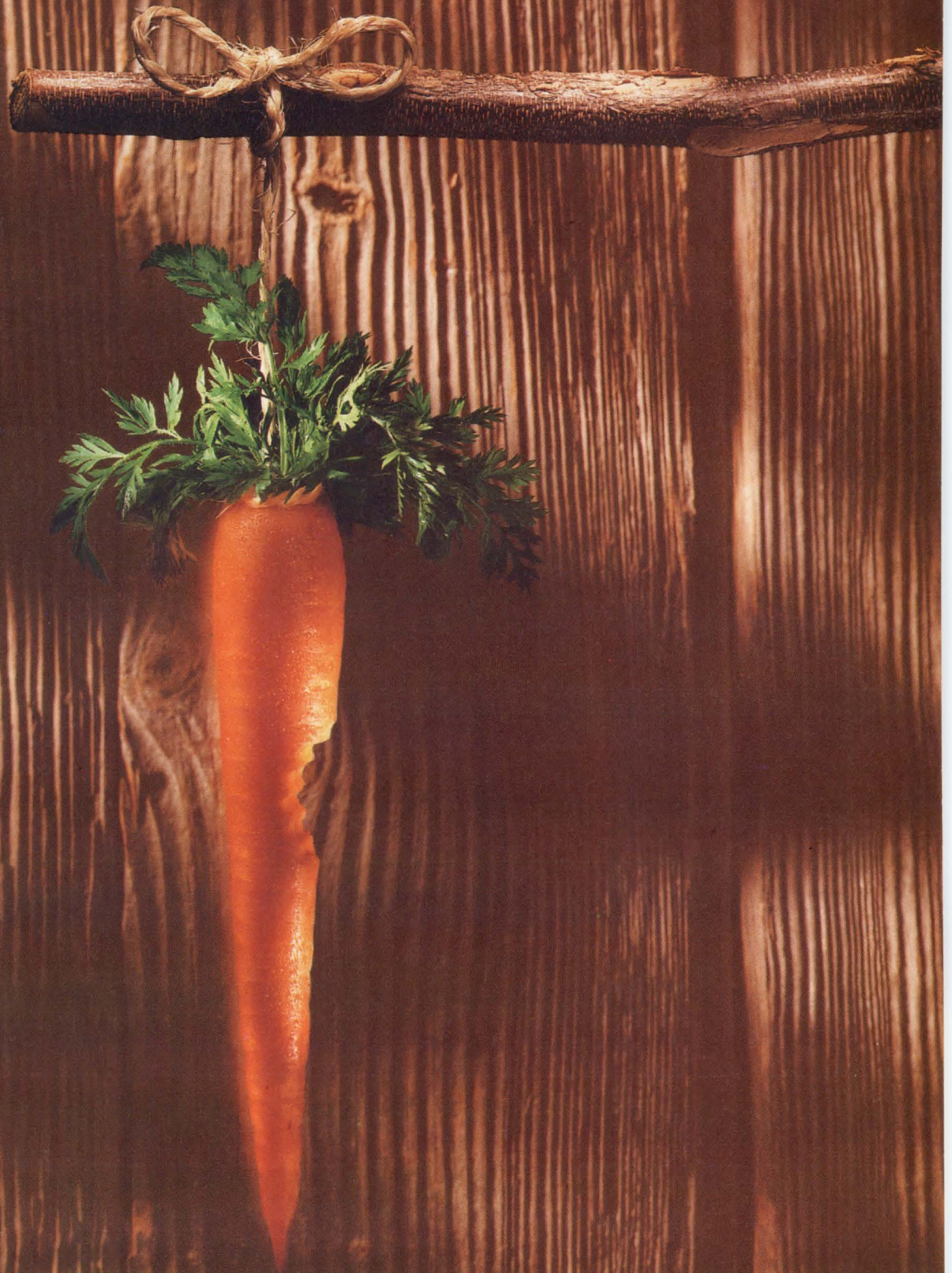

out of reach, think again. just \$3.

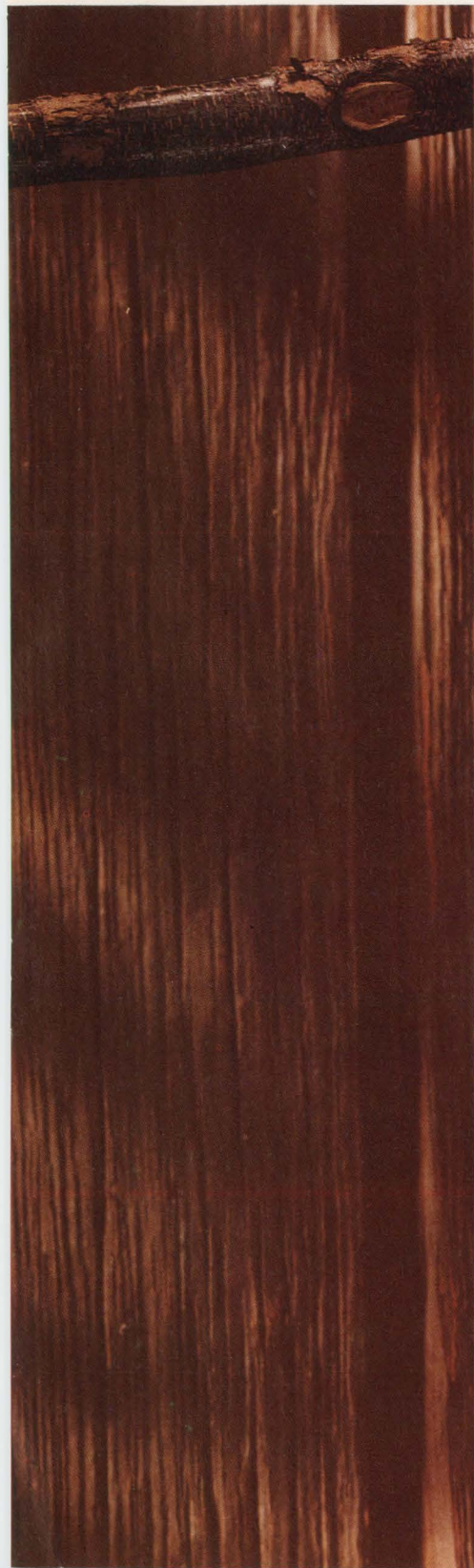

Cost is no longer a barrier to using DSPs. At Texas Instruments, our TMS320 family is well within your reach, thanks in large part to a decade of DSP leadership.

16-bit DSPs as low as \$3

Our 16-bit, fixed-point solutions begin at \$3. At that, they are on a price par with microcontrollers and are as easy to use, yet give you 10X the performance.

These DSPs are extremely well suited to high-volume applications, providing you with opportunities to optimize price/performance ratios. In fact, our 16-bit DSPs are replacing microcontrollers in mainstream applications such as answering machines and disk drives.

32-bit DSPs starting at \$25

You can get floating-point performance at a fixed-point price. Starting as low as \$25, our 32-bit floating-point DSPs are finding widespread use in embedded, cost-sensitive applications. Performance is superior to RISC processors because of highly paralleled architectures.

In addition to a low unit price, several features contribute to overall cost-effectiveness. These devices are inherently easy to use and are optimized for use with high-level-language compilers, which helps you get to market faster.

When you require a custom approach, we have the unique capability to adapt our 16- and 32-bit DSPs to your needs.

The entire TMS320 family is supported by an extensive array of development tools, readily accessible applications help and full documentation to help enhance your productivity and cut development time.

Passing savings on to you

In the 10 years since TI introduced its first single-chip DSP, we have shipped tens of millions of these devices worldwide. And we have applied the principles of manufacturing excellence learned from our commitment to DRAM manufacturing. This has resulted in the economies of scale that enable us to provide you with true value and dependable prices.

To put TI's DSPs within reach, call 1-800-336-5236, ext. 3536

We'll send you information on our TMS320 family, world-class support and customizable capability (cDSP). You'll also get our interactive disk, "Designing with DSPs is Easy" – a look at TMS320 support and the TMS320 Programmer's Interface.

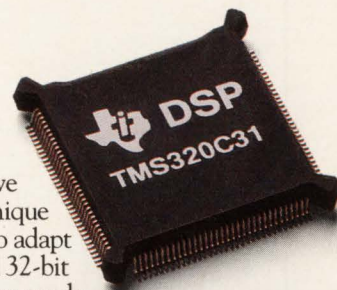

 **TEXAS
INSTRUMENTS**

LANIER

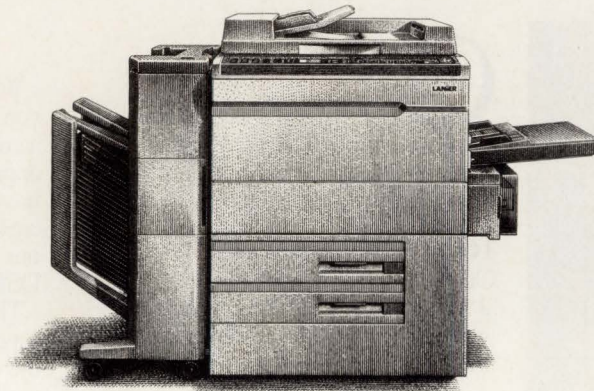

**New Employees Promise
To Perform, Too. But Will
They Put It In Writing?**



Lanier does. In fact, our Performance Promise* guarantees that you'll be completely satisfied with your copier, or we'll replace it at no charge. And if it's

down more than 8 hours, we'll provide a free loaner. For details and a free copier information package, call your local Lanier rep. Or **1-800-852-2679**. You'll see why we outperform the others. Promise.

Tools help find mixed-signal-IC test problems

The \$80,000 Dantes (design and test engineering system) software tools from Cadence speed the development of analog and mixed-signal-IC tests that will run in production on large-scale automatic test systems. Currently, more than 50% of the time required to develop analog and mixed-signal ICs is spent developing and debugging the test programs, and in some cases, the specialized hardware required to make the programs run. For the most part, test development for these ICs takes place after silicon is available. Because test development takes so much time and takes place in series with the rest of the IC-design process, test development has a major impact on an IC's development cost and time to market. With the software, IC manufacturers will now be able to run simulated production tests on models of devices under development so that they can learn how to modify the device designs and the test methodology to maximize throughput and yield.

The software provides tools for describing the attributes of mixed-signal ATE; determining whether a proposed test methodology can be implemented on a particular tester; determining what specialized hardware is not part of the test system—and therefore must be placed on a "load board" that's unique to an IC or IC family; generating a load-board layout; sequencing the tests so that tests most likely to fail run first; and, sequencing the tests so that ones that leave the tester or device in states critical to proper operation of subsequent tests run in the proper order. The software will be available by the third quarter of 1992. Description files for testers from Hewlett-Packard, LTX, Teradyne, and Yokogawa will be available from the ATE suppliers. Cadence Design Systems Inc, San Jose, CA, (408) 943-1234, FAX (408) 943-0513.

—Dan Strassberg

Electrical rules drive place-and-route tool

If your high-performance-circuit schematic designs need reams of paper to tell the board-design specialist the do's and don'ts of laying out the board, you might want to consider a product that lets you integrate the rules

into your design. Board Station 500 from Mentor Graphics accommodates network topology control, signal path lengths, matched path lengths, stub lengths, layer restrictions, via limits, balanced pair routing, parallelism control, and shielding generation.

A circuit designer uses the software to work with parameters such as time

delays and timing skew limits. The integrated transmission-line analysis tools from Quad Design (Camarillo, CA) translates the timing parameters into physical design rules—such as line lengths, widths, and length matching—that the board designer needs to complete the pc-board or multichip-module design. The \$125,000 software is available on HP-Apollo, HP Series 700, and Sun SPARCstations. Mentor Graphics Corp, Wilsonville, OR, (800) 547-3000 Dept 107, FAX (503) 685-8001.

—Doug Conner

Dual-port SRAMs offer semaphores

The CY7B13X and CY7B14X family dual-port static RAMs from Cypress Semiconductor provide on-chip logic that helps simplify memory-access arbitration in multiprocessor systems. The logic includes interrupts, Busy signals, and semaphores, which help processors on each port communicate their use of shared memory. The devices are also fast enough to support 50-MHz systems; family members offer access times as fast as 15 nsec. They come in 4k × 8-bit and 8k × 9-bit configurations, with differing sets of arbitration signals. Prices range from \$42.10 to \$84.20. Cypress Semiconductor, San Jose, CA, (408) 943-2600.

—Richard A Quinnell

Develop DSP systems under Windows

DSPworks Version 2.0 operates under Windows, letting you develop and test DSP systems on a personal computer. Functions let you acquire and process data and then display it, save it to a file, or put it out to a DSP board. The software supports DSP boards from a variety of suppliers, including Ariel, Data Translation, Spectrum Signal Processing, and Sonitech. In addition to acquiring data, you can use the software to generate and process test signals to test and debug your DSP applications. Additional tools from the company let you develop filters and produce code for commercial DSP chips. Momentum Data Systems, Costa Mesa, CA, (714) 557-6884, FAX (714) 557-6969.—Jon Titus

DSP μ P boosts digital-cellular applications

The power, size, and processing requirements of digital-cellular telephones are extremely stringent. AT&T Microelectronics has addressed all three issues with a single DSP1616 DSP μ P programmed to perform the VSELP speech compression and speech error-correction function required in IS-54 digital-cellular terminals. (VSELP is the type of

Text continued on pg 20

Mass-storage chip set offers programmability

Hard-disk-drive designs typically require custom analog circuits to handle data and servo functions, but that may change with a 3-chip set from AT&T Microelectronics. The chip set uses a combination of programmable analog- and digital-signal-processing techniques to provide designers with the necessary flexibility in a standard product. The three chips are the Search1 servo-channel device, the Reach2 read-channel device, and the Spin1 servo-processor interface. All three are implemented in 0.9- μm CMOS and collectively dissipate $<1\text{W}$ when active.

A main feature of the chip set is its programmability, supporting multizone, constant-density recording at data rates from 6.67 to 40 Mbps. Factors such as pulse-detector qualification thresholds, analog-filter corner frequencies, data precompensation, and data-synchronizer window shift combine with a programmable timing generator and DSP to give you control of virtually all of the operating parameters and qualification levels in your disk drive.

A development kit is available to help speed your system design effort using the Search1 chip set. The kit includes an evaluation board, source code for actuator and servo-spindle control, DSP and microcontroller assemblers, and application notes. You can use the board with any 80C31 emulator for debugging control software. The board also includes a prototyping area. Sample prices are approximately \$10 for the Search1 and Reach2 chips and \$4 for the Spin1. The devices come in shrink quad flatpacks. AT&T Microelectronics, Allentown, PA, (800) 372-2447, ext 829, FAX (215) 778-4106.—Richard A Quinnell

Text continued from pg 19

speech coder specified for the IS-54 digital-cellular standard.) To ensure high speech quality, the DSP1616 VSELP engine (\$37 (10,000)) has an S/N ratio of 34 dB, which is 12 dB higher than required by the standard. To lengthen talk times and reduce the weight of the telephone, the device consumes less than 60 mA of current from a 5V battery when driven with a 20-MHz clock. The de-

vice comes in a 100-pin shrunken quad flatpack that stands less than 1.5 mm high and measures $14 \times 14 \text{ mm}^2$. The device includes a selectable spectral post filter, a selectable loopback function for testing, and flexible host and codec interfaces. The company provides a set of hardware- and software-development tools for the DSP, which together cost approximately \$7500.

The company also announced a partnership

with Mitsui Co Ltd (Tokyo, Japan; in the US, Mitsui Comtek Corp, Saratoga, CA), and Teknekron Communications (Berkeley, CA) to market the chip globally. The VSELP device is the first product from the development effort, and it's just one piece of the digital-telephone subsystem. Mitsui is primarily serving a distribution function, but Teknekron Communications is a software company that provides expertise in algorithm design, DSP software, and system integration. An entire chip set for the subsystem will be available early next year. AT&T Microelectronics, (800) 372-2447; in Canada, (800) 553-2448.

—Anne Watson Swager

Math routines in C simplify DSP tasks

If you're developing software for Texas Instrument's (Dallas, TX) TMS320C30, C31, and C40 DSP ICs and writing programs in C, you may be able to speed up your software's math operations. A series of math routines in the Fastar library developed by Tartan Inc (Monroeville, PA) can reduce C-code execution times for math operations by an average of 40%. To apply the routines, you replace existing math routines in Texas Instrument's C compiler with those supplied by Tartan. The company also defines 14 new

math routines such as cot, asinh, and invsqrt (inverse of the square root). The math routines cost \$495 and are available from Spectrum Signal Processing Inc, Burnaby, BC, Canada, (604) 438-3046, FAX (604) 438-3046.—Jon Titus

It's not too late to buy Heathkits

In March, the New York Times reported that Heath (Benton Harbor, MI) was closing out the last of its electronics kits to concentrate on home-improvement products and educational materials. However, the company doesn't expect to run out of kits until the end of the year. Heath's latest catalog has 14 pages of kits ranging from laptop computers to logic analyzers to surround-sound processors. The 10 beginners' kits include electronic dice, an infrared motion detector, a wireless microphone, and a digital clock. Phone (800) 253-0570 for a catalog.

—Julie Anne Schofield

EEPROM packs more speed in smaller package

Seeq Technology Inc has shrunk its 28C010 1-Mbit ($128\text{k} \times 8\text{-bit}$) EEPROM, reducing the die area by 44%. The smaller device now fits into a 32-pin leadless chip carrier, offering a board density improvement over the device's original 44-pin pack-

Text continued on pg 22

IS A 50¢ LINEAR REGULATOR BURNING UP YOUR BOARD?

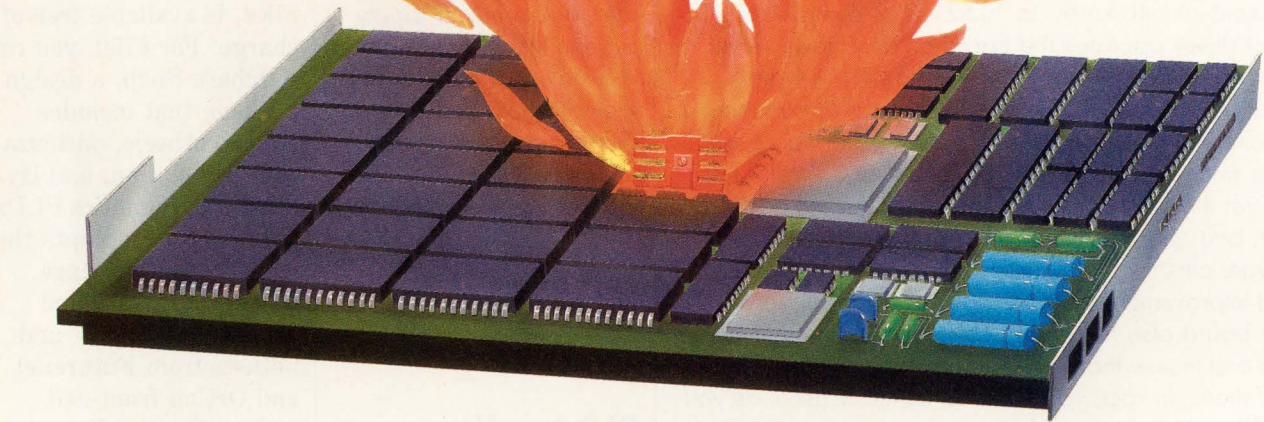

PLAY IT COOL WITH OUR 1.5 AMP INTEGRATED SWITCHING REGULATOR

Do you have a board with a 3-terminal linear regulator that's generating more heat than an irate customer? Are you locked into a tight compact design that leaves no extra space for a larger heatsink? Fortunately, you can now play it cool with an innovative product from Power Trends—a 1.5 Amp Integrated Switching Regulator (ISR) that needs no heatsink.

Power Trends' 1.5 Amp ISR is pin-compatible with existing 3-terminal "78 and 79 Series" linear regulators, fits into the same space, and is just as easy to use. With 85% efficiency, our ISR provides a cool replacement alternative

for a hot linear regulator. Of course it costs more, but it could save you thousands.

Specifications include: laser-trimmed output voltages from 3.3 to 15 volts, calculated MTBF of over 1,000,000 hours, 0.2% line and 0.4% load regulation, and power densities of 25 to 100 watts per cubic inch.

So if you have a heat/space/reliability problem now, or just want to make sure you don't have one in the future—check out Power Trends' super-efficient ISR. Call or write for more information, and ask about samples.

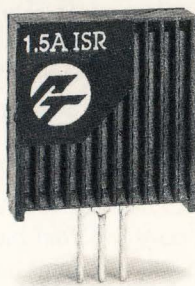

POWER TRENDS

Power Trends, Inc. 1101 North Raddant Road, Batavia, IL 60510 • (708) 406-0900 • FAX (708) 406-0901

CIRCLE NO. 70

EDN May 7, 1992 • 21

SBus card speeds graphics and adds users

You can augment graphics performance and add fast multiuser capabilities to SBus-based workstations with the GXTRA/1 graphics-accelerator board. The \$1995 board occupies one slot and has software-programmable display resolutions of 640 × 480 to 1152 × 900 pixels. A SunOS display driver operates the board as an XNews server that accepts OpenWindows, X-Window X11R4 and X11R5, and Sunview display commands, all simultaneously. The company claims that the graphics performance of this card is twice that of Sun Microsystems' GX accelerator card, yet the card consumes only 4 Mbytes of address space, one quarter of that consumed by the GX card. A hardware cursor on the card is responsible for part of the speed improvement, and it eliminates cursor flicker.

The board also has a port for a Sun-compatible keyboard and mouse that lets you add a user to SPARC-based workstations. In fact, you can add as many users as you have SBus slots. Each added user requires one GXTRA/1 card, a keyboard, and a mouse (additional \$298), as well as a color display monitor. The company says that the total cost of these parts is less than \$2900 per user, but it also recommends that you add memory for each new user. The GXTRA/1 is a cost-reduced version of the company's \$2500 GXTRA/W series, which can operate displays with resolutions to 1600 × 1280 pixels but lacks the programmable-resolution ability. Tech-Source Inc, Altamonte Springs, FL, (407) 830-8301, FAX (407) 339-2554.

—Steven H Leibson

Text continued from pg 20

age. It is also the same size as 256-kbit EEPROMs. The smaller die brings a performance boost to the part. The device's access time has dropped from 120 to 90 nsec and its write cycle from 5 to 3 msec. As with the larger version, the smaller 28C010 offers on-chip error correction and software write protection. The device costs \$354 (100); a MIL-STD-883 version costs \$510. Samples will be available in May. Seeq Technology, San Jose, CA, (408) 432-5801, FAX (408) 432-1640.

—Richard A Quinnell

Mix JFET and bipolar with amp input stage

Analog Device's OP-275 dual op amp uses a newly patented input architecture (named the Butler architecture for the IC's designer). This architecture combines bipolar- and JFET-transistor design techniques to provide the accuracy and low-noise performance of bipolar designs with the speed and dynamic range of JFET op amps. The OP-275 (\$0.99 (100)) saves power and board space and increases speed, voltage-

noise, and distortion performance compared with all-bipolar or all-JFET designs. Key specifications include 0.0006% THD plus noise, voltage noise of 6 nV/√Hz at either 30 Hz or 1 kHz, a 25V/μsec slew rate, and 5 mA of supply current. Input offset voltage is a maximum of 1 mV and typically is 200 μV. The device comes in an 8-pin surface-mount package. Analog Devices Inc, Precision Monolithics Div, Santa Clara, CA, (408) 562-7456.

—Anne Watson Swager

PLD handles 32-bit-wide bus structures

The PML2852 PLD from Signetics provides enough I/O capacity to handle two 32-bit buses, offering 29 dedicated input pins, 16 dedicated output pins, and 24 bidirectional pins. It also offers a flexible internal logic structure. The device's core includes 96 258-input NAND gates and 20 buried J-K flip-flops. The output pins of the gates and flip-flops fold back into the array, enabling you to cascade logic without sacrificing I/O pins. The device has a 35-nsec propagation delay and comes in 84-pin plastic leaded chip carriers (\$24) or J-leaded ceramic quad packages (\$70 (1000)). It is also available in a 50-nsec speed grade.

Signetics supports the device with test hardware on chip and design software. The test hardware

lets you configure the device in a scan-test mode, letting you examine or change states of I/O pins through a serial-interface port. The design software comes in two varieties. A basic design package, Slice, is available free of charge. For \$750, you can purchase Snap, a design package that includes logic synthesis, optimization, simulation, and layout for all Signetics PLDs. The software accepts the Abel design language, schematics, state and Boolean equations, and netlists from Futurenet and OrCad front-end tools. Signetics Co, Sunnyvale, CA, (408) 991-2321, contact Paul Sasaki.

—Richard A Quinnell

Flash memory reaches 8-Mbit density

Intel Corp released a 1M × 8-bit flash EEPROM device organized as 16 independently erasable 64-kbyte blocks with 100,000-cycle endurance. The 28F008SA (\$29.90 (10,000)) offers self-completing write and erase cycles, enabling you to access the device much like a static RAM. Because writing or erasing an EEPROM location requires 10 μsec, the device also offers a ready/busy status pin to signal the system that it is not yet available for another write command. The device, however, does let you read from one block while another is being

Text continued on pg 24



Chips, lead frames, carriers
and molding compound
can't lift you out of the crowd.

Dale® is the partner you need to convert surface mounting from concept to reality. We can save you time by providing a wide range of functions from one proven source.

This includes the industry's most versatile choice of surface mounted thick and thin film chip resistors and resistor networks. Plus wirewound resistors, chip potentiometers, thermistors, inductors, transformers and oscillators.

Partnering with Dale gives you broad compatibility with automatic placement equipment and standard soldering methods, plus ship-to-

Dale® Can.

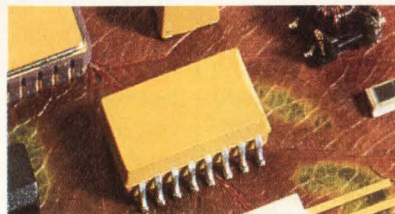

stock capability assured by strong emphasis on statistical process control.

For complete information, call:

Thermistors: 915-592-3253;
Thick Film Resistor Networks,

CIRCLE NO. 26

Thick/Thin Film Chips:
402-371-0080; **Wirewound Resistors:** 402-563-6506;
Chip Potentiometers, Oscillators:
602-967-7874; **Inductors, Transformers:** 605-665-9301.

A COMPANY OF
VISHAY

DALE®

Neural system incorporates versatile hardware unit

Neural Technologies' NT5000 neural-networking system consists of software and hardware to let you set up, train, and investigate performance of a neural network in a range of applications. The PC-based, mouse-supported software lets you develop a network of 4000 neurons, 32,000 connections, and a user-specified number of hidden layers. Using a graphical user interface, you also use the software to define and set up a hardware configuration from a selection of modules in the processing unit. You then download data via RS-232C from the PC to the processing unit and proceed to train the network with data from live signal inputs.

The processing unit contains I/O modules that include a 16-bit bidirectional digital interface, a dc to 150-kHz analog input, audio amplifier, and optional CCIR video interface. Other integrated hardware includes an internal loudspeaker, a 5-channel multiplexer, filters, an 8-bit DAC, and an LCD. The processing unit is portable, measures 275 × 280 × 85 mm, and operates from an external 9V supply, which is provided with the package. Once you have set up, downloaded, and trained your network, you can disconnect the processing unit from the PC and transport it to your application.

Extensive facilities exist for network editing during and after the training phase of operation. For example, you can either prune out or add whole layers to the network, or progressively remove low-effect interconnections to speed up operation. While training, you receive visible feedback of the network's performance from actual and rms error plots, and a weighted histogram indicates overall effectiveness. At any time you can halt operation, edit the network, and continue training from the same point or restart. In addition, you can import entire networks to NT5000 from other neural software, such as California Scientific Software's Brainmaker and Neuralware's Neuralworks.

The system comes in basic, turbo, or video versions. The basic configuration includes software and a processing unit for 630 neurons, 4500 connections, 2k-interconnects/sec, and 5-kHz analog signals (\$7500). Turbo version extends capacity to 4000 neurons, 32,000 connections, 2M interconnects/sec, and includes 32-bit digital I/O (\$9900). Video version adds CCIR interface and video monitor, and includes image processing (due third quarter of 1992). Neural Technologies Ltd, Petersfield, UK, 730-260256, FAX 730-260466. In US, California Scientific Software, Nevada City, CA, (916) 478-9040, FAX (916) 478-9041.

—Brian Kerridge

Text continued from pg 22

erased. You can read data as fast as 85 nsec.

The company has used the device to build its Series 2 Flash Memory Cards on the PCMCIA 2.0 card standard. The series offers densities of 4, 10, and 20 Mbytes and will be available in 5 and 3.3V versions. The 4-, 10-, and 20-Mbyte cards cost \$163.50, \$331.50, and \$611.50, respectively, (1000). Intel Corp, call or fax your local office.—Richard A Quinnell

ASIC family offers 600,000 gates three ways

LSI Logic is accepting designs for its 300K family of ASICs based on a 0.6- μ m (drawn) CMOS process. You can obtain devices as large as 600,000 used gates with more than 800 I/O pins. If you're after the lowest design cost, use the LCA300K compacted-array series. The series is a sea-of-gates design that has ECL-like I/O buffers and built-in termination resistors. For the highest density, the LCB300K series uses standard-cell design and features libraries with both SPARC and Mips processors. Striking a balance between the two is the LEA300K series, which you design by using a combination of standard cells and gate arrays. You can then begin wafer fabrication before your design has been fully tested by using the gate-array portion to make last-minute

corrections. Nonrecurring engineering charges for the family start at \$30,000, and production shipments begin by the fourth quarter of 1992. LSI Logic, Milpitas, CA, (408) 433-8000.—Richard A Quinnell

Perform time-domain analysis in Windows

Snap-Master Analysis lets you analyze, display, store, and retrieve time-domain data while working in the Microsoft Windows 3.0 or 3.1. This \$495 program includes arithmetic, trigonometric, logarithmic, and statistical functions. It also provides auto- and cross-correlation, smoothing, three types of differentiation, and five types of integration. A tabular format defines and stores constants, equations, and algorithms. You create an analysis procedure by dragging icons from the program's on-screen toolbox. You can define data flow by using data pipes to connect icons.

You view data using y-time, y-x, and trip-chart emulations. Disk I/O elements let you store and replay both the equation definitions and the resultant data in your files. You can read more than one data file at a time and analyze multiple data files simultaneously. You can use the software with a \$995 Snap-Master Data Acquisition program that also operates within. HEM Data Corp, Southfield, MI, (313) 559-5607.—J D Mosley

When You Need Service, Illinois Capacitor Stands Tall.

The best capacitors with the best service and support... that's what Illinois Capacitor is all about.

IC starts by helping you choose the right capacitor to fit your application and budget.

You'll save labor too, with IC's value-added services, which include epoxy end sealing, tape and reel/ammo pack, cut leads, and selection to special capacitor tolerances. Whatever your needs, your order will be filled with 100% burn-in tested capacitors to assure dependability and save you QC time.

Don't settle for just capacitors. Demand the industry's best quality capacitors and service. Call your local IC distributor or IC. Do it today!

Ask for **FREE**
Capacitor Engineering Guide.

CIRCLE NO. 27



ic[®]
ILLINOIS CAPACITOR, INC.

3757 West Touhy Avenue, Lincolnwood, IL 60645
(708) 675-1760 • Fax: (708) 673-2850



RF TRANS

Over 50 off-the-shelf models...

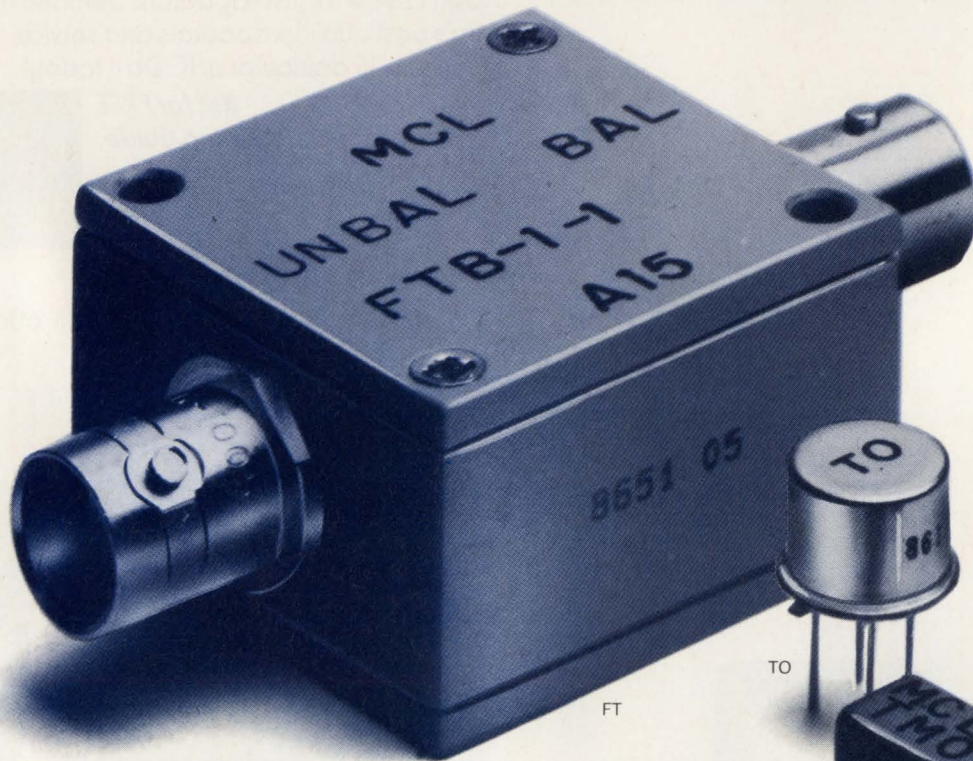

Having difficulty locating RF or pulse transformers with low droop, fast risetime or a particular impedance ratio over a specific frequency range? ... Mini-Circuits offers a solution.

Choose impedance ratios from 1:1 to 36:1, connector or pin versions (plastic or metal case built to meet MIL-T-21038 and MIL-T-55831 requirements*). Ultra-wideband response achieves low droop and fast risetime for pulse applications. Ratings up to 1000M ohms insulation resistance and up to 1000V dielectric voltage. For wide dynamic range applications involving up to 100 mA DC primary current, use the T-H series. Coaxial connector models are offered with 50 and 75 ohm impedance; BNC standard; request other types. Available for immediate delivery with one-year guarantee.

Call or write for 68-page catalog or see our catalog in EEM, or Microwaves Product Data Directory.

*units are not QPL listed

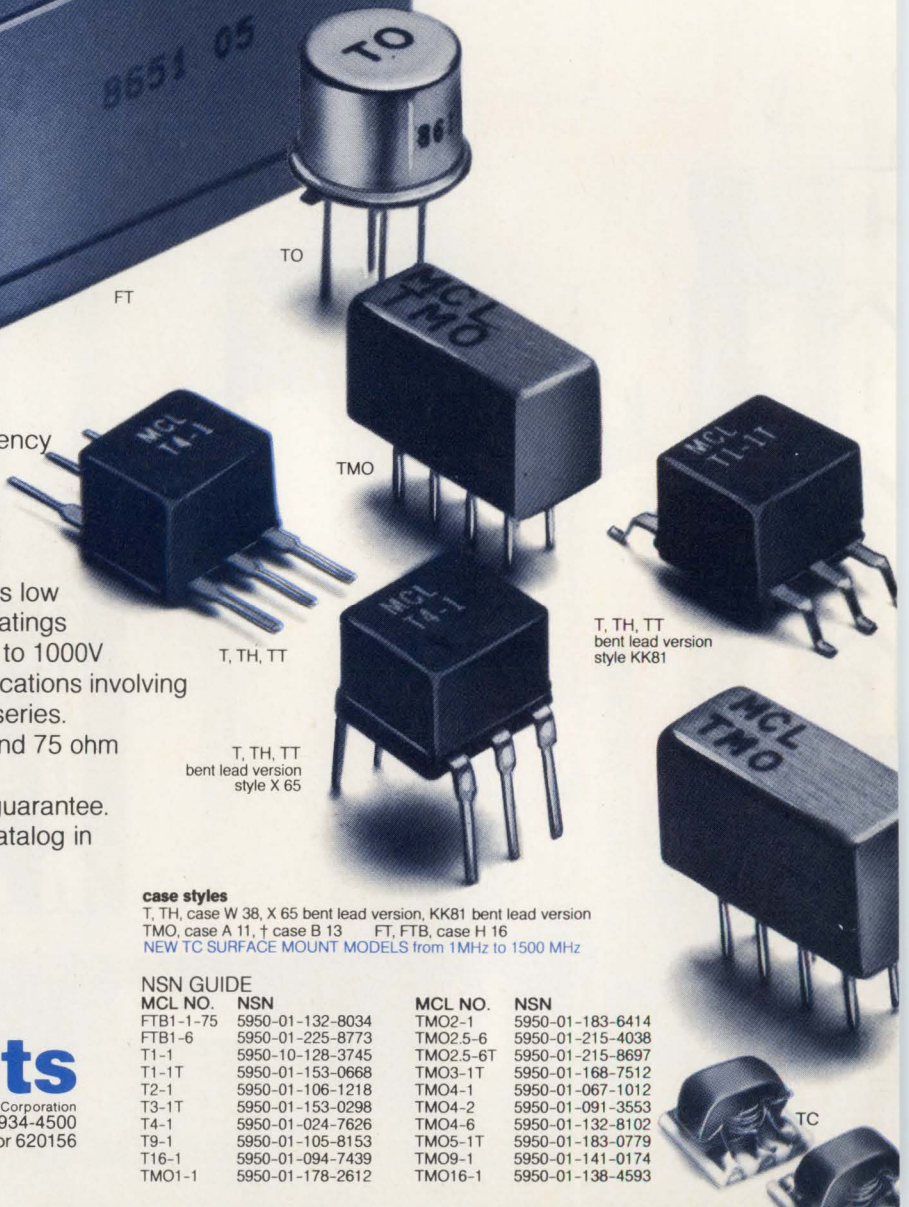

case styles

T, TH, case W 38, X 65 bent lead version, KK81 bent lead version
TMO, case A 11, † case B 13 FT, FTB, case H 16
NEW TC SURFACE MOUNT MODELS from 1MHz to 1500 MHz

NSN GUIDE

MCL NO.	NSN	MCL NO.	NSN
FTB1-1-75	5950-01-132-8034	TMO2-1	5950-01-183-6414
FTB1-6	5950-01-225-8773	TMO2.5-6	5950-01-215-4038
T1-1	5950-10-128-3745	TMO2.5-6T	5950-01-215-8697
T1-1T	5950-01-153-0668	TMO3-1T	5950-01-168-7512
T2-1	5950-01-106-1218	TMO4-1	5950-01-067-1012
T3-1T	5950-01-153-0298	TMO4-2	5950-01-091-3553
T4-1	5950-01-024-7626	TMO4-6	5950-01-132-8102
T9-1	5950-01-105-8153	TMO5-1T	5950-01-183-0779
T16-1	5950-01-094-7439	TMO9-1	5950-01-141-0174
TMO1-1	5950-01-178-2612	TMO16-1	5950-01-138-4593

finding new ways ...
setting higher standards

Mini-Circuits

A Division of Scientific Components Corporation

P.O. Box 350166, Brooklyn, New York 11235-0003 (718) 934-4500

Fax (718) 332-4661 Domestic and International Telexes: 6852844 or 620156

FORMERS

3KHz-800MHz from \$3²⁵

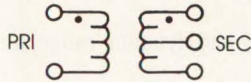
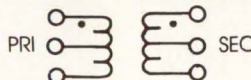
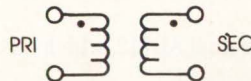
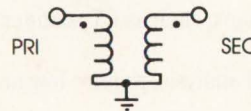
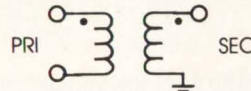
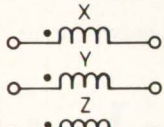
case style number see opposite page	MODEL NO.	Ω RATIO	FREQUENCY MHz	INSERTION LOSS			PRICE \$		
				3dB MHz	2dB MHz	1dB MHz			
A* 	T	T1-1T	1	.05-200	.05-200	.08-150	2-80	4.45	
		T1-6T	1	.003-300	.003-300	.01-150	02-50	6.95	
		T2-1T	2	.07-200	.07-200	.1-100	5-50	4.95	
		T2.5-6T	2.5	.01-100	.01-100	.02-50	50-20	4.95	
		T3-1T	3	.05-250	.05-200	.1-200	5-70	4.95	
		T4-1	4	2-350	2-350	.35-300	2-100	3.25	
		T4-6T	4	.02-250	.02-250	.05-150	0.1-100	4.45	
		T5-1T	5	3-300	3-300	6-200	5-100	4.95	
		T8-1T	8	.03-140	.03-140	.10-90	1-60	7.95	
		T13-1T	13	3-120	3-120	.7-80	5-20	4.95	
		T16-6T	16	.03-75	.03-75	.06-30	1-20	5.65	
		TH	T4-1H	4	10-350	10-350	15-300	25-200	5.95
		TMO	TMO1-1T	1	.05-200	.05-200	.08-150	2-80	7.95
			TMO2-1T	2	.07-200	.07-200	.1-100	5-50	8.45
			†TMO2.5-6T	2.5	.01-100	.01-100	.02-50	05-20	8.45
			†TMO3-1T	3	.05-250	.05-250	.1-200	5-70	7.95
		TMO4-1	4	2-350	2-350	.35-300	2-100	6.25	
		TMO5-1T	5	3-300	3-300	6-200	5-100	8.45	
		TMO13-1T	13	3-120	3-120	.7-80	5-20	8.45	
B* 	TT	TT1-6	1	.004-500	.004-500	.02-200	1-50	6.95	
		TT1.5-1	1.5	.075-500	.075-500	2-100	1-50	5.95	
		TT2.5-6	2.5	.01-50	.01-50	.025-25	05-10	6.45	
		TT4-1	3	.05-200	2-50	2-50	1-30	5.95	
		TT4-1A	4	0.1-300	0.1-300	0.2-250	0.3-180	6.95	
		TT25-1	25	.02-30	.02-30	.05-20	1-10	9.95	
		TTMO	TTMO25-1	25	.02-30	.02-30	.05-20	1-10	11.95
			TTMO1-1	1	.005-100	.005-100	.01-75	05-40	11.45
			TTMO4-1A	4	0.1-300	0.1-300	0.2-250	0.3-180	13.95
	C 	T	T1-1	1	.15-400	.15-400	.35-200	2-50	3.25
		T1.18-3	1.18	0.01-250	0.01-250	0.02-200	0.03-50	5.65	
		T1-6	1	.01-150	.01-150	.02-100	05-50	5.65	
		T1.5-1	1.5	.1-300	.1-300	2-150	5-80	4.45	
		T1.5-6	1.5	.02-100	.02-100	.05-50	0.1-25	5.65	
		T2.5-6	2.5	.01-100	.01-100	.02-50	05-20	4.45	
		T4-6	4	.02-200	.02-200	.05-150	1-100	4.45	
		T9-1	9	.15-200	.15-200	3-150	2-40	3.95	
		T16-1	16	3-120	3-120	.7-80	5-20	4.45	
		T36-1	36	.03-20	.03-20	.05-10	1-5	6.95	
		TO	TO-75	1	10-500	—	10-500	40-250	6.95
		TH	T1-1H	1	8-300	8-300	10-200	25-100	5.95
			T9-1H	9	2-90	2-90	3-75	6-50	6.45
			T16-H	16	7-85	7-85	10-65	15-40	6.45
		TMO	TMO1-02	1	1-800	1-800	2-500	—	9.45
			TMO1-1	1	.15-400	.15-400	.35-200	2-50	6.25
			TMO1.5-1	1.5	.1-300	.1-300	2-150	5-8	8.45
			†TMO2.5-6	2.5	.01-100	.01-100	.02-50	05-20	7.95
			†TMO4-6	4	.02-200	.02-200	.05-150	1-100	7.95
			TMO6-1	6	3-200	3-200	5-150	5-50	7.95
		TMO9-1	9	.15-200	.15-200	3-150	2-40	7.95	
		TMO16-1	16	3-120	3-120	.7-80	5-20	7.95	
D 	T	T2-1	2	.050-600	.050-600	1-400	5-200	3.95	
		T3-1	3	5-800	5-800	2-400	—	4.45	
		T4-2	4	2-600	2-600	5-500	2-250	3.95	
		T8-1	8	.15-250	.15-250	25-200	2-100	3.95	
		T14-1	14	2-150	2-150	5-100	2-50	4.95	
		TMO	TMO2-1	2	.050-600	.050-600	1-400	5-200	7.95
			TMO3-1	3	5-800	5-800	2-400	—	8.45
			TMO4-2	4	2-600	2-600	5-500	2-250	7.95
			TMO8-1	8	.15-250	.15-250	25-200	2-100	7.95
			TMO14-1	14	2-150	2-150	5-100	2-50	8.45
E 	FTB	FTB-1	1	2-500	2-500	.5-300	1-100	36.95	
		FTB1-6	1	.01-125	.01-125	.05-50	1-25	36.95	
		■FTB-1-75	1	5-500	5-500	5-300	10-100	36.95	
F 	T	T-622	1	0.1-200	0.1-200	0.5-100	5-80	3.25	
		T626	1	0.01-10	0.01-10	0.2-5	0.4-2	3.95	

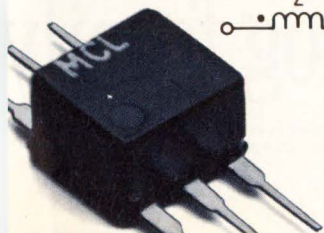

■ Denotes 75 ohm models

* FOR A AND B CONFIGURATIONS

Maximum Amplitude Unbalance
0.1 dB over 1 dB frequency range
0.5 dB over entire frequency range

Maximum Phase Unbalance
1.0° over 1 dB frequency range
5.0° over entire frequency range

CIRCLE NO. 28

C72-2 REV. B

One loud part can ruin the perf



got the right combination of specifications, performance and price, regardless of your design needs.

AUDIO DESIGNERS SHOULD LISTEN TO THIS.

If you're designing audio components and want superb transient response, ambience, clarity and dynamic range, our products will be music to your ears.

The SSM-2017 microphone preamp has impressive noise performance (950 pV/ $\sqrt{\text{Hz}}$) and ultralow THD (<0.01% @ $G = 100$); while the new dual OP-275 has

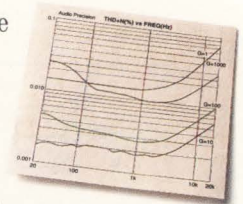

great sonic characteristics, low noise (6 nV/ $\sqrt{\text{Hz}}$) and low power requirements. And the dual AD712, which has a low offset voltage of 0.30 mV, drift of 7 $\mu\text{V}/^\circ\text{C}$ and a 16 V/ μs min slew rate, delivers high performance at a low price.

A system that isn't working in harmony is a system bound for failure. Particularly if the part acting up is your low noise op amp.

Whether it's current noise or voltage noise you're concerned about, there's a simple way to make sure your system keeps humming along. Get your low noise op amps from Analog Devices.

With the broadest line of low noise op amps around, we've

THIS WILL MAKE MEDICAL EQUIPMENT DESIGNERS FEEL BETTER.

Major medical applications, such as CT scanners, digital X-ray and fluid analysis, require low noise and pA bias currents. And we've got just the right prescription.

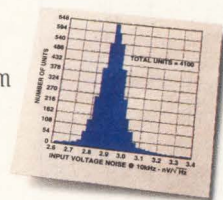

For those who want low voltage noise,

but not at the expense of current noise, the AD743 and the

The Analog family

Authorized North American Distributors: Alliance Electronics 505-292-3360 • Allied Electronics 817-595-3500 • Anthem Electronics 408-453-1200 • Bell Industries 213-826-6778 • Future Electronics 514-694-7710 • Hall-Mark Electronics 214-343-5000 • Newark Electronics 312-784-5100 • Pioneer-Standard Electronics 800-874-6633 • Pioneer Technologies Group 800-227-1693 • Zentronics 416-564-9600

Performance of your entire system.

higher speed AD745 offer the best combination of specs — 3.2 nV/ $\sqrt{\text{Hz}}$ and 6.9 fA/ $\sqrt{\text{Hz}}$. If your emphasis is vice versa, then the AD645 has the specs you want — 0.6 fA/ $\sqrt{\text{Hz}}$ for current noise, and 9 nV/ $\sqrt{\text{Hz}}$ for voltage noise.

OP AMPS THAT ARE INSTRUMENTAL FOR INSTRUMENTATION.

If you're working in instrumentation applications, our op amps could prove to be instrumental in your design.

The world's lowest current noise (0.11 fA/ $\sqrt{\text{Hz}}$) monolithic op amp, the AD549, has 60 fA of input bias current — which is ideal for interfacing with very high

Model	Voltage Noise nV/ $\sqrt{\text{Hz}}$ @ 1 kHz typ	Current Noise fA/ $\sqrt{\text{Hz}}$ @ 1 kHz typ	Vos mV max	Supply Current mA typ	Input Bias Current max	SR V/ μs typ
AD829	2.0	1.5	0.5	5	7 μA	230
OP-27/OP-37	3.0	400	.025	3	40 nA	2.8/17
AD743/745	3.2	6.9	0.5	8	250 pA	2.8/12.5
OP-275 (dual)	6	1500	1	4	350 nA	22
AD645	9	0.6	0.25	3	1.5 pA	2.0
AD712 (dual)	18	0.01	0.7	5	75 pA	20
AD548/648 (dual)	30	1.8	0.25/0.3	.34	10 pA	1.8
AD549	35	0.11	0.5	.60	60 fA	3

impedance sources. The AD548 (single) and AD648 (dual) deliver low bias current (10 pA), extremely low current noise (1.8 fA/ $\sqrt{\text{Hz}}$) and low power consumption at a highly attractive price. And the industry-standard OP-27 and OP-37 offer ultralow noise (3 nV/ $\sqrt{\text{Hz}}$ at 1 kHz) and precision dc performance.

THE FASTEST LOW NOISE OP AMP AROUND.

If you need low noise but don't want to give up speed, then consider the extremely versatile AD829. It has low voltage and current noise (2 nV/ $\sqrt{\text{Hz}}$ and 1.5 pA/ $\sqrt{\text{Hz}}$, respectively), high speed (230 V/ μs slew rate) and excellent video performance (0.02% differential gain and 0.04° differential phase). Making it perfect for a range of applications including office automation, imaging and data acquisition systems.

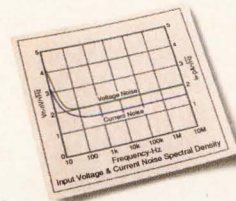

GIVE US A SHOUT IF YOU NEED HELP.

Since all of these op amps are specifically designed for applications where low noise is critical, you can just drop them into your design and virtually forget about them.

Should you ever have a question, you'll be glad to hear that our products are backed by the most responsive applications support staff in the industry.



How responsive? Give us a shout at 1-800-262-5643 and see for yourself. We'll answer any questions you've got on choosing the right low noise op amp, plus send you a free low noise op amp selection guide and SPICE model library.

Or for more information on our low noise op amps, write to Analog Devices, P.O. Box 9106, Norwood, MA 02062-9106.



CIRCLE NO. 29

of low noise op amps.

FLUKE®



PHILIPS

Our counters satisfy 3 basic human needs:

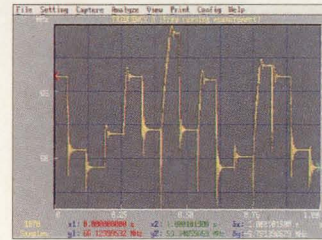

Money.

Power.

Prestige.

Our PM 6660 Family of frequency counters offer exceptional performance at low cost. With value-rich features you'd expect only on high-priced counters:

- High resolution reciprocal counting
- GPIB programmability
- AUTO trigger level setting
- Reliable design with MTBF of over 50,000 hours
- Unique MTCXO timebase with oven-like stability - at *less than half* the price of comparable models
- Budget-friendly prices starting at \$725

Our PM 6680 Timer/Counter is top of the line in our series of feature-packed counters offering powerful measuring capabilities including:

- Phase, duty factor, rise/fall time and Vpeak measurements
- 500 ps single-shot time resolution
- 2,000 reading per second to internal memory
- Unique arming control to measure any complex signal
- Frequency range to 4.5 GHz
- All this power starts at \$2075

If price has kept powerful Time Interval Analysis tools off your bench, get your hands on our new TimeView™ software for your PC. Teamed with the power of the PM 6680, TimeView offers:

- Simple, cost-effective analysis in the modulation domain - for less than *one third* the price of competing solutions
- Repetitive sampling rates to 10MS/s
- Display of frequency vs. time with accurate cursor measurements
- Histograms for distribution plus FFT for analysis of jitter

For literature, application guides, or our Counter Selection Guide, call **1-800-44-FLUKE**.

John Fluke Mfg. Co., Inc., P.O. Box 9090, M/S 250C, Everett, WA 98206-9090. U.S. (206) 356-5400. Canada (416) 890-7600. Other countries: (206) 356-5500. ©1992. All rights reserved. Ad No. 00218.

FLUKE®

Why manufacturing facilities are crumbling

Dan Strassberg's editorial (EDN, February 17, 1992, pg 55) raises the question, Why . . . is our infrastructure . . . crumbling?

It's easy to blame management for taking a short-term view of business. Quarterly profits seem to be more important than long-term success. Although management may be partially at fault, we, the stockholders of public corporations, are really to blame by demanding short-term performance. When a company takes a strategic write-down, investors dump the stock so that they can invest in one promising better, more immediate profits. Management is forced to respond to stockholder demands, reasonable or not.

We gas consumers are really responsible for the Exxon Valdez accident. By shopping around for the cheapest possible gas, we force Exxon to buy cheap, single-hulled tankers. If the company went out on a limb to be "environmentally responsible" and added an extra charge to pay for this, it would quickly go out of business.

One of the wonderful things about privately held companies [as opposed to public corporations] is that they can work toward long-term goals. Making a profit this quarter or this year is often not important.

High-tech companies suffer in comparison with, say, the real-estate market. Bankers just cannot understand what the information revolution is all about. They can put a lien on a piece of property, but high tech's real assets are intellectual. For example, if my business lost every desk and chair, every computer and scope, we would easily survive. If we lost our files (CAD, programs, database, and related information), we would be out of business instantly. The value of technology lies not so much in "stuff" as it does in information.

I think the one profound strategic advantage held by the Japanese is

the availability of low-cost capital. Their government makes cheap, long-term loans to small businesses.

*Jack G Ganssle, President
Softaid Inc*

Columbia, MD

Computerized "thinking"

[In response to Charles Small's article, "Innovation software stimulates engineering creativity" (EDN, February 3, 1992, pg 59),] using a computer program isn't going to enhance *your* thinking abilities. So why not learn to think more creatively? People like Edward de Bono and Tony Buzan have been saying this for years, and I've found their techniques very useful.

Thinking, of whatever kind, doesn't come naturally. Creative thinking is particularly difficult for people with scientific training, such as professional engineers, who have been taught to reason rationally and deductively. Indeed, society at large favors this approach above irrational [sic] processes.

At least Small gave a suitably skeptical review for Active Life, the software that offers to schedule every minute of your day. With items on the screen like "4:45p Call Kim to arrange lunch [:15]," all that was missing was an entry or ten for using the program itself.

Whoops, I have to go. I have an appointment with the coffee machine in two minutes.

Mike Lavocah

Cabletime Ltd

Newbury, Berkshire, England

Free enterprise needs self-regulating economy

In response to Dan Strassberg's editorial, "Where have all the investments gone?" (EDN, February 17, 1992, pg 55), a self-regulating economy is in effect an automatic-gain-control (AGC) system. The only serious problem in designing an AGC system is to keep time de-

LCD Proto Kit

Everything you need to start your LCD application
... create complex screens
in just a few hours!



Kit also includes:



\$495 - Kit
Popular LCD Starter Kit.



(\$595 pre-assembled & tested)

*The CY325 CMOS 40-pin DIP and 44-pin PLCC LCD Controller IC are available from stock @ \$75/singles, \$20/1000s.

CyberneticMicroSystems

Box 3000 • San Gregorio CA 94074
Tel: 415-726-3000 • Fax: 415-726-3003

lays short enough so that phase shifts in the control loop don't cause "motorboating," thus rendering the feedback positive.

In the construction cycle for commercial real estate, there are several delays that contribute to overshooting:

1. Market study to verify that a perceived need is real enough and large enough to justify investment.
2. Deciding exactly what to build and where to put it to best fulfill the need.
3. Acquisition of land and municipal code approval, which are often inter-dependent.
4. Design and design approval.
5. Securing financing.
6. Bidding and letting contracts.
7. Subletting contracts.
8. Actual construction, including contractors' intervals in procurement.
9. Final inspection and occupancy.

It's customary to press for reduced intervals by running these

steps concurrently and even slighting one or more of them sometimes. The principal incentive for speed is the desire for an early return on capital. But the system does "motorboat," so there's obviously a need to reduce delays still more.

The first two steps are probably the longest, but the hardest to shorten. To guard against possible competition until the project must finally be made public, each entrepreneur proceeds in secrecy. And each commits himself to a project with scant and inaccurate knowledge of what else is being committed. Shortening later steps increases the risk of tying up money unwisely and losing it.

Real-estate operators may find fault with this analysis. (I have seen mostly municipal planning and approval.) But they cannot deny that too many operators start and finish too many developments too late, so

the market is overbuilt. Better communication in the early stages might remedy [this situation].

Any enterprise process involves delays, which are the greatest peril to ultimate success. But freedom is too precious to submit to imposed control systems. Control is necessary, as part of the responsibility that freedom entails, in a system of free enterprise as elsewhere. But it must be collaborative, not dictatorial, or it will destroy that freedom.

*Donald H Rogers
Warminster, PA*

HAVE YOUR SAY

EDN's Signals & Noise column provides a forum for readers to express their opinions on issues raised in the magazine's articles or on any topic that affects the engineering industry. Send your letters to Signals & Noise Editor, EDN Magazine, 275 Washington St, Newton, MA 02158.

UNIVERSAL INPUT SWITCHING POWER SUPPLIES

FEATURING:

- 90-264 VAC (continuous) UNIVERSAL INPUT
- FCC CLASS 'B', VDE 0871 'B' OPTIONAL
- HIGH SURGE CURRENTS ON +12V OUTPUTS
- PRICE, DELIVERY AND QUALITY

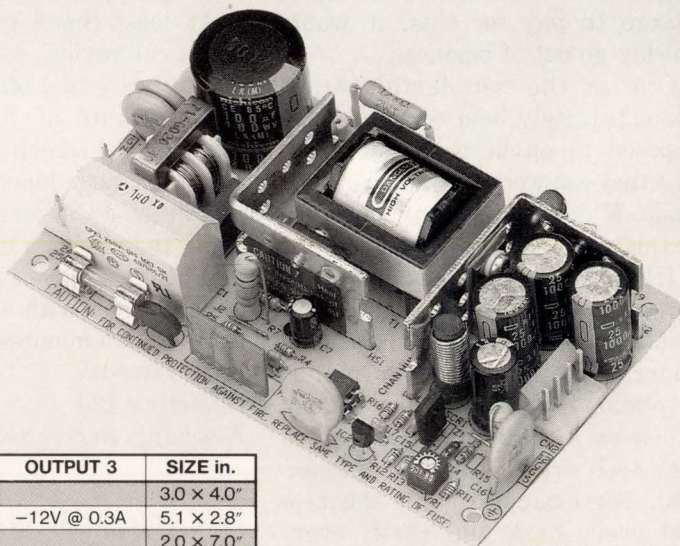

WATTS	MODEL NUMBER	OUTPUT 1	OUTPUT 2 (Peak)	OUTPUT 3	SIZE in.
20	UPS20 - 5002	+5V @ 1.6A	+12V @ 1.0A (2.0)		3.0 x 4.0"
30	UPS30 - 4003	+5V @ 1.5A	+12V @ 1.5A (3.0)	-12V @ 0.3A	5.1 x 2.8"
40	UPS40 - 1002	+5V @ 3.0A	+12V @ 2.0A (4.5)		2.0 x 7.0"
40	UPS40 - 2002	+5V @ 3.0A	+12V @ 2.0A (4.5)		3.0 x 5.0"
40	UPS40 - 2003	+5V @ 3.0A	+12V @ 2.0A (4.0)	-12V @ 0.3A	3.0 x 5.0"
50	UPS50 - 1002	+5V @ 3.0A	+12V @ 3.0A (5.5)		2.0 x 7.0"
50	UPS51 - 2002	+5V @ 4.0A	+12V @ 3.0A (5.5)		3.0 x 5.0"
65	UPS65 - 1002 - X	+5V @ 3.5A	+12V @ 4.0A (7.0)		3.5 x 6.0"
65	UPS65 - 1003	+5V @ 6.0A	+12V @ 2.5A (4.0)	-12V @ 0.5A	3.5 x 6.0"

SINGLE AND QUAD OUTPUT MODELS ARE AVAILABLE.



CALL NOW...

818-341-6123

9301-101 JORDAN AVENUE
CHATSORTH, CA 91311
FAX: 818-341-5726

The first name in disc drives is now the first name in performance, too.

For years, Seagate has set disc drive industry standards for availability, reliability and product range. But you may

This 2 head parallel Sabre-7 (ST83050K) gives you 3 gigabytes of storage in an 8" form factor, with a transfer rate of 9.34 megabytes per second and a 12 millisecond average seek time.

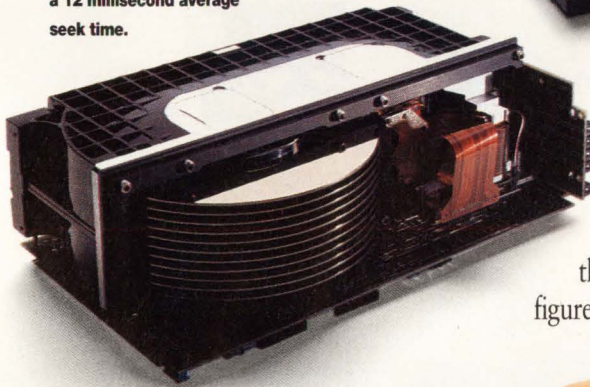

be surprised to learn that we're consistently leading the industry in performance as well.

The drives featured here are available now—setting performance standards in systems like yours all over the world.

The 5.25" Elite 1 offers gigabyte-plus capacity (1352 megabytes) at 5,400 RPM, for an average latency of only 5.56 milliseconds.

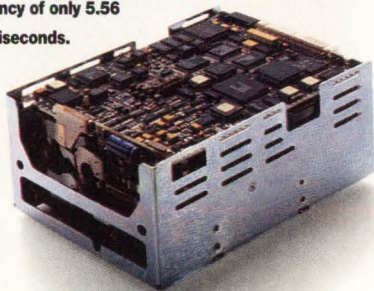

Today, as your competitive environment demands faster, less expensive processing than ever before, you need

At 2.5", the ST9144 offers 127 formatted megabytes with a choice of AT and SCSI-2 interfaces and an average seek time of only 16 milliseconds.



drives like these. Because when you take a few milliseconds' performance advantage and multiply it by thousands of transactions a day... well, the results translate into some figures that might surprise you.

The ST3283 family of 1" high 3.5" drives holds more than 245 formatted megabytes, with a 4,500 RPM spindle which reduces latency to 6.67 milliseconds.

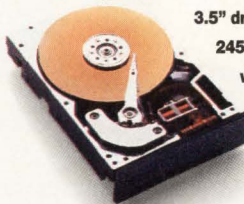

In fact, depending on the amount and nature of processing you do, high-performance drives like these can save you enough to pay back your disc drive investment within weeks—or days. For help in selecting the



The digital servo on this ST3600 family of low-profile 3.5" drives reduces average seek time to 10.5 milliseconds, with capacities up to 525 formatted megabytes.

drive you need, or for more information about any Seagate drive, call Seagate at 408-438-6550 or contact

This full-height 5.25" Wren-9 (ST42100ND) offers up to 2.2 gigabytes of storage and a synchronous data transfer rate of up to 20 megabytes per second.

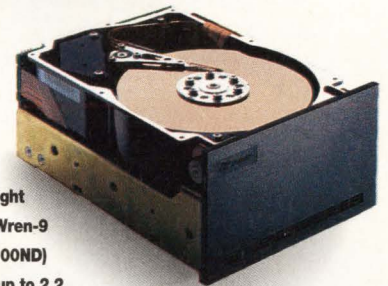

your authorized Seagate distributor.

And get on a first-name basis with performance, Seagate style.



The 3.5", half-height ST11200 family, with up to 1.2 gigabytes of storage, boasts a 256 kilobyte multi-segmented cache buffer and an average seek time of 10.5 milliseconds.



The Key Building Block in High-Frequency EDA Applications

From cellular and satellite communications to radar and electronic defense, EEsof's electronic design automation (EDA) software suite is the key building block in today's rapidly growing RF and microwave applications. In fact, EEsof is the world leader in EDA software tools for high-frequency analog circuit and system design.

Top electronic engineering firms like AT&T, General Electric, IBM, Motorola, Raytheon and Texas Instruments use EEsof's powerful design-for-manufacturing software to increase design efficiency, reliability and yields while reducing time-to-market.

Our easy-to-use tools provide engineers with a complete hierarchical suite to support

advanced circuit design... from top-down design of high-frequency systems, to bottom-up development of detailed electrical models. EEsof provides the most complete line of high-frequency simulators, along with libraries of circuit and system models. We support industry manufacturing standards like Gerber,TM GDSII,TM and IGES,TM and interfaces to Cadence, Mentor Graphics

and other top EDA vendors.

Make EEsof the key building block in your applications. Call, FAX or write EEsof for more information on the complete

suite of integrated high-frequency analog simulation software.

5601 Lindero Canyon Road
Westlake Village, CA 91362 USA
Phone: 1-800-34-EESOF
FAX: 1-818-879-6467.

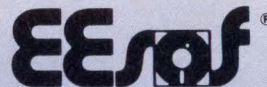
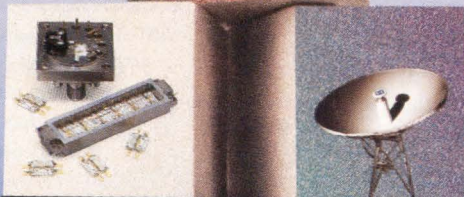
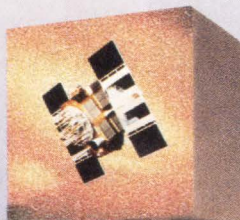

© 1992, EEsof Incorporated

NOW
WHO'S
LEADING
THE HERD
IN
DRAMs?

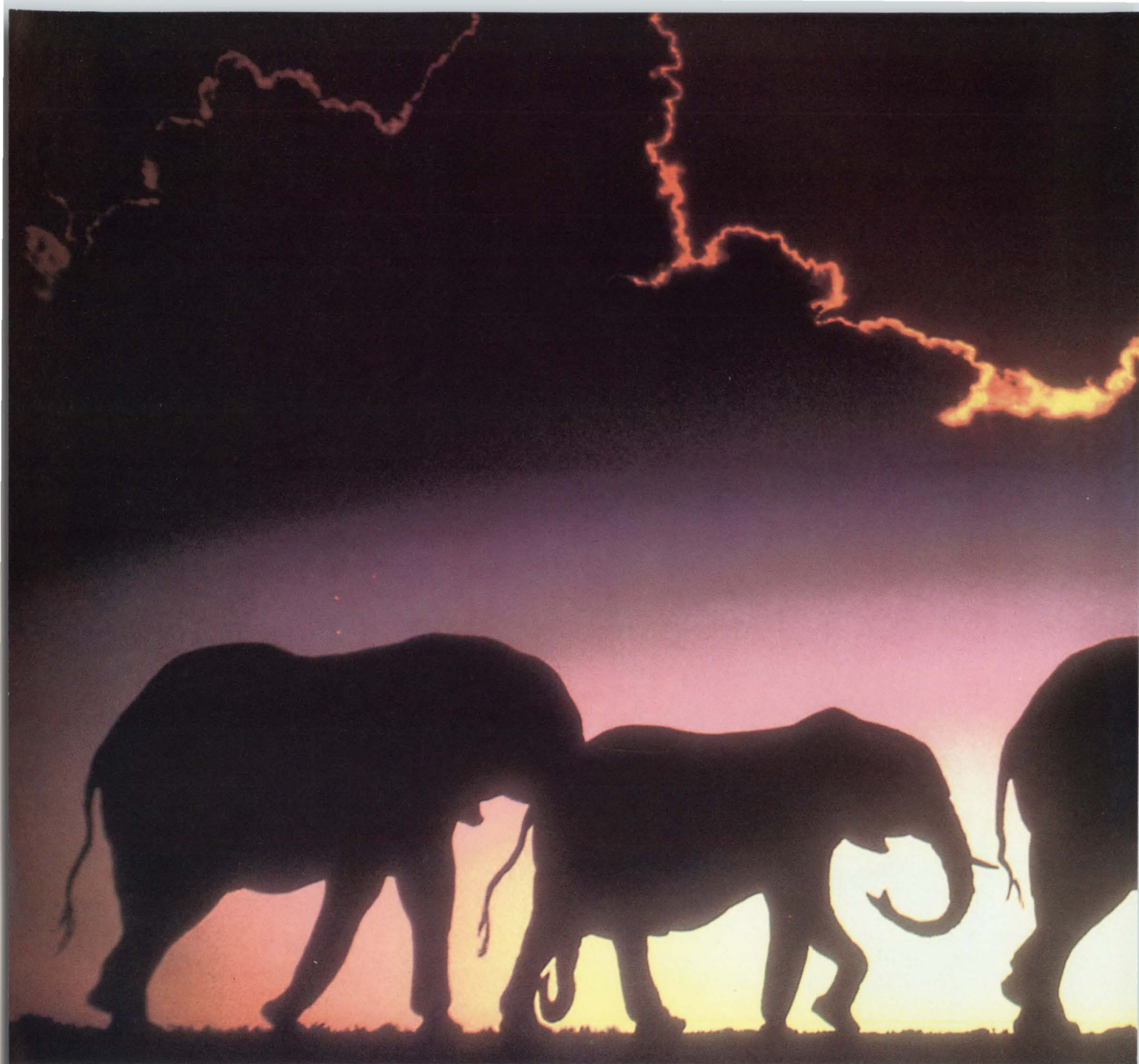

GOLDSTAR ELECTRON DRAMS..

4M DRAMs

Now Goldstar Electron has moved to the head of the herd with its advanced second generation family of 4M DRAMs. The new chips have access times as fast as 60ns, and standby current ratings as low as 200 μ A—a feature of special importance in laptops and other battery-powered systems. The products are manufactured on two of the

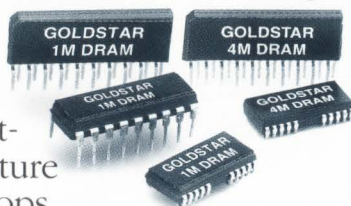

world's finest submicron lines, and they are currently offered in both x1 and x4 organizations in industry-standard 300-mil surface-mount SOJs and 400-mil ZIPs. Designs for other multi-bit organizations such as x8/9 and x16/18 are also in development.

1M DRAMs

If you're not ready yet for the crossover to 4M DRAMs, Goldstar Electron will

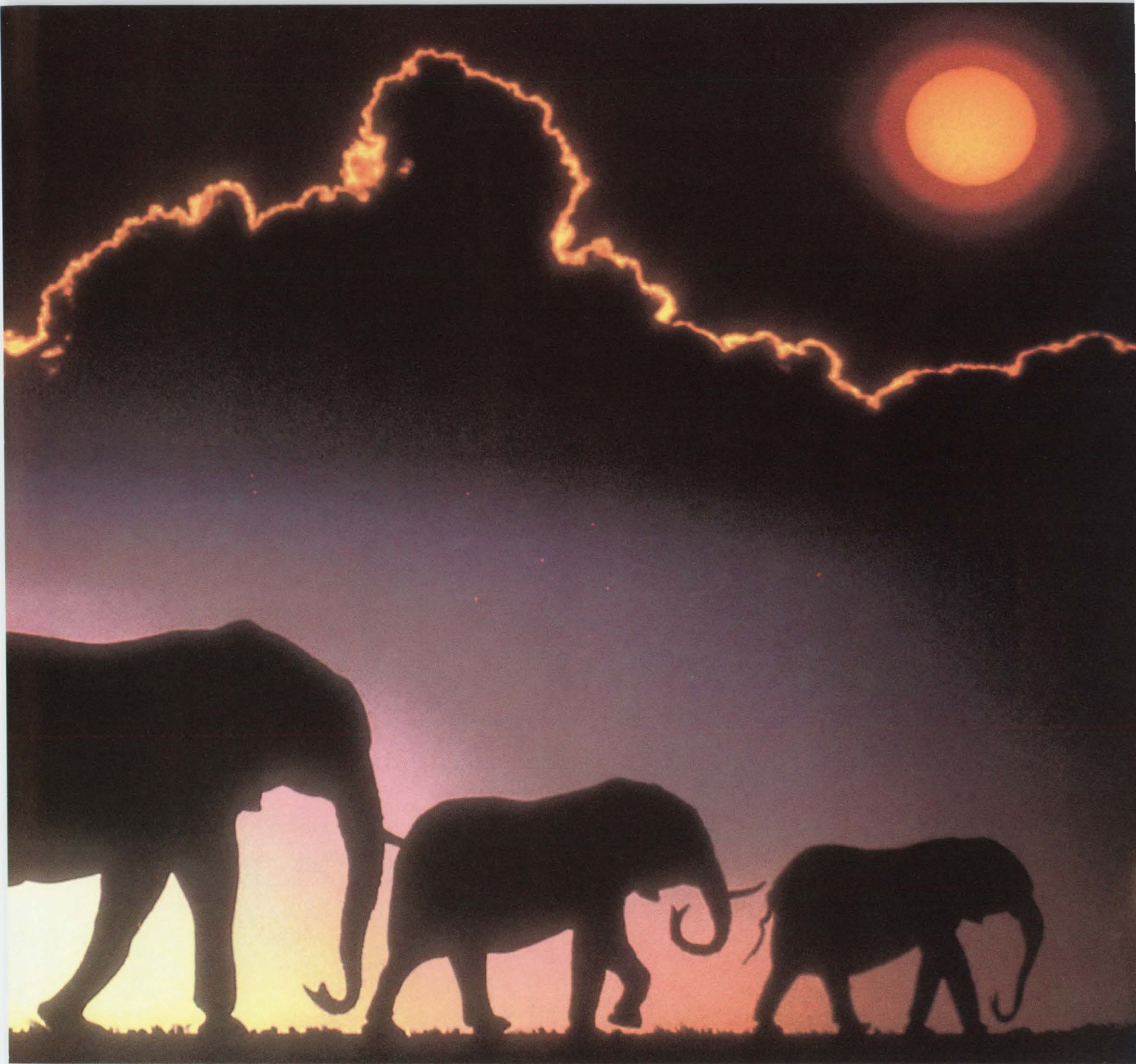

. AN AWESOME FAMILY.

keep you supplied with our high-quality 1M DRAMs until you are. We offer these state-of-the-art 1M DRAMs with the same fast access times, low-power options, organizations, and packages as our 4M DRAMs.

Modules

Both our 4M and 1M DRAMs can also be provided in modules with a wide variety of different organizations and

depths—including 1M x 8/9, 4M x 8/9, 512K x 36, and 1M/2M x 36.

So for high-quality, high-performance DRAMs and modules—take a good look at Goldstar Electron's awesome family.



GoldStar
ELECTRON AMERICA INC.

THE GOLDSTAR DRAM FAMILY

CMOS DYNAMIC RAMs

ORG	TYPE NO.	MAX ACCESS TIME (ns)	CURRENT (mA)		FEATURE	PACKAGE (MIL)
			ACTIVE	S/B (CMOS)		
4M x 1	GM71C4100A - 60	60	110	1	FAST PAGE MODE	20 SOJ (500) 20 ZIP (400)
		70	100			
		80	90			
	GM71C4100AL - 60	60	110	0.2	FAST PAGE MODE/ L-POWER	20 SOJ (500) 20 ZIP (400)
		70	100			
		80	90			
1M x 4	GM71C4400A - 60	60	110	1	FAST PAGE MODE	20 SOJ (500) 20 ZIP (400)
		70	100			
		80	90			
	GM71C4400AL - 60	60	110	0.2	FAST PAGE MODE/ L-POWER	20 SOJ (500) 20 ZIP (400)
		70	100			
		80	90			
1M x 1	GM71C1000 - 60	60	90	1	FAST PAGE MODE	20 SOJ, 18 DIP (300) (300) 20 ZIP (400)
		70	80			
		80	70			
	GM71C1000L - 60	60	90	0.2	FAST PAGE MODE/ POWER	20 SOJ, 18 DIP (300) (300) 20 ZIP (400)
		70	80			
		80	70			
256K x 4	GM71C4256A - 60	60	90	1	FAST PAGE MODE	20 SOJ, 20 DIP (300) (300) 20 ZIP (400)
		70	80			
		80	70			
	GM71C4256AL - 60	60	90	0.2	FAST PAGE MODE/ L-POWER	20 SOJ, 20 DIP (300) (300) 20 ZIP (400)
		70	80			
		80	70			
*512K x 8	GM71C4800/L - 60	60		TBD	FAST PAGE MODE L-POWER	28 SOJ (400)
		70				
		80				
*512K x 9	GM71C4900/L - 60	60		TBD	FAST PAGE MODE L-POWER	28 SOJ (400)
		70				
		80				

*Available 2nd Half '92.

DRAM MODULES

ORG	TYPE NO.	MAX ACCESS TIME (ns)	CURRENT (mA)		FEATURE	PACKAGE (MIL)
			ACTIVE	S/B (CMOS)		
1M x 8	GMM78100NS - 60	60	220	2	FAST PAGE MODE	30 PIN SOCKET
		70	200			
		80	180			
1M x 9	GMM791000NS - 60	60	310	3	FAST PAGE MODE	30 PIN SOCKET
		70	280			
		80	250			
4M x 8	GMM784000S - 60	60	880	8	FAST PAGE MODE	30 PIN SOCKET
		70	800			
		80	720			
4M x 9	GMM794000S - 60	60	990	9	FAST PAGE MODE	30 PIN SOCKET
		70	900			
		80	810			
1M x 36	GMM7361000SG - 60	60	1240	12	FAST PAGE MODE	72 PIN SOCKET
		70	1120			
		80	1000			
256K x 36	GMM736256SG - 70	70	920	20	FAST PAGE MODE	72 PIN SOCKET
		80	800			
512K x 36	GMM736512SG - 70	70	950	40	FAST PAGE MODE	72 PIN SOCKET
		80	830			
2M x 36	GMM7362000SG - 60	60		TBD	FAST PAGE MODE	72 PIN SOCKET
		70				
		80				

The combination of high performance with high density in Goldstar's 1M and 4M devices has been achieved by the use of sub-micron design rules, an advanced triple-poly, double-metal CMOS process technology, and the use of state-of-the-art manufacturing equipment and facilities. For complete product specs, send for data sheets.

A WORD ABOUT GOLDSTAR QUALITY

Goldstar's Quality Assurance System and Reliability Testing covers all phases of design and manufacturing. In the development stage, we *design* reliability into our products. During manufacturing, we *build* reliability into our products. And in the test stages, our quality assurance inspection *verifies* that the required quality and reliability have been achieved.

Our stringent standards have resulted in an Acceptable Outgoing Quality Level (AOQL) of 50 PPM or better on all DRAMs shipped by

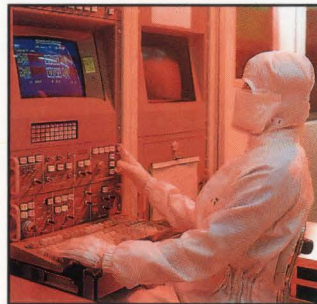

Goldstar Electron. To further ensure quality, all DRAMs are burned-in under high voltage stress. Other key features implemented by Goldstar Electron in its Quality Program are in-process inspection gates, assembly process gates, 100% electrical inspection, redundant QA testing, on-going reliability and process monitoring, and use of real-time Statistical Process Control. That's how we produce some of the world's finest DRAMs in our state-of-the-art facility at Chung Ju, Korea.



GoldStar
ELECTRON AMERICA INC.

Goldstar Electron America, Inc., 3003 North First Street, San Jose, California 95134-2004.
Phone: (408) 432-1331. FAX: (408) 432-6067

KOREA
GOLDSTAR ELECTRON CO., LTD.
Tel: 02519-2854
Fax: 02-519-2800

HONG KONG
GOLDSTAR (H.K.) LTD.
Tel: 524-2040
Fax: 868-1434, 845-9416

JAPAN
GSEN JAPAN OFFICE
Tel: 03-224-0123
Fax: 03-582-7948

SINGAPORE
GSEN SINGAPORE OFFICE
Tel: 65-226-1191
Fax: 65-221-8575

TAIWAN
GSEN TAIWAN OFFICE
Tel: 02-703-2295
Fax: 02-703-7470

GERMANY
GOLDSTAR Deutschland GmbH
Tel: 49-2154-492172
Fax: 49-2154-4336

If you're looking for easier embedded debugging, try our new environment.

Real-time software performance analyzer profiles your code and speeds optimization.

User-configurable tools offer intuitive operation and share common look and feel.

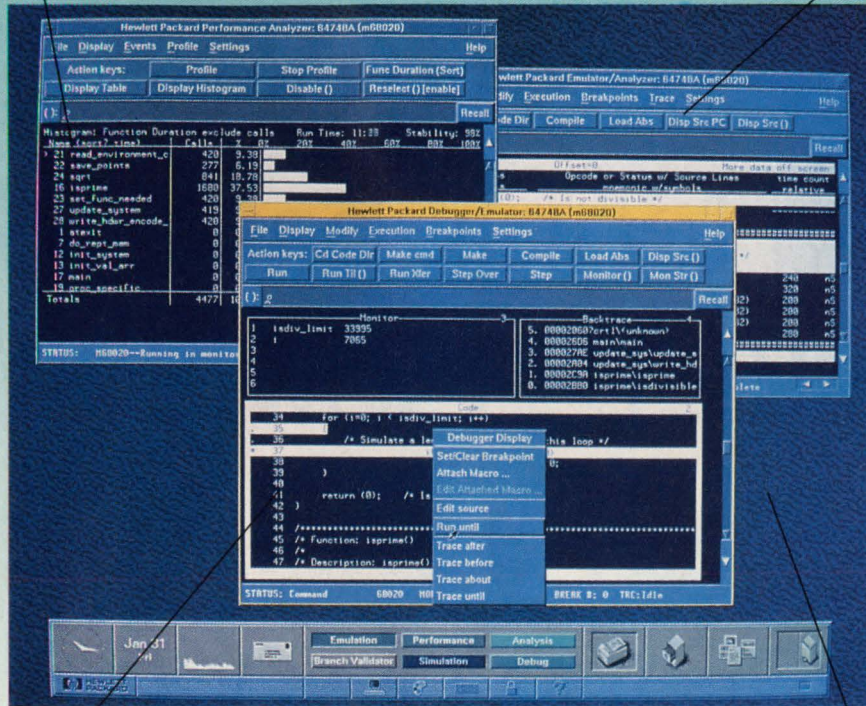

Full-featured C debugger runs in-circuit with our emulator.

Concurrent real-time analyzers and debuggers provide simultaneous, linked views of target.

The new HP 64000 embedded debugging environment makes it easy.

If easier embedded debugging is what you're looking for, the HP 64000 can point you in the right direction, with a new graphical user interface that has pull down menus for workstation hosted products. Point and click measurements. And rapid action keys to speed up routine tasks.

For most popular processors, the interface is always the same. So you don't have to learn new commands for different jobs.

And the interface is completely integrated. Emulators, debuggers,

and the software performance analyzer all operate consistently and interactively. Which means you can share data between tools, and enjoy all the productivity benefits of synchronized measurements operating in a multiple window, high-performance environment.

So, if you're looking for a simpler way to develop embedded systems, call 1-800-452-4844. Ask for Ext. 3036, and we'll send you a free video that shows you how the HP 64000 embedded debugging environment makes it easy.

© 1992 Hewlett-Packard Co. TMCOL205/EDN

EMULATORS ⁽¹⁾		
MOTOROLA		
68000/EC000	68331/332	68030/EC030
68HC000/001	68340	68040/EC040
68302	68020/EC020	68LC040
INTEL		
80960SA/SB	80C186EA/EB/EC	8086/88
80960KA/KB	80C186XL	80C186/188
		80286/C286
PLATFORM SUPPORT		
HP 9000 Series 300, 400 & 700		
Sun Microsystems SPARCstations		
IBM PC Compatibles		
<small>(1) Also support for AMD, Texas Instruments, Zilog, National Semiconductor, ATT, NEC, Hitachi and Mitsubishi; call for more information.</small>		

There is a better way.

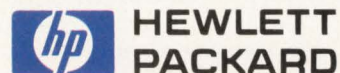

"Speed fascinates me. The 2,193 mph. Instant face lift. push the needle over 200 m served a tennis ball 138 mp run? 3:46.32. Now that's fas sider it takes a snail five day And speaking of speed, ther of programmable logic. Wi 12ns and system clock freq fast, low skew routing with of 3ns or less. Whooooosh! It faster than MAX 7000. We're

©1992, Altera Corporation. MAX is a registered trademark of Altera Corporation.

Air Force has a jet that hit
A Lamborghini Diablo can
ph. There's a guy who once
h. And the fastest mile ever
t. Especially when you con-
s to cover the same ground.
e's Altera's MAX 7000 family
th pin-to-pin logic delays of
uencies over 80 MHz. Plus
a predictable delay
just doesn't get any
talking warp speed."

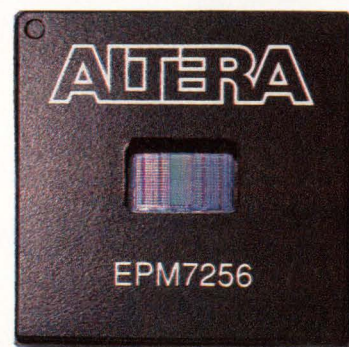

MAX7000

They're big. They're fast. They're everything you've asked for. Want to know more? Speed dial 800-800-7256.

Somewhere in the world a Sanyo battery is being "designed-in" to a high performance application.

Right now.

Industry leaders select industry leaders.

CADNICA. In 1964 Sanyo's proprietary technology led to a breakthrough battery that withstands continuous overcharging and overdischarging...the sealed, rechargeable nickel cadmium Cadnica.

LITHIUM. Sanyo developed the technology for manganese dioxide compounds to be used in Lithium batteries which produced a cell with high voltage and high energy density characteristics.

CADNICA EXTRA. Sanyo's Cadnica E series incorporates high-density electrode plates in a new concept design for 40% greater capacity than conventional batteries and 1-hour charge capability via Sanyo's ΔV voltage sensor changing method.

SOLAR. Sanyo leads the development of solar cells with the application of amorphous silicon for physical flexibility and the ability to be fabricated into large-area cells.

NiMH. Sanyo's proprietary electrode manufacturing process and built-in resealable safety vent lead the development of high capacity, high performance rechargeable, Nickel Metal Hydride batteries.

If you're developing an industry leading product right now, perhaps you should contact Sanyo...

right now.

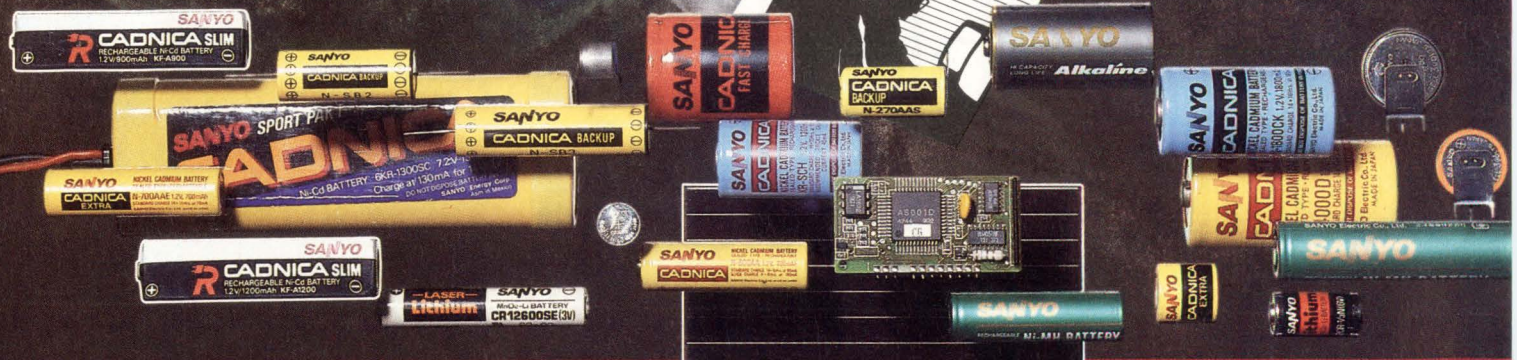

For specification and design assistance please contact your regional Sanyo sales office at the following address:

SANYO Energy (U.S.A.) Corporation
2001 Sanyo Avenue
San Diego, California 92173
(619) 661-6620

In Florida: (904) 376-6711
In Illinois: (312) 595-5600
In New Jersey: (201) 641-2333
In Georgia: (404) 279-7377
In Dallas: (214) 480-8345

CIRCLE NO. 37

SANYO

SANYO Energy (USA) Corporation

Reader looking for discontinued parts

Like many of the readers in your forum, I'm looking for a key-component replacement part. In my case, the part needed is a Texas Instruments SN76477 or SN76488 sound-generator chip.

The parts are discontinued components, and I have been unable to find them in any quantity. If anyone has or knows of a comparable component, we would be glad to buy any amount. *Ariel Spivakovsky*
Biofeedtrack Inc
Brooklyn, NY

By using the Computer Aided Product Selection (CAPS) system, which is available from Cahners Technical Information Service, we found that those parts are indeed discontinued and that there are no pin-for-pin replacements or upgrades. If any reader has SN76477s or SN76488s, please contact Ask EDN.

Electronic glove can interface to PC

A while ago I bought a Mattel Power Glove. The glove connects to Mattel and Nintendo entertainment systems as a hand-tracking device. I wanted the Power Glove to work with my personal computer. Following an article published in the July, 1990, issue of *Byte* magazine, I built a small micro-computer interface. A small machine program residing in an EPROM reads the glove's orientation and button status and passes it to my PC. From the view of the PC, the glove and microcomputer behave like a non-proportional pointing device similar to a joystick.

Recently I heard that the Power Glove is also equipped with a proportional mode, so the glove and micro-computer interface could be made to appear to my PC like a pointing device similar to a mouse. Unluckily, the article from *Byte* did not provide any information on the proportional mode. Do you know where I could obtain information on the proportional mode?

Christian Pfarrherr
Hannover, Germany

Scott Fullam, an engineer with Abrams/Gentile Entertainment Inc (New York, NY), responds:

The Power Glove was developed by my company in 1988 and was manufactured and sold by Mattel beginning in 1989. The glove is equipped with a high-resolution mode for special games. A special interface box is required to activate this mode. This box decodes the raw data from the glove and formats it as a serial-data stream running at 9600 bps. In this high-resolution mode, the glove provides *x*, *y*, and *z* special data; 12-position roll data; 2 bits of flex data for the thumb, index, and middle fingers; and all keypad information. This box is available from Dave Richers of Syracuse University. Please write to him for details.

Dave Richers
Advanced Graphics Lab
Syracuse University
820 Comstock Ave
Syracuse, NY 13244

Compilers available for Z80

Can you tell me where I can purchase or otherwise get a C compiler that produces Z80 code?

Yves Ephraim
Cable and Wireless
Antigua, West Indies

All the cross-compiler companies, such as Boston Systems Office and Intermetrics, have cross compilers for the old Z80. Your Zilog field engineers should have a list. Also check out Z-World, which has a tricky combination of a turbo-C-like compiler/debugger that compiles into a ROM emulator. You write your code, press the go button, and it's running in your target system.

Boston Systems Office
411 Waverly Oaks Rd
Waltham, MA 02254
(617) 894-7800

Intermetrics Inc
733 Concord Ave
Cambridge, MA 02138
(617) 661-0072

Z-World
1340 Covell, Suite 101
Davis, CA 95616
(916) 753-3722

SCPI standard is yours for the asking

How or where can I get the SCPI (Standard Commands for Programmable Instruments) standard details so that I can develop SCPI protocols for my instruments?

Alan Rasmussen
Larson Davis Labs
Provo, UT

You can get SCPI information and copies of the standard from

Fred Bode
SCPI Consortium
8380 Hercules Dr
La Mesa, CA 92042.

Thrifty reader seeks 8051 real-time kernel

Does anybody know where to find a cheap 8051 real-time kernel? I'm working on some home-control projects and would like to try them out in a real-time environment. I am aware that these kernels can be achieved for about \$1000, but my private budget will not allow me to spend that amount.

Claus Dahm
Copenhagen, Denmark

Several 8051 kernels written in C are on the /util Special Interest Group on the EDN bulletin-board system (BBS) and are free for the downloading. However, the 8051 is a pretty poor match for the underlying hardware that C assumes (a DEC PCP-11), so a kernel written in C might not work that well when compiled for the 8051.

Have you been stumped by a design problem? Can't interpret a spec sheet? Ask EDN. If EDN's editors can't solve a problem, we'll find an expert who can, or we'll print your letter and ask your peers for help. Address your questions and answers to Ask EDN, 275 Washington St, Newton, MA 02158; FAX (617) 558-4470; MCI: EDNBOS. Or, send us a letter on EDN's bulletin-board system. You can reach us at (617) 558-4241 and leave a letter in the /ask_edn Special Interest Group.

We provide more
to a place few co

©1992 FORCE Computers, Inc.

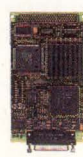
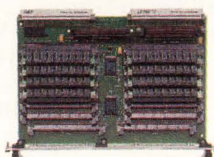
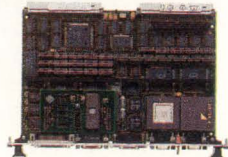
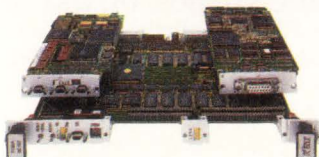

**e solutions because we've been
mpanies have dared to venture.**

When it comes to embedded systems design, nobody offers better solutions than FORCE.

But, we have to admit, we had a little help. From you.

At FORCE, we get inside the heads of our customers to learn about their requirements.

The result is the world's most advanced CISC and SPARC™ based VME single board computers, including the latest SPARC CPU-2E boards.

What else did you have in mind? How about bus extensions – like SBus and our own FLXibus™ Plus SunOS™ and the widest variety of real-time operating systems and kernels.

And when your designs need to evolve to the next generation, count on FORCE for the best in VME64/Plus™ or Futurebus/Plus™. Because better products come from better knowledge.

For a partner that can get your application up and running fast, call 800-237-8863, ext. 10. In Europe, call 49.89.608-14-0.

And thanks for keeping an open mind.

FLXibus, VME64/Plus and Futurebus/Plus are trademarks of FORCE Computers, Inc. All other brands or products are trademarks of their respective holders.

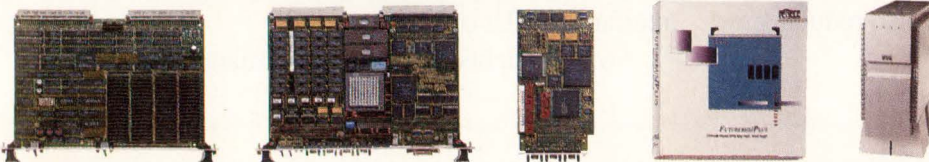

3165 Winchester Blvd., Campbell, CA 95008-6557
Prof.-Messerschmitt-Str. 1 W-8014 Neubiberg/München

CIRCLE NO. 38

Now you can afford to

Presenting a very small development in Ethernet.*
Chipsets that are matched to your system and your budget. In fact, they cost you as little as 5 square inches. Which, by the way, is less total real estate than any competitive solution. But sizable reductions don't stop with board space, because we're also reducing the price up to 30 percent.

Needless to say, true plug-and-play simplicity requires an intelligent network interface. So our new high-integration 82503 Dual Serial Transceiver goes beyond IEEE 802.3 to include automatic port selection, polarity switching and a jumperless interface to AUI or TPE.

For unmatched desktop performance, we offer

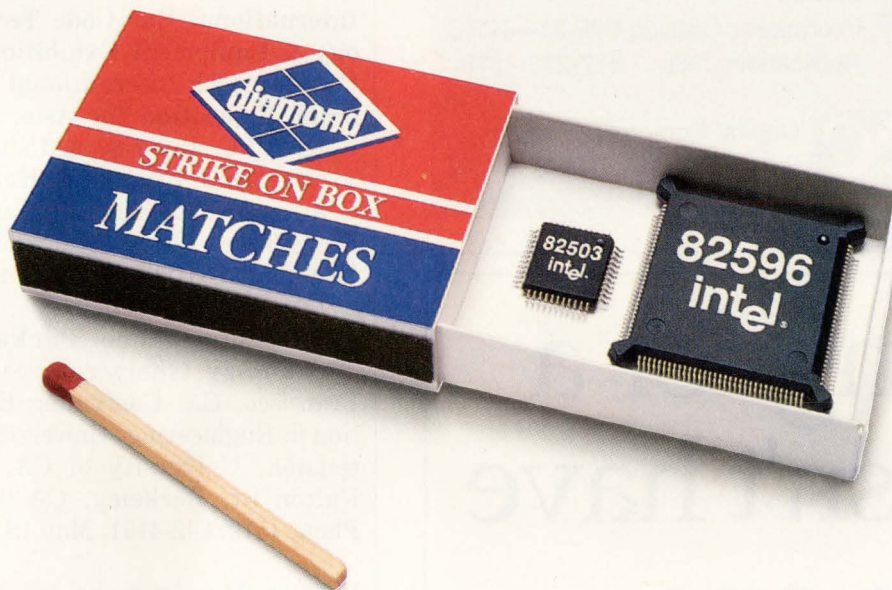

put Ethernet in any box.

a complete family of 82596 LAN coprocessors, each optimized to a specific Intel486™ CPU for maximum throughput. And our 82593 is the perfect LAN controller for Intel386™ SL notebooks.

Best of all, these true two-chip solutions give you the flexibility to simplify your design and deliver your product to market in the smallest of timeframes.

So look into today's hottest Ethernet chipsets. Call (800) 548-4725 and ask for Lit. Packet #YA23. And learn why we have the perfect match for your next box.

intel®

The Computer Inside.™

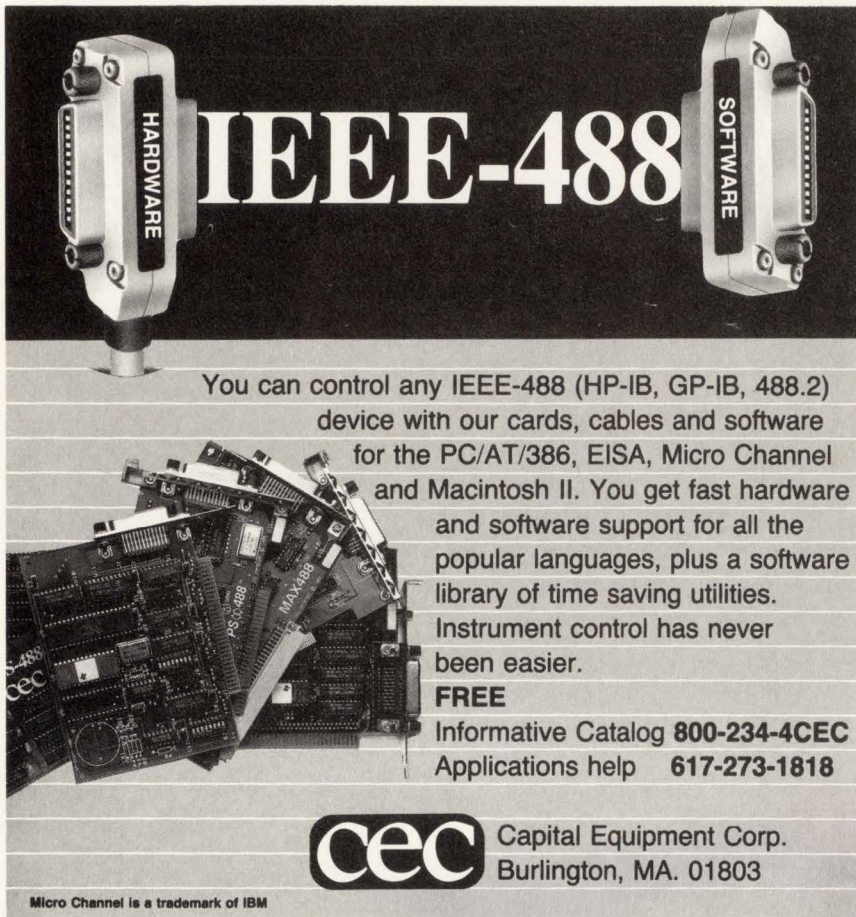

IEEE-488

You can control any IEEE-488 (HP-IB, GP-IB, 488.2) device with our cards, cables and software for the PC/AT/386, EISA, Micro Channel and Macintosh II. You get fast hardware and software support for all the popular languages, plus a software library of time saving utilities. Instrument control has never been easier.

FREE
Informative Catalog **800-234-4CEC**
Applications help **617-273-1818**

cec Capital Equipment Corp.
Burlington, MA. 01803

Micro Channel is a trademark of IBM

CIRCLE NO. 43

Looking for a job doesn't have to be one.

EDN's Career Opportunities section keeps you informed of current job openings from coast-to-coast

TURN TO
PAGE 278

Test & Design Exposition, Somerset, NJ. Miller Freeman Expositions, Test & Design Expo, 1050 Commonwealth Ave, Boston, MA 02215. Phone (617) 232-3976. May 11 to 14.

Electro/92, Boston, MA. Electro/92, 8110 Airport Blvd, Los Angeles, CA 90045. Phone (310) 215-3976. FAX (310) 641-5117. May 12 to 14.

IEEE Instrumentation & Measurement Technology Conference, Meadowlands, NJ. IMTC/92, 3685 Motor Ave, Suite 240, Los Angeles, CA 90034. Phone (310) 287-1463. FAX (310) 287-1851. May 12 to 14.

International Bar Code Technology & Equipment Exhibition and Computer 92: International Computer Exposition for Asia, Hong Kong, PRC. Business & Industrial Trade Fairs Ltd, 28/F Harbour Centre, 25 Harbour Rd, Wanchai, Hong Kong. Phone (852) 575-6333. FAX (852) 834-1171. May 12 to 15.

High-Performance Packaging Technology (short course), San Francisco, CA. Continuing Education in Engineering, University Extension, University of CA, 2223 Fulton St, Berkeley, CA 94720. Phone (510) 642-4151. May 13 to 15.

Project Management for Engineers (seminar), St Louis, MO. NSPE Seminars, 655 15th St NW, Suite 300, Washington, DC 20005. Phone (202) 639-4115. FAX (202) 347-6109. May 14 to 15.

Electronic Components & Technology Conference, San Diego, CA. Jim Bruorton, Publicity Chair, Kemet Electronics Corp, Box 5928, Greenville, SC 29606. Phone (803) 963-6621. May 18 to 20.

Industry Strategy Symposium: Europe 92, Versailles, France. SEMI, 805 E Middlefield Rd, Mountain View, CA 94043. Phone (415) 964-5111. May 18 to 20.

1,156 position
LGA Socket

249 position
Stacking
Connector

BUTTON BOARD SOLUTIONS FOR TODAY'S HIGH SPEED NEEDS

Versatile CinApse Interconnect Devices

Today's high speed semiconductor devices can achieve even better performance when they're interconnected by exceptional CinApse button board technology.

CinApse is densely packaged in extremely low profile configurations that maintain the highest speed signal integrity possible. It was designed to interface microprocessor devices to printed circuit boards without solder. Because

CinApse technology is so flexible and efficient, the world's leading computer and semiconductor manufacturers rely on it in a broad range of demanding commercial and military applications, including:

- Board (or flex-to-board) stacking
- LGA sockets
- Test/Burn-in sockets
- MCM/hybrid interconnect devices
- Various custom interconnects

Lightweight, yet extremely durable, CinApse accommodates temperature extremes ranging from as high as 200° C to as low as the cryogenic temperatures of liquid nitrogen. CinApse also provides excellent shock and vibration resistance. Specify the technology that enables your designs to perform at their optimum level – CinApse.

Call today for a free design consultation or sample –

708.981.6000, Ext. 4291.

CIN::APSE by **CINCH**
Solutions That Connect

A Division of Labinal Components & Systems, Inc.

© 1992 Labinal Components & Systems, Inc.

105 position
MCM Interconnect

PRESYS 1000

Data Acquisition System With A Thousand Faces.



Here is a microprocessor-based data acquisition, simulation, and control system so flexible, so versatile, and so user friendly that it literally becomes all things to all users.

MULTIPLE FUNCTIONS

The PreSys 1000 chassis has 15 slots for thousands of possible card combinations: A/D conversion, D/A conversion, multiplexers, computer interfaces, FIFO memory expansion, diagnostics, chassis expansion logic, plus many others. And any card works in any slot!

MULTIPLE USERS

PreSys 1000 can handle up to six unique

users, each with their own inputs, outputs, and internal processing. This makes the system ideal for use by individuals or teams in research and engineering applications.

MULTIPLE INTERFACES

PreSys 1000 can interface with any computer system used in the instrumentation field. Interface options include CSPI, DEC, VME, HP, DG, IEEE488, and RS232.

If you want a data acquisition system you can configure to today's needs, with full scope for tomorrow's requirements, you want PreSys 1000. Request our informative, full-color brochure today.



PRESTON SCIENTIFIC

805 E. Cerritos Ave., Anaheim, CA 92805 • Phone (714) 776-6400, Fax (714) 776-3660

CIRCLE NO. 46

Zenith's ZPS-45

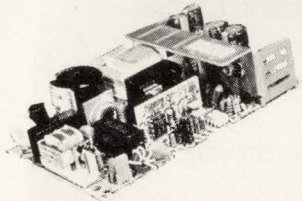

BIG 45 watt universal input power supply in a small 3" x 5" size

Who said big things don't come in small packages? The ZPS-45 with universal input gives you increased power density in a miniature 3" x 5" footprint — with no minimum load requirements.

Available for new systems design and replacement, the triple output ZPS-45 automatically operates from any continuous AC voltage between 90 and 265 VAC or DC voltage between 120-364 VDC. Choose the ZPS-45 with +5V output, in either the ± 12V or the ± 15V version, open-frame or enclosed configuration. It's designed to meet rigid international safety and EMI standards: UL, CSA, IEC and VDE/B. And it's backed by a one year warranty from Zenith — a leading worldwide OEM supplier with over 70 years of electronics experience.

Zenith Model	Maximum Output Power (Watts)	Main Output		2nd Output		3rd Output	
		Volts DC (Nominal)	Amps (Min/Max)	Volts DC (Nominal)	Amps (Min/Max)	Volts DC (Nominal)	Amps (Min/Max)
ZPS-45	45	+ 5.0	0.0/5.0 PK 7.0	+ 12.0	0.0/2.0 PK 3.0	- 12.0	0.0/0.7
ZPS-45-15	45	+ 5.0	0.0/5.0 PK 7.0	+ 15.0	0.0/1.5 PK 2.0	- 15.0	0.0/0.7

At Zenith, the quality goes in before the name goes on!®

ZENITH magnetics

1000 Milwaukee Avenue
Glenview, IL 60025-2493
Fax: (708) 391-7078

U.S. and International Stocking Distributors

For more information call:
1-800-827-8720



Inquire about the ZPS-30 — our 30 watt triple output 3"x5" power supply.

Midwest Electronics Exposition, Minneapolis, MN. Miller Freeman Expositions, 1050 Commonwealth Ave, Boston, MA 02215. Phone (800) 223-7126; (617) 232-3976. May 18 to 21.

International Conference on Computer Architecture, Queensland, Australia. Jean-Luc Gaudiot, University of Southern California, Dept of EE Systems, SAL 300, Los Angeles, CA 90089. Phone (213) 743-0249. May 19 to 21.

Annual Symposium on Frequency Control, Hershey, PA. Michael Mirarchi, Synergistic Management Inc, 3100 Route 138, Wall Township, NJ 07719. Phone (908) 280-2024. May 27 to 29.

1992 Mathematica Conference, Boston, MA. Wolfram Research Inc, 100 Trade Center Dr, Champaign, IL 61820. Phone (217) 398-0700. FAX (217) 398-0747. May 27 to 31.

Silicon Mountain Symposium, Colorado Springs, CO. Colorado Marcom Network, Box 49462, Colorado Springs, CO 80919. Phone (719) 540-1842. May 31 to June 2.

International Microwave Symposium, Albuquerque, NM. IEEE, Box 1331, Piscataway, NJ 08855. Phone Tammy Ferguson, (505) 845-8806. June 1 to 5.

EESof Users' Group Meeting, Albuquerque, NM. Linda Harmon, 5601 Lindero Canyon Rd, Westlake Village, CA 91362. Phone (818) 879-6200. FAX (818) 879-6467. June 2.

International VLSI Multilevel Interconnection Conference, Santa Clara, CA. Dr Thomas E Wade, College of Engineering, University of South Florida, 4202 Fowler Ave, Tampa, FL 33620. Phone (813) 974-3786. FAX (813) 974-5094. June 2 to 3.

SOME
SEE OUR
INTEGRATED
PROCESSOR
AS THE
FUTURE OF
FULL MOTION
VIDEO.

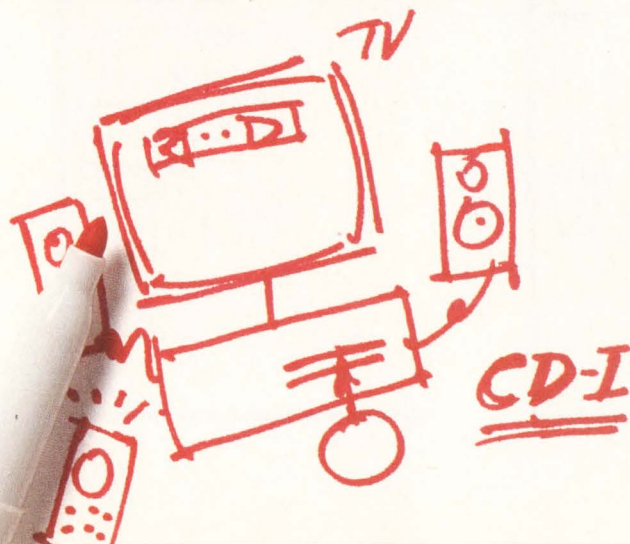

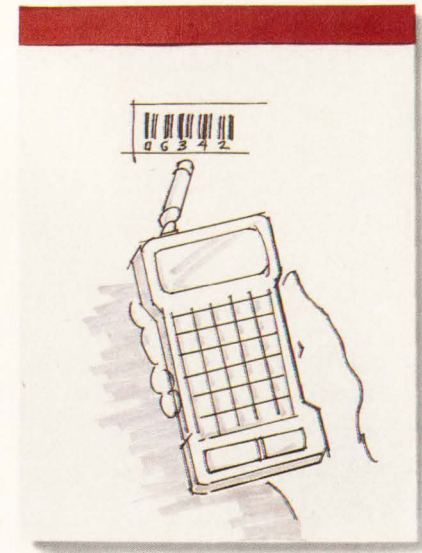
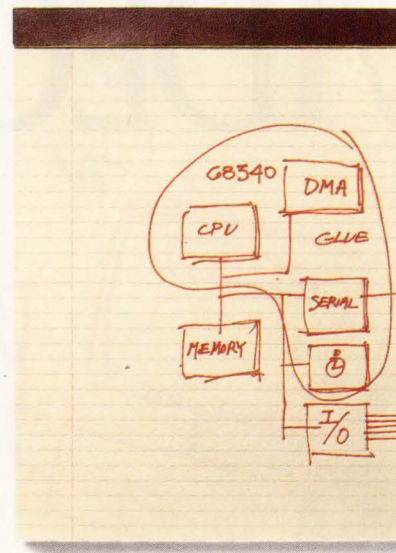
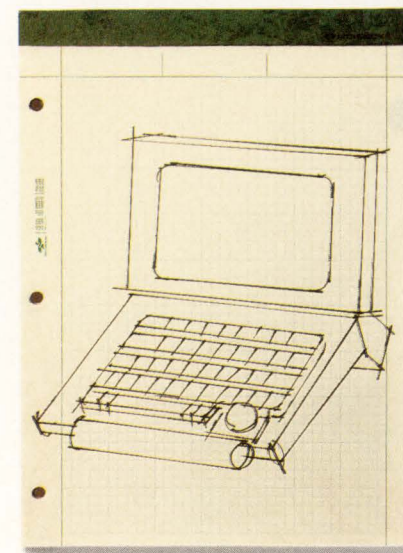
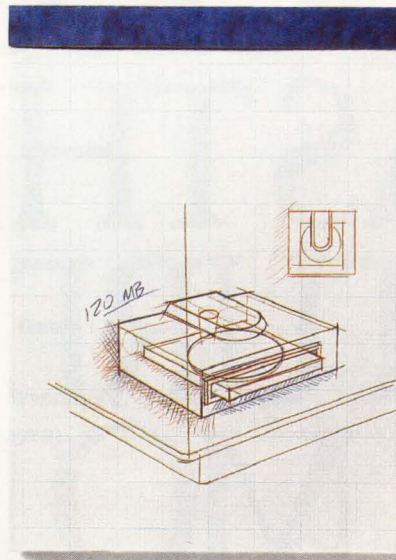
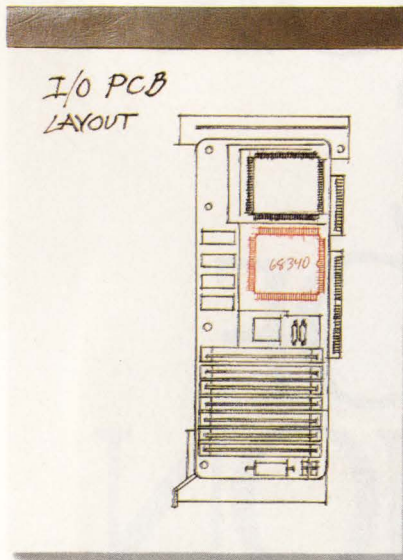
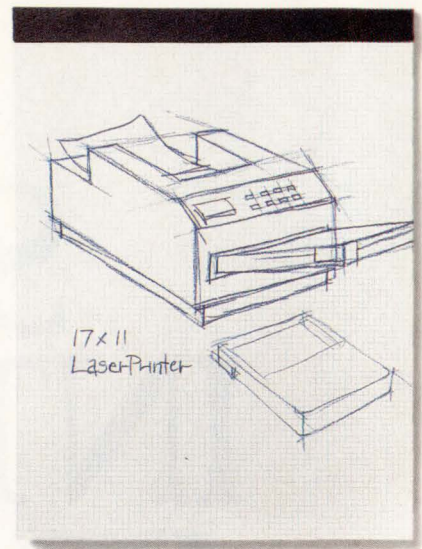
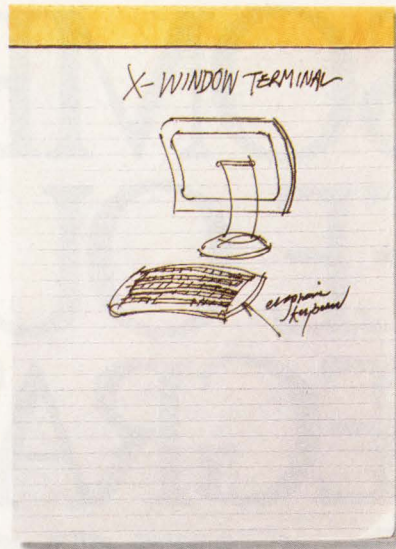
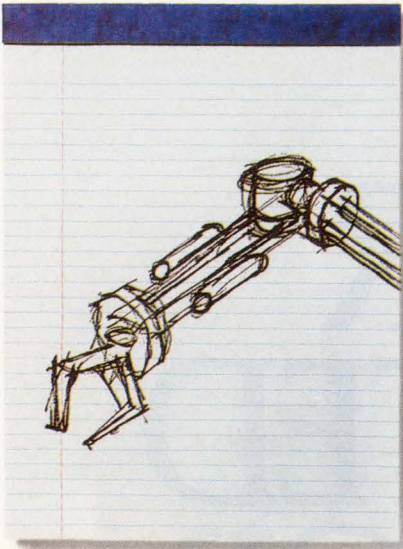

BUT YOU MAY SEE IT DIFFERENTLY.



Look at it this way.

The first thing you'll see is a flat-out screaming data mover. Namely, Motorola's 68340

Integrated Processor with DMA. The first and only processor with the performance to meet the high speed data handling needs of next generation applications.

Applications like future Compact Disc-Interactive multimedia machines. Or applications like yours. Say, for instance, optical drives, laser printers, hand-held computers, telecommunication switches and line cards, workstation I/O processors, servers, terminals, robotics or that hot new project only you know about.

A closer look at the 68340 will reveal a 32-bit integrated processor built on a 68020 foundation with a host of pertinent peripherals on-chip. Foremost among these is a two channel DMA (direct memory access) controller that delivers a sustained data transfer rate of

33 megabytes per second. Imagine for a moment what you could do with that.

Also on the chip are a pair of serial I/O channels, a couple of timers and a whole bunch of glue logic you won't have to add elsewhere. And, of course, you get all that power in one tidy little package.

Speaking of power, the 68340 doesn't use much at all. In fact, its low power consumption and standby mode make it perfect for a wide variety of battery-powered applications.

But then again, as the highest performance data mover you'll see anywhere, the 68340 is perfect for a whole lot of applications.

Including yours. So call Motorola at 1-800-845-MOTO for a free sample.* Or contact your Motorola Semiconductor Sales Office.

You'll like what you see.

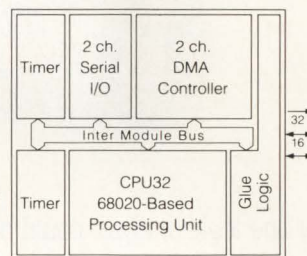

68340 Integrated Processor with DMA



MOTOROLA

*Limited quantities available. All brand and product names appearing in this ad are registered trademarks or trademarks of their respective holders. © 1992 Motorola, Inc.

LAST SEPTEMBER, 85 MILLION PEOPLE DESPERATELY WANTED A DEMONSTRATION OF OUR FINEST LOGIC ANALYZER.



Only one logic analyzer could have brought the most crippling communications failure in U.S. history to a swift conclusion.

The new DAS/SE from Tektronix. With 200 MHz synchronous clocking, thousands of cycles of memory depth, and literally hundreds of channels, the DAS/SE is without question the fastest and most powerful logic analyzer around. And with 11



different stimulus & acquisition modules, it can be configured to solve any of your digital debug problems. For a personal demonstration, call Tektronix today and ask about the DAS/SE. The logic

analyzer that could very well prevent another banner year. **TALK TO TEK/1-800-426-2200 EXT. 73**

Tektronix
Test and Measurement

DSP—Transform your world



Although digital signal processors or DSP chips have only been available for a decade, they're being used in more and more applications. To many engineers, DSP is still black magic. For example, at first glance it's difficult to understand how a series of multiplication and addition instructions can be made to "filter" or transform a signal.

While the IEEE has been sponsoring the International Conference on Acoustics, Speech, and Signal Processing (ICASSP) for many years, there hasn't been a good forum for those designers who wanted to know more about the practical aspects of signal processing. Luckily, the DSP scene is changing. EDN, in conjunction with Reed Exhibitions (a part of our parent company), has been putting together a DSP conference meant for potential DSP users and designers who have just started to use DSP products. In short, the conference concentrates on the practical aspects of DSP. You'll learn more about what's going on in DSP, about new products, and about how others have solved the DSP-related problems you may be facing.

Although the conference goes by a long-winded name, The International Conference on Digital Signal Processing Applications and Technology, we've nicknamed it DSPx. It's set for October 14 to 16, 1992, in the San Jose Convention Center in San Jose, CA. The technical sessions will explore how DSP is being used in fields of computers, communications, consumer and automotive products, industrial and medical areas,

and in military and aerospace projects. You'll get more than an overview. Speakers will tell you about their applications, what they did, and how they did it. You'll get details that will help you design DSP-based circuits, software, and products.

In addition, you'll have the opportunity to meet and talk with representatives from most DSP-related companies. Whether they supply chips, boards, systems, or software, companies will exhibit their wares at DSPx. We're also setting aside time for short manufacturer presentations on new products and technologies. If you're a designer or a manager who is using, or who anticipates using DSP, make plans to be in San Jose in October for the DSPx gathering.

I am actively soliciting papers for all the sessions. The conference committee has appointed session administrators, and I'll forward your proposals to them. The main point is that papers can't be product pitches or descriptions. Instead, they must talk about DSP applications, and they must give attendees information they can use. If you're interested in presenting a 20-minute talk or in attending, you can drop me a note by FAX or by MCI (EDNTITUS), and I'll send you information. You can also send requests to DSPx, Reed Exhibitions, 999 Summer St, Stamford, CT 06905 USA. Phone (203) 352-8367, FAX (203) 964-0176. If you're interested in introducing a new DSP-related product, I'd like to hear from you, too. You should submit entries by June 1, 1992.



Jesse H. Neal
Editorial Achievement Awards
1990 Certificate, Best Editorial
1990 Certificate, Best Series
1987, 1981 (2), 1978 (2),
1977, 1976, 1975

American Society of
Business Press Editors Award
1991, 1990, 1988, 1983, 1981

Jon Titus
Editor

Send me your comments via FAX at (617) 558-4470, or on the EDN Bulletin Board System at (617) 558-4241 300/1200/2400, 8,N,1; on 9600-bps modems try (617) 558-4580, 4582, or 4398.

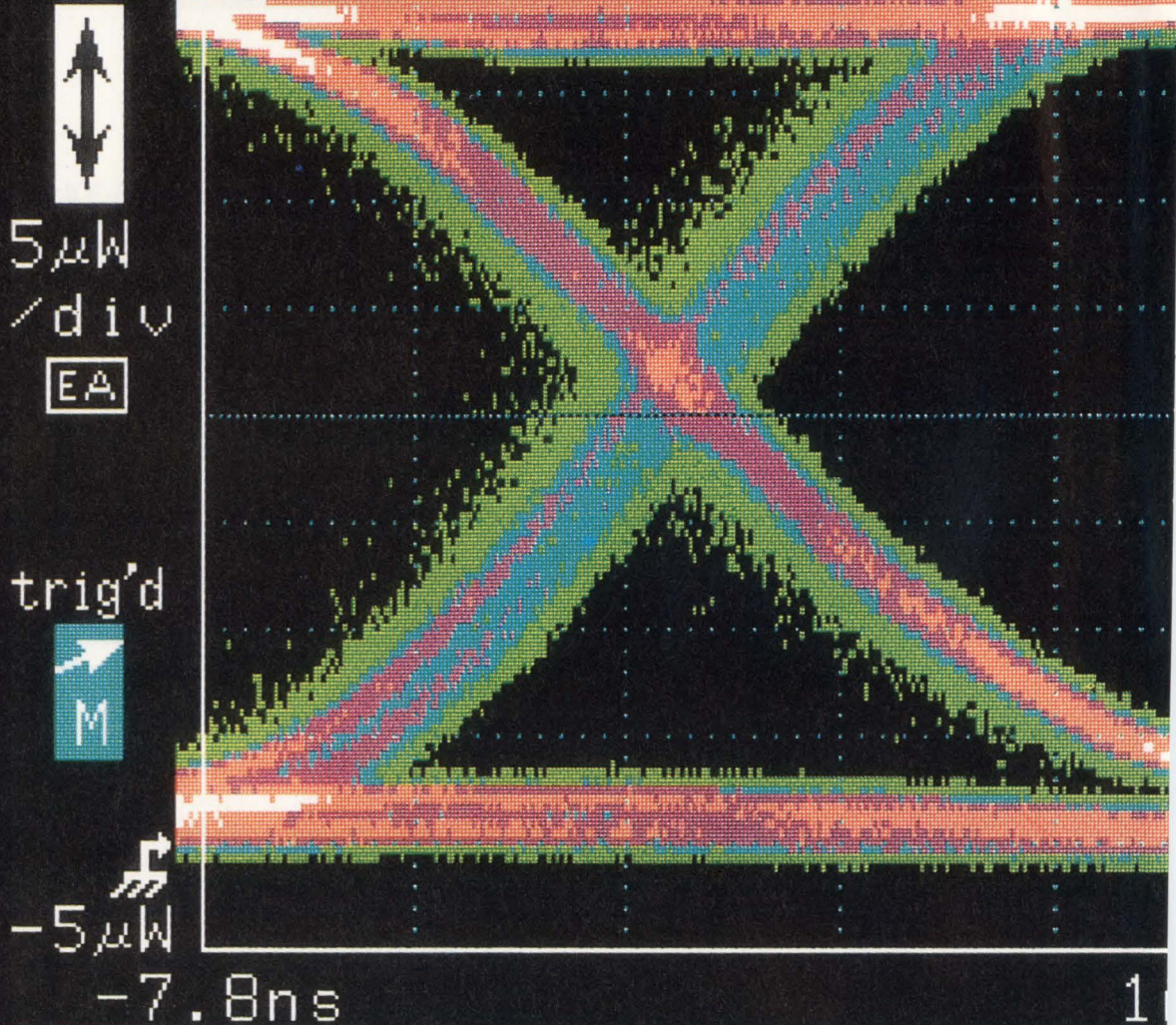

Rise (S)	Jitter (S)	Noise (S)
2.760 ns	144.8 ps	912.2 nW

WE'LL GIVE YOU

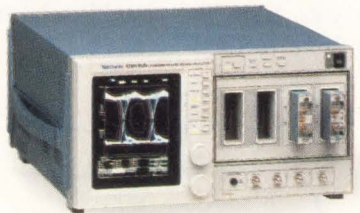

In a world so dependent on communicating, your customers don't take kindly to interruptions. So in the interest of keeping folks in touch with one another, Tektronix makes communications signal

analyzers that let you measure jitter and noise automatically. And bit error rate testers that can lock onto and test specific or pseudo-random patterns—even those millions of bits long. But these devices are just part of a sophisticated collection that includes optical-to-electrical converters, SDH/SONET reference

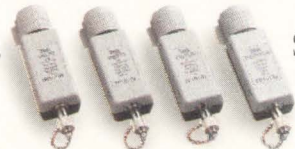

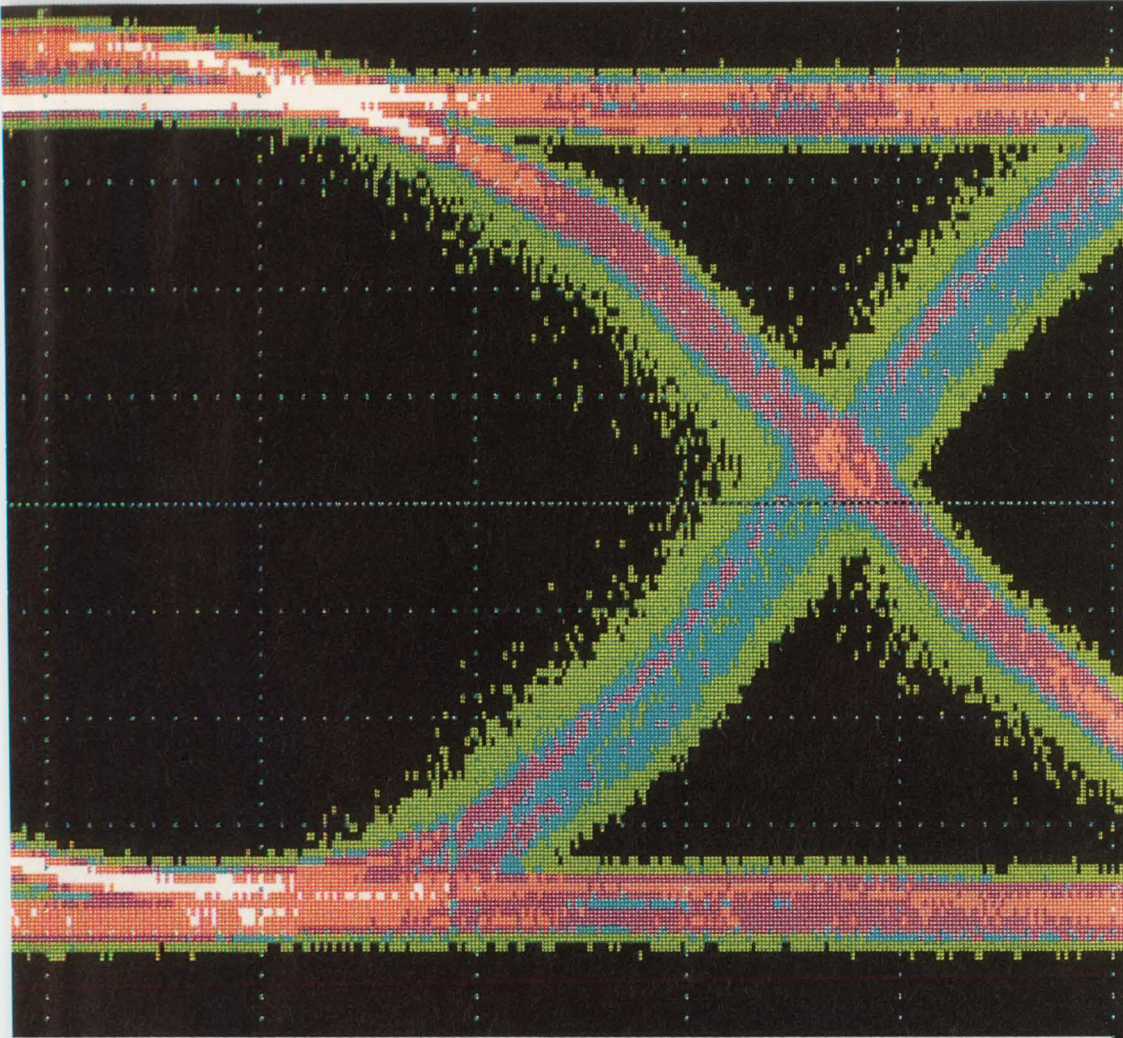

/div

2.2ns

Measure-
ments

Vert Size: R3

5 μ W/div

Vert Offset: R3

20 μ W

THE JITTERS.

receivers, optical attenuators, and optical and metallic time-domain reflectometers.

High-performance equipment for everyone from design engineers to field service technicians.



So to make sure your customers are getting all the right messages, talk to Tek today. We promise, we'll do everything we can to help you keep the lines of communication open. **TALK TO TEK/1-800-426-2200**

Tektronix

Test and Measurement

CIRCLE NO. 51

EDN May 7, 1992 • 59

Low Delays.

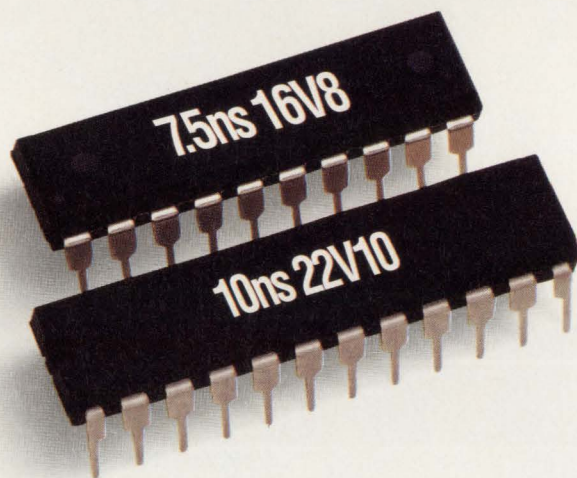

High-Speed 7.5ns CMOS PAL® Devices.

There's nothing we hate more than delays. That's why we developed high speed CMOS PAL devices that no one can beat—our CMOS 7.5ns 16V8H-7 and 10ns 22V10H-10 PAL devices.

In fact, nobody even comes close to our in-system performance, with the fastest set-up

and clock-to-out times available. Both come in PLCC and DIP varieties. All on state-of-the-art submicron EE CMOS.

High-Volume, High-Speed Delivery.

Again, there's nothing we hate more than delays. You can get huge volumes of our new CMOS PAL devices now.

And they're on the shelf at your local dis-

No Delays.



tributor, too. So you can get the quantity and speed you need, whenever you need them.

What more can you expect from the company that sells more programmable logic than all of its competitors combined?

So pick up the phone and place your order today, or call **1-800-222-9323** for more information.

Because at AMD, we don't believe in long delays either.



Advanced Micro Devices

901 Thompson Place, P.O. Box 3453, Sunnyvale, CA 94088 © 1991 Advanced Micro Devices, Inc. PAL is a registered trademark of Advanced Micro Devices. All brand or product names mentioned are trademarks or registered trademarks of their respective holders.

Power tool



KEPCO 360~1080 WATT MAT POWER SUPPLIES ARE PROGRAMMABLE WITH YOUR MOUSE.

Other power supplies have knobs or keypads. Kepco's "MAT" lets you use your mouse... **POINT..CLICK..SET**

Kepco's MAT power supplies implement LabWindows.⁽¹⁾ The interactive screen lets you use your mouse to set voltage and current and even open and close load and polarity relays. Kepco's MAT power supplies report back their actual voltage, current and status.

Use the IEEE-488 bus or communicate directly between your PC and power supply over a 2-wire telephone-like serial bus.

With Kepco's LabWindows driver, your mouse becomes a REAL power tool able to control thousands of watts with a single click.

⁽¹⁾LabWindows © National Instruments

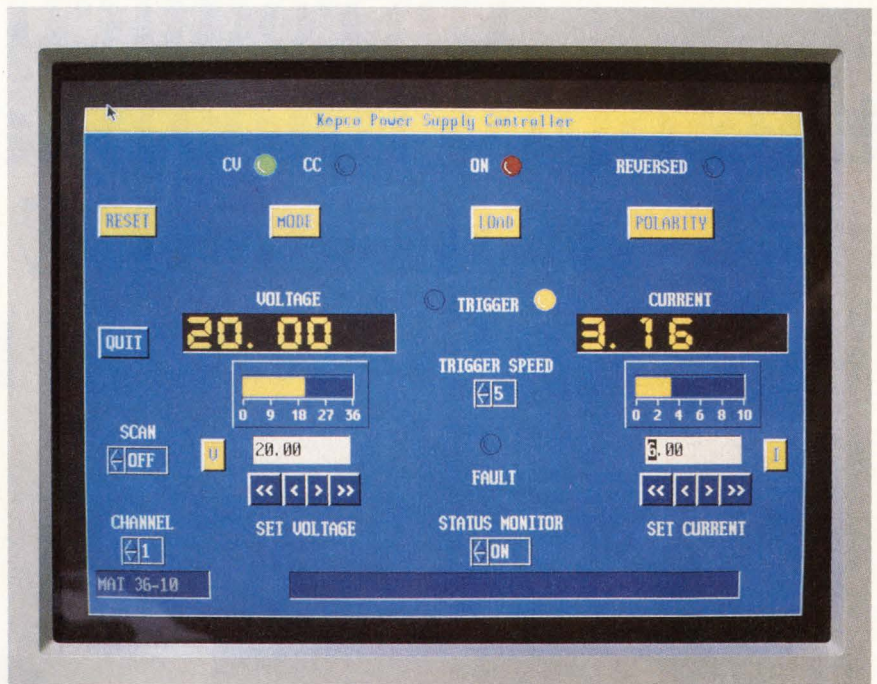

Three 360W Power Modules shown in RA 50 Housing

Instrumentation and Bench



146-1785

Switching a-c to d-c and d-c to d-c



146-1760



SEE US AT ELECTRO '92, KEPKO BOOTH 4503, 4505

SEE OUR PAGES IN VOLUME D **eem**

Kepco, Inc., 131-38 Sanford Avenue, Flushing, NY 11352 USA • Tel: (718) 461-7000 • Fax: (718) 767-1102 • Easylink (TWX): 710-582-2631
Eastern Region: 131-38 Sanford Avenue, Flushing, NY 11352 USA • Tel: (718) 461-7000 • Fax: (718) 767-1102 • Easylink (TWX): 710-582-2631
Western Region: 800 West Airport Freeway, Suite 320 LB 6018, Irving, TX 75062 USA • Tel: (214) 579-7746 • Fax: (214) 579-4608
Kepco Europe, Ltd., London, England: Salamander Quay West, Park Lane, Harefield, Middlesex UB9 6NZ • Tel: +44 895 825046 • Fax: +44 895 825045



CIRCLE NO. 53

EDN May 7, 1992 • 63

Introducing the only linears approved to meet IEC 950 and Level B EMI.

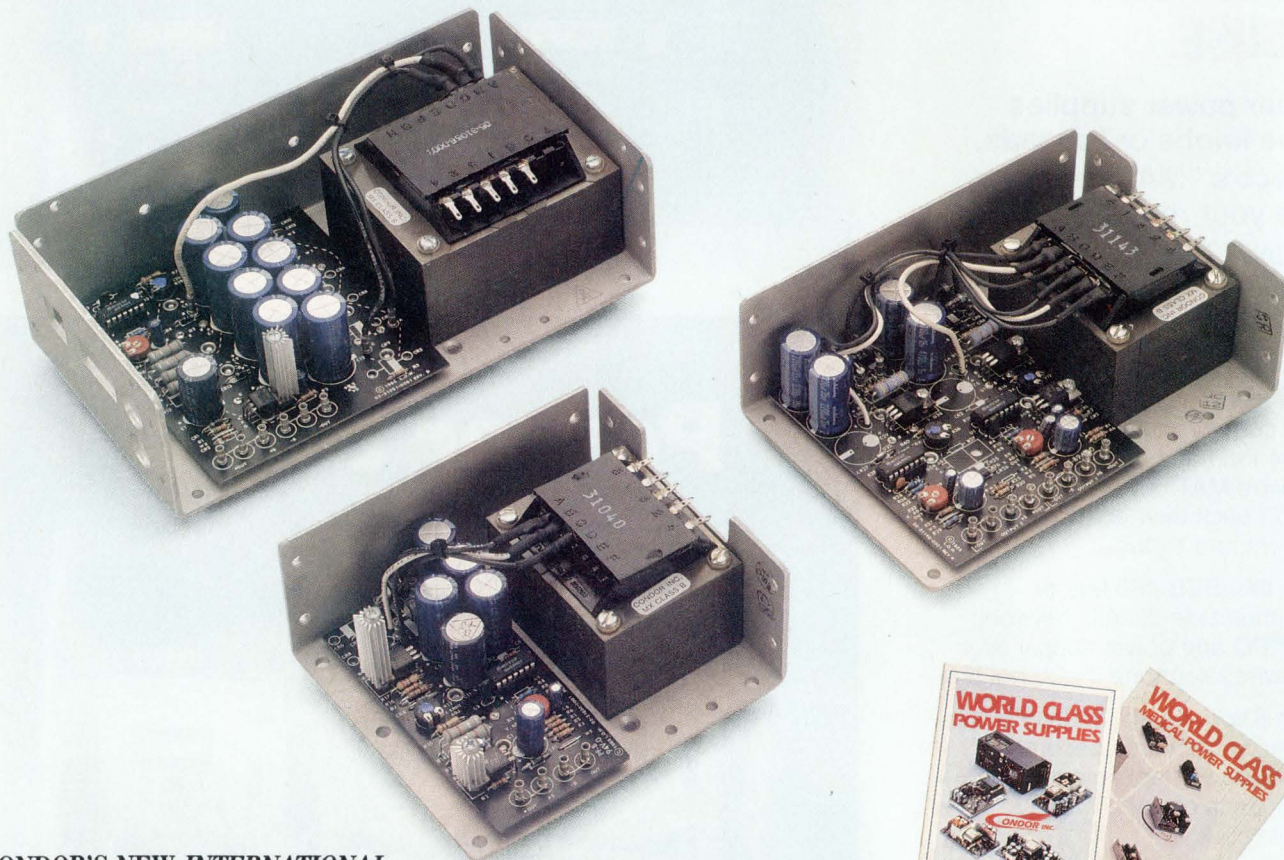

CONDOR'S NEW *INTERNATIONAL PLUS* LINEAR D.C. POWER SUPPLIES MEET TOMORROW'S TOUGH STANDARDS TODAY!

Our International Plus linears offer you performance, price and one more important feature: the agency approvals you need for the 90's, including IEC 950 and VDE 0871 level B EMI. And Condor has more approved linears in stock than anyone in the industry (including more than 30 models in IEC 601 medical versions).

International Plus linears have what you're looking for:

- 115 models (single and multi-output)
- 7 power levels — 3 to 288W
- Worldwide AC input ranges
- OVP on all 5V outputs

- Hermetically sealed power transistors
- MTBF 200,000+ hours per Mil Hndbk 217E
- 2-hour burn-in with cycling (8 hours on medicals)
- Computerized testing (data sheets furnished)
- 3-year warranty — longest in the industry
- 30-day FREE evaluation (call us for samples)

If you need world class performance, quick turnaround, competitive pricing *and* full agency approvals, call Condor — the leader in linear D.C. power supplies.



Call for our
FREE catalogs!

- 300+ power supplies
- Standard and medical
- Switchers and linears
- Open frame and enclosed
- Custom capability

CONDOR

Condor Inc. D.C. Power Supplies
2311 Statham Parkway
Oxnard, CA 93033 • (805) 486-4565
CALL TOLL-FREE:
1-800-235-5929 (outside CA)
FAX: (805) 487-8911

Generators take the hassle out of defining waveforms

DAN STRASSBERG, Technical Editor



A signal source that uses digital technology and includes libraries of predefined functions can make short work of specifying waveforms.

Signal sources that produce predefined as well as user-defined functions are making waves in the once-stodgy waveform-generation field. These instruments are a step beyond first-generation arbitrary-waveform generators (ARBs). First-generation ARBs sometimes aren't especially easy to use. But by now they're old hat to many EEs, and most of them do provide nearly all of the flexibility you ever could want. They use D/A-converter technology, but they're not just DACs under another name. (See box "You need more than a DAC to build an ARB.")

The problem that many users had with first-generation ARBs was getting the instruments to produce common signals (waveforms) without having to go through the time-consuming step of waveform definition. Regardless of how cleverly vendors designed the waveform-definition software used with ARBs, or how well ARBs' built-in waveform-generation features worked, users who merely wanted common signals balked at getting involved with any process more complex than pushing a few buttons or setting a few switches.

Through such techniques as using function libraries, instruments based on ARB technology now make obtaining basic waveforms simple. In most cases, they achieve

this simplicity without sacrificing the ability to produce user-defined and customized waveforms. In several cases, the generators use local intelligence—even DSP μ Ps—to synthesize the waveforms from data stored as algorithms. Algorithmic storage uses much less memory than point-by-point storage.

Compared with classic analog function generators, units based on digital technology are more flexible: the repertoires of most go well beyond analog generators' standard menu of sine, square, ramp, triangle, and sawtooth waves. With most digital units, you can combine library waveforms to create custom signals, instead of having to define them



Emphasizing the importance of waveform generation's long tradition is this montage of the panel of Hewlett-Packard's 8904A overlaying a photo of the company's venerable 200C. The 200C, a sine-wave oscillator, is a close descendent of Bill Hewlett's 1939 original 200A.

WAVEFORM GENERATORS

from scratch. Also, the digital units' outputs are more stable and predictable than those of typical analog generators. Most analog generators derive their timebases from RC oscillators, whereas most digital units have crystal timebases. Some digital units develop their output frequencies from the timebase via direct digital (frequency) synthesis (DDS).

DDS helps to make waves

Direct digital synthesis is at the heart of several instruments listed in **Table 1**. Some vendors refer to these DDS-based generators as

function synthesizers. Although some function synthesizers lack the custom-waveform-generation capabilities of ARB-based units, DDS provides a long list of benefits, including the abilities to set frequencies with many digits of precision; change frequencies rapidly; and provide phase continuity when the frequency changes. (That is, the generators introduce no discontinuities in supposedly continuous waveforms.)

In this era of ASICs, companies that use DDS see little, if any, downside in the technology. Stan-

ford Research Systems' Dave Kruse says flatly that in a very short time, all waveform generators, except possibly some low-cost models used in education and field-service, will use DDS.

Stanford's original DS345 prototype, built from discrete components, occupied a densely packed 11×14-in. pc board. However, in less than a year, the firm reduced the design to one CMOS ASIC that consumes a small fraction of the discrete design's power and space and runs at higher frequencies. Implementing DDS via ASIC technology

You need more than a DAC to build an ARB

Any D/A converter can generate a signal that is an arbitrary function of time; all you have to do is supply the DAC with the correct data at periodic intervals. Indeed, if you are designing a product whose operation depends on synthesizing waveforms, but whose main purpose is something else, a single DAC will probably generate the waveforms quite satisfactorily. But function-generator instruments must serve a range of applications; the simplest possible implementations can't meet the expectations of many users.

A general-purpose generator needs several features not found in straightforward DACs. General-purpose generators must produce waveforms of varying amplitude. To be sure, a generator can vary the amplitude of a DAC's output by scaling the DAC's digital inputs, but at low-output amplitudes this approach uses only a small portion of the DAC's dynamic range. The result is that the DAC's fixed quantization error of $\frac{1}{2}$ LSB (the least-significant-bit weight) becomes a large percentage of the output-signal amplitude, and the signal-to-noise ratio deteriorates. One solution is to add a second DAC—a multiplying DAC—to scale the output.

Adding such a multiplying DAC (or gain DAC) also provides a convenient place to introduce a signal that modulates the amplitude of the output waveform. Some generators assign the gain-control and amplitude-modulation functions to separate multiplying DACs, however. Note that if a multiplying DAC performs the modulation, the generator won't accept externally generated modulating signals in analog form. Moreover, to see the modulating waveform as something other than the envelope of a modulated carrier, you must set the main DAC to produce dc.

If the output waveform must ride on a programmable dc baseline level, single-DAC designs can experience a dynamic-range problem similar to the one found in generators that use one DAC for both waveform synthesis and gain control. The values that represent the waveform at the DAC input can include a quantity corresponding to the baseline. However, such numeric offsets reduce the portion of the DAC's dynamic range usable for representing the waveform. A more flexible approach uses an offset DAC whose output sums with the output of the waveform DAC (or the output of the waveform DAC multiplied by a scale factor set by the gain DAC).

Here a DAC, there a DAC, everywhere a DAC

So a single-channel waveform generator can include four DACs, one for generating the output waveform, one to perform amplitude modulation, and one each to control the gain and to provide a dc offset. But the number of DACs doesn't tell the whole story about signal generators' DAC requirements. Obtaining artifact-free waveforms requires special care, particularly to remove glitches from the outputs of the DACs that generate the output waveform and that introduce modulation. The sources of these glitches or transients include time skew among the DACs' several bit inputs and coupling of logic-level signals through the capacitance of the DACs' bit switches. The remedies range from using double-rank registers for correcting time skew among the DACs' digital inputs to using specialized sample-and-hold circuits (deglitchers) to smooth the DAC output transitions.

Unlike the majority of component-level DACs, most general-purpose waveform generators can drive reasonably heavy loads. Typical specifications are $\pm 5V$

permits small size, low cost, and low power that are very attractive for waveform generators. Kruse says the question now is not *whether* competing companies that aren't using DDS will make the switch, but *when* they will do so.

Analogic, which also uses DDS, in its 2030 and 2030A, has found some ways to refine the already elegant DDS technique. At high frequencies, close to the clock frequency, DDS runs into limitations on the resolution of frequency adjustments. To overcome these limitations, the Analogic generators

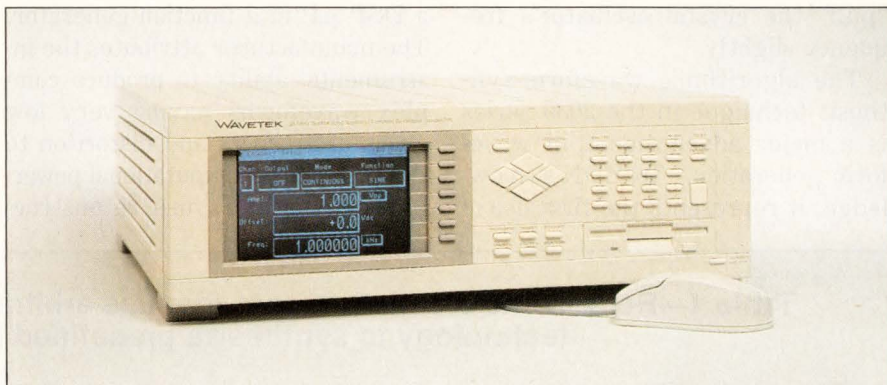

Attractive styling, relatively simple panels, and displays with graphics capability characterize the look of many of today's waveform generators. This one is Wavetek's 295, a unit with a 50-MHz data rate and as many as four channels. The generator stores waveform definitions in nonvolatile memory.

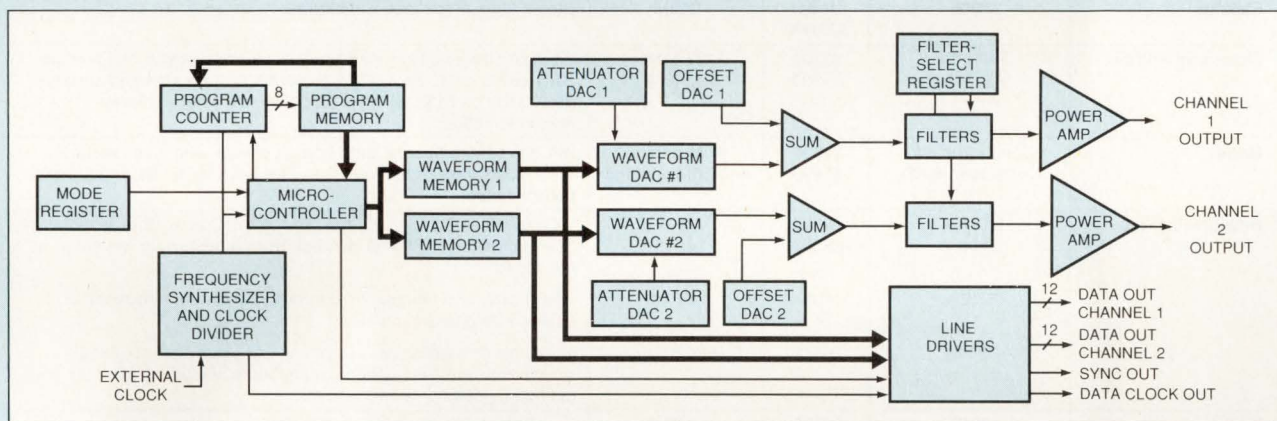

Fig A—This 2-channel generator, Signatec's AWG502, fits on a single ISA bus board. Note the use of waveform, attenuation, and offset DACs for each channel. Also note the programmable-cut-off-frequency lowpass filters and power amplifiers for each channel.

into 50Ω and $\pm 10V$ into an open circuit. Those specifications translate to a maximum output current of 100 mA. Therefore, in addition to all of the other components that make up the instrument—the several DACs mentioned already; the memory; the oscillator; the microprocessor(s) and other digital circuits; the power supply; the front panel; and the panel interface—a general-purpose function generator includes one or more output amplifiers. And each of these amplifiers can have its own gain and offset DACs.

Fig A shows the block diagram of the Signatec AWG502, 2-channel ISA bus waveform generator board, a commercial product that uses most of the techniques discussed in this box. (The AWG 502 has no modulation DAC.) Don't assume, however, that all of the generators in **Table 1** have basically similar architectures—they don't; the products use many different circuit approaches.

Note the AWG502's switchable-frequency lowpass filters. Although these 3-pole filters may prove inadequate for converting square waves into high-quality sine waves, some vendors (Stanford Research, for example) produce low-distortion sinusoids by using automatically tuned high-order lowpass filters to remove square-wave harmonics. Because a square wave's digital representation requires a minimal-length sequence—just 2 samples/cycle—many generators can produce square waves at half their clock rate; waveforms whose representations require more samples have lower maximum frequencies. Thus, at a given clock frequency, a generator that creates sine waves by lowpass-filtering square waves can produce higher-frequency sine waves than a generator that uses longer data sequences and little or no filtering.

WAVEFORM GENERATORS

"pull" the crystal oscillator's frequency slightly.

The algorithmic waveform-synthesis technique in the 2030 series is a major advancement in waveform generation. To EDN's knowledge, it represents the first use of

a DSP μ P in a function generator. The manufacturer attributes the instruments' ability to produce complex waveforms having very low levels of artifacts and distortion to the DSP chip's computational power.

The generators use reconstruc-

tion filters to attenuate artifacts inherent in synthesizing waveforms from a finite number of sampled data points. Unavoidably, the reconstruction filters introduce distortion of their own. However, this distortion is predictable; to mini-

Table 1—Representative instruments that use arbitrary-waveform-generation technology to synthesize predefined functions

Vendor	Model	Base US list price	Maximum data rate (samples/sec)	Comments
Analogic	2030	\$2995	50M	Compared with the 2030, the 2030A adds extensive waveform libraries and arbitrary-waveform capabilities. Other models have rates to 8000 Msamples/sec.
	2030A	\$3995	50M	
Flexstar	7000	Under \$20,000	250M	Stores eight predefined waveforms.
Fluke and Philips	PM 5138	\$3700	20.48M	Specified data rate is for arbitrary waveforms, which can contain 1024 points each. Standard waveforms include sine and squares (to 10 MHz on 5138; 20 MHz on 5139) and others at lower maximum rates.
	PM 5139	\$4300	20.48M	
Gage	Compugen 840	\$1900	40M (8 bits) and 20M (12 bits)	ISA bus plug-in boards. Both boards offer 8- and 12-bit resolutions. Load waveforms from disk. The 840A lacks the 840's digital pattern output.
	Compugen 840A	\$1400		
Hewlett-Packard	E1340A	\$2500	42M	VXI modules: E1340A is B size; E1445A is C size. Both respond to SCPI commands. E1445A can hop from waveform to waveform at full speed.
	E1445A	\$8000	42M	
	8770A	\$26,000	125M	Offers extensive modulation capability. Changes frequency in 8 nsec with phase continuity.
	8904A	\$3175	600 kHz ¹	Multifunction-synthesizer — not an ARB. Produces six fixed waveforms (and, with options, many more, including complex ones defined by deep data sequences).
Keithley	3910	\$1695	1 MHz ¹	Function synthesizer. Adds sweep and burst over full range. Adds arbitrary-waveform and dual-synthesizer capability.
	3930A	\$3590	1.2 MHz ¹	
	3940	\$5390	20 MHz ¹	
LeCroy	9101	\$10,900	200M	1 channel, 8 bits, 64-kbyte memory. 2 channels, 12 bits, 64k-words/channel. Other models at intermediate prices.
	9112	\$15,900	50M	
Pragmatic	2201A	\$9985	2M	3 channels, 16 bits, 64k-words/channel. 1 channel, 12 bits, 32k-word memory. 2 channels, 12 bits, 256k-words/channel. 1 channel, 16 bits, 64k-word memory.
	2202A	\$2495	20M	
	2205A	\$10,985	50M	
	2411A	\$2495	2M	
Rapid Systems	R4010	\$2995	10M	PC-based unit. With vendor's R4 software (\$995), recalls predefined waves, lets you define and edit waveforms. ISA bus direct-digital-synthesis function generators. Sine, triangle, noise, sawtooth built in. 12 bits. 8k-word arbitrary-function memory. R4300 lacks R4350's high-speed pulse capability.
	R4350	\$1495	5M (pulse) ² or 300 kHz ² (other waveforms)	
	R4300	\$995		
Signatec	AWG502	\$3500	50M	Plugs into 16-bit ISA bus. Has two independent 12-bit channels. Uses either or both as 12-bit digital word generator. 64k-word waveform memory for each channel. Loop/branch capability lets you define very long waveforms. Ten lowpass filters per channel.
Stanford Research	DS345	\$1895	40M	Direct-digital-synthesis generator, 1- μ Hz frequency resolution. 16k-word arbitrary-waveform memory. 12-bit amplitude resolution. Built-in sine, ramp square, triangle, and noise waveforms.
Wavetek	75A	\$1695	5M	Nine waveforms stored in nonvolatile memory. Arbitrary waves to 8192 points. Allows one to four channels; outputs can be summed. Stores waveforms in nonvolatile memory and on optional floppy disk.
	295	\$5995	50M	

Notes:

¹Maximum sine frequency

²Output frequency

The Race for Quality . . .

They say in the race for quality there's no finish line. But there are milestones, and we passed some long ago:

- 1985** PTS introduces a 2-year warranty, among the first in the industry.
- 1986** PTS introduces an 8 year flat rate \$350 service charge for any out-of-warranty repair (covers years 3 through 10 of ownership).

From all the recent press, you might think the concept of quality was invented in the last few years. Well, at PTS we've been building quality frequency synthesizers for well over a decade, and backing that up with our warranty and service plan. And with more than 30,000 years of instrument service in the field, we have a proven failure rate of less than 3% per year.

High Reliability Frequency Synthesizers

PTS manufactures a complete line of frequency synthesizers covering the 100 KHz to 1 GHz band with switching time as fast as $1\mu\text{s}$ for our Direct Digital (DDS) models. And plenty of other options as well, such as resolution down to 0.1 Hz, GPIB and digital phase rotation.

Whether it's ATE, SATCOM, EW or MRI/NMR imaging, PTS has a frequency synthesizer to fit your needs. PTS synthesizers carry one or more of these approvals:



Call (508) 486-3008 FAX (508) 486-4495

PTS

PROGRAMMED TEST SOURCES, INC.

9 Beaver Brook Road, P.O. Box 517, Littleton, MA 01460

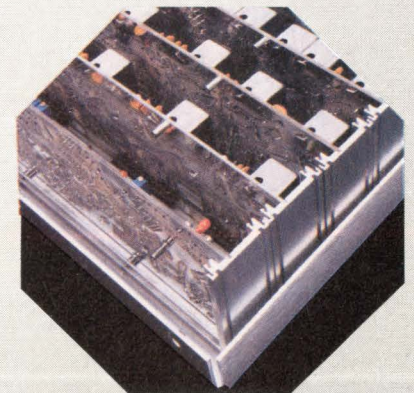
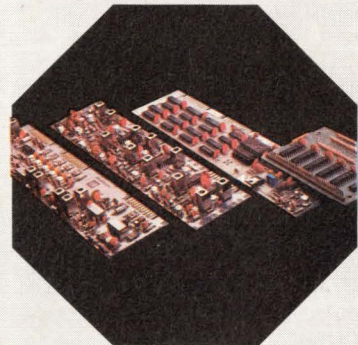
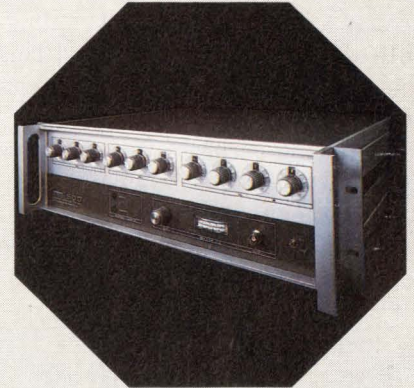

CIRCLE NO. 55

WAVEFORM GENERATORS

mize it, the generators intentionally correct the numeric data they send to their DACs. This correction is the inverse of the filter's distortion. A second correction term compensates for the $\sin(x)/x$ sampling roll-off. Each time you adjust the generator's output, the DSP μ P reconvolves the sampled data with the inverse of the filter and sampling-roll-off functions and modifies the waveform memory's contents accordingly.

Producing accurate waveforms is only part of the challenge waveform-generator designers face. Making the instruments easy to use is another big challenge. Generator

designers have invested considerable effort and creativity in designing the controls and displays you use to define arbitrary or custom waveforms on their equipment. The importance that vendors attach to this human interface is entirely appropriate; the interface has a profound effect on users' productivity and, therefore, on users' reactions to a product.

Some vendors take the position that the best way to define waveforms is to run a specialized software package on your PC. According to this argument, cluttered lab benches and cramped instrument panels just aren't conducive to do-

ing a good job of waveform definition; you'll do the job best while you are seated in front of the PC, with its large screen, full keyboard, and mouse or trackball.

But a quick look at the brochures for the instruments in **Table 1** reveals that using PCs to define waveforms is far from universal. Several vendors have devoted much effort to building waveform-definition features into their instruments and to making the use of those functions natural and intuitive.

One such firm is Pragmatic Instruments. Pragmatic's generators work with a mouse or a trackball and connect to virtually any analog or digital oscilloscope. The scope display allows you to watch the results as you define and edit arbitrary waveforms or combine and customize predefined ones. By using algorithmic waveform storage, the firm's 2202A and 2411A each store 20 predefined signals that you can make part of custom waves. Unlike the Analogic 2030 series, though, the Pragmatic generators don't use DSP μ P's. Instead, the units' main μ Ps translate the mathematical signal definitions into point-by-point waveform replicas. Because the generators include RS-232C interfaces and offer IEEE-488 ports, users who prefer to define waveforms on a PC have the option of doing so.

User interfaces run the gamut

For combining and customizing the waveforms in its repertoire, the Analogic 2030A relies on displaying block diagrams of mathematical operations on a backlit LCD screen. This scheme portrays the manipulations you request the generator to perform in a way that mirrors how you probably think about the operations. Like the Pragmatic generators, this unit offers users the freedom to download waveforms via RS-232C or IEEE-488 ports.

You don't get the precision, ver-

For more information . . .

For more information on the waveform generators discussed in this article, circle the appropriate numbers on the Information Retrieval Service card or use EDN's Express Request service. When you contact any of the following manufacturers directly, please let them know you read about their products in EDN.

Analogic Corp

8 Centennial Dr
Peabody, MA 01960
(508) 977-3000
FAX (508) 531-1266
TLX 6817021

Circle No. 700

Flexstar

2040 Fortune Dr, No. 101
San Jose, CA 95131
(408) 433-0770
FAX (408) 433-1766
Michael Witte

Circle No. 701

John Fluke Mfg Co Inc

Box 9090
Everett, WA 98206
(800) 443-5853;
(206) 356-5500

Circle No. 702

In Europe:

Philips Test & Measurement

Building TQIII
5600MD Eindhoven
The Netherlands
Phone local office

Circle No. 703

Gage Applied Sciences Inc

5465 Vanden Abeele
Montreal, PQ H4S 1S1
Canada
(514) 337-6893
FAX (514) 337-8411

Circle No. 704

Hewlett-Packard Co

19310 Pruneridge Ave
Cupertino, CA 95014
(800) 752-0900

Circle No. 705

Keithley Instruments Inc

28775 Aurora Rd
Cleveland, OH 44139
(800) 552-1115;
(216) 248-0400
FAX (216) 248-6168

Circle No. 706

LeCroy Corp

700 Chestnut Ridge Rd
Chestnut Ridge, NY 10977
(914) 425-2000
FAX (914) 425-8967

Circle No. 707

Pragmatic Instruments Inc

7313 Carroll Rd
San Diego, CA 92121
(800) 772-4628;
(619) 271-6770
FAX (619) 271-9567

Circle No. 708

VOTE . . .

Please also use the Information Retrieval Service card to rate this article (circle one):

High Interest 473

Medium Interest 474

Low Interest 475

Rapid Systems Inc

433 N 34th St
Seattle, WA 98103
(206) 547-8311
FAX (206) 548-0322
Jann Hegle

Circle No. 709

Signatec Inc

357 N Sheridan St, Suite 119
Corona, CA 91270
(714) 734-3001
FAX (714) 734-4356

Circle No. 710

Stanford Research Systems

1290D Reamwood Ave
Sunnyvale, CA 94089
(408) 744-9040
FAX (408) 744-9049
TLX 706891

Circle No. 711

Wavetek Corp

9045 Balboa Ave
San Diego, CA 92123
(800) 874-4835;
(619) 279-2200
FAX (619) 565-9558

Circle No. 712

Device

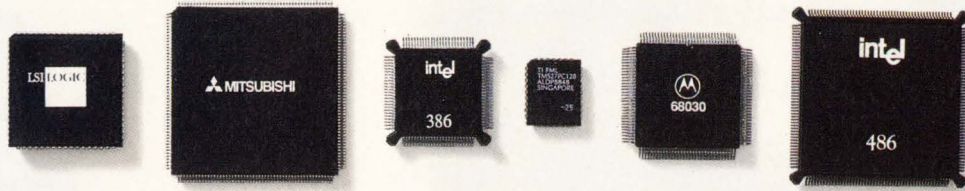

& Conquer.

It seems like every time you turn around, another device appears on the scene. Smaller SMDs, finer pitched leads, congested boards. Device testing has become a real challenge.

Fortunately, Pomona helps you conquer the problem.

With Pomona's new FIN™ (Flexible Interface Network) test clips, set-up time is dramatically reduced. You can rely on repeatable contact with every pin, every time. No messy soldering to traces or leads, no wasted time chasing the wrong problem. Interfacing with your logic analyzer or other test equipment is simple and quick.

FIN clips "lock-on" to high pin count (100-, 132- and 196-pin) JEDEC plastic or ceramic QFPs, and you can choose from three styles in each pin count to work best with your equip-

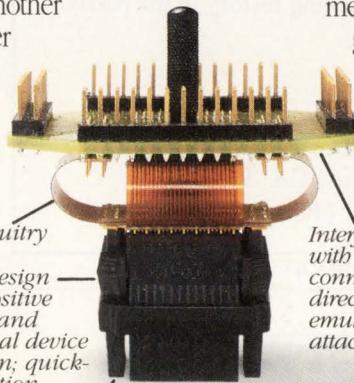

Flex circuitry

Lock-on design insures positive electrical and mechanical device connection; quick-release action

Individual contact wiping action conforms to variances in lead dimensions

Interface board with edge connectors provides direct access or emulation board attachment

ment. There's a platform with .100" headers for easy grabber attachment or connection to industry standard (IDC) connector cables, another with .050" connectors on flex circuitry for direct attachment to your own emulation board, or a FIN clip with integral .050" connectors for interface with most instrument ribbon cable assemblies.

And don't forget the complete family of Pomona test clips or handy clip kits for DIP, SOIC and PLCC packages including PGA adapters, breakouts and 18 styles of EIAJ adapters. Whether it's design or emulation, production testing or field service, call us or FAX your

requirements for a quick solution.

Pomona Electronics, 1500 E. Ninth Street, P.O. Box 2767
Pomona, CA 91769. (714) 469-2900 FAX (714) 629-3317.

We're Making Technology Easier To Live With.

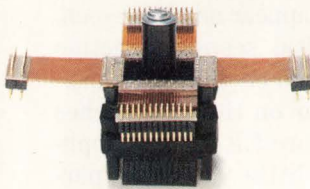

PQFP clip with flex-circuitry-to-.050" connector interface.

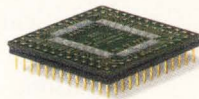

SMT/PGA converter allows low-cost SMDs to be plugged onto thru-hole boards.

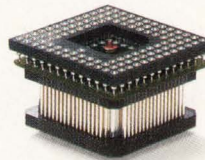

PGA spring-loaded Pin Adapter for SMT boards enables board testing without mounted device.

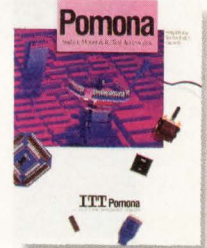

Call. FAX or write today for your free copy of Pomona's full-color Surface Mount and IC Test Accessories brochure.

ITT Pomona

The World Leader In Test Accessories

CIRCLE NO. 56



WORLD'S SMALLEST Surface Mount Resistor Network

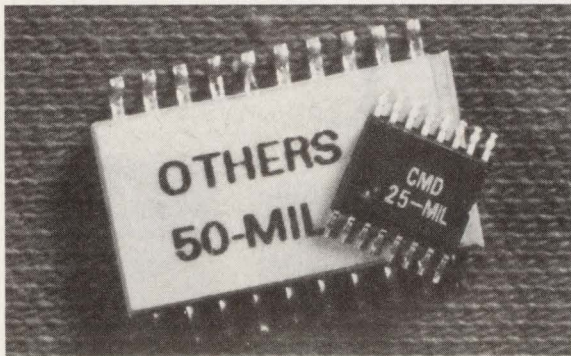

Introducing 25-mil lead pitch resistor networks that are 1/3 the size and 1/4 the weight of conventional thick film networks. These resistors offer a world of superior performance characteristics such as tighter tolerance, greater stability and lower noise.

Call us today to find out how we are making history in the passive component market.



California Micro Devices
215 Topaz Street, Milpitas, CA 95035
Tel: (408) 263-3214 • Fax: (408) 263-7846

CIRCLE NO. 57

EDN-TECHNOLOGY UPDATE

WAVEFORM GENERATORS

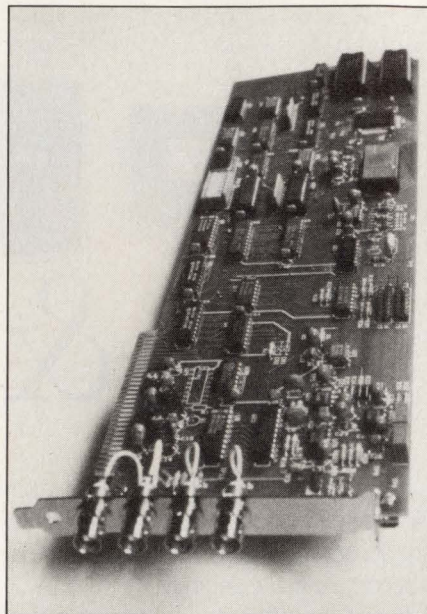

Waveform generators come in a variety of shapes and sizes. This unit, the R4300 from Rapid Systems, plugs into the ISA bus. At \$995, it is the least expensive unit in Table 1.

HIGH POWER FACTOR

Custom Switching Power Supplies
for ● Engineering work stations

- Computer main frames
- Computer peripheral equipment
- Business equipment
- Telecommunications
- etc.



- High power factor 0.99
- Design, manufacturing in Japan
- Repair center in U.S.A.

FDK also specializes in DC-DC converters, hybrid ICs, memory cards, ferrite cores, lithium batteries, stepper motors, optical isolators, etc.

FDK Your Best Strategic Partner
FDK AMERICA, INC.

A Division of Fuji Electrochemical Co., Ltd.
2880 Zanker Road, #102 San Jose, California 95134, U.S.A.
TEL: 408-432-8331 FAX: 408-435-7478

Dallas TEL: 214-650-7742 FAX: 214-650-7792
Boston TEL: 617-487-3198 FAX: 617-487-3199

CIRCLE NO. 58

satility, and repeatability of these digital generators for free. The price range of the units in Table 1 is \$995 to \$26,000, excluding options (2/3 of the units have prices below \$5000). On the other hand, a good-quality basic analog generator whose maximum output frequency is several MHz costs just a few hundred dollars. So, like analog oscilloscopes, analog function generators are not destined to disappear any time soon. But, like digital scopes, function generators based on digital technology will appear on the lab benches of more and more EEs whose applications allow little room for performance compromises. EDN

Article Interest Quotient
(Circle One)

High 473 Medium 474 Low 475

HIGH-POWER MODULAR SWITCHING POWER SUPPLIES

Custom-configured supplies promote design flexibility

BRIAN KERRIDGE, Technical Editor

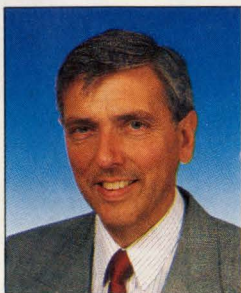

Power supplies made up of submodules let vendors satisfy wide-ranging power and voltage demands at lightning speed and without an engineering charge.

Predicting power-supply requirements before a design is complete is a headache familiar to all designers of electronic products. When the product consumes power in the 200 to 2000W range and has multiple voltage rails, the headache intensifies.

Some modular-power-supply vendors offer relief from this burden by offering a class of custom-configured supplies that employ submodule construction. Essentially, within the same modular enclosure the vendor can mix and match submodules to adapt a power supply to meet your product's specific output requirements. What's more, vendors have fine-tuned their manufacturing process to the point where a delivery time of 10 days or less is the norm.

Such flexibility allows you some freedom to make design changes or offer product upgrades without being constrained by a fixed-design power source. You can make these changes with minimal delay to your own development schedule. Some modular supplies accept as many as eight submodules, which gives you enough margin to introduce a new voltage rail to your design if necessary or boost current capability on an existing rail with a parallel module. Conversely, if you've been overly conservative in power budgeting at the outset of a design, you can reduce the margin and pass lower line-

power requirements to your customers.

For the majority of power supplies in this class, the internal power-supply configuration for each design is fixed by the vendor at manufacture. Generally, the submodules are soldered to an internal subframe mother board. Philips and Vicor recently introduced modular power supplies that let users change around the submodules; that is, the supplies are field configurable. The submodules use plug and socket connectors,

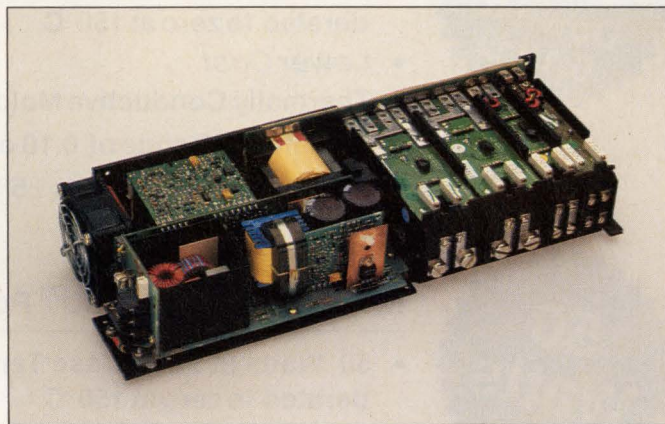

Taking the cover off a Coutant-Lambda 600W MML series switcher shows a snug fit for as many as six output submodules. Fan cooling, power-factor correction, and a single input range of 85 to 265V ac are standard features. The company guarantees 10-day delivery for this series.

and you can remove submodules after releasing a few fixing screws. This facility offers the possibility of shipping extra power-supply submodules to customers as part of a product upgrade kit—for example, when adding a floppy drive or extra plug-in cards to a system.

Although configurable power supplies bring considerable benefits to the user, the original motivation for using submodules came from manufacturers

And Now
50 Watts!

CADDOCK
ELECTRONICS, INCORPORATED

More New Power Resistors

Non-Inductive Designs

TO-220 Style Power Packages

**20
Watts**
Down to
0.05 Ω

MP 820 Kool-Tab[®] Power Film Resistor

- 20 Watts at 25°C Case Temperature derated to zero at 175°C
- Metal Mounting Tab
- Best High Frequency Performance
- Resistance Range of 0.05 ohm to 10K
- Tolerance $\pm 1\%$, $\pm 2\%$, $\pm 5\%$ or $\pm 10\%$

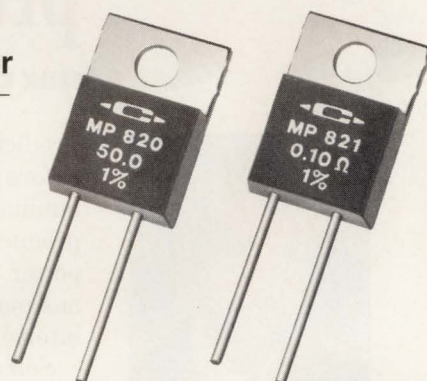

**16
Watts**
Down to
0.10 Ω

MP 816 Kool-Pak[™] Power Film Resistor

- 16 Watts at 25°C Case Temperature derated to zero at 150°C
- *Lower Cost*
- Thermally Conductive Molded Package
- Resistance Range of 0.10 ohm to 10K
- Tolerance $\pm 1\%$, $\pm 2\%$, $\pm 5\%$ or $\pm 10\%$

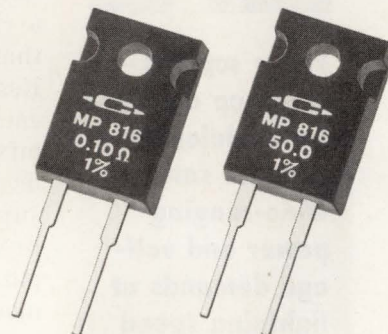

**50
Watts**

MP 850 Kool-Pak[™] Power Film Resistor

- 50 Watts at 25°C Case Temperature derated to zero at 150°C
- Copper Heat Sink Integral in the Molded Package
- Resistance Range of 1.0 ohm to 10K
- Tolerance $\pm 1\%$, $\pm 2\%$, $\pm 5\%$ or $\pm 10\%$

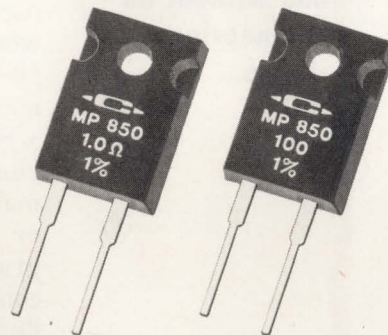

More high
performance
resistor products
from

CADDOCK
ELECTRONICS, INCORPORATED

These products are manufactured with Caddock's exclusive Micronox[®] or Tetrinox[®] Resistance Film Technologies.

Applications Engineering
Caddock Electronics, Inc.
17271 North Umpqua Hwy.
Roseburg, Oregon 97470
Phone: (503) 496-0700
Fax: (503) 496-0408

Sales Office - USA and Canada
Caddock Electronics, Inc.
1717 Chicago Avenue
Riverside, California 92507
Phone: (714) 788-1700
Fax: (714) 369-1151

The 23rd Edition of the Caddock General Catalog includes specifications on over 200 models of high performance resistor products. Call for your copy.

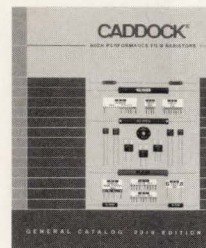

HIGH-POWER MODULAR SWITCHING POWER SUPPLIES

themselves. Submodules let vendors offer products with a range of voltage-level and power-output combinations while minimizing the number of subassembly variants passing along their production lines. Naturally, this approach has a cost penalty. But set against the design flexibility and rapid delivery that results, it's a penalty users find acceptable.

Table 1 shows specifications for a selection of power supplies that use submodule construction for fast-delivery custom products.

Lack of standardization exists be-

tween models from different vendors, and this variation can be both a weakness and a strength in your choice of model. Physical constraints will lock you to one vendor because, although the external dimensions column shows similar overall sizes for different models, the fan position and input-output connectors are quite different. But conversely, because submodules' maximum output power also differs among vendors, your requirements may form a better match with one vendor's submodule power capacity than with another's.

Regarding overall power-handling capacity, one important point to note is the maximum operating temperature at which the supply will deliver its full power. Different vendors choose to specify this temperature as 40, 50, or 55°C. The power-derating figure for a modular supply in this class is typically 2.5%/°C. This figure indicates that if a supply's full power limit is specified as 50°C, then at 70°C the power-output capability will have already dropped by half. Rather obvious, but worth pointing out, is that in some models a full set of sub-

Table 1—Representative custom-configurable modular power supplies

Manufacturer	Model	Standard output voltages (V)	Maximum total power (W)	Maximum operating temperature before derating (°C)	Maximum submodule power (W)	Maximum number of output submodules	Enclosure dimensions (in.)	Comments	Price* (25+)
Astec Standard Power	Spectrum-VS	2,3,3,12,15,24,28,36, or 48	1200	50	240	4	5.0 × 5.0 × 11.0	Single input range of 85 to 264V ac; holdover storage 30 msec; due second quarter of 1992, prices provisional.	\$1975
			2000	50	240	4	5.0 × 8.0 × 11.0		\$3150
Coutant-Lambda	Omega	5,12,24, or 48	600	50	60	6	2.5 × 5.0 × 13.75	Power-factor correction standard; single input range of 85 to 265V ac; meets VDE 0871 Curve B.	1447
		5,12,24, or 48	1500	50	200	5	5.0 × 8.0 × 11.0		1861
Deltron	Moduflex-M	2,3,3,5,12,15,18,24,36, or 48	750	50	150	7	2.5 × 5.2 × 9.6	DM series accepts dc input; power-factor correction and fan cooling optional.	\$875
Philips Industrial	300 Family	5,12,24, or 48	800	55	800	2	4.0 × 5.0 × 12.0	Field configurable; power-factor-correction standard.	\$1100
		5,12,24, or 48	1600	55	800	2	8.0 × 5.0 × 12.0		\$1800
Power-One	SMP/SPF series	2,3,3,5,8,10,12,15,24,28,36, or 48	1500	50	1250	5	5.0 × 8.0 × 11.0	Dual- and triple-output modules available; optional power-factor-correction submodule takes up one slot.	\$1200
Qualidyne Systems	21 to 36 series	4,5,12,24, dual 24, or 48	2000	50	1500	5	5.0 × 8.0 × 13.75	Wide output adjustment; for example, 5V nominal adjustable 2 to 56V.	\$1695
Unipower	U-series	2,3,3,5,12,15,24, or 48	800	50	240	7	3.75 × 8.0 × 11.0	Similar P-series with low-profile enclosure.	\$1520
	H-series	2,3,3,5,12,15,24, or 48	1200	50	624	6	5.0 × 8.0 × 11.0	Power-factor correction standard.	\$1269
Vicor	Flatpac	5,12,15,24,28, or 48	600	40	200	3	1.37 × 7.4 × 8.6	Similar Compac family accepts 24 or 48V dc inputs; power-factor correction planned.	\$575
	Mini Stakpac	2,3,3,5,12,15,24, 28, or 48	600	40	200	4	1.9 × 5.5 × 12.0	Power-factor correction not available	\$963
	Stakpac	2,3,3,5,12,15,24,28, or 48	1200	40	200	8	3.2 × 5.5 × 11.5	Power-factor correction to 0.75 optional; adds approximately 10% to the price.	\$1634
	Megapac	2,3,3,5,12,15,24,28,48, or 96	1200	40	200	8	3.4 × 6.0 × 11.7	Field configurable; power-factor correction planned.	\$1436

*Assumes maximum power capability and maximum number of submodules.

HIGH-POWER MODULAR SWITCHING POWER SUPPLIES

modules running at their individual full power would exceed the maximum power rating of the supply overall.

Another power-limiting factor to observe concerns the voltage-trimming adjustment found on all models. The maximum-output-power specification for a submodule determines an output-current maximum assuming nominal output voltage. If you adjust the voltage down, the specified current maximum remains the same; therefore, the total output-power capability falls. On several models the adjustment range is approximately $\pm 10\%$, so the corresponding drop in power is probably within your design margin. On other models, such as members of Coutant-Lambda's Omega series, the voltage-adjustment range extends from $+20\%$ to -60% of the nominal output. In this case, you need to identify clearly the consequent drop in power when the supply is running at well below the nominal voltage.

You should also consider other current-limiting factors when selecting a power supply. In particular, transient currents in your de-

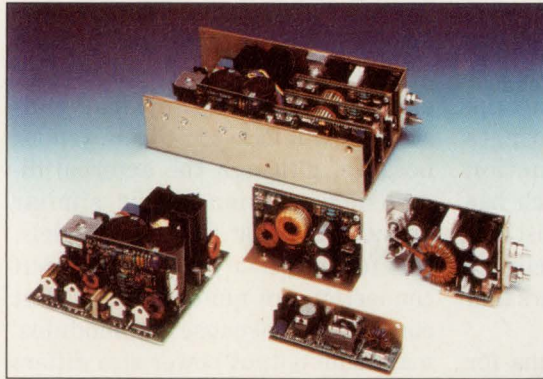

The submodular design of Deltron's 750W Moduflex M switching power supply includes optional power-factor correction circuitry, fan cooling, and as many as seven output modules.

sign can cause temporary overload that may reflect back into the supply and reappear as glitches on other voltage outputs. Start-up currents can easily double average running levels, particularly when motors are involved. A submodular custom-configured power supply's transient current is typically 50% overload for 500 msec.

Switchers neutralize notoriety

Switching power supplies have the reputation of being rogue products when it comes to generating EMI and distorting the line supply. The trend by power-supply manufacturers to adopt EMC (electromagnetic-compatibility) specifica-

tion VDE 0871 and line-disturbance specification IEC (International Electrotechnical Commission) 555 effectively counters this infamy, but many switchers in use have yet to conform.

The German VDE specification is the most stringent of the EMC requirements, and a few manufacturers choose to comply with its more demanding Curve-B limits (Fig 1). Many products that use switching power supplies, such as computing equipment, do not have to meet such strict EMC requirements themselves. But using a VDE-compliant switcher builds in extra margin.

Equally attractive is a switcher

For more information . . .

For more information on the power-supply products discussed in this article, circle the appropriate numbers on the Information Retrieval Service card or use EDN's Express Request service. When you contact any of the following manufacturers directly, please let them know you read about their products in EDN.

Astec Standard Power

401 Jones Rd
Ocean Side, CA 92054
(619) 757-1880
FAX (619) 439-4243

Circle No. 713

Astec Standard Power Europe

Unit 2B, Carlisle Close, Sheffield Rd
Chesterfield S41 9ED, UK
(246) 455946
FAX (246) 450428

Circle No. 714

Coutant-Lambda

Kingsley Ave
Ilfracombe EX34 8ES, UK
(271) 863781
FAX (271) 864894

Circle No. 715

Deltron

Box 1369
North Wales, PA 19454
(215) 699-9261
FAX (215) 699-2310

Circle No. 716

Philips Industrial

Box 218, 5600 MD Eindhoven,
The Netherlands
(40) 786280
FAX (40) 785968

Circle No. 717

Power-One

740 Calle Plano
Camarillo, CA 93012
(805) 987-8741
FAX (805) 388-0476

Circle No. 718

Qualidyne Systems

3055 Del Sol Blvd
San Diego, CA 92154
(619) 575-1100
FAX (619) 429-1011

Circle No. 719

Unipower

2981 Gateway Dr
Pompano Beach, FL 33069
(305) 974-2442
FAX (305) 971-1837

Circle No. 720

Vicor

23 Frontage Rd
Andover, MA 01810
(508) 470-2900
FAX (508) 475-6715

Circle No. 721

VOTE . . .

Please also use the Information Retrieval Service card to rate this article (circle one):

High Interest 476 Medium Interest 477 Low Interest 478

Melcher DC-DC Converters: WINNERS OF THE POWER STRUGGLE

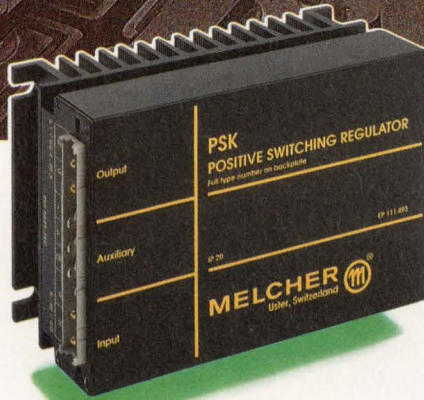
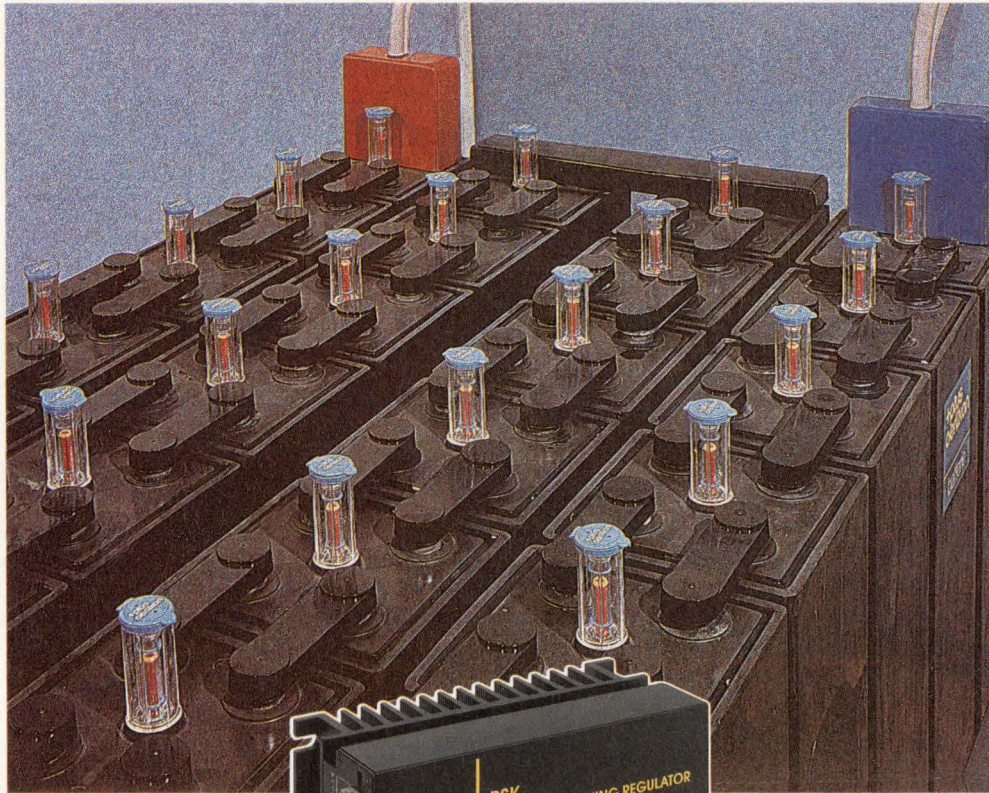

© Diener 022USA/Spe4

Choose the right power supply from the wide spectrum of Melcher products: whether you need to conserve battery capacity or protect sensitive on-board electronics from dangerous transients. Melcher has power converters ranging from 1 to 720 Watts with single or multiple outputs in any combination; and with input voltage ranges for all commercial battery

voltages between 12 and 220 V DC, wide enough for the most severe transients and surges! Melcher power supplies come with or without electrical isolation; they are designed for telecom systems, locomotives, commercial aircraft, ships, and many other forms of transport. And, of course, they are designed to win the power struggle for precious battery capacity.

CIRCLE NO. 61

Supplying great Performance

MELCHER

MELCHER Inc., Chelmsford, MA 01824
Telephone (800) 828-9712, Fax (508) 256-4642



HIGH-POWER MODULAR SWITCHING POWER SUPPLIES

that observes IEC 555 Section 2, which applies to the harmonic distortion of the line supply. High-power switchers have been a major cause of gross distortion in line supplies (Ref 1). The effect results from the single short shot of line current drawn each time the line voltage passes its peak value.

IEC 555-compatible designs include control circuitry that ensures that many line-current pulses are drawn over one half cycle of the line voltage instead of one cycle. In addition, the density of the current pulses tracks the magnitude of the line-voltage waveform. The mean current and voltage waveforms are therefore of the same shape and in phase; ideally, the result is unity power factor. In practice, the technique achieves a power factor of approximately 0.99. An added bonus of supplies that use this technique is a single ac input-voltage range, which manufacturers generally specify as 85 to 265V.

When selecting a switcher, you

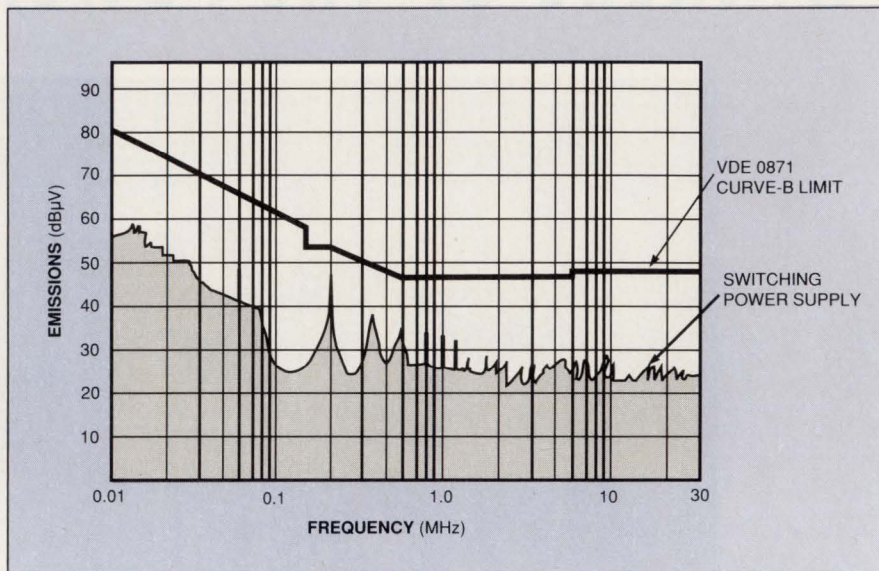

Fig 1—Power-factor-correction techniques alone still leave excessive levels of switching-frequency ripple current on the line supply. Additional internal ripple-current-cancellation techniques can make switching power supplies meet the tough Curve-B limits of the VDE 0871 specification by a comfortable margin. (Figure courtesy Coutant-Lambda)

need to check carefully how the product includes power-factor correction. Some vendors—notably Astec, Coutant-Lambda, and Philips—include the feature as

standard. Other vendors offer power-factor correction as an option that may require an additional bolt-on unit. Generally, lower-power models are less likely than high-

Facing Europe's EMC law

Users of modular power supplies are well aware of potential EMI problems associated with the high-voltage switching techniques these products use. If you intend to incorporate a modular supply into a product destined for the European market, be aware that in the future your product will need to conform to EMC (electromagnetic compatibility) regulations by law.

The two specifications likely to apply to your product are European Standard EN 55022, which concerns emissions from information-technology equipment, and EN 60555, which is equivalent to IEC 555 and concerns line disturbances.

Although the EMC law was supposed to be in place throughout Europe January 1, 1992 (Ref 2), legislation has yet to reach the statute books in most European Community countries. Because of this delay and the wide-ranging commercial implications of the law, EC authorities have set up a transition period during which manufacturers can opt to conform to existing national regulations or to meet the terms of the new EMC law straightaway. The transition period will end on Decem-

ber 31, 1995. After this date, only conformance to the law will be acceptable.

The difficulty now facing manufacturers is as much deciding if the law applies to their product as it is deciding how to get the product approved. Recently, the Commission of European Communities, in an effort to clarify its position, classified products into the broad categories of components, apparatus, systems, and installations. Their overall objective is to reduce the amount of duplicated test work. So, for example, components do not need to comply to the EMC law because they will be built into products that fall into the apparatus category, which must comply.

Strictly speaking, modular power supplies that are part of a larger product do not need to comply. In practice, however, switcher manufacturers accept that the law changes little for them. Their customers already expect conformance to EMC regulations and are now starting to expect power-factor correction as well. Europe's new EMC law only serves to reinforce those user demands.

Universal 85-270v Input AC/DC Power Supplies With Full Safety Agency Approvals

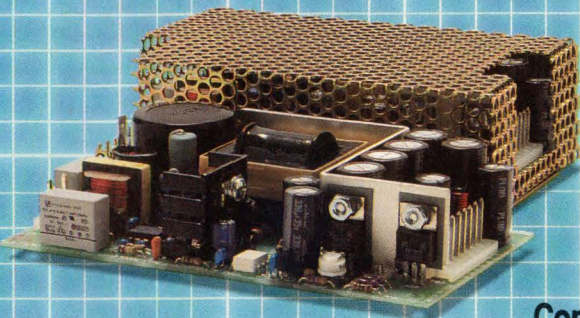

SRW SERIES FEATURES:

- Low Profile
- One to Four Outputs
- FCC/VDE Level "B" Input Filter
- All Models UL, CSA and TUV Certified
- Optional Chassis & Cover

Compact 3" x 5" x 1.12" size

45 watt SRW-45

Model No.	Output 1	Output 2	Output 3	Output 4
QUADS				
SRW-45-4001	+5V@5A	-5V@2A	+12V@0.7A	-12V@0.7A
SRW-45-4002	+5V@5A	-5V@2A	+15V@0.7A	-15V@0.7A
SRW-45-4003	+5V@5A	+24V@1A	+12V@0.7A	-12V@0.7A
SRW-45-4004	+5V@5A	+24V@1A	+15V@0.7A	-15V@0.7A
SRW-45-4005	+5V@5A	+24V@1A	-12V@0.7A	-5V@0.7A
SRW-45-4006	+5V@5A	+15V@2A	-15V@0.7A	-15V@0.7A
TRIPLES				
SRW-45-3001	+5V@5A	+12V@3A		-12V@0.7A
SRW-45-3002	+5V@5A	+15V@2A		-15V@0.7A
SRW-45-3003	+5V@5A	+24V@1.5A		-12V@0.7A
DUALS				
SRW-45-2001	+5V@5A	+12V@3A		
SRW-45-2002	+5V@5A	-5V@4A		
SRW-45-2003	+5V@5A	+24V@1.5A		
SRW-45-2004	+12V@3A	-12V@2A		
SRW-45-2005	+15V@2.5A	-15V@2A		
SINGLES				
SRW-45-1001	+5V@9A			
SRW-45-1002	+12V@3.75A			
SRW-45-1003	+15V@3A			
SRW-45-1004	+24V@1.9A			

Other output combinations available, please consult factory

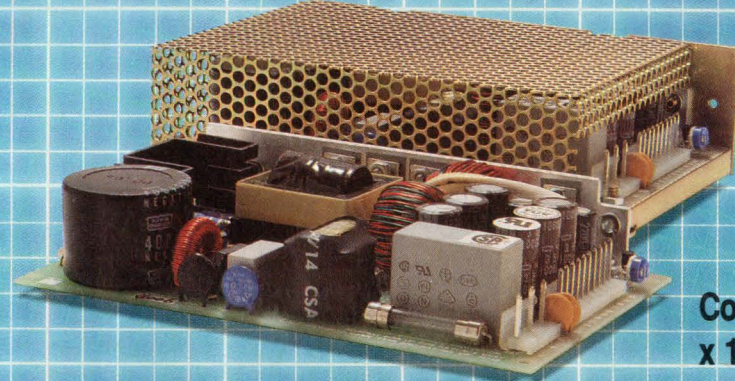

Compact 4" x 6" x 1.12" size

65 watt SRW-65

Model No.	Output 1	Output 2	Output 3	Output 4
QUADS				
SRW-65-4001	+5V@5A	-5V@3A	+12V@2A	-12V@2A
SRW-65-4002	+5V@5A	+12V@1A	+12V@2A	-12V@2A
SRW-65-4003	+5V@5A	+24V@1A	+12V@2A	-12V@2A
SRW-65-4004	+5V@5A	-5V@3A	+15V@2A	-15V@2A
SRW-65-4005	+5V@5A	+24V@1A	+12V@2A	-5V@2A
SRW-65-4006	+5V@5A	+24V@1A	+15V@2A	-15V@2A
TRIPLES				
SRW-65-3001	+5V@5A		+12V@3A	-12V@1A
SRW-65-3002	+5V@7A		+12V@2A	-12V@2A
SRW-65-3003	+5V@7A		+15V@2A	-15V@2A
SRW-65-3004	+5V@5A		+12V@2A	-12V@2A
SRW-65-3005	+5V@5A	-5V@4A	+24V@1A	
DUALS				
SRW-65-2001	+5V@7A		+12V@3A	-5V@5A
SRW-65-2002	+5V@7A			
SRW-65-2003	+12V@3A			-12V@2.5A
SRW-65-2004	+15V@2.5A			-15V@2A
SRW-65-2005	+5V@7A		+24V@1.5A	
SINGLES				
SRW-65-1001	+5V@13A			
SRW-65-1002	+12V@5.4A			
SRW-65-1003	+15V@4.3A			
SRW-65-1004	+24V@2.7A			

Other output combinations available, please consult factory



Compact 4.25" x 7" x 1.25" size

115 watt SRW-115

Model No.	Output 1	Output 2	Output 3	Output 4
QUADS				
SRW-115-4001	+5V@12A	-5V@4A	+12V@4A (6Apk)	-12V@2A
SRW-115-4002	+5V@12A	+24V@1A	+12V@4A (6Apk)	-12V@2A
SRW-115-4003	+5V@12A	-5V@4A	+15V@3A (4Apk)	-15V@2A
SRW-115-4004	+5V@12A	+24V@1A	+15V@3A (4Apk)	-15V@2A
SRW-115-4005	+5V@12A	+12V@1A	+24V@3A	-12V@1A
TRIPLES				
SRW-115-3001	+5V@12A		+12V@4A (6Apk)	-12V@2A
SRW-115-3002	+5V@12A		+15V@4A (6Apk)	-15V@2A
SRW-115-3003	+5V@12A		+24V@3A	-12V@1A
DUALS				
SRW-115-2001	+5V@12A		+24V@3A	
SRW-115-2002	+12V@5A			-12V@5A
SRW-115-2003	+15V@5A			-15V@5A
SRW-115-2004	+24V@2.5A			-24V@2.5A

Other output combinations available, please consult factory

IP INTEGRATED POWER DESIGNS

300 Stewart Road, Wilkes-Barre, PA 18706
Phone: (717) 824-4666 Fax: (717) 824-4843

Reserve your evaluation units or get additional information on our **ready-to-ship universal input switchers.**

CIRCLE NO. 62

All Models Above are Approved by:



Recognized to UL 1950



Certified to CSA 22.2 No.950
CSA 22.2 No.234



Certified to VDE 0805
IEC 950
EN60 950

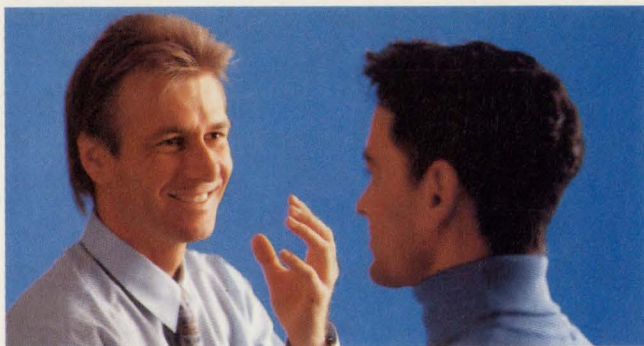

He knows that with multilayer



pressing he can not only save time



and money but also improve quality.

With FELA Multiklav MK-2012, vacuum and oil ensure optimal pressure and temperature distribution. The advantages? No warping, no air pockets, no unnecessary resin flow; time-saving set-up and working process, minimal need for adjustments; low power consumption and floor space requirements.

fela

■ FELA Tec AG
 CH-5432 Neuenhof
 Phone 41-56-86 15 91
 Fax 41-56-86 15 39

Sales Representatives:
 U.S.A. 1-603 329-5678/9 (Fax 1-603 329-4021)
 Korea 82-2-534-2310 (Fax 82-2-534-5798)
 Taiwan 886-3-322 68 26 (Fax 886-3-322 70 16)
 Singapore 65-269-3933 (Fax 65-269-0619)
 Japan 81-33-277-5500 (Fax 81-33-273-5050)
 Hong Kong 85-2-524-1155/6 (Fax 85-2-845-9061)

CIRCLE NO. 63

MODULAR POWER SUPPLIES

power supplies to include this feature as standard. In Europe, compliance will soon become mandatory for power levels greater than 300W. The **box**, "Facing Europe's EMC law," briefly explains the law's background. **EDN**

References

1. Strassberg, Dan, "Power-factor-corrected switching power supplies," *EDN*, April 11, 1991, pg 90.
2. Kerridge, Brian, "Europe lays down EMC law," *EDN*, September 16, 1991, pg 57.

Brian Kerridge, Technical Editor, can be reached in the UK at (508) 28435; FAX (508) 28430.

Article Interest Quotient
 (Circle One)

High 476 Medium 477 Low 478

See it.
 Believe it.
 EL flat panel
 displays.



CIRCLE NO. 168

If You're Buying Flash Or E²PROMs From Somebody Else, You're Missing A Few Parts.

Catalyst offers the largest selection of nonvolatile memories in these parts. And worldwide.

We start with a full range of CMOS Flash memories—reliable, cost-effective E²PROM alternatives, with access times as low as 120ns and densities up to 1 Megabit. And we're the only manufacturer to offer both 12V and 5V designs.

Next we offer a wide variety of serial and parallel E²PROMs, giving you the exact densities, bus structures and voltage levels you need. Then we add parts with innovative design features, such as ZERO Power™ standby current and our password-protected Secure Access E²PROMs.

We also play an important part in the RAM world with our low-power CMOS NVRAM.

These quality Catalyst parts offer compatibility with industry-standard memories and exceptional ease of interfacing. Most come in commercial and industrial temperature ranges and a complete choice of packaging options.

So now you not only have unparalleled design freedom. You also have the convenience of working with one vendor for all your memory needs—including high-speed CMOS EPROMs.

If you're missing any of these devices, call today for a product selection guide—or a part-to-part talk: (408) 748-7700. Or write Catalyst Semiconductor, Inc., 2231 Calle de Luna, Santa Clara, CA 95054.

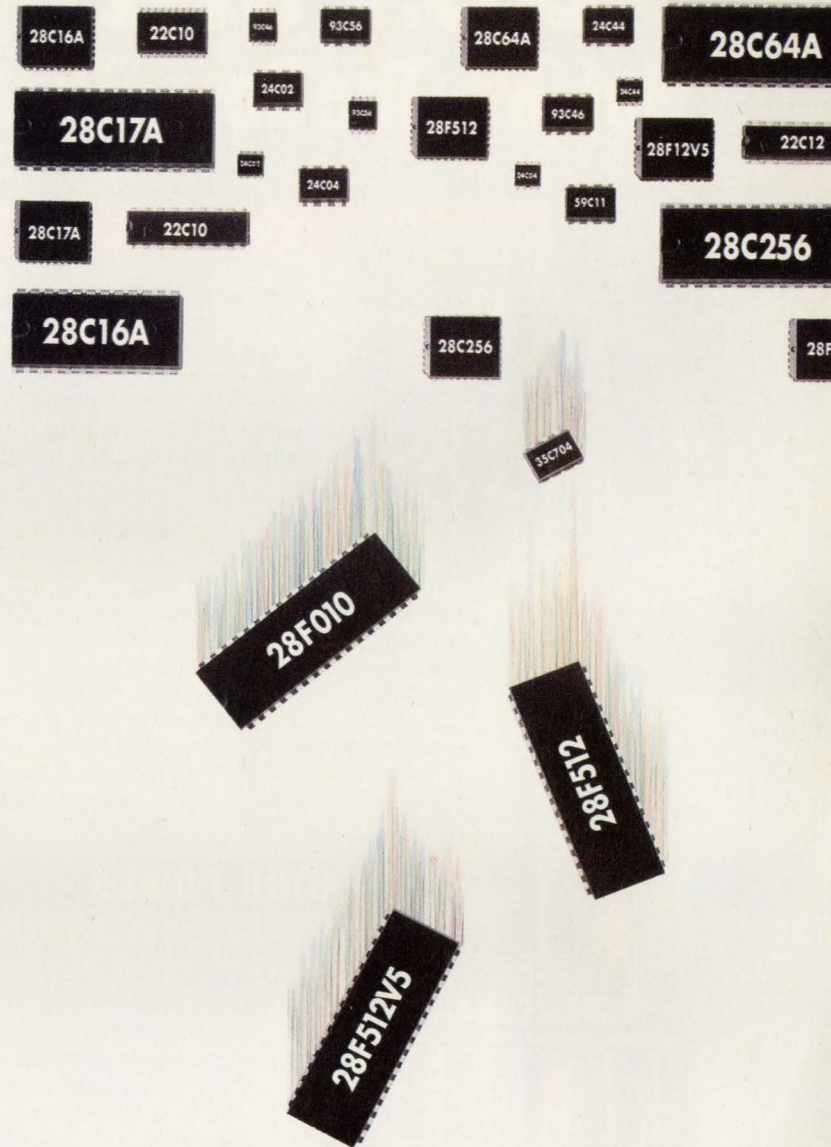

CATALYST
SEMICONDUCTOR

We Deliver More For Less.

CIRCLE NO. 64

POWER-ONE D.C. POWER SUPPLIES

Not Only The Best...The Best Selection, Too

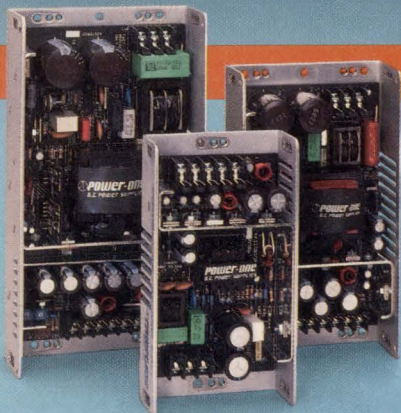

SWITCHERS

POWER-ONE'S International Switcher Series incorporates the latest state-of-the-art switching technology while providing POWER-ONE's traditional high quality at low prices. With certification to the world's toughest safety agency requirements, the series is especially suited for products sold not only domestically, but internationally as well. • 85 models . . . 40 watts to 400 watts • Efficient . . . reliable . . . economical • VDE construction • Up to 5 fully regulated outputs • Full international safety and EMI approvals

LINEARS

POWER-ONE'S International Linear Series is the world's undisputed leader in versatile, cost-effective linear power supply products. A long-time favorite of designers and engineers worldwide, the series is the most widely purchased power supply line through distribution in the industry. The most popular voltage and current combinations are available in a wide variety of off-the-shelf standard models. • Popular industry standard packages • 77 models . . . 6 watts to 280 watts • $\pm 0.05\%$ regulation • Up to 4 fully regulated outputs • Worldwide safety approvals

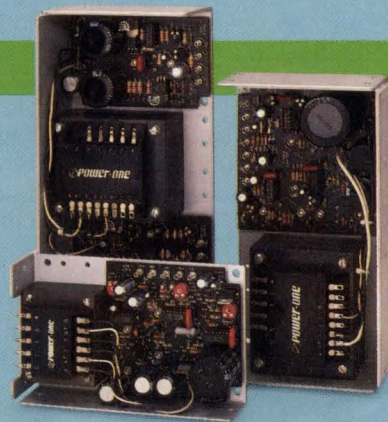

HIGH POWER

POWER-ONE'S International High Power Series is a true fully-modular high power product line. Specify a power system that meets your exact requirements from a wide selection of single, dual and triple output plug-in power modules. Virtually any combination of output voltage and current rating can be delivered from stock. • 500 watts to 2,000 watts • Fully modular construction • Up to 15 fully regulated outputs • UPS battery backup option • Parallelable outputs with current sharing • Power Factor Correction optional

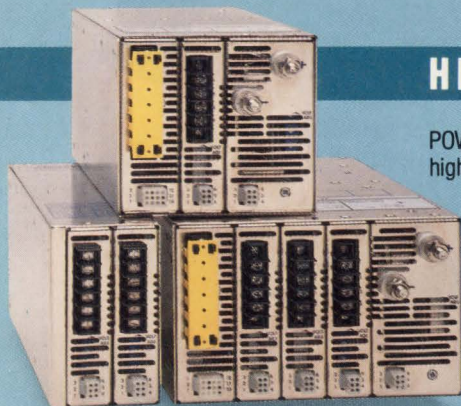

**TOLL FREE
LITERATURE
HOT-LINE:
(800) 678-9445**



POWER-ONE offers one of the largest selections of switcher, linear, and high power standard models in the world. Most models available off the shelf from authorized distributors. So, whatever your D.C. power supply requirement, make POWER-ONE your first choice and be sure you're getting the best—quality, selection, value and quick delivery. Call today for our new Reference Guide and the location of our closest authorized distributor.

"Innovators in Power Supply Technology"
POWER-ONE
D.C. POWER SUPPLIES

POWER-ONE, INC.
740 Calle Plano • Camarillo, CA 93012-8583
Phone: (805) 987-8741 • FAX: (805) 388-0476



Crystal oscillators provide precision in high-speed systems

TOM ORMOND, Senior Technical Editor



As system operating speeds increase, the need for high-precision clock sources gains importance. Crystal oscillators can provide the necessary precision and can do so without exacting any cost or packing-density penalties.

High speed and high density seem to be the two major design goals for today's system designers. When you look to provide a timing source for such systems, the crystal oscillator can fill the bill on both counts.

Crystal oscillators with output frequencies in the hundreds-of-megahertz range are readily available today. These devices have accuracies on the order of 0.01%. When it comes to density considerations, many of today's oscillators are housed in low-profile DIPs, and a good number of crystal oscillators are starting to appear in surface-mount packages.

Crystal oscillators offer designers another positive feature—flexibility. When you go looking for a clock source, you'll find it quite easy to select only as much oscillator as you need for the job at hand. There's no need to buy an oscillator with all the bells and whistles when you have no need for them. Oscillators are available that use a number of technologies that let you pretty much match your needs with the standpoint of frequency, stability, size, and cost that you want.

The most basic design is an uncompensated crystal oscillator (XO). In an XO, the overall frequency stability of the output relies solely on the capability of the internal crystal. Basically, the XO contains the crystal and buffer circuitry to develop logic-level outputs. Commonly available with outputs rang-

ing from 1 to 150 MHz, today's XOs feature stabilities ranging to ± 100 ppm over an operating range of 0 to 70°C. Units that provide lower or higher frequencies are also available. These oscillators typically use frequency dividers or multipliers, or they utilize a harmonic (overtone) of the basic quartz-crystal frequency.

The prime advantages of the XO are low cost and small size. On the negative side, XOs have relatively poor stability. However, designers will find that the simple XO is a good choice as a clock source in digital systems where environmental conditions are not too severe.

AVX/Kyocera, Champion, CTS, KDS America, M-tron, and Pletronics all offer basic crystal oscillators (Table 1). Available output frequencies range from 156 kHz to 120 MHz—certainly a good spectrum. All of these XOs come in DIP-style packages to accommodate high-density applications. Frequency stabi-

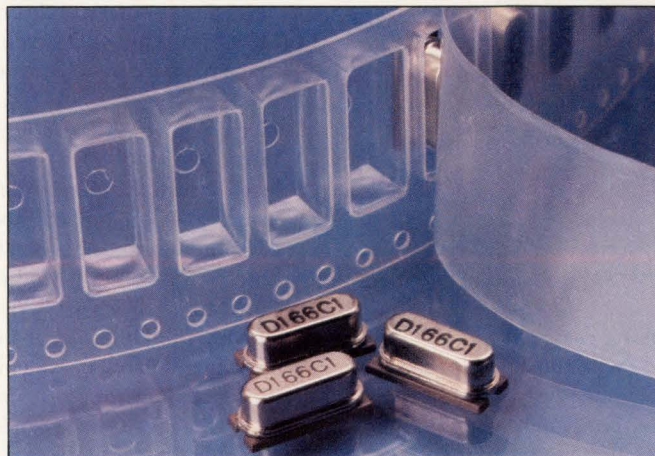

Housed in a 0.45 × 0.2 × 0.18-in. package, DSO-49 oscillators from KDS America are designed for high-density applications. They have outputs ranging from 0.156 to 50 MHz and feature a 50- to 100-ppm stability from -10 to +70°C.

POWER To Configure

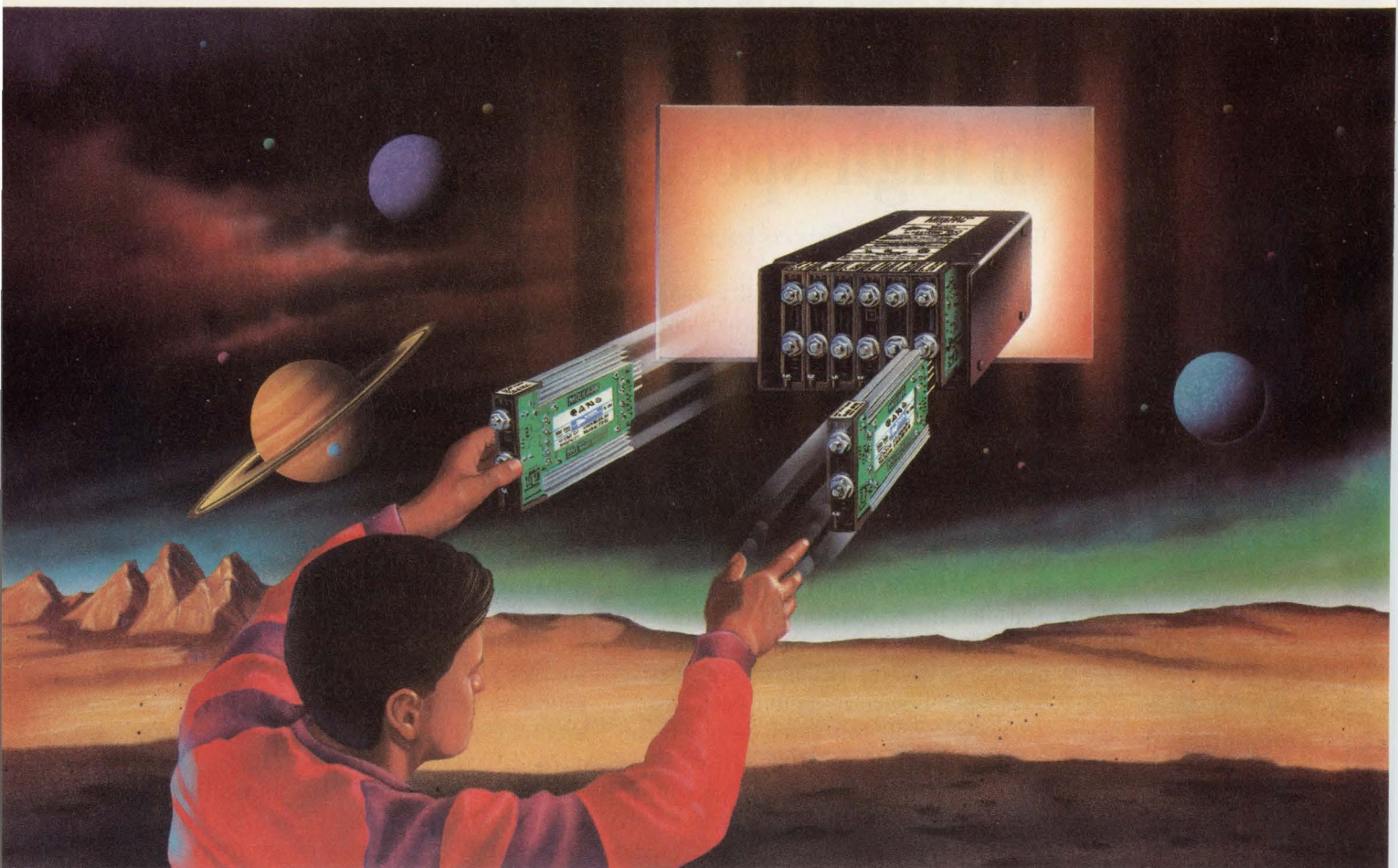

MegaPAC™

Power: Up to 1200 Watts

Input: 110/220 VAC, strappable; 300 VDC

Outputs: 1 to 8 isolated and fully regulated,
2 to 95 VDC

Size: 11.8"L x 6.0"W x 3.4"H



Plug into instant power supply configurability with the new MegaPAC switcher from our Westcor division. MegaPAC outputs can be configured in virtually an infinite number of voltage and power combinations using up to 8 slide-in

ModuPAC™ assemblies. Want to change a voltage or power level at your factory or at a customer site? No problem. . . shut down input power, slide out the ModuPAC you want to replace and slide in the new one. It's that simple.

MegaPAC's instant configurability takes Westcor's popular StakPAC to the next level of customization and flexibility. And its improved manufacturability means a substantial price reduction too! At the heart of each plug-in ModuPAC is a standard Vicor VI-26X series DC-DC converter module. . . over 1 million are operating reliably in systems world-wide. With potential applications around the globe, MegaPAC is designed to meet stringent UL, CSA, and IEC safety standards (approvals in process).

So take the risk out of specifying your system power supply. Contact us today and request ordering information. . . then sit back and relax. . . your custom-tailored MegaPAC will be delivered within four weeks.

Call VICOR EXPRESS (800) 735-6200 for information and be sure to ask for a MegaPAC data sheet. Or call WESTCOR (division of Vicor) at (408) 395-7050. Fax us at (508) 475-6715 or (408) 395-1518.



VICOR Corporation
23 Frontage Road, Andover, MA 01810

CRYSTAL OSCILLATORS

ties range to 100 ppm and quantity pricing goes as low as \$2.

The XO establishes a baseline for gauging crystal oscillator capability. At the other end of the stability spectrum is the oven-controlled crystal oscillator (OCXO). The OCXO represents the practical limit in commercial output-frequency stability. OCXOs are used as the main clock in large telecommunications systems, earth station networks, military applications, and other critical applications. Output frequency stability can be in the 0.001-ppm range.

In an OCXO, a temperature-controlled module houses the crystal and associated electronics. This module maintains the crystal at a stabilized temperature that is slightly higher than the highest ambient in which the oscillator is expected to operate. The OCXO is unmatched when it comes to output frequency stability—over a -55 to $+85^{\circ}\text{C}$ range, stability figures of 0.001 ppm are not uncommon. Over

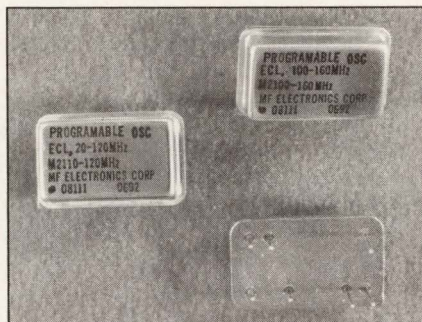

Featuring a 100- to 170-MHz output capability, the M2100 from MF Electronics uses the system μP to let users program the output in 1-kHz increments. The oscillator output is ECL compatible and features a frequency stability of ± 50 ppm.

a narrower operating range, frequency stability figures will be even better.

Unfortunately, you have to pay for this performance. OCXOs draw considerably more power than other crystal oscillator designs. The OCXOs also require more pc-board space, take time to warm up to operating status, and are expensive.

Two factors affect power consump-

tion—the amount of oven insulation used in the design and the temperature differential between the oven temperature and the ambient temperature. Warm-up time defines the time it takes for the oscillator to reach the operating temperature required to stabilize its output frequency. For the most part, warm-up time depends on the amount of power available and the thermal mass of the oven. Warm-up time can range into tens of minutes.

It is possible to use a single supply to power an OCXO, but it is much wiser to use one supply for the oscillator and one for the oven. For powering the oscillator, the supply must have the same regulation and noise characteristic as the supply being used to power system-logic circuitry. You really don't need a well-regulated supply to power the oven.

Bliley, Genwave, and Vectron all offer classical oven-controlled crystal oscillators. These manufacturers offer products that cover a 1-kHz

Table 1—Representative crystal oscillators

Manufacturer	Model	Type ¹	Frequency (MHz)	Stability (ppm)	Operating range ($^{\circ}\text{C}$) ²	Size (in.)	Price
AT&T Microelectronics	154	VCXO	10 to 55	50	-40 to $+85$	$0.825 \times 0.5 \times 0.3$	\$10 to \$30
AVX/Kyocera	KXO-01	XO	4 to 50	100	0 to 70	$0.83 \times 0.5 \times 0.2$	\$2 (1000)
Bliley Electric	N26S	OCXO	0.001 to 20	0.005	0 to 70	$2 \times 2 \times 1$	\$205.70 (100)
Champion Technologies	K11041	XO	40 to 70	100	0 to 70	$0.8 \times 0.5 \times 0.3$	\$26.03 (100)
Connor-Winfield Corp	EV535-100	VCXO	25 to 80	50	0 to 70	$0.8 \times 0.5 \times 0.26$	From \$65 (10)
CTS Corp	EX075	XO	250 to 400	100 to 1000	0 to 70	$0.8 \times 0.5 \times 0.39$	\$175 (100)
Genwave Corp	250-0502	OCXO	10	0.015	-30 to $+70$	$2 \times 2 \times 1$	\$355
KDS America	DSO-49S	XO	0.156 to 50	50 to 100	-10 to $+70$	$0.45 \times 0.2 \times 0.18$	\$2.10 (1000)
MF Electronics	M2100	MCXO	100 to 170	50	0 to 85	$0.825 \times 0.5 \times 0.2$	\$35 (1000)
M-tron Industries	MEH	XO	40 to 200	50	0 to 70	$0.52 \times 0.52 \times 0.24$	\$14 (1000)
Murata Erie	DC2210 AH	DCXO	10 to 25	1	-40 to $+85$	$0.79 \times 0.79 \times 0.45$	\$75 (1000)
Pletronics	SM1100	XO	1 to 120	25 to 500	0 to 70	$0.485 \times 0.39 \times 0.185$	\$4 to \$10 (10,000)
Q-Tech Corp	QT 2010	MCXO	10	0.03	-55 to $+85$	$2 \times 4 \times 1$	\$780 (100)
Raltron	TF-65010-B	OCXO	1 to 20	0.2	-20 to $+70$	$1.38 \times 1.06 \times 1.0$	\$65 (10,000)
TEW North America	TXS-1134M	VCVCXO	12.8 to 26	2.5	-30 to $+70$	$0.45 \times 0.45 \times 0.18$	\$21 (OEM qty)
Vectron Labs	CO724	OCXO	25 to 140	0.005	0 to 50	$2 \times 2 \times 1$	\$282 (100)

Notes:

¹XO, uncompensated crystal oscillator; TCXO, temperature-compensated crystal oscillator; DCXO, digitally compensated crystal oscillator; MCXO, microcomputer-compensated crystal oscillator; VCXO, voltage-controlled crystal oscillator; TCVCXO, temperature-compensated, voltage-controlled crystal oscillator; OCXO, oven-controlled crystal oscillator.

²Operating range for specified stability.

CRYSTAL OSCILLATORS

to 140-MHz frequency spectrum. And with figures of 0.005 to 0.015 ppm, the improvement in output stability is obvious. Just as obvious, however, are the price and space penalties. All the OCXOs listed in **Table 1** are housed in packages measuring 4 in.³, and prices are now in the \$200 to \$300 range. Even though the data is not included in **Table 1**, the OCXOs listed have typical power requirements of 4 to 6W during turn on and warm up, and continuous power requirements ranging from 1.7 to 2W.

Where's the oven?

Raltron is also listed as a supplier of OCXOs. However, their oscillator is somewhat different and deserves a closer look.

Raltron's Model TF-65010-B utilizes oven-like compensation techniques to achieve its stability of 0.22 ppm over -20 to +70°C. In addition,

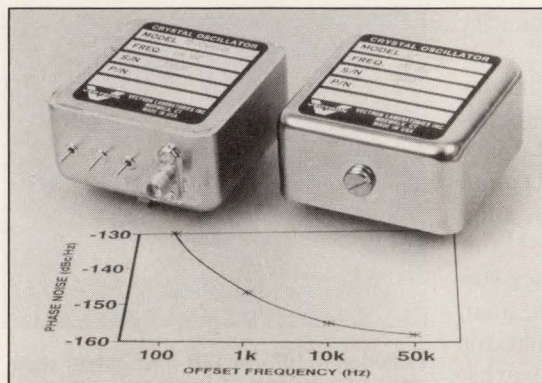

Offering output frequencies ranging to 140 MHz, Vectron's C0724 OCXOs have a ± 0.005 -ppm frequency stability from 0 to 50°C and provide an HCMOS-compatible output.

the oscillator reaches this stability level in 2 minutes, drawing 3W, which is far less power consumption than the typical oven-controlled oscillator would require. Such performance opens up a number of high-stability applications that you would have previously avoided because of the cost.

Because the unit does not use classical oven control for compensation, it reacts to temperature variations

in real time, and it has no hysteresis characteristics. Phase noise at 10 kHz is specified at -140 dBc. Because you can adjust the output frequency over a maximum range of ± 6 ppm, you can compensate for more than 10 years of aging. The oscillator operates from supply voltages of 5 to 12V.

In a classical oven-controlled crystal oscillator, a resistance-wire heater controls the temperature of

For more information . . .

For more information on the crystal oscillators discussed in this article, circle the appropriate numbers on the Information Retrieval Service card or use EDN's Express Request service. When you contact any of the following manufacturers directly, please let them know you read about their products in EDN.

AT&T Microelectronics
Dept 52A1040420
555 Union Blvd
Allentown, PA 18103
(800) 372-2447
FAX (215) 778-4106
Circle No. 722

AVX/Kyocera
801 17th Ave S
Myrtle Beach, SC 29577
(803) 448-9411
FAX (803) 448-6042
Lisa Gianturco
Circle No. 723

Bliley Electric Co
Box 3428
Erie, PA 16508
(814) 838-3571
FAX (814) 833-2712
David Bliley
Circle No. 724

Champion Technologies Inc
2553 N Edgington St
Franklin Park, IL 60131
(708) 451-1000
FAX (708) 451-7585
Circle No. 725

Connor-Winfield Corp
1865 Selmarten Rd
Aurora, IL 60505
(708) 851-4722
FAX (708) 851-5040
Circle No. 726

CTS Corp
Frequency Control Div
400 Reimann Ave
Sandwich, IL 60548
(815) 786-8411
FAX (815) 786-9743
Circle No. 727

Genwave Corp
2 New Pasture Rd
Newburyport, MA 01950
(508) 465-6064
FAX (508) 465-6637
Circle No. 728

KDS America
10901 Granada Lane
Overland Park, KS 66211
(913) 491-6825
FAX (913) 491-6812
Circle No. 729

MF Electronics Corp
10 Commerce Dr
New Rochelle, NY 10801
(914) 576-6570
FAX (914) 576-6204
Circle No. 730

M-tron Industries Inc
Box 630
Yankton, SD 57078
(605) 665-9321
FAX (605) 665-1709
Pamela Rickenbach
Circle No. 731

Murata Erie North America Inc
1900 W College Ave
State College, PA 16801
(814) 234-1431
FAX (814) 238-2748
Circle No. 732

Oscillatek
620 N Lindenwood Dr
Olathe, KS 66062
(913) 829-1777
FAX (913) 829-3505
Circle No. 733

Pietronics Inc
19015 36th Ave W
Suite H
Lynwood, WA 98036
(206) 776-1880
FAX (206) 776-2760
Les Podgorny
Circle No. 734

Q-Tech Corp
10150 W Jefferson Blvd
Culver City, CA 90232
(213) 836-7900
FAX (213) 836-2157
Brian Rose
(310) 836-7900
Circle No. 735

Raltron Electronics Corp
2315 NW 107th Ave
Miami, FL 33182
(305) 593-6033
FAX (305) 594-3973
Sandy Cohen
Circle No. 736

TEW North America
5903-B Peachtree Industrial Blvd
Norcross, GA 30092
(800) 762-0420
FAX (404) 441-3076
Michael Watson
Circle No. 737

Vectron Laboratories Inc
166 Glover Ave
Norwalk, CT 06850
(203) 853-4433
FAX (203) 849-1423
Larry Jawitz
Circle No. 738

VOTE . . .

Please also use the Information Retrieval Service card to rate this article (circle one):
High Interest 479 Medium Interest 480 Low Interest 481

BUSCON
'91 East
Product of the Year.

The competition will call us ruthless. You can call us at 1-800-234-4VME.

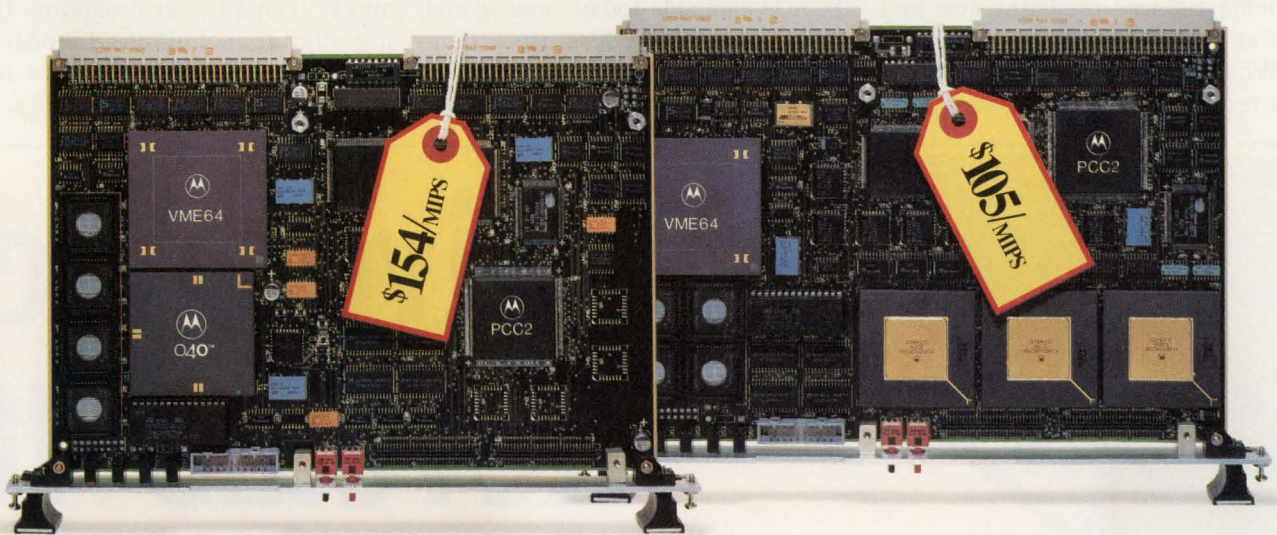

It's enough to make other VME board builders call us names. Or call it quits. A new 38 MIPS* VME single board computer based on the 88100 RISC microprocessor. Or a new 26 MIPS* VME board based on the 68040 CISC microprocessor.

Both are built by Motorola and offered at \$3,995 each. That's just \$105/MIPS for the RISC board, which compares nicely with the \$1,000/MIPS you've been asked

to pay for somebody else's board. And it's just \$154/MIPS for the CISC board.

The MVME187 (RISC) and MVME167 (CISC) boards employ VME D64 architecture. And both come with four 32-bit timers.

For a free color brochure, call the 800 number above. And see why the competition undoubtedly wishes we'd call the whole thing off.



MOTOROLA
Computer Group

Motorola and the  are registered trademarks of Motorola, Inc. ©1992 Motorola, Inc. All rights reserved. *MIPS rating based on Dhrystone 1.1 test results where 1757 Dhrystones/s is 1 MIPS (VAX™ II/780). MIPS performance is based on the Diab 2.36E compiler.

CIRCLE NO. 67

EDN May 7, 1992 • 93

CRYSTAL OSCILLATORS

an oven that houses the crystal and associated electronics. The combined thermal mass of the oven and the crystal retards crystal heating, and it can take as long as 10 minutes to stabilize an oven-controlled crystal oscillator. Model TF-65010-B's design lets the oscillator heat the crystal directly by positioning the temperature sensor inside the crystal case and in direct contact with the crystal. This scheme provides an accurate and real measurement of crystal temperature and significantly shortens warm-up time.

Because the resistance heating element acts directly on the Model TF-65010-B's crystal, the unit has no power requirements for oven heating. Thus, the direct heating scheme reduces oscillator size and power consumption.

When it comes to performance, the temperature-compensated crys-

tal oscillator (TCXO) falls between the XO and the OCXO. The TCXO's low noise and output frequency range from 1 Hz to 100 MHz. TCXOs suit applications involving thermal stress because they feature some degree of external-frequency control. Over an operating range of -40 to $+85^{\circ}\text{C}$, frequency-stability figures will be in the 1-ppm range.

Although they can't match the stability performance of OCXOs, TCXOs do have some advantages. Warm up time for the TCXO is significantly shorter (in the microsecond range) and power consumption for TCXOs is measured in milliwatts. TCXOs are also smaller and less expensive than OCXOs.

There are actually two types of TCXOs available today—analogue and digital. Analogue TCXOs use a temperature-sensitive, custom-tailored compensation network to tune the

oscillator just enough to offset the uncompensated frequency change with temperature. As is the case with the OCXO, the performance of a TCXO will be better over narrower operating ranges. But unlike the case with the OCXO, you can power a TCXO with a single supply without running into problems.

Today, you can also find crystal oscillator designs that use digital techniques for compensation and/or increased flexibility. These digital devices are somewhat larger than the analogue TCXO, and they are somewhat more expensive. However, they offer better stability over wider operating ranges than the analogue TCXOs.

MF Electronics, Murata Erie, and Q-Tech all offer oscillators that use digital techniques to provide temperature compensation or output frequency programmability.

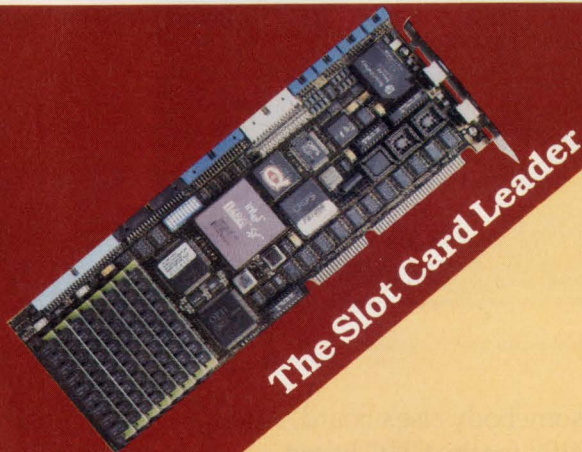

Diversified Reveals Its

If your single board computer contact DTI to solve

GEN. MANAGEMENT	Your Supplier	DTI
Employee turn-over approaches zero		✓
Filled 100,000 plus piece orders for Fortune 500 companies		✓
Slot-card technology pioneer, i.e., excess of 20 yrs.		✓
100% FCC & U.L. certified computer boards		✓
Subjected to Fortune 100 quality audits		✓
Products currently employed in rigid Belcore applications		✓
Provided product into Desert Storm		✓
Implemented a formal customer service organization		✓
Excess of 100,000 product catalogs mailed annually		✓

FINANCE	Your Supplier	DTI
Computerized financial system, from order entry to final invoice		✓
Financial performance rated in upper 10% of Fortune 500 companies		✓
Committed ongoing capital equipment program		✓
Financial independence, i.e., no outside investors		✓
Inventory turns more than 5 times per year		✓
Routine statistical cycle counting of inventory		✓
40 consecutive quarters of profitability		✓

ENGINEERING	Your Supplier	DTI
State-of-the-art development tools		✓
New product development cycles completed in under 60 days		✓
All product designs performed in-house		✓
Routinely develops custom hardware products		✓
Provide custom BIOS		✓
Considered the technology leader in product market place		✓
All products fully validated to insure industry standard compatibility		✓

MF Electronics uses microprocessor control to provide a variable frequency capability (rather than temperature compensation) for the M2100 ECL-compatible oscillator. The unit will output any frequency in the 100- to 170-MHz range with a resolution of ± 1 kHz. The design makes it unnecessary to specify a particular frequency output in advance. You can simply program the oscillator output under software control. Because the M2100 is crystal based, the output has an overall tolerance of ± 100 ppm.

The programmable oscillator offers users two key benefits. First, the M2100 can replace several oscillators in applications where only one frequency is needed at any given time. In many video applications, for example, you may have to generate several frequencies for different presentations or to match



Housed in all-metal DIPs, KXO-01 crystal oscillators from AVX/Kyocera output frequencies of 4 to 50 MHz. They meet FCC EMI specifications and feature a ± 100 -ppm stability from 0 to 70°C.

frequencies of various monitors. Instead of having to use a specific oscillator for each frequency, you can use one programmable M2100.

The second benefit involves design-time considerations. By using the M2100 programmable oscillator, you can optimize the operating frequency during the time you're pro-

ducing the board—there's no need to go through an extensive calculation in advance to order a specific frequency value. The result is a faster time to market, which saves on the lead time required to order optimized oscillators.

In their Model DC2210 AH, Murata Erie uses an ASIC to provide digital temperature compensation. The ASIC integrates the majority of oscillator and compensation functions associated with high-stability crystal oscillators on a single chip, replacing more than seven discrete ICs that are normally required. Contained in a 28-pin plastic leaded chip carrier, the ASIC is based on 1.5- μ m CMOS technology.

The ASIC implements a self-contained adaptive measurement and control system. Also included on the chip is an amplifier that serves as the gain stage for compen-

Technology, Inc.

Secret Of Success...

supplier does not meet these requirements, your computer needs.

MANUFACTURING	Your Supplier	DTI
All products manufactured in-house		✓
Strong "Buy America" policy		✓
Perform double sided surface mount technology		✓
All computer products environmentally stressed prior to shipment		✓
State-of-the-art MRP computer system		✓
Rigid configuration control system		✓
All components bought against formal component specifications		✓

QUALITY	Your Supplier	DTI
100% SPC trained staff (Statistical Process Control)		✓
SPC 10-week training classes conducted in-house on continuing basis		✓
Single board computers subjected to 24 2-hour thermal shock cycles (0-70°C) under power		✓
Anti-static devices provided for products in each shipment		✓
Rigid quality tests conducted on all ordered parts received & shipped		✓



Call us toll free for orders and information.

1-800-443-2667

U.S.A. - (601) 856-4121

Fax (601) 856-2888

Outside U.S.A. - (201) 891-8718/Fax (201) 891-9629

CIRCLE NO. 68

PICO AC-DC POWER SUPPLIES

meet all your
military, computer
and industrial
requirements

INDUSTRIAL



- Both Linear and Switching Models available New Switching Series .500" Tall
- Linear available with terminal strip or PC mount
- Single, Dual, Triple Outputs
- No Derating to 70°C
- Regulated—Isolated

OPEN-FRAME

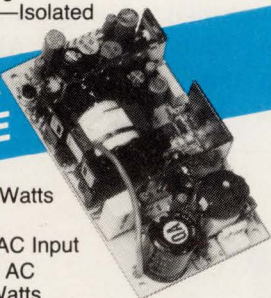

- Up to 200 Watts available
- Universal AC Input 85—264V AC up to 65 Watts
- Jumper Selectable Inputs up to 200 Watts
- Short Circuit Protection
- UL-CSA-TUV Compliant
- Regulated-Isolated
- Multiple Outputs

HI-RELIABILITY and MILITARY Applications

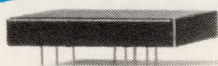

- Low Profile .500" Height
- Meet MIL-STD-704D Input Requirements
- Optional -55°C to +85°C Operating Temperature
- Selected Environmental Screening per MIL-STD-883 available

PICO
Electronics, Inc.

453 N. MacQuesten Pkwy. Mt. Vernon, N.Y. 10552

Call Toll Free **800-431-1064**

IN NEW YORK CALL **914-699-5514**

FAX **914-699-5565**

See EEM
or send direct for
FREE PICO Catalog

CRYSTAL OSCILLATORS

sation scheme, and a temperature sensor. An A/D converter measures the ambient temperature. The microcontroller uses the A/D converter output to execute an interpolation algorithm to find the data required to compensate the oscillator output frequency at the current temperature. This data is then converted to an analog voltage by a 10-bit D/A converter and fed back to the oscillator.

A nonvolatile EEPROM on the ASIC stores the required compensation data and certain calibration constants. Other on-chip memory includes a ROM that contains the system operating software and some RAM for temporary storage.

Q-Tech's QT 2010 microcomputer compensated crystal oscillator (MCXO) uses hybrid crystal-oscillator circuits combined with an ASIC and a microcontroller. The unit provides frequency and time accuracies of 0.030 ppm over an operating range of -55 to +85°C with negligible warm-up time and power consumption.

The ASIC contains the signal mixers, divider chains, counters, phase comparators, digital-control logic, and a direct-digital synthesizer (DDS). Two oscillators operating from a single 10-MHz crystal resonator drive the system. One oscillator excites the third overtone C-mode (F_0), while the second excites the fundamental C-mode (F_F). The difference frequency, F_B , is a nearly linear function of temperature and provides a precision measurement of the actual temperature of the quartz crystal.

F_B is measured in a counter, which outputs a numerical value, N_1 , that corresponds to temperature. The microcomputer, or memory unit, solves an equation (unique to a particular crystal) that relates the correction frequency, F_D , to each value of N_1 . The DDS generates F_D and a PLL synchronizes the 10-MHz VCXO to the sum of F_0 and F_D .

In the frequency mode, dividers

from the 10-MHz output drive the timing outputs of the QT 2010. In the Clock mode, F_F drives the DDS to generate the timing outputs directly. In the Clock mode, the PLL and portions of the digital circuitry are turned off to save power.

Rounding out the field

The voltage-controlled crystal oscillator (VCXO) rounds out the selection of crystal oscillators. VCXOs offer a little more capability than the simple XO. The VCXO has an input terminal that lets you apply a control voltage and pull the oscillator output frequency in either direction. VCXOs are 100 times more sensitive to external voltage control than a TCXO.

VCXOs are used extensively in applications involving PLLs. You can construct a PLL with a lowpass filter, a phase shifter, and a VCXO. Currently, VCXOs have sensitivities ranging to ± 100 ppm/V. Frequency outputs for VCXOs are approaching the 100-MHz range.

Actually the VCXO is not a distinctly separate type of oscillator. You can apply voltage control to any of the basic oscillator technologies. TEW North America uses voltage control in the TCXO units, and AT&T and Connor-Winfield feature voltage control in basic XO designs.

EDN

Article Interest Quotient
(Circle One)

High 479 Medium 480 Low 481

NEXT IN EDN

In EDN News Edition's May 14, 1992, issue, watch for stories on

- High-resolution graphics/HDTV
- Datacomm hardware

And look for details of hot products and news on careers.



Learner's Permit.

FOR JUST \$50, MOTOROLA'S NEW 68HC705KICS KIT CAN PUT YOU ON THE ROAD TO AN ECONOMICAL 8-BIT DESIGN.

Learning to design Motorola's low-cost, 68HC05 K-Series microcontroller into your application is fast – and easy – with the new 68HC05 K-Series In-Circuit Simulator Kit.

By combining software simulation with an innovative hardware interface, the 68HC705KICS gives you real hardware emulation at simulator speeds – to put you in the driver's seat from the word go.

It helps you learn everything you need to know about using the 16-pin 68HC05 K-series, Motorola's newest addition to the world's most popular 8-bit microcontroller family. These low-pin count microcontrollers are ideally suited for cost-sensitive applications requiring 8-bit performance at 4-bit prices.

THIS SPECIAL OFFER COULD PUT YOU BEHIND THE WHEEL OF A NEW FORD EXPLORER.

Just order the 68HC705KICS kit, take it for a test drive, and enter your 68HC705KICS application in our design contest.

We'll judge designs based on creative and efficient use of the 68HC705K1 features, like the on-chip personality EPROM, and cost savings realized from reduced component count.*

The winner gets to drive off in a top-of-the-line 1992 Ford Explorer.

FULLY LOADED: \$500 WORTH OF DEVELOPMENT TOOLS AND ACCESSORIES FOR ONLY \$50!

Order your 68HC705KICS kit during this special offer, and you'll get a great package deal that includes:

- In-circuit source level simulator/programmer board with target cable
- Screen-oriented editor/ assembler/ debugger/ simulator software from P&E Microcomputer Systems
- 68HC705K1 windowed EPROM-version microcontroller
- Technical literature, including a handy introductory guide to understanding and using small microcontrollers.

HURRY, YOUR LEARNER'S PERMIT EXPIRES JUNE 30.

The low \$50 sticker price on the 68HC05 K-Series In-Circuit Simulator Kit is good only through participating Motorola distributors! But you better act now. This special offer ends June 30, 1992. And at \$50, the 68HC705KICS kit is priced to move.



MOTOROLA

* Official information on rules, regulations and contest deadlines is included with each 68HC705KICS kit. Government employees and Motorola employees and their families are not eligible for the 68HC705KICS contest. If the winner is not permitted to accept this prize by his or her employer's policies or practices, Motorola will donate an equivalent cash amount to an appropriate charity designated by the winner. Void where prohibited or restricted by law. (M) and Motorola are registered trademarks of Motorola, Inc. © 1992 Motorola, Inc.

WHEN YOU PLUNGE INTO ASIC DESIGN, YOU WANT SUPPORT TOOLS THAT WORK.

Oki's Advanced ASIC Tools Reduce Your Risk.

As an ASIC designer, you know the sinking feeling of working for weeks on a high-density design—only to have it crash. You know the risks involved using tools that offer no assurances.

Oki's advanced tools provide the lift you need to dive comfortably into high-level ASIC design:

Timing-driven layout - for an improved design-to-silicon match.

Clock tree structures - for optimized clock distribution.

Power calculator - for increased overall system reliability.

Coupled with our 0.8 μ m SOG technology and high-level support—such as Verilog, Synopsys, and IKOS—these Oki software tools optimize ASIC performance *and* design time.

So take the plunge. Call 1-800-OKI-6388, Dept. 050, for Oki's ASIC capabilities brochure. See how risk-free ASIC design can be.



Oki ASIC Design Tool Support for 0.8 μ m, 1.0 μ m, & 1.2 μ m

Vendor	Platform	Operating System/Application
Cadence	Sun/Solbourne	Verilog: Simulation, fault grading, design verification
IKOS	IKOS	Simulation, fault grading
Mentor Graphics	HP/Apollo Sun/Solbourne	Design capture, simulation Parade: Layout, clock and timing structures
Synopsys	Sun-4 Interface to Mentor, Valid, Viewlogic	Design synthesis, test synthesis
Valid	Sun/Solbourne DECstation 3100 IBM RS6000	Design capture, simulation Design check GED, ValidSIM, RapidSIM
Viewlogic	Sun-4 PC386	Design capture, simulation Design check



OKI
Semiconductor

785 North Mary Avenue
Sunnyvale, CA 94086-2909
1-800-OKI-6388, Dept. 050

TRANSFORMING TECHNOLOGY INTO CUSTOMER SOLUTIONS

FLUKE®



PHILIPS

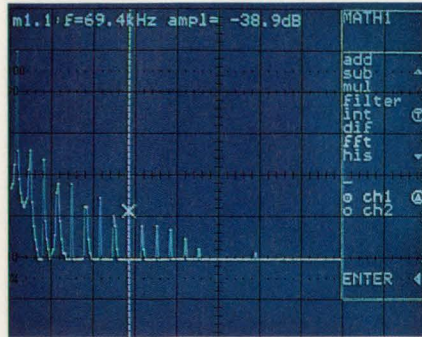

Powerful DSP signal analysis, including almost real-time FFT

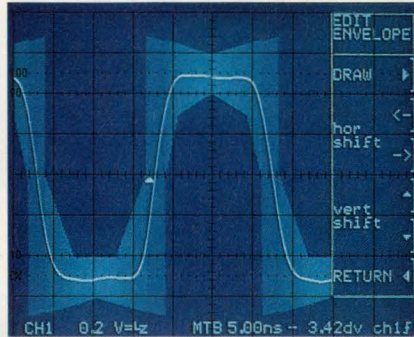

Automatic go/no-go decisions with template and limit tests

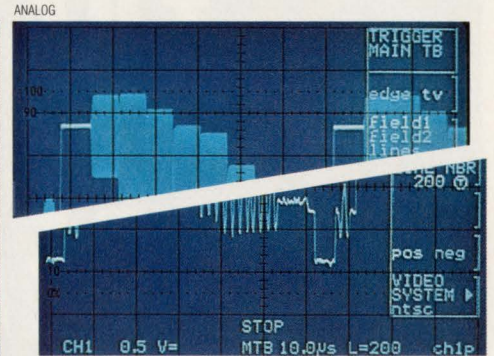

Push a button to better view complex signals in the analog mode

If you can't instantly see why our digital/analog DSOs are better than HP® or Tek...

	Fluke PM 3394	Tek® TDS Series	HP® 545xx
Analog/Digital Combination	YES	NO	NO
Limit Test	YES	YES	YES
Template Test	YES	NO	NO
Analysis Functions Int., Diff., Hist., Filter, FFT	YES	NO	NO
FFT	YES	NO	NO
4 Channels	YES	YES	NO
Analog Display	YES	NO	NO

maybe you need specs.

Believing is seeing. Philips DSOs from Fluke give you the sophisticated measurement and analysis features of an advanced digital scope costing up to five



times as much. Plus the familiarity of analog, for visual proof with infinite display resolution and speed. Looking for an easy-to-use scope? Our Touch Hold and Measure™, Autose, and pull-down menus define the term. And we back our combination DSOs with a 5-year CRT warranty (3-year on the mainframe). Now that's value you just have to see to believe.

For literature or a demonstration, call **1-800-44-FLUKE**.

John Fluke Mfg. Co., Inc., P.O. Box 9090, M/S 250C, Everett, WA 98206-9090. U.S. (206) 356-5400. Canada (416) 890-7600. Other countries: (206) 356-5500. ©1992. All rights reserved. Tek® and HP® are registered trademarks of Tektronix, Inc., and Hewlett-Packard, Inc. Ad No. 00180.

FAST ANSWERS

FLUKE®

**THE SHOCKING
REASON THE
TELECOMMUNICATIONS
INDUSTRY
TURNED TO
OMRON.**

Recently, the telecommunications industry needed a new breed of low-signal relay — a relay that could withstand a shocking 2,500 volts, almost double the present standard, yet small enough for dense PCB mounting. They turned to Omron.

Omron responded with the G6N relay. It not only withstands a 2.5KV surge between coil and contacts, its footprint is almost 40% smaller than the previous standard. The G6N is the latest product to join Omron's family of low-signal relays for telecommunications, computer peripherals, office automation and more.

Why did the telecom industry turn to Omron? Because we not only have the broadest line of relays, switches and photomicrosensors in the industry, we also have a proven



track record of innovation. Last year alone, we invested over \$170 million in R&D, employed over 1,000 R&D engineers and introduced nearly 100 new products. The telecom industry was also impressed with our highly-automated manufacturing systems, which enable us to provide products of consistent quality in high volumes. The G6N, for example, undergoes 100% automated inspection on 13 critical performance parameters.

With more than 90 affiliates and subsidiaries, 1,500 sales locations and 17,000 employees worldwide, Omron also met the telecom industry's need to provide product and service support around the globe.

Omron's ability to meet the rigorous demands of the telecom industry may come as a shock to some people. But it effectively demonstrates our ability to meet the control demands of any industry. For complete information on our broad line of control components, call us at

OMRON
WE HAVE THE FUTURE IN CONTROL.

both now and in the future.
1-800-62-OMRON.

CIRCLE NO. 72

EDN May 7, 1992 • 101

*A hot product,
made to order, delivered fast,
with everything on it.*



For fast answers, call us at:

USA Tel:1-800-632-3531. Fax:1-800-729-9288. Germany Tel:0211-650302. Fax:0211-6503490. The Netherlands Tel:040-445-845. Fax:040-444-580. Sweden Tel:08-753-6020. Fax:08-755-3506.
France Tel:1-3067-5800. Fax:1-3946-3663. Spain Tel:1-504-2787. Fax:1-504-2860. Italy Tel:02-6709108. Fax:02-66981329. UK Tel:0908-691133. Fax:0908-670290. Ireland Tel:01-6794200.
Fax:01-6794081. Hong Kong Tel:755-9008. Fax:796-2404. Taiwan Tel:02-719-2377. Fax:02-719-5951. Korea Tel:02-551-0450. Fax:02-551-0451. Singapore Tel:253-8311. Fax:250-3583.
Australia Tel:03-8878012. Fax:03-8878014. Japan Tel:03-3454-1111. Fax:03-3798-6059.

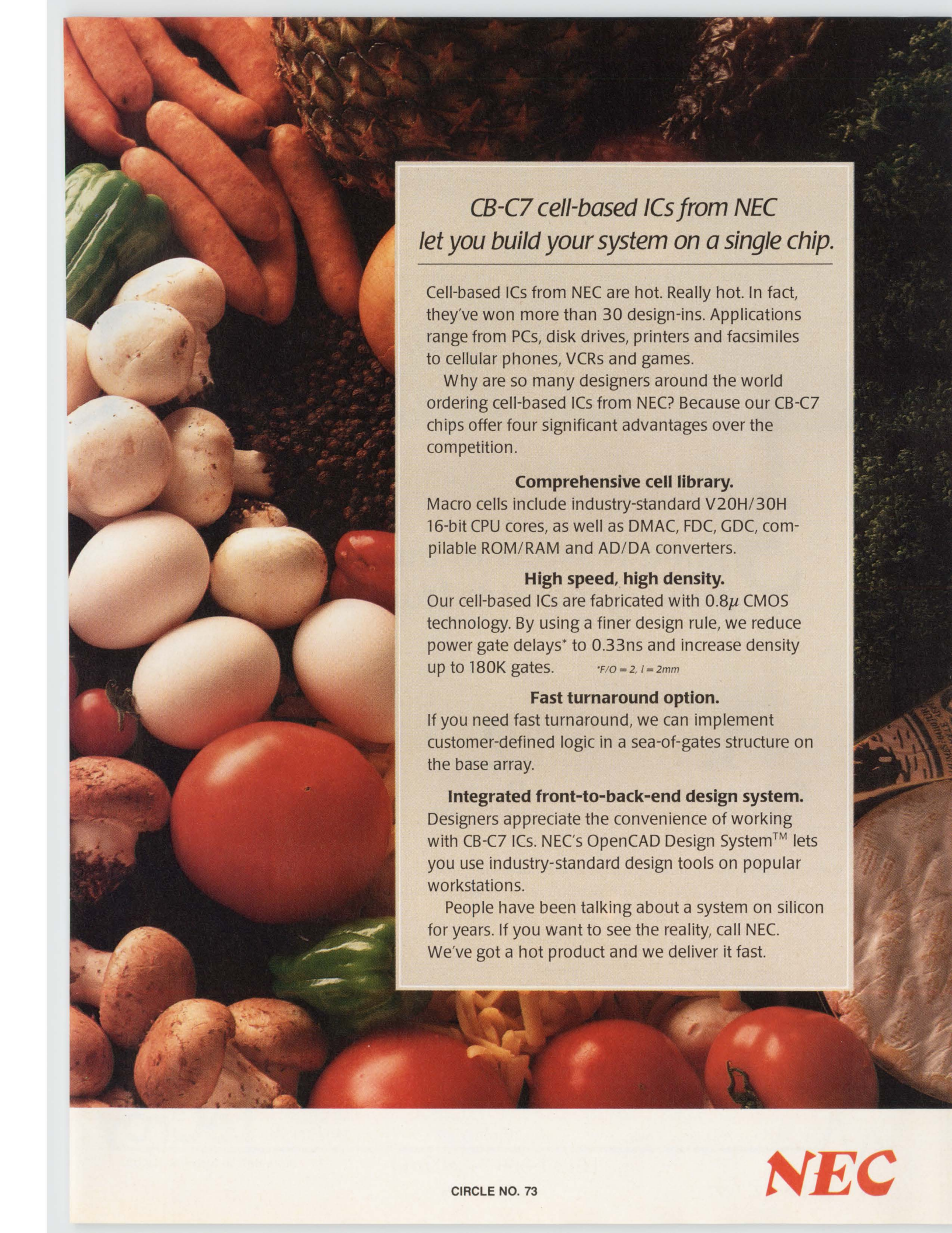

*CB-C7 cell-based ICs from NEC
let you build your system on a single chip.*

Cell-based ICs from NEC are hot. Really hot. In fact, they've won more than 30 design-ins. Applications range from PCs, disk drives, printers and facsimiles to cellular phones, VCRs and games.

Why are so many designers around the world ordering cell-based ICs from NEC? Because our CB-C7 chips offer four significant advantages over the competition.

Comprehensive cell library.

Macro cells include industry-standard V20H/30H 16-bit CPU cores, as well as DMAC, FDC, GDC, compatible ROM/RAM and AD/DA converters.

High speed, high density.

Our cell-based ICs are fabricated with 0.8μ CMOS technology. By using a finer design rule, we reduce power gate delays* to 0.33ns and increase density up to 180K gates. *F/O = 2, l = 2mm

Fast turnaround option.

If you need fast turnaround, we can implement customer-defined logic in a sea-of-gates structure on the base array.

Integrated front-to-back-end design system.

Designers appreciate the convenience of working with CB-C7 ICs. NEC's OpenCAD Design System™ lets you use industry-standard design tools on popular workstations.

People have been talking about a system on silicon for years. If you want to see the reality, call NEC. We've got a hot product and we deliver it fast.



3 good reasons to buy your next pulse generator from LeCroy.

1.
PERFORMANCE.
(300 MHz, 300 ps)

2.
PRICE.
(around \$8,000)

3.
RELIABILITY.
(backed by a 5-year warranty)

The 9210 GPIB programmable pulse generator mainframe accepts up to two plug-in modules that feature a wide range of repetition rates, edge transition times and output swings.

	with 9211 Module	with 9212 Module	with 9213 Module
TRANSITION SPEED	1 ns - 1 ms	300 ps - 1 ns	6.5 ns - 95 ns
MAX. REP RATE	250 MHz	300 MHz	50 MHz
OUTPUT SWING	5V pp (50Ω)	5V pp (50Ω)	16V pp (50Ω)
VARIABLE EDGES	Yes	Yes	Yes
TIMING ACCURACY	± (0.5% + 0.2ns)	± (0.5% + 0.2ns)	± (0.5% + 0.2ns)
DC LEVEL ACCURACY	± (1% + 5mV)	± (1% + 5mV)	± (1% + 5mV)
LIST PRICE - 1 CHANNEL	\$7,500	\$8,100	\$6,900
2 CHANNELS	\$8,900	\$9,900	\$7,900



LeCroy, 700 Chestnut Ridge Road, Chestnut Ridge, NY 10977-6499 • FAX: 1-914-578-5981

LeCroy

TEL: 1-800-5-LeCroy

Innovators in Instrumentation

Programmable-connection IC promises quick and easy prototypes

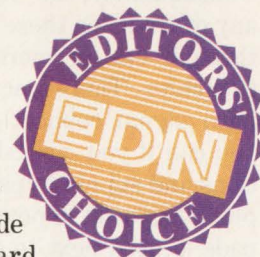

Now that you're accustomed to programmable memories and logic, prepare yourself for programmable interconnect, a technology that promises to reshape the way you design, prototype, and build hardware. Never before have you had the option of working with programmable connections in one component on the scale made possible by the AX1024 field-programmable interconnection component. It's a CMOS IC that can create a resistive circuit path between any two of its 940 I/O pins. Coupled with some innovative prototyping hardware and associated development software being introduced along with the chips, programmable-interconnect technology may soon make cut-and-jump prototyping methods seem intolerably slow and archaic.

The interconnection IC employs a RAM-based programming scheme so you can reprogram its connections on the fly. You send programming instructions to the chip through a serial port. A programmed connection employs a pass transistor to electrically join two of the I/O pins with a typical resistance of 150Ω. Once activated, the pass transistor in one of these connections remains on, so the connection's bandwidth is independent of the transistor's switching speed. High-speed connections experience 5 to 10 nsec of delay through the device. Because the base fabrication technology is 5V CMOS, signals sent through the chip must stay between 0 and 5V, but they need not conform to any logic levels and can, in fact, be analog signals.

Initially, the company is offering the chip in two versions. The \$2938 AX1024D provides 64 diagnostic pins on an attached flex cable in addition to its 940 interconnect pins.

You can connect these diagnostic pins to test equipment, thus gaining access to any part of your design that's routed through the IC without having to use probes. This device employs an exotic package having spring-loaded connecting pins and is intended for prototype troubleshooting (the "D" suffix means "development").

The \$1105 AX1024R lacks the 64 diagnostic pins and is packaged in a slightly more conventional surface-mountable pin-grid array (it has stubby pins). The "R" suffix stands for "reprogrammable," although both devices are actually reprogrammable. Both parts connect to a pc board using a 32×32-pad array on 40-mil centers. Less expensive, one-time programmable devices are planned but aren't part of the initial product introduction.

The two AX1024 versions are nearly pin compatible, but one has the mirror-image pinout of the other. That's not an accident. The mirror imaging allows you to attach one

of each device to the same set of circuit pads by placing one on either side of the pc board.

Consequently, you can solder an AX1024R permanently to a board and use the AX1024D as a probe by clamping it to the opposite side of your board. In this configuration, both parts will link the same pad sets when programmed with the same configuration information.

Because these are field-programmable devices, you need software to make them do anything useful. The initial release of the development software runs on SPARCstations and costs \$15,000. The company plans to announce PC software shortly. The company also offers two prototyping boards, which it has dubbed "field-programmable circuit boards" or "FPCBs," to help you use the AX1024 chips. The field-programmable characteristic of these board products stems from



Chip, board, and software products together provide field-programmable interconnections for circuit boards. Prototype construction may never be the same.

the linkage between every hole in the FPCB to one of the AX1024 I/O pins. In addition, the AX1024s have global connections between them. Consequently, no IC connects to any other IC on these boards except through one or more interconnection chips. There's no need to make hard signal connections, although you can if you wish. Power connections and supply bypassing are simple, using a set of power and ground pads located next to each hole. For power connections, you use a surface-mountable shunt or a very short wire. For bypassing, the pads accept an SMT bypass capacitor.

The \$1538 FPCB-AT accepts three AX1024s and plugs into the ISA bus. The \$1154 FPCB-GP2 accepts two AX1024s and conforms to no particular form-factor standard. These prices do not include the programmable-interconnect ICs. Special hole patterns on both boards accept a variety of IC packages.

You can plug in through-hole DIPs of all widths. In addition, the hole patterns accept existing SMT package adapters from various third-party sources, so you can plug just about any device into an FPCB. Alternatively, the company offers a \$15,000 FPCB compiler for custom designs.

For design troubleshooting, you can pick either a \$5000 diagnostic software package or a \$7500 package geared specifically for the Hewlett-Packard 16500 and 1650 logic-analyzer families. The spiffier software package communicates directly with the logic analyzer over an RS-232C or IEEE-488 connection and configures the signal names in the analyzer directly from your schematic. With the less expensive diagnostic software, you have to configure the logic analyzer manually. You have to set up trigger conditions manually with either package. If you purchase the HP-specific package, you'll probably

want the \$769 interface pod, which provides some signal conditioning and simplifies the connection between the AX1024D's flex cable and the logic analyzer.

At first glance, the component costs for reprogrammable interconnect technology look high. However, for prototyping, you can easily recoup that money if you avoid a few pc-board revisions and save a few weeks in your development cycle. While many production-volume applications of field-programmable interconnections will await lower-cost (perhaps one-time-programmable) devices, some applications requiring fast rerouting of large numbers of signals will find this technology's cost and speed superior to existing alternatives.

—Steven H Leibson

*Aptix Corp, 225 Charcot Ave,
San Jose, CA 95131, Phone (408)
428-6200. FAX (408) 944-0646.*

Circle No. 740

We've taken SMDs to a higher power...

Central's SOT-89 & SOT-223 high-power SMD packages.

And we do it from start to finish... with complete inventory... short lead times... and competitive pricing. Plus improved power dissipation, up to 2 Watts... total traceability back to wafer level, thanks to part number marking and date codes... excellent PPMs... a complete line of standard devices... an expanding list of unique devices. And Central backs it all up with superior service... a full commitment to SOT-89 and SOT-223... and a willingness to build what your design calls for.

Available Types:

SOT-89

CBCX68 CXT4033
CBCX69 CXT5401
CXT2222A CXT5551
CXT2907A CXTA14
CXT3019 CXTA42
CXT3904 CXTA64
CXT3906 CXTA92

SOT-223

CBCP68 CZT4033
CBCP69 CZT5401
CZT2222A CZT5551
CZT2907A CZTA14
CZT3019 CZTA42
CZT3904 CZTA64
CZT3906 CZTA92

Take your SMD applications to the highest power in SMD manufacturing... Central. For more information, write or call.

Central™ 
Semiconductor Corp.

Central: We make the difference.

145 Adams Avenue, Hauppauge, NY 11788
Tel: (516) 435-1110 • Fax: (516) 435-1824

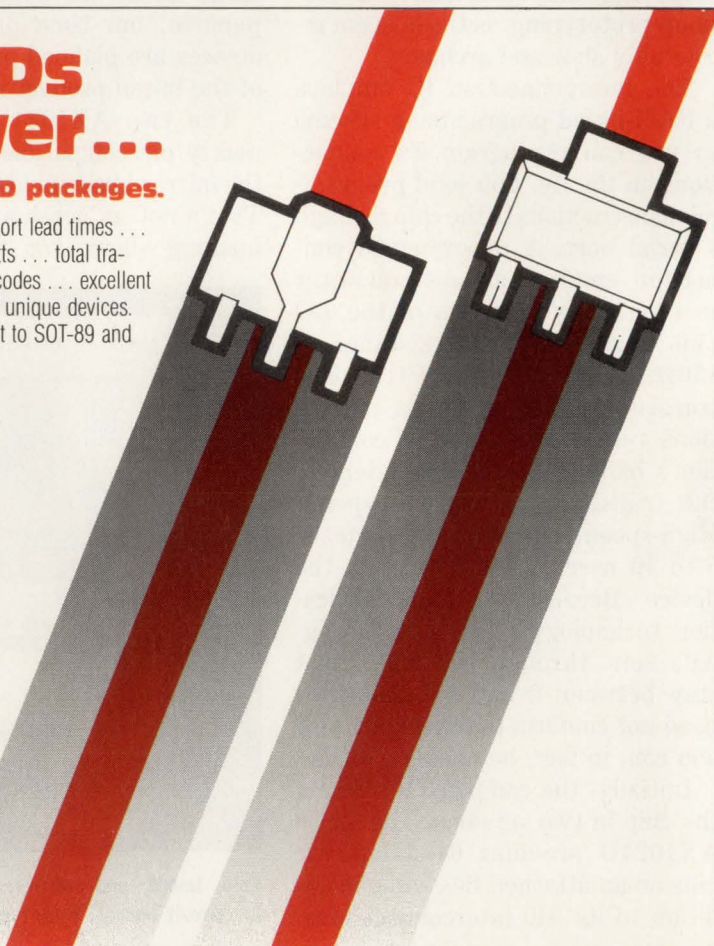

Drive your DSP design all the way home.

Why complicate your travel plans? Zip along the entire DSP design route with SPW™ – the Signal Processing WorkSystem® from Comdisco.

SPW is the only DSP and communications design software tool that's complete and integrated. The only one that can take you all the way from idea to implementation. No matter where you're headed. No matter which road you take. And it's fast. It has all the horsepower you need to cut design time by as much as 90 percent.

First, SPW helps you choose your destination. You can quickly draw from its extensive libraries of reusable function blocks. And you can take advantage of SPW's open architecture to incorporate your own models.

After this, SPW automatically transforms your design into an



error-free simulation program. One that lets you perform accurate design, prototyping and analysis. One that confirms that you're headed in the right direction.

And, to assure that your way is free from bumps, potholes, and those awful "dead end" signs, SPW comes with the industry's widest range of implementation options. Options that generate code for floating- and fixed-point DSP chips as well as DSP systems with multiple processors. Options for bit-true fixed-point simulation that automatically generate VHDL and provide seamless links to the leading logic synthesis tools. Options that pave the way to fast FPGA and ASIC production.

So, how about a test drive? Call us at 415-574-5800. And learn how SPW can put you in the fast lane to market.

COMDISCO[®]
SYSTEMS, INC

U.S.: Telephone 1-415-574-5800, Fax 1-415-358-3601 Europe: Telephone 44-454-614256, Fax 44-454-614700

CIRCLE NO. 76

EDN May 7, 1992 • 107

Crying
for micro
interconnects
but nobody
listening?



CPU boards use SPARC to handle embedded uses

A pair of CPU boards that target embedded and real-time applications perform the function of a complete SPARCstation-2-compatible computer. The CPU-2E is a VMEbus-compatible board, and the CPU-2S is a board that does not include a system bus. Both boards fit VMEbus 6U single slots. The CPU-2S uses VMEbus connectors only for power and ground.

The boards share a number of features. Both include two SBus-compatible expansion connectors. The boards can accommodate as much as 32 Mbytes of memory each, and you can add another 32 Mbytes with daughter cards. They each include two serial ports, a keyboard/mouse interface, an audio port, an Ethernet port, and a SCSI-2 port, all of which are accessible from the front panel. You can run the SunOS Unix-based operating system and any Sun application programs on the boards, as well as real-time operating systems.

The CPU-2E also includes Open Boot firmware, which supports dynamic reconfiguration of the system resources and is currently in the IEEE standardization process.

Open Boot lets a variety of peripherals operate with the system by loading appropriate operating-system drivers on boot up. The Open Boot firmware also includes a Forth monitor and debugger.

The CPU-2E board uses a 64-bit VMEbus implementation, called VME64, and also supports the proposed IEEE P1014R SSBLT (source-synchronous-block-transfer method) protocol. SSBLT increases the maximum VME64 data-transfer rate from 80 to 160 Mbytes/sec. The CPU-2E includes an additional SCSI-2 port, a floppy-disk controller, and a speaker that you can access via the VMEbus P2 connector.

The company plans to ship production units of the CPU-2E by July. The board costs \$7995, \$9495, or \$12,490 for 16-, 32-, and 64-Mbyte, respectively, memory configurations. You can buy the CPU-2S now, and the price ranges from \$7495 to \$11,990, based on memory configuration.—**Maury Wright**

Force Computers Inc, 3165 Winchester Blvd, Campbell, CA 95008. Phone (408) 370-6300. FAX (408) 374-1146.

Circle No. 741

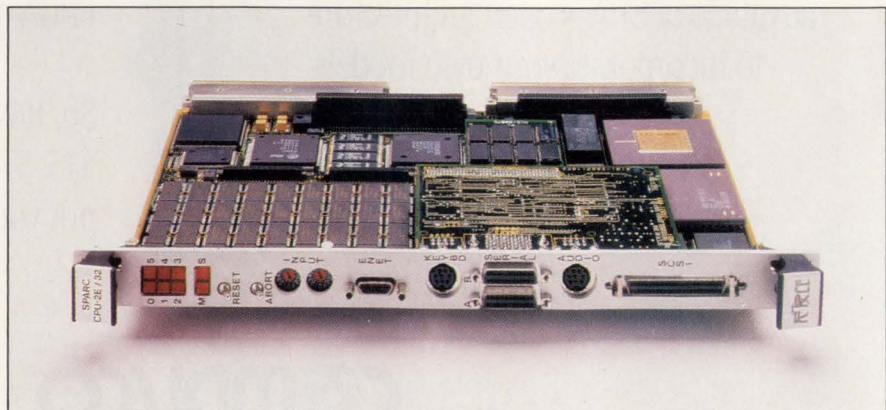

The CPU-2E combines a SPARCstation-2-compatible design with 64-bit VMEbus compatibility and support for the new 160-Mbyte/sec SSBLT protocol.

Samtec hears your smallest request.

Nobody reacts to small interconnects and small orders better than Samtec.

Whether you need to shrink your centers or lower your profile, Samtec has the solutions you need. And even when you only need a small quantity, Samtec still jumps to fill your order fast.

Our new *Sudden Solution Guide* shows thousands of Micro Interconnect solutions.

Call 1-800-SAMTEC-9 for your free copy today!

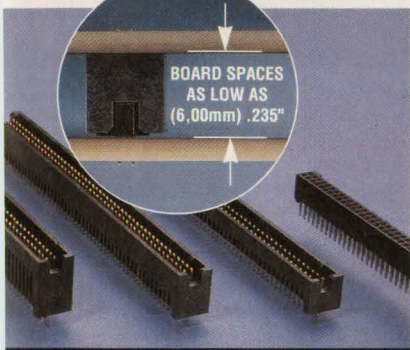
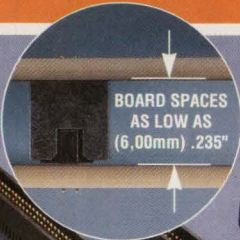
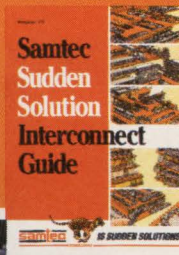

.050" x .050"

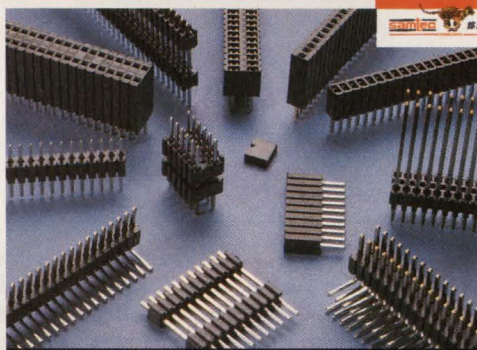

.050" x .100"

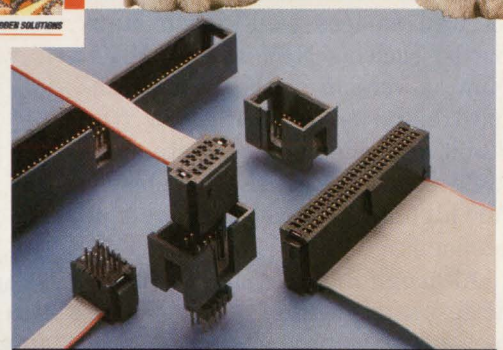

.050" x .100" IDC

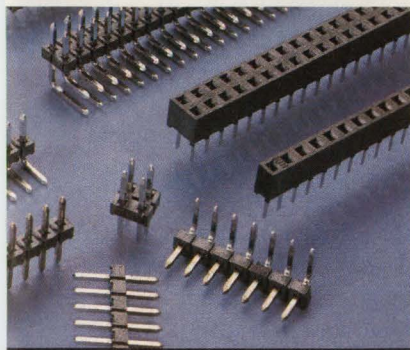

2mm x 2mm

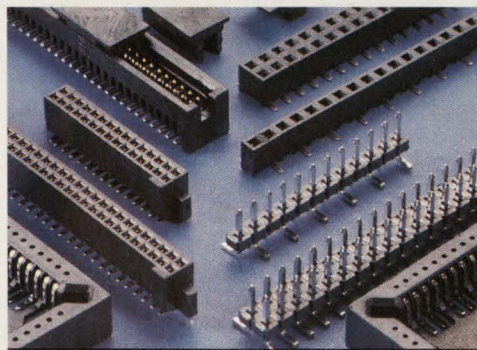

SURFACE MOUNT

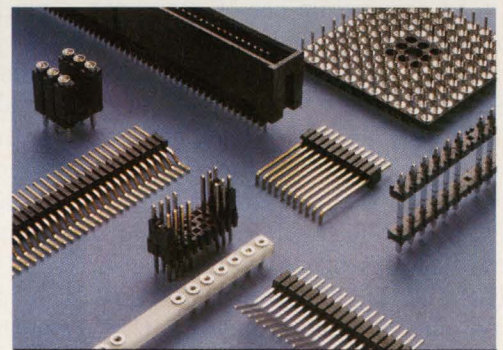

CUSTOM & MODIFIED

samtec



IS SUDDEN SOLUTIONS

New Albany, Indiana USA • Cumbernauld, Scotland UK • Singapore

SAMTEC, INC. P.O. Box 1147 • New Albany, IN 47151-1147 USA • Phone 812-944-6733 • Fax 812-948-5047 • TWX 810-540-4095 • Telex 333-918

CIRCLE NO. 77

EDN May 7, 1992 • 109

Low-cost modular-instrumentation standard uses passive EISA backplane

Some people view the PCXI (PCs extended for industry) system originated by Rapid Systems as competitive with VXI (VME extensions for instrumentation) systems. Others view the two modular-instrumentation standards as complementary. Whichever way you look at PCXI, you have to agree that the standard offers designers of PC-based instrumentation systems, particularly those produced in small to moderate quantities, a low-cost alternative to IEEE-488 and VXI as well as less well-known standards, such as NIM and CAMAC. Now, a version of the PCXI standard based on the EISA bus (the 32-bit extended industry-standard architecture) lets PCXI systems offer high performance as well as economy.

Although Rapid Systems, the Seattle-based vendor of test-and-measurement products for PCs, is the driving force behind PCXI, the PCXI consortium has 16 members, all of which are suppliers of instruments and related products for PCs. Several of these firms expect to announce EISA bus PCXI products in coming months; Rapid has already announced several EISA PCXI modules. Of course, one of the beauties of a system based on EISA is that it can also use cards designed for the 8- and 16-bit ISA buses.

Despite a strong software component, PCXI is first and foremost a packaging scheme. A PCXI mainframe incorporates a passive backplane; the system designers deemed the mother-board concept of most PCs to be inappropriate for industrial use. In the event of a failure, replacing a standard mother board takes too much time. By keeping the backplane passive and

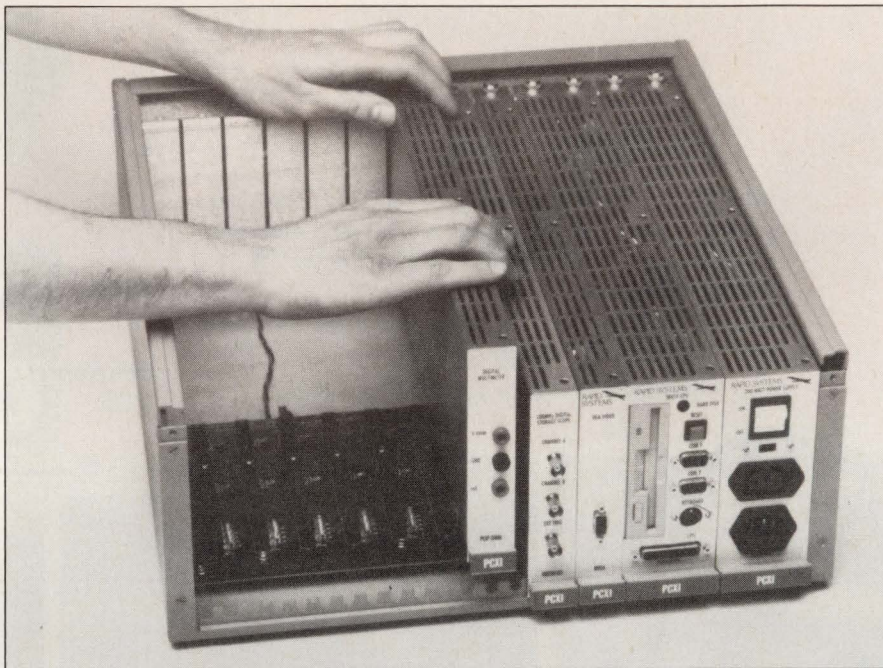

When you lift the hood of a PCXI chassis, you see how simple reconfiguring and replacing modules is. Note the system power supply in a double-width module at the far right. Next to it is a double-width module that houses the system CPU with its floppy-disk drive. The adjacent single-width module is the video controller.

placing the system CPU and memory in plug-in modules, replacing a failed CPU is much easier as is upgrading to system controllers based on new and more powerful μ Ps.

For several reasons, the system architects also decided that, for industrial applications, the modules had to be enclosed instead of having an open-board construction. First, without the mechanical shielding provided by a cover, modules not installed in a backplane would be vulnerable to damage unless handled with care. Second, ambient electrical noise is a problem in industrial environments. A metal cover that provides mechanical shielding can also provide electrical shielding. Third, a shield that reduces the effects of noise that originates outside the system enclosure will have a similar effect on noise

generated by neighboring modules. Hence, modules that handle low-level signals become practical.

To accommodate the shield, PCXI modules mount on 1.2-in. centers instead of the 0.8-in. centers used by standard ISA and EISA bus cards. To use a standard ISA or EISA card in a PCXI system, you remove the card's standard front panel and replace it with a new and slightly wider panel that mounts a bit further ($\sim 1\frac{3}{4}$ in.) from the end of the card than the standard panel does. Connectors that were attached to the original card remain attached; cables lead to new connectors on the wider panel. This arrangement permits attaching module covers.

When the EISA bus was first engineered, its designers did not envision a passive-backplane version.

ANALOG

Digital

ANALOG

Digital

Analog

DIGITAL

Analog

digital

ANALOG

.digital.

ANALOG

DIGITAL

DON'T BUY IT.



There is a far side to the world of oscilloscopes, a place filled with all sorts of bizarre characters. Like those who swear you need digital, for the sole reason that digital is all they wish to sell. Then there's the gang

that wants to push nothing but analog. Luckily, there's also a place called Tektronix. Where they manufacture a complete line of analog and digital scopes. Making them uniquely qualified to provide you with a more honest assessment

of your needs. With anyone else, you could be hearing only half the story. For complete information



on the full line of Tektronix analog and digital oscilloscopes, get in touch with a Tek representative today.

TALK TO TEK/1-800-426-2200

Tektronix

Test and Measurement

03W-188147 Copyright © 1991, Tektronix, Inc.

CIRCLE NO. 78

EDN May 7, 1992 • 113

They did foresee automatic system configuration at power-up—a feature the EISA bus shares with the VXIbus. To let a CPU poll each backplane slot to determine its contents, EISA bus systems have lines that separately link each I/O slot with the CPU. To accommodate daughter-board-mounted CPUs, the passive-backplane EISA standard had to let the CPU slot access the slot-specific signals for all of a system's I/O slots. An extra connector on the CPU slot performs this function.

In the area of software, PCXI advocates claim superiority over VXI. You must be the judge of how true those claims will be for you. Often, you can deal with message-based VXI modules as if they were IEEE-488 instruments. System developers who are familiar with IEEE-488 require little or no time to learn how to program such VXI units. On the other hand, several virtual-instrument software packages do away with conventional programming for controlling and gathering data from PC-based instruments, including PCXI modules. With such software, the PCXI learning curve is not a problem, even for developers unfamiliar with IEEE-488. Such software can offer higher throughput than can message-based IEEE-488 communication.

More than 175 PCXI modules are available, so a comprehensive treatment of prices would look like a vendor price list, especially when you include the long list of ISA bus products compatible with EISA-based PCXI systems. Typical system prices such as the following illustrate PCXI's economy: A system that includes a 20-MHz, 2-channel DSO; a 4½-digit DMM; a 100-channel matrix switch; and a 5-Msample/sec arbitrary-waveform generator costs approximately \$15,000.

—Dan Strassberg

Rapid Systems Inc, 433 N 34th St, Seattle, WA 98103. Phone (206) 547-8311. FAX (206) 548-0322. TLX 265017. Circle No. 739

Engineered With Vision



Built With Care

SEALED LEAD-ACID & NICKEL CADMIUM BATTERIES

For quality performance,
on-time delivery, service,
and competitive pricing...

THE #1 NAME IS POWER-SONIC

For more information or a copy of our catalog contact:

POWER-SONIC CORPORATION
3106 Spring St., Redwood City, CA 94063 (415) 364-5001 Fax: (415) 366-3662

POWER SONIC
SEALED RECHARGEABLE BATTERIES

CIRCLE NO. 79

See us at Electro Booth #4217

DID YOU KNOW?

EDN serves
electronic engineers and
engineering managers in more than
100 countries worldwide.

EDN MAGAZINE
EDITION
NEWS
EDITION.

New VME Controller Formula . . . Delivers 40MHz SBC

VME+MIPS+Real Time Software = Performance Breakthrough

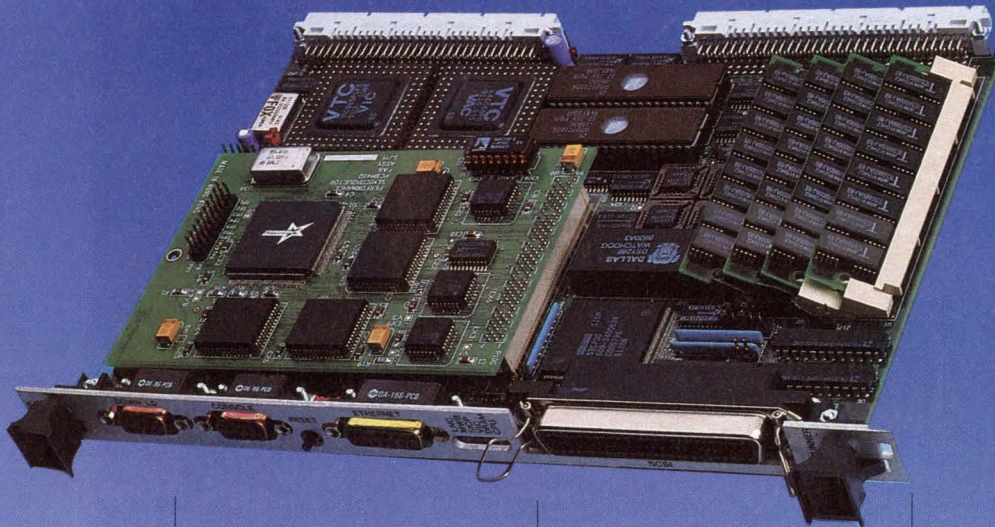

VME

PaceRunner3400 SBC (6U Form Factor)

The PaceRunner3400™ 40MHz/33-MHz VME single-board computer is designed to serve the high-performance real-time market and UNIX-based processor applications.

Features

- SCSI I/O processor & 32-bit DMA
- Ethernet Communication controller (IEEE 802.3 compatible)
- DRAM 4M and 16M options
- Three 16-bit programmable timers
- VIC/VAC/VME master/slave interface
- Single slot, 6U form factor
- Lithium powered watchdog timer/50 bytes NVRAM
- Seven levels of interrupt handler support

MIPS RISC

PCBM/3400 MIPS Module

The PCBM3400 (Printed Circuit Board Module) is a highly integrated 32-bit RISC processor module. It can be purchased as a standalone product or as part of the PaceRunner 3400 SBC.

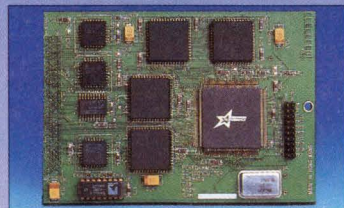

Features

- ANSI/IEEE 754-1985 floating point
- 40MHz/33MHz performance options
- PaceWrap write/read/parity buffer interface
- 64KBytes of instruction and 64KBytes of data cache
- Small form factor: 3.45 x 5.04 inches
- Integrated startup
- Simple and flexible interface

Software

Support Options/ Board Support Packages (BSPs)

- Wind River Systems VxWorks™ offers a PaceRunner 3400 BSP compliant with a UNIX-based development and debugging environment
- PaceRunner 3400 prom monitor (BSP) is an option available as EPROMs. The debug prom monitor permits quick evaluation, software development, & diagnostics

Additional Software Available for the PaceRunner3400

Company	Software
SCO	UNIX
USL	UNIX
DDCI	Ada Run Time Executive

Performance

Benchmarks for PaceRunner3400 VME System 40MHz, 64K Cache

- Combined SPECmark 32.4
- 33 VAXMips
- 11.6 MegaFlops LINPACK
- 6.7 MegaFlops Double precision LINPACK

Benchmarks for 40MHz PaceRunner 3400 V_xWorks

- Raw Context Switch - 2 μ s
- Resume/Switch/Suspend/Switch - 10 μ s
- Cyclic Kernel Test - 40 μ s

For more information from the leading volume and speed supplier of MIPS RISC components call Performance Semiconductor . . .

In the United States call

408 734-9000

In Europe call

44-256-59585 (U.K.)

CIRCLE NO. 80

PERFORMANCE
SEMICONDUCTOR CORPORATION
610 East Weddell Drive, Sunnyvale, California 94089

Broaden your RF horizons.

S_{11} SWR
REF 1.0



RF performance, DC to 50 GHz.

THIS IS AMP TODAY.



START 0.0000GHZ
STOP 50.0000GHZ

No matter what range you're working, your work goes better and faster with connectors engineered for the right balance of properties. AMP has the coax connectors you need for top performance, consistent electrical characteristics, and maximum manufacturability.

Select from a line that spans the spectrum—DC to 50 GHz—in a variety of 50 or 75 ohm versions. Our selection delivers the advanced

design and controlled properties you need, with commercial versions that exhibit Mil-equivalent performance. Our fully Mil-qualified versions offer productivity gains, as well, including our proven crimp/seal technology.

We support the broadest selection of RF connectors available with the broadest range of mounting options as well: from cable to bulkhead, panel to board—and now including

custom and semi-custom high-speed coax and transmission cable assemblies.

We'd like to extend all that support to you. For literature or the name of your nearest AMP Distributor, call the AMP Product Information Center at 1-800-522-6752 (fax 717-986-7575). In Canada call 416-475-6222. AMP Incorporated, Harrisburg, PA 17105-3608.

AMP

CIRCLE NO. 81

EDN May 7, 1992 • 117

RELIABILITY YOU CAN DEPEND ON!

MILITARY DC-DC CONVERTERS

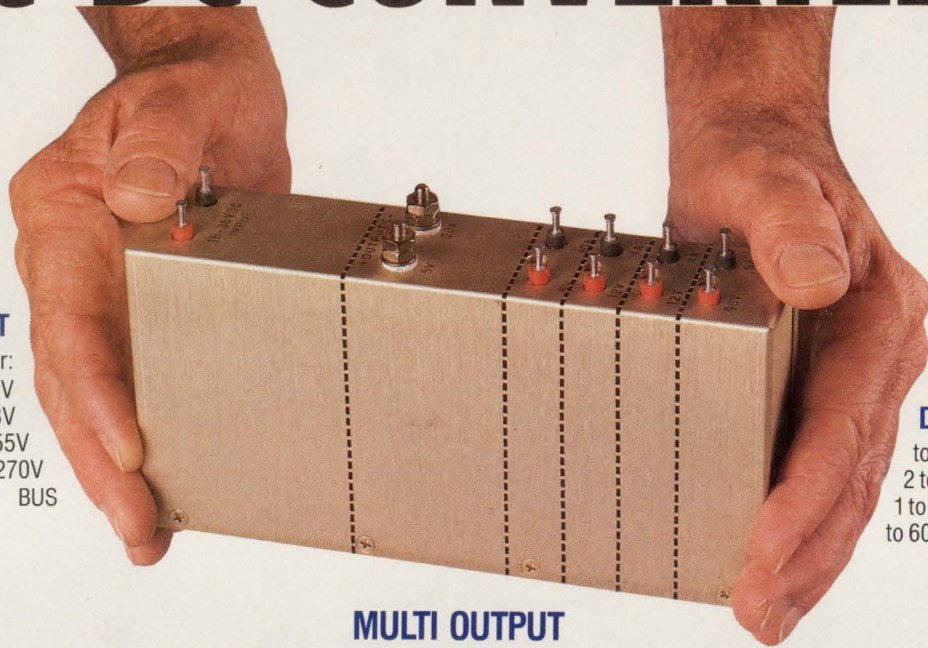

DC INPUT

18-300V for:
28V
48V
155V
270V
BUS

DC OUTPUT

to 110A
2 to 300V
1 to 8 outputs
to 600 watts

MULTI OUTPUT
EL2000 SERIES

WE PUT IT ALL TOGETHER

CONDITIONED INPUTS FOR LAND, SEA & AIR

- Surge and spike protection to input requirements of Mil-Std-1275A and Mil-Std-704D.

- Operation to Mil-Std-810D environments.

- High density designs to 24 watts/in.³.

- Efficiencies to 80%+.



Mil-Std-1275A

- Extended MTBF to >500,000 hours.
- Low EMI/RFI options available.

- Meets applicable requirements of Mil-E-5400T,

Mil-E-16400,
Mil-E-4158E and
Mil-Std-454J.

- Design and derating to NAVMAT P4855-1.



Mil-Std-704D

- Mil-I-45208A facilities and systems.

- Standard products for custom applications without NRE.

- Short lead times...deliveries in weeks not months.

For complete brochure and applications assistance please call **Toll Free 1-800-421-8181** (in CA 805/484-4221)

ARNOLD MAGNETICS

ARNOLD MAGNETICS CORPORATION

4000 Via Pescador, Camarillo, California 93012 • Phone: (805) 484-4221 • FAX: (805) 484-4113

VISIT US
ELECTRO/92
BOOTH 4433

RISC μ P enlarges instruction cache and adds data cache

Embedded systems place additional demands on RISC processors: Users need high performance coupled with cost-effective memory and deterministic performance. Intel kicked up the performance of its superscalar i960CA, a 32-bit superscalar RISC (reduced-instruction-set-computer) processor, by as much as 60% in some applications. This μ P employs a larger, 4-kbyte instruction cache and a 1-kbyte data cache, as well as an optimizing compiler.

Currently, the i960 is one of the major RISC architectures for embedded applications, especially in laser printers and emerging X-terminals. In addition, the i960 is penetrating the high-end networking world, showing up in network routers, bridges, and servers. This move is aided by the i960's sophisticated external bus controller, which

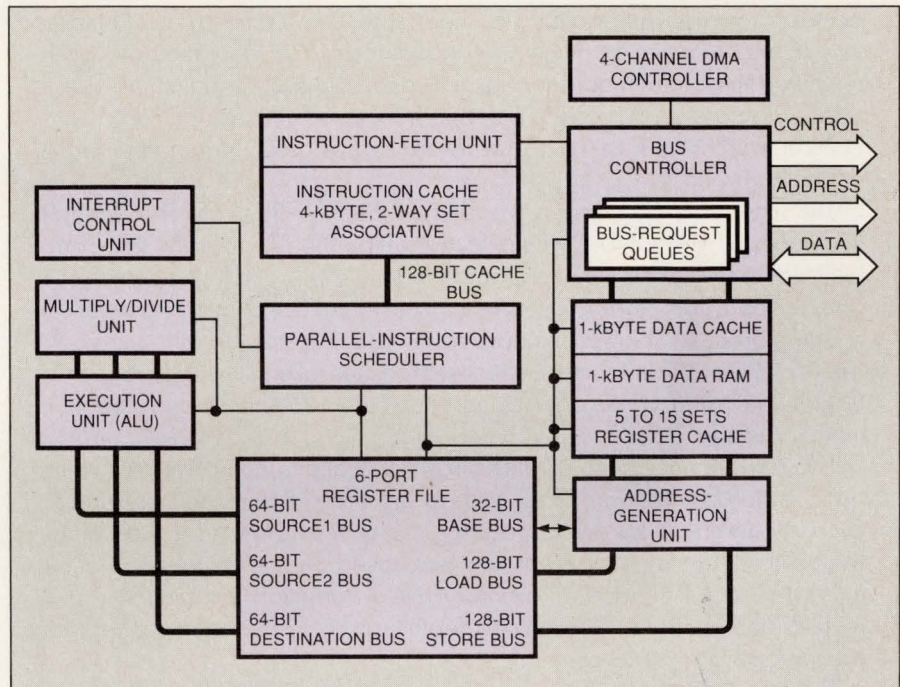

The i960 has a superscalar architecture; it can issue as many as 3 instructions/clock cycle.

The Intel i960CF

- 16-, 33-MHz clock
- Superscalar; issue to 3 instructions; 2 sustained
- MPY, DIV instructions: MPY (32-/16-bit; 4/2 clocks)
- 6-port register file (32 \times 32 bit); 128- or 64-bit paths
- 4-kbyte instruction cache, 2-way set associative 1-kbyte direct-mapped data cache write-through, 1-kbyte RAM/(register set cache)
- 32-bit pipelined, external memory interface with multiple memory regions, burst mode
- 3-stage pipeline (2-stage branch)
- 4 functional units: MPY/DIV, instruction/fetch, integer, address generation; no FPU
- Branch-prediction bit; out-of-order branch execution
- Pipelined store (3-deep buffer)
- 4 DMA channels; sophisticated bus controller
- 196-pin PQFP, 168-pin PGA (33 MHz)
- 16-MHz version, \$105.80 (10,000); 33-MHz version, \$165.30 (sample qty); production qty by fourth quarter 1992

supports as many as four DMA channels. In addition, the JIAWG (Joint Integrated Avionics Working Group) selected the i960 MX as an acceptable 32-bit Instruction Set Architecture.

The first RISC designed for embedded applications, the i960 comprises a family of embedded RISC processors, ranging from the i960SA, which costs less than \$20, to the massive i960MM, which suits military applications.

The new addition to the family, the i960CF, extends the high-end i960CA processor's performance. Designers enlarged the CPU's instruction cache from 1 kbyte to 4 kbytes. Holding as much as 1k 32-bit instructions, the instruction cache is big enough to cache the repetitive inner-processing loops for many embedded applications. The cache is 2-way set associative, with a 4-instruction-word line size. Similar to that of the earlier i960CA, the cache can be locked (1/2 of the

cache at a time), enabling programmers to lock key interrupt service routines or application inner-loop code into the cache. Locking ensures that time will not be lost while fetching key service code.

To raise processor throughput further, the μ P has a 1-kbyte data cache to hold key data values for on-chip processing. Previous designs relied on on-chip data RAM, which held register sets and data. Now, with this data cache, the compiler and programmers have the option of relying on caching for on-chip data values as well as holding key values in the dedicated RAM. The RAM also acts as an effective buffer for DMA and other I/O transfers.

The i960's architecture supports as many as 15 register sets—each with 16 active, 32-bit registers. Using register sets, context switches take 750 nsec, which is the time to swap register sets (this speed is a result of the μ P's 128-bit-wide internal buses.) Register sets, like

Profile-driven compilation

Traditionally, software tools such as compilers were decoupled from the actual hardware. Compilation was independent of the hardware; compiler optimization did not automatically change based on how the hardware executed the code in question. RISC processors are changing this because they are far more dependent on compiler efficiency than earlier computer architectures—a bad software mapping can trigger large processing inefficiency.

The Intel GNU C compiler is based on the Free Software Foundation's (Cambridge, MA) GNU C compiler. Targeting the i960 family, the compiler closes the link between the RISC hardware and compilation, gaining an additional 20% performance. For critical code, compilation becomes a 2-step process. The working application code is compiled with built-in trace facilities to track code efficiency: branches taken, function usage (for later in-lining), cache operations, code block placement, and global memory usage.

This performance data, profiling the application, then drives a second optimization compilation. Thus, code is optimized based on its previous interaction with the hardware, resulting in higher efficiencies. For example, the compiler sets branch prediction bits based on the actual application execution rather than on an arbitrary rule. In addition, the compiler reviews and optimizes function call depths, source and destination register usage, and load/store performance.

The Intel GNU C compiler is available now. A PC platform costs \$350, and a Unix platform costs \$400. The DOS version is object code only; the Unix version includes source code. Software support is also available on a yearly basis: \$6000 (full software support) or \$2500 (software assistance by phone). Profile-driven compilation will also be available on Intel 960 compilers at some time later this year.

register windows, are effective for small applications or if use is tightly controlled. Using a register window for each function called can be a real-time disaster in a complex-function application: Once all the register sets are used, an overflow will make processing indeterminate. Thus, register sets must be used with care.

Processor throughput is enhanced via the μ P's superscalar architecture. Unlike a standard RISC, the CA/CF is superscalar: as many as three instructions can be issued simultaneously and executed in parallel if there are no outstanding data dependencies. The processor picks up and decodes as many as four instructions at a time. Intel claims a sustained processing rate of 2 instructions/instruction clock cycle.

In contrast, a standard RISC processor can, by definition, execute 1 instruction/instruction clock cycle at most.

The enlarged instruction cache and additional data cache help raise processor performance by providing a larger store for instructions and data. The on-chip caches buffer processing from the chip's 32-bit bus interface. CPU processing rates will fall for processing that is dependent on sustained access to external memory. The external 32-bit bus is no match for the 128-bit internal buses; however, this problem can be solved with a desktop-type wide external bus, even though it's costly for many embedded applications.

Intel engineers took an alternative approach to the bus architecture of the i960MM, which has two

external buses, a slower, multiplexed 32-bit system bus, and a fast 64-bit local bus for high-throughput processing.—**Ray Weiss**

Intel Corp, Embedded Processor Group, 5000 W Chandler Ave, Chandler, AZ 85226. Phone (602) 554-2388.

Circle No. 742

68HC11 adapts to 3.3V designs

For 3V designs, engineers working with the Motorola 68HC11 will no longer be left out of the low-power arena. With the Motorola 3.3V 68HC11E9 and 68HC11L6 (3 to 6V range, $\pm 10\%$), designers can decrease power consumption significantly and keep the same processor design in place.

At 3.3V, the parts run with a 1.05-MHz clock rate. Typically, 68HC11 microcontroller (μ C) clock rates run from 2 to 4 MHz max. Power dissipation for the 3.3V 68HC11E9 is 12.6 mW in Single

The Motorola 68HC11E9

- 1.05-MHz bus clock (4.20 MHz external); 1- μ sec cycle
- ADD (direct) 3 cycles; NOP 2 cycles
- Two 8-bit accumulators; 16-bit: 2 index, 1 stack pointer, index, program-counter registers
- Single 64-kbyte address space
- 12-kbyte ROM program memory (one-time-programmable EPROM version, the 68HC711E9, available for prototyping); 512-byte EEPROM data/program; 512-byte data RAM
- 5 I/O ports with 38 I/O pins
- 2 serial ports: SPI, SCI
- 16-bit timer with 5 input compare and 3 output capture registers and prescaler, watchdog timers
- 14-bit PWM function
- 8-bit A/D (32-clock conversion)
- 1 external interrupt; 18 interrupt sources
- 3 to 6V ($\pm 10\%$) operation
- 52-pin PLCC; 64-pin quad flatpack
- \$9.15 (10,000) (sample qty); same pricing for 68HC11L6

Three Things
You Should
Think About
Before You Design
Your Next
Gate Array.

CIRCLE NO. 83

Visit us at CICC. Booths #50, 51, 58 & 59

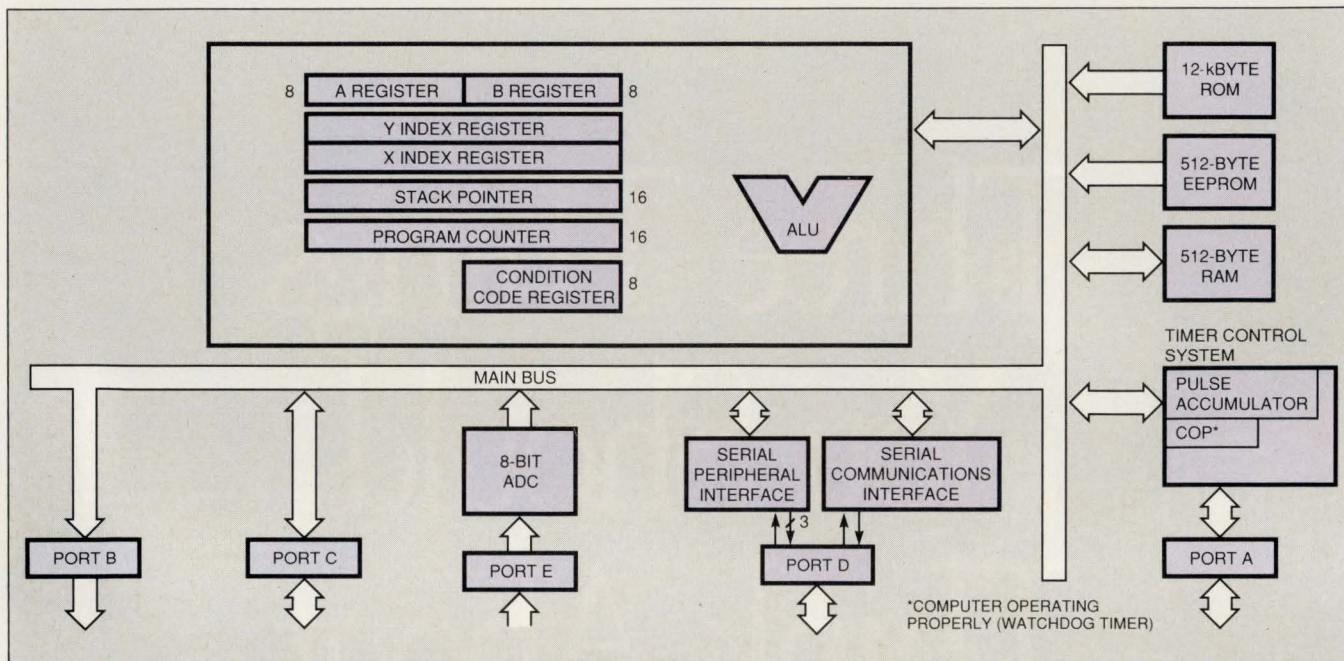

The 68HC11 is an accumulator-based architecture with a highly structured instruction set.

Chip Mode (uses on-chip memory only) and 18 mW in Expanded Multiplexed Mode (uses off-chip memory). Power dissipation decreases further by the μ Cs' dropping into one of two power-saving modes, Wait or Stop. In Wait Mode—with all peripheral functions shut down except the timer—the total supply current is 1.5 mA, and 2.5 mA for Expanded Mode. In Stop Mode—all peripherals, including the timer are stopped—total supply current drops to 2.0 mA.

Motorola's 68HC11 is a major μ C architecture. A descendant of the early 6800/01, the 68HC11 is an 8-bit μ C aimed at mid- to high-end, 8-bit applications. The μ C operates as a single-chip solution, with as much as 32 kbytes of program ROM and 1 kbyte of data RAM. The chip can be used stand-alone or with external memory. It services as much as 64 kbytes (less on-chip memory) of external memory.

The 68HC11 instruction set is relatively clean and easy to use. The CPU architecture is accumulator based, with two 8-bit accumula-

tors, supplemented by 16-bit index registers, a stack pointer, and a program counter. The μ Cs support a range of peripherals, including an 8-bit A/D converter, timers, serial I/O, and complex timer functions.

The 68HC11E9 μ C features 12 kbytes of program ROM, 512 bytes of both RAM and EEPROM, and a peripheral set that includes an 8-

bit A/D converter, a 16-bit timer, two serial ports, and 38 I/Os. The 68HC11L6 has a larger ROM (16 kbytes) and more I/Os (46 pins).

—Ray Weiss

Motorola Inc, Advanced Microcontroller Div, 6501 William Cannon Dr W, Austin, TX 78735. Phone (512) 891-3465. FAX (512) 891-2652.

Circle No. 743

μ C combines 4-bit peripherals with 8-bit CPU

Cost-conscious embedded-system designers have had to choose between 4-bit microcontrollers (μ Cs), which have peripherals, and 8-bit μ Cs, which have processing power. That choice may no longer be your only option, as 4-bit peripherals migrate to the 8-bit world. Taking advantage of 4-bit μ Cs, NEC's 8-bit line integrates peripherals from its 4-bit 75xxx family with the 8-bit 78K2 line of μ Cs. The

78K0 series targets low- to midrange embedded applications, delivering 4-bit peripherals backed by an 8-bit processor.

The 78K0 builds around a stripped-down 78K2; the sophisticated automatic-peripheral-handling feature is gone, and the minimal instruction cycle (1-byte instruction) is 480 nsec, up from the K2's 330-nsec cycle. The 78K0 is, however, code compatible with the older version, enabling engineers to use existing code, as well as providing an upward migration path.

Basically, the 78K0 is a midrange 8-bit μ C, with 64-, 80-, and 100-pin versions. It supports a set of stan-

Think Performance.

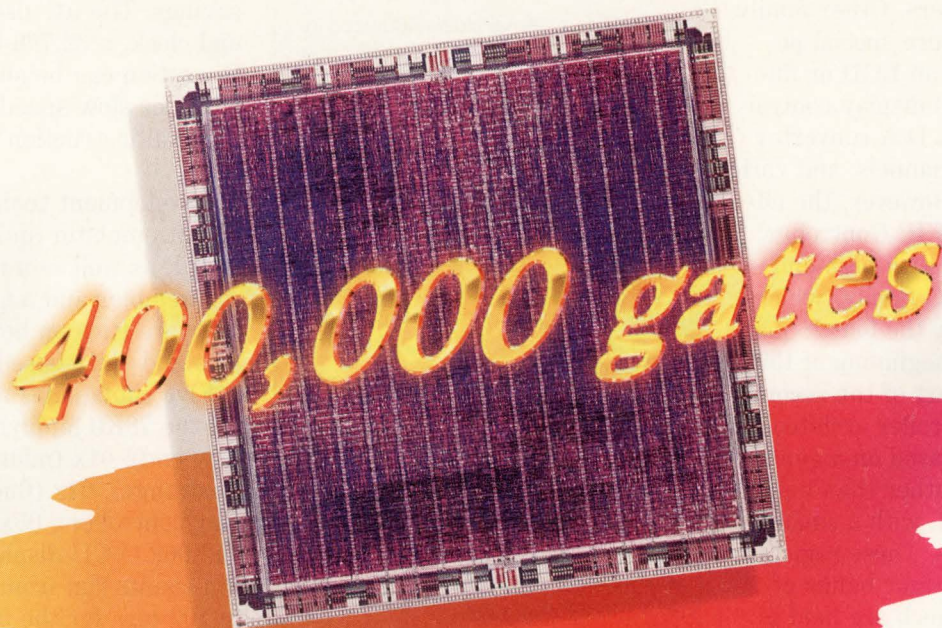

Think Mitsubishi Gate Arrays.

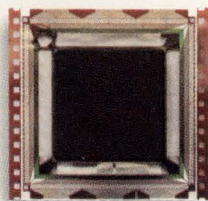

Before you design your next gate array, or even your first, you've got to think about performance. Your very next thought ought to be: **Mitsubishi Gate Arrays.**

Mitsubishi's triple-layer metal, 0.8 μ m gate arrays offer 400,000 gates with over 60% utilization, and a typical loaded delay as fast as 215 picoseconds. We also give you up to 512 I/Os and pin counts as high as 576 in our exclusive μ Pitch TAB™ packaging.

We also offer design kits for the industry's most popular workstations, from logic synthesis, to simulation, to automatic test pattern generation (ATPG). So you can design on your own workstation or ours.

Mitsubishi offers both local design support and the global resources of a stable, well-capitalized company. As one of the world's top 10 semiconductor suppliers, we've been in the ASIC business over 15 years and we're continuing to invest in technologies for the next decade.

When you think gate arrays, think performance. Then think Mitsubishi. You'll be glad you did.

Phone (408) 730-5900 ext. 2106

VISION®
ACTION
REALITY

 **MITSUBISHI**
ELECTRONIC DEVICE GROUP

standard peripherals, including an 8-bit A/D converter, 16- and 8-bit timers, and watchdog timers. Other family members will feature special peripherals, such as an LCD or fluorescent-tube (FIP) display controller/driver, an 8-bit D/A converter with two output channels, and variable clock rates. However, the advanced LCD and FIP Controller/Drivers will come with high-end members of the μ C family, which will be available by the fourth quarter of 1992 or the beginning of 1993.

The K2/K0 is part of the second wave of microcontroller architectures; this μ C is based on a general set of registers, rather than being accumulator based, with a small set of special registers. These registers are organized into four banks of eight registers, which are held in on-chip RAM. Switching between register banks provides a mechanism for fast context switches and interrupt handling.

This 78K0 is the first of NEC's 8-bit μ Cs to use the variable clocking scheme in the 75xxx family. A static design, the chip clock rate can

The NEC K0 μ PD7801x

- 10-MHz external clock (480-nsec instruction cycle); also a 32.8-kHz sub-system clock
- Can dynamically change clock speed divide by 8, 16, 32, 64
- ADD (direct) 3 cycles; NOP 2 cycles
- Four RAM-based register banks; eight 8-bit registers/bank
- Single 64-kbyte address space
- 8-, 16-, 24-, 32-kbyte program ROM (32-kbyte one-time-programmable/EPROM prototype); 544/1056-byte data RAM
- 53 I/O pins
- 2 clocked serial ports (1 with automatic data transfer)
- 5 timers: 16-bit timer/counter clock timer; two 8-bit timer/counters, watchdog timer
- 8-bit A/D (8 channels)
- Buzzer output (2, 4, 8 kHz)
- 4 external interrupts
- 2.7 to 6V operation
- 64-pin shrink DIP or PQFP
- 78011GC with 8-kbyte ROM, \$5.15; 78014GC with 16-kbyte ROM, \$6.25 (5000)

be dynamically changed to meet application conditions. Using a 10-MHz main clock, the clock can be

divided by 8, 16, 32, and 64 for reduced execution speeds and power savings. The μ C also supplies a second clock, a 32.768-kHz base clock. Operation can be switched to this clock for slow speed operation: a minimal instruction cycle is 122 μ sec.

Development tools include an in-circuit emulator and evaluation board, as well as a relocating macro-assembler and a C compiler. The software runs on both DOS-based PCs and Unix-based workstations.

Five subfamilies are defined for the 78K0 family: the 78K00x (low end), 01x (midrange), 01xY (midrange), 04x (fluorescent display/controller), 05x (high I/O), and 06x (LCD display/controller). Pin counts run from 64 for the 00x to 100 pins for the 06x; of these, 53 to 89 are I/O pins. The first parts available are from the 00x and 01x subfamilies. Prices begin at \$4.50 (5000) for the 78K001.

—Ray Weiss

NEC Electronics, Box 7241, Mountain View, CA 94039. Phone (415) 960-6000.

Circle No. 744

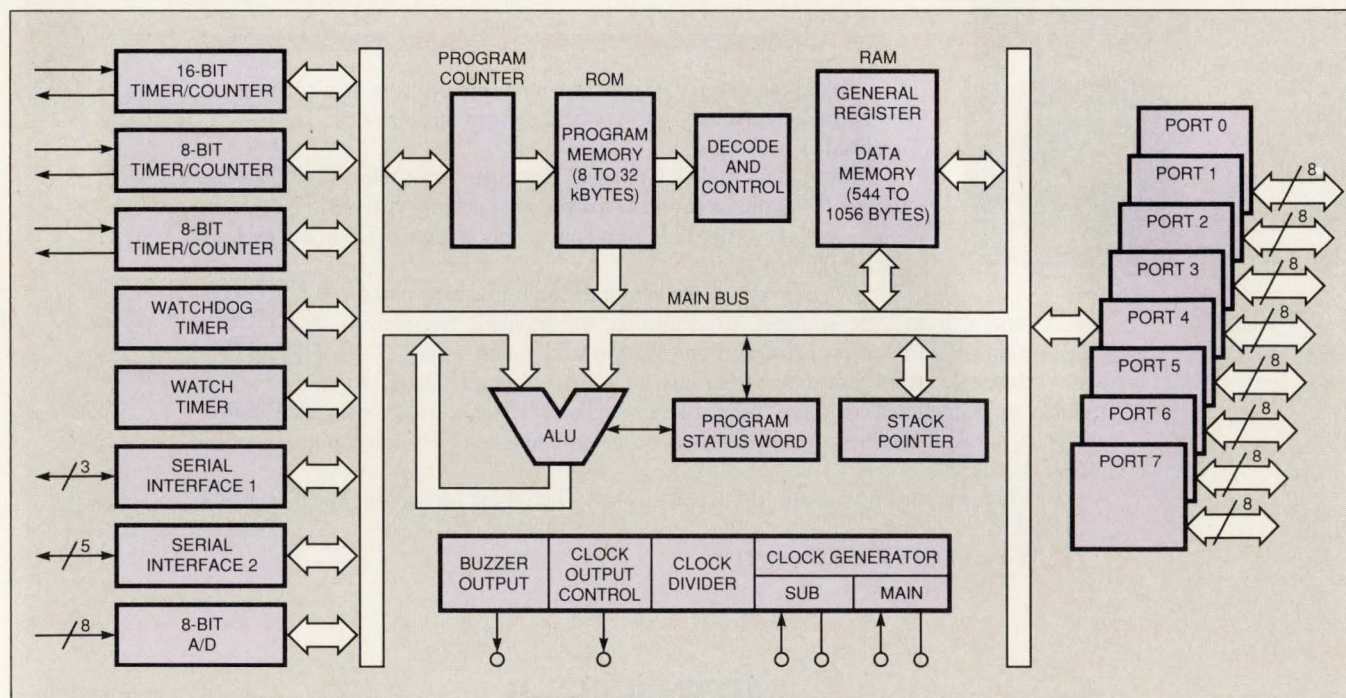

This 8-bit μ C combines an 8-bit architecture with 4-bit peripherals. The clock rate is dynamically adjustable.

Think Low Power.

2.4 μ W/MHz/gate

Think Mitsubishi Gate Arrays.

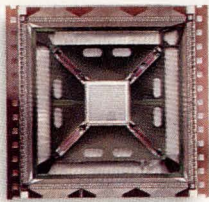

Whether you're designing your next gate array, or your first, you've got to think about system power requirements. Your very next thought should be: **Mitsubishi Gate Arrays.**

Our 0.8 μ m arrays give you four speed/power options to control total chip power consumption. Four transistor sizes within each macro allow optimization for either high speed or low power. The result is power dissipation as low as 2.4 μ W/MHz/gate, at 5V. And, with Mitsubishi's 3V library, you can achieve even lower power dissipation. You can switch more nodes in

the array, control the power and still use lower-cost, plastic packaging.

Add to all of this 400,000 gates, 512 I/Os, and Mitsubishi's exclusive μ Pitch TAB™ packaging with pin counts as high as 576.

We also offer design kits for industry's most popular workstations, from logic synthesis, to simulation, to automatic test pattern generation (ATPG). So you can design on your own workstation or ours.

With both local design support and the global resources of a stable, well-capitalized company, Mitsubishi is one of the world's top 10 semiconductor suppliers. We've been in the ASIC business for over 15 years and we're continuing to invest in technologies for the next decade.

When you think gate arrays, think low power. Then think Mitsubishi. You'll be glad you did. Phone (408) 730-5900, ext. 2106.

VISION®
ACTION
REALITY

 **MITSUBISHI**
ELECTRONIC DEVICE GROUP

Static chip runs at 20 MHz and reduces EMI

The Zilog Z8S180 doubles its internal clock speed to 20 MHz and is built around a power-saving static core. This new core is more efficient than its predecessor, reducing instruction cycle time by an average of 20%.

The chip is pin compatible with the earlier—and slower—dynamic Z80180 μ Cs. With the Z8S180, you can upgrade existing Z80180 designs, needing only faster memory to kick up the processor throughput rates. Zilog engineers also built in EMI suppression to cope with higher clock rates. You can program the power levels of the chip-output pins, significantly reducing EMI by as much as 75% (see Fig 1).

The Z8S180 and Z80180 are high-

end 8-bit μ Ps built around the 8-bit Z80 processor. Both chips have an enhanced Z80 design that's based on a Hitachi implementation (64180), which features an on-chip memory-management unit (MMU). Thus, the Z8S180 can handle large application programs. It supports as much as 1 Mbyte of external memory and bank switches between 64-kbyte local-address spaces. Memory design is easy for the Z8S180; the chip has a programmable wait-state generator, which allows for adjusting to varying memory implementations.

The chip features four power-management levels: Run, Sleep, System Stop, and Standby. In Sleep mode the CPU is stopped while on-chip I/O continues to run; in System Stop mode the CPU and peripherals are stopped, decreasing power consumption further. The Z8S180 adds another mode, called

The Zilog Z8S180

- 16- or 20-MHz clock (divide by 1 internal clock)
- ADD (to register) 9 cycles; NOP 6 cycles (300 nsec at 20 MHz)
- 2 register sets (eight 8-bit registers): 1 special register set with two 16-bit index, stack pointer, and program counter
- 64-kbyte local-address space; MMU extends space to 1 Mbyte off-chip memory
- 2 DMA channels
- Programmable wait-state generator
- Programmable low EMI/power output
- One clocked serial port; two asynchronous serial channels
- Two 16-bit timers
- Four external interrupts
- 68-pin PLCC; 80-pin quad flatpack
- \$14.29 for 16-MHz version; \$17.86 for 20-MHz version (10,000)

Standby. In Standby mode, the clock and internal clock and external oscillators are also stopped,

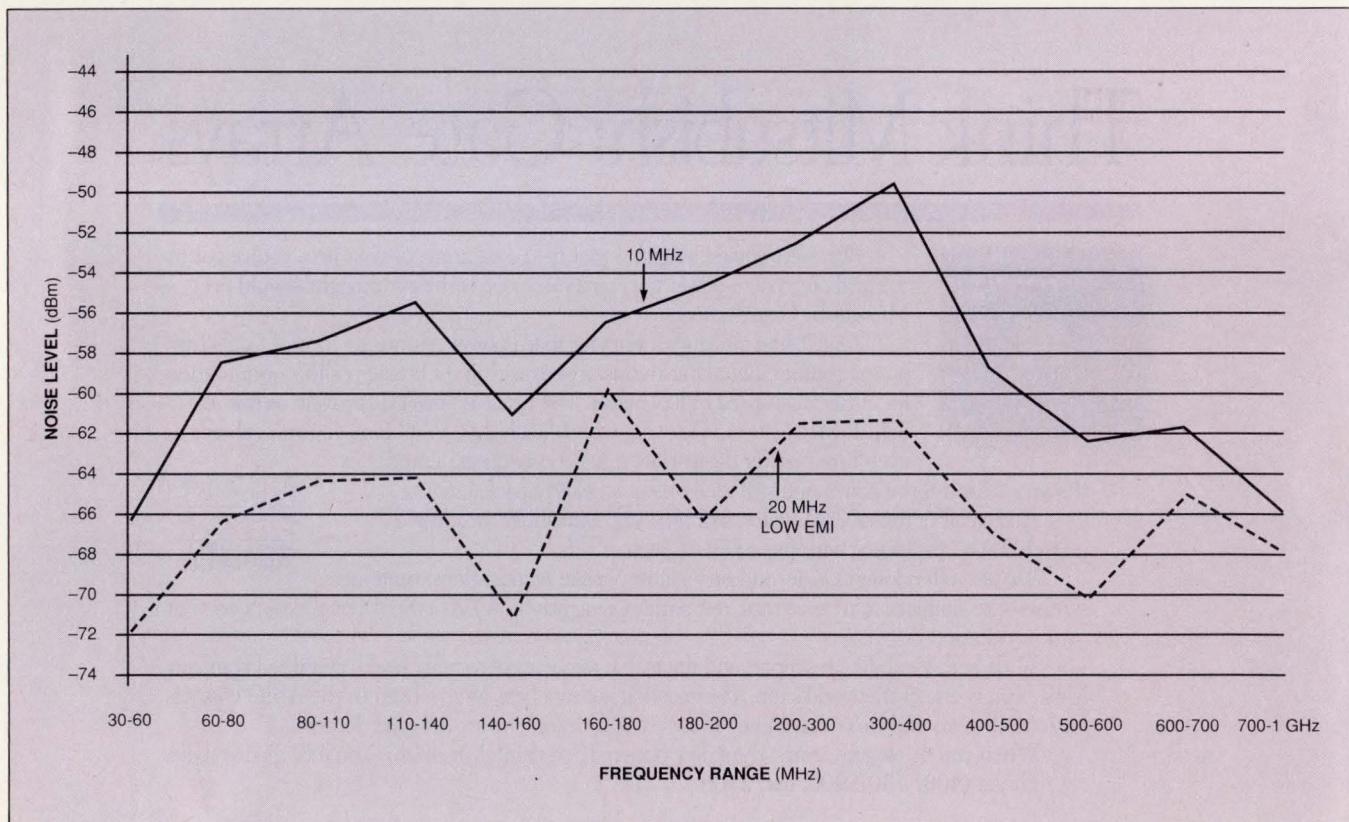
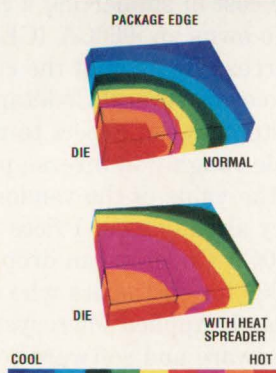

Fig 1—The Z8S180 doubles the Z80181 CPU clock rate but minimizes EMI increases by reducing output pin current. This reduction is programmable.

Think Packaging.

μ Pitch TABTM

Think Mitsubishi Gate Arrays.



Whether it's your next gate array design, or your first, you've got to think about packaging. Your very next thought should be: **Mitsubishi Gate Arrays.**

We offer the packaging solutions for fast, compact and gate-intensive systems.

For example, our exclusive μ Pitch TABTM packaging, with its ultra-fine 0.25mm lead pitch, gives you pin-counts as high as 576.

Mitsubishi also offers power-cooling packages for higher reliability in fast, gate-intensive arrays. Available in both μ Pitch TAB and QFP, power packaging features an aluminum heat spreader that transfers heat from the die across the entire package. The result is a much cooler die and higher reliability. We also give you over 100 packaging options, including plastic and ceramic QFPs and PGAs.

VISION[®]
ACTION
REALITY

Mitsubishi's 0.8 μ m arrays give you the highest gate count (400,000 gates) and lowest power dissipation (2.4 μ W/MHz/gate) you can get.

We also offer design kits for the industry's most popular workstations, from logic synthesis, to simulation, to automatic test pattern generation (ATPG). So you can design on your own workstation or ours.

We're one of the world's top 10 semiconductor suppliers, and we've been in the ASIC business for over 15 years. As a result, you can depend on local design support and the global resources of a stable, well-capitalized company.

When you think gate arrays, think packaging. Then think Mitsubishi. You'll be glad you did.

Phone (408) 730-5900, ext. 2106.

 **MITSUBISHI**
ELECTRONIC DEVICE GROUP

dropping power consumption to less than 10 μ A.

Huntsville Microsystems, Softaid, and Sophia Systems all supply in-circuit emulators for the Z8S180. The chip is code compatible with the Z80/Z80180 and can be programmed with existing assemblers and C compilers. Zilog also offers a \$175 20-MHz evaluation board for the chip.—**Ray Weiss**

Zilog Inc, 210 Hacienda Ave, Campbell, CA 95008. Phone (408) 370-8092. FAX (408) 370-8092.

Circle No. 745

Low-cost debug tool ups system developers' productivity

Intel's i960CA is fast and powerful. Embedded systems based on the μ P are big, and the teams that develop the necessary system software can include more than two dozen members. Ultimately, debug-

ging the code for such systems requires expensive tools; prices of i960CA in-circuit emulators (ICEs) start in the mid-\$20,000 area and can go much higher. This cost leads companies to limit the number of such instruments teams can buy. Yet if a software engineer sits idle for an hour waiting to use an ICE, the cost to the company can approach \$100. At that rate, if tool availability costs each member of a 25-person team just one day during a development project, the lost time would pay for another ICE.

Recognizing that large teams need many debugging setups, Applied Microsystems is offering a hardware and software-based tool called a Codetap that costs much less than an ICE. Though the tool doesn't obviate a full-fledged ICE, it lets developers do much more complete debugging than they can with software-only tools. It is aimed at the middle of the debugging process—after the logical flaws have been excised, but before the final system integration (which requires

an ICE). Last year, the company introduced Codetaps for the 80386 and 80186. Now it is announcing a Codetap for the i960CA. The superscalar μ P is the most complex chip for which the firm has announced a Codetap tool.

The i960CA Codetap hardware consists of a target-access probe and a communications adapter. The adapter plugs into the RS-232C port of the host Sun workstation or PC. The unit provides visibility and control of code execution by the target at the CPU's full clock speed—without necessitating code modifications, without adding wait states, and without usurping target memory, interrupts, or I/O ports. The Codetap includes the vendor's Validate/XEL symbolic source-level debugger for C and assembly-language code.

For the price of one i960CA ICE, a company can purchase at least three (and in some cases, six or more) Codetaps. This pricing strategy recognizes two facts: customer support represents a substantial portion of the cost of supplying debugging tools for embedded systems based on complex μ Ps, and the cost of supporting a customer who owns an i960CA ICE will not increase by much if the customer also owns several Codetaps. Hence, customers can expect to pay on a scale roughly in inverse proportion to the value of the vendor's tools they already own. Prices for the i960CA Codetap can drop nearly \$4000 for customers who own enough Applied Microsystems hardware and software tools.

—**Dan Strassberg**

Applied Microsystems Inc, Box 97002, Redmond, WA 98073. Phone (800) 426-3925; (206) 882-2000. FAX (206) 883-3049. TLX 185196.

Circle No. 746



Consisting of a target-access probe, based on emulator technology, and a communications adapter, the Codetap 960CA is a much lower-cost tool than an in-circuit emulator for debugging embedded systems based on the i960CA superscalar μ P. At the same time, it is a much more powerful tool than a software debugger.

40 MB/SEC DUAL-PORT VME/VSB MEMORY

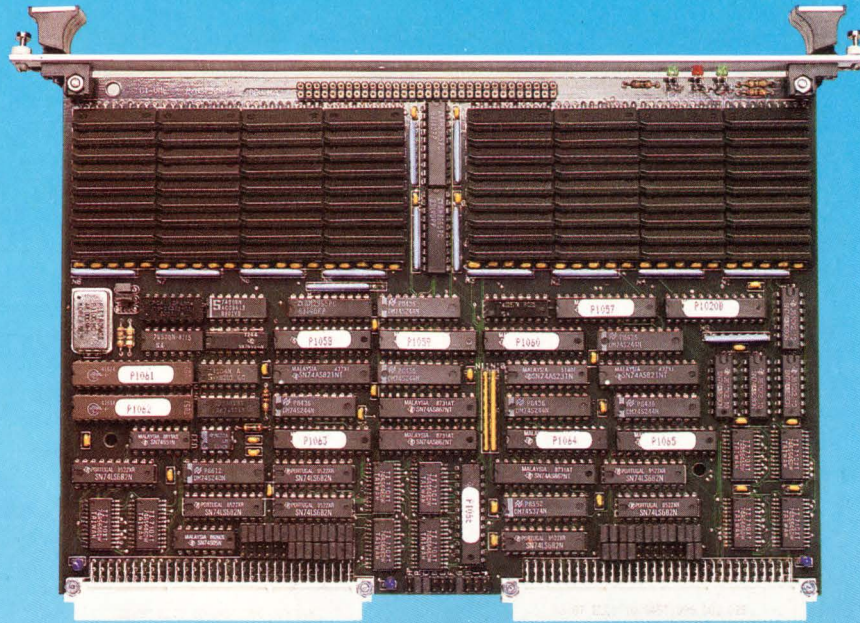

CI-VME40

The CI-VME40 is the ultimate high-speed, high-capacity DRAM memory board with a dual-port interface to the VME and VSB Busses. The CI-VME40 is optimized for Block Transfer Cycles yielding a bus transfer rate up to forty megabytes per second. Chrislin is the only memory supplier to offer such an advanced and versatile dual-ported VME/VSB memory!

THE CI-VME40 FEATURES:

- 20ns write/20ns read ACCESS TIMES in BLOCK CYCLE
- 90ns write/140ns read ACCESS TIMES in SINGLE CYCLE
- 63ns write/83ns read CYCLE TIMES in BLOCK CYCLE
- 195ns write/195ns read CYCLE TIMES in SINGLE CYCLE
- 4MB, 8MB, 16MB, 32MB, 64MB in one VMEbus/VSB slot
- Byte Parity Error Detection
- Memory start and end addresses selectable on 256KB boundaries
- VMEbus and VSB memory start and end addresses configured independently

ALSO AVAILABLE FOR THE VMEBUS ARE...

THE CI-VMEemory FEATURES:

- Low-cost high-power VME memory with 4, 8, or 16MB
- VME Revision C.1 compatibility
- Lower and upper memory addresses independently selectable in 64K byte increments
- Byte Parity Error Detection with selectable trap on Parity Error
- On-board Control Status Register

THE CI-VSB-EDC FEATURES:

- Low-cost high-power dual-ported VMEbus/VSB EDC (Error Detection and Correction) memory
- 4, 8, 16, 32 or 64MB in one VMEbus/VSB slot
- VME Revision C.1 compatibility, VSB Revision C
- Lower and upper memory addresses independently selectable on 256K byte boundaries
- Single-Bit Error Detect and Correct, Double-Bit Detect



Chrislin Industries, Inc.

31312 Via Colinas, Suite #108, Westlake Village, CA 91362

TEL: (818) 991-2254 FAX: (818) 991-3490

Providing Top Quality Memory for Over 16 years!

CALL TOLL FREE: (800) 468-0736 (PST)

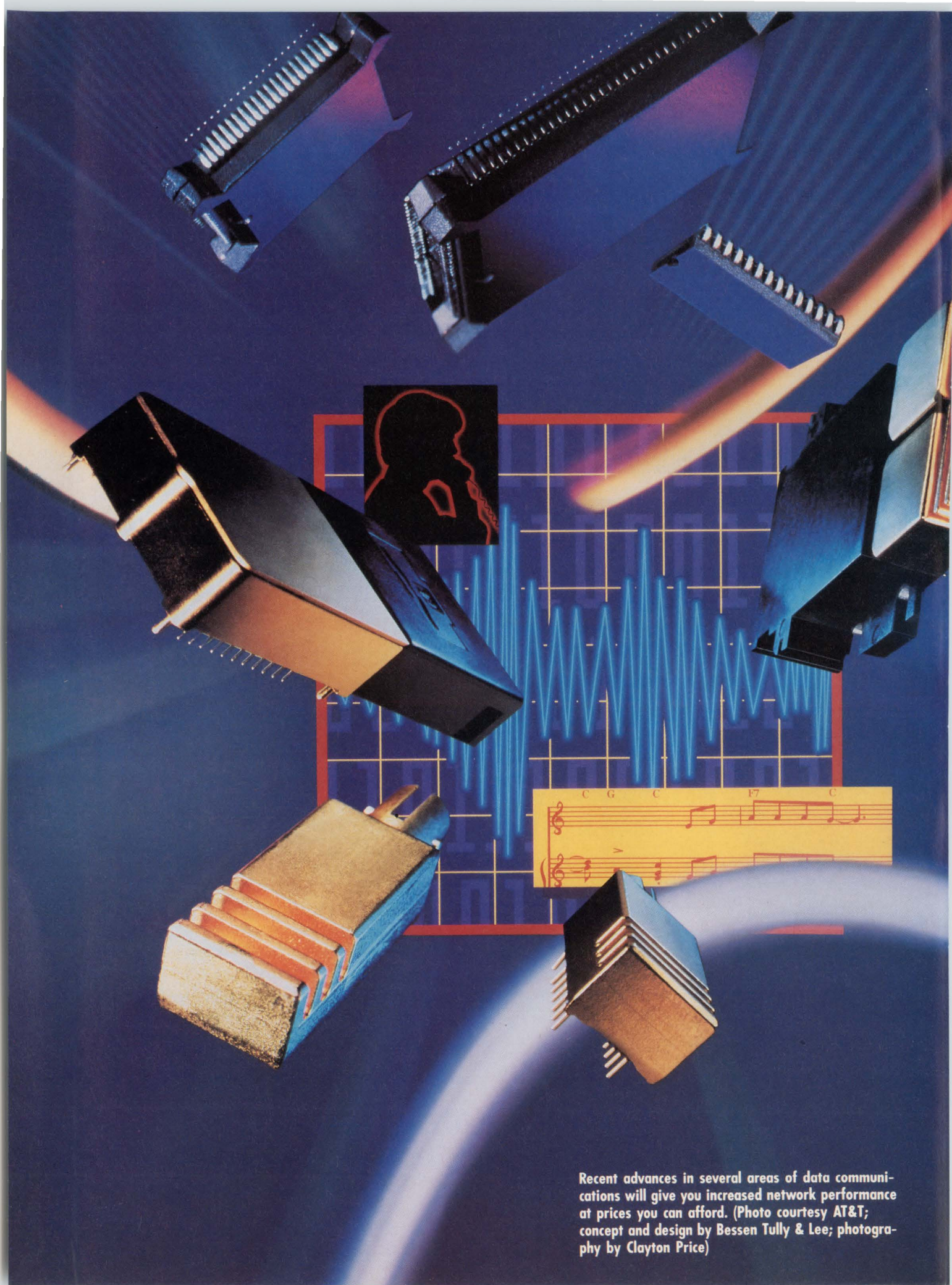

Recent advances in several areas of data communications will give you increased network performance at prices you can afford. (Photo courtesy AT&T; concept and design by Bessen Tully & Lee; photography by Clayton Price)

Data COMMUNICATIONS

High-speed schemes, such as copper FDDI and Fiber Channel, promise to allow engineers to design systems that take advantage of LANs' utility without reducing system performance or breaking the bank.

Maury Wright, Technical Editor

Designers have substantially improved all areas of computer-system performance in recent years, except for network performance. But you can expect a number of data-communications developments soon that will drown the performance drought. ANSI workgroups will shortly adopt low-cost alternatives to standard FDDI (fiber distributed-data interface), and semiconductor companies have compliant ICs waiting in the wings. Other companies, tired of waiting for the standards effort, already offer proprietary high-speed LANs (local-area networks). But coming higher-integration FDDI chip sets should offer lower prices for standard FDDI connections. And, finally, manufacturers have just introduced the first chips for the new Fiber Channel scheme, which can speed data communications an order of magnitude faster than FDDI.

In the past, only computer users that could afford the several-thousand dollars per system for FDDI attachments could gain suitable network performance. Ethernet and Token Ring LANs simply don't offer the bandwidth high-end PCs and faster systems require. In addition, LANs haven't kept up with other system resources. You need only look at the numbers to understand the performance discrepancy between a LAN connection and the rest of a computer system.

Disk drives for PCs, for example, now offer data-transfer rates as fast as 4 Mbytes/sec, and even low-end drives typically attain 2-Mbyte/sec rates. Drives targeted at other system architectures transfer data even faster. Yet Token Ring offers a 16-Mbps (2-Mbyte/sec) maximum transfer rate, and most Token Ring LANs operate at only 4 Mbps. Ethernet operates at a maxi-

Data

COMMUNICATIONS

mum rate of only 10 Mbps. In addition, each system can access only a portion of a network's bandwidth. Because many systems can share a LAN, any given system may have to wait some period of time to gain access to the network. Furthermore, protocol software such as TCP/IP (transmission-control protocol/internet protocol) for Unix-based LANs adds substantial overhead to data transfers on a network. A workstation typically realizes data transfers at 30 to 50% of the network maximum.

Yet LANs are necessary. Consider situations that range from an engineering team using CAE tools over a network to design a product to a business office sharing a mailing list. Managers and users demand LANs despite the sluggish performance most LANs offer. System administrators like the LAN concept also. The administrators cringed when the barrage of users with distributed PCs revolted against multiuser minicomputers. They feared that key data might be lost or mismanaged. Furthermore, administrators of a legion of PCs faced major headaches anytime maintenance or software updates were required. The LAN concept allows administrators to manage key data and handle software updates on a network server. In fact, most administrators would prefer to assign users diskless workstations.

Today, most LANs store shared data and some programs on a server. But users of performance-hungry programs typically demand local storage. For example, most engineers store frequently used CAE programs locally. Likewise, a power PC user would be reluctant to load Windows or Windows' applications over a network. The next generation of LANs and other data-communications links may make local storage unnecessary.

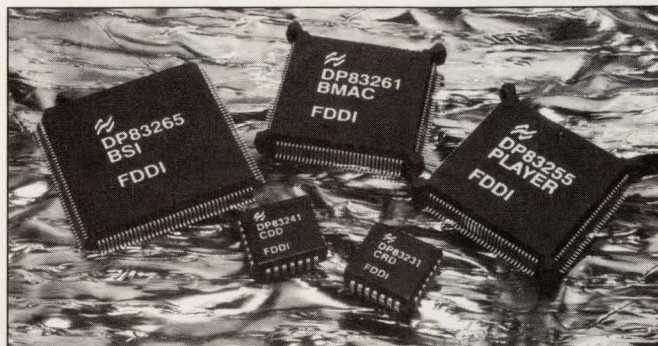

Station-management features such as group-address matching and source routing are handled by National Semiconductor's DP83200 family of FDDI chips.

Proponents have long championed FDDI as the LAN that solves the performance bottleneck. The ANSI X3T9.5 standard specifies a network that offers 100-Mbps data rates using a dual counter-rotating ring topology. **Fig 1** depicts the FDDI topology (see **Refs 1, 2, and 3** for more background information). FDDI's high bandwidth and token-passing scheme can serve PCs, workstations, and even larger systems well, despite overhead added by network software protocols. But the cost of implementing FDDI has remained at least \$2000 more expensive per node than Ethernet and Token Ring, and, therefore, the faster LAN has largely been delegated to serving as a backbone that connects lower-speed departmental LANs. The fiber optics, the connectors, and the optical transceiver modules required for FDDI keep the cost high. Furthermore, vendors of FDDI chips have been unable to cut costs substantially because production volumes have remained low.

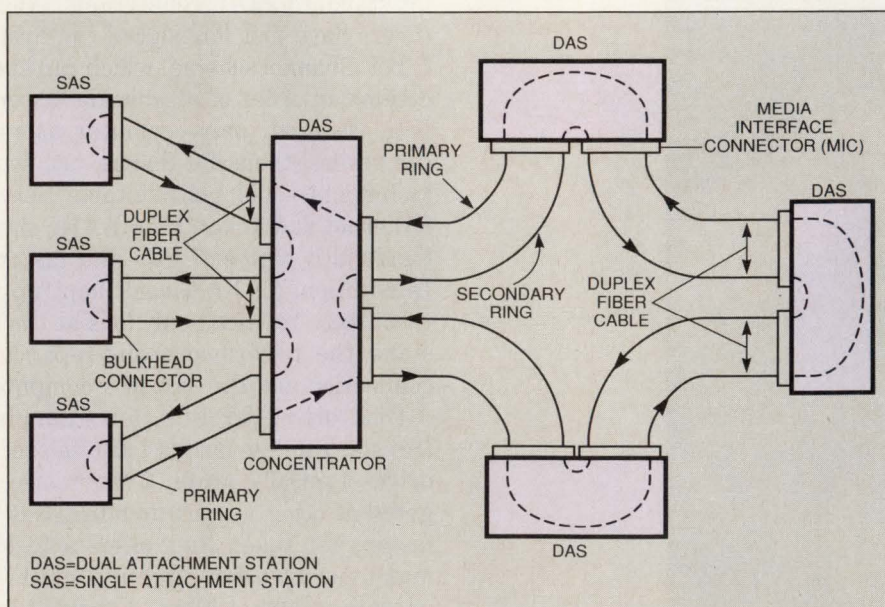

Fig 1—The FDDI LAN employs a Token Ring architecture, includes dual counter-rotating rings for reliability, and allows you to use concentrators to reduce the cost of node adapters for individual workstations.

You should consider adding FDDI or an alternative to your new system designs in spite of present high prices. Users are nearing the point of demanding faster networks, and a number of developments promise to relieve the price hurdles that have kept FDDI from

the desktop. Working groups within the ANSI X3T9.5 committee have been busily attempting to standardize on two lower-cost media that can handle FDDI's speed and data encoding (see **box**, "Low-cost FDDI").

This month, expect the committee to endorse a

Low-cost FDDI

The relatively high cost of FDDI has kept the 100-Mbps LAN from challenging Ethernet or Token Ring for the PC and workstation marketplace. Primarily, the fiber-optic medium, the connector, and the optical transceiver required to meet the FDDI spec boost the cost. High cost has thus far relegated FDDI to use as a high-speed backbone network that connects multiple departmental or subnetworks that use Ethernet or other less expensive LAN technologies. However, two ANSI X3T9.5 committee working groups have been developing alternatives to standard FDDI that should lower costs.

The FDDI spec defines a dual-ring topology that ensures reliability. But the spec also describes a multiport concentrator that can be used to connect stations that have a single-ring interface to the dual-ring main network. (**Fig 1** (main text) depicts a concentrator on an FDDI network.) The concentrator handles network reliability and includes circuitry that can wrap and self-heal the network when connected single-ring stations or nodes on the dual ring fail. Concentrators are expensive—ranging from \$5000 to more than \$50,000 based on the number of ports included.

The groups working on low-cost alternatives intend to lower the cost of both concentrators and the node controllers for individual stations. One of the groups has concentrated on developing a lower-cost fiber-optic implementation. Meanwhile, the second group has been working on a way to attain 100-

Mbps transmissions on copper wire.

Bob Fink, head of communications and network resources at Lawrence Berkeley Labs, chairs the low-cost-fiber working group. Fink reports that the low-cost-fiber proposal is in draft format and is in the ANSI review process. Therefore you can assume the specification is fairly solid. It defines a fiber-optic LAN that can only stretch 500m between nodes compared with 2 km for standard FDDI. The low-cost-fiber version uses the same fiber medium as standard FDDI but should require substantially less expensive optical transceivers to drive the shorter cable lengths.

Defining copper standards

The group working on the copper-wire alternative is not as far along but has certainly been in the news more often recently. The effort to define a standard copper-wire alternative to FDDI is almost two years old. The effort has centered on achieving 100-Mbps transfers on three types of wire: shielded twisted pair, data-grade unshielded twisted pair, and voice-grade unshielded twisted pair. Furthermore, the group would like communication to be reliable at distances of at least 100m.

A number of companies have made presentations to the working group on data-encoding methods that achieve the desired speed on copper. Recently, the working group made two key decisions. The group decided that no proposed encoding scheme would work reliably at 100m on voice-grade un-

shielded twisted pair. The group therefore decided to concentrate its efforts on a scheme that would work for the other two types of wire, despite the fact that much of the installed wire for 10Base-T Ethernet is voice-grade unshielded twisted pair.

The working group also decided to concentrate on two proposed encoding schemes. The MLT-3 (multilevel transitional) code backed by Crescendo Communications and AT&T is one of the schemes. National Semiconductor backs the other scheme, which it has trademarked 100Base-T and which is also known as preemphasized NRZI (non return to zero inverted). Currently, Hewlett-Packard, with help from other interested parties, is performing unbiased test of the two technologies to determine whether the two proposals meet the working group's goals. The encoding schemes also must be able to meet FCC RFI requirements.

Bill Cronin, principle engineer at Digital Equipment Corp, chairs the working group for copper FDDI alternatives. Cronin hopes to decide on a copper FDDI scheme in meetings this month. He expects Hewlett-Packard to report on the test, and, after discussion among the group, he expects to hold a vote on the two proposals. The working group can then move forward with completing the standards process. But, more importantly, companies can proceed to build products that will meet the standard. For more details on the history of the copper FDDI effort, see **Ref 3**.

method for running FDDI data over shielded twisted-pair wire and data-grade unshielded twisted-pair wire. Such a method will allow many to run FDDI over existing network wiring. Furthermore, the committee is already reviewing a standard that specifies a lower-cost fiber-optic medium that covers shorter distances.

The new media don't require complete new FDDI chip sets either. They only affect chips that implement the PMD (physical medium dependent) sublayer of the FDDI spec. Designers can therefore use a single FDDI implementation to serve all types of FDDI media. You simply customize the board- or system-level implementation with a daughter card—or even an external plug-in module—that handles the physical interface.

The FDDI architecture will allow you to mix and match different media using concentrators. Therefore, you can match FDDI to your needs. The type of medium that you have previously installed can also affect your choice of FDDI medium because cable-installation cost can exceed the cost of new hardware. A small office that needs short cable runs can stick strictly with the lowest cost choice—copper wire. Larger installations can use a main dual ring that uses standard

FDDI and concentrators that connect to the dual ring can provide low-cost loops to individual stations. Stations that connect using copper wire can be 100m from the concentrator, whereas low-cost-fiber stations can stretch as far as 500m away. Bob Fink, chairman of the low-cost-fiber working group believes a low-cost-fiber node will cost about \$15 more than a copper node.

You should be able to buy the ICs that you'll need to implement all types of FDDI soon. Currently, Advanced Micro Devices (AMD), Motorola, and National Semiconductor all offer complete FDDI chip sets. AT&T has a chip that handles strictly the physical layer of the standard. Expect either National or AT&T to have a PMD chip for FDDI on copper by mid-year at the latest. Which company will be the first to market will depend on the decision that the working group makes on which encoding method to use with copper wire. Regardless, expect the first PMD chip out to work with FDDI chip sets from all three vendors. And other vendors will follow the first with their own PMD chips shortly after. Each company has committed to following the standard adopted by the committee. Apparently, you can use existing PMD chips to implement

Manufacturers of data-communications products

For more information on data-communications products such as those described in this article, circle the appropriate numbers on the Information Retrieval Service card or use EDN's Express Request service. When you contact any of the following manufacturers directly, please let them know you saw their products in EDN.

You can buy copies of ANSI-approved and draft standards such as FDDI and Fiber Channel from:

Global Engineering
2805 McGaw Ave
Irvine, CA 92713
(800) 854-7179;
(714) 261-1455
FAX (714) 261-7892

For a copy of IBM's ESCON specification, write:

IBM Corp
Enterprise Systems
Central Architecture
Box 950, Dept E57
Poughkeepsie, NY 12602

Advanced Micro Devices Inc
Box 3453
Sunnyvale, CA 94088
(800) 222-9323;
(408) 749-5703
FAX (408) 987-2800
Circle No. 650

AMCC
6195 Lusk Blvd
San Diego, CA 92121
(619) 450-9333
FAX (619) 450-9885
Circle No. 651

Ancor Communications Inc
6130 Blue Circle Dr
Minnetonka, MN 55343
(612) 932-4000
FAX (612) 932-4037
Circle No. 652

AT&T Microelectronics
555 Union Blvd
Allentown, PA 18103
(800) 372-2447
FAX (215) 778-4106
Circle No. 653

Canstar
3900 Victoria Park Ave
North York, ON M2H 3H7
Canada
(416) 756-4100
FAX (416) 756-3990
Circle No. 654

Crescendo Communications
710 Lakeway Dr
Sunnyvale, CA 94086
(408) 732-4400
FAX (408) 732-4604
Circle No. 655

Cypress Semiconductor Corp
3901 N First St
San Jose, CA 95134
(408) 943-2600
FAX (408) 943-2741
Circle No. 656

Hewlett-Packard Components Group
350 W Trimble Rd
San Jose, CA 95131
(408) 435-4266
FAX (408) 435-4303
Circle No. 657

IBM Corp
37th St and Hwy 52 N
Rochester, MN 55901
(507) 253-5005
FAX (507) 253-7732
Circle No. 658

Motorola Inc
6501 William Cannon Dr W
Austin, TX 78735
(512) 891-2140
FAX (512) 891-2652
Circle No. 659

National Semiconductor Corp
Box 58090
Santa Clara, CA 95052
(800) 272-9959;
(408) 721-5880
FAX (408) 749-8532
Circle No. 660

PC-Office Inc
4901 Morena Blvd, Suite 805
San Diego, CA 92117
(619) 273-1442
FAX (619) 273-2706
Circle No. 661

Thomas-Conrad Corp
1908-R Kraner Ln
Austin, TX 78758
(800) 332-8683;
(512) 836-1935
FAX (512) 836-2840
Circle No. 662

Triquint Semiconductor Inc
Box 4935
Beaverton, OR 97076
(503) 644-3535
FAX (503) 644-3198
Circle No. 663

Vitesse Semiconductor Corp
741 Calle Plano
Camarillo, CA 93012
(805) 388-3700
FAX (805) 987-5896
Circle No. 664

VOTE . . .

Please also use the Information Retrieval Service card to rate this article (circle one):

High Interest 482
Medium Interest 483
Low Interest 484

low-cost fiber already, although down the road the companies may choose to create new chips specifically for the new standard.

Choosing among the available FDDI chip sets to implement your design probably will require you to match the architecture of your design to the available ICs. You may find that one of the chip sets mates to your choice of controlling μ P more easily than the rest. But the key to your choice will most likely center on the chip set that offers the best performance in your design.

Just two to three years ago, the trend in LAN-adaptor designs was to use a dedicated μ P to control network operations and possibly even off-load the task of executing the network protocol from the host. Such an architecture still works fine, but it proves too costly for most desktop applications. In many cases, the CPU in a PC or workstation has to wait for the network to move data anyway. Therefore, you may as well let the CPU perform the network-protocol task.

So the key to performance in your design may be

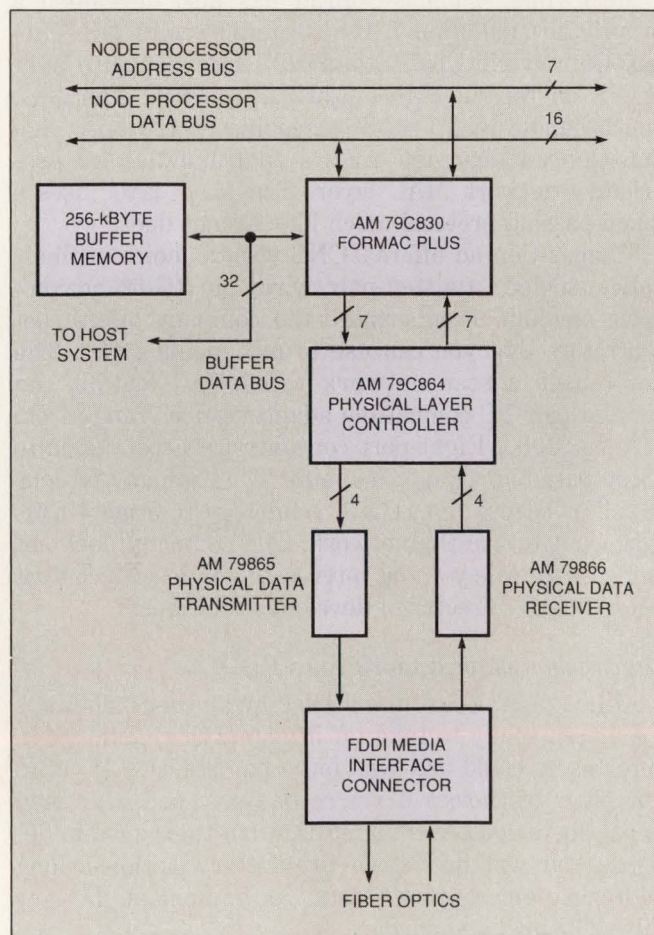
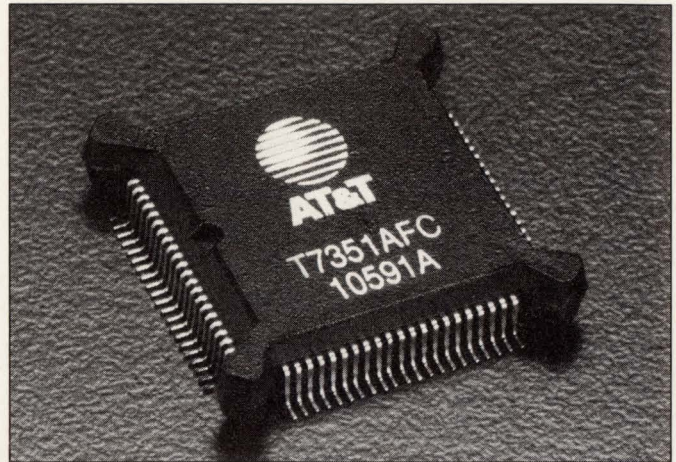

Fig 2—The MAC, PHY, and PMD sublayers defined by the FDDI specification map directly to ICs in AMD's Supernet 2 family of chips.



The T7351A PHY chip from AT&T includes a dedicated 8-bit station-management bus and dissipates less than 800 mW of power.

how well the FDDI chip set can take data directly from main memory and send it down the network medium with no latency. AMD, Motorola, and National all claim direct memory transfers to be among the key performance features of their chips. Their chips purportedly minimize latency by eliminating memory-to-memory transfers.

AMD pioneered the FDDI chip business with its Supernet 1 family and now offers the 4-chip Supernet 2 set shown in Fig 2. The set includes a MAC (media-access control) chip that also includes the system-interface circuitry. The Am79C864 PLC (physical layer controller) IC performs the PHY (physical) sublayer of the FDDI spec and handles the connection-management portion of the FDDI station-management requirements. Separate ICs handle the send and receive PMD tasks. The Supernet 2 set adds a tag-mode feature that allows the ICs to transfer data directly to and from main memory. The Supernet 2 chip set costs \$159.75 (1000).

Motorola's chip set includes a dedicated IC that handles the system interface—the MC68839 FDDI System Interface. The IC uses a 128-bit-wide internal bus and has dual 32-bit I/O ports. The set also includes a MAC IC (the MC 68838), the MC68837 elasticity buffer and link manager, which handles connection management and portions of the physical layer, and the MC68836 FDDI clock generator, which connects to external driver and receiver chips. This chip set costs \$186 (1000).

IC handles station management

National's DP83200 family of chips is partitioned similarly to Motorola's, except the National family uses a fifth chip to do clock distribution. Key features of National's set include the ability to automatically sort incoming low- and high-priority frames. The ICs also

Data

COMMUNICATIONS

perform station-management group-address matchings, and the PHY chip includes a multiplexer for concentrator applications. Finally, the chip set includes a bus-master interface for SBus systems such as Sun SPARCstations. The chip set costs \$190 (1000).

AT&T currently offers only an IC that handles the PHY sublayer. The company's T7351A performs the 4B/5B encoding and the NRZI (nonreturn-to-zero-inverted) data recovery specified by the FDDI standard. The PHY chip costs \$50 (1000). AT&T marketing

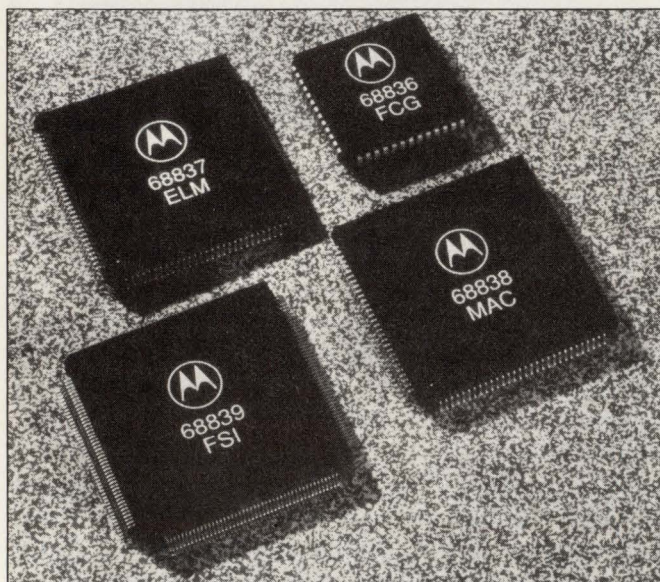

The MC68800 chip set from Motorola includes two 32-bit I/O ports and uses a 128-bit-wide internal bus to move data at the 100-Mbps FDDI speed.

manager Juan Figueroa states that the company wants to offer a single-chip FDDI implementation rather than a chip set. And Figueroa believes that AT&T will offer such a chip next year.

FDDI chip-set prices seem reasonable now but have yet to experience a drop caused by high-volume demand. Standard FDDI transceiver modules can still cost \$500 or more, and you need two for a dual-ring connection. (Ref 4 contains more information on FDDI transceivers.) The new low-cost fiber and copper standards should remove the transceiver-cost obstacle.

Proprietary LANs are here now

But if you can't wait, a couple of companies already offer other ways to add 100-Mbps communications to a system. The proprietary schemes don't offer compatibility with a standard such as FDDI, but they can be bridged to any standard network. Furthermore, you can realize even lower-cost designs than you will be able to with low-cost FDDI.

PC-Office, for example, designed a proprietary LAN

that can operate at 50 or 100 Mbps, depending on cable length and the type of wire used. The LAN uses cable that includes six twisted pairs, so it most likely will not operate over existing wiring. But John Costello, company president, points out that the 6-pair cable costs only \$0.06 per ft. The PC-Office LAN uses a collision-detection scheme similar to Ethernet, and you bus the cable from system to system. Without concentrators or signal repeaters, the network operates over a total cable length of 800 ft.

The best feature of the PC-Office LAN is its price, however. A 16-bit ISA bus card (model T100) costs only \$295. Furthermore, the company sells the 6100 IC, which drives the network, for less than \$90. The 6100 includes a 16-bit host interface. The company also plans to offer a 2-chip set with a 32-bit host interface for less than \$180. Although the PC-Office LAN doesn't have FDDI's dual-ring topology to ensure reliability, or offer the cable length FDDI does, it can serve departmental needs well. And you can still bridge the departmental LAN to a main network.

Meanwhile, Thomas-Conrad has also developed a proprietary 100-Mbps LAN it refers to as TCNS (Thomas-Conrad Network Standard). The company built TCNS on top of AMD's Am7968/Am7969 Taxichips, which handle NRZI 4B/5B encoding at 100 bps. Thomas-Conrad designed ASICs that handle the proprietary network MAC layer. The MAC layer uses a token-passing protocol much like Arcnet does.

Thomas-Conrad offers TCNS with a choice of fiber-optic, shielded twisted-pair wire, or RG-62 coaxial-cable medium. Furthermore the company offers concentrators that you can use to mix media types. The LAN uses a star network topology. Coaxial and twisted-pair PC-compatible adapter prices range from \$595 to \$1000. Eight-port concentrators cost \$2000 to \$3000 based on type of medium. The company intends to sell or license the TCNS technology to other OEMs that want to use the network. The company does not have ICs for sale yet, but interested parties can contact Peter Rauch, director of developer relations.

Many systems need more than FDDI

Although it looks like FDDI and other 100-Mbps LANs are ready to take off in popularity, many computer users could use even more bandwidth. You have a number of choices if you're one of those who need to add faster data communications to their system designs. You will find some proprietary options along with some emerging ICs that can implement the new Fiber Channel standard.

AMD's Taxichip mentioned previously, for example, has been available for some time in 125- and 175-MHz speed grades. The grades support 100- and 140-Mbps

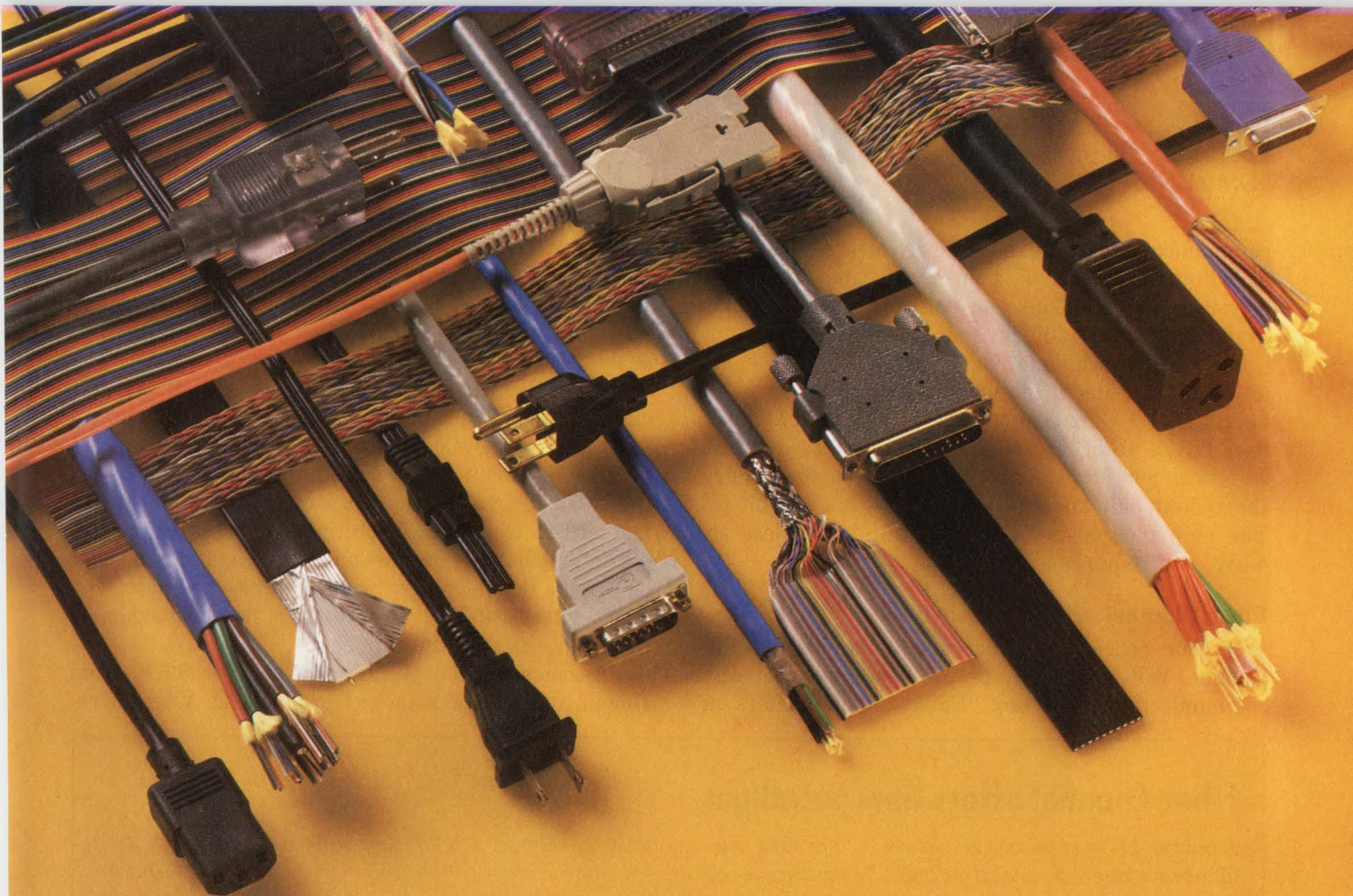

BELDEN brings out the custom in our customers.

Belden is known worldwide as a leading supplier of wire and cable products including fiber optic cables, multi-conductor/multi-paired cables, flat cable and connectors, coaxial cables, lead wire, plenum cables, power supply cords, and molded cable assemblies. What is not so well-known is the fact that every "standard" wire and cable in our Master Catalog started out as a custom design for a specific application.

World's largest wire and cable engineering facility.

In May, 1990, Belden dedicated the most progressive and innovative cable development facility in the world today: the Belden Engineering Center (BEC). Housing over 100 engineers and technicians, this 70,000 square foot facility is committed

to keeping our OEM customers on the leading edge of technology with product development samples, process capabilities equipment, compound materials analysis, and testing and evaluation labs.

The BEC is where Belden brings out the custom in our customers with custom design or co-development of new products, custom modification of standard products, and all the technical assistance you need to keep you ahead of your competition.

Quality you can stake your reputation on.

As a leading edge manufacturer, Belden's mission is continuous improvement toward a goal of 6-Sigma quality. Total Quality Control is the central theme in

all of our processes, from vendor quality assurance through customer service. That's why original equipment manufacturers (OEMs) like IBM, Black & Decker, Motorola, DEC, Skil, Makita, and Milwaukee Electric Tool rely on Belden for wire, cable, cords, and assemblies they can count on for flawless performance and exceptional reliability.

For more information about how Belden can turn your dreams into reality, call:

1-800-BELDEN-4

COOPER

Belden

Quality from Cooper Industries

Data

COMMUNICATIONS

communications rates, respectively, using NRZI 4B/5B encoding. The Am7968 transmitter and Am7969 receiver cost \$36 (1000) per pair for the lower-speed grade and \$44.75 (1000) per pair for the faster ICs.

Triquint, meanwhile, has used its GaAs (gallium arsenide) manufacturing process to produce an IC that operates at 1 GHz. The company's Hot Rod 2-chip set uses NRZI 4B/5B encoding and can realize data rates as fast as 800 Mbps. The chip set uses a 40-bit bus on the system side and is compatible with all 32-bit μ Ps. The chip pair costs \$440 (100), dissipates less than 4.5W, and requires a 5V supply.

Fiber Channel offers 100 Mbytes/sec

If your concern is adherence to standards, Fiber Channel will most likely be the best choice for faster communications (see **box** "Fiber Channel offers new

paradigm"). Fiber Channel defines 100-Mbyte/sec point-to-point communications channels and a matrix of switches called a fabric that can perform a network-like function. The standard also specifies operations at slower speeds such as 25 and 50 Mbytes/sec.

Vitesse Semiconductor recently introduced the first chip set capable of handling Fiber Channel communications. Vitesse developed the 4-chip set using its GaAs process and architectural assistance from AMD. Called the G-Taxichip set, the ICs can actually operate as fast as 1.25 Gbits/sec. A multiplexer chip and a transmitter chip handle the transmit function, and a receiver chip and a demultiplexer bring data into the host. The chip set uses a 40-bit bus on the host side. **Fig 3** depicts the architecture of the chip set.

Vitesse sells the G-Taxichip set for \$900. Tom Dugan, director of standard products at Vitesse, re-

Fiber Channel offers new paradigm

A number of communications schemes that have been discussed throughout the industry can boost network-communications speeds past the 100-Mbps FDDI rate. Fiber Channel currently appears to be the most practical in the short term.

The point-to-point data-communications scheme offers a maximum 100-Mbyte/sec data-transfer rate but can also operate at $\frac{1}{2}$, $\frac{1}{4}$, or $\frac{1}{8}$ of maximum speed. The fiber-optic communications channel can connect two devices over a distance of 4 to 10 km based on the type of fiber optic used. It uses an 8B/10B data-encoding scheme.

You may wonder why a point-to-point communications standard is relevant in a discussion about LANs. It's certainly relevant here because FDDI is actually no more than a network made up of point-to-point links. You could also make a fast network with Fiber Channel links. However, the Fiber Channel standard being shepherded by the ANSI X3T9.3 committee defines a new paradigm for communications that may transcend LANs.

Fiber Channel defines a communications channel in the same sense

that IBM uses channels to connect mainframe computers and subsystems together. And, in a sense, the Fiber Channel physical interface resembles a mass-storage interface because it doesn't rely on software protocols to ensure reliable data transfers.

The fabric of fiber

Fiber Channel depends on dedicated hardware to control communications. The standard requires no network protocol and handles errors in hardware. The standard defines a set of switches, called a fabric, that performs a function similar to that of a large telephone-system switch. Each computer system or peripheral attaches to the fabric with dedicated send and receive lines. And the switch can route any incoming signal to any output port.

The fabric, at first glance, doesn't look like a network. In reality, however, the fabric is similar to many LAN installations, most of which use a star-wired topology that requires a cable from each system to route into a central wiring closet. Network administrators demand such a topology to ensure

reliability against single-point failures and to simplify troubleshooting. The Fiber Channel fabric's switches actually form temporary direct links between systems. But the hardware can change connections so quickly that Fiber Channel can perform the same functions as a LAN, only far more efficiently.

Fiber Channel fabrics require you to add switches if you want to add systems to a network, whereas typical LANs require you to add multipoint concentrators to add network stations. Adding to a Fiber Channel fabric, however, adds to the total bandwidth of the network because the fabric supports multiple point-to-point communications channels simultaneously. In contrast, adding nodes to a LAN actually reduces the bandwidth for each station.

Also realize that 100-Mbyte/sec Fiber Channel links deliver data at that rate. The standard actually uses a 1.0625-Gbps communications rate that includes error detection data. The 100-Mbyte/sec rate is a realizable rate and is not partially wasted by network protocols.

SIEMENS

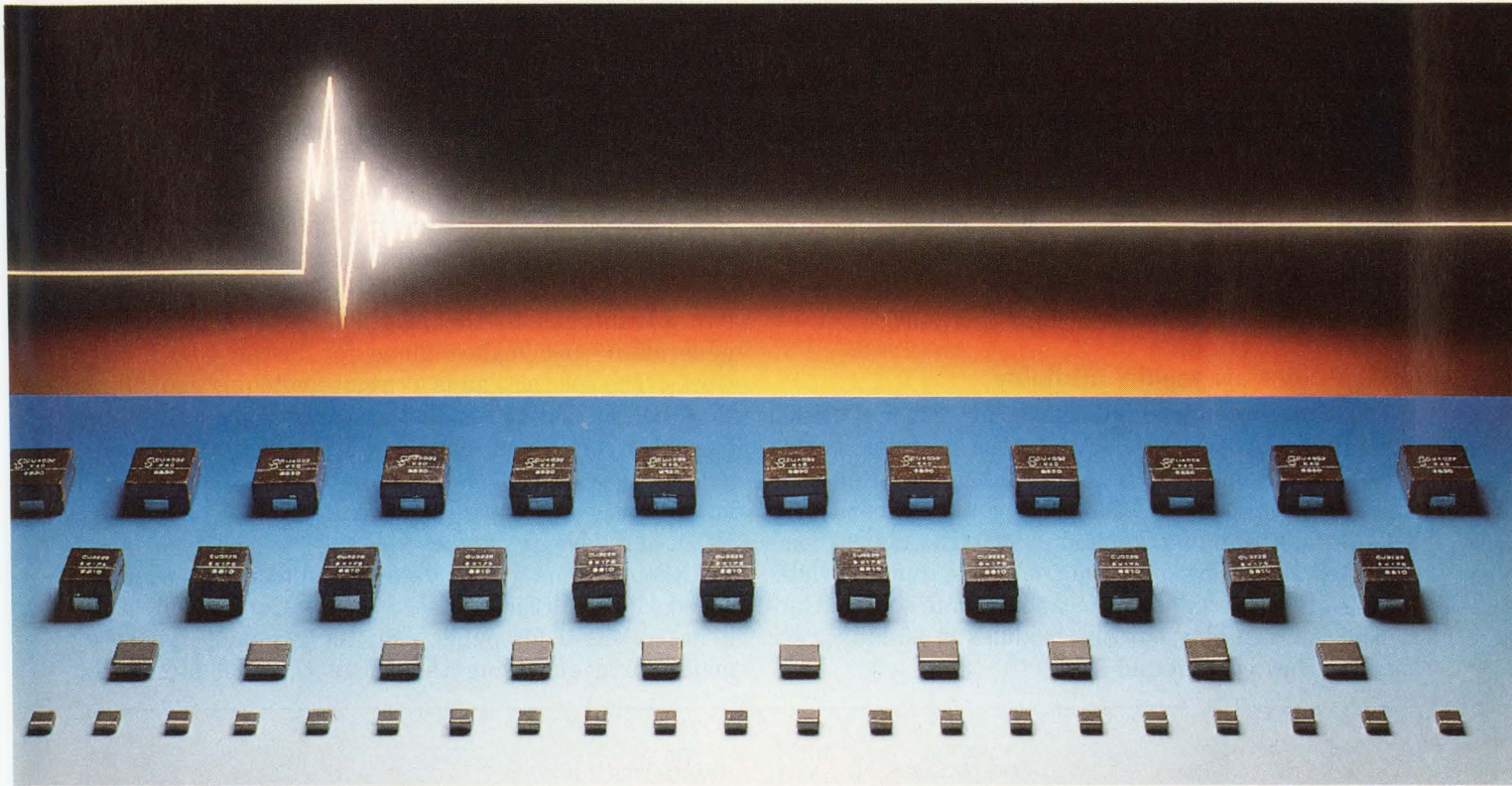

Mighty miniatures.

Siemens surface mount varistors.

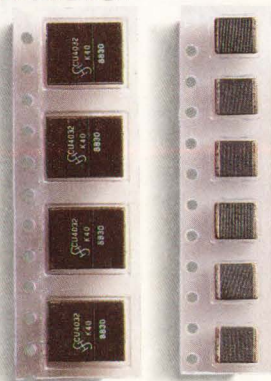

Standard packaging in blister tape and reel, ideal for automatic insertion. (Shown actual size.)

Increase your design flexibility and board compression with Siemens varistors in *four industry standard* surface mount packages.

- CN1210: Multilayer construction, equivalent to Siemens radial-leaded SR1210 series, subminiature low voltage disc, 4-8V AC RMS
- CN2220: Multilayer construction, equivalent to Siemens radial-leaded SR2220 series, subminiature low voltage disc, 4-8V AC RMS
- CU3225: Monolithic construction, equivalent to Siemens radial-leaded 5mm disc series, AC RMS ratings up to 300V.
- CU4032: Monolithic construction, equivalent to Siemens radial-leaded 7mm disc series, AC RMS ratings up to 300V.



Automotive Types: Included in Siemens broad offering are two

multilayer products specifically designed to meet severe electrical requirements of the automotive industry. Our automotive varistor in the 1210 package is rated at 2 Joules, and in the 2220 package is rated at 12 Joules under load dump conditions. Both feature jump start characteristics of 24.5V for 5 minutes @ 25°C.

Call Siemens Components at 1-800-222-2203 today for complete details!

CIRCLE NO. 89

SCI-1010

Data

COMMUNICATIONS

ports that customers have shown interest in using the chip set in applications ranging from LAN backbones to parallel bus serialization to video distribution. AMD also has the right to sell the G-Taxichip set but has chosen not to at this time. AMD did just introduce its own Fiber Channel-compatible version of its Taxichip line. The Am79168/Am79169 offer 25-Mbyte/sec Fiber Channel communication using 8B/10B encoding. The companies' other Taxichips use 4B/5B encoding. The new chips cost about \$55 (1000) per pair.

You can expect a few other companies to offer Fiber Channel chips shortly. AMCC has described a 2-chip set at ANSI meetings that they will formally announce this quarter. The company will build the 100-Mbyte/sec chips using its ECL process. Cypress Semiconductor is also expected to introduce chips this year.

Optical links are readily available

You can buy optical-link cards for Fiber Channel from IBM and Hewlett-Packard. The modules include a 10-bit-wide interface to a transmitter/receiver pair. The cards, dubbed OLC 266, perform the Fiber Channel's serialization function and include the optical components. IBM developed the modules, but Hewlett-Packard recently signed on as an alternate source. Currently, you can only buy the modules in 25-Mbyte/sec speeds. They cost around \$500.

Ancor Communications plans to offer a fabric shortly that will use the OLC 266 module. The Ancor fabric will feature a modular architecture that users can expand in 16-port increments. Ancor also had to develop an ASIC to handle the Fiber Channel coding and framing requirements not handled on the OLC 266. The company is considering selling the ASIC, although it expects fabrics to be its primary product for Fiber Channel. Canstar also plans to offer a fabric, and, like Ancor, is working on an ASIC to handle higher layers of the Fiber Channel standard. The company currently has no plans to sell an IC however.

A number of other standard data-communications efforts may merit your continuing attention for future use. The FDDI-II standard is well defined and adds two advantages to the original spec. The second-generation spec makes plans for faster FDDI networks. The spec also adds a circuit-switching capability to FDDI so that the LAN can carry voice as well as data. No companies offer FDDI-II chips as yet, but you may see an IC from AT&T later this year. Several large Japanese companies are rumored to be testing FDDI-II LANs already as well.

Although IBM has a data-communications scheme called ESCON (Enterprise Systems Connection) that it has released for public use, the company is also a major force endorsing the Fiber Channel standard.

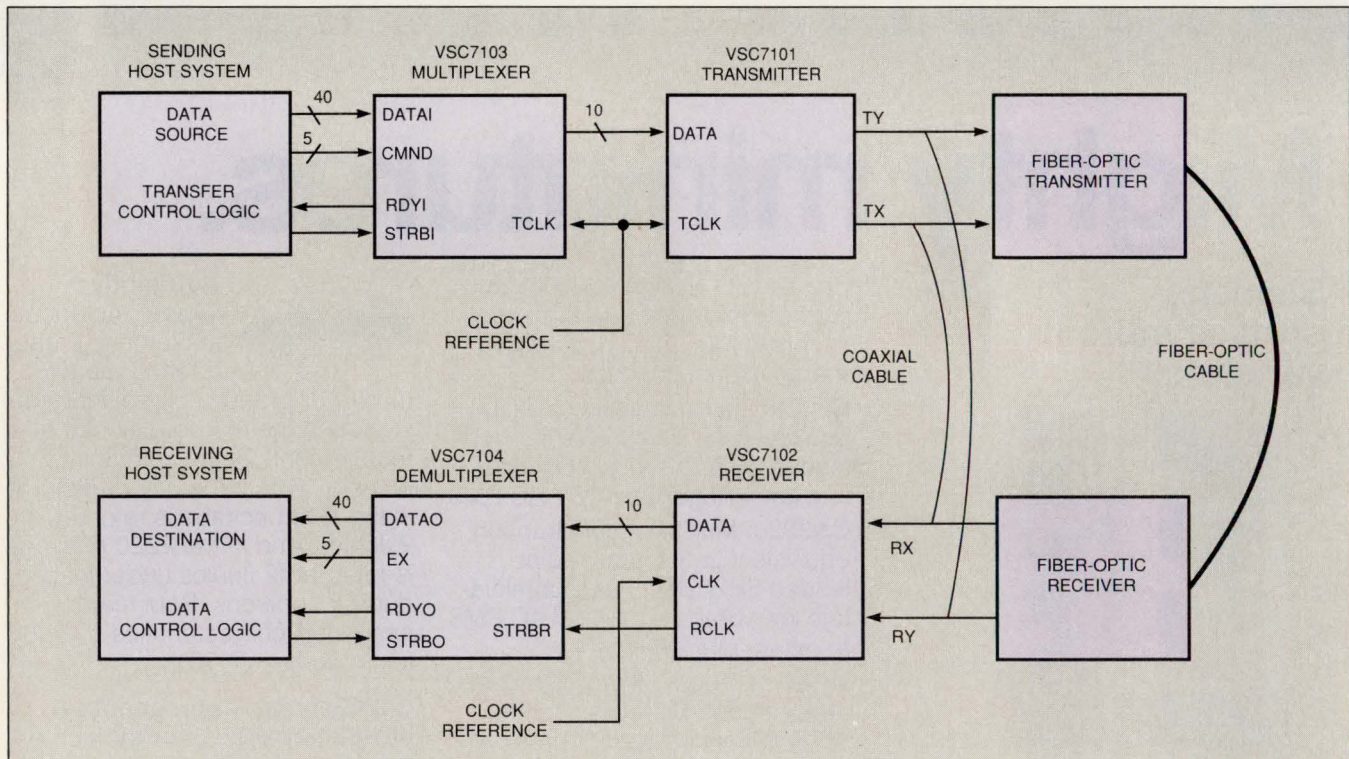
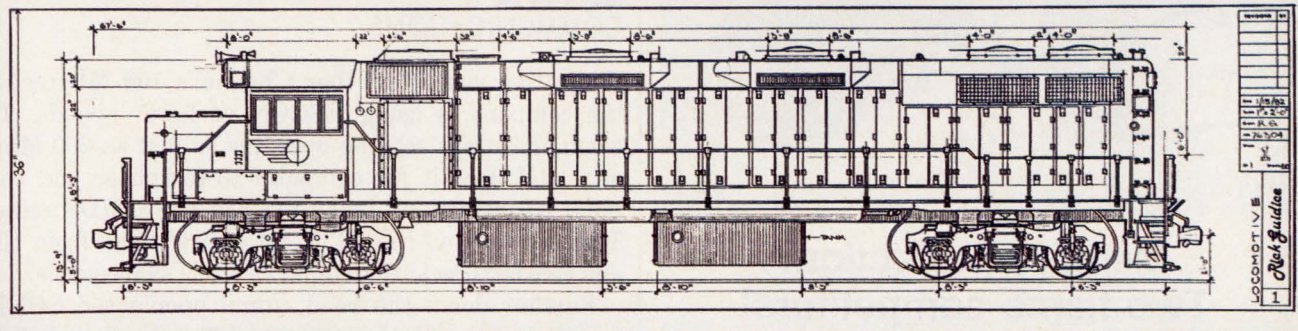
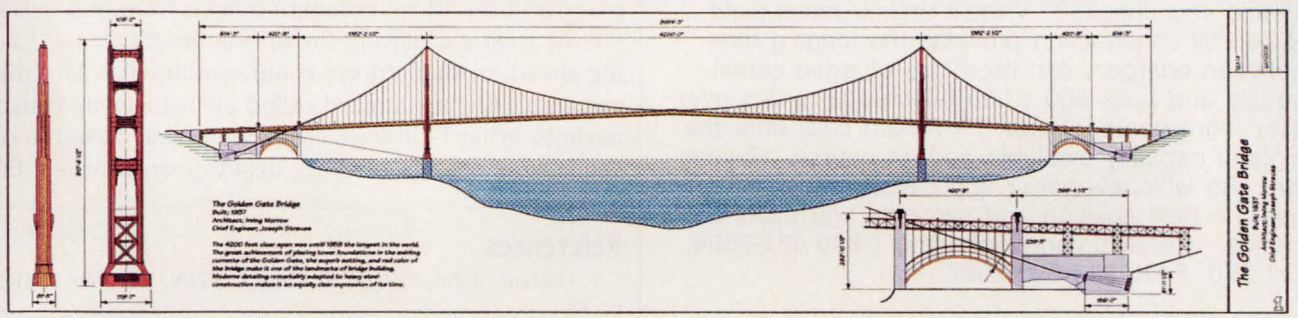

Fig 3—You can design Fiber Channel point-to-point links that operate at 100 Mbytes/sec using the G-Taxichip set from Vitesse Semiconductor.



Copy



Plot

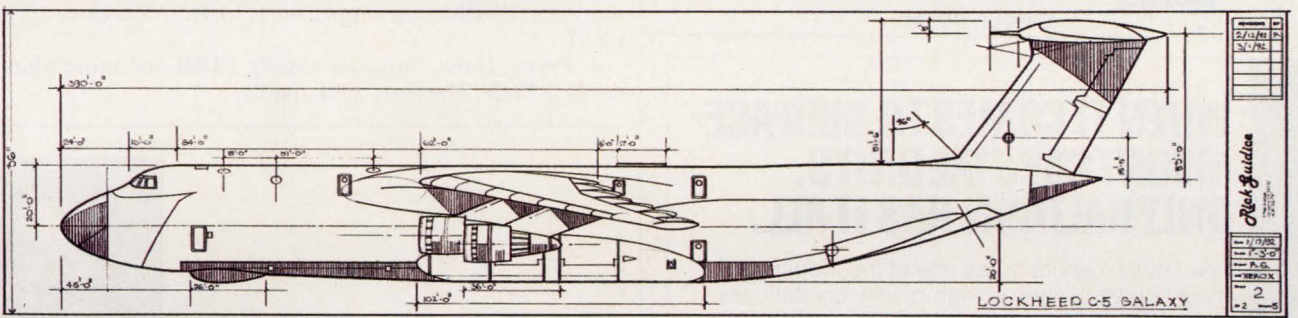

Fax

We've dedicated ourselves to helping you make it big.

If you want to take your business to new heights, as well as widths and lengths, you needn't look any further than Xerox.

Xerox Engineering Systems offers the most complete range of products to plot, copy and fax your biggest and brightest ideas.

To begin with, the size of our copier line is as big as our reputation. Choose from a variety of A-E size engineering copiers to reduce, enlarge or restore your drawings.

Got a big plot? XES can handle it. Our sizable line of Versatec laser, electrostatic and thermal plotting systems

connects to virtually all computing systems and all networks.

And when it comes to faxing full scale drawings, our D-size facsimile copier comes through in a big way. Anywhere in the world, in just three minutes.

At Xerox, we are constantly adding accessories and improvements that will make a huge impact on productivity. Features like document sorters, stackers and cut sheet feeders to name just a few.

And of course, our products are backed by the Xerox Total Satisfaction Guarantee. If you're not happy with our product, just return it. Pretty big of us, isn't it?

Here's another big advantage. XES offers a full range of service plans, supplies and support. Plus the kind of financial plans that only a company our size can provide. It's a little something called dedication from a company that wants to see you make it big.

For a free brochure on our complete product line, call 800-538-6477; or in California, 800-341-6060.

And welcome to the big time. **The engineering document company.**

Xerox Engineering Systems

2710 Walsh Ave., Santa Clara, CA 95051. Xerox is a trademark of Xerox Corporation. © 1992 XES, Inc.



Memory protection: Two fierce competitors!

For memory protection, NiCd rechargeables and lithium primary cells go head-to-head. Which should you choose? Varta's unique mass-plate NiCd cell construction provides the longest time between charges, can be trickle charged continuously and lasts 500-1,000 full-charge cycles over 4 or more years. Varta CR lithium cells offer the highest capacity available and, of course, 10-year life. So whichever your application requires, Varta has the best solution and can help you make the choice. Contact Varta Batteries, 1-800-431-2504, Ext 270. FAX: 914-592-2667.



CIRCLE NO. 91

WHEN IT COMES TO SURFACE MOUNT CRYSTAL UNITS, ONLY RALTRON HAS IT ALL.

RALTRON manufactures one of the industry's most complete lines of high quality crystal units. Call us for all your crystal needs from micro-processor to AT strip to tuning fork to high accuracy. Or call us for our 28 page catalogue.

NEW! SURFACE MOUNT CRYSTAL UNIT— 2.5 MM HEIGHT — T25 SMD

- Frequency Range: 3.5 MHz-50 MHz
- Oscillation Mode: Fundamental to 3rd O.T.
- Frequency Tolerance: ± 50 ppm @ 25°C
- Frequency Stability: ± 50 ppm (-10°C to +60°C)

NEW! SURFACE MOUNT CRYSTAL UNIT— 3.0 MM HEIGHT— HC-49 SHORT SMD

- Frequency Range: 8 MHz-50 MHz
- Oscillation Mode: Fundamental to 3rd O.T.
- Frequency Tolerance: ± 50 ppm @ 25°C
- Frequency Stability: ± 100 ppm max (-10°C to +60°C)

• Crystals • Crystal Oscillators • Crystal Filters • Ceramic Resonators

RALTRON ELECTRONICS CORP.

2315 NW 107th Avenue, Miami, Florida 33172 U.S.A.
FAX (305) 594-3973 TELEX 441588 RALSEN
(305) 593-6033

CIRCLE NO. 92

Data

COMMUNICATIONS

While they wait for Fiber Channel's 100 Mbytes/sec, the company is using ESCON at lower speeds. The communications scheme operates as fast as 200 Mbps, and IBM uses it for computer-to-computer and computer-to-subsystem links. You can use AMD's newest Taxichip set and the OLC 266 optical links from IBM and Hewlett-Packard to build an ESCON interface.

Further down the road, some people see SONET (synchronous optical network) as the do-all end-all for data communications. SONET was designed as a replacement for T1 telecommunications links and initially will be used exclusively for telecommunications. Looking ahead, manufacturers could combine it with a data-communications standard called asynchronous transfer mode to bring 1-Gbit/sec connections that have the convenience of a LAN to every desktop worldwide. **EDN**

References

1. Gallant, John, "FDDI Stations," *EDN*, October 1, 1991, pg 88.
2. Wright, Maury, "Reduced costs key FDDI's acceptance," *EDN*, September 14, 1989, pg 81.
3. Pryce, Dave, "Opposing groups struggle to define standards for FDDI using copper wire," *EDN*, March 2, 1992, pg 57.
4. Pryce, Dave, "Modules satisfy FDDI and other standards," *EDN*, March 1, 1991, pg 61.

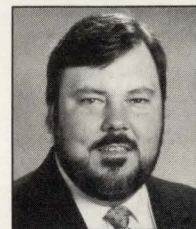

Technical Editor Maury Wright can be reached at (619) 748-6785; FAX (619) 679-1861.

Article Interest Quotient (Circle One)
High 482 Medium 483 Low 484

WHAT'S COMING IN EDN

In the May 21, 1992, issue of EDN Magazine we take a look at analog simulation—its capabilities, limitations, and pitfalls. Technical Editor Anne Watson Swager presents the results of an EDN hands-on project in which we invited vendors of DOS-based analog-simulation software to simulate several circuits. The results of these simulations, compared with the circuits' actual performance, may provide you with some interesting insight on your next analog-circuit design project.

50 MHz ARB, Independent Channels, Modulation, Noise, And Much More.

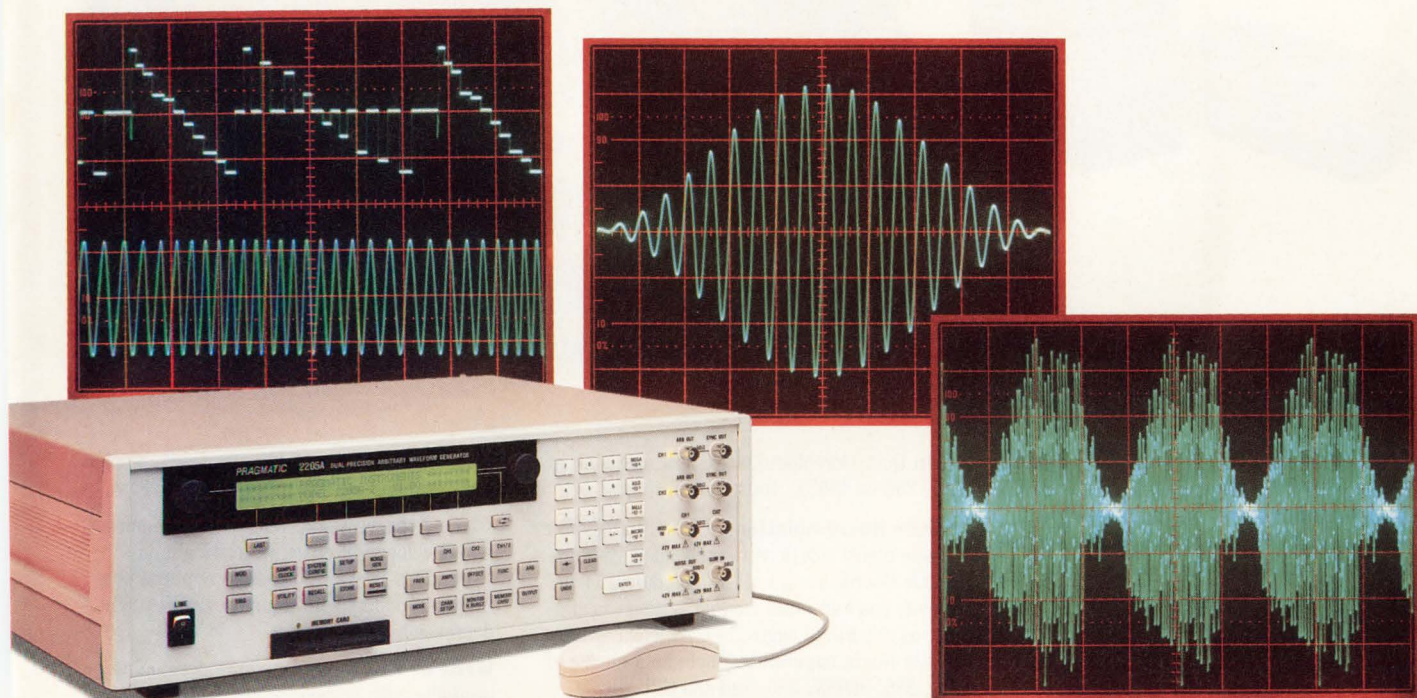

That's Pragmatic!

The Pragmatic 2205A Dual-Precision Arbitrary Waveform Generator.™

In addition to its 50 MHz sample rate, dual independent channels, multiple modulation modes and built-in noise generator, the 2205A offers you an array of unique features:

- AM, SCM, QAM and synthesized FM
- Vertex Formatting™ Software for easy waveform creation and editing
- 250K memory, expandable to Megaword
- A logical, functional front-panel design
- Standard IEEE 488.2 and RS-232C interfaces

PRAGMATIC INSTRUMENTS PRODUCT TABLE

Model	Channels	Sample Clock	Amplitude Resolution	Waveform Memory
2411A	1	2 MHz	16 Bits	64 K
2202A	1	20 MHz	12 Bits	32 K
2201A	3	2 MHz	16 Bits	64 K/Ch

To fully appreciate the 2205A's unparalleled performance, you must see a comprehensive demonstration. **Contact Pragmatic Instruments TODAY.**

PRAGMATIC[™]
INSTRUMENTS, INC.

7313 Carroll Road, San Diego CA 92121-2319 • Tel. (619) 271-6770 • Fax (619) 271-9567

Toll Free (800) PRAGMATIC or (800) 772-4628

Circle No. 17 Call Me I'm Interested

Circle No. 18 Send Literature

EDN May 7, 1992 • 147

GOOD IDEA. SAME IDEA.

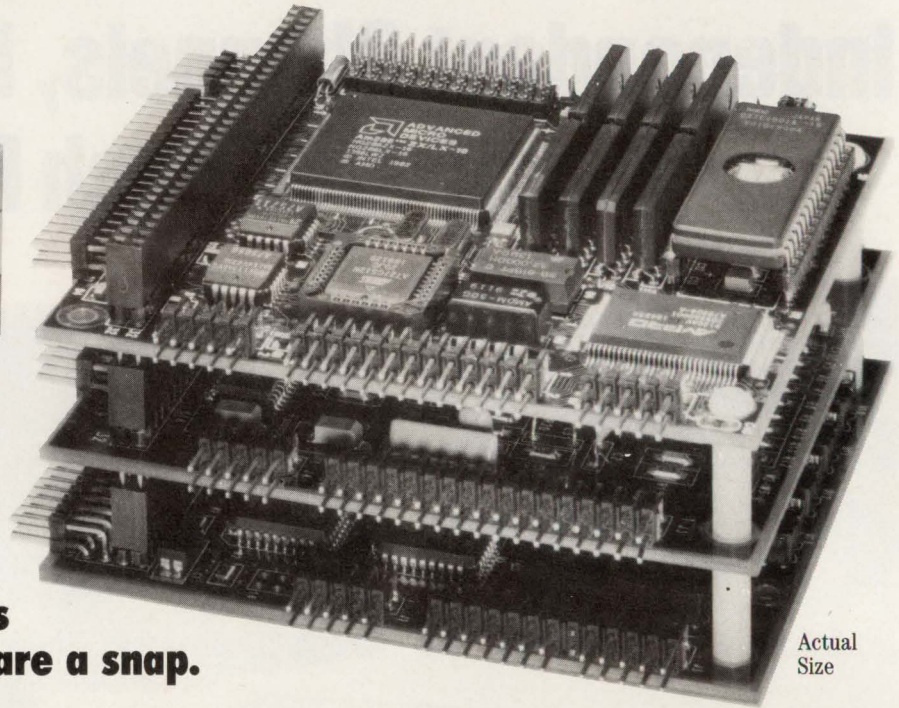
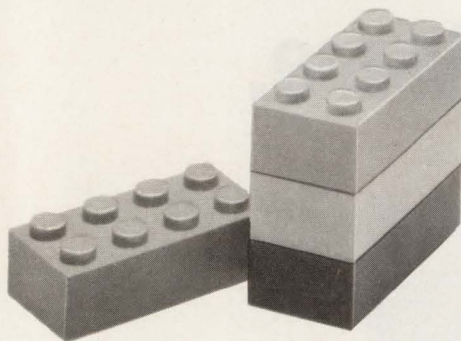

When time-to-market is critical, embedded PCs are a snap.

Ampro offers you fast, flexible answers to embedded PC development. Little Board™ single board systems on the left below, CoreModule™ CPUs on the right. Plus Mini-Modules™ that snap onto either. That means you can snap together a system customized to your specific application. Now.

Above, shown actual size: a complete AT-compatible system. 80286 processor, 4Mbytes of DRAM, floppy and IDE I/O, 2 serial and one parallel port, SVGA display driver . . . and more. It was snapped together in less than two minutes using Ampro's CoreModule/286 and two MiniModules. It fits in a space just 3.6"×3.8"×1.8." And it draws under 5W. Embedded PCs don't get easier

than that. CoreModules are now available in XT, 286 or 386SX. Your choice.

Single Board Solutions. Little Boards offer single board solutions to embedded systems. Little Boards accept all MiniModules. That means you can build custom systems as simply as stacking Leggos.™ PC/AT-compatible Little Board capabilities include: a choice of PC, 286, 386SX, 386, and 486 CPU. Up to 16Mbytes of on-board DRAM. Dual serial and one parallel controller. Floppy, IDE and SCSI controllers. Bootable solid state disk . . . and more. Plus, compatibility with all PC/AT operating systems and software. All, in the form factor of a 5.25" disk drive.

The PC/104 standard. Ampro started it. But today you can buy PC/104 StackThru modules from 15 state-of-the-art manufacturers on three continents. The result? Snap-together systems specific to your embedded application.

Flexible answers. When it comes to embedded PC/AT computer systems, you can't buy faster, smaller, or more flexible answers. CoreModule or Little Board-based systems. Mini-

Modules. Development systems. And complete technical support. Flexible answers. Fast.

Hitting the window. When time-to-market and development costs are critical considerations in your embedded applications, Ampro products can help you significantly decrease both.

Write or call today. If you're developing products with embedded controllers, Ampro offers fast, cost-effective alternatives to in-house development. Call, write or fax. We'll send you Ampro's 80-page, full line catalog. Proven, cost-effective answers to high development costs and product introduction delays. Embeddable systems. In a snap.

Fast Answers. Toll Free
1-800-966-5200

AMPRO®

Proven Solutions for Embedded Control

Ampro Computers, Inc.
990 Almanor Ave., Sunnyvale, CA 94086
Phone: (408) 522-2100 Fax: (408) 720-1305

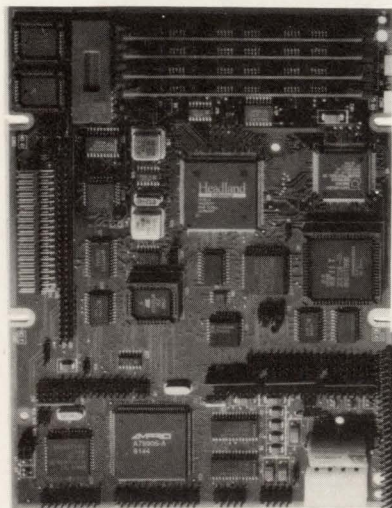

Little Board
PC, 286, 386SX, 386 and 486

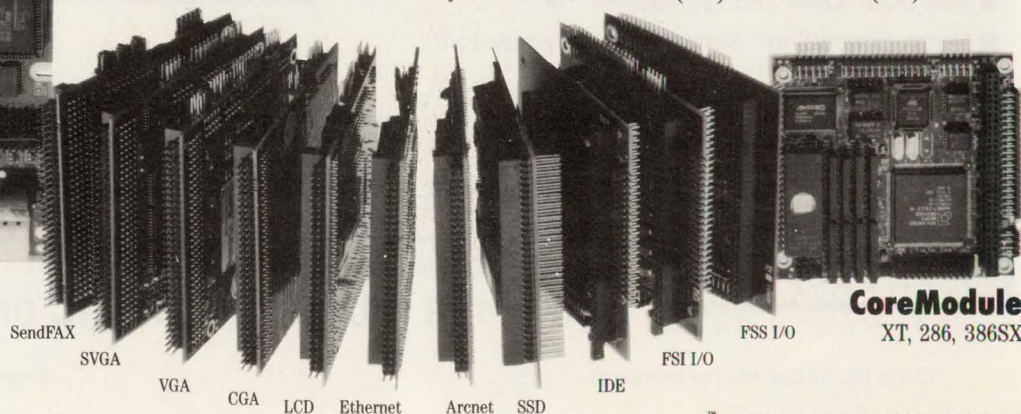

CoreModule
XT, 286, 386SX

PRECISION SINGLE-SUPPLY DUAL OP AMPS

Precision to go.

World-class precision for low-power applications.

Now you can take it with you. Because our amazingly accurate single-supply CMOS dual op amps fit into everything from hand-held meters to battery-powered transducer systems (883/SMD devices will be available).

In fact, they're ideal for any design that craves the low power of the LMC6082 (900 μ A) or the ultra-low power

FEATURES

- 350 μ V offset voltage*
- 1 μ V/ $^{\circ}$ C offset voltage drift
- 10fA input bias current
- 85dB CMRR
- 85dB + PSRR/94dB - PSRR
- Rail-to-rail output swing
 LMC6082: 4.98V-0.02V
 (100k Ω)*
 4.50V-0.40V
 (600 Ω)*
 LMC6062: 4.99V-0.01V
 (100k Ω)*
 4.975V-0.02V
 (25k Ω)*
- Free SPICE model

*guaranteed max/min specs

of the LMC6062 (32 μ A). All while slewing at 1.5V/ μ s and 0.035V/ μ s, respectively.

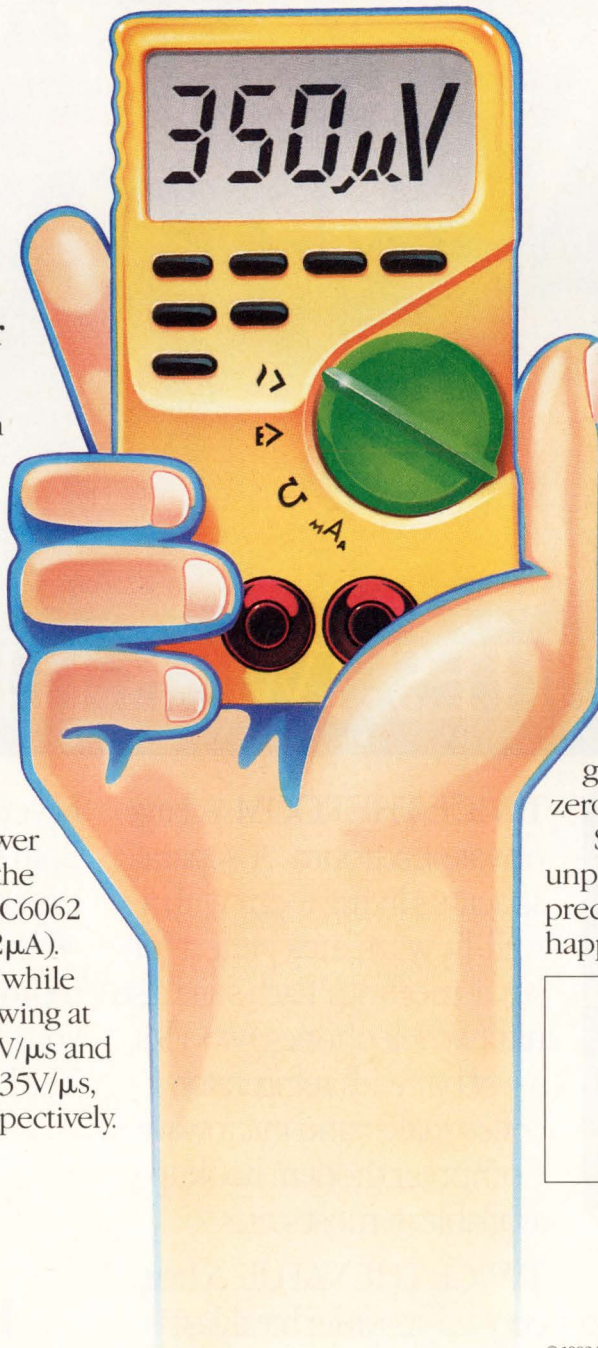

Single-supply operation with rail-to-rail output swing.

The LMC6082/6062 guarantees maximum signal range thanks to its rail-to-rail output swing — a feature that's especially critical in single-supply systems where every millivolt matters.

What's more, its input common-mode range includes ground. Which means you can zero in on even the lowest signals.

So now you can count on unparalleled, single-supply precision. Wherever you happen to be.



Go for it.

For your *free* sample kit and SPICE model, call:
 1-800-NAT-SEMI, Ext. 183.
 Or, fax: 1-800-888-5113.

TWO ROOMS. TWO BUSINESS DEALS. TWICE THE PRODUCTIVITY.



EMBASSY SUITES®. TWICE THE HOTEL.™



Free, cooked-to-order breakfast.

For people who travel a lot on business, there is no better partner than Embassy Suites hotels.

+ Subject to state and local laws.

152 • EDN May 7, 1992

TWICE THE ROOM. A large private bedroom. A separate spacious living room with a well-lit work area perfect for small meetings. Each suite also has two telephones, two TVs, a wet bar with refrigerator, coffee maker and microwave. Computer modem hookup available in most suites.

TWICE THE VALUE. A free, cooked-to-order breakfast is served each morning. Two hours of complimentary

beverages+ each evening. Both sure to help keep your expense report in line.

Next time you need a hotel room, Think Twice.™ Then call your travel agent or Twice The Hotel.™ 1-800-EMBASSY.



**EMBASSY
SUITES**™

In Canada, call 1-800-458-5848. In Mexico, call 95-800-362-2779.
Hawaii, call 1-800-GO-2-MAUI.

CIRCLE NO. 94

ELECTRO'92 BOSTON

Focusing on the needs of design engineers, *Electro/92* will offer more than 60 technical sessions and 800 exhibits. Technical courses and management seminars round out the program.

Dave Pryce, Technical Editor

THE CITY OF BOSTON, noted for its cultural and historical attractions, will host *Electro/92* on May 12, 13, and 14. This year, all *Electro* events will be held at the Hynes Convention Center, which is located on Boylston Street adjacent to the Prudential Center in downtown Boston.

The theme of *Electro/92* is "New Directions in High-Tech Innovation." In keeping with this theme, and in response to the increasing significance of software innovation, this year's show will feature several sessions on software in engineering. You'll be exposed to the

most current software programs and methods, and be able to meet the experts at the forefront of software development.

Helping to kick off *Electro/92* will be Jim P. Manzi, president and CEO of Lotus Development Corp. Manzi will deliver the keynote address, entitled "Networks and Mobile Users: Personal Computing in the 90s." The keynote program will take place at a luncheon at noon, Tuesday, May 12, in the Hynes Convention Center. Tickets are \$25.

Following the keynote luncheon, IEEE life members are invited to attend the seminar on

“The Father of Radio: E H Armstrong.” Professor William Siebert, Ford Professor of Engineering at MIT, will deliver the talk at 2:30 pm in the Hynes Convention Center.

In addition to the focus on software engineering, Electro/92 includes more than 50 other technical

sessions (see table). The categories for these sessions are

- Concurrent-engineering methodologies
- Concurrent-engineering technology
- Semiconductor-device technology
- Manufacturing, quality, and reliability

- Engineering and technical education
- Going international
- Current topics.

Complementing the technical sessions are several conferences, technical short courses, and management seminars. An all-industry

Electro/92 technical-session schedule

Day/time	Concurrent-engineering methodologies	Concurrent-engineering technologies	Semiconductor device technology	Manufacturing, quality, and reliability	Software engineering	Engineering and technical education
Tuesday May 12, 1992 9:15 am to 11 am		Session 1 New trends and techniques in system-level verification	Session 2 Model availability and how we achieve it	Session 3 Total-quality-management trends	Session 4 A re-engineering process for large software systems	Session 5 Competitive engineering methodology
1 pm to 2:45 pm	Session 8 Expert-system development and application	Session 9 TCAD for total quality control	Session 10 Modern solid-state microwave design	Session 11 Customer-driven product design	Session 12 Software-engineering process trends and overviews	Session 13 Restructuring the engineering resource for the 21st century
3:15 pm to 5 pm	Session 16 Knowledge-based engineering/expert systems	Session 17 Impact of integrated-component information management	Session 18 Building design-for-test into your ASICs	Session 19 Supportability-assessment systems and model-development environments	Session 20 Software reliability engineering	Session 21 Systems for keeping world-class engineers up to date
Wednesday May 13, 1992 9:15 am to 11 am	Session 24 Product data sharing using STEP	Session 25 Innovations in CAD for electromechanical design	Session 26 FPGAs—Where is the industry going?	Session 27 Design-to-cost	Session 28 Object-oriented design	Session 29 Education for total quality management
1 pm to 2:45 pm	Session 32 ECAD frameworks: standardization in the marketplace	Session 33 PC-board technology trends	Session 34 FPGA design technology enhances design productivity	Session 35 SMT processing	Session 36 Software development and applications using object-oriented and other technologies	Session 37 Software education for open systems
3:15 pm to 5 pm	Session 40 Improving the design process—the best of theory and practice	Session 41 Computer-aided-design tools for solid-state-device development	Session 42 Programmable architectures	Session 43 An approach to building distributed applications on the plant floor	Session 44 Software re-use issues	Session 45 Career planning for the 1990s
Thursday May 14, 1992 9:15 am to 11 am	Session 48 Managing concept-to-commercialization cycle time: opportunities and expectations	Session 49 Concurrent engineering in ASIC design	Session 50 Multichip modules	<div style="border: 1px solid black; padding: 5px; width: fit-content; margin: auto;"> Admission to technical sessions and exhibits is complimentary. *Sessions 7 and 39 require special registration. </div>		
1 pm to 2:45 pm	Session 53 Concurrent engineering	Session 54 Current issues in thermal management	Session 55 Cache-memory design: what's new?			
3:15 pm to 5 pm			Session 58 Specialty memory: applications and innovations			

conference, titled "How the North-east Can Grow in the World Marketplace," will be held Tuesday, May 12, from 9:15 to 11:00 am. Tickets are \$20. A purchasing conference, titled "Teambuilding: The Ultimate Vendor," will be held Wednesday, May 13, from 1:00 to

2:45 pm. Again, tickets are \$20.

The technical short courses include full-day seminars on such topics as programming with the X-Window system, the Demeter method for object-oriented design, surface-mount technology, use of Spice for modern analog simulation, and concurrent engineering. The cost of these technical courses ranges from \$300 to \$400.

The management seminars feature idea-generating topics such as project management, doing business with the Japanese, and prepar-

ing and delivering effective presentations. These seminars cost \$300 each. The technical short courses and the management seminars will be held on Monday, May 11, from 9 am to 5 pm.

Exhibits abound

Engineers attend Electro as much for the diverse exhibits as for the technical sessions and other programs. Perhaps nowhere else can an engineer gain as much knowledge of available products as in the aisles of these exhibits.

Going international	Current topics
Session 6 Global engineering	Session 7* All-industry conference
Session 14 Government support to international trade	Session 15 Super glue: high-speed logic for the 1990s
Session 22 European perspective: overview of Europe on becoming a single market	Session 23 Current topics in medical electronics
Session 30 Avoiding legal landmines in global marketing strategies	Session 31 Getting started: the right steps in starting and growing your own high-tech company
Session 38 Third-world manufacturing	Session 39* Purchasing conference
Session 46 International finance	Session 47 Marketing in Asia
Session 51 Specs and standards go international	Session 52 Recent developments in high-performance storage batteries
Session 56 Forming international relationships	Session 57 Energy management from utility to customer
Session 59 The use of on-line resources for scientific, technical, and marketing research	

Traveling to Electro

The site of this year's Electro show is the Hynes Convention Center, located at 900 Boylston Street adjacent to the Prudential Center in the Back Bay section of Boston.

From the west, you can reach the Convention Center by taking the Massachusetts Turnpike (Route 90) to the Prudential Center exit.

From Logan Airport and points north, take Route 93, which runs north and south through Boston, to the Storrow Dr exit at Copley Square. Turn right on Beacon St, left on Massachusetts Ave, and left on Boylston St.

From the south or east, take the Southeast Expressway (Route 93/3) to the Massachusetts Ave exit. Continue on Massachusetts Ave to Boylston St.

Park 'n ride locations

To avoid the rush-hour traffic and to address the limited parking available in downtown Boston, four park-and-ride locations will operate Tuesday through Thursday, May 12 to 14. You can park in one of three suburban locations and take the free Electro shuttle to the Hynes Convention Center.

The shuttle location for the north is the Showcase Cinema in Woburn; for the west, Shoppers World in Framingham; and for the south, the Showcase Cinema in Dedham.

Shuttle buses will leave at 20-minute intervals from 7:40 to 9:00 am and return from the Convention Center from 4:00 to 5:30 pm on Tuesday and Wednesday and 3:00 to 4:30 pm on Thursday.

Bayside parking

"In-town" parking will be available at the Bayside Expo Center in Boston. The cost to park will be \$5. Shuttle service to the Hynes Convention Center will run from 8:30 am to 5:30 pm and will operate at 20-minute intervals most of the day.

You can reach Bayside from the north or south by taking exit 15 from Route 93/3. From the west, take the Massachusetts Turnpike east until it merges with the Fitzgerald Expressway and Route 93 in Boston; follow the signs to Route 93 South.



Prime Real Estate Available in a Great Location.

Locate your next product on a VME MXbus™ SideCard™ adjacent to a Mizar CPU card and you get your product to market faster because you start with an off-the-shelf CPU that comes up with the debugger the first time you power it on. And if you want to use a commercially available real-time OS, it is probably already ported to the board.

By building your custom design on a proven hardware and software foundation you also minimize your design risk. But you need not sacrifice any design flexibility because Mizar supplies a variety of configurations based on Motorola processors, including the 040. And the VME MXbus™ accommodates single high 3U, conventional double height 6U, as well as unconventional 9U and custom configurations.

Call us today to take advantage of this opportunity to put your next design in a great location. It's a unique solution from Mizar that you can build on.

MIZAR

1419 Dunn Drive • Carrollton, TX 75006

1-800-635-0200 FAX 214-242-5997

©1992 Mizar Digital Systems, Inc.

Mizar is a registered trademark of Mizar Digital Systems, Inc. Other names are trademarks of their respective manufacturers.

CIRCLE NO. 95

DID YOU KNOW?

EDN serves
electronic engineers and
engineering managers in more than
100 countries worldwide.

EDN MAGAZINE
EDITION
NEWS
EDITION.

Nearly 400 manufacturers will display products ranging from components, hardware, and semiconductors to CAD/CAE tools, test equipment, power supplies, and production equipment.

Exhibits will be open from 9 am to 5 pm on Tuesday and Wednesday (May 12 and 13), and from 9 am to 4 pm on Thursday, May 14. Registration at the door is \$5 for IEEE members and \$10 for nonmembers. However, if you bring a complimentary registration form with you to Electro, you'll receive free admission to the show. Registration will be located on the second floor of the Hynes Convention Center.

Digital Equipment Corp has invited Electro/92 attendees to DECWorld '92, which is being held at Boston's World Trade Center from April 27 through May 15. DECWorld will present a line-up of personal computing and supercomputing products. The exhibits will highlight new services and business practices and will feature advanced business applications available from DEC and hundreds of its business partners.

Electro attendees will be able to register for specially scheduled tours at the DECWorld booth in the Hynes Convention Center. Bus transportation will be available between the Hynes Center and the World Trade Center.

With its wealth of historical attractions and its notably good food and entertainment, Boston is always a favorite spot for Electro visitors. After a full day of attending technical sessions and visiting the exhibits, you can relax and enjoy the best that the city has to offer. **EDN**

Dave Pryce, Technical Editor, can be reached at (617) 558-4326; FAX (617) 558-4470.

Article Interest Quotient
(Circle One)

High 470 Medium 471 Low 472

NO ONE OFFERS MORE 1 MEG SRAMS. PERIOD.

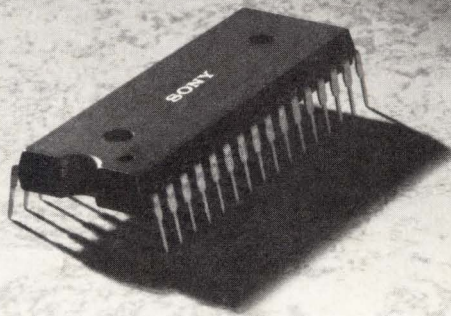

More variety. More speeds. More packages.
SRAMs built to run at extended operating temperatures, yet take only 12 μ A.

Plus fast cache and quick delivery so you can get better products to market sooner.

Sony knows low power, small spaces, high volume, quality, and reliability like no other company.

Call 1-800-288-SONY. Or FAX your current requirements to (714) 229-4333 in U.S.A., (416) 499-8290 in Canada.

We make the chips. You make the history.

The Sony 1 Megabit SRAM Family

Model	Speed (ns)	Package	Standby Current (μ A)	Special Features
CXK581000P	100/120	DIP 600 mil	12/50	-25° - +85°C
CXK581000M	100/120	SOP 525 mil	12/50	-25° - +85°C
				-40° - +85°C
CXK581100TM	100/120	TSOP	12/50	
CXK581100YM	100/120	TSOP (rev.)	12/50	
CXK581001P	70/85	DIP 600 mil	12/50	
CXK581001M	70/85	SOP 525 mil	12/50	
CXK581020SP	35/45/55	DIP 400 mil		
CXK581020J	35/45/55	SOJ 400 mil		
CXK581021J	47	SOJ 400 mil		
CXK581120J	15/17/20	SOJ 400 mil		
CXK77910J	20	SOJ 400 mil		Sync., 128K x 9

Note: All packages SV, 32 pin, 128K x 8, unless otherwise noted.

© 1992 Sony Corporation of America
Sony is a trademark of Sony

SONY

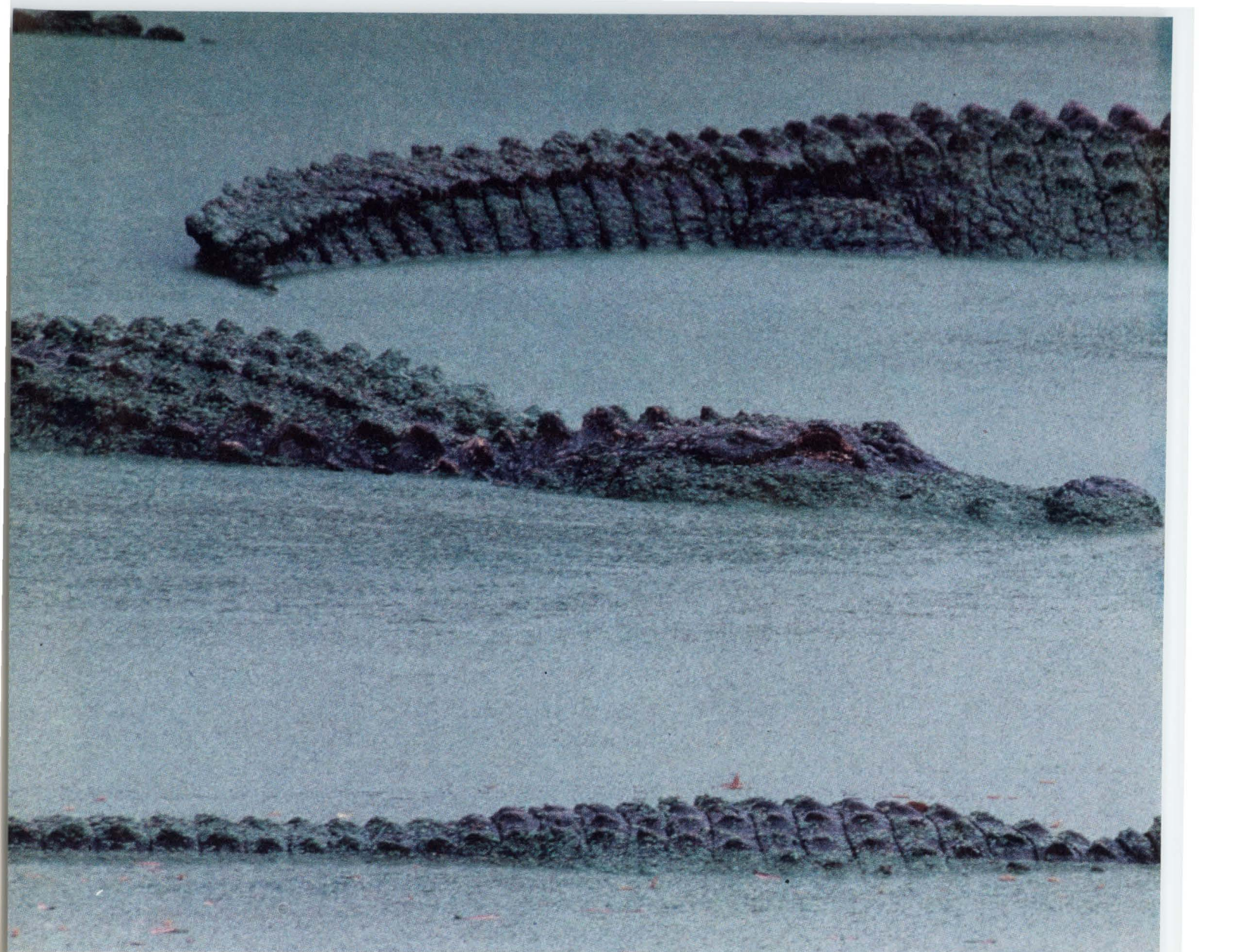

Your friends would tell you if they were using a LONBUILDER 2 Developer's Workbench to develop new products, wouldn't they?

Not if they're also your competitors, they won't.

Because using a LONBUILDER™ 2 Developer's Workbench and LONWORKS™ technology gives them a tremendous advantage. They can develop and produce intelligent distributed control applications very quickly and inexpensively. And market new products that can interoperate and perform more functions, more efficiently.

For example: In an office environment, switches, lights, security sensors, and thermostats from different manufacturers can work together to maximize efficiency and productivity. On a factory floor, equipment can be tied into the building automation system to maximize control and conserve energy. The applications are endless, and the companies that develop them first will reap the benefits.

At the heart of this competitive advantage is LONWORKS control network technology, developed by Echelon®. LONWORKS networks are made up of a series of interoperating "nodes." Each node contains a NEURON® CHIP, made by Toshiba, the first company to ship them in production quantity. There are two types: the NEURON 3120™ CHIP for applications where size and cost are most critical; and the NEURON 3150™ CHIP with external memory support for more complex applications.





Each node also contains an interface that allows NEURON CHIPS to communicate over a wide variety of common media, using the common LONTALK™ protocol.

There are a host of LONWORKS products available, including control modules, bridges and routers, network management tools, and the LONBUILDER 2 Developer's Workbench.

Really 3 tools in 1, the Developer's Workbench is: a multi-node system for developing and debugging LONWORKS nodes; a network manager for installing and debugging the integrated network; and a protocol analyzer for network monitoring and testing. An easy to use interface called LON® Navigator takes you through the process, then compiles, links, loads and configures your applications with a single command.

All of which makes LONWORKS technology the first low cost, off the shelf solution to your distributed control application needs. More than 200 companies have already recognized its potential and are using LONBUILDER 2 Workbenches to develop their next generation of products.

Call for more information about how quickly you can begin using your own LONBUILDER 2 Developer's Workbench to add LONWORKS control network technology to your products. Then you won't have to ask your friends about the advantages. You can show them.

For more information and the location of the Toshiba Demonstration Office nearest you, call the LONWORKS Hotline at **1-800-879-7566**. Or fax **1-415-856-6154**. (From outside the U.S., please fax.) Or write to Echelon Corporation, 4015 Miranda Avenue, Palo Alto, CA 94304.

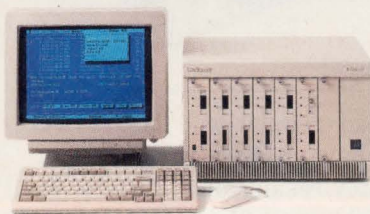

 **ECHELON**

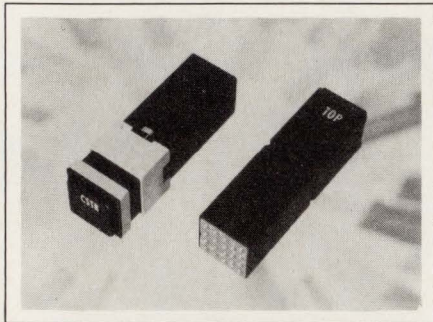

Lighted Pushbutton Switches

The Series 584 lighted pushbutton switches includes an extended-capsule model that provides a 75° cone of vision. Other models are a rod-mount model that permits gang-mounting into small panel openings and a termination system that permits easy assembly and disassembly of wires. The 5/8-in. switches and indicators have an 8A rating. Matrix-mount switches accept poke-home terminals conforming to the MIL-C-39029/57-354 standard. Options include RFI/EMI protection, drip- or slash-proof seals, switch guards, and spacers for light-plate thicknesses. \$95 to \$285 (1000).

Eaton Corp, Aerospace and Commercial Controls Div, 4201 N 27th St, Milwaukee, WI 53216. Phone (414) 449-7326. Booths 2233 and 2235. Circle No. 400

Fine-Pitch Sockets

The Socket/Adapter System lets you temporarily surface mount a quad flatpack (QFP) on a pc board. The lower portion of the socket surface mounts to a footprint pattern of the QFP via a gull-wing lead frame. The upper portion of the socket, which houses the QFP device, connects to the lower assembly. When the QFP device no longer requires a socket, you can surface mount the device directly to the board without redesign costs. The unit accepts any QFP having lead pitches of 0.025 in. or less. Units are available for 100-, 128-,

132-, 164-, 196-, and 208-pin devices. 100-pin unit, \$272.

Advanced Interconnections Corp, 5 Energy Way, West Warwick, RI 02893. Phone (401) 823-5200. FAX (401) 823-8723. Booths 3412 and 3414. Circle No. 401

In-Circuit Emulator

The Emul16/300-PC is an in-circuit emulator for Motorola's 16-bit 68HC16 and 32-bit 68300 μ Cs. The emulator consists of an ISA bus plug-in board, a 5-ft twisted-pair ribbon cable, a pod board, and an optional trace board. The software runs under Windows 3.0, which lets

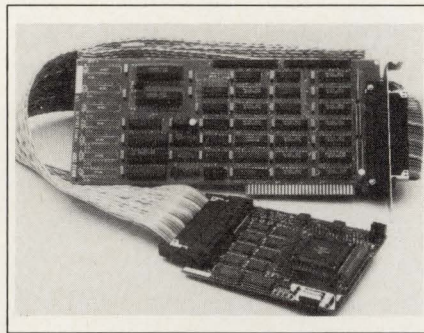

you monitor several functions at the same time. For example, you could link the contents of a shadow-RAM to an Excel cell while the emulator is running at full speed. The emulator provides real-time emulation at 16.78 MHz. The pod board has 256 kbytes of emulation RAM, and the ISA bus board has 1 Mbyte of shadow RAM that writes to both external and internal memory at full speed. \$1995.

Nohau Corp, 51 E Campbell Ave, Campbell, CA 95008. Phone (408) 866-1820. FAX (408) 378-7869. Booths 5403 and 5405. Circle No. 402

Universal Programmer

You can use the BP-1200 universal programmer to program EPROMs, EEPROMs, bipolar PROMs, PLDs, and all microcontrollers. The unit can change the voltage on any pin,

which eliminates the need for DACs. The programmer weighs less than 6 lbs and measures 9.56 x 6.75 x 3 in. You can choose among versions with 32-, 40-, or 48-pin driver cards; all versions come with a 48-pin ZIF DIP IC socket. The universal SMT-84 surface-mount socket accepts 20- to 84-pin plastic leaded chip carriers and small-outline packages. BP-1200/32, \$2500; BP-1200/40, \$3000; BP-1200/48, \$3500. SMT-84 surface-mount socket, \$750; individual plastic-leaded-chip-carrier sockets, \$90.

BP Microsystems Inc, 10681 Haddington Dr, Houston, TX 77043. Phone (800) 225-2102; (713) 461-9430. Booth 1106. Circle No. 403

Switching Power Supply

The ZPS-45 switching power supply operates with a single-phase 85 to 265V ac or 120 to 364V dc input voltage. The unit provides 40W max using convection cooling and 45W max using air-flow cooling. The triple-output unit supplies 5V dc at 5A; 12V dc at 2A; and -12V dc at 0.7A. The 5V output has a

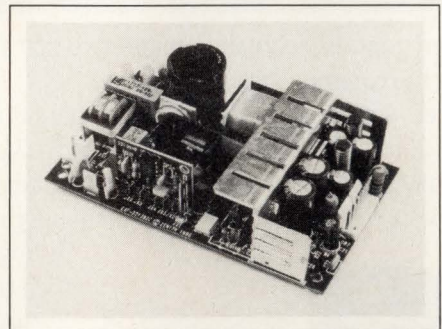

$\pm 3\%$ load regulation. The $\pm 12V$ outputs have $\pm 5\%$ load regulation. The supply resides on a 3 x 5-in. pc board and has a 1.25-in. profile. The supply meets FCC Part 15J Class B and VDE 0871/B EMI emission standards and has a 100,000 MTBF. \$55.

Zenith Magnetics, 1000 Milwaukee Ave, Glenview, IL 60025. Phone (708) 391-8510. FAX (708) 391-7078. Booths 1101 to 1105. Circle No. 404

It's our process that makes them compatible.

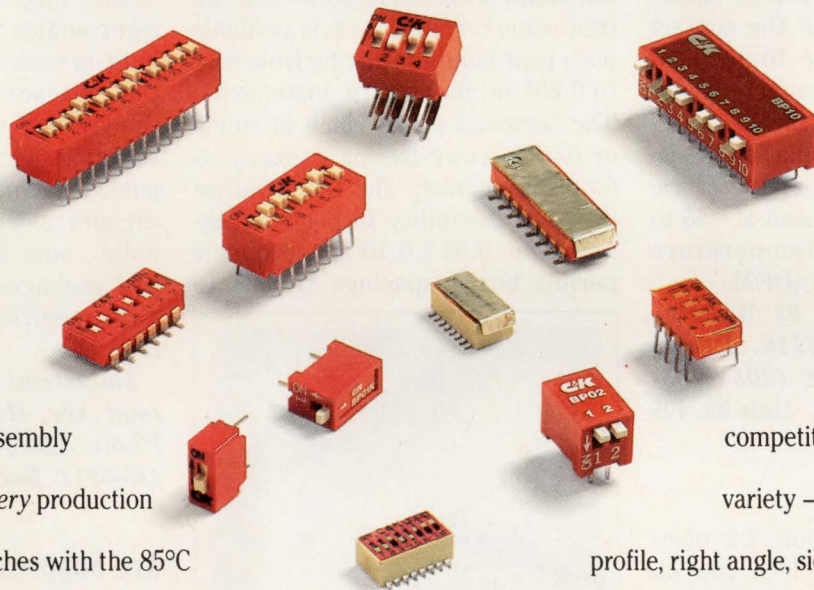

Our DIP switches are compatible with today's demanding assembly methods. We audit every production lot of sealed DIP switches with the 85°C Flourinert 60-second immersion test for proven seal integrity. We apply this same care to our entire line of DIP switches to guarantee the highest

quality standards. High quality at a competitive price. Broadline variety – surface mount, low profile, right angle, side actuated and our new .050 pitch miniature make C&K your primary DIP switch source. For free catalog and engineering samples – Call (800)635-5936 or Fax (617)527-3062.



C&K Components, Inc.
15 Riverdale Avenue
Newton, MA 02158-1082

The Primary Source Worldwide®

Manufactured in the USA: MA, NC, CT; and Worldwide: Hong Kong, England, Costa Rica

See us at Electro/92 Booth #1510, 11511 & 1512
CIRCLE NO. 98

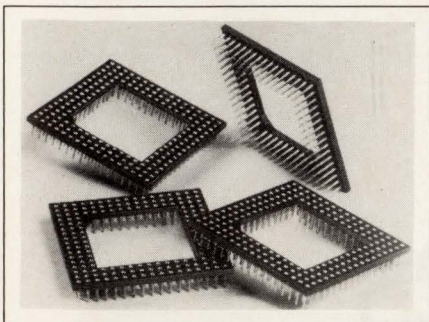

PGA Sockets

The Series MD cold-formed pin-grid-array (PGA) sockets come in five grid sizes ranging from 11×11 to 17×17 pins. The sockets have 68 to 168 pins. Seamless BeCu contacts require a typical insertion force of 1.5 oz. Molded standoffs and a liquid-crystal-polymer insulator allow vapor-phase or IR soldering. A cold-form sleeve prevents solder wicks from forming in the contact area. Features include 10-mΩ contact resistance, 3A contact rating, 2-pF contact-to-contact capacitance, 1×10⁶-MΩ insulation resistance, 1000V ac (rms) dielectric withstanding voltage, and a -55 to +125°C operating temperature range. \$0.01 to \$0.018 (OEM).

Marc Eyelet Inc, 63 Wakelee Rd, Wolcott, CT 06716. Phone (203) 756-8847. FAX (203) 755-9410. Booth 4318. Circle No. 405

CAD Software

The HiWire II Version 2.2 electronic CAD package lets you do schematic capture and circuit-board design. A menu-driven executive program automatically organizes projects and files. A graphical editor uses a single pull-down menu, which contains frequently used commands. You can draw schematics and circuit-board drawings having as many as 200 ICs within the 640-kbyte MS-DOS limit. In addition, the editor supports 32 Mbytes of expanded memory and 15 Mbytes of extended memory for more complex designs. The drawing grid can

be in inch or millimeter scales. A utility for rubber bands and rats nests simplifies both editing and placement. Two autorouters feature 1-mil resolution and support buried and through-hole vias. From \$995 to \$2395.

Wintek Corp, 1801 South St, Lafayette, IN 47904. Phone (800) 742-6809; (317) 742-8428. FAX (317) 448-4823. TLX 709079. Booth 1216. Circle No. 406

Terminal Strips

The company has expanded its line of 0.05-in. microconnectors to include headers having variable post and body heights. The MTMS Series lets you order custom post heights without long lead times or minimum orders. The 0.05×0.10-in. centerline terminal strip is available with post heights ranging from 0.10 to 0.605 in. in 0.005-in. increments. The terminal strips come in single or double rows having as many as 50 positions/row. The DWM Series provides flexibility in board stacking. The 0.05×0.10-in. terminals permit board spacings of 0.38 to

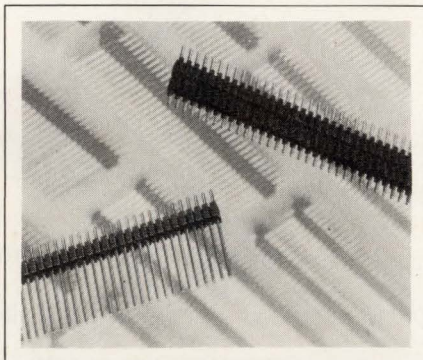

0.92 in. when they mate with the company's SLM and SMS Series socket strips. Plating options and a variety of lead styles are available for both series. MTMS and DWM Series, from \$0.028 and \$0.031 per pin, respectively.

Samtec Inc, Box 1147, New Albany, IN 47151. Phone (800) 726-8329. FAX (812) 948-5047. Booth 3322. Circle No. 407

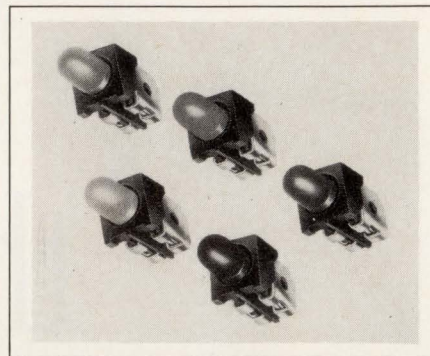

Surface-Mount LEDs

The SMT LEDs are a line of T-1 and T-1 3/4 surface-mount LEDs. The LEDs are available in five colors—red, green, amber, yellow, and blue. Bicolor (red/green) LEDs are also available. The units withstand IR and vapor-phase mounting and have standoffs to ease cleaning solder flux. The LEDs mount at right angles to the board and have built-in resistors for 5 or 12V operation. A black-molded housing meets the UL 94V-0 rating. Solder-coated terminals employ a self-aligning 6-point attachment to ensure electrical and mechanical integrity. The units come in antistatic tape and reel packages that conform to EIA 481 specifications. From \$0.78 (1000).

Industrial Devices Inc, 260 Railroad Ave, Hackensack, NJ 07601. Phone (201) 489-8989. FAX (201) 489-6911. Booth 1430. Circle No. 408

Arc Suppression Networks

The Type LNEM metalized-polyester suppression network suits arc-suppression and snubber applications. The network provides a series-connected capacitor and resistor in a single component. Laser-produced patterns create 60 to 1000Ω resistors that dissipate 0.5 to 2W. Capacitance is 0.1 or 0.5 μF (±20%), rated for 600V dc or 250V ac. The unit has been tested to withstand one billion 330V peak-to-peak pulses. The axial-lead networks are available in bulk quanti-

TO-5 RELAY TECHNOLOGY

The Surface Mount Centigrad[®]

- Leads formed for direct surface mounting
- High performance military relay
- RF switching through 1 GHz

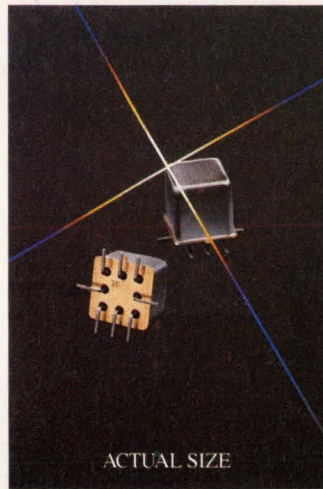

There's only one new thing about the newest Centigrad[®] relay. It has leads formed for direct PC board surface mount "onsertion."

Everything else is the same. The same 100% all welded construction and rugged uniframe design. Operating power as low as 200mW. High force/mass ratios for increased resistance to shock and vibration.

Electrical characteristics are the same, too. Precious metal

contact material with gold plating assures switching capabilities from dry circuit to 1 amp. Low intercontact capacitance and contact circuit losses make it an excellent choice for RF switching at frequencies through 1 GHz.

In other words, Teledyne Relays has done it again. We've taken a popular, reliable product based on proven TO-5 technology, and adapted it to the latest produc-

tion techniques without affecting its performance. And it's that performance, after all, that has won Centigrad its place in your hearts and designs.

The Surface Mount Centigrad. It's available in both general purpose and sensitive versions. Call or write today for complete information.

 **TELEDYNE RELAYS**
Innovations In Switching Technology

Home Office, 12525 Daphne Avenue, Hawthorne, CA 90250 • Telephone: 213-777-0077 • FAX: 213-779-9161

U.S. REGIONAL SALES OFFICES: EASTERN: (908) 272-0020, SOUTHEAST: (407) 682-9044, NORTH CENTRAL: (708) 529-1060, CENTRAL: (214) 348-0898, WESTERN: (408) 978-8899.
OVERSEAS: GERMANY, 0611-7636-0, ENGLAND: (081) 571-9596, FRANCE: 47-61-08-08, BELGIUM: (02) 673-99-88, JAPAN: (3) 3797-6956.

ties or tape and reel packages for automatic insertion. 0.1 μ F, 600V dc, 100 Ω , 0.5W unit; \$0.58 (1000).

Aerovox, 742 Belleville Ave, New Bedford, MA 02745. Phone (508) 999-1000. FAX (508) 990-8696. Booth 2221. Circle No. 409



Optical Rotary Encoder

The Series 61 optically coupled rotary-encoder switch provides two quadrature encoded output signals. The switch produces the output signals by interrupting a light beam or allowing light to fall on a pair of phototransistors. Because there are no metal-to-metal contacts, the switch's rated lifetime is one million cycles of operation. An integral pushbutton switch lets you set the 2-bit output code for a desired setting. \$10.50 (100).

Grayhill Inc, 561 Hillgrove Ave, LaGrange, IL 60525. Phone (708) 354-1040. FAX (708) 354-2820. Booths 3504 and 3506. Circle No. 410

Switching Power Supplies

The MSC Series includes 350, 400, and 750W triple-output and a 400W dual-output switching power supplies. The supplies power multiple synchronous disk-drive systems. Each supply can maintain 1% regu-

lation on the 12V line when powering as many as 16 disk drives. The 350 and 400W triple-output units deliver 35A from a primary 5V output and 26A peak from secondary \pm 12V outputs. The 750W unit delivers 120A from 5V, 27A from 12V, and 6A from -12V. The 400W dual-output unit has input and output connectors instead of standard barrier strips. The dual-output unit delivers 20A at 5V and 25A from 12V. An autorange option automatically selects a 115 or 230V ac range. \$300 to \$500.

Todd Products Corp, 50 Emjay Blvd, Brentwood, NY 11717. Phone (800) 223-8633; (516) 231-3366. FAX (516) 231-3473. Booths 5308 and 5310. Circle No. 411

DIN Enclosures

The E Series DIN-standard enclosures are available in a black wrinkle-finish powder coat. The enclosures are made from extruded aluminum shapes that lock together to create rectangular or square enclosures of any length. Standard units are 6- or 8-in. deep and have integral grooves that are 0.08-in. wide on

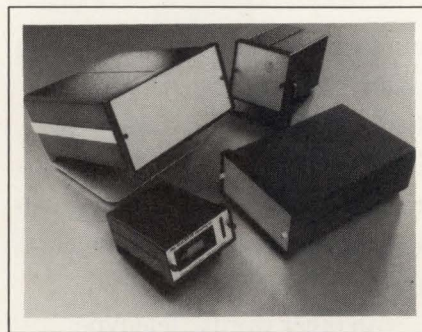

0.2-in. centers. The spacing lets you mount boards vertically or horizontally. Side bars lock the units in place when you mount them in a panel. The enclosures have a PVC vinyl-coated tilt handle. A 44 \times 91-mm, 6-in.-deep case, \$16.05 (25).

Buckeye Stamping, 555 Marion Rd, Columbus, OH 43207. Phone (614) 445-8433. Booths 4404 and 4406. Circle No. 412

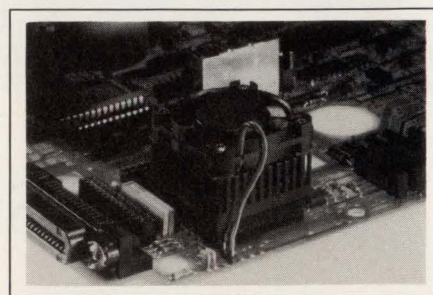

PGA Cooling Modules

The Thermalloy Cooling Modules consist of a pin-fin heat sink and a brushless dc fan. The five standard modules cool Intel's i486, i860, i960, Advanced Micro Devices' Am29000, and Motorola's 68040 μ Ps. The units also fit on pin-grid arrays (PGAs) having 15 \times 15, 17 \times 17, 18 \times 18, or 21 \times 21 pins. You can select a 5 or 12V fan for the module. Cooling with a 5V fan is 5 to 9 times more efficient than natural convection cooling and 2.7 times more efficient than forced-air convection at a 400 ft/min (fpm) linear airflow. For example, a module for a 17 \times 17-pin PGA has a thermal resistance of 1.4 $^{\circ}$ C/W as compared with 10 $^{\circ}$ C/W for natural convection cooling and 3.9 $^{\circ}$ C/W for 400-fpm forced-air cooling. \$13.24 (500).

Thermalloy Inc, Box 810839, Dallas, TX 75381. Phone (214) 243-4321. FAX (214) 241-4656. TLX 203965. Booth 5136. Circle No. 413

Impact Printers

The TG and TXG Series impact printers come in an injection-molded housing having a 7.8 \times 6-in. footprint. The nine models provide a range of 24 to 42 print columns and have an RS-232C, RS-422, or Centronics parallel port. The 24-column model prints 144 dots/line; the 42-column model prints 252 dots/line. An input buffer and bit-image graphics are standard on all models. The TXG Series has a 6912-character input buffer, and the TG Series has a 2048-character input buffer. The units operate from a

All the μ C Peripherals you need.



In one chip.

PSDTM3XX: A family of field-programmable peripherals with logic and memory. For embedded-control designs.

WSI's PSD3XX single-chip μ C peripherals pack all the programmable logic, SRAM, and EPROM needed for your embedded-control design. Plus advanced features like paging, cascading, address/data tracking — and more. PSD3XX devices configure in just minutes to interface with any 8- or 16-bit microcontroller. And they're available with 256Kb, 512Kb, or 1Mb of program store to suit every embedded-control design.

In use the world over, PSD3XX μ C peripherals are the ideal solution wherever higher-level integration is required: from industrial controllers to cellular phones — and thousands of other applications.

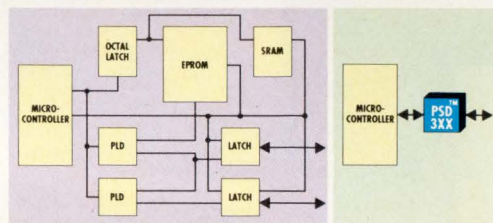

For a *free* design kit, call today:



47280 Kato Road
Fremont, California 94538

800/877-6220

In Canada, call Intelatech, Inc.: 416/629-0082

The new Tektronix 224 is as powerful as they come. And goes!

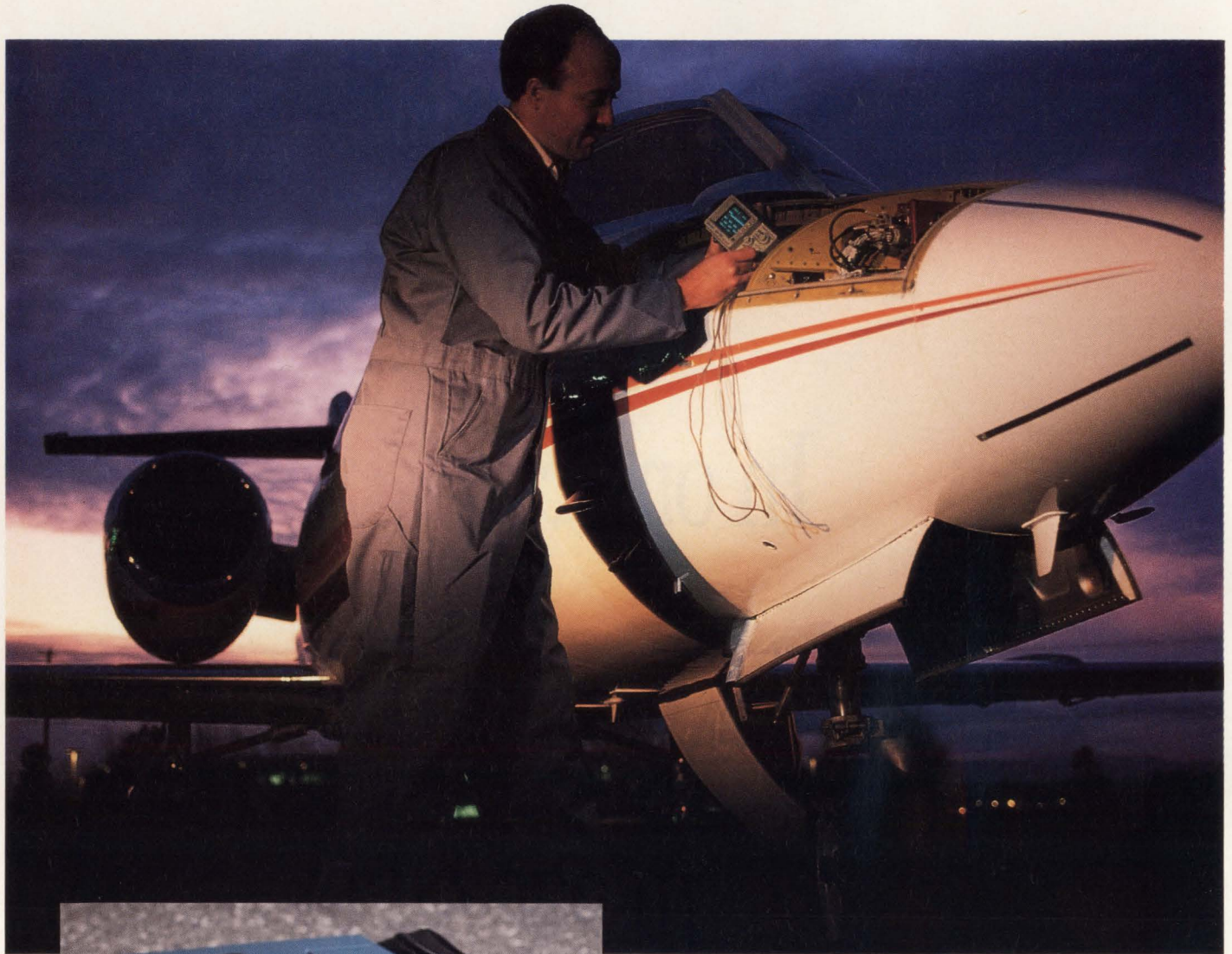

With this new 60 MHz digital oscilloscope, Tektronix takes handheld performance to an even higher plane! The 224 packs more power per pound than any other product and — with its on-board rechargeable batteries — goes wherever duty calls.

With its exclusive IsolatedChannel™ architecture, you can make two-channel floating measurements without the risk of shock or damage to delicate electronics. Such standards as Tek's sharp, bright CRT, rapid update rate and wide viewing angle make measuring fast and efficient. And the 224's familiar front panel and fully automated features keep it simple.

You get advanced capabilities like video line triggering and 10 MS/s digitizing per channel for excellent single-shot performance, plus time-correlated single-shot waveforms for easy comparison. With CAT200 software you can even control the 224 over phone lines from halfway round the world.

Call 1-800-426-2200 Ext. 83 to get the full story. We'll show you more of the 224 — and ways it's giving bench performance wings!

Tektronix
Test and Measurement

TEKTRONIX DISTRIBUTORS TEST AND MEASUREMENT PRODUCTS Stocking Distributors

Alaska

Frigid North
Anchorage, AK
(907) 561-4633

Arizona

CMI-Metermaster
Tempe, AZ
(602) 431-0880

Jensen Tools Inc.

Phoenix, AZ
(602) 968-6241

Arkansas

Carlton Bates
Little Rock, AR
(501) 562-9100

California

Instrument Engineers
San Diego, CA
(619) 268-8344

ITC Electronics

Los Angeles, CA
(213) 388-0621

Marshall Industries

El Monte, CA
(800) 522-0084

RAG

Canoga Park, CA
(818) 998-6500

Zack Electronics

Milpitas, CA
(408) 942-5432

Florida

EMSCO
Orlando, FL
(407) 849-6060

Georgia

Dow Electronics, Inc.
Norcross, GA
(404) 446-2620

Illinois

Joseph Electronics
Niles, IL
(312) 297-4200

Klaus Radio, Inc.

Peoria, IL
(309) 691-4840

W.W. Grainger

North Suburban, IL
(708) 913-7459
(800) 521-5585

Maryland

HARCO
Aberdeen, MD
(301) 838-7990

TESSCO

Hunt Valley, MD
(301) 785-5300

Massachusetts

Contact East
North Adover, MA
(508) 682-2000

Michigan

Great Lakes
Battle Creek, MI
(616) 963-6282

R.S. Electronics

Livonia, MI
(313) 525-1155
(800) 366-7750

Minnesota

Stark Electronics Supply
Minneapolis, MN
(612) 332-1325

Missouri

Olive Electronics
Maryland Heights, MO
(314) 997-7709

Electronic Supply Co.

Kansas City, MO
(314) 931-0250

ISL Corporation

St. Louis, MO
(314) 423-3141

New Mexico

Electronic Parts Co.
Albuquerque, NM
(505) 293-6161

New York

Instrument Mart, Inc.
Great Neck, NY
(516) 487-7430

Transcat

Rochester, NY
(716) 458-4801
(800) 828-1470
(outside New York)

Pennsylvania

Leff Electronics
Braddock, PA
(412) 351-5000

Sunshine Scientific

Instruments, Inc.
Philadelphia, PA
(215) 673-5600

South Carolina

Dixie Electronics
Columbia, SC
(803) 779-5332

Texas

INOTEK
Dallas, TX
(214) 243-7000

ENTEST

Dallas, TX
(214) 980-9876

Utah

Standard Supply Company
Salt Lake City, UT
(801) 486-3371

Washington

Radar Electric
Seattle, WA
(206) 282-2511

120V ac wall-mount power supply; a 12V dc power input is available as an option at no extra cost. Options for the TG series include one or two cash-drawer drivers for point-of-sale applications. From \$177 (100). Delivery, 8 to 10 weeks ARO.

Telpar Inc, Box 796, Addison, TX 75001. Phone (214) 233-6631. FAX (214) 233-8947. Booth 2308.

Circle No. 414

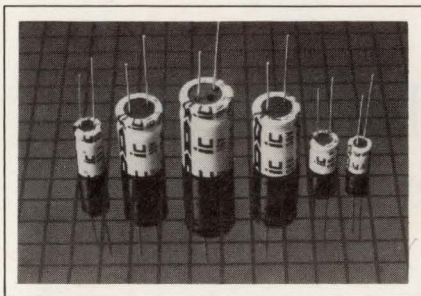

Aluminum Capacitor

A line of low-leakage, radial-lead, aluminum capacitors offers an alternative to tantalum capacitors. The devices feature a 0.1- to 1000- μ F capacitance range, a working voltage range of 10 to 50V dc, a minimum leakage current of 0.4 μ A; an operating temperature range of -40°C to $+85^{\circ}\text{C}$; and a storage temperature range of -55°C to $+85^{\circ}\text{C}$. Standard capacitance tolerance is $\pm 20\%$; $\pm 10\%$ tolerance is optional. From \$0.04 (1000).

Illinois Capacitor Inc, 3757 W Touhy Ave, Lincolnwood, IL 60645. Phone (708) 675-1760. FAX (708) 673-2850. TLX 724361. Booth 4514.

Circle No. 415

Digital Voltmeter

AP-501 Series digital voltmeters have a 3 $\frac{1}{2}$ -digit LED display and a measurement accuracy of 0.1% of the reading or 1 digit at room temperature. The four meters in the series span the measurement range from 200 mV to 200V. The two low-voltage models have a differential

input, and the two high-voltage models have a single-ended input. Other features include automatic zero and decimal-point adjustment. When an input signal exceeds the display range, the meter displays an overrange indicator. The meters measure 48 \times 96 \times 12.2 mm and weigh 50 grams. The meter's conversion rate is 2.5 sec. \$71.

Delco Products Co, 7580 Stage Rd, Buena Park, CA 90621. Phone (800) 257-3526; (714) 521-8673. FAX (714) 739-1507. Booth 4305.

Circle No. 416

PC-Board AC/DC Converters

The YAS and YAW series 5 and 10W ac/dc converters have single and dual outputs, respectively. The units mount to a pc board and have autoranging inputs that handle 100 to 240V ac. The 5W units measure 58 \times 45 \times 19.5 mm, and the 10W units measure 65 \times 45 \times 21 mm. Both series come in 5V, ± 12 V, or ± 15 V output models. Other features include 20-msec holding time,

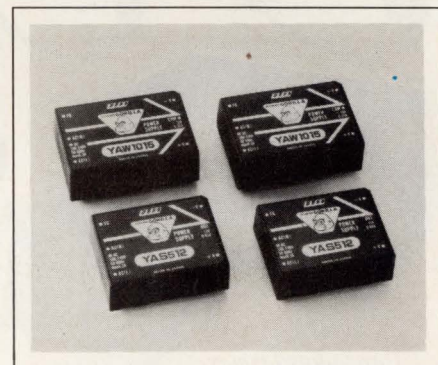

47- to 440-Hz frequency range, typical inrush current of 20A for 100V ac inputs and 40A for 200V ac inputs, and automatic recovery from overcurrent operation. The units operate from 0 to 55 $^{\circ}\text{C}$. They can withstand 10g vibration from 10 to 55 Hz and an impact of 50g for 11 msec. \$41 to \$48 (100).

US Elco Inc, 2930 Scott Blvd, Santa Clara, CA 95054. Phone (800) 888-3526. FAX (408) 980-9754. Booth 1405.

Circle No. 417

Tektronix

Test and Measurement

Power Supply

The M series 3500W power supply comes in a 5×8×11.5-in. package. Models in the series have 2 to 6V dc outputs. Because the 100-kHz switcher has a current-controlled MOSFET H-bridge, you can connect as many as eight supplies in a parallel current-sharing configura-

tion. The supply has overvoltage, overcurrent, and over-temperature protection. The supply accepts a 3-phase, 47- to 63-Hz, 220V ac input or a 230V dc input. An input power-fail flag indicates when the input power drops below the minimum line voltage. Other features are 0.1% line regulation, 0.2% load

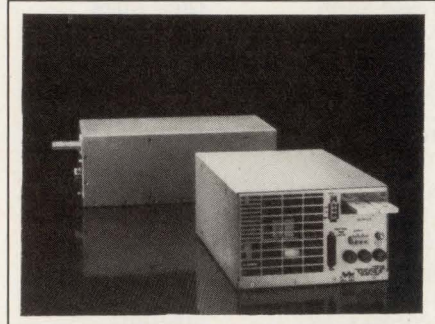

POWER SYSTEM DESIGNER'S CASEBOOK

What's the *One* Thing that Every Distributed Power System Needs?

A reliable, high-efficiency low-cost front end.

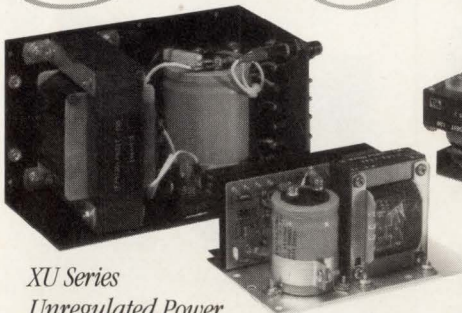

XU Series Unregulated Power Supplies are also the perfect choice for other applications like relays, stepper motors and dc lamps.

And the most reliable, high-efficiency, low-cost front end you can get is an XU Series Unregulated DC Power Supply from Xentek. XU

Series models are available in output power ratings from 15W to 1000W. Input is 115/230VAC, 50/60Hz. Output voltage is your choice — up to 48VDC in standard models. And all standard XU models are recognized under UL478. It's just what *your* distributed power system needs.

Xentek

A Taiyo Yuden Company

THE POWER TO SUCCEED

760 Shadowridge Drive / Vista, CA 92083 / (619) 727-0940 / Fax: (619) 727-8926

regulation, and a maximum inrush current of 30A peak. The unit weighs 22 lbs. \$2495.

Opt Industries Inc, 300 Red School Lane, Phillipsburg, NJ 08865. Phone (908) 454-2600. FAX (908) 454-3742. Booths 5128 and 5130.

Circle No. 418

Spectrum Analyzer

The Model 2610 portable RF spectrum analyzer can operate at 1.0 GHz. The 4.5×11.8×13.4-in. unit weighs 20 lbs and runs from ac or battery power. For communications measurements, you can select a fixed RF bandwidth of 1 MHz regardless of the scan-width setting. The analyzer has a rechargeable battery and battery charger as well as a 100-MHz, 80-dB μ V calibration signal. The unit has a switch-selectable input impedance that



matches either 50 or 75 Ω cable. The analyzer comes with a 75 Ω input cable, BNC-to-F connector adapter, CRT hood, adjustment tool, spare fuses, and a manual. \$2995.

B+K Precision, 6770 W Cortland Ave, IL 60635. Phone (312) 889-1448. FAX (312) 794-9740. Booth 2132.

Circle No. 419

WE'VE GOT TWO WORDS FOR PEOPLE LIKE YOU.

FAX VODem™ \ faks-vo-dem \ n
[origin: Yamaha LSI] **1:** world's first single-chip
multimedia communications device **2:** Fax/data/
ADPCM voice and caller I.D. **3:** transfers data,
fax and voice via a single line

If you're one of those people who goes around integrating communications devices into PCs, laptops and other hardware, we've got two words for you — FAX VODem™.

What do they mean? In a word, plenty. Yamaha defined FAX VODem on September 26, 1991, as a major breakthrough in multimedia communications. And now it's going to change the way you communicate. Because with FAX VODem, you'll be able to integrate Fax. Data. ADPCM voice communications. And caller I.D. All on a single line. And all with a single-chip LSI that'll give your products multimedia communications capabilities you never thought possible.

Sound too good to be true? It's not. And we'd like to prove it to you. Just call us at 1-800-543-7457 or write and we'll send you all the nitty gritty technical details that wouldn't fit in this ad.

So start integrating FAX VODem into your new products. And when your colleagues notice what a great communicator you've become, just tell them you've got two words for people like them.

YAMAHA[®] LSI

Yamaha Corporation of America
Systems Technology Division
981 Ridder Park Drive, San Jose, CA 95131
(408) 437-3133 FAX (408) 437-8791

Portable Digital Oscilloscope

The 465 portable digital oscilloscope can simultaneously sample two channels at 200 Msamples/sec, thus providing a 100-MHz signal bandwidth for both channels. The unit has a 2-Gsample/sec equivalent time-sampling rate for repetitive signals. Other features include 8-bit resolution for all input sensitivities,

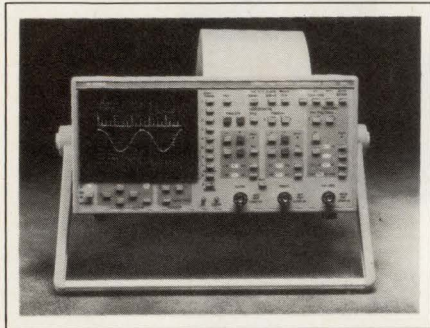

three nonvolatile waveform memories, 400V input protection, and a battery option for field-service ap-

plications. The scope conforms to the IEEE-488.2 Standard Commands for Programmable Instruments (SCPI) standard. On-screen cursors facilitate voltage and time measurements, and the automatic setup feature evaluates a signal to optimize scope settings. \$3490.

Gould Inc, Test and Measurement Group, 8333 Rockside Rd, Valley View, OH 44125. Phone (216) 328-7263. FAX (216) 328-7400. Booth 2303. Circle No. 420

Vertical Enclosures

Models in the Frugal Frame line of vertical enclosures incorporate top and base cowlings as part of the frame. The enclosures accept most of the company's accessories, including cooling devices, mounting channels, hardware, shelves, power strips, drawers, writing surfaces,

panels, and doors. The enclosures are available in 21- to 78-in. panel heights having 19-in. widths. Depths of 25½ or 30 in. are optional. The enclosures have a textured finish, and panels, doors, and tops are available in a variety of standard colors. A modular design permits series-mounted and multibay configurations. Typical cost for a 61 × 19 × 25½-in. console is \$450 including frame, top panel, side panels, and rear door.

Amco Engineering Co, 3801 N Rose St, Schiller Park, IL 60176. Phone (800) 833-3156; (708) 671-6670. FAX (708) 671-9469. Booths 1415 and 1417. Circle No. 421

Futurebus + Products

A line of Futurebus+ floor-standing tower chassis meets Profile A, B, and F specifications. The multi-

HARRIS GENERATES INNOVATIONS WITH

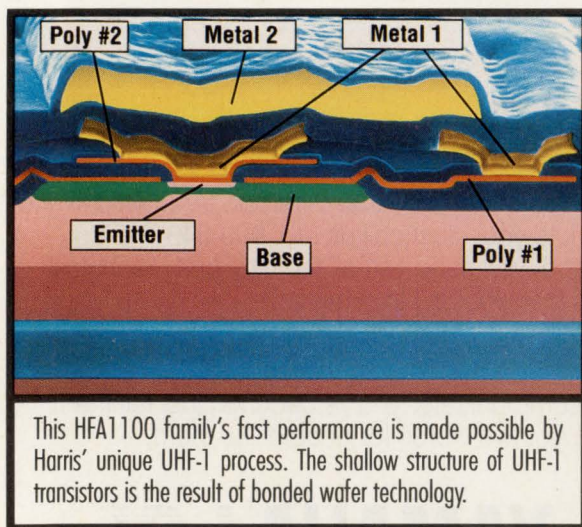

This HFA1100 family's fast performance is made possible by Harris' unique UHF-1 process. The shallow structure of UHF-1 transistors is the result of bonded wafer technology.

Harris HFA1100

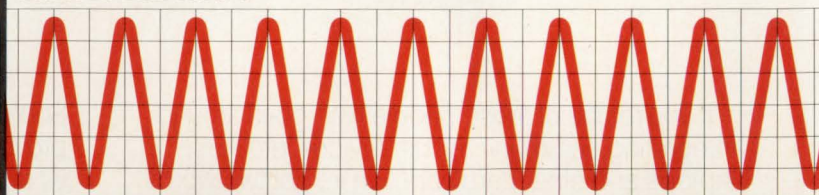

Ordinary high-speed op amp

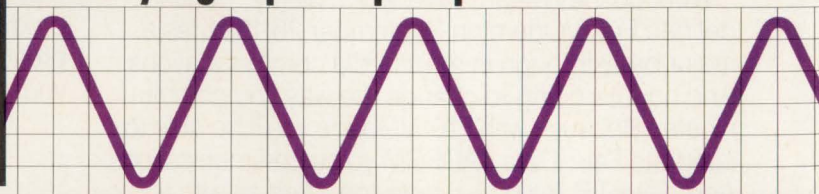

Once again, the latest breakthrough in ultra-high-speed op amps comes to you from Harris.

This time, it's the HFA1100. Three times as fast as the old record holder. And just what

fast-thinking engineers like you have been waiting for. Quickly imagine what you can do with a bandwidth so huge. Providing excellent phase linearity and a remarkable gain

flatness of 0.14 dB to 100 MHz.

And your creativity needn't stop with standard products. Because the HFA-1 process is available in semicustom, as part of Harris' industry-leading

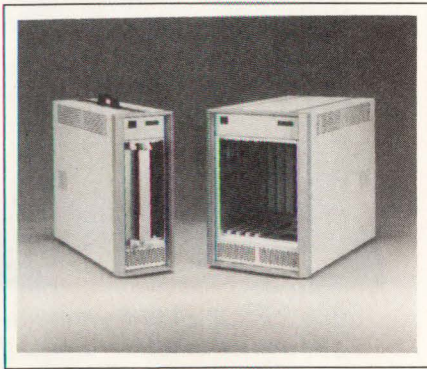

layer 64-bit, 192-pin backplane has three I/O slots. The chassis feature RFI/EMI shielding and come with a fan and power supply. A line of backplanes that meet Profile A, B, and F specifications is also available. The multilayer, impedance-controlled backplanes have 3 to 14 slots and 192 I/O pins for 64-bit data transfers. The backplanes feature surface-mount terminators, distributed and central arbitration, and 2-

mm metric connectors. Chassis, from \$3000. Backplanes, from \$850 for a 3-slot version; \$2150 for a 14-slot version.

Schroff Inc, 170 Commerce Dr, Warwick, RI 02886. Phone (800) 451-8755; (401) 732-3770. FAX (401) 738-7988. Booth 5424.

Circle No. 422

Digital Multimeter

The Model 2001 digital multimeter (DMM) has a resolution range of 4½ to 7½ digits. Other features include 18-ppm dc voltage accuracy (90 days); 0.05% ac voltage accuracy; average, rms, and peak ac measurements; frequency measurement to 15 MHz; a 1100V input rating; and a resistance resolution of 1Ω. You can program the DMM's 10-channel scanner to measure different functions on each channel. In addition,

the DMM can simultaneously display multiple measurements of the same signal. The DMM can take as many as 45 readings/sec, and you can specify the reading rate. The unit can change ranges and func-

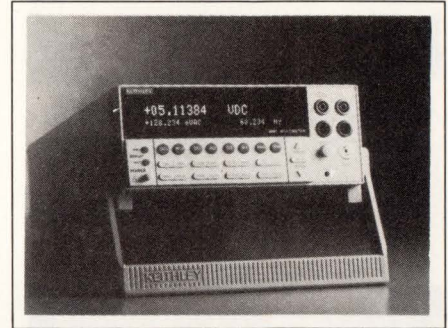

tions in 20 to 150 msec, and the trigger delay is 20 μsec. \$2695.

Keithley Instruments Inc, 28775 Aurora Rd, Cleveland, OH 44139. Phone (800) 552-1115; (216) 248-0400. FAX (216) 248-6168. Booth 2418.

Circle No. 423

ASTOUNDING FREQUENCY

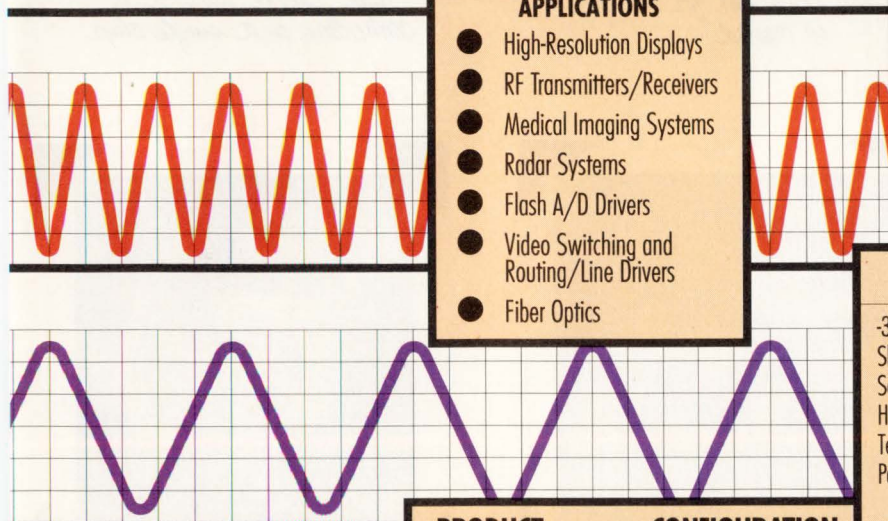

APPLICATIONS

- High-Resolution Displays
- RF Transmitters/Receivers
- Medical Imaging Systems
- Radar Systems
- Flash A/D Drivers
- Video Switching and Routing/Line Drivers
- Fiber Optics

PRODUCT

HFA1100 op amp
HFA1120 op amp
HFA1130 clamped op amp
HFA1110 buffer
HFA1112 buffer

CONFIGURATION

Standard pinout
Output offset adjust
User-defined output clamp
Standard buffer pinout
Standard op amp pinout

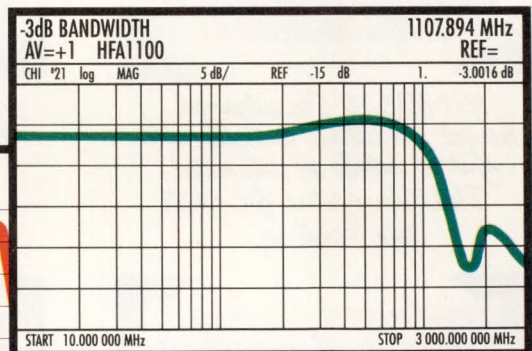

	HFA1100/20/30	HFA1110/12
-3dB Bandwidth	870 MHz	700 MHz
Slew Rate	2500V/μsec	2500V/μsec
Settling Time (0.1%)	11 ns	7 ns
High Current Output	60 mA	60 mA
Temperature Range	-40°C to 85°C	-40°C to 85°C
Packages	8-pin PDIP, CerDIP, SOIC	8-pin PDIP, CerDIP, SOIC
Price (100s)	\$9.95	\$5.95

FASTRACK™ design system.

So rev up your oscilloscopes. And get your hands on some HFA1100s today. Just call 1-800-4-HARRIS, ext. 1173. Today.



CIRCLE NO. 104

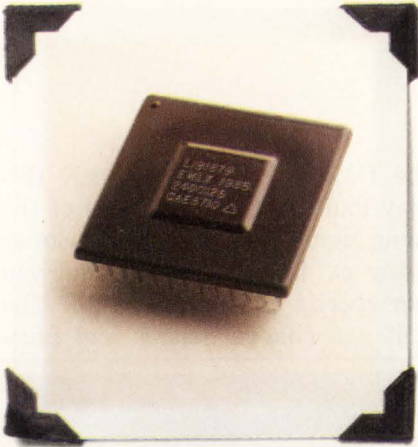

1986-MAC100. We introduce a combined disk formatter and buffer controller in a single disk controller chip.

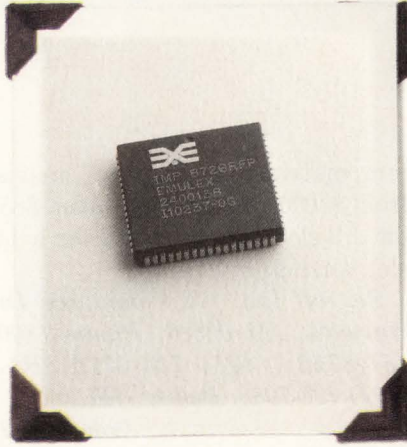

1987-ESP100. The industry's first high-performance SCSI chip is born at Emulex.

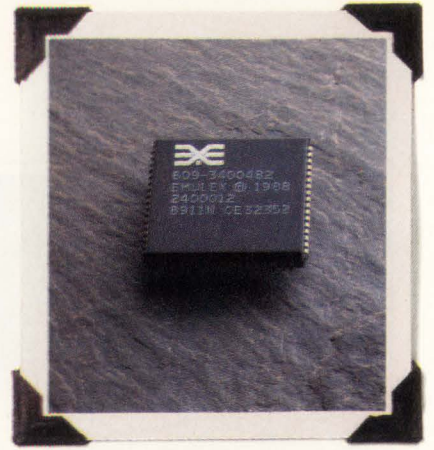

1988-ESP200. Second generation SCSI arrives with SCSI-2 support and parity pass-through.



1988-MAC200. Our advanced merged architecture controller is the first to include an automated Data Flow feature for faster data handling.

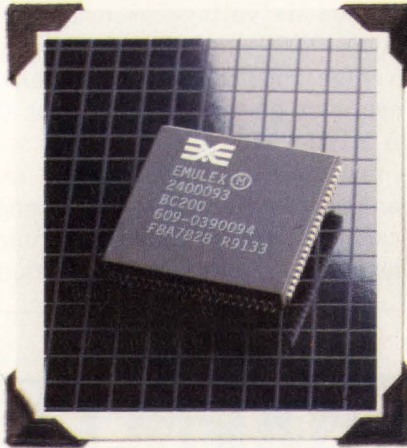

1989-BC200. A dynamic 4-port DMA controller for DRAMs is created.

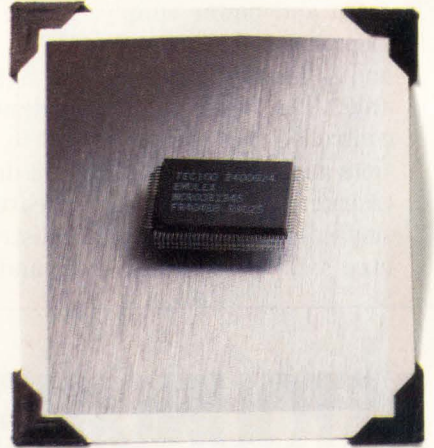

1989-TEC100. EMD combines disk, buffer, and SCSI controllers in a single chip.

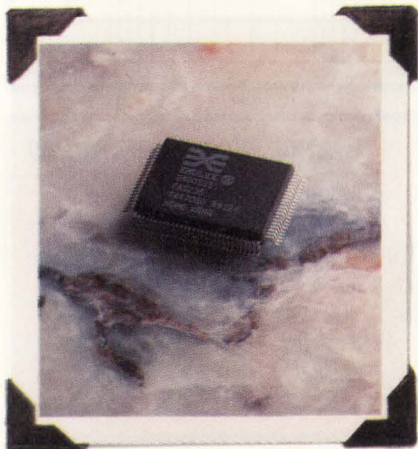

1990-FAS236. We deliver the first Fast SCSI chips with a 16-bit DMA port.



1991-TEC 200. Our second-generation TEC becomes the industry's first Fast single-chip disk controller.



1991-TEC256. The first Fast and Wide SCSI disk controller also boasts the fastest disk data rate and highest system bandwidth.



1988-ESP2X6. We give SCSI a 16-bit split-bus architecture for greater efficiency and throughput.



1990-TEC 100A. Mid-to-low capacity SCSI drives get a reduced-price version of the TEC 100.

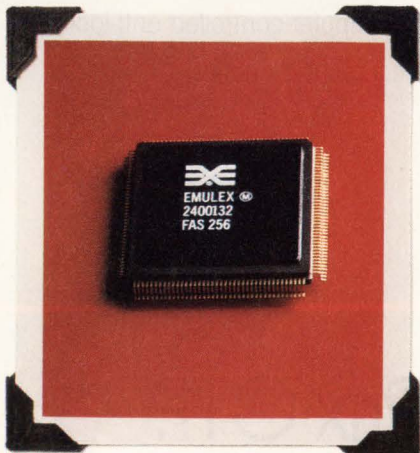

1991-FAS 256. 16-Bit Fast and Wide SCSI brings SCSI-2 support to host adapters and peripherals including drive array applications.

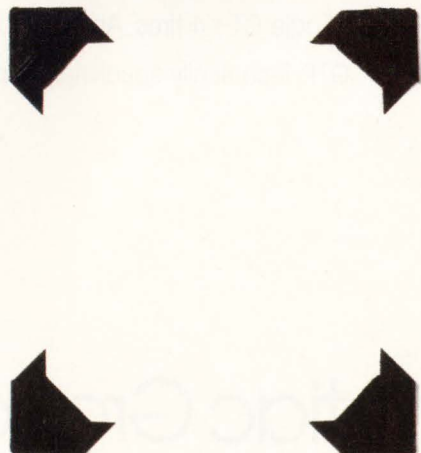

1992-Emulex Chips. A whole new generation of firsts is due.

WE CREATED A FAMILY OF FIRSTS. WE'RE NOT DONE YET.

In all honesty, we've been building a history of innovative microcontroller products for disk and system applications right from the start.

In fact, the first high-performance SCSI chips we designed have become an industry standard in workstation and PC platforms. And our ESP chips have been so popular they're the interfaces of choice for OEMs and systems integrators worldwide.

But that's just for openers.

We've continued to lead the evolution of SCSI power—in speed, single-chip integration, full SCSI-2 support, Fast and Wide architecture, and more. Plus, we've created matching disk controller and buffer controller devices.

And now we're preparing to launch a new generation of products—a whole new family of microcontrollers...to again pioneer new industry standards in SCSI and other bus interfaces.

Look for our announcements to start soon.

Or if you can't wait, call us. We'll send you a preview of the big picture—so you can begin to spec for the future...now.

Firsts are part of our tradition. And we're not done yet.

Emulex Micro Devices.



3545 Harbor Blvd., Costa Mesa, CA 92626
Outside California: 1-800-ON-CHIP-1
Inside California: (714) 662-5600

Emulex Micro Devices Sales Representatives: NEW ENGLAND: Advanced Tech Sales, Inc. (508) 664-0888 • CANADA: Electro Source (416) 675-4490 • MICHIGAN: JMJ Associates (616) 774-9480 • SOUTHEAST: Montgomery Marketing, Inc. (919) 851-0010 • MIDWEST: Oasis Sales Corporation (708) 640-1850 • NORTHERN CALIFORNIA: Promerge Sales (408) 453-5544 • NORTHWEST: QuadRep-Crown, Inc. (503) 620-8320 • SOUTHERN CALIFORNIA: QuadRep Southern, Inc. (714) 727-4222 • FLORIDA: Sales Engineering Concepts (407) 830-8444 • MID-ATLANTIC: T.A.I. Corporation (609) 778-5353 • ROCKY MOUNTAINS: Wescom Marketing, Inc. (303) 422-8957 • TEXAS FOUR-STATES: West Associates (214) 680-2800
© 1992 by Emulex Corporation. All rights reserved.

It's a Technical Knockout.

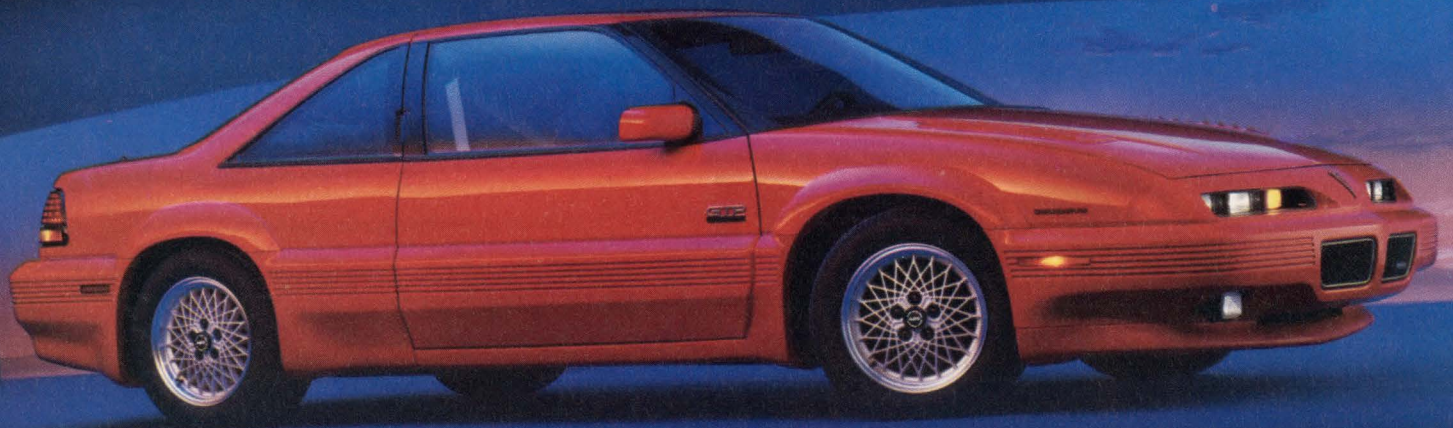

The tale of the tape says it all. Weighing in with 210 horsepower, the 24-valve Twin Dual Cam V6 GTP delivers the knockout punch in seconds. One look at its imposing body shows you why. It's pumped to the max and holds its ground with the help of a rally-tuned sport suspension. It moves on aluminum alloy wheels and 16" high-performance Goodyear Eagle GT+4 tires. And it stops with computer-controlled anti-lock brakes. The new Pontiac® Grand Prix™ GTP. Technically speaking, it's pure excitement in motion.

Pontiac Grand Prix GTP. A New Kind of Excitement.



PONTIAC CARES...with an extensive 3-year/36,000-mile no-deductible warranty (see your dealer for terms of this limited warranty) plus 24-hour Roadside Assistance. Call toll-free 1-800-762-4900 for more product information and dealer locations.  BUCKLE UP, AMERICA! © 1992 GM CORP. ALL RIGHTS RESERVED.

Phase compensation optimizes photodiode bandwidth

Jerald Graeme, Burr-Brown Corp

There is a trick to compensating photodiode amplifiers for stable operation and maximum bandwidth. Classical analysis is more likely to confuse you than to help you, but an intuitive understanding of the circuits' operation can quickly lead to selecting the best compensation.

Photodiodes' large capacitance severely restricts the bandwidth of basic photodiode circuits. An op amp connected as a current-to-voltage converter greatly improves the bandwidth by isolating the capacitance from the signal voltage. Removing the signal voltage from the photodiode prevents the diode's capacitance from shunting the signal away from the load. However, the current-to-voltage converter's interaction with the photodiode capacitance complicates calculating the stability conditions, the phase compensation, and the resulting bandwidth. Even so, by examining the circuit behavior, you can develop a simple, intuitive approach to each of these calculations.

When operated with a direct resistor load, as in Fig 1a, a photodiode exhibits a bandwidth limited mainly by its internal capacitance. In Fig 1b, which models the bandwidth limit, the photodiode acts primarily as a current source. A large resistance, R_D , and the capacitance of the diode junction, C_D , shunt this source. The capacitance ranges from 2 to 20,000 pF depending for the most part on the diode area. In parallel with the shunt is the monitor amplifier's input capacitance, C_{IA} . With the monitor amplifier shown, $C_{IA} = C_{ICM}$, the common-mode input capacitance of the op amp.

In practice, load resistances are small compared with R_D , so you can usually ignore the diode resistance. Similarly, the input resistance of the op amp is so high that the amplifier exhibits little shunting effect on R_L . The net input-circuit capacitance and R_L then deter-

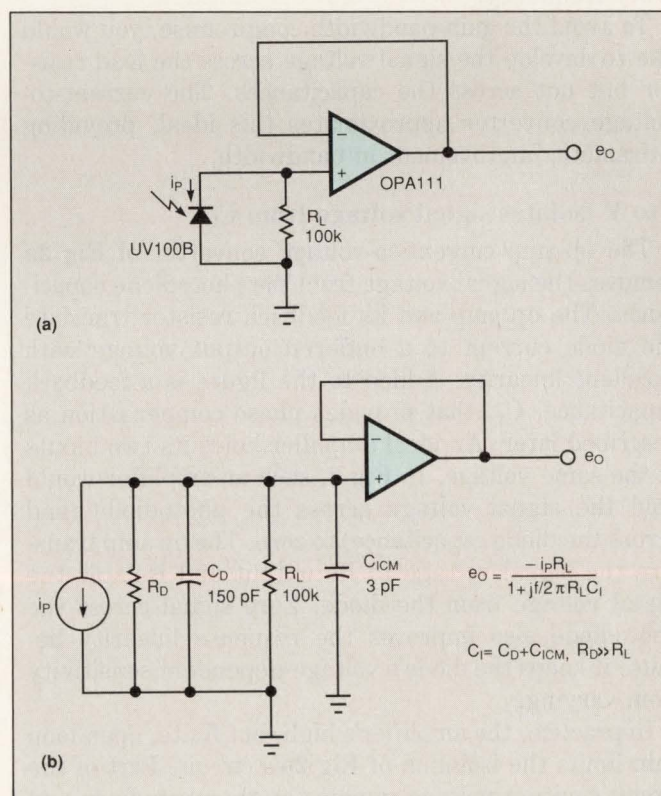

Fig 1—Load-voltage swing across the diode capacitance limits the basic photodiode bandwidth.

PHOTODIODE-AMPLIFIER PHASE COMPENSATION

mine the input circuit's response rolloff. The resulting input circuit response has a break frequency, f_1 . For Fig 1 the response is

$$\frac{e_o}{i_p} = \frac{-R_L}{(1+jf/f_1)}$$

where, $f_1 = 1/2\pi R_L C_1$,
and $C_1 = C_D + C_{ICM}$.

For this single-pole response, the circuit's -3-dB bandwidth equals the pole frequency and the typical components of the Fig 1 circuit set $BW = f_1 = 10$ kHz.

The above expression reflects a typical gain-vs-bandwidth compromise. Increasing R_L gives greater gain but reduces f_1 . From a circuit perspective, this compromise results from impressing the signal voltage on the circuit capacitances. The signal voltage in Fig 1b appears across C_D and C_{ICM} . The resulting capacitive currents shunt a portion of i_p , the signal current, away from the load resistor. Increasing R_L to raise the gain also increases the signal voltage on the capacitances and increases the portion of the signal current that the capacitances shunt away from the load. Such changes move the -3-dB response point of the circuit to a lower frequency.

To avoid the gain-bandwidth compromise, you would like to develop the signal voltage across the load resistor but not across the capacitances. The current-to-voltage converter approximates this ideal, providing a dramatic improvement in bandwidth.

I to V isolates signal voltage from C_1

The op-amp current-to-voltage converter of Fig 2a removes the signal voltage from the photodiode capacitance. The op amp and its feedback resistor translate the diode current to a buffered output voltage with excellent linearity. Added to the figure is a feedback capacitance, C_L , that provides phase compensation as described later. An ideal amplifier holds its two inputs at the same voltage. In Fig 2, such an amplifier would hold the signal voltage across the photodiode (and across the diode capacitance) to zero. The op amp transfers the signal voltage to its output and isolates the signal voltage from the diode. Zero signal across the photodiode also improves the response linearity because it keeps the diode's voltage-dependent sensitivity from varying.

In practice, the amplifier's high, but finite, open-loop gain limits the isolation of Fig 2a's circuit. Part of the circuit's output voltage remains on the photodiode and produces a new bandwidth limit. Determining this new bandwidth limit is more difficult than determining the

bandwidth of Fig 1's circuit. Despite Fig 2a's simplicity, the current-to-voltage converter exhibits complex ac performance as analyzed below. As a result of an input circuit that appears as an inductance and capacitance in parallel, this circuit has a 2-pole—rather than a single-pole—response. Feedback resistances above some maximum cause the circuit to resonate and oscillate. A direct mathematical analysis of this ac behavior is complex, but a more intuitive analysis results in simple design equations.

To ensure that a current-to-voltage converter is stable, you must usually supply phase compensation. Because phase compensation and bandwidth are related, you must consider them together. This discussion develops a bandwidth and phase-compensation background that extends to other photodiode amplifiers. This background also applies to other op-amp applications that present source capacitance to the amplifier. Also, this background applies to any op-amp circuit in which high feedback resistance reacts with the amplifier's input capacitance.

To find the bandwidth of the current-to-voltage converter, you first determine the locations of the circuit's

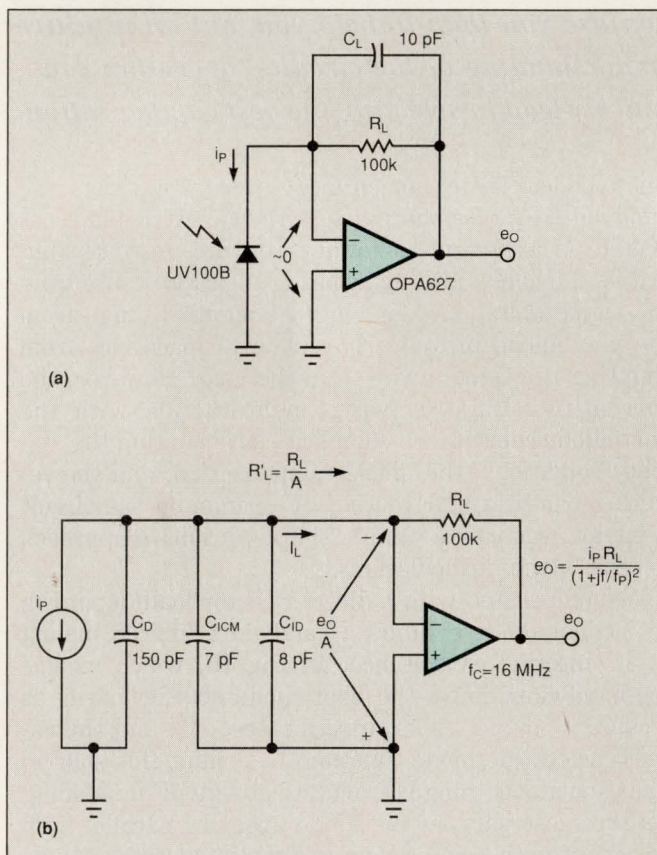

Fig 2—The simple current-to-voltage converter isolates the load voltage swing from the photodiode capacitance.

response poles. Then, you design the phase compensation, which defines the overall bandwidth. **Fig 2b** models the circuit for these analyses. Here, a current source and a capacitance, C_D , replace the photodiode. Also, the op-amp input capacitance is separate from the amplifier. The remainder of the amplifier replaces **Fig 1's** R_L with an effective load resistance R_L' . For the first step of locating the poles, **Fig 2b** excludes **Fig 2a's** phase-compensation capacitor, C_L , as well as the negligible, high resistances of the reverse-biased diode and the op-amp input.

The input break frequency controls the response of **Fig 2b's** circuit. At the op-amp summing junction, this circuit faces the impedance R_L' . By definition, R_L' equals the voltage across this impedance divided by the current, i_L , supplied to the impedance. The relevant voltage is that from the op amp's inverting input to ground—simply the amplifier's gain-error signal, e_o/A . Because of the amplifier's finite open-loop gain, A , this signal must exist between the amplifier inputs to support the output voltage, e_o .

The output voltage is $e_o = i_L R_L$, so the voltage across R_L' becomes $i_L R_L/A$. Dividing this voltage by the current, i_L , defines $R_L' = R_L/A$. This resistance breaks with the capacitance of **Fig 2b's** input circuit at

$$f_p = \frac{A}{2\pi R_L C_1} \approx A f_i,$$

where $C_1 = C_D + C_{ID} + C_{ICM}$.

Above, the break frequency of the input circuit increases from f_i of **Fig 1** by a factor approximating the open-loop gain, A .

This factor is approximate because the input capacitance C_1 is actually smaller for **Fig 1**. There, C_1 is the diode capacitance plus the C_{ICM} presented by the voltage follower. In **Fig 2**, however, the amplifier adds its differential input capacitance, C_{ID} , to the total input-circuit capacitance, so $C_1 = C_D + C_{ICM} + C_{ID}$. For most photodiodes $C_D \gg C_{ID}$, and the C_{ID} difference between the two circuits is not significant. Therefore, the current-to-voltage converter increases the response-pole frequency by a factor essentially equal to the gain, A .

However, this gain varies with frequency, so the actual improvement factor isn't immediately obvious. To calculate the actual pole location, you must determine the relevant ac value of A . This value is the open-loop gain at f_p . To find this gain, consider an approximation to the op amp's open-loop response. In all practical cases, f_p occurs where the gain of the amplifier exhibits a single-pole roll-off. There, you can approximate the amplifier's gain magnitude as $|A| = f_c/f$,

where f_c is the amplifier's unity-gain crossover frequency. At f_p , $|A| = f_c/f_p$. For **Fig 2's** circuit, substituting this expression for A in the f_p equation yields a pole location of

$$f_p = \sqrt{f_i f_c},$$

where $f_i = 1/2\pi R_L C_1$, and $C_1 = C_D + C_{ID} + C_{ICM}$.

In this new f_p expression, the pole location is the geometric mean of the old pole frequency, f_i , and the op-amp crossover frequency, f_c . Thus, as long as $f_c > f_i$, the current-to-voltage converter increases the response speed. A typical increase is a factor of 10 to 100, as seen from evaluating $f_p/f_i = \sqrt{f_c/f_i}$. With the high-speed OPA627 and the other components of **Fig 2**, the improvement factor is 38:1, and the pole is at 380 kHz. In the rare cases where $f_c < f_i$, the current-to-voltage converter reduces the bandwidth. Even then, however, the current-to-voltage converter provides the improved response linearity mentioned before.

Input circuit forms an L-C tank

Once you have found f_p , you can determine the required phase compensation. Further analysis shows f_p to result from a double—rather than a single pole. Consequently, you must pay careful attention to bandwidth and stability. With the simple, resistive load of **Fig 1**, a single pole controls the response, and the -3-dB frequency, f_i , coincides with the pole location. Capacitive shunting of a resistive load defines this simple pole. **Fig 2** exhibits similar shunting, but of a frequency-dependent load rather than a purely resistive one. As shown above, R_L' varies with frequency and is an impedance, Z_L' , not a resistance.

In **Fig 2**, as the frequency increases and the gain, A , declines, the load of $Z_L' = R_L/A$ rises. A load impedance that rises with frequency is inductive. Confirming the inductive character of R_L/A is the phase shift of the gain, A . Over most of the amplifier's useful frequency range, A has a phase lag of 90°. The 180° phase inversion of the basic amplifier gain converts this lag to a 90° phase lead. You can see this effect by including phase information in the previous approximation for A , where $|A| = f_c/f$ for most of the amplifier frequency range. If you include phase in this approximation, $A = 2\pi f_c/s$. Then, the load impedance is $R_L/A = R_L s/2\pi f_c$. With s in the numerator, this impedance appears inductive.

This inductive load resonates with the capacitance of the input circuit at a frequency equal to f_p above. If the resonance occurs at a low enough frequency, it

PHOTODIODE-AMPLIFIER PHASE COMPENSATION

produces oscillation in the current-to-voltage converter. Oscillation occurs if the amplifier's open-loop gain is above unity at the resonant frequency, f_p . Above the unity-gain crossover frequency, the amplifier lacks the gain needed to sustain oscillation. In most cases, $f_p < f_c$, which meets the condition for oscillation.

In L-C tank circuits that can oscillate, you can introduce degeneration by adding resistance in series with either the capacitor or the inductor. For **Fig 2**, this solution would add resistance in the input path of the photodiode-signal current. Signal voltage developed on this added resistance would appear across the photodiode and would degrade the response bandwidth and linearity. In **Fig 2a**, capacitor C_L degenerates the inductive $Z_L' = R_L s / 2\pi f_c$. Adding C_L in parallel with R_L converts the resistive load to $R_L / (1 + R_L C_L s)$. Then, $Z_L' = R_L s / 2\pi f_c (1 + R_L C_L s)$, which adds an s term to the denominator of the impedance. This denominator s term counteracts the numerator's s term to degenerate the L-C tank circuit.

Feedback analysis quantifies stability

The feedback analysis that guides the selection of the degeneration capacitor, C_L , quantifies the component's effect. Plotted comparisons of the amplifier and feedback characteristics illustrate how this phase compensation controls the frequency stability. A plot of both the op-amp open-loop gain and the feedback demand for that gain indicates the net conditions for a stable feedback loop. **Fig 3** shows this graphical analysis for the uncompensated current-to-voltage converter of **Fig 2b**. This figure combines the amplifier's open-loop gain response with the reciprocal of the feedback factor, $1/\beta$. Superimposed on the plot is the resulting current-to-voltage frequency response. As expected from the previous discussion, this response reveals a resonant peak at f_p .

Fig 3's $1/\beta$ curve represents the feedback demand, which arises from the feedback factor, β —the fraction of the output fed back to the amplifier input. The voltage-divider action of the feedback network determines β . In **Fig 3**, the voltage divider formed by R_L and C_I produces $\beta = 1 / (1 + R_L C_I s) = 1 / (1 + s / 2\pi f_i)$. Here, C_I is the total input-circuit capacitance or $C_I = C_D + C_{ID} + C_{ICM}$. The feedback factor reflects the pole at f_i introduced into the feedback path by the input circuit. The pole attenuates the feedback signal supplied to the amplifier input. The attenuated input signal requires the amplifier gain to increase at higher frequencies to sustain the amplifier output. The rise in the $1/\beta$ curve, which begins with the response zero of the expression $1/\beta = (1 + s / 2\pi f_i)$, reflects this greater gain demand.

Within the limit of its open-loop gain response, the amplifier meets the feedback demand. At low frequen-

cies, the $1/\beta$ curve is flat at unity as expected from simple resistor feedback around an op amp. At f_i , in response to the attenuated feedback signal, the $1/\beta$ curve begins its rise. Initially, the curve remains below the open-loop gain curve and the vertical distance between the two curves represents the excess gain available, that is, the loop gain. As the frequency increases, the rising $1/\beta$ increases the gain demand. Moreover, the op amp's gain curve drops simultaneously.

Where the two curves meet, the required gain equals the total available gain so that there can be no further frequency increase. This meeting point is the critical intercept fundamental to feedback stability analysis. At frequencies beyond the intercept, the amplifier gain is insufficient to support the feedback demand and the response rolls off. Thus, the intercept defines the frequency of the response poles. Graphical analysis of the curves (**Ref 2**) confirms that $f_p = \sqrt{f_i f_c}$, as indicated above.

The slopes of the $1/\beta$ and gain curves predict the frequency stability conditions through the two curves' rate of closure. For stability analysis, the rate of clo-

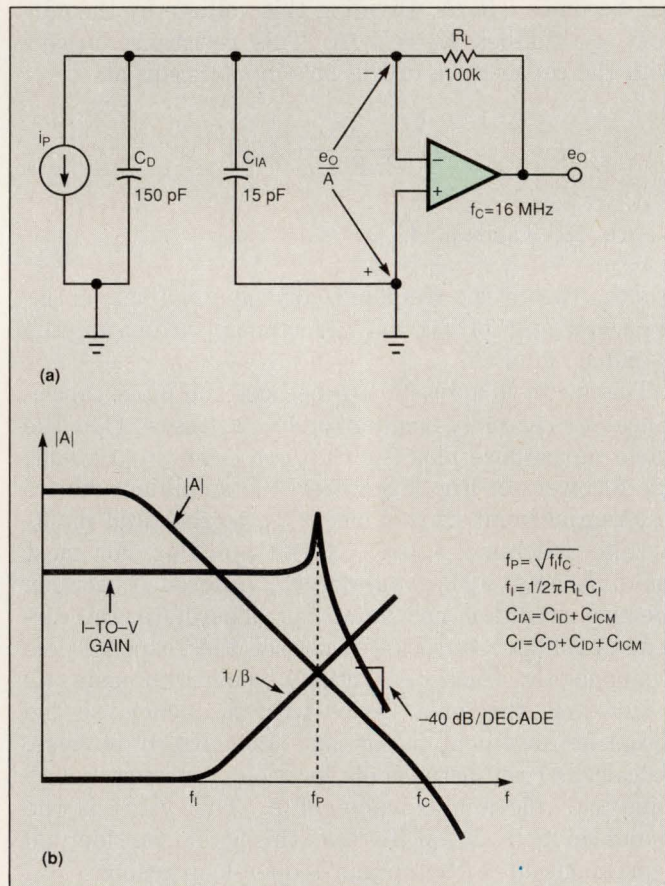

Fig 3—Capacitance at the input of the current-to-voltage converter causes the $1/\beta$ curve to rise and results in a resonant response peak.

sure is the difference between the slopes of the two curves at their intercept. Oscillation can occur where the rate of closure is 40 dB/decade. Each 20 dB/decade of slope corresponds to 90° of phase shift, so the 40 dB/decade of the criterion corresponds to 180° (Ref 2). Added to this is the 180° phase shift of the op-amp gain inversion, producing a net feedback phase shift of 360°. At the intercept, the loop gain is unity. If the phase shift is 360° at the unity-gain frequency, the feedback signal becomes self-sustaining; that is, the circuit oscillates.

For Fig 3, both the $1/\beta$ rise and the op-amp roll-off are the result of a single zero or pole, so each has a 20-dB/decade slope. The difference in slopes at the intercept is the critical 40 dB/decade, as anticipated from the earlier resonance discussion. The current-to-voltage response curve of the figure reflects this resonance with a high, sharp peak at f_p , where oscillation will probably occur. Even if oscillation doesn't actually occur, the stability will be poor, with excessive over-

shoot and ringing. Such stability problems are familiar to everyone who has used high feedback resistances with op amps. With large feedback resistors, the phase shift introduced by the input capacitance alone disturbs the circuit response.

Phase compensation levels $1/\beta$

In Fig 4, to restore stability, place phase-compensation capacitor C_L across feedback resistor R_L . This compensation was added in Fig 2a and removed in Fig 2b for determining the phase-compensation requirements. Capacitor C_L bypasses R_L at high frequencies to boost the feedback signal at the amplifier input. C_L produces a response zero in the feedback factor and counteracts the pole created by capacitance of the input circuit. Then, for Fig 4,

$$\beta = \frac{1 + s/2\pi f_L}{1 + s/2\pi f_1}$$

where $f_L = 1/2\pi R_L C_L$,
and $f_1 = 1/2\pi R_L (C_D + C_{ID} + C_{ICM} + C_L)$.

The response zero added to β at f_L is a pole of the inverse function, $1/\beta$. In Fig 4, the pole levels off $1/\beta$ and reduces the rate of closure for improved stability. To increase the bandwidth, you must sacrifice some stability. Choosing a large C_L could easily make the rate of closure a simple 20 dB/decade, which would yield uncompromised stability. However, this choice would unnecessarily limit the bandwidth. Although the bypass action of C_L counteracts a feedback pole, it degrades the circuit's ability to convert current to voltage at high frequencies. To produce an output signal, the current-to-voltage converter depends on the voltage developed across R_L . Bypassing that resistor to re-establish frequency stability also shunts the output signal and limits the bandwidth.

To optimize the ± 3 -dB bandwidth, use a simple guideline to choose a compromise that provides 45° of phase margin. This guideline holds for all practical circuit cases. The phase margin is the difference between the critical 360°, which produces oscillation, and the actual phase shift of the feedback loop. This phase difference is important only at the intercept of the $1/\beta$ and gain-magnitude curves (Ref 2). For basic feedback stability, the op amp, because of its gain inversion, starts by injecting 180° of phase shift. The phase margin is thus 180° minus the added phase shifts through the op amp and the feedback network.

The following analyses determine the phase margin of the current-to-voltage converter under two conditions. The relative proximity of f_p to the other circuit-response singularities differentiates these cases. In the

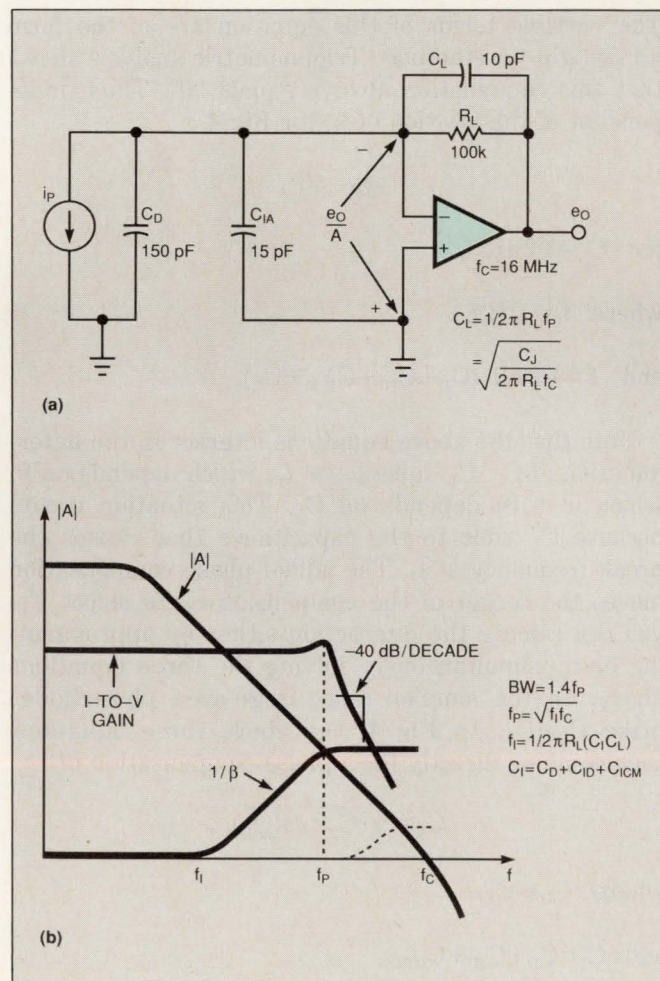

Fig 4—A simple design guideline establishes the phase compensation provided by feedback capacitor C_L .

PHOTODIODE-AMPLIFIER PHASE COMPENSATION

simpler case, f_p is more than a decade away from any of the circuit's other response poles or zeros. In that case, any pole or zero at a frequency lower than f_p develops essentially a full 90° of phase difference at the intercept frequency. Similarly, any pole or zero at a frequency higher than f_p contributes essentially zero phase shift at the intercept. For Fig 3, this simple case results in 90° of added phase shift from both the first op-amp pole and the $1/\beta$ zero. For this case, the far-removed poles around f_c cause no phase shift at f_p . Therefore, the amplifier and feedback loop add a net phase shift of 180° , leaving a phase margin of zero and ensuring oscillation.

To restore the phase margin in Fig 4, add C_L to reduce the phase shift from the $1/\beta$ curve. For 45° of phase margin, choose C_L to break with R_L right at the intercept frequency, f_p . At its break frequency, a response singularity's phase effect is exactly 45° . Therefore, placing the f_L break frequency at f_p reduces the $1/\beta$ phase shift at the intercept from 90° to 45° and boosts the phase margin from zero to 45° .

Fortunately, this simple guideline remains accurate even as f_p approaches f_c , as often occurs in practice. In this second case, the frequency difference between f_p and the other singularities is less than a decade. Hence the phase contribution of these singularities differs from the simple 90° of the first analysis. This condition occurs with smaller photodiode capacitances, which move the input break frequency f_i to the right in Fig 4. A dashed curve in Fig 4 represents $1/\beta$ for this second condition, in which f_p moves down the open-loop gain curve toward f_c , and the phase shift at the new f_p enters the higher-frequency poles' range of influence around f_c . However, frequency f_i simultaneously moves to the right (the dashed curve in Fig 4). This movement compresses the distance between the new f_i and the corresponding new f_p . This compression reduces the phase effect of the lower-frequency singularity at f_i .

For first-order analyses, these two phase adjustments cancel, leaving the choice of C_L unchanged. To demonstrate this effect, consider the op-amp response to be essentially 2-pole in nature with the second pole occurring at the unity-gain crossover frequency, f_c . Although this situation is not the actual one, it accurately portrays the op-amp phase response at frequencies as high as f_c . This simple model shows that the amplifier phase shift increases with frequency and produces 135° of phase shift at f_c . Such phase shift is a conservative model of the performance of most op amps. Beyond f_c , the exact phase response of the amplifier is not usually important. At these frequencies, the loop gain is below unity and will not support oscillation.

With the 2-pole amplifier model, four response singu-

larities determine the net phase margin. Two of these singularities follow from the first case: the first amplifier pole and the break frequency of C_L . As before, this amplifier pole decreases the phase margin from 180 to 90° and the $1/\beta$ leveling provided by C_L restores 45° . In the second analysis, the closer proximity of f_p to f_i and f_c alters the phase from the initial 135° . No longer does f_i introduce a complete 90° of phase shift nor is the influence of f_c zero.

To find the actual effects on the phase margin in Fig 4, the following equations express the influences of f_i and f_c with higher resolution:

$$\phi_M = 135^\circ - \arctan(f_p/f_i) - \arctan(f_p/f_c).$$

From before, $f_p = \sqrt{f_i f_c}$. Substituting this expression in the above equation produces:

$$\phi_M = 135^\circ - \arctan\sqrt{f_i/f_i} - \arctan\sqrt{f_i/f_i}.$$

The variable terms of this equation are of the form $\arctan(a/b) + \arctan(b/a)$. Trigonometric analysis shows that this combination always equals 90° . Thus, independent of the location of f_i , for Fig 4

$$\phi_M = 45^\circ,$$

for $C_L = 1/2\pi R_L f_p$,

where $f_p = \sqrt{f_i f_c}$,

and $f_i = 1/2\pi R_L (C_D + C_{ID} + C_{ICM} + C_L)$.

Note that the above equations interact in the determination of C_L . C_L depends on f_p , which depends on f_i , which in turn depends on C_L . This situation occurs because C_L adds to the capacitance that causes the break frequency at f_i . The added phase compensation moves the target of the compensation. To select C_L , you can remove the interaction either by approximating or by simultaneously solving the three equations above. In the simpler case, large-area photodiodes make $C_D \gg C_L$. In Fig 4, the above three equations then combine directly for a phase compensation of

$$C_L = \sqrt{(C_i/2\pi R_L f_c)},$$

where $C_D \gg C_L$

and $C_i = C_D + C_{ID} + C_{ICM}$.

This result simplifies to an easily memorized relationship in which C_L is the geometric mean of two capaci-

PHOTODIODE-AMPLIFIER PHASE COMPENSATION

tances. Defining an artificial capacitance, $C_C = 1/2\pi R_L f_C$, relates f_C to R_L just as the resistance relates to f_1 and f_L . The above result simplifies to the geometric mean $C_L = \sqrt{C_1 C_C}$. The phase compensation capacitor C_L equals the geometric mean of the input circuit's total capacitance and the capacitance that represents f_C . This result parallels the expression $f_p = \sqrt{f_1 f_C}$ in which f_p is the geometric mean of the analogous frequencies. For C_L , one of these capacitances, C_1 , is real and the other simply represents the op-amp bandwidth, f_C . For the typical current-to-voltage photodiode amplifier, set the phase compensation at

$$C_L = \sqrt{C_1 C_C},$$

for $C_D \gg C_L$

where $C_1 = C_D + C_{ID} + C_{ICM}$ and $C_C = 1/2\pi R_L f_C$, and where f_C is the unity-gain crossover frequency of the op amp.

In the more comprehensive case, select C_L to accommodate even small photodiode capacitances. Don't use the previous approximation. Instead, solve the preceding simultaneous equations for $\phi_M = 45^\circ$. For Fig 4, this approach yields

$$C_L = (C_C/2)(1 + \sqrt{1 + 4C_1/C_C}),$$

where $C_C = 1/2\pi R_L f_C$,

and $C_1 = C_D + C_{ID} + C_{ICM}$.

You need this more exact expression where there are lower circuit capacitances that are more sensitive to parasitic capacitances. Depending on where they occur, these parasitics can alter the value of C_L in either direction. Some board parasitics add to the C_1 term but others supplement C_L . A final tuning adjusts for these unknowns empirically.

Two features benefit bandwidth

When you set the phase compensation by choosing C_L , you determine the bandwidth of the current-to-voltage converter. This circuit's 2-pole response is actually advantageous because gain peaking extends the bandwidth. Excessive damping is inherent in the single-pole response of Fig 1; this damping fixes the 3-dB bandwidth at the pole location. The 2-pole case of Fig 4 permits an underdamped response and extends the bandwidth beyond the pole frequency. Just how much the bandwidth increases depends on the required response accuracy. Where you can accept the traditional ± 3 -dB deviation, the damping factors and the resulting responses (Ref 3) show a factor of 1.4 increase for a 45° phase margin. Gain peaking is then just +3 dB

followed by the final bandwidth limit at the -3-dB point. Thus, for the current-to-voltage converter of Fig 4, with C_L breaking at f_p ,

$$BW = 1.4f_p = 1.4\sqrt{f_1 f_C},$$

where $f_1 = 1/2\pi R_L (C_D + C_{ID} + C_{ICM} + C_L)$.

For the components shown in Fig 4, $f_1 = 9.1$ kHz and $f_C = 16$ MHz for $BW = 534$ kHz. This represents a 53:1 bandwidth improvement over the 10-kHz limit of the basic circuit in Fig 1.

The above expression displays an advantageous gain-bandwidth relationship because of the square-root function. The R_L in the expression for f_1 is the element that sets the current-to-voltage converter's transresistance or gain. Increasing R_L for greater gain reduces the bandwidth, but by less than you might expect. Normally, in voltage-amplifier applications, an increase in gain causes an equal reduction in bandwidth. For the current-to-voltage converter, the gain-bandwidth product is $R_L(BW)$. Substituting BW from its equation above shows this product to be $1.4\sqrt{R_L f_C / 2\pi C_1}$ —proportional to $\sqrt{R_L}$. Thus, the maximum practical value of R_L yields the maximum gain-bandwidth product. Above a certain R_L value, parasitic capacitance rolls off the gain that this resistor provides.

The Bode plots of Fig 4 explain this reduced gain-bandwidth sensitivity. Consider what happens when you start with the dashed curve and move back to the solid $1/\beta$ curve. Increasing R_L moves f_1 down in frequency and shifts the $1/\beta$ curve in direct proportion, lowering the bandwidth-defining intercept of $1/\beta$ with the amplifier gain-magnitude curve—but not in direct proportion. Because the gain-magnitude curve rises as the frequency decreases, the intercept recedes more slowly. The equal slopes of the gain and $1/\beta$ curves make this bandwidth decrease one-half that of $\log(f_1)$, and the log scale converts this fraction to a square root.

An alternate approach to increasing the gain-bandwidth product enjoys the same square-root benefit. By using larger area photodiodes, you increase the overall circuit response to the light source at a rate greater than the accompanying bandwidth decline. Both the photodiode's capacitance and its responsiveness to light are directly proportional to the diode area, A_D . Increasing A_D produces a directly proportional increase in the light-to-voltage gain of the circuit. However, the bandwidth, described by the previous equation, declines only by the square-root of C_D . Thus, gain-bandwidth product for the current-to-voltage converter is proportional to $\sqrt{A_D}$. The maximum gain-bandwidth product results from a photodiode area that covers as much of the area illuminated by the light source as is practical.

Commitment to Technology

EDN Asia provides
leading edge, state-of-the-art
technology information to 28,000
Asian Engineering Professionals.



EDN ASIA

Serving the World's Fastest Growing Electronics Market

PHOTODIODE-AMPLIFIER PHASE COMPENSATION

To maximize the bandwidth instead of the gain-bandwidth product, choose R_L to take advantage of the full amplifier bandwidth. In Fig 4, making R_L smaller moves f_i to the right—to the limit imposed by f_C . Beyond f_C , the amplifier lacks the bandwidth required for further extension of the current-to-voltage converter response. To maximize the bandwidth, select R_L to place the intercept frequency, f_p , at the amplifier's unity-gain crossover frequency, f_C . This choice moves the $1/\beta$ curve to the right, compressing its rise to zero and making the three response-defining frequencies coincide; $f_i = f_p = f_C$. Given this condition, the expression for f_i sets the feedback resistor in Fig 4 to

$$R_L = 1/2\pi f_C (C_D + C_{ID} + C_{ICM}), \text{ for maximum bandwidth.}$$

Any further increase in bandwidth must come from using a higher speed op amp that moves the f_C limit to a higher frequency. Once again, a square-root relationship determines the improvement, because f_p is proportional to $\sqrt{f_C}$. Fig 4 shows the wideband OPA627 instead of Fig 1's slower OPA111. This change increases f_C from 2 to 16 MHz for a $\sqrt{8}$ increase in current-to-voltage-converter bandwidth. In Fig 1, changing amplifiers would offer no benefit because the photodiode in front of the op amp limits the bandwidth.

EDN

References

1. J Graeme, "FET op amps convert photodiode outputs to usable signals," *EDN*, October 29, 1987, pg 205.
2. J Graeme, "Feedback plots offer insight into operational amplifiers," *EDN*, January 19, 1989, pg 131.
3. J Graeme, "Feedback models reduce op-amp circuits to voltage dividers," *EDN*, June 20, 1991, pg 139.

Author's biography

Jerry Graeme, a prolific contributor to EDN, is one of the very few EEs who have worked for a single employer for a quarter century. Jerry manages instrument-components design for Burr-Brown Corp in Tucson, AZ. At Burr-Brown, he has personally designed many analog ICs. He holds a BSEE from the University of Arizona and an MSEE from Stanford. He lists his hobbies as scuba diving, photography, and woodworking.



Article Interest Quotient (Circle One)
High 485 Medium 486 Low 487

If you can see it, we can print it.

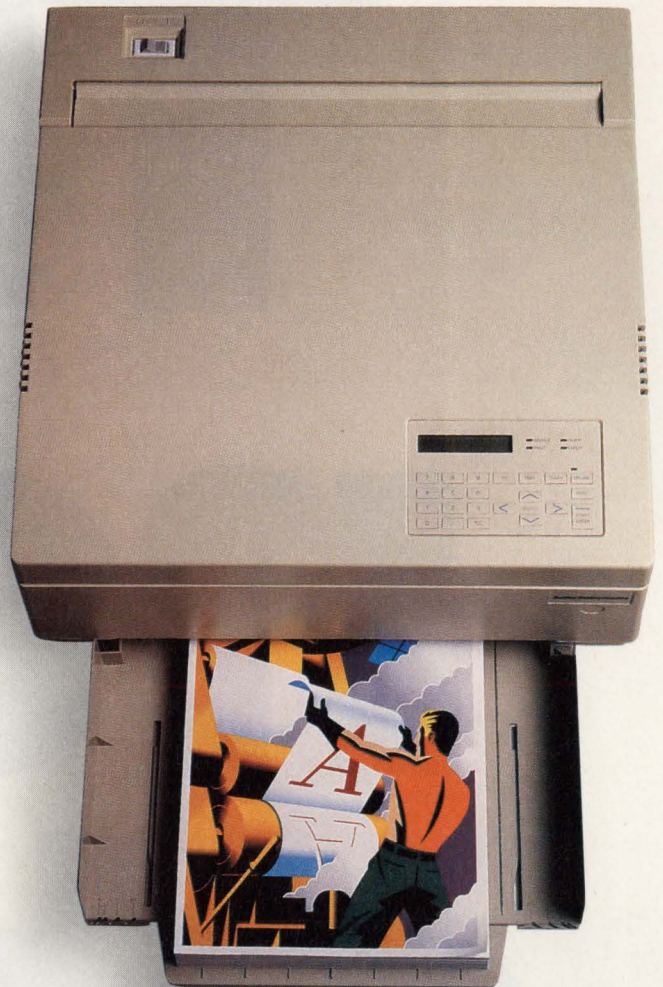

No matter what application you're using, no matter what monitor you're viewing it on, the CH5500 video color printer can produce a hard copy. It supports over 350 video sources—more than any other printer.

Moreover, since the CH5500 doesn't use software, it captures your image fast—so you can get back to work. And it offers outstanding 300 dpi quality in both A and B sizes.

To find out more, give us a call at 1-800-873-4561, Dept. SI-C4.

After all, we pioneered video color printing. And we still do it best. Anybody can see that.

SII 
Seiko Instruments

The new new at Maxtor

It's a new commitment to leadership shared by every one of us.

You see, at Maxtor we're driven to ensure that our customers are satisfied with every aspect of the way we do business. From innovative technology and designs to outstanding quality, competitive pricing,

on-time delivery and unmatched service and support.

What's more, we're committed to setting product trends. Take our new MXT-1240. It's simply the highest performance, highest capacity 3.5 inch drive in the industry today. Or consider our new 7213, which sets

Let's a drive Maxtor.

new value standards in 200MB-class 3.5 inch drives.

And this is just the beginning. In the coming months, you'll see even more remarkable new products.

Leadership products that will extend the limits of your application and push

the limits of technology.

Because at Maxtor, being the best in the business is a goal shared by all.

And that's a point worth driving home.

Maxtor[®]

Maxtor Corporation, 211 River Oaks Parkway, San Jose, CA 95134 1-800-2-MAXTOR.

Coilcraft Designer's Kits

**First they save you time.
Then they save you money.**

These kits make it easier than ever to pick the right coils, chokes and other magnetics for your project.

Why waste hours calling around

for samples or trying to wind them yourself. Coilcraft's low-cost kits put dozens of values right at your fingertips!

You not only save time on engineering. You also save money when you go into production

because we stock just about all the parts in our kits at low off-the-shelf prices.

Call in today, and you can have your kit tomorrow!

To order, phone 800/322-COIL.

"Unicoil" 7/10 mm Tuneable Inductors

.0435 μ H - 1.5 μ H
49 shielded, 49 unshielded (2 of each)
Kit M102 \$60

"Slot Ten" 10 mm Tuneable Inductors

0.7 μ H - 1143 μ H
18 shielded, 18 unshielded (3 of each)
Kit M100 \$60

Surface Mount Inductors

4.7 nH - 10 μ H
42 values (10 of each)
Kit C100 \$125

Axial Lead Chokes

0.1 μ H - 1000 μ H
25 values (5 of each)
Kit F102 \$50

Horizontal Mount Inductors

Tuneable and fixed
Inductance: 31.5 - 720nH
33 values (3 of each)
Kit M104 \$60

Common Mode Data Line EMI Filters

Attenuation bandwidth: 15 dBm, 1.5 - 300 MHz
DC current capacity: 100 mA
2, 3, 4 and 8 line, surface mount and leaded
(4 of each)
Kit D103 \$75

Common Mode Line Chokes

Current: .25 - 9 amps RMS
Inductance: 508 μ H - 10.5 mH
8 styles (2 of each)
Kit P202 \$100

Current Sensors

Sensing range: 0.5 - 35 amps
Freq. resp.: 1 - 100 kHz, 50 - 400 Hz
Transformer and sensor-only versions
8 styles (15 total pieces)
Kit P203 \$50

Base/Gate Driver Transformers

Inductance: 1.5 mH Min.
Frequency: 10 - 250 kHz
2 single, 2 double section (2 of each)
Kit P204 \$50

Mag Amp Toroids

Current: 1, 5 amps
Volt-time product: 42 - 372 V- μ sec
6 styles (2 of each)
Kit P206 \$100

Power Filter Chokes

Current: 3, 5, 10 amps
Inductance: 5 - 300 μ H
18 styles (48 total pieces)
Kit P205 \$75

Axial Lead Power Chokes

Current: .04 - 4.3 amps
Inductance: 3.9 μ H - 82 mH
30 styles (2 of each)
Kit P209 \$150

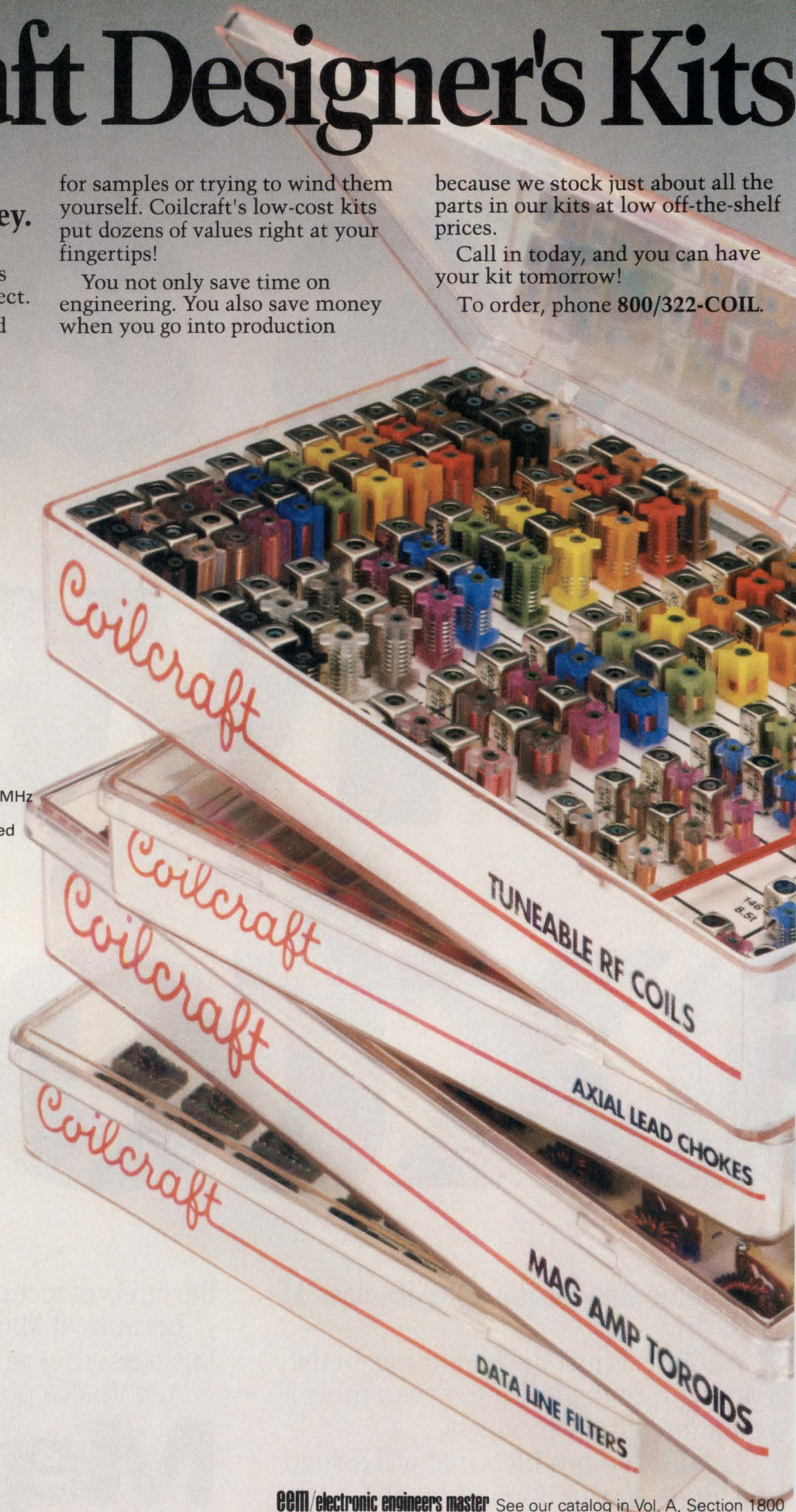

Coilcraft

CEM/electronic engineers master See our catalog in Vol. A, Section 1800

1102 Silver Lake Rd., Cary IL 60013 800/322-COIL Fax 708/639-1469

Concurrent engineering speeds development time, lowers costs

Jon Turino, Logical Solutions Technology Inc

To be competitive in the 1990s, your company must embrace concurrent-engineering philosophies. Implementing these philosophies requires that everyone in your organization understands the basics of the product-development cycle—the frequency of activity in each phase and where the costs associated with each phase are actually determined.

Today's shorter product life cycles and increased pressure for shorter time to market make it imperative to replace the "redo it until it's right" philosophy with the "do it right the first time" philosophy—concurrent engineering. Using concurrent engineering, you can determine design tradeoffs for the overall success of the product (and the business) given the specific customer requirements, business capabilities, and competitive environment from the onset.

For example, a change in the silicon for an ASIC may cost weeks (or even months) in terms of time to market. Seemingly unimportant or simple things can cause design changes: a lack of communication between the ASIC designer and the system designer; neglecting to simulate the overall product; redesigning the part to include boundary scan so that manufacturing can test the product containing the part; or inadequate input from product marketing.

There are many causes, and even more excuses, for product designs going over time and budget. There is only one prevention—concurrent engineering. Even though its practice won't prevent all of the problems

all of the time, you have a much better chance to improve your "hit ratio" when you use it properly.

The overall product cycle in a business moves in the direction of design, manufacture, test, and finally, service. The design activity is a nonrecurring cost—or at least it is supposed to be. Products are designed once per product type. They are built once per product, as you duplicate the design in manufacturing. They are tested at many levels, and must often be serviced in the field.

The objective of concurrent engineering is to make the right decisions during the nonrecurring activity. By making good decisions early, you maximize productivity during the recurring activities—activities that may last for years. Making good up-front decisions is referred to as creating maximum leverage. Not maximum leverage in banker's terms, but in terms of investing a little time and money during product design to reap larger profits over the life of the product.

You cannot attain maximum leverage by redoing a design once you discover that the original is difficult, time consuming, and expensive to produce. You can attain some leverage by improving the design in the review stage, but this may still require a redesign either on paper or in software.

Time and money

Reduced design cost is not the only benefit of concurrent engineering. Design engineers are under intense pressure to bring products to market as quickly as possible. One of the most frequent complaints heard from design engineers is that of unrealistic design schedules imposed by management. And one of the most frequent excuses from management for not using

CONCURRENT ENGINEERING

concurrent engineering is that there is no time—they need to get the product designed as quickly as possible.

That kind of narrow and short-term attitude needs significant adjustment, because time to market is not just design time. Time to market is the time it takes to get a product into your customer's hands at a competitive price. If you must redesign the product to lower manufacturing and test costs, or to fix glitches because of inadequate design verification, you've negated the advantage of rushing a design through.

Concurrent engineering helps speed the product's actual time to market, even if that means spending a little more time making sure the design is flawless in its performance and making sure you can manufacture, test, and service the product.

Burr-Brown used concurrent engineering in the design of D/A and A/D converters for DSP applications with excellent results. The personal interaction among design team members yielded better and more manufacturable designs. The process started when design, test, and manufacturing input was encouraged during the final revisions of product proposals from marketing, rather than during final revisions of the product de-

signs themselves. Input continued during design, test development, characterization, prototype production, and device qualification.

Each team member was not only encouraged, but also expected, to ask questions, make suggestions, and offer alternatives. The primary team consisted of members from design, test, manufacturing, and marketing, led by a product manager.

Personnel with additional expertise—purchasing, production, etc—were called upon as needed during the product design. Weekly meetings kept team members in communication to discuss reallocation of funds or other issues. The result was that time to market was cut by six to nine months.

Studies show that somewhere between 60 and 95% of overall product cost is determined during the design phase. Product parts, assembly, test, and service costs are dictated far more often by the product's design than by the actual manufacturing, testing, or servicing. The earlier design decisions are made, the larger their impact.

Concurrent engineering helps you make early design decisions that minimize costs over the life of the prod-

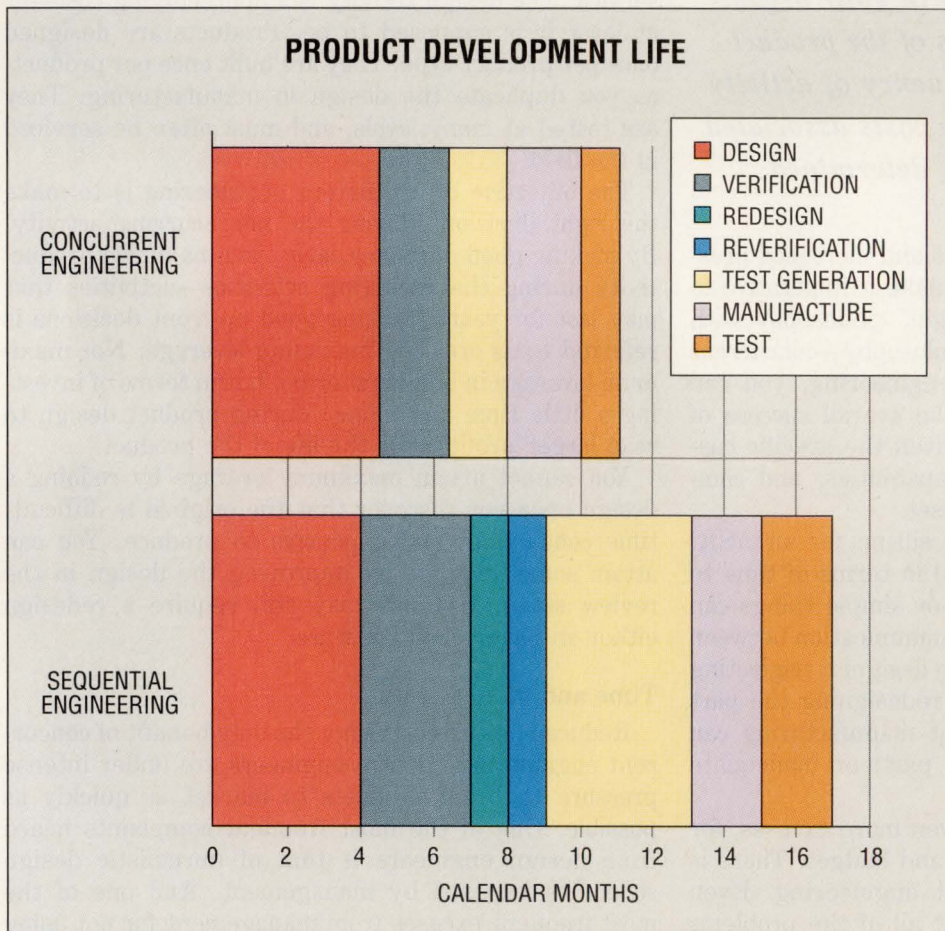

Not only will you eliminate redesign and reverification costs using concurrent engineering, you will save time in design verification, test generation, and test because of the efficiency early in the design. The savings in time to market typically amount to between 10 and 25% and result in a better product.

uct. For example, designing the product to fit into an existing manufacturing process, rather than requiring a new process (and new capital equipment), can have a big impact on cost. By being included in the initial design decisions, manufacturing can propose this cost-effective suggestion, whereas alone (sequential engineering), the designers may not take the extra costs of buying new capital equipment into consideration. Taking some extra design time to ensure error-free assembly by using a minimal number of assembly operations can also significantly lower overall product costs.

The five most important design-for-performance issues faced by designers are product size, weight, speed of operation, human factors, and product-reliability goals. Overall design guidelines often require tradeoffs in these factors. All too often, those decisions are made without considering all the factors, such as in the case of using an existing manufacturing process. Concurrent engineering takes all of these factors into consideration from the beginning.

Reaping the benefits

Hewlett-Packard (HP) used the concurrent-engineering philosophy of total quality control to improve not only its manufacturing performance, but also its administrative and engineering performance. The elements of HP's program include management commitment, customer focus, statistical control, systematic problem solving, and total participation.

Top management's commitment in the form of learning, understanding, and leading the quality-control efforts with a well-communicated, unwavering purpose, including ongoing management involvement, was critical. The results for HP were scrap and rework costs cut 80 to 95%, manufacturing costs reduced by as much as 42%, parts inventories cut by 70%, manufacturing cycle times reduced by 95%, and overall product development time cut by 35%.

You can switch to concurrent engineering in mid-project and still see cost benefits. Texas Instruments (TI) had tremendous results with the redesign of a complex infrared sight (Fig 1). By redesigning the sight (and without reinventing the factory that produced it), TI achieved some impressive reductions in the number of parts and assembly steps and, therefore, the overall assembly time.

Experience shows that many product design decisions in organizations that practice sequential engineering are made based on opinions, not facts. Concurrent engineering changes that and simplifies your designs in the process. Complexity for complexity's sake is counterproductive. After all, how many of the fea-

	Serial Engineering	Concurrent Engineering	Reduction (%)
Assembly Time (months)	129	20	85
Total Number of Parts	47	12	75
Total Number of Steps	56	13	71

Fig 1—By creating more efficient designs through concurrent engineering, you can reduce the number of parts you need and reduce the number of steps in manufacturing. Texas Instruments cut the assembly time of their infrared sight by 85%.

tures of most of your sophisticated electronic products do you (or your customers) actually use on a regular basis? Sometimes simplifying the product makes it more marketable. That's why you need accurate input from all of the business elements when making design decisions.

Getting closer to customers—with one-on-one meetings between potential product users and the actual product-design team—is one way of gathering the facts regarding which design features and parameters are most important to customers. Partnering with customers and suppliers can also help the product birthing team come up with the kinds of quantitative information that they need to make truly informed design decisions.

People in manufacturing, test, quality, and service often have large amounts of data regarding the overall time and cost associated with bringing certain products to market (and their on-going production and warranty/service costs). You should take these facts into account when designing new products. You can learn from what you've done right (or wrong) before.

A word to the wise to those in manufacturing, test, quality, and service: The facts you bring forward must be timely, accurate, and presented in the proper manner. The data you hold gives you power. Use it wisely—for improvement, not punishment of other organizations (or, worse yet, specific people in other groups).

The types and granularity of time and cost data required for good concurrent-engineering design decisions are illustrated in Fig 2, which shows detailed breakdowns of each of the major cost elements associated with each major business activity. The design and design-verification cost are the nonrecurring cost elements in the product development, manufacturing, and service cycle. Depending upon the exact nature of your organization and your products, you may need to expand the list. Note that these costs need to be estimated for each type of device, board, subassembly, or complete product.

CONCURRENT ENGINEERING

Usually a very small increase in design cost will result in a moderate decrease in design-verification cost, and a large decrease in fault-simulation and test-generation costs. Concurrent design also provides the opportunity to eliminate the redesign cost.

Fig 2 also details the cost elements that make up the actual material cost of a product. Here again, depending upon product configuration, you may need to expand the list and, as before, develop the data for the entire product. For example, there are occasions when you can use ASICs to replace glue logic (and, conversely, when developing an ASIC is simply not justified). There may be occasions when an increase in the cost of a part (for improved testing characteristics) will be offset by a decrease in board, subsystem or system test, and troubleshooting costs. Sometimes breaking a large board into two smaller (and simpler) boards makes sense. The decreased cost for the individual bare boards can offset the extra connector cost (reducing the number of layers required, for example).

Assembly cost is another significant element in the cost of a product, depending again upon its size and complexity, and the methods used to manufacture it. The costs estimated should include not only the recurring costs at each level of integration, but also the nonrecurring cost for capital equipment, machine pro-

gramming, and the like (amortized over the total estimated number of products of each type to be built).

The recurring test and diagnosis costs for each element of the overall product also need to be ascertained or estimated. Then you can estimate the deltas to determine whether design changes for testability are warranted and, if so, just how much testability is affordable based on potential increased costs for components.

Design improvements may not make a large difference in go/no-go testing costs but they can make a big difference in troubleshooting times and costs. The test cost list in Fig 2 is for recurring test costs—you should also estimate the cost for capital equipment, test programs, and test fixtures for the total number of items you are building to come up with a per item cost that you can use during design to make tradeoffs.

Quality costs are another significant element in the overall product cost equation. It might actually be more appropriate to term the costs identified in Fig 2 as the cost of not quality, since products that you can produce perfectly every time do not require inspection, rework, or scrap costs. Escape cost refers to the premium paid when a defect escapes a test (say at board level) and must be detected, diagnosed, and repaired at a later stage (say at system test) at a much higher cost.

It is also necessary to have yield (or failure rate)

<p>DESIGN-COST DATA FOR DEVICES, BARE BOARDS, LOADED BOARDS, AND SYSTEMS</p> <ul style="list-style-type: none"> • DESIGN VERIFICATION \$ _____ • DESIGN-VERIFICATION COST \$ _____ • FAULT-SIMULATION COST \$ _____ • TEST-GENERATION COST \$ _____ • ITERATION COST \$ _____ 	<p>PARTS COST</p> <ul style="list-style-type: none"> • GLUE LOGIC \$ _____ • DISCRETES \$ _____ • ASICs \$ _____ • BARE BOARDS \$ _____ • CAGES/BACKPLANES \$ _____ 	<p>ASSEMBLY COST</p> <ul style="list-style-type: none"> • BOARD ASSEMBLY \$ _____ • SUBSYSTEM ASSEMBLY \$ _____ • SYSTEM ASSEMBLY \$ _____
<p>TEST COST, CAPITAL, PROGRAMS, FIXTURES PLUS:</p> <ul style="list-style-type: none"> • DEVICE TEST \$ _____ • BOARD TEST \$ _____ • BOARD DIAGNOSIS \$ _____ • SYSTEM TEST \$ _____ • SYSTEM DIAGNOSIS \$ _____ 	<p>QUALITY COST AT EACH LEVEL</p> <ul style="list-style-type: none"> • INSPECTION COST \$ _____ • REWORK COST \$ _____ • ESCAPE COST \$ _____ • SCRAP COST \$ _____ 	<p>SERVICE COST</p> <ul style="list-style-type: none"> • FIELD SERVICE CALL \$ _____ • DEPOT REPAIR \$ _____ • NO FAULT FOUND \$ _____ • SPARES INVENTORY \$ _____

Fig 2—Every design has a variety of cost considerations. Depending on the nature of your products, you may need to expand the list.

and fault distribution figures for each testing and/or inspection step in order to calculate quality costs. Gathering this data, however, can also help in identifying areas where the manufacturing operation itself, without affecting product designs, can be improved to reduce costs and raise quality levels.

Finally, there is service cost data. The list of service cost data identifies the major categories of costs you should estimate over the service life of a product with the predicted failure rate factored in to come up with a per item service cost.

You should take these estimates, along with all of the other elements shown in Fig 2, into account during the concurrent-engineering design phase. Only when all of the factors are considered, and all of the proper engineering expertise applied, is it possible to develop the best product at the lowest cost in the shortest time.

You must plan out product goals, strategies, and tactics as early as possible in the product development cycle—preferably right at the beginning when the product is specified. Those of you in functions that are currently downstream from design engineering must take it upon yourselves to get involved in the product design process if you are going to be a source of solutions.

If customer requirements dictate a design approach outside the scope of current company capabilities, everyone needs to know about it so that you can develop plans to cope with it. If you can modify the design approach to fit into current company capabilities, so much the better.

Concurrent engineering can reduce the time and cost of test generation, while simultaneously helping to increase fault coverage. Reductions of as much as 50% in test-program generation and fault-simulation times, while still achieving 99.9% fault-coverage levels, are typical.

You can also reduce service costs in several ways. The cost of a field service call continues to rise due to heightened customer expectations and increased product complexity, personnel costs, spare inventory costs, and travel expenses. If you can diagnose systems remotely, you can send boards (instead of people with boards) to the customer. Proper design for serviceability, as part of the concurrent-engineering discipline, can significantly cut service costs.

NCR Worldwide Service, for example, actually supplies NCR manufacturing with funds for service connectors and EEPROMs that are put on certain products. The savings in service costs more than pays for the added parts costs (which, because they are paid for by the service organization, do not impact the accounting department's interpretation of manufacturing costs).

There are many more creative ways to save time and money in areas other than manufacturing, test, and service. Shortened cycle time, for example, can help reduce inventory levels, thus saving interest costs and freeing up working capital. The bottom line, then, is that the proper application of concurrent engineering can increase profits and make an organization more competitive. Implementing concurrent engineering is not easy and cannot be done instantly. But it can be done.

Yes, it takes investment—nothing comes for free. Yes, it takes commitment—nothing happens overnight. Yes, it takes culture change—the barriers must come down. It may take time and significant educational efforts to realize the benefits of concurrent engineering. But it can, and indeed must, be done if your organization is to be competitive in the 1990s. **EDN**

Adapted from Concurrent Engineering by John Turino, Logical Solutions Technology Inc, Campbell, CA, 1991. ISBN 0-912253-09-6.

Author's biography

Jon Turino is President and CEO of Logical Solutions Technology Inc, a consulting firm in Campbell, CA. Jon has more than 20 years of experience in the engineering field and has been a full-time consultant for more than 12 years. He studied engineering and management at West Coast University (Orange, CA) and El Camino College (Via Torrance, CA).



Article Interest Quotient (Circle One)
High 488 Medium 489 Low 490

HAVE YOUR SAY

EDN's Signals & Noise column provides a forum for readers to express their opinions on issues raised in the magazine's articles or on any topic that affects the engineering industry. You can use one of several easy ways to reach us: Mail your letters to Signals & Noise Editor, EDN Magazine, 275 Washington St, Newton, MA 02158. Or, send us a message via MCI mail at EDNBOS. Finally, you can reach us EDN's bulletin-board system at (617) 558-4241 and leave a letter in the EDITORS Special Interest Group. You'll need a 9600-bps or less modem and a communications program set for eight data bits, no parity, and one stop bit, or 300/1200/2400/9600 8,N,1 in shorthand.

Tango. Powerful PCB layout tools.

Tango

For **FREE** evaluation software and product specs, call **800 488-0680**



Tango gives you two powerful choices in printed circuit board design. There's Tango-PCB PLUS, our advanced PCB layout tool for the designer with complex design requirements and our entry-level Tango-PCB, a comprehensive, yet low-cost program for less demanding designs.

Tango's interface puts you never more than two mouse clicks away from any command. On-line help, pop-up menus, dialog boxes, prompt line and unique "speed palette" and "hot spots" all combine to make Tango quick to learn, intuitive and easy to use.

Tango-PCB and Tango-PCB PLUS both feature: user-defined sizes of tracks, pads, arcs, fills, text and grids; versatile moving, mirroring, rotating and releasing of components; full support for net lists from popular schematic programs; comprehensive block operations; design verification tools; SMT support; unlimited zoom levels and autopanning; NC drill files; and crisp output to a wide array of printers, plotters and photoplotters.

Tango-PCB PLUS increases design productivity by adding: automated component placement; integrated design rule check; photoplot file viewer; output in DXF and PostScript™; and EMS (expanded memory) support.

Both packages give you Tango's well-known price-performance leadership. And as with all of ACCEL's complete Tango family of electronic design automation tools (schematic entry, board layout and autorouting, PLD design, thermal analysis and logic simulation), our customers receive service, documentation and technical support that is second to none. Call us to learn more about how a modest investment in Tango PCB tools can help you become more productive.

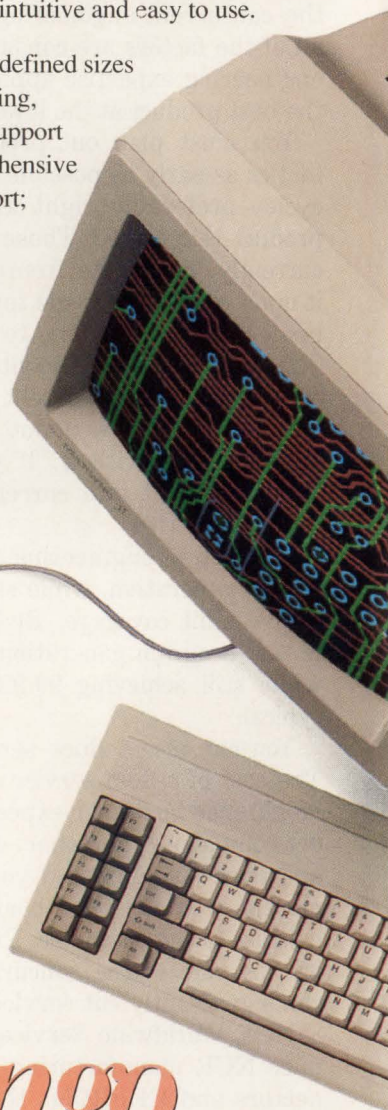

Tango

Helping good ideas become great products.

ACCEL Technologies, Inc.
6825 Flanders Drive • San Diego, CA 92121 USA
Service & Support 619/554-1000 • Fax 619/554-1019

CIRCLE NO. 110

the A inputs of the adder. Because the clock period is slightly greater than the setup time, the result of the addition is written into IC₁₁ and IC₁₂ on the rising edge of SYSCLK, and IC₇ stores the carry bit. In the next clock period, IC₁₁ transmits data to the RAM bus

while the circuit generates write pulse WRF. Thus, the current-phase byte overwrites the previous value.

The algorithm repeats the same triad of operations four times with two exceptions. On the last cycle of the third addition, the circuit generates the \overline{LW} pulse

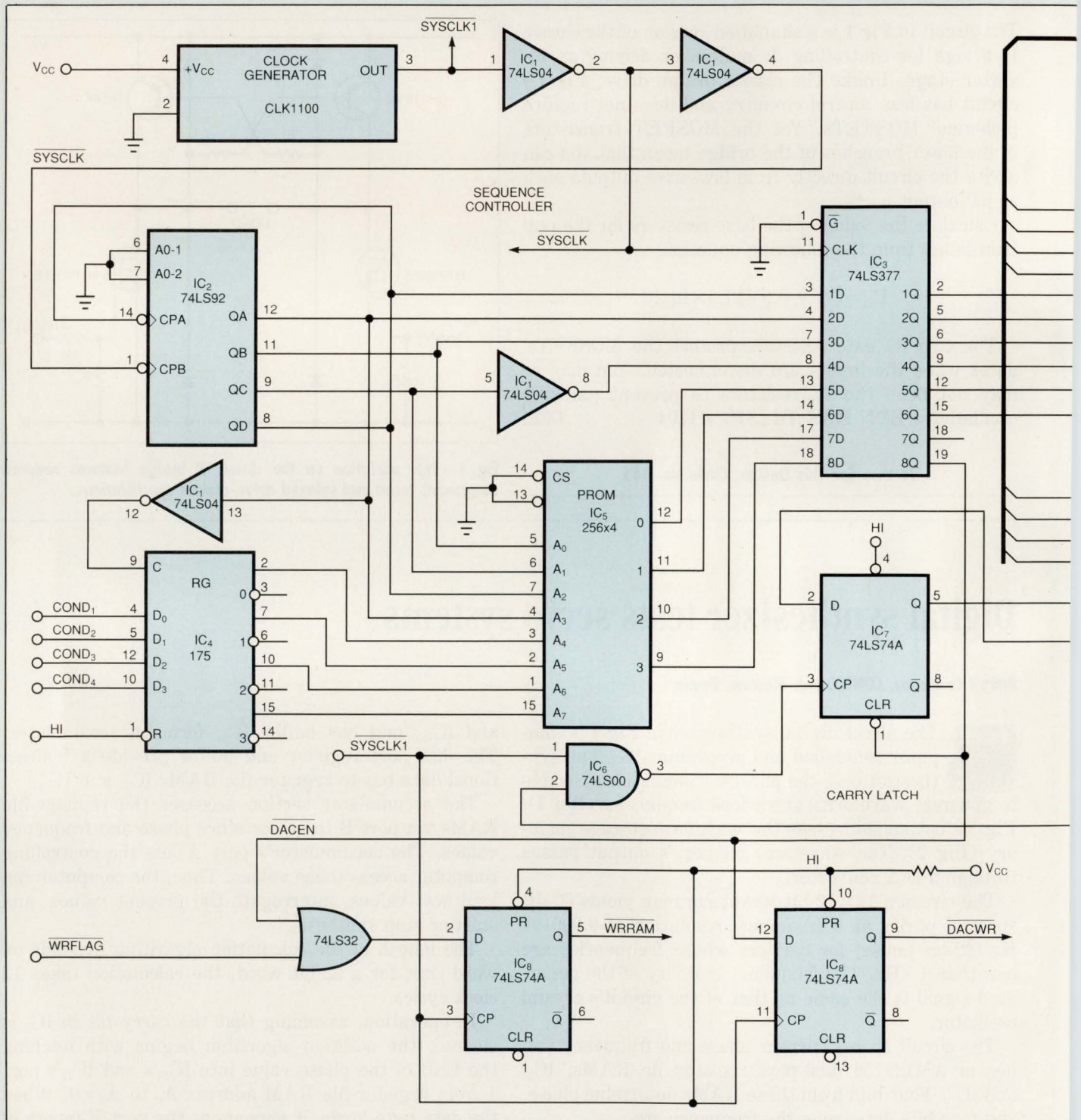

Fig 1—This digital synthesizer yields 60-dB spectral purity at a frequency resolution of 0.000194 Hz (32-bit phase) for carriers whose frequencies are less than 1 kHz.

EDN-DESIGN IDEAS

to write the low-order byte of the waveform memory's address into IC₁₁. On the last cycle of the fourth addition, the circuit generates the DACWR strobe and clears carry-flag register IC₇.

The phase value at the outputs of IC₁₁ and IC₁₂ is

stable within two clock periods, so even slow static RAMs, such as the 6164, are suitable for waveform-table storage.

The control computer accesses the current phase and frequency through the standard A₀ to A₃, RD/WR,

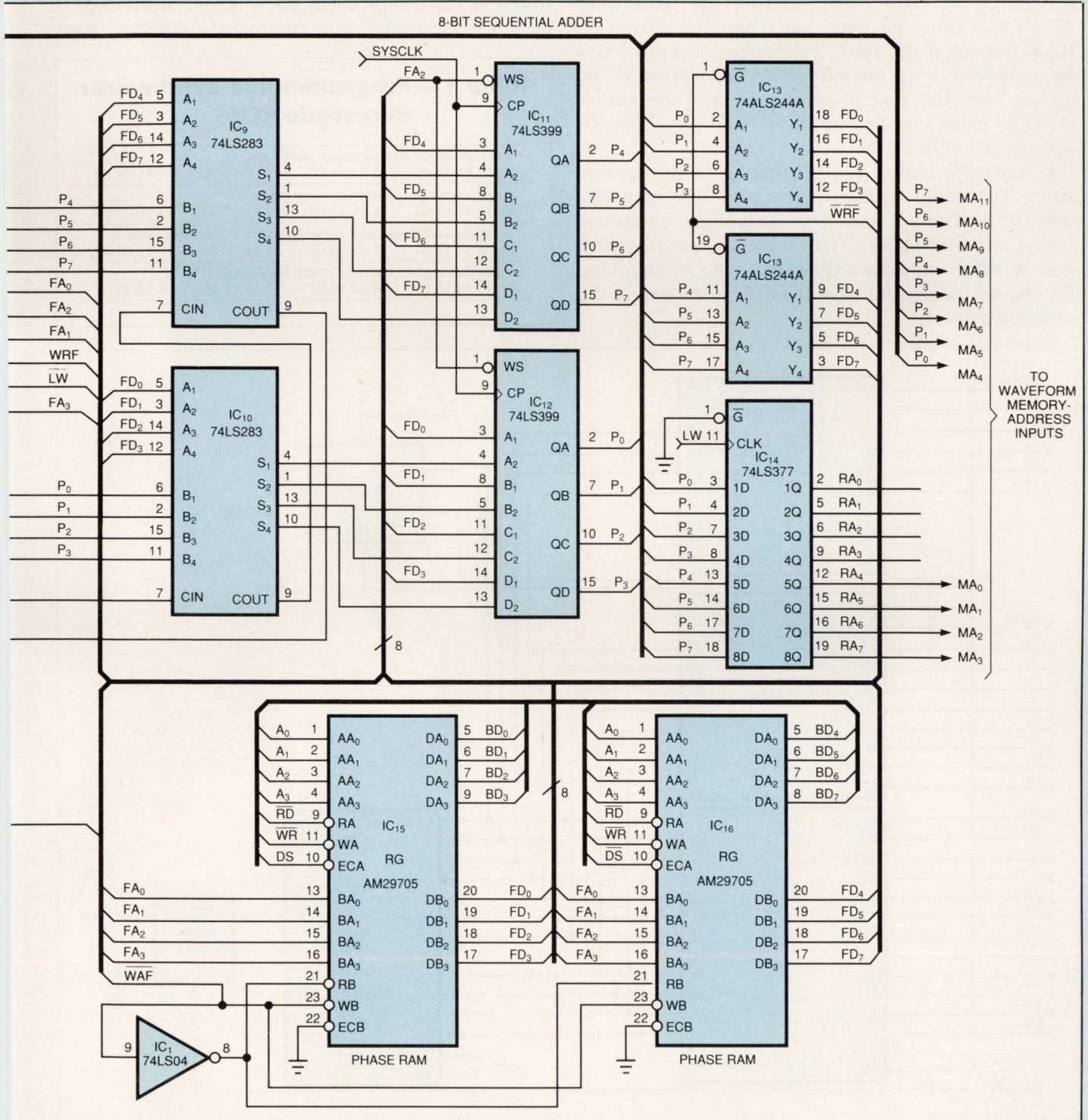

CA, and BD₀ to BD₈ I/O interfaces of an IBM PC. The computer loads the waveform RAM in a different manner. First, it sets the frequency to zero and the phase to point at the desired memory location. Second, the computer writes waveform data to the 74LS374 registers (Fig 2), LSB first. Writing the MSB sets WRFLAG, thus the data loads into the waveform RAM instead of the DAC. The computer repeats this sequence for each waveform-RAM location to be loaded, providing that the writes do not come earlier than the phase-update loop takes to finish (about 1.2 μsec for a 10-MHz clock).

IC₂ and IC₅ control the sequencing of the synthesizer. You could replace these two ICs with one GAL16V8. Table 1 lists the controlling microcode loaded into PROM IC₅. The microcode has 16 pages, each of which supports a different mode of operation. IC₄ latches the current page number at the end of the accumulation loop.

Note that the AM29705 phase RAMs, IC₁₅ and IC₁₆, actually hold 16 words, but the synthesizer uses 8 words at a time for 32-bit phase accumulation. The different sequencer modes treat the phase RAMs as having upper and lower 8-bit banks. Page 0 (normal mode) in Table 1 performs the sequence described. If page 1 (sync mode) is in control, the current phase

Table 1—Programmable synthesizer microcode ROM

normal mode, access phase RAM page 0			
00: 15 11 11 00	11 11 11 00	11 11 10 00	11 11 01 00
sync requested, take phase from page 1			
20: 17 11 11 00	13 11 11 00	13 11 10 00	13 11 01 00
halt requested, use phase RAM page 0, but write to page 1			
40: 15 11 13 00	11 11 13 00	11 11 12 00	11 11 03 00
alternate signal=switch to phase RAM page 1			
60: 17 13 13 00	13 13 13 00	13 13 12 00	13 13 03 00

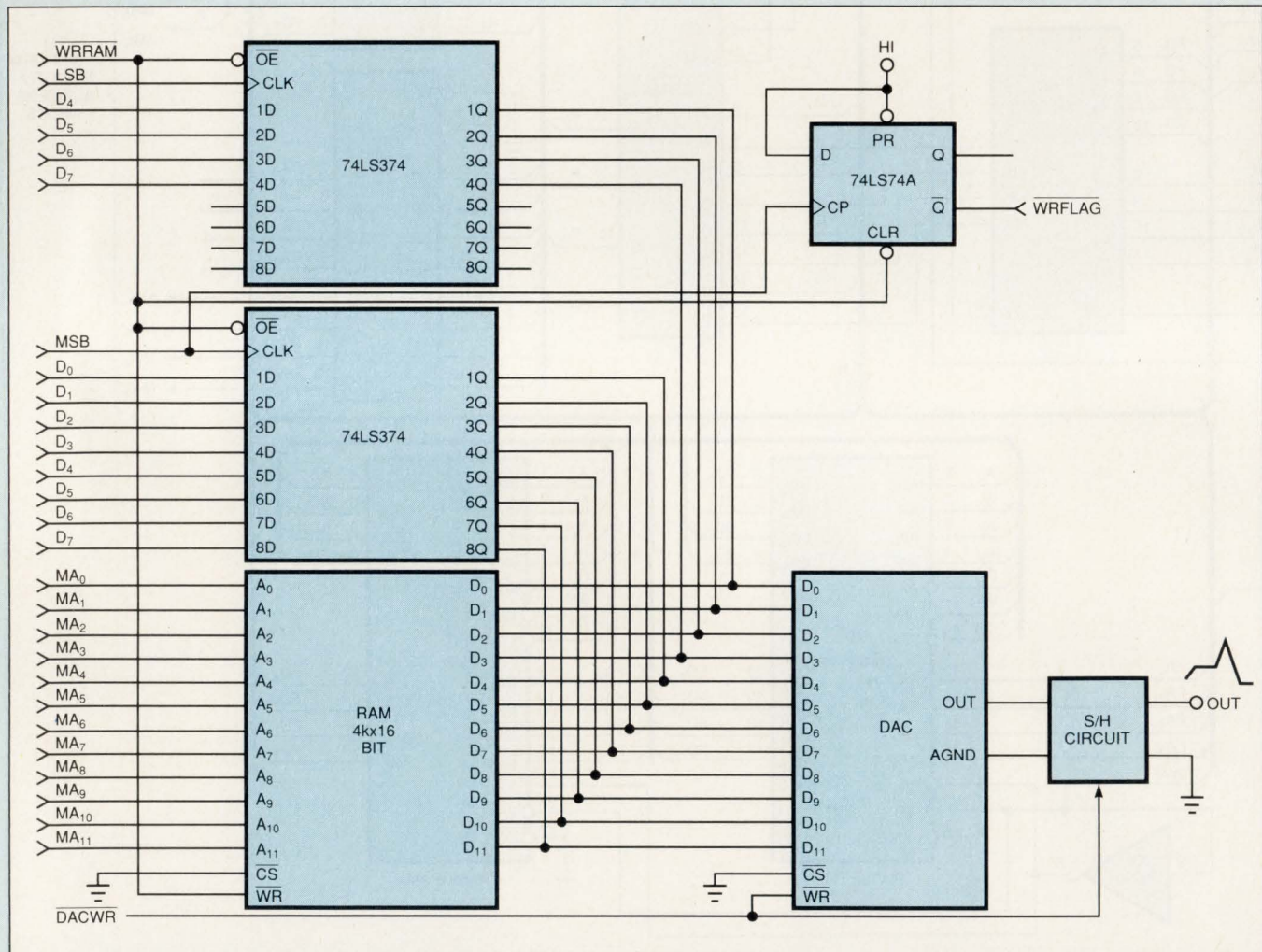

Fig 2—The synthesizer in Fig 1 accesses various locations in the programmable waveform memory. A D/A converter develops an analog output from the waveform memory's output data.

comes from the upper page and gets written into the corresponding page in the lower bank. Thus, the phase is "preset" to the value written into the upper bank. In page 2 (halt mode), writes to the phase RAM's lower bank are disabled, so the waveform suspends at the current phase value until the lower bank is re-enabled. In page 3 (alternate-signal mode), the synthesizer operates like Page 0, except that it uses the upper phase-RAM bank, so the waveform immediately switches to a second phase and frequency.

You can control which ROM sequencer page is in control via software or through the COND1 to COND4

inputs. These same inputs implement the waveform-burst mode. You can get copies of the documentation, sequencer-ROM program, and a P-CAD version of the schematics from the EDN BBS.

EDN BBS /DI_SIG #1105

EDN

To Vote For This Design, Circle No. 666

Reference

1. McCune, E, "Create signals having optimum resolution, response, and noise," *EDN*, March 14, 1991, pg 95.

Buffer tree multiplies dc supply voltages

Ian M Wiles, IPR Technology, Basingstoke, Hants, UK

The "buffer tree" in Fig 1 can multiply a dc supply voltage by any whole number. The circuit successively adds the supply voltage to itself using a cascaded circuit element. The circuit element comprises two capacitors and paralleled HEX inverters configured as a noninverting buffer. The circuit relies on the bidirectional properties of MOSFETs.

Fig 2 shows the complete circuit for the first two stages of the buffer tree. The oscillator in Fig 2 produces a 50-kHz clock drive. Lowering this frequency increases efficiency at the expense of lessening the output current. The efficiency of a breadboarded circuit was 90% for a 5-mA output from a 3-stage circuit (multiplier of 4) and dropped to 75% for a 15-mA output.

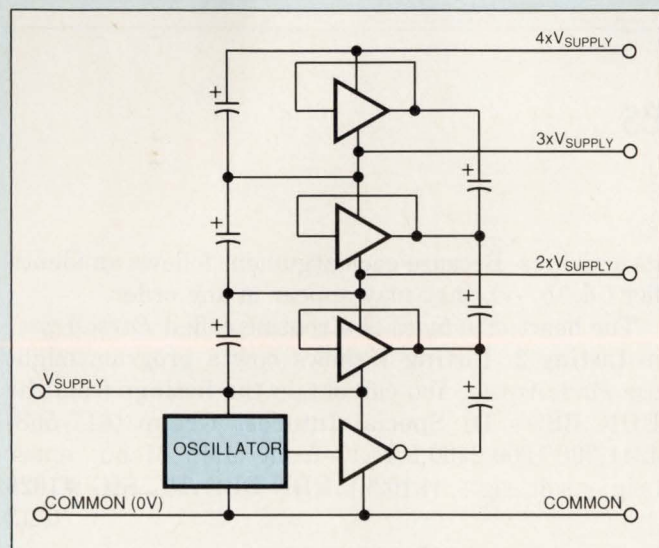

Fig 1—You can cascade buffer elements to multiply a supply voltage by any whole number.

You can realize an inverting multiplier by treating the positive supply rail as a common and rearranging the circuit accordingly. EDN BBS /DI_SIG #1103

EDN

To Vote For This Design, Circle No. 667

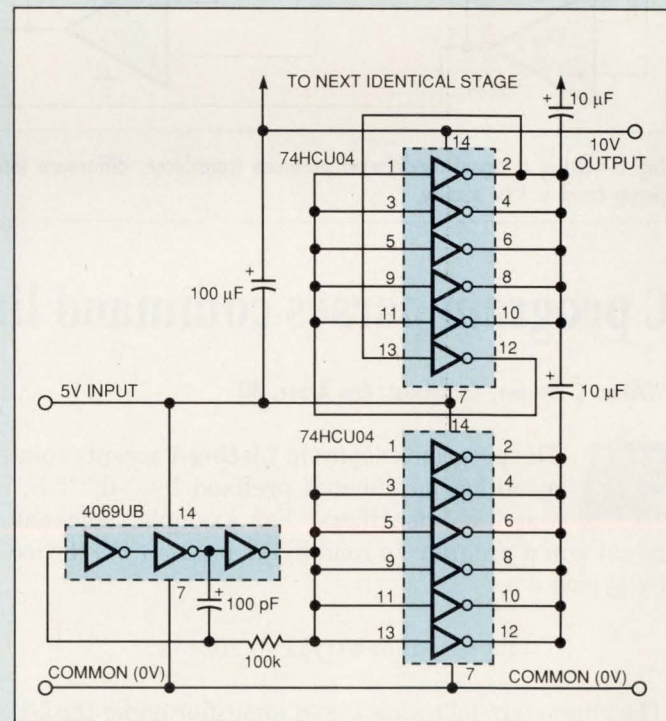

Fig 2—Expanding on Fig 1, this diagram shows the first two stages of a buffer tree. Note that each HEX inverter's configuration makes it a noninverting buffer.

Motor controller powers peristaltic pump

T G Barnett and M J George, Queen Mary and Westfield College, London, England

The circuit in Fig 1 is a simple, low-cost motor controller, initially designed to control a peristaltic pump. These pumps often require input-drive voltages of 30V. Also, any steady-state error in the pump's proportional control system may not be acceptable. The circuit monitors pressure using a signal-conditioned pressure transducer suited for the required operating range. The typical output voltage of the pressure transducer will be between 1 and 5V. The output of the transducer drives a voltage follower, IC_{1A}. The potentiometer sets the reference voltage, which is obtained from a ZNREF050 diode of a second follower, IC_{1B}. The outputs of each of these followers form the inputs to a

Norton-type current-differencing amplifier, IC₂. The circuit configures this amplifier as a difference integrator. The exact value of C_{INT} depends on the particular application. A dc/dc converter provides IC₂ with a supply of 30V. The overall circuit operates from a 12V supply. You can easily modify this circuit. For example, you can use additional LM324 op amps, which come in quad packages, to provide offset voltages for fine adjustment and to amplify or attenuate sensor and reference voltages. EDN BBS /DI_SIG #1052

To Vote For This Design, Circle No. 668

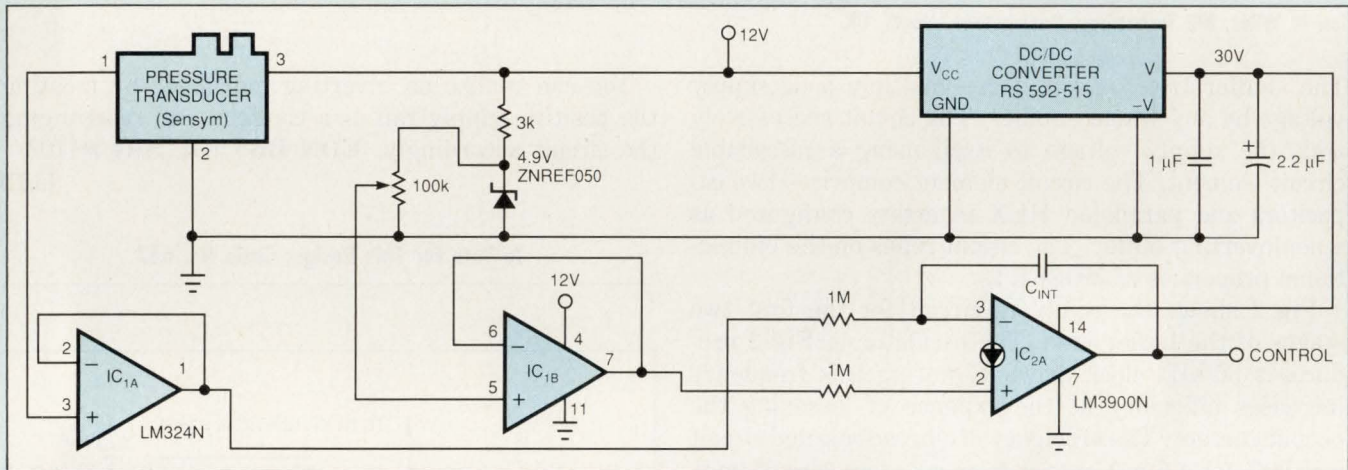

Fig 1—Using a signal-conditioned pressure transducer, difference integrator, and dc/dc converter, this motor controller drives a peristaltic pump from a 12V supply.

C program parses command lines

William C Warner, Consultant, Ann Arbor, MI



The program *inbytes* in Listing 1 accepts command-line arguments prefixed by “-d,” “-b,” and “-v” identifiers. For example, someone might run a program to read bytes from an I/O device by typing

```
inbytes -d /dev/tty11 -b 1024 -v.
```

The characters following the -d identifier name the I/O device. The number after -b is the maximum number of bytes to read from the device. The -v, if present, stands for “verbose,” which tells the program to report

its activities. Because each argument follows an identifier (-d, -b, -v), they may appear in any order.

The heart of *inbytes* is a routine called *ParseArgs()* in Listing 2. Listing 1 shows how a program might use *ParseArgs()*. You can obtain the listings from the EDN BBS's DI Special Interest Group (617-558-4241,300/1200/2400,8,N,1—from Main Menu, enter (s)ig, <s/di_sig>, rk1026). EDN BBS /DI_SIG #1026

EDN

To Vote For This Design, Circle No. 669

Listing 1—Command-line-argument parsing program

```

#include <stdio.h>
#include <fcntl.h>
#include <errno.h>

/* OS global error number */
extern int errno;

/* calling sequence for a routine to parse cmd line args */
int ParseArgs(char *pArgv[], int nArgc, char *pIdent, char *pFmt, void *pValue);

/*
** Program: inbytes
**
** Invoked as follows:
**
**   inbytes -d <device name> -b <bytes> [-v]
**
**   where <device name> names an I/O device
**         <bytes> is the max number of bytes to read from the device
**         -v, if present, has the program report its activities
**
** Like all C programs, this program accepts two arguments from the
** operating system. "argc" is a count of the command line strings.
** "argv" is the address of an array of pointers to the command line
** strings.
*/

main( argc, argv )
int argc;          /* number of command line strings */
char *argv[];     /* argv[] holds ptrs to cmd line strings */
{
    int fVerbose;  /* flag: true to report activities */
    int nCnt;      /* max number of bytes to read from device */
    char szDevName[40]; /* name of device */
    static char buf[1024]; /* buffer for characters read */
    int rd, fd;

    /* establish defaults */
    strcpy( szDevName, "" );
    nCnt = sizeof( buf );
    fVerbose = 0;

    /*
    ** Call ParseArgs() to possibly override defaults with values
    ** from command line
    */
    ParseArgs( argv, argc, "-d", "%s", szDevName );
    ParseArgs( argv, argc, "-b", "%d", &nCnt );
    fVerbose = ParseArgs( argv, argc, "-v", "%d", NULL );

    /*
    ** Passed here, szDevName[] holds the name of a device, nCnt
    ** holds a count value, and fVerbose is TRUE if the program
    ** should report its activities
    */

    /*
    ** Check arguments: must have device name, bytes must
    ** not overflow buf[]
    */
    if ( strcmp( szDevName, "" ) == 0 )
    {
        printf( "inbytes: bad device name\n" );
        exit();
    }
    if ( nCnt > sizeof( buf ) )
    {
        printf( "inbytes: byte count too big (max: %d)\n", sizeof( buf ) );
        exit();
    }

    if ( fVerbose )
        printf( "inbytes: opening device '%s'\n", szDevName );

    /* open device */
    fd = open( szDevName, O_RDONLY );
    if ( fd < 0 )
    {
        printf( "inbytes: failed to open device '%s' (errno: %d)\n",
            szDevName, errno );
        exit();
    }

    if ( fVerbose )
        printf( "inbytes: reading up to %d bytes\n", nCnt );

    /* read in nCnt bytes */
    rd = read( fd, buf, nCnt );
    if ( rd < 0 )
    {
        printf( "inbytes: failed to read device (errno: %d)\n", errno );
        exit();
    }

    if ( fVerbose )
    {
        printf( "inbytes: %d bytes read\n", rd );
        printf( "inbytes: first byte: 0x%02x\n", ((int) buf[0]) & 0xff );
    }

    close (fd);
    exit();
}

```

Listing 1—Command-line-argument parsing subroutine

```

/*
** ParseArgs()
** Parse command-line arguments.
**
** C call:      int ParseArgs( pArgv, nArgc, pIdent, pFmt, pValue )
**
** Parameters: char *pArgv[]
**              Address of array of pointers of command line strings
**
**              int nArgc
**              Number of command line strings
**
**              char *pIdent
**              String used to identify a certain cmd line arg (i.e., "-v")
**
**              char *pFmt
**              Format string for scanning argument value (i.e., "%d" )
**
**              void *pValue
**              Pointer to storage for the argument value, if any.
**              This parameter can be NULL if no value is expected.
**
** Returned:   1 if match found for "pIdent"; or
**              0 if not
**
** This routine searches the cmd line strings for a match to pIdent. If
** found and pValue is NULL, this routine returns 1 to signify that the
** cmd line argument was present. If found and pValue not NULL, this
** routine scans the value following the identifying characters according
** to the format string *pFmt and into storage at *pValue.
*/

int ParseArgs( pArgv, nArgc, pIdent, pFmt, pValue )
char *pArgv[];
int nArgc;
char *pIdent;
char *pFmt;
void *pValue;
{
    int i, ret = 0;
    char *pScan = NULL;

    /*
    ** Check all cmd line arguments for a match to pIdent
    */
    for ( i = 0; i < nArgc; i++ )
    {
        /* check one arg for match with pIdent */
        if ( strcmp( pArgv[i], pIdent, strlen( pIdent ) ) )
            continue; /* no match */

        /* got match */

        /* return now if don't need value */
        if ( pValue == NULL )
        {
            ret = 1;
            break;
        }

        /* check for value following ident with no space or after space */
        if ( strlen( pArgv[i] ) != strlen( pIdent ) )
        {
            /* value following with no space */
            pScan = &( pArgv[i][ strlen( pIdent ) ] );
        }
        else if ( (i+1) < nArgc )
        {
            /* value following after space - scan next cmd line string */
            pScan = pArgv[i+1];
        }

        /* scan the value and return 1 if value scans */
        if ( pScan != NULL )
        {
            ret = ( sscanf( pScan, pFmt, pValue ) == 1 ) ? 1 : ret;
            break;
        }
    }

    return (ret);
}

```

How to use our bulletin board



This icon identifies those Design Ideas that have computer-readable material posted on EDN's bulletin-board system (BBS). Call our free BBS at (617) 558-4241 (300/1200/2400/9600 8,N,1). Not every Design Idea has downloadable material, but each one does have a BBS number printed at the end of it. Once you get into the system, you can use that number to find more information on a particular idea. If you'd like to comment on any Design Idea, include the number in the subject field of your message.

Polynomial linearizes thermocouple

Robert S Villanucci, Wentworth Institute, Boston, MA

By combining a second-order-polynomial curve-fitting circuit and a scaling amplifier having the proper offset, you can reduce thermocouple-linearization costs. Yet, you can still achieve a worst-case system response—over an extended temperature range—of less than 4°C. A low-cost analog-multiplier IC provides the squared term of the second-order polynomial.

The circuit in Fig 1 uses a chromel-constantan (type-E) thermocouple, sensing temperature from 0 to 650°C. Adding a series-opposing correction voltage, V_C , to the sensor cancels the cold-junction error voltage, V_R . IC₁, a cold-junction compensator, tracks the ambient temperature, T_A , and produces this temperature-dependent V_C . V_C has the same sensitivity (60.0 $\mu\text{V}/^\circ\text{C}$) as the cold-junction thermocouple junctions.

IC₂ amplifies the thermocouple's low-level signal with a gain of 100 and applies the amplified signal,

V_T , to the curve-fitting and scaling circuitry. The output voltage of the curve-fitting and scaling circuitry yields an overall sensitivity of 10 mV/°C.

Fig 2, a plot of V_O vs V_T , shows that the thermocouple's response is linear above 350°C and nonlinear below this transition temperature. You scale the section above 350°C (where $V_T = 2.4961\text{V}$) for a 10-mV/°C sensitivity with the linear expression

$$V_O = (1.24V_T + 0.399\text{V}) \times \mu(V_T - 2.4961\text{V})$$

where μ is a step function added to indicate that this linear equation is valid only for temperatures above 350°C. You set the required gain of 1.24 in Fig 1's circuit with feedback resistor R_1 and input-resistance network $R_2 \parallel R_3$. IC_{3D} generates the 0.399V offset. Comparator IC₅ combines with analog switch IC₆ to

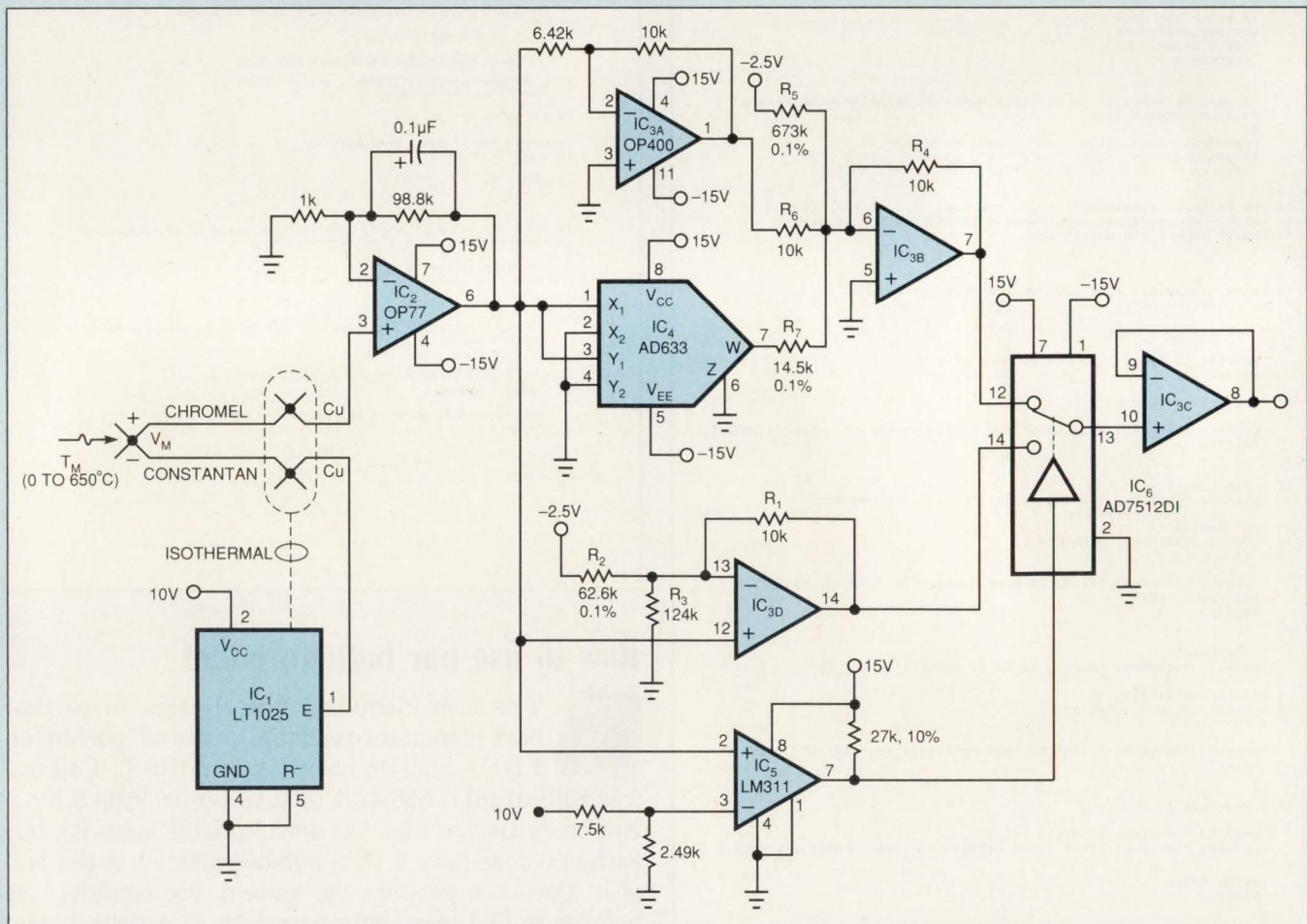
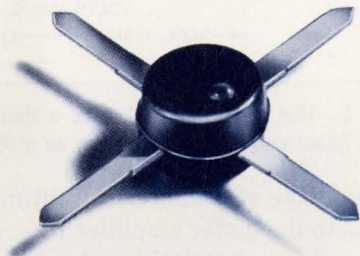

Fig 1—Switching in circuitry having a second-order-polynomial response, at the proper point in the thermocouple's response curve, linearizes the output of a type-E thermocouple.

99¢

from



dc to 2000 MHz amplifier series

SPECIFICATIONS

MODEL	FREQ. MHz	GAIN, dB			Min. (note)	• MAX. PWR. dBm	NF dB	PRICE \$ Ea.	Qty.
		100 MHz	1000 MHz	2000 MHz					
MAR-1	DC-1000	18.5	15.5	—	13.0	0	5.0	0.99	(100)
MAR-2	DC-2000	13	12.5	11	8.5	+3	6.5	1.35	(25)
MAR-3	DC-2000	13	12.5	10.5	8.0	+8□	6.0	1.45	(25)
MAR-4	DC-1000	8.2	8.0	—	7.0	+11	7.0	1.55	(25)
MAR-6	DC-2000	20	16	11	9	0	2.8	1.29	(25)
MAR-7	DC-2000	13.5	12.5	10.5	8.5	+3	5.0	1.75	(25)
MAR-8	DC-1000	33	23	—	19	+10	3.5	1.70	(25)

NOTE: Minimum gain at highest frequency point and over full temperature range.

- 1dB Gain Compression
- +4dBm 1 to 2 GHz

designers amplifier kit, DAK-2
5 of each model, total 35 amplifiers
only **\$59.95**

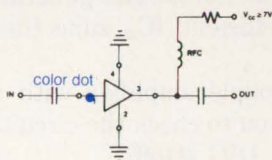

Unbelievable, until now...tiny monolithic wide-band amplifiers for as low as 99 cents. These rugged 0.085 in.diam., plastic-packaged units are 50ohm* input/output impedance, unconditionally stable regardless of load*, and easily cascadable. Models in the MAR-series offer up to 33 dB gain, 0 to +11dBm output, noise figure as low as 2.8dB, and up to DC-2000MHz bandwidth.

*MAR-8, Input/Output Impedance is not 50ohms, see data sheet.
Stable for source/load impedance VSWR less than 3:1

Also, for your design convenience, Mini-Circuits offers chip coupling capacitors at 12 cents each.†

Size (mils)	Tolerance	Temperature Characteristic	Value
80 x 50	5%	NPO	10, 22, 47, 68, 100, 220, 470, 680, 1000 pf
80 x 50	10%	X7R	2200, 4700, 6800, 10,000 pf
120 x 60	10%	X7R	.022, .047, .068, 1µf

† Minimum Order 50 per Value

• Designers Kit, kcap-1, 50 pieces of each capacitor value, only \$99.95

finding new ways...
setting higher standards

Mini-Circuits

A Division of Scientific Components Corporation
P.O. Box 350166, Brooklyn, New York 11235-0003 (718) 934-4500
Fax (718) 332-4661 Domestic and International Telexes: 6852844 or 620156

C113-Rev. D

CIRCLE NO. 111

EDN May 7, 1992 • 205

ADVANCED QFP/PQFP Socket/Adapter System

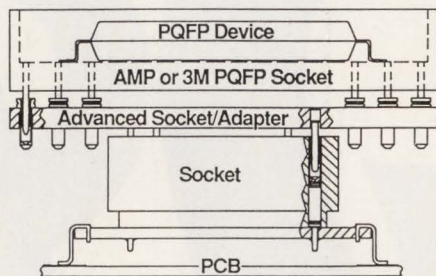

For Fine Pitch Devices

- Allows interface of fine pitch device to surface mount footprint for testing.
- Allows interconnecting of fine pitch device without soldering device to PCB.
- Socket/Adapter system can be spaced a minimum of .150" from each other.
- Socket/Adapter system affords repeated use of PQFP socket.



Advanced Interconnections®

5 Energy Way, P.O. Box 1019, W. Warwick, RI 02893
Tel. (401) 823-5200 Fax. (401) 823-8723 TWX 9102403453

Socket/Adapter System is covered by patent rights issued and/or pending. Advanced Interconnections is a registered trademark.

TITLE: **Blueprint of ADVANCED Technology**

NOTE: **See us at Electro '92 • Booths 3412-3414**

CIRCLE NO. 112

AUDIO PRO II

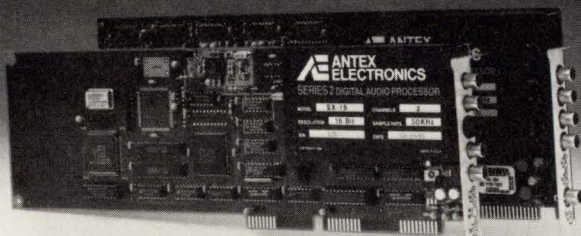

AUDIO PRO II
Model SX-15

AUDIO PRO
Model SX-10

Introducing... second generation CD quality, stereo hi-fidelity digital audio record/playback for PC-AT 386/486 or compatible. Now with DVI/CDI/CD-ROM XA audio compression up to 44.1 kHz.

Featuring... real time direct-to-disk data transfer... 18 bit resolution... 64x oversampling... 22kHz audio response... 0.005% THD... 6.25 to 50 kHz programmable sample rate... 92dB dynamic range... 90db s/n... plus 4:1 ADPCM compression.

For broadcast quality recording, editing and transmission in high-end entertainment systems, A/V presentations and interactive CDI/DVI applications. Phone 1 (800) 338-4231 for details on the 2nd generation AUDIO PRO Model SX-15.

ANTEK ELECTRONICS

16100 S. Figueroa St. • Gardena, CA 90248 (USA) • Tel (310) 532-3092 • FAX (310) 532-8509

CIRCLE NO. 113

EDN-DESIGN IDEAS

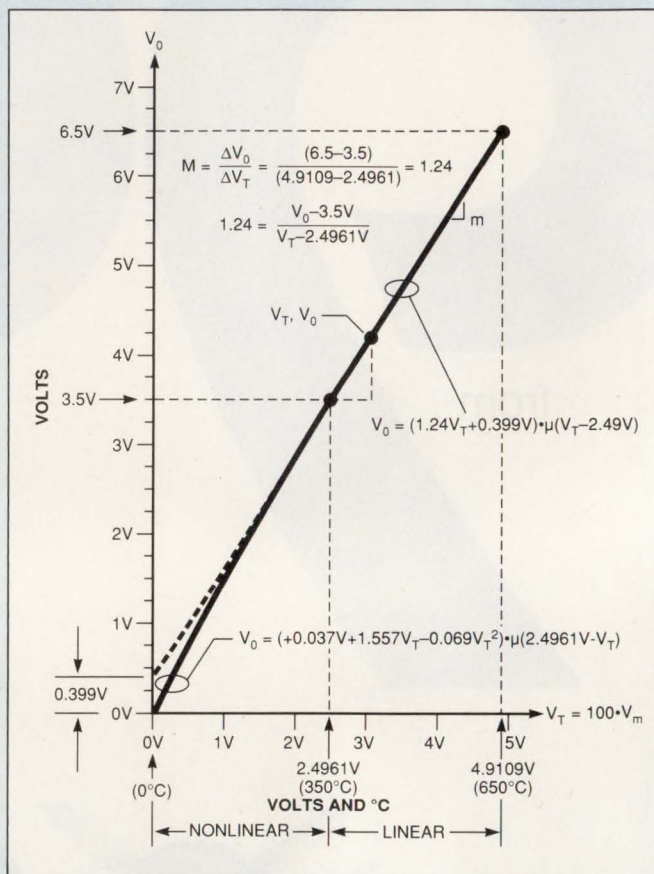

Fig 2—The circuit in Fig 1 uses a thermocouple whose response has linear and nonlinear regions on either side of 350°C.

create the step function, routing the linear output of IC_{3D} to the buffer amplifier IC_{3C} , only when the voltage exceeds the 2.4961V breakpoint.

For temperatures below 350°C, the output of comparator IC_5 goes low, switching IC_{3B} 's output through the analog switch IC_6 to the output-buffer amplifier IC_{3C} . The method of least squares yields the second-order polynomial,

$$V_0 = (0.037V + 1.557V_T - 0.069V_T^2) \times \mu(2.4961V - V_T).$$

In Fig 1, the attenuation of R_4 and R_5 creates the positive 0.037V offset from the $-2.5V$ reference. R_4 and R_6 set IC_{3A} 's gain to -1.557 . IC_4 creates the squared term, and the combination of R_4 and R_7 removes the device's 10V scale factor and generates the squared term's -0.069 coefficient. IC_{3B} sums the terms of the polynomial.

Replacing the thermocouple amplifier with a low-impedance source allows you to check the circuit's performance. EDN BBS/DI-DIG #1092

EDN

To Vote For This Design, Circle No. 670

High Density Hermaphroditic Connectors

- Identical contacts on mating halves
- Close pitch .050" centers

Meritec 50 ohm, impedance matched Hermaphroditic Connectors feature .050" centers, with board spacing as close as .394" (10 mm), making them ideal for dense package applications. Two, three and four row connectors are available, in straight or right angle versions, with through hole or SMT contact tails. Precision, high strength molded terminations are reliable in the most critical applications. The connectors are designed to meet IR or vapor phase reflow requirements.

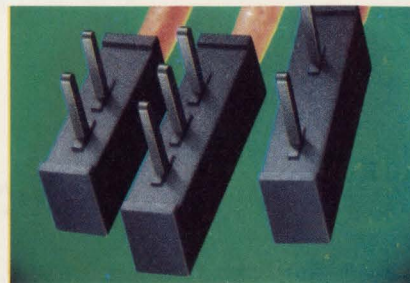
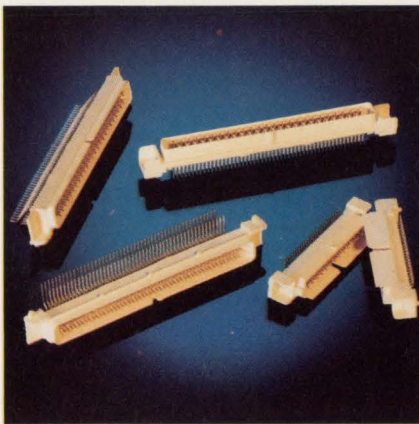

Impedance matched PCB Solderable Interconnects

- Solders directly to the PCB
- Low profile

Meritec's PCB Solderable Interconnects can be soldered directly to the PCB for a permanent connection. Pin lengths of .110" and .160" are available for different board thicknesses. The impedance matched connectors feature precision, high strength molded terminations for reliability in critical applications. Available in 1x2 and 1x3 configurations, the connectors are side-to-side stackable and feature heights as low as .150" from the PCB, making them ideal for dense package applications. The connectors can be terminated to a variety of different cable styles.

Digital and analog interconnect systems that maximize board density and budget.

If you need speed and performance in a digital or analog interconnect system but have a limited budget, turn to Meritec. Meritec digital and analog interconnect systems are designed to meet the requirements of electrically sensitive applications using high speed CMOS, ECL or GaAs logic. Our systems are engineered to provide controlled impedance and propagation delay while minimizing crosstalk. You get ship to stock quality, backed up with technical service and applications support. All at a cost that's well in line with tight project budgets.

For more information and free literature on the complete line of Meritec digital and analog interconnect systems, call 216-354-3148.



Where quality assures performance

1359 West Jackson Street
P.O. Box 8003
Painesville, Ohio 44077
Phone: 216-354-3148
FAX: 216-354-0509

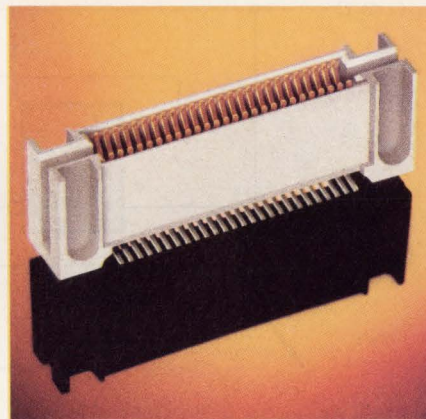

Close Pitch Card Edge Connectors

- .050" centers
- 50 Ω impedance matched

Meritec's high density Card Edge Connectors are designed with .050" centers to minimize board space requirements. The 50 Ω , impedance matched connectors are ideal for high density board-to-board applications. The connectors are designed to meet IR or vapor phase reflow requirements. Through hole and SMT contact tail configurations are available. Precision, high strength molded terminations provide reliability in critical applications.

Dual-frequency clock's outputs have low skew

Louis Pandula, Pandula Consulting, Sunnyvale, CA

The clock circuit in Fig 1 produces both a reference clock and a half-frequency clock. The circuit's multiplexer-based logic exhibits low skew between the two outputs. If you use 74ACT or 74F logic to implement this circuit, the skew can be less than 1 nsec.

In the circuit, flip-flop IC₁ divides the input clock by two. Flip-flop IC₂ mirrors the state of IC₁, delayed by half a clock cycle. Multiplexer IC₄ selects the output of IC₁ during the low clock state and the output of IC₂ during the high clock state. Thus IC₄ generates a divide-by-two clock that changes state one propagation delay after the input clock.

Multiplexer IC₃ simply develops the inverse of the input clock, again adding a delay. As long as the two multiplexers reside in the same IC, their delays will match closely, and the resulting skew between the two output clocks will be very low.

EDN BBS /DL_SIG #1082

EDN

To Vote For This Design, Circle No. 671

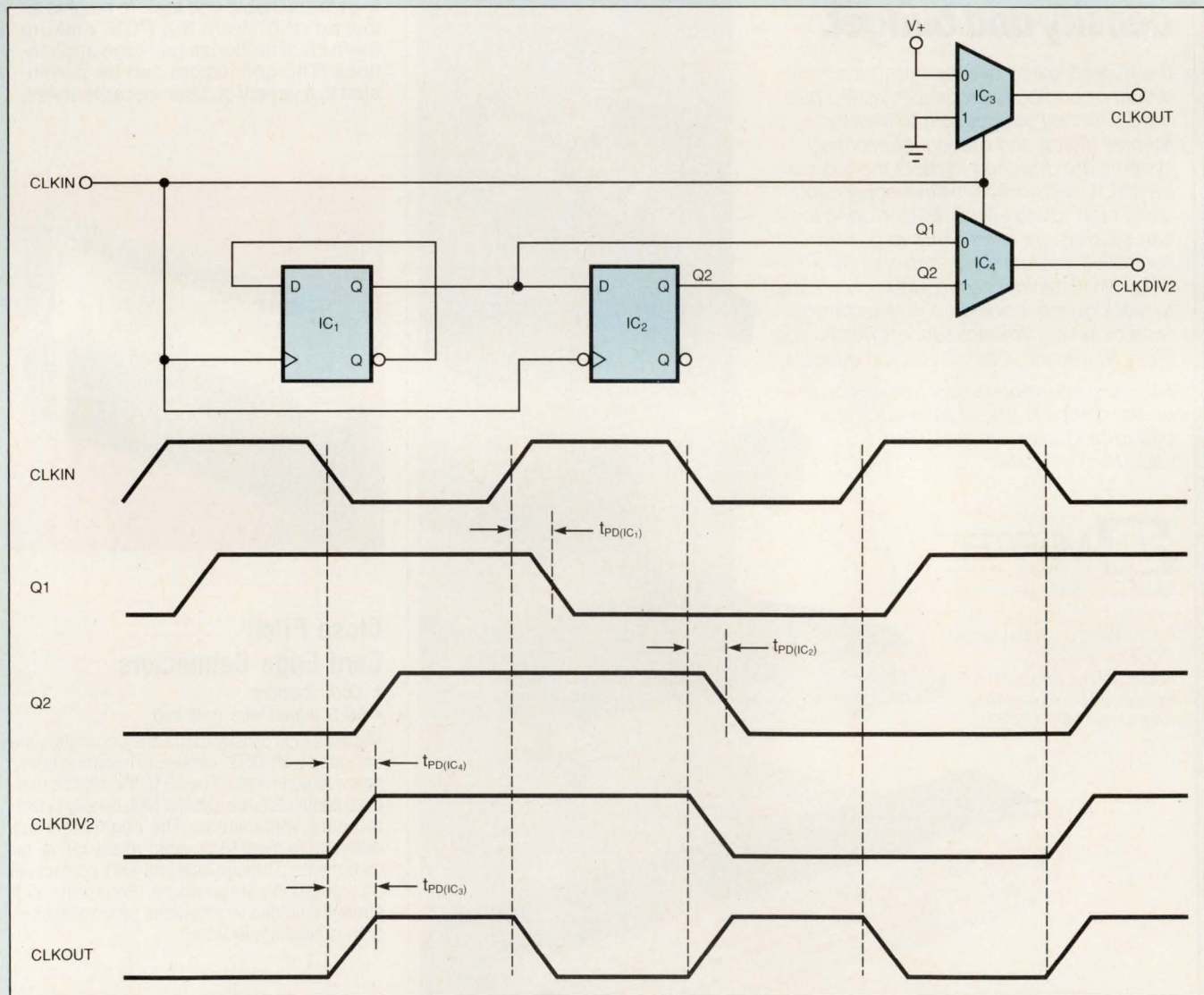

Fig 1—Clever use of multiplexer logic produces a pair of in-phase clock signals. One clock runs at half the speed of the other.

How many design options will you find
with our KK[®] connector system?

The possibilities
are endless.

Here's a connector system that's as broad as your imagination. The Molex family of KK[®] connectors includes 15 basic units. You can combine these in an almost endless number of reliable, cost-efficient board-board and wire-board system designs. Look at the possibilities:

Specify KK connectors with .100" or .156" center spacing...top, side or bottom pin entry PC board connectors...tin, gold, or surprisingly low cost selective gold plating...crimp, solder tail or insulation displacement terminations.

KK connectors give you still another choice: standard KK dual cantilever or unique Trifurcon[®] terminals with 3 contact points for highest reliability in tough operating conditions.

See how much flexibility, reliability – and economy – you can get for your connector dollar. Ask your Molex representative for more information on the incredible KK connector system.

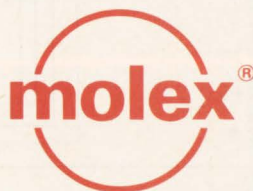
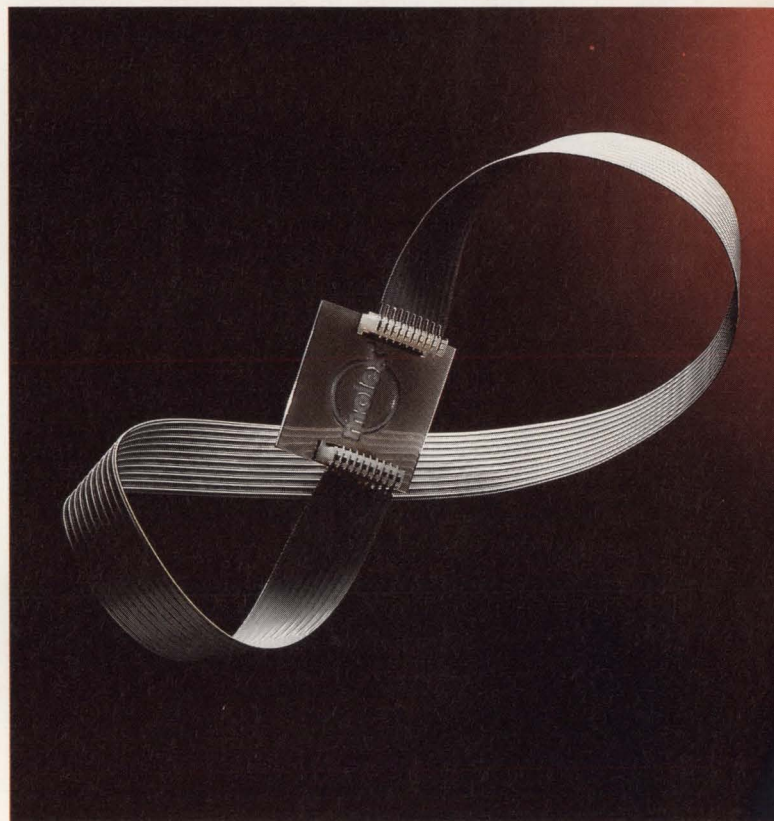

Bringing People & Technology Together, WorldwideSM

See us at Electro Booth #5418

Corporate Headquarters: 2222 Wellington Ct., Lisle, IL 60532 U.S.A., Tel: (708) 969-4550 • European Headquarters: Munich, Germany, Tel: 49-89-413092-0
Far East North Headquarters: Tokyo, Japan, Tel: 81-427-21-5539 • Far East South Headquarters: Jurong Town, Singapore, Tel: 65-660-8555

Digitally controlled amplifier takes 1-dB steps

Mark Williamsen, Ansan Industries Ltd, Rockford, IL

Fig 1 shows a 2-stage digitally controlled amplifier that features accurate logarithmic gain steps and has excellent linearity and headroom at all gain settings. The circuit is well suited for audio, ultrasonic, and instrumentation applications. The circuit connects resistor-divider networks to two analog multiplexers. Under digital control, the multiplexers switch various taps of the resistor chain to the inverting inputs of two JFET-input op amps, thereby changing the gain. The resistor divider chains are set up so that each digital input bit corresponds to a binary-weighted gain change of 1, 2, 4 dB, and so on. Cascading the two stages allows adding together the dB gain for the stages. Thus, you can connect the digital control lines to 6 bits of an output register in a μC , for instance, to provide instantaneous switching to any gain from 0 dB to 63 dB in 1-dB increments.

Every element of the circuit operates optimally. Each gain stage drives a constant and linear resistive load. A low-impedance, constant voltage source drives each feedback divider chain. The divider chains are loaded only by the high-impedance input of an op amp through the analog multiplexer. The analog multiplexer operates in a voltage mode instead of the more common current mode. Switching the op amp's inverting input from one tap to the next has essentially no effect on signals present in the divider, aside from the desired gain change. Analog voltages present at the selected tap are immediately carried through to the

multiplexer's common output terminal. Since essentially no current flows through the selected multiplexer channel, there is no voltage drop and therefore virtually no nonlinearity in the circuit over the full bipolar range of output voltages.

Note that digital controls D_0 , D_1 , and D_5 connect to one multiplexer and D_2 , D_3 , and D_4 connect to a second multiplexer. This digital control allows the two stages to balance the required gains. In the circuit shown, the 32-dB bit (D_5) is combined with the 1-dB (D_0) and 2-dB bits (D_1), so that the worst-case gain for the second stage is 35 dB. The first stage then receives the control bits for 4-dB (D_2), 8-dB (D_3), and 16-dB (D_4) gain changes. The total gain for the first stage is 28 dB.

Industry-standard 4051 analog multiplexers are recommended because of their built-in decoders and level shifters. These provide an extra measure of isolation between the digital control inputs (which are likely to carry an assortment of hash, noise, and spikes) and the analog signal path. The separate V_{EE} pin connects to a negative power supply to allow handling of bipolar analog signals while maintaining standard ground-referenced logic levels.

No bias resistor is needed for the op amp's inverting input, since it's always biased by the op-amp output through the analog multiplexer and divider chain. The multiplexer's inhibit input is tied low to ensure that the op amp remains biased at all times. While this portion of the circuit should be dc coupled, blocking

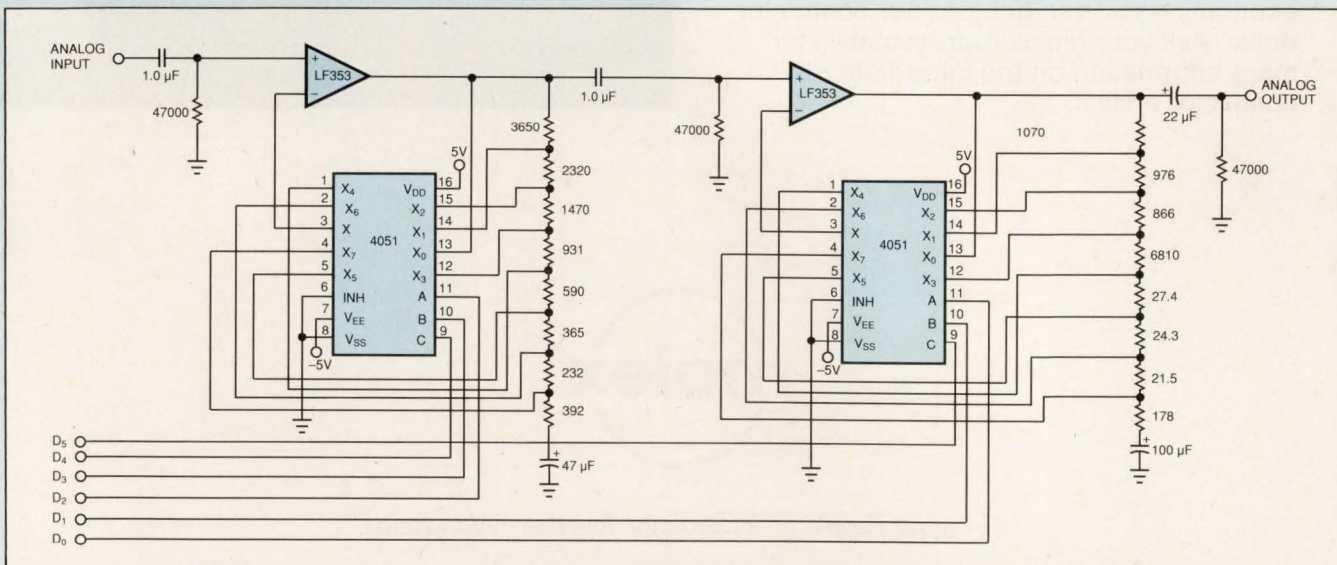
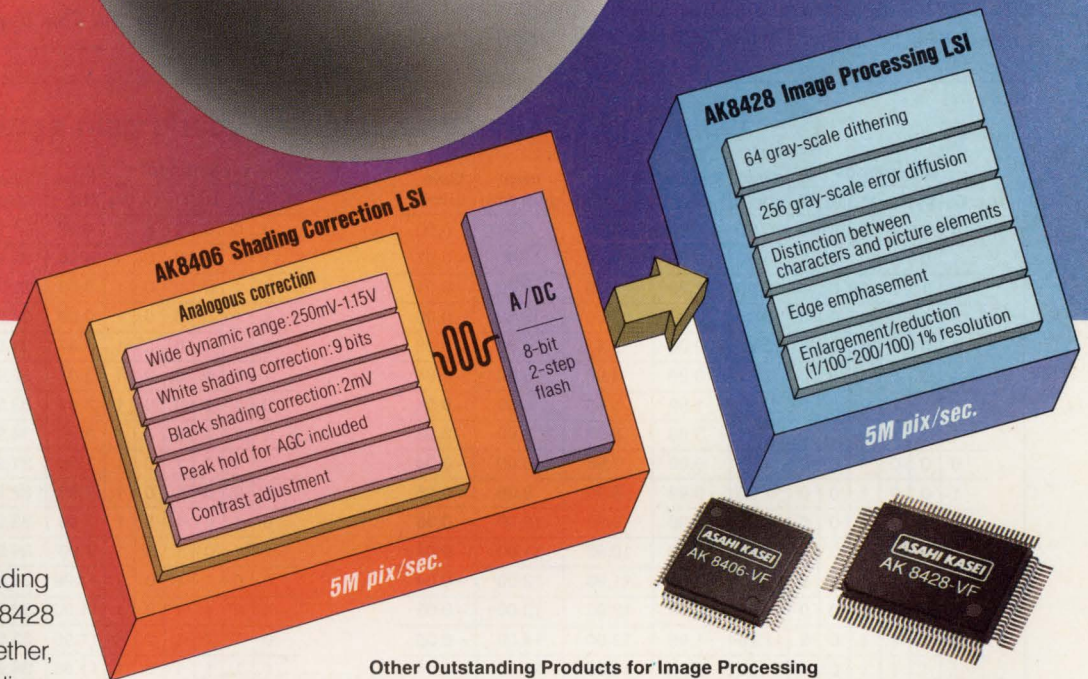

Fig 1—This 2-stage, digitally controlled amplifier balances the gain between the two stages and uses carefully selected resistor values to achieve a dynamic range of 63 dB, which digital inputs can change in 1-dB increments.

Intelligent half tone for image scanning— For 256 shades of gray.



Asahi Kasei Microsystem has developed two advanced products that pack crispness into image scanning. The AK8406 Shading Correction LSI. And the AK8428 Image Processing LSI. Together, they extend gray-scale shading correction to 256 halftones — remarkable performance for image scanners and facsimile machines, too.

Other Outstanding Products for Image Processing

Product	Performance/function
AK8405	Shading correction LSI 16 levels of gray scale • 2M pix/sec.
AK8424	Image processing LSI 16 levels of gray scale • Dithering
AK8426	Image processing LSI 16 levels of gray scale • Distinction between characters and picture elements • Edge emphesement • Reduction • Sensor clock generation



Asahi Kasei Microsystems Co., Ltd.

Yoyogi Community Bldg. 3F, 11-2, Yoyogi 1-chome, Shibuya-ku, Tokyo 151, Japan
Phone: (03) 3320-2062 / Fax: (03) 3320-2072/73

(U.S.A)

CA (NORTH) — PINNACLE SALES (Phone 408-249-7400/Fax 408-249-5129)

CA (SOUTH) — SOLUTECH (Phone 714-374-0130/Fax 714-374-0131)

IL, WI, IA, IN, TX, OK, IW — RICHMAR ELECTRONICS (IL—Phone 708-968-0118/Fax 708-968-0197), (TX—Phone 214-424-8388/Fax 214-424-9170)

NC, SC, GA, FL, AL, TN, MS, AR, LA — CARTWRIGHT & BEAN (GA—Phone 404-368-0160/Fax 404-368-0125), (FL—Phone 407-889-9100/Fax 407-889-2168)

Upstate NY — Interactive Component Sales (Phone 315-445-9600/Fax 315-445-8700)

(EUROPE)

DIP ELECTRONICS LTD. — Sheraton House Castle Park, Cambridge CB3, OAX, U.K. (Phone (44)-223-462244/Fax: (44)-223-467316)

DIP ELECTRONICS DIPEX AB — Box 15046 Hasthomsvagen 28, 104, 65, Stockholm Sweden (Phone (46)-8-449190/Fax (46)-8-430047)

Contact in France: Mr. Laumonier — (Phone (33)-1-69-01-68-82/Fax (33)-1-64-49-86-26)

BECK GMBH & CO. ELEKTRONIK BAUELEMENTE KG — Eltersdorfer Str. 7, 8500 Nürnberg 90 Germany (Phone (49)-911-3405-0/Fax (49)-911-340528)

HERIBER LEHNER OPTO-UND SPEZIAL ELEKTRONIK GMBH — Assbrook 4-6, D2351 Wiemersdorf, Germany (Phone (49)-4192-5007-0/Fax (49)-4192-5007 11)

ALTRAC-AG — Mühlehaldestrasse 6, CH-8953, Dietikon, Switzerland (Phone (41)-1-741-4644/Fax (41)-1-741-1690)

capacitors may be added at the noninverting input and at the low end of the divider chain in ac applications. This will eliminate any spurious outputs due to op-amp offset voltage by reducing dc gain to unity. Note that because the multiplexer handles bipolar signals and all signals are referenced to ground, no special precautions are needed in dc applications, aside from using low-offset or adjustable-offset op amps whose common-mode input range includes any expected analog input signals.

Fig 1 includes blocking capacitors that will remove any dc offsets from the output. Frequency response is flat from subaudio to ultrasound ranges. The circuit's accuracy is limited only by the precision of the resistors in the divider chains. Note that the resistor values shown are standard 1% values. The actual calculated values needed for precise logarithmic steps are slightly different, as shown in Table 1. Note also that steps need not be logarithmic, nor do they need to be uni-

form. For instance, you can set up step sizes of 2, 5, and 10 for instrumentation applications.

Although the circuit responds instantly to gain changes with no audible ticks or pops of its own, any sudden gain changes that occur when the output level is nonzero will result in a step function at the output. This is true for any step attenuator or amplifier. You can minimize this effect by waiting for a zero-crossing, or by making a number of small gain changes in sequence instead of one large change. If a zero-crossing detector is used, you must carefully isolate its output from the analog signal path. The choice of 64 steps of 1 dB resulted from consideration of the desired dynamic range. You can calculate other step sizes for different applications. **EDN BBS /DL_SIG #1114**

EDN

To Vote For This Design, Circle No. 672

Table 1—Digitally controlled amplifier's gain settings

Bit settings*						First stage	Second stage	Actual gain (dB)	Ideal gain (dB)	Gain error
D ₀	D ₁	D ₂	D ₃	D ₄	D ₅					
0	0	0	0	0	0	0.00	0.00	0.00	0.00	0.00
1	0	0	0	0	0	0.00	0.99	0.99	1.00	-0.01
0	1	0	0	0	0	0.00	1.99	1.99	2.00	-0.01
1	1	0	0	0	0	0.00	3.00	3.00	3.00	0.00
0	0	1	0	0	0	3.97	0.00	3.97	4.00	-0.03
1	0	1	0	0	0	3.97	0.99	4.96	5.00	-0.04
0	1	1	0	0	0	3.97	1.99	5.96	6.00	-0.04
1	1	1	0	0	0	3.97	3.00	6.97	7.00	-0.03
0	0	0	1	0	0	7.96	0.00	7.96	8.00	-0.04
1	0	0	1	0	0	7.96	0.99	8.95	9.00	-0.05
0	1	0	1	0	0	7.96	1.99	9.95	10.00	-0.05
1	1	0	1	0	0	7.96	3.00	10.96	11.00	-0.04
0	0	1	1	0	0	11.96	0.00	11.96	12.00	-0.04
1	0	1	1	0	0	11.96	0.99	12.95	13.00	-0.05
0	1	1	1	0	0	11.96	1.99	13.95	14.00	-0.05
1	1	1	1	0	0	11.96	3.00	14.96	15.00	-0.04
0	0	0	0	1	0	15.99	0.00	15.99	16.00	-0.01
1	0	0	0	1	0	15.99	0.99	16.98	17.00	-0.02
0	1	0	0	1	0	15.99	1.99	17.98	18.00	-0.02
1	1	0	0	1	0	15.99	3.00	18.99	19.00	-0.01
0	0	1	0	1	0	20.05	0.00	20.05	20.00	0.05
1	0	1	0	1	0	20.05	0.99	21.04	21.00	0.04
0	1	1	0	1	0	20.05	1.99	22.04	22.00	0.04
1	1	1	0	1	0	20.05	3.00	23.05	23.00	0.05
0	0	0	1	1	0	24.05	0.00	24.05	24.00	0.05
1	0	0	1	1	0	24.05	0.99	25.04	25.00	0.04
0	1	0	1	1	0	24.05	1.99	26.04	26.00	0.04
1	1	0	1	1	0	24.05	3.00	27.05	27.00	0.05
0	0	1	1	1	0	28.09	0.00	28.09	28.00	0.09
1	0	1	1	1	0	28.09	0.99	29.08	29.00	0.08
0	1	1	1	1	0	28.09	1.99	30.08	30.00	0.08
1	1	1	1	1	0	28.09	3.00	31.09	31.00	0.09

Bit settings*						First stage	Second stage	Actual gain (dB)	Ideal gain (dB)	Gain error
D ₀	D ₁	D ₂	D ₃	D ₄	D ₅					
0	0	0	0	0	1	0.00	31.98	31.98	32.00	-0.02
1	0	0	0	0	1	0.00	32.98	32.98	33.00	-0.02
0	1	0	0	0	1	0.00	33.98	33.98	34.00	-0.02
1	1	0	0	0	1	0.00	34.97	34.97	35.00	-0.03
0	0	1	0	0	1	3.97	31.98	35.95	36.00	-0.05
1	0	1	0	0	1	3.97	32.98	36.95	37.00	-0.05
0	1	1	0	0	1	3.97	33.98	37.95	38.00	-0.05
1	1	1	0	0	1	3.97	34.97	38.94	39.00	-0.06
0	0	0	1	0	1	7.96	31.98	39.94	40.00	-0.06
1	0	0	1	0	1	7.96	32.98	40.94	41.00	-0.06
0	1	0	1	0	1	7.96	33.98	41.94	42.00	-0.06
1	1	0	1	0	1	7.96	34.97	42.93	43.00	-0.07
0	0	1	1	0	1	11.96	31.98	43.94	44.00	-0.06
1	0	1	1	0	1	11.96	32.98	44.94	45.00	-0.06
0	1	1	1	0	1	11.96	33.98	45.94	46.00	-0.06
1	1	1	1	0	1	11.96	34.97	46.93	47.00	-0.07
0	0	0	0	1	1	15.99	31.98	47.97	48.00	-0.03
1	0	0	0	1	1	15.99	32.98	48.97	49.00	-0.03
0	1	0	0	1	1	15.99	33.98	49.97	50.00	-0.03
1	1	0	0	1	1	15.99	34.97	50.96	51.00	-0.04
0	0	1	0	1	1	20.05	31.98	52.03	52.00	0.03
1	0	1	0	1	1	20.05	32.98	53.03	53.00	0.03
0	1	1	0	1	1	20.05	33.98	54.03	54.00	0.03
1	1	1	0	1	1	20.05	34.97	55.02	55.00	0.02
0	0	0	1	1	1	24.05	31.98	56.03	56.00	0.03
1	0	0	1	1	1	24.05	32.98	57.03	57.00	0.03
0	1	0	1	1	1	24.05	33.98	58.03	58.00	0.03
1	1	0	1	1	1	24.05	34.97	59.02	59.00	0.02
0	0	1	1	1	1	28.09	31.98	60.07	60.00	0.07
1	0	1	1	1	1	28.09	32.98	61.07	61.00	0.07
0	1	1	1	1	1	28.09	33.98	62.07	62.00	0.07
1	1	1	1	1	1	28.09	34.97	63.06	63.00	0.06

Notes:

*Bit weight for D₀=1 dB; D₁=2 dB; D₂=4 dB; D₃=8 dB; D₄=16 dB; D₅=32 dB.

from
Noritake

Express yourself ...
With VFD Graphic Module flexibility,
a new world is at your command.



One module that will do the work of several.

itron® VFD Graphics Module

- Low cost
- Easy, flexible programming
- High visibility, high brightness
- Six models to choose from
- Controller, character generator and RAM on board
- Simultaneous graphic and character overlay

Call or write to see our entire line:

Noritake

Los Angeles
23820 Hawthorne Blvd.
Suite 100
Torrance, CA 90505
Tel. 213-373-6704
Fax 213-772-3918

Chicago
2635 Clearbrook Dr.
Arlington Heights, IL 60005
Tel. 708-439-9020
Fax 708-593-2285

Boston
263 Winn St.
Suite 1D
Burlington, MA 01803
Tel. 617-270-0360
Fax 617-273-2892

Dallas
2454 Trade Mart
Dallas, TX 75207
Tel. 214-742-9389
Fax 214-747-5065

Europe
Frankfurter Strasse 97-99
6096 Raunheim
F.R. Germany
Tel. 06142-43095/96/97
Fax 06142-22799

CIRCLE NO. 117

Registers build FIFO memory for ASICs

Michael Fitzsimmons, Interphase, Dallas, TX

If your ASIC vendor's library contains no FIFO (first-in, first-out) memories and the library's RAM cells are too troublesome to use, building a FIFO out of simple registers may be the best solution. Using registers instead of RAM to build a FIFO memory eliminates read/write pointers and data multiplexing.

The 16-word \times 32-bit FIFO memory in Fig 1's block diagram requires 512 registers for the memory plus some associated control logic and clock buffers. You can adapt the design to FIFO memories of other sizes as well.

In Fig 1, the column labeled "ELEVATOR CONTROL" controls the stack. The "elevator" goes up on writes and down on reads. The highest logical 1 in the elevator points to the next empty location in the stack of data registers. The elevator always has "floor" 0 set to 1 because you read data out from floor 0. You can bring out elevator-control bits Q_7 and Q_{15} as flags for half-full and full conditions, respectively.

Fig 2 is a sketch of the FIFO data registers; Figs 3 and 4 show the control logic for shifting data from floor to floor during read and write cycles.

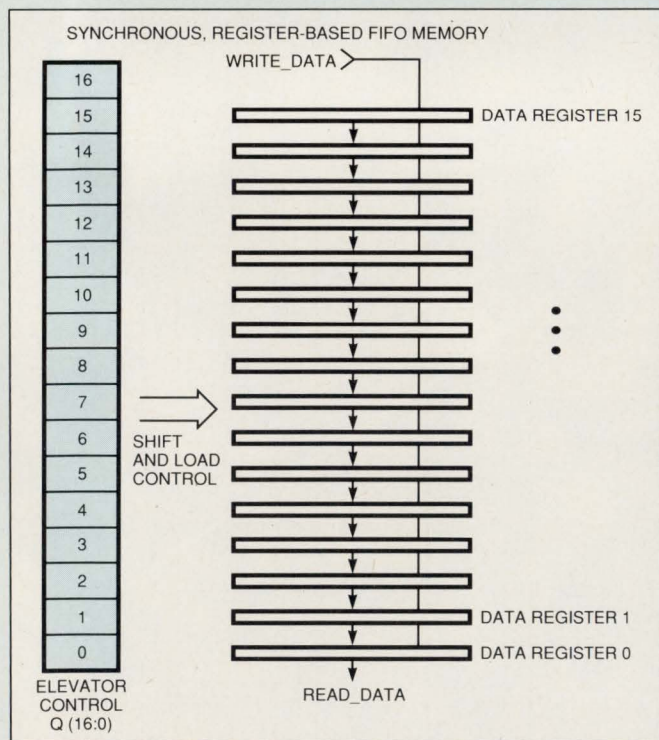

Fig 1—This block diagram serves as a conceptual model for a small FIFO memory you can implement in ASICs by using load/shift registers.

After you write your first word into FIFO register 0 by asserting WRITE (and therefore LD(0)), elevator bit Q_1 will go high, pointing to register 1 for the next write. Subsequent writes will raise the elevator one floor for each write. A simultaneous read and write

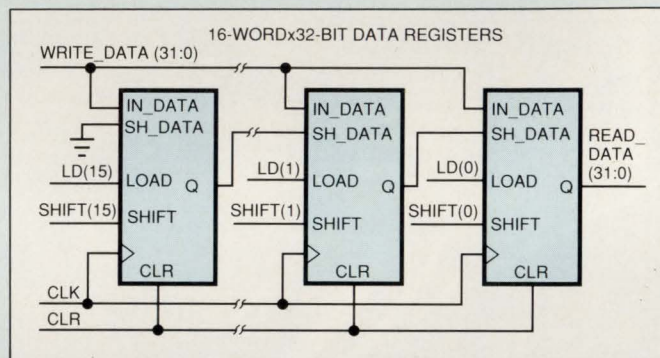

Fig 2—This chain of registers, under the control of the load/shift logic in Figs 3 and 4, moves one bit of each word stored in the FIFO memory up and down the stack in response to read and write commands.

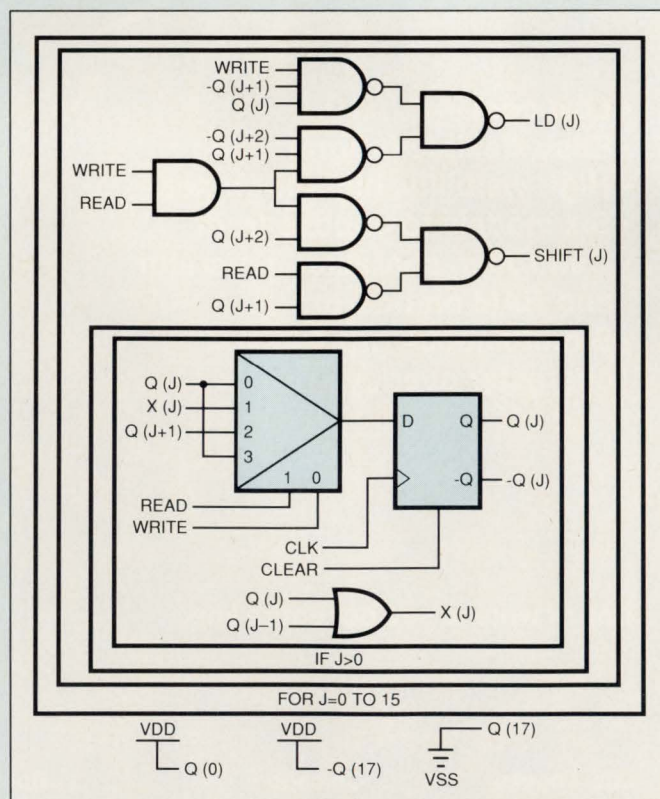

Fig 3—This ASCII macro will generate load/shift logic for each of the vertical strings of bit registers in the FIFO memory.

A GIANT IN COMPUTERS, A WELL KNOWN MEDICAL FIRM AND A MAJOR TELECOMMUNICATIONS COMPANY HAVE ALL CHOSEN HUGHES FLEX CIRCUITS.

WHY?

Unless you're one of the above, you're probably surprised about this. Because we've been so busy expanding our efforts in commercial flex circuits we forgot to tell anyone.

We've been too busy delivering high speed, high density solutions like fine line with 2 mil spacing, and Gold Dot™, the highest density flex circuit interconnects on the planet. Too busy perfecting true high volume SPC manufacturing for six sigma quality. And far too busy producing products like single-sided, double-sided and multi-layer flex circuits with up to 24 layers. Plus, a variety of integrated assemblies.

And frankly, we plan to stay busy. So if you need unique flex circuit experience for everything from 3D electronic packages and multichip modules to semiconductor test heads and ABS braking systems, call Hughes. We'll send you the new Hughes

Interconnect Systems brochure and show you what we're talking about.

Oh, about those companies we mentioned above. Did you ever get the feeling that there's a lot going on at Hughes you might not know about? We're ready to connect you to more than 25 years of flex know-how.

Call toll-free **1-800-821-2998**.



HUGHES

INTERCONNECT SYSTEMS DIVISION

Industrial Electronics Group

Design Entry Blank

\$100 Cash Award for all entries selected by editors. An additional \$100 Cash Award for the winning design of each issue, determined by vote of readers. Additional \$1500 Cash Award for annual Grand Prize Design, selected among biweekly winners by vote of editors.

To: Design Ideas Editor, EDN Magazine
Cahners Publishing Co
275 Washington St, Newton, MA 02158

I hereby submit my Design Ideas entry.

Name _____
 Title _____ Phone _____
 Company _____
 Division (if any) _____
 Street _____
 City _____ State _____
 Country _____ Zip _____
 Design Title _____
 Home Address _____

Social Security Number _____
(US authors only)

Entry blank must accompany all entries. Design entered must be submitted exclusively to EDN, must not be patented, and must have no patent pending. Design must be original with author(s), must not have been previously published (limited-distribution house organs excepted), and must have been constructed and tested. Fully annotate all circuit diagrams. Please submit software listings and all other computer-readable documentation on a 5¼-in. IBM PC disk in plain ASCII.

Exclusive publishing rights remain with Cahners Publishing Co unless entry is returned to author, or editor gives written permission for publication elsewhere.

In submitting my entry, I agree to abide by the rules of the Design Ideas Program.

Signed _____
 Date _____

ISSUE WINNER

The winning Design Idea for the February 3, 1992, issue is entitled "Circular RAM buffer generates long delays," submitted by Yongping Xia of West Virginia University (Morgantown, WV).

Your vote determines this issue's winner. All designs published win \$100 cash. All issue winners receive an additional \$100 and become eligible for the annual \$1500 Grand Prize. **Vote now**, by circling the appropriate number on the reader inquiry card.

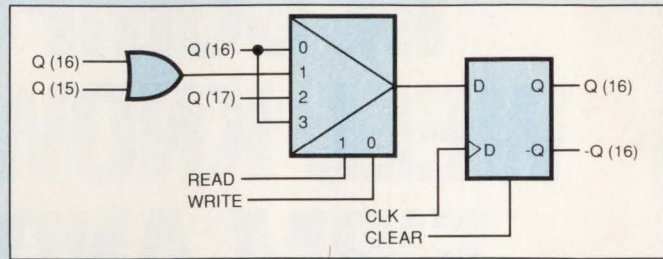

Fig 4—The last location in the FIFO memory needs "top-floor" control logic.

will have no effect on the elevator bits. Read operations always cycle out the word from register 0 and shift all the other stored words down one floor.

Note that this FIFO memory is synchronous and runs on one clock signal. Setup times for the SHIFT and LOAD signals going to the registers limit the circuit's performance. You must optimize the read and write control signals for both minimal gates and fan-out. **EDN BBS /DI_SIG #1102**

EDN

To Vote For This Design, Circle No. 673

Design Ideas are continued on pg 218

GREASE Q-PAD II®

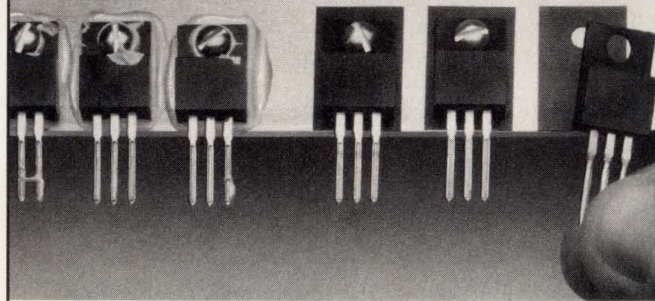

Replace Messy Grease Under Isolated Transistors

- Q-Pad II replaces grease in applications where isolation is not required (isolated transistors).
- Q-Pad II provides maximum heat transfer between interfaces. 0.1 °C/Watt TR.
- .006 in. thickness, Silicone / Alum. Foil construction, 2.5 W/m-k Therm. Cond., available in standard configurations and custom shapes.

Contact Bergquist for a Free Copy of the New Sil-Pad Design Guide, 1-800-347-4572

BERGQUIST

5300 Edina Industrial Blvd., Minneapolis, MN 55439
 Tel: (612) 835-2322 • Fax: (612) 835-4156

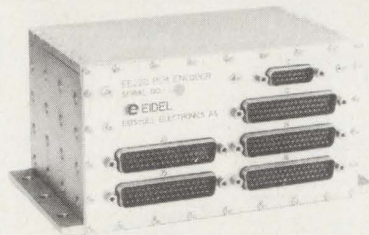

PCM ENCODER EE 220

INPUTS:

64 Analog differential inputs, individual selection of gain.
56 Digital inputs. Expander and Slave Encoder inputs.
Signal Conditioning and Filter modules available.
All inputs have individual selection of sampling rate.

FORMAT:

Synthesized Bitfrequency to 5 MHz. Selectable Wordlength.
Up to 8 totally different PCM Formats stored in one PROM.
User selectable Format structure compatible to IRIG std. 106.

PROGRAMMING:

All Format structure and Signal select information are programmed on a PC, then downloaded to the EE220 non-volatile memory through an RS232 link.

APPLICATIONS:

Designed to meet the requirements of Military, Industrial and Scientific environments. Approved for high shock and vibration. MIL parts and factory burn-in ensures excellent reliability.



EIDEL

Eidsvoll Electronic AS

Box 38, N-2081 Eidsvoll, Norway
Tel: +47 6 96 42 30. Fax: +47 6 96 20 48

CIRCLE NO. 121

Satisfied customer

Thank you very much for deciding to publish my Design Idea #1030 "High-frequency VCOs top 100 MHz." I was very, very happy when I received your letter. Please extend my thanks to everyone on your staff involved in the decision.

Di Paolo Franco

Ericsson-Fatme

*Dept: XT/TT Via Anagina, 203
00040 Roma, Italy*

Reader suggests corrections

The description of DI #999 (EDN, August 19, 1991, pg 156) probably should say that the circuit generates a 68-msec positive-going pulse on power-up. On loss of power, the signal diode must discharge C_1 . If the power supply has a low impedance, or its output crow-bars, the discharge current will probably destroy the signal diode. Also, the "instant reset" provided by the resistor network on power-down may not be very "instant." The IC may not recognize a low transition until its pin 1 drops to around 0.9V or less, meaning that the power supply has already dropped to about 1.5V. That's a little late to attempt an orderly shutdown of a system. An absolute threshold, not a ratio, needs to be sensed. Everything works against you in this circuit: the 1.67:1 sensing ratio and the fact that the negative-going transition threshold of IC_1 decreases with decreasing V_{CC} .

*William N Schroeder, Hardware Engineering Mgr
Intecom Inc*

*601 Intecom Dr
Allen, TX 75002
(214) 727-9141*

Errata

The Design Idea "Backup time-out saves battery," on page 174 of the October 24, 1991 issue of EDN, contains an error. The connection between pin 8 of IC_1 and ground should be through a 10-k Ω resistor, and not directly to ground as incorrectly drawn.

*Anne Watson Swager
Design Ideas Editor*

The schematic for the Design Idea "8051 μ C converses with dual-port RAM" in the June 6, 1991 issue of EDN, pg 176, contains two potentially misleading typos. The signal $\overline{XDAT_AC}$ should *not* have a bar over it as this signal is active high, and the signals $XDAT_RD$ and DPR_WR should have overbars as they are active low. These are errors in name only—the circuit diagram itself is correct.

Bold indication with no power required

New



Series 37 Pushbutton Switches with vivid Last Status Retention (LSR) indicator offer solder/wash process compatibility and DPDT switching in maintained or momentary versions. An assortment of buttons and indicator colors is available.

Patent Applied For.



BUSSE



IF YOU SELL TO THE WORLD, WORK WITH A WORLD LEADER.

Selling worldwide calls for special capabilities: strict adherence to the standards of Europe, Asia and the Americas; a working knowledge of different applications and local needs; and listing by standards agencies—to name just a few. ■ Bussmann's been there. We're there right now, with local offices and distribution. Add to this Bussmann's sales leadership in numerous key markets and you have the prime fuse supplier to fill it. In glass tube fuses (time-delay and fast-acting), holders and clips—5x20mm, 1/4" x 1-1/4". And Bussmann's advanced high-performance fuses are ready when you are ready to redesign or to lower your costs to compete harder. For example, our

PC-Tron® current-limiting fuses and SMD Tron® surface-mount fuses hold the destructive energy of fault currents down to a fraction of their potential. So you can now feature protection of circuit - board components, as well as the equipment. ■ And for conventional subminiature applications, Bussmann's Microtron® fuse line offers everything you demand for your high-volume production. Like the PC-Tron

and SMD Tron, the Microtron fuse withstands the rigors of automated wave soldering and board washing. ■ For full information on Bussmann products, contact your Bussmann distributor.

BUSSMANN—WORLD'S LEADING CIRCUIT PROTECTION MANUFACTURER.

BUSSMANN
PO Box 14460
St. Louis, MO 63178
Phone: (314) 394-2877
Fax: (314) 527-1445

BUSSMANN
Beswick Works
Frome, Somerset BA 11 1PP
United Kingdom
Phone: +44-373-464311
Fax: +44-373-473175

BUSSMANN
Wettenburger Str. 70
8000 Munich 81
Germany
Phone: +49-89-92404138
Fax: +49-89-92404200

BUSSMANN
Prince Edward Road
No. 04-07 Finger Pier Bldg.
Singapore 0207
Republic of Singapore
Phone: +65-2275346
Fax: +65-2275384

Quality from
Cooper Industries

COOPER

Bussmann

EDN REPRINTS

A Designer's Guide to Linear Circuits

Volume I

This original, 186-page collection by Jim Williams offers a wealth of analog design information. It includes practical and efficient ways to use op amps, comparators, data converters, and other analog ICs.

A Designer's Guide to Linear Circuits

Volume II

Jim Williams' analog design articles - from 1983 to 1986 - in Volume II. Volume II covers more complex circuits and systems in 66 pages.

Surface-Mount Technology Design Project

This 48-page, four-color reprint follows the progress of EDN editor Steve Leibson as he designs a 2M-byte memory board using surface-mount technology. He includes typical problems you might encounter and objectively reports about both good and bad design decisions made along the way.

Mail coupon to: Cahners Reprint Services, 1350 E. Touhy Ave., Des Plaines, IL 60018. Or call **708/390-2777** or FAX: 708/390-2779. US currency only.

Please send the following:

_____ copies of *A Designer's Guide to Linear Circuits*.

Volume I

- \$7.70 (USA)
 \$10.70 (non-USA)

Volume II

- \$10.70 (USA)
 \$13.70 (non-USA)

_____ copies of the combined set of *A Designer's Guide to Linear Circuits*

Volumes I&II

- \$12.70 (USA)
 \$16.70 (non-USA)

_____ copies of *Surface-Mount Design Project*

- \$6.70 (USA)
 \$8.70 (non-USA)

Please print clearly.

- Payment enclosed Bill me Visa Mastercard

Credit Card Number _____ Exp. Date _____

Signature _____

Name _____

Title _____

Company _____

Address _____

City _____ State _____ Zip _____

Note: All prices above include shipping & handling.

AT&T DSP32Cs communicate serially

*Steven J Roome and Steven Denny, Data Sciences Ltd
Farnborough, Hants, UK*

The simple assembler program in EDN BBS /DL_SIG #1106 sets up two AT&T SDP32C DSP μ Ps for inter-process communication via their serial ports. The program saves you from having to use DMA.

To Vote For This Design, Circle No. 674

Routine adds 68302 interrupt pins

*Robert W O'Dell, Motorola
Austin, TX*

The listing in EDN BBS /DL_SIG #1107 increases the number of interrupt pins on a 680302 μ C from 7 to 19.

To Vote For This Design, Circle No. 675

Program establishes trim range

*John Dunn
Merrick, NY*

Given the gain of a noninverting amplifier, the value of a trimming potentiometer, and the desired adjustment range, the program in EDN BBS /DL_SIG #1111 can determine the values of the fixed resistors needed to complete the amplifier's feedback loop.

To Vote For This Design, Circle No. 676

C utility computes 10 CRCs

*Gábor Kiss
Budapest, Hungary*

The C program in EDN BBS /DL_SIG #1110 computes CRCs (cyclic redundancy checks) 10 different ways. Use it as a check against other CRC routines. As a bonus, the package contains a program for converting Gregorian dates to Julian dates, and vice versa.

To Vote For This Design, Circle No. 677

Spice models a solar array

*Steven C Hageman, Caltech Mfg Co Inc
Pleasant Hill, CA*

Along with complete documentation, the Spice program in EDN BBS /DL_SIG #1109 models solar arrays so that you can simulate solar-powered equipment.

To Vote For This Design, Circle No. 678

NATIONAL STANDARDS



Model 4950 Multifunction Transfer Standard

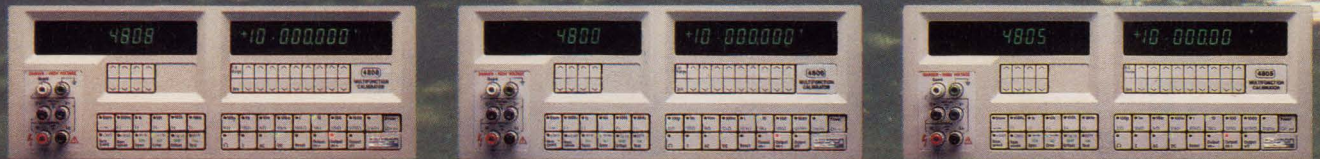

Series 4800 Multifunction Calibrators

Unlike most family trees, ours is fully traceable.

Just like gaps in genealogy, gaps in the traceability of multimeter calibration simply leave you guessing. So let Datron eliminate the guesswork – by making the calibration of all your multimeters fully traceable to National Standards.

The Series 4800 calibrators are specifically designed to be calibrated, on-site, by the new Model 4950 Multifunction Transfer Standard, which calibrates every range of every function at the calibrators' terminals. So with the need to send calibrators away for recalibration eliminated, they can remain firmly in place to

satisfy the most demanding workloads.

And with three Series 4800 calibrators to choose from, we've taken care of the economics as well. The low-cost Model 4805 calibrates analog meters and digital multimeters up to 5½ digits of resolution, while the Models 4800 and 4808 give you the capability to calibrate the entire range of multimeters – right up to the latest 7½ and 8½ digit DMMs.

All three models give you DCV, ACV, DCI, ACI and Ohms capability. Their integral power amplifiers are capable of driving 1000V at 33kHz

without the need for additional boxes or interconnections.

Supported by the 4950 MTS, Series 4800 calibrators offer you the best in fully automated, fully traceable, in-place, multimeter calibration. A winning team that will satisfy the requirements of calibration audit and quality standards worldwide.

For a complete family tree of all Datron calibration products call our United States Sales Office on:

Western: (619) 279-2200
Eastern: (516) 454-8440

datron
WAVETEK

THE AIR CONDITIONER FOR HARSH ENVIRONMENTS

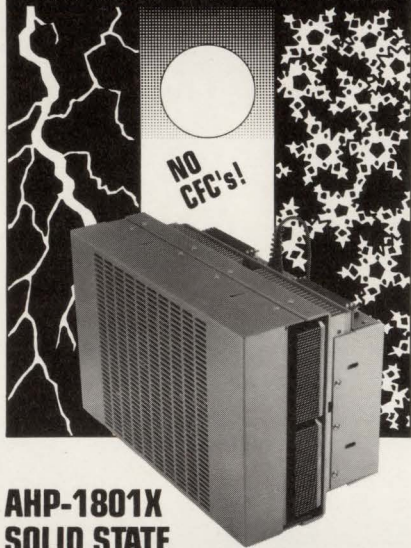

AHP-1801X SOLID STATE AIR CONDITIONER

Reliable Protection From Heat Build-up
in NEMA (12,4,4x) Electronic Enclosures

Designed to excel in harsh industrial environments such as NEMA-4X.

Can withstand corrosive salt spray, shock, vibration, windblown dust, rain, and water hose down in outdoor and indoor use.

Applications range from steel mills, foundries, papermills, to communication and remote microwave antenna installations. Entirely sealed and gasketed, mil-spec fans are the only moving parts.

FEATURES:

- **Operating Range:** -30 °C to +80°C ambients
- **Power Input:** 115 or 230 VAC@50-60 HZ
- **Capacity:** 1500 BTU/HR in cooling (heating optional)
- **Size:** Compact 16"x12.7"x9.7", weight 45 lbs
- **Mounting:** Any orientation, vertical or horizontal plane (gasket and mounting hardware included)
- **Technology:** Thermoelectric, no compressor, fluorocarbons or piping. (Environmentally safe)
- **Temperature Control:** Three position thermostat, Model TC-5F included

To learn more about the AHP-1801X and our entire cooling line, contact:

teca

ThermoElectric Cooling America Corp.
4048 W. Schubert
Chicago, Illinois 60639
312/342-4900 • FAX: 312/342-0191

Made in U.S.A.
Visit us at the Electro Booth #1421

CIRCLE NO. 126

EDN-DESIGN IDEAS

Software Shorts

Computer reads DMM chip

*Yongping Xia, West Virginia University
Morgantown, WV*

The C++ program and circuit diagram in EDN BBS /DL_SIG #1094 allow you to read an ICL7106 DMM chip's 7-segment LCD outputs with a computer.

To Vote For This Design, Circle No. 679

Switcher syncs with slow peripherals

*Gregor Said Jackson, Azad International,
Hamburg, Germany*

The complete design package in EDN BBS /DL_SIG #1062 details a pair of high-speed PAL-device designs that allow a Mips R3000 RISC μ P to synchronize with slow peripherals by switching clock sources. Circuit diagrams are Postscript files.

To Vote For This Design, Circle No. 680

22V10 detects hung 680xx

*Dave Splitz, Stratus Computer,
Marlboro, MA*

The Abel file attached to EDN BBS /DL_SIG #1064 produces a 22V10 that will detect when a 680xx μ P is hung and will return an error signal. Thus your system will not hang as long as the current bus master asserts AS* and can detect the bus-error signal.

To Vote For This Design, Circle No. 681

Modular 8051 routine converts bases

*Kenneth W Arnold, Compaq Computer Corp,
Houston, TX*

Using a modular approach, the 8051 routines in EDN BBS /DL_SIG #1065 convert n -digit BCD numbers to m -byte binary numbers. The routines execute as fast as earlier, specialized base-conversion routines.

To Vote For This Design, Circle No. 682

These Software Shorts listings are too long to reproduce here. You can obtain the listings from the Design Idea Special Interest Group on EDN's bulletin-board system (BBS): (617) 558-4241, 300/1200/2400/9600 8,N,1. From Main Menu, enter ss/DL_SIG, then rknnnn, where nnnn is the number referenced above.

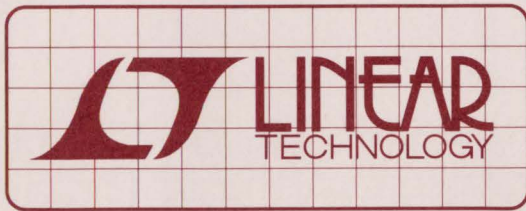

DESIGN NOTES

A Simple, Surface Mount Flash Memory Vpp Generator – Design Note 58

Steve Pietkiewicz
Jim Williams

“Flash” type memories add electrical chip-erase and reprogramming to established EPROM technology. These features make them a cost effective and reliable alternative for updatable non-volatile memory. Utilizing the electrical program-erase capability requires linear circuitry techniques. Intel flash memory, built on the ETOX™ process, specifies programming operation with 12V amplitude pulses. These “Vpp” amplitudes must fall within tight tolerances, and excursions beyond 14.0V will damage the device.

ETOX is a trademark of Intel Corporation.

Providing the Vpp pulse requires generating and controlling high voltages within the tightly specified limits. Figure 1's circuit does this. When the Vpp command pulse goes high (trace A, Figure 2) the LT1109 switching regulator drives L1, producing high voltage. DC feedback occurs via the regulator's sense pin. The result is a smoothly rising Vpp pulse (trace B) which settles to the required value. Trace C, a time and amplitude expanded version of trace B, details the desired settling to 12V. Artifacts of the switching regulator's action are discernible, although no overshoot or poor dynamics are displayed.

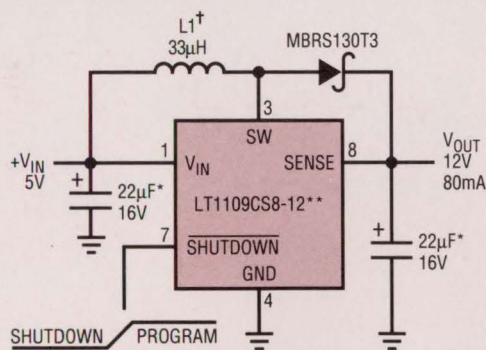

- † L1 = SUMIDA CD54-330N (708-956-0666)
- * HILTON CSTDD226M016TC (813-371-2600)
- ** USE LT1109A FOR 120mA OUTPUT (CONSULT LTC FACTORY)

DN58 • TA02

TRACE A = 5V/DIV
TRACE B = 5V/DIV
TRACE C = 0.1V/DIV
(OUTPUT)

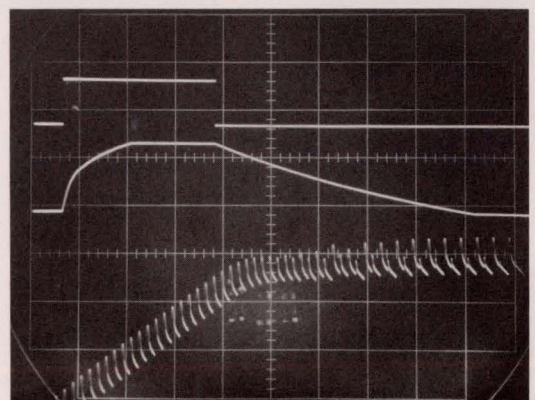

A & B HORIZ = 1 ms/DIV
C HORIZ = 50µs/DIV

DN58 • TA03

Figure 1. All Surface Mount Flash Memory Vpp Generator

Figure 2. Waveforms for the Flash Memory Pulser Show No Overshoot

This circuit is well suited for providing V_{pp} power to flash memory. All associated components, including the inductor, are surface mount devices. As such, the complete circuit occupies very little space (see Figure 3). In the shutdown mode the circuit pulls only 300 μ A. Output voltage goes to V_{CC} minus a diode drop when the converter is in shutdown mode. This is an acceptable and specified condition for flash memories and does not harm the memory. A 0V output is possible by placing a 5.6V Zener diode in series with the output rectifier (Figure 4A). An alternative configuration, suggested by J. Dutra of LTC, AC couples the output to achieve a 0V output (Figure 4B). Both of these methods add component count, decrease efficiency and slightly limit available output current. They are unnecessary unless the user desires a 0V output on the V_{pp} line.

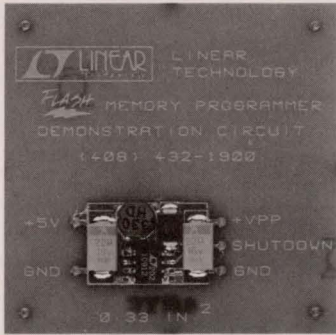

Figure 3. Simple Flash Memory Pulser Uses All Surface Mount Components

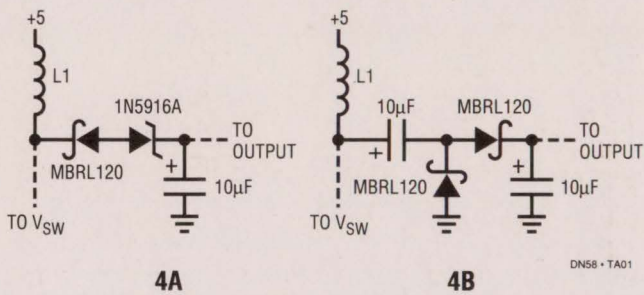

Figure 4. Two Arrangements for Obtaining a 0V Output

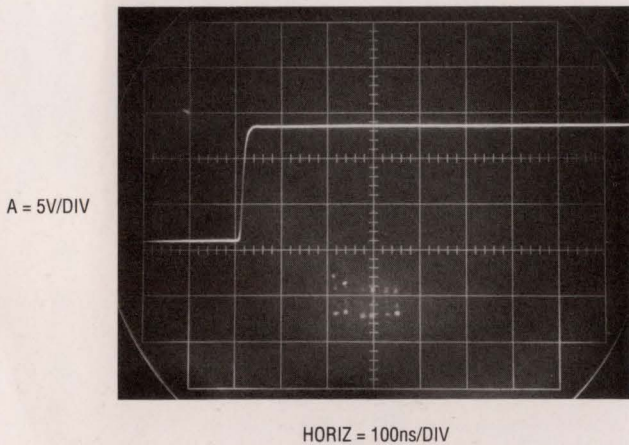

Figure 5. An "Ideal" Flash EPROM V_{pp} Pulse

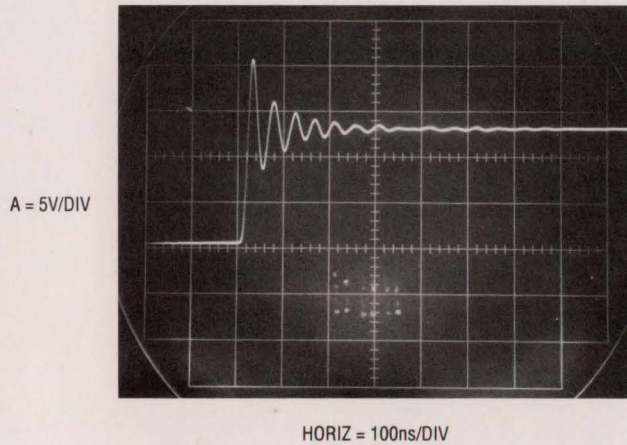



Figure 6. Rings at Destructive Voltages After a PC Trace Run

For literature on our DC-DC Converters, call (800) 637-5545. For applications help, call (408) 432-1900, Ext. 456



**Any kind of
surface mount
in no time.
Flat.**

You already know General Instrument's reputation for quality, reliability and high volume production capacity.

You also know the advantages of surface mount rectifiers: How they withstand mechanical strain and thermal stress, facilitate high-speed pick and place and reduce board size by increasing surface density.

Now you can have all the advantages of General Instrument *plus* all the benefits of flat pack – because General Instrument has the industry's broadest range of chip technology in surface mount.

SMA, B and C. In standard, fast and ultrafast recovery, Schottky, Zener and TVS. And when reliability is most critical, only General Instrument has the flat pack *Superectifier*.™

Of course, cylindrical MELF-style surface mounts are still available, too.

The answer to every rectifier application has come to the surface – at General Instrument.

For more information, contact General Instrument, Power Semiconductor Division, 600 West John Street, Hicksville, NY 11802; (516) 933-3333.

**GENERAL
INSTRUMENT**
POWER SEMICONDUCTOR DIVISION

EDN-NEW PRODUCTS

Components & Power Supplies

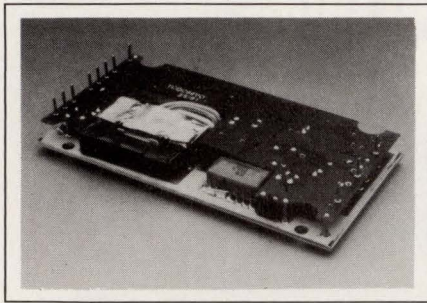

DC/DC converter. HFS 200 dc/dc converters feature single outputs of 3 to 48V (200W power capability) and accept inputs of 18 to 36, 36 to 72, and 200 to 400V. The converters operate at 700 kHz to minimize the size of magnetic components. Line and load regulations equal $\pm 0.5\%$, and efficiency figures range from 81 to 88%. The converters feature overvoltage and overtemperature protection and meet VDE 0871A conducted EMI standards. The inductor of the integral filter is integrated with the main transformer and magnetically coupled to cancel ripple current in the output. The converters include a limiter circuit that limits current at 115% of rated current. \$250. **Computer Products**, 7 Elkins St, South Boston, MA 02127. Phone (617) 268-1170. FAX (617) 268-0300. **Circle No. 351**

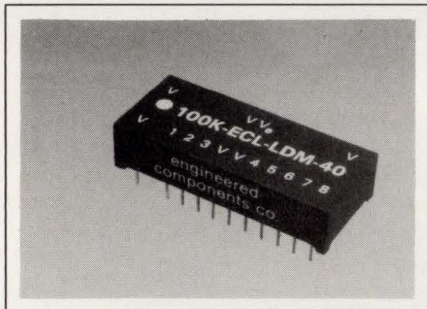

Logic delay lines. 100K ECL LDM logic-delay modules provide tapped delays with required driving and pick-off circuitry compatible with ECL 100K circuits. Housed in a 24-pin DIP, the modules provide delays ranging from 9 to 80 nsec. Each module includes taps at 12.5% increments of total delay. Each delay module will drive as many as 70 ECL dc loads on a single tap. The hybrid construction employs integrated circuitry and passive RLC networks. The modules accept either logic 1 or 0 inputs and reproduce the logic at the selected output tap without inversion. \$30 (100). **Engineered Components Co.**, Box 8121, San Luis Obispo, CA 93403. Phone (800) 235-4144; (805) 544-3800. FAX (805) 544-8091. **Circle No. 352**

Varistor. This high-capacitance varistor protects sensitive automotive circuitry from overvoltages while suppressing EMI from dc motors. It's designed for operating voltages as high as 26V, therefore it's compatible with the 12 and 24V systems standard in the automotive industry. The units are available with four capacitance values ranging from 0.47 to 1.5 μF . The devices can absorb spikes of 1J. \$0.65 (5000). **Siemens Components Inc.**, 186 Wood Ave S, Iselin, NJ 08830. Phone (800) 222-2203; (201) 321-3900. **Circle No. 353**

Power resistors. V3PR precision foil resistors are available in two sizes. HI-OHM Model 300589 is a standard 1-in.-square plate, which can be trimmed to any value between 10 Ω and 5 k Ω . Tolerance is $\pm 0.005\%$. The LO-OHM family features resistance values of 0.25 to 2 Ω . Model 300589 versions, \$38.09 (100). **Vishay Resistors**, 63 Lincoln Hwy, Malvern, PA 19355. Phone (215) 644-1300. FAX (215) 640-9081. **Circle No. 354**

Transient protectors. Series 160 devices limit transient level at the input to electronic equipment. The 161 operates on 120V ac single-phase service, and the 162 protects 120/208V ac single-phase, 3-wire service. The 163 protects 120/208V ac, 3-phase, 4-wire lines. LEDs mounted on the front panel indicate protection status. From \$141. **MCG Electronics Inc.**, 12 Burt Dr, Deer Park, NY 11729. Phone (800) 851-1508; (516) 586-5125. FAX (516) 586-5120. **Circle No. 355**

Subminiature fans. These pc-board-mountable subminiature dc fans are designed for applications where density is a prime problem. The line includes a 23 \times 20 \times 20-mm model, which operates from 4V. The line also includes models that measure 25 \times 25 \times 10 mm and 40 \times 40 \times 10 mm. \$8 (1000). Delivery, stock to eight weeks ARO. **Evov-Rifa Inc.**, 100 Tri-State International, Suite 290, Lincolnshire, IL 60069. Phone (708) 948-9511. FAX (708) 948-9320. **Circle No. 356**

Conformal-coated inductors. Series 9130 molded inductors have values ranging from 0.1 to 1000 μH . The devices are constructed to be compatible with automatic-insertion equipment and meet all the requirements of MIL-C-

15305. From \$0.15 (OEM qty). **J W Miller Division**, 306 E Alondra Blvd, Gardena, CA 90247. Phone (310) 515-1720. FAX (310) 515-1962. **Circle No. 357**

Terminal blocks. These bidirectional terminal blocks come in 36-position versions with a 5-mm contact pitch. The plug portion mounts on a pc board, and the mating portion plugs in either horizontally or vertically. The brass terminals are rated for 10A, and the insulators meet UL 94V-0 standards. Mated pair, \$19.16. **E-Mark Inc.**, 4 Daniels Farm Rd, Suite 328, Trumbull, CT 06611. Phone (203) 452-1003. **Circle No. 358**

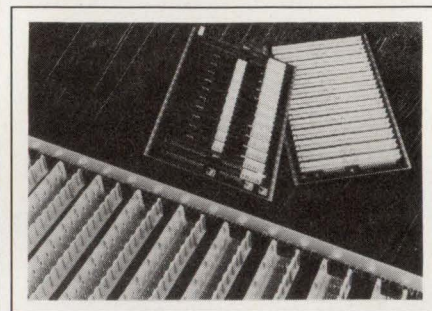

Backplane. This Profile F Futurebus+ backplane is a 13-slot, 16-layer design. The unit is 12SU high and supports 265 \times 288-mm daughter boards. Surface-mount resistors and capacitors are arranged to match the length of each signal trace exactly and minimize signal skew. Power for all supply rails is supplied via a low-impedance connector. \$2000. **Bicc-Vero Electronics Inc.**, 1000 Sherman Ave, Hamden, CT 06514. Phone (203) 288-8001. FAX (203) 287-0062. **Circle No. 359**

Computer battery. The TA-4511 alkaline battery is a direct replacement for the Rayovac Model 844 battery. It is rated at 4.5V dc and 1.25 Ahr and will last approximately five years in normal service. The battery comes with leads, a 4-pin, gold-contact connector, and a hook-and-loop fastener with woven-mat polyolefin with adhesive backing for easy mounting. \$10.95. **Tauber Electronics Inc.**, 4901 Morena Blvd, Suite 314, San Diego, CA 92117. Phone (619) 274-7242. FAX (619) 274-2220. **Circle No. 360**

Pin-grid-array socket. These PGA sockets conform to Intel's specification for their i80486DX. The socket insulator

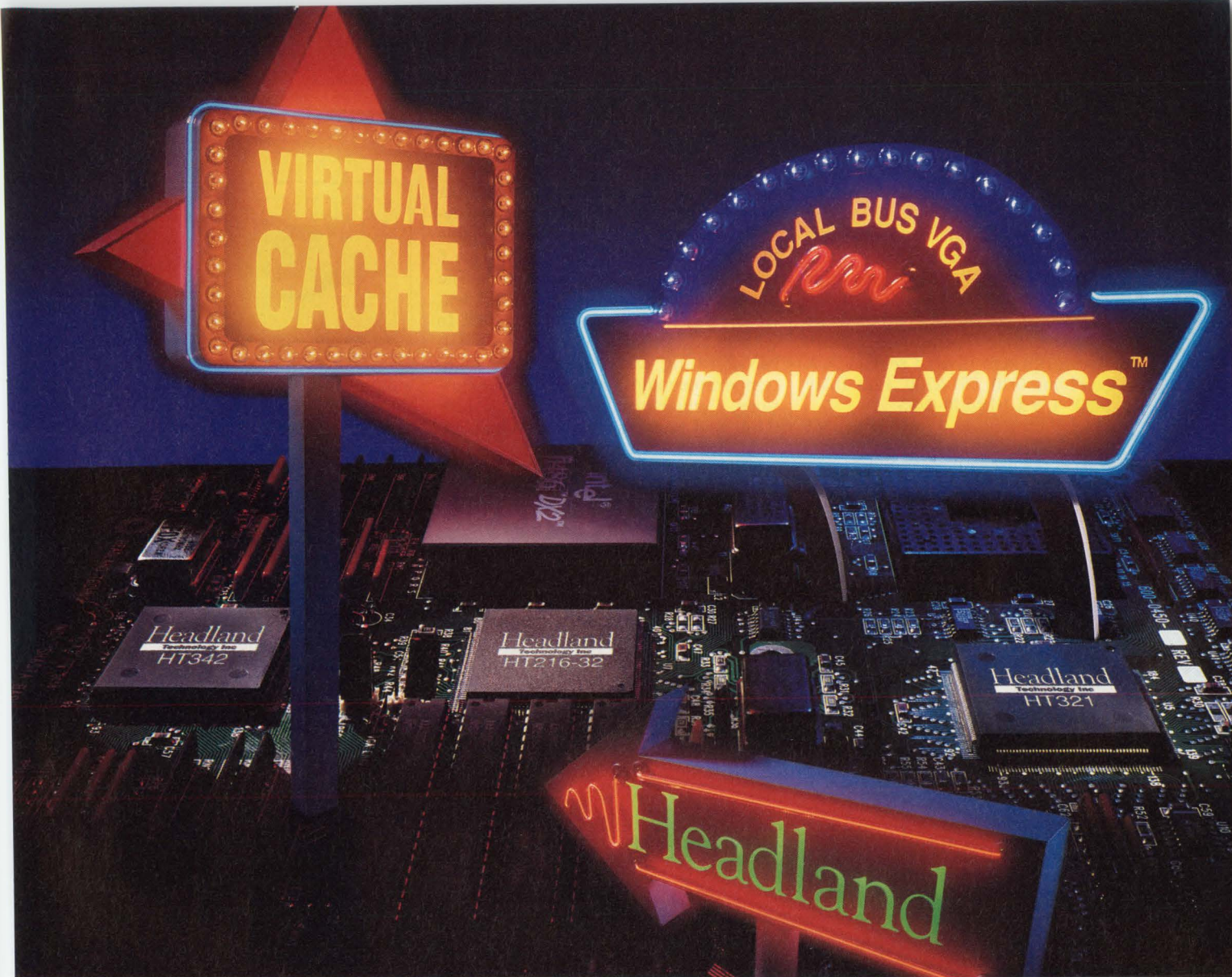

MORE SIGNS OF THE TIMES.

The signs of the times are everywhere. Designers are demanding greater speed and greater functionality at lower cost. And they're turning to Headland's Virtual Cache™ 486 Chip Set and Windows Express™ Local Bus VGA for unbeatable price/performance.

HTK340

Virtual Cache™ 486 Chip Set

Team up Headland's HTK340 Virtual Cache 486 core logic chip set with Intel's new super-fast 486DX2.

The result is a blistering 29.3 MIPS—without external cache. With special features like byte gathering write buffer and out-of-order operations, the HTK340 offers the best price/performance in the business.

CORE LOGIC
(486DX2) + (HTK340) = 29.3 MIPS
POWER METER 1.7

HT216-32

Windows Express™ Local Bus VGA

With Headland's HT216-32 local bus, commands

GRAPHICS
WINMARK = 8.1M

and data are transferred at speeds up to 33MHz. By incorporating Windows™ raster operations, the Windows Express local bus graphics controller will boost the performance of Windows applications significantly—as much as four times faster than SVGAs. *Without a costly co-processor or VRAM.*

Call Headland now for more information on our complete line of local bus core logic and graphics products. And follow the signs to the products of the future.

Headland
Technology Inc

46221 Landing Parkway, Fremont, CA 94538
 800-238-0101

© 1992 Headland Technology Inc.
 Virtual Cache™ and Windows Express™ are trademarks of Headland Technology Inc. All other brand and product names are trademarks or registered trademarks of their respective companies.

EDN-NEW PRODUCTS

Components & Power Supplies

is molded of PPS thermoplastic, which carries a UL 94V-0 rating. A variety of contacts and platings are available including very low insertion force and ultra low insertion force options. Part #169H008B5-1780R gold-plated, ultra-low-insertion-force contact option, \$4.25 (1000). **McKenzie Technology**, 44370 Old Warm Springs Blvd, Fremont, CA 94538. Phone (510) 651-2700. FAX (510) 651-1020. TWX 910-240-6355.

Circle No. 361

Surface-mount connectors. FH10A Series surface-mount connectors are designed for flat flexible-cable and flexible printed circuitry. They provide from 6 to 30 pins spaced on a 1-mm pitch. The connectors will accept cable or flex-circuit thicknesses ranging from 0.25 to 0.31 mm. PPS insulators carry a UL 94V-0 rating and accommodate high-temperature and harsh-solvent applications. Connector contacts are rated for 0.5A, and resistance equals 20 mΩ. In-

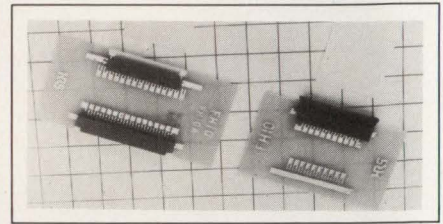

sulation resistance is $5 \times 10^8 \Omega$ at 100V dc, and withstanding voltage rating is 150V ac. \$1.14 for a 20-pin model. **Hirose Electric Inc**, 2685-C Park Center Dr, Simi Valley, CA 93065. Phone (805) 522-7958. FAX (805) 522-3217.

Circle No. 362



8051 & 68HC11

PC-Based In-Circuit Emulators

Nohau Covers All Your Development Needs for the 8051 and 68HC11 Families!

Free Demo

You can start your debugging with this **FREE** demo simulator. You can load up to 512 bytes of code, assembler, C, or PL/M and do full debugging/simulation in assembly and source level. A great way to get started for **FREE**. Fantastic for schools! Just call and we'll send it!

Full Simulator

The full-blown simulator is an extension of the DEMO. You can load up to 64K of code and use 64K of XDATA space. You can program an "external environment" to interact with your code to simulate your target system. The emulator is the hardware extension of the simulator!

In-Circuit Emulation

The 30MHz real-time emulator has been the industry standard for years. With its complex breakpoint logic and advanced trace, nobody can beat it for performance. Plug-in or RS-232 configuration. All 8051 derivatives are supported!

NOHAU CORPORATION

51 E. Campbell Avenue, Campbell, CA 95008
(408) 866-1820 • FAX (408) 378-7869

Call Nohau's 24-hour information center to receive info on your FAX 408-378-2912

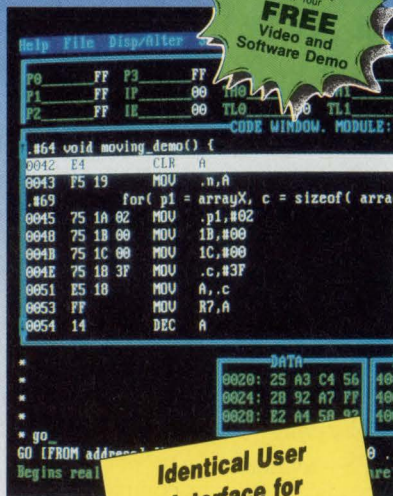

Identical User Interface for All Three Products - You Can't Go Wrong!

Surface-mount inductors. RL2515 Series inductors are compatible with automatic-insertion equipment. The 35 values cover an inductance range of 0.15 to 100 μ H with a dc current rating of 70 to 610 mA. The units operate over a -25 to $+80^\circ\text{C}$ range and can be supplied in bulk or on tape and reel. \$0.25 (2500). Delivery, stock to eight weeks ARO. **Renco Electronics Inc**, 60 Jefryn Blvd East, Deer Park, NY 11729. Phone (516) 586-5566. Circle No. 363

Coaxial adapter. The model PE9206 is a type N female to type BNC female adapter. The unit has a brass, nickel-plated body, utilizes PTFE insulation, has a gold-plated contact, and operates over a -65 to $+165^\circ\text{C}$ range. The adapters meet the interface requirements of MIL-39012. \$12.95. **Paster-nack Enterprises**, Box 16759, Irvine, CA 92713. Phone (714) 261-1920. FAX (714) 261-7451. Circle No. 364

Terminal strip. Model 8142 is available in marked or unmarked versions. Units with 5-mm contact spacings are available in 2- to 24-contact sizes; models with 10-mm spacings come in 2- to 12-contact versions. Ratings for 5- and 10-mm units equal 300V at 15A and 600V at 5A, respectively. All units accept #12 through #22 AWG wire. 2-position model, from \$0.7375 (100). **Wieland Inc**, 466 Main St, New Rochelle, NY 10801. Phone (914) 633-0222, ext 229. Circle No. 365

Power supplies. NTDM Series single- and multiple-output power supplies are housed in a $5 \times 8 \times 12.5$ -in. package. They deliver from 500 to 2000W and come with a number of optional features—battery backup, active power-

Australia (02) 654 1873, Austria (0222) 38 76 38, Benelux +31 1858-16133, Canada (514) 689-5889, Czechoslovakia 0202-2683, Denmark (42) 65 81 11, Finland 90-452 1255, France (01)-69 41 28 01, Germany 08131-25083, Great Britain 0962-73 31 40, Greece 01-862-9901, Hungary (1) 117 6576, Israel (03) 48 48 32, Italy (011) 771 00 10, Korea (02) 784 784 1, New Zealand (09) 392-464, Portugal 01-80 9518, Norway 02-649050, Singapore (065) 284-6077, Spain (93) 217 2340, Sweden 040-9224 25, Switzerland (01) 740 41 05, Taiwan (02) 7640215, Thailand (02) 281-9596, Yugoslavia 061 621066.

See us at Electro Booth #5403

CIRCLE NO. 129

NOW SHIPPING

The fastest high density PLD.



System clock rates up to 80 MHz. And a propagation delay of only 15ns pin-to-pin. That's the kind of performance you get with our new pLSI™ family of high density PLDs. Comprised of four devices ranging in density from 2,000 to 8,000 PLD gates, they give you absolute timing predictability, right from the data sheet. Lattice also offers the ispLSI™ family—an in-system programmable (isp) version of the pLSI family that delivers non-volatile, 5-volt only in-system programming capability.

pLSI and ispLSI devices are backed by Lattice's proven E²CMOS® technology. With low power,

reprogrammability and 100% DC, AC and functional testing, the pLSI and ispLSI families offer the highest quality available. Not to mention high-speed programming and 100% programming yield. And they are available now in production quantities off-the-shelf.

So pull into the high density PLD fast lane. Call **1-800-327-8425** and ask for information packet #209.



Leader in E²CMOS PLDs.

Circle #42 For Literature

EDN-NEW PRODUCTS

Components & Power Supplies

factor correction, N + 1 redundancy, and automatic current sharing. \$0.60/W (OEM qty). **Technology Dynamics Inc.**, 100 School St, Bergenfield, NJ 07621. Phone (201) 385-0500. FAX (201) 385-0702. **Circle No. 366**

Hermetically sealed resistors. The SMH MELF resistor line includes two models—the SMH55 rated for 200 mW at 70°C, and the SMH60 rated for 250

mW at 70°C. Minimum resistance value is 10Ω for both models. Maximum resistance value is 1.21 MΩ and 2.49 MΩ for SMH55 and SMH60 versions, respectively. All units are available with ±0.05 to ±1% tolerances. SMH55, 10 kΩ, 1% unit, \$2.22 (300). Delivery, 10 to 12 weeks ARO. **Angstrom Precision Inc.**, c/o Dale Electronics Inc, Box 609, Columbus, NE 68602. Phone (301) 739-8722. FAX (301) 797-6852.

Circle No. 367

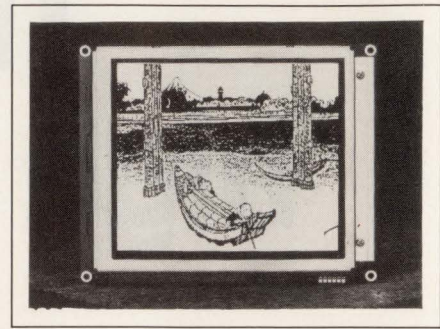

LCD module. This Series G321D LCD module incorporates cathode-fluorescent, edge-lighting and film-supertwist technology. Display brightness measures 100 cd/m, and the module measures just 166 × 134 × 15.1 mm. The module has a 70° viewing angle and operates from 5V and -24V supplies. G321D black-and-white module with controller chip, \$238; blue version without controller, \$210. **Seiko Instruments USA Inc.**, 2990 W Lomita Blvd, Torrance, CA 90505. Phone (213) 517-7770. FAX (213) 517-7792. **Circle No. 368**

Panel meter. Model 2152 is a dual-meter model designed to meet MIL-M-10304 and MIL-M-16034 requirements. Units can be stacked vertically or horizontally without limitation. Magnetic interaction is nil because the moving coil movement is self-shielded. The sealed waterproof case is also an effective magnetic shield. From \$850. **International Instruments**, Box 185, North Branford, CT 06471. Phone (203) 481-5721. FAX (203) 481-8937. **Circle No. 369**

Switching regulator. Model 78SRI33HC features a 90-W/in.² power density, 85% min efficiency, a self-contained inductor, and internal short-circuit and over-temperature protection. The regulator is available in vertical- or horizontal-mount packages, which measure 0.88 × 0.92 × 0.3 in. Less than \$10 (OEM qty). **Power Trends Inc.**, 1101 N Raddant Rd, Batavia, IL 60510. Phone (708) 406-0900. FAX (708) 406-0901. **Circle No. 370**

Snap-acting switches. These snap-acting switches are available with 20A and 25A ratings in either spdt or spst versions. Units have a variety of actuators, including standard-pin plungers, wide-pin plungers, levers, lever rollers, and simulated rollers. Termination styles include solder terminals, standard quick-connect, offset quick-connect, and screw terminals. From \$1.50

SMALLER FOOTPRINT

BIGGER FEATS

TOYOCOM's New Ceramic Subminiature SMD in 3- and 5-volt versions.

Our TCO-787 Series Subminiature SMD Crystal Oscillator lets you save board space without compromising the high performance you need in palm-top computer applications.

And, with dimensions as small as .472" x .224" x .098", it takes up less than half the surface area of typical SMD oscillators.

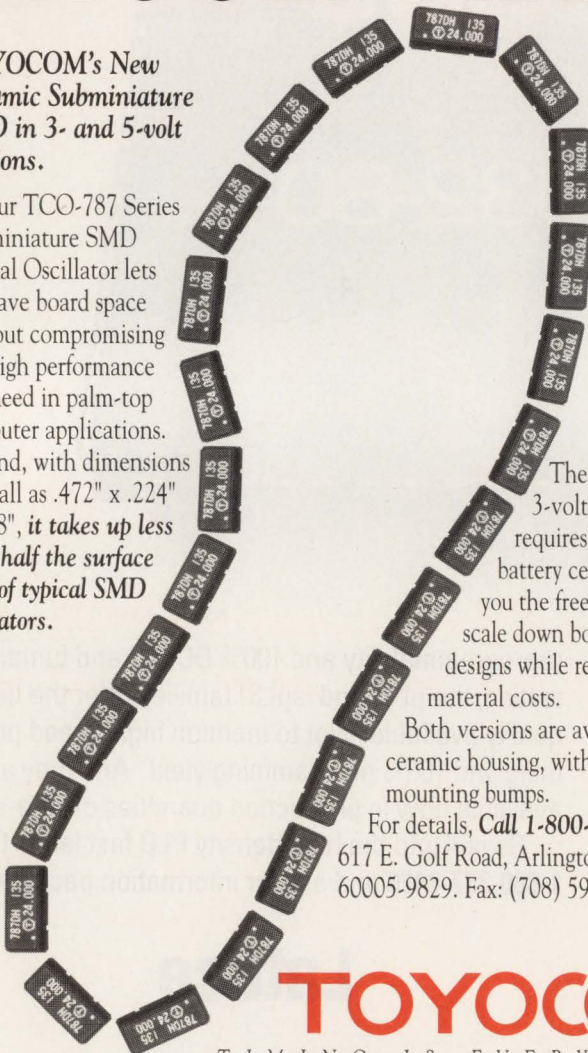

The low-powered 3-volt version requires just one battery cell, assuring you the freedom to scale down board designs while reducing material costs.

Both versions are available in a ceramic housing, with or without mounting bumps.

For details, Call 1-800-TOYOCOM. 617 E. Golf Road, Arlington Heights, IL 60005-9829. Fax: (708) 593-5678.

TOYOCOM

TIMING IS EVERYTHING

See us at Electro '92 Show

CIRCLE NO. 130



You Can Try Building Your Own Real-Time Operating System,

Building your own operating system for a real-time application can cost you up to a year in expensive programming time. And lost business opportunities. In a fast-moving market, it simply doesn't make sense to build. Not when VxWorks™ from Wind River Systems lets you move right in.

VxWorks gives you all the components and tools you need to start developing applications immediately. Which cuts your costs dramatically. And because VxWorks offers a more full-featured development platform than any other off-the-shelf operating system, it gets your product to market

HOSTS	TARGETS
Sun	68K
HP	SPARC
DEC	MIPS
IBM	i960

VxWorks supports multiple platforms.

because VxWorks offers a more full-featured development platform than any other off-the-shelf operating system, it gets your product to market

Or You Can Feel Right At Home With VxWorks.



faster. It's the one true turn-key solution, fully compatible with industry standards right out of the box.

Wind River Systems pioneered off-the-shelf high-speed UNIX® networking for real-time applications. And VxWorks still leads with the most complete, robust networking available. The lean, efficient wind™ kernel gives it unsurpassed multi-tasking speed and functionality.

So before you invest the time and money trying to build your own real-time operating system from the ground up, find out more about VxWorks. And feel right at home from day one.

1-800-677-1586.

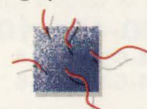

WIND RIVER
SYSTEMS

Real-Time Solutions for The Real World

ULTRA-MINIATURE SURFACE MOUNT

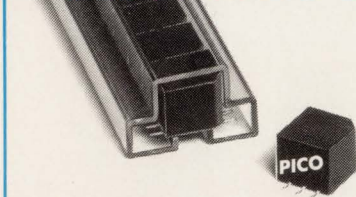

Actual Size

DC-DC Converter Transformers and Power Inductors

All PICO surface mount units utilize materials and methods to withstand extreme temperature (220°C) of vapor phase, IR, and other reflow procedures without degradation of electrical or mechanical characteristics.

These units have gull wing construction and are packaged in shipping tubes, which is compatible with tube fed automatic placement equipment or pick and place manufacturing techniques. Transformers can be used for self-saturating or linear switching applications. The Inductors are ideal for noise, spike and power filtering applications in Power Supplies, DC-DC Converters and Switching Regulators.

- Transformers have input voltages of 5V, 12V, 24V and 48V. Output voltages to 300V.
- Transformers can be used for self-saturating or linear switching applications
- Schematics and parts list provided with transformers
- Inductors to 20mH with DC currents to 23 amps
- Inductors have split windings

Delivery—
stock to one week

See EEM
or send direct for
FREE PICO Catalog

PICO Electronics, Inc.

453 N. MacQuesten Pkwy. Mt. Vernon, N.Y. 10552

Call Toll Free **800-431-1064**

IN NEW YORK CALL **914-699-5514**
FAX **914-699-5565**

CIRCLE NO. 69

232 • EDN May 7, 1992

EDN-NEW PRODUCTS

Components & Power Supplies

(OEM qty). Delivery, eight weeks ARO. **Unimax**, Box 152, Wallingford, CT 06492. Phone (800) 624-4308; (203) 269-8701. FAX (203) 265-5398.

Circle No. 371

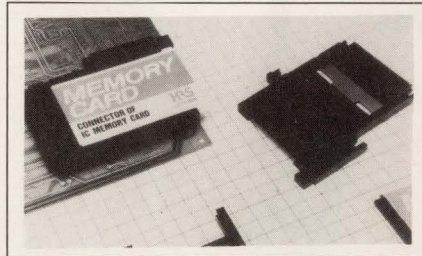

Memory card connectors. IC1FB memory card connectors have a 0.5A/pin current rating and will handle 125V ac. The connectors are available in 68-pin versions with contacts spaced on 0.05-in. spacings. The brass contacts are selectively gold plated. The connectors conform to Version 4 of the JEIDA specification and PCMCIA Release 2.0. \$10.10. **Hirose Electric Inc.**, 2685-C Park Center Dr, Simi Valley, CA 93065. Phone (805) 522-7958. FAX (805) 522-3217.

Circle No. 372

Crystal oscillator. The model OC2541DT is a 10-MHz, oven-compensated crystal oscillator. It has a stability of ± 0.02 ppm from 0 to 50°C. Operating current is 90 mA at 25°C. \$200 (1000). **Murata Erie North America**, 2200 Lake Park Dr, Smyrna, GA 30080. Phone (800) 831-9172.

Circle No. 373

Power supplies. These 1000W supplies accept inputs of 90 to 264V ac. The line includes single- and triple-output models. The supplies feature floating outputs, overvoltage protection on the main output, and remote sense on all outputs. Output ripple and noise is limited to less than 1%. Single-output model, \$800 (OEM qty). **Acme Electric Corp.**, 20 Water St, Cuba, NY 14727. Phone (716) 968-2400.

Circle No. 374

Surge protectors. DLP-10, DLP-20, and DLP-30 surge protectors protect 2- to 8-wire configurations for RS-232C, RS-422, RS-423, and 20-mA loop interfaces. Clamp voltage ratings range from ± 6 to ± 200 V. Series resistance equals 15 Ω , and energy-handling capability measures 50J/line. From \$58. **MCG Electronics**, 12 Burt Dr, Deer Park, NY 11729. Phone (800) 851-1508; (516) 586-5125. FAX (516) 586-5120.

Circle No. 375

books that work
the way you work

**Analog Circuit Design:
Art, Science, Personalities**

**Jim Williams, Linear
Technology Corp., Editor**

"If you do any analog circuit design, buy this book!...The well-indexed volume ... provides a picture of analog design, in all its diversity, as a way of thinking and a way of approaching problems."

Dan Strassberg, EDN
1991 352pp. cloth
0 7506 9166 2 \$44.95 (£30.00)

Based on the EDN Series
-- 20% New Material!

**Troubleshooting
Analog Circuits**

**Robert A. Pease, National
Semiconductor**

"Here's a chance to take advantage of [Pease's] years of experience designing analog circuits--and working the bugs out of them. This book is for you whether you're designing analog circuits at the board, box, system, or IC level."

Electronic Design
1991 208pp. cloth 0 7506 9184 0
\$32.95 (£19.95)

Loaded with practical information

**Rechargeable Batteries
Applications Handbook**

**Technical Staff, Gates
Energy Products**

This is a comprehensive reference on proper selection, specification and application guidelines from one of the world's largest sealed-cell manufacturers.

May 1992 432pp. cloth
0 7506 9227 8 \$49.95 (£38.50)

1-800-366-2665

M-F 8:30-4:30 E.T.

FAX 617-279-4851

BUTTERWORTH-HEINEMANN

80 Montvale Avenue
Stoneham, MA 02180

The EDN Series
for Design Engineers

U.K. and Europe:

Reed Book Services Ltd.

Special Sales Department

P. O. Box 5

Rushden, Northants NN10 9YZ U.K.
TEL. 0933 58521 FAX 0933 50284

CAHNERS 14.89

CIRCLE NO. 132

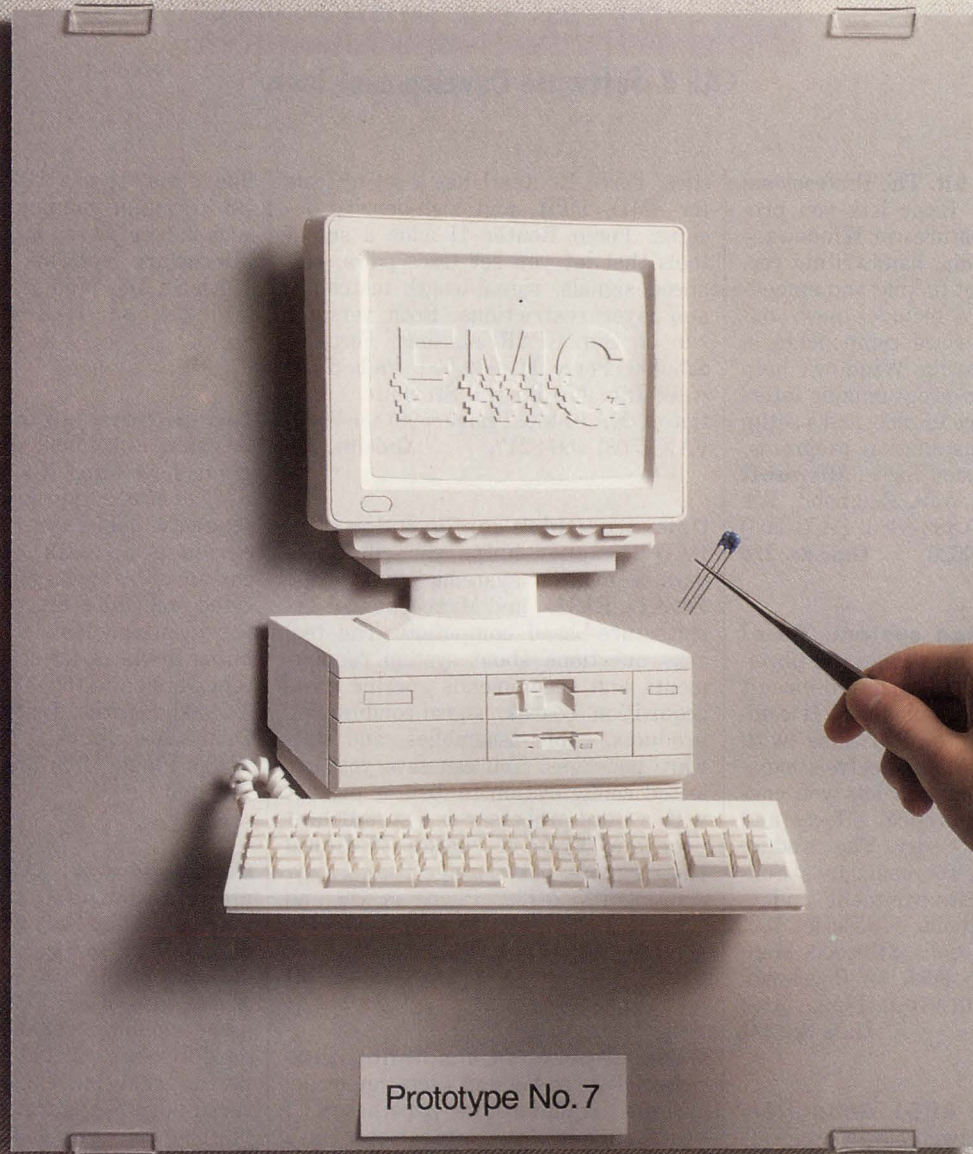

Your First Line Of Defense.

TDK Low-Profile EMI/RFI Suppression Components.

If EMI prevention is not considered at the critical design stage, otherwise well designed products may be vulnerable to serious noise-related problems.

TDK's extensive experience in ferrite and ceramics materials technology gives design engineers a first line of defense against interference. We offer a wide selection of low-profile noise suppression components that can help you create compact circuit designs that will stand up to EMI/RFI.

Whatever your application, TDK can help you meet today's tough EMI/RFI standards. Call or write us today for more information.

TDK Products: •EMI/RFI Suppression Filters •Through Hole EMI/RFI Filters
 •Ferrite Chip EMI Suppressors (Ferrite Chip Beads) •Ferrite Chip EMI Filters
 •Leadless EMI Filters •Power-line Leadless Inductors •Leadless Line Choke SF Coils
 •Common Mode Choke Coils/Line Choke Coils (SF Type) •UL Recognized (CSA, VDE, SEV, SEMKO, BS) Ceramic Capacitors •Feed-Through Ceramic Capacitors •EMI/RFI Suppression Ferrites •Ferrite Bead Cores •Varistors •Radio Wave Absorber Materials •Radio Wave Anechoic chambers



TDK CORPORATION OF AMERICA 1600 Feehanville Drive, Mount Prospect, IL 60056, USA Phone: 708-803-6100 INDIANAPOLIS Phone: 317-872-0370 NEW YORK Phone: 908-494-0100 SAN FRANCISCO Phone: 408-437-9585 LOS ANGELES Phone: 310-539-6631 DETROIT Phone: 313-462-1210 BOSTON Phone: 508-624-4262 HUNTSVILLE Phone: 205-464-0222 GREENSBORO Phone: 919-292-0012 DALLAS Phone: 214-506-9800

GERMANY • FRANCE • ITALY • U.K. • KOREA • TAIWAN • HONG KONG • SINGAPORE • THAILAND • CHINA • BRAZIL

TDK CORPORATION Tokyo, Japan

CEL, TDK's Component Engineering Laboratory in Torrance, CA, can custom design and test manufacture TDK EMI/RFI suppression components to meet your specific requirements. For more information, call (213) 530-9397

CAE & Software Development Tools

Visual Basic tool kit. The Professional Toolkit for Visual Basic lets you program the latest features in Windows—including multimedia, handwriting recognition, and object linking and embedding. The package includes new controls for user-interface components; a compiler for creating Windows help files; an application-programming interface (API) on-line reference; and a setup kit for creating installation programs. \$299; \$495 with Visual Basic. **Microsoft Corp.**, 1 Microsoft Way, Redmond, WA 98052. Phone (206) 882-8080. FAX (206) 936-7329. TLX 160520. **Circle No. 376**

Integrated design system. Board Station 500 helps you design the physical representation of printed-circuit boards and multichip modules. It combines place-and-route algorithms (with timing constraints) and analysis capabilities. The combination lets you control and analyze physical effects and maintain signal integrity. The product is a component of the company's Concurrent Design Environment and is available on HP Apollo, HP Series 700, and Sun SPARCstations. \$125,000. **Mentor Graphics Corp.**, 8005 SW Boeckman Rd, Wilsonville, OR 97070. Phone (408) 436-1500. **Circle No. 377**

High/low-level 8051 debugger. Chip View 51 is available in two versions for 8051 C compilers: as a simulator/debugger and as a front end for Nohau's EMUL51-PC emulator. It is keystroke-compatible with Borland's Turbo Debugger. Features include point-and-click data browsing of C structures and linked lists, plus context-sensitive hypertext help. Simulator version, \$795; emulator version, \$595; combination, \$995. **Chip Tools**, 1232 Stavebank Rd, Mississauga, ON L5G 2V2, Canada. Phone (416) 274-6244. FAX (416) 891-2715. **Circle No. 378**

Ada text editor. Amacs, an Ada implementation of the Emacs programmer's editor, can be made to emulate nearly any other editor. It requires MS-DOS 2.0 or higher and any combination of hard- and floppy-disk drives. \$150. **Xadax Inc.**, 34-32 57th St, Woodside, NY 11377. Phone (718) 672-6500. FAX (718) 397-0972. **Circle No. 379**

Autorouters for Unix workstations. Pads-Force Routers use gridless technology and a shape-based data struc-

ture. Force Router I has a set of tools for SMD, PTH, and high-density designs. Force Router II adds a set of tools that let you set trace pairs, balanced signals, signal-length matching, and layer restrictions. Both versions run on Sun SPARCstations. Force I, \$25,000; Force II, \$39,000. **Pads Software Inc.**, 119 Russell St, Suite 6, Littleton, MA 01460. Phone (508) 486-9521. FAX (508) 486-8217. **Circle No. 380**

Data-acquisition configuration tool. DAQ Designer helps you configure data-acquisition systems for PC/XT-, PC/AT-, EISA-, and Micro Channel Architecture-based computers. The tool asks questions about system requirements and recommends specific data-acquisition boards, signal-conditioning products, cable assemblies, and software packages. You can save your selected configuration to disk or print it with a word processor or a spreadsheet program. Free of charge. **National Instruments**, 6504 Bridge Point Pkwy, Austin, TX 78730. Phone in USA and Canada, (800) 433-3488; (512) 794-0100. FAX (512) 794-8411. TLX 75637. **Circle No. 381**

General-purpose simulation program. Tutsim Version 7 lets you model systems, equations, or hypotheses. If you change a block, a parameter, or a concept, the software will show a changed result. The software accommodates both linear and nonlinear functions. Professional version, \$695; personal version (not for corporate or government use), \$149. **Tutsim Products**, 200 California Ave, Suite 212, Palo Alto, CA 94306. Phone (415) 325-4800. FAX (415) 325-4801. **Circle No. 382**

Parallel-computer Fortran. The DECmcpp Fortran compiler automatically optimizes programs to run on computers with massively parallel processor architectures. The compiler runs on the DECmcpp 12000 Series computer under the Ultrix operating system. License, \$11,800. **Digital Equipment Corp.**, Maynard, MA 01754. Phone (508) 493-6767. **Circle No. 383**

Command shell for OS-9. Mshell, a command shell for the OS-9 real-time operating system, provides functions common to popular Unix shells. It is compatible with existing Microware shells at the command-line and script-

file levels. It can be installed on any OS-9 system running OS-9/680x0 version 2.3 or later. \$300 (1); \$90 (100). **Microware Systems Corp.**, 1900 NW 114th St, Des Moines, IA 50325. Phone (515) 224-1929. FAX (515) 224-1352. **Circle No. 384**

Test-pattern generator for ICs. Testgen automatically creates programs for testing ICs. It supports a variety of circuit types: combinatorial and sequential logic; synchronous and asynchronous circuits; ASICs and full-custom ICs; and chips with sophisticated embedded functions. The product provides high fault coverage and minimizes the need for scan circuitry. Custom version, \$160,000; ASIC version, \$95,000. **Sunrise Test Systems**, 1095 E Duane Ave, Suite 207, Sunnyvale, CA 94086. Phone (408) 739-4000. FAX (408) 739-4081. **Circle No. 385**

Debug monitor. XVME-991 is an implementation of the Probe+ debug monitor from Software Components Group. This particular implementation is compatible with the supplier's XVME-630, a 68EC030 VMEbus processor module. Enhancements to standard Probe+ include power-up diagnostics, real-time-clock access routines, serial-port configuration, user-accessible memory test, and console I/O support. \$500. **Xycom Inc.**, 750 N Maple Rd, Saline, MI 48176. Phone (800) 289-9266; (313) 429-4971. FAX (313) 429-1010. **Circle No. 386**

Test-vector generator for ASICs. TDX-130 is a low-cost workstation version of the supplier's Test Design Expert. It generates test vectors for ASIC designs having as many as 25,000 2-input gate equivalents from behavioral and structural circuit descriptions. The software runs on Sun SPARCstations. From \$95,000. **Expertest Inc.**, 810 E Middlefield Rd, Mountain View, CA 94043. Phone (415) 965-2000. FAX (415) 969-3932. **Circle No. 387**

Vocoder software. The Self-Excited Vocoder (SEV) and new versions of the Subband Coder (SBC) are algorithms that compress digital representations of speech signals to minimize the number of bits. Applications for SEV include mobile radio, cellular telephony, secure voice systems, and satellite-based communications; SBC suits answering ma-

FINALLY, One Company offers you the Power and the ease... with integrated Workstation tools from PADS...

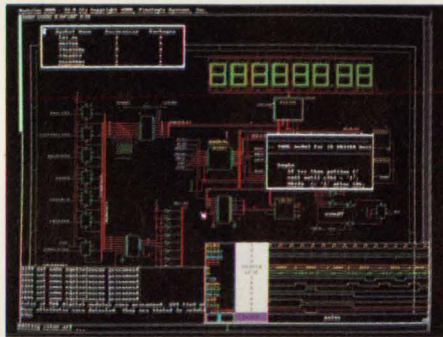

PADS-View

- ▲ A complete design entry & simulation solution
- ▲ Mixed-Mode analog/digital simulator
- ▲ Multiple-windows featuring cross-probing of nets to/from PADS-2000 with waveform analysis
- ▲ Built-in analysis tools for Engineering Rules Check and Logic Simulation

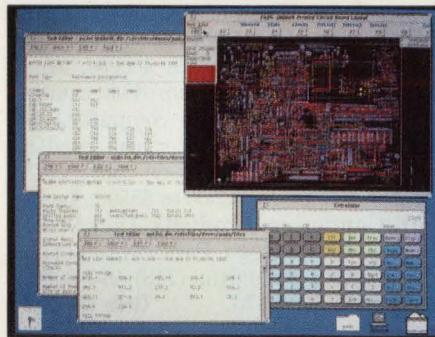

PADS-2000/UX

- Interactive and automatic PCB design bundle with placement and auto-interactive/batch auto-routing tools
- Comprehensive SMT and analog design support with copper pour and edit
- Bi-directional interface to PADS-View supporting back-annotation and ECO's

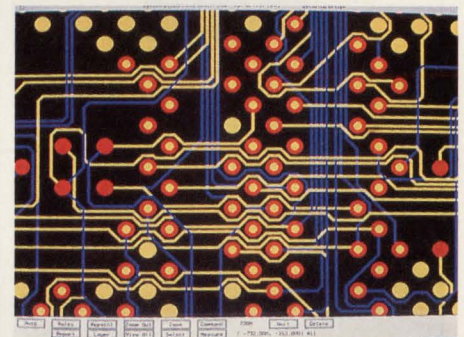

PADS-ForceRouter

- AutoRouting for High Density Design and Testability
- Gridless routing thru shape-based architecture
- Comprehensive high-speed design features with table-driven cross-talk analysis
- State-of-the-Art Design for Manufacturability

PADS offers hardware independent EDA Solutions within your budget and to meet your toughest engineering challenges. PADS products offer you a consistent, easy-to-learn, easy-to-use design environment. For database compatibility, total migration and a common design philosophy between PC's and Workstations, call **1-800-554-SALES**.

VIEWlogic[®]

The Premiere Design Environment for ASIC, IC, and System Design
VIEWlogic and the VIEWlogic logo are registered trademarks of VIEWlogic, Inc.

PADS
Software, Inc.

Tel: (508) 486-9521 Fax: (508) 486-8217
Toll Free: 1-800-554-SALES

CIRCLE NO. 134

See us at Electro Booth #1226

sun
microsystems

The #1 Choice in Workstations:
Sun SPARC Family of Products
SUN is registered trademark of Sun Microsystems, Inc.
SPARC is a registered trademark of SPARC International, Inc.
developed by Sun

Sprague-Goodman

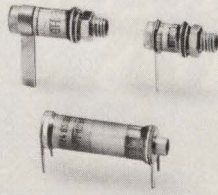

Glass and Quartz Pistoncaps®

- Designed to meet MIL-C-14409D
- QPL models
- Extremely stable over temperature, frequency, voltage, etc.
- Cap ranges: 0.5-3.0 pF to 1.0-120 pF
- Zero backlash multiturn adjust mechanism
- Operating temp: -55° to +125°C (models to +200°C)
- Q to 1500 at 20 MHz
- Wide variety of configurations for PC and panel mounting
- Voltage ratings from 500 to 5000 V

Phone, fax or write today for
Engineering Bulletin SG-205A.



134 Fulton Ave., Garden City Park, NY 11040
Phone: 516-746-1385 • Fax: 516-746-1396

CIRCLE NO. 135

Sprague-Goodman

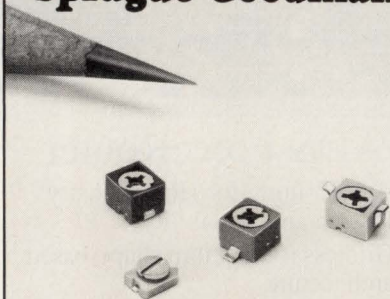

Surftrim® Surface Mount Trimmer Capacitors

- 2 sizes:
3.2 x 4.5 x 1.6 mm
4.0 x 4.5 x 2.7 mm (sealed)
- 4 mounting configurations
- Carrier and reel, or bulk pack
- 1.7 to 50 pF in 7 cap ranges
- Operates to 85°C

Phone, fax or write today for
Engineering Bulletin SG-305B.



134 Fulton Ave., Garden City Park, NY 11040
Phone: 516-746-1385 • Fax: 516-746-1396

EDN-NEW PRODUCTS

CAE & Software Development Tools

chines, voice mailboxes, and automated attendant systems. SEV license, \$35,000; SBC license, \$20,000. **Atlanta Signal Processors Inc**, 770 Spring St, Atlanta, GA 30308. Phone (404) 892-7265. FAX (404) 892-2512. **Circle No. 388**

C++ graphics library. Objectgraphics extends Borland's C++ with Application Frameworks and Turbo C++ for Windows to create graphics in Windows applications. It masks the graphics "engine" of Windows and allows you to use a simple set of graphics objects, rather than many primitive function calls. \$195. **The Whitewater Group**, 1800 Ridge Ave, Evanston, IL 60201. Phone (708) 328-3800. FAX (708) 328-9386. **Circle No. 389**

Disk-access software. Comlock controls user access to program and data floppy disks. Users of the software can designate disks as either "group" or "nongroup" for selective access. Any disk copied from a group disk cannot be read by a nongroup computer, although a group computer can read a nongroup disk. Single-user copy, \$125 to \$275; 100 users, \$2500 to \$5500. **Techmar Computer Products Inc**, 98-11 Queens Blvd, Rego Park, NY 11374. Phone (800) 922-0015; (718) 997-6666. FAX (718) 520-0170. **Circle No. 390**

PLD-design software. PLDshell Plus, an expanded PLD-design software package, has been expanded to support the development of all Intel PLDs. The software package adds simulation capability and logic minimization features and supports features of the 5AC312 and 5AC324 PLDs. Free of charge. **Intel Corp**, Literature Packet #IP-91, Box 7641, Mt Prospect, IL 60056. In US and Canada, phone (800) 548-4725. **Circle No. 391**

LAN-based CASE system. Pose 4.3 is a multiuser, multiproject, front-end CASE tool that lets you run a suite of modular Pose (Picture Oriented Software Engineering) tools on any NetBIOS-compatible LAN. In addition to facilitating multiple users and projects, this version includes more than 20 enhancements. \$1195 to \$2995. **Computer Systems Advisers Inc**, 50 Tice Blvd, Woodcliff Lake, NJ 07675. Phone (201) 391-6500. FAX (201) 391-2210. **Circle No. 392**

Where you can learn a little black magic.

If you'd like to learn a few new tricks in analog design, check the schedule of the Analog Devices Advanced Linear Design Seminar below and then reserve your space by calling 1-800-ANALOGD (in Canada, call 617-937-1430) today.

NORTH AMERICA

City	Date
Cleveland, OH	May 5
Detroit, MI	May 6
Santa Clara, CA	May 7
Burlington, MA	May 7
Pleasanton, CA	May 8
Milwaukee, WI	May 11
San Diego, CA	May 11
Chicago, IL	May 12
Irvine, CA	May 12
Houston, TX	May 13
Woodland Hills, CA	May 13
Dallas, TX	May 14
Phoenix, AZ	May 14
Dayton, OH	May 15
Denver, CO	May 15
Minneapolis, MN	May 18
Huntsville, AL	May 18
Waterbury, CT	May 19
Atlanta, GA	May 19
Whippany, NJ	May 20
Tampa, FL	May 20
Smithtown, NY	May 21
Orlando, FL	May 21
Santa Clara, CA	May 27
Rochester, NY	May 27
Beaverton, OR	May 28
Toronto, Can	May 28
Bellevue, WA	May 29
Montreal, Can	May 29
Waltham, MA	June 1
Raleigh, NC	June 2
Ft. Washington, PA	June 3
Baltimore, MD	June 4
McLean, VA	June 5

EUROPE

City	Date
Copenhagen, Denmark	May 4
Berlin, Germany	May 5
Wiesbaden, Germany	May 6
Hamburg, Germany	May 7
München, Germany	May 8
Vienna, Austria	May 11
Zürich, Switzerland	May 12
Lyon, France	May 13
Paris, France	May 14
London, England	May 15
Edinburgh, Scotland	May 18
Eindhoven, Netherlands	May 19
Stockholm, Sweden	May 20
Rome, Italy	May 21
Milan, Italy	May 22

Far East and Japan seminars to be held in June. Please call 1-617-937-1430 for schedule.



If you've always thought linear design involved a little black magic, here's where you can learn a few of the tricks.

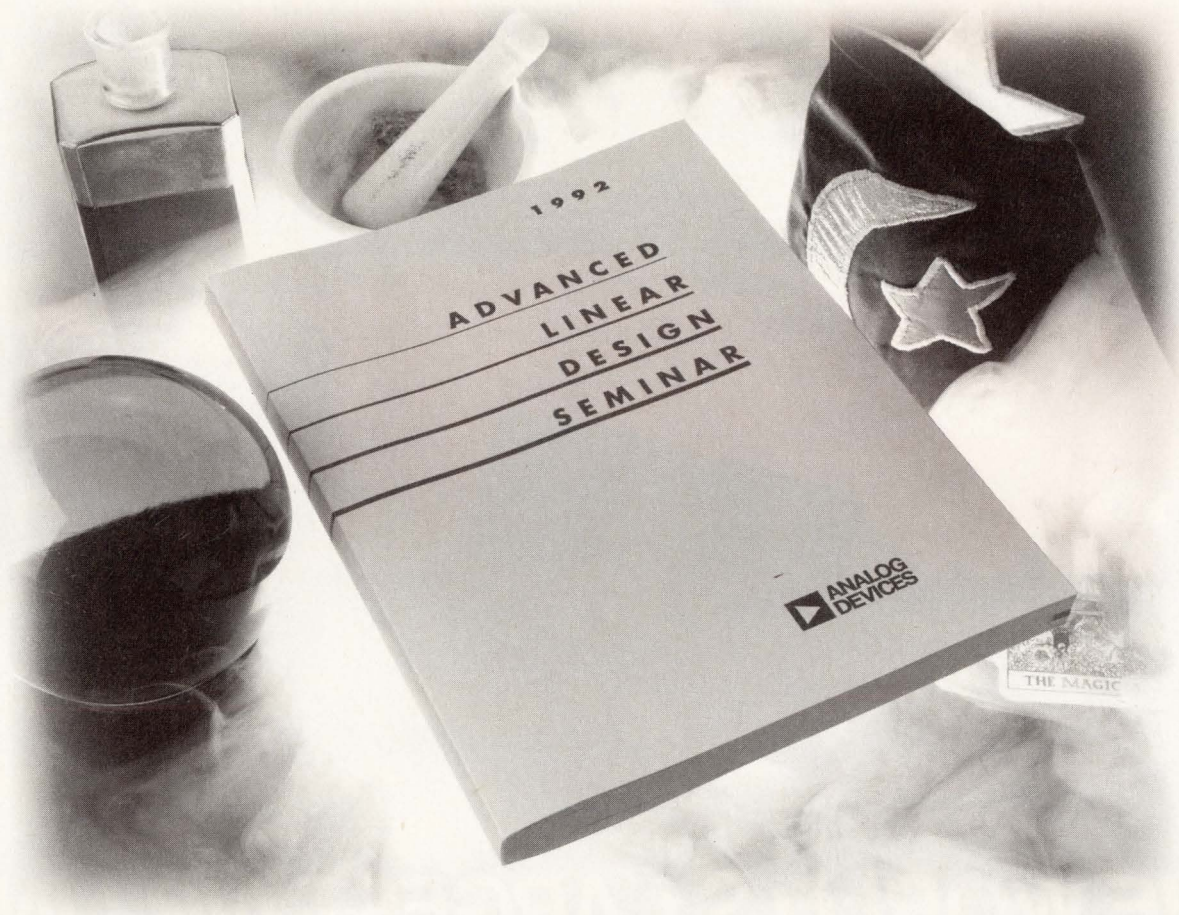

If you're one of the few engineers who realizes the world of analog design isn't all that mysterious, you'll appreciate our Advanced Linear Design Seminar. Because it's the perfect opportunity to pick up a few new tricks.

Hosted by Analog Devices, one of the leading suppliers of analog and mixed-signal ICs, and its distributors, the seminar series will include talks by prominent design wizards such as Derek Bowers, Paul Brokaw, Lou Counts, Barrie Gilbert, Walt Jung, and others.

The full-day tutorials also include solutions-oriented discussions that are geared towards showing you how to increase system performance while actually lowering overall cost. Plus you'll get free product samples, our 700-page *Amplifier Applications Guide*, other technical reference materials, and more.

Admission to the seminar is just \$20, and it includes everything above, lunch, and refreshments.

So if you're a design wizard who wants to add to your repertoire of linear design tricks, it's no secret what you should do — call 1-800-ANALOGD (in Canada, call 617-937-1430) and reserve a seat today. Before they all disappear.



The Analog Devices Advanced Linear Design Seminar.

Analog Devices, Inc., One Technology Way, P.O. Box 9106, Norwood, MA 02062-9106. Headquarters: (617) 329-4700. Offices, applications support and distribution available worldwide.

PAPST

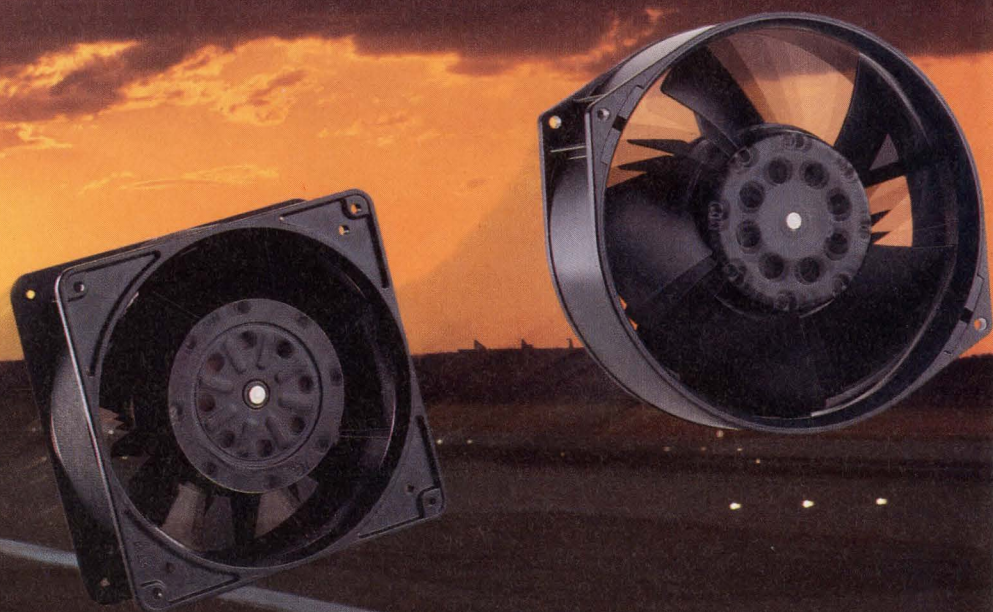

THE WORLD'S LARGEST AIR LINE JUST GOT BIGGER.

Introducing PAPST's new 5000 & 7000 series AC & DC fans.

PAPST not only adds an extra dimension in air performance and noise reduction to the world's largest selection of fans, but gives you the technical advantage of specifying PAPST quality in sizes never before available.

The 5000 series (148-160 CFM) completes our line between 120mm square fans and 172mm

round fans. The 7000 series (213-242 CFM) features an entirely new line of DC fans and redesigned AC fans.

And like all PAPST fans, they're designed to last. They use less power than other fans. They're made of quality electrical grade lamination, not fender grade steel. They have larger-than-average

bearings, larger oil and grease reservoirs and thicker shafts.

Take off with PAPST. Call **1-800-245-FANS** for a free catalog.

PAPST MECHATRONIC CORPORATION
Aquidneck Industrial Park
Newport, RI 02840
CIRCLE NO. 138

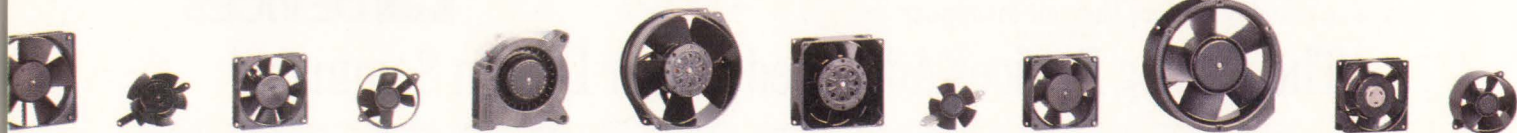

See You at Electro Booth #4226-4228

◀ For More Information on Lambda Circle No. 59

Test & Measurement Instruments

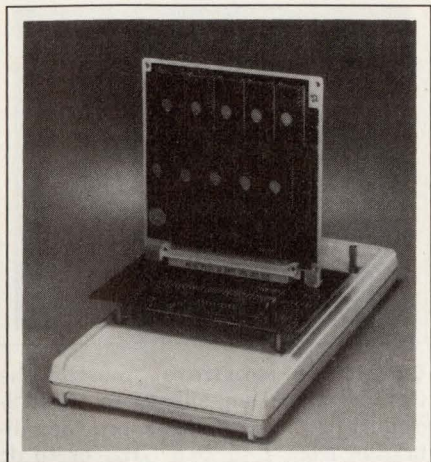

In-circuit programmer. The T-2000 in-circuit programmer programs EPROMs, EEPROMs, and microcontrollers already mounted on pc boards. The hardware consists of an ISA bus coprocessor board, a connecting cable, a programming head, and a universal adapter. The programmer works with boards that have 8- or 16-bit-wide data buses and contain as many as 32 programmable ICs. You can set up the programmer to handle devices using nonstandard supply voltages and programming algorithms. You configure the programmer via fill-in-the-blanks software that creates configuration files. The vendor supplies three styles of pc-board adapters. Both the configuration files and the adapters work with the vendor's production in-circuit programmers that simultaneously program multiple boards. T-2000, \$3500; adapters, \$450 to \$750. **Sunrise Electronics Inc**, 524 S Vermont Ave, Glendora, CA 91740. Phone (818) 914-1926. FAX (818) 914-1583.

Circle No. 425

RF counter/timer for PCXI bus. The PX2235, which plugs into the PCs extended for industry (PCXI) bus, provides 10-digit resolution from 10 Hz to 2.4 GHz and counts directly to 150 MHz. It uses reciprocal counting for low-frequency measurements and provides 10-mV sensitivity to 1.6 GHz. \$839. **Rapid Systems Inc**, 403 N 34th St, Seattle, WA 98103. Phone (206) 547-8311. FAX (206) 548-0322. TLX 265017.

Circle No. 426

Test-generation software for Xilinx PLDs. You use LCA2ICT to develop pin-level tests for Xilinx logic-cell arrays. The software exploits the devices' reprogrammability by loading a simple design that checks for board-level as-

sembly faults and also verifies that the device can load a configuration and can drive and sense its pins. The software reads the original design and creates a test design that uses the same pins. \$3000 to \$4500 if added to the vendor's existing products; from \$14,000 otherwise. **Acugen Software Inc**, 427-3 Amherst St, Suite 391, Nashua, NH 03063. Phone (603) 881-8821.

Circle No. 427

Background-mode emulator for 68300 series. The Series 300 Performance Plus background-mode emulator works with the MC 68300, 68331, 68332, 68333, 68340, and 68HC16. The instrument, which can have 512 kbytes of simulation memory and 256 kbytes of ROM-overlay memory, lets you boot your system from RAM and use the μ Ps' background-mode debugging ports to conduct software performance analysis. For testing μ P-based boards in production, the emulator includes a facility for writing custom diagnostics in C. These diagnostics run from simulation memory and make calls to the target board via the background-mode port. Performance Plus model, \$3050; field unit upgradable to Performance Plus version, \$2450. **Embedded Support Tools Corp**, 10 Elmwood St, Canton, MA 02021. Phone (617) 828-5588. FAX (617) 828-7941.

Circle No. 428

Function generator and frequency counter. The OscPC version B4.0 device includes an analog output with 16-bit resolution and 0.005% error. The frequency counter detects pulses as narrow as 12 nsec at frequencies to 12 MHz, which it measures with an error of 1 Hz or 5 ppm. You can program both the rate (to 2 MHz) and the width of the output pulses; pulse-width increments are $\frac{1}{4}$ μ sec. \$180 to \$200. **StarPC Instruments**, Box 64418, Sunnyvale, CA 94086. Phone (408) 739-5117.

Circle No. 429

Calibrated light meter. The Cal-light measures ambient illumination. The vendor calibrates each unit against nationally accepted standards. The unit's spectral sensitivity matches that of the human eye. The unit produces readings in user-selectable units—either foot-candles (fc) or lux. Maximum readout is 400,000 fc. \$345. **Cooke Corp**, Box 209, Buffalo, NY 14216. Phone (716) 833-8274. FAX (716) 836-2927.

Circle No. 430

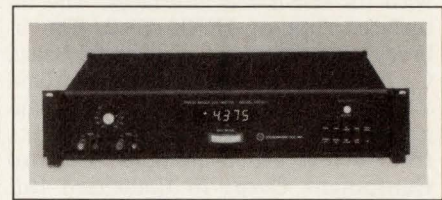

25- and 54-kHz digital phase-angle voltmeters. You can use the TMI 4001C-1 (10 Hz to 25 kHz) and 4001C-2 (autoranging 26 Hz to 54 kHz) phase-angle voltmeters for synchro/resolver testing; in-phase and quadrature voltage measurement; amplifier gain and phase testing; and impedance-angle measurement. They have isolated reference and signal inputs and indicate results on $4\frac{1}{2}$ -digit LED displays. The units require no calibration or frequency locking. The 4001C-1's phase error is $< \pm 0.5^\circ$; its voltage error is $< \pm 2\%$ of full scale across its bandwidth. The 4001C-2's phase error is $\pm 0.25^\circ$. The unit's voltage error depends on its mode but when measuring in-phase or quadrature signals to 1.5 kHz, it can be as low as $\pm 0.05\%$ of full scale 0.07% of reading. 4001C-1, \$4190; 4001C-2, \$9800. Delivery, 12 weeks. **ARO. Transmagnetics Inc**, 210 Adams Blvd, Farmingdale, NY 11735. Phone (516) 293-3100. FAX (516) 293-3793. TWX 510-224-6420.

Circle No. 431

Optical attenuation and return-loss test set. The FOT-150 series measures at wavelengths of 1300 and 1550 nm. It has a dynamic range of +10 to -75 dB in the attenuation mode and -8 to -70 dB in the return-loss mode. Its resolution is 0.01 dB. An IEEE-488 interface is optional. \$2800 to \$11,000. **Exfo EO Engineering Inc**, 465 Godin, Vanier, QC G1M 3G7, Canada. Phone (418) 683-0211. FAX (418) 683-2170.

Circle No. 432

Digital megohmmeters. The ST700201 meter measures resistance to 2000 M Ω and ac voltage to 600V. The ST700200 meter is similar but offers higher sensitivity at the expense of reduced ability to measure high resistances (100 M Ω max). Each unit, \$748. **Davis Instrument Mfg Co Inc**, 4701 Mt Hope Dr, Baltimore, MD 21215. Phone (800) 368-2516. FAX (410) 358-0252.

Circle No. 433

Turbo C++ support for IEEE-488 interfaces. Turbo C++ Software is available separately for \$95 or at no cost as part of the library the vendor supplies

EDN-NEW PRODUCTS

Test & Measurement Instruments

with its IEEE-488 interfaces. The interfaces support IEEE-488.2. The library supports most dialects of Basic, C, Pascal, and Fortran from Borland and Microsoft, as well as assembly language and high-level-language dialects from a few other vendors. **Capital Equipment Corp**, 76 Blanchard Rd, Burlington, MA 01803. Phone (617) 273-1818. FAX (617) 273-9057. **Circle No. 434**

Instrument-control software. Total Control for Windows allows developers to design MS-Windows-based applications that control robots, read bar-coded data, and work with programmable logic controllers. A network module is compatible with Novell, IBM, and DEC networks. Development kit, \$1995; licenses for each unit sold by a developer, \$200. **Hudson Control Group Inc**, 44 Commerce St, Springfield, NJ 07081. Phone (201) 376-7400. FAX (201) 376-8265. **Circle No. 435**

Burn-in board tester and X-Y table. The BTS-2000 tester makes 2- and 4-wire resistance measurements and uses

a driven guard. Adding cards lets you upgrade the 256-channel system to 1024 channels. The system tests boards from their edge connectors and also connects to individual devices mounted on boards. The system computer, an MS-DOS PC, provides full-color graphics displays that highlight failing-component locations. From \$22,000. Delivery, 8 to 12 weeks ARO. **Aehr Test Systems**, 1667 Plymouth St, Mountain View, CA 94043. Phone (415) 691-9400. FAX (415) 641-9300. TWX 415-691-0938.

Circle No. 436

IEEE-488 interface for Silicon Graphics workstations. The GPIB-SG-S kit lets you control as many as 14 IEEE-488 instruments from the SCSI (small-computer systems interface) port of an Iris Indigo RISC-based workstation. The kit uses a SCSI-to-IEEE-488 converter that mounts outside the workstation. \$1695. **National Instruments Corp**, 6504 Bridge Point Pkwy, Austin, TX 78730. Phone in US and Canada, (800) 433-3488; (512) 794-0100. FAX (512) 794-8411. TLX 756737. **Circle No. 437**

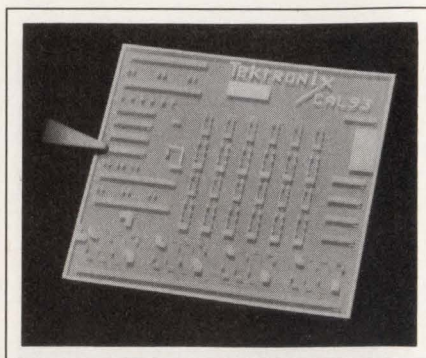

Calibration substrate. You use the Cal93 calibration substrate with 2-contact probing systems to provide calibration from 1 to 26.5 GHz, or to dc with a low-band load. A metrology-grade sapphire substrate and laser trimming produce low-inductance resistors with >30-dB of return loss. \$995. **Tektronix Inc**, Box 1520, Pittsfield, MA 01202. Phone (800) 426-2200.

Circle No. 438

IEEE-488.2 driver software for MS-DOS PCs. Versions of NI-488.2 V2.0 work with MS-DOS memory extenders

Breakthrough multichip modules



EDN-NEW PRODUCTS

Test & Measurement Instruments

from Rational systems and Phar Lap. A new MS-Windows driver also incorporates standard dynamic-link-library entry points. Driver software with IEEE-488 interface kits for the 16-bit ISA and Micro-Channel Architecture buses, \$395 to \$495; DOS memory-extender-compliant versions of the drivers, \$200. **National Instruments Corp.**, 6504 Bridge Point Pkwy, Austin, TX 78730. Phone in US and Canada, (800) 433-3488; (512) 794-0100. FAX (512) 794-8411. TLX 756737. **Circle No. 439**

Pin-driver electronics for PLD test.

The PLD Driver pin card fits within the test head of the firm's Vista Series test systems and tests a variety of programmable devices including PROMs, field-programmable gate arrays, and programmable electrically erasable logic devices. You can equip one system with as many as three of the boards, thus enabling the system to produce high programming voltages on 24 channels. \$10,000/board. **Credence Systems Corp.**, 47211 Bayside Pkwy, Fremont, CA 94538. Phone (510) 657-7400. FAX (510) 623-2560. **Circle No. 440**

IEEE-488-based digital I/O subsystem.

The Digital488HS/32 houses 16 digital input lines and 16 digital outputs. It includes complete handshaking facilities, provides a trigger output, and transfers data to and from the bus at 1 Mbyte/sec. \$795. **Iotech Inc.**, 25971 Cannon Rd, Cleveland, OH 44146. Phone (216) 439-4091. FAX (216) 439-4093. **Circle No. 441**



Ethernet and Token Ring protocol analyzers. The Interview 80 series uses an interface board and software that

you can install in your own PC for \$12,000. There are separate versions for Ethernet and Token Ring networks. For \$19,995, you can obtain the board and software in a laptop PC that has a monochrome plasma display. For \$24,995, you can buy the items in a laptop PC that has an active-matrix color LCD. All configurations perform real-time monitoring, data recording, protocol decoding, and performance analysis. **Telenex Corp.**, 7401 Boston Blvd, Springfield, VA 22153. Phone (703) 644-9000. FAX (703) 644-9011. TLX 197733. **Circle No. 442**

Automatic-testing software. AutoCAT V3.0 works with MS-DOS PCs. It directly controls instruments connected to RS-232C and IEEE-488 ports without the need for drivers or high-level languages. The software collects data, stores it, and displays it or prints it out. Use of the software does not require a knowledge of programming. \$495. **Neos Technologies Inc.**, 4451B Enterprise Ct, Melbourne, FL 32934. Phone (407) 259-2090. FAX (407) 255-0274. **Circle No. 443**

for breakneck speeds.

That's AT&T "Customerizing."

If beyond 50MHz performance is where you're heading in workstations, AT&T's multi-layer Multichip Module (MCM) solution is the most reliable, viable way to go.

POLYHIC packaging, developed by AT&T Bell Laboratories, combines copper thin film with our patented polymer. It delivers one of the industry's lowest dielectric constants (2.8) to minimize access times between CPU and memory devices. And low-loss POLYHIC technology helps prevent timing problems on critical paths.

Every AT&T MCM is comprehensively tested to meet critical function requirements.

Designs work right the first time because Bell Labs' design expertise assures that your crucial high performance requirements are met. And POLYHIC MCM modularity helps you get system designs up and running faster.

Should the going get rough, AT&T engineers are on stand-by to advise you. Analyze your circuits. Even recommend a solution to take you

to the next generation of high-end workstation performance. That's "Customerizing."

For more about the POLYHIC power of AT&T's MCMs, call AT&T Microelectronics at 1 800 372-2447, ext. 900.

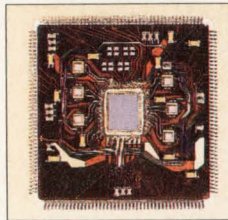

CIRCLE NO. 139



AT&T
Microelectronics



Universal 8051/52 Family

Intel 8031	32 MHz
Intel 8032	24 MHz
Intel 80C31	32 MHz
Intel 80C32	24 MHz
Intel 80C51FA	16 MHz
Intel 80C152	16 MHz
Intel 8048/49/50	11 MHz
AMD/Siemens 80515	16 MHz
AMD/Siemens 80535	16 MHz
AMD/Siemens 80C535	16 MHz
Siemens 80537	16 MHz
Siemens 80C537	12 MHz
Siemens 80C517	16 MHz
Signetics/Philips 80C451	16 MHz
Signetics/Philips 83C451	16 MHz
Signetics/Philips 87C451	16 MHz
Signetics/Philips 80C552	16 MHz
Signetics/Philips 8XC552	16 MHz
Signetics/Philips 83C751	16 MHz
Signetics/Philips 87C751	16 MHz
AMD 80C321	16 MHz
AMD 80C325	16 MHz
AMD 80C525	16 MHz
AMD 87C525	16 MHz

Intel 8096/196

(KB, KC, KR, KQ, JR, JQ)

8096/80196	16 MHz
8098/80198	12 MHz

Zilog Z8. Super-8

Z8	20 MHz
86C94	30 MHz
Super-8	20 MHz

Texas Instruments DSP's

320C10/15	33 MHz
320C16	35 MHz
320C17	20 MHz

Let's talk
real 8051
8096/196
in-circuit
emulation.
... and
DSP's too!

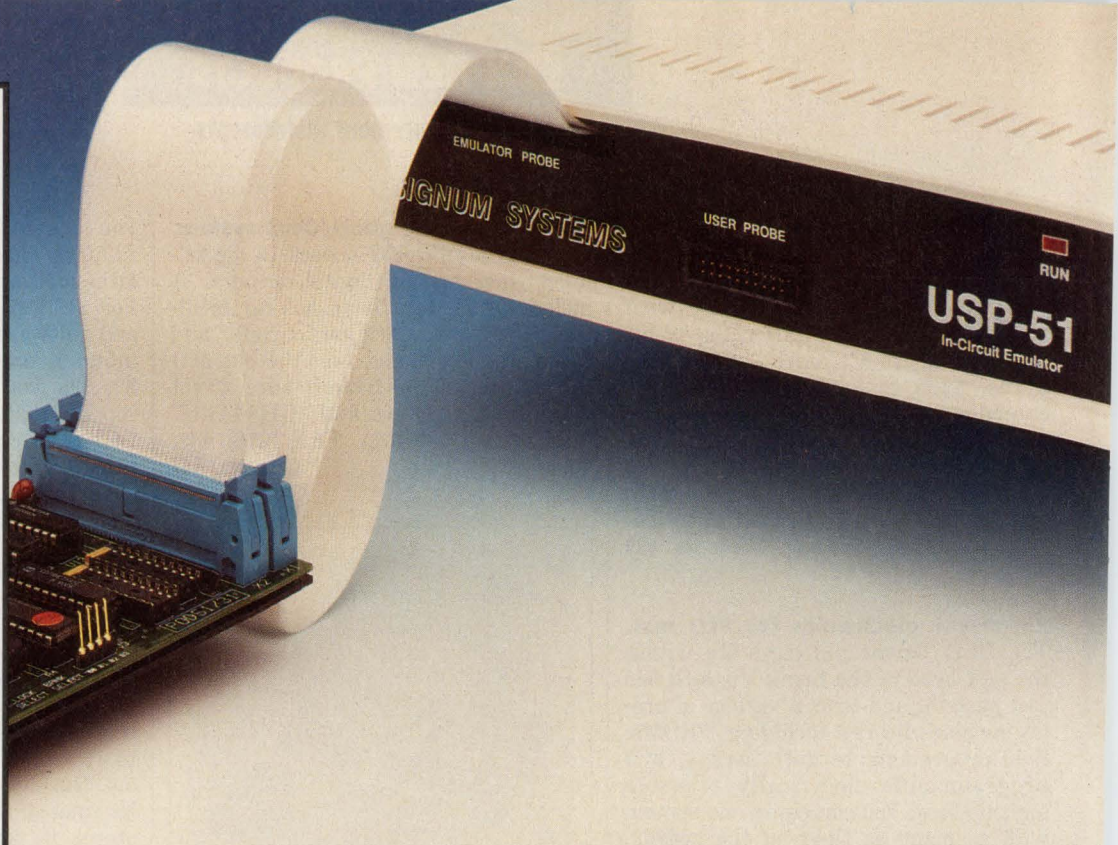

Signum Systems' in-circuit emulators offer more standard features than you'd expect, and some you wouldn't.

Features You'd Expect

- Windowed/mouse interface
- Flash download 115 k-baud
- Debug in C and PL/M
- Non-intrusive to target or PC
- Full speed emulation

Signum Extras

- C-51 and C-96 HLL debugger with locals support
- Full bank switching support
- Up to 256K emulation program RAM
- Graphic trigger window
- 32K x 80 real-time trace
- Access on-the-fly to:
 - All emulation RAM contents
 - 3 complex trace triggers
 - 8 level sequencer
 - Trace and execution displays
 - 256K address breakpoints
 - 2 16-bit event counters
- Performance analysis
- Unlimited user support

**Performance . . .
Ultimately Depends on You**

See what **Graphic Triggering** can do for you. For the first time you can have intuitive, precise control of the full debugging power of your emulator. You'll avoid errors and get more done.

Debugging in a High Level Language means that eventually you will have to track something right down to a member of a local complex structure. Signum lets you zoom in on any structure—**with just the click of a mouse.**

**Opportunity . . .
The Signum Advantage**

The right tools do make a difference, and there's no equality among emulators. You have to actually use them to appreciate what they can do for you. Better features that are easier to use mean you're finished sooner. That's performance, and that is exactly what we are about at Signum Systems.

Prove it to yourself, check out a Signum emulator today! Write or call to evaluate the Signum advantage.

10 DAY FREE TRIAL

SIGNUM SYSTEMS

... for the most discerning

171 East Thousand Oaks Blvd.
Thousand Oaks, CA 91360
Tel: 805-371-4608
Fax: 805-371-4610

England	(0254) 682-092
France	(33) (74) 43 80 45
Italy	(39) (2) 688-00548
Switzerland	(41) (91) 568-721
Poland & Eastern Europe	(48) (71) 484-221

© 1991 Signum Systems
* System capable of 32 MHz; actual emulation speeds limited by current device speeds.

As easy as building blocks

New easy-to-assemble anechoic chambers from Tokin

- Small-sized hexahedral
- FCC Filing and 10m regulations
- Portable chambers

The more you need anechoic chambers, the more you'll appreciate Tokin.

Why?

Because Tokin's new assembly method makes building them as easy as child's play.

Look.

With Tokin, panels (120 cm × 120 cm) come with ferrite tiles already attached. You don't have to waste time—or money—attaching 10 cm tiles, piece by piece, yourself. Then, Tokin's panels are lightweight, and put together with a hanging bar—simplicity itself.

But assembly ease is not their only strong point. Tokin's chambers are designed by computer simulation using the most reliable testing and advanced EMC technology. So whatever your needs are for diversified EMI counter measurement, Tokin skillfully meets them.

If you're in the business of measuring noise immunity and EMI, you'll find it worthwhile to look into these new Tokin chambers.

They're the basic building blocks of your new success.



Small-sized anechoic chamber for EMI and EMS

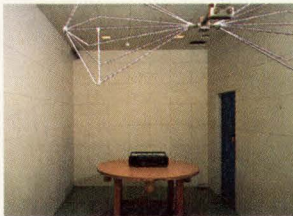

Portable anechoic chamber



Anechoic chamber (FCC Filing and 10m Regulations)

TOKIN

Tokin Corporation

Hazama Bldg., 5-8, Kita-Aoyama 2-chome, Minato-ku, Tokyo 107, Japan
Phone: 03-3402-6166 Fax: 03-3497-9756

Korea Representative Office

#602, Champs-Elysees Bldg., 889-5,
Daechi-Dong, Kangnam-gu, Seoul, Korea
Phone: (2) 569-2582-5 Fax: (2) 544-7087

Tokin America Inc.

155 Nicholson Lane, San Jose, California 95134, U.S.A.
Phone: 408-432-8020 Fax: 408-434-0375

Chicago Branch

9935 Capitol Drive, Wheeling, Illinois 60090, U.S.A.
Phone: 708-215-8802 Fax: 708-215-8804

Boston Branch

945 Concord Street, Framingham, Massachusetts 01701, U.S.A.
Phone: 508-875-0389 Fax: 508-875-1479

Tokin Electronics (HK) Ltd.

Room 806 Austin Tower, 22-26A Austin Avenue,
Tsimshatsui, Kowloon, Hong Kong
Phone: 367-9157 Fax: 739-5950

Taiwan Liaison Office

3F-4, No. 57 Fu Shing N. Road, Taipei, Taiwan
Phone: (02) 7728852 Fax: (02) 7114260

Singapore Branch

140 Cecil Street, No. 13-01 PIL Bldg., Singapore
Phone: 2237076 Fax: 2236093, 2278772

Tokin Europe GmbH

Knorrstr. 142, 8000 München 45, Germany
Phone: 089-311 10 66 Fax: 089-311 35 84 Telex: 5 24 537 tokin d

EDN-NEW PRODUCTS

Integrated Circuits

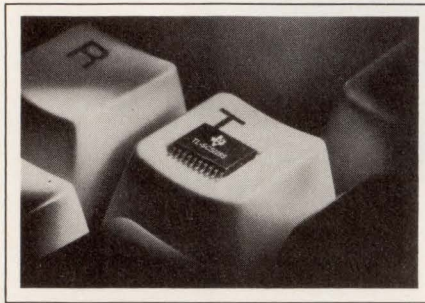

Voltage regulator for active SCSI termination. The TL-SCSI285 voltage regulator allows designers to use the high-speed Small Computer Systems Interface (SCSI) standard in desktop and battery-powered computers. The regulator exceeds the SCSI specification for active termination. For example, the device allows the input voltage to drop as low as 3.45V while maintaining an output voltage of 2.85V. This maximum drop-out of 0.6V satisfies both the 1V drop-out requirement of desktop computers and the 0.6V drop-out requirement of battery-operated laptop and notebook computers. The TL-SCSI285 comes in DIPs, TO-220 packages, and to accommodate space-restricted systems, TSSOP, (thin-scaled small-outline package) that are 0.040 in. thick, from \$1.60 to \$1.70 (1000). **Texas Instruments Inc**, Semiconductor Group (SC-92001), Box 809066, Dallas, TX 75380. Phone (800) 336-5236, ext 3990; (214) 995-6611, ext 3990. **Circle No. 444**

Graphics chip. The TVGA8900CX increases resolution, speeds Windows applications, and offers 24-bit color support. The chip interfaces with ISA, MCA, and Local buses. The Local bus interface bypasses the 8-MHz bottleneck of the ISA bus and allows the chip to communicate with 386 and 486 processors. Operating at a 108-MHz dot-clock rate, the chip supports resolutions to 1280x1024 pixels and 256 colors. In 160-pin plastic quad flatpack, \$20 (1000). **Trident Microsystems Inc**, 205 Ravendale Dr, Mountain View, CA 94043. Phone (415) 691-9211. FAX (415) 691-9260. **Circle No. 445**

Crosspoint switch. The TQ8016 16x16 digital crosspoint switch operates at data rates to 1.3 Gbps. The differential switch suits high-speed telecom and datacom applications such as SONET at 1.244 Gbps, FDDI from 100 Mbps to 1.3 Gbps, and Fiber Channel at 266 Mbps and 1 Gbps. Propagation delay

is 1.2 nsec, and the delay match from any input to any output is ± 200 psec. TQ8016, \$157 (1000). **Triquint Semiconductor Inc**, 3625A Murray Blvd, Beaverton, OR 97005. Phone (503) 644-3535. FAX (503) 644-3198. **Circle No. 446**

Read/write preamplifier. Accommodating the low-power needs of portable computers, the XR-9010 read/write preamplifier operates from a 5V supply. The IC consumes 1 mW in idle mode and 125 mW in read mode. Featuring read/write control for four channels, the chip provides read-mode amplification, write-current control, and head selection. The 9010R option provides internal 750 Ω damping resistors. The read preamplifier has a 60-MHz bandwidth, and the write drive supports 50 mA of write current. XR-9010/9010R, less than \$3 (OEM qty). **Exar Corp**, 2222 Qume Dr, San Jose, CA 95161. Phone (408) 434-6400. FAX (408) 943-8245. TWX 910-339-9233. **Circle No. 447**

DRAM/SRAM chip. The M5M44409TP integrates a 1Mx4-bit dynamic RAM (DRAM) with a 4kx4-bit static RAM (SRAM). The combination device attains 100-MHz cache-hit performance, and you can couple it directly to the CPU without buffers. The device is available with cache access times of 10, 15, or 20 nsec. M5M44409TP, in a 44-pin thin SO package, from \$15 to \$16.20 (100). **Mitsubishi Electronics America Inc**, 1050 E Arques Ave, Sunnyvale, CA 94086. Phone (408) 730-5900. **Circle No. 448**

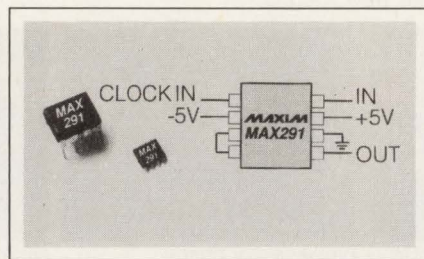

Small eighth-order lowpass filters. A series of four lowpass filters offers a choice of two responses. The MAX291/MAX295 provide a Butterworth response; the MAX292/MAX296 provide a Bessel response. The filters' corner frequency is set by the frequency of a clock signal. The clock-to-corner-frequency ratio for the MAX291/MAX292 is 100:1 with a 0.1-Hz to 25-kHz corner-frequency range. The frequency ratio for the MAX295/MAX296 is 50:1 with

a 0.1-Hz to 50-kHz corner-frequency range. You can drive the clock with an external CMOS-level signal or with the internal oscillator's utilizing an external capacitor to set its frequency. All of the filters operate from 5 or ± 5 V supplies. In 8-pin DIPs and 8- or 16-pin SOIC packages, from \$2.95 (1000). **Maxim Integrated Products**, 120 San Gabriel Dr, Sunnyvale, CA 94086. Phone (408) 737-7600. **Circle No. 449**

Compression chip. Featuring 30-Mbyte/sec performance, the 9706 data-compression chip offers direct connection to a microprocessor's high-speed local bus. You can configure the chip for 16- or 32-bit data transfers. A sleep mode reduces current drain to 300 μ A as soon as compression tasks are completed. \$19.90 (OEM qty) (50,000). **Stac Electronics**, 5993 Avenida Encinas, Carlsbad, CA 92008. Phone (619) 431-7474. FAX (619) 431-0880. **Circle No. 450**

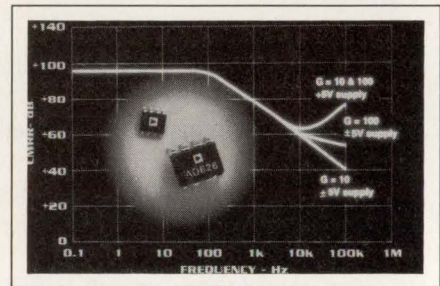

Monolithic, single-supply difference amplifier. Using a single AD626, you can replace traditional difference or instrumentation amplifiers that normally require several discrete op amps. The monolithic device can operate from a single 2.4 to 12V supply or a dual ± 1.2 to ± 6 V supply. Output swings are from $-V_s$ to within 300 mV of the positive rail. The common-mode voltage range, which exceeds the supply range, is 0 to 24V for a 5V supply and ± 24 V for a ± 5 V supply. Common-mode rejection is typically 90 dB, enabling the measurement of small signals. Operating from 5V, the AD626 has a quiescent current of 230 μ A, suiting it for battery-operated applications. In 8-pin miniDIP and SOIC packages, from \$2.85 (1000). **Analog Devices**, 804 Woburn St, Wilmington, MA 01887. Phone (617) 937-2507. **Circle No. 451**

Synchronous SRAM. The MCM62110 synchronous static RAM (SRAM) integrates a 32kx9-bit SRAM core with address registers, two sets of input data

Custom shielding in record time.



For custom shielding, nobody helps you beat the clock—and the costs—like Instrument Specialties.

Using the most modern CAD capabilities plus a half-century of EMC experience, our experts can quickly determine the best shielding for your design... often before you've built it.

With maximum flexibility and minimum tooling, our prototyping capabilities are both fast and economical. We've even dedicated an entire fabricating operation just for short runs. Our in-house design, plating, photoetching and heat treating also keep your costs down. Or we could modify our standard

shielding products to fit your application... helping you save even more time and money.

When you do decide to start full production, you'll have the complete in-house capabilities of a leading worldwide shielding supplier behind you... including wire EDM toolmaking, sophisticated fabrication techniques,

and comprehensive EMC testing—all assuring just-in-time deliveries.

So call Instrument Specialties for your next custom shielding project. Because whether you need 5 parts or 5 million, we'll be on time... and on budget.



Instrument Specialties

Headquarters: Delaware Water Gap, PA 18327-0136
TEL: 717-424-8510 FAX: 717-424-6213

Western Division: 505 Porter Way, Placentia, CA 92670
TEL: 714-579-7100 FAX: 714-579-7105

European Division: 3 Avenue du Progres, B4432 Alleur, Belgium
TEL: +32-41-63-3021 FAX: +32-41-46-4862

See us at Electro 92 Booth #5613

CIRCLE NO. 142

EDN-NEW PRODUCTS

Integrated Circuits

registers, two sets of output latches, active-high and active-low chip enables, and a parity checker. The dual I/O allows isolation of the processor bus from the memory bus, reducing capacitive loading on the local bus. MCM62110, in a 52-pin plastic leaded chip carrier, comes in 17- and 20-nsec speed ratings; \$32.60 and \$30.50, respectively, (1000). **Motorola Inc**, MOS Memory Products Div, Box 6000, Austin, TX 78762. Phone (512) 928-7726. **Circle No. 452**

Ground-sensing comparator. Featuring a response time of 12 nsec, the LT1116 comparator can sense signals near the negative supply rail while operating from a single 5V supply. The comparator's common-mode input range extends from 2.5V below the positive rail to the negative rail. Complementary outputs interface directly to TTL logic. Unlike other fast comparators, the LT1116 remains stable for slow transitions through the active region,

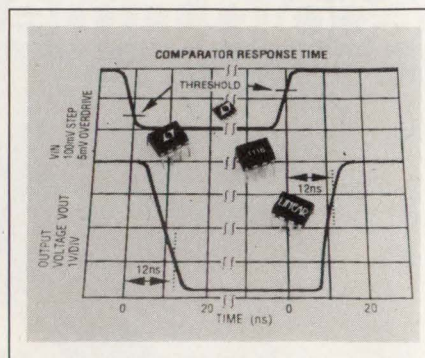

with no minimum slew-rate requirement. In 8-pin DIP and SO packages, \$3.50 and \$3.75, respectively, (100). **Linear Technology Corp**, 1630 McCarthy Blvd, Milpitas, CA 95035. Phone (800) 637-5545; (408) 432-1900. FAX (408) 434-0507. **Circle No. 453**

Quad audio switch. The SSM-2404 fits four spst bilateral switches in a single 20-pin DIP or SOIC package. The switches have a maximum on-resistance of 45Ω (25Ω typ). With a 2V 1-kHz signal, THD is only 0.0065% into a 10-kΩ load, and off-isolation and crosstalk are -100 and -94 dB, respectively. The SSM-2404 operates from single 12 to 24V or dual ±5.5 to ±12V supplies. \$3.45 (100). **Analog Devices Inc**, Precision Monolithics Div, 1500 Space Park Dr, Santa Clara, CA 95052. Phone (408) 562-7513. **Circle No. 454**

3V submicron ASICs. Capable of operating over a supply range of 2.7 to 5.5V, the MSM10S0000 sea-of-gates family comes in seven sizes, from 11k to 225k total gates. Using a 3V supply, these high-density ASICs can operate to 50 MHz. Typical gate delays are less than 300 psec, and flip-flop toggle rates extend to 500 MHz. **Oki Semiconductor**, 785 N Mary Ave, Sunnyvale, CA 94086. Phone (408) 720-1900. FAX (408) 720-1918. **Circle No. 455**

Motor-control IC. The SSI 32H6810 features low-resistance drivers that support 5V, 0.7A drive capability for voice-coil motors and sensorless spindle motors. A power-down mode and low-voltage head retraction aid the design of 1.8- and 2.5-in. drives. A low-voltage condition or an external command can initiate head retraction or delayed spindle braking. \$5 (OEM qty). **Silicon Systems**, 14351 Myford Rd, Tustin, CA 92680. Phone (714) 731-7110. FAX (714) 669-8814. **Circle No. 456**

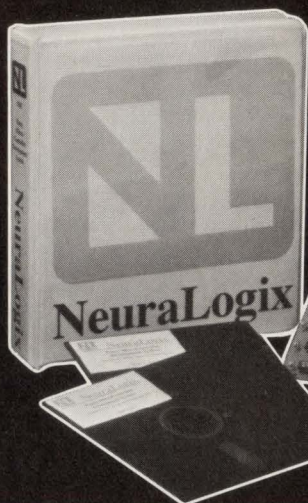

Fuzzy Logic Training Kit!

Introduce yourself to the hot technology of the '90s! The ADS230 Fuzzy Logic Applications Development Kit gives you hands-on exposure. The PC-compatible card includes an NLX230 MicroController—allowing you to develop and test applications for hardware-based fuzzy logic. The kit includes all necessary controlling software and documentation.

From America's fuzzy logic leader!

\$395

NeuraLogix

407-322-5608

411 Central Park Dr. • Sanford, FL 32771
FAX 407-322-5609

Take This Opportunity To Meet Our Distinguished Panel

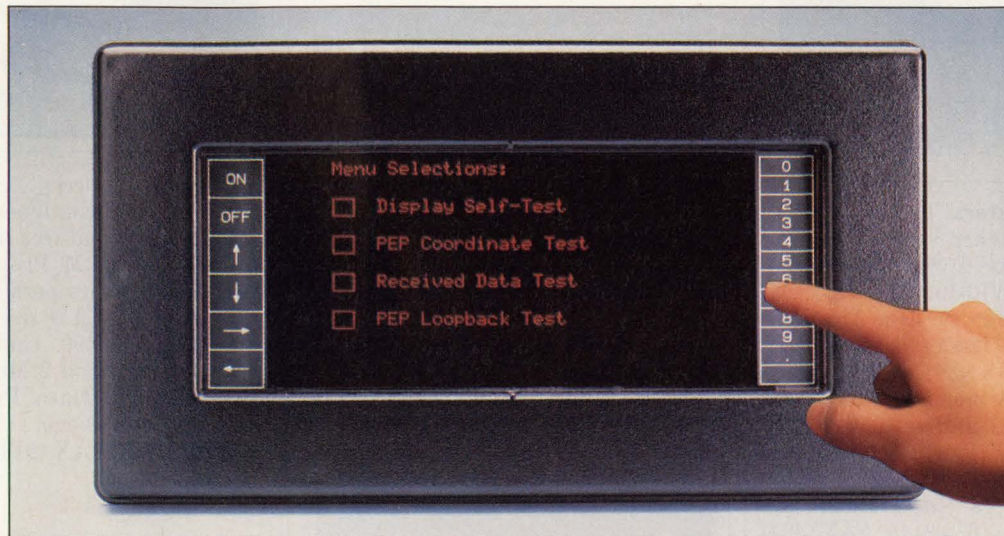

The PEP™ 4286 Interactive Flat Panel Display

Ideal for Menu-Driven Applications

The PEP™ 4286 interactive flat panel display provides you with a complete touchscreen man-machine interface that is ideal for menu driven applications. PEP 4286 combines a full-dot DC gas plasma display with a highly reliable infrared touchscreen switch matrix.

Exceptional LAB-6™ Brightness... Even in Sunlight!

The display's LAB-6™ cathode coating provides a brightness level of 200fL before filtering, and unsurpassed contrast. PEP 4286 can be used in high ambient light applications. This coating also allows the display to be used over a wide -20 to +75°C temperature range.

A Complete Touchscreen Sub-system

As a complete touchscreen sub-system, the module includes a drip proof, polycarbonate bezel which seals to your front panel, a circular polarized filter which has two side areas for fixed function switch legends, and a rear chassis cover. 14K bytes of battery backed CMOS RAM is built-in for canned messages.

Ergonomically Distinguished

- User friendly touchscreen input
- Minimize training time and errors with menu driven input choices
- Bell output for touch confirmation
- 200fL brightness is software-dimable in 6 steps for comfortable long term viewing
- IR switch matrix means a clear, sharp display without distorting overlays
- Dedicated fixed function switch areas for most commonly used functions

Economically Distinguished

- Complete subsystem simplifies your design process and minimizes your time-to-market
- Replace banks of switches and dials with soft keys
- Display and touchscreen self-test speeds up QA and in-field diagnostics
- Compact flat panel is only 3" deep—fits where CRTs can't
- Battery backed canned message RAM reduces host memory overhead

Display Features

- 240×120 accessible dots form a 12 line by 40 character display, using a nominal 5×7 dot matrix character
- 96-character U.S. ASCII character set in regular height-width, double height, double width, double height-width; all in regular and reverse video
- 96-character ISA Graphics character set
- 14.10×7.85×3.00" (W×H×D)

Operation

- Requires only +5.0VDC TTL supply and an unregulated 11-29VDC panel supply
- Serial I/O RS-232-C (with CTS and DTR) and RS-422 interfaces at 1200 or 9600 baud
- ANSI-standard VT100 compatible control codes

*Industrial Electronic Engineers, Inc.
Industrial Products Division
7740 Lemona Avenue
Van Nuys, CA 91409-9234
Tel.: (818) 787-0311, ext. 418
FAX: (818) 901-9046*



Circle No. 40 For Immediate Response

Circle No. 41 For Future Reference

See us at the Eastern EDN Caravan, now through June '92.

EDN May 7, 1992 • 249

EDN-NEW PRODUCTS

Computers & Peripherals

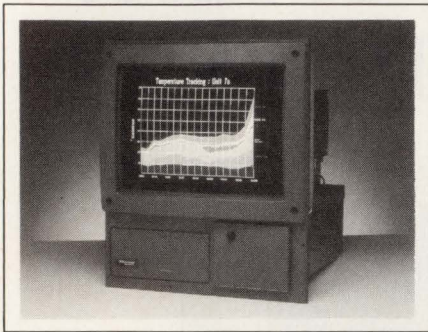

Industrial computers. The WS3002-20P and WS3002-20R are stand-alone and rackmount industrial workstations, respectively. The WR3102-00R workrack is a small footprint version. The computers contain a 12-slot passive backplane, an 80386SX μ P, a VGA board and a 20-in. VGA monitor, a 52-Mbyte hard-disk drive, and a 1.44-Mbyte floppy-disk drive. Workstations, from \$7495; workrack, from \$4995. **Intecolor**, 2150 Boggs Rd, Duluth, GA 30136. Phone (404) 623-9145. FAX (404) 623-9163. **Circle No. 682**

V.32bis fax modems. The PM14400 FXSA and PM14400FX are stand-alone and half-card versions, respectively, of a V.32bis fax modem. The data-transfer rate is 14,400 bps. The units provide V.42 error correction and V.42bis data compression. Detecting credit-card "bong" tones, the modems can assist phone credit-card dialing. The units can also translate alphanumeric phone numbers to their numerical equivalent. PM14400FXSA, \$549; PM14400FX, \$499. **Practical Peripherals**, 31245 La Baya Dr, Westlake Village, CA 91362. Phone (818) 706-0333. FAX (818) 706-2474. **Circle No. 683**

Embedded control modules. The Lonworks twisted-pair control modules are miniature circuit cards for the company's Lonworks embedded-control networks. They contain the company's Neuron chip, a PROM socket, and a communications transceiver. As many as 32,000 modules can communicate on the network using a common twisted-pair cable. Distributed modules intelligently control and supervise sensors and output devices, such as triacs and relays, on the Lonworks network. Two versions communicate at 78 kbps using Manchester-encoded data or an RS-485 protocol. A third version communicates at 1.25 Mbps using Manchester-encoding. A programmable, event-driven program lets you tailor the modules to

particular applications. RS-485 module, from \$35 (OEM qty). **Echelon Corp.**, 4015 Miranda Ave, Palo Alto, CA 94304. Phone (415) 855-7400. FAX (415) 856-6153. **Circle No. 684**

20-in. color monitor. The ECM 2000 is a series of 20-in. monitors that automatically adjust to horizontal scan rates from 15 to 38 kHz and vertical scan rates from 45 to 120 Hz. A digital-memory-sizing feature lets you store scan rates in memory to eliminate resizing an image when the scan rate changes. The units have a 0.31-mm dot pitch and support CGA through VGA, Super VGA, XGA, 8514A, and MAC II resolutions. Approximately \$3195. **Electrohome Ltd.**, 809 Wellington St, North Kitchener, ON N2G 4J6, Canada. Phone (519) 744-7111. **Circle No. 685**

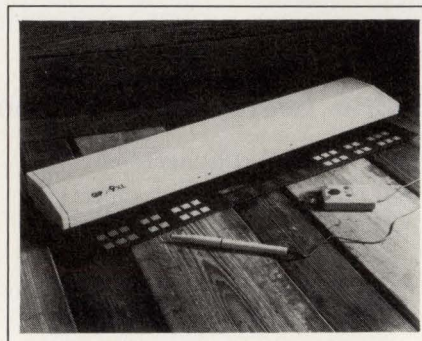

Nontablet digitizer. The GP-9-XL digitizer doesn't require a tablet or work surface. It uses the company's sonic-digitizing technology to digitize an area of 40x60 in. The portable unit measures 7x26x2.5 in. and digitizes drawings, maps, x-rays, and projected images on a flat surface. Input devices include a stylus or 4-button cursor. \$2495. **Science Accessories Corp.**, 200 Watson Blvd, Stratford, CT 06497. Phone (203) 386-9978. FAX (203) 381-9270. TLX 964300. **Circle No. 686**

Monochrome inkjet plotter. The Protracer monochrome inkjet plotter produces C-size drawings in less than 5 minutes. It also produces B-size drawings in 2.5 minutes and A-size drawings in 1.5 minutes. An Intel i960 RISC (reduced-instruction-set-computer) controller produces 360-dpi resolution and solid-area fills with no banding or streaking. The plotter prints on plain, bond, or plotter paper as well as vellum. Two optional sheet feeders automatically feed A- and B-size cut-sheet paper and business-size envelopes. In addition,



tion, the plotter accepts cut-sheet paper 17 in. wide and continuous feed fanfold paper. Other features include Epson LQ-1050 and IBM Proprinter emulations, a Centronics parallel and a serial port, an AutoCAD driver, and 512-kbyte RAM. \$1499. Unit with HP-GL emulation card and 2 Mbytes of RAM, \$1999. **Pacific Data Products**, 9125 Rehco Rd, San Diego, CA 92121. Phone (619) 552-0880. FAX (619) 552-0889. **Circle No. 687**

Graphics controller board. This board contains three of the company's ASICs—a GUIEngine/ALG2101 video-graphics chip with built-in GUI (graphical user interface) and Super VGA functions; an ImgDAC/ALG1101 IBM XGA chip having RAMDAC to display 64k simultaneous colors; and an ALG3102 clock-generator chip. You can also work with the company to incorporate the three ASICs in customized graphics designs. \$56 (2000). **Avance Logic Inc.**, 46750 Fremont Blvd, Suite 105, Fremont, CA 94538. Phone (510) 226-9555. FAX (510) 226-8039. **Circle No. 688**

SPARCstations. These five workstations use SPARC CPUs. The Station 1, Station 2, and Station 2 GX have three Sbus expansion slots and either a 25- or 40-MHz CPU. The Station VME and Station 2 VME use a 33- or a 40-MHz CPU and have six 6U VMEbus expansion slots. From \$6900 to \$11,800. **DTK Computer Inc.**, 17700 Castleton St, Suite 300, City Of Industry, CA 91748. Phone (818) 810-8880. FAX (818) 810-5233. **Circle No. 689**

Video display board. The model IMH-1210 is a graphics display board for the ISA bus, VMEbus, or EISA bus. It uses a TMS34020 and 8 Mbytes of dual-port video RAM to drive four independent displays. Each display can have a resolution of 2048x1024x8 bits. In addition, the board has 4 Mbytes of overlay RAM and hardware zoom, pan,

So many surface mount choices.

One solution.

A supplier to top your list.

Augat supplies the ideal surface mount solutions for all your semiconductor and board-to-board interconnection needs, as well as the premier solutions in surface mount switches.

For true innovation.

Look to Augat's patented EII and PAI Contact Technologies found in our ultra performance backplane interconnects, our LGA sockets, and our new MEZ-CON (mezzanine board connector) line. These systems solve problems associated with interconnecting components on high density surface mount grids. They're truly innovative because they require no solder, thus eliminating the tedious job of inspecting solder joints or making sure all points along the process are precisely calibrated. These systems have many applications, and each is reliable in the extreme (for example, they are the industry's most tolerant solution regarding board warpage).

If your needs are more in line with current surface soldering technology, Augat has the solution for you as well. Our SMT PLCC, PGA, and DIP sockets all meet strict industry standards to assure unsurpassed performance.

All the answers in DIP switches.

Augat is the leading supplier of DIP switches. Our new and novel ultra-low-profile, half-pitch GDH DIP series is finding many applications with new types of electronic equipment. Other Augat switch solutions include: slide, toggle, pushbutton, and rotary DIP styles.

More ways to help.

Augat SMT solutions maximize the experience, technology, and quality you're looking for. We have a trained staff ready to answer each of your questions, and to take your orders for immediate delivery. Why not call now?

AUGAT[®] *Quality and Innovation*
INTERCONNECTION PRODUCTS DIVISION

452 John Dietsch Boulevard
Attleboro Falls, MA 02763 USA
Tel: (508) 699-9800 FAX: (508) 699-6717

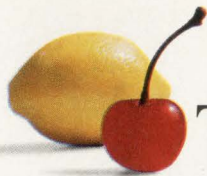

There's only one
alternative to quality.

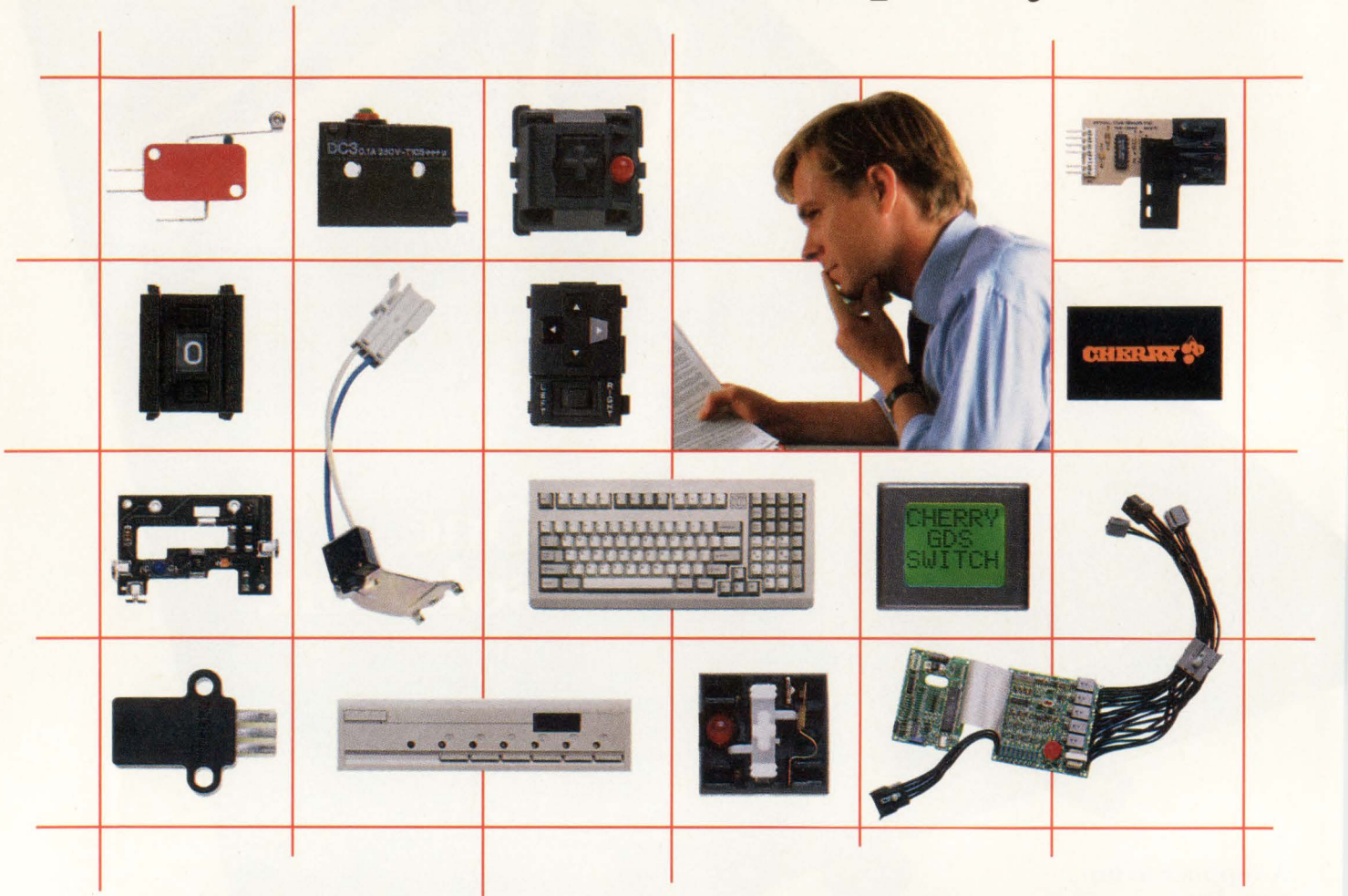

And Cherry has so many quality alternatives.

Success is no longer a matter of knowing the right button to push or switch to choose. Now, it's a matter of engineering entire assemblies and systems. For Cherry, it's *designing for manufacturability*, with capabilities such as solid modeling and finite element analysis. In final production, success means that *every one* of our products is the result of our Total Quality Leadership—so that *every one* of *your* products starts with the finest control devices. Sure, Cherry provides every switch, sensor and control device shown above (and much, much more), but more important, we have success stories for every one.

Call us now for information on these Cherry success alternatives.

For specific application success stories, call 1-708-360-3518.

For general product information, call 1-708-662-9200.

Make it the Cherry Best



Cherry Electrical Products

3600 Sunset Avenue

Waukegan, IL 60087

Phone: 708-662-9200

Facsimile: 708-360-3566

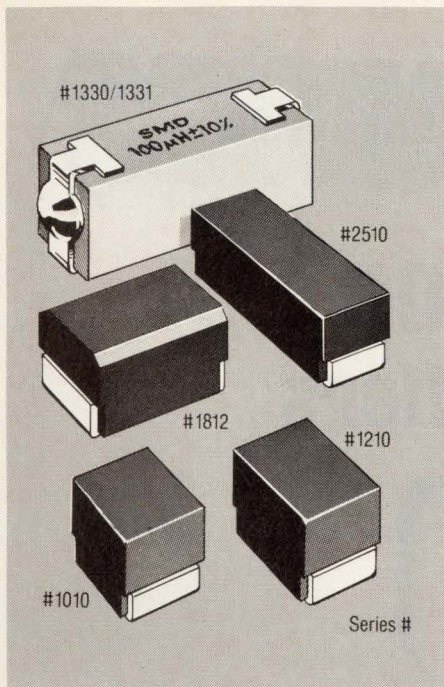

THE MOST COMPLETE OFFERING OF SURFACE MOUNT WIRE-WOUND INDUCTORS

- Expanded line of low-profile Industry Standard Series 1010, 1210 & 1812 inductors
- Series 1330/1331 and 2510 are direct physical and electrical replacements for our standard axial leaded inductors
- Inductance values from 0.22 μ H to 1000 μ H - shielded units to 560 μ H
- Designs to MIL C-83446 (slash 20-27)
- Exclusive "J" termination offers proven reliability with any soldering method
- Our SM Inductor designs are covered by U.S. Patent numbers 4,914,804, 4,801,912 and 4,934,048
- Designs available in 1%, 2%, 3%, and 5% tolerances
- Complete lot traceability

DELEVAN / SMD Divisions
AMERICAN PRECISION INDUSTRIES
 Electronic Components Group

270 Quaker Road, East Aurora, NY 14052-0449
 (716) 652-3600 FAX (716) 652-4814

MADE IN AMERICA BY AMERICAN CRAFTSMEN
 TO AMERICAN STANDARDS OF EXCELLENCE

CIRCLE NO. 145

EDN-NEW PRODUCTS

Computers & Peripherals

and scroll. The board supports the TIGA graphics standard. \$2000/display driver. Delivery, 90 days ARO. **Imagraph**, 11 Elizabeth Dr, Chelmsford, MA 01824. Phone (508) 256-4624. FAX (508) 250-9155. TLX 4946300.

Circle No. 690

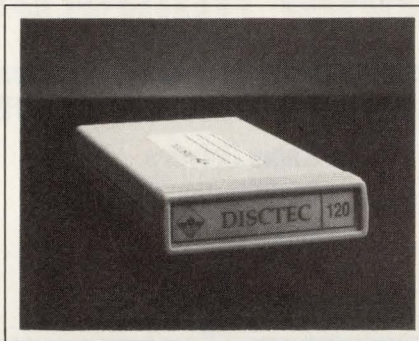

Removable hard-disk drives. The RHD 120 removable hard-disk drive provides 120 Mbytes of storage. The palm-sized unit measures 3 x 5 x 0.81 in. and weighs less than 7 oz. Its Docking Bracket installs in standard 5/4-in. half-height or 3/2 x 1-in. bays for notebook, laptop, and desktop computers having

an IDE interface. The access time is 15 msec, the track-to-track seek time is 3 msec, and the maximum data-transfer rate is 10 Mbps. The unit can withstand an operating shock of 10g and a nonoperating shock of 100g. Because the drive is compatible with the company's 20-, 60-, and 80-Mbyte drives, you don't have to reboot the computer to access data on the lower-capacity drives after using the RHD 120. \$1295. **Disk Technology Corp**, 925 S Semoran Blvd, Suite 114, Winter Park, FL 32792. Phone (800) 553-0337; (407) 671-5500. FAX (407) 671-6606. Circle No. 691

Disk mirror. The SCSI Disk Mirroring system implements Raid 1 technology for fault redundancy. The company offers the system as an option for its Smartcache Plus SCSI controllers. The hardware system offloads mirror overhead from the CPU and provides an alternative for operating systems that don't offer a software mirror. **Distributed Processing Technology**, 140 Candace Dr, Maitland, FL 32751. Phone (407) 830-5522. FAX (407) 260-5366.

Circle No. 692

262,144 Colors Perform Here



- Pixel Replicate™
- Nibble Mode
- VGA/SVGA
- 8514/A
- XGA™

MUSIC's graphics color palettes are fine-tuned for your graphics subsystem applications. MUSIC gives you the sharpest graphics and truest colors available at the lowest cost. So whether you're designing desk-top computers, graphics add-in cards, low-power laptops or multi-media systems, contact MUSIC Semiconductors, The Specialty Memory Company. For your Free design kit call: USA 1-800-788-MUSIC (6874), Europe +31-45-467878, Asia 63-2-816-2477

MUSIC
 SEMICONDUCTORS

CIRCLE NO. 146

World Leader **élan**tec

in High-Speed Analog

High-Speed Amps/Buffers

MONOCHROME & COLOR VIDEO AMPLIFIERS

- Cable Drivers
- Distribution Amps
- Gain Blocks

Singles/Duals/Quads
P-DIP, SO-8
Composite

CURRENT MODE FEEDBACK VIDEO AMPS

P/N	BW	\$ @ 100 pc.
EL2020	50 MHz	2.80
EL2232 _{quad}	60 MHz	3.90
EL2130	85 MHz	3.25
EL2120	100 MHz	2.80
EL2030	120 MHz	3.25
EL400/ EL2070	200 MHz	4.95

HDTV

VOLTAGE FEEDBACK VIDEO AMPS

P/N	GBW	\$ @ 100 pc.
EL2044	120 MHz	1.80
EL2073	200 MHz	4.95
EL2074	400 MHz	5.25
EL2075	2 GHz	5.25

VIDEO BUFFERS

P/N	BW	I/O	\$ @ 100 pc.
EL2001	70 MHz	±160 mA	2.45
EL2002	180 MHz	±160 mA	2.95
EL2003	100 MHz	±230 mA	3.45
EL2072	730 MHz	±70 mA	4.95
EL2008	55 MHz	±1.8A	6.79
EL2009	90 MHz	±1.8A	6.79
EL2012	100 MHz	±350 mA	5.49

HIGH
SPEED

HIGH
POWER

GENERAL PURPOSE HIGH-SPEED AMPS/BUFFERS

- High-Speed Signal Processing
- Instrumentation
- Medical Instruments

FAST AMPLIFIERS

P/N	GBW	S/R*	\$ @ 100 pc.
EL2424 _{quad}	60 MHz	200	6.95
EL2242 _{quad}	30 MHz**	40	5.25
EL2243 _{quad}	70 MHz**	90	5.25
EL2041	90 MHz	250	3.75
EL2006	60 MHz	450	22.59
EL2029	100 MHz	900	4.40
EL2038	1 GHz	1000	3.90
EL2039	600 MHz	550	2.75

*V/μs **BW

FAST BUFFERS

P/N	BW	S/R*	\$ @ 100 pc.
EL2004	350 MHz	2500	21.00
EL2005	140 MHz	1500	20.15
EL2031	550 MHz	7000	40.00

*V/μs



ANNOUNCING THE EL2044C 120 MHz VOLTAGE FEEDBACK OP AMP

- ONLY 1.5¢/MHz
- 325 V/μs Slew Rate
- 120 MHz (-3 dB) BW @ Gain = 1
- Drives Unlimited Load Capacitance
- Single or Split Supplies as Low as 2.5V
- \$1.80 @ 100 pc. - P-DIP (\$1.90 - SO-8)

FOR SAMPLES CALL OUR APPLICATIONS HOTLINE - (800) 333-6314 ext 311, Literature Only - ext 234

ELANTEC, INC. ■ 1996 Tarob Court ■ Milpitas, CA 95035 ■ (408) 945-1323 ■ (800) 333-6314 ■ FAX (408) 945-9305

Your Total Source for...

Low Noise OCXOs

(Oven Controlled Crystal Oscillators)

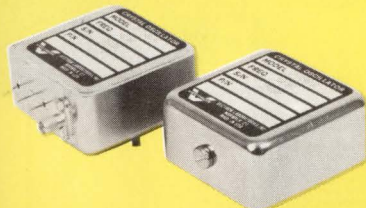

**VHF (25-140 MHz)

Model	CO-724	CO-724SL2
1 x 10 ⁻⁹ /day	2 x 10 ⁻⁹ /day	5 x 10 ⁻⁷ /year
2 x 10 ⁻⁶ /year	±2 x 10 ⁻⁸	±5 x 10 ⁻⁹
	±1 x 10 ⁻⁷	±3 x 10 ⁻⁸
	-115 dBc/Hz	-130 dBc/Hz
	-130 dBc/Hz	-145 dBc/Hz
	-145 dBc/Hz	-157 dBc/Hz

*HF (4-25 MHz)

Type	CO-717	CO-718SL2
Aging	1 x 10 ⁻⁹ /day	5 x 10 ⁻¹⁰ /day
	3 x 10 ⁻⁷ /year	1 x 10 ⁻⁷ /year
0°C to +50°C	±1 x 10 ⁻⁸	±5 x 10 ⁻⁹
-55°C to +75°C	±5 x 10 ⁻⁸	±3 x 10 ⁻⁸
Phase Noise 100 Hz	-135 dBc/Hz	-150 dBc/Hz
1 kHz	-145 dBc/Hz	-160 dBc/Hz
50 kHz	-150 dBc/Hz	-168 dBc/Hz

* Also available with logic output, 40 kHz-17 MHz

** Higher stability models available at sacrifice in phase noise

To order, or for complete engineering assistance, call:
(203) 853-4433

VECTRON

The Crystal Oscillator Company

VECTRON LABORATORIES, INC.

166 Glover Avenue, Norwalk, CT 06850.
Phone: (203) 853-4433. FAX: (203) 849-1423.

CIRCLE NO. 148

EDN-NEW PRODUCTS

Computers & Peripherals

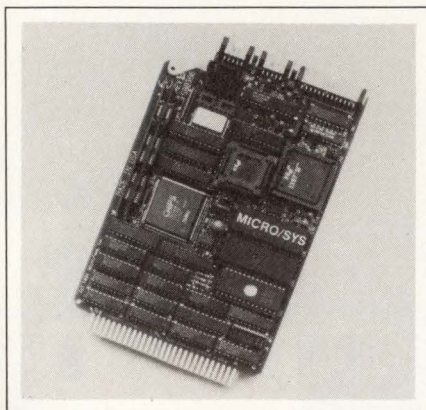

80386SX STD-Bus SBC. The SB8386 STD Bus single-board computer (SBC) uses a 16- or 20-MHz 80386SX μ P. It also has as much as 8 Mbytes of RAM and sockets for as much as 1.8 Mbytes of EPROM, flash EPROM, static RAM (SRAM), or battery-backed SRAM. Other features include COM1 and COM2 serial ports, an LPT1 printer port, a real-time clock, a keyboard port, and a floppy-disk controller. \$995. **Micro/sys Inc**, 1011 Grand Central Ave, Glendale, CA 91201. Phone (818) 244-4600. FAX (818) 244-4246. **Circle No. 693**

Stepper-motor controller. The Opti-step system consists of an ISA bus motion-control card, a 2- or 3-axis driver board, and a power supply. The system has optoisolation on all control-signal and I/O lines. Software routines include linear and circular interpolation and programmable velocity and acceleration. 2-axis system, \$758. **Microkinetics Corp**, 1220 Kennestone Circle, Suite J, Marietta, GA 30066. Phone (404) 422-7845. FAX (404) 422-7854.

Circle No. 694

4- and 8-mm tape backup. The DR600 is a series of 4-mm digital-audio-tape (DAT) and 8-mm helical-scan backup subsystems. They operate with Digital's Digital Storage Systems Interconnect (DSSI) VAXcluster computers. The DAT provides as much as 32 Gbytes of storage, and the helical-scan devices have as much as 10 Gbytes of storage. Both products connect to the host's DSSI port. DATs, \$7900 to \$17,500; helical-scan subsystems, \$11,000 to \$16,800. **Emulex Corp**, Box 6725, Costa Mesa, CA 92626. Phone (800) 854-7112; (714) 662-5600. **Circle No. 695**

FIFO, the trick chip, performs here

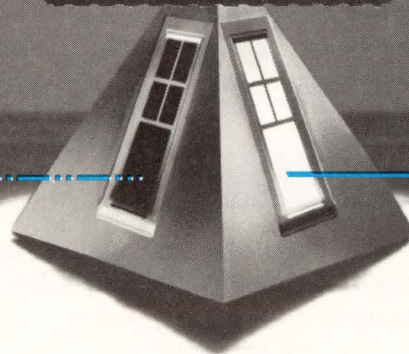

MUSIC's FIFOs offer from 512 through 4096 nine-bit words in pin-compatible packages and easily expand using minimal external logic with no degradation in performance. So whether your application is high-performance data buffers, LANs/WANs, data compression/decompression, or DSP, contact MUSIC Semiconductors, The Specialty Memory Company. For your FREE design kit call: USA 1-800-788-MUSIC (6874), Europe +31-45-467878, Asia 63-2-816-2477



CIRCLE NO. 149

FUTABA

Sets the Standards in Custom Vacuum Fluorescent Displays and Vacuum Fluorescent Modules



CUSTOM DESIGN

Futaba is the leading global supplier of vacuum fluorescent displays and modules. We have the capability, technology, and market knowledge to provide you with the most cost effective display system tailored to your specific application.

Futaba's high brightness fluorescent display products range from simple numeric and dot matrix displays to large multi-color graphic panels.

TECHNICAL SUPPORT

Futaba engineers have a broad range of application experience including automotive, point of sale, appliance, medical, and instrumentation products. They are ready to assist you in optimizing your display system design.

U.S. MANUFACTURING

Futaba's state-of-the-art SMD manufacturing facility in Schaumburg, Illinois provides local service, JIT delivery, and reinforces its commitment to supply the North American market.

QUALITY

Futaba's number one commitment is supplying products having the highest level of quality. Quality begins with the initial design and is controlled throughout the manufacturing process by using SPC and having well trained and motivated employees.

Futaba is dedicated to the principal of continuous improvement and always strives to provide the highest level of customer satisfaction.

Pick up the phone - take advantage of our superior technical background and design expertise. Call or write for more information on Futaba custom vacuum fluorescent display modules.



Electronic Instrument Panel to J.I. CASE Tractors.



NCR "S1" Supplier.



Appliance Control Display.



711 E. State Parkway
Schaumburg, IL 60173
708-884-1444
FAX 708-884-1635

EDN-NEW PRODUCTS

Computers & Peripherals

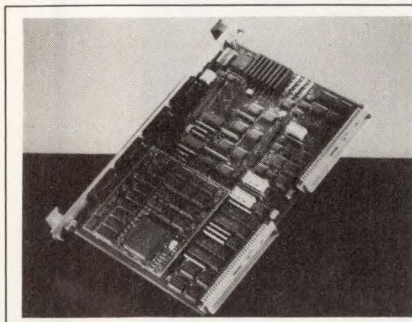

VMEbus DSP board. The ZPB3400 board provides the option of using one or two AT&T DSP32C or TI TMS320C31 chips. The DSP chips mount on separate daughter boards, which plug into the VMEbus board. Each DSP chip has a dedicated high-speed serial port and 256 kbytes of static RAM. The VMEbus board has 1 or 4 Mbytes of triple-port dynamic RAM. \$4495. **Burr-Brown Corp.**, Box 11400, Tucson, AZ 85734. Phone (800) 548-6132; (602) 746-1111. **Circle No. 696**

Quadra removable drive. The Bernoulli Macinsider 90 is a removable storage device for Macintosh Quadra 900 computers. It provides 90 Mbytes of storage per removable disk. A Mactools Deluxe utility from Central Point Software provides data compression. A 32-kbyte cache delivers a 19-msec effective access time and 20-Mbps transfer rate. \$999. **Iomega Corp.**, 1821 West-4000 S, Roy, UT 84067. Phone (800) 777-6179; (801) 778-3345. FAX (801) 778-3450. **Circle No. 697**

VMEbus 10Base-T. The ENET-1T Ethernet controller board for the VMEbus conforms to twisted-pair 10Base-T networks. It uses AMD's Am7990 Local Area Network Controller (LANCE) chip. The board also implements the company's T-Stream protocol suite, which consists of TCP/IP, address-resolution protocol, Ethernet link-level access, and serial-line internet protocol. \$2195. **Radstone Technology**, 20 Craig Rd, Montvale, NJ 07645. Phone (800) 368-2738; (201) 391-2700. FAX (201) 391-2899. **Circle No. 698**

386SX single-board computer. The 5.75 x 7.75-in. SBC-SX board uses a 16-MHz 80386SX μ P. It has 4 Mbytes of dynamic RAM, two COM ports, a printer port, a battery-backed real-time clock, and hard- and floppy-disk-drive interfaces. The board consumes 4.3W

and drives CRTs and flat-panel displays. A licensed BIOS lets you run MS-DOS from a floppy-disk, hard-disk, or onboard ROM-disk drive. \$971 (100). **Computer Dynamics**, 107 S Main St, Greer, SC 29650. Phone (803) 877-8700. FAX (803) 879-2030. **Circle No. 699**

Real-time imaging module. The model PX3013 is a module for the PCs Extended for Industry (PCXI) architec-

ture. The module digitizes images as fast as 60 MHz. A 1-Mbyte image buffer provides 1024 x 1024-pixel resolution, a programmable line length as long as 65,536 pixels, and simultaneous read and write operations. The module accepts 8-bit digital and analog inputs with separate sync signals. \$7495. **Rapid Systems Inc.**, 433 N 34th St, Seattle, WA 98103. Phone (206) 547-8311. FAX (206) 548-0322. TLX 265017. **Circle No. 748**

WHEN YOUR
CHIPS ARE DOWN,
ALEXANDER'S
CHARGE YOU UP!

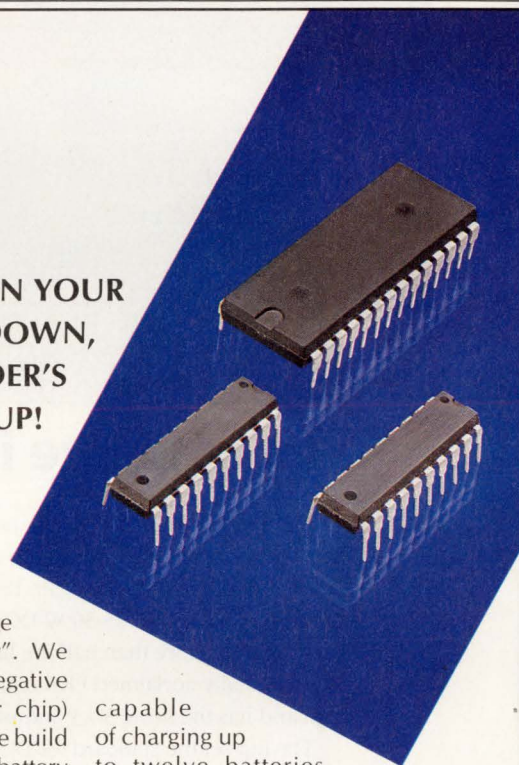

At **Alexander Batteries**, battery chargers and charge control I.C.'s are far from "new". We developed the only patented negative slope (- Δ V) detection I.C. (or chip) over ten years ago. Presently we build Ni-CD (Nickel Cadmium) battery chargers utilizing a standard 20 pin D.I.P. providing the most flexible Ni-CD or Ni-MH (Nickel Metal Hydride) control imaginable. By combining - Δ V detection with an adjustable timer backup and temperature integration this I.C. can be utilized with charge rates from 14 minutes to 14 hours.

Alexander's expertise does not stop with the I.C. itself. We do not just sell chips, we know how to apply them. In addition to selling this component, we have applied over 25 years of knowledge. We have chips that test and condition batteries, chips

capable of charging up to twelve batteries simultaneously and charger control I.C.'s. These chips are the brain of Alexander Batteries' Smart Charger[®] and Optimizer[®] used in the medical, transportation management, cellular, communication and electronic news gathering fields.

From application assistance, state of the art controller I.C.'s, to finished product, no one has more experience designing, building or applying nickel-cadmium batteries and fast chargers.

Contact Alexander Batteries for your batteries and battery maintenance system needs, we'll charge you up.

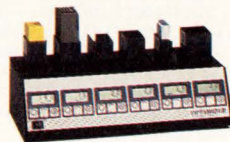

Alexander's Optimizer[®], the complete battery maintenance system, incorporates patented I.C. technology.



**Alexander
Batteries**

1-800-388-8314

P.O. Box 28880 San Diego, CA 92198

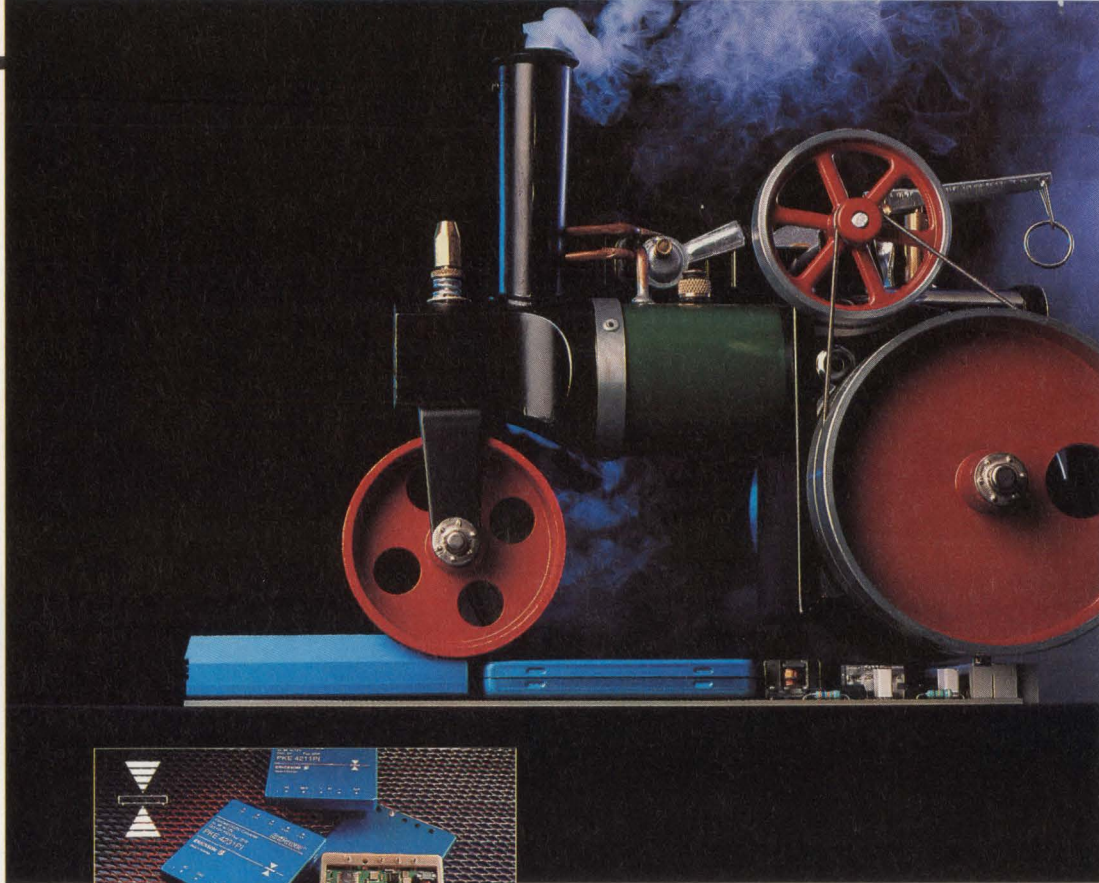

The Power in Telecommunications

The squeeze is on

Slimming is an obsession in the electronics industry as engineers face the task of making thinner cards to fit even more functions into standard racks. Once again Ericsson can help.

The new PKE is a 25-30 W DC/DC converter squeezed into a slim package little more than half the height of its predecessor, the internationally acclaimed PKA converter. The PKE is only 10.7 mm (0.42") high and has the same 3"x3" industry-standard footprint and pin out.

Having set the standard for DC/DC converters in 1983, Ericsson's new series represents a remarkable leap forward in power supply technology. The PKE needs no power derating over its entire ambient temperature range of -45 to +85 °C. Quite simply, no one else achieves this in so little space. And you can choose from versions with one, two or three regulated outputs.

Perhaps most surprisingly, performance is in no way compromised by the size reduction. In fact, the PKE is even better than the PKA. A wide input voltage of 38 to 72 VDC is complemented by 1500 VDC isolation, 80-85% typical efficiency and two million hours MTBF at +45 °C ambient.

The PKE converter from Ericsson - slim, compact and beautifully formed. Squeeze in the time to call us for more information.

- France: Ericsson Components Europe, Guyancourt, Tel: +33-1-30 64 85 00 Fax: +33-1-30 64 11 46
- Germany: Ericsson Components Europe, Neu-Isenburg, Tel: +49-6102-200 50 Fax: +33-6102-20 05 33
- Great Britain: Ericsson Components Europe, Coventry, Tel: +44-203-55 36 47 Fax: +44-203-22 58 30
- Hong Kong: Ericsson Components, East Asia, Wanchai, Tel: +852-5-75 66 40 Fax: +852-834 53 69
- Italy: Ericsson Components Europe, Milano, Tel: +39-2-33 20 06 35 Fax: +39-2-33 20 06 41
- Norway: Ericsson Components A/S, Oslo, Tel: +47-2-65 01 90 Fax: +47-2-64 41 38
- Sweden: Ericsson Components AB, Stockholm, Tel: +46-8-757 43 84 Fax: +46-8-757 44 21
- United States: Ericsson Components Inc, Richardson, TX, Tel: +1-214-997-6561 Fax: +1-214-680-1059

Please send me your latest information

EDN 5-7-92

Name _____

Company _____

Job Title _____

Address _____

Telephone _____

Fax _____



EDN-NEW PRODUCTS

Computers & Peripherals

Operator interface module. The Qterm-III user-configurable interface module communicates with a host via an RS-232C port. It drives any LCD module having 1 row x 8 characters to 4 rows x 40 characters and 9 digital devices. You can select and input a keypad having from 1 to 48 keys. You can assign a shifted or unshifted string or a repeat code to any code. \$122 (25) **QSI Corp.**, 2212 SW Temple, #46, Salt Lake City, UT 84115. Phone (801) 466-8770. FAX (801) 466-8792. **Circle No. 749**

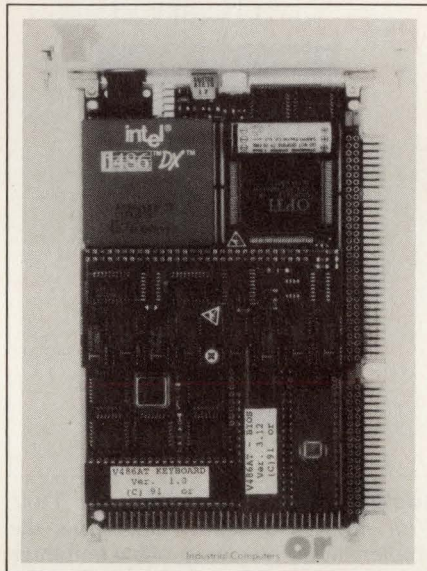

VMEbus industrial PC. The 486-SX/DX DOS-compatible VMEbus module contains a 20-MHz 80486SX or a 33-MHz 80486DX μ P. It provides a real-time clock, keyboard interface, DMA and interrupt controllers, and 1, 2, 4, or 8 Mbytes of dynamic RAM. The BIOS can access a 1-Mbyte flash ROM as a solid-state disk. The module contains a 16-bit ISA bus and a VMEbus connector. \$2564 (OEM qty). **Dynatem**, 15795 Rockfield Blvd, Suite G, Irvine, CA 92718. Phone (714) 855-3235. FAX (714) 770-3481. **Circle No. 750**

DAT drives. The Turbo SL family Digital-Audio-Tape (DAT) drives store 5 Gbytes on 4-mm tape. The half-height 5¼-in. drives can back up Netware software at 300 kbytes/sec. One family member, the Server DAT, resides at a filesaver and the other member, the LANDAT, resides at a workstation. Flash memory lets you upgrade firmware in less than 90 sec. **Gigatrend Inc.**, 2234 Rutherford Rd, Carlsbad, CA 92008. Phone (619) 931-9122. FAX (619) 931-9959. **Circle No. 801**

WE FIND THAT QUALITY IS THE BEST DEFENSE



Defense is the most critical environment for electronic components, posing unique problems and demanding unfailing high performance.

With a tradition dating back fifty years, Oxley Developments have become the cutting edge of technology in this stringent environment. Founded in the heat of the Second World War, we boast a proud history in the development and supply of high performance defense components.

Today's panel mounting indicator lamps and assemblies continue that tradition of quality. Solid state LEDs provide ultimate reliability, with the options of sunlight visibility, electromagnetic and night vision goggle compatibility. IR-free secure lamps are also available for covert applications. All lamps feature a rugged metal and glass construction offering full environmental performance.

Naturally, this extensive range of indicator lamps is qualified to MIL and DESC standards. The range being manufactured and quality assured within our ISO 9001, CECC and NATO-AQAP-1 (MIL-Q-9858A) approved system.

Today's quality is forged from a history of excellence: a tradition of expertise to help you build a confident future.

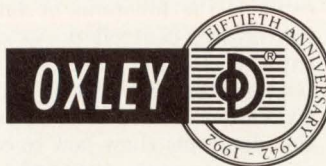

OXLEY INC
25 Business Park Drive, PO Box 814, Branford CT 06405
Tel: (203) 488 1033 Tlx: 910-350 6660 Fax: (203) 481 6971

TECHNOLOGY WORTH WATCHING

CIRCLE NO. 153

EDN May 7, 1992 • 259

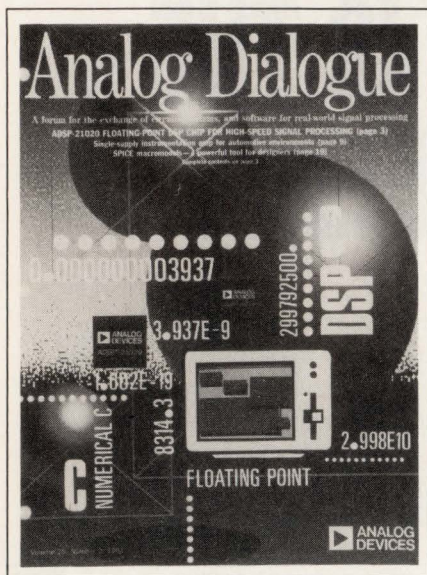

Technical journal on circuits, systems, and software. Vol 25, No. 2 of *Analog Dialogue* focuses on the IEEE-compatible floating-point ADSP-2100 for high-speed signal processing. Related articles follow, including "Numerical C Speeds Code Development and Execution," and "Development Tools and Third-Party Support for Floating-Point DSP." The *Ask the Applications Engineer* column answers the question, "When is a wire not a wire?" **Analog Devices**, Literature Center, 70 Shawmut Rd, Canton, MA 02021. FAX (617) 821-4273. **Circle No. 457**

Paperback on DOS.5. *Voodoo DOS, Tips & Tricks With an Attitude* explains shortcuts, notes, and tips for using DOS version 5.0. It contains 10 main sections: getting started—upgrading and setup; the secret of the Shell; working with programs; command-line sleight-of-hand; disks and hard drives; formulas in DOS 5.0; organizing batch files; getting the most from Doskey; understanding arcane commands; and managing DOS memory. \$19.95. **Ventana Press**, Box 2468, Chapel Hill, NC 27515. Phone (919) 942-0220. FAX (919) 942-1140.

INQUIRE DIRECT

Products for the IEEE-488 bus. The 1992 Catalog of IEEE-488-bus products is divided into sections dealing with the bus's use for IBM PCs, workstations, Macintosh computers, data acquisition, support, and serial devices. Two other sections cover accessories and ordering information. Each section begins with a selection guide and an overview of the products. The 142-pg publication

specifies, describes, illustrates, and provides command summaries for the products. **Iotech Inc**, 25971 Cannon Rd, Cleveland, OH 44146. Phone (216) 439-4091. FAX (216) 439-4093.

Circle No. 458

Electrical equipment/HVAC-R service equipment. The 1992 Electrical/HVAC-R (heating, ventilation, air-conditioning-refrigeration) Service Equipment catalog describes the Series 10 DMMs and Series 30 Current Masters clamp meters. It also presents the problem of harmonics in office buildings and factories. The 18-pg publication features a compatibility and selection chart and discusses current clamps, multimeters, thermometers, and accessories for the electrical service industry. **John Fluke Mfg Co Inc**, Box 9090, Everett, WA 98206. Phone (800) 873-5853; (206) 347-6100. FAX (206) 356-5116. TLX 185102. **Circle No. 459**

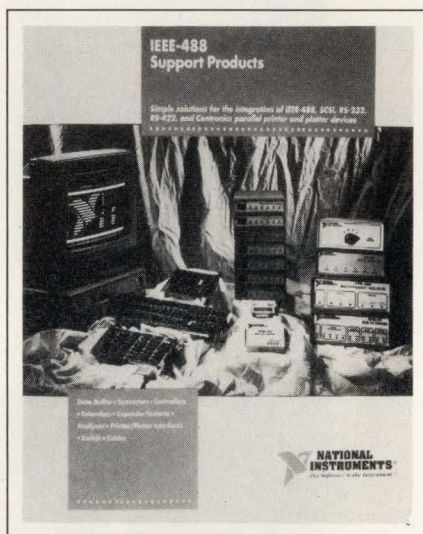

Foldout of IEEE-488 support products. This 6-pg foldout brochure describes more than 16 support products and how to use them to integrate IEEE-488, SCSI, RS-232C, RS422, and Centronics parallel devices for engineering and scientific applications. It explains the functions of data buffers, converters, controllers, extenders, an expander/isolator, a bus analyzer/monitor, printer and plotter interfaces, a switch box, and several cables. Application diagrams show how to connect the products to each other and to PCs and workstations. **National Instruments Corp**, 6504 Bridge Point Pkwy, Austin, TX 78730. Phone in US and Canada, (800) 433-3488; (512) 794-0100. FAX (512) 794-8411. **Circle No. 460**

"Diskless demo" of ICEs. Destined for disk-inundated engineers, this 30-pg booklet describes 80188, 80186, 68000, and Z180 in-circuit emulators. It illustrates a typical C-language debugging session. The booklet allows you to read at leisure, without needing a computer. **Softaid Inc**, 8300 Guilford Rd, Columbia, MD 21046. Phone (800) 433-8812; (301) 290-7760. **Circle No. 461**

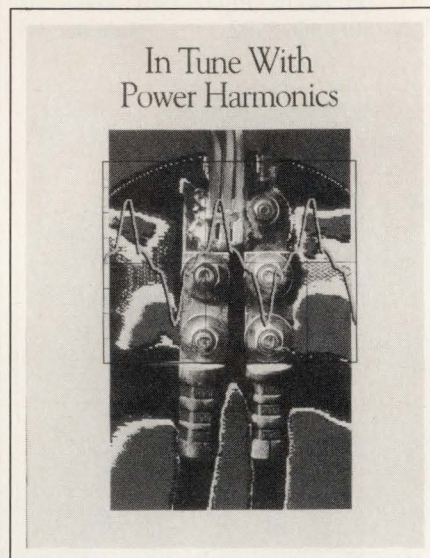

Booklet about harmonics. *In Tune With Power Harmonics* addresses the problem of harmonics in office buildings and factories. The booklet deals with sources of harmonics, the effects of harmonic currents, how to find harmonics, the troubleshooting tools needed, and how to solve the problem. Tools described in the booklet include the 30 Series Current Masters clamp meters and the 87 DMM. **John Fluke Mfg Co Inc**, Box 9090, M/S 250-E, Everett, WA 98206. Phone (800) 873-5853; (206) 347-6100. FAX (206) 356-5116. TWX 910-445-2943. **Circle No. 462**

Data book on multiprocessing computers. The 350-pg *Technical Data Book* deals with multiprocessing computers for test and control applications and includes STD 32 offerings and other new products. Guides to product features, an index, and a low-power/extended temperature directory allows a quick overview of the products. Other features include an STD-80 Bus Specification and a 12-pg overview of STD 32 with illustrations from its specification. The publication also mentions two services provided by the vendor: a systems-engineering course and an electronic bulletin board. The data book provides



Prove your product's performance against any world power.

Make sure that your world-class products are ready to operate anywhere and everywhere. Since power specifications vary greatly from country to country, and even within the same country, you need power with proven capabilities to test your product. Elgar offers a comprehensive family of AC power sources for commercial, industrial and military test applications.

- Power sources for manual bench-top or rack-mounted ATE systems
- Sag, surge, dropout and distortion test capabilities

- Solid-state frequency changers
- Linear and switching AC power sources
- Bulk power AC systems up to 216 kVA

With over 25 years experience in solving test power problems, Elgar is ready for your test challenge. For more information about Elgar's complete line of AC power products and your free book, *ELECTRIC CURRENT ABROAD*, call 1-800-73-ELGAR (1-800-733-5427) or FAX to (619) 458-0257 today.

CIRCLE NO. 154

ELGAR

POWERFUL SOLUTIONS

End the connector compromise...

1. 17-490 LOW INSERTION FORCE CONTACTS

2. MODELS QUALIFIED TO D55302

3. METRIC HARDWARE AND DIMENSIONS

...in high-density PC-board connections.

Only Hypertronics ends the compromise in high-density printed circuit board connectors for electronic equipment...by replacing unreliable connections with Low Insertion Force (LIF) high reliability connectors.

The KA 2, 3, 4 and 5 row connectors with .100 row spacing include the Hypertac[®] hyperboloid socket. The unique design provides contact resistance of less than 5 milliohms, cycle life in excess of 100,000 cycles and electrical integrity under extremes of shock and vibration (tested to 2 nano-seconds), flow solder PC, crimp, wire wrap[®] and solder cup meet a range of termination requirements.

Now you can have it all...in printed circuit board connectors requiring up to 490 contacts by calling 1-800-225-9228, toll free.

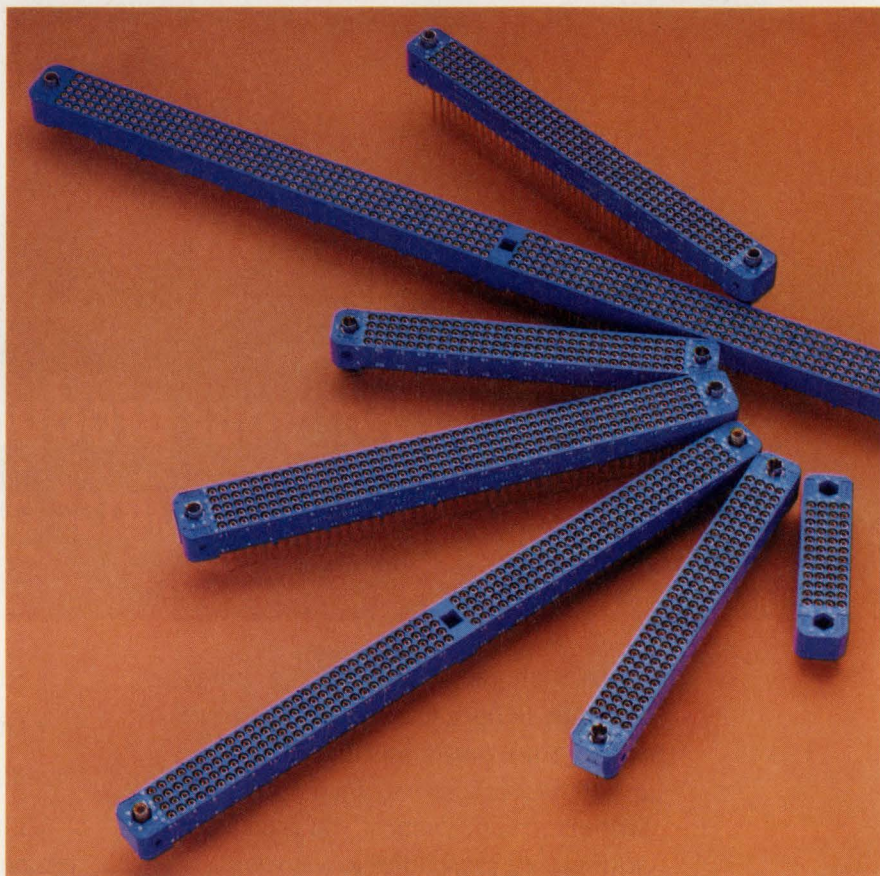

HYPERTAC[®]: Inserting pin into hyperboloid sleeve.

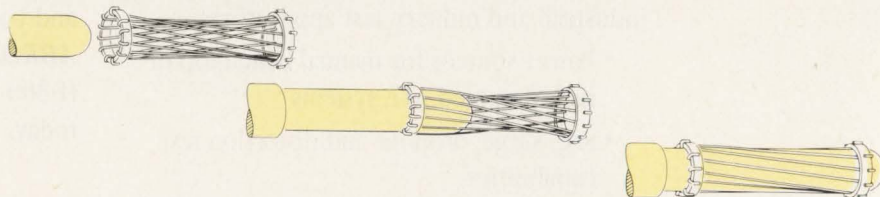

HYPERTRONICS CORPORATION

"New Horizons in Connectors"

16 Brent Drive, Hudson, MA 01749 (508) 568-0451 FAX (508) 568-0680

CIRCLE NO. 155

a list of application notes and technical briefs. **Ziatech Corp**, 3433 Roberto Ct, San Luis Obispo, CA 93401. Phone (805) 541-0488. **Circle No. 463**

Brochures on cable assembly and microwave designs. A 4-pg brochure lists custom RF and microwave cable assemblies. It deals with flex and semirigid assemblies. Another 4-pg booklet lists custom services for RF and microwave-design engineers, such as low-cost commercial and military-specification design, turnkey and contract manufacturing, and parts-screening and device selection, including environmental testing. **Penstock Inc**, 520 Mercury Dr, Sunnyvale, CA 94086. Phone (408) 730-0300. FAX (408) 730-4782. **Circle No. 464**

Temperature-measurement handbook. This handbook contains technical specifications and pricing for more than 10,000 temperature-measurement and control products. It describes thermocouple, RTD, and thermistor probes. The 270-pg publication also lists tem-

perature-indicating, -controlling, and -recording devices. It also features 50 pages of technical notes, as well as application data and test results for temperature measurement of plastics processing, heat-treating, glass manufacturing, and aerospace applications. **Nanmac Corp**, 9-11 Mayhew St, Framingham Centre, MA 01701. Phone (508) 872-4811. TWX 710-321-0075. **Circle No. 465**

Publication on fast-pulse generators. Catalog No. 8S1 discusses high-speed pulse generators and laser-diode drivers that are not included in the General Catalog No. 8. It emphasizes 10- and 50-MHz general-purpose laboratory pulse generators, 40 and 100A laser-diode drivers, and 800 to 900V pulse generators. **Avtech Electrosystems Ltd**, Box 265, Ogdensburg, NY 13669. Phone (315) 472-5270. FAX (613) 226-2802. **Circle No. 466**

Data-acquisition and control products. This 1992 catalog features plug-in boards and software for applications such as precision-temperature measure-



ment, weighing, and chromatography, and it also includes IEEE-488 instrumentation. The catalog highlights WorkbenchPC and WorkbenchMac, which use icon-based software for measuring, analyzing, and responding to data with no programming. **Strawberry Tree Inc**, 160 S Wolfe Rd, Sunnyvale, CA 94086. Phone (408) 736-8800. FAX (408) 736-1041. **Circle No. 467**

F O R P O W E R P R O T E C T I O N

I Trust My Job to Sola

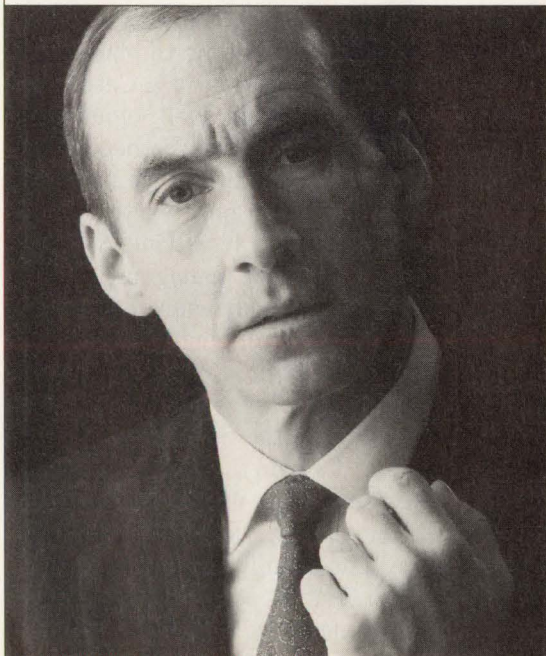

I'm good at my job. I take it seriously. I work hard at it, and I expect my computer to deliver productivity, not problems.

That's why there's a Sola installed on my LAN. You see, if the power goes down in my shop, my job doesn't go down with it. It's secure, available; protected at all times by Sola.

Sola Uninterruptible Power Systems are dependable; reliability I can count on. Quality I can trust.

Sola. I'd stake my job on it.

Sola offers a wide range of power protection choices including UPS systems, connectivity packages, power conditioners and DC power supplies. Sola protects PCs to mainframes; networks, telephone and retail systems; laboratory and production floor equipment. Compare UPS features and choose power you can trust.

UPS Comparison Chart		
Capability	Sola	Other Brands
On-line Alerts & Controls	Yes	?
Full line of UL & CSA UPS Systems	Yes	?
Windows™ Monitoring Software	Yes	?
90 Day Risk-Free Offer	Yes	?
Complete Line Of UPS's from 0-100 kVA	Yes	?

Trust Your Job to Sola. Call 1-800-Buy-Sola. In Illinois: 708-439-2800

SOLA
Power You Can Trust

Take control of your time

JAY FRASER, Associate Editor

During the Great Depression, Charles Schwab was the president of Bethlehem Steel Company. One day he was talking to a management consultant named Ivy Lee about how he wanted to accomplish more with his time.

Lee suggested a simple method. In the evening, take a blank piece of paper and write down the six most important tasks you have to do the next day. Number them in order of priority and put the paper in your pocket. Next morning, take out the list and begin on task number one. Work on it until you finish it, then start on task number two, and so on. Don't worry if you only complete one or two tasks each day, because they will be the most important ones. After you go home, tear up the piece of paper and write out a new list for the following morning.

Schwab asked Lee what fee he wanted for the advice. Lee replied that Schwab should try the method for as long as he wanted, then send him a check for whatever he thought it was worth.

One month later, Schwab mailed Lee a check for \$25,000—a huge sum during the Depression—and said that it was worth every penny because finally he and his executives were getting first things done first. Schwab went on to make Bethlehem Steel the largest independent

You won't
have to work
long hours if you
manage your
time better.

steel producer in the world and amass a personal fortune of more than \$100 million.

Managing your time effectively can pay big dividends, those dividends can arrive quickly, and time-management methods can be straightforward and easy to implement.

Time is your most precious resource, and it's nonrenewable. Each of us spends time at exactly the same rate, yet some people accomplish more with it than others. You'd probably like to get more done on your job, but maybe you just don't seem able to do it. You may even have worked extra hours sometimes, but it didn't help much. Working extra hours isn't the answer. Achieving better control of your time is.

The well-known management consultant E B Osborn once said,

"If your aim is control, it must be self-control first. If your aim is management, it must be self-management first. Beside the task of acquiring the ability to organize a day's work, all else you will ever learn about management is but child's play."

Take the time to plan well

The greatest time-waster is lack of planning. Many people don't devote sufficient time to planning because they don't understand the benefits it brings. Engineers, especially, tend to want to get into the lab, get their hands on the equipment, and see what it will do. That may be satisfying, but it usually isn't the best use of time.

Not taking the time to plan thoroughly may put you in a Catch-22. If you don't plan well, you may spend more time than is necessary on your work, and if you spend more time than is necessary on your work, you won't have time to plan well. If you're a manager, insufficient planning may cause emergencies to keep cropping up. If your days are taken up dealing with emergency after emergency, you may not have the time to plan sufficiently. It's true that good planning takes time, but it's also true that in the long run, good planning saves more time than it takes.

The first step in effective time management is to establish your

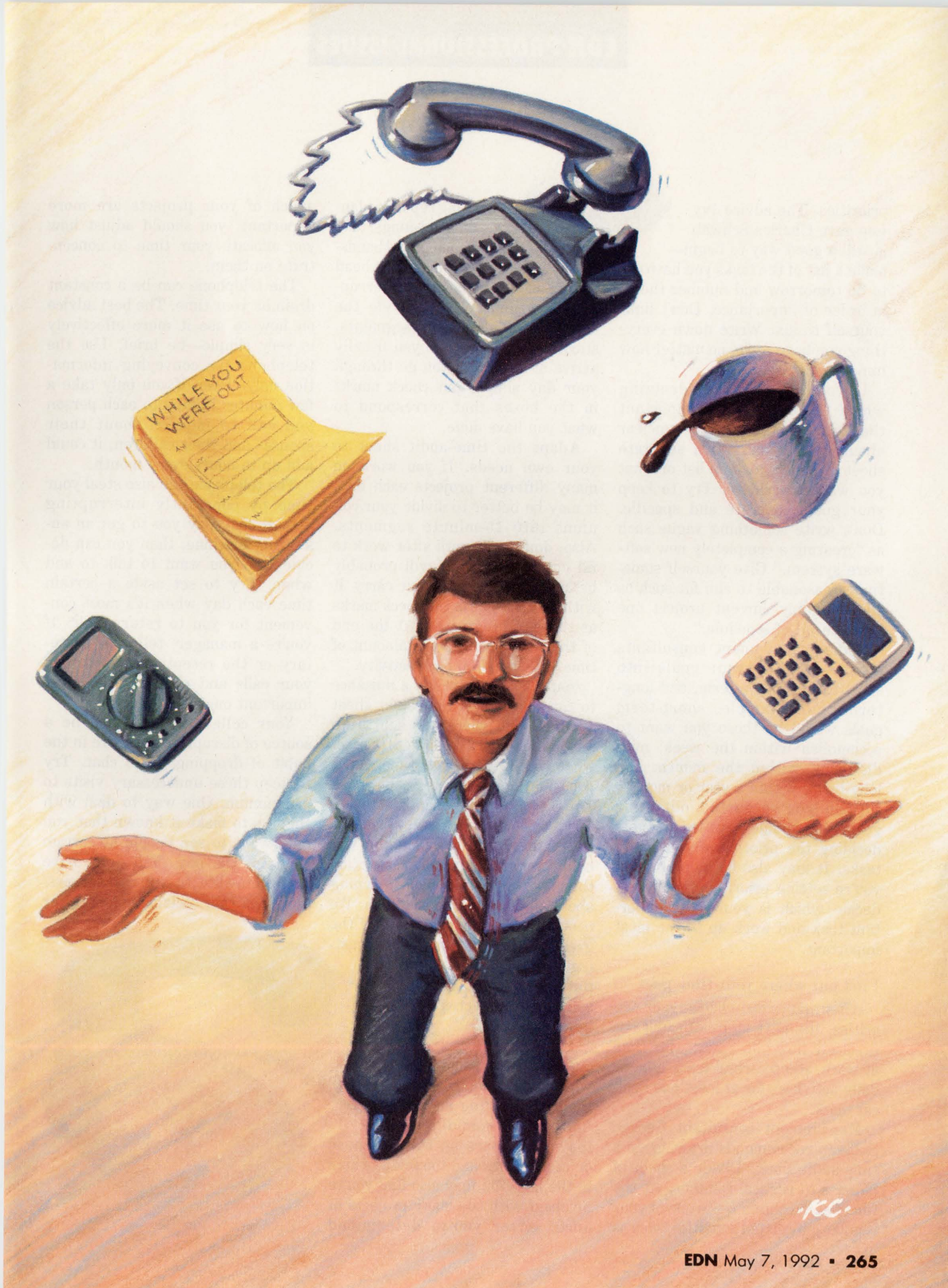

RC

priorities. The advice Ivy Lee gave Charles Schwab is still a good way to begin—make a list of the tasks you have to do tomorrow and number them in order of importance. Don't limit yourself to six. Write down everything you have to do, no matter how minor it may seem.

If you have trouble deciding which tasks are more important than others, you may be unclear about your goals. On a separate sheet of paper, make a list of what you want to achieve. Try to keep your goals concrete and specific. Don't write something vague such as "creating a completely new software system." Give yourself something reasonable to aim for such as "finishing my current project one week ahead of schedule."

Some management consultants advise dividing your goals into short-term, middle-term, and long-term. For example, short-term goals would be those you want to accomplish within the week; middle-term, within the month; and long-term, within a year or more.

Once you've sorted out your goals, you should have less trouble deciding the priority of your daily tasks. It may also be helpful when you're setting priorities if you first decide which is your least important task and work up to the most important.

Find out where your time goes

After you've established your priorities, the next step is to find out precisely how you spend your time at work. Keep careful track of your daily activities for at least one typical week.

Management consultant George Sullivan recommends drawing up a time-audit sheet. Divide a sheet of paper into vertical columns. At the top of each column write one of your regular job-related activities, such as



writing reports, planning, meetings, telephoning, and hands-on work. Also head one column "interruptions." Then divide the columns into half-hour segments, starting with the time you usually arrive at work. As you go through your day simply put check marks in the boxes that correspond to what you have done.

Adapt the time-audit sheet to your own needs. If you work on many different projects each day, it may be better to divide your columns into 15-minute segments. Also, don't wait until after work to fill out the sheet. It will probably be more accurate if you carry it with you and put in the check marks as the day progresses. At the end of the week, add up the amount of time you spend on each activity.

You may feel that it's a nuisance to carry around a time-audit sheet all week, but there's no substitute for meticulously keeping track of what you do with your time. As R Alec Mackenzie wrote in his book *The Time Trap*, "The time inventory, or log, is necessary because the painful task of changing our habits requires far more conviction than we can build from learning about the experience of others. We need the amazing revelation of the great portions of time we are wasting to provide the determination to manage ourselves more effectively in this respect."

Many people are surprised to discover where their time is actually going. You may find you're spending too many hours on the telephone or in meetings and too few working in the lab. You may also find you're involved with too many projects at once. After you've determined

which of your projects are more important, you should adjust how you allocate your time to concentrate on them.

The telephone can be a constant drain on your time. The best advice on how to use it more effectively is very simple—be brief. Use the telephone for conveying information only. Even if you only take a few minutes talking to each person you call to inquire about their spouses and their children, it could add up to hours every month.

The telephone can also steal your time by constantly interrupting you. It may pay you to get an answering machine, then you can decide who you want to talk to and when. Try to set aside a certain time each day when it's most convenient for you to return calls. If you're a manager, tell your secretary or the receptionist to screen your calls and put only the most important ones through to you.

Your colleagues can also be a source of disruption if they're in the habit of dropping by to chat. Try to keep these unnecessary visits to a minimum. One way to deal with them is to make it known that you only want to see people at certain times of the day. You don't have to be impolite to your coworkers. Just save your socializing until after

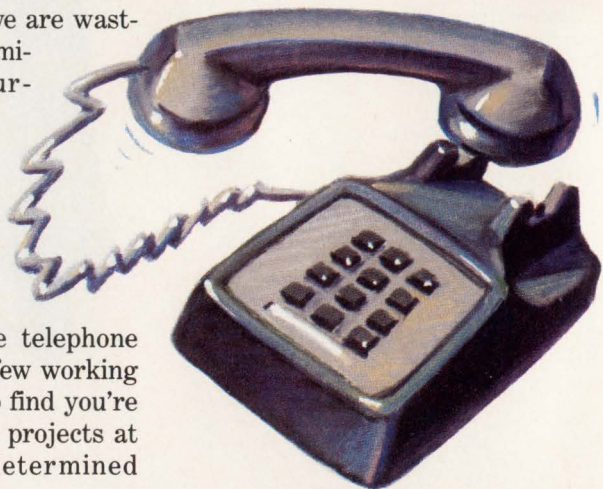

No Matter What The Application...

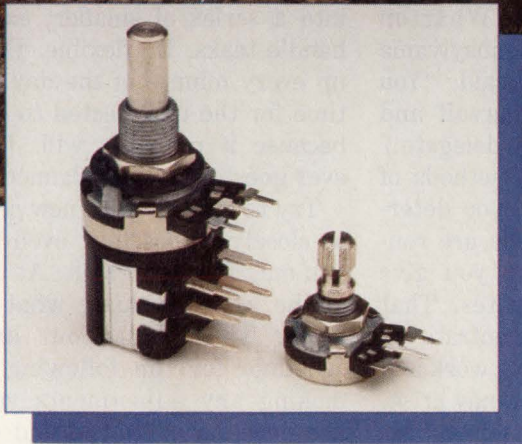
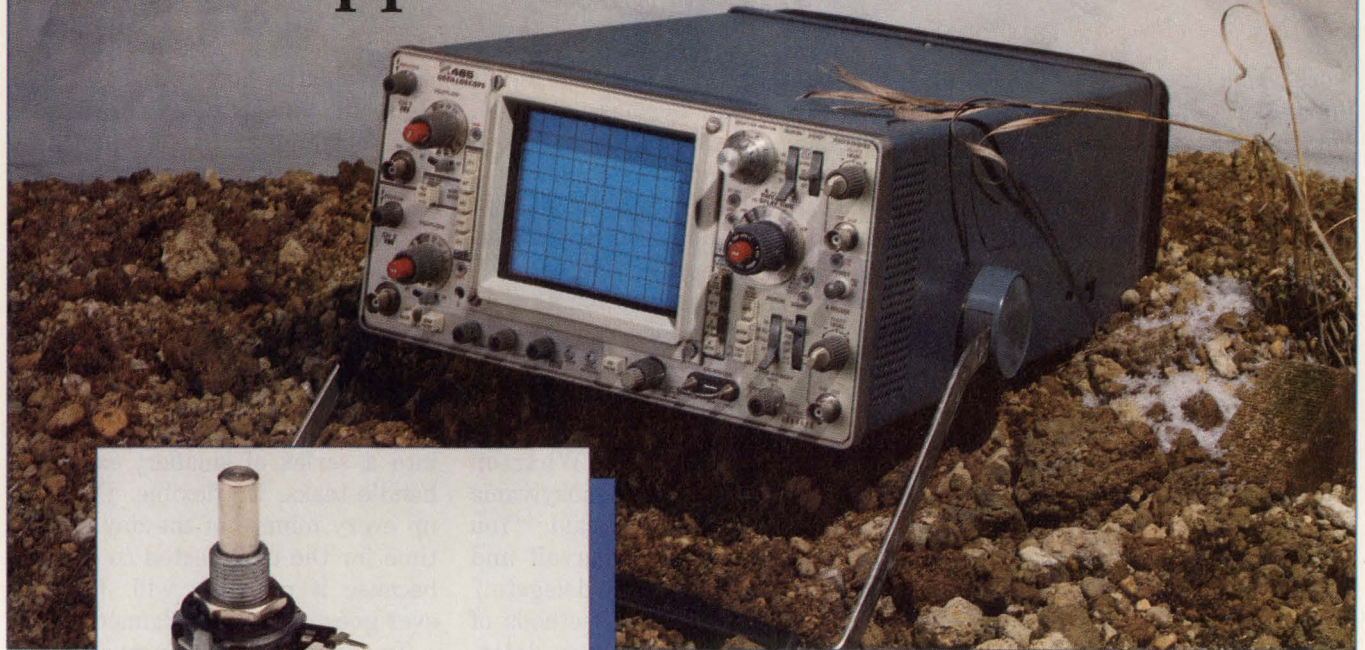

With Piher Controls, You Won't Be Left Out In The Cold

Piher quality (winner of the prestigious Ford Q-1 award), versatility and fast efficient response to your inquiries puts you in control with these potentiometers. **Model PC16** is completely insulated and is available in a wide variety of mounting configurations. Its dust proof case is made from autoextinguishable plastic and is dust and solvent resistant. Up to 4 PC16s may be ganged; if required, switches can be incorporated in the assembly. These controls have wide application including industrial and electronic test equipment, lighting and audio circuitry. All configurations are custom made.

Models **T16** and **T21** are control potentiometers with outstanding mechanical and electrical properties. Each comes in a wide variety of types and with an impressive range of options for essentially any design application. Both may be ganged and are available with switches. The **T16** comes in carbon only while the **T21** is offered in cermet. The **T21** has higher wattage ratings, higher temperature coefficients and more versatile mounting characteristics. And with **Piher's** high level of technical and customer service, you won't be left "out in the cold".

High quality...wide application...rapid quantity delivery and price competitive. **You're** in control with the *new* Piher.

Other Piher Products...

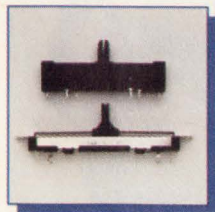

Slide Potentiometers



Modular Potentiometers



Trimmer Series

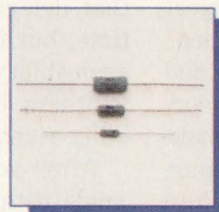

Wirewound Resistors

PIHER

A **MEGGITT** Co.
ELECTRONICS

903 Feehanville Drive
Mount Prospect, IL 60056
In Illinois: (708) 390-6680
Fax: (708) 390-9866
Toll Free: (800) 323-6693

work. Your company may have an open-door policy, but you will be better off if you close yours sometimes.

If you have to meet with someone



who has a tendency to rattle on, set a time limit on the meeting. Also, try to meet in his or her office. That makes it much easier for you to leave when you want.

Another way to safeguard your time is to find some quiet place you can retreat to, from time to time, to work without interruption. It may be your company's library or an empty conference room or the office of an absent coworker. If your job allows it, you could also try working at home once in a while.

Keep firm control of meetings

Poorly planned and poorly run meetings are another serious waste of time. Many organizations hold meetings at the same time each week. Sometimes their original purpose changes or disappears altogether, but the meetings continue out of habit. If you find yourself involved in such meetings, suggest that their purpose be re-examined.

If you're in a position to plan and conduct a meeting, you can do yourself and others a big favor by making sure it has a well-defined purpose and a firm agenda. When you're running a meeting, don't let

the participants' minds wander away from the business at hand. Your meeting should have a goal, and everyone in the meeting should work toward it until it's accomplished. Also, make sure your meeting starts and ends on time.

If you're a manager, you have an advantage because you can delegate some work to others. Delegation isn't really an option. It's a necessity. As Ross Webber, professor of Management at the Wharton School, University of Pennsylvania (Philadelphia, PA) has said, "You can't do everything yourself and live very long. You must delegate."

There are two basic methods of delegation. In the first, you determine which of your tasks are routine and repetitive and you give them to your subordinates. That leaves you free to concentrate on more important or unique work and on any emergencies that may arise. This is termed management by exception.

The other common method is to delegate those tasks that you don't like or do especially well to others and keep the ones that you do best. If one of your subordinates can handle a job more easily and quickly than you can, you should give it to him or her. If no one who works with you has any expertise in a certain area, don't be afraid to call in a specialist from outside.

The most important aspect of delegating is to make sure your subordinates understand what they are supposed to do. Give them clear instructions and explain what the goal of each project is. Also, remember that delegating will give you more time, but it won't give you less responsibility. You can pass work on to others, but the ultimate responsibility remains with you.

After you have determined your goals, established the priority of the tasks you have to do, and tracked

and evaluated how you spend your time, the final step is to create a new schedule.

Draw up a schedule for one full week. Use whatever you feel most comfortable with—a wall chart, a desk calendar, a pocket notebook, or just a plain piece of paper. Give yourself goals that you can accomplish in a reasonable amount of time. If a large project is looming ahead for you, try to break it down into a series of smaller, easier-to-handle tasks. Be flexible. Don't fill up every minute of the day. Leave time for the unexpected to occur—because it probably will. Nothing ever goes exactly as planned.

Try to stick to your new schedule as closely as possible, even though you may find it difficult. At the end of the week, evaluate what you've done. Then write out another schedule for the following week, making any adjustments you feel are necessary. At the end of just one week you should feel you have better control of your time, your job, and your life. **EDN**

Jay Fraser, Associate Editor, can be reached at (617) 558-4561, FAX (617) 558-4471.



Article Interest Quotient
(Circle One)
High 518 Medium 519 Low 520

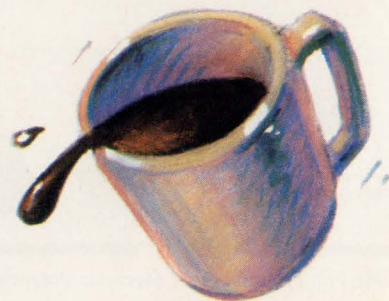

Here's your opportunity to get in on the ground floor of EDA and find out what the design engineers' and their managers' current and future views are on tool use. Join John Whitmarsh, Editor of EDN News Edition, as he kicks-off this "must attend" industry event, EDN's EDA/CASE Industry Forum. He will present the results of EDN's 3rd annual survey of EDA/CASE tool use.

• What You'll Learn

Find out the habits and buying intentions of some of the most prolific EDA and CASE users in the industry — EDN's readers. Hear how extensive EDA and CASE tool use is today; what kinds of designs the tools are used for; which vendors are the winners and which are the losers; and which tools and vendors electronics design engineers and their managers will adopt in the near-term future?

EDA & CASE

*Redefining the Design Equation
for the '90s*

EDN NEWS EDITION'S EDA/CASE INDUSTRY FORUM

• Who Should Attend?

Design engineers, engineering managers, EDA vendors and CASE suppliers will benefit from this industry update. The survey clearly defines the key trends in system-level design automation.

When:

June 9, 1992
6:30-8:00 p.m.

Where:

Anaheim Marriott
Salon 3 & 4
700 W. Convention Way
Anaheim, CA 92802
714/740-2422

Presented By:



Attendance is free.
Limited seating.

Hear Three Industry Leaders React

Joe Costello

President/CEO
of Cadence Design Systems

Wes Patterson

President/CEO
of Xilinx

Lou Mazzucchelli

Co-founder/VP/Chief Technical Officer
of Cadre Technologies

These three industry leaders will give their own views on how changing user patterns will affect future product development and introduction strategies.

For more information: Call Pam Winch at 617/558-4660.

EPSON

THE CRYSTALMASTER™

leads new crystal oscillator technologies into the 90's with...

the most cost effective hi-temp SMD crystals and oscillators and low cost plastic thru-hole crystal oscillators.

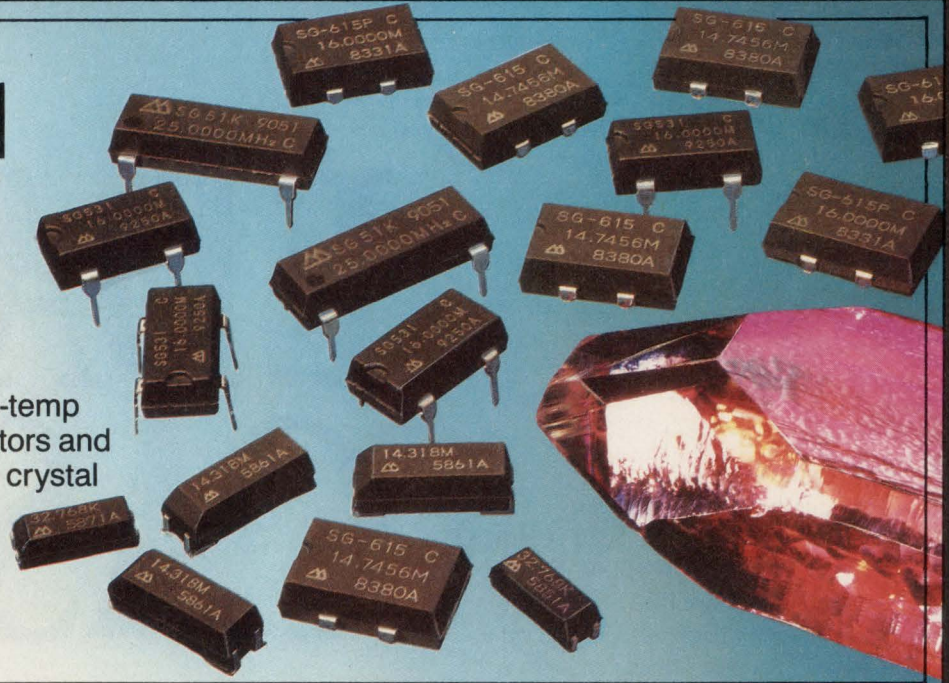

EPSON SURFACE MOUNT CRYSTALS AND OSCILLATORS

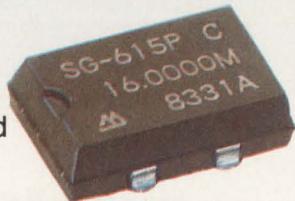

Epson has pioneered the first truly heat resistant crystal for use in its surface mount crystals and crystal oscillators. Capable of withstanding 260°C for 20 seconds... far above the demands of standard IR and vapor phase reflow processing systems... these labor-saving high-temp SMD crystals have become the accepted standard for surface mount crystal and oscillator components.

MODEL SG-615 OSCILLATOR
 Frequency: 1.5 to 66.7 MHz
 Symmetry: 45/55 (TYP)
 Rise/Fall Time: 5 nsec (TYP)
 Tristate: Available
 Compatible Technology: CMOS and TTL
 Op. Temp. Range: -40°C to 85°C

MODEL MA 505/506 CRYSTAL
 Frequency: 4.00 to 66.7 MHz
MODEL MC-405 CRYSTAL
 Frequency: 32.768 KHz

EPSON® EPSON AMERICA, INC.
 Component Sales Department Telephone: 213/787-6300

EPSON THRU-HOLE OSCILLATORS REPLACE METAL CAN OSCILLATORS

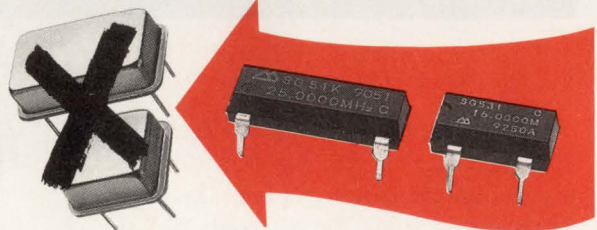

Epson has introduced the first plastic low cost, high performance auto-insertable thru-hole crystal oscillator. Its unique hermetically sealed crystal, embedded in a plastic package, gives the same EMI protection and higher performance than metal can oscillators... at a much lower cost. And, the auto-insertion feature reduces manufacturing costs associated with hand inserting metal cans... into standard full-size or half-size hole patterns.

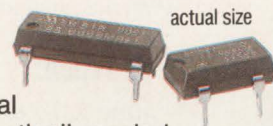

MODEL SG-51/SG-531 OSCILLATOR

Frequency: 1.5 to 66.7 MHz
 Symmetry: 45/55 (TYP)
 Rise/Fall Time: 5 nsec (TYP)
 Tristate: Available
 Compatible Technology: CMOS and TTL

EPSON® EPSON AMERICA, INC.
 Component Sales Department Telephone: 213/787-6300

CALL YOUR SALES REP TODAY

EPSON Sales Representatives: AL-GA-TN Concord Components 205/772-8883 • AZ-NM Fred Board Assoc. 602/994-9388 • CA-No. Costar 408/446-9339 • CA-Sa. Bager Electronics 714/957-3367 • CO-UT Wn. Region Mktg. 303/428-8088 • FL Dyne-A-Mark 407/831-2822 • IL-WI LTD Technologies 708/773-2900 • IN-KY C C Electro 317/921-5000 • KS-MO-IA Microtronics 913/262-1444 • MA-NH-CT Rosen Assoc. 617/449-4700 • MD-VA Tech Sales Assoc. 301/461-7802 • MN Electro Mark 612/944-5850 • NC-SC WLA Assoc. 919/231-9939 • NJ JMR Sales 201/525-8000 • NY Elcom Sales 716/385-1400 • Metro, NY Niktronix 516/929-4671 • OH-MI J. D. Babb Assoc. 216/934-4454 • OR-WA Matrex 503/245-8080 • PA Omega Sales 215/244-4000 • TX-OK Component Tech. 214/783-8831 9101

CIRCLE NO. 158

EDN

PRODUCT MART

This advertising is for new and current products.

Please circle Reader Service number for additional information from manufacturers.

ROM-IT EPROM EMULATION SYSTEM



NEW 4-MEGABIT VERSION

- Emulates up to 8 4-Megabit EPROMs with one control card.
- Downloads 2-Megabit programs in less than 23 seconds.
- Allows you to examine and modify individual bytes or blocks.

- Accepts Intel Hex, Motorola S-Record and Binary files.
- Software available for IBM PC and compatibles and Macintosh systems.
- Base 27256 EPROM System \$395.00 Other configurations available.

ORDER TODAY--IT'S EASY
CALL OR FAX FOR MORE INFORMATION



Incredible Technologies, Inc.
(708) 437-2433
(708) 437-2473 Fax
VISA now accepted.

CIRCLE NO. 325

UNIVERSAL PROGRAMMER, EMULATOR & TESTER

TUP-400 \$745.00
TUP-300 \$645.00

- New improved hardware and software.
- The most complete PC-based Universal Programmer. Programs PLD (PAL, GAL, FPL, EPLD, PEEL, MAX, MACH...), E/EI PROM (up to 16 Mbit), Flash EPROM, B/PROM, Special PROM, MPU (87XX, 68XX, Z8, PSD301, PIC16XX, TMS320CXX, UPD75PXXX, HD637XXX...).
- Covers DIP, PLCC, QFP, SOP, and PGA with 8 to 84 pins. Gang Programming adapters available also.
- EPROM EMULATION capability.
- Tests digital ICs and DRAMs (SIMM/SIP adapter available).
- Free software updates and new devices added upon request.
- IC Manufacturers' approval.
- 1 year warranty, 30 day money back guarantee.



CALL TODAY
FOR MORE INFORMATION.
Distributors are welcome!



Tribal Microsystems Inc.
44388 S. GRIMMER BLVD. FREMONT, CA 94538
TEL: (510) 623-8859
FAX: (510) 623-9925

CIRCLE NO. 326

New Easy to Use Cabinet and Case Catalog from Schroff



SCHROFF INC., announces the availability of a new Cabinet and Case Catalog featuring its standard electronic enclosures which can be shipped assembled from stock. The new full color brochure has been designed to provide the non-technical customer with a simple and easy design guide for ordering standard "off-the-shelf" cabinets and cases.

Some of the features of this new 44 page brochure will be a "user-friendly" format which consists of such key information as construction, physical dimensions, and ordering information for each cabinet and case offered. A handy ordering form with easy to follow directions will be included in the brochure to enable a customer to select and purchase products with minimal customer service assistance. To receive a copy of the new Schroff Cabinet and Case Catalog, call 1-800-451-8755. Or write Schroff Inc., 170 Commerce Drive, Warwick, R.I. 02886.

CIRCLE NO. 327

Natural Voice Playback

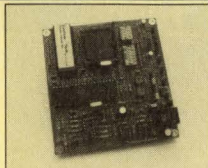

DataVoice - DV-64

Add a high quality Recorded Natural Voice to your product. Recorded Voice vocabularies consisting of over 100 words or multiple phrases up to 1 minute in a Natural Voice is saved in Non-Volatile E-Prom memory. We'll record your message(s) in a male or female voice - or - you can record the library of words and phrases by using the optional SDS-1000 development system with an IBM or compatible computer. OEM designs are available.

Parallel input word select
500 ma. keyline output
32 Kb sampling rate
Multiple modes
Selectable timing

- Point of Sale Terminals
- Site Alarms
- Remote Telemetry
- Weather Stations
- Multiple Languages
- Repeater Identifiers
- Test Systems
- ADA Requirements
- Emergency Announcements

8 ohm Audio output
600 ohm Audio output
+9v to +14v Supply
Size : 4.00" x 4.25"
Under \$ 100 - OEM qty

Several different models available - Call for a demonstration
Palomar Telecom, Inc.
300 Enterprise St. Suite E - Escondido, Ca. 92029
(619) 746-7998 Fax (619) 746-1610

CIRCLE NO. 328

MICROCONTROLLERS

- C Programmable
- Data Acquisition
- Control / Test
- Excellent Support
- From \$159 Qty 1
- New Keyboard Display Modules

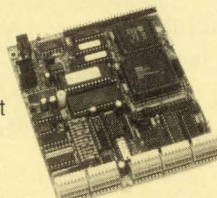

Use our Little Giant™ and Tiny Giant™ miniature controllers to computerize your product, plant or test department. Features built-in power supply, digital I/O to 48+ lines, serial I/O (RS232 / RS485), A/D converters to 20 bits, solenoid drivers, time of day clock, battery backed memory, watchdog, field wiring connectors, up to 8 X 40 LCD with graphics, and more! Our \$195 interactive Dynamic C™ makes serious software development easy. You're only one phone call away from a total solution.

Z-World Engineering

1724 Picasso Ave., Davis, CA 95616
(916) 757-3737 Fax: (916) 753-5141
Automatic Fax: (916) 753-0618
(Call from your fax, request catalog #18)

CIRCLE NO. 329

EXPRESS

Best Value in the World
for
5
DAY TURN
PRINTED CIRCUIT PROTOTYPES

2 PIECE PRICES					
LAYERS	1	2	3&4	5&6	7&8
15	\$212	\$265	\$581	\$715	\$850
30	240	300	658	815	983
60	283	354	775	954	1034
90	325	407	891	1097	1304
120	350	442	949	1092	1417

■ 5 PIECES x 1.34
■ 10 PIECES x 1.67

EXTRAS	DISCOUNTS
<ul style="list-style-type: none"> Photo Plotting Testing Gold Contacts - \$50 25% - Below 8 Mil 	<p>10% 5% </p> <ul style="list-style-type: none"> ■ COD ■ NET 10 ■ CREDIT CARD SALES

FOR MORE INFORMATION CALL OR FAX

Ken Bahl
Sierra Circuits, Inc.
Phone (408) 735-7137 FAX (408) 735-1408 Modem (408) 735-9842

CIRCLE NO. 330

To advertise in Product Mart, call Joanne Dorian, 212/463-6415

ARINC 629



MIL-STD-1553 and ARINC 429/629 databus boards and software for IBM-PC and VMEbus
Call toll-free: 1-800-829-1553

PC629 in stock!

Ballard Technology

1216 NW 75th St., Seattle, WA 98117
(206) 782-8704 FAX: (206) 782-8174

CIRCLE NO. 331



Schematic Capture for the Macintosh

DESIGNWORKS

Schematic features Menu-driven, mouse-controlled operations • cut/copy/paste between circuits • right-angle rubberbanding. **Digital simulation** 13-state, event-driven simulation • logic analyzer-style timing window • PLD support. **Libraries** Fully-simulated 7400, 4000, 10K series, PLDs, PROMs and RAMs, non-simulated analog and discrete components • User-definable, simulated custom symbols. **Interfaces** Formats for Douglas CAD/CAM, Cadnetix, Calay, Orcad, Tango, Racal Redac, Spice. • user-definable printers, dot-matrix printers, HP, Houston, Roland pen plotters.

CALL (800) 444-9064 TODAY FOR YOUR FREE DEMONSTRATION KIT!

CAPILANO COMPUTING
(604) 522-6200 Fax (604) 522-3972

CIRCLE NO. 332

DAR is the only EDA Directory Source you will ever need.

DAR (Design Automation Research) is an electronic directory. DAR can save hours in searching for ASIC and CAD/CAE vendors. DAR supports the entire top-down design process from CONCEPT to REALITY. DAR requires a PC with a hard disk.

- Select vendors' suite of design tools from a search form.
- Pull-down menus.
- Performs powerful search statements.
- Works with Microsoft-compatible mouse drivers.
- Each field contains a search word list.
- Updates occur on a quarterly basis.
- \$395 annual subscription fee.

Call for a FREE evaluation disk.



16321 Gothard Street, #F, Huntington Beach, CA 92647
714/848-3477

CIRCLE NO. 333

CMOS 186
Single Board Computer

Runs C or QuickBASIC™ Programs

Powerful 16-bit computer directly executes EPROM's containing any C or BASIC .EXE file. NO LOCATORS! Software includes multi-tasking, multi-drop comm, PID control, OPTOMUX.™

- 10, 12, 16 MHz 80C186
- CMOS design
- 512K RAM
- 384K EPROM
- STD BUS Expansion
- COM1 RS232/485
- COM2, LPT1
- RTC Avail
- 80C187 Avail
- OEM discounts



MICRO/SYS

3447 Ocean View Blvd., Glendale, CA 91208
(818) 244-4600 FAX (818) 244-4246

CIRCLE NO. 334

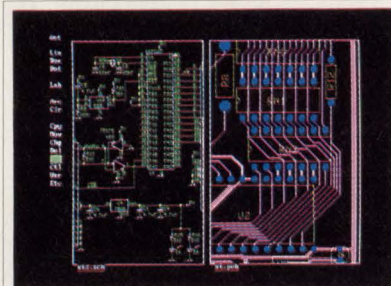

New Schematic and PCB Software

With support for extended and expanded memory, HiWIRE II can handle your most demanding schematic and PCB designs quickly and easily. The unique HiWIRE editor allows you to display and edit schematics and PCBs simultaneously, using the same commands for each. HiWIRE II is \$995, and is guaranteed.

Wintek Corporation

1801 South St., Lafayette, IN 47904
(800) 742-6809 or (317) 448-1903

CIRCLE NO. 335

Model 8551 - by Tabor Electronics



50MHz Pulse/Function Generators

- Two available models from under \$3000.
- High fidelity waveforms from 10.00mHz to 5000 MHz and from 10.00mV to 32.0Vp-p.
- Auto-calibration preserves full accuracy from 0°C to 50°C.
- Fully complies with the new IEEE-488.2 standard.
- Built-in GPIB compiler makes model 8551 bus compatible with HP's model 8116A device - dependent commands.
- Provides sine, triangle, variable/fixd duty cycle pulses, positive and negative ramp waveforms; triggered, gated, and counted burst modes; pulse width, amplitude, and frequency modulation modes; lin/log sweep modes; automatic PLL to an external source with a ±180° phase offset range.

Tabor Electronics
25 Rutgers Ave. Cedar Grove, NJ 07009
Tel: U.S.A. (201)239-0425; ISRAEL (04)675868

CIRCLE NO. 336

FREE CATALOG



Affordable tools for programmable devices are just a phone call away.

- Unbeatable values on Data I/O® device programmers, software, updates, and accessories
- 30-day, money-back guarantee

Access to Data I/O's toll-free technical hotline and on-line bulletin board

To order your FREE catalog, call Data I/O Direct today.
1-800-3-DataIO
(1-800-332-8246)

DATA I/O

CIRCLE NO. 337

Get more schematic design power, for less.



For just \$895*, FutureNet® Schematic Designer gives you the most features and support for your money.

- Extended memory support for large, complex designs
- Standard EDIF 200 netlist writer
- Graphical symbol browser
- Integrated post-processing
- Unlimited hierarchy

Get a FREE Cadnetix translator when you order FutureNet! Call Data I/O® Direct today.
1-800-3-DataIO
(1-800-332-8246)

*U.S. list price only.

Look for FutureNet in the Data I/O Direct Catalog.

DATA I/O

CIRCLE NO. 338

8051 80C196 80C186 68HC11 64180



Orion's 8620 Analyzer-Emulator Supports These Processors & Over 180 More!

- Cost-effective, PC-based emulation for over 180 8- and 16-bit CPUs
- Source level and symbolic debug support
- Interactive triggering
- Program Performance Analyzer
- Tremendous macro capabilities
- Built-in EPROM programmer
- Two-week evaluation program
- Backed by over 11 years of emulation experience!

Call or fax today for more info and a FREE DEMO DISK.

Limited offer — 1 month free with 3 month rental!
1-800-729-7700
Fax 415-327-9881

ORION
INSTRUMENTS

180 Independence Dr., Menlo Park, CA 94025

CIRCLE NO. 339

To advertise in Product Mart, call Joanne Dorian, 212/463-6415

Advin



ADVIN versus DATA I/O

- **Data I/O and Model 2900:** reputable company, dependable equipment, supports 40-pins. Software updates: fair amount.
- **Advin and PILOT-U40:** reputable company, dependable equipment, supports 40-pins. Software updates: free via electronic BBS.

ADVIN SYSTEMS INC.

Smaller Company, Better Service.

800-627-2456, 408-243-7000, Fax 408-736-2503

CIRCLE NO. 340

SM LAND/SOCKET

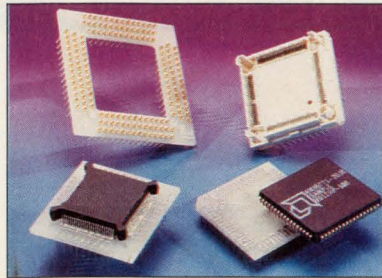

PLUGGABLE SURFACE MOUNT

The QFP and PLCCSM LAND/SOCKET provides a very reliable solution for socketing QFPs or PLCCs in production or ZIF (test/burn-in) patterns. The device is surface mounted to the SM LAND/SOCKET which converts the QFP or PLCC to a base pin array of the production or ZIP QFP socket and can then be soldered to target board or socketed using Ironwood's sockets receptacles. This results in a reliable connection at a reasonable cost. From \$20.

IRONWOOD ELECTRONICS

P.O. BOX 21151, ST. PAUL, MN 55121
(612) 431-7025 FAX (612) 432-8616

CIRCLE NO. 341

883D SRAMs



Something for Everyone.

- 25ns to 120ns
- 512Kx8, 256Kx8, 128Kx8
- **DESC 883D Qualified**
- **QML-38534 per EQC-92-070**
- Low Power CMOS Operation
- JEDEC 32-pin DIP/Co-fired Ceramic
- Military, Industrial, and Commercial Temperatures
- Facility Certified to MIL-STD-1772

White Technology, Inc.

A wholly owned subsidiary of Bommar Instrument Corporation
4246 E. Wood Street • Phoenix, Arizona 85040
Tel: (602) 437-1520 • FAX (602) 437-9120

CIRCLE NO. 342

Imagine if
YOUR
product
could
talk!

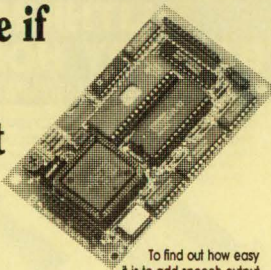

To find out how easy it is to add speech output to your own products, call for your free V8600 data book today!

- Converts plain ASCII text into high quality speech
- Use in computers, voice-mail, warning systems, etc.
- Requires only a single 5V supply and speaker
- Built in μ P, serial and printer interfaces
- Less than \$100 in OEM quantities
- Technology licensing available

RC SYSTEMS

121 W. Winthrop Rd. - Bothell, WA 98012

USA/Canada Phone/Fax: (206) 672-6909

UK/Europe 81 539 0285 Fax: 81 558 8110

CIRCLE NO. 343

How Hot is Your Circuit Board?

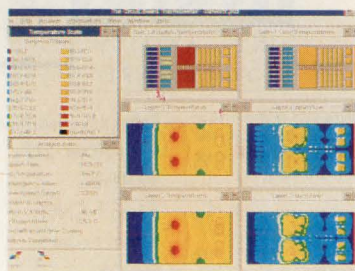

Before you build your circuit board, *The Circuit Board Thermometer for Windows* can predict its operating temperatures. Very easy to use, ver. 2.0 now includes time saving translators for PADS-PCB, P-CAD, Tango, and ORCAD. Features include Conduction, Forced & Natural Convection Cooling, & Transient or Steady State Analyses. Satisfied customers worldwide. Come see us at ELECTRO'92 in the DGA booth (#1218) on May 12th and 13th.

Lakeview Software Corp. Laurel, Maryland, USA
1-800-669-4315 or 3011-317-0726 FAX: 301-317-0587

CIRCLE NO. 344

SUPERPRO[®] now \$599 (US only)



Over 2,000 devices, desktop programmer for your IBM PC with high speed & reliability.

- Easy to use menu drive software
- Universal programming for E(EP)ROM, Flash E(EP)ROM, Bipolar PROM, PAL, FPL, PEEL, GAL, E(EP)PLD, & micro-controller, etc.
- Test TTL/CMOS logic ICs, & memory (DRAM/ SRAM).
- Life time free S/W updates on BBS & tec. support.
- 1 year H/W warranty & 30-day moneyback guarantee.
- Developed & made in U.S.A.
- Call for demo disk. EPROM programmer ROM MASTER: \$149 Low cost universal programmer 764 San Aleso Avenue Sunnyvale, CA 94086 (408) 745-7974 FAX (408) 745-1401 BBS (408) 745-7256

XELTEK

CIRCLE NO. 345



dV * Timing Diagram
dt Accelerator

The Digital Designer's Spreadsheet!

- Create timing diagrams in minutes
- Get effective tradeoffs on memory, wait states and logic speeds
- Analyze worst-case uncertainty
- Display available time between edges
- Create timing documentation quickly and easily

CALL engineerium for your FREE DEMO!

619-292-1900

8950-1200 Villa La Jolla Drive, LaJolla, CA 92037

CIRCLE NO. 346

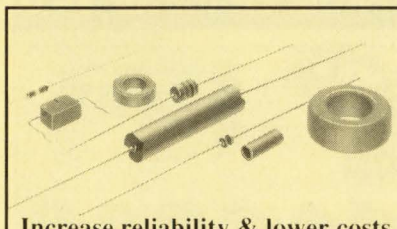

Increase reliability & lower costs with Quality PCB components.

Quality Components, Inc. manufactures powdered iron & phenolic molded winding forms for a wide range of inductors, close tolerance fixed capacitors, surge arrestors, bobbins with molded leads, sleeves, circuit jumpers, surface mount winding forms and powdered iron toroid cores.

These reliable components are ideal for all electronic applications. High volume applications, requiring automatic insertion are our specialty.

Increase design flexibility, reliability, and quality.

For detailed information or samples contact:



Quality Components, Inc.
P.O. Box 113, St. Marys, PA 15857
TEL: (814) 834-2817 FAX: (814) 834-9141

CIRCLE NO. 347

FREE DEMO DISKS



See why over 20,000 engineers rely on SCHEMA for their design needs.

- ✓ Schematic Capture
- ✓ PCB layout & routing
- ✓ Simulation
- ✓ PLD design

Call 800-553-9119



801 Presidential • Richardson, TX 75081
(214) 231-5167 • FAX (214) 783-9072

CIRCLE NO. 348

To advertise in Product Mart, call Joanne Dorian, 212/463-6415

DC/CAD

introducing...

THE TERMINATOR

Super High Density Router
(Complete with Schematic & PCB EDITOR)

Features the following powerful algorithm & capability:

- Rip-up and Retry
- Pre-routing of SMT components
- Real-Time via minimization
- Real-Time clean up passes
- User defined strategies
- Window 3.0 capability as DOS Task
- 1-mil Autoplacer and Autoplanning
- Two-way Gerber and DXF
- Automatic Ground Plane w/ Cross Hatching
- Complete w/ Schematic & Dolly Libraries
- Optional simulation capability & protected mode for 386 users

Call for
FREE DEMO DISK
price range:
\$295 - \$1495

* PCB LAYOUT SERVICE AT LOW COST *
LEASE PROGRAM & SITE LICENSE AVAILABLE

DESIGN
COMPUTATION

1771 State Highway 34, Farmingdale, NJ 07727
(908) 681-7700 • (908) 681-8733 (FAX)

"DC/CAD...The focal point of future CAD market"

CIRCLE NO. 349

"NO KNOBS"

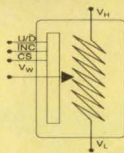

E²POT™ Digitally Controlled
Potentiometers

- Allow Automated System Adjustments
- Nonvolatile Wiper Position Storage
- Low Power CMOS Technology
- Temperature Compensated
- Improve System Reliability
- Through Hole & Surface Mount Packages

Xicor

Xicor, Inc., 1511 Buckeye Drive, Milpitas, California 95035-7493
(408) 432-8888 X3549 FAX 408-432-0640

CIRCLE NO. 350

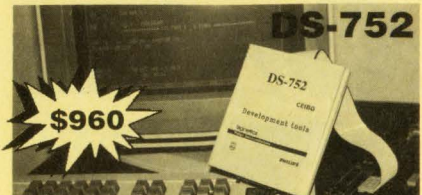

IN-CIRCUIT EMULATOR FOR 8XC751/2 MICROCONTROLLERS

Real time and transparent in-circuit emulator, supports Philips/Signetics 83C751/2 and 87C751/2 microcontrollers, Symbolic Debugger compatible with intel object files, Source Level Debug for C and PLM, 2K hardware breakpoints and conditional breakpoints, 2K of internal memory, 64K Software Trace, serially linked to IBM PC or compatible hosts, On-line Assembler and Disassembler, easy to follow pull-down menus and windows, small size 1" x 5" x 6" (2.4cm x 13cm x 15cm).

Also available from CEIBO: Microcontroller and EPROM Programmers, Development Boards and other Emulators.

CEIBO 1 BALLARD TERRACE LEXINGTON MA 02173
TEL: 617-863-9927 FAX: 617-863-9649
ISRAEL:
MERKAZIM BUILDING, P.O. BOX 2106 HERZELIA 46120
TEL: 972-52-555387 FAX: 972-52-553297

CIRCLE NO. 751

400 MHz Logic Analyzer

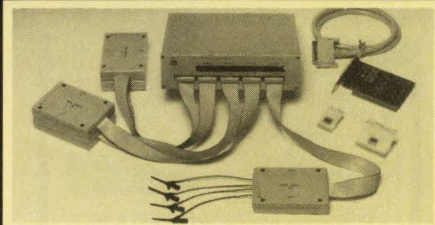

- upto 128 Channels, Timing and State
- 400 MHz Max Sampling Rate
- Timing and State Simultaneous on Same Probe
- 16K Samples/Channel (high speed mode)
- 16 Levels of Sequential Triggering
- Variable, TTL, or ECL Logic Threshold Levels
- 8 External Clocks
- FREE Software Updates on 24 Hour BBS

\$799 - LA12100 (100 MHz)

\$1299 - LA32200 (200 MHz-32channels)

\$1899 - LA32400 (400 MHz-32channels)

\$1950 - LA64200 (200 MHz-64channels)

\$2750 - LA64400 (400 MHz-64channels)

UNIVERSAL PROGRAMMER

PAL
GAL
EPROM
EEPROM
PROM

87xxx...

22V10

26CV12

16Bit EPROMs FLASH EPROMs

5ns PALs 4 Meg EPROMs

FREE software updates on BBS

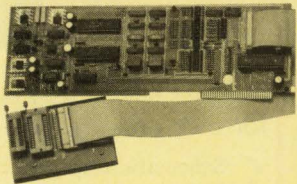

\$475

Call - (201) 808-8990
Link Computer Graphics, Inc.

369 Passaic Ave., # 100, Fairfield, NJ 07004 FAX: 879-8786

CIRCLE NO. 755

Relax

RELIABILITY
SOFTWARE

The
Intuitive
Solution!

Analyze and improve your product reliability using this advanced, state-of-the-art set of software tools.

Relax products are noted for their outstanding quality, ease-of-use, flexibility, and comprehensive array of features. A wide range of packages are available to meet your product requirements. And all Relax products are fully guaranteed!

Call 410-788-9000 Today
For More Information!

INNOVATIVE SOFTWARE DESIGNS, INC.

Two English Elm Court • Baltimore, MD 21228 USA
410-788-9000 • FAX 410-788-9001

* Reliability Prediction

- MIL-HDBK-217
- Bellcore
- French CNET
- Parts Count

* FMECA

- * Maintainability
- * Fault Tree
- * Thermal
- * Weibull
- * more ...

CIRCLE NO. 753

EPROM Emulator V4.0

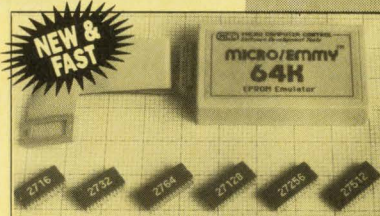

- 64K Download in only 14 seconds
- Emulates ALL Standard MOS and CMOS EPROMs, 2716/32/64/128/256/512
- Battery backed memory, No Reloading for Power Cycles
- "TRUE" Emulation at Power-Up, Stand-Alone Operation
- Two Target Reset Lines (HIGH and LOW)
- All Cables and Software included
- Price/Performance Leader, only \$295

MCC

MICRO
COMPUTER
CONTROL
Software
Development Tools

P.O. Box 275
Hopewell, NJ 08525
USA
Tel: (609) 466-1751
Fax: (609) 466-4116

CALL TODAY FOR A
FREE TECHNICAL BULLETIN

CIRCLE NO. 756

LITHIUM BATTERY HOLDERS

FOR HORIZONTAL CYLINDER CELLS

CYLINDER
HOLDER*
Standard PC
version
See table



CYLINDER
HOLDER*
Tab version
See table



PC Board Terminals

Fast-On
Tab Terminals

Memory Protection was Never Easier.

Now, solder MPD's horizontal battery standard holder right on your PC board. Or use tab holder with fast-on or hardware connect. Standard holder allows for 3/4" PC board stacking. Standard 3-volt Lithium cylinder cells for reliable memory back-up systems clip right in. Also accepts Ni-Cad, Carbon-Zinc and Alkaline horizontal cylinder cells.

• Sturdy, high-temp UL94V-0 Valox® material • Stainless steel nickel plated contacts • Easy insertion and removal of batteries • Efficient, economical • Custom battery holders available on request

MODEL #	SIZE	3/16"	1/2"	3/8"	1"	1 1/2"	2"
FAST-ON/TAB	BH-C/3A	BH-1/2AA	BH-3/8AA	BH-1AA	BH-1 1/2C	BH-2C	BH-3C

* Patent 4,495,257

For all the details, call or write today.

Memory Protection Devices Inc.™
320 Broad Hollow Rd., Farmingdale, NY USA 11735 • (516) 293-5891

See us at Booth #2222
CIRCLE NO. 754

A
Configurations
Available

The Heart of the Matter...

RTXC™

Real-Time Multitasking Executive

- INTEL 80x88/x86, 80x96, 80x51 • HITACHI 6303
- MOTOROLA 680x0, 683xx, 68HC11, 68HC16
- INMOS T400, T800 • ZILOG Z80/Z180

- Preemptive Scheduling
- Fixed or Dynamic Priorities
- Timeout on some services
- Configurable and ROMable
- Intertask Communications
- Messages
- Queues
- Semaphores
- Memory Management
- Resource Manager
- Over 50 Executive Services Available
- System Level Debugging Utility
- System Generation Utility
- Written in C
- Source Code Included
- No Royalties
- Technical Support
- Broad C Compiler Support
- Sensible License Agreement
- 450+ Page User's Manual

Ask about ASSIST™
Our new PC Development
Package Combination

One Time License Fee From \$995
Discounts for Multiple Licenses/Ports
The only real-time kernel you'll ever need™

A.T. BARRETT & ASSOCIATES, INC.
11501 Chimney Rock, Houston, TX 77035
FAX 713/728-1049
Phone 800/525-4302 or 713/728-9688

FREE DEMO
AVAILABLE

CIRCLE NO. 757

To advertise in Product Mart, call Joanne Dorian, 212/463-6415

48 Channel 50MHz Logic Analyzer

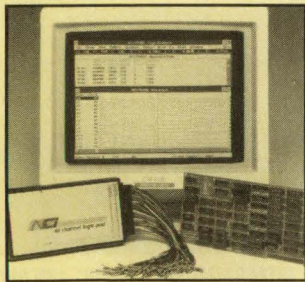

Complete System \$1895.00

New Windows 3.0 Compatible Software

- 48 Channels @ 50 MHz x 4K words deep
- 16 Trigger Words/16Level Trigger Sequence
- Storage and recall of traces/setups to disk
- Disassemblers available for: 68000, 8088, 8086, 6801, 6811, Z80, 8085, 6502, 6809, 6303, 8031

NCI □ 6438 UNIVERSITY DRIVE,
HUNTSVILLE, AL 35806
(205) 837-6667 FAX (205) 837-5221

CIRCLE NO. 758

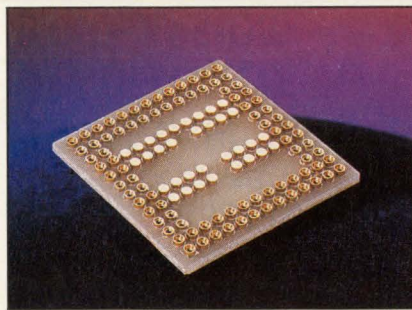

Over 300 Prototyping Adapters

- Adapt-A-Boards™ make it easy to adapt standard or high-density prototyping boards to a variety of packages.
- For all package types: LCC, PLCC, PGA, PQFP, SDIP (shrink DIP devices), SOIC and more!
- Bottom configurations adapt to wire wraps or solder tail pins. Boards conform to Mil-C-45204.
- Quick turnaround on custom engineering services, if needed. For a free catalog, contact:

Emulation Technology, Inc.
2344 Walsh Ave. Santa Clara, CA 95051
Phone: 408-982-0660 FAX: 408-982-0664



CIRCLE NO. 759



**An Established Foothold In
The Device Programming Arena**



**The Traditional
Market Leader In Japan**

U.S. Tel./Fax 1-619-727-4683 / 5232
Europe Tel./Fax 353-1-2892136 / 2892070
Japan Tel./Fax 81-3-3344-2001 / 2007
Daisan Maruzen Bldg., 6-16-6 Nishi Shinjuku,
Shinjuku-Ku, Tokyo 160, Japan.

AVAL CORPORATION

CIRCLE NO. 760

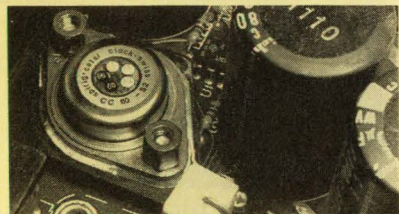

**Put a low cost temperature monitor
CelsiClock® on any surface.**

The indicating triangle of the CelsiClock® labels turns permanently black when the surface reaches the specific »switch« temperature level of that triangle. Highly reliable labels are available as single temperature spots or in multiple sequenced temperature increments. Labels are self-adhesive and quickly placed on any dry surface. Temperature ranges from 105° F (40°C) to 550° F (260°C). **FREE SAMPLE** on all inquiries. **CELSI's, the reliable »Temperature Watch-dog« for years.**

SAT

Solder Absorbing
Technology Inc.

144 Oakland Street, Springfield MA 01108
(413)788-6191/call TOLL FREE (800)628-8862
Fax (413)788-0490

CIRCLE NO. 761

RAYOVAC LITHIUM BATTERY GUIDE

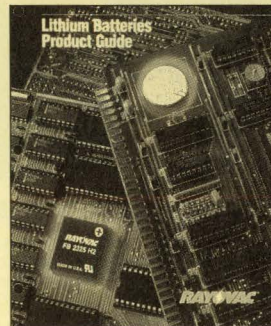

Design engineers looking for data on lithium batteries will find a wealth of information in Rayovac's "Lithium Batteries Product Guide." For your free guide, contact Rayovac Technical Sales, 601 Rayovac Dr., Madison, WI 53711, or call (608) 275-4694 Fax: (608) 275-4994

CIRCLE NO. 762

Interactive/Real-Time

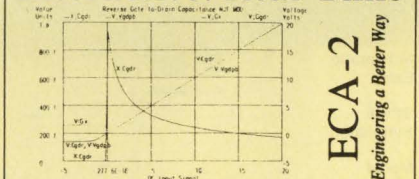

ECA-2
Engineering a Better Way

Analog Circuit Simulation

- AC, DC, Transient, Fourier, Temperature, MonteCarlo and/or Worst-Case Analysis
- Interactive or batch modes
- Full nonlinear simulation
- On-line real time graphics
- Multiple plots
- 2 to 50 times faster than SPICE
- Component optimization sweeping
- New 424 pg. manual

**All the Features, Twice the Speed
at Half the Cost**

Call for FREE DEMO!
313-663-8810

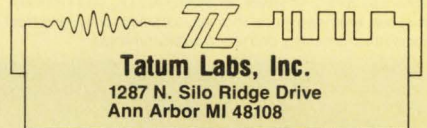

CIRCLE NO. 763

State Machine Design

For Complex & High Density PLDs

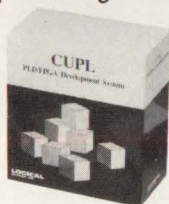

The most powerful PLD/FPGA CAE design software from \$495.00

CUPL™ 4.2

1-800-331-7766 **LOGICAL DEVICES, INC.**

CIRCLE NO. 764

Device Programming

Certified by the Semiconductor Industry

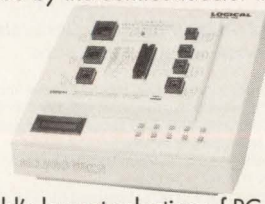

World's largest selection of PC based and stand-alone programmers from \$395.00 to \$10,000.

ALLPRO™ 88

1-800-331-7766 **LOGICAL DEVICES, INC.**

CIRCLE NO. 765

See us at Electro Booth #2317
WRITE OR CALL FOR SAMPLE
Low Cost Tempilabel® Temperature Monitor.

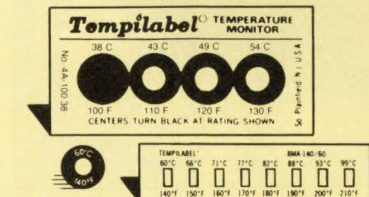

How to put a low cost temperature gauge on everything.

Label's center spot turns black when surface to which it is affixed reaches specified temperature. Single- or multi-spot labels with pre-determined increment of ratings: 100°F (38°C) to 600°F (316°C). 1% accuracy guaranteed. 1 thru 8 ratings on each monitor with various increments. Self-adhesive, removable.

TEMPIL, Big Three Industries, Inc.
2901 Hamilton Blvd., South Plainfield, NJ 07080
Phone: (908) 757-8300 Telex: 138662

CIRCLE NO. 766

To advertise in Product Mart, call Joanne Dorian, 212/463-6415

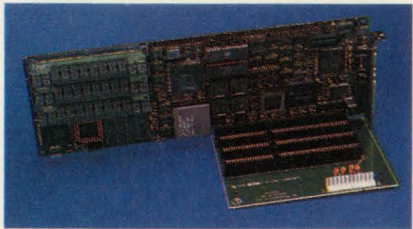

VMAX® 386DX COMPLETE COMPUTER

- FAST, 80386 DX 40Mhz processor
- COMPACT size, AT Bus or stand alone
- 100% DOS Compatible, AMI, BIOS
- CONTROL SVGA, IDE, FDC, 2Ser, Bi-Par
- SOLID STATE DISK 2 drives to 1.5 Meg
- SOFTWARE included for SSD, EMM, VGA
- CACHE to 128K. DRAM to 48M
- Made in the USA, 1 Year Warranty
- \$1195 Qty 1 OK

VMAX
TEMPUSTECH, INC.

TEL: (800) 634-0701 295 Airport Road
FAX: (813) 643-4981 Naples, FL 33942

CIRCLE NO. 767

20-BIT RESOLUTION A/D CONVERTER

For IBM PC/XT/AT
& Compatibles

- * Delta-Sigma conversion for excellent noise rejection
- * 6-pole low-pass filter
- * Linearity is 0.005 percent of full scale
- * Software included

\$300

We manufacture a broad line of data acquisition products.

LAWSON LABS, INC.

74 4TH AVE. NW
KALISPELL, MT 59901
800 321-5355 or 406 257-5355
FAX 406 257-5572



CIRCLE NO. 768



FULLY INTEGRATED, RACK MOUNT AND RUGGED SUN SPARC WORK STATION

STANDARD FEATURES INCLUDE:

- * SPARK ENGINE 2 CPU WITH 16MB RAM
- * 207MB HARD DISK, 150MB TAPE DRIVE
- * 644MB CDROM, REMOVEABLE HARD DISK
- * 1.44MB FLOPPY, 2 RS-232 AND S BUS PORTS
- * SCSI-2 AND ETHERNET INTERFACE
- * 16 INCH RACK MOUNT COLOR MONITOR
- * KEYBOARD, MOUSE AND SunOS 4.1

FOR CUSTOM CONFIGURATIONS AND FURTHER DETAILS
CONTACT: **IBI SYSTEMS INC.**, 6842 NW 20M AVE.,
FT. LAUDERDALE, FL 33309, 305-978-9225
FAX: 305-978-9226

CIRCLE NO. 769

Analog Circuit Simulation

- Schematic Entry
 - SPICE Simulation
 - Model Libraries
 - Waveform Processing
- only \$990

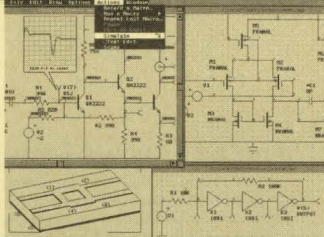

Powerful - Affordable

FULLY INTEGRATED, EASY TO USE, ANALOG CIRCUIT SIMULATION ENVIRONMENT, FROM ONE VENDOR, FEATURING:
A powerful SPICE simulator performing AC, DC, and Transient, analyses, extensive model libraries, schematic entry, graphical waveform processing, and report quality printouts.

Call Or Write For Your Free Demo and Information Kit!
Tel. 310-833-0710



P.O. Box 710 San Pedro,
CA 90733-0710
Fax 310-833-9658

CIRCLE NO. 770

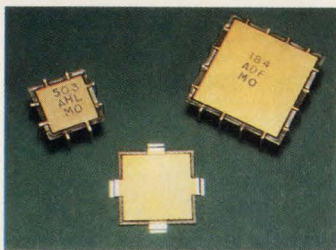

CUT PGA/PLCC NOISE

MICRO/Q® 3000 capacitors reduce noise associated with PGA and PLCC devices. Designed to be mounted under the device, take no extra board space. Can be used under MPUs, Gate Arrays, and ASICs. Choose from Z5V, X7R, and P3J dielectrics. Available in both thru-hole and surface mount versions. Several sizes available to fit all devices.

Circuit Components Inc.
2400 S. Roosevelt St., Tempe, AZ 85282
602/967-0624

CIRCLE NO. 771

MICROPROCESSOR EMULATORS

Zax provides a comprehensive series of real-time emulation support for Motorola, Intel, NEC, Zilog, and Hitachi microprocessors. Some of the highlighted features include source-level debug, real-time trace, and performance analysis.

Call now for more information:

(800) 421-0982
(714) 474-1170 (Inside CA)
(714) 474-0159 (Fax)

ZAXTEK

42 Corporate Park Irvine, CA 92714

CIRCLE NO. 772

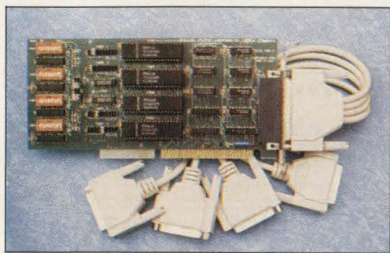

VERSA COMM+4

- * FOUR RS-232 PORTS WITH ALL MODEM CONTROL SIGNALS
- * INDIVIDUALLY SELECTABLE PORT ADDRESSES
- * INDIVIDUALLY SELECTABLE INTERRUPT (AT & XT)
- * 16550 BUFFERED UART OPTIONAL
- * SOFTWARE AVAILABLE FOR INTERRUPT BUFFERING
- * EXCELLENT TECHNICAL SUPPORT
- * AVAILABLE FROM STOCK



SEALEVEL SYSTEMS INC.
PO BOX 830
LIBERTY, SC 29657
803-843-4343

CIRCLE NO. 773



8020 Series - by
Tabor Electronics

20MHz Pulse/Function Generators

- Three available models, from under \$1500.
- Units provide sine, triangle, pulses, positive and negative ramp waveforms; triggered and gated modes; pulse width, amplitude, and frequency modulation modes; lin/log sweep modes.
- High fidelity waveforms from 2.00MHz to 20.00MHz and from 10.0mV to 30.0Vp-p.
- Ruggedized metal case for improved RFI/EMI shielding. Fully complies with VDE & UL safety standards.
- Optional IEEE-488 interface.
- Built-in, independently-programmed, asynchronous trigger generator.
- Suitable for numerous industrial applications in r&d, production, schools, and automatic test systems.



Tabor Electronics
25 Rutgers Ave. Cedar Grove, NJ 07009
Tel: U.S.A. (201)239-0425; ISRAEL (04)678868

CIRCLE NO. 774



Free Catalog

The World's Largest Collection of Adapters & Accessories for VLSI/Surface Mount Devices

- Emulator Pods & Adapters
- Debug Tools
- Programming Adapters
- Socket Converters
- Debugging Accessories
- Prototyping Adapters
- Custom Engineering

Emulation Technology, Inc.
2344 Walsh Ave. Santa Clara, CA 95051
Phone: 408-982-0660 FAX: 408-982-0664



CIRCLE NO. 775

To advertise in Product Mart, call Joanne Dorian, 212/463-6415

REMOVE HARDWARE LOCKS

**PROTECT YOUR INVESTMENT!
MAINTAIN PRODUCTIVITY!**
Software utility that allows for
the removal of hardware locks.

Available for most major
CAD/CAM and PCB
software programs

Easy - Simple - Guaranteed

Programs start at \$99.00 U.S.
Visa and Mastercard Welcome
Call or Fax for more information

SafeSoft Systems Inc.
202-1100 Concordia Ave. Phone (204) 669-4639
Winnipeg, Mb. R2K 4B8 FAX (204) 668-3566
Canada

CIRCLE NO. 776

8051 68HC11 COP8

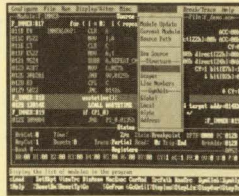

iceMASTER Your Window To Emulation Productivity

- Easy to learn & use
- Windowed interface -- user configurable
- FAST! Download -- < 3 sec. typ. at 115KB
- Source Level debug

- A 4K frame trace buffer with advanced searching capabilities.
- iceMASTER connects easily to your PC, requires no disassembly, or expansion slots. Works on any PC (DOS or OS/2), MicroChannel or EISA. Even laptops!
- iceMASTER is versatile: iceMASTER-8051, iceMASTER-68HC11 and iceMASTER-COP8 support most family derivatives.
- Rental and 10-day trials available.
- 68HC11 A,D,E,F; 8XC528; 8XC552; 8XC515A and 8XC517A support.
- Call today for free demo disk and ask about a free 8051 Macro Assembler! (800) 638-2423

MetaLink
Corporation

MetaLink Corporation P.O. Box 1329 Chandler, Ar 85244-1329
Phone: (602) 926-0797 FAX: (602) 926-1198 TELE: 4998050MILNK



CIRCLE NO. 777

16 MHz CPU
DRAM to 512K
20 MHz DSP
SRAM to 96K
DAPL™ Operating System
100+ standard commands
Custom commands in C

**The
Intelligent
Solution
For
Data
Acquisition**

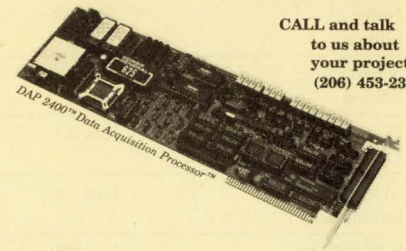

CALL and talk
to us about
your project.
(206) 453-2345

ANALOG I/O
DIGITAL I/O

Inputs to 25K samples per second
Outputs to 250K samples per second

**MICROSTAR
LABORATORIES**
2265 116th Avenue NE
Bellevue, WA 98004
FAX (206) 453-3199

Or call for
FREE demo diskette.

CIRCLE NO. 778

SEE US AT ELECTRO BOOTH 1106

From the company that brought
you the industries first lifetime
free software update policy,
we bring you a truly innovative
universal device programmer.
See the latest from BP Microsys-
tems as well as the entire line of
affordable programmers.

BP MICROSYSTEMS

The Engineer's Programmer™

CIRCLE NO. 779

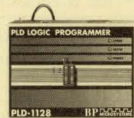

PLD-1128 LOGIC DEVICE PROGRAMMER \$995.00

- Program over 1100 different PLDs including the latest architectures from AMD, Cypress, NS
- Qualified by **AMD, Lattice, National Semiconductor, Signetics** and others
- Supports all MACH and MAPL devices, **all versions of 22V10, including the /4 from AMD, -5 & -7 PLDs from NS, and Altera 900 & 1800 series EPLDs**
- Only uses the **manufacturer approved** programming algorithms to ensure accuracy
- LIFETIME FREE SOFTWARE UPDATES VIA BBS and US MAIL**
- Risk free 30-day money-back guarantee
- MADE IN THE USA**

BP MICROSYSTEMS

1-800-225-2102

Houston, Texas 77043-3239 • (713) 461-9430 • (713) 461-7413

CIRCLE NO. 780

SCANTEAM® INSTANT INTERFACE PRODUCTS

CCD BAR CODE TECHNOLOGY



The **Welch Allyn SCANTEAM® 3000** is a light-weight, rugged, easy-to-use bar code scanner which eliminates the need for an external decoder box. Utilizing solid state CCD imaging technology, this ergonomically designed long-life scanner is a cost-effective solution for POS, PC and CRT based terminals, or portable data collection applications. The SCANTEAM 3000 contains no moving parts, and the interchangeable interface cable determines output parameters. Automatic or manual triggering can be programmed based upon your application requirements.

Welch Allyn

For more information call 1-315-685-8945.

CIRCLE NO. 782

VGA Distribution Amp



TwinSplit™

- Connect 2 VGA monitors up to 200 feet away at once
- Supports all VGA/SVGA cards and monitors
- 4 and 8 output models available
- Only \$295, 1 year warranty.

**Communications
Specialties, Inc.**

TEL: 516-273-0404 FAX: 516-273-1633

CIRCLE NO. 783

Telecom Solutions from Teltone

R1/R2 MF Transceivers

M-986 transceivers transmit and receive CCITT R1 or R2 forward and backward

NOW AVAILABLE IN PLASTIC multi-frequency signals. For trunk adapters, test equipment, paging terminals, traffic recorders, PBX circuitry, etc.

- Single or dual channel versions available
- Binary or 2 of 6 input/output format
- Complete microprocessor interface
- 40-pin thru-hole/44-pin PLCC packages
- 5-volt power, crystal time base

1-800-426-3926

Or: 206-487-1515 Fax: 206-487-2288

TELSTONE®

INNOVATING SOLUTIONS
In Telecom Interface Components

Teltone Corporation, 22121-20th Avenue SE, Bothell, WA 98021

CIRCLE NO. 784

To advertise in Product Mart, call Joanne Dorian, 212/463-6415

EDN May 7, 1992 • 277

EDN-CAREER OPPORTUNITIES

1992 Recruitment Editorial Calendar

Issue	Issue Date	Ad Deadline	Editorial Emphasis
News Edition	May 28	May 14	Communication ICs • CAE Software • Regional Profile: Texas, Oklahoma, Kansas
Magazine Edition	June 4	May 14	ASICs/PLDs • DSP Software • CAE/Software/Interoperability • Digital ICs & Semiconductors
News Edition	June 8	May 21	CAE SPECIAL ISSUE • EDA/CASE Supplement • DAC Hot Products • Software Engineering • Diversity Special Series
Magazine Edition	June 18	May 28	Microprocessors • Electromechanical Devices • ICs & Semiconductors
SOFTWARE ISSUE	June 18	May 28	SOFTWARE ENGINEERING SPECIAL ISSUE (To be polybagged with the June 18th Magazine Edition issue)
News Edition	June 25	June 11	MILITARY ELECTRONICS SPECIAL ISSUE • DSP Hardware • Military Electronics • Regional Profile: Florida, Alabama
Magazine Edition	July 6	June 11	INTERNATIONAL PRODUCT SHOWCASE—Vol. I • Hardware & Interconnect • Software • ICs & Semiconductors • Power Sources
Magazine Edition	July 20	June 25	INTERNATIONAL PRODUCT SHOWCASE—Vol. II • Computers & Peripherals • Components • CAE • Test & Measurement
News Edition	July 23	July 9	Engineering PCs & Workstations • CAE Software • SIGGRAPH Hot Products • Graphics Technology • Engineering Management Special Series • Regional Profile: Arizona, New Mexico
Magazine Edition	Aug. 6	July 16	Microprocessor Development Tools • ICs & Semiconductors • Technical Article Database Index • EDN's "Innovation Crusade"—Finalists Coverage • Reader Vote Contest: All advertisers in the issue qualify
News Edition	Aug. 13	July 30	DSP ICs • EDN's "Innovation Crusade"—Finalists Coverage • Telecom Software • Engineering Management Special Series
Magazine Edition	Aug. 20	July 30	MILITARY ELECTRONICS SPECIAL ISSUE • Military Computers Design • Test & Measurement • Memory Technology • Components
News Edition	Aug. 27	Aug. 13	Embedded Software • Software • Regional Profile: Washington DC, Maryland, Virginia
Magazine Edition	Sept. 3	Aug. 13	ASICs SPECIAL ISSUE • CAE Tools & Techniques • Computer Peripherals • Computer Buses • Sensors & Transducers • Buscon Show Coverage
News Edition	Sept. 10	Aug. 27	CAE • Test & Measurement • Diversity Special Series
Magazine Edition	Sept. 17	Aug. 27	Field-Programmable Gate Arrays • DSP Directory • Embedded Computers • CAE
SOFTWARE ISSUE	Sept. 17	Aug. 27	SOFTWARE ENGINEERING SPECIAL ISSUE (To be polybagged with the Sept. 17th Magazine Edition issue)
News Edition	Sept. 24	Sept. 10	Automotive Electronics • Sensors • Computers & Peripherals • Regional Profile: Oregon, Washington
Magazine Edition	Oct. 1	Sept. 10	TEST & MEASUREMENT SPECIAL ISSUE • European Technology Update • Data Acquisition Software • Superconductors • How to Design it Right the 1st Time Series—Part I • PLD/FPGA Directory
News Edition	Oct. 8	Sept. 24	CAE • PC/Workstation Design • Engineering Management Special Series
Magazine Edition	Oct. 15	Sept. 24	Disk Drives • Portable-Computer Design • Switching Power Supplies • Design it Right Series—Part II
News Edition	Oct. 22	Oct. 8	Data Storage Technology • Communications Technology • Regional Profile: Michigan, Illinois, Missouri
Magazine Edition	Oct. 29	Oct. 8	ELECTRONICA SHOW ISSUE • Object-oriented Programming • Chipsets for PCs • Design it Right Series—Part III • Wescon Preview Issue
News Edition	Nov. 5	Oct. 22	COMDEX/WESCON SPECIAL ISSUE • Special Supplement: Design for Portability • Microprocessors • Wescon/Comdex Hot Products • CAE Software • Diversity Special Series
Magazine Edition	Nov. 12	Oct. 22	COMDEX/WESCON SPECIAL ISSUE • Integrated Circuits • Test & Measurement • Design it Right Series—Part IV

Call today for information on Recruitment Advertising:

East Coast: Janet O. Penn (201) 228-8610

West Coast: Nancy Olbers (603) 436-7565

National: Roberta Renard (201) 228-8602



LEADERSHIP

The capacity to show the way by taking the lead. To influence or direct the activities of others.

Some appear to be the leader. But actions speak much louder than muscle. We believe in the personal power of the individual. Which is why, at Motorola Semiconductor Products Sector (SPS), we encourage our people to be champions. To establish goals. To influence by example. As a result, we're an international innovator in the semiconductor industry.

The microelectronics technology leader. Naturally, it's the Microprocessor and Memory Technologies Group, Motorola SPS. Openings now exist in our Texas facility for:

IC DESIGN ENGINEER Design logic and CMOS control circuitry for a RISC-based microprocessor cache. Involves circuitry definition, modeling, and verification, plus integration of custom SRAM cache and MMU arrays. Requires BS/MSEE with emphasis on computer engineering and 3+ years VLSI CMOS design experience. Cache/MMU control design expertise is a must.

CUSTOM SRAM DESIGN ENGINEER Design custom on-board CMOS SRAM cache and tag arrays for a RISC-based microprocessor. Requires BS/MSEE and 3+ years CMOS SRAM experience with emphasis in complex circuit design, analysis and verification. Microprocessor logic design background preferred.

SOFTWARE ENGINEER Develop, port and support RISC architecture debuggers. Includes UNIX X Window graphics HW/SW tools and porting of cross-tools to various development platforms. Requires BSCS and 4+ years C/UNIX experience with a minimum of 2 years in UNIX X Window graphics. C++ skills preferred.

SENIOR DESIGN ENGINEERS Participate in specification, design and implementation of next generation 68000 microprocessors. Requires BS/MSEE and 5 years experience with a strong background in new product specification, behavioral modeling, VLSI and microprocessor design.

GRAPHICS/EMBEDDED CONTROL

MARKETING MANAGER Develop/implement marketing strategies for 88000 and PowerPC graphics embedded control products with an emphasis on facilitating design wins in targeted areas. Requires BSEE and 2-5 years experience marketing embedded control microprocessors. Knowledge of HW/SW development tools and key operating system software is essential.

SYSTEM VERIFICATION ENGINEERS Develop verification programs/behaviorals to verify RISC/68000 microprocessor families' functions and perform failure analysis at system and chip levels. Requires BS/MSEE and 3-5 years experience with proficiency in C/UNIX.

CAE DESIGNERS Develop an integrated VLSI CAD platform based on vendor tools and design/code. Includes evaluation, design methodology and tool support. Requires BS/MSEE, plus 3-5 years experience in workstation tool development and SW integration. Knowledge of relational database and graphical user interfaces (X, motif) would be a plus.

There's no company — or opportunity — in the world like this one. Be part of it. For consideration, send your resume to: **Motorola Recruitment, Dept. ATX-9208, 505 Barton Springs Rd., One Texas Center, Suite 400, Austin, TX 78704. (800) 531-5183; (512) 322-8811 FAX.** Equal Opportunity/Affirmative Action Employer.



MOTOROLA

Microprocessor and Memory Technologies Group

**CMOS LOGIC AND CIRCUIT DESIGN
SYNTHESIS • BUS INTERFACE • SIMULATION
RISC ARCHITECTURE • MICROPROCESSOR DESIGN
MICROPROCESSOR ARCHITECTURE**

CACHE MEMORY SYSTEMS • DEVELOPMENT TOOLS

Knock, Knock.

In EDN's
Magazine
and News
Editions,
opportunity
knocks all
the time.

EDN Magazine
Edition
News
Edition

Great Work. Great Living. IBM Burlington, Vermont.

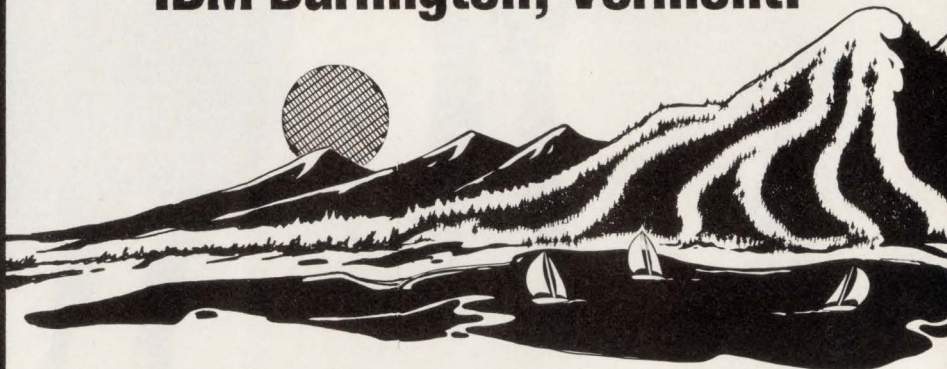

One of the world's most advanced semiconductor operations is what you'll find at IBM's major development and manufacturing facility in Burlington, where continued business growth is matched by a superb living environment. We now have outstanding career opportunities for engineers with the specialized computer skills to make significant impact on RISC microprocessor development.

Logic Design

Responsible for definition, logic design and verification of high performance RISC microprocessors. To qualify, you must possess a BSEE or higher, with an emphasis on Computer Engineering, and be capable of carrying logic design through to physical chip design stage. Minimum of 3 years in logic/chip, CMOS and VLSI design required. RISC experience is key. Background in microprocessor and multiprocessor design desirable.

Circuit Design

Will design CMOS circuitry for RISC-based microprocessor functions. Includes custom SRAM cache design, complex logic dataflow circuitry, random logic, IO, clocking and other circuitry in custom microprocessor layouts. Requires BSEE or higher with emphasis on Computer Engineering or Circuit Design. Ability to design complex CMOS or Bi CMOS circuits and perform circuit analysis and verification is essential, along with minimum of 3 years circuit design experience in industry. CMOS, VLSI, digital circuit design is a prerequisite.

Physical Design

Responsible for CMOS VLSI chip physical design of RISC microprocessor in advanced CMOS technology. Includes using state-of-the-art CAD tools to perform chip layout, wiring and chip timing analysis. A BSEE or higher, with emphasis on Computer Engineering or Circuit Design, is essential, along with at least 3 years of physical design experience in industry. RISC and CMOS, VLSI design experience (chip layout/wiring) necessary. Background in microprocessor design desirable.

Located between Lake Champlain and Vermont's Green Mountains, Burlington offers year round recreation and open space. Unspoiled beauty, affordable housing and a sense of community come together here. This is life at its most enjoyable; technology at its best.

IBM offers salaries commensurate with qualifications and a comprehensive benefit package. For confidential consideration, please send your resume, indicating area of interest, to: **IBM Corporation, Professional Recruiting, 1000 River Street, Essex Junction, VT 05452.**

IBM®

An equal opportunity employer.

Engineers

GaAs EXPLOSION ROCKS COMPETITION

Vitesse Semiconductor Corporation burst upon the scene a few years ago and is now the world's leading supplier of digital VLSI GaAs IC's. Our technology is sending shock waves through the high performance industry. To fuel this mushrooming growth, we are currently seeking qualified and motivated people for the following highly visible and technically challenging positions:

- **DEVICE MODELLING ENGINEER**
- **LINE MAINTENANCE TECHNICIANS**
- **MANUFACTURING TEST/PROCESS ENGINEER**
- **PROGRAM MANAGER (MARKETING)**
- **PRODUCT/TEST ENGINEERS**
- **SUSTAINING TEST ENGINEER**
- **PRODUCT ENGINEERING MANAGER**
- **PROCESS ENGINEERING MANAGER**
- **TELECOM PRODUCT ENGINEER**
- **SR. ETCH ENGINEER**

Vitesse is headquartered in Camarillo, California, 40 miles south of Santa Barbara and only minutes from the beach. Our Product Development Center is located in Sunnyvale, California, in the heart of Silicon Valley. We offer a generous compensation package that includes relocation assistance, tuition reimbursement and equity participation. If you have a keen interest in becoming a part of the GaAs explosion and not a part of the fallout, FAX/mail your resume to: **Vitesse Semiconductor Corporation, 741 Calle Plano, Camarillo, CA 93012, Attn: Phil Helmrich, Dept. EDN 5/7/92. FAX: (805) 389-7188.** We are an equal opportunity employer supporting Affirmative Action. M/F/H/V. Principals only please.



First in Readership Among Design
Engineers and Engineering
Managers in Electronics

EDN Magazine
Edition
News
Edition

ENGINEERS

The Search for Excellence Begins with Cummins Electronics

Cummins Electronics Co. is a customer driven company whose mission is to become a world class company in electronic systems and products for harsh or critical environments where durability and reliability are key. One of our operating principles is to strive for excellence in all we do, and to assure the development and success of our customers and our employees. We're currently in the process of increasing our staff in the engineering disciplines to develop advanced electronic products. This has led to an active search for talented, highly motivated and success driven people to join us and share in our success. Current career opportunities include:

SENSOR ENGINEER - BSEET, BSEE, BSME, or BSMET with EE or Physics background. Must understand sensor reliability prediction and be familiar with FMEA. Background and pressure, temperature and/or massflow is preferred. Must have good testing and documentation skills and the ability to write detailed specifications. In addition, we prefer the individual to have automotive, heavy duty or severe environment experience. Requires knowledge of test methods, test design and the operations of source approval testing for various types of sensors.

SYSTEMS ENGINEER - BSEE or equivalent. 3 or more years experience in systems design and integration working with either electro mechanical controls or electronic microprocessor based control systems. Must be familiar with system analysis, FMEA, system testing, sensors and actuators application. Must have documentation skills and be able to write detailed specifications. In addition, we prefer the individual to have automotive, heavy duty or severe environment experience.

PROJECT ENGINEER - BSEE plus minimum 5 years of experience developing electronic control systems with an emphasis on the systems/software engineering role. Must be technically oriented, capable of independent operation and self motivated. In addition, we require the individual to have automotive, heavy duty or severe environment experience. Previous experience performing FMEAs, writing system specifications, and performing systems test would be a plus.

ELECTRONIC DESIGN ENGINEER - BSEE plus 2 years applicable experience designing electronic hardware utilizing controllers and their peripheral circuits. Working knowledge of internal combustion engines and designing for harsh environments desirable.

Qualified candidates looking for an opportunity to enhance their capabilities and advance their career goals should submit resumes along with names, addresses, and phone numbers for three references to:

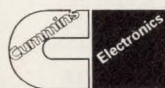

Cummins Electronics

P.O. Box 2361 • Columbus, IN 47201-7449

An Equal Opportunity Employer

Wholly-owned subsidiary of Cummins Engine Company

For more information about our Company and the job, dial up our line Career Network. DIAL: (603) 432-2742. Press RETURN twice and enter password UNIQUE.



If you're looking for work, just look here.

EDN Magazine
Edition
News
Edition

EDN-BUSINESS STAFF

Business/Publishing Headquarters

275 Washington St
Newton, MA 02158
Fax: (617) 558-4470

VP/Publishing Director

Peter D Coley
(617) 558-4673
Ora Dunbar, Sales Coordinator

VP/Publisher

Roy W Forsberg
(617) 558-4367
Darlene Fisher, Assistant

Advertising Sales Director

Jeff Patterson
(617) 558-4583

Marketing/Business Director

Deborah Virtue
(617) 558-4779

VP/Production/Manufacturing

Wayne Hultizky

Director of Production/Manufacturing

John R Sanders

Production Staff

Andrew A Jantz, Supervisor
Sheilagh Hamill, Manager
Lynn Morelli, Assistant

NEW ENGLAND/NY

Chris Platt, Clint Baker
199 Wells Ave
Newton, MA 02159
Tel: (617) 964-3730
Fax: (617) 332-7128

NEW YORK CITY/NEW JERSEY

Dan Rowland
249 W 17th St
New York, NY 10011
Tel: (212) 463-6419
Fax: (212) 463-6404

SOUTHEAST CORRIDOR/PA

Steve Farkas
487 Devon Park Dr
Wayne, PA 19087
Tel: (215) 293-1212
Fax: (215) 293-0359

IL, IN, KY, MI, OH, TN

Greg Anastos
Cahners Plaza
1350 E Touhy Ave, Box 5080
Des Plaines, IL 60018
Tel: (708) 635-8800
Fax: (708) 635-0929

IL, MN, NE, IA, KS, ND, SD, WI, MO, AL, AR, OK, CANADA

Jack Johnson
Cahners Plaza
1350 E Touhy Ave, Box 5080
Des Plaines, IL 60018
Tel: (708) 635-8800
Fax: (708) 635-0929

ARIZONA

John Huff
44 Cook St
Denver, CO 80206
Tel: (303) 388-4511
Fax: (303) 394-4709

COLORADO

Bill Klanke
44 Cook St
Denver, CO 80206
Tel: (303) 388-4511
Fax: (303) 394-4709

ORANGE/RIVERSIDE/ SAN DIEGO COUNTIES

Jim McErlean
18818 Teller Ave, Suite 170
Irvine, CA 92715
Tel: (714) 851-9422
Fax: (714) 752-6867

LOS ANGELES/ SOUTHERN CA, NV

Charles J Stillman
12233 W Olympic Blvd
Los Angeles, CA 90064
Tel: (213) 826-5818
Fax: (213) 207-1067

Susan N Green
18818 Teller Ave, Suite 170
Irvine, CA 92715
Tel: (714) 851-9422
Fax: (714) 752-6867

NORTHERN CA/ SILICON VALLEY

Phil Branon, Bill Klanke
James W Graham, Frank Granzeiser
3031 Tisch Way, Suite 200
San Jose, CA 95128
Tel: (408) 243-8838
Fax: (408) 243-2144

WASHINGTON, OREGON

Pat Dakin
1750 SW Skyline Blvd, Box 6
Portland, OR 97221
Tel: (503) 297-3382
Fax: (503) 297-4305

TEXAS

Al Schmidt
Two Forest Plaza
12201 Merit Dr, Suite 730
Dallas, TX 75251
Tel: (214) 419-1825
Fax: (214) 419-1829

UK

John Waddell
Crystal Communications
Purland House
151 Nathan
London SE28 0AB
Tel: 44-81-312-4444
Fax: 44-81-310-1201

ITALY

Gianni Soddu
International Advertising Network
Via Cassola 6
20122 Milano Italy
Tel: 39-2-545-1833
Fax: 39-2-546-2573

SCANDINAVIA

Stuart Smith
27 Paul St
London EC2A 4JU
Tel: 44-71-628-7038
Fax: 44-71-628-5984

FRANCE/BELGIUM

Laura Whiteman
14 Rue des Parisiens
92600 Asnieres sur Seine
France
Tel: 331-47900507
Fax: 331-47900643

BAVARIA

Karin Steinbacher
New Media Munchen
Ismaniger Str 108
8000 Munchen 80
Germany
Tel: 49-89-98-51-35
Fax: 49-89-981-0117

SPAIN

Luis S Giner
Urbanizacion Santa Barbara
Edificio Cumbre, Apt 7B
08870 Sitges (Barcelona) Spain
Tel: 3-894-43-26
Fax: 3-894-88-37

HUNGARY

Erika Alpar
Publicitas Budapest
Kossuth L ter 18
1055 Budapest, Hungary
Tel: 111-48-98 or 111-44-20
Tel: 111-12-69

AUSTRIA

Harald Brandt
Permedia
Mozartstrasse 43
A-4020 Linz
Tel: 732-79-34-55
Fax: 732-79-34-58

ISRAEL

Asa Talbar, Talbar Media
Box 22917
Tel Aviv 61228, Israel
Tel: 972-3-223-621
Fax: 972-3-524-2177

SWITZERLAND

Peter Combaz, Roswitha N Kunzle
Exportwerbung AG
Kirchgasse 50, 8024 Zurich 1
Tel: 41 1 261 4690
Fax: 41 1 251 45 42

NETHERLANDS/NORTHWEST GERMANY (NIELSEN 1,2)

Albert Ticheler
Dialtic
Busweg 46
5632 PN Eindhoven
Tel/Fax: 31-40-41-37-27

CENTRAL/SOUTHWEST GERMANY

Franz Fleischmann, MediaPac
Hanauer Landstrasse 294
D-6000 Frankfurt/Main 1
Germany; Tel: 4969 42 2951
Fax: 49 69 421288

HONG KONG

Adonis Mak
Cahners Asia Limited
22nd fl, Lo Yung Court
Commercial Bldg
212-220 Lockhart Road
Wanchai, Hong Kong
Tel: 852-572-2037
Fax: 852-838-5912

JAPAN

Kaoru Hara
Dynaco International Inc
Suite 1003, Sun-Palace Shinjuku
8-12-1 Nishishinjuku, Shinjuku-ku
Tokyo 160, Japan
Tel: 81-3-366-8301
Fax: 81-3-366-8302

KOREA

Jeong-guon Seo
DooBee International Inc
Centre Bldg, 1-11 Jeong-dong
Choong-ku, Seoul, Korea
Tel: 82-2-776-2096
Fax: 82-2-755-9860

SINGAPORE/MALAYSIA

Hoo Siew Sai
Major Media Singapore PTE Ltd
52 Chin Swee Rd
#06-00 Resource Bldg
Singapore 0316
Tel: 65-738-0122
Fax: 65-738-2108

AUSTRALIA

Alexandra Harris-Pearson
World Media Network Pty Ltd
Level 2, 285 Clarence Street
Sydney, NSW 2000 Australia
Tel: 61-2-283-2788
Fax: 61-2-283-2035

TAIWAN

Parson Lee
Acteam International Marketing Corp
Box 82153, Taipei, Taiwan ROC
Tel: 886-2-7114833
Fax: 886-2-7415110

PRODUCT MART

Joanne Dorian
249 W 17th St
New York, NY 10011
Tel: (212) 463-6415
Fax: (212) 463-6404

INFO CARDS/ LITERATURE LINK

Heather McElkenny
Tel: (617) 558-4282

CAREER OPPORTUNITIES/ CAREER NEWS

Roberta Renard
National Sales Manager
Janet O Penn, Eastern Sales Manager
Diane Philipbar, Sales Assistant
103 Eisenhower Pkwy
Roseland, NJ 07068
Tel: (201) 228-8602, 228-8610,
228-8608; fax: (201) 228-4622

Nancy Olbers
Western Sales Manager
238 Highland St
Portsmouth, NH 03801
Tel: (603) 436-7565
Fax: (603) 436-8647

Direct Mail Service
(708) 390-2361

Wendy A Casella, Mary Beth Cassidy,
Muriel Murphy
Advertising/Contracts Coordinators
(617) 964-3030

Cahners Magazine Div

Terry McDermott, President
Cahners Publishing Co
Frank Sibley, Executive Vice President/
General Manager, Boston Div
Tom Dellamaria, VP/Production &
Manufacturing

Circulation: Denver, CO
(303) 388-4511

Reprints of EDN articles are available on a custom printing basis at reasonable prices in quantities of 500 or more. For an exact quote, contact Andrea Marwitz, Cahners Reprint Service, Cahners Plaza, 1350 E Touhy Ave, Box 5080, Des Plaines, IL 60017. Phone (708) 390-2240.

the fast FFT spectrum analyzer

Wide Dynamic Range

Two tone response of -90 dBc is easily measured. Averaging enhances spurious signal visibility.

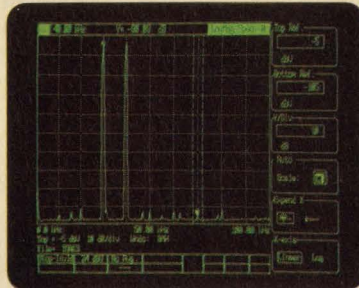

Analysis Capabilities

Easy to use analysis functions are included. Data tables monitor up to 200 frequencies.



Spectral Comparisons

Menu selected math operations can be used to measure spectral differences.

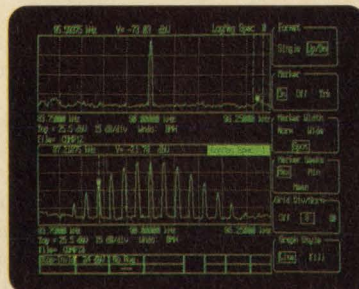

The SR760 FFT Spectrum Analyzer

With a *fast* 100 kHz real-time bandwidth, the SR760 computes the FFT in less time than it takes to acquire the signal. It can average full span data 10 times *faster* than the HP35665A. And a 90 dB dynamic range and much lower noise floor give the SR760 10 dB more usable range. Capabilities include harmonic, band, sideband and 1/3 octave analysis, plus PSD, THD, data tables, limit testing and more. Responsive, intuitive controls make it *fast* and easy to use.

The *fast* SR760.... better performance than analyzers costing 3 times more.

SR760.....\$4350 (U.S. list)

- DC to 100 kHz frequency range
- 90dB dynamic range
- 100 kHz real-time bandwidth
- 500 μ Hz resolution
- Input range -60 dBV to +30 dBV
- Analysis, data tables and help menus
- 3.5 inch DOS formatted disk drive
- Direct hardcopy to printers and plotters
- GPIB, RS232 and printer interface



STANFORD RESEARCH SYSTEMS

1290-D Reamwood Avenue, Sunnyvale, CA 94089

PHONE: (408)744-9040, FAX: 4087449049, TELEX: 706891 SRS UD

EDN-INTERNATIONAL ADVERTISERS INDEX

ACCEL Technologies Inc	196	Epson America Inc	270	Molex Inc	209
Advanced Interconnections Corp . .	206	Ericsson Components	258	Motorola Inc	93
Advin Systems	273	Euro ASIC*	30	Motorola Semiconductor Products Inc	51-53, 97
Alexander Batteries	257	FDK	72	Music Semiconductor	253, 255
Altera Corp	40-41	Fela AG	86	National Instruments	2
AMD	12-13, 60-61	Force Computers Inc	44-45	National Semiconductor Corp . .	149-151
American Neurologix	248	Futaba	256	NEC Corp	102-103
AMP	116-117	General Instrument	225	NCI	275
Ampro Computers Inc	148	Goldstar Electron America Inc . .	35-38	Nohau Corp	228
Analog Devices Inc	28-29, 236-237	Harris Semiconductor	172-173	Noise Laboratory Co	277
Antex Electronics	206	Headland Technology	227	Noritake Electronics Inc	213
Array Microsystems Inc	220, 232	Hewlett-Packard Co	C2, 39	Oak Grigsby	286
Arnold Magnetics Corp	118	Hughes Interconnect Systems	215	Ohmite Mfg Co	287
Asahi Glass Optrex	211	Hypertronics Corp	262	OKI Semiconductor	98
AT&T	240-243	IBI Systems Inc	276	Omaton Inc	273
AT Barrett & Assoc	274	IEE	249	Omron Electronics Inc	100-101
Augat	251	Illinois Capacitor	25	Orion Instruments	272
Autec Power Systems	32	Incredible Tech	271	Oxley	259
Aval Corp of Ireland	275	Innovative Software Designs	274	PADS Software Inc	235
Axion	272	Instrument Specialties Co Inc	247	Palomar Telecom Inc	271
Ballard Technology	272	Integrated Device Technology Inc . .	10	Papst Mechatronic Corp	238
Belden Wire & Cable	141	Integrated Power Design	85	Performance Semiconductor Corp . .	115
Berquist Co	216	Intel	46-47	Philips Semiconductor*	97-99
BP Microsystems	277	Intelligent Systems Inc	285	Philips Industrial Elec Div*	40-41
Bussmann	219	International Rectifier	C3	Pico	96, 232
Caddock Electronics Inc	80	Intusoft	276	Piher International Corp	267
California Micro Devices	72	Ironwood	273	Planar Systems	86
Capilano Computer Systems Inc . . .	272	ITT Cannon	3	Pontiac	176
Capital Equipment Corp	48	ITT Pomona Electronics	71	Power Convertibles	288
Catalyst Semiconductor Inc	87	ITW Switches	218	Power-One Inc	88
Ceibo Ltd	274	John Fluke Manufacturing Co Inc	6, 30, 99	Power-Sonic Corp	114
Central Semiconductor	106	Kepeco Inc	62-63	Power Trends Inc	21
Cherry Electrical Products Inc	252	Lakeview Software	273	Pragmatic Instruments	147
Chrislin Industries	133	Lambda Electronics Inc	73-78	Preston Scientific	50
Cinch Connector Div	49	Lanier/Copier	18	Programmed Test Sources Inc	69
C&K Components Inc	161	Lattice Semiconductor Corp	229	Quality Components	273
Coilcraft	190	Lawson Labs	276	Raltron	146
Comdisco	107	LeCroy Corp	104	Rayovac	275
Communications Specialties Inc	277	Linear Technology Corp	223-224	RC Systems	273
Condor	64	Link Computer Graphics Inc	274	Rogers Corp	276
Cybernetic Micro Systems	31	Logical Devices Inc	275	Safe Soft Systems	277
Cypress Semiconductor	8	MathSoft Inc	11	Samsung Semiconductor	14-15
Dale Electronics Inc	23	Maxtor	188-189	Samtec Inc	108-109
Data I/O Corp	C4, 272	Melcher	83	Sanyo	42
Datel	129-132, 291C	Memory Protection Devices	274	SAT Solder Absorbing Tech	275
Datron Wavetek	221	Meritec	207	Schroff Inc	271
Delevan Div, API	253	Metalink Corp	277	Seagate Technology	33
Design Computation Inc	274	Microcomputer Control	274	SeaLevel Systems	276
Diversified Technology	94-95	Microstar Laboratories	277	Seiko Instruments	185-187
Echelon	158-159	Micro/Sys	272	Siemens Components Inc	143
EEsof	34	Mini-Circuits Laboratories	26-27, 205, 290	Sierra Circuits	271
EG&G Wakefield Engineering Inc . . .	285	Mitsubishi Electronics America Inc	121, 123, 125, 127	Signum Systems	244
Eidsvoll Electronics	218	Mizar Inc	156	Siliconix Inc	4
Elantec	254			Sola Electric	263
Electronic Measurements Inc	217			Sony	157
Elgar	261			Sprague-Goodman Electronics Inc . .	236
Embassy Suites	152			Stanford Research Systems Inc	283
Emulation Technology Inc	275				
Emulex Corp	174-175				
Engineerium	273				

EDN-INTERNATIONAL ADVERTISERS INDEX

Tabor Electronics	272, 276	Xerox Engineering Systems/ Versatec Products	145
Tatum Labs	275	Xicor Inc	274
TDK Corp of America	233	Yamaha LSI	171
TECA	222	Zaxtek	276
Tektronix	54-56, 58-59, 111-113, 166-169	Zenith Magnetics	50
Teledyne Relays	163	Ziatech Corp	1
Teltone Corp	277	Z-World	271
Tempil Div	275		
Tempustech Inc	276		
Texas Instruments Inc*	6, 16-17		
Tokin Corp	245		
Toyocom	230		
Tribal Microsystems	271		
		Recruitment Advertising 278-281	
Varta Batteries Inc	146	Cummins Electronics	
Vectron Laboratories Inc	255	Motorola-SPS	
Versatec	145	Vitesse Semiconductor	
Welch-Allyn	277		
Westcor	90		
White Technology	273		
Wind River Systems	231		
Wintek Corp	272		
WSI	165		
Xeltek	273		
Xentek	170		

*Advertiser in European edition

This index is provided as an additional service. The publisher does not assume any liability for errors or omissions.

RTXC™ & RTX/MP™

Written in C Portable by design Message based Transparent Distributed operation	Intel 80x86, 80x96, 8051 Motorola 68HC11/16, 68xxx TI TMS320C30/C40 Zilog Z80, Zx80 Hitachi 6303 Inmos T2xx, T4xx, T8xx
Dynamic priorities Task management Timer management Memory management Semaphores Message mailboxes FIFO queues Resource management	From 8-bit microcontrollers to multiple 32-bit processors : same API with /MP! Four different and compatible versions!
Virtual Single Processor with RTX/MP !	Distributed debugger System generation tool Tracing monitor Standard I/O & runtime Signal Processing Lib
No royalties Source code 3 months free upgrades and support	Free demo and evaluation kit Step-in at 900 US \$. New version 3.0.

Intelligent Systems International
 Lindestraat 9, B-3210 Linden, Belgium
 Tel. (+32)16.62 15 85. Fax. (+32)16.62 15 84

CIRCLE NO. 160

HEAT SINKS for INTEL 80486 and i860XR MICROPROCESSORS

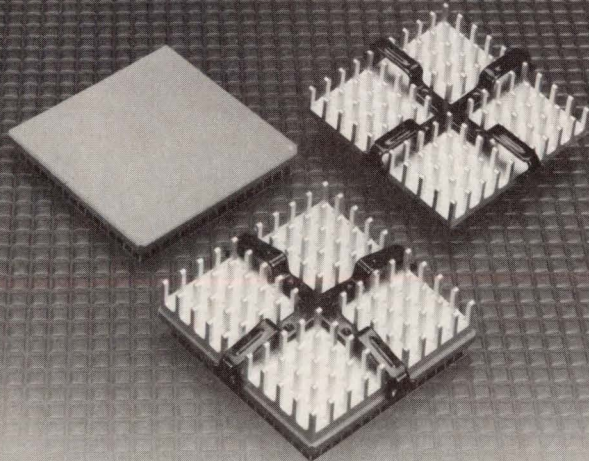

Designed for use with the Intel 80486DX and 80486SX microprocessors and the Intel i860XR RISC processor, packaged in 168-pin ceramic PGAs, the EG&G Wakefield 669 Series Heat Sink/Clip Assembly offers a cost-effective heat dissipation solution for today's high-speed microprocessors. This assembly provides the highest clamping force available with a nylon-coated stainless steel clip, for the most efficient interface heat transfer and to meet system shock and drop test requirements.

Our omnidirectional heat sink offers optimized heat dissipation and ease of application; the symmetrical clip is suitable for high volume installation with the EG&G Wakefield 162-IT installation tool.

Heat dissipation with the 669 Series Heat Sink/Clip Assembly is optimized for PC, workstation, and server applications with low airflows (e.g., 50-200LFM). Pressure drop is minimized in multiple-processor applications.

Intel, 80486, i860XR, and 80386 are trademarks of Intel Corporation.

Call our Application Engineering Department today at (617) 245-5900 for information about the EG&G Wakefield Engineering 669 Series (patent pending) and other heat sinks for the Intel 80386 and 80486 microprocessor family. Also ask for information about the EG&G Wakefield DELTEM™ family of heat sinks for cooling high-speed cache RAM used with 50 MHz microprocessors.



EG&G WAKEFIELD ENGINEERING

60 AUDUBON ROAD, WAKEFIELD, MA 01880
 TEL: (617) 245-5900 • FAX: (617) 246-0874

CIRCLE NO. 161

OakGrigsby On Rotary Switches

2

OF A SERIES

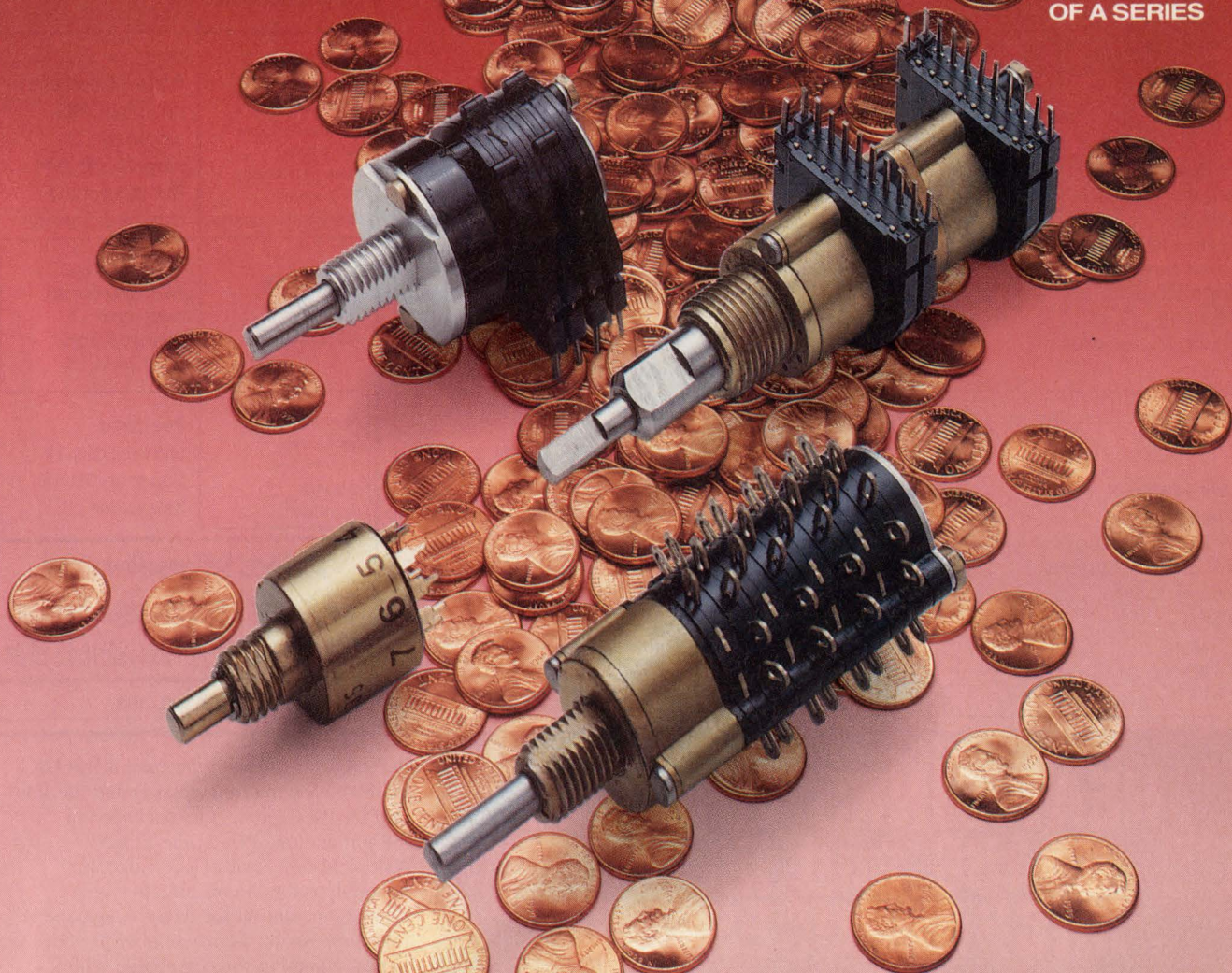

Excellence That Actually Costs Less.

At a progressive company like OakGrigsby, excellence is expected. Which is one reason it costs less.

Take our rotary switches, which we offer *customized* for significantly less cost than the *standard* components of our leading competitor.

They are produced in a quality-driven manufacturing environment which, therefore, lowers production cost. They may be purchased through a flexible customization program which allows us to react quickly to customer needs . . . shortening lead times.

Discover affordable excellence . . . the hallmark of today's most progressive electronics manufacturer.

Discover OakGrigsby.

OAK GRIGSBY™

Committed to customer satisfaction.

88 North Dugan Road • P.O. Box 890
Sugar Grove, Illinois 60554-0890
Phone: 708/556-4200 • Fax: 708/556-4216

Features

- ½" Enclosed Rotary Switches and Binary Coded Switches
- Compact sizes (.500" and .562" diameter)
- PC or solder lugs
- Sealed versions
- Fixed or adjustable stops
- Commercial or to military specifications

EDN-ACRONYMS & ABBREVIATIONS

A/D—analog to digital
ANSI—American National Standards Institute
ARB—arbitrary-waveform generator
ASIC—application-specific integrated circuit
CAE—computer-aided engineering
CMOS—complementary metal-oxide semiconductor
CPU—central processing unit
D/A—digital to analog
DAC—digital-to-analog converter
DCXO—digitally compensated crystal oscillator
DDS—direct digital (frequency) synthesis
DIP—dual in-line package
DSP—digital signal processing
EC—European Community
ECL—emitter-coupled logic
EEPROM—electrically erasable programmable read-only memory
8B/10B—a data-encoding scheme used in Fiber Channel that can encode eight data bits in ten clock cycles
EMC—electromagnetic compatibility
EMI—electromagnetic interference
ESCON—Enterprise Systems Connection; a fiber-optic-based data-communication scheme developed by IBM
FCC—Federal Communications Commission
FDDI—Fiber Distributed Data Interface
4B/5B—a data-encoding scheme used in FDDI that can encode four data bits in five clock cycles
GaAs—gallium arsenide; an alternative to silicon used as a substrate in ICs
IC—integrated circuit
IEC—International Electrotechnical Commission
IEEE-488—The Institute of Electrical and Electronics Engineers' standard for communication with instruments
I/O—input-output
ISA—Industry Standard Architecture; the I/O bus of most MS-DOS PCs
ISO—International Standards Organization
LAN—local-area network
MAC—media access control; a layer in a communication-protocol stack that handles network bandwidth allocation
MCXO—microcomputer-compensated crystal oscillator
MLT-3—multilevel transitional; a proposed encoding scheme that allows 100-Mbps communications on twisted-pair wire
NRZI—nonreturn to zero inverted; a data-encoding scheme used in data-storage and network applications
OCXO—oven-controlled crystal oscillator
OEM—original equipment manufacturer
100Base-T—a proposed encoding scheme that allows 100-Mbps communications on twisted-pair wire
OSI—Open Systems Interconnect; the 7-layer communication model defined by the ISO
pc board—printed-circuit board
PC—personal computer
PHY—physical, an FDDI sublayer that corresponds to the upper half of the physical layer defined in the OSI 7-layer stack
PLL—phase-locked loop
PMD—physical medium dependent; an FDDI sublayer that corresponds to the lower half of the physical layer defined in the OSI 7-layer stack
ppm—parts per million
RFI—radio-frequency interference

RS-232C—an Electronic Industries Association standard for serial communication popular in PCs
SBus—an expansion bus used in workstations made by Sun Microsystems
SCSI—Small Computer System Interface
SMT—station management; a part of the FDDI standard that lies outside the bounds of the 7-layer OSI model
SONET—synchronous optical network; a telecommunication standard conceived to replace T1
TCNS—Thomas-Conrad Network Standard; a proprietary 100-Mbps LAN designed by Thomas Conrad Corp

TCP/IP—transmission control protocol/internet protocol; a standard set of network protocols typically used with the Unix operating system
TCXO—temperature-compensated crystal oscillator
10Base-T—a type of Ethernet that operates on twisted-pair wire
VCXO—voltage-controlled crystal oscillator
VDE—German National Standards Institution (from its title in German)
XO—crystal oscillator

This list includes acronyms and abbreviations found in EDN's Special Report, Technology Updates, and feature articles.

GET MORE FROM OHMITE!

More Selection. More Performance. More Reliability.

Ohmite's advanced surface mount power resistor design gives you the broadest selection in the industry:

- Six Power Ratings – 0.8 to 3.0 watts
- Five Package Sizes
- Two Mounting Styles – Pedestal and Recessed Foot Mount
- Three Construction Types – Film, Wirewound, and Power Film
- Wide Ohm Range – .005 ohm to 10 Megohm
- Wide Tolerance Choice – 0.1% to 5%

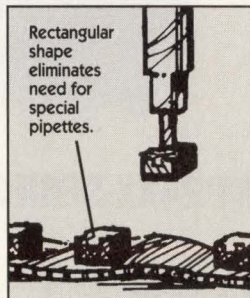

You get even more from Ohmite with full compatibility to major vacuum pick and place equipment and our patented flexible J-bend terminations which reduce solder joint breakage due to thermal expansion and vibration.

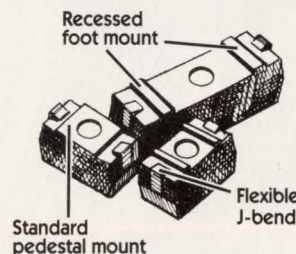

Your answer to Surface Mount Power Resistor Technology is Ohmite.
Tel 708-675-2600 Fax 708-675-1505

OHMITE®

Since 1925, Ohmite Manufacturing Co. has been in the forefront of innovative electronic component technology. Progressive and competitive, Ohmite maintains a tradition of quality and service.

Ohmite Manufacturing Co., 3601 Howard St., Skokie, IL 60076 Tel 708-675-2600 Fax 708-675-1505

POWER OVER

THE WIDE OPEN RANGE

When driving your system through a wide range of changing input voltages, take those curves with a Power Convertible.

You get high performance even under extreme temperatures. Nothing handles better in telecom and portable applications.



Cruise into distributing power with Power Convertibles' SMT construction, sleek profile and compact styling.

Burr-Brown quality and reliability fuel long lifetime mileage. The low cost will let you leave your power supply design worries in the dust.

3 WATT REGULATED DC/DC CONVERTER

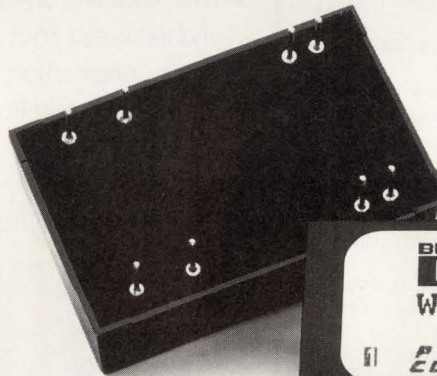

WPR4XX SERIES

- 2:1 Input Range
18-36 VDC
36-72 VDC
- DIP Package
- Extended Temperature Range
-40° to +85° C
- Low Cost - \$22⁹⁰
(1,000 pcs. US)

DRIVE THE WIDE RANGE with **POWER CONVERTIBLES™**

Call 1-800-548-6132 • Fax 1-602-741-3895

CIRCLE NO. 164

BURR-BROWN®
BB

Vendor designs demo package, creates \$50 data-acquisition unit

What Dataq had in mind was demonstrating its Codas computer-based oscillograph and data-acquisition system more effectively than a simple demo disk could. In its full-priced version, Codas embodies—besides software—hardware for the 16-bit ISA bus or the Micro Channel

module that you can easily connect to any PC.

The resulting \$49.95 package includes the 2×2×0.75-in. DI-100 module. The module plugs into a PC's COM1 RS-232C port and draws all of its operating power from the port. It contains a 1-channel, 10-bit, 5-ksample/sec

ADC, a digital-input port, and an oscillator that you can use as a signal source. You can use the module, as we did, simply to observe the oscillator's output waveform. But you can also apply signals of your own, digitize the data, store it on disk, and recall it for subsequent analysis. That analysis can include not just measurements of maximum and minimum values, but also DSP functions such as spectrum analysis and filtering.

Besides the module and data sheets, the package that EDN received from Dataq included an extension cable terminated in 9-pin D-subminiature

connectors. There was also a 9-pin male to 25-pin female D-subminiature adapter. You make your input-signal connections to a 4-position screw-terminal block on the module.

Also in the package were 5¼-in., 1.2-Mbyte and 3½-in., 1.44-Mbyte disks containing the demo software

and data files. The files are in packed form; running the Install program places them on your hard disk, where they occupy 1.5 Mbytes. Your PC must have 480 kbytes of free RAM. The demo disk contains data files that simulate the ADC output; therefore, if you obtain a copy of the disk from a friend (something that Dataq encourages) but you don't get the ADC module, you can still run the demo software.

The data sheet and the disk label indicate the need for a 640×480-pixel VGA display. Neither one states that a color display is needed, and, indeed, the monochrome display of our Toshiba T2000 laptop seemed quite adequate; there was no need to modify the display's mapping of colors to shades of gray. Several times, though, the speed of the laptop's LCD proved frustratingly slow; to obtain an acceptable waveform display, we had to try different effective sweep speeds. Were it not for the demo's promotional messages (complete with high-resolution graphics), a display with resolution lower than 640×480 pixels probably would work acceptably—if the software included appropriate drivers; it doesn't.

If your data-acquisition requirements are modest and involve only one channel, Dataq's \$49.95 demo package is a real bargain. Version 5.3 of the full-scale AT/MCA Codas product, including a data-acquisition board, sells for \$2790. Owners of earlier versions of the software can upgrade to Advanced Codas V3.1 for \$595.—**Dan Strassberg**

Dataq Instruments Inc, 825 Sweitzer Ave, Akron, OH 44311. Phone (800) 553-9006; (216) 434-4284.

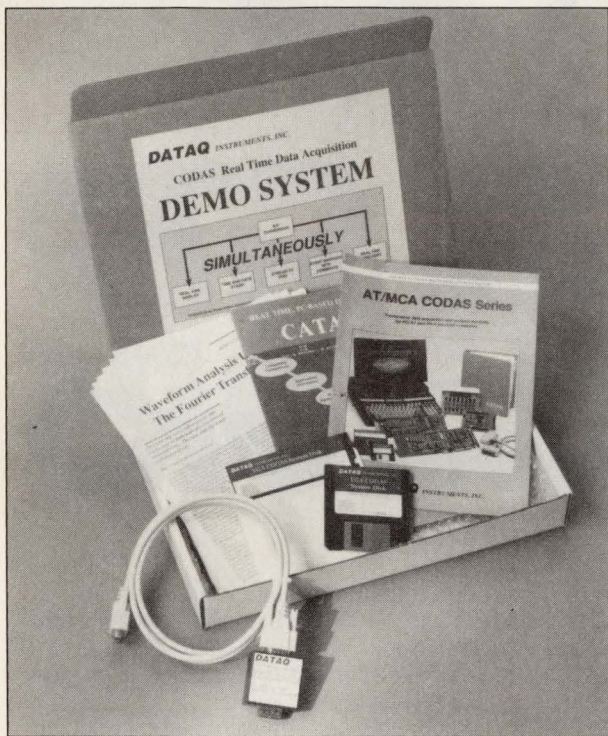

The RS-232C-interfaced ADC module in Dataq's Codas Demo version isn't very big. You can see it attached to the extension cable at the bottom of the photo.

Architecture bus. Although a disk containing demo software and files of previously acquired waveforms can provide a decent idea of what interacting with the real product is like, a demo that could let you acquire actual waveforms in real time would provide an even better simulation. So Dataq's engineers designed a minimum-cost hardware

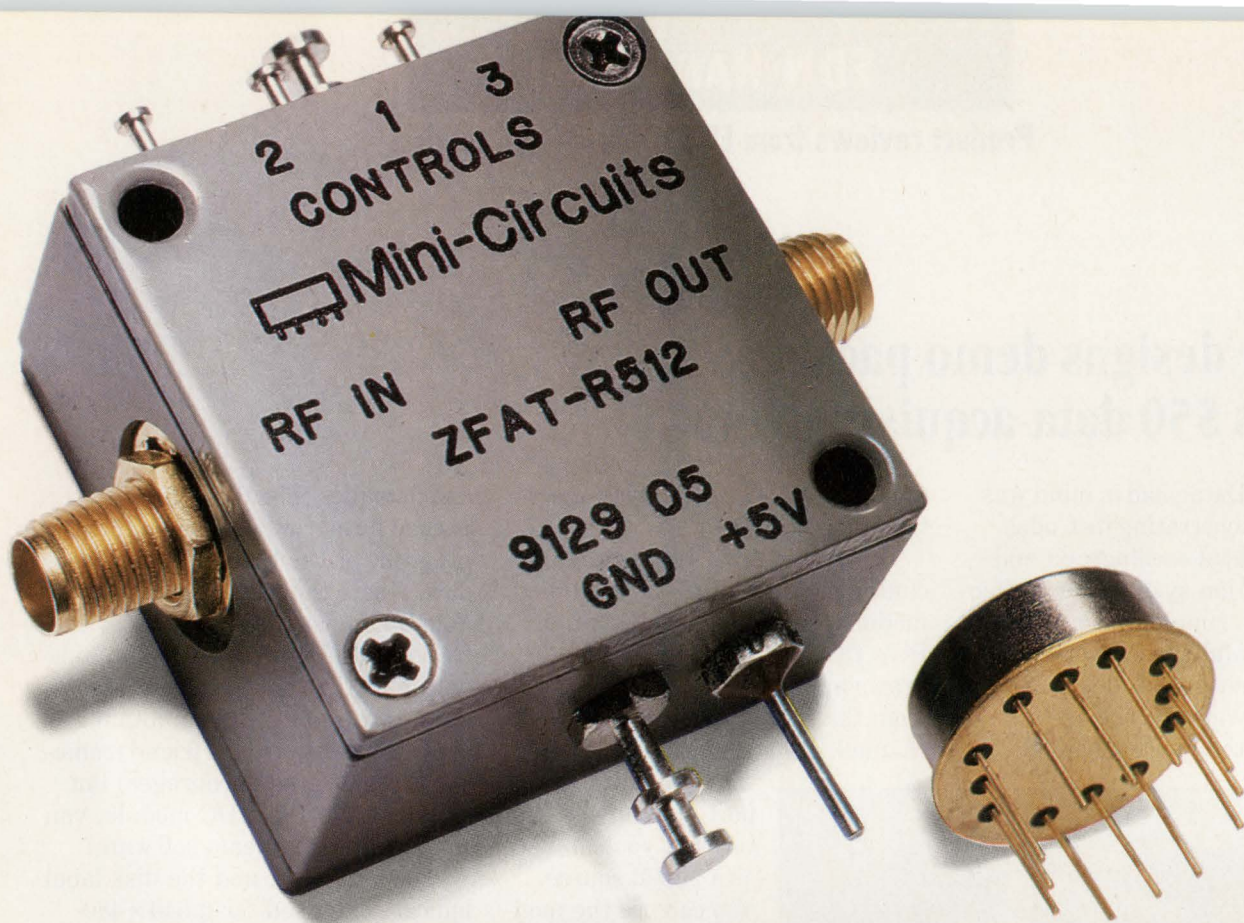

DIGITAL STEP ATTENUATORS

up to 35dB
10 to 1000MHz
FROM **\$59.95**

TOAT-R512 ZFAT-R512 Accuracy (dB) (+/-dB)	TOAT-124 ZFAT-124 Accuracy (dB) (+/-dB)	TOAT-3610 ZFAT-3610 Accuracy (dB) (+/-dB)	TOAT-4816 ZFAT-4816 Accuracy (dB) (+/-dB)	TOAT-51020 ZFAT-51020 Accuracy (dB) (+/-dB)					
0.5	0.12	1.0	0.2	3.0	0.3	4.0	0.3	5.0	0.3
1.0	0.2	2.0	0.2	6.0	0.3	8.0	0.3	10.0	0.3
1.5	0.32	3.0	0.4	9.0	0.6	12.0	0.6	15.0	0.6
2.0	0.2	4.0	0.3	10.0	0.3	16.0	0.5	20.0	0.4
2.5	0.32	5.0	0.5	13.0	0.6	20.0	0.8	25.0	0.7
3.0	0.4	6.0	0.5	16.0	0.6	24.0	0.8	30.0	0.7
3.5	0.52	7.0	0.7	19.0	0.9	28.0	1.1	35.0	1.0

Price \$ (1-9 qty) TOAT \$59.95/ZFAT \$89.95
bold faced values are individual elements in the units

Finally...precision attenuation accurate over 10 to 1000MHz and -55°C to +100°C. Standard and custom models are available in the TOAT(pin)- and ZFAT(SMA)-series, each with 3 discrete attenuators switchable to provide 7 discrete and accurate attenuation levels.

The 50-ohm components perform with 6μsec switching speed and can handle power levels typically to +15dBm. Rugged hermetically-sealed TO-8 units and SMA connector versions can withstand the strenuous shock, vibration, and temperature stresses of MIL requirements. TOAT pin models are priced at only \$59.95 (1-9 qty); ZFAT SMA versions are \$89.95 (1-9 qty).

Take advantage of this striking price/performance breakthrough to stimulate new applications as you implement present designs and plan future systems. All units are available for immediate delivery, with a one-yr. guarantee, and three-sigma unit-to-unit repeatability.

finding new ways...
setting higher standards

Mini-Circuits™

P.O. Box 350166, Brooklyn, New York 11235-0003 (718) 934-4500 Fax (718) 332-4661

Distribution Centers / NORTH AMERICA 800-654-7949 • 417-335-5935 Fax 417-335-5945 EUROPE 44-252-835094 Fax 44-252-837010

For detailed specs and computer-automated performance data (CAPD), refer to Thomas Register Vol. 23, MicroWaves Product Directory, EEM, or Mini-Circuits' 718-pg Handbook.

CIRCLE NO. 165

F 140 REV. I

MORNING EDITION

TECHNOLOGY
INNOVATION
SECTION

AMPERE NEWS

IR 900 And 1200 Volt IGBTs Replace Bipolar.

Current Events.



IR announces 900v and 1200v IGBTs in TO-3P and TO-220 packages.

They're the more efficient, faster switching, easier-to-design alternative to bipolar.

It's now official. Bipolar is yesterday's news.

IR announces

They're also more rugged, take up less board space, and less budget space. And like their 600v predecessors, they're bound to set new performance standards wherever they're designed in.

For more information



about the new 900v and 1200v TO-3P and TO-220 IGBTs, just phone your local IR rep, or the IR IGBT Marketing Group at 310/640-6534.

Or if you like your news delivered, we'll send you specs and samples.

IR International Rectifier

WORLD HEADQUARTERS: 233 KANSAS ST., EL SEGUNDO, CA 90245, U.S.A. (310) 322-3331. FAX (310) 322-3332. TELEX 472-0403. EUROPEAN HEADQUARTERS: HURST GREEN, OXTED, SURREY RH8 9BB, ENGLAND TELEPHONE (0883) 713215. TELEX 95219

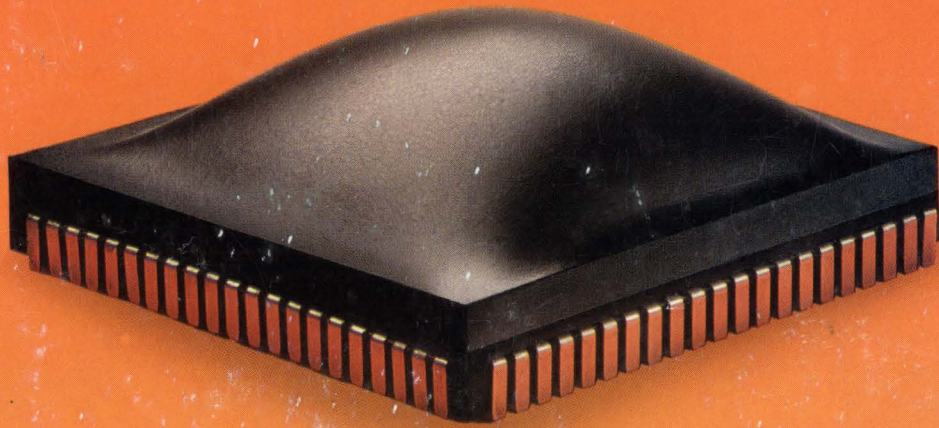

Pack more logic into every FPGA.

NEW ABEL-FPGA helps you get the most out of the latest FPGAs. If you want to take advantage of the sophisticated capabilities of today's FPGAs, only Data I/O's new ABEL-FPGA™ Design Software has the power to pack in maximum logic. It combines the industry-standard ABEL Hardware Description Language (ABEL-HDL™) with our new intelligent FPGA Device Fitter™

technology. So, you can create more complex designs with less effort — ABEL-FPGA does the hard work for you!

ABEL-FPGA's powerful Device Fitters automatically optimize your circuits for minimum area or maximum speed. Fitters are available for all the leading architectures, including Actel, Altera, AMD, Atmel, Cypress, ICT, National, Plus Logic, Texas Instruments, and Xilinx. And with built-in knowledge of its target architecture, each fitter masters the

complex features of its device automatically, intelligently.

Practical, detailed documentation, complete with FPGA design examples, also helps to ensure that you get the most from each architecture. And for added design power and flexibility, ABEL-FPGA lets you specify place-and-route constraints directly in your circuit description, so you can easily migrate the same design between multiple FPGA vendors.

Pack more logic into your next FPGA design, with the single solution to all your FPGA behavioral entry needs:

ABEL-FPGA.

Call us today to find out more about NEW ABEL-FPGA.



1-800-3-DataIO
(1-800-332-8246)

DATA I/O

CIRCLE NO. 167

ABEL-FPGA

Design Software

NEW
ABEL-FPGA
with FPGA
Device Fitters!

Data I/O Corporation 10525 Willows Road N.E., P.O. Box 97046, Redmond, WA 98073-9746, U.S.A. (206) 881-6444
1-800-3-DataIO (1-800-332-8246)
Data I/O Canada 6725 Airport Road, Suite 302, Mississauga, Ontario L4V 1V2 (416) 678-0761
Data I/O Europe 660 Eskdale Road, Winnersh, Wokingham, Berkshire, United Kingdom RG11 5TS, 0734 448899
Data I/O GmbH Lochhamer Schlag 5A, 8032 Grafelfing, Germany, -49 (0)89-858590
Data I/O Japan Sumitomo Seimei Higashi-Shinbashi Bldg., 8F, 2-1-7, Higashi-Shinbashi, Minato-Ku, Tokyo 105, Japan
011-81-3-3432-6991
Data I/O Limited 660 Eskdale Road, Winnersh, Wokingham, Berkshire, United Kingdom RG11 5TS, 0734 440011
©1992 Data I/O Corporation