

# EDN<sup>®</sup>

THE DESIGN MAGAZINE OF THE ELECTRONICS INDUSTRY

NEW PRODUCTS



LeCroy's 2G-sample/sec DSO stores 8M samples pg 150

February 3, 1994

## TECHNOLOGY UPDATES

PCI local bus gathers momentum pg 25

Digital HDTV system links computers with telecommunications pg 35

## DESIGN FEATURES

Step-up/step-down converters power small portable systems pg 79

Pick the right package for your next ASIC design pg 91

## DESIGN IDEAS

pg 71

Color video travels on twisted-pair cable

Circuit vocalizes telephone number

MOSFET replaces switch

Correlator works in presence of noise

Special Report:

**EMC components administer first aid**

pg 54

# CURRENT SHOWCASE

## Hall-Effect Latches For High-Temperature Operation — 3185

The 3185 Hall-Effect Latch is an extremely temperature-stable and stress-resistant sensor especially suited for operation over extended temperature ranges to +150°C. Superior high-temperature performance is made possible through a novel Schmitt trigger circuit that maintains operate and release point symmetry by compensating for temperature changes in the Hall element. Additionally, internal compensation provides magnetic switch points that become more sensitive with temperature, hence offsetting the usual degradation of the magnetic field with temperature. The symmetry capability makes these devices ideal for use in pulse-counting applications where duty cycle is an important parameter.

- Symmetrical Switch Points
- Superior Temperature Stability
- Operation From Unregulated Supply
- Open-Collector 25 mA Output

- Reverse Battery Protection
- Activate With Small, Commercially Available Permanent Magnets
- Solid-State Reliability ... No Moving Parts

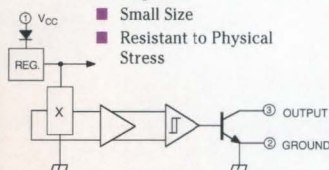

- Small Size
- Resistant to Physical Stress

## Ultra-Sensitive Bipolar Hall-Effect Switches — 3132

These Hall-Effect switches are designed for magnetic actuation using a bipolar magnetic field, i.e., a north-south alternating field. They combine extreme magnetic sensitivity with excellent stability over varying temperature and supply voltage. The high sensitivity permits their use with multi-pole ring magnets over relatively large distances.

- 4.5 V to 24 V Operation
- Reverse Battery Protection
- Superior Temperature Stability
- Superior Supply Voltage Stability
- Activate with Multi-Pole Ring Magnets
- Solid-State Reliability ... No Moving Parts
- Small Size
- Constant Output Amplitude
- Resistant to Physical Stress

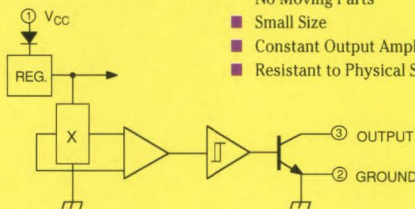

## Hall-Effect Switches For High-Temperature Operation — 3121

These Hall-Effect switches are monolithic integrated circuits with tighter magnetic specifications and switch points, designed to operate continuously over extended temperatures to +150°C, and are more stable with both temperature and supply voltage changes. The unipolar switching characteristic makes these devices ideal for use with a simple bar or rod magnet.

- Superior Temperature Stability for Automotive or Industrial Applications
- 4.5 V to 24 V Operation ... needs only an unregulated supply
- Open-Collector 25 mA Output ... Compatible with Digital Logic
- Reverse Battery Protection
- Activate with Small, Commercially Available Permanent Magnets
- Solid-State Reliability ... no moving parts
- Small Size
- Resistant to Physical Stress

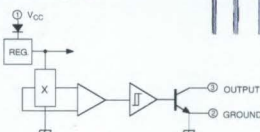

## Ratiometric, Linear Hall-Effect Sensors — 3503

The 3503 Hall-Effect sensor accurately tracks extremely small changes in magnetic flux density—changes generally too small to operate Hall-Effect switches.

As motion detectors, gear tooth sensors, and proximity detectors, they are magnetically driven mirrors of mechanical events. As sensitive monitors of electromagnets, they can effectively measure a system's performance with negligible system loading while providing isolation from contaminated and electrically noisy environments.

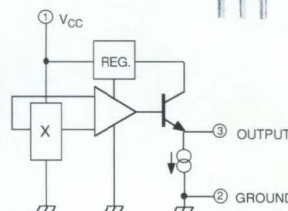

- Extremely Sensitive
- Flat Response to 23 kHz
- Low-Noise Output
- 4.5 V to 6 V Operation
- Magnetically Optimized Package

## Take A Test Drive... Call For Samples

Try these Allegro ICs in your breadboard. You'll find that you'll reduce your component count, increase reliability through use of monolithic solutions and protection features, as well as potentially lowering overall manufacturing costs. Sample and detailed technical information are now available. Just give us a call.

THE PACE QUICKENS



FORMERLY SPRAGUE SEMICONDUCTOR GROUP

CALL 1 • 508 • ALLEGRO

115 Northeast Cutoff, Worcester, Massachusetts 01615

**SUPERIOR SERVICE  
JUST GOT BETTER!**

**SAME-DAY**



**SHIPMENT**

**On orders entered by:  
5:00 pm central time.**

*Call, write or fax for your  
FREE CATALOG today!*

**NO RUSH FEES!!  
Plus, new extended hours -  
Now open until  
7:00 pm central time.**

**Digi-Key**<sup>®</sup>  
CORPORATION

701 Brooks Ave. So., Thief River Falls, MN 56701  
Toll Free: 1-800-344-4539, FAX: 218-681-3380

CIRCLE NO. 38

# Building Permit.

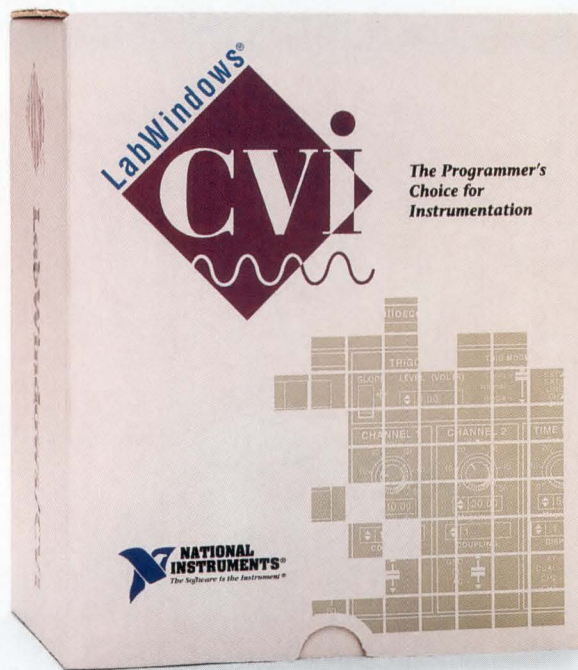

## Introducing LabWindows®/CVI for Windows and Sun

Constructing an instrumentation system? Whether it's data acquisition, process monitoring, or automated test, you'll have to integrate your system hardware and software, on time and under budget. Welcome to LabWindows/CVI – the software tools to take your system from blueprint to reality.

### Industry-Standard Foundation

LabWindows/CVI is based on industry standards – so it's flexible enough for any job. Program in C. Run under Windows or UNIX. Acquire data and control your instruments using the standard NI-488.2™, NI-VXI™, and NI-DAQ® driver software. Simplify instrument control with the 300+ drivers in the growing LabWindows GPIB, VXI, and RS-232 instrument libraries.

### Open Software Architecture

LabWindows/CVI is built on an open soft-

ware architecture. You can integrate external DLLs, object modules, or libraries into your LabWindows/CVI programs. Or, use the DDE or TCP/IP libraries to communicate with other applications and computers. And, you can run all of your programs created with LabWindows for DOS.

### Interactive Programming Tools

LabWindows/CVI combines the productivity of interactive code generation with the speed and flexibility of ANSI C programming. Whether you are a casual developer or a professional software engineer, you'll assemble instrumentation systems faster, easier, and more effectively with LabWindows/CVI.



Call now for a  
FREE brochure!  
(800) 433-3488  
(U.S. and Canada)



6504 Bridge Point Parkway • Austin, TX 78730-5039 • Tel: (512) 794-0100 • 95 (800) 010 0793 (Mexico) • Fax: (512) 794-8411

Branch Offices: Australia 03 879 9422 • Austria 0662 435986 • Belgium 02 757 00 20 • Canada 519 622 9310 • Denmark 45 76 26 00 • Finland 90 527 2321 • France 1 48 65 33 70 • Germany 089 714 50 93  
Italy 02 48301892 • Japan 03 3788 1921 • Netherlands 01720 45761 • Norway 32 848400 • Spain 91 640 0085 • Sweden 08 730 49 70 • Switzerland 056 27 00 20 • U.K. 0635 523545

© Copyright 1993 National Instruments Corporation. All rights reserved. Product and company names listed are trademarks or trade names of their respective companies.

# DC-2000 MHz AMPLIFIERS

In plastic and ceramic packages, for low-cost solutions to dozens of application requirements, select Mini-Circuits' flatpack or surface-mount wideband monolithic amplifiers. For example, cascade three MAR-2 monolithic amplifiers and end up with a 25dB gain, 0.3 to 2000MHz amplifier for less than \$4.50. Design values and circuit board layout available on request.

It's just as easy to create an amplifier that meets other specific needs, whether it be low noise, high gain, or medium power. Select from Mini-Circuits' wide assortment of models (see Chart), sketch a simple interconnect layout, and the design is done. Each model is characterized with S parameter data included in our 740-page RF/IF Designers' Handbook.

All Mini-Circuits' amplifiers feature tight unit-to-unit repeatability, high reliability, a one-year guarantee, tape and reel packaging, off-the-shelf availability, with prices starting at 99 cents.

Mini-Circuits' monolithic amplifiers...for innovative do-it-yourself problem solvers.

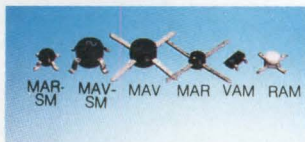

Models above shown actual size

from **99¢** Unit price \$ (25 qty)

PLASTIC SURFACE-MOUNT	MAR-1	MAR-2	MAR-3	MAR-4	MAR-6	MAR-7	MAR-8	MAV-11
add suffix SM to model no. (ex. MAR-ISM)	1.04	1.40	1.50	1.60	1.34	1.80	1.75	2.15
	MAV-1	+MAV-2	+MAV-3	MAV-4				
	1.15	1.45	1.55	1.65				
CERAMIC SURFACE-MOUNT	RAM-1	RAM-2	RAM-3	RAM-4	RAM-6	RAM-7	RAM-8	
	4.95	4.95	4.95	4.95	4.95	4.95	4.95	
PLASTIC FLAT-PACK	MAV-1	+MAV-2	+MAV-3	+MAV-4				MAV-11
	0.99	1.35	1.45	1.55	1.29	1.75	1.70	2.10
	MAR-1	MAR-2	MAR-3	MAR-4	MAR-6	MAR-7	MAR-8	
	0.99	1.35	1.45	1.55	1.29	1.75	1.70	
Freq. MHz, DC to	1000	2000	2000	1000	2000	2000	1000	1000
Gain, dB at 100MHz	18.5	12.5	12.5	8.3	20	13.5	32.5	12.7
Output Pwr. +dBm	1.5	4.5	10.0	12.5	2.0	5.5	12.5	17.5
NF, dB	5.5	6.5	6.0	6.5	3.0	5.0	3.3	3.6

Notes: + Frequency range DC-1500MHz ++ Gain 1/2 dB less than shown

designer's amplifier kits

**DAK-2:** 5 of each MAR-model (35 pcs), only \$59.95

**DAK-2SM:** 5 of each MAR-SM model (35 pcs) only \$61.95

**DAK-3:** 3 of each MAR, MAR-SM, MAV-11, MAV-11SM (48 pcs) \$74.95

designer's chip capacitor kit

**KCAP-1:** 50 of 17 values, 10pt to 0.1µf (850 pc), \$99.95

chip coupling capacitors at .12¢ each (50 min.)

Value  
Size (mils)  
80 x 50 10, 22, 47, 68, 100, 220, 470, 680 pf  
80 x 50 1000, 2200, 4700, 6800, 10,000 pf  
120 x 60 .022, .047, .068, .1µf

Typical Circuit Arrangement

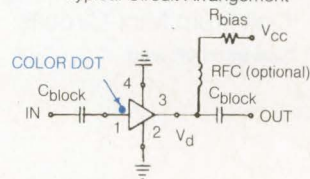

finding new ways ...  
setting higher standards

## Mini-Circuits™

WE ACCEPT AMERICAN EXPRESS AND VISA

P.O. Box 350166, Brooklyn, New York 11235-0003 (718) 934-4500 Fax (718) 332-4661

Distribution Centers / NORTH AMERICA 800-654-7949 • 417-335-5935 Fax 417-335-5945 EUROPE 44-252-835094 Fax 44-252-837010

For detailed specs on all Mini-Circuits products refer to • THOMAS REGISTER Vol. 23 • MICROWAVES PRODUCT DIRECTORY • EEM • MINI-CIRCUITS' 740-pg HANDBOOK.

F154 REV. A

CIRCLE NO. 40

# RF TRANSFORMERS

Over 80 off-the-shelf models...

3KHz-1500MHz from \$1<sup>95</sup>

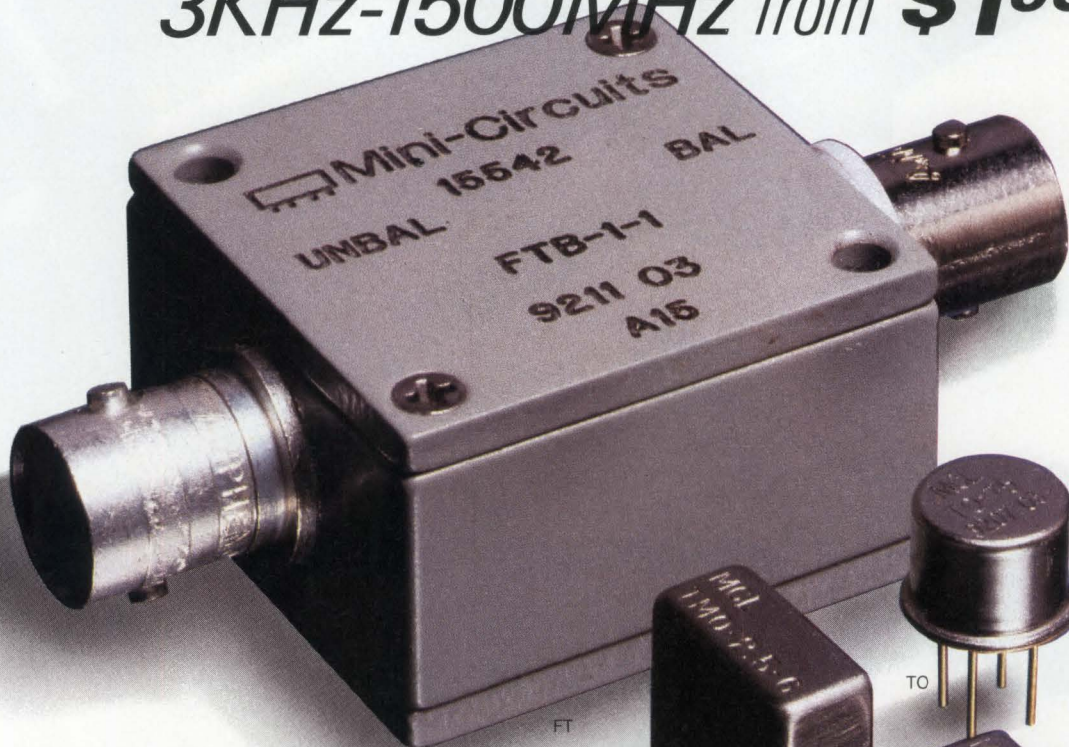

Having difficulty locating RF or pulse transformers with low droop, fast risetime or a particular impedance ratio over a specified frequency range?... Mini-Circuits offers a solution.

Choose impedance ratios from 1:1 to 36:1, in connector, TO-, flatpack, surface-mount, or pin versions (plastic or metal case built to meet MIL-T-21038 and MIL-T-55631 requirements\*). Coaxial connector models are offered with 50 and 75 ohm impedance; BNC standard, other types on request.

Ultra-wideband response achieves low droop and fast risetime for pulse applications. Ratings up to 1000M ohms insulation resistance and up to 1000V dielectric voltage. For wide dynamic range applications involving up to 100mA primary current, use the T-H series. Fully detailed data appear in our 740-pg RF/IF Designer's Handbook.

Need units in a hurry?...all models are covered by our exclusive one-week shipment guarantee. Only from Mini-Circuits.

\*units are not QPL listed.

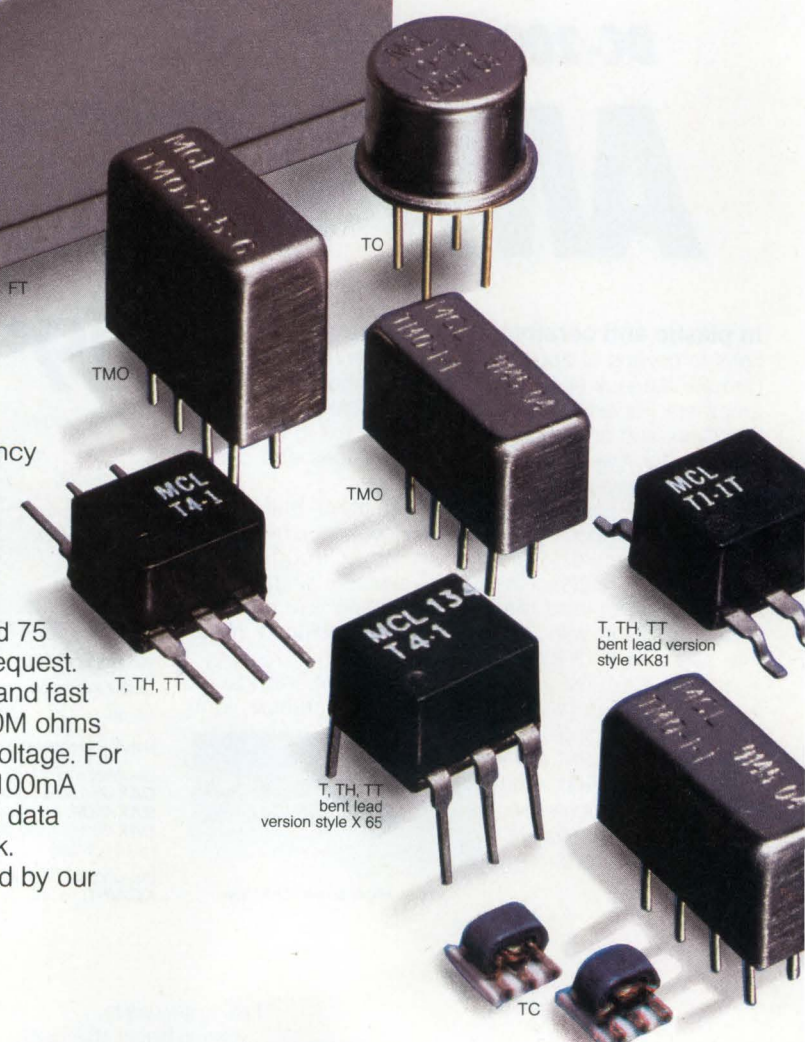

## Mini-Circuits®

P.O. Box 350166, Brooklyn, New York 11235-0003 (718) 934-4500 Fax (718) 332-4661

For detailed specs on all Mini-Circuits products refer to • THOMAS REGISTER Vol. 23 • MICROWAVES PRODUCT DIRECTORY • EEM • MINI-CIRCUITS' 740-pg HANDBOOK.



**On the cover:** Don't let your design become an EMC casualty—designing in components such as ferrite cores and beads, connector shields, gaskets, and conductive tape will help your product meet specification. See our Special Report beginning on .....**PG 54**  
(Photo courtesy 3M Electronic Products)

THE DESIGN MAGAZINE OF THE ELECTRONICS INDUSTRY

### SPECIAL REPORT

## EMC components administer first aid

54

Discovering late in the day that your product fails to comply with EMC regulations implies a tough redesign. A host of passive parts, applied simply and superficially, could be your salvation.

—*Brian Kerridge, Technical Editor*

### DESIGN FEATURES

## Step-up/step-down converters power small portable systems

79

Using four alkaline AA cells to power a product has many advantages. Simplicity of the regulated supply, however, isn't necessarily one of them. Even so, you have several choices of regulator topology—each with strengths and weaknesses.—*Bruce D Moore, Maxim Integrated Products*

## Pick the right package for your next ASIC design

91

The quest for higher integration levels in ASICs and competitive pressures to reduce system manufacturing costs has driven IC manufacturers to improve package capabilities and develop new methods. This article should help you evaluate the many choices available to find the best match of design performance and system costs.—*David P Pivin, ASIC Division, Motorola Semiconductor Products Sector*

EDN Magazine offers Express Request, a convenient way to retrieve product information by phone. See the Reader Service Card in the front for details on how to use this free service.

**EXPRESS REQUEST**

### DESIGN IDEAS

## Color video travels on twisted-pair cable

71

## Circuit vocalizes telephone number

72

## MOSFET replaces switch

72

## Correlator works in presence of noise

74

*Continued on page 7*

EDN® (ISSN 0012-7515, GST Reg. #123397457) is published 38 times per year, bi-weekly with one additional issue per month, by Cahners Publishing Company, A Division of Reed Publishing USA, 275 Washington Street, Newton, MA 02158-1630. Robert L. Krakoff, Chairman and Chief Executive Officer; Timothy C. O'Brien, Executive Vice President/Finance and Administration; Michael Wisner, Senior Vice President/General Manager, Boston Division; Michael Wisner, Vice President/Publishing Director. Circulation records are maintained at Cahners Publishing Company, 44 Cook Street, Denver, CO 80206-5800. Telephone (303) 388-4511. Second-class postage paid at Denver, CO 80206-5800 and additional mailing offices. **POSTMASTER: Send address changes to EDN®, PO Box 173377, Denver, CO 80217-3377.** EDN® copyright 1994 by Reed Publishing USA. Rates for non-qualified subscriptions, including all issues: US, \$140.00 one year, \$238.00 two year; Canada, \$209.00 one year, \$355.00 two year (includes 7% GST, GST# 123397457); Mexico, \$195.00 one year, \$332.00 two year; Foreign surface \$245.00 one year, \$417.00 two year; Foreign air expedited surcharge add \$152.00 one year, \$304.00 two year. Except for special issues where price changes are indicated, single copies are available for \$10.00 US and \$15.00 foreign. Please address all subscription mail to EDN®, 44 Cook Street, Denver, CO 80206-5800. EDN® is a registered trademark of Reed Properties Inc., used under license.

(Printed in USA)

What do you get with Siliconix'  
new 60-V, 8-m $\Omega$  MOSFET?

# COOLER ELECTRONICS FOR HOTTER CARS.

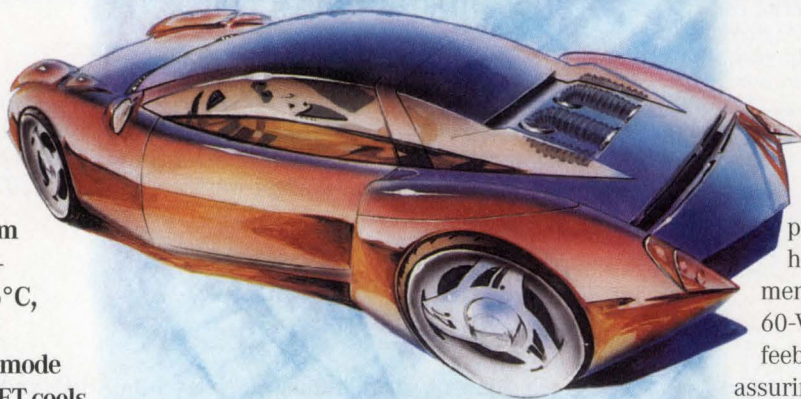

With maximum junction temperature of 175°C, this n-channel enhancement-mode TO-220 MOSFET cools down motor control.

It's unsurpassed for improving reliability and reducing part count. And has been funded in part by Daimler-Benz as an ideal motor control solution for HVAC, memory seat systems, and electric power steering. It can also be used in uninterruptible power supplies for computers.

#### Lower on-resistance for higher reliability.

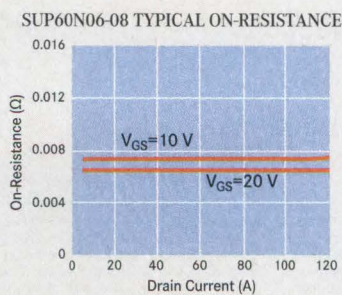

The rugged SUP60N06-08, with its guaranteed 8-m $\Omega$  maximum on-resistance and 175°C maximum junction temperature, will reduce power dissipation and enhance

performance in the harshest of environments. This is a robust 60-V solution, not a feeble 50-V product, assuring you of continuous operation, load dump...after load dump ...after load dump.

#### Unparalleled part count reduction.

Produced with Siliconix' new ultra-high density technology, this device eliminates the need for heatsinks and makes paralleling MOSFETs obsolete – use it to replace three industry-standard TO-220s and shrink your system size and cost.

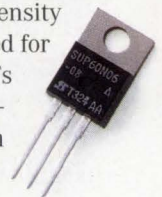

#### Create cooler car electronics.

Contact your local Siliconix/TEMIC sales office. Or call our toll-free hot line now! 1-800-554-5565, ext. 991. Ask for your SUP60N06-08 Design Kit, including SPICE model and free sample.

**Siliconix**  
A Member of the TEMIC Group

TEMIC/Siliconix U.S. Headquarters: 2201 Laurelwood Road, Santa Clara, CA 95056 Fax: (408)970-3950, Attn. 43-991. © Copyright 1993 Siliconix inc.  
TEMIC International Sales: UNITED KINGDOM: (0344)485757. GERMANY: (07131)670. FRANCE: (1) 30.60.70.00. ITALY: (02) 489-52258.  
SCANDINAVIA: 08-733-0090. SINGAPORE: 65-7886668 ext. 249. HONG KONG: 852-724-3377. JAPAN: 3-3578-0823.



**Home Office**

275 Washington St, Newton, MA 02158  
EDN Bulletin Board: (617) 558-4241  
MCI: EDNBOS  
Phone (617) 558-plus 4-digit extension below  
Fax (617) 558-4470

To send a message to an EDN editor via Internet, add "@MCI.MAIL.COM" to his or her MCI address.

**Publisher**

Jeffrey Patterson -4454

**Editor-in-Chief**

Steven H Leibson -4214

**Managing Editor**

Joan Morrow Lynch -4215

Gary Legg, *Senior Technical Editor* -4404

Charles Small, *Senior Technical Editor* -4556

MCI: EDNSMALL

Dan Strassberg, *Senior Technical Editor* -4205

MCI: EDNSTRASSBERG

John A Gallant, *Technical Editor* -4666

Frances T Granville, *Senior Associate Editor* -4344

Erin Haskell, *Associate Editor* -4333

James P Leonard, *Associate Editor* -4324

Gillian A Caulfield, *Production Editor* -4263

Doug Conner, *Technical Editor*

Atascadero, CA: (805) 461-9669

MCI: EDNDCONNER

Richard A Quinnell, *Technical Editor*

Aptos, CA: (408) 685-8028

MCI: EDNQUNNELL

David Shear, *Technical Editor*

Corvallis, OR: (503) 754-9310

MCI: EDNSHEAR

Anne Watson Swager, *Technical Editor*

Wynnewood, PA: (215) 645-0544

MCI: EDNSWAGER

Ray Weiss, *Technical Editor*

Woodland Hills, CA: (818) 704-9454

MCI: EDNWEISS

Brian Kerridge, *Technical Editor*

22 Mill Rd, Loddon

Norwich, NR14 6DR, UK

(5085) 28435

MCI: EDNKERRIDGE

EDN Asia, Mike Markowitz, *Editor*

Cahners Asia Limited

19th Floor, Centre Point

181-185 Gloucester Rd, Wanchai, Hong Kong

Phone (852) 838-2666; fax (852) 575-1690

**Contributing Technical Editors**

Robert Pease, Don Powers, Dave Pryce, Bill Travis

**Assistant to Editor-in-Chief**

Kathy Leonard -4405

**Editorial Services**

Helen Benedict, Senior Secretary -4681

**Art Staff**

Robert L Fernandez, *Art Department Director*

Ken Racicot, *Senior Art Director* -4708

Chinsoo Chung, *Associate Art Director* -4446

**Marketing & Business Director**

Deborah Virtue -4779

**Marketing Communications**

Patricia Tyler, *Director of Marketing Services*

and *Custom Publishing* -4526

Jean Graham, *Promotion Assistant* -4698

**EDN Products**

301 Gibraltar Dr, Box 650

Morris Plains, NJ 07950

Phone (201) 292-5100

Fax (201) 292-0783

**Group Publisher**

Terry McCoy, Jr

**Associate Publisher**

Steven P Wirth, (201) 292-5100, ext 380

**Editorial Director**

Richard Cunningham, (702) 648-2470

**Editor-in-Chief**

Bruce Bennett, (201) 292-5100, ext 390

**Managing Editor**

Carol Coleman, (201) 292-5100, ext 330

**Production Manager**

Sheila Rodgers, (201) 292-5100, ext 287

**Customer Service Manager**

Jen Brinkman, (201) 292-5100, ext 322

**Design Director, Art Director**

John M Angelini, Beverly Blake

**TECHNOLOGY UPDATES**

**PCI local bus gathers momentum 25**

Both the PCI local bus and the VL bus let high-speed peripherals bypass a PC's slow expansion bus. But PCI is gaining favor among designers, and a crop of new PCI components is starting to simplify local-bus design.—*Gary Legg, Senior Technical Editor*

**Digital HDTV system links computers with telecommunications 35**

After almost seven years of proposals, testing, and FCC advisory-committee meetings, a US standard for HDTV could be in its final testing phase by the end of this year. Some early technical decisions define the minimum system requirements.—*Anne Watson Swager, Technical Editor*

**EDITORIAL**

**Raise your expectations 18**

You tend to get what you expect. If you expect the worst, it can generally find you. However, expect the best, and events can go your way.—*Steven H Leibson, Editor-in-Chief*

**NEW PRODUCTS**

Embedded Systems .....	110
Integrated Circuits .....	115
Electronic Design Automation .....	133
Computers & Peripherals .....	139
Components & Power Supplies .....	141
Boards and Buses .....	147
Test & Measurement .....	150

**DEPARTMENTS**

News Breaks .....	13
Career Opportunities .....	156
Business Staff .....	159
EDN's International Advertisers Index .....	160

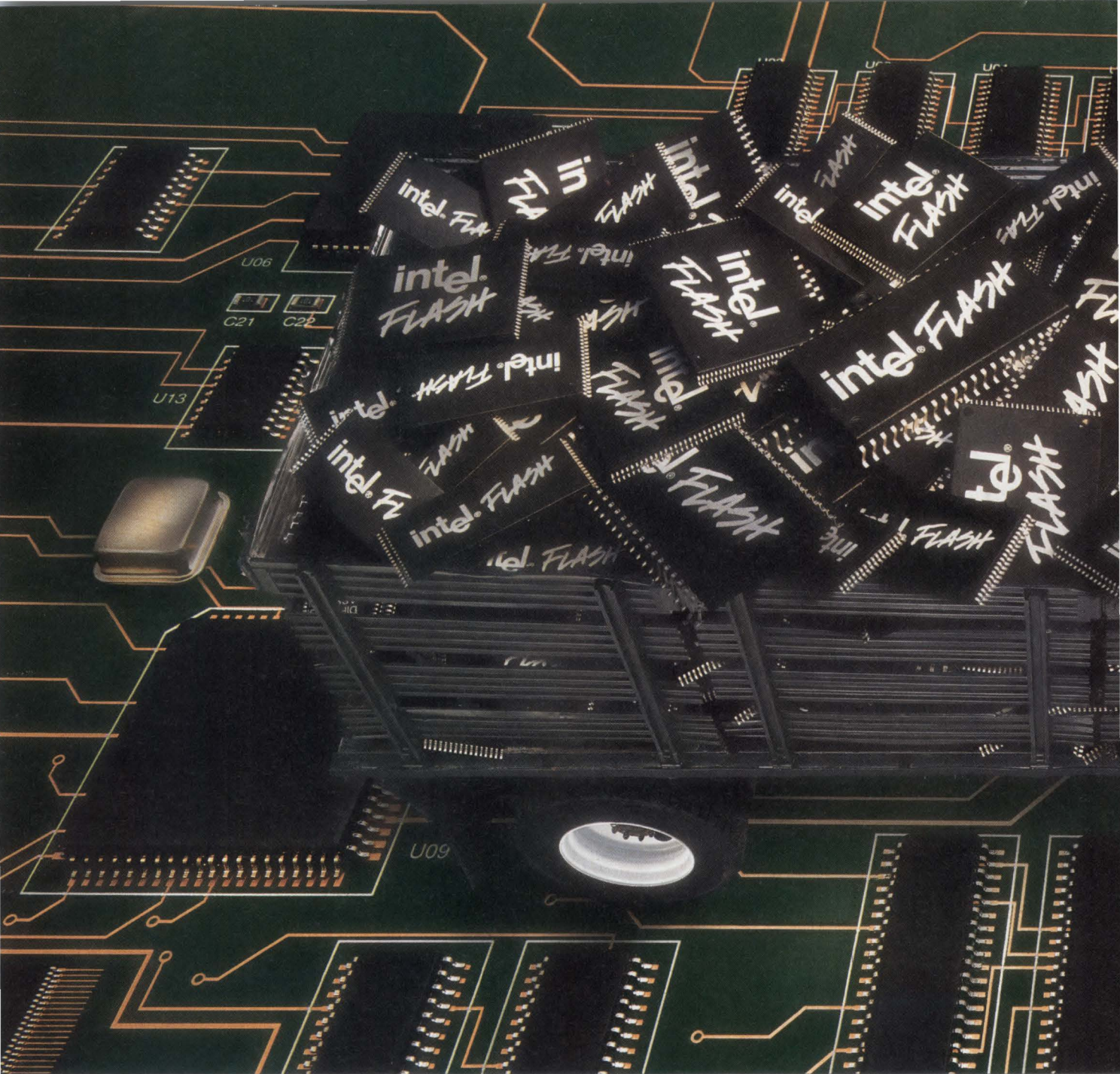

# We not only have a ton of these,

Intel Flash Memory is shipping in high gear. Our factory capacity is up. Our prices are coming down. And we're leading the industry in flash technology.

The shortage is over. With three flash factories now on line, Intel can support both your immediate and long-term needs. In fact, our sub-micron process

in each factory allows us to provide multiple sources for our flash products to ensure delivery.

What's more, our new capacity is so huge, we'll outsupply all other flash manufacturers. Combined!

We're also growing the market by driving down flash prices, making Intel Flash

Intel Flash Memory Factory Output

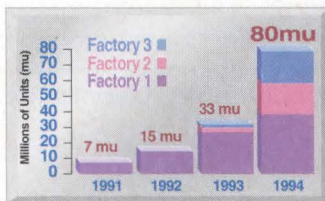

Intel Flash Component Pricing Trend\*

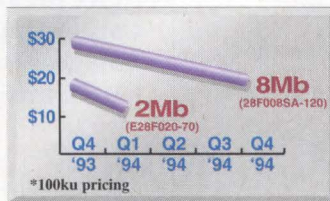

© 1994 Intel Corporation. \*Based on 9/93 Dataquest forecast of total flash units to ship in 1994.

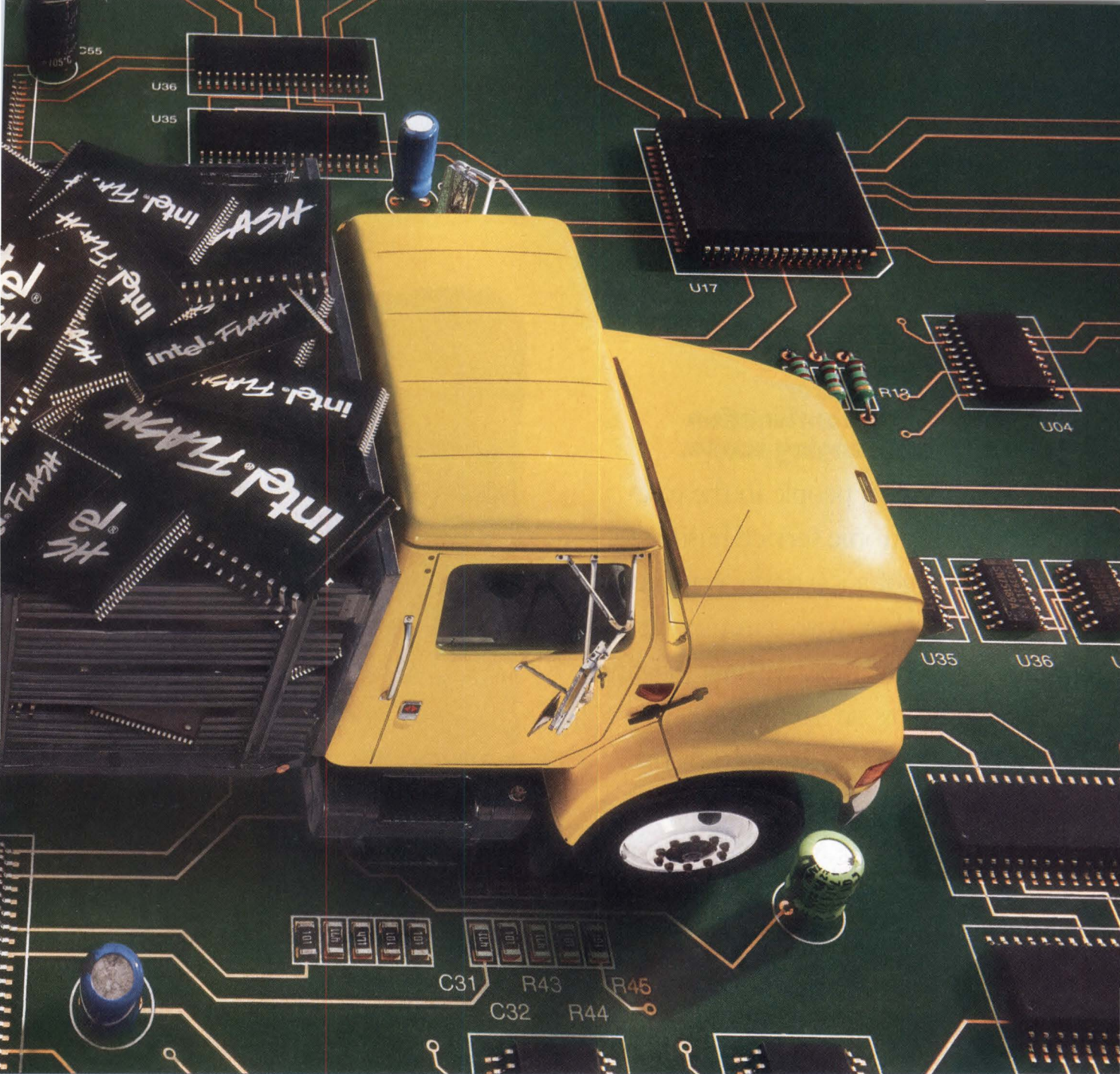

# but now you'll also save a ton.

Memory a viable option for virtually any new design. In fact, since Q4 '93, we've dropped prices by as much as 31 percent. And by the end of the year, the volume price for our 120ns, 8Mb FlashFile™ devices will be as low as \$20.

This is an opportune time to get the design wheels rolling, too. Because you can now purchase one hundred 8Mb devices for just \$25 each.

With chips from 256Kb to 32Mb, to PCMCIA Flash Cards and ATA Flash Drives, Intel also gives you

by far the broadest, most technologically advanced line of flash products in the industry.

So if you're ready to load up on flash memory, call 1-800-879-4683, ext. 101 for complete information. Because Intel is more than ready to deliver.

**intel**®

# The newest tool

## Introducing TekMeter.<sup>™</sup> The easy-to-use combination DMM and autoranging scope.

If you're like most people in the electrical and electronic service business, when you've got a job to do, you need to get it done fast, with a minimum of hassle. And preferably without juggling a bunch of tools on site.

To answer these concerns, Tektronix created TekMeter. Designed with input from customers, TekMeter is the only test and measurement tool that integrates true RMS multimeter and auto-ranging oscilloscope capabilities in one

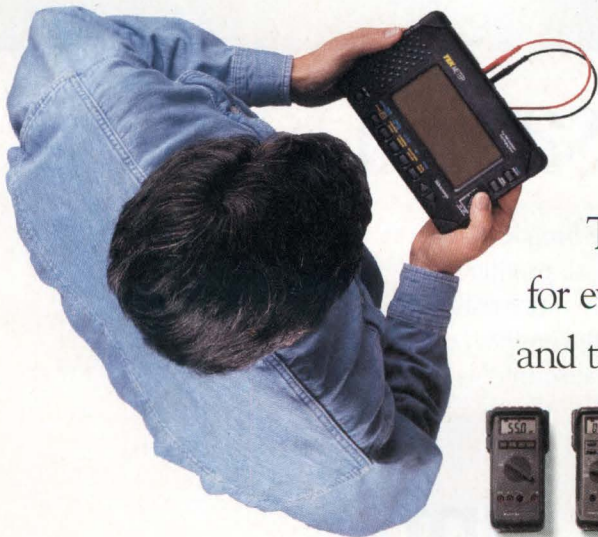

powerful yet lightweight package.

Best of all, you don't have to learn scope skills. TekMeter has a familiar DMM-like interface for every function. You just hook up the probes and toggle between DMM and waveform. At the



Check out the entire TekTools<sup>™</sup> line for all your measurement needs.

# ol of the trades.

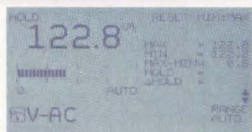
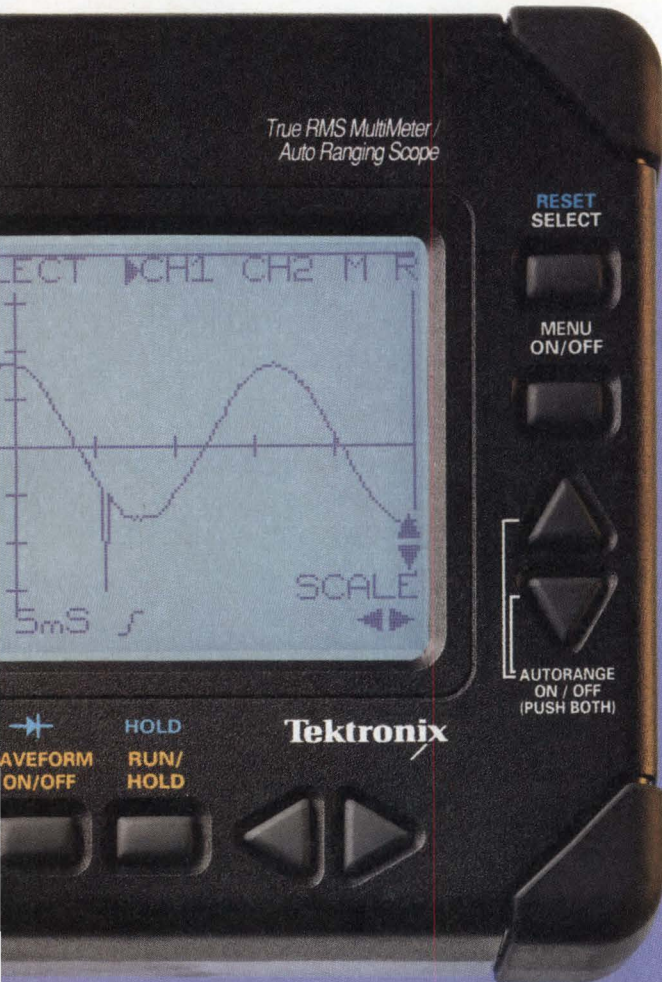

distributor, call 1-800-426-2200, ext. 800 and put one to the test.

Once you've seen everything TekMeter can do—and how easily it does it—we think you'll agree it's the one tool you won't want to trade for anything else.

push of a button, you'll see exactly what you're measuring.

### **Easy to afford, too.**

At only 2.2 pounds, TekMeter won't weigh heavily on your belt, and it won't do much damage to your wallet, either. Starting at \$859,\* the TekMeter packages a remarkable set of capabilities that will enhance your productivity and will be easy to justify.

### **Put one in your hands today.**

Of course, the best way to take full measure of TekMeter is to try it for yourself. For the name of your nearest authorized Tektronix



*Come test drive the TekMeter at your local distributor and judge for yourself.*

# Tektronix

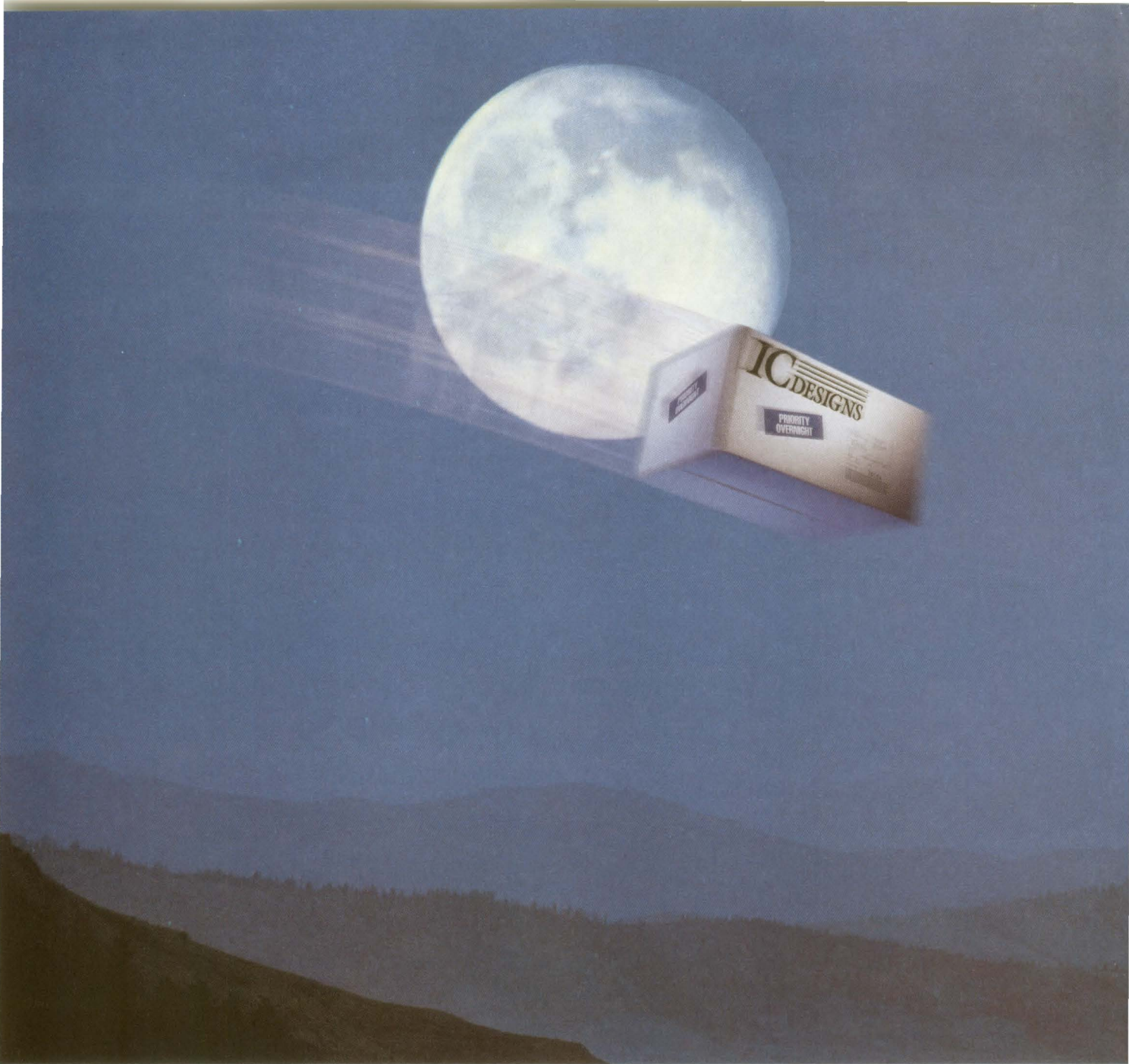

## **CUSTOM OSCILLATORS. OVERNIGHT.**



Don't wait weeks for custom oscillators. Get them programmed overnight. Introducing QuiXTAL™ ICD6233 Programmable Metal Can Oscillators from the IC Designs subsidiary of Cypress Semiconductor.

QuiXTAL is a direct replacement for conventional metal can oscillators—identical in form, fit, and function—and can be programmed to generate any frequency from 0.6 to 120 MHz. Your order is programmed the same day you call and shipped to you the very next day. Not only will you save time, you'll save money. QuiXTAL oscillators offer a 30% savings over other custom-frequency oscillators.

Call for our overnight order package! **1-800-858-1810\* Dept. C4D.**



\*In Europe, fax your request to the above department at (32) 2-652-1504 or call (32) 2-652-0270. In Asia, fax to the above department at 1-415-940-4343. IC Designs is a subsidiary of Cypress. QuiXTAL is a trademark of IC Designs. © 1993 Cypress Semiconductor, 3901 North First Street, San Jose, CA 95134 Telephone 1-408-943-2600, Telex 821032 CYPRESS SNJ UD, TWX: 910-997-0753.

EDITED BY FRAN GRANVILLE

## Synopsys and Xilinx announce 5-year partnership

Synopsys and Xilinx have announced a 5-year partnership in an effort to reduce overall time to market of the companies' designs. The two companies want to collaborate to reduce the time to create a hardware-description-language (HDL) design. But HDL design is only part of the problem. Designers must also synthesize the design into cells and place and route the design. Furthermore, to be competitive, a design must be speed and area efficient compared with other design methodologies. The partnership will focus on improving every step in the process from design to production, including the creation of an FPGA family for HDL-design tools.—by Doug Conner

Synopsys Inc, Mountain View, CA, (415) 962-5000. **Circle No. 500**

Xilinx Inc, San Jose, CA, (408) 559-7778. **Circle No. 501**

## Chinon and Microsoft offer Visual C++ bundle

Microsoft and Chinon are offering a hardware/software package that includes Visual C++ Professional Edition version 1.5 and a choice of an internal or an external Chinon CD-ROM drive. The \$749 package is available until February 28 to registered users of Visual C++. The package shaves \$300 off the separate products' retail prices.

The drives offer 220-msec access times and are MPC2 and multisession photo CD compatible; adding a \$99 driver option lets the CDX-535 read Macintosh CD-ROM disks. Both drives are fully compatible with the Windows NT operating system and come with a SCSI adapter card, cables, and software.

Visual C++ Professional Edition version 1.5 offers enhancements over previous versions, such as wizards for mastering Object Linking and Embedding (OLE) 2.0 and Open Database Connectivity (ODBC). The program can now run under Windows NT, as well as Windows 3.1.

A concurrent \$649 offer combines the

16-bit Visual C++, Professional Edition, version 1.5 with the recently released Visual C++ 32-bit Professional Edition. The resulting Visual C++ 16/32-bit Professional Development systems for Windows and Windows NT contains both products, as well as a choice of the Chinon drives.

—by Fran Granville

Chinon America Inc, Torrance, CA, (800) 441-0222. **Circle No. 502**

Microsoft Corp, Redmond, WA, (206) 882-8080. **Circle No. 503**

## PCMCIA card connects notebooks to IEEE-488.2 bus

The ines IEEE-488.2 PCMCIA (Type II) interface adapter allows PCs with PCMCIA slots to communicate with GPIB systems. The device includes software drivers for DOS and Microsoft Windows applications. These drivers support HPIB IEEE-488.2-bus implementations that use standard commands for programmable instrumentation (SCPI) or Hewlett-Packard's standard instrumentation-command language (SICL).

A 25-way ribbon cable connects the card to an in-line standard HPIB connector. The card uses the company's i72010 GPIB controller chip—the latest in a line of GPIB chips. The i72010 is a 3.3V, 100-pin quad flatpack device that will be generally available beginning in the second quarter of this year.

The 68-pin plastic leaded chip carrier i72010 costs DM 100, and the 40-pin DIP i7210 costs DM 50. The company plans to offer an i9914 version, which is pin compatible with Texas Instruments' 9914 chip, in the second quarter.

Although backward compatible with the older NEC7210 and TI9914 GPIB chips, the ines chips also expand 488.2 bus implementation beyond some features of National Instruments' later TNT4882 controller chip. For example, the 2×255-byte FIFO buffer in the ines chip allows an interface to transfer character-hungry SCPI data strings independently of a PC processor and at a maximum bus rate of 1.1 Mbytes/sec (8-bit mode) under software control. The ines's chips also allow simultaneous recognition of 3 end-of-string

## SHORTS

**Arrow acquires Field.** Arrow Electronics has acquired the electronic-component division of Field Oy, Helsinki, Finland. Field, the largest distributor of electronic components in Finland, is a subsidiary of Instrumentarium Corp. Principal suppliers to Field include Advanced Micro Devices, Hewlett-Packard Co, Motorola, and Xilinx. Arrow Electronics, Melville, NY, (516) 391-1300. **Circle No. 511**

**TSSI expands into EDA.** Test System Strategies Inc (TSSI), known for its test-software tools that link data from CAE tools to automatic test equipment, has announced intentions to enter the electronic-design-automation industry. The company's goals are to facilitate top-down design methodologies based on efficient use of hardware-description languages.

**Circle No. 512**

**Color terminal costs less than \$400.** Pagine has introduced a DEC VT420 terminal that costs \$399. The C20A drop-in replacement for conventional monochrome VT420 terminals offers 32 independent and simultaneous colors—16 foreground and 16 background—from a palette of 262,144 colors. Pagine Corp, San Jose, CA, (408) 944-9728.

**Circle No. 513**

**Protel redefines distribution.** Protel Technology, a developer of Windows-based EDA tools, has appointed the following regional distributors for North America: Abcor, Houston; Beta Lamda, Freehold, NJ; CADForce, Toronto; Software Tools, Waukesha, WI; Syntek, Bellevue, WA; Trilogic Inc, Wilmington, MA; Trilogic Sunforce, West Melbourne, FL; and Tusar, Scottsdale, AZ. Protel Technology, Santa Clara, CA, (800) 544-4186.

**Circle No. 514**

(EOS) bytes, a message-available (MAV) reset, and T8 timer support for interface-clear (IFC) commands.

In addition, it supplies evaluation boards and device-driver development kits, which include a license-free IEEE-488.2 ANSI C module for you to recompile. The IEEE-488.2 PCMCIA (Type II) interface with drivers costs DM 1875.—by Brian Kerridge

ines-Innovative Elektronik Systeme GmbH, Cologne, Germany, (221) 492299. **Circle No. 504**

ines-Innovative Elektronik Systeme Inc, Englewood, CO, (303) 779-8354.

**Circle No. 505**

## Siemens develops hand-gesture-recognition system

Researchers at Siemens in Munich have developed a system that responds to hand movements. A wave of a finger can cause objects on a screen to move or rotate, or the gesture can initiate a command sequence.

The system recognizes gestures in two stages. First, it uses information from a video camera to compute the contour of a hand and the direction the hand is facing. Second, the system uses rules to classify the type of movement the hand is making. For example, it can differentiate among a fist, a pointed

index finger, and a thumb moving to the left or right. Once the system registers a motion, it assigns a meaning to that motion. For example, a thumb gesture to the left can move the screen contents to the left. The delay between the motion and the response is less than 0.1 sec; standard image rate is 25 images/sec.

The technology will have applications in virtual environments. For example, users could "walk through" a simulated office using hand movements and move and manipulate objects simply by "touching" them. Another application involves intuitive track diagrams for a train switch yard in which users could move freely across a simulated site, set the switches, and obtain information by "tapping" the desired objects, such as freight cars.—by Fran Granville

Siemens AG, Munich, Germany, (089) 2340. **Circle No. 506**

## Synopsys and Logic Modeling to merge

Subject to stockholder and regulatory approvals, Synopsys and Logic Modeling Corp (LMC) expect to merge in March. LMC will remain as a different business unit with headquarters in Beaverton, OR. LMC President and Chief Executive Officer William Lattin will continue to serve as president of the Logic Modeling unit. LMC is the leading source of models for board and system-level simulation.—by Doug Conner

Logic Modeling Corp, Beaverton, OR, (503) 690-6900. **Circle No. 507**

Synopsys Inc, Mountain View, CA, (415) 962-5000. **Circle No. 508**

## Skip the commercials

Arthur D Little has developed a technology called Commercial-Free, which automatically eliminates commercials from any VCR-recorded TV program. While the VCR is recording, the system monitors the broadcast for video and audio events, such as black frames and low sound energy, which occur at the beginning and end of each commercial. Simultaneously, the system writes a binary tim-

ing and recording-session identification code into a nonviewable portion of the video signal recorded onto the videotape.

At the conclusion of recording, the system uses a proprietary algorithm to identify which of the audio and video events noted mark the beginning and end of each commercial break. The system time-stamps, stores in memory, and post-processes the audio and video events. It then creates a playback "map" for the recorded program and stores it in memory.

Upon playback, the system reads the identification code for the recording session from the tape and retrieves the playback map from memory. The moment the program enters the leading break for a commercial, it displays a flat blue field on the screen, and the VCR enters "forward-search" mode. The blue screen masks the garbled high-speed picture normally associated with the VCR's forward-search mode, thus making the process transparent to the viewer. Furthermore, because today's VCRs can scan through 3 minutes of recorded material in less than 5 sec, the process is unintrusive. At the conclusion of the commercial break, the VCR re-enters play mode, and the video picture returns to the screen.

—by Fran Granville

Arthur D Little Enterprises Inc, Cambridge, MA, (617) 498-5000.

**Circle No. 509**

## Software helps solve serviceability problems

Boothroyd-Dewhurst has released version 1 of the Design for Service (DFS) analysis program. The software allows engineering teams to consider serviceability issues while performing traditional design-for-assembly (DFA) analysis. DFS provides information on disassembly and reassembly times; a serviceability rating index; and labor, operation, part, and replacement costs. Boothroyd-Dewhurst has integrated the software with version 7 of the company's DFA software, which uses assembly information to generate DFS reports.—by Fran Granville

Boothroyd-Dewhurst Inc, Wakefield, RI, (401) 783-5840. **Circle No. 510**

## LITERATURE

**Literature describes modulation analyzers.** This free 6-pg, color brochure describes the ME2627B digital modulation analyzer and provides full specifications. Anritsu Wiltron Sales Co, Morgan Hill, CA.

**Circle No. 515**

**Catalog describes intelligent data-acquisition peripherals.** This free, 32-pg color catalog describes the vendor's high-performance ISA-bus-based data-acquisition boards and accessories. The publication details the processors that run a real-time operating system and the host software. Microstar Laboratories Inc, Bellevue, WA.

**Circle No. 516**



# DESIGN COMPLEX PLDs WITHOUT LEAVING YOUR SYSTEM BEHIND

PLSyn is the most advanced desktop programmable logic synthesis system available. Part of the **Design Center** family of products, it offers device-independent logic synthesis fully integrated with a mixed-signal design environment.

## DESIGN YOUR SYSTEM...

PLSyn lets you concentrate on your system, not on the PLDs. It is the only desktop system that allows you to design and simulate a system containing programmable logic, discrete digital, and analog parts all on the same schematic. You can describe your logic using a powerful synthesis language, logic symbols, or a combination of both. Programmable logic is automatically compiled and simulated with the rest of your system—even if it includes analog! You no longer need to piece together separate programmable logic, discrete logic, and analog simulations to be sure your system will work.

## ...THEN CHOOSE THE PARTS

When logic design is complete, PLSyn helps you find the best parts to use. You define your own goals for price, speed, and power consumption. PLSyn does the rest. It searches a library of over 4,000 devices, including the new large complex PLDs from AMD and others. PLSyn can even automatically partition your design into several different types of parts to meet your design goals. Whether you are new to programmable logic, or an experienced PLD user, the **Design Center's** PLSyn is your most productive programmable logic design system. Call today for more information!



SCHEMATIC CAPTURE



MIXED-SIGNAL SIMULATION



DIGITAL SIMULATION

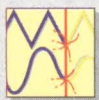

ANALOG SIMULATION



SIGNAL INTEGRITY



PROGRAMMABLE LOGIC SYNTHESIS

Design Center and PSpice are registered trademarks of MicroSim Corporation. All other trademarks are the property of their respective owners.

• CIRCLE NO. 150 FOR IBM

• CIRCLE NO. 152 FOR SPARCSTATION



**MicroSim Corporation**

*Providing the Best in Desktop EDA*

20 FAIRBANKS • IRVINE, CA 92718 • USA  
(714) 770-3022 • (800) 245-3022  
FAX: (714) 455-0554 • BBS: (714) 830-1550

Some people SEE  
**HOT VIDEO** technology.

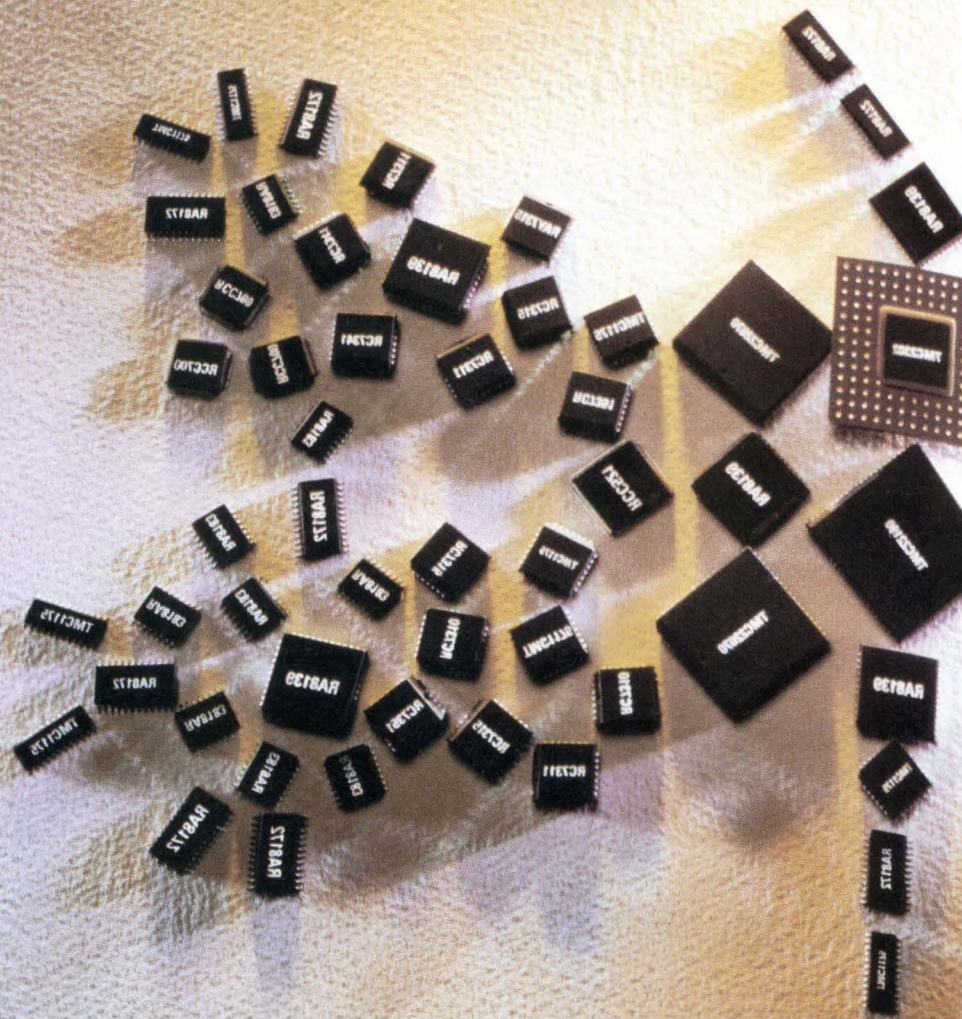

Some people SEE  
**ADVANCED ATE.**

To see your visions take shape, choose a partner who's committed to delivering higher performance at a lower cost.

When you think of innovative and affordable ICs, what comes to mind?

If it's not Raytheon Semiconductor, then maybe you should take a closer look at one of today's most valuable and experienced partners.

You see, Raytheon Semiconductor offers you advanced solutions to help you get the absolute most from video, high-speed communications and ATE designs. This includes bringing you — at the right price — a full family of ICs that push the limits of performance. And whether you need standard products or semi-custom ICs, we'll work with you at every step.

# Some people SEE HIGH-SPEED COMMUNICATIONS.

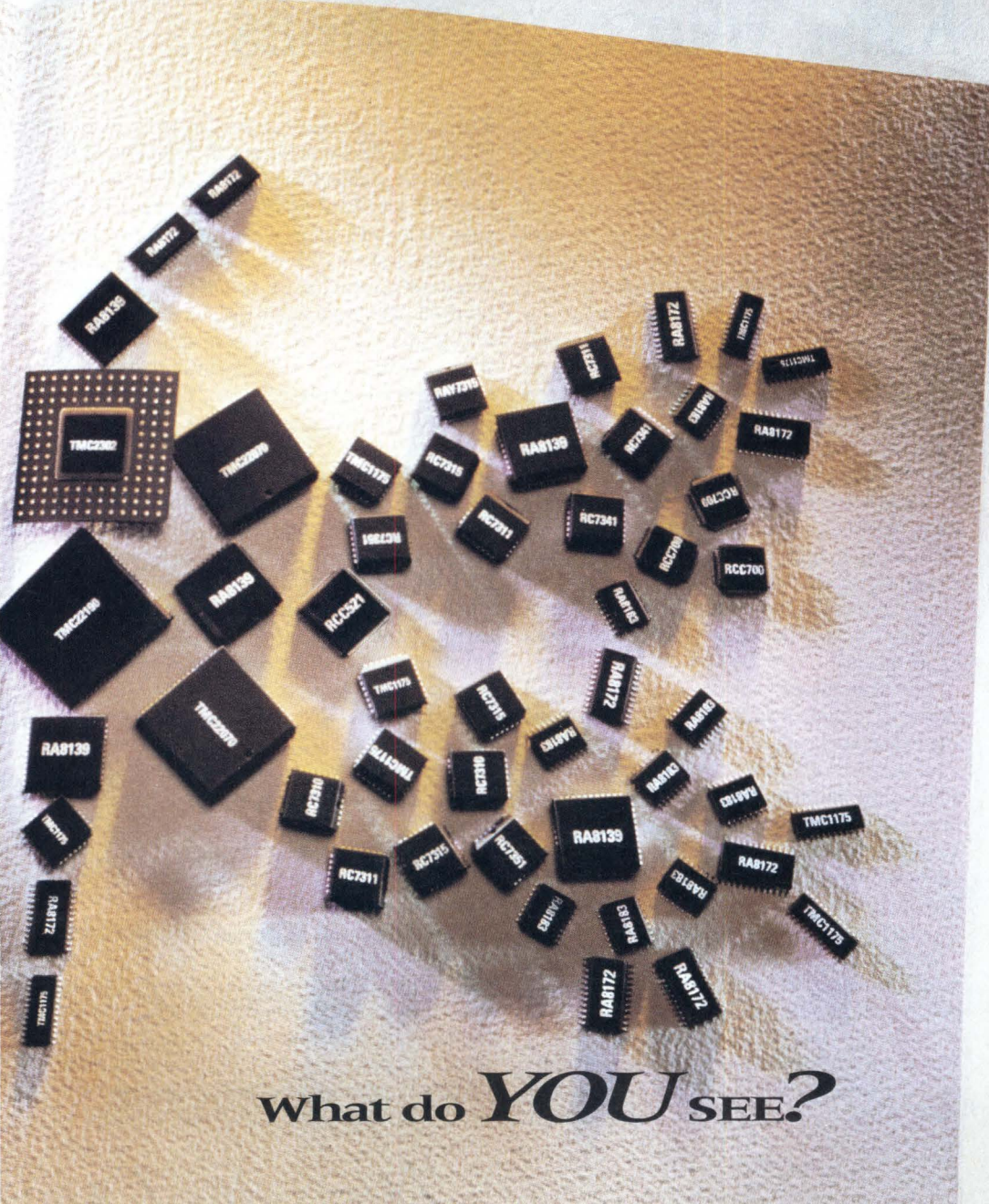

What do *YOU* SEE?

All of which means you can aspire to more. Like more breakthroughs in high-quality conversion and manipulation of video signals. More blazing speed for your serial link LAN or WAN. More compact designs and higher frequency testing in ATE. Or more of whatever you've set your sights on.

So call us now for your 1994 Databook. Because when you're working with Raytheon Semiconductor, great things always come to mind.

1-800-722-7074

**Raytheon**  
Semiconductor Division

# Raise your expectations

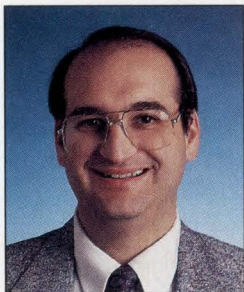

It was unprecedented: Apple, IBM, and Motorola teamed up to create the PowerPC 601  $\mu$ P. The companies created a facility called Somerset in the Arboretum section of northern Austin to house the processor-development team. Planners located and "facilitized" a building in an unusually short time. Local-area networks and computing equipment sprouted overnight. Team members worked around the clock, during weekends, and over holidays. More important, the  $\mu$ P rolled out of the wafer-fab facility 100% functional, on schedule, and running at frequency.

Somerset achieved these goals because a lot of people worked very hard. But people work hard on many projects and don't experience the success achieved by the Somerset team. One reason for this success—perhaps the most important reason—was the team's expectations.

The Somerset team leaders expected these excellent results. The leaders made sure that their team members were highly motivated (they were out to best a major competitor and to prove that the unlikely collaborative trio could work), and they made sure that everyone understood that they expected the 601  $\mu$ P to appear on time and fully functional. They set the team's expectations precisely on the desired outcome.

Meanwhile, a group of British entrepreneurs in Nottingham have established a beachhead in Nashua, NH, where they plan to take the desktop-publishing market by storm with a \$59.95 Windows-based product called PagePlus 2.0. The company, named Serif ((603) 889-1127), has a presence in

Europe. Its nearest competitor pricewise in the United States is Microsoft Publisher, but Serif claims that its software offers the features of high-end desktop-publishing packages costing 10 times more. I met some Serif employees at Fall Comdex '94. They were demonstrating PagePlus, and they virtually seethed with high expectations during their enthusiastic and impressive demo. Call it wish fulfillment; call it self-fulfilling prophecy; call it whatever you like, but recognize the power of your expectations.

No one claims that high expectations are all you need to succeed. Certainly, the Somerset team must have hit a roadblock or two, and it took more than high hopes to hurdle the obstacles. Serif certainly has some major hurdles looming in the immediate future. But setting your expectations high must certainly be the first step on the road to success. If you don't expect success, if you're not constantly looking for that favorable outcome, then the probability of achieving your goals drops substantially. Without those high expectations, team members (including you) may feel that something less than success is acceptable. So step back for a minute, and ask yourself just what you expect of your current projects. I suggest you set your expectations high.

Perhaps the initial PowerPC project experience was a fluke, and the Somerset clan will never again hit the bull's eye. Maybe Serif won't scramble to the top of its market. However, I certainly wouldn't bet against these companies. Somerset has a lot more PowerPC processors heading our way, and Serif is rolling PagePlus 3.0 out the door.



Jesse H. Neal  
Editorial Achievement Award  
1990 Certificate, Best Editorial  
1990 Certificate, Best Series  
1987, 1981 (2), 1978 (2),  
1977, 1976, 1975

American Society of  
Business Press Editors Award  
1991, 1990, 1988, 1983, 1981

Steven H. Leibson  
Editor-in-Chief

Send me your comments via fax at (617) 558-4470, or on the EDN Bulletin Board System at (617) 558-4241, 300/1200/2400 8,N,1. From the Main System Menu, enter ss/soapbox and select W to write us a letter.

# HOW OTHER GAL SUPPLIERS DEAL WITH NOISE.

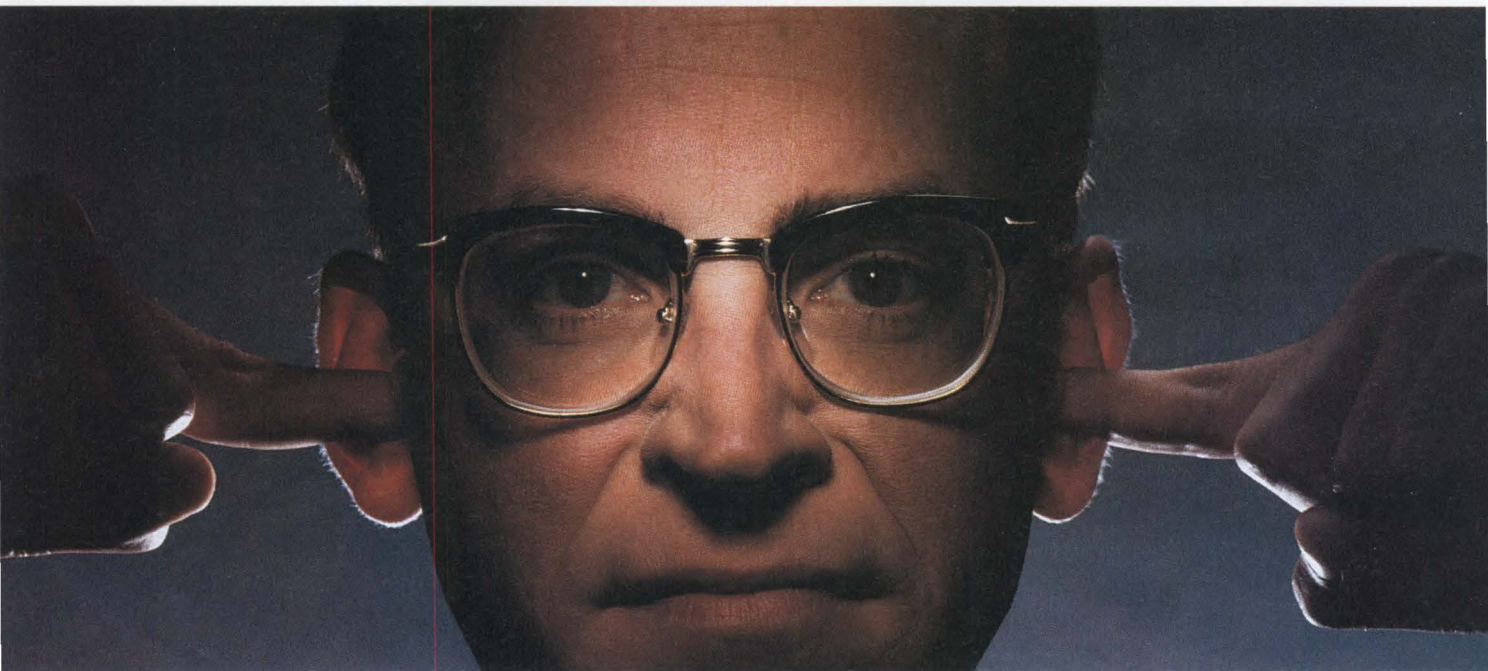

Our competitors are ignoring the problem of noise. They don't want to hear about ground bounce, so they're keeping silent about how it degrades overall system performance and quality. And they definitely don't like the sound of National's new Quiet Series™ GALs®. That's because we offer the best CMOS noise specs in the industry. And we guarantee the lowest noise at 10ns with all outputs switching ( $V_{OLP} \leq 1.5V$ ,  $V_{OLV} \geq -1.2V$ ). To hear more, call us at 1-800-NAT-SEMI, Ext. 269.

The competition has heard enough.



*Why now?*

## *Our* NEW 4-MEG VRAM.

*[Because its FAST PAGE MODE is so rapid.]*

The new 4-meg VRAM doesn't just give you the most memory any VRAM ever has. If it's a Samsung part, it also gives you the highest *performance* any VRAM ever has.

Thanks to an advanced Fast Page Mode that makes pages

move at unheard-of speeds.

The chip's extended data out feature gives it a Fast Page Mode cycle time of 25 ns. Which gives your customers the ability to build products with increased visual performance. And gives *you* one more reason

to use the 4-meg *now*.

Unlike some lesser-performance 4-megs, this 60 ns chip is a full-SAM VRAM—the design that will be the industry standard. It gives you an 8-column block write.

And like all semiconductor

*The Samsung VRAMs*

PART	ORG.	SPEED
KM4216C256*	256K x 16	60ns
KM428C257	256K x 8	60ns
KM428C256	256K x 8	60ns
KM428CI28	128K x 8	60ns
KM424C257	256K x 4	60ns

\*Sampling now; all others in production quantities now.



products from Samsung, it has the kind of quality that has won us ISO 9001 certification.

For us at Samsung, this 4-meg VRAM is one more way we're advancing our leadership position in memory—and adding to our remarkable

achievement in building the world's first 16-meg DRAM.

All of which is why you may want to act fast yourself. To learn about the VRAMs with the blazing Fast Page Mode, please call 1-800-446-2760 or 408-954-7229 today. Or write to VRAM

Marketing, Samsung Semiconductor Inc., 3655 North First Street, San Jose, California 95134.



**SEMICONDUCTOR**

*A Generation AHEAD.*

# POWER-ONE D.C. POWER SUPPLIES

## Not Only The Best...The Best Selection, Too

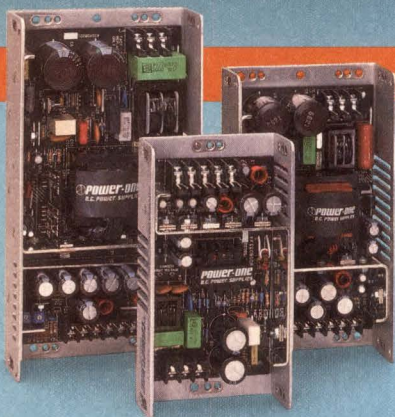

### SWITCHERS

POWER-ONE'S International Switcher Series incorporates the latest state-of-the-art switching technology while providing POWER-ONE's traditional high quality at low prices. With certification to the world's toughest safety agency requirements, the series is especially suited for products sold not only domestically, but internationally as well. • **85 models**... **40 watts to 400 watts** • **Efficient**... **reliable**... **economical** • **VDE construction** • **Up to 5 fully regulated outputs** • **Full international safety and EMI approvals**

### LINEARS

POWER-ONE'S International Linear Series is the world's undisputed leader in versatile, cost-effective linear power supply products. A long-time favorite of designers and engineers worldwide, the series is the most widely purchased power supply line through distribution in the industry. The most popular voltage and current combinations are available in a wide variety of off-the-shelf standard models. • **Popular industry standard packages** • **77 models**... **6 watts to 280 watts** • **± 0.05% regulation** • **Up to 4 fully regulated outputs** • **Worldwide safety approvals**

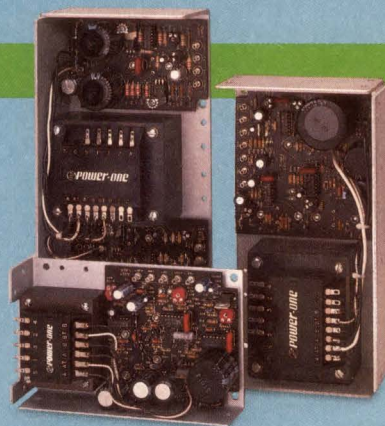

### HIGH POWER

POWER-ONE'S International High Power Series is a true fully-modular high power product line. Specify a power system that meets your exact requirements from a wide selection of single, dual and triple output plug-in power modules. Virtually any combination of output voltage and current rating can be delivered from stock. • **500 watts to 2,000 watts** • **Fully modular construction** • **Up to 15 fully regulated outputs** • **UPS battery backup option** • **Parallelable outputs with current sharing** • **Power Factor Correction optional**

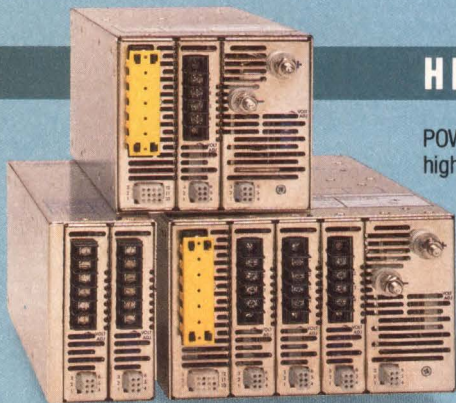

**TOLL FREE  
LITERATURE  
HOT-LINE:  
(800) 678-9445**



POWER-ONE offers one of the largest selections of switcher, linear, and high power standard models in the world. Most models available off the shelf from authorized distributors. So, whatever your D.C. power supply requirement, make POWER-ONE your first choice and be sure you're getting the best—quality, selection, value and quick delivery. Call today for our new Reference Guide and the location of our closest authorized distributor.

"Innovators in Power Supply Technology"  
**POWER-ONE**  
D.C. POWER SUPPLIES

POWER-ONE, INC.  
740 Calle Plano • Camarillo, CA 93012-8583  
Phone: (805) 987-8741 • FAX: (805) 388-0476





# PCI local bus gathers momentum

GARY LEGG, Senior Technical Editor

**Both the PCI local bus and the VL bus let high-speed peripherals bypass a PC's slow expansion bus. But PCI is gaining favor among designers, and a crop of new PCI components is starting to simplify local-bus design.**

When a flood of data from fast peripherals meets a slow PC-expansion bus, something has to give. And so, with applications in graphics, video, and imaging proliferating rapidly, computer designers are now connecting peripherals directly to a system processor's local bus. But connecting directly to a local bus can result in unpredictable performance, as many designers have learned the hard way. Fortunately, though, help is on the way from the Peripheral Component Interconnect (PCI) bus.

With data throughput as high as 132 Mbytes/sec (even higher in future implementations), the PCI bus smashes the I/O bottleneck of traditional expansion buses. So does the VESA local (VL) bus, for that matter; in fact, the VL bus did it first. But the VL bus is losing ground in the race for market acceptance, mainly because the PCI bus offers a more attractive technology-migration path to the future. In addition, a whole

lineup of new products is now making it easier to implement the PCI bus and PCI-compliant peripherals.

## Long-range plan prevails

The contest between the PCI and VL buses is much like the race between the tortoise and the hare. VL, developed by the Video Electronics Standards Association, jumped to an early start with a quick-time-to-market solution. It did so, however, with a specification that was somewhat shortsighted and, in the opinion of many designers, rather "casual." PCI, developed by Intel but now an open standard, started more slowly but took a longer range view. PCI components and systems have only recently started appearing on the market, but most designers praise the PCI spec's thoroughness and orientation toward the future.

PCI's forward-looking plan includes processor independence, compatible 32- and

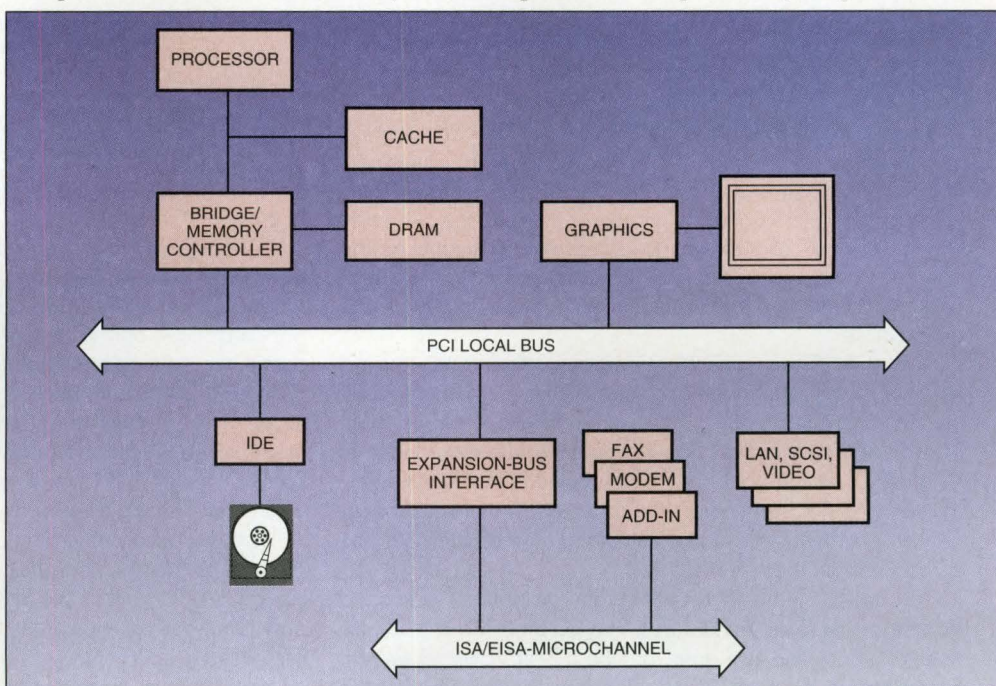

**Fig 1—The PCI local bus provides a high-bandwidth data path for PCI peripherals that can be on a mother board, on add-in cards, or external. With bridge chips, you can connect other standard peripherals, including expansion boards for ISA/EISA or MicroChannel systems.**

## PCI LOCAL BUS

64-bit buses, and a smooth transition from 5 to 3.3V devices (see **box**, "PCI-bus highlights"). In fact, the PCI bus specification (**Ref 1**) already contains details for those features. VESA recently added similar features to its VL-bus spec (**Ref 2**), but not before the PCI bus had already gained a good deal of market momentum. In addition, because the VESA additions increased the VL bus's complexity, they diminished its main selling point—low implementation cost.

Processor independence has contributed a great deal to the PCI bus's success. You can implement the bus on Intel processors, but that doesn't exclude using other processors. For example, Digital Equipment Corp (DEC) is linking PCI to its Alpha processors; Apple, IBM, and Motorola are using it with the Power PC. Any PCI-compliant peripheral works with any of the systems, sparing manufacturers the task of designing models with different interfaces.

The PCI bus is also compatible with standard expansion buses. You can have both bus types connected to the system processor, or, as **Fig 1** shows, you can put a slow expansion bus—ISA, EISA, or MicroChannel (MC)—on top of a PCI bus. With PCI-to-PCI bridge chips com-

ing soon from DEC and IBM, you can even put one PCI bus on top of another.

With a secondary PCI bus, you can put multiple peripheral functions on a single add-in card. These functions, if implemented as bus masters, can communicate with each other over the bus without involving the system processor. Access to the system processor is still possible, however, via the two cascaded PCI buses.

PCI peripherals can exist as chips (for use on a mother board or a single-board computer), as add-in cards, or as external devices with a card interface. A typical PCI desktop computer has

three PCI-card slots plus two peripheral functions—for example, a graphics accelerator and a LAN—on the mother board. According to rule-of-thumb guidelines for PCI design, you can put 10 electrical loads on the bus. Each mother-board function or bridge chip counts as one load; each card connector counts as two.

PCI add-in cards are mechanically compatible with ISA-, EISA-, or MC-based systems, provided that those systems also have some PCI connectors on the mother board. The PCI-card connector is the MC style, and two types of attachable brackets adapt a standard

## PCI-bus highlights

- Synchronous, processor-independent 32- or 64-bit local bus
- Operation at 5, 3.3V, and combination
- Forward and backward compatibility of 32- and 64-bit PCI components and add-in boards
- Bus speeds as high as 33 MHz
- Transfer rates as high as 132 Mbytes/sec (264 Mbytes/sec for 64-bit bus) via burst mode
- Full multimaster capability
- Hidden (overlapped) central arbitration
- Concurrency with processor/memory subsystem
- Write-back and write-through cache support
- Automatic configuration of PCI add-in cards at power-up

## PCI bus vs VL bus

The latest specification for the VESA local (VL) bus (**Ref 2**) mirrors some of the features of the Peripheral Component Interconnect (PCI) bus. It provides for expansion to 64 bits, for example, and it achieves processor independence by providing "bridge" connections to a processor's local bus. The original VL bus was essentially the same as a 486 local bus, and you could implement it only with 486- and 386-type architectures.

The new VL-bus spec also increases clock rates—to 66 MHz on a mother board and to 50 MHz across card connectors. Previously, the clock rate was 33 MHz on both boards and connectors. Some designers with experience in VL and PCI design are concerned that the higher clock rates, especially across connectors, will cause unreliable operation. Others, however, say that new shielded connectors should be able to handle the faster clock.

The newly specified 64-bit VL bus multiplexes data and addresses, as does the PCI bus. The 32-bit PCI bus also multiplexes addresses and data, but the 32-bit VL bus does not. So, although 64-bit PCI and VL buses require roughly the same number of connections, a 32-bit PCI bus requires con-

siderably fewer than does a 32-bit VL bus. Both the PCI and VL buses provide 32-/64-bit transparency. A 64-bit add-in card works on a 32-bit bus, and a 32-bit card works on a 64-bit bus.

PCI cards are more adaptable to different types of systems, however. A PCI card works in any ISA-, EISA-, or MicroChannel (MC)-based system that also has PCI slots; VL-bus cards have both a VL connector and an ISA, EISA, or MC connector, so they're limited to only one type of system.

In terms of performance, the PCI bus enjoys some advantages over VL. Burst reads and writes, for example, can be essentially any length on PCI. With VL, they're limited to 16 bytes or fewer, thus incurring more overhead for setting up addresses on long transfers.

PCI-bus concurrency allows the system processor to operate independently, and thus not get delayed, when a bus-master peripheral gets bus possession. The VL bus, which until now has been essentially the 486 processor's local bus, has not allowed concurrency. Concurrency will be possible with VL-bus bridge chips, however, and will be available if designers choose to implement it.

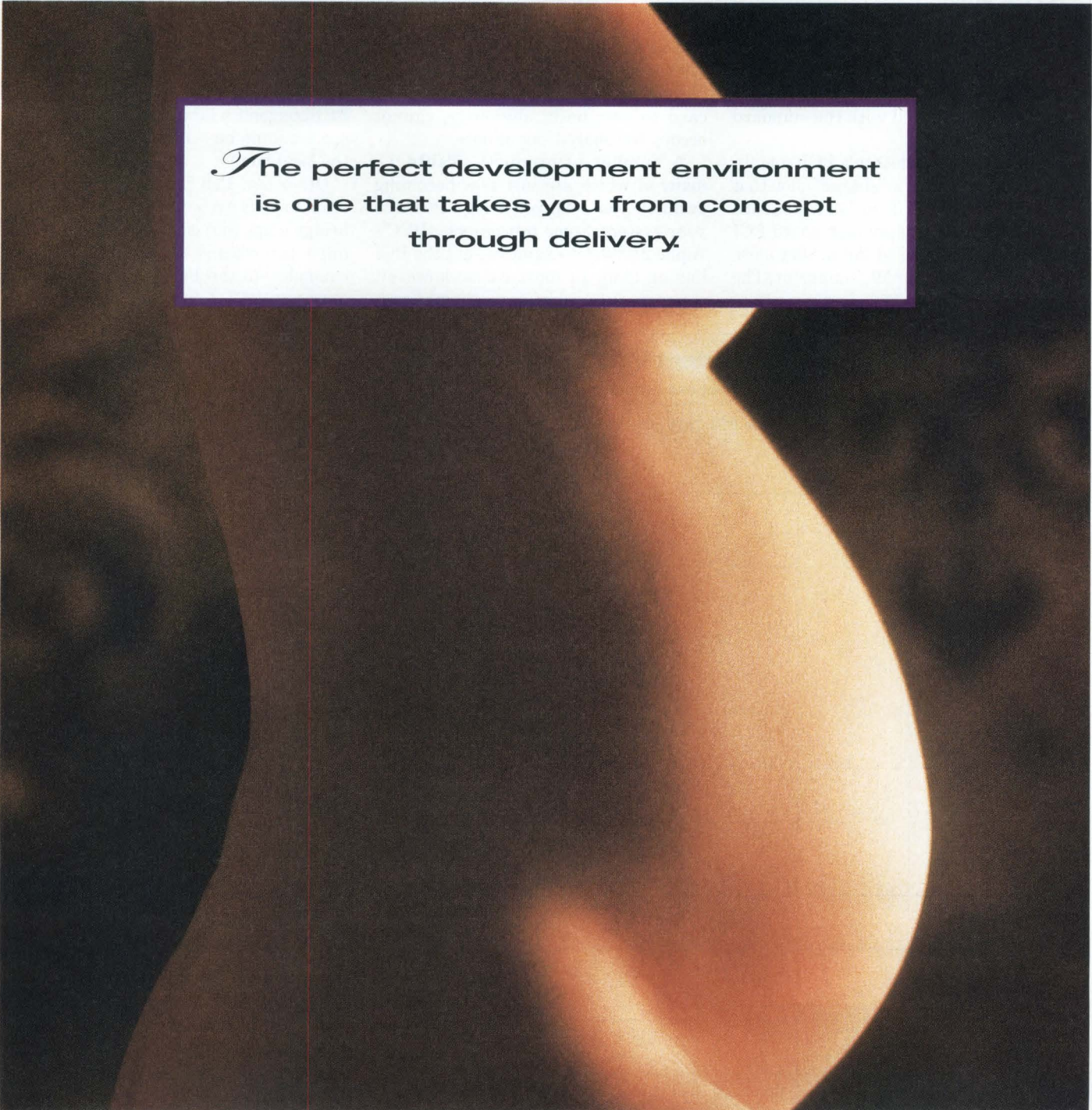

*The* perfect development environment  
is one that takes you from concept  
through delivery.

**Introducing the world's first high-performance  
VHDL simulator with ASIC sign-off.**

Now you can stay in your high-level design environment all the way to ASIC sign-off with Synopsys' new VHDL System Simulator (VSS) family. The set of multi-engine simulators gives seamless performance from concept to sign-off simulation. So you can deliver healthy chips a lot faster and with a lot less pain than with any other simulator available today.

Call 1-800-568-2619, dept. NI, for this free and informative booklet.

**synopsys**<sup>®</sup>

SIMULATION  
FOR HIGH-LEVEL  
DESIGN

## PCI LOCAL BUS

PCI card for mechanical installation in an ISA/EISA or a MC system. The PCI specification also provides for a smaller 7-in. card, compared with the standard 12.325-in. card.

One of the card slots in a PCI-compliant system can be a "shared" slot that accommodates a PCI card or a standard expansion card. The mother-board PCI connector for a shared slot is very close to the ISA, EISA, or MC connector. The component side of a PCI card is opposite

that of the other cards to enable either type of card to fit into roughly the same physical space. You choose which type of card to use; both, obviously, cannot occupy the shared slot at once.

A number of products (Table 1), many of which are just now becoming available, can help you design PCI into your system. Some processors—DEC's Alpha 21066, for example—put the PCI bus on chip. In most cases, however, separate PCI chip sets—sometimes

called bridges—essentially create a PCI bus and connect it to a processor's local bus. (Technically speaking, the PCI bus isn't a local bus. It's more like a mezzanine bus that is closely tied to the local bus.)

Other new PCI products add peripherals to your system. Some of these are bridge chips that connect existing standard interfaces—SCSI or IDE, for example—to the PCI bus. Other products are PCI-compliant peripherals implemented as chips or add-in cards. Graphics accelerators and Ethernet controllers are the most prevalent of these.

If you're designing your own PCI-compliant peripheral device, your product options are somewhat limited for now. General-purpose PCI-interface chips aren't yet commercially available, although at least two are in development. PLDs and FPGAs have trouble driving the PCI bus, although Intel says it will introduce some PCI-compatible devices this year.

You can, of course, connect to the PCI bus with an ASIC of your own design. Most ASIC vendors now have PCI drivers in their cell libraries. If you can wait a couple of months, though, the availability of PCI-interface chips could help you avoid the up-front costs of an ASIC.

With PCI-controller chips now in development, you can create a complete interface between a  $\mu$ P and the PCI bus. One controller chip, from American Micro Circuits Corp, interfaces to practically any  $\mu$ P. The chip provides a 32-bit address/data path, all required address decoding, and all the necessary registers and other features for a PCI connection. PLX Technology is developing a similar chip for the i960  $\mu$ P. Both chips should be available in the second quarter of this year.

For general guidance in PCI design, start with the PCI Special Interest Group (PCI SIG). PCI SIG oversees the PCI specification and provides additional design guidelines that aren't formally specified. The group now has more than 200 member companies; many are developing PCI components and add-in boards. Contact PCI SIG (see **box**, "For free information...") for a list.

The next few months will see a flood of PCI products. Some will be new; others will be products that are just

**Table 1—Peripheral Component Interconnect-bus ICs**

Manufacturer	IC functions available				
	PCI on $\mu$ P	$\mu$ P on PCI	IDE on PCI	SCSI on PCI	ISA on PCI
Adaptec Circle No. 301			x	x	
Advanced Micro Devices Circle No. 302				x	
American Micro Circuits Circle No. 303		x			
Appian Technology Circle No. 304			x		
BusLogic Circle No. 305			x	x	
Contaq Circle No. 306					x
Digital Equipment Corp Circle No. 307	x				
Future Domain Circle No. 308				x	
IBM Microelectronics Circle No. 309	x				
Intel Circle No. 310	x				
NCR Corp Circle No. 311				x	
Opti Circle No. 312	x				
PLX Technology Circle No. 313		x			
QLogic Circle No. 314				x	
Symphony Circle No. 315	x		x		
VLSI Technology Circle No. 316	x				



### the new abbot SM200.

- Highest density in a military power supply
- 50 Watts per cubic inch
- Size: 2.4" W x 4.6" L x .5" H
- Power limit: up to 280 Watts
- Fixed frequency; no derating
- Temperature range of operation: -55°C to +100°C
- Extended input voltage range: 11-40Vdc
- Output: 5, 12, 15, 24, 28Vdc; sync pin, trim pin
- OVP, TTL included
- Remote Error Sensing
- Qualifications: Mil-Stds 704D, 810E, 901C
- Board-mountable
- Readily available, off-the-shelf military
- Price: *very* competitive

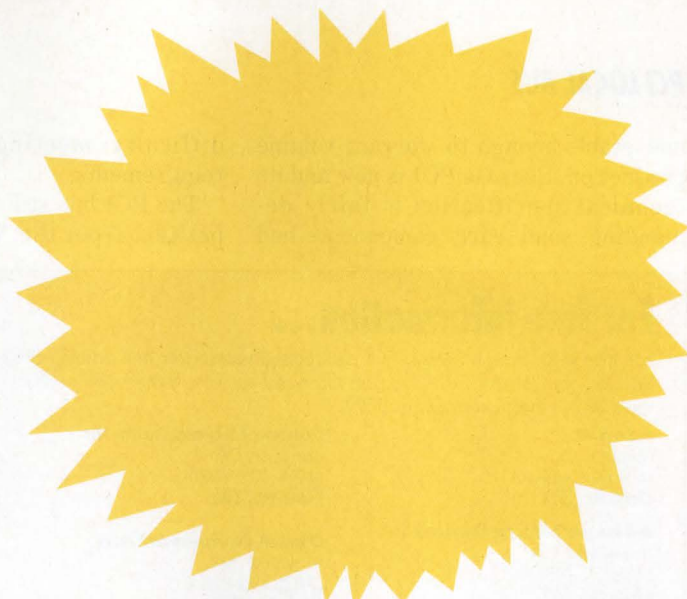

### the sun.

- Highest density in the solar system
- 500,000,000,000,000 Watts per cubic inch
- Size: diameter = 864,000 miles
- Power limit: undetermined
- Variable frequency; derating nonverifiable
- Temperature range of operation: +5500°C to +15,000,000°C
- Extended input voltage range: 1-10<sup>43</sup>Vdc
- Output: unchanneled; scattered dispersion
- Output protections: shade, sunscreen
- No system of error sensing/detection
- Mil-Std qualifications: none
- Board-mountable: *not*
- Readily available; not deliverable in unit form
- Price: *very* expensive

# COMPARE OUR VERY-HIGH-DENSITY POWER SUPPLY WITH ITS CLOSEST COMPETITOR.

While the competition is admittedly tough, a closer look at the specs should serve to convince even the most skeptical reader of the many practical benefits of our new SM200 very-high-density power supply, which, despite its shorter track record, in reliability is second to — only one.

**abbott**

when reliability is imperative®

Abbott Electronics, Inc., 2727 S. La Cienega Blvd., Los Angeles, CA 90034-2643 • Telephone 310/202-8820 • Fax 310/836-1027

CIRCLE NO. 50

EDN February 3, 1994 • 29

## PCI LOCAL BUS

now stable enough to warrant volume production. Because PCI is new and its technical specification is fairly demanding, some early components had

difficulty meeting all the spec's requirements.

The PCI bus still faces market competition from the VL bus (see **box**,

"PCI bus vs VL bus"), but the long-range outlook seems to favor PCI. The VL bus's main advantage is that it is essentially the same as the 486 local bus

### For free information...

For free information on the PCI products discussed in this article, circle the appropriate numbers on the postage-paid Information Retrieval Service card or use EDN's Express Request service. When you contact any of the following manufacturers directly, please let them know you read about their products in EDN.

**Adaptec**  
Milpitas, CA  
(408) 945-8600  
Circle No. 301

**Advanced Micro Devices Inc**  
Sunnyvale, CA  
(408) 732-2400  
Circle No. 302

**American Micro Circuits Corp**  
San Diego, CA  
(619) 450-9333  
Circle No. 303

**Appian Technology Inc**  
Sunnyvale, CA  
(408) 730-5406  
Circle No. 304

**BusLogic Inc**  
Santa Clara, CA  
(408) 492-9090  
Circle No. 305

**Contaq Microsystems Inc**  
San Jose, CA  
(408) 428-9025  
Circle No. 306

**Digital Equipment Corp**  
Maynard, MA  
(508) 493-5111  
Circle No. 307

**Future Domain Corp**  
Irvine, CA  
(714) 253-0913  
Circle No. 308

**IBM Microelectronics**  
Somers, NY  
(914) 765-1900  
Circle No. 309

**Intel Corp**  
Santa Clara, CA  
(408) 765-8080  
Circle No. 310

**NCR Corp**  
Colorado Springs, CO  
(800) 334-5454  
Circle No. 311

**Opti Inc**  
Santa Clara, CA  
(408) 980-8178  
Circle No. 312

**PLX Technology**  
Mountain View, CA  
(415) 960-0448  
Circle No. 313

**QLogic Corp**  
Costa Mesa, CA  
(714) 438-2200  
Circle No. 314

**Symphony Laboratories**  
Santa Clara, CA  
(408) 986-1701  
Circle No. 315

**VLSI Technology Inc**  
Tempe, AZ  
(602) 752-8574  
Circle No. 316

### Super Circle Number

For more information on PCI products available from all of the vendors listed in this box and in **Table 1**, you need only circle one number on the postage-paid reader service card.

Circle No. 317

80386 & 80486  
Single Board Computers  
Also Available

# PENTIUM-PCI/VE

## Passive Backplane Single Board

**Fan Connector**      **IDE Connector**      **Floppy Connector**      **Parallel Port**

**Industry Standard Auxiliary Ports**

**512Kb External Secondary WriteBack Cache**

**ISA**

**EISA**

**PCI**

**Up to 128Mb of DRAM Onboard**

**PCXI P3/P4 Compatible Expansion Bus**

**ISA Bus Architecture**

**32 bit EISA Bus**



and thus is inexpensive to implement in a 486-based system. As the use of other processors increases, however, the balance will tip to PCI.

Once start-up difficulties subside, the PCI bus could substantially change the "flavor" of PCs, both on the desktop and in embedded systems. By putting peripheral-I/O speeds on a par with processor speeds—and by doing so with standard, high-volume, off-the-shelf components—PCI could make possible a range of products and applications that previously were technically or economically infeasible. The PCI bus could, in fact, become one of the enabling technologies of the decade.

EDN

## References

1. "PCI Local Bus Specification, Revision 2.0," PCI Special Interest Group, Hillsboro, OR, 1993.
2. "VL-Bus 2.0," Video Electronics Standards Association, San Jose, CA, 1993.
3. *The PCI Local Bus: A Technology Overview*, Intel Corp, Santa Clara, CA, 1993.

4. Rowell, Dave, "PCI Local Bus Has Arrived," *PC Magazine*, November 9, 1993, pg 187.
5. Mosley, JD, "Bypass the PC Bus to Speed up Your System," *EDN*, February 18, 1993, pg 65.

You can reach Senior Technical Editor Gary Legg at (617) 558-4404, fax (617) 558-4470.

Article Interest Quotient (Circle One)  
High 598 Medium 599 Low 600

## Looking ahead

The Peripheral Component Interconnect (PCI) bus's bandwidth is adequate even for bus-hogging applications like full-motion video, but bandwidth requirements will undoubtedly increase. Fiber-interface communication can easily consume 100 Mbytes/sec, and high-definition television (HDTV) and multimedia will also be very demanding.

Extending the PCI bus to 64 bits will satisfy many of those demands, stretching bandwidth from 132 to 264 Mbytes/sec. A 64-bit specification is in place, and 64-bit PCI products should start appearing this year.

To further increase data throughput, the PCI clock rate could eventually double, to 66 MHz, or even quadruple. The higher rate could initially prove troublesome across card connectors, but single-board systems—without the connectors' added capacitance—will be less of a challenge.

A second PCI bus—implemented on top of another PCI bus via a bridge chip—offers some interesting possibilities for new system architectures. A secondary bus on an add-in card, for example, will let you include multiple PCI-peripheral functions on the card. The PCI SIG is also investigating a card-top connector that links cards via a secondary bus.

# SAVISA

## Computer Architecture

Now Available

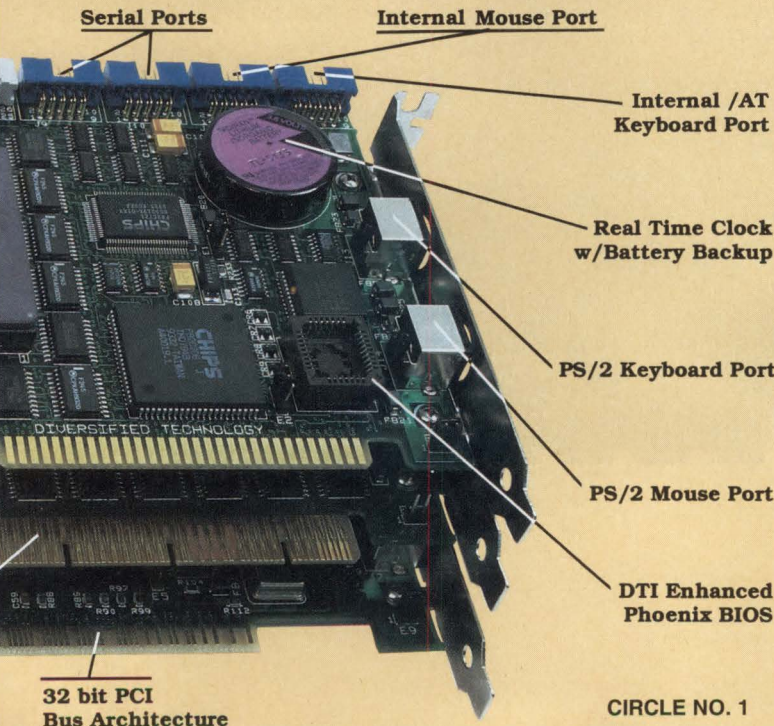

SPECIFICATIONS	ISA PENTIUM	EISA PENTIUM	PCI PENTIUM
60/66MHz PENTIUM	✓	✓	✓
16Kb Integrated Pipelined Cache	✓	✓	✓
512Kb WriteBack 2nd Cache	✓		
256Kb/512Kb WriteBack 2nd Cache		✓	✓
Up to 128Mb DRAM Onboard	✓		
Up to 192Mb DRAM Onboard		✓	✓
8Kb EISA Non-Volatile RAM		✓	
FLASH BIOS Support		✓	✓
2 Serial Ports / 1 Parallel Port	✓		
IDE/Floppy Interface	✓		
PS/2 Mouse Support	✓	✓	✓
/AT-PS/2 Keyboard Support	✓	✓	✓
ISA Bus Architecture	✓		
EISA Bus Architecture - Up to 8 EISA Bus Masters		✓	
PCI/ISA Bus Architecture - Up to 2 PCI Bus Masters			✓
Manufactured In-House(USA)	✓	✓	✓
Powermeter 1.2 MIPS-60MHz	40.2	N/A	N/A

**Diversified Technology**  
An Ergon Co.

Call us toll free for orders and information.  
**1-800-443-2667**

U.S.A. - (601) 856-4121 Fax (601) 856-2888  
Outside U.S.A. - (201) 891-8718/Fax (201) 891-9629

Product names are trademarks or registered trademarks of their respective companies. 386, 486 & PENTIUM are trademarks of Intel Corp.

CIRCLE NO. 1

Welcome to  
engineering in the '90s.

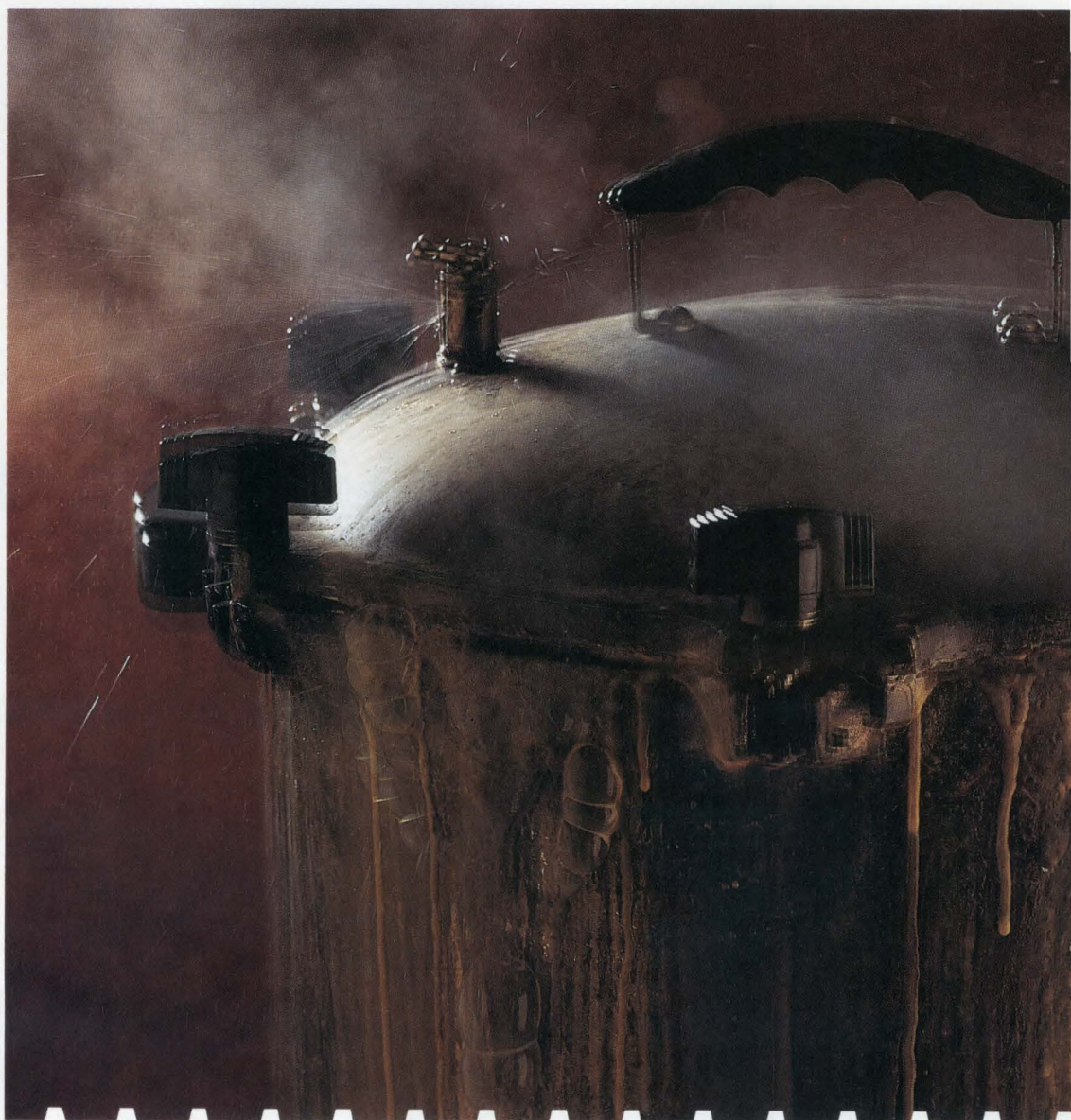



Everything needs to be done yesterday.

Only smaller and using less power. But with twice as many features. For the same money as last year's model.

And if it turns out other-

wise, you'll hear about it.

Look, we can't claim to alleviate all your problems, no one can.

But we'll tell you this. There's no one better to have in the stew with you

than Xilinx®.

First of all, no one is pushing the technology faster or farther.

As the leader, that's our job. And while it's not cheap, it is worth it.

Our product line now includes over 350 different versions—low power, high density, high speed, special packaging like TQFPs—you name it.

So you have more choices to work with. And our software is now so powerful, there's no corner of our parts you can't get to, work on, and make better.

Which, by the way, is exactly what we're constantly doing to our software.

Then there are our new EPLDs, with more speed, predictability, features, and just plain usability than EPLDs have ever offered.

Allowing you to integrate more devices, faster, and deliver a smaller, cleaner, more efficient design—for less money.

Finally, our FPGAs have never offered more density or more speed.

And nothing will get you to market faster.

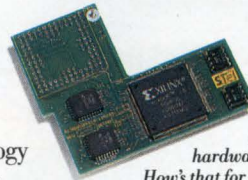

*Stanford Telecom chose our XC4005 to build a custom signal processor and got operational hardware in less than 5 weeks. How's that for taking the pressure off?*

Literally months faster than a conventional gate array. Nothing is more forgiving in the design process, either.

There's no penalty for changes, and you can program our parts at your desk, or even reprogram them in the system. All in less time than it takes to figure out why your supposedly non-recurring engineering costs keep recurring.

One more reason why the cost of going with us is a lot lower than you think.

Well, that about covers it. To learn more about how we can help you get a better handle on your next project, talk to your Xilinx representative, or call our 24-hour literature hotline at 800-231-3386.

Then you better get back to work before somebody blows a gasket.

 **XILINX®**  
The Programmable  
Logic Company.™

©1993 Xilinx, Inc., 2100 Logic Drive, San Jose, CA 95124. Europe, 44 (932) 349401; Japan, 81 (3) 297-9191; Asia, 852 (3) 721-0900.

Xilinx is a registered trademark, and The Programmable Logic Company is a service mark of Xilinx, Inc. All other trademarks or registered trademarks are the property of their respective holders.



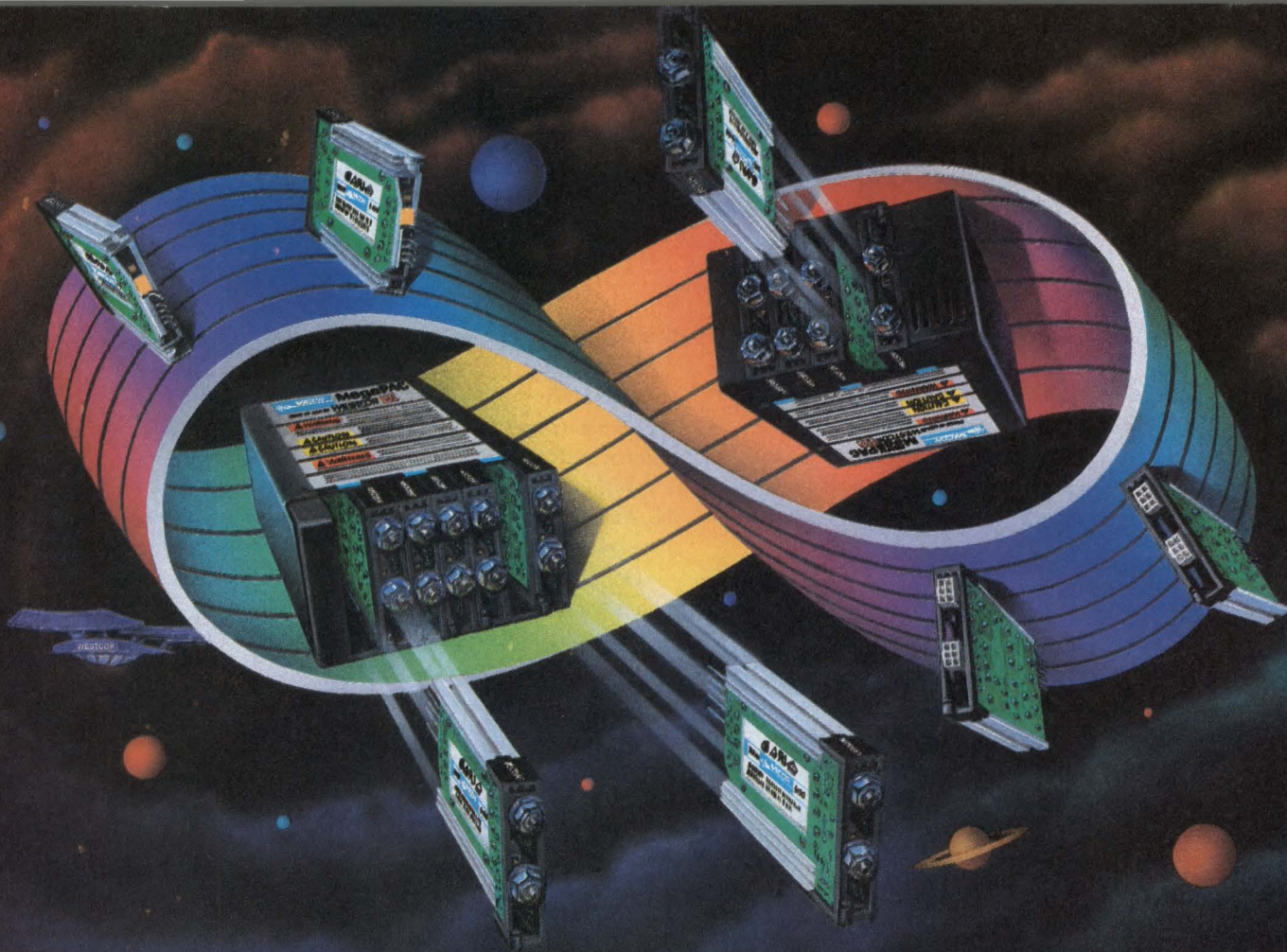

# Endless Power Options

## Field-Configurable MegaPAC™ Switching Power Supplies

Your opportunities are endless to mix and match MegaPAC options. And with so many possible power solutions available, you can define one precisely to fit *your* needs.

But MegaPAC flexibility doesn't end there. If your needs change, so can your switcher ...which gives you another reason to choose MegaPAC power supplies: they're *the only field-configurable power supplies* on the market. To alter voltage or power levels on site, just loosen a screw, slide out a ModuPAC converter assembly, and slide in a new one. It's that simple.

Take a look at our new additions to the MegaPAC family, highlighted at right.

For details about MegaPAC switching power supplies, call Vicor Express at 800-735-6200 or Vicor's Westcor Division at 408-395-7050 (FAX 408-395-1518).

### Size Options

- **MegaPAC**—8 ModuPAC slots  
11.8"L x 6.0"W x 3.4"H
- **Mini MegaPAC**—5 ModuPAC slots  
9.4"L x 6.0"W x 3.4"H **NEW smaller size!**

### Input Options

- 120/240 VAC strappable
- 120/240 autostrapping universal input  
**NEW! Automatically senses line voltage and straps power supply accordingly.**
- 85-264 VAC universal input with power factor correction **NEW! Meets IEC 555.**

### Output Options

- Up to 1600 watts total
- Up to 100 or up to 200 watts per output
- 1-16 outputs, isolated & fully regulated
- 1 to 95 VDC

### ModuPAC slide-in converter assemblies:

- Standard—one output, up to 200 watts
- **NEW DualPAC™**—two outputs, up to 100 watts each
- **NEW TachoPAC™**—for fast transient response to high-speed load changes
- **NEW RamPAC™**—for very low noise
- **NEW VXI Option**—for low noise and low ripple to meet instrumentation standard VXI

### Family Options

- DC OK (Power Good)—TTL signal high when output is  $\geq 90\%$  of nominal
- Trim range  $\pm 10\%$  or 40-110% of nominal
- Industrial or military grade modules
- Hardwired local sense
- Enable/Disable—TTL signals inhibit or enable each output; includes one-pin global shutdown

## Component Solutions For Your Power System

Vicor Corporation • 23 Frontage Rd., Andover, MA, 01810 USA • TEL: (508) 470-2900 • FAX: (508) 475-6715  
 Vicor GmbH • Tel: +49-89-329-2763 • Fax: +49-89-329-2767 • Vicor Far East • Tel: +886-2-9188240 • Fax: +886-2-9132982

# Digital HDTV system links computers with telecommunications

ANNE WATSON SWAGER, Technical Editor



**After almost seven years of proposals, testing, and FCC advisory-committee meetings, a US standard for HDTV could be in its final testing phase by the end of this year. Some early technical decisions define the minimum system requirements.**

From specialized image-compression ICs to op amps, manufacturers have touted high-definition television (HDTV) as a potential application for products introduced within the last few years. This promotion occurred despite the fact that manufacturers had no firm notion of the actual form that US HDTV would take. However, that form is finally beginning to take a very definite shape.

Since 1987, when the FCC began organized efforts to draft a broadcast standard, US HDTV has gone from a system with digital compression and analog transmission to a hybrid digital/analog transmission system to the current all-digital system.

The proposed US system places a heavy emphasis on computer-compatible progres-

sive-scanning techniques—as opposed to traditional NTSC TV's interlaced mode—and MPEG-2 compression and decompression techniques. According to Glenn Reitmeier, the director of the High Definition Imaging and Computing Laboratory at the David Sarnoff Research Center in Princeton, NJ, this emphasis points to a future in which MPEG may become the de facto standard for the multimedia industry. "We're on our way to a very interoperable format between computers and HDTV," says Reitmeier. "Future consumer products may have a much more multimedia feel than does traditional TV," he adds.

The proposed system, which its proponents describe in terms of layers (Fig 1), is a very flexible system that encompasses mul-

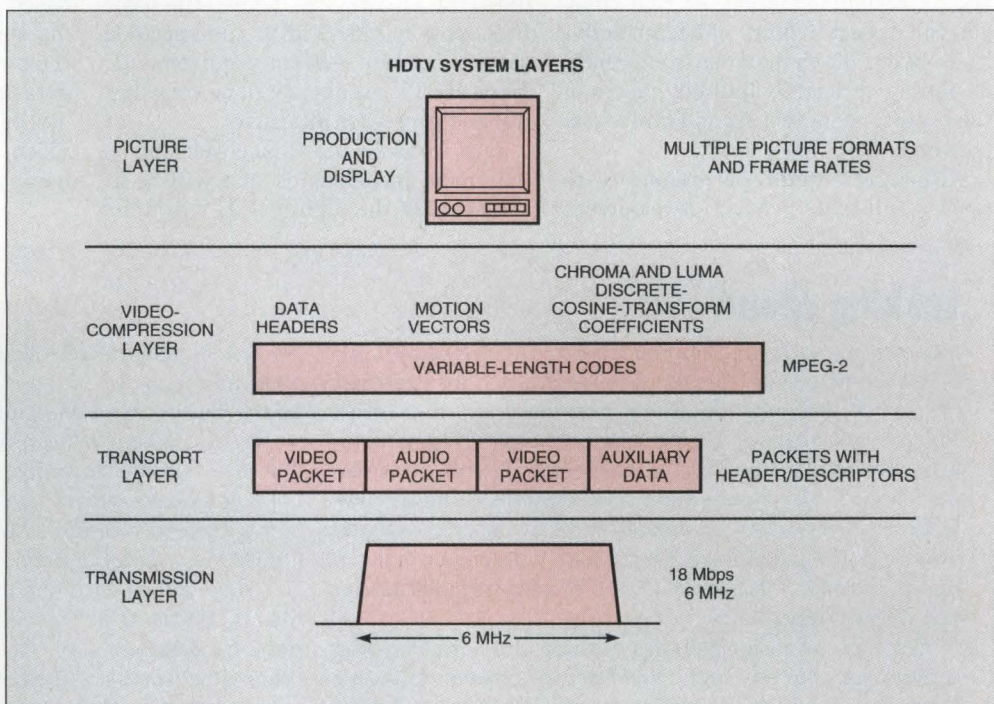

Fig 1—The HDTV system proposed by the Grand Alliance is a very flexible digital system with a layered architecture.

## US DIGITAL-HDTV STANDARD

multiple picture formats and frame rates and a flexible transport channel that shares video and audio signals.

The current activity on the US digital HDTV standard—for which some key technology decisions were announced last fall and others are due early this year—is an effort of both compromise and expediency. After the 7-year process of proposals, testing, and FCC recommendations, the surviving companies—and former opponents—banded together last year to form the Grand Alliance. Working together, the members hope to bring HDTV signals and sets into US homes as early as 1996.

This Grand Alliance includes AT&T, General Instrument Corp, the Massachusetts Institute of Technology, Philips Consumer Electronics, Thomson Consumer Electronics, the David Sarnoff Research Center, and Zenith Electronics Corp (see **box**, “For more information...”).

According to its members, the alliance could save a year or more in HDTV implementation by reducing the risk of inconclusive test results and the possibility of legal challenges. All members hope that by the end of this year or early next year, the FCC advisory committee will make its final and complete HDTV recommendation. At that time, you can expect a flurry of design activity to begin. Each member is currently designing or actively building pieces of the prototype for testing and evaluation (see **box**, “Looking ahead”).

Although it would be premature to start a full-scale product development

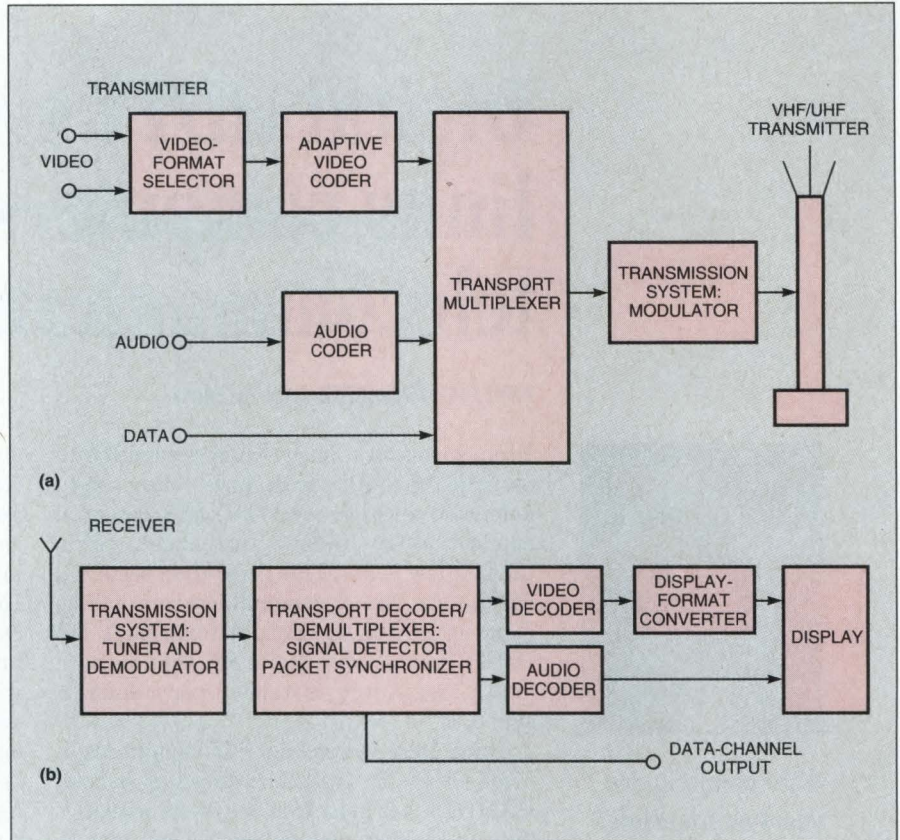

**Fig 2—The Grand Alliance has defined the functional building blocks of the proposed US HDTV system's transmitter (a) and receiver (b).**

before the FCC approves the final standard, the alliance has defined the basic functional blocks (**Fig 2**) and specified some minimum system requirements. Final HDTV products will be very digital and processor intensive.

Last October, the alliance decided on four main technologies that will be at the heart of the digital HDTV system:

digital video-compression technology based on MPEG-2 parameters, including the use of B-frames (bidirectional frames for motion compensation); a data-transport system based on packets of virtually any combination of video, audio, and data; interlaced- and noninterlaced- (progressive) scanning

*Text continued on pg 46*

## Looking ahead

Now that the Technical Subgroup of the FCC's Advisory Committee on Advanced Television Service (ACATS) has endorsed the initial technical decisions presented by the Grand Alliance, members of this alliance are constructing a prototype. Before they can build a complete prototype, however, the alliance must choose a transmission system. The alliance tentatively scheduled for January trials of Zenith's vestigial-sideband (VSB) digital-modulation and -transmission technology and General Instrument's quadrature-amplitude-modulation (QAM) approaches.

Once the alliance makes this decision and has completed a prototype, the advisory committee will conduct extensive laboratory tests in the United States and Canada to verify that

the system meets expectations. The alliance could then recommend the system to the FCC and begin field-test verification of the system's performance.

The FCC in turn will consider the alliance's recommendation in a rule-making proceeding, which alliance members hope can be concluded by the end of this year. Regardless of the adopted standard, the FCC requires that anyone can license the applicable technology on reasonable terms.

Finally, the alliance and the FCC hope that Canada and Mexico initiate similar procedures to assure that the US standard becomes a North American standard. The alliance seems determined not to delay the process to study any other system for which hardware or software doesn't exist.

# CACHE PROBLEM SOLVED.

50MHz Cache

Cache RAM tAA = 40ns - 12ns - 5ns - 3ns - 4ns = 16ns tAA  
 2 cycles clock to address latch delay detouring 486 setup

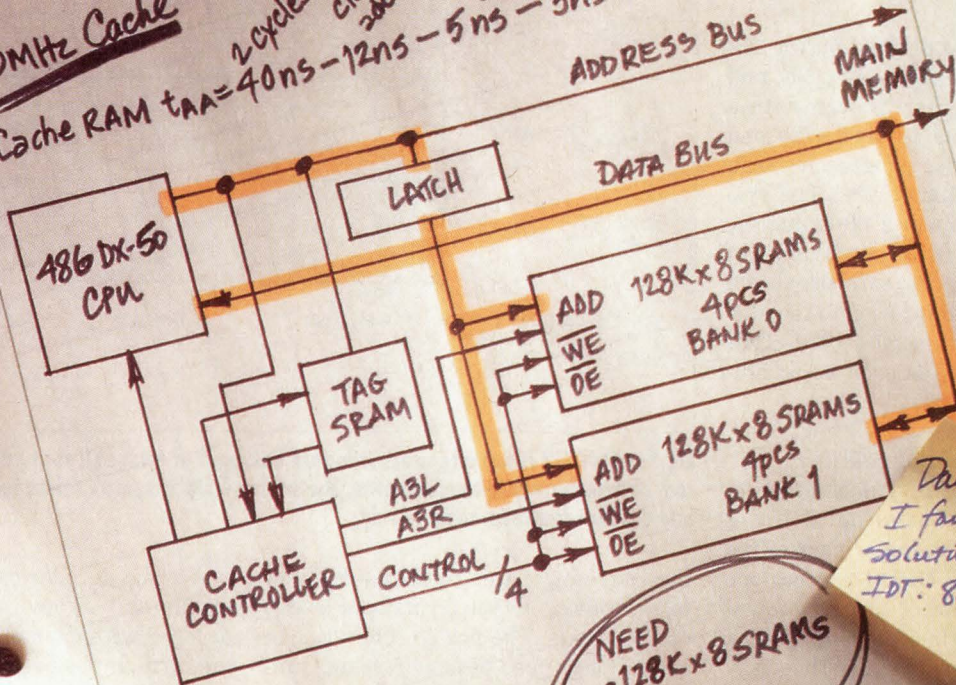

WANT  
 • 1Mb Cache size  
 • Zero-wait-state performance  
 • Minimal board space

NEED  
 • 128Kx8 SRAMS  
 • 15ns  
 • 300mil SOJ

Dave  
 I found the  
 solution! Call  
 IDT: 800 345-7015  
 Mike.

**We'll provide the 15ns 128K x 8 300mil SOJ SRAMs for your first board!**

IDT is the only 1Mb SRAM vendor to offer 15ns, 300mil SOJ SRAMs in volume, now. IDT's leading CMOS technology provides the performance and manufacturability to make the IDT71024 the ideal 1Mb SRAM for your design. Available in 300mil SOJ and 400mil SOJ/DIP packages, our 128K x 8 SRAM is the ideal solution for both high-density board designs and performance upgrades of existing systems. Interested? Call us or FAX in the coupon today to get technical data, application briefs, and details on our free 300mil SOJ 1Mb SRAM offer.

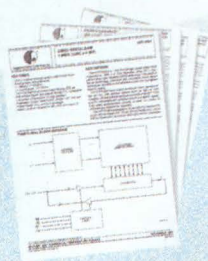

NAME \_\_\_\_\_  
 TITLE \_\_\_\_\_  
 COMPANY \_\_\_\_\_  
 ADDRESS \_\_\_\_\_  
 CITY ( ) \_\_\_\_\_ STATE ZIP \_\_\_\_\_  
 PHONE ( ) \_\_\_\_\_  
 FAX \_\_\_\_\_  
 E-MAIL \_\_\_\_\_

**(800) 345-7015**  
**FAX: 408-492-8674**  
**ASK FOR KIT CODE 8101**



**Integrated Device  
 Technology, Inc.**

## US DIGITAL-HDTV STANDARD

capabilities with a heavy emphasis on progressive; and the 5.1-channel Dolby AC-3 audio technology for digital surround sound. However, at the time, the alliance did not make one important decision: which transmission scheme the HDTV system will use (see **box**, "Looking ahead").

The alliance also decided on the following scanning formats: 24-, 30-, and 60-frame/sec progressive scan with a pixel-by-line format of 1280x720 and 24- and 30-frame/sec progressive scan with a format of 1920x1080. The system will also perform a 60-frame/sec interlaced scan with a format of 1920x1080. These formats provide a foundation for the migration to the ultimate goal of a 60-frame/sec, 1920x1080 progressive format as soon as technically feasible.

### MPEG-2 plays a major role

The chosen digital video-compression technology, based on MPEG-2 parameters, forms a major part of the evolving standard. MPEG-2 is not one standard but a kind of tool kit of syntactic elements that encompasses a range of compression grades that vary in performance and cost. **Fig 3** shows

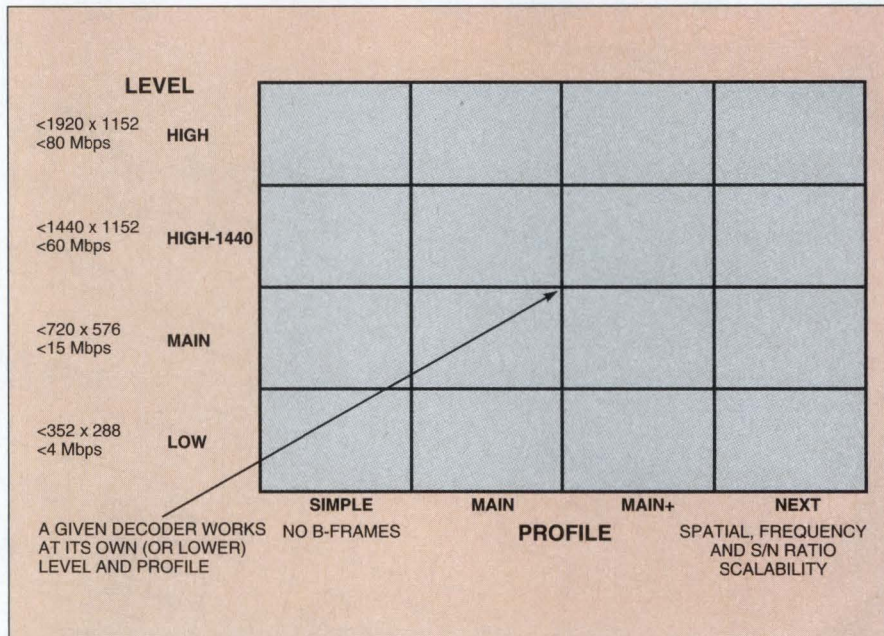

**Fig 3—MPEG-2 is not one exact standard but more of a tool kit that addresses a variety of cost and performance requirements. The level and profile syntax refers to various resolutions and decoder features, respectively.**

the elements of this toolbox—referred to as profiles—vs the formats, or levels, on the y-axis. The profile refers to one of the four types of compression: simple, main, main+, and next.

A given decoder can work at its own profile and its own or lower level. A decoder with a simple profile uses only forward-motion prediction. A main profile implies the use of bidirectional prediction, which requires two frames of storage but improves picture quality. Thus, conforming to a main profile implies a receiver with much more memory than one that conforms only to the simple profile. Operating at different levels requires vastly different data rates, as **Fig 3** shows.

Although the level and profile syntax defines a certain level of performance, MPEG-2 does not specify any details of the hardware and software architectures that produce this performance. However, the syntax does imply many things. A decoder that performs at the MPEG-2 main profile and high level implies how fast the decoder must operate and how much memory it needs to have. A system that can perform to multiple MPEG formats requires some electronic format-conversion circuitry. System-performance specifications to consider include speed, I/O bandwidth, and memory size. The alliance has yet to nail down the numbers that correspond to these specifications. However, system clock speeds may be as high as 75 MHz.

The MPEG-2 levels and profiles pro-

## For more information...

For free information on the MPEG-2-decoder ICs, circle the appropriate numbers on the postage-paid Information Retrieval Service card or use EDN's Express Request service. Also use the following list to directly contact members of the Grand Alliance. When you contact any of the following manufacturers directly, please let them know you read about their products in EDN.

### AT&T Microelectronics

Berkeley Heights, NJ  
(908) 771-3268  
Circle No. 318

### General Instrument Corp

San Diego, CA  
(619) 455-1500  
Circle No. 319

### Massachusetts Institute of Technology

Cambridge, MA  
(617) 253-2703  
Circle No. 320

### Philips Consumer Electronics

Knoxville, TN  
(615) 521-3274  
Circle No. 321

### David Sarnoff Research Center

Princeton, NJ  
(609) 734-3038  
Circle No. 322

### SGS-Thomson Microelectronics

Phoenix, AZ  
(602) 867-6100  
Circle No. 323

### Thomson Consumer Electronics

Washington, DC  
(202) 872-0672  
Circle No. 324

### Zenith Electronics Corp

Glenview, IL  
(708) 391-7000  
Circle No. 325

### Super Circle Number

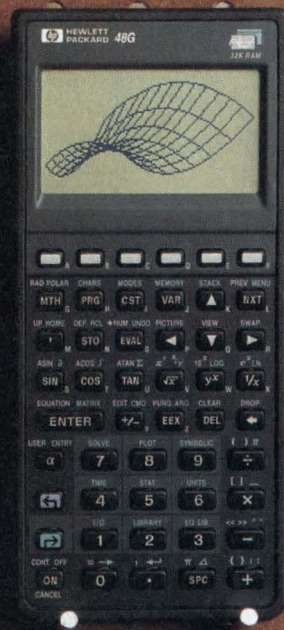

For more information on MPEG-2-decoder IC products available from all of the vendors listed in this box, you need only circle one number on the postage-paid reader service card. **Circle No. 326**

# Time-saving Solution-producing Engineer-pleasing HP 48G



## Quicker. Easier. To save you time.

To get solutions quickly, carry the best portable tool for engineering computation. The HP 48G graphic calculator. Focused problem-solving environments in the HP 48G lead you to answers fast.

Press  and EQUATION. Create equations that look the same way you'd write them. Press  and SOLVE. Then just choose the kind of problem you want to solve. Like differential equations, a system of linear equations, or others. It's your choice.

## You'll quickly learn to operate it!

Pull-down menus guide you through problem-solving smoothly and quickly.

Push a button, select an entry from the pull-down menu, and fill in the blanks. Entering data is that easy.

## The tool you would have designed for yourself!

Technically sophisticated. It contains over 300 built-in equations grouped into 15 technical subjects. Electricity, forces and energy, stress analysis, and other technical categories.

And, it lets you work with many different object types for solving problems. Real numbers with units, polar forms of complex numbers, symbolic constants, variables in formulas, matrices, and lots more. It's an engineer's dream tool!

## Special money-saving offer on Sparcom's CalcWare PC/Mac Link software and connectivity cable.

The HP 48G (and its RAM card expandable cousin, the HP 48GX) can be linked to your desktop PC or Mac. Sparcom is offering a special \$49.95 price (\$10.00 off) on its HP 48 CalcWare PC/Mac Link. This connectivity software and cable are being offered at a special price from October 1, 1993 until June 30, 1994.

To get more information on the HP 48 along with this and other special Sparcom offers, call 800-443-1254, Dept. 421.



**New High Voltage Amplifiers At New Low Prices**



\*\$13.60/10K

**The PA41/42 Is The Industry's First 350V High Voltage Monolithic Power Amplifier in a SIP Priced at \$13.60\***

**Also New From Apex ... 450V Hybrid in a SIP**

Looking for more voltage? The PA87 is the industry's first high voltage hybrid to be offered on a 10-pin SIP. Capable of operating on a 100V to 450V supply, the PA87 features 300mA peak output current and consumes just 3mA of quiescent current.

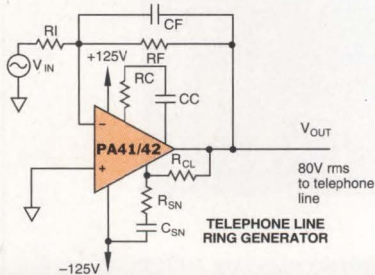

**PRODUCT SPECIFICATIONS**

Part #	V <sub>SS</sub>	I <sub>0</sub> mA Cont/Peak	I <sub>0</sub> Max	P <sub>D</sub>	\$/10K
PA41/42	100V-350V	60/120	2mA	9W	\$13.60
PA87	100V-450V	200/300	3mA	7.5W	\$52.00

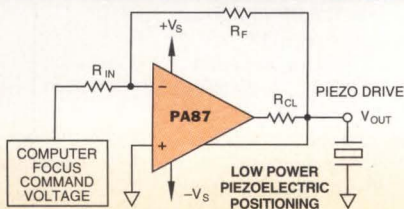

**APEX MICROTECHNOLOGY CORPORATION**  
5980 N. Shannon Road, Tucson, AZ 85741

For Product Information or Applications Assistance Call  
1-800-862-1015 or FAX (602) 888-3329  
Deutschsprachig 0130 81 3599

- AUSTRALIA/N.Z. (08) 277 3288
- BELGIUM/LUX (323) 458 3033
- CANADA (613) 592 9540
- DENMARK (45) 97 25 0816
- DEUTSCHLAND (6172) 5113
- ESPAÑA (1) 530 4121
- FRANCE (1) 69 07 08 24
- HUNGARY/CZECH 1 176 2783
- ISRAEL (3) 9345171
- ITALIA (2) 66400 339
- INDIA (212) 339836
- NETHERLAND (10) 451 9533
- NORGE (2) 50 06 50
- ÖSTERREICH (222) 505 15 220
- REP. S. AFRICA (021) 23 4943
- SCHWEIZ (0049) (6172) 5113
- SUOMI 0 522 122
- SVERIGE (8) 795 9650
- TURKIYE (1) 337 2245
- U.K. (844) 278781

**CIRCLE #2 IN U.S.**

**CIRCLE #107 IN EUROPE**

**US DIGITAL-HDTV STANDARD**

vide the flexibility necessary to deal with compressing, transmitting, and decompressing types of pictures. The need to transmit data at megabits/second over the FCC-mandated 6-MHz channel requires some form of lossy compression. The optimum compression scheme depends on a picture's contents and requires a compromise between spatial resolution, frame rate, and amount of acceptable compression artifacts. Optimum resolutions and rates vary for different kinds of pictures.

With the standard close to completion, much product development will soon be necessary, particularly in the area of displays and powerful compression and decompression ICs. MPEG-2 ICs are already starting to appear. For example, AT&T Microelectronics and SGS-Thomson Microelectronics are both sampling MPEG-2 ICs. The first of a family of MPEG-2 devices planned by AT&T, the AC6101 decodes all the MPEG-2 video layers in real time without external processor support. The device uses a 27-MHz clock and just 8 Mbits of external memory. The chip will be available in volume in the first half of this year. The company hasn't set firm pricing but expects the IC to cost between \$50 and \$75 in large volumes.

SGS-Thomson's Sti3500 decodes MPEG-1 and -2 bit streams in real time up to a 16-Mbps input-data rate. Samples are available now, and production quantities will be available this quarter. Price is \$48 (100,000).

In addition to decoder ICs, the HDTV standard will impact the design of many other systems, including receivers, displays, studio and transmission equipment, peripheral equipment, programming and software-development systems, and semi-conductors. Within a year, specific details will be available so that designers can begin work on these products.

**EDN**

You can reach Anne Watson Swager at (215) 645-0544.

Article Interest Quotient  
(Circle One)

High 595 Medium 596 Low 597

**PICO**

**ULTRA-MINIATURE Surface Mount Audio Transformers**

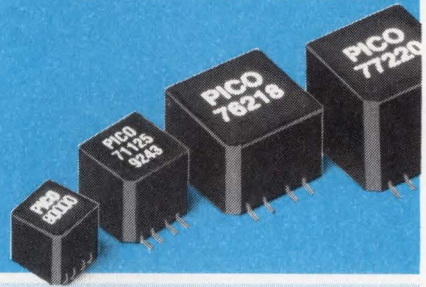

**Low Profile .2" Ht.**

- **Manufactured and tested to MIL-T-27**
- **Frequency range 20 Hz to 250 KHz**
- **Available from 100 milliwatts to 3 watts**
- **Impedance from 20 ohms to 100 K ohms**
- **Operating temperature -55° C to +130° C**
- **Low profile .2" ht.**

PICO surface mount units utilize materials and methods to withstand extreme temperature (220°C) of vapor phase, I.R., and other reflow procedures without degradation of electrical or mechanical characteristics.

**Delivery—stock to one week**

See EEM or send direct for **Free PICO Catalog.**

Call toll free **800-431-1064**  
in NY call **914-699-5514**  
FAX **914-699-5565**

**PICO Electronics, Inc.**

453 N. MacQuesten Pkwy., Mt. Vernon, N.Y. 10552  
**CIRCLE NO. 3**



# Start with OrCAD. Finish with OrCAD.

**Schematics. Printed Circuit Board Layouts. FPGAs . OrCAD has what it takes to get the job done. Fast.**

OrCAD offers a complete solution for your printed circuit board and FPGA designs. More than 76,000 engineers have used OrCAD's schematic design tools to create their designs. No other EDA software has been used more. And now, the all new, enhanced versions of our entire 386+ product line offer workstation capacity, with the fastest graphics in the industry. And all of our products run in a DOS session under Microsoft Windows®.

## Reduce your PCB cycle time.

By coupling schematic design and printed circuit board layout with SDT 386+ 1.10 and PCB 386+ 1.10, you can quickly get your boards from design to manufacturing. PCB 386+ 1.10 includes an extensive library with over 1000 footprints, an automatic footprint generator, on-line all object editing, and the best embedded 100% completion autorouter on the PC. Finish your design with complete manufacturing output.

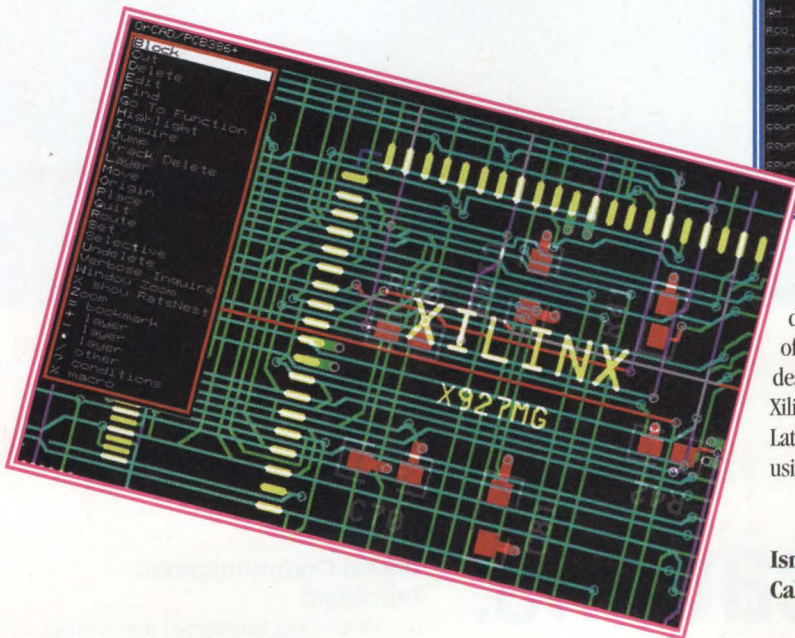
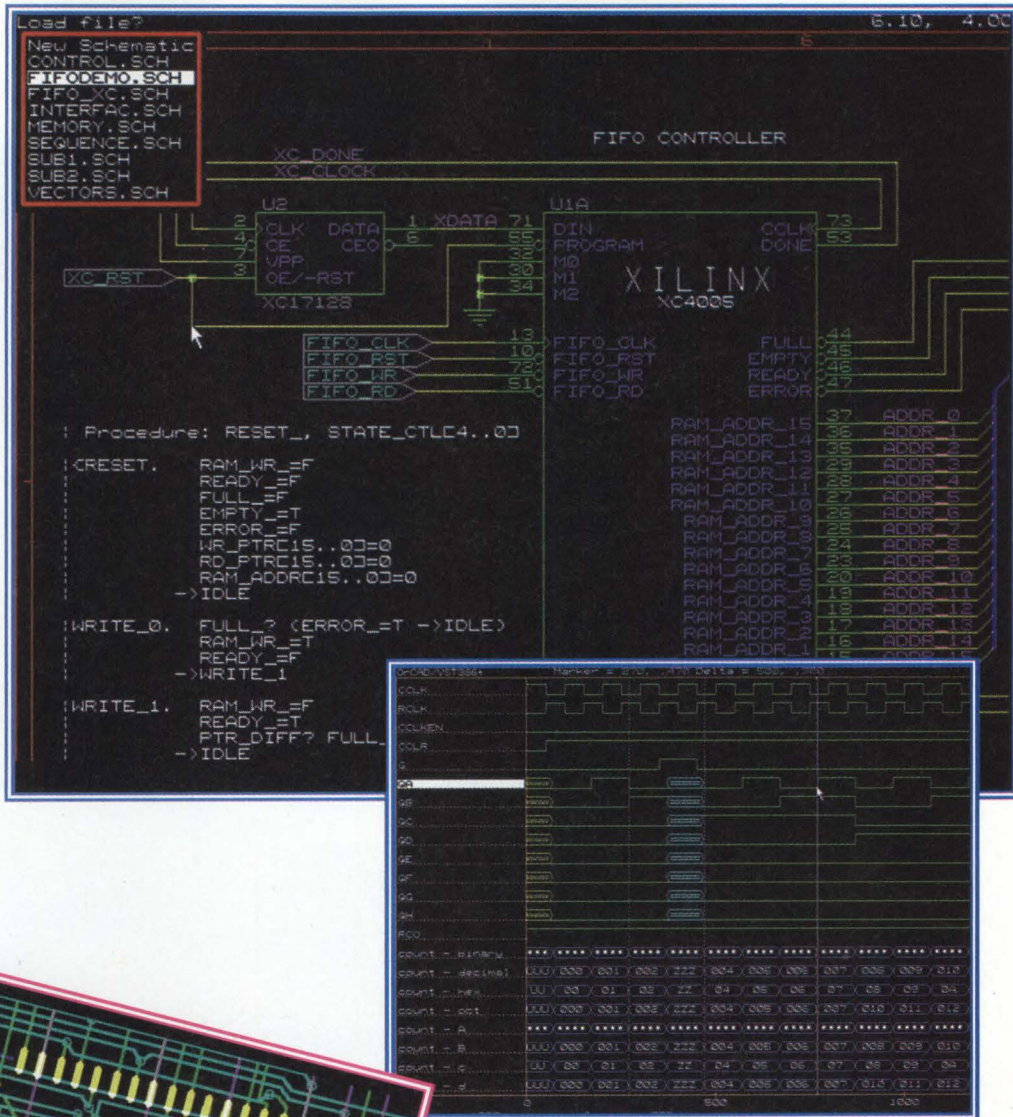

## Target virtually any FPGA device.

Capture your design in OrCAD schematics, OrCAD hardware description language, or both. The multi-level synthesis capability of OrCAD's PLD 386+ 2.00 rapidly compiles your largest FPGA designs. Target devices from Actel, Intel Flexlogic, Xilinx 2000, Xilinx 3000, Xilinx 4000, Xilinx EPLDs, AMD MACH, AMD MACHXL, Lattice PLSI, Texas Instruments, and many others. Finish the job using VST 386+1.10 to verify the timing of your routed design.

**Isn't it time you got your whole job done with OrCAD?  
Call us.**

CIRCLE NO. 53

# SIEMENS

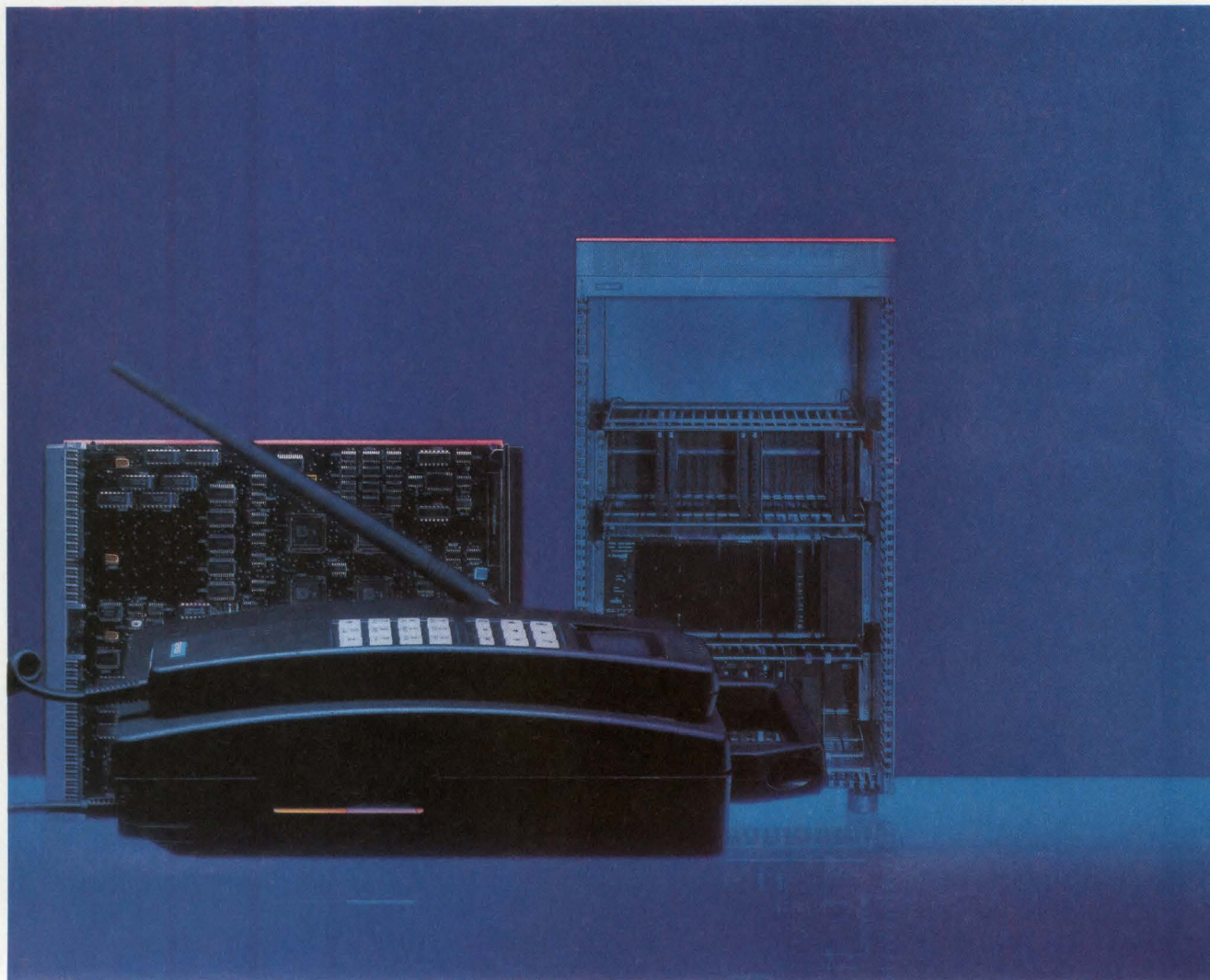

Systems in Silicon for Information Technology.

## Global Communications.

Siemens gives you what you need to win in today's global market, with complete system solutions featuring state-of-the-art integration, performance and packaging technologies. And the R&D, technical support and volume production you need, whenever you need it.

### **Digital Communication Terminals.**

Our leadership position in this market comes from innovations like the PEB2086. This full-duplex ISDN transceiver features a HDLC controller for D channel signaling, making it ideal for uses including ISDN terminals, NT (Network Termination), and PBX line card and terminal applications.



PMB 2705 GOLD – GSM One-Chip Logic Device – is a densely integrated chip in 1- $\mu$ m CMOS technology that combines virtually all the logic functions of a GSM mobile phone.

ROSE & REINARTZ A19100-HL9102-USA-7600

With our ARCOFI-SP (PSB2165 Audio Ringing Codec Filter-Speech Circuit), we also offer the world's most advanced speakerphone IC for digital terminals. The only codec filter with near-full duplex for real-time conversation, its high level of integration allows switching between receive and transmit paths in only 125 microseconds, eliminating clipping common in most speakerphones and providing nearly full duplex communication.

#### **Data Communications ICs.**

Siemens has earned a reputation for advanced data communications with products like the HSCX2 (SAB82525) for telecommunications and the ESCC2 (SAB82532), the first 2 Mbit

asynchronous multiprotocol communications controller. Today, this innovation is evident in products like the ESCC8 Enhanced Serial Communication Controller (SAB82538) – the industry's first 8-channel multi-protocol Data IC. The ESCC8 provides four times the data throughput of standard 2-channel devices, easy integration and the fastest speeds in the industry.

#### **Wireless Communications.**

With our new PMB2230 transmitter and PMB2430 receiver, we've introduced the world's most advanced 2-chip wireless solution designed specifically for wireless cellular applications. By integrating multiple tasks

onto each component, this solution cuts your real-estate requirements drastically, which means lower manufacturing costs, greater ease-of-design and quicker time to market for your wireless designs.

To find out how we can help you succeed in the global market, call us today at

**1-800-77-Siemens, ext. 210.**

We'll show you how a partnership with Siemens can open up a whole new world of possibilities in communications.

© 1993 Siemens Components, Inc. Integrated Circuit Division.

*Broaden your RF horizons.*

$S_{11}$     SWR  
REF    1.0

***THIS IS AMP TODAY.***



*RF performance, DC to 50 GHz.*



START 0.0000GHz  
STOP 50.0000GHz

No matter what range you're working, your work goes better and faster with connectors engineered for the right balance of properties. AMP has the coax connectors you need for top performance, consistent electrical characteristics, and maximum manufacturability.

Select from a line that spans the spectrum—DC to 50 GHz—in a variety of 50 or 75 ohm versions. Our selection delivers the advanced

design and controlled properties you need, with commercial versions that exhibit Mil-equivalent performance. Our fully Mil-qualified versions offer productivity gains, as well, including our proven crimp/seal technology.

We support the broadest selection of RF connectors available with the broadest range of mounting options as well: from cable to bulkhead, panel to board—and now including

custom and semi-custom high-speed coax and transmission cable assemblies.

We'd like to extend all that support to you. For literature or the name of your nearest AMP Distributor, call the AMP Product Information Center at 1-800-522-6752 (fax 717-986-7575). In Canada call 416-475-6222. AMP Incorporated, Harrisburg, PA 17105-3608.

**AMP**

# EMC components administer + first aid +

**BRIAN KERRIDGE, Technical Editor**

*Discovering late in the day that your product fails to comply with EMC regulations implies a tough redesign. A host of passive parts, applied simply and superficially, could be your salvation.*

Not often in design work do you get a chance to make a product meet specification by bolting on a few basic parts. With electromagnetic compatibility (EMC), you have that option simply because many EMC failures concern a product's peripheral features such as cabling and apertures. Components such as ferrite cores and beads, feedthrough capacitors, connector shields, gaskets, and conductive tapes can all prevent unwanted signals from reaching the outside world. Conversely, the same components also offer a design some immunity from external interference. Not only do these basic components provide your design an important source of EMC first aid, but they can also throw a permanent lifeline to a finished product that would otherwise be an EMC casualty.

Applying first-aid fixes at

the back end of a design cycle opposes almost everything EMC experts believe in. They advise, advocate, and even implore you to design in EMC from day one. That way, you suppress emissions at the source and prevent noncompliant noise levels from ever reaching the extremities of your product. Much of that preventive design work involves building in certain features at pc-board layout (**Ref 1**). While the advice is good—and appeals to the common-sense instincts of most designers—the fact remains that designers' priorities often lay elsewhere.

This situation prevails despite an increasing awareness of the importance of EMC and Europe's EMC Directive (**Ref 2**). That directive will ultimately enforce conformance by law; it applies equally to new products and products designed

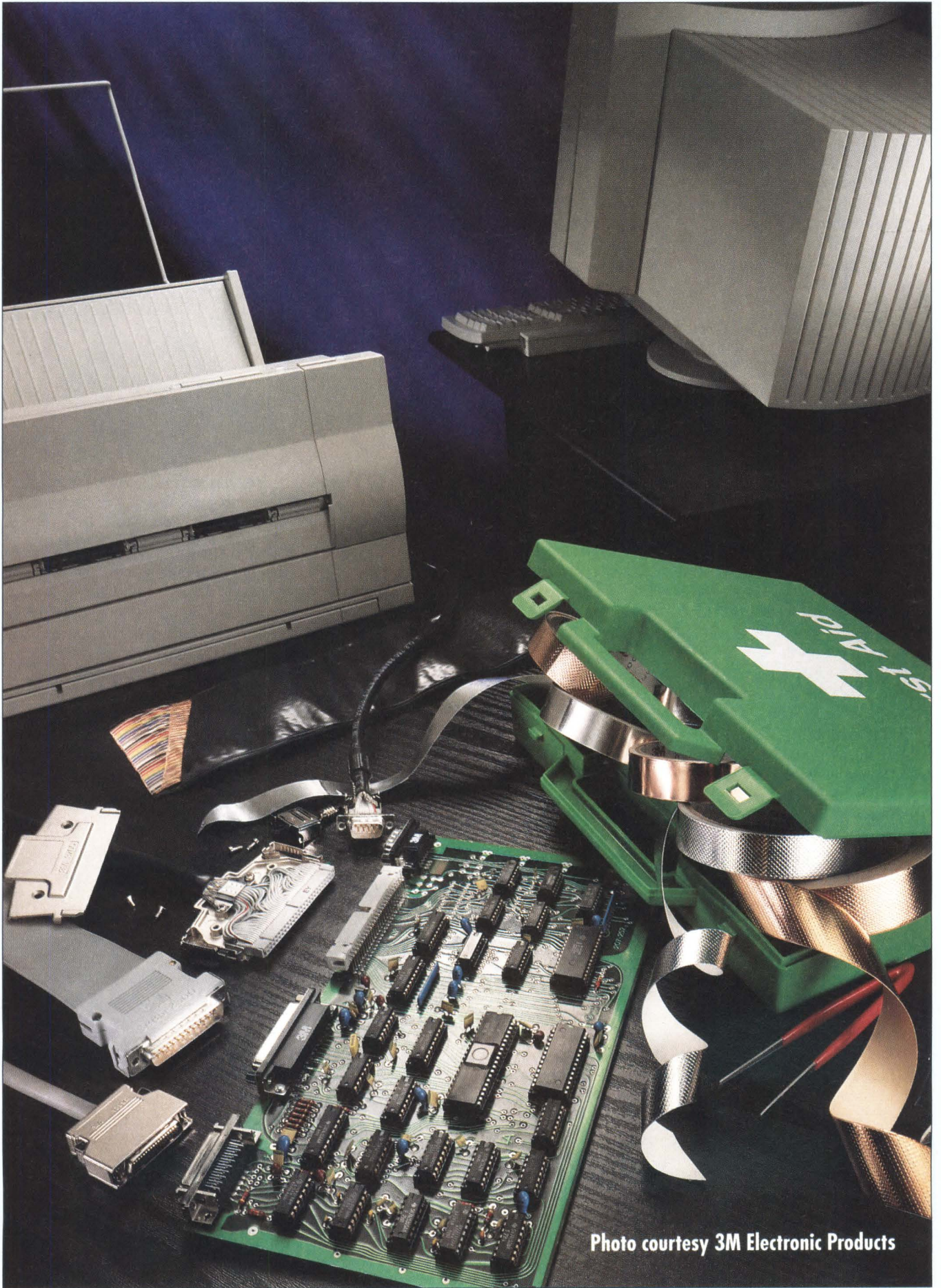

Photo courtesy 3M Electronic Products

## EMC COMPONENTS

well before EMC became a hot topic. On older designs, applying first-aid measures is the only cost-effective compliance route and represents a genuine need for that approach.

So, for the time being, applying quick fixes remains a popular and necessary way—although not the purist's preferred method—to treat EMC-design problems. For a quick reference, see **Table 1**, which shows the range and variety of EMC components that can administer first aid to a finished design.

Broadly speaking, undesirable emissions occur either as radiations directly from your circuit board or indirectly, first by conduction along connecting cables and then by radiation. Directly radiated emissions leak through apertures or poor electrical joints in a product's shielding, and it's here that conductive adhesive tapes, wire mesh, and gaskets are effective remedies. Connector backshields, filtered connectors, cable shields, ferrites, and feedthrough capacitors all reduce emissions conducted onto connecting cables.

For the purpose of meeting EMC specifications, assume conducted emissions concern signal frequencies of 150 kHz to 30 MHz, and radiated emissions cover 30 MHz to 1 GHz. At present, international standards for conducted emissions consider mainly effects on line cords, and, therefore, it's common practice to design in a line filter. By contrast, standard requirements overlook conducted emissions on I/O cables, and because I/O signals vary widely anyway, these lines are largely left unfiltered. Undesirable emissions on I/O cables give rise to the majority of EMC failures, and radiated-emission tests pick up those failures.

Whatever EMC tools you employ to make your tests (**Ref 3**), it's often most expedient to adopt a trial-and-error approach when solving EMC problems. It helps, though, to have some understanding of what each type of first-aid component can reasonably achieve. In most cases, however, your adding components will not upset the fundamental perfor-

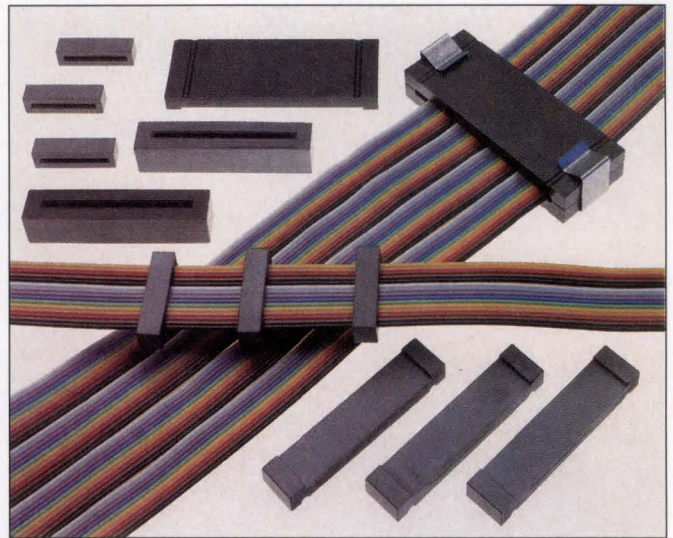

**MMG-Neosid's range of ferrite cores includes loops for suppressing common-mode current on ribbon cables. The company also provides Spice models for designing series-mode filters with its ferrite beads.**

mance of the product. But in a few cases they can—for example, if you set about filtering a high-speed data bus.

The difference between series- and common-mode signals is a key distinction to appreciate in addressing EMC problems on cables. Series (or differential)-mode signals are legitimate data signals that consist of signal currents with a forward and return path. Common-mode signals are wholly illegitimate and occur mainly because of poor grounding somewhere in your overall system.

Both series- and common-mode currents can radiate non-compliant emissions, but series-mode problems are fewer simply because of a tendency of radiation from forward and return

## Looking ahead

Although EMC specialists regard first-aid measures a non-preferred route to compliance, there is strong evidence that this is the path many companies will follow.

Tim Williams, EMC design consultant with Elmac Services, notes a wide variation in the way European companies plan to treat product EMC. He says most medium- to large-sized companies now know they need to take action, and that action means a wholesale reeducation program for designers, test engineers, and maintenance staff. Some companies still are totally unaware of the requirements, particularly in European countries having no official "awareness" campaign. It remains to be seen how they implement the EMC directive.

At present, Williams says large multinational companies already have, or are developing, internal procedures for designing in product EMC. He also says the majority of other companies plan no action, mainly because they believe the cost of designing in EMC is too high.

In the United States, Joe Butler, director of EMC-testing services at Chomerics, draws a distinction between companies

with military- and commercial-product experience. He says military companies have well-established EMC design procedures, but commercial companies, broadly speaking, do not. Butler asserts that apart from large multinational companies with EMC engineers already on staff, most companies, though aware that some EMC testing will ultimately be required, still treat EMC design as an 11th-hour activity.

Butler predicts a mad scramble to have products tested as the 1996 European directive deadline approaches. He estimates the requirement for immunity tests, as well as a wider scope (over FCC requirements) of products needing tests, may surprise some US vendors. In particular, he warns that companies with products currently exempt from FCC regulations and having a lot of mostly unshielded cabling will face serious problems trying to comply.

Butler forecasts moves by EMC component vendors to address the needs of commercial users in high-growth markets such as computing and wireless communications. In particular, he sees low cost as the principal driving force in extending acceptance of designing for EMC.



currents to cancel out. Although common-mode currents cause most cable-borne EMC failures, fortunately, it's this type of current that EMC first-aid measures readily suppress.

Your two options are to pass your I/O cable through a single ferrite loop or to insert common-mode chokes in series with each signal and return pair at the I/O interface. Vendors offer ferrite loops in an immense range of sizes, styles, and frequency specifications. To ease installation, loops are round, oblong, and either complete or in halves with a clamp. For both ferrite loops and common-mode chokes, you have to rely on trial-and-error. Most ferrite suppliers encourage this route by offering diagnostic kits containing an assortment of types. Calculations are impossible because you have no idea what value to assign to impedances around a common-mode loop. On that basis, it generally pays to install as large a component as space allows. In the case of ferrite loops, passing a cable through the loop more than once or adding more loops is also beneficial. The merit of ferrites is that they absorb, rather than reflect, radiation locally, and they dissipate the energy as heat.

In the case of series-mode signals, you *can* estimate circuit source, transmission, and load impedances. Therefore, you can design a passive lowpass filter to bandlimit I/O lines (**Ref 1**). The range of filter components is wide, but a common characteristic is definable low inductance. Again, the simplest component is a ferrite core, although in this case the ferrite needs to surround each signal path and needs careful selection. Also available are ferrite plates with holes to match popular connectors' pinout configurations. Other possible filter components include 3-terminal capacitors with and without ferrite beads, chip inductors and capacitors, feedthrough capacitors, and ready-made encapsulated filters.

The easiest and neatest way to apply in-line filtering is either to swap a regular connector for a filtered type or to insert a filtered adapter between your present plug and socket. Filtered connectors exist mainly as replacements for D-type connectors, although you have a wide array of filter-component combinations within the range. With feedthrough capacitor values ranging from 50 to 2000 pF and using or discarding ferrite plate inductors (impedance  $35\Omega$  at 100 MHz), you can tailor lowpass bandwidth to your application.

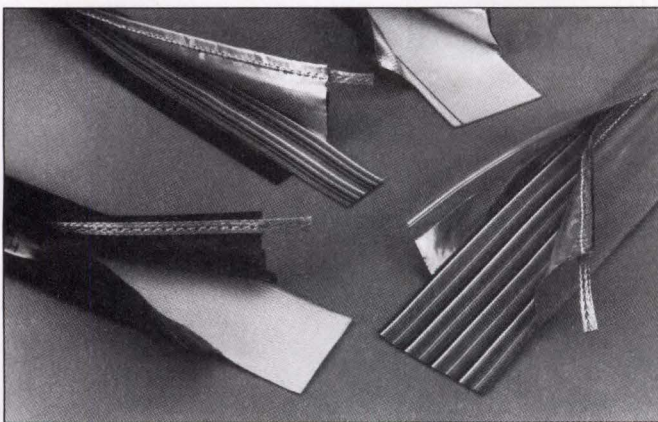

Zipper-Technik's zip-on screened jackets suit multicore or ribbon cables. The screens consist of vinyl impregnated nylon cloth laminated to aluminum foil or wire mesh. Both types include a finned copper braid joined to the zip joint as a ground connection.

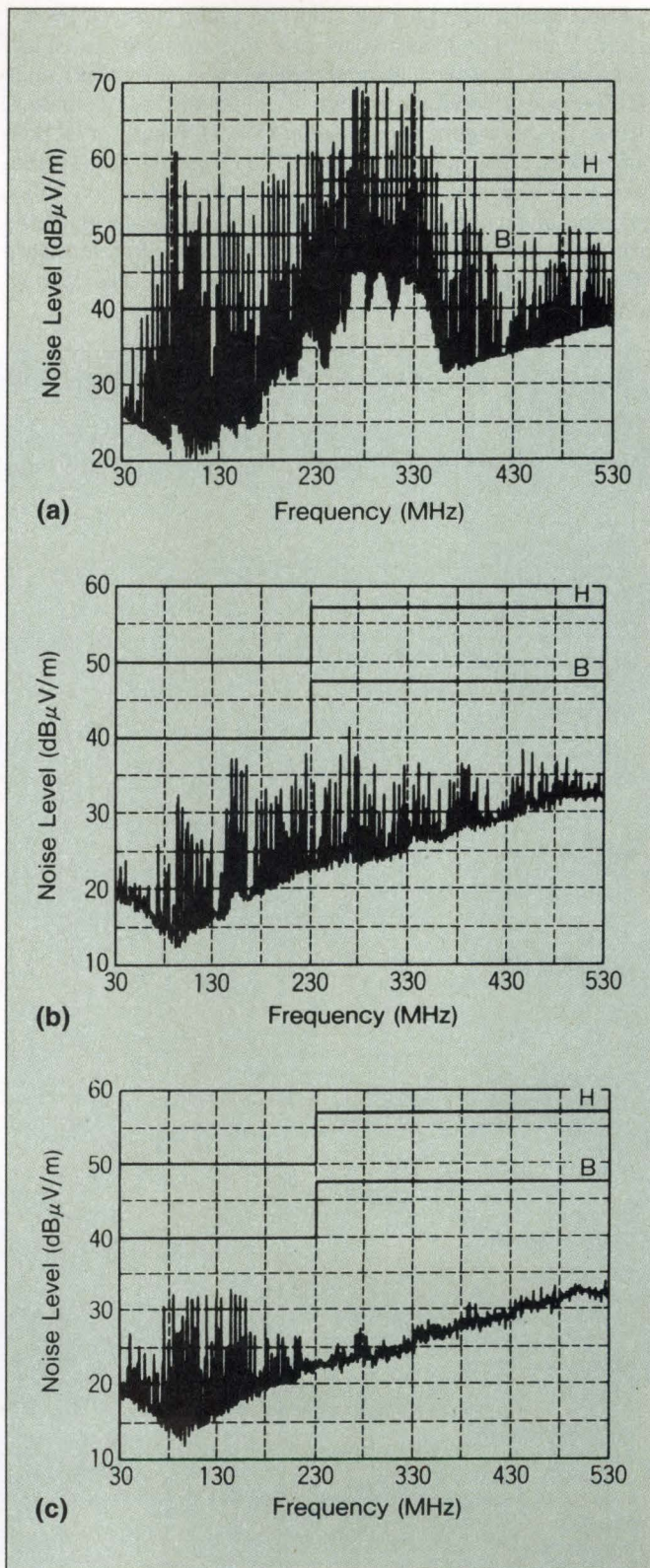

Fig 1—(a) shows typical noise radiation from 100 mm of unshielded ribbon cable carrying a 5-MHz, 8-bit data bus from a standard connector on a shielded case; (b) and (c) illustrate the benefits of using a 250-pF shielded connector and 270-pF 3-terminal in-line capacitors, respectively (data supplied by Murata).

## EMC COMPONENTS

Cable shielding is the next step, and again, your options are many. Your main decisions are how thick to make the shield and whether to make a ground connection at one or both ends of the cable. If your knowledge of shielding theory is rusty, there's no shortage of revision notes (**Ref 1**). Whatever method you choose, a low impedance connection from shield to system ground is essential. The sight of a pigtail connection—alias, common-mode impedance—appalls EMC experts, and it's the primary function of connector back shields to eliminate these offensive joints. Connector backshields, like filtered connectors, generally suit D-type connectors.

If you're using an unshielded ribbon cable, as a first step, try ribbon with a single-sided aluminum-shield backing. Beyond that, you'll need to use a complete braid of zip-on sheath.

If you've applied all the first-aid fixes to your I/O cables, but EMC problems persist, it's time to consider enclosing your main circuit components. Here's where adhesive conductive foils excel. Foils form the most adaptable EMC diagnostic material. Foil material is either copper or aluminum, with a choice of conductive or nonconductive adhesive. Foil surface is either smooth or embossed, the embossed version

**Table 1—Representative EMC components**

Vendor	Ferrite	Common-mode choke	Filtered connector	Feed-through capacitor	3-terminal capacitor	Cable shield	Connector backshield	Foil	Mesh	Gasket	Other
Adhesive Research Circle No. 334							X				
Band-It Circle No. 335											Cable shield clamp
Beck Electronics Circle No. 336		X									Feedthrough filter
Chomerics Circle No. 337						X		X	X	X	Conductive compound and spray paint
Coolstead Magnetics Circle No. 339	X										
Dontech Circle No. 340											Window shield
Fair Rite Circle No. 342	X										
Ferrishield Circle No. 343	X										
Ferronix Circle No. 345	X										
Ferroperm Circle No. 346	X		X	X							
Instrument Specialties Circle No. 347							X		X	X	Conductive finger strip
Kabelwerk Eupen Circle No. 348											Ferrite-coated cable and tape
Kern Electrical Components Circle No. 350							X				
Kemtron International Circle No. 349								X	X	X	
Kitagawa Circle No. 351	X					X		X	X	X	

## Europe's directive forces the pace

Anticipating EMC regulations' becoming law in Europe on January 1, 1996, governmental departments in France, Germany, and the United Kingdom are conducting EMC-awareness campaigns. Efforts in the United Kingdom are particularly strenuous, where the campaign features a free journal for board-level executives; technical reports for people implementing EMC measures; an EMC workbook for people organizing seminars

and training; a network of nine EMC clubs for disseminating knowledge; *EMC Update*, a 4-pg bimonthly publication that supports club activities with EMC news and case-study information; and three videos. Also available is an EMC nontechnical telephone help line (dial UK (country code 44) then 61 954 0954), which offers general information, including supply sources for documents and contact names of specialists.

	Ferrite	Common mode-Common	Filtered connector	Feed-through capacitor	3-terminal capacitor	Cable shield	Connector backshield	Foil	Mesh	Gasket	Other
MMG-Neosid Circle No. 352	X										Spice models
Murata Electronics Circle No. 353	X	X	X		X						
Omega Shielding Products Circle No. 355										X	Conductive finger contacts
Oxley Developments Circle No. 354			X	X							Window shield
Philips Components Circle No. 356	X										
Provertha Circle No. 357			X								
RFI Shielding Circle No. 358										X	
Schaffner EMC Circle No. 359		X		X							
Siemens-Matsushita Circle No. 360	X			X	X						
Steward Circle No. 361	X										
TDK Circle No. 362	X										
3M Electronic Products Circle No. 364						X	X	X			
Tusonix Circle No. 363	X										
Warth Circle No. 365						X		X	X	X	Conductive finger strip, window shield
Zipper-Technik Circle No. 366						X		X			

## EMC COMPONENTS

providing lower contact resistance (approximately 1 mΩ/in.<sup>2</sup>) to a supporting surface and other layers of foil.

You can readily fit foil screens to individual components or to whole sections of a circuit as an experiment. You can also use foils to improve contact along enclosure seams, which is a useful way of testing the need for a proper EMC gasket (Ref 5). Additionally, where an enclosure is already sealed except for essential display windows or cooling vents, foil temporarily placed across these apertures will also test the likely benefit of installing EMC mesh. Another experimental use of foils is as an alternative to conductive spray paints for lining the inside of plastic product enclosures.

If you reach the stage of installing gaskets, mesh, or EMC windows, then your work transmutes from low-cost first aid to high-cost intensive care. But, this is the penalty you pay for ignoring experts' words of caution. Even so, applying exotic modifications this late to a design may still be the most profitable way forward. For, as well as providing permanent low-cost solutions, EMC first-aid components will sustain a product at higher cost until it's convenient or worthwhile to conduct major surgery. EDN

## References

1. Williams, Tim, *EMC for Product Designers*, Butterworth-Heinemann, 1992.
2. Kerridge, Brian, "Europe Lays down EMC Law," *EDN*, September 16, 1991, pg 57.
3. Kerridge, Brian, "EMC Bench Tools," *EDN*, October 1, 1992, pg 78.
4. Anderson, Mark, "EMI Countermeasures," Euro-EMC conference proceedings, October, 1993, Reed Exhibitions, Richmond, UK.
5. Bates, Ron, "EMC Gaskets—Traps to Avoid," Euro-EMC conference proceedings, *Ibid*.

## Acknowledgment

*Thanks to Tim Williams, EMC design consultant with Elmac Services, for advice and guidance with this article.*

*Technical Editor Brian Kerridge can be reached in the UK at (508) 528435; fax (508) 528430.*

Article Interest Quotient  
(Circle One)

High 592 Medium 593 Low 594

## Manufacturers of EMC components

For free information on EMC components such as those described in this article, circle the appropriate numbers on the postage-paid Information Retrieval Service card or use *EDN's* Express Request service. When you contact any of the following manufacturers directly, please let them know you read about their products in *EDN*.

**Adhesives Research**

Glen Rock, PA  
(717) 235-7979  
Circle No. 334

**Band-It**

Denver, CO  
(303) 320-4555  
Circle No. 335

**Beck Electronics**

Great Yarmouth, UK  
(493) 856282  
Circle No. 336

**Chomerics**

Woburn, MA  
(617) 935-4850  
Circle No. 337

**Coilcraft**

Cary, IL  
(708) 639-2361  
Circle No. 338

**Coolstead Magnetics**

Welwyn, UK  
(438) 814054  
Circle No. 339

**Dontech**

Doylestown, PA  
(215) 348-5010  
Circle No. 340

**Electronic Component Industry Federation**

London, UK  
(71) 497-2311  
Circle No. 341

**Fair Rite**

Wallkill, NY  
(914) 895-2055  
Circle No. 342

**Ferrishield**

New York, NY  
(212) 268-4020  
Circle No. 343

**Ferronix**

Fairport, NY  
(716) 388-1020  
Circle No. 345

**Ferroperm**

Wrexham, UK  
(978) 823990  
Circle No. 346

**Instrument Specialties**

Delaware, PA  
(717) 424-8510  
Circle No. 347

**Kabelwerk Eupen**

Eupen, Belgium  
(87) 554771  
Circle No. 348

**Kemtron International**

Ferrers, UK  
(245) 325555  
Circle No. 349

**Kern Electrical Components**

Reading, UK  
(734) 811571  
Circle No. 350

**Kitagawa**

Egelsbach, Germany  
(6103) 42097  
Circle No. 351

**MMG-Neosid**

Letchworth, UK  
(462) 481000  
Circle No. 352

**Murata Electronics**

Fleet, UK  
(252) 811666  
Circle No. 353

**Oxley Developments**

Ulverston, UK  
(229) 582621  
Circle No. 354

**Omega Shielding Products**

Cedar Grove, NJ  
(201) 890-7455  
Circle No. 355

**Philips Components**

Eindhoven, The Netherlands  
(40) 783749  
Circle No. 356

**Provertha**

Pforzheim, Germany  
(7231) 7740  
Circle No. 357

**RFI Shielding**

Braintree, UK  
(376) 342626  
Circle No. 358

**Schaffner EMC**

Wokingham, UK  
(734) 770070  
Circle No. 359

**Siemens-Matsushita**

Bracknell, UK  
(344) 396000  
Circle No. 360

**Steward**

Chattanooga, TN  
(615) 867-4100  
Circle No. 361

**TDK**

Redhill, UK  
(737) 772323  
Circle No. 362

**Tusonix**

Tucson, AZ  
(602) 744-0400  
Circle No. 363

**3M Electronic Products Group**

Bracknell, UK  
(344) 858509  
Circle No. 364

**Warth International**

East Grinstead, UK  
(342) 315044  
Circle No. 365

**Zipper-Technik**

Neu-Isenburg, Germany  
(6102) 33066  
Circle No. 366

## Super Circle Number

For more information on EMC components available from all of the vendors listed in this box, you need only circle one number on the postage-paid reader service card.

Circle No. 367

Do you get 24-bit true color at 1024 x 768 resolution from your PC graphics designs?

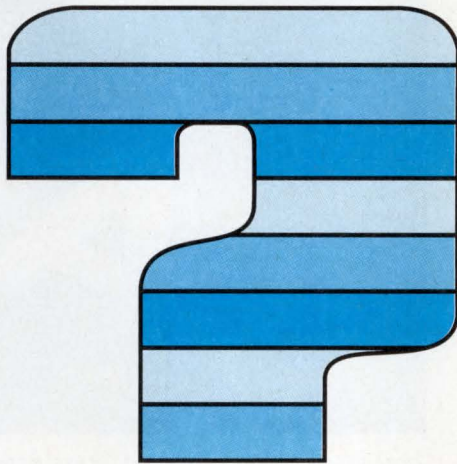

You can with TI's TVP3020.  
The 64-bit, low-cost video interface palette.



The TVP3020 from Texas Instruments is the industry's first video interface palette to offer a 64-bit pixel bus plus a separate VGA port, making it an excellent choice for PC graphics/Windows™ accelerators. And it's flexible. The TVP3020 is available in three speed grades of 135 MHz, 175 MHz and 200 MHz so its benefits can be achieved on engineering workstations and color X-terminals as well.

TVP3020 Color Depth and Resolution			
Screen resolution	Approximate dot-clock (72 Hz frame rate)	Max. number of colors† 64-bit pixel bus palette (TVP3020)	Typical 32-bit pixel bus palette
1024 x 768	85 MHz	16 million (24-bit true color)	64K
1280 x 1024	135 MHz	64K (16-bit true color)	256
1600 x 1280	200 MHz	64K (16-bit true color)	N/A

If you need it	We've got it
• More colors at high resolution	• 64-bit pixel bus
• Simplified VGA interface	• Separate VGA port
• High-screen resolution	• Dot clock up to 200 MHz
• Faster graphics performance	• Hardware cursor
• Lower cost external TTL PLL	• Internal frequency doubler
• More accurate color rendition	• Gamma-corrected true color
• Control of overlays for multimedia	• Color-key switching

The TVP3020 allows flexibility in designing photo-realistic graphics systems up to 16 million colors. It enables you to support 24-bit true color at 1024 x 768 as well as 16-bit true color at both 1280 x 1024 and 1600 x 1280 with a single design.†

TVP3020		
Speed	Part Number	Price*
135 MHz	TVP3020-135MDN	\$36.00
175 MHz	TVP3020-175MDN	\$84.00
200 MHz	TVP3020-200MDN	\$100.00

The TVP3020 is already supported by some of the world's top PC graphics controller manufacturers. If you're ready to move to the next generation of video interface palettes, just return the reply card. Or call us at **1-800-477-8924, ext. 3446**. We'll help you get to the next level of graphics performance for less than you might expect.

EXTENDING YOUR REACH WITH TOTAL INTEGRATION™



© 1993 TI  
† Application based on a direct interface to VRAM with a maximum serial port speed of 50 MHz.  
™ Total Integration and Extending Your Reach With Total Integration are trademarks of Texas Instruments Incorporated. Windows is a trademark of Microsoft Corporation.

00-8420  
\*Suggested resale price per unit in quantities of 1,000.

For more information on any of these subjects: call 1-800-447-1500 and request appropriate extension number.

Europe – use EDN Information Retrieval Service or contact us direct via fax on +31 40-724825.

All Philips Semiconductors plants worldwide are ISO 9000 certified

## High-speed depletion-mode FETs offer big savings in telephone applications

Introduced for use as line current interrupters in telephone sets, new n-channel depletion-mode vertical D-MOS FETs from Philips can be driven directly from low voltage CMOS logic, permitting the elimination of as many as six gate-drive components from telephone designs.

Compared with the p-channel enhancement-mode FETs which are frequently used in this application, the new depletion-mode devices can

## First one-chip receiver front-end for advanced wireless designs

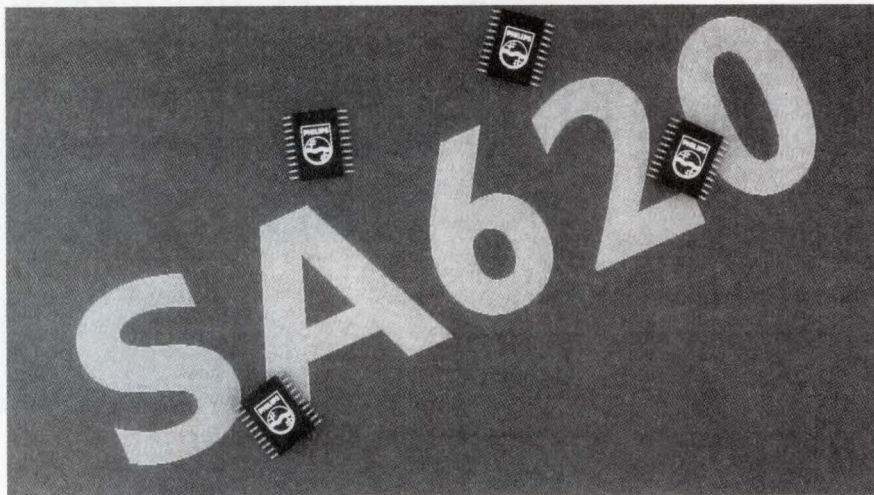

*Low power consumption makes the SA620 ideal for portable wireless communication units.*

The SA620 is the first RF IC to integrate a low-noise amplifier (LNA), mixer and voltage-controlled oscillator (VCO) in a single 3 V device. It replaces up to 20 discrete components in 900 MHz cellular and cordless phones, allowing designers to cut design cycles while increasing reliability and dramatically reducing size.

The Philips development is a complete 3 V front-end solution based on advanced QUBiC™ BiCMOS process technology, with performance that surpasses today's best silicon and GaAs discrete designs. Applications include portable cellular radios (900 MHz), cordless phones, RF data links, UHF frequency conversion and spread spectrum receivers.

The LNA, which is matched to 50 Ω, exhibits a 1.6 dB noise figure and 11.5 dB

power gain at 900 MHz. The active mixer supplies an additional 3 dB of power gain with a 8.5 dB noise figure. The integrated VCO reduces external component cost and simplifies design; an internal tracking bandpass filter and automatic levelling loop removes spurious responses and maintains a constant signal level into the mixer.

Low power consumption (10.4 mA at 3 V) makes the SA620 ideal for portable wireless communication units; fast power-down functions for the LNA, mixer and VCO further cut current consumption to 1.2 mA. The SA620 is housed in the SSOP20, the smallest commercially-available surface mount IC package.

Call 1-800-447-1500 Ext 1106  
Europe: circle no. 40

result in simpler and more cost-effective line interruption circuitry for new telephone designs, particularly when the FETs are used with telephone ICs from Philips such as the PCA1070 multi-standard CMOS transmission circuit.

The devices feature a maximum drain-source voltage of 250 V and an on-resistance of 20 Ω. With a drain current capability as high as 250 mA DC and maximum switch-on and switch-off times of 10 and 30 ns respectively, they are also

suitable for general industrial applications such as high-speed switches, line transformer drivers and relay drivers. For maximum design flexibility, the BSD254, BSP124 and BST124 provide approximately the same FET specification in TO92, SOT223 and TO126 packages respectively, with the TO92-packaged device available in three different pin-out arrangements.

Call 1-800-447-1500 Ext 5012  
Europe: circle no. 41

## Stereo decoder/noise blanker enhances car radio performance

Targeted for use in high-performance car radios, the TDA1592 stereo decoder/noise blanker is pin and function compatible with Philips' existing TDA1591. The new IC offers a very low muting offset at its audio outputs, a superior signal-plus-noise/noise ratio of 82 dB and input overdrive capability of 6 dB, plus an automatic FM/AM high cut control feature which improves sound quality under weak signal conditions.

The stereo decoder section incorporates an alignment-free phase-locked loop that operates with a 456 kHz ceramic resonator, and features a pilot tone detector for automatic stereo/mono switching and pilot cancellation. An additional control input, driven with an analogue voltage derived from the receiver's IF stage level detector, allows smooth stereo/mono changeovers as the received signal strength increases and decreases.

Soft muting is performed before demultiplexing of the input signal into the stereo channels and results in a DC voltage shift at the decoder's output of less than 50 mV, making interruption for RDS updating free from audible clicks. To eliminate ignition noise and

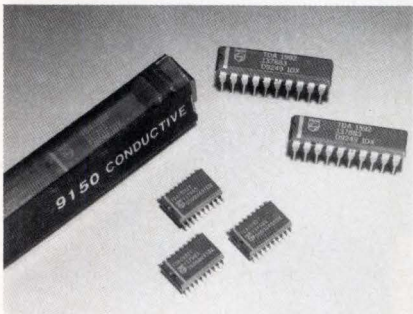

The TDA1592 stereo decoder/noise blanker for high performance car radios is available in 20-pin DIL or SO packages.

other pulse interference, the TDA1592's noise blanker detects these pulses and gates them out of the audio outputs. The ability to sum the MPX audio signal and an IF-stage-derived interference signal at the op-amp input, combined with an automatic sensitivity control in the circuit's interference detector, ensures optimum triggering of the noise blanker under all signal conditions.

**Call 1-800-447-1500 Ext 1107**  
**Europe: circle no. 42**

## Single-chip speech, transmission and listening-in circuit optimizes featurephone performance

Two new high-integration-level bipolar ICs from Philips Semiconductors provide speech, transmission and listening-in functions designed for optimum performance over a very wide range of telephone line conditions.

The TEA1096 and TEA1096A feature a unique active set impedance, the value of which is programmed by an external CR network, which compensates complex line impedances to maintain a flat frequency response on the telephone line over a 3.4 kHz speech bandwidth. Speech quality is further enhanced by dynamically limiting the signal amplitude in the ICs' microphone and loudspeaker amplifiers to prevent clipping in their output stages under input overdrive or low line supply conditions. Automatic gain control in the microphone and receiver channels compensates for line losses, which are deduced automatically by sensing the available line current.

On-chip current-splitting voltage regulation ensures that the maximum amount of line current is available to drive the listening-in loudspeaker under all line conditions. The line current sensing used by the AGC circuit is also used to switch



The TEA1096 and TEA1096A offer highly integrated single-chip solutions to all the speech, transmission, listening-in and line monitoring functions required in modern line-powered featurephones.

automatically between two anti-sidetone networks optimized for short and long telephone lines.

The TEA1096 has an adjustable stabilized voltage output to supply peripheral circuits, while the TEA1096A has a fixed voltage stabilizer but features DC voltage control of the loudspeaker volume. Both ICs are available in 28-pin DIL or SO packages.

**Call 1-800-447-1500 Ext 1108**  
**Europe: circle no. 43**

## Contactless angular-displacement sensor is encapsulated and ready-to-use

The new KMA10/70 contactless sensor provides a fully-encapsulated, non-wearing and adjustment-free solution to angular position measurement in a wide range of automotive and industrial applications such as active suspension units, accelerator pedal position sensing and servo control actuators. Its sealed housing, wide operating temperature range and high degree of EMC immunity make it particularly useful in safety-critical applications.

Based around the Philips KMZ11B1 magneto-resistive sensor element, the KMA10/70 has an integral input shaft which allows the magnet's magnetic field to be rotated over the sensor element. The resultant changes in the sensor element's resistance are detected by a thick-film hybrid signal conditioning circuit which produces a temperature-compensated 4 to 20 mA output signal that matches the angular displacement of the input shaft. The sensor has a displacement range of  $\pm 35^\circ$  and is free from the microlinearity error and noise problems associated with potentiometers,

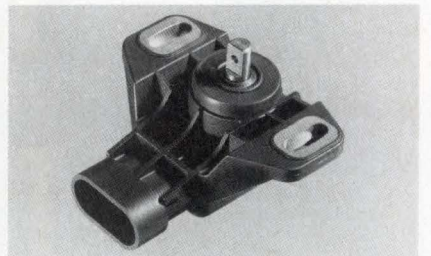

The KMA10/70 contactless angular-displacement sensor is fully-encapsulated to survive extreme environmental conditions.

particularly when they suffer wear and corrosion.

The KMA10/70 has an operating temperature range of  $-40$  to  $+100^\circ\text{C}$  and a lifetime in excess of  $10^8$  operating cycles. It is a 3-terminal device which operates over an 8.1 to 11.0 V supply voltage range, producing a short-circuit-protected, current-mode output which is independent of supply voltage changes.

**Call 1-800-447-1500 Ext 5013**  
**Europe: circle no. 44**



# PHILIPS

**THE SHOCKING  
REASON THE  
TELECOMMUNICATIONS  
INDUSTRY  
TURNED TO  
OMRON.**



Recently, the telecommunications industry needed a new breed of low-signal relay — a relay that could withstand a shocking 2,500 volts, almost double the present standard, yet small enough for dense PCB mounting. They turned to Omron.

Omron responded with the G6N relay. It not only withstands a 2.5KV surge between coil and contacts, its footprint is almost 40% smaller than the previous standard. The G6N is the latest product to join Omron's family of low-signal relays for telecommunications, computer peripherals, office automation and more.

Why did the telecom industry turn to Omron? Because we not only have the broadest line of relays, switches and photomicrosensors in the industry, we also have a proven



track record of innovation. Last year alone, we invested over \$170 million in R&D, employed over 1,000 R&D engineers and introduced nearly 100 new products. The telecom industry was also impressed with our highly-automated manufacturing systems, which enable us to provide products of consistent quality in high volumes. The G6N, for example, undergoes 100% automated inspection on 13 critical performance parameters.

With more than 90 affiliates and subsidiaries, 1,500 sales locations and 17,000 employees worldwide, Omron also met the telecom industry's need to provide product and service support around the globe.

Omron's ability to meet the rigorous demands of the telecom industry may come as a shock to some people. But it effectively demonstrates our ability to meet the control demands of any industry. For complete information on our broad line of control components, call us at

**OMRON**  
WE HAVE THE FUTURE IN CONTROL.

both now and in the future.  
on our broad line of con-  
1-800-62-OMRON.

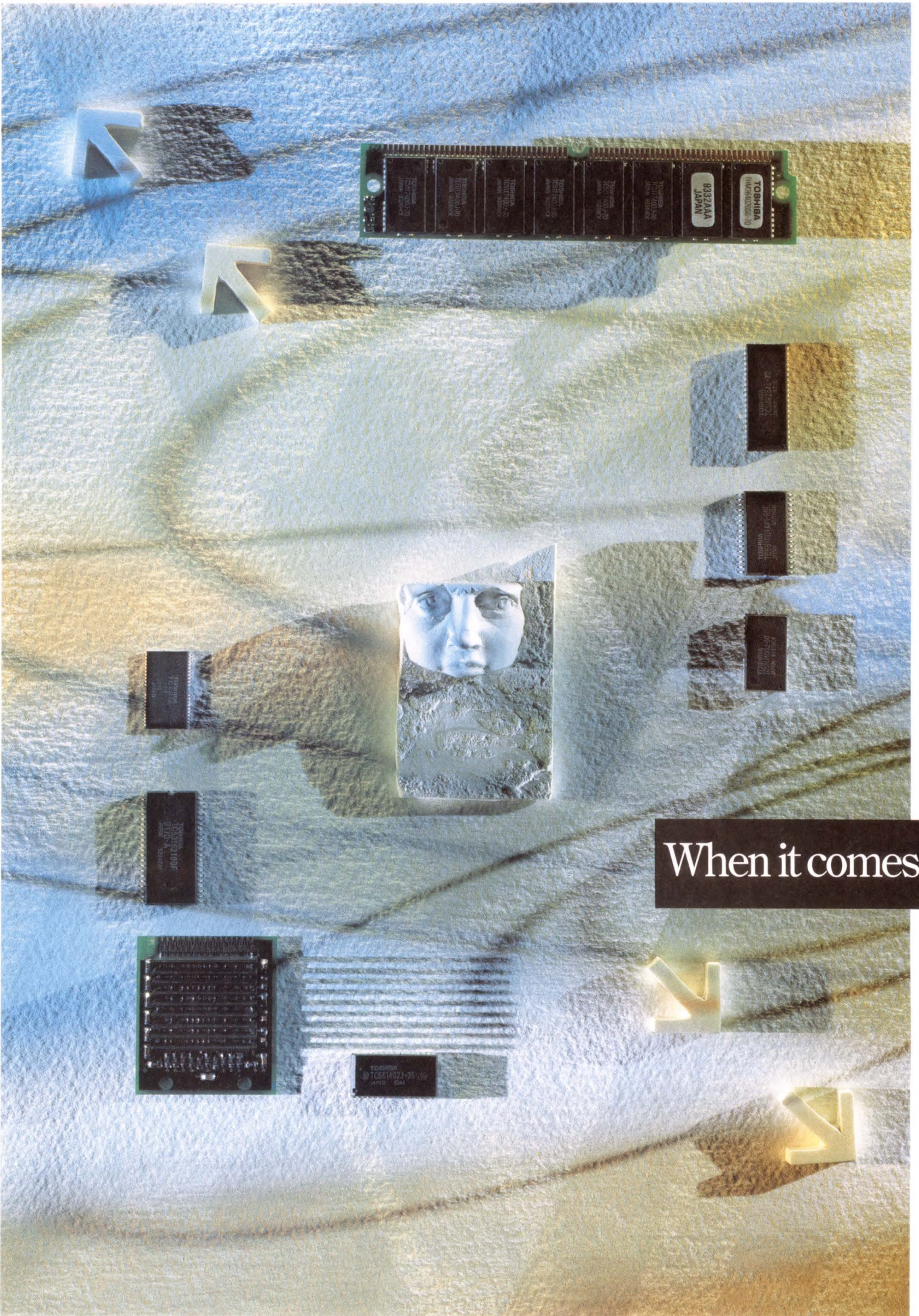

When it comes to

At Toshiba, we sell more memory products than anyone else in the world.

Anyone.

An achievement we're justifiably proud of.

And why no matter where you look, you'll find our DRAM, SRAM, Non-Volatile products and Memory Cards in more places than anyone else.

Naturally, we're in all types of computers, from PCs to workstations, minis to mainframes, Personal Digital Assistants to supercomputers.

But our influence extends much further.

To laser, dot matrix and color thermal printers.

National Semiconductor, Samsung and others, we're helping take technology to places never before dreamed possible — while standardizing it for everyone's use.

All of which translates into more than just the industry's most expansive line

of memory products.

It means consistent supply, due to huge manufacturing capabilities. Performance advantages, from a long history of

technological innovation and product quality. Reliable alternate sourcing. And the kind of customer service, financial strength and overall stability you'd expect from one of the world's largest corporations.

That's why more companies the world over depend

on Toshiba for memory. And it's what keeps us in the most important place of all — first.

**memory, we're in all the right places.**

Modems and digital switches. Handheld instruments.

Consumer products like mobile phones, faxes and copiers. Even automobiles and electric vehicles.

And thanks to strategic partnerships with companies like IBM, Motorola, Siemens, Rambus,

For more information, or a free product guide, just call 1-800-879-4963.

Then follow the lead of systems manufacturers worldwide.

And commit our name to memory.



In Touch with Tomorrow  
**TOSHIBA**

TOSHIBA AMERICA ELECTRONIC COMPONENTS, INC.

CALL ME CIRCLE #60

SEND MORE INFORMATION CIRCLE #59

# All This.

# In This.

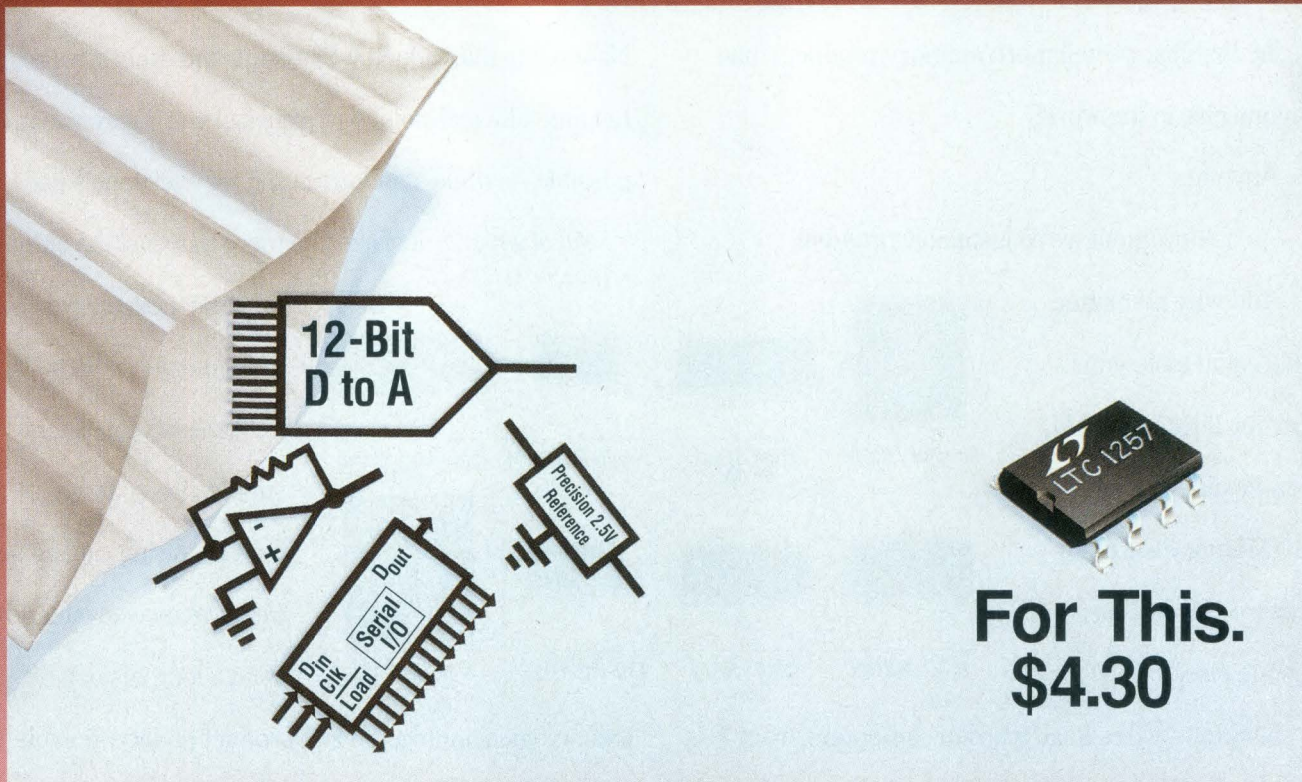

## The LTC1257. Complete 12-Bit Serial SO-8 DAC.

Using a 12-bit DAC is now easier than ever! The new LTC1257 is a complete 12-bit DAC in a very small 8-pin SO package. No external components are needed.

And the price may be the easiest thing of all! Included is an output buffer amplifier, a 2.048V voltage reference and an easy to use cascadable three-wire serial interface.

The power supply current is a very low 350 $\mu$ A typ. when using a 5V supply. Excellent differential non-linearity—less than 1/2 LSB—guarantees monotonicity and makes the LTC1257 ideal for control and adjustment applications. And you get flexibility—the single supply voltage can go from 4.75 to 15.75 volts and you

can override the internal reference to extend the output range as high as 0-12 volts.

The DAC's small size and low power consumption

make it ideal for battery powered systems. And with the cascadable serial interface, applications using multiple DACs are a breeze. So if you want to reduce your system

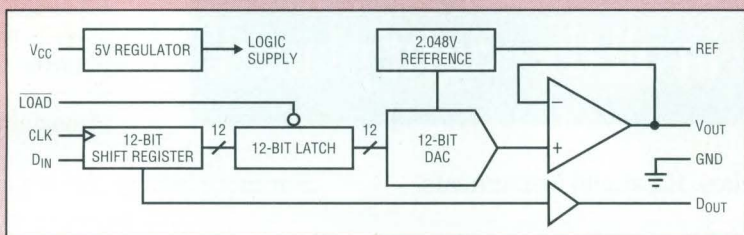

cost and complexity, the LTC1257 is a natural choice. Parts are available in 8-pin SO packages or 8-pin DIP. Pricing in 1000-up quantities starts at \$4.30. For more details, contact Linear Technology Corporation, 1630 McCarthy Blvd., Milpitas, CA 95035/408-432-1900. For literature only, call 1-800-4-LINEAR.



FROM YOUR MIND TO YOUR MARKET  
AND EVERYTHING IN BETWEEN.

## Color video travels on twisted-pair cable

Raphael Horton, National Semiconductor, Santa Clara, CA

Telephone lines and local-area networks commonly use inexpensive twisted-pair cables. Video-system designers can also take advantage of this low-cost cable to transmit composite-color-video signals. Using the circuit techniques in **Fig 1**, you can transmit video anywhere phone lines exist. Although the circuit has more electronic components than the traditional single amplifier used to drive a coax cable, you can easily justify the additional electronics required to drive twisted-pair cables. Four-wire, twisted-pair cable typically sells for 7 cents/ft, yet RG-59 cable can be priced over 20 cents/ft. If just 500 ft of cable is necessary, the cost difference is \$65, which more than covers the cost of a few LM6181 amplifiers.

The system consists of two circuits. The first converts the composite video signal to a differential signal using amplifiers  $IC_1$  and  $IC_2$ . Using a differential signal reduces line loss and distortion that could occur from driving the twisted pair single ended. Converting the signal to differential also removes possible ground-plane errors that occur when there is a difference in the ground potential between two pc boards.

The circuit has a minimum signal gain of two to compensate for the terminations' 6-dB signal drop. You can easily adjust the gain of  $IC_2$  by decreasing the value of  $R_G$  to make up for the line losses caused by various twisted pair and coax cable lengths.  $R_G$  serves as a single system adjust and as an optional contrast adjustment for the video system.

In the second circuit,  $IC_3$  converts the differential signal back to single ended. This circuit has a gain of two to drive a back-terminated RG-59 coax cable out to a monitor. The video amplifier you choose for this application must have high-output-drive capability. The LM6181 is guaranteed to drive a back-terminated 75 $\Omega$  cable over the full industrial temperature range.

This circuit treats the twisted-pair cable as a transmission line that is back-terminated with 75 $\Omega$  resistors. This termination method is superior to using the 600 $\Omega$  characteristic impedance of the twisted-pair. A 600 $\Omega$  termination results in smearing and blurring caused by the RC time constant of the cable capacitance and the termination resistance. Because an increasing RC time constant degrades sharp signal transi-

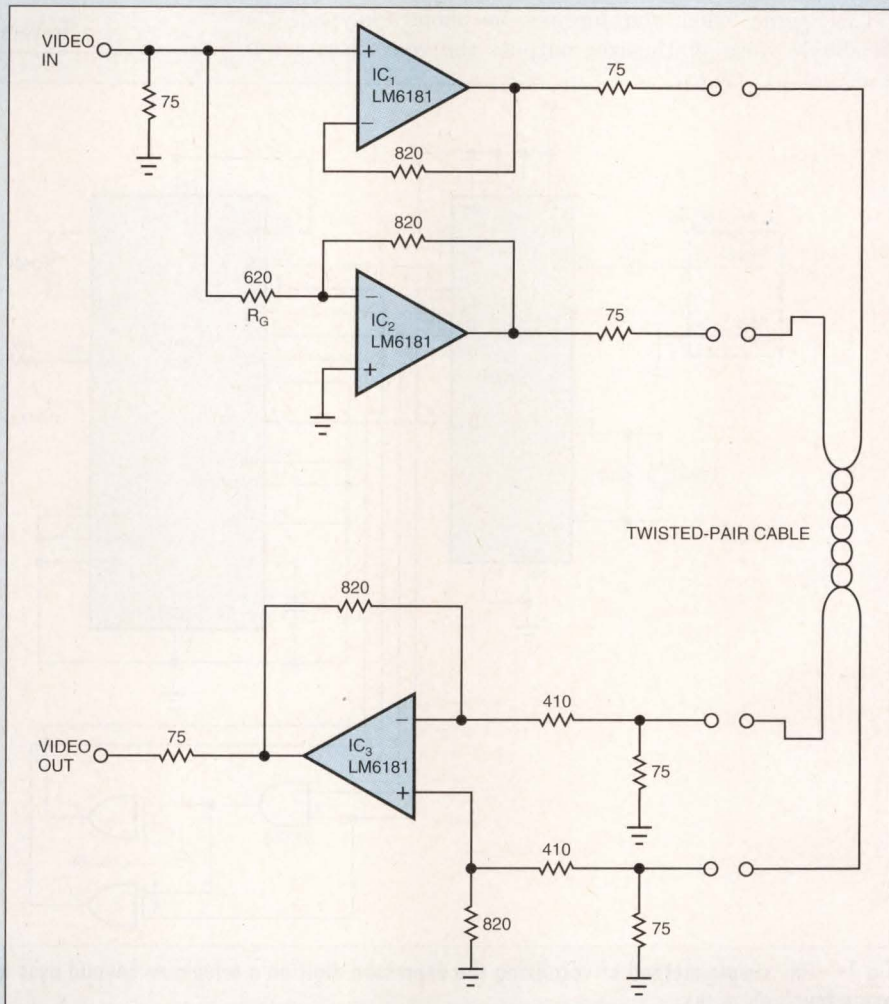

**Fig 1**—By transmitting differential signals and using video amplifiers with high-output-drive capability, this circuit can drive video signals down inexpensive twisted-pair cable.

tions, this circuit uses standard 75 $\Omega$  terminations to maintain a clear, sharp picture. This circuit does not use shielded twisted-pair cable because of its high distributed capacitance, which contributes to the RC time constant.

No visible difference exists between a reference picture and a transmitted one. Using a Tektronix-type 520 NTSC vector-scope, the measured differential gain and phase of the entire system—which comprises three LM6181 amplifiers, a 100m twisted-pair cable, and a 50-ft RG-49 coax cable from amplifier  $IC_3$ —was less than 0.5% and 0.6°, respectively. Keeping the current-feedback amplifiers' feedback resistors equal to the recommended value of 820 $\Omega$  gives the op amp its proper frequency compensation. The feedback resistor sets amplifier bandwidth and is always required for proper operation, even in unity gain. **EDN BBS /DI\_SIG #1361** EDN

To Vote For This Design, Circle No. 435

# Circuit vocalizes telephone number

Shwang-Shi Bai, Chun-Shan Institute of Science and Technology, Lung-Tan, Taiwan

The circuit in **Fig 1** is a simple method of vocalizing the digit number of a telephone keypad, which, for someone visually impaired, provides helpful voice confirmation. A 75T202 dual-tone multifrequency (DTMF) receiver decodes the DTMF signal when you depress the phone's keypad. The TC8801N voice synthesizer outputs the voice data corre-

sponding to the data input code. A TA7368P audio power IC amplifies the result. The logic gates perform necessary code conversion for the voice-synthesizing IC's input. **EDN BBS /DI\_SIG #1357**

EDN

To Vote For This Design, Circle No. 436

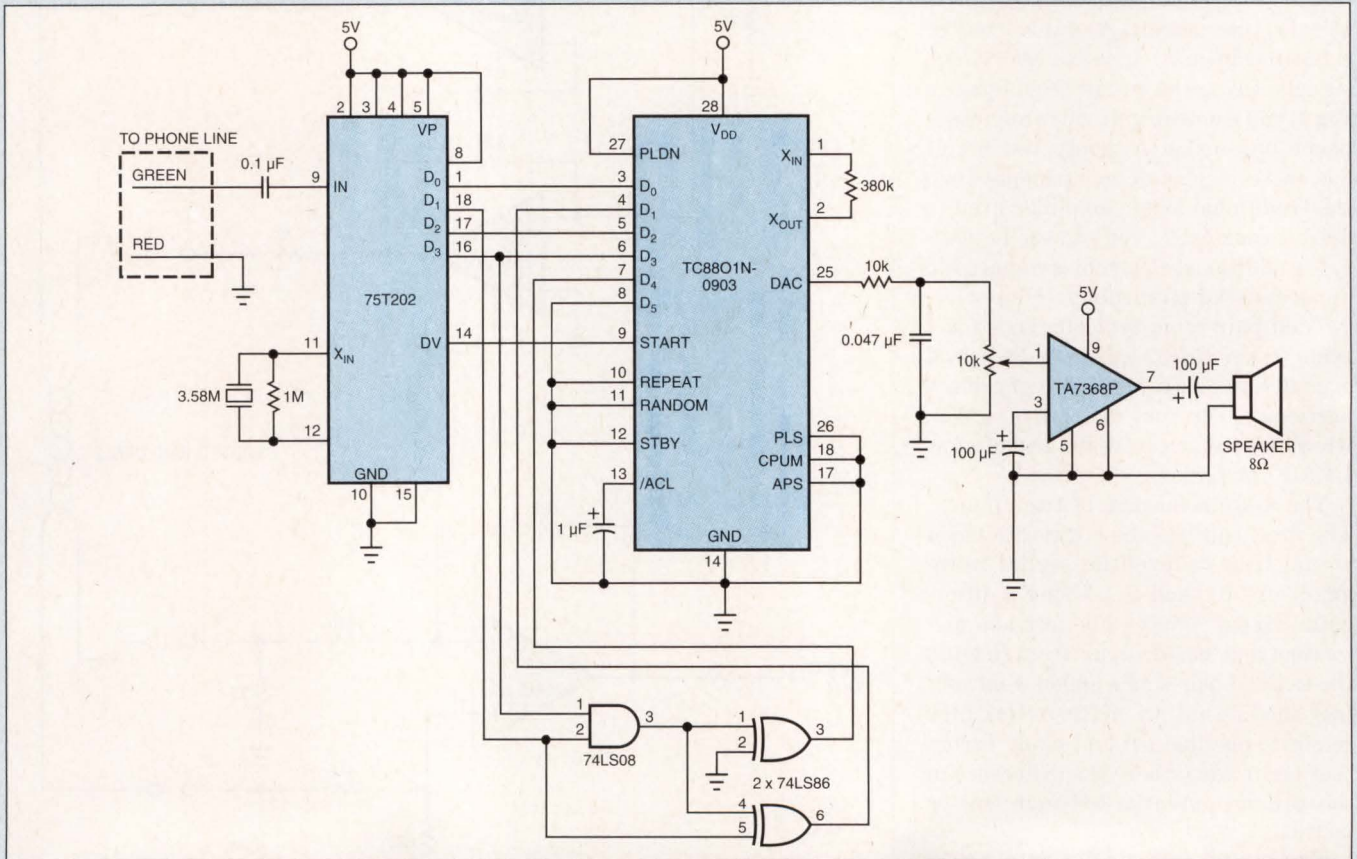

Fig 1—This simple method of vocalizing the depressed digit on a telephone keypad uses a DTMF receiver, voice synthesizer, audio amp, and a few logic gates.

# MOSFET replaces switch

Malcolm Watts, Wellington Polytechnic, Wellington, New Zealand

By using a cheap, readily available MOSFET, you can use a single-pole switch to turn a bipolar power supply on and off without consuming extra power. In **Fig 1**, the switch simply controls the MOSFET gate, which switches on the negative supply. Resistor R, which can be several megohms, is not necessary if the ±6V rails are permanently connected to a load, for example an op-amp circuit. Because the MOSFET's  $R_{DS(ON)}$  is a fraction of an ohm, power loss is minimal, and the circuit suits moderate-consumption, battery-operated circuitry. **EDN BBS /DI\_SIG #1360**

EDN

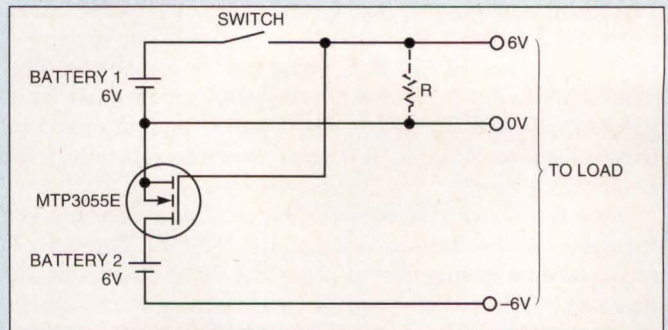
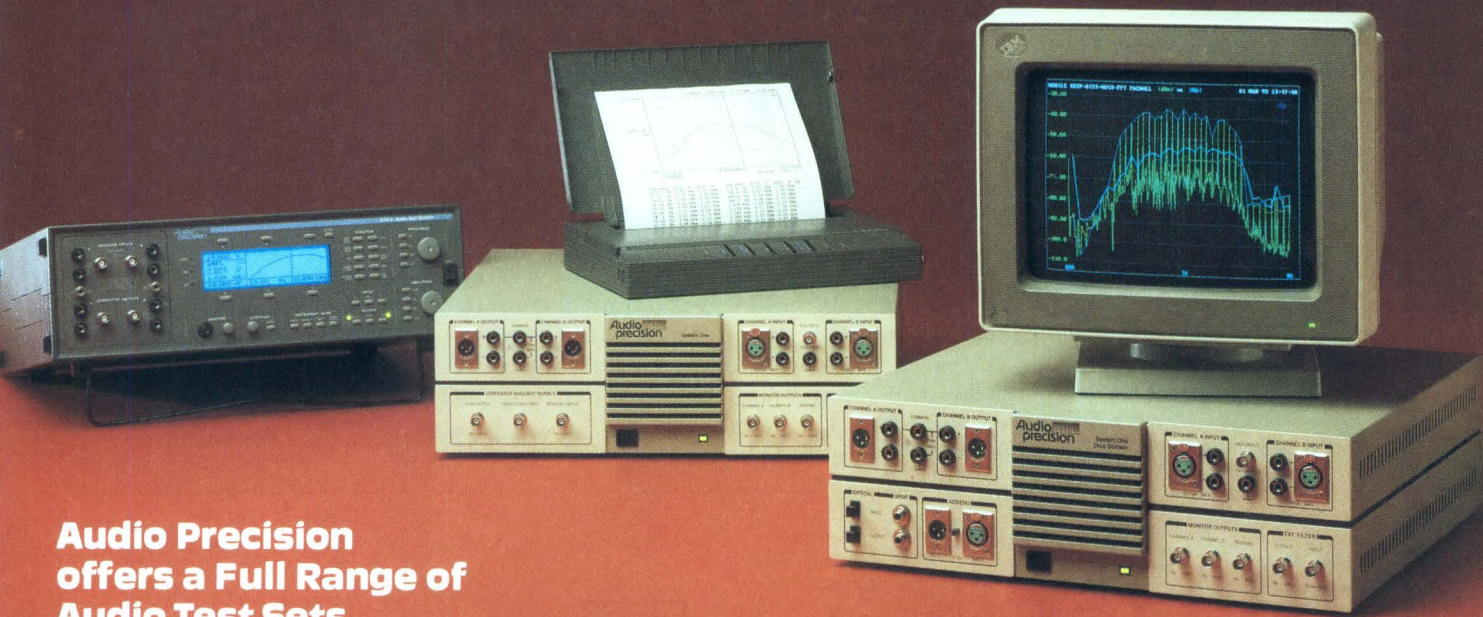

Fig 1—The switch simply controls this circuit's MOSFET gate to turn the negative supply on and off.

To Vote For This Design, Circle No. 437

# FAST FASTER FASTTEST

## High Speed Audio Frequency Testing



### Audio Precision offers a Full Range of Audio Test Sets...

#### FAST

**ATS-1** is a competitively priced audio test set featuring front panel and GPIB programmable operation as well as higher performance and speed than the typical audio testers it replaces. Both Audio Precision and HP 8903B GPIB command sets are supported. A sample suite of 43 measurements<sup>1</sup> takes only 33 seconds. The dual channel ATS-1 is at home in production floor environments thanks to its rugged fan-cooled enclosure and front or rear mount modular connector panels.

#### FASTER

**System One** automated integrated audio test sets measure distortion, frequency, phase, wideband or selective noise, and crosstalk in production test environments benefiting from high speed and performance. System One can make a sample suite of 43 measurements<sup>1</sup> in 21 seconds. Optional spectrum analysis and digital domain signal generation and analysis capabilities make it the one-stop audio test system. Available both in GPIB and PC controlled versions, System One is today's recognized standard in audio testing.

#### FASTTEST

**System One DSP** versions test any audio channel in the *fastest* possible time. With DSP power, **FASTTEST** completes the 43 measurement<sup>2</sup> example above in 2 seconds! System One **FASTTEST** technology generates and analyzes special multi-sinewave test signals. These wideband signals provide complete frequency response, distortion and noise measurements from a single stimulus acquisition.

**Audio  
precision**

P.O. Box 2209  
Beaverton, OR 97075-3070  
(503) 627-0832 (800) 231-7350  
FAX: (503) 641-8906

<sup>1</sup>Sample suite of GPIB programmed audio measurements included 1) noise measurement (20Hz-22kHz bandpass).

<sup>2</sup>31 point single tone frequency response sweep over 20Hz-22kHz range, and 3) 11 point distortion sweep over 20Hz-22kHz range.

<sup>3</sup>**FASTTEST** uses multi-tone stimulus and analysis to make the same measurements listed above.

INTERNATIONAL DISTRIBUTORS: **Australia:** IRT Electronics Pty. Ltd., Tel: 2 439 3744 **Austria:** ELSINCO GmbH, Tel: (222) 815 04 00 **Belgium:** Trans European Music NV, Tel: 2/466 5010 **Brazil:** INTERWAVE LTDA, Tel: (21) 325-9221 **Bulgaria:** ELSINCO, h.o. Strelbishte, Tel: 92 581 698 **Canada:** GERRAUDIO Distribution, Tel: (416) 598-2779 **China, Hong Kong:** A C E (Int'l) Co. Ltd., Tel: 424-0387 **Czech Republic:** ELSINCO Praha spol. s r.o., Tel: (2) 4702 1 451 452 **Denmark:** npp Elektronik a/s, Tel: 86 57 15 11 **Finland:** Genelec OY, Tel: 77 13311 **France:** ETS Mesureur, Tel: (1) 45 83 86 41 **Germany:** RTW GmbH, Tel: 221 70913-0 **Greece:** KEM Electronics O.E., Tel: 01-8478514/5 **Hungary:** ELSINCO KFT, Tel: (1) 112 4854 **India:** HINDITRON Services P.V., Tel: 22 836-4560 **Israel:** Dan-El Technologies, Ltd., Tel: 3-544-1466 **Italy:** Audio Link s.n.c., Tel: 0521/648723 **Japan:** TOYO Corporation, Tel: 3 (5688) 6800 **Korea:** B&P International Co., Ltd., Tel: 2 546-1457 **Malaysia:** Test Measurement & Engineering Sdn. Bhd., Tel: 3 734 1017 **Netherlands:** TM Audio B.V., Tel: (0) 30 414070 **New Zealand:** Audio & Video Wholesalers, Tel: 7 847-3414 **Norway:** Lydconsult, Tel: 9 19 03 81 **Poland:** ELSINCO Polska sp. z o.o., Tel: (22) 39 69 79 **Portugal:** Acutron Electroacustica LDA, Tel: 1 9414087 / 9420862 **Singapore:** TME Systems Pte Ltd., Tel: 298-2608 **Slovakia:** ELSINCO Bratislava spol. s r.o., Tel: (7) 784 165 **South Africa:** SOUND FUSION, Tel: 11 477-1315 **Spain:** Telco Electronics, S. A., Tel: 1 531-7101 **Sweden:** Tal & Ton Elektronik AB, Tel: 31 80 36 20 **Switzerland:** Dr. W.A. Gunther AG, Tel: 1 910 41 41 **Taiwan:** ACESONIC Intl Co., Ltd., Tel: 2 719 2388 **United Kingdom:** SSE Marketing Ltd., Tel: 71 387-1262

# Correlator works in presence of noise

John Charlton, Lancaster, CA

The clipped-signal correlator in **Fig 1** outperforms any resistor-capacitor clipped-signal correlator, and the circuit has no race paths.

In operation, the reset signal first clears  $IC_3$  and  $IC_4$  to all zeros. Signals 1 and 2, both of which are clipped so that they resemble square waves, beat against each other in XOR gate  $IC_1$ . If Signals 1 and 2 are both the same value at the instant the clock signal CK goes low, counter  $IC_3$  counts. The clock signal's frequency must be high enough that the clock signal takes five to 20 samples of the  $IC_1$ 's output before  $IC_1$  changes state. You have to determine the appropriate clock rate for your application.

$IC_3$  and  $IC_4$  are in a race to see which counter finishes first. If  $IC_4$  completes its count before  $IC_3$ ,  $IC_{6A}$  will clock a zero into shift register  $IC_7$ . If  $IC_3$  completes its count (that is, the inputs are correlated during enough of the sampling period), then  $IC_{6A}$  clocks a one into the shift register.

Each one clocked into the shift register  $IC_7$  energizes a voltage increment. Summer  $IC_8$  totals all of these increments, and comparator  $IC_9$  compares the total voltage to a reference voltage. (The **figure** shows a single shift register for clarity. An actual implementation of this concept used

four shift registers in series, yielding a 32-bit comparison.)

To calibrate the circuit for your application, first apply test signals to the inputs. You must use a signal generator that can produce test signals having your required S/N ratio. Then experiment by connecting different combinations of the Q outputs of counter  $IC_4$  to the 8-input AND gate,  $IC_5$ . When you get just the right combination of outputs connected,  $IC_{6A}$  outputs equal numbers of ones and zeros. Although this condition may sound vague and difficult to detect, don't worry; when you hit the right combination, the circuit snaps into calibration. Continue experimenting to determine the proper threshold for the summer/comparator circuit.

This circuit works with any logic family and most common op amps. The resistors at  $IC_7$ 's outputs are usually all the same value. You could use differing values, but doing so always causes a processing loss. The circuit's detection-update rate is the rate of the RESET signal, and the integration time is equal to the number of bits of shift register  $IC_7$  divided by the RESET signal's rate.

EDN

EDN BBS /DI\_SIG #1369

To Vote For This Design, Circle No. 438

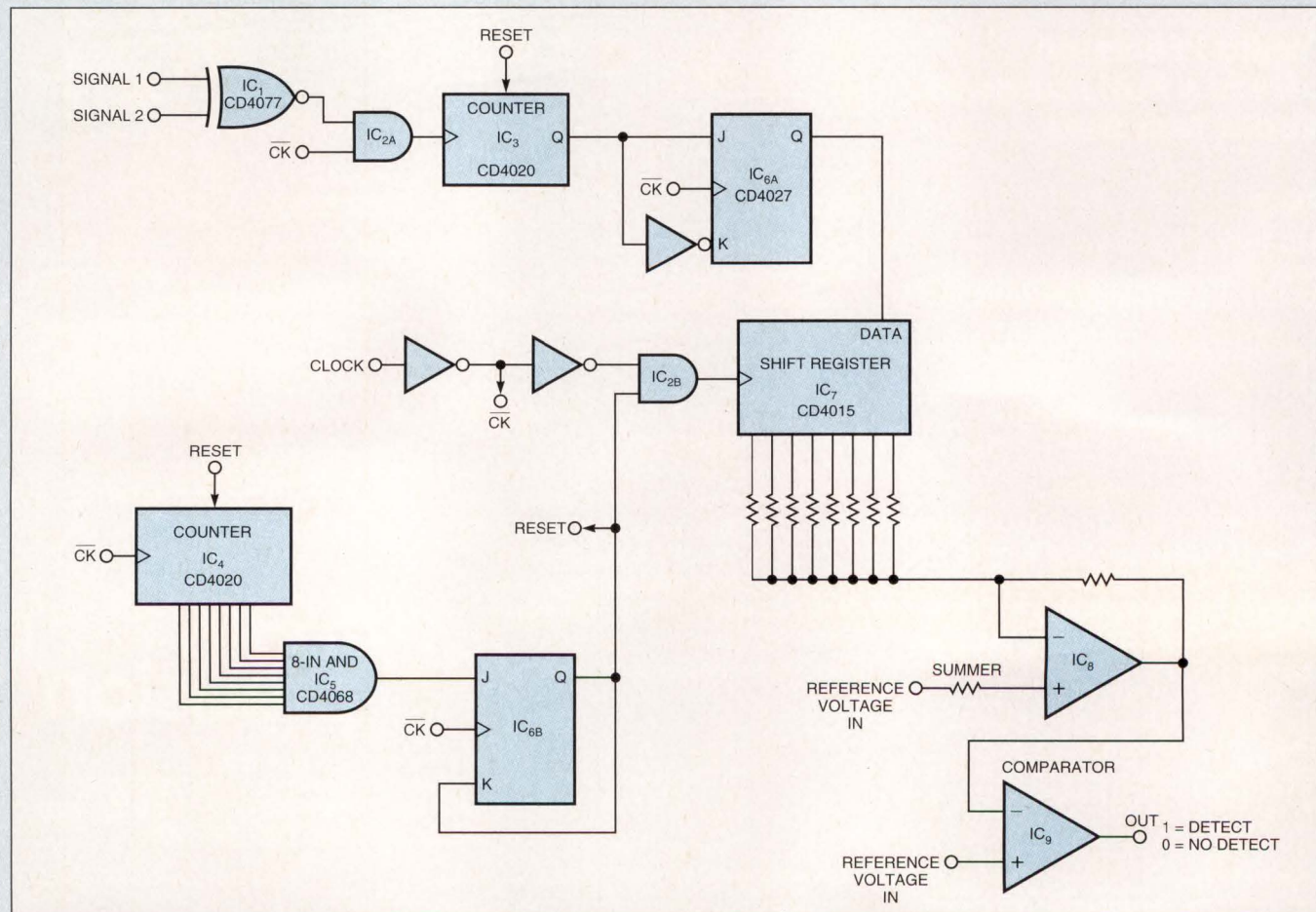
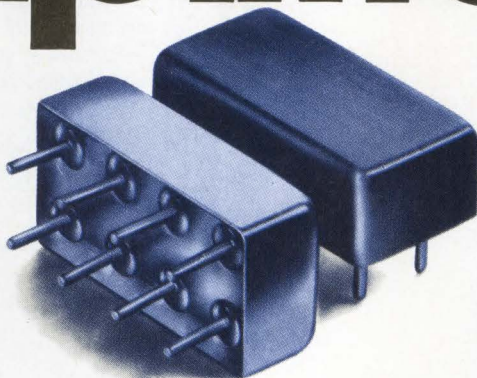

Fig 1—This correlator can determine when two signals are substantially the same, even in the presence of noise.



# rugged plug-in amplifiers



**0.5 to 2000 MHz** from **\$13.95** (10 to 24 qty)

Tough enough to meet full MIL-specs, capable of operating over a wide  $-55^{\circ}$  to  $+100^{\circ}\text{C}$  temperature range, in a rugged package... that's Mini-Circuits' new MAN-amplifier series. The MAN-amplifier's tiny package (only 0.4 by 0.8 by 0.25 in.) requires about the same pc board area as a TO-8 and can take tougher punishment with leads that won't break off. Models are unconditionally stable and available covering frequency ranges 0.5 to 2000 MHz, NF as low as 2.8dB, gain to 28dB, isolation greater than 40dB, and power output as high as +15dBm. Prices start at only \$13.95 *including* screening, thermal shock  $-55^{\circ}\text{C}$  to  $+100^{\circ}\text{C}$ , fine and gross leak, and burn-in for 96 hours at  $100^{\circ}\text{C}$  under normal operating voltage and current. Internally the MAN amplifiers consist of two stages, including coupling capacitors. A designer's delight, with all components self-contained. Just connect to a dc supply voltage and you are ready to go.

### The new MAN-amplifiers series...

- wide bandwidth • low noise • high gain
- high output power • high isolation

MODEL	FREQ. RANGE (MHz)	GAIN dB	MAX PWR† dBm	NF dB (typ)	ISOL. dB (typ)	DC PWR V/ma	PRICE \$ ea. (10-24)
MAN-1	0.5-500	28	1.0 +8	4.5	40	12/60	13.95
MAN-2	0.5-1000	18	1.5 +7	6.0	34	12/85	15.95
MAN-1LN	0.5-500	28	1.0 +8	2.8	39	12/60	15.95
MAN-1HLN	10-500	10	0.8 +15	3.7	14	12/70	15.95
MAN-1AD	5-500	16	.05 +6	7.2	41	12/85	24.95
MAN-2AD	2-1000	9	0.4 -2	6.5	28	15/22	22.50
MAN-11AD	2-2000	8	0.5 -3.5	6.5	22	15/22	29.95

††Midband  $10f_L$  to  $f_{U/2}$ ,  $\pm 0.5\text{dB}$  † 1dB Gain Compression ◇ Case Height 0.3 in. Max input power (no damage) +15dBm; VSWR in/out 1.8:1 max.

Free...48-pg "RF/MW Amplifier Handbook" with specs, curves, handy selector chart, glossary of modern amplifier terms, and a practical Question and Answer section.

finding new ways...  
setting higher standards

## Mini-Circuits

A Division of Scientific Components Corporation  
P.O. Box 350166, Brooklyn, New York 11235-0003 (718) 934-4500  
Fax (718) 332-4661 Domestic and International Telexes: 6852844 or 620156

# SELECTION

## In Crystals and Oscillators.

Selection means choice and convenience. You can be confident you'll find just what you need for your application. With Ecliptek crystals and oscillators.

Uncompromising quality standards and competitive pricing you can rely on. Plus fast delivery to help you meet your deadlines.

We put crystals and oscillators in a whole new light. See EEM 1993/94 for technical details. Or call 714-433-1200.



The Crystal and Oscillator Specialists

CIRCLE NO. 4

## EDN-DESIGN IDEAS

### Design Entry Blank

**\$100 Cash Award for all published entries selected by editors. An additional \$100 Cash Award for the winning design of each issue, determined by vote of readers. Additional \$1500 Cash Award for annual Grand Prize Design, selected among biweekly winners by vote of editors.**

To: Design Ideas Editor, EDN Magazine  
Cahners Publishing Co  
275 Washington St, Newton, MA 02158

I hereby submit my Design Ideas entry.

Name \_\_\_\_\_

Title \_\_\_\_\_ Phone \_\_\_\_\_

Company \_\_\_\_\_

Division (if any) \_\_\_\_\_

Street \_\_\_\_\_

City \_\_\_\_\_ State \_\_\_\_\_

Country \_\_\_\_\_ Zip \_\_\_\_\_

Design Title \_\_\_\_\_

Home Address \_\_\_\_\_

Social Security Number \_\_\_\_\_  
(US authors only)

#### **Entry blank must accompany all entries.**

Design entered must be submitted exclusively to EDN, must not be patented, and must have no patent pending. Design must be original with author(s), must not have been previously published (limited-distribution house organs excepted), and must have been constructed and tested. Fully annotate all circuit diagrams. Please submit software listings and all other computer-readable documentation on a 5¼-in. IBM PC disk in plain ASCII.

Exclusive publishing rights remain with Cahners Publishing Co unless entry is returned to author, or editor gives written permission for publication elsewhere.

In submitting my entry, I agree to abide by the rules of the Design Ideas Program.

Signed \_\_\_\_\_

Date \_\_\_\_\_

The winning Design Idea for the June 24, 1993, issue is entitled "VCO spans wide frequency range," submitted by Einar Abell of ADA Instruments (Three Rivers, CA).

The winning Design Idea for the July 8, 1993, issue entitled "PC printer port programs PROMs," submitted by Yongping Xia of EBT Inc (Torrance, CA).

**Your vote determines this issue's winner.** All designs published win \$100 cash. All issue winners receive an additional \$100 and become eligible for the annual \$1500 Grand Prize. **Vote now**, by circling the appropriate number on the reader inquiry card.

# Power Supply savings.

Or how to get the lowest cost-per-amp fast, simple and easy.

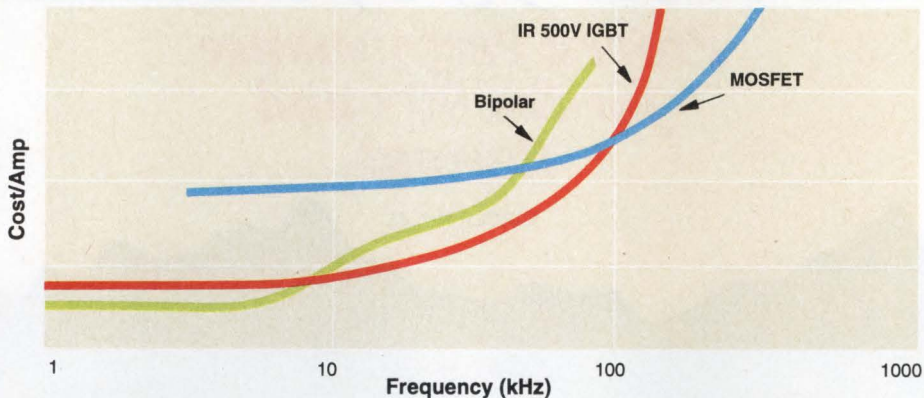

Just plug in IR's UltraFast 500V IGBT. And you instantly improve the efficiency and cost-per-amp of your single-ended off-line switch-mode power supplies. Without redesigning.

Our IGBTs also come paired with IR super-soft recovery diodes in *CoPacks* for half-bridge supplies. All give you the lowest conduction losses ever. And fast switching speeds.

Available from the most cost-effective IGBT line today. Value priced to save you money. In stock to save you delivery time. Send for our IGBT data pack. Or call. 310-322-3331, ext 2529.

You'll easily save more for your converters.

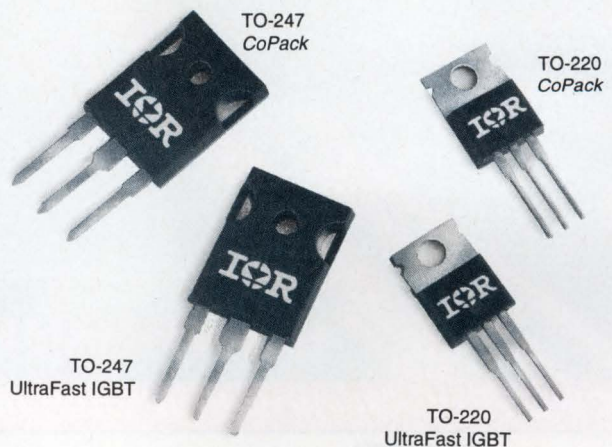

*Available now at key IR distributors.*

**IR International Rectifier**

WORLD HEADQUARTERS: 233 KANSAS ST., EL SEGUNDO, CA 90245, USA 310-322-3331, FAX 310-322-3332, TELEX 66-4464. EUROPEAN HEADQUARTERS: HURST GREEN, OXTED, SURREY RH8 9BB, ENGLAND, (0883) 713215, FAX (0883) 714234

CIRCLE NO. 65

EDN February 3, 1994 • 77



# *FAST* Track to *FAST* SCSI

**90's Challenges.** The 90's demand higher levels of performance and faster delivery than ever. Time-to-market, technological demands, and changing user needs make fast, simple SCSI seem as elusive as the horizon. To stay ahead in these challenging times, you need products you can count on, with proven ability to deliver the quality and reliability your customers require.

**90's Products.** After over a decade of industry leadership, NCR is still working hard to meet your needs and the challenges of the 90's. The NCR 53C90 family of SCSI Controllers is constantly evolving, implementing and offering state-of-the-art products. For example, the NCR 53C90 family supports multiple bus architectures, advanced SCSI-2 commands, fast SCSI data transfers and provides our exclusive TolerANT® SCSI driver and receiver technology, for reliable data transfers in every SCSI system.

**90's Solutions.** The SCSI challenges of the 90's can't be solved with silicon alone. NCR quality and service provide you with the competitive edge that can make your industry leading designs a reality. Whether you require SCSI-1 or fast SCSI-2, in any system architecture, NCR has the product to meet your needs today. You can count on us to keep you on the fast track with the right technology, at the right price, at the right time for all your SCSI requirements.

## The NCR 53C90 Family

*Proven Performance  
for the 90's and  
Beyond*

CIRCLE NO. 66



***NCR SCSI: Real Products, Real Solutions, Real Fast!***

SCSI	FAST SCSI*	
<b>53C90A</b>	<b>53CF90A</b>	<i>Single-bus architecture; SCSI sequences controlled by hardware state machine to minimize host intervention</i>
<b>53C90B</b>	<b>53CF90B</b>	<i>Adds pass-through parity for increased system reliability</i>
<b>53C94</b>	<b>53CF94</b>	<i>Adds split-bus architecture for more flexibility</i>
<b>53C96</b>	<b>53CF96</b>	<i>Adds support for differential transfers</i>

\*NCR Fast SCSI devices transfer SCSI data at 10 MB/s synchronous or 7 MB/s asynchronous

*For more information about  
NCR SCSI products  
and a free poster,  
call 1-800-334-5454.*



# Step-up/step-down converters power small portable systems

Bruce D Moore, Maxim Integrated Products

*Using four alkaline AA cells to power a product has many advantages. Simplicity of the regulated supply, however, isn't necessarily one of them. Even so, you have several choices of regulator topology—each with strengths and weaknesses.*

In small portable systems, marketing considerations—not engineering convenience—often drive the choice of a battery. A classic example is the battery that comprises four alkaline AA cells. AA cells are available in gift shops around the world. Though they are slim enough to fit in handheld systems, four of them can drive a 1W system all day.

Ref 1 reviews practical regulator topologies for battery-powered systems, emphasizing low-power, nonisolated regulators. It compares the circuits with each other and explains how to choose the one that best suits a given application. An important—and related—problem is deriving the regulated 5V from a 4-cell battery stack.

The voltage available from four alkaline cells in series (6.2V, gradually declining to 3.6V), is not a convenient input for a 5V regulator. The battery voltage ranges above and below 5V, so the usual designs—buck and boost regulators—won't work. Moreover, not only must the regulator boost and buck, but it also must exhibit high efficiency, low supply current, and small size. Although these requirements present a challenge,

many circuits can meet them. The following are several possibilities:

#### Many topologies

Of the many solutions to the 4-cell problem, none stands out as the clear winner. Instead, each option offers tradeoffs in size, efficiency, input range, and other parameters. Some general circuit configurations include

- Flyback
- Inverter
- Low-dropout linear regulator
- Boost with linear postregulator
- Boost with linear preregulator
- Step-up/step-down topology.

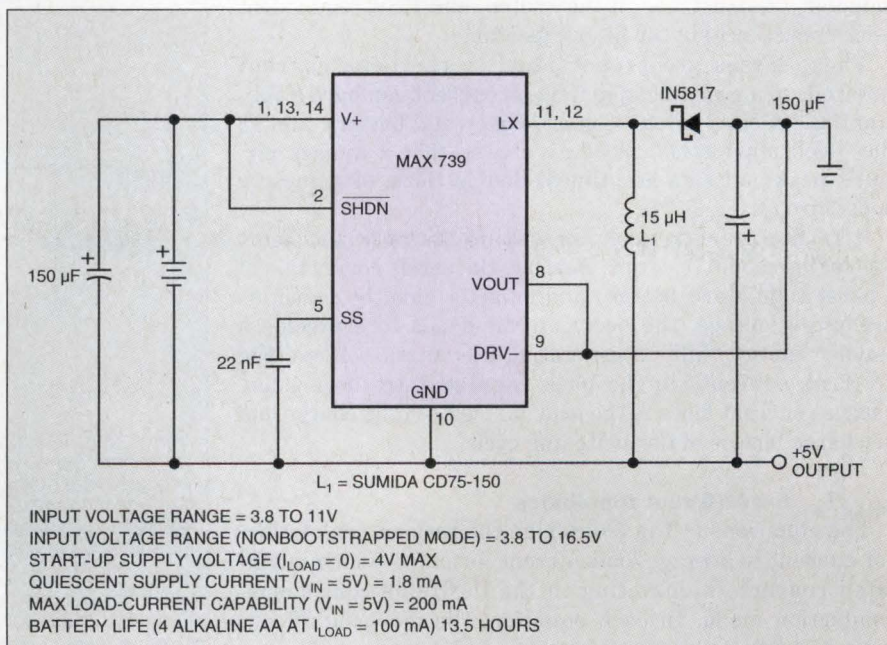

**Fig 1**—By floating its battery and grounding its output, this negative-boost regulator produces a positive output at its ground terminal.

## STEP-UP/STEP-DOWN CONVERTERS

Other possibilities include the Cuk and various isolated topologies, but these are either too complex or require too many energy-storage elements to be attractive for small battery-powered systems.

### Why not flyback?

Flyback topologies seem an obvious first choice for the step-up/step-down problem. Flyback circuits include a transformer that electrically isolates the output winding from the input (battery) voltage, thereby solving a problem that derails the simpler boost and buck topologies. Indeed, any isolated dc-dc supply, including the forward converter, can function as a step-up/step-down converter.

The most serious contender among transformer-isolated regulators is the flyback regulator, whose simple switching circuit requires only one power transistor and a single magnetic core. Flyback circuits have poor efficiency, though, thanks to their high peak currents and consequent power losses.

### Flyback vs buck or boost

To illustrate the flyback configuration's poor efficiency, compare it with the more favored buck and boost topologies. The flyback circuit's main problem is high peak current, which produces high  $I^2R$  loss. Peak currents cause dissipation in small parasitic resistances: series resistance in the inductor, on-resistance in the switch, and ESR (equivalent series resistance) in the filter capacitor.

These losses are proportional to the peak current squared, so a minor change in peak current can have a substantial effect on conversion efficiency and battery life. In the 4-cell application, physics ensures that a flyback circuit's peak currents are almost double those of a buck or boost circuit.

It is intuitive that peak currents in the buck and boost topologies should be lower. Because the series connection of a boost regulator's battery and inductor aids the inductor-discharge voltage, the boost circuit needs to overcome a smaller energy "hill" in generating the output voltage (Fig 1). Peak currents in the buck regulator are lower, too, because current flows to the load during both the charge and discharge phases of the switching cycle.

### $I_{PEAK}/I_{AVG}$ for different topologies

The equations in Fig 2 describe the ratio of peak inductor current to average load current for pulse-width-modulated converters operating in the desirable continuous-conduction mode. In each equation, the most significant term is the first one, which represents the average dc component of inductor (primary) current. Efficiency in the flyback equation is degraded mainly by the num-

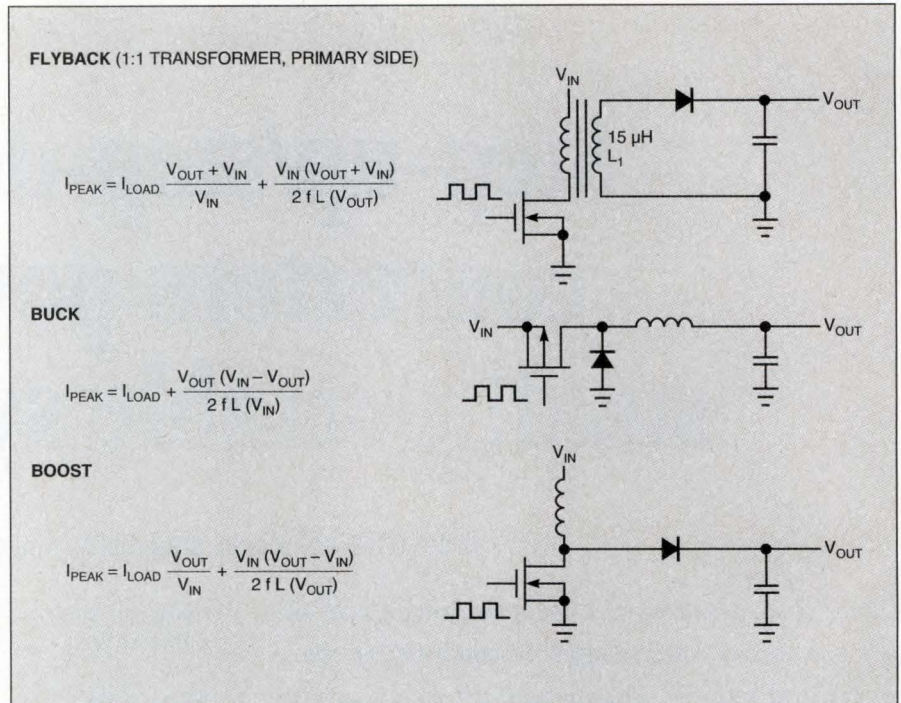

Fig 2—These equations describe the ratio of peak inductor current to average load current for pulse-width-modulated converters operating in the desirable continuous-conduction mode.

erator ( $V_{OUT} + V_{IN}$ ), which represents excessive peak current.

The ac switching loss also degrades the efficiency. This parameter equals  $V^2fC$ , where  $V$  is the peak voltage swing (equal to  $V_{IN}$  for buck regulators or  $V_{OUT}$  for boost regulators), and  $C$  is stray capacitance at the switching node. For a

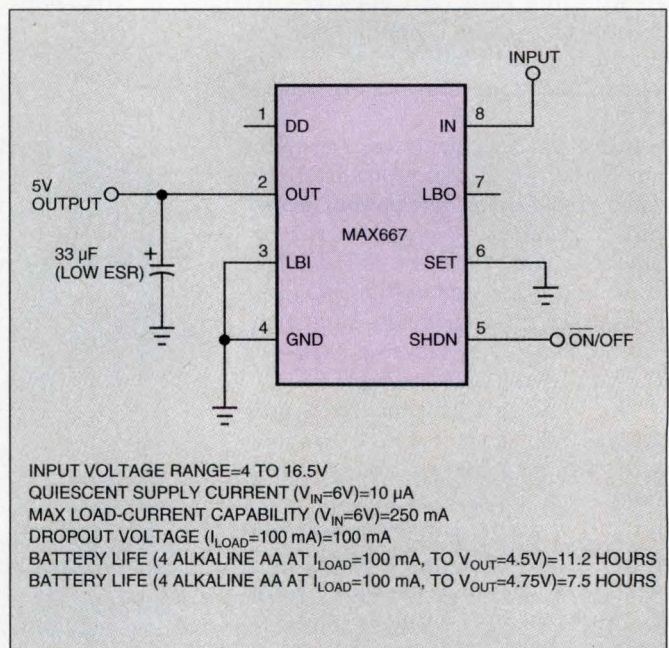

Fig 3—In some applications, a linear regulator with low dropout voltage can deliver more of a battery's energy to a load than can a switching regulator.

flyback circuit with a 1:1 transformer,  $V = V_{IN} + V_{OUT}$  (as a minimum).

$I^2R$  and switching losses handicap the flyback configuration. The resulting efficiency (70 to 80%) is inferior to that of buck and boost topologies (85 to 95%). The use of large and expensive power-switching components (or other drastic measures) can raise the flyback circuit's efficiency to 85% or so. Nevertheless, the flyback approach is useful if you need a wide input-voltage range or multiple outputs via extra windings, and if low cost is more important than battery life.

### Inverting the battery

Another way to generate 5V from four cells is to first invert the battery voltage with a switch-mode inverter, creating -5V. By connecting this negative output to the system ground you produce +5V at the other output terminal. This approach has some disadvantages, though:

Peak currents are no lower than those in a flyback circuit (indeed, the inverting and 1:1 flyback topologies are exact electrical equivalents). The inverting circuit also joins the 5V output to the battery's negative terminal. This can be a problem if other circuit loads are referenced to ground or if other voltages are generated from the same battery stack. And, finally, the inverting circuit requires a pnp or p-channel FET high-side power switch vs a less expensive and more efficient npn or n-channel FET low-side switch.

Despite the drawbacks, the inverting regulator's simplicity and wide range of input voltage make it attractive for many portable-equipment designs. The wide input range lets the system accept alternate power sources such as ac/dc adapters and 12V lead-acid batteries. As another advantage, the inverter output moves to zero in shutdown mode, a condition not always guaranteed for other regulating topologies.

### Low-dropout linear regulators

A step-down, low-dropout linear regulator would seem a poor choice for the 4-cell application. It converts only so much of the battery's energy; spent batteries still have considerable energy left in them. Even so, the linear regulator offers better battery life than some switching regulators. In the 4-cell application, the theoretic

cal efficiency is lowest when the battery is fresh ( $5/6V \times 100\% = 83\%$ ) and rises toward 100% as the battery voltage approaches 5V.

What's more, the heat and  $I^2R$  losses associated with pulsed current are absent in a linear regulator, and the con-

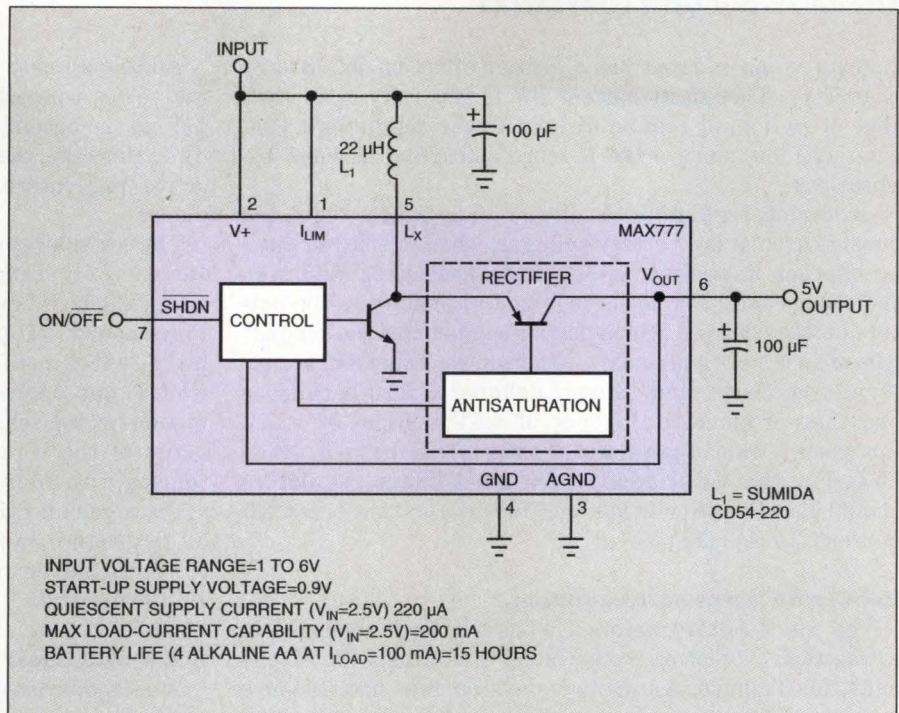

**Fig 4**—By combining a linear regulator and a switching regulator, this IC prevents the series connection of the inductor and rectifier from pulling  $V_{OUT}$  above 5V when the battery is fresh.

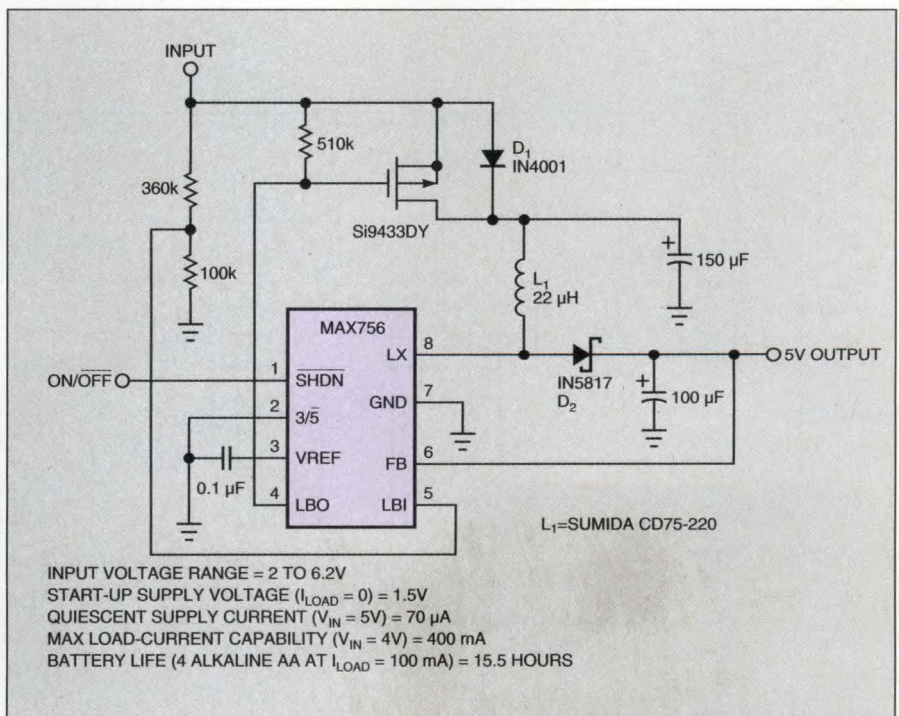

**Fig 5**—Diode  $D_1$  preregulates the input voltage to this boost switching regulator.

## STEP-UP/STEP-DOWN CONVERTERS

tinuous supply current has a gentler effect on the battery chemistry. Though its battery life is generally lower than that of switching regulators, the linear regulator's cost, size, and low noise make it more attractive in some applications.

Switching regulators usually provide tightly regulated outputs even at low battery voltages; when the output finally collapses, it does so in milliseconds. Linear regulators, on the other hand, drop out slowly and gracefully as the battery voltage decays. This behavior complicates the comparison of switchers and linears. When do you consider the battery to be discharged? Simply defining a dead battery as one that produces an output of 4.5V instead of 4.75V increases a linear regulator's battery life by more than 50%. For the 4-cell application, good linear regulators should have low dropout voltage (100 mV) and low quiescent current (10  $\mu$ A) (Fig 3).

### Boost with linear postregulation

The best 4-cell regulators use boost or buck topologies in a way that overcomes input-voltage limitations. Boost circuits, for example, feature low peak current and a simple schematic. They just keep boosting the battery voltage (to 5V) until the battery's energy completely dies.

Adding a linear regulator to a boost regulator prevents the series connection of the inductor and rectifier from pulling the output above 5V when the battery is fresh (Fig 4). In this case, the linear regulator is implemented with an active (pnp) internal rectifier instead of the usual Schottky diode.

The switching-regulator IC in Fig 4 is also unusual. Instead of a standard CMOS or "junk" bipolar process, this chip is fabricated with an advanced, complementary-bipolar RF process. The result is a combination of high switching frequency (normally the strength of CMOS) and operation below 1V (normally a strength of bipolar processes). Synchronous rectification overcomes many of the limitations inherent in the simple boost topology. In addition to the step-up/step-down function, synchronous rectification allows the output to be shorted to ground, and it automatically (and completely) disconnects battery from the load when the IC is placed in shutdown mode.

### Boost with linear preregulation

A second boost-plus-linear approach is to preregulate the input to a boost switcher (Fig 5). The switching regulator is disabled when the battery is fresh, so an external silicon rec-

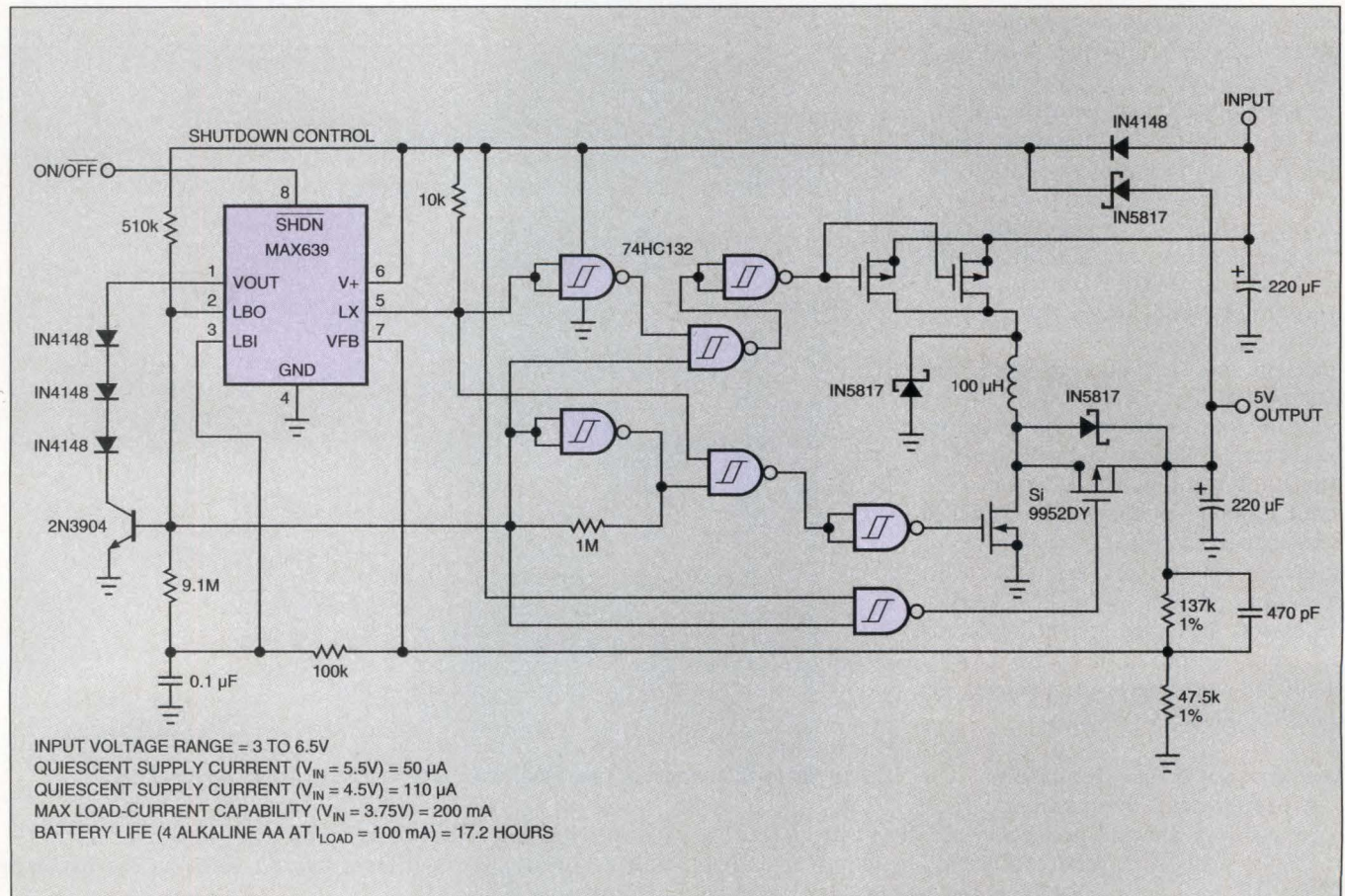

Fig 6—Complexity is the penalty paid for a step-up/step-down regulator that can derive 5V from a battery whose output passes through 5V during its discharge.



# CUT RS-485 POWER CONSUMPTION IN HALF!

## Lowest Power RS-485 IC Uses 250 $\mu$ A Supply Current—Max

The new MAX487 RS-485 transceiver uses a scant 250 $\mu$ A, making it the lowest power RS-485 IC available. The MAX487's  $\frac{1}{4}$  unit load input impedance allows up to 128 transceivers on the bus at one time. Plus, slew-rate-limiting dramatically lowers radiated EMI while reducing reflections caused by mismatched cable terminations.

- ◆ 250 $\mu$ A Supply Current
- ◆ Full Duplex Available
- ◆ 2.5Mbps Guaranteed Data Rate
- ◆ 128 Transceivers on Bus
- ◆ 1 $\mu$ A Shutdown Mode

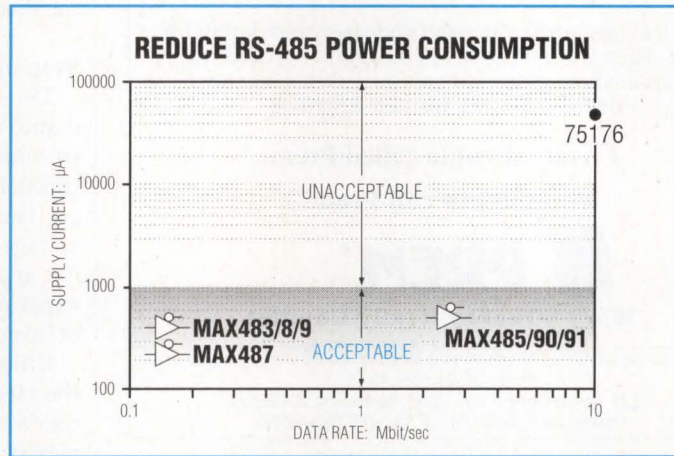

## Specify the Optimum Low-Power RS-485 Transceiver for Your Design

Part	#Tx/Rx	Data Rate Mbps	Max# on Bus	ISUPPLY ( $\mu$ A)	Full/Half Duplex	Price†	Feature
MAX481	1/1	2.50	32	500	Half	\$1.25	10 $\mu$ A Shutdown
MAX483	1/1	0.15	32	350	Half	\$1.25	Reduce EMI 100 Times
MAX485	1/1	2.50	32	500	Half	\$1.25	LTC485 Second Source
MAX487	1/1	0.15	128	250	Half	\$1.25	250 $\mu$ A ISUPPLY 128 MAX487s on Bus
MAX488	1/1	0.15	32	350	Full	\$1.25	8-pin SO
MAX489	1/1	0.15	32	350	Full	\$1.25	Separate Tx/Rx Enable
MAX490	1/1	2.50	32	500	Full	\$1.25	LTC490 Second Source
MAX491	1/1	2.50	32	500	Full	\$1.25	LTC491 Second Source

† Price is 1000-up recommended resale, FOB, USA

NEW  
NEW  
NEW  
NEW

**FREE Interface Design Guide—Sent Within 24 Hours!**  
Includes: Data Sheets and Cards for Free Samples

CALL TOLL FREE 1-800-998-8800  
For a Design Guide or Free Sample

MasterCard® and Visa® are accepted for Evaluation Kits or small quantity orders.

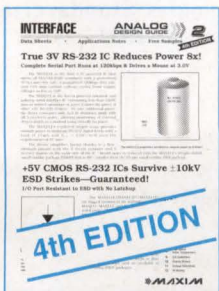

# MAXIM



Maxim Integrated Products, 120 San Gabriel Drive, Sunnyvale, CA 94086, (408) 737-7600, FAX(408) 737-7194.

Distributed by Arrow, Bell, Digi-Key, Elmo, Hamilton Hallmark, and Nu Horizons. Authorized Maxim Representatives: AL, M-Squared, Inc.; AZ, Techni Source Inc.; CA, Mesa, Pro Associates, Inc.; Infinity Sales, Inc.; CO, Component Sales; CT, Comp Rep Associates; DE, TAI Corporation; FL, Sales Engineering Concepts; GA, M-Squared, Inc.; ID, E.S. Chase; IL, Heartland Technical Marketing Inc.; IN, Technology Marketing Group; IA, JR Sales Engineering, Inc.; KS, Delltron; LA, BP Sales; MD, Micro-Comp, Inc.; MA, Comp Rep Associates; MI, Micro Tech Sales; MN, Mel Foster Technical Sales, Inc.; MS, M-Squared, Inc.; MO, Delltron; MT, E.S. Chase; NE, Delltron; NV (Reno, Tahoe area only) Pro Associates, Inc.; NH, Comp Rep Associates; NJ, Parallax, TAI Corporation; NM, Techni Source Inc.; NY, Parallax, Reagan/Compar; NC, M-Squared, Inc.; OH, Lyons Corporation; OK, BP Sales; OR, E.S. Chase; PA (Pittsburgh area) Lyons Corporation, (Philadelphia area) TAI Corporation; SC, M-Squared, Inc.; TN, M-Squared, Inc.; TX, BP Sales; UT, Luscombe Engineering Co.; VA, Micro-Comp, Inc.; WA, E.S. Chase; WI, Heartland Technical Marketing, Inc.

Distributed in Canada by Arrow. Authorized Maxim Representative in Canada: Tech Trek.

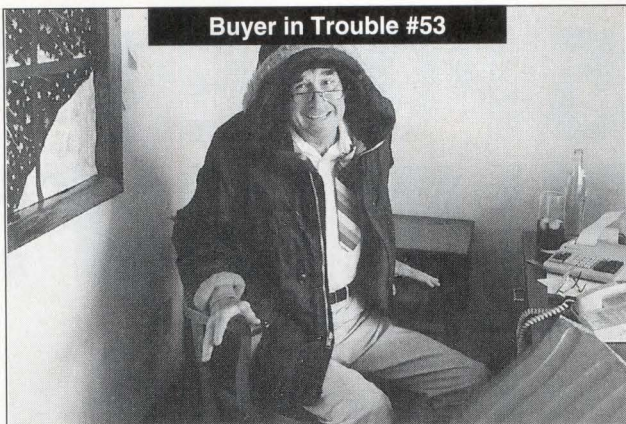

## Love Potion # B.S.I.

"She had beautiful eyes. She said she could design for B.S.I. Then she left me out in the cold. I'm dead meat. Prem has a whole series of transformers that already have British Standard Institute approval.

I really shoulda called Prem.

You oughta call Prem!"



# PREM®

Where Quality Really Counts!

For Prem's new catalog or additional product information, call or write  
Prem Magnetics, Inc.  
3521 North Chapel Hill Road, McHenry, IL 60050.  
Phone: 815-385-2700. FAX: 815-385-8578.

CIRCLE NO. 9

## THE NEW TCXO SOLUTIONS FROM RALTRON.

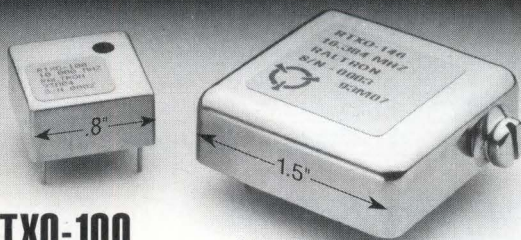

### RTXO-100 RTXO-146

- Small size
- Wide temperature range
- +5 VDC, +12 VDC
- Wide frequency range
- Voltage control option
- Custom options
- Lower cost

#### FREQUENCY STABILITY:

100: -30°C to +70°C: ±1ppm

146: -40°C to +85°C: ±1ppm

#### DIMENSIONS: 100 146

Length	.8"	1.5"
Width	.8"	1.5"
Height	.4"	.5"

Call or fax your specs to Sandy Cohen.

## RALTRON

ELECTRONICS CORP.

2315 NW 107 AVENUE  
MIAMI, FLORIDA 33172 U.S.A.  
FAX (305) 594-3973  
TELEX 441588 RALSEN  
(305) 593-6033

### ONLY RALTRON HAS IT ALL

Crystals / Crystal Oscillators  
Crystal Filters / Ceramic Resonators

CIRCLE NO. 16

### STEP-UP/STEP-DOWN CONVERTERS

tifier ( $D_1$ ) drops the worst-case high input voltage from 6.3 to 5.4V. This cheap-and-dirty equivalent to a linear regulator requires a minimum load of 100  $\mu$ A or so to prevent output overvoltage due to the diode leakage current. The circuit continues to operate even with battery voltages of 3V and below. Typical efficiency is 80% when the battery is fresh, rising to 90% as the battery voltage declines to 4V.

To accommodate higher input voltages, you can easily substitute a linear regulator for  $D_1$ . And if low cost is your goal, omit the p-channel FET switch-over circuit. Performance with the diode alone is still comparable to that of a flyback circuit.

#### Step-up/step-down topology

The step-up/step-down regulator achieves high performance at the cost of complexity by switching from buck mode to boost mode as the declining battery voltage passes through 5V (Fig 6). And it does all this with a single inductor. Switch-mode operation over the entire range of battery voltage yields higher efficiency than does the boost-plus-linear approach, yet the step-up/step-down regulator does not experience the high peak current and consequent  $I^2R$  losses of inverting and flyback approaches.

Efficiency exceeds 90% over most of the battery's range, and the step-up/step-down circuit extracts nearly all of the battery's energy. The penalty for this high performance is a complexity. The circuit requires three MOSFETs (or four—as shown—if you parallel two p-channel devices for a lower  $r_{DS(ON)}$ ). Also, the switch from buck to boost causes an  $\sim\pm 2\%$  change in the output voltage as the battery voltage reaches 5V.

Built into IC<sub>1</sub> is a comparator that decides when to switch from step-down to step-up operation. The comparator monitors the battery or output voltage, whichever is higher, via a diode-OR connection. As the buck regulator begins to lose control (drop out), the output begins to fall. When the input reaches 4.95V, the circuit switches from buck to boost, causing the output-regulation point to shift from 4.92 to 4.98V. If for some reason the battery voltage rises above 5.15V, the circuit switches back to buck mode. EDN

#### Reference

1. Moore, Bruce D, "Regulator Topologies Standardize Battery-Powered systems," *EDN*, January 20, 1994, pg 59.

#### Author's biography

For Bruce Moore's biography, see Ref 1.

Article Interest Quotient  
(Circle One)

High 586 Medium 587 Low 588

#### Attention aspiring authors . . .

Publishing an article in EDN can be a satisfying and rewarding experience. And, you don't have to be a professional writer to get published in EDN. If you can communicate useful technical information clearly, our editors can guide you in writing articles that we'll be proud to publish. We also pay you an honorarium, based on your article's length. Submit article ideas to Joan Lynch, EDN, 275 Washington St, Newton MA 02158.

# 1-CELL (1.1V) INPUT STEP-UP GUARANTEES 5V, 30mA OUTPUT

## Internal Synchronous Rectifier Assures Complete 20 $\mu$ A Shutdown

The MAX777/MAX778/MAX779 step-up dc-dc converters deliver more power from a single battery cell (1.1V) than any other IC solution available. An internal active rectifier diode increases efficiency and provides true 20 $\mu$ A shutdown. Only 2 capacitors and a small 22 $\mu$ H inductor are needed, saving space and cost. Guaranteed start-up is 1V (10mA load). In shutdown, the internal switched rectifier opens the DC path from the input to the output, stopping current drain associated with conventional step-up converters. Also, the Active Rectifier™ allows these regulators to act as buck/boost converters, providing regulation for input voltages above and below the output voltage. Order the complete surface-mount evaluation kit (MAX778EVKIT-SO) to speed your design.

- ◆ **5V @ 30mA or 3.3V @ 60mA from 1.1V Inputs, Guaranteed**
- ◆ **Internal Synchronous Rectifier**
- ◆ **True 20 $\mu$ A Shutdown Supply Current**
- ◆ **3.3V or 5V Regulated Output from 1V to 6.2V Input**
- ◆ **8-Lead DIP or SOIC Package**
- ◆ **MAX777: 5V Output**  
**MAX778: 3.3V/3V Output**  
**MAX779: Adjustable Output (2.7V to 6V)**
- ◆ **Evaluation Kit Available**

**HIGH OUTPUT CURRENT vs. LOW INPUT VOLTAGE**

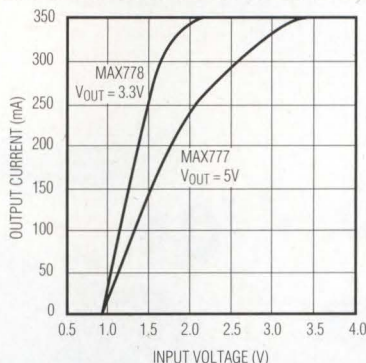

**1V INPUT STEP-UP CONVERTER  
USES ONLY 3 COMPONENTS**

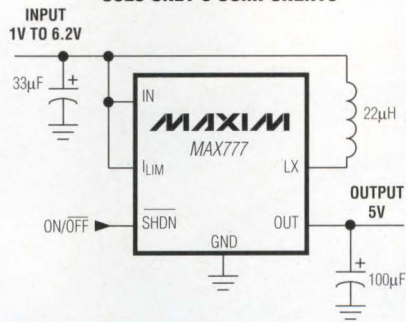

**FREE Power Supply Design Guide—Sent Within 24 Hours!**  
**Includes: Data Sheets and Cards for Free Samples**

**CALL TOLL FREE 1-800-998-8800**  
**For a Design Guide or Free Sample**

MasterCard® and Visa® are accepted for Evaluation Kits or small quantity orders.

**MAXIM**

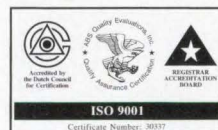

Maxim Integrated Products, 120 San Gabriel Drive, Sunnyvale, CA 94086, (408) 737-7600, FAX(408) 737-7194.

Distributed by **Arrow, Bell, Digi-Key, Elmo, Hamilton Hallmark, and Nu Horizons**. Authorized Maxim Representatives: **AL**, M-Squared, Inc.; **AZ**, Techni Source Inc.; **CA**, Mesa, Pro Associates, Inc.; **CO**, Component Sales; **CT**, Comp Rep Associates; **DE**, TAI Corporation; **FL**, Sales Engineering Concepts; **GA**, M-Squared, Inc.; **ID**, E.S. Chase; **IL**, Heartland Technical Marketing Inc.; **IN**, Technology Marketing Group; **IA**, JR Sales Engineering, Inc.; **KS**, Delltron; **LA**, BP Sales; **MD**, Micro-Comp, Inc.; **MA**, Comp Rep Associates; **MI**, Micro Tech Sales; **MN**, Mel Foster Technical Sales, Inc.; **MS**, M-Squared, Inc.; **MO**, Delltron; **MT**, E.S. Chase; **NE**, Delltron; **NV** (Reno, Tahoe area only) Pro Associates, Inc.; **NH**, Comp Rep Associates; **NJ**, Parallax, TAI Corporation; **NM**, Techni Source Inc.; **NY**, Parallax, Reagan/Compar; **NC**, M-Squared, Inc.; **OH**, Lyons Corporation; **OK**, BP Sales; **OR**, E.S. Chase; **PA** (Pittsburgh area) Lyons Corporation, (Philadelphia area) TAI Corporation; **SC**, M-Squared, Inc.; **TN**, M-Squared, Inc.; **TX**, BP Sales; **UT**, Luscombe Engineering Co.; **VA**, Micro-Comp, Inc.; **WA**, E.S. Chase; **WI**, Heartland Technical Marketing, Inc.

Distributed in Canada by **Arrow**. Authorized Maxim Representative in Canada: **Tech Trek**.

™ Active Rectifier is a trademark of Maxim Integrated Products

Maxim is a registered trademark of Maxim Integrated Products. © 1993 Maxim Integrated Products



New Wave Memories

# 16M Synchronous DRAMs

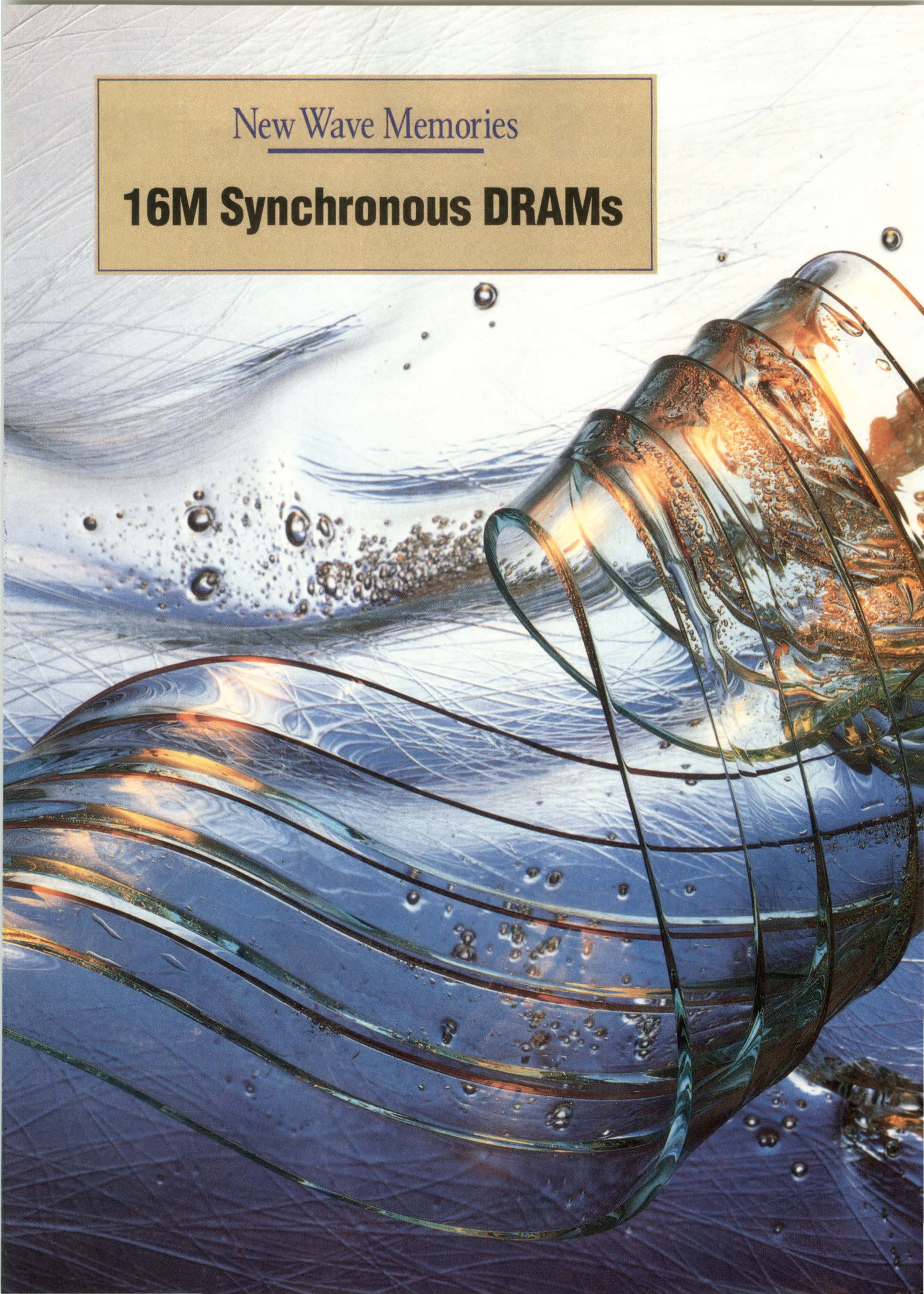



**F**orget about cost/performance trade-offs. Our new 16M Synchronous DRAMs give you big benefits in both areas. Operating at 100MHz clock, they eliminate CPU wait states. So workstation designers save by eliminating costly cache SRAMs. And PC designers gain a quantum leap in system speed.

Our new 16M Synchronous DRAMs provide a minimum cycle time of 10 nanoseconds (100MHz) and a maximum data transfer rate of 200M bytes per second (x16 device) with a 3.3V power supply. They're designed with 3-level pipeline architecture and 0.5-micron CMOS technology. Other features include:

- Full JEDEC compatibility
- Programmable mode register for burst length, wrap type and  $\overline{\text{CAS}}$  latency
- Dual memory banks for ping-pong operation
- Clock suspend and power-down operation

To meet your system needs, our 16M Synchronous DRAMs are available in a variety of speeds and organizations. Clock-speed versions are 66, 75, 83, and 100MHz. Bit organizations are x4, x8 and x16. Package types are 44-pin or 50-pin 400mil TSOPII.

Breaking cost/performance barriers—that's what new wave memories are all about. To receive more information about our 16M Synchronous DRAMs, or to order your samples, call NEC today.

**From the leader in memory technology**

**For fast answers, call us at:** USA Tel:1-800-366-9782, Fax:1-800-729-9288.  
Germany Tel:0211-650302, Fax:0211-6503490, The Netherlands Tel:040-445-845, Fax:040-444-580, Sweden Tel:08-753-6020, Fax:08-755-3506, France Tel:1-3067-5800, Fax:1-3946-3663, Spain Tel:1-504-2787, Fax:1-504-2860, Italy Tel:02-6709108, Fax:02-66981329,  
UK Tel:0908-691133, Fax:0908-670290, Ireland Tel:01-6794200, Fax:01-6794081,  
Hong Kong Tel:886-9318, Fax:886-9022, Taiwan Tel:02-719-2377, Fax:02-719-5951,  
Korea Tel:02-551-0450, Fax:02-551-0451, Singapore Tel:253-8311, Fax:250-3583,  
Australia Tel:03-8878012, Fax:03-8878014, Japan Tel:03-3454-1111, Fax:03-3798-6059.

**NEC**

CIRCLE NO. 69

87

# élantec

ANALOG INTEGRATED CIRCUITS

Advancing State-of-the-Art  
High-Speed Power  
MOSFET Driver Technology

## CMOS Power MOSFET Drivers

Single Channel, 4.0 Amps Output  
**EL7104**

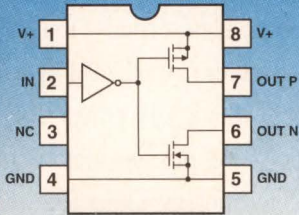

**Non-Inverting**

- Isolated Drains
- 20 ns Switching Time
- \$1.96 – 100's P-DIP

**EL7114**

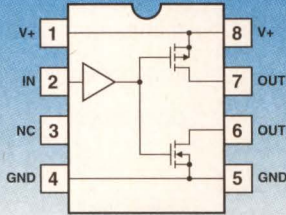

**Inverting**

- Isolated Drains
- 20 ns Switching Time
- \$1.96 – 100's P-DIP

Dual Channel, 2.0 Amps Output  
**EL7202**      **EL7212**      **EL7222**

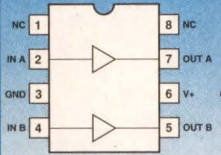

**Non-Inverting**

- 20 ns Prop Delay
- 20 ns Switch. Time
- \$1.96 – 100's P-DIP

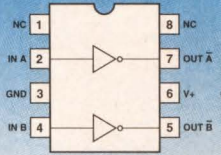

**Inverting**

- 20 ns Prop Delay
- 20 ns Switch. Time
- \$1.96 – 100's P-DIP

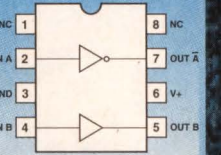

**Complementary**

- 20 ns Prop Delay
- 20 ns Switch. Time
- \$1.96 – 100's P-DIP

3-State Line Driver/Dual Input Line Driver,  
4.0 Amps Output  
**EL7134**

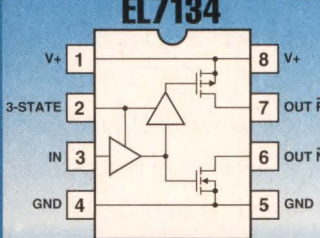

- 20 ns Prop Delay
- 20 ns Switching Time
- \$2.40 – 100's P-DIP

**EL7144**

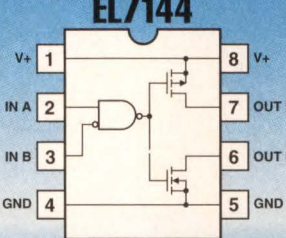

- 20 ns Prop Delay
- 20 ns Switching Time
- \$2.40 – 100's P-DIP

Dual Channel/Dual Input, 2.0 Amps  
**EL7242**      **EL7252**

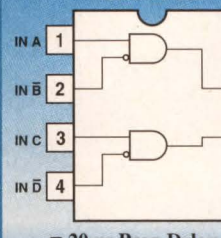

- 20 ns Prop Delay
- 20 ns Switching Time
- \$2.25 – 100's P-DIP

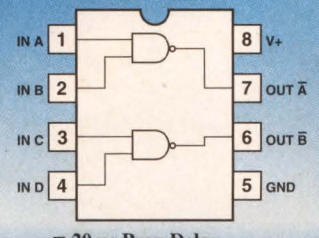

- 20 ns Prop Delay
- 20 ns Switching Time
- \$2.25 – 100's P-DIP

CCD Driver/Dual Channel 3-State Line Driver  
**EL7182**      **EL7232**

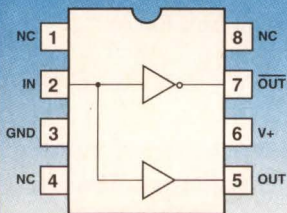

- Reduced Clock Skew
- 20 ns Switching Time
- \$2.65 – 100's P-DIP

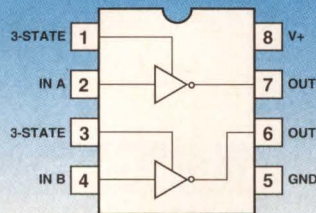

- 20 ns Prop Delay
- 20 ns Switching Time
- \$2.25 – 100's P-DIP

Dual Channel – Isolated Drains, 2.0 Amps  
**EL7262**      **EL7272**

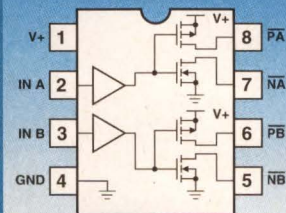

- 20 ns Prop Delay
- 20 ns Switching Time
- \$2.25 – 100's P-DIP

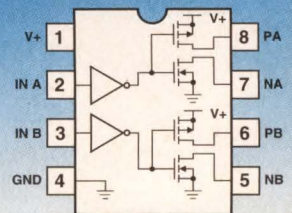

- 20 ns Prop Delay
- 20 ns Switching Time
- \$2.25 – 100's P-DIP

**Applications:** • Clock Drivers • Line Drivers • CCD Drivers • Ultrasound Transducer Drivers • Switching Power Supplies • Bus Driver • Motor Control • Charge Pumps • Pin Drivers • EPROM Programming • Resonant Charging Non-overlapped Switching

FOR SAMPLES CALL OUR APPLICATIONS HOTLINE - (800) 333-6314 ext 311, Literature Only - ext 234

ELANTEC, INC. ■ 1996 Tarob Court ■ Milpitas, CA 95035 ■ (408) 945-1323 ■ (800) 333-6314 ■ FAX (408) 945-9305

Authorized Distributors: MARSHALL INDUSTRIES • NU HORIZONS • INSIGHT ELECTRONICS



# Imagine electronics without noise.



## Now make it real.

As regulations become increasingly strict, finding the ideal solution to noise-emission problems isn't always easy.

TOKIN Simplifies your search by starting from the bottom up, developing original materials and technologies for

a vast and growing lineup of EMC devices. A close look will reveal TOKIN EMC devices in many of the products you use every day. From the smallest

electronic diaries to advanced communications equipment; from camcorders to automotive electronics. Indeed, TOKIN supplies many of the leading electronics

manufacturers—and countless smaller makers—around the world.

If electromagnetic noise is interfering with your progress, discover the source that offers a full line of EMC precision.

We'll be waiting for your call.

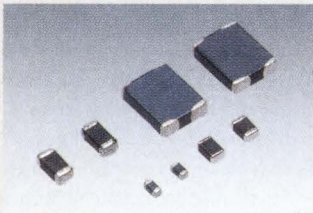

**Solid Chip Suppressors NZ Series / Solid Chip Common Mode Chokes**

Surface-mount EMC products with complete monolithic structure

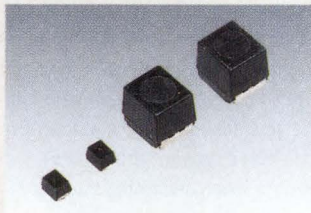

**Wire-wound Chip Inductors**

High inductance; unique construction features compact, highly accurate ferrites

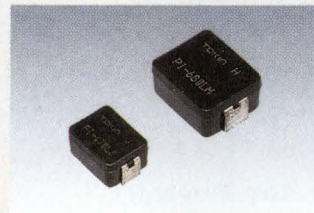

**Leadless Power Inductors P-I Series**

Compact, surface-mount type; superior dust core production technology

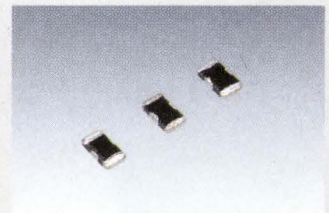

**Three-terminal Chip Capacitor**

Superior high-frequency characteristics

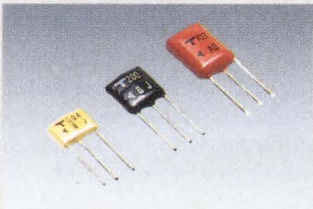

**Distributed Constant Filters**

Excellent wide-frequency characteristics due to distributed constant effects

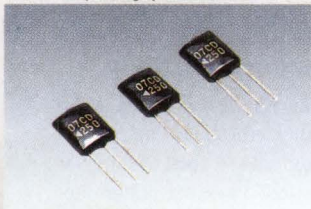

**Distributed Constant Filters for High Frequencies**

Excellent attenuation for frequencies over 50MHz

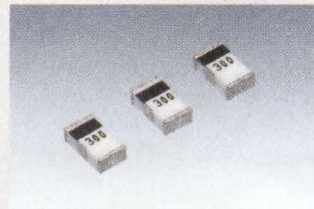

**Three-terminal Noise Suppressor**

Ideal for preventing radiated emissions from high-speed data lines in electronic equipment

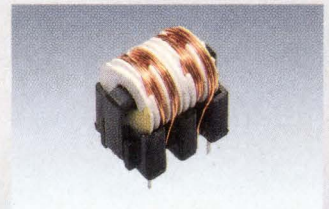

**SS Coils SS10V Series**

Compact, with large inductance; prevents noise over a wide frequency range

# TOKIN

### Tokin Corporation

Overseas Sales Division  
KSP. B. 220, 2-1, Sakato 3-chome, Takatsu-ku, Kawasaki-shi,  
Kanagawa-ken 213, Japan  
Phone: 044-812-7901 Fax: 044-812-7908  
Korea Representative Office  
#602, Champs-Elysees Bldg., 889-5, Daechi-Dong, Kangnam-gu,  
Seoul, Korea  
Phone: (2) 569-2582 ~ 5 Fax: (2) 544-7087

### Tokin America Inc.

155 Nicholson Lane, San Jose, California 95134, U.S.A.  
Phone: 408-432-8020 Fax: 408-434-0375  
Chicago Branch  
9935 Capitol Drive, Wheeling, Illinois 60090, U.S.A.  
Phone: 708-215-8802 Fax: 708-215-8804

### Tokin Electronics (HK) Ltd.

Unit 705-707, Chiwan Tower, Park Lane Square, 1 Kimberly Rd.,  
Tsimshatsui, Kowloon, Hong Kong  
Phone: 730-0028 Fax: 375-2508  
Taiwan Liaison Office  
Phone: (02) 7728852 Fax: (02) 7114260  
Singapore Branch  
Phone: 2237076 Fax: 2236093, 2278772

### Tokin Europe GmbH

Knorrstr. 142, 80937 München, Germany  
Phone: 089-311 10 66 Fax: 089-311 35 84

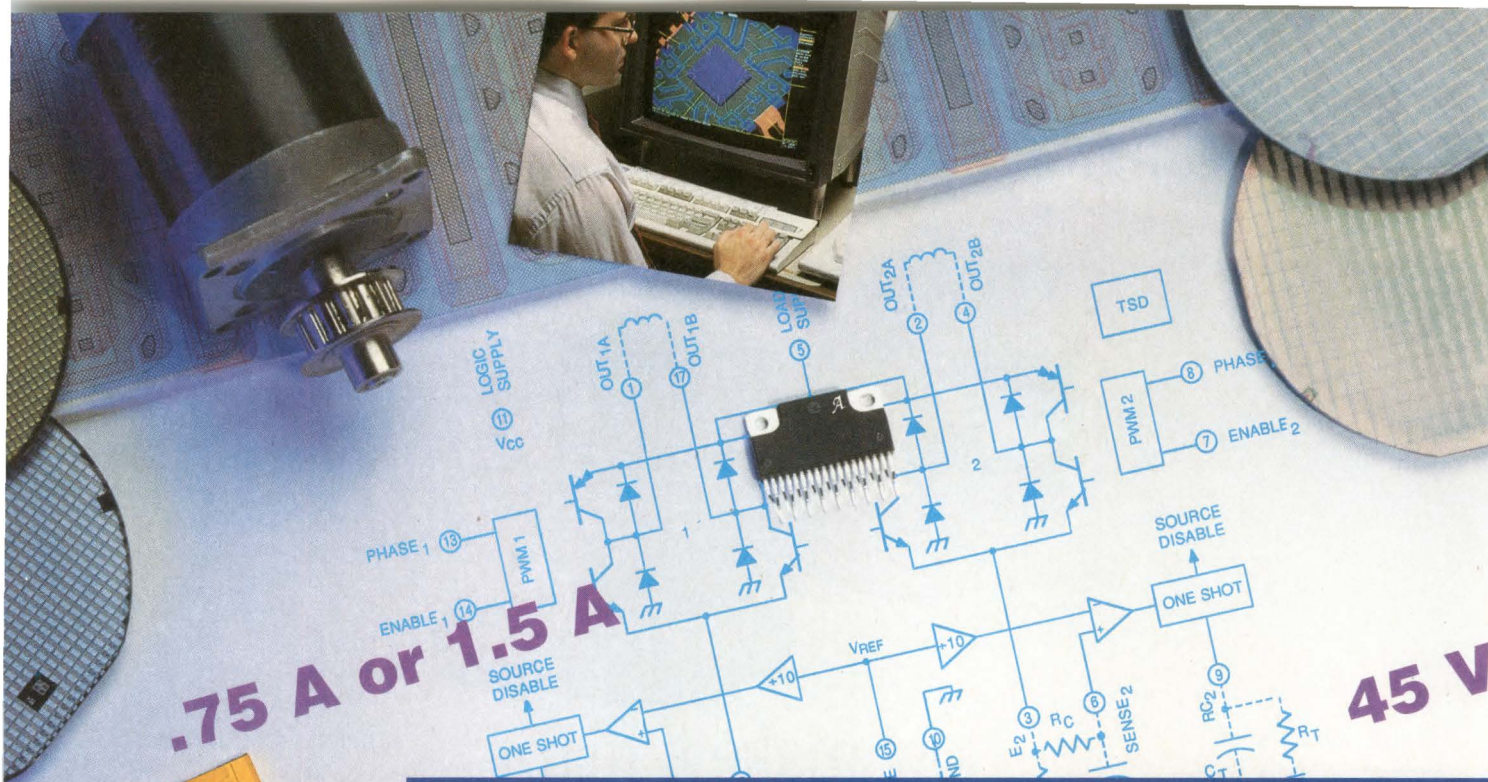

**.75 A or 1.5 A**

**45 V**

**THE POWER TO DRIVE 2 WINDINGS WITH ONE IC**  
**2916, 2917, & 2918 Dual Full-Bridge PWM Motor Drivers**

**FEATURES**

- For Bipolar Stepper Motors or For Two DC Motors
- $\pm .75$  A or  $\pm 1.5$  A Continuous Output Current
- 45 V Output Sustaining Voltage
- Internal PWM Current Control
- Internal Clamp Diodes
- Internal Thermal Shutdown

**Circuitry Elegantly Engineered To Meet Your System Requirements**

Containing two full bridges, the Allegro's 2916, 2917, & 2918 motor drivers are designed to drive both windings of a bipolar stepper motor or bidirectionally control two dc motors. Each bridge is capable of sustaining

45 V and includes internal pulse-width modulation (PWM) control of the output current to  $\pm .75$  A (2916) or  $\pm 1.5$  A (2917, 2918). Current is determined by the user's selection of a reference voltage and sensing resistor. Included on chip are ground clamp and flyback diodes for protection against inductive transients. Internally generated delays prevent cross-over currents when switching current direction. Thermal protection circuitry disables the outputs if the chip temperature exceeds safe operating limits.

**Designed For Manufacturability**

Allegro's ICs are "designed-for-manufacturability" under stringent standards of Total-Quality. Design/Production teams, under our

PACE (Product And Cycle-time Excellence) program, work closely with our customers to meet their time-to-market and quality/reliability objectives.

Headquartered in Worcester, Massachusetts, Allegro operates two Wafer-fabrication plants as well as assembly/test facilities. Design centers are located worldwide, sharing common cell libraries and design tools.

**Take A Test-Drive... Call For Samples**

Samples are available now. Just give us a call at 1•508•ALLEGRO and we'll have our Sample Pack in the mail to you the same day. After all, the measure of our success can only be your total satisfaction.

**THE PACE QUICKENS**



Formerly Sprague Semiconductor Group

**CALL 1 • 508 • ALLEGRO**

115 Northeast Cutoff, Worcester, Massachusetts 01615

CIRCLE NO. 71



# Pick the right package for your next ASIC design

David P Pivin, ASIC Division, Motorola Semiconductor Products Sector

*The quest for higher integration levels in ASICs and competitive pressures to reduce system manufacturing costs has driven IC manufacturers to improve package capabilities and develop new methods. This article should help you evaluate the many choices available to find the best match of design performance and system costs.*

Today's system designers have at their disposal the benefit of several generations' worth of ASIC-package development. The variety of packages makes it a challenging task to make a decision that meets price and performance goals. However, armed with a detailed understanding of the various package types, their performance attributes, and their costs, you can choose a package that meets your goals.

This article focuses on packages for applications ranging from high-end consumer to workstation/servers and computers. It discusses various technologies, most of which ASIC designers can use today. It also discusses cost—typically the deciding factor in selecting among the package choices. However, this article goes beyond the cost of the package itself. It also discusses those incurred in manufacturing and during the life cycle of a product, as well as how to reduce costs in an existing product. For example, you may be able to achieve higher performance for the same or lower parts costs, although doing so may require different manufacturing techniques from those you currently use.

This article compares each package in a matrix of parameters detailing their cost, thermal and electrical performance, physical dimensions, and ease of manufacturing (see **Table 1** and **Fig 1**).

One of the deciding factors in choosing a package is pin count, which has accelerated from an average of 100 pins a few years ago to an average of 160 pins today. Just as the plastic leaded chip carrier (PLCC) extended the range of pins beyond the capabilities of a DIP, the quad flatpack (QFP) has provided a solution PLCCs cannot reach.

Key in driving the demand for higher pin counts

is the rapid increase in  $\mu$ P bus widths from 8 to 16 to 32 bits. Most current designs are 32 bits wide, with some pushing out to 64 bits. Multiplexed buses have also given way to separate address and data paths from the processor in RISC architectures. As some designs move into new generations or are cost reduced, integrating several designs into one or two chips, the pin count of individual ASICs rises.

Power dissipation is bound to rise with the increase in pins, which also strains the capabilities of low-cost packages. The power dissipation of CMOS devices is directly proportional to system clock frequencies, which range from 20 to 66 MHz. Most power dissipation occurs during the transitions of signals from high to low or low to high. Signal transitions charge and discharge the load capacitance on each I/O pin. Internal signals, although lightly loaded, are numerous. In contrast, there are only a few I/O buffers, but because they deal with much larger loads, they can consume more power than do the core cells.

Although pin counts increase with architectural improvements, the ratio between gates and I/O buffers has changed little. In the past few years, average gate count has risen from 25,000 to more than 40,000 gates. Unless there is an improvement in power dissipation per gate or I/O buffer, the combination of higher clock frequencies with bus-width-dri-

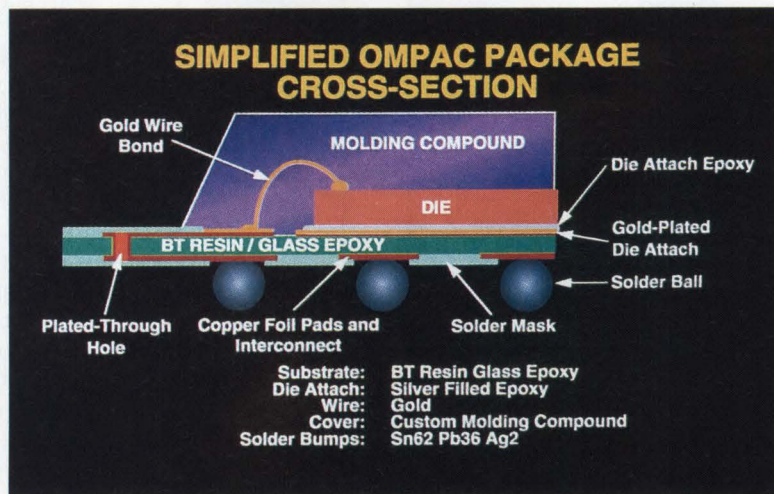

The plastic ball-grid array provides the density of a pin-grid array at the cost of a plastic quad flatpack.

## ASIC PACKAGES

ven density produces a severe demand on the thermal-dissipation capabilities of a package.

To offset the effects of increased clock frequency, some designers use 3.3 instead of 5V power in components, thus alleviating some of the pressure to move to higher cost packages. Fig 2 shows the power dissipation resulting from changing a design to run from 3.3 instead of 5V as a function of clock frequency. You can implement this hypothetical design in a technology that lets you select among power-rail configurations. By selecting the I/O buffers, the core, or both sections of the ASIC to operate from a 3V supply, you can switch from a 15°C/W package to a much less expensive 45°C/W package.

However, the 3V option may not suit your application. To complicate matters, some enclosures have little or no airflow. Most PCs have access to some airflow because they incorporate fans that draw air out of the power supply. Strategically placed louvers in the power supply and outer case draw air into the case. This cooling method may lead to islands of dis-

sipation on large mother boards that lie flat at the bottom of the case, with no directed airflow: a worst-case scenario.

## Smaller footprints affect package choices

Another problem in selecting a package is physical constraints. Smaller footprints for systems such as disk drives and laptops, along with the PCMCIA form factor, have caused these constraints. These new lows in size also apply to package height; the PCMCIA form factor requires total component height lower than 2 mm when components are placed on both sides of a circuit board.

The number of power pins a design requires also affects a design's physical format. Most ASIC designs have a large number of power pins: 20 to 33% of total pins are power pins. The designs require so many pins because the I/O buffers require transient currents, which should go through as low a resistance and inductance as possible. Extra pins also ensure that noisy return paths do not share pins with those of sensitive inputs.

The most significant factor in power-pin count is the need to support simultaneously switched-output (SSO) buffers. The spike of current associated with an output buffer in transition aligns with each buffer's input signal because a common clock signal switches the input signal, an unavoidable byproduct of synchronous operation. On-chip power rails may droop, ground pads may bounce, and the resulting false signals may disrupt chip or system operation.

The clock and data-signal frequencies of most current systems do not reach the levels at which the package RLC values can cause significant degradation of those signals.

Transmission-line effects, especially those of the reflections caused by line-impedance changes, also represent a serious detriment to signal integrity. A design should have a narrow range of values for the impedance of signal lines as they change from die pad on one chip to wire bond, package, pin, board traces, and die pad on another chip. Otherwise, the signal tends to ring the RLC elements like a bell, reflecting many times from each change in impedance. These reflections may defeat any attempts to reduce the cycle time of the system. The simplest method is to insert a series-termination resistor between the memory controllers and the DRAMs. This method damps the reflections enough to preserve signal integrity. You may need to use more dramatic methods when your application requires cycle times shorter than the 70 or 80 nsec that DRAMs provide. However, some methods for reducing impedance mismatches and reflections affect the package.

Another aspect of building high-frequency designs is that they require differential signals. These signals offer a lot of immunity to noise, which is common to both leads, and the ability to more easily control the impedance. Pin density aggravates another transmission-line problem—coupling of signals on adjacent pins of a package or pc board. This increase in coupling is probably the most challenging interconnection problem because solutions typically add cost.

As you can see, high performance challenges the goal of keeping within budget. But for the lowest manufacturing cost, the components and process must suit automated high-

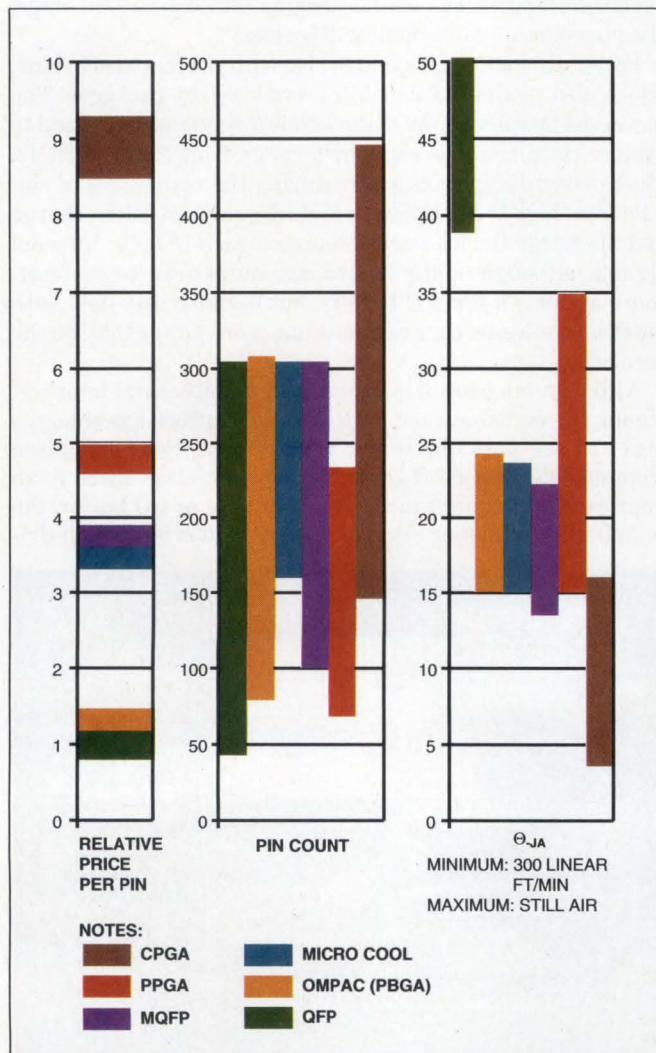
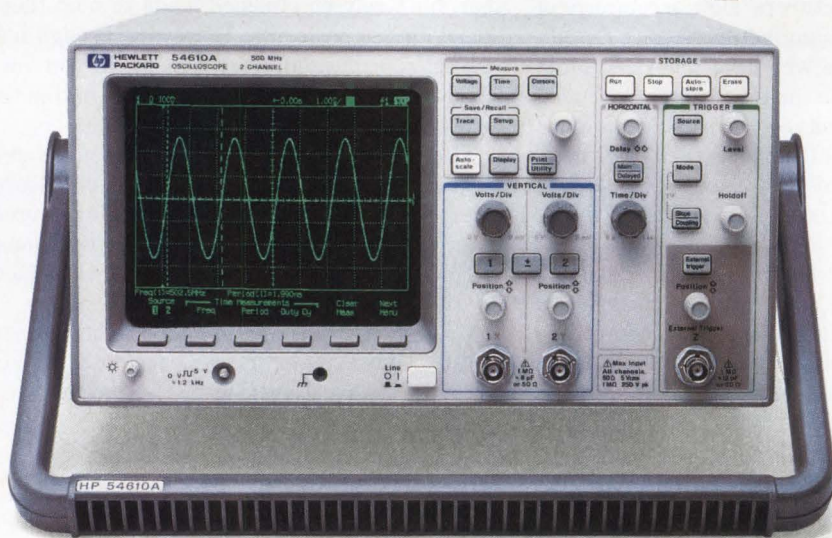

Fig 1—Compare price per pin, pin count, and thermal performance of some common packages.

# The best thing about our 500 MHz scope isn't the price.



**\$4,995**  
U.S. list price

## It's what you get for it.

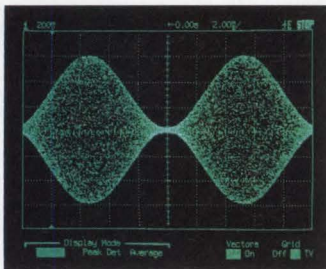

*Just like an analog scope, HP's 500 MHz oscilloscope has a real-time display that responds instantly to changes in your waveforms or controls.*

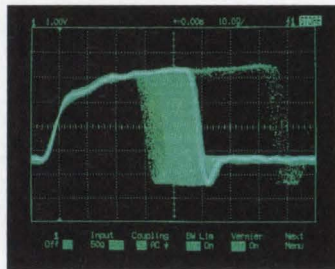

*A bright trace and convenient, push-button functions like Autostore let you easily see and store tough-to-find signals.*

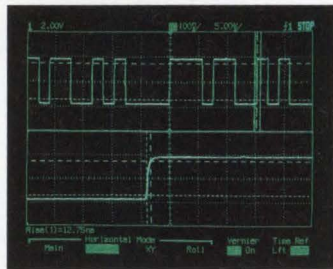

*Pretrigger viewing and delayed sweep mode help you save time by grabbing and displaying signals before or after the trigger event.*

### How we can offer you a 500 MHz, delayed sweep scope that's within budget, without compromise.

High bandwidth digital scopes have always forced you to sacrifice two things you love about analog scopes: a familiar look and feel and immediate, believable displays.

Our engineers didn't think you should have to make that compromise. So they designed the HP 54610A oscilloscope with the analog-style interface you're comfortable with, and a new digital architecture that produces waveform displays superior to analog scopes.

The result: you get the quality and performance you'd expect from HP. At a price you wouldn't.

**Call HP DIRECT at 1-800-452-4844\*, Ext. 7667 to talk to an HP engineer about your scope needs.**

Want to speak to someone about the HP 54610A scope features and specifications, or your specific application needs? Calling HP DIRECT is the fast, easy way to get all your questions answered — with no obligation to order.

You see, HP DIRECT is your direct line to information and solutions for HP basic test instruments. With one simple call, you can get quick product specifications or any

technical literature you may need to make the right decision. Or if you want one-on-one technical support,

you can speak to an engineer who has first-hand experience with HP products. And, of course, if you're ready to order, we can help you do that, too.

So give us a call. And discover how much more you really get from HP today.

\* In Canada, call 1-800-387-3867, Dept. 476.

**There is a better way.**



## ASIC PACKAGES

volume assembly. Board manufacturers' slow acceptance of fine-pitch QFP shows that some manufacturers don't readily adapt to new technologies. Those who have tried fine-pitch QFPs find that they cannot use the same processes they used successfully on previous generations of QFPs using standard pitch. New requirements of 4-mil lead coplanarity,  $\pm 3$  mils,  $<0.1^\circ$  placement accuracy, and the last resort—manual hot-bar soldering—are some of the costly new additions to the manufacturing process.

Most designers choose surface mounting as an assembly method because most components used in this method—from passives to many large ICs—are available at competitive costs. The common techniques for assembling and soldering most surface-mounted components have matured quickly. Assembly equipment handles the various shapes and sizes

that don't rely on clinched leads to hold themselves on the board during soldering. However, through-hole components require special handling. For example, you can mix different-sized QFPs and lead pitches. Although this technique is not a good idea, you cannot always avoid it.

The cost of a package becomes most evident when it adversely impacts the board-test yield. Board-test failures often relate to interconnection problems, presenting manufacturers with "repair-or-no-repair" decisions. Manufacturers must repair a board that fails a test or face the loss of all invested components and labor.

When a customer returns a defective board, the manufacturer must again decide whether to repair the board or throw it away. Logistic costs add to the penalty of a

*Text continued on pg 104*

### Table 1—Comparison of package parameters

	CPGA	CPGA-w/ planes & slug	PPGA	SMPGA	QFP	CQFP (side brazed)	MQFP	Micro- Cool	VQFP	TQFP	TAB	PBGA	CBGA	C-4	COB
Range of # of Pins in common use	72-250+	200-500+	72-300+	200-500+	64-160	64-304	64-304	160-304	64-304	80-120	150-500+	86-313	144-256	150-700+	8-200+
Die Mounting Surface	Gold/ Ceramic	Gold/Cu Slug	Gold/Cu Flag	Gold/ Ceramic	Alloy-42 Lead Frame	Gold/ Ceramic	Cu Lead Frame	Gold/Cu Flag	Cu Lead Frame	Cu Lead Frame	Cu Lead Frame	Gold/Cu Flag	Gold/ Ceramic	Gold/Cu	Gold/Cu
Case/Substrate Material	Ceramic	Ceramic	FR-4	Ceramic	n/a	Ceramic	Anodized Al	FR-4 PCB	n/a	n/a	Polyimide	BT Epoxy	Ceramic	FR-4 PCB	FR-4 PCB
Cover/lid/encapsulant	Metal	Metal	Epoxy	Metal	Epoxy	Metal	Anodized Al	Epoxy	Epoxy	Epoxy	Epoxy (top only)	Epoxy	Metal	Epoxy Edge Seal	Epoxy Glob
Cost per pin relative to 120 QFP	3	7	2.2	4	0.8 - 1.0	5	3 - 4	3 - 5	1.0 - 1.2	0.7 - 1.0	1.5	1.2 - 1.3	3.5 - 4.5	0.1	0.2 - 0.4
Pin Pitch (mm)	2.54	2.54	2.54	1.27	0.65, 0.8, 1.0	0.5, 0.65, 0.8, 1.0	0.5, 0.65, 0.8, 1.0	0.5, 0.65	0.5	0.5, 0.4	0.25, 0.3, 0.4, 0.5	1.5, 1.65	1.5, 1.65	0.075, 0.1	0.75 - 1.0
Area per pin (sq.-mm/pin)	6 - 10	6 - 10	6 - 10	3 - 8	4 - 8	4 - 8	4 - 8	4 - 8	4.7 - 6	3.7 - 4.5	0.3 - 1	2.9 - 3.9	2.9 - 3.9	0.2 - 0.4	0.5 - 0.8
Mounted height (mm)	3.5	4	4 - 6	5	3.8	3.8	3.8	3.8	3.8	1.5 - 2	1 - 2	1.6 - 1.9	1.6 - 3.0	0.6 - 1.0	0.5 - 1.5
Inductance (nH)	6 - 10	1 - 10	5 - 10	3 - 8	8 - 10	8 - 12	4 - 10	4 - 12	8 - 12	4 - 8	3 - 10	3 - 11	3 - 8	<1	<3
Capacitance (pF)	7 - 10	10	1 - 2	7 - 10	1 - 2	7 - 10	1 - 2	1 - 2	1 - 2	1 - 2	1 - 2	1	5 - 8	<1	<1
SSO performance	3	1	2	1	2	2 - 3	2	2	3	3	3	2	1	1	2
High Frequency performance <sup>a</sup>	4	3	3	1	2	3	2	2	3	3	2	2	2	1	2
Still-air thermal perf. (°C/W)	25 - 35	12 - 16	25 - 50	14 - 23	45 - 70	25 - 35	16 - 23	16 - 23	38 - 45	38 - 45	30 - 50	23 - 30	20 - 25	15 - 30	15 - 30
300 LFM thermal perf. (°C/W)	15 - 24	4 - 9	20 - 40	12 - 15	38 - 48	18 - 24	13 - 18	15 - 18	28 - 38	28 - 38	20 - 35	15 - 18	12 - 18	10 - 18	10 - 18
Conductive thermal performance <sup>b</sup>	2	1	3	2	4	3	2	2	4	4	1 - 3	2	1 - 2	1	1 - 2
Manufacturability <sup>c</sup>	1	1	1	4	2	2 - 3	2 - 3	2	2 - 3	4	3 - 4	4	4 - 5	4 - 5	3
Board Testability <sup>d</sup>	1	1	1	3	2	3	3	3	3	3	4	3	3	4	3
Repairability <sup>e</sup>	2	2	2	1	1	1 - 2	1 - 2	1 - 2	1 - 2	1 - 2	2 - 3	1	1	3	3
Maturity <sup>f</sup>	M	M	M	L	M	S	S	S	S	G	L	N	N	L	S
Use <sup>g</sup>	W,M	W,M	W,I	W	W,C,I,T	M,W	W,T	W,T	C,W	C,W	C,M	C,W,T	M,W,T	W,M	C,W
Production Volume <sup>h</sup>	M	L	M	VL	VH	L	L	L	M	H	L/M	H	L	L	H

a. 1=Superior, highest performance applications, 2=Good, 3=OK, but limited, 4=Not Suitable in average situation

b. 1= $<4^\circ\text{C/w}$ , 2= $<8^\circ\text{C/w}$ , 3= $<16^\circ\text{C/w}$ , 4= $<24^\circ\text{C/w}$ , 5= $<32^\circ\text{C/w}$

c. 1=Well understood mature process, 2=Process mature 3=Process widely known, 4=Process in adoption, 5=Process in development

d. 1=Probe and/or Socket testable, 2=Probe testing only, 3=limited probe test on select pins or testpoints, 4=pins/contacts not accessible, testpoint only

e. 1=Easily removed and replaced, 2=Difficult Removal and Replacement, 3=Impractical repairability

f. M=Mature, S=Standard, G=General Adoption, L=Limited, N=New Technology, Lab Environment

g. C=Consumer, W=Workstation/Computer, I=Industrial, M=Military, T=Telecommunications

h. VL=Very Low(Prototyping/Engr. Lab  $<1\text{K/yr}$ ), L=Low( $<10\text{K/yr}$ ), M=Medium( $<100\text{K/yr}$ ), H=High( $<1\text{M/yr}$ ), VH=Very High( $>1$ )

TAKE THE TI/EDN DSP  
PRODUCT DESIGN CHALLENGE!

GRAND  
PRIZE!

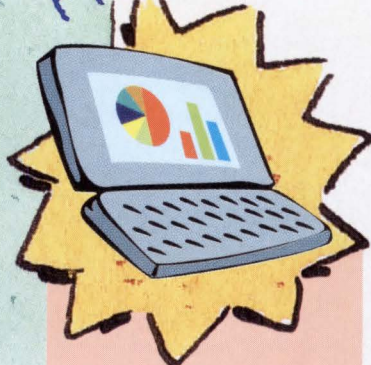

A Texas  
Instruments  
Color 486  
Notebook  
Computer!  
(See Details Inside.)

JOIN FORCES  
WITH  
TEXAS  
INSTRUMENTS  
TO BEAT YOUR  
COMPETITION!

ACME  
ENGINEERING

Play to Win...



# ACME ENGINEERING COMPANY

## TYPICAL PRODUCT DEVELOPMENT CYCLE

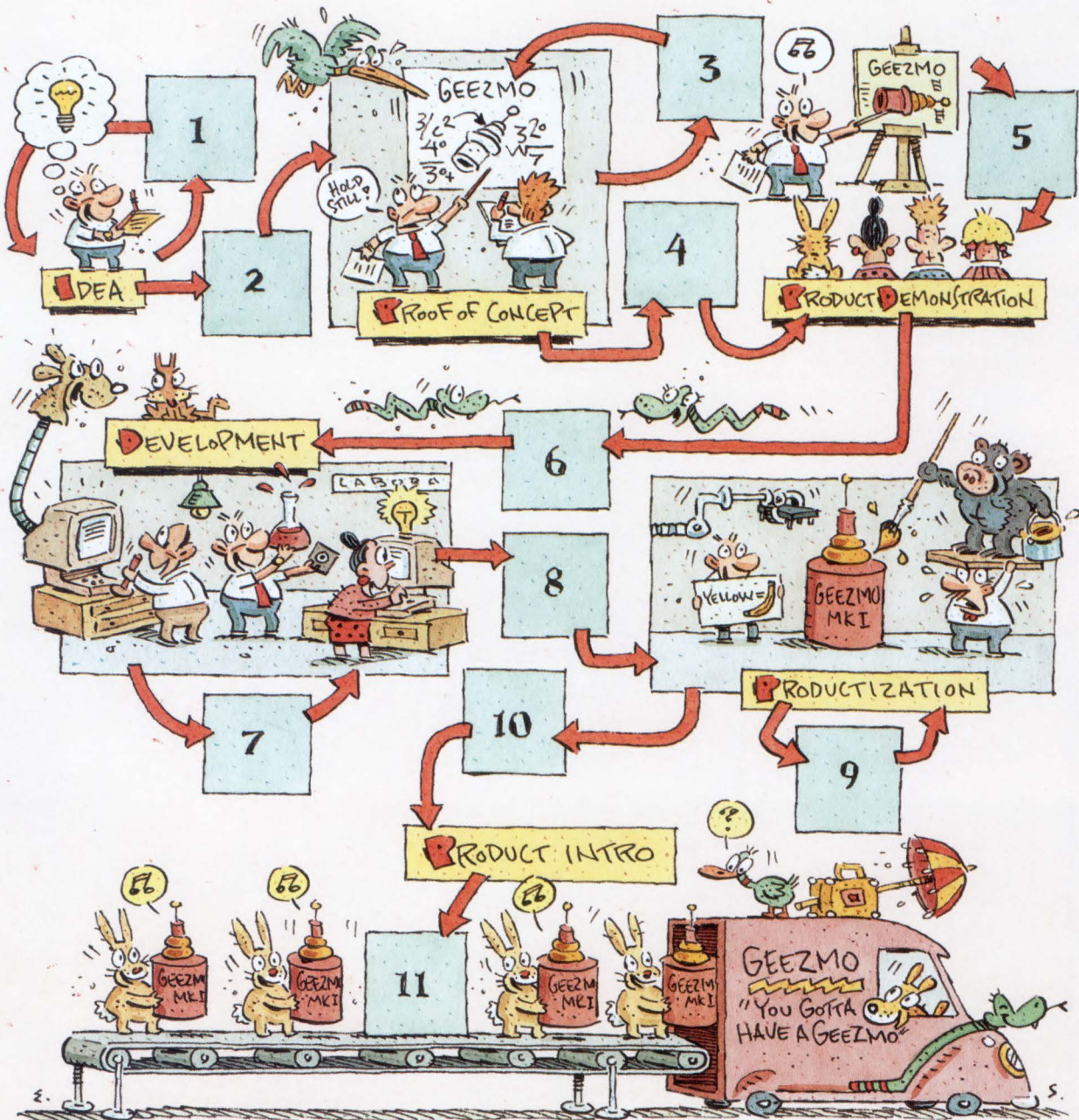

### OFFICIAL ENTRY BLANK:

Name \_\_\_\_\_ Title \_\_\_\_\_  
 Company \_\_\_\_\_ Phone \_\_\_\_\_  
 Address \_\_\_\_\_  
 City \_\_\_\_\_ State \_\_\_\_\_ Zip \_\_\_\_\_ Country \_\_\_\_\_

For contest rules, see back page of this supplement. Entries must be received by March 31, 1994.  
 Send entries to: TI/EDN DSP Product Design Challenge, Texas Instruments Incorporated,  
 P.O. Box 172228, Denver, CO, U.S.A. 80217-9270

Please check if you do not wish to receive future mailings from Texas Instruments as a result of this contest. SPR993ED402R

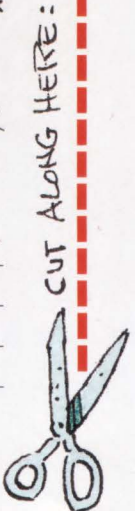

Overwhelmed by DSP product design problems?  
Then team up with TI as you  
**BEAT YOUR COMPETITION**  
through Total Integration!

READ AHEAD AND PLAY TO WIN!

**Y**ou're the Chief Design Engineer at Acme Manufacturing Company and you've just come up with a really revolutionary idea for a remarkable new DSP-based widget. Studying your design plan, you realize that this isn't a job for novices. You need the extensive DSP product design experience that only Texas Instruments can deliver through its Total Integration program.

To help you blaze the Product Design trail, the TI Design Team has created a Product Development Cycle puzzle. So, join the fun and play along, by cutting out and filling in the missing pieces on the game board on page 2, using clues spread throughout the text. Then send in your design to qualify for the grand prize.

In completing the puzzle, you'll learn how working with TI, you can create a winning product every time!

### READY, SET, GO!

To beat your competition to market you need a well marked path that leads you from your idea to the finished product. You realize that you must get some technical advice immediately to get this project rolling. You can call in a **consultant** to help you develop your idea, or you can call the Texas Instruments **hotline** at (713) 274-2320 and speak with an expert in DSP. Or fax your question to (713) 274-2324 in the U.S.

or 33 1 30701032 in Europe.

So, beat your competition out of the starting block by making the best choice! Find the game piece that corresponds, and paste the piece at **Position 1** on the game board.

### TEST THE IDEA

Talking to the technical advisor was a great help, but you'll have to pick up the pace if you want to stay in front of the competition. As you zip along the path that transforms your general idea into a distinct concept, you know that you don't want to get bogged down learning how to use new evaluation tools. TI's U.S.\$99 **DSP Starter Kit (DSK)** is perfect for the first-time evaluator. The DSK is a card that connects to your PC. It comes with its own DSK assembler, debugger, onboard DSP and several example programs.

On the other hand, your design may require more extensive evaluation. In that case, consider using TMS320 **Evaluation Modules (EVMs)** for device evaluation, benchmarking and limited system debugging. An EVM is a half-size PC card that lets you benchmark and evaluate DSP code in real time for less than U.S.\$1000.

So you've reached another decision point. Pick the proper piece and stick it on the game board at **Position 2**. Your competition doesn't have a chance if you keep making such smart decisions!



## PUZZLE PIECES

If you need technically superior DSP advice, the TMS320 hotline is staffed with TI application experts.



The TMS320 hotline offers applications assistance to answer your questions about development tools, documentation and upgrade options.



To reach one of TI's DSP application experts, simply call (713) 274-2320. (In Asia, contact your local sales office.)



The TMS320 Technical Hotline can also be reached by sending a fax to (713) 274-2324 or 33 1 30701032 in Europe.



Need a helping hand? Get a third party to build a TMS320-based add-in board for your system..



You don't have to tackle this project alone. Third parties offer TI DSP-based products for an array of general and specialized hardware solutions.



TMS320 Evaluation Modules (EVMs) are low-cost development systems that you can use for evaluating devices, benchmarking your design and performing limited system debugging.



For less than U.S.\$1000, the EVM lets you single-step through your software to locate breakpoints and debug your code. You can upload and download from your host computer or access trigger data and provide control signals.



## PUZZLE PIECES



The TMS320 Bulletin Board Service (BBS) gives you on-line access to the most current DSP technical and application information. All you need is your computer and a modem.



Go on-line with TI to update your computer files with the latest DSP application information and source code or to exchange ideas and solutions with other TMS320 application designers. Just call (713) 274-2323 or 44 2 34223248 in Europe.



DSP consultants offer design services for the TMS320 family that will cut your development time and speed your product to market.



Independent DSP consultants can provide expertise in specialized design areas such as speech encoding, vector quantization and system analysis.



DSP consultants can make your design an anxiety-free process if they have the expertise your design team lacks.



Don't re-invent the wheel! Cut your development time to the minimum by tapping the design savvy of an independent DSP consultant.



If you are a first-time TMS320 evaluator, the DSP Starter Kit (DSK) is a PC board that includes everything you need to test and benchmark your application. This kit makes it simple to develop code on your PC and download it to the DSK for execution.



This kit comes with its own DSK assembler, debugger and several example programs. You can even build daughter boards that plug into the DSK, because the board routes all device signals to easily accessible headers.

# Total Integration™ clears your

## PICK A CHIP

**A**s you begin to use the tool you selected, you start to consider the assortment of DSP chips you can use to execute your design. TI offers a family of DSPs that feature more than thirty 16- and 32-bit devices. Based on an advanced Harvard architecture, TMS320 DSPs maximize system performance by executing multiple operations per machine cycle. And internal parallelism supports an instruction set that contains DSP-specific commands. So a single instruction—such as a multiply/accumulate/data move—can cause several operations to execute simultaneously. The competition will never catch you once you've tapped into that kind of computational power.

TI offers five generations of 16-bit fixed-point and 32-bit floating-point DSPs for a wide variety of price/performance points. With volume prices for 16-bit chips starting as low as U.S.\$3, you can get an edge on the competition if price is a major marketing factor. Then again, your product can command a solid performance advantage if you opt for the 275 MOPS/50 MFLOPS speed of a floating point processor. On the other hand, a low-power 3-volt fixed-point DSP would be a perfect choice for a battery operated design. Or maybe you want to optimize your design with a customizable DSP (cDSP) from TI, allowing you to integrate a DSP core with other components in a single chip.

Considering the options and benefits, you pick your **DSP fixed-point or floating-point engine**. Select the piece that

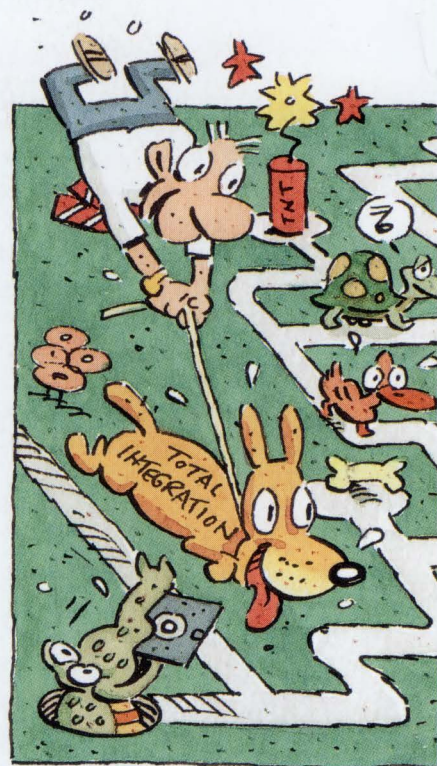

corresponds to this decision, and glue it to the game board at **Position 3**. You smile smugly as you imagine the competition choking on your dust as you blaze a trail to corporate glory!

You leave your office—congratulating yourself along the way—and look up to see your boss chomping down the hall. Running to catch up, you tell her your general idea in order to get some feedback. She thinks you have a great idea, but you need to prove that the concept will work. And she wants to schedule a product demo... immediately.

## SO PROVE IT!

Don't panic! Just assemble your technical team. You call a meeting of your best engineers and tell them about your idea. Your excitement is contagious and soon you've accumulated the





# way through the design maze

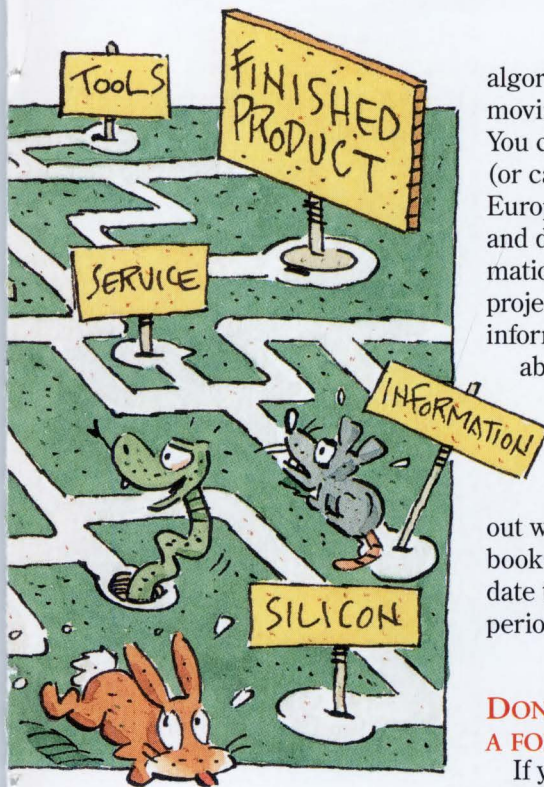

algorithms to get your team moving in the right direction. You can call (713) 274-2323 (or call +44 2 34223248 in Europe) to access the BBS and download application information and source code for the project. Maybe you can exchange information with other BBS users about the host of third-party products that are available for TI's DSP family.

And you may have to get some advice to figure out which user's guides and textbooks will let your people validate the concept in the shortest period of time.

## DON'T GET LOST IN A FOREST OF INFORMATION.

If you need them, the experts at TI can help you narrow your options. Weigh the benefits of each service and make your decision by pasting the proper piece onto the game board just after the proof of concept at **Position 4**. You begin to consider how nice the title Vice President will look on your business cards.

But just as you place the game piece on the board, your telephone rings. It's your boss, but she's not offering you a promotion. She suspects that the company's arch rival is working on a similar design concept. To make sure that your product is the first (and the best) on the market, you're going to have to pick up your pace and verify every development step.

*The race is on!*

suggestions and observations you needed to make the product demo happen within your boss' timetable. You can practically hear your competitors quaking in their boots.

But, you realize that you may need to schedule some training for your team by the experts at TI. You can call (800) 336-5236, x3904 (or fax 49 81 61804010 in Europe) to find out when the next hands-on DSP training workshop will be held. Or perhaps you should call in a **consultant**. After all, more than 100 third-party vendors and DSP consultants offer expertise in areas ranging from speech encoding to vector quantization to system analysis.

Then again, TI's **bulletin board (BBS)** can provide some down-loadable software

## PUZZLE PIECES

For as little as U.S.\$3 you can plug the power of a fixed-point 16-bit DSP into the heart of your system. Reach maximum speeds with device cycle-times as fast as 25 ns for 40 MIPS operation. Or choose a 3-volt version for battery-powered applications.



If an off-the-shelf DSP doesn't provide the level of integration your application demands, our customizable DSPs let you reduce power consumption, board space and system cost while maximizing performance.



If your design team prefers the ease of programming and code portability offered by a high-level language such as C or Ada, select compilers and programming tools to optimize your code and simplify your software development task.



TI offers a library of software algorithms that cover a wide range of DSP functions, including speech recognition, modems, image coders and audio coders.



TI offers a Custom Manufacturing Service to meet your manufacturing needs when your in-house capability can't meet the volume-production capacity that your hot new product will require.



By eliminating the need for dedicated microprocessors, TMS320 DSPs offer the telecom designer inherent system flexibility, increased channel capacity and lower system costs.



TMS320 floating-point DSPs are designed for multiprocessing at a 320 MBPS interprocessor data-transfer rate. This kind of processing power gives your imaging and graphics-intensive computer applications state-of-the-art throughput.

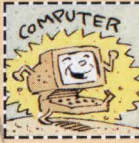

When cost-sensitivity is a major design constraint, you can turn to the TMS320 fixed-point DSPs to give you the power for speech I/O, digital recording, and sophisticated control functions for as little as U.S.\$3.



## PUZZLE PIECES



When processing power is critical to your application's success, select a 32-bit floating point DSP. Single-chip performance can reach 275 MOPS and 50 MFLOPS, great for applications such as real-time control and multi-media.



With five generations of 16-bit fixed-point and 32-bit floating-point DSPs available, you're sure to find a device that meets the price/performance needs of almost every application.



Want to make sure that your code is as compact and efficient as possible? Turn to the TMS320 macro assembler/linker for hex conversion, error diagnostics, and memory configuration control.



TI offers many design centers worldwide with expertise in DSP system design to keep you a step ahead of the other guys.

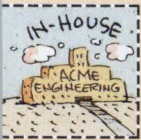

If your manufacturing capabilities are sufficient for volume production, remember to get your manufacturing and production people involved in the design process at an early stage to avoid potential problems.



Need to perform numerical or robotic control? How about security access or power-line monitoring? TMS320 DSPs provide the speed for real-time control that meets industrial requirements.



The TMS320 DSPs are available in military versions, and an Ada compiler provides support for designing your military applications.



When you require closed-loop control, turn to the TMS320 family of DSPs. They will provide the processing power you need for power-train management, body and chassis control, antitheft security and vibration reduction.

# The other guys never had a chance...

**BRING IN THE SUITS**  
**Y**our team has been working feverishly to come up with a product demonstration for the marketing and production folks. The big day arrives and as you unveil your brainchild, the department heads cheer! Marketing

or **DSK** to keep your DSP development entirely in-house. Well, you have a lot to choose from, so pick your playing piece and place it on the game board at **Position 5**.

As you rise to leave the room, your boss pulls you aside. She hasn't been able



assures you that this will be the hottest product the company has ever produced—if you can do it while meeting the cost goals they've established. Production observes that the only way to meet that cost is to keep the design as simple and uncluttered as possible.

You may need some help along the way as you fine-tune your product. You can turn to one of TI's many **design centers** for ideas so that you can turn your new baby into a lean, mean DSP machine. Or you can select a **third-party developer** that has a board you can use in your system to save time. Then again, you can always use an **EVM**

to find out the status of the competition's design, but she knows that they're trying to rely solely on in-house expertise. You smile as you consider the world-class team of experts and advisors you've assembled through TI's Total Integration concept. Which expert will you consult with next? The **hotline**, **BBS**, a **third party developer**, a **consultant**, or a **TI design center**? Make your choice and place the playing piece on the game board at **Position 6**. Nope, the competition doesn't have a chance!

## TI SPEAKS YOUR LANGUAGE

You need to decide whether to program your DSP using



**assembly code** or a **high-level language (HLL)** such as C. If you need to keep the coding as compact as possible, the PC-based TMS320 macro assembler/linker converts TMS320 assembly language source code into executable machine code. On the other hand, you may prefer to program in C to maximize code portability. The TMS320 C compilers perform local and global optimizations that improve code efficiency.

You weigh your options, keeping in mind that the competition has to make the same choice. Choose the appropriate game piece and stick it on the design path at **Position 7**.

#### PICK THE BEST PARTS

Next you need to select the system components. When it comes to ICs, TI can supply your design team with the memory, logic and linear chips it needs to build a working prototype of the product. Then your team can clean up any loose ends by using an **Evaluation Module**, obtaining an XDS510 in-circuit emulator, or getting a **third party development tool**. Pick the game piece that meets your needs and paste it at **Position 8**.

#### BUILD IT TO GO

It's finally time to fine-tune the prototype into a manufacturable product. Manufacturing and Quality Assurance become more involved at this step to ensure that the items will roll efficiently off the production line. Marketing and Production make sure that the criteria they established at the product demonstration are still valid. Now that the product is a reality, you can

decide whether your usage volume will allow you to use a customizable version or a standard DSP.

With ASIC-like ease, you can turn your design into a custom chip and speed your way to market dominance with increased performance. TI's **customizable DSP (cDSP)** capability lets you tuck a board full of components into a single chip. Combine a TMS320 DSP core with RAM and ROM modules, peripherals, analog, and ASIC logic to reduce your board space, power dissipation, system noise, and overall cost while increasing reliability and performance levels.

On the other hand, a **standard DSP** may better suit your needs. Regardless of your choice, you know that TI's products and Total Integration savvy can help you make your design the best it can be to keep you ahead of the competition. Make your decision and stick the game piece at **Position 9**.

#### ONE MORE CHOICE...

Your final decision is where to manufacture your product. You can build it **in-house** if you have enough production capability. However, TI also offers **custom manufacturing** services that can accommodate your needs. Pick your game piece and complete the product-development path at **Position 10**.

#### TA-DA!

Now you're ready to introduce your product and show it off to the whole world. So tell us...what kind of product is it?

## PRIZES!

### WIN A TI/EDN DSP PRODUCT DESIGN T-SHIRT!



Complete the puzzle and mail your entry to get your very own DSP Product Design Challenge shirt. It's stylish, it's comfortable, and it will let everyone know that you're a savvy engineer who knows the benefits of TI's Total Integration.

### GRAND PRIZE: TEXAS INSTRUMENTS TRAVELMATE COLOR NOTEBOOK COMPUTER



One lucky DSP product designer will win the ultimate blend of 486 power, portability, and color.

Enter today, because YOU may be the winner of a TI TravelMate 4000E WinDX2/50 Active Matrix Color Notebook computer!  
*(See contest rules for details.)*

Find the game piece that reflects the market your product will address: **automotive, military, consumer electronics, computers, communications, or industrial**. Paste that piece in the product box at **Position 11** and prepare to enjoy the fruits of your labor! You succeeded in beating the competition, achieving corporate hero status and creating a wildly successful product because TI's Total Integration capabilities helped you develop your Terrific Idea!



## SALES OFFICES

**ALABAMA**  
Huntsville  
(205) 430-0473

**ARIZONA**  
Phoenix  
(602) 224-7800

**CALIFORNIA**  
Irvine  
(714) 660-1200  
San Diego  
(619) 278-9600  
San Jose  
(408) 894-9000  
Woodland Hills  
(818) 704-8100

**COLORADO**  
Aurora  
(303) 368-8000

**CONNECTICUT**  
Wallingford  
(203) 269-0074

**FLORIDA**  
Altamonte Springs  
(407) 260-2116  
Ft. Lauderdale  
(305) 973-8502  
Tampa  
(813) 885-7411

**GEORGIA**  
Norcross  
(404) 662-7900

**ILLINOIS**  
Arlington Heights  
(708) 640-2925

**INDIANA**  
Carmel  
(317) 573-6400  
Ft. Wayne  
(219) 482-3311

**IOWA**  
Cedar Rapids  
(319) 395-9550

**KANSAS**  
Overland Park  
(913) 451-4511

**MARYLAND**  
Columbia  
(301) 964-2003

**MASSACHUSETTS**  
Waltham  
(617) 895-9100

**MICHIGAN**  
Farmington Hills  
(313) 553-1500  
Grand Rapids  
(616) 957-4200

**MINNESOTA**  
Eden Prairie  
(612) 828-9300

**MISSOURI**  
St. Louis  
(314) 994-2131

**NEW JERSEY**  
Iselin  
(201) 750-1050

**NEW MEXICO**  
Albuquerque  
(505) 291-0495

**NEW YORK**  
East Syracuse  
(315) 463-9291  
Fishkill  
(914) 897-2900  
Melville  
(516) 454-6600  
Pittsford  
(716) 385-6770

**NORTH CAROLINA**  
Charlotte  
(704) 527-0930  
Raleigh  
(919) 876-2725

**OHIO**  
Beachwood  
(216) 464-6100  
Beavercreek  
(513) 427-6200

**OREGON**  
Beaverton  
(503) 643-6758

**PENNSYLVANIA**  
Blue Bell  
(215) 825-9500

**PUERTO RICO**  
Hato Rey  
(809) 753-8700

**UTAH**  
Salt Lake City  
(801) 466-8972

**WASHINGTON**  
Redmond  
(206) 881-3080

**WISCONSIN**  
Waukesha  
(414) 798-1001

**CANADA**  
Nepean  
(613) 726-1970  
Richmond Hill  
(416) 884-9181  
St. Laurent  
(514) 335-8392

**ARGENTINA**  
Buenos Aires  
541/ 748-3699

**AUSTRALIA**  
Melbourne  
8 255-2066  
Sydney  
2 887-1122

**BELGIUM**  
Brussels  
(02) 242 30 80

**BRAZIL**  
Sao Paulo  
11-535-5133

**DENMARK**  
Ballerup  
(44) 68 74 00

**FINLAND**  
Espoo  
(0) 802-6517

**FRANCE**  
Velizy-Villacoublay  
(1) 30 70 1003  
Cedex

**GERMANY**  
Freising  
(49) 8161 80-0

**PUERTO RICO**  
Hannover  
(49) 511 904960  
Ostfildern  
(49) 711 34 030

**HOLLAND**  
Amsterdam  
(31) 20 545 0600

**HONG KONG**  
Kowloon  
(81) 977 721111

**HUNGARY**  
Budapest  
(36) 1 269 8310

**IRELAND**  
Dublin  
(353) 1 781677

**ITALY**  
Agrate Brianza  
(39) 39 63221  
Roma  
(39) 6 6512651

**JAPAN**  
Tokyo - Kita-Aoyama  
Minato-Ku  
(81) 03 498-2111  
Tokyo - Shibaura,  
Minato-Ku  
(81) 03 769-8700

Tokyo - Akebono-cho,  
Tachikawa-shi  
(81) 0425-27-6760

Chuou-ku, Osaka  
(81) 06 204 1881

Nakamura-ku, Nagoya  
(81) 052 583-8691

Kanazawa-shin Ishikawa  
(81) 0762-23-5471

Matsumoto-shi, Nagano  
(81) 0263-33-1060

Yokohama-shi, Kanagawa  
(81) 045-338-1220

Shimogyo-ku, Kyoto  
(81) 075-341-7713  
Kumagaya-shin, Saitama  
(81) 0485-22-2440  
Kitsuki-shi, Oita  
(81) 09786-3-3211

**KOREA**  
Seoul  
2-551-2800

**MALAYSIA**  
Kuala Lumpur  
3 230 6001

**MEXICO**  
Colonia del Valle  
5 639-9740  
5 639-9234

**NORWAY**  
Oslo  
02 155 090

**PEOPLE'S REPUBLIC OF CHINA**  
Beijing  
(86) 1 500 2255

**PHILIPPINES**  
Makati, Manila  
(63) 2 8176031

**PORTUGAL**  
Moreira da Maia  
(351) 2 948 1003

**SINGAPORE (& INDIA, INDONESIA, THAILAND)**  
United Square  
(65) 390 7100

**SPAIN**  
Madrid  
(91) 372 8051  
Barcelona  
(93) 317 91 80

**SWEDEN**  
Kista  
(46) 8 752 5800

**SWITZERLAND**  
Dietikon  
(41) 1 744 2811

**TAIWAN**  
Taipei  
(886-2) 378 6800

**UNITED KINGDOM**  
Bedford  
(44) 0 234 270 111

## RULES

### TEXAS INSTRUMENTS/EDN DSP PRODUCT DESIGN CHALLENGE

1. NO PURCHASE NECESSARY.
2. The sweepstakes is open to any individual who satisfies the following criteria: (i) he/she is at least 18 years of age; (ii) is a resident of the United States, its territories and possessions, or of Canada (excluding residents of the province of Quebec), United Kingdom, France, Germany, and those Asia Pacific countries to which EDN Asia is distributed (excluding Malaysia, New Zealand, The Philippines, and Singapore); and (iii) who completes the "TEXAS INSTRUMENTS/EDN DSP Product Design Challenge" puzzle. Employees (and their immediate families and household members) of Reed Elsevier Inc., Texas Instruments Incorporated, its subsidiaries and affiliates, and McCann Erickson are not eligible.
3. To enter, contestants should complete (i.e. puzzle must be completed in its entirety, in addition to name and address portion of form) the official "TEXAS INSTRUMENTS/EDN DSP Product Design Challenge" entry form. Additional entry forms can be obtained by sending a self-addressed, stamped envelope (no stamp required for residents of Vermont, Washington, and France) to EDN, c/o Cahners Publishing Company, 275 Washington Street, Newton, MA 02158-1630. Entries may be handwritten or typed. Entries must be received by Texas Instruments by March 31, 1994.
4. All entries become the property of TEXAS INSTRUMENTS and will not be acknowledged or returned. EDN and TEXAS INSTRUMENTS, their agents and others working for them or on their behalf, will have the right to photograph the grand prize winner, and entry constitutes permission to use of his/her name, picture, likeness and city and state of residence in advertising for no additional compensation.
5. Only one entry per person will be permitted.
6. All contestants who submit a completed (as defined in paragraph 3 above), official "TEXAS INSTRUMENTS/EDN DSP Product Design Challenge" entry form will receive a gift valued at no less than U.S.\$4.50. Contestants who submit a completed official entry form will also be eligible to participate in a random drawing to qualify for a grand prize of a Texas Instruments Active Matrix Color Notebook computer (Travel Mate 4000E WinDX2/50, value: U.S.\$5,000.00).
7. There will be one random drawing for the grand prize and it will take place under the supervision of Texas Instruments. In order to be eligible for the grand prize in Canada, the qualifier selected by the random drawing must first correctly answer a mathematical skill-testing question to be administered by mail. Participants agree to be bound by these rules and all decisions of the judges, whose decisions on all aspects of this drawing are final. The winner will be notified by mail by May 31, 1994, and may, at EDN's and Texas Instruments sole discretion, be required to execute an affidavit of eligibility and compliance with contest rules and release of liability. Odds of winning will depend on the number of eligible entries received. EDN AND TEXAS INSTRUMENTS MAKE NO WARRANTIES WITH REGARD TO THE PRIZES. Prizes are not transferable. There will be no substitutions for prizes, and prizes are not redeemable for cash value, but Texas Instruments reserves the right to substitute prizes of equal or greater value.
8. EDN and Texas Instruments shall not be responsible for printing errors or for lost, late or misdirected mail. Entries that are printed by machine, mechanically reproduced, mutilated or tampered with, illegible, late or incomplete are not eligible.
9. Grand prize must be claimed by May 31, 1995. Failure to execute and return any requested document within 14 days of receipt, or return of notification or prize as undeliverable may result in forfeiture of prize and an alternate potential winner being selected at the sole discretion of Texas Instruments.
10. Contest rules are governed by U.S. law. The sweepstakes is void where prohibited or restricted by law in the United States and in all foreign countries and is subject to all foreign and United States Federal, State, and Local laws and regulations. All taxes, applicable customs duties, including import/export regulations, and other obligations on grand prize are solely the responsibility of the winners. The grand prize is subject to reporting for tax purposes.
11. To learn name of grand prize winner, send a self-addressed postage-paid envelope by May 31, 1995 to "TI/EDN DSP Product Design Challenge," Cahners Publishing Company, 275 Washington Street, Newton, MA 02158-1630, U.S.A.

 **TEXAS INSTRUMENTS**

**EDN**

# Top Choices.

Fluke meters are your top choice for accuracy, reliability, and performance. They offer

more combinations of features and functions than any other meters on the

Fluke 97  
ScopeMeter®

market. Features like true-rms measurements, high resolution,

Smoothing™ and Peak Hold. Or simultaneous scope and meter

functions in one portable package. Whichever Fluke meter

you choose you can count

on benchtop accuracy,

test lab versatility, and

handheld convenience.

Plus, Fluke keeps you

covered with a full line of quality

accessories, strong customer support,

and product warranties that measure up

to any in the industry. When it's up to you to get the job done, look to

Fluke for the choices you need to get it done right. See your

Fluke distributor, or call **1-800-87-FLUKE**

8060A

for a catalog and the name of the

distributor nearest you.

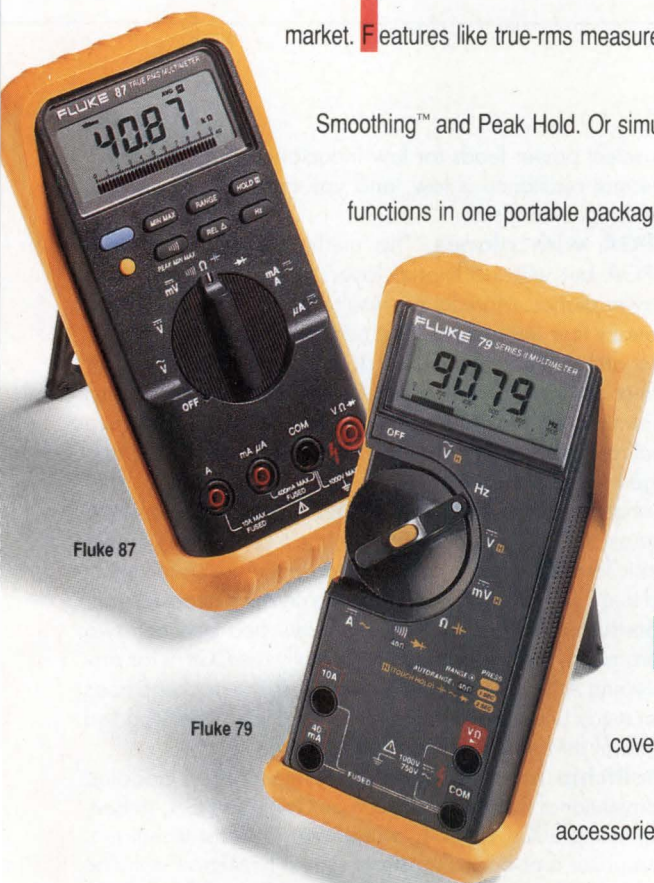

Fluke 87

Fluke 79

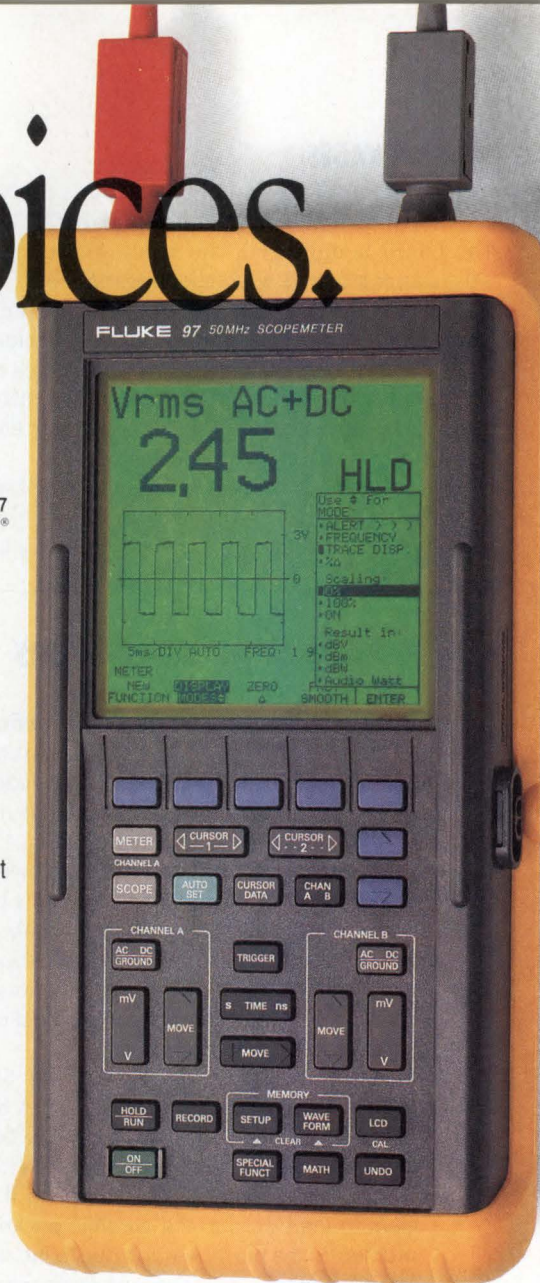

## FLUKE 79 FLUKE 87 8060A FLUKE 97

The Fluke meters listed above feature diode test, auto and manual range, continuity, and frequency measurements.

Lo-Ohms measurements	True-rms	True-rms	True-rms ac, or dc & ac
Capacitance measurements	Capacitance measurements	Resistance measurements to 300 MΩ	Scope, Meter or simultaneous meter and scope display
Smoothing™	Duty Cycle measurements	High-impedance DC voltage function	Dual Trace 50 MHz bandwidth
4000 count display	20,000 count high resolution display	20,000 count display	40 nanosecond glitch capture
Basic accuracy 0.3%	Offset/Relative reference	Offset/Relative reference	Store waveforms and setups
	1 millisecond Peak Hold	dB measurements	dBm, dBV, dB Relative and Audio Watt calculations
	Basic accuracy 0.1%	Basic accuracy 0.04%	Basic accuracy 0.5%

John Fluke Mfg. Co., Inc.  
P. O. Box 9090, Everett, WA 98206  
For more information call:  
(416) 890-7600 from Canada  
(206) 356-5500 from other countries

© Copyright 1992 John Fluke Mfg. Co. Inc. All rights reserved.  
Ad No. 00282

**FLUKE**®  
CIRCLE NO. 73



## ASIC PACKAGES

repair, and, if the component is a difficult to remove and the board is damaged, the accumulated costs can be substantial compared with the original costs of the package.

Electrical performance is just as important as a package's manufacturability. Although most new-package development focuses on density, electrical characteristics remain the most important consideration. The most efficiently designed host board cannot overcome a package's poor electrical characteristics.

Capacitance, particularly interlead capacitance, couples signals from one lead to another, and, thus, unwanted signals can appear on adjacent pins. The high-frequency content of

high-edge-rate signals in high-performance systems couples more readily than that of slower or controlled edge rates. Design techniques that reduce lead-to-lead capacitance are helpful. Using ground planes to reduce capacitance is effective but costly. You can isolate sensitive input signals by grounding adjacent pins.

Capacitance on power leads is desirable because it maintains constant voltage. However, increasing capacitance adds cost. It is most practical to add capacitors only to those applications that are insensitive to cost.

Inductance is typically not a problem on signal leads of low-cost packages at frequencies lower than several hundred

## Glossary of package types

- **Controlled-collapse chip connection (C-4):** Similar to the plastic ball-grid array's (PBGA's) solder-ball method but at a microscopic level, the C-4 includes balls or bumps that attach to the IC, mating to a matching grid of pads on the substrate. A complex process, C-4 requires relatively expensive substrates yet has lower RLC properties than those of any other package. C-4's balls can connect anywhere on an IC requiring a connection, resulting in very efficient power connections and optimum signal isolation and skew management. Although not in widespread use, this approach can also act as a substitute for wire bonding within a package.
- **Ceramic ball-grid array (CBGA):** Similar to a PBGA but with a ceramic substrate, a CBGA has no pins, so it offers lower cost than that of pin-grid array (PGA). One significant drawback of large CBGAs is the need to reduce shear stress on the balls by matching the thermal coefficient of the board to the ceramic package. This is not a problem in the plastic version due to the relatively small difference between most common pc-board materials and the BT resin/glass substrate of the package.
- **Chip on board (COB):** This method mounts an IC directly on a pc board, a reasonable approach for extremely low-cost assembly, such as that used in consumer-game applications. An epoxy glob protects chip and wire bonds, which is adequate for this type of application. This technique does not suit high-reliability commercial systems.
- **Ceramic pin-grid array (CPGA):** This package is popular because it offers low thermal resistance and a well-understood manufacturing process. The process involves attaching gold-plated pins to an alumina substrate in a regular pattern on the bottom surface of the package. Several conductor layers, usually tungsten, connect pins to gold-plated, wire-bond fingers. Aluminum wire bonds connect to the die, which is bonded into a gold-plated depression in the substrate. Cost depends primarily on the size of the substrate area and the number of interconnect layers. The high dielectric constant of the ceramic substrate results in a relatively large capacitance at each pin; inductance varies widely from pin to pin, depending on the routing of the interconnect. You need to select power leads for low inductance. The package's thermal resistance is low, and you can further reduce it by using a heat sink.
- **CPGA with planes:** This method is the same as a CPGA but with additional layers dedicated to multiple power planes. More layers result in higher cost but exceptionally low inductance. The addition of a metal slug for die attachment in a cavity-down configuration further enhances thermal resistance. A top-mounted slug can also directly attach to a heat sink for the lowest possible thermal resistance. This is the most expensive single-chip package in commercial use.
- **Ceramic quad flatpack (CQFP):** A ceramic cousin to the plastic quad flatpack (PQFP), the CQFP comes in two basic forms: the side-braze-lead version, more closely related to a PGA in construction, and the ceramic-quad version, constructed with a lead frame sandwiched between two ceramic layers. Manufacturers typically use CQFPs for prototyping ASICs; because of its high cost, the package does not enjoy wide use in commercial products. It offers good thermal performance.
- **Multichip module (MCM):** Designers have adapted conventional form factors, such as QFP and PGA, to handle multiple ICs. MCM-L, a relatively low-cost technique, comprises a pc-board substrate similar to Micro Cool. The technique involves wire bonding the ICs with gold wires and encapsulating them with epoxy like a PQFP. Cost is typically slightly higher than the cost of the sum of the plastic parts; however, the lower space requirements and the superior electrical performance of the MCM-Ls justify their expense. For even better thermal and electrical performance, the MCM-D, with a ceramic substrate, is available at much higher cost.
- **Micro Cool quad flatpack (Micro Cool QFP):** This package has the same form-factor as that of a PQFP but with the die mounted on a metal slug surrounded by a pc-board substrate with an integral lead frame. The IC connects to a lead frame with gold wire bonds and is encapsulated using a PQFP mold. The package offers better thermal performance than that of a PQFP, very good electrical performance, and lower capacitance and inductance than a PQFP. The package cost is higher than

megahertz, yet it can be devastating on power leads on all packages, even at relatively low frequencies. Switching outputs generate voltage spikes proportional to the rate of change in current. Load capacitance, rather than resistance, presents a heavy load during the initial change of a signal level, and only the drive transistor's low-source impedance limits current. Several outputs switching simultaneously need a current that may cause spikes of several volts at the bond pads of power leads for those drive transistors. The spikes raise the ground or drop the supply level, resulting in signal-level shifts on all pins sharing power and ground leads.

Paralleling several power pins, especially on the ground

side, is a reasonably inexpensive method of reducing power-lead inductance. ASIC designers have developed a healthy respect for manufacturers' power and ground rules, which may call for dedicating 20 to 30% of the leads to power and distributing them evenly around a chip that's carefully chosen for minimum inductance.

Another way to address both capacitance and inductance problems is to use power planes. Grouping several wire bonds to a common broad-package bond post and having a few package pins share the group can be effective in lowering inductance. The most effective solution is to place several parallel and contiguous planes close to each other, providing large

that of a PQFP and lower than that of a PGA. The package's construction allows designers to add power planes to larger sizes.

- **Metal quad flatpack (MQFP):** Similar to the CQFP, the MQFP has anodized aluminum instead of ceramic forming the sandwich. The package offers lower cost than that of a CQFP, very good thermal characteristics, lower lead capacitance than that of a PQFP, and similar inductance to that of a PQFP.
- **Plastic ball-grid array (PBGA):** This new surface-mounting technique uses a thin pc-board substrate, conventional wire-bond die attachment, and epoxy encapsulation on the top surface. PBGAs look like a PGA without pins; the key difference is that a PBGA substitutes the pins with tiny solder balls that collapse during conventional reflow processing. Pin density compares with that of a PGA, yet cost is more in line with that of QFP. The board assembly yield is dramatically better than that of a QFP, especially a fine-pitch QFP. Motorola offers this technology for ASICs under the name Over Molded Pad Array Carrier (OMPAC).
- **Plastic pin-grid array (PPGA):** This package is a PGA in which a multilayer pc board replaces the ceramic substrate of the PGA. The IC is wire-bonded with gold leads and encapsulated in epoxy. Some configurations have a metal lid. This offers a much lower cost than, lower lead capacitance than, and comparable inductance to the CPGA. Adding power planes adds cost. The device also comes in a cavity-down, heat-slug version to achieve high power dissipation but also at much higher cost than that of the basic configuration.
- **Quad flatpack (QFP)/plastic QFP (PQFP):** Ubiquitous in its molded-plastic form, this package offers a low cost per pin for 120 to 208 leads. The EIA JEDEC-metric form factor dominates ASICs in these packages. The package typically dissipates 1W using low airflow. It also offers relatively low lead capacitance; however, because the package uses corner leads, inductance is a problem, especially in larger sizes.
- **Surface-mounted PGA (SMPGA):** This package is the same as a conventional PGA, except that the leads are very short and are soldered onto pads without a through-hole.

It allows much higher pin density for the same area as a PGA; 400 pins fit into 1 square in. The cost of the package is roughly the same as that of a same-area PGA. Solder joints are a concern, although manufacturing is compatible with that of other surface-mount packages.

- **Tape-automated bonding (TAB):** These packages offer the highest density lead frame and are similar in footprint to that of the QFP. TAB packages are composed of layers of copper and polyamide film. A TAB package's lead frame attaches to an IC via bumps of solder or gold on the pads. The package attaches to a pc board via hot-bar reflow. A thin epoxy coating protects the IC interconnection. TAB's cost is not very high for the pin density, but manufacturing costs are higher than those of any other package type, a significant barrier to use. The die-to-board interface drives TAB's thermal characteristics; compared with a QFP, TAB's capacitance is low, and inductance is comparable. A variation is to mount the IC flipped-over, bringing the TAB leads directly down to the pc board with little or no fan-out. This mounting results in the lowest possible inductance and capacitance of any "packaged" IC but places a further burden on the manufacturing process, making the lead pitch extremely tight.
- **Thin quad flatpack (TQFP):** These fine-pitch parts offering radically lower height than that of other packages suit applications in portable and handheld products and disk drives with low-height restrictions. TQFPs' body sizes are smaller than those of QFPs, and capacitance and inductance are also lower. However, thermal resistance is significantly higher in TQFPs than in QFPs. Construction is basically the same as that of the QFP.
- **Very fine-pitch PQFP (VQFP):** This package has a 0.5-mm or less lead pitch and a body size the same as that of a PQFP. The package accommodates up to 304 leads on a 40-mm body. It typically supports 256 I/O signals; power and ground take up the remaining signals. The package proves difficult to assemble when designs are moving up from a PQFP. The package is not significantly different from a PQFP in inductance, capacitance, and thermal resistance at the same body size. Cost is significantly higher than that of a PQFP, especially when including pc-board manufacturing-cost increases.

## ASIC PACKAGES

plane-to-plane capacitance and a low-inductance and -resistance path for power. The high cost of this solution may be the only alternative in high-pin-count packages where paralleling of leads has a detrimental effect because of large-package geometry and poor selection of low-inductance leads.

The thermal characteristics are another vital area to consider when selecting a package. The least expensive plastic packages can handle as much as 1W of dissipation without exceeding an acceptable junction temperature. With the rapid increases in density and clock speed, it is increasingly difficult to keep designs below this level.

A chip's junction temperature changes as the chip flows through a series/parallel combination of thermal resistances between it and its cooler environment. However, there are ways to control these temperature fluctuations. For example, moving air can effectively carry heat from the surface of a package. Increasing the surface area, the velocity, or the density of the air also improves cooling. Unfortunately, the lowest cost systems use natural convection for cooling and must live with the high thermal resistance from the junction to ambient for still air.

Heat sinks are common on bipolar ASIC circuits where dissipation exceeds 5W. Their effectiveness depends on the amount of air that a fan can direct or that convection allows to flow across the heat sink. However, designers of many current CMOS devices have avoided the use of heat sinks, primarily because they offer only 1W or less of power dissipation. However, the high pin count and density of new designs can easily result in 2 to 3W of power dissipation.

You can extend the thermal performance of conventional plastic packages by using a metal heat spreader within the plastic encapsulation. The spreader provides some increase in capability but is not sufficient for many designs requiring dissipation higher than 2W.

From the perspective of the package alone, conduction cooling is more effective than convection for roughly the same price, but it relies on having physical contact with a much more expensive cold plate or other nearby lower temperature surface to encourage heat flow from the package.

Efficient conduction from a package into its surrounding physical structures that have larger surface areas to radiate and convectively transfer heat to the nearby air is quite cost effective but requires a designer to carefully coordinate package selection, board layout, and enclosure design. Inexpensive packages are likely to be the weak link in that chain.

Packages' thermal resistance from junction to ambient ( $\Theta_{JA}$ )—an important reliability concern over the lifetime of a product—ranges from less than 10 to greater than 70°C/W of power dissipated in still air. The PLCC offers 40 to 80°C/W. The common QFP ranges from 40 to 70°C/W. Ceramic pin-grid-array (PGA) packages at 4 to 35°C offer the lowest

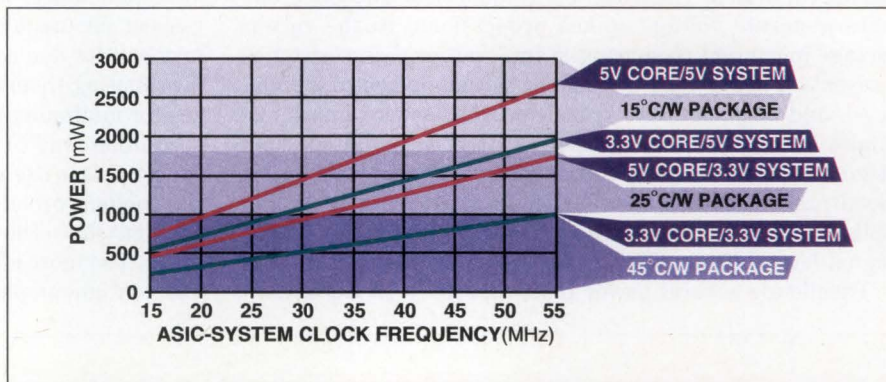

Fig 2—The power dissipation of a 40,000-gate ASIC with 120 signal pins varies with the clock frequency. By using a 3.3 instead of 5V power supply in the core or I/O, you can realize significant power savings, thus letting you use a less expensive package.

thermal resistance from  $\Theta_{JA}$ . Plastic PGAs are 20 to 50°C/W.

Studies show that the more devices and interconnections, the greater the electrical stress and operating voltage, and the higher the junction temperature an IC has, the more likely that IC is to fail. This failure can limit a product's expected life to 3 minutes past the end of the warranty period or two days after Christmas, whichever happens first.

The responsibility of choosing a maximum allowable junction temperature lies with a system's designer. The designer sets a goal for reliability, or the corporate reliability philosophy dictates that goal. The designer then works backward to reach a junction temperature that will provide the necessary reliability. Therefore, asking a supplier: "How much will the package dissipate?" leads to the following series of questions that the designer had to ask when designing the package:

- "What is the ambient temperature and expected air-flow?"
- "What is the approximate dissipation of the circuit?"
- "What is the maximum junction temperature?"

A designer must know or estimate the answers to these questions when doing the initial design and the uncertainty of the combination of the values leads to a wide range of possible required  $\Theta_{JA}$  as much as 3:1 ratio. In the initial design phase, the designer can still adjust partitioning or package type.

Analytical tools for calculating power can help a designer make an accurate decision only if the designer knows all parameters. Accurate ( $\pm 10\%$ ) determination of an ASIC's dissipation is impossible until the circuit netlist is complete and you have a set of test vectors representing the operating-system stimulus. Without detailed information, only experience can lead to a good correlation between estimates and actual results because a system's switching characteristics are unique to the application's operating conditions.

#### Consider mechanical characteristics

Last, designers must consider the mechanical features of a package, which, although not as important as electrical and thermal characteristics, are important to the manufacturability and cost of a system.



# SIMPLE $\mu$ P RESET SIMPLE PRICE

Replace 1 TL7705, 1 Resistor, and 2 Capacitors for Less Cost

Tell Us What Price Quote You Need!

MAX709 versus TL7705  
Comparison

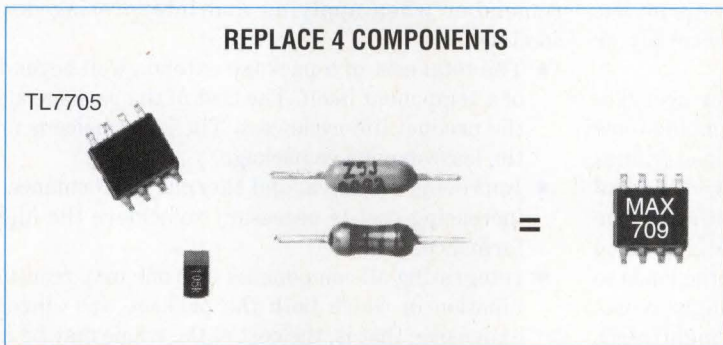

The MAX709 replaces four components, and protects  $\mu$ Ps by asserting a continuous reset when the power fails or is turned off.

- 3V, 3.3V, and 5V Versions
- Guaranteed  $\overline{\text{RESET}}$  Valid to  $V_{CC} = 1V$
- Five Reset Thresholds: 4.65V, 4.40V, 3.08V, 2.93V, 2.63V

Feature	MAXIM	TI
External Components Required	0	3
Operating Supply Current: +5V	65 $\mu$ A	1.8mA
+3V	35 $\mu$ A	1.8mA
Power Supply Glitch Immunity	Yes	No
+5V Reset Threshold Options	2	1
+3V Reset Threshold Options	3	1
Guaranteed Min Reset Delay	Yes	No

## Low-Cost $\mu$ P Supervisors Replace Several Components

Part	Reset Threshold (V)	Manual Reset	Extra Comparator (Power Fail)	Battery Backup Switchover	Watchdog Timer	Active High Reset
MAX703	4.65	✓	✓	✓		
MAX704	4.40	✓	✓	✓		
MAX705	4.65	✓	✓		✓	
MAX706	4.40/3.08/2.93/2.63	✓	✓		✓	
MAX707	4.65	✓	✓			✓
MAX708	4.40/3.08/2.93/2.63	✓	✓			✓
MAX709	4.65/4.40/3.08/2.93/2.63	✓	✓			✓
MAX813L	4.65	✓	✓		✓	✓



**FREE  $\mu$ P Supervisory Design Guide—Sent Within 24 Hours!**  
Includes: Data Sheets and Cards for Free Samples

CALL TOLL FREE 1-800-998-8800  
For a Design Guide or Free Sample

MasterCard<sup>®</sup> and Visa<sup>®</sup> are accepted for Evaluation Kits or small quantity orders.

# MAXIM



Maxim Integrated Products, 120 San Gabriel Drive, Sunnyvale, CA 94086, (408) 737-7600, FAX(408) 737-7194.

Distributed by Arrow, Bell, Digi-Key, Elmo, Hamilton Hallmark, and Nu Horizons. Authorized Maxim Representatives: AL, M-Squared, Inc.; AZ, Techni Source Inc.; CA, Mesa, Pro Associates, Inc.; Infinity Sales, Inc.; CO, Component Sales; CT, Comp Rep Associates; DE, TAI Corporation; FL, Sales Engineering Concepts; GA, M-Squared, Inc.; ID, E.S. Chase; IL, Heartland Technical Marketing Inc.; IN, Technology Marketing Group; IA, JR Sales Engineering, Inc.; KS, Delltron; LA, BP Sales; MD, Micro-Comp, Inc.; MA, Comp Rep Associates; MI, Micro Tech Sales; MN, Mel Foster Technical Sales, Inc.; MS, M-Squared, Inc.; MO, Delltron; MT, E.S. Chase; NE, Delltron; NV (Reno, Tahoe area only) Pro Associates, Inc.; NH, Comp Rep Associates; NJ, Parallax, TAI Corporation; NM, Techni Source Inc.; NY, Parallax, Reagan/Compar; NC, M-Squared, Inc.; OH, Lyons Corporation; OK, BP Sales; OR, E.S. Chase; PA (Pittsburgh area) Lyons Corporation, (Philadelphia area) TAI Corporation; SC, M-Squared, Inc.; TN, M-Squared, Inc.; TX, BP Sales; UT, Luscombe Engineering Co.; VA, Micro-Comp, Inc.; WA, E.S. Chase; WI, Heartland Technical Marketing, Inc.

Distributed in Canada by Arrow. Authorized Maxim Representative in Canada: Tech Trek.

Maxim is a registered trademark of Maxim Integrated Products. © 1993 Maxim Integrated Products

## ASIC PACKAGES

Today's standard surface-mount packages, such as plastic QFPs (PQFPs), provide significant challenges to the manufacturing process when lead count exceeds 160. Most companies reach a threshold of pain when the manufacturing process becomes difficult. This threshold seems to occur at the 0.5-mm, fine-pitch level. A PQFP's geometry requires either a larger body or a tighter lead pitch to increase pin count. A 160- and a 208-pin QFP have the same footprint but don't necessarily require the same placement accuracy or solder-paste thickness.

Tin-plated Alloy 42 (steel) is a good choice for over-0.5-mm-pitch DIPs, PLCCs, and QFPs where die-stamping tools are practical, but not a good choice for fine-pitch lead frames that are typically tin-plated, etched-copper alloy. To avoid bending these frames, you must handle them with extreme care; otherwise, you may end up with solder bridging or no connection at all. You must maintain the plane of the leads to within  $\pm 4$  mils to reduce soldering problems. Slight twists in the leads and trimming burrs can cause other nightmares in using these materials.

Package area is becoming more of a problem as designers of surface-mount boards face the double problems of fine pitch and larger body size. Perimeter-leaded packages such as QFPs have reached a practical limit for high-volume reflow soldering with 40-mm body size and 0.5-mm lead pitch for a 304-lead QFP. The high-volume manufacturability constraints of package suppliers and pc-board builders dictates these size and pitch limits.

You can achieve higher pin densities by using an area-based interconnection, such as a PGA, where you can place 500 leads in the same footprint as that of a 28-mm, fine-pitch 208-lead QFP. Unfortunately, this is a relatively expensive solution. Recent developments have modified the concept to surface mounting with short butt-joint leads or solder balls. In addition, manufacturers have dramatically reduced costs by using molded-plastic ball-grid arrays instead of ceramic PGAs.

Laptops, palmtops, and the PCMCIA-card form factor require low height and thus surface mounting. There are a variety of surface-mounting choices—from thin QFPs to tape-automated bonding (TAB) to placing chips on a board. Another solution is the multichip module, which you can fit into many plastic-package form factors.

In packaging, each standard evolved and pin count increased until area or lead pitch became too costly or technically infeasible to support in volume manufacturing. The following chart shows the evolution of packaging. The techniques in the left column led to the advances in the right column:

Discrete transistors DIPs	ICs in the DIP package PLCCs, the birth of ASICs; users can pick the package that best fits the application
PLCCs	QFPs, surface mount becomes the mode of assembly techniques
QFPs	VQFPs, fine pitch enables higher densities
QFPs, VQFPs	PBGAs and other area-based connections combine with surface mounting for performance and economy

The exotic technological concepts that do not find acceptance in volume manufacturing may distract designers looking for the best solution. However, designers should support standards because end users are those driving these standards. ASIC suppliers prefer those customer requests that other customers share.

The following list offers some key things for designers to remember when applying and interpreting design constraints:

- The total cost of a package extends well beyond the cost of a component itself. The cost of the package also affects the product life-cycle cost. The best choice is not always the least expensive package.
- Improving electrical and thermal performance and thus increasing cost is necessary to achieve the highest performance.
- Integrating all components into one may result in a combination in which both the package and silicon are too expensive; that is, the cost of the whole may be more than the sum of the costs of the parts.

The following list offers some suggestions to successfully address design problems:

- Logic-design engineers should visit trade shows on surface-mount manufacturing techniques to learn more about assembly and partitioning issues and emerging manufacturing technology.
- Manufacturing and packaging engineers should review designs early in the design cycle and suggest manufacturable alternatives to new problems.
- Designers should plan implementation of manufacturing for new package technologies before or simultaneously with adopting a design.
- Designers should contain costs by using industry-standard, multiple-source packages. EDN

## References

1. Pivin, David, "High-Performance Mixed-Voltage Interfaces for Mixed 3.3 and 5V Systems," Presentation, Silicon Valley Personal Computer Design Conference, July 22, 1993.
2. "H4C Series Design Reference Guide," Motorola, 1993.

## Author's biography

David Pivin is a technical marketing manager for Motorola's ASIC Div, Chandler, AZ. He holds a BSEE from the University of California, Irvine, and an MS in Engineering Management from Northeastern University, Boston. He has been involved in the ASIC field—as a designer, an applications engineer, and a product planner—since 1982. He is a member of IEEE and Mensa.

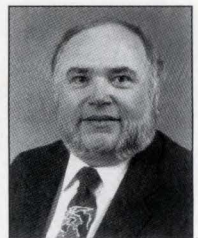

Article Interest Quotient  
(Circle One)

High 589 Medium 590 Low 591

# MAX691A $\mu$ P SUPERVISORS

## REDUCE POWER 50x<sup>†</sup>

**Shortest  $\overline{CE}$  Gate Delay: 10ns Max.\***

Monitor battery voltage or other power line requiring low operating current and short  $\overline{CE}$  gate delay, with the MAX691A and MAX693A. These newest additions to our extensive supervisor family offer the most functions with the highest accuracy.

- ◆ **Lowest Operating Supply current:**  
35 $\mu$ A (MAX691A/693A)  
200 $\mu$ A (MAX690A/692A)
- ◆ **Shortest  $\overline{CE}$  Gate Delay:**  
6ns Typ., 10ns Max.\*
- ◆ **Highest Output Current Drive:**  
250mA, 1.2 $\Omega$  (MAX691A)
- ◆ **Lowest  $V_{BATT}-V_{OUT}$  On Resistance:**  
25 $\Omega$  (MAX691A)
- ◆ **Most Accurate Power Fail:**  
 $\pm 2\%$  over temp.  
(MAX800L/M, MAX802L/M)

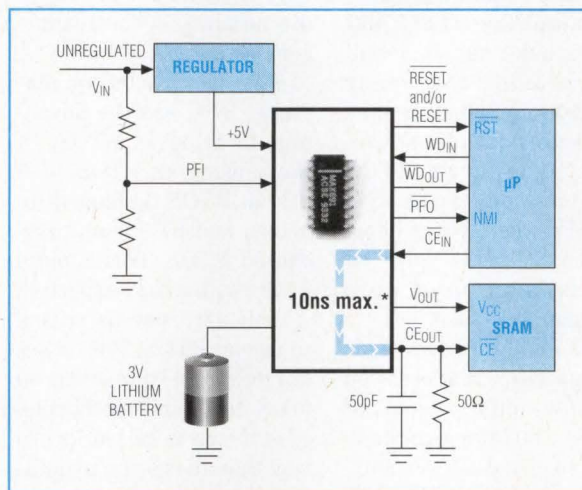

The MAX691A provides complete  $\mu$ P supervision including RESET & RESETE, watchdog timing, chip-enable gating, power-fail warning, and battery-backup switchover.

Part	Reset Threshold (V)	Power-Fail Comparator	Battery-Backup Switch	Watchdog Timer	Active-High Reset	$\overline{CE}$ Protect	Batt-ON Output	Low-Line Output	I <sub>SUPPLY</sub> ( $\mu$ A, Typ)
MAX691A	4.65	✓	25 $\Omega$	✓	✓	✓/10ns	✓	✓	35
MAX693A	4.40	✓	25 $\Omega$	✓	✓	✓/10ns	✓	✓	35
MAX690A	4.65	✓	400 $\Omega$	✓					200
MAX692A	4.40	✓	400 $\Omega$	✓					200
MAX800L	4.65	✓/ $\pm 2\%$ accuracy	25 $\Omega$	✓	✓	✓/10ns	✓	✓	35
MAX800M	4.40	✓/ $\pm 2\%$ accuracy	25 $\Omega$	✓	✓	✓/10ns	✓	✓	35
MAX802L	4.65	✓/ $\pm 2\%$ accuracy	400 $\Omega$	✓					200
MAX802M	4.40	✓/ $\pm 2\%$ accuracy	400 $\Omega$	✓					200

\* Tested with 50 $\Omega$  driver and 50pF load. Some competitors misrepresent this specification by not stating test conditions.

<sup>†</sup> Compared with industry Standard MAX691.



**FREE  $\mu$ P Supervisory Design Guide—Sent Within 24 Hours!**  
Includes: Data Sheets and Cards for Free Samples

**CALL TOLL FREE 1-800-998-8800**  
**For a Design Guide or Free Sample**

MasterCard® and Visa® are accepted for Evaluation Kits or small quantity orders.

# MAXIM

Maxim Integrated Products, 120 San Gabriel Drive, Sunnyvale, CA 94086, (408) 737-7600, FAX(408) 737-7194.

Distributed by Arrow, Bell, Digi-Key, Elmo, Hamilton Hallmark, and Nu Horizons. Authorized Maxim Representatives: AL, M-Squared, Inc.; AZ, Techni Source Inc.; CA, Mesa, Pro Associates, Inc., Centaur Corporation; CO, Component Sales; CT, Comp Rep Associates; DE, TAI Corporation; FL, Sales Engineering Concepts; GA, M-Squared, Inc.; ID, E.S. Chase; IL, Heartland Technical Marketing Inc.; IN, Technology Marketing Group; IA, JR Sales Engineering, Inc.; KS, Delltron; LA, BP Sales; MD, Micro-Comp, Inc.; MA, Comp Rep Associates; MI, Micro Tech Sales; MN, Mel Foster Technical Sales, Inc.; MS, M-Squared, Inc.; MO, Delltron; MT, E.S. Chase; NE, Delltron; NV (Reno, Tahoe area only) Pro Associates, Inc.; NH, Comp Rep Associates; NJ, Parallax, TAI Corporation; NM, Techni Source Inc.; NY, Parallax, Reagan/Compar; NC, M-Squared, Inc.; OH, Lyons Corporation; OK, BP Sales; OR, E.S. Chase; PA (Pittsburgh area) Lyons Corporation, (Philadelphia area) TAI Corporation; SC, M-Squared, Inc.; TN, M-Squared, Inc.; TX, BP Sales; UT, Luscombe Engineering Co.; VA, Micro-Comp, Inc.; WA, E.S. Chase; WI, Heartland Technical Marketing, Inc.

Distributed in Canada by Arrow. Authorized Maxim Representative in Canada: Tech Trek.

Maxim is a registered trademark of Maxim Integrated Products. © 1993 Maxim Integrated Products

EMBEDDED SYSTEMS, by David Shear, Technical Editor

## EDN readers are RTOS aware

Last summer, I asked you if you were "RTOS aware." The reason for the question was that I had been hearing numbers that just didn't make sense. I had been hearing that many software engineers are skeptical about any advantages in using an RTOS (real-time operating system). Further, I was hearing that about 80% of RTOSs being used were developed in-house.

This little survey reveals that, as *EDN* readers, you are not only aware of RTOSs, you often use them.

We received 137 responses to the informal survey based on questions posed in

the August 19, 1993, Embedded Systems column. To respond, the reader had only to circle the appropriate number on the reader-service card.

The overwhelming majority, 87%, see the advantage of using an RTOS. Of those using an RTOS, 43% use an RTOS developed in-house, and 57% use a purchased RTOS. This is more in line with what I expected.

Only 13% saw no reason to use an RTOS. This is not surprising. Like with so many tools and methodologies, if your mind works in a way that allows you to naturally use the tools, you use them. If you think different-

ly, the tool just gets in the way. That's probably the case with the 13% of respondents who found other programming techniques to get their jobs done.

But what did surprise me was that when looking at only those who see the advantage in using an RTOS, only 13% have decided against it. I find it difficult to program without using an RTOS, but sometimes I could probably do just as well without one. It was gratifying to learn that 87% of those who understand the advantages of an RTOS actually use one.

I have a strong hunch that the percentage of those

using in-house RTOSs will decline as new products based on purchased RTOSs replace those currently in production. You now have many options for RTOSs that didn't exist a few years ago: Virtually all  $\mu$ Ps offer a choice of RTOSs.

Here are the results of the survey (total response: 137):

- 18, or 13%, saw no advantage to using an RTOS.
- 16, or 12%, saw the advantage of using an RTOS but decided against it.
- 44, or 32%, used an in-house-developed RTOS.
- 59, or 43% used a purchased RTOS.

## DEC embeds its Alpha AXP into products for real-time applications

Beginning next month, Digital Equipment Corp will begin to introduce products for use in embedded systems. The company is basing all the products on the Alpha AXP  $\mu$ P family.

The reason for the move is that DEC is trying to create a full line of products for embedded real-time applications—from just the  $\mu$ P to complete systems. The company is also planning to provide a scalable family of  $\mu$ Ps and operating systems (OSs). The company expects this family to span from the simplest embedded application to the largest and most complex multiprocessor-based distributed application.

Because each  $\mu$ P shares the same instruction set, the new products enable you to learn one set of tools and one software architecture for all projects, thus minimizing the time needed for learning architectures and tools. More important, this consistency lets you reuse more code.

The products allow you to choose between two DEC Unix-based OSs—DEC OSF/1 Unix, which has real-time

extensions, and DECcelx, which is for hard real-time applications. Both OSs comply with Posix 1003.4 Draft 11.

DEC based DEC OSF/1, which is in its third release (version 1.2), on the Open Software Foundation's OSF/1. DEC OSF/1 builds on a modular Mach kernel and includes threads, memory-mapped file support, and advanced virtual memory.

DECcelx, an embedded local executive, provides an integrated Unix environment for software development. A host computer running DEC OSF/1 provides editing and compiling services and then downloads the runtime code to the target for execution under DECcelx.

The ElxGBD Windows-based debugger runs on the host and the target and allows source-level debugging of the target. It also provides performance-evaluation tools that show timing and processor use.

The DECcelx multitasking kernel uses preemption and priority-based scheduling for the predictable response required by hard real-time applica-

tions. DECcelx runs on the Alpha AXP and Motorola 68000  $\mu$ Ps. The DECcelx runtime software includes the executive, multitasking support, network facilities, local file systems, I/O, utility libraries, and boot-ROM support.

DEC is now focusing on the high end of the market for embedded systems—applications that require a significant amount of computing power and speed. Such applications include distributed process control, robotics, telecommunications, and medical imaging.

DEC is also planning to introduce a family of scalable, distributed OSs that will let you pick the appropriate  $\mu$ P and then get just as much OS as your application needs. The company will also offer VME and evaluation boards in addition to the its currently available VME, PC, and workstation boards. The VME boards will include one based on DEC's 66-MHz 21068  $\mu$ P and one based on the company's 166-MHz 21066  $\mu$ P.

—David Shear

Digital Equipment Corp, Marlborough, MA. (800) 344-4825. Circle No. 328



**The same old wave** of analog I/Cs just won't cut it anymore — what with the emergence of pocket-sized personal electronics, communications superhighways, and automobiles made more of silicon than metal. That's why National Semiconductor is introducing a bold, new generation of analog solutions guaranteed to help you meet the design challenges of the digital future. Solutions built to deliver the tightest specs you'll find anywhere. You see, we want to be the supplier you look to for all your analog needs. So, the next time you're faced with a really tough analog problem, give us a call. Or simply turn the page. And see for yourself why we're **not the same old wave.**

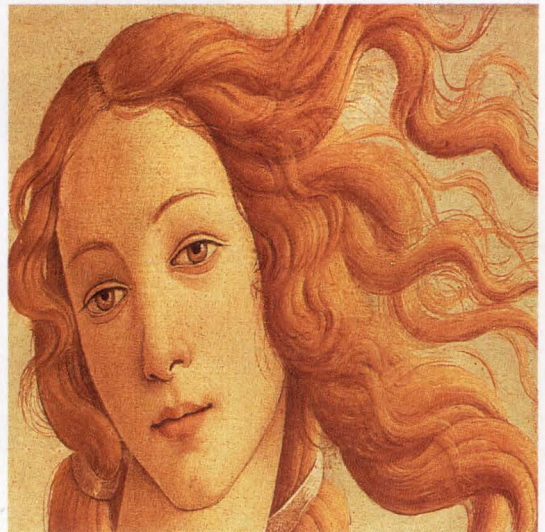



NOT THE SAME OLD WAVE

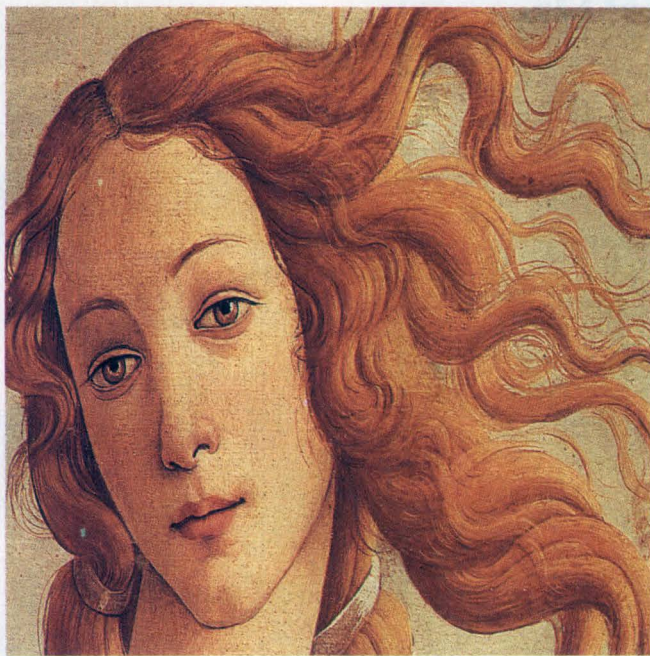

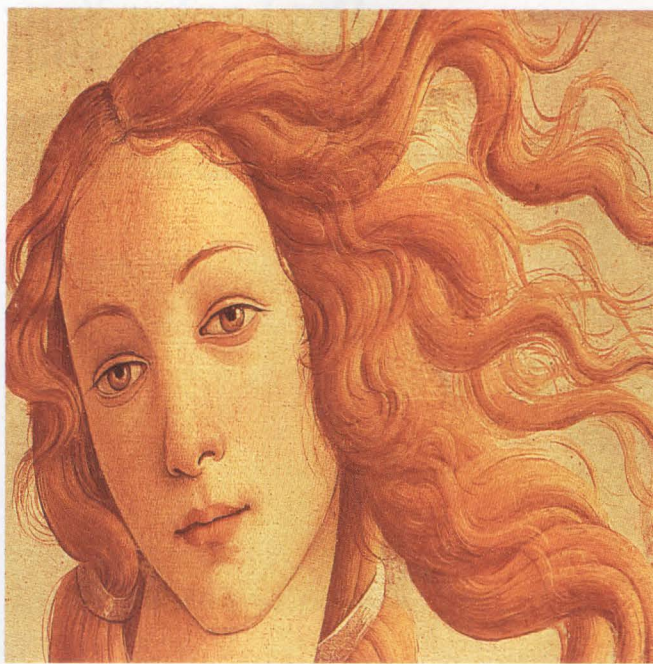
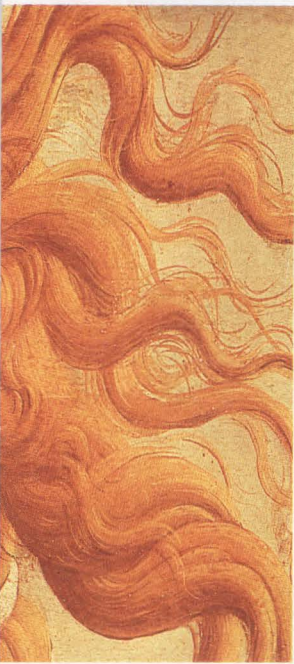

**The ADC12062** ~ Fast sampling rate of 1MHz ~ Ultra low power dissipation of 75mW max. @ +5V ~ For demanding instrumentation and communications applications ~ EEPROM trimming architecture guarantees excellent DC and AC performance (Gain error =  $\pm 1$ LSB; Offset error =  $\pm 1.25$ LSB; DNL =  $\pm 0.95$ LSB; INL =  $\pm 1.0$ LSB; SNR = 69.5dB; THD = 70dB) ~ 2-channel MUX, on-board sample/hold and high-speed parallel interface

~ For a free product sample kit and ordering information, call 1-800-NAT-SEMI, Ext. 271.

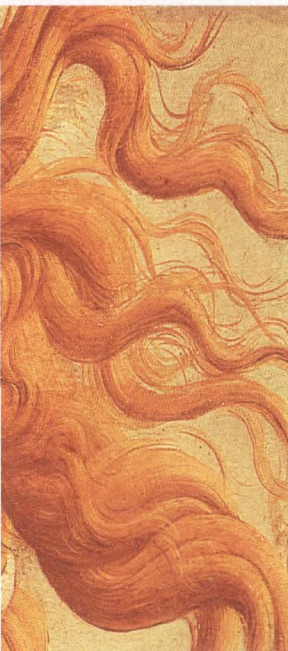

The world's  
lowest  
power  
1 MHz 12-bit ADC

©1994 National Semiconductor Corporation. NORTH AMERICA: P.O. Box 7643, Mt. Prospect, IL 60056-7643 (Tel: 1-800-628-7364, Ext. 271 Fax: 1-800-888-5113). All rights reserved.

# The Faster Your Designs Change,

# The More You Need Mini-Fit.

Let the Mini-Fit family of power connectors help you solve the challenges associated with requalifying. You can save time and money after every design change, because requalifying is not required—each Mini-Fit family member uses the same proven contact interface design.

One of the highest density power connectors on the market, Molex Mini-Fit products are rated up to 9 amperes per circuit. For maximum design flexibility, Mini-Fit connectors can also carry signal current, having a maximum 10-milliohm contact resistance. Molex's unique spring

**Versatile Molex Mini-Fit Connectors Let You Redesign, Without Requalifying.**

beam design with high pressure, gas tight contact points makes these increased capacities possible.

The Molex Mini-Fit connector family meets CSA, UL and TUV standards, is available in circuit sizes 2-24 and includes:

- Mini-Fit, Jr™— a cost effective, high performance design for power and signal applications.
- Mini-Fit, BMI™ (Blind Mating Interconnect)—a self-aligning

drawer type design that reduces assembly and field service time.

- Mini-Fit, TPA™ (Terminal Position Assurance)—a polyester housing design with a secondary lock to ensure secure connections.

High power, high density Mini-Fit connectors help you push higher currents through smaller packages. By sharing the same contact interface design to eliminate connector requalification, they can help in your push to stay ahead of rapidly changing requirements.

Contact Molex today for your FREE Mini-Fit Family Reference Chart.



*Bringing People & Technology Together, Worldwide<sup>SM</sup>*

Corporate Headquarters: 2222 Wellington Ct., Lisle, IL 60532 U.S.A., Tel: (708)969-4550 • European Headquarters: Munich, Germany, Tel: 49-89-413092-0  
Far East North Headquarters: Tokyo, Japan, Tel: 81-427-21-5539 • Far East South Headquarters: Jurong Town, Singapore, Tel: 65-660-8555

CIRCLE NO. 77

©1993, Molex Incorporated

Mini-Fit™  
Interconnect  
Family



## Cypress FPGA hits 100-MHz counters

Cypress Semiconductor has entered the FPGA fray, melding the QuickLogic FPGA architecture and antifuse technology with its own 0.65- $\mu$ m FPGA architecture. The Cypress pASIC38x FPGAs combine a proprietary antifuse technology with a single flip-flop/multiple-output core logic element and X-Y-matrix chip routing. Cypress claims FPGA clock rates up to 100 MHz for loadable counters and 85 MHz for chip-to-chip operations.

Built on a 0.65- $\mu$ m CMOS process, the FPGA architecture relies on an amorphous-silicon antifuse. The antifuse is blown to make a connection and has a resistance of 50V with less than 1-fF capacitance. The relatively fine-grained core-logic cells each have one register and six basic input gates. The FPGA architecture also provides a 23-input fan-in (input signals) and multiple outputs, including two 6-input gates, two multiplexer terms, and a flip-flop true output. The inputs include the clock and dc set and reset for the D flip-flop.

The architecture provides 1000 to 4000 usable gates, and Cypress plans an architecture with larger chips and more gates to follow. Chip I/Os range from 40 to 122 pins. The architecture provides eight high-drive input cells for high-fan-out I/O inputs and two high-drive clock cells for clocking. I/O cells do not have sequential elements. Each I/O is bidirectional and is driven internally by an enabled inverter fed by a

2-input OR gate (one input negated).

The X-Y routing resources cover the chip in a matrix with horizontal and vertical wiring channels. The vertical X channels include 16 segment wires (to local elements) and four express wires (chipwide). The vertical Y channels have four quad (to four elements) and eight segment (local) wires. Each core element has 23 inputs and as many as five outputs. Logic input and output delays are on the order of 4 nsec (signal in to chip, through element, signal off chip). The combinatorial delay through a cell is 1.9 (one load) to 4.8 nsec (eight loads). Flip-flop setup time is 2.2 nsec, with a zero-hold-time requirement. The chips have a JTAG input for scan-chain test of the logic-cell registers.

Cypress supplies a VHDL-based tool set, Warp3, for development. Warp3 supports the pASIC380 family as well as Cypress's PLDs. The kit provides VHDL top-level design and simulation, including device targeting and device-specific timing simulation. The tool set supports both manual and automatic placement, mapping logic onto the FPGA elements. Routing, however, is fully automatic. The 7C381/2/3/4 are available now. The 7C385/6 will be available for sampling in February, and Cypress plans to begin production in March.—Ray Weiss

Cypress Semiconductor, San Jose, CA.  
(408) 943-2600.

Circle No. 330

QuickLogic Corp, Santa Clara, CA.  
(408) 987-2000.

Circle No. 331

## Gate arrays mesh sea of gates with sea of I/O

ASIC design is fast approaching the complexity of system design. A single ASIC can now support designs that used to take one or more boards. The gate arrays to handle these complexity levels have expanded I/O and pin counts, as well as providing larger, more efficient "canned logic," or megacells, which supply large logic functions. SGS-Thomson's new ISB35000 gate-array family delivers more than 1 million usable gates and as many as 648 I/Os capable of handling clock rates over 200 MHz.

Based on a new 0.5- $\mu$ m, 3-layer metal process, the HCMOS5 crams approximately 5500 equivalent gates into 1 mm square. Designed for 3.3V operation, the SGS array family has a typical gate speed of 210 psec (2-input NAND, two loads). Power dissipation averages 0.76 mW/MHz, reduced from 5 mW/MHz for the company's earlier 0.7- $\mu$ m ISB2800 series. The new HCMOS5 process uses stacked tungsten alloy plugs for interconnections between metal layers; these plugs allow vias between different layers to be stacked atop one another and reduce gate-wiring area by up to 20%.

Structured as a sea of gates, the array builds on a new smaller cell, composed of four N and four P transistors. These cells have a 1 to 2V source-drain resistance that eliminates the need for first-level metal power buses. Additionally, the cells can be paired for higher drive and switching speeds. I/O cells surround the core sea of gates. Using a sea of transistors, you can adjust and program these I/O cell pads. Thus, you can configure the I/O cells for different pad-drive capabilities and pad sizes. These cells support 800 to 1000 pins and handle 3.3 and 5V interfaces. Cell I/Os can sink up to 24 mA and source a drive up to 12 mA. Ball-grid-array, flip-chip packaging is available for high-density arrays. Other packages include grid quad flatpack, plastic quad flatpack, and pin-grid array.

SGS-Thomson furnishes a large

### Cypress pASIC38x FPGA family

	7C381	7C382	7C383	7C384	7C385	7C386
Usable gates	1000	1000	2000	2000	4000	4000
Logic cells	96	96	192	192	384	384
I/O cells	32	56	56	68	68	114
HD cells	8	8	8	8	8	8
CK cells	2	2	2	2	2	2
Package	44-pin PLCC	68-pin PLCC	68-pin PLCC	84-pin PLCC	84-pin PLCC	144-pin PLCC

## EVERYBODY'S TALKING ABOUT ARIEL!

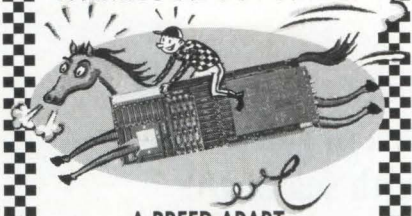

### A BREED APART

When *COMPUTER* Magazine labeled our DSP-96 board a "true thoroughbred," we couldn't help but take notice. Those two simple words really capture the essence of our mission here at Ariel: to be a breed apart—providing DSP solutions that always come in first place.

*"Ariel's DSP-96 Is A True Thoroughbred In The Field Of DSP"*

IEEE COMPUTER MAGAZINE 9/93

### THE DSP PEDIGREE

The PC-based DSP-96 is a great example of the kind of high-performance single and multiprocessor DSP products Ariel makes for VME, PC and SBUS platforms. And all Ariel products feature flexible, high-quality analog and digital I/O to complement our raw DSP horsepower.

### WIN...PLACE...SHOW

Like all our products, the DSP-96 comes bundled with a C-callable interface library and easy to understand example programs (which, according to the same reviewer, "executed flawlessly"). And of course we provide comprehensive software development tools for all our products.

### JOCKEY INTO FIRST PLACE

Ariel's stable of DSP products gives you the advantage right out of the starting gate. So, quit horsing around and call us today.

### Ariel

433 River Road  
Highland Park, NJ 08904  
Tel: (908) 249-2900  
Fax: (908) 249-2123  
email: ariel@ariel.com

CIRCLE NO. 17

116 • EDN February 3, 1994

## EDN-NEW PRODUCTS INTEGRATED CIRCUITS

logic-cell and megacell library. Library elements include 196 SSI/MSI logic functions, 150-MHz-GTL, 250-MHz-PECL transmitter/receiver I/O, fast single- and dual-ported SRAMs, up to 64-kbyte DRAMs, up to 512-kbyte ROMs, USARTs, and a 10-nsec 64364-bit multiplier. Other megacells include a 16-bit DSP core, PLLs, 200-MHz RAMDACs, serial transputer links, and a 16-bit T425 transputer. For testing, SGS-Thomson offers a scan-test macro library that complies with JTAG 1149.1.

The ISB35000 arrays integrate standard CAE tool sets; they include a Verilog-XL HDL, Synopsys and Cadence VHDLs, the Synopsys design and test compiler, the Cadence Opus back-end tools, and the full Mentor 8.2 tool set.

—Ray Weiss

SGS-Thomson Microelectronics, Lincoln, MA. (617) 259-0300. **Circle No. 332**

### SGS-Thomson ISB35000 gate-array family

Device	ISB35030	ISB35083	ISB35166	ISB35279	ISB35389	ISB35484	ISB35532
Gross gates	32,000	82,944	166,454	278,784	389,376	484,416	891,744
Usable gates	25,000	58,060	116,524	195,148	253,094	314,870	499,046
Maximum I/O cells	96	172	244	316	372	416	544

## Instant connectivity. Instant productivity. Guaranteed.



*ScopeView*®

- Live, full color waveform displays.
- Complete VXI and benchtop scope control.
- Effortless data and image connectivity.
- Automatic command file generation.
- No programming required.

### Visualize the possibilities.

*ScopeView* connects you with the productivity power of Microsoft® Windows™. Add remote control to your scope. Expand your signal analysis horizons. Drive down documentation time while increasing precision and quality. Let *ScopeView* help bring your projects in on time, and under budget.

Decision-Science Applications, Inc.  
1755 Telstar Drive, Suite 201  
Colorado Springs, Colorado 80920



**1-800-551-5990**

1-719-593-5974, Fax 1-719-593-5978

Internet: scopeview@dsai.com

CIRCLE NO. 19



# Your clock has the jitters? We can help!



AKM's Stereo DACs don't mind a little jitter. Or even a lot!  
Up to 100ns is no problem. AKM's unique architecture provides high tolerance to clock jitter, ideal monotonicity and low distortion — all without trimming.

Choose AKM's low cost, easy-to-use DAC products for any application — digital CATVs, satellite receivers, digital audio systems, digital music keyboards, digital sound recording systems, CD players, etc.

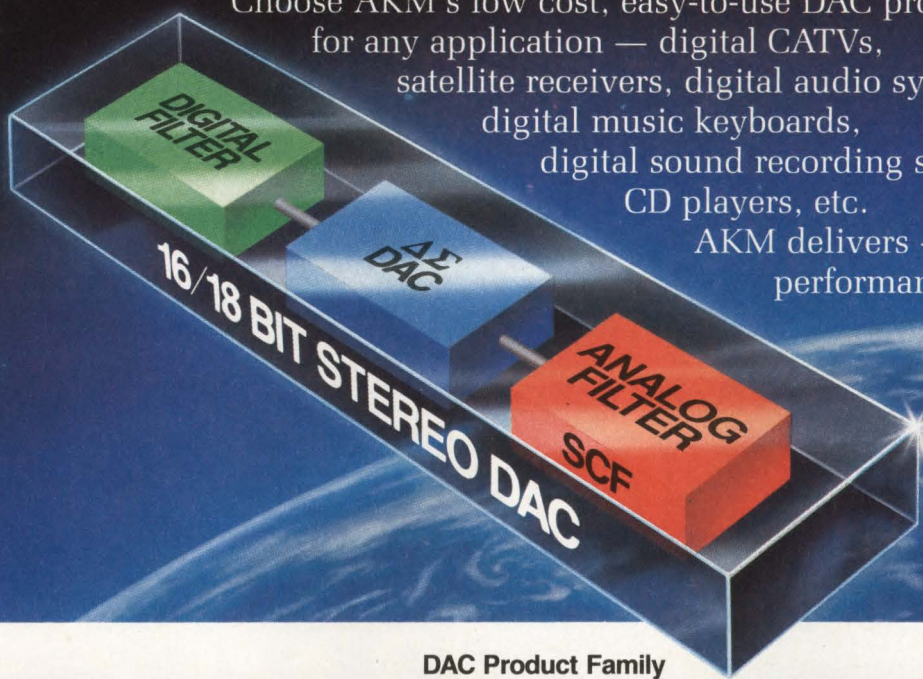
AKM delivers — price, performance, quality.



DAC Product Family

Device	# of bits	DR	S/N	THD + N	Special Features	Voltage
 <b>AK4316</b>	16	90dB	90dB	0.01%	• High tolerance to clock jitter	+5V
 <b>AK4318</b>	18	97dB	97dB	0.0025%	• High tolerance to clock jitter • De-emphasis control circuit • Soft mute function	+5V
 <b>AK4313</b>	18	93dB	93dB	0.004%	• High tolerance to clock jitter • De-emphasis control circuit • Soft mute function • Low voltage	2.7~4.0V



## Asahi Kasei Microsystems Co.,Ltd.

JAPAN — TS Bldg. 24-10, Yoyogi 1-chome, Shibuya-ku, Tokyo 151, Japan Phone: (03) 3320-2067 / Fax: (03) 3320-2072  
USA — 2055 Gateway Place, Suite 415, San Jose, CA 95110 Phone: (408) 436-8580 / Fax: (408) 436-7591  
EUROPE — Avenue Louise 326, Bte 056, 1050 Brussels, Belgium. Phone: (32) 2-649-7831 / Fax: (32) 2-640-1809

### For more information, contact:

<b>J.S.A.)</b>			
WA, OR, MT (Western); CANADA-BC, Alberta	Quest Marketing, Inc.	Phone (206) 228-2660	Fax (206) 228-2916
CA (Northern), NV (Northern), ID, UT, CO	Pinnacle Sales	Phone (408) 453-7500	Fax (408) 453-7667
CA (Southern)	Solotech, Inc.	Phone (714) 374-0130	Fax (714) 374-0131
NV (Southern), AZ, NM, MEXICO-Sonora, Chihuahua	Fred Board Associates	Phone (602) 994-9388	Fax (602) 994-9477
IA, WI, IL, IN	Richmar Electronics Corp.	Phone (708) 968-0118	Fax (708) 968-0197
NY (Upstate)	Interactive Component Sales	Phone (315) 445-9600	Fax (315) 445-8700
NY (Southern), CT, NJ, PA, DE	WD-TMI	Phone (914) 779-8738	Fax (914) 779-8840
MD, VA, DC	Eltron Sales, Ltd.	Phone (703) 635-7201	Fax (703) 635-1933
TN, NC, SC, GA, AL, MS	E-Squared Marketing	Phone (205) 430-3000	Fax (205) 430-3350
FL, Puerto Rico	Micro Concepts, Inc.	Phone (407) 830-8889	Fax (407) 834-0649
<b>EUROPE)</b>			
Austria, Germany, Italy, Spain, Switzerland, Greece	Austria Mikro Systeme International AG	Phone (43) 3136/500-267	Fax (43) 3136/500-491
Other European Countries	AKM Europe	Phone (32) 2-649-7831	Fax (32) 2-640-1809

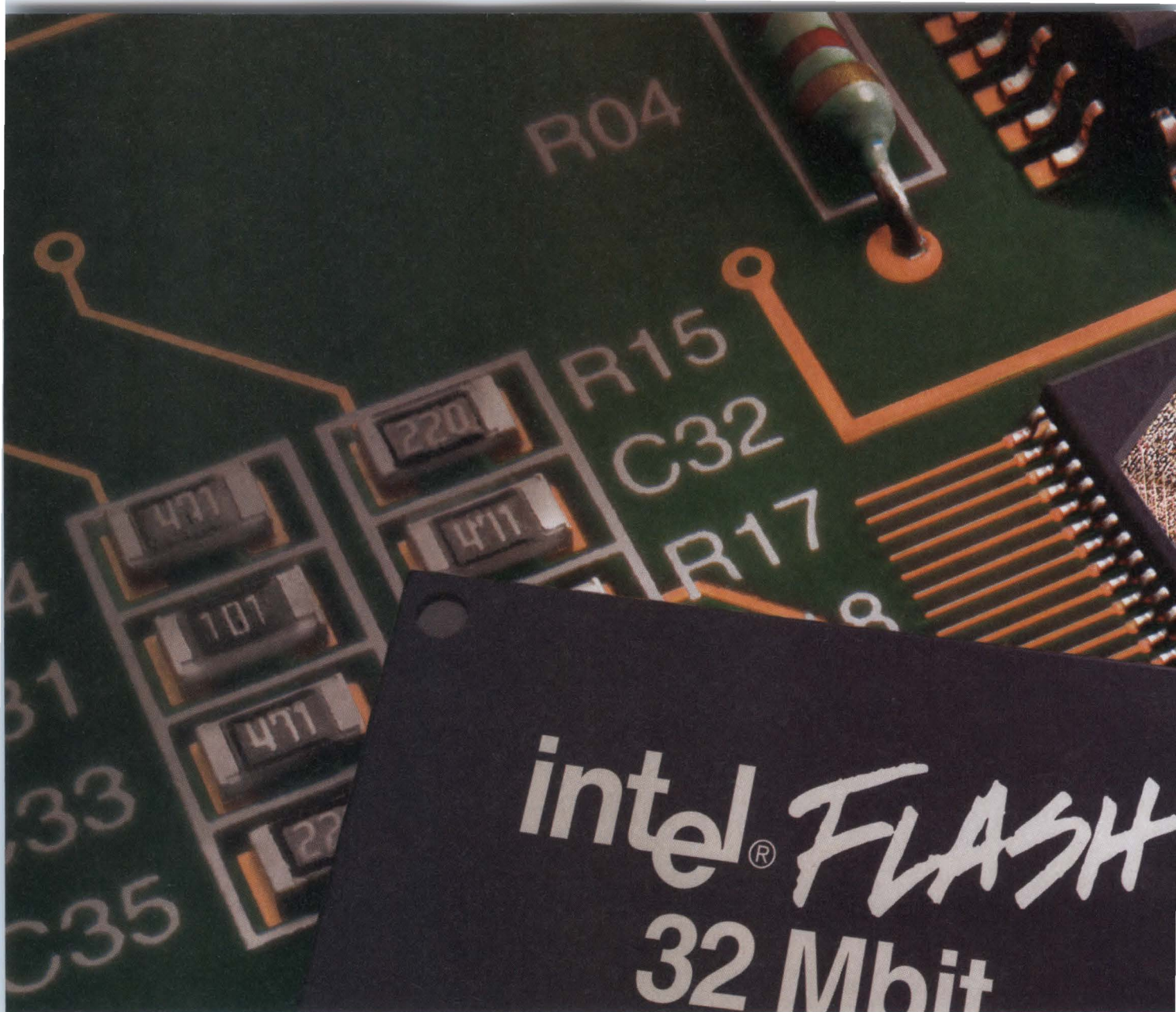

intel<sup>®</sup> FLASH  
32 Mbit

# When it comes to solutions, nobody pa



## Introducing Intel 16 & 32Mb FlashFile™ Memory.

If you need high-density, nonvolatile flash memory for your mobile PC and embedded designs, we've got the ticket: New 16 and 32Mb FlashFile™

components—the smallest, fastest, most power-efficient flash chips we've ever fielded.

The 32Mb chip's dual-die design doubles the

density of the 16Mb chip in the same 1.2mm-slim, 56-lead TSOP package, making it the only component to enable 200MB-per-cubic-inch flash arrays.

Both components offer a 70ns read access time at 5V. And fast data storage is enabled by on-chip buffers, which boost sustained write performance to 1.7MB per second in 32-bit systems.

To save power, both chips support 3.3V read operations, and can be configured as either x8 or x16. And silicon power management automatically shifts

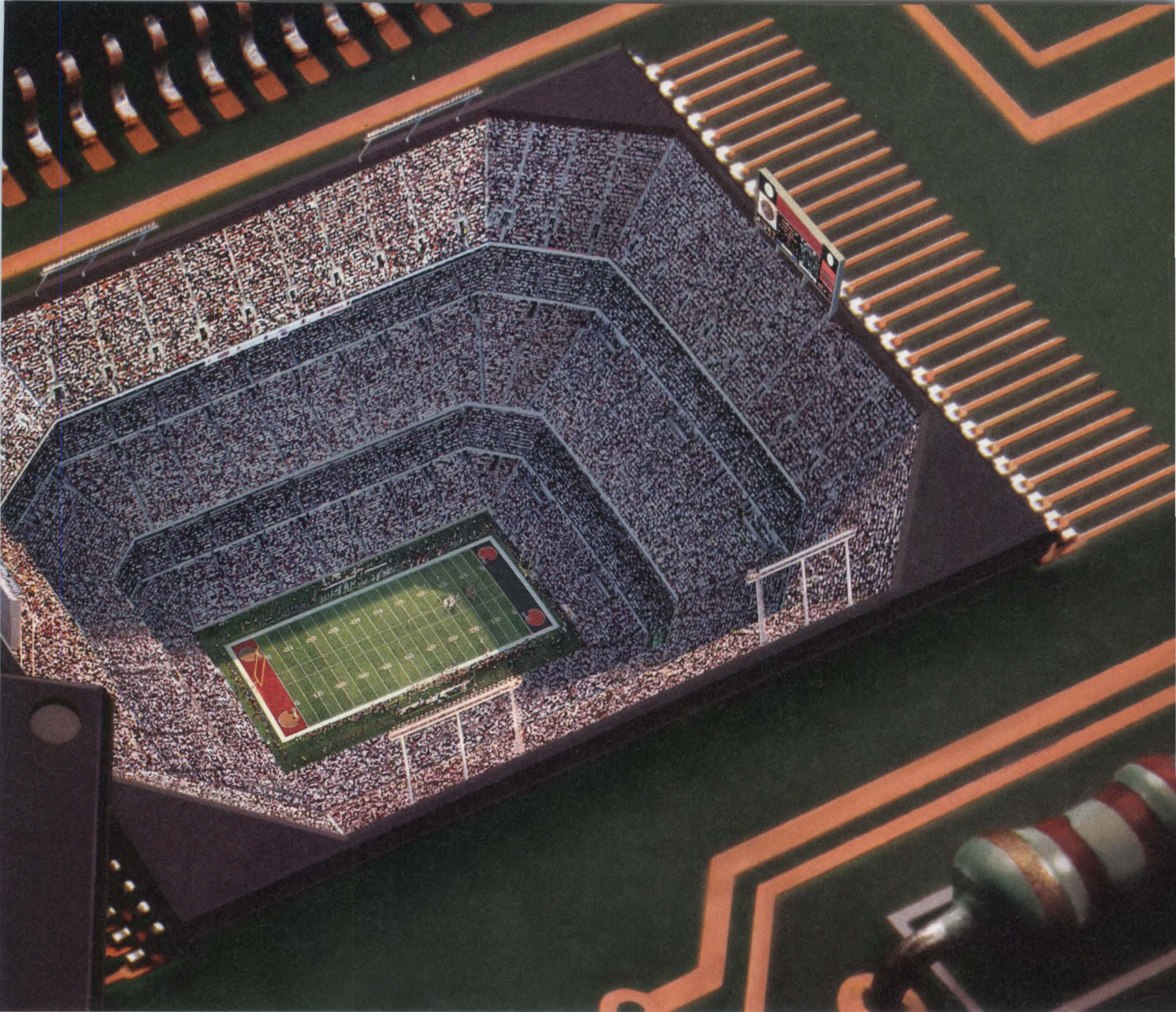

# high-density flash kicks them in like Intel.

current consumption down to a 1 to 2mA static mode, while sleep mode further drops it to just 1 to 2 $\mu$ A.

Compatible with existing FlashFile designs, these chips can replace ROM/RAM and disks in storing applications, O/S and data files. Supporting one million erase cycles per block, FlashFile architecture also enables mass storage subsystems like our Type I and II, PCMCIA Flash Cards and ATA Flash Drives.

And when it comes to flash value, Intel is in a league all by itself. In fact, the 16Mb FlashFile

component is the most cost-effective 3.3V flash memory available, at just \$85 in volume quantities.

So if you want density, call for literature at 1-800-879-4683, ext. 102. Or dial the FaxBack\* system at 1-800-628-2283, cat. #2. Because when it comes to high-density flash, nobody else is even in the ballpark.

**intel**<sup>®</sup>

# Faster than Fast Page Mode

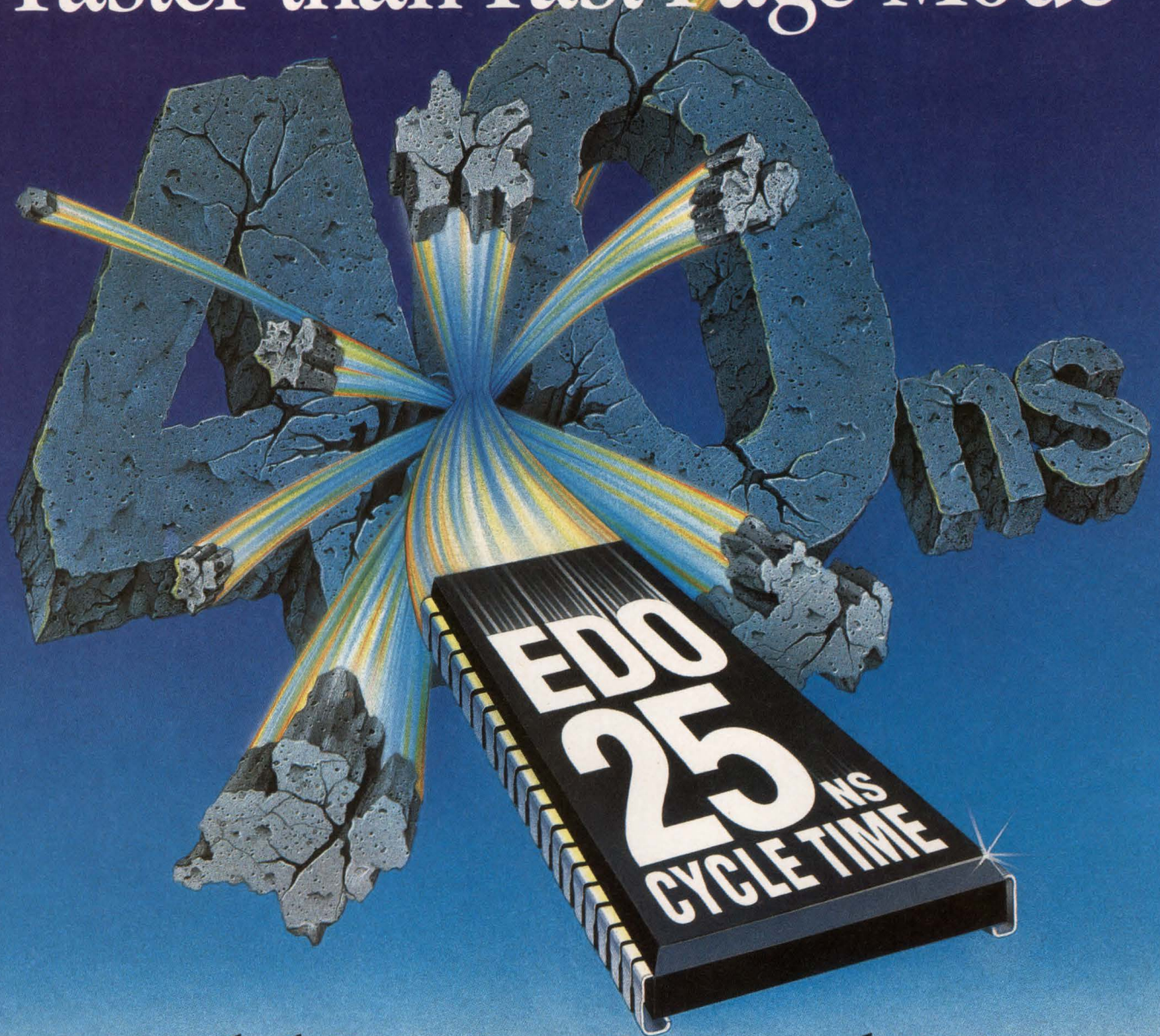

## Extended Data-Out DRAMs and VRAMs

Break through the 40ns time barrier with Micron's 25ns Extended Data-Out DRAMs and VRAMs.

Our EDO DRAMs and VRAMs provide true faster-than-Fast-Page-Mode performance by letting your system start a page-mode read access before completing the previous one.

And because they increase peak memory bandwidth by up to 60% and don't require system architecture changes, Micron EDO DRAMs and VRAMs are the simplest and most cost-effective way to enhance system performance.

So call our Micron DataFax<sup>SM</sup> line today at 208-368-5800 and have our EDO selector guide automatically faxed to you — break through the 40ns time barrier.

Micron. Technology that works for you.



Part Number	Density	Organization	Speed Grades/ Cycle Times (ns)	Samp./Prod. Availability
<b>DRAMs</b>				
MT4LC4M4E9	16 Meg	4 Meg x 4	60/25, 70/30	2Q94/4Q94
MT4LC2M8E7	16 Meg	2 Meg x 8	60/25, 70/30	3Q94/4Q94
MT4LC4007J	4 Meg	1 Meg x 4	60/25, 70/30	Now/2Q94
MT4C16270	4 Meg	256K x 16	60/25, 70/30	Now
<b>VRAMs</b>				
MT42C256K16A1	4 Meg	256K x 16	60/24, 70/27	Now
MT42C8256	2 Meg	256K x 8	60/24, 70/27	Now

**MICRON**  
SEMICONDUCTOR, INC.

2805 E. Columbia Road, Boise, ID 83706 208-368-3900, Micron DataFax 208-368-5800

Customer Comment Lines: U.S. 800-932-4992 Intl. 01-208-368-3410

©1994, Micron Semiconductor, Inc. Micron DataFax is a service mark of Micron Semiconductor, Inc.



## INTEGRATED CIRCUITS

### FREE INFO, FREE POSTAGE

Use our postage-paid reader-service cards to get more information on any of these products.

**ICs drive optocouplers or serve as power-supply front ends.** The UC39431 and UC39432 ICs contain an accurate voltage reference, a high gain-bandwidth error amplifier, and a linear-transconductance output-stage current source. In optocoupler applications, the linear transconductance amplifier replaces a common-emitter transistor amplifier, which has inherent nonlinear characteristics, to provide accurate control of the LED current. The UC39431 also includes three precision, low-temperature-coefficient resistors, which you connect to provide one of six regulated output voltages. An external resistor programs the UC39432's transconductance amplifier, allowing a more stable design in closed-loop optocoupler-feedback applications. Both ICs cost \$1.25 (1000). **Unitrode Integrated Circuits Corp.**, Merrimack, NH. (603) 424-2410. **Circle No. 397**

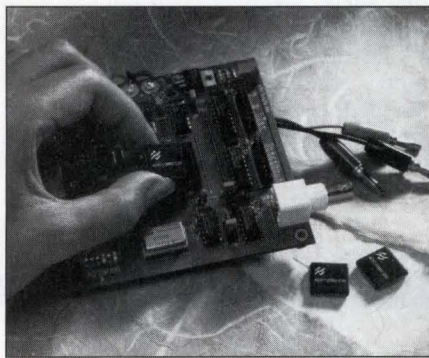

**Instrumentation 12-bit ADCs have >1-MHz throughput.** Competing with hybrid converters for high-speed instrumentation applications, the ADC12062 and ADC12662 feature throughputs of 1 and 1.5 MHz and maximum power dissipation of 75 and 200 mW, respectively. In power-down mode, both devices consume just 125  $\mu$ W. Both ADCs offer a 2-channel input and an on-chip S/H amplifier. Guaranteed maximum integral nonlinearity for the two devices is  $\pm 1$  and  $\pm 1.5$  LSB, respectively. Both devices have a maximum differential nonlinearity of  $\pm 0.95$  LSB. The respective S/N ratios of the 12062 and 12662 are guaranteed at 70 and 68 dB. Both devices are available in 44-pin plastic-leaded chip carriers and quad flatpacks. Prices begin at \$29.21 and \$33.70 (1000), respectively. **National Semiconductor**, Santa Clara, CA. (408) 721-2302. **Circle No. 398**

**Video RAMDAC incorporates clock generators.** The ICS5340 merges a triple 8-bit video DAC with a color-palette RAM and two timing genera-

tors. The device handles 24-bit color through 8-bit pseudocolor at clock rates to 135 MHz. Its timing generators provide a selection of eight video clocks and two memory clocks. Samples and demonstration boards are available. Prices begin at \$6.95 (50,000). **Integrated Circuit Systems Inc.**, Valley Forge, PA. (215) 630-5300. **Circle No. 399**

**Buffer slews at 2000V/ $\mu$ sec.** The BUF634 high-speed, unity-gain buffer amplifier features a 250-mA output in an SO-8 package. You can program the buffer for a bandwidth of 30 MHz with 1.5 mA of quiescent current or boost the bandwidth to 180 MHz with 15 mA of quiescent current. The device operates from  $\pm 2.25$  to  $\pm 18$ V and has an internal current limit and thermal shutdown to withstand load faults and short circuits. \$2.60 (1000). **Burr-Brown Corp.**, Tucson, AZ. (800) 548-6132. **Circle No. 400**

**DAC takes a maximum of 400  $\mu$ A.** The 12-bit MAX530 parallel-input, voltage-output DAC operates on 5 or  $\pm 5$ V supplies. An internal bandgap reference provides a 2.048V output that you can amplify, attenuate, invert or leave unconnected for multiplying applications. The IC performs 4-quadrant multiplication without external resistors or op amps, and the output-voltage range in those applications includes both supply rails. Otherwise, the internal buffer amplifier's gain-setting resistors define the output ranges of 0 to 2.048, 0 to 4.096, or  $\pm 2.048$ V. The DAC is guaranteed monotonic over temperature with a relative accuracy of  $\pm \frac{1}{2}$  LSB. The device comes in 24-pin DIPs and SOICs, and prices start at \$5.45 (1000). **Maxim Integrated Products**, Sunnyvale, CA. (408) 737-7600. **Circle No. 401**

**MOSFET driver operates from 8 to 60V.** The LT1161 quad driver, a ruggedized N-channel device, provides a full 100% operating-voltage margin in 24 and 28V systems. Each of the four switch channels contains an internal charge pump and requires no external components to boost the n-channel MOSFET gate 12V above the supply rail. Channel-independent protection circuits function as four electronic cir-

cuit breakers. You can externally program the device's current limit, delay time, and automatic-restart period. In 20-pin DIPs and SOICs, the device costs \$3.14 and \$3.44 (1000), respectively. **Linear Technology Corp.**, Milpitas, CA. (408) 432-1900. **Circle No. 402**

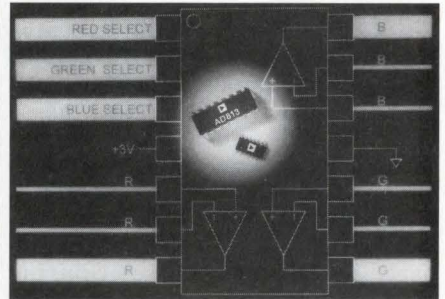

**Triple and dual video op amps dis-able in 80 nsec.** For \$3.74 (1000), the AD813 provides three current-feed-back op amps, each with an independent fast-disable function. The AD812 (\$2.48, 1000) is the dual version. The op amps operate from a single 3V supply to a dual  $\pm 15$ V supply with 4-mA of supply current per amplifier. Video characteristics include a 125-MHz unity-gain  $-3$ -dB bandwidth, 0.03% differential gain error and 0.06° differential phase error. The op amps accommodate external loads in excess of 150 $\Omega$  and offer 0.1-dB gain flatness to 50 MHz. In 14-pin (triple) and 8-pin (dual) DIPs or SOICs, the devices operate from  $-40$  to 85°C. **Analog Devices**, Wilmington, MA. (617) 937-1428. **Circle No. 403**

**Read-channel IC integrates functions.** The MC34244 provides all of the functions required for the read-write channel of a constant-density hard-disk drive. The IC includes an AGC amplifier, an active filter, a pulse detector, a data synchronizer, a frequency synthesizer, a servo demodulator, an RLL1,7 encoder/decoder with write precompensation, and power management. The IC can operate at a 48-Mbps data rate with a supply voltage as low as 2.7V. \$18.50 (10,000). **Motorola Inc.**, Tempe, AZ. (602) 897-3615. **Circle No. 404**

**256-kbit SRAMs achieve 12-nsec access time.** The L7C199 and L7C199-L 256-kbit SRAMs come in 12-, 15-, and 25-nsec speeds. The 32k-word $\times$ 8-bit devices operate from a 5V supply; inputs and outputs are TTL compatible. Power consumption is <800 mW max at a 25-nsec cycle time. In TTL standby mode, the SRAMs consume 100 mW for the standard version and 50 mW for the

# EDN-NEW PRODUCTS

## INTEGRATED CIRCUITS

low-power version. Using CMOS levels the dissipation drops to 10 mW for the standard version and 1 mW for the low-power version. The L7C199 and L7C199-L cost \$4.92 and \$5.41 (1000), respectively. **Logic Devices Inc**, Sunnysvale, CA. (408) 737-3300. **Circle No. 405**

**Clock-distribution circuit operates from 10 to 125 MHz.** The DA400 clock-distribution chip combines programmable timing generation, phase delay, and eight buffers in one package. The device achieves tight skew tolerance with an internal feedback circuit, which synchronizes the input and output clocks. The feature reduces part-to-part skew in applications requiring multiple clock drivers. Each of the eight outputs has its own programmable phase-delay circuitry with phase delays as short as 250 psec. \$25.50 (5000). **AT&T Microelectronics**, Allentown, PA. (800) 372-2447. **Circle No. 406**

**4-Mbit SRAM family features 3.3 or 5V operation.** The CXK584000 family of asynchronous 4-Mbit SRAMs features 3.3 or 5V operation. The fami-



ly is available in 24 versions, including two power levels, three speeds, and four package types. The 524k×8-bit memory devices use polysilicon thin-film technology to reduce current requirements and increase data retention. The three speed choices include 55, 70, and 100 nsec at 5V ±10%. Access times double when operating at 3.3. A 55-nsec, low-power version costs \$257.10 (1000). **Sony Component Products Co**, Cypress, CA. (800) 288-7679. **Circle No. 407**

**PCMCIA host adapter has DMA support.** The CL-PD6722 dual-slot host adapter provides direct-memory

support for peripherals on the ISA bus. The DMA relieves CPU intervention when large data transfers are required from a PCMCIA I/O-card device. Because the system DMA is designed for moving data from an I/O device to memory, it can complete this task faster, using less bandwidth than the CPU would by doing the equivalent I/O cycles to the card. The adapter requires only 2 square in. to implement a full-slot control subsystem. \$20 (1000). **Cirrus Logic**, Fremont, CA. (510) 226-2261. **Circle No. 408**

**FIFO family meets telecomm-equipment requirements.** The SN74ACT222X FIFO family synchronizes two serial data streams in telecommunications equipment. The dedicated 1-bit FIFOs provide a cost-effective solution to the 4-, 8-, or 9-bit standard FIFOs used to synchronize two serial streams. The devices also support time-division-multiplexing applications in which several asynchronous communication signals are mapped into one higher-rate aggregate signal. In addition, the FIFOs provide elastic store to synchronize the instan-

# We go to great lengths to give

## Dual-circuit stackable mini-switches... new from Grayhill

Double your switching capacity in a fraction of your available board space! That's what these new switches are all about.

Grayhill went to great lengths to develop them—but then, that's not unusual for us. When a customer asked for a truly miniature,

stackable push button switch that was process sealed, we didn't waste a minute. In a matter of weeks, we developed the smallest, most flexible switch on the market. It's been so successful, we now offer it as The Grayhill Series 32.

Features include:

- SPST-N.O. and SPST-N.C.
- Push Button Operation
- Process Compatible — Completely Sealed
- Side-by-Side Stackability
- .272" high x .4" deep, .2" between button centers

Developing innovative new products is one of the ways Grayhill serves you best. To find out more about our new stackable Series 32 mini-switch, call us at 708-354-1040 or fax us at 708-354-2820.

Companion LED and LED Holder available.

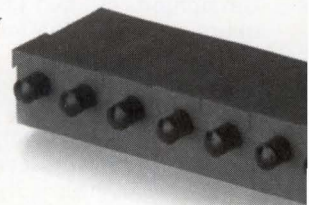



# EDN-NEW PRODUCTS

## INTEGRATED CIRCUITS

taneous difference between multiple clocks. Prices range from \$3.50 to \$6.50. **Texas Instruments Inc**, Denver, CO. (800) 477-8924, ext 4500. **Circle No. 409**

**Switching regulator adds over-temperature protection.** The MIC631 and MIC641 series are pin-compatible, plug-in replacements for MAX631/41 regulators. The MIC631/32/33 use only two external components in power conversion up to 150 mW. The MIC641/42/43, with an external FET, deliver up to 10W of output power. Both series are available in 5, 12, 15, and 3.3V output-voltage versions. A thermal-protection circuit prevents catastrophic IC failure by providing shutdown protection at specified overtemperature levels. With a 5V output, quiescent current is 120  $\mu$ A. In 8-pin DIPs and SOICs, the 5V versions cost \$2.45 (1000). **Micrel Semiconductor Inc**, San Jose, CA. (408) 944-0800. **Circle No. 410**

**T1 device provides SONET speeds.** The TDC5101 high-level data-link controller (HDLC) sends and receives data over public communications networks

at 51.84 Mbps, the rate specified as SONET STS-1. The device interfaces to LANs, such as Ethernet and token ring. It also interfaces to Frame Relay, X.25, and other slower public WANs, including T-1, T-3, E-1, E-2, E-3, and JT-2 WANs. The device has a no-limit packet length, which provides more flexibility than do strictly fixed-length devices. The device also supports fixed-length packets of 300, 2400, or 9600 bytes. \$55 (1000). **Texas Instruments Inc**, Denver, CO. (800) 477-8924, ext 4500. **Circle No. 411**

**Fast SCSI adapter interfaces to PCI bus.** The AIC-7870, a single-chip adapter for mother boards, offers an on-chip 10-MIPS RISC processor that manages all SCSI sequences. Workstations and servers using a 133-Mbps PCI local bus can transfer data at fast and wide SCSI speeds of 20 Mbps. Optional differential cabling lets you transfer data reliably at high speeds. The chip includes a host interface, the SCSI protocol section, a 10-MIPS  $\mu$ P, and a 256-byte FIFO buffer. The chip comes in a 160-pin package. \$39 (OEM). **Adaptec Inc**, Milpitas, CA. (800) 934-2766. **Circle No. 412**

**Fibre-channel set runs full speed.** The EZ-Link chip set runs the Fibre Channel protocol, FC-0 layer at a 1.0625-Gbps data rate. The transmitter and receiver operate at 3.3V, offer TTL I/O levels, and come in 44-pin plastic quad flatpacks. Price for the pair is <\$90 (1000). **Vitesse Semiconductor**, Camarillo, CA. (805) 388-3700.

**Circle No. 413**

**Audio IC handles 16-bit stereo.** Offering all the functions of the Sound Blaster Pro except FM synthesis, the 82C928 costs just \$15 (1000). The device offers interfaces for the Windows Sound System, the AT bus, the OPL-3 and -4, and MIDI. It also has a CD-ROM-drive interface and handles 16-bit data at a 48-kHz data rate. **Opti Inc**, Santa Clara, CA. (408) 980-8860.

**Circle No. 414**

**PCI graphics chip set uses DRAM.** The ALG2301 graphics-accelerator chip set offers autoconfiguring PCI and feature-connector interfaces, a 24-bit RAMDAC, and dual clock generators in a 3-chip set for <\$20. The set uses

# you better ideas in switches.

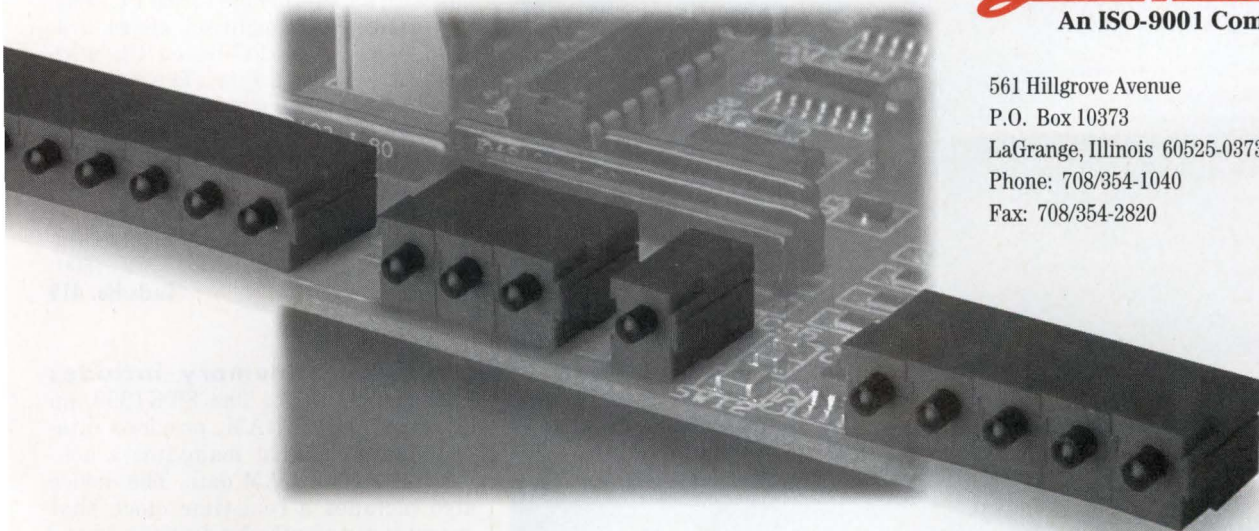

**Grayhill**  
INC.  
An ISO-9001 Company

561 Hillgrove Avenue  
P.O. Box 10373  
LaGrange, Illinois 60525-0373 USA  
Phone: 708/354-1040  
Fax: 708/354-2820

CIRCLE NO. 20

EDN February 3, 1994 • 125

# EDN-NEW PRODUCTS

## INTEGRATED CIRCUITS

256k×4- or×16-bit DRAM and provides resolution to 1280×1024 pixels. BIOS and driver software are available. **Avance Logic Inc**, Fremont, CA. (510) 226-9555. **Circle No. 415**

**PWM controllers operate at 1 MHz.** The UC3823A/B and UC3825A/B family of current-mode controllers typically require a start-up current of 100  $\mu$ A, which makes them ideal for off-line switching power supplies and dc/dc con-

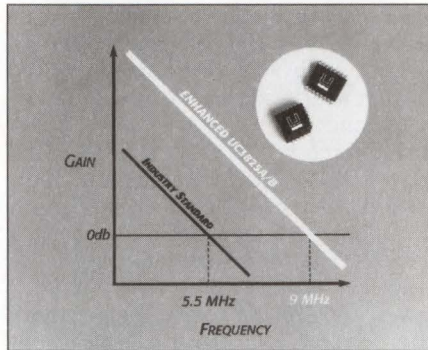

verters. The parts have a 9-MHz unity-gain bandwidth, drive a 2A pk output load, offer leading-edge blanking, and operate in push-pull or single-ended mode. A high-speed overcurrent comparator with a 1.2V threshold sets an internal latch to ensure full discharge of the soft-start capacitor before allowing a restart. From \$3.96 and \$4.73 (1000), respectively. **Unitrode Integrated Circuits Corp**, Merrimack, NH. (603) 424-2410. **Circle No. 416**

# HANSEN

## THE BEST THING GOING.

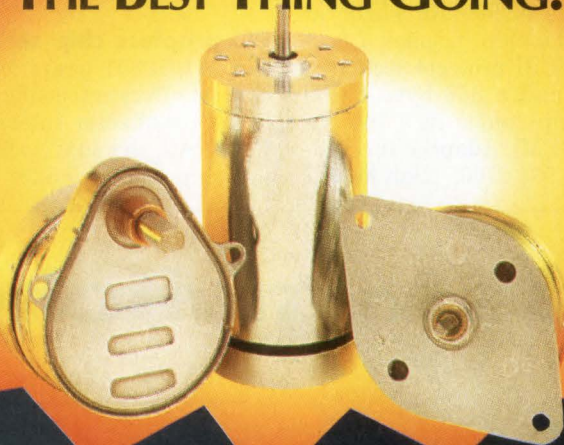

Hansen's precision motors have a reputation for efficient and productive service...even under the most demanding conditions.

**DC Motors.** High performance, long life and reasonable costs are characteristic of Hansen's DC motors, ideally suited for a number of applications.

**Stepper Motors.** Generate precision motion control with a Hansen stepper motor. A wide range of sizes (from 14 through 28) are utilized by our customers in the computer, office machine, medical equipment and automotive industries.

**Synchron Motors.** Hansen is a leader in synchronous motor technology and proudly supplies millions of synchronous motors annually for a variety of applications. Hansen's built-in quality and on-time delivery are supported by our customer service.

We will work with you to custom design the motor for your specific needs and match your application with the correct power source.

Tomorrow's ideas for today's technology...that's what Hansen is all about. Our motors are simply the best things going.



## Hansen Corporation

Hansen Corporation  
A Minebea Group Company  
P.O. Box 23 • Princeton, IN 47670-0023  
Phone: 812-385-3415 • Fax: 812-385-3013

CIRCLE NO. 26

**Single IC embodies key Ethernet functions.** The NCR92C120 contains the Manchester codec, 802.3 AUI, and 10Base-T transceiver logic in a 100-pin plastic quad flatpack. It performs automatic media-type determination and polarity correction. To reduce cost in multiport switching applications, it lacks bus-interface and buffer-management logic. \$14.95 (10,000). **NCR Corp**, Dayton, OH. (800) 334-5454.

**Circle No. 417**

**Voice chip attains consumer pricing.** The ISD1100 is a solid-state analog record and playback device that stores 10 sec of sampled audio. Because it stores the audio as analog charge levels in EEPROM, the device does not need A/D conversion. It contains input and output preamplifiers, AGC, and filters on-chip. Cost is \$5.48 in DIP packages; \$4.18 as bare die (1000). **Information Storage Devices**, San Jose, CA. (800) 332-8638. **Circle No. 418**

**PowerPC chip set offers PCI bus.** Combining a CPU bridge to the PCI bus with an ISA bridge to the PCI bus, the IBM27-82650 chip set allows creation of a Power PC-based PC with local-bus compatibility. The set supports a 64-bit memory bus, operates at 33 MHz on the ISA bus and 66 MHz on the Power PC bus, and includes bus error detection and correction. Cost is \$53 (50,000), and full production is scheduled for April. **IBM Microelectronics**, Hopewell Junction, NY. (800) 426-0181. **Circle No. 419**

**Nonvolatile memory includes real-time clock.** The STK1390, an 8k×8-bit CMOS RAM, provides integral EEPROM that maintains a non-volatile copy of RAM data. The device also includes a real-time clock that operates for months by drawing power from an external capacitor. The device comes in DIP and SOIC packages with

# Quick Just Got Quicker



## 4000 Usable Gate FPGA at over 150 MHz.

A new breed of superfast antifuse FPGA's is blowing away the competition in standard PREP™ benchmarks.

The *WildCat* series of FPGA's from QuickLogic introduces its first member - the *WildCat* 4000. With more than 4000 usable gates this cost-effective *WildCat* flies at an astounding 150 megahertz in the PREP DataPath benchmark.

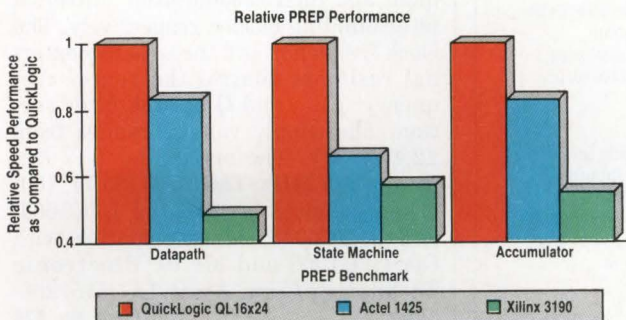

### Free Evaluation Tools

Be one of the first 100 to fax your business card to QuickLogic, and receive our complete suite of powerful software evaluation tools at no cost. This \$3000 value will run simulation and synthesis tests to prove your design and to show off the awesome speed of the *WildCat* 4000.

Look to the company that lives up to its name for fast solutions to today's high speed, high density design requirements. For QUICK response fax us at (408)987-2012 or call 1-800-842-FPGA (3742) to learn more about *WildCat* SuperFast FPGAs.



## QUICKLOGIC

*We Live Up To Our Name*

2933 Bunker Hill Lane, Santa Clara, California 95054

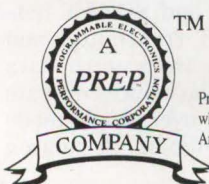

TM

Presentations use or include the most recent PREP PLD Benchmark data which was measured according to Benchmark Suite #1, Version 1.2, dated 3/28/93. Any analysis is not endorsed by PREP.

©1994 QuickLogic Corporation. PREP is a trademark of the Programmable Electronics Performance Company.

# EDN-NEW PRODUCTS

## INTEGRATED CIRCUITS

30-, 35-, and 45-nsec speeds. Prices begin at \$13.99 (1000). **Simtek Corp.**, Colorado Springs, CO. (719) 531-9444.

Circle No. 420

**Clock adapter matches international rates.** Compatible with both the US T1 and European E1 transmission rates, the LXP610 performs clock frequency conversion without using crystal oscillators. The device extracts the incoming data's clock and uses PLL-

based frequency synthesis to match the system's backplane rate. It accepts input clocks between 1.544 and 8.192 MHz, providing 17 selectable input/output frequency combinations. Cost is \$11 (1000). **Level One Communications Inc.**, Folsom, CA. (916) 985-3670.

Circle No. 421

**PC chip set beats Energy Star power restrictions.** The Redwood System controller chips, PT86C618 and

PT86C668, reduce a 486-based PC's power requirements from 150 to 20W peak, 10W average, and 2W standby. The chip set manages system power consumption by monitoring CPU activity and turning off unused system circuits during each clock cycle. It also controls CPU clock speed, slowing the CPU during idle periods. Price is \$30 (10,000). **PicoPower Technology**, San Jose, CA. (408) 954-9898. **Circle No. 422**

**MPEG audio decoder fits in small package.** The SAA2500 MPEG decoder complies with MPEG Layers 1 and 2 and automatically conforms to the audio data rate. It also demultiplexes ancillary data in the audio bit stream. The device has selectable output-data precision from 16 to 22 bits and provides automatic de-emphasis of the decoded audio. Sample cost is \$25. **Philips Semiconductors**, Sunnyvale, CA. (800) 447-1500, ext 3000.

Circle No. 423

# Isokinetics.

## The most effective way to get from "before" to "after."

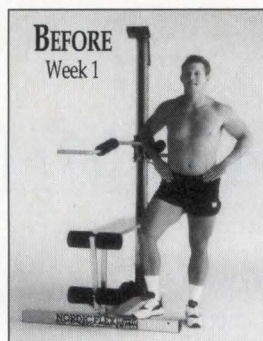

**BEFORE**  
Week 1

<b>Don — Age 27</b>	
<b>Before</b>	<b>After*</b>
Body weight: 194 lbs.	Body weight: 175 lbs.
% Body fat: 11.5%	% Body fat: 6%
Waist: 33 inches	Waist: 31 inches
Arms: 12.5 inches	Arms: 15.5 inches
Chest: 40.5 inches	Chest: 44.5 inches

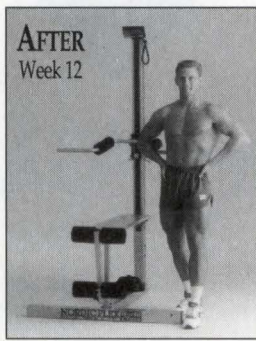

**AFTER**  
Week 12

**NordicFlex Gold®** strength conditioners from **NordicTrack** are unlike any other strength training system available today. Only NordicFlex Gold is designed with a **patented isokinetic resistance mechanism** which has been proven by exercise physiologists to produce results more effectively than free weights or rubber band systems. With just three, 30-minute NordicFlex Gold workouts a week, you can get your own impressive results in only 12 short weeks.

### Increase muscle strength more effectively.

Our exclusive isokinetic resistance system automatically matches the strength you apply during every repetition. Isokinetic resistance engages more muscle fibers than other systems, working each muscle to 100% of its maximum capacity. You get strong — fast.

### Less muscle soreness.

NordicFlex Gold provides **positive-only resistance** which virtually eliminates stress on tendons and connective tissue common to negative resistance systems. The superior, positive-only resistance offered by NordicFlex Gold greatly minimizes after-exercise soreness and shortens your recovery time. You can train harder with less pain.

### Better exercise form for better results.

Only NordicFlex Gold strength conditioners operate with **ergonomically correct linear motion**. This ensures that you maintain proper exercise form and technique at all

times for each targeted muscle group. By successfully isolating each muscle group, you get more effective results and avoid incorrect form or "cheating" movements which can cause injuries.

### Complete training program.

You receive an exclusive workout video and a complete training manual with a detailed daily workout guide. It's like having your own personal trainer. Whether you're experienced or new to strength training and conditioning, you'll have the exact program you need to attain your peak level of fitness.

### Costs less than you'd expect.

With all these advantages, NordicFlex Gold is the best value available. **Our NordicFlex Gold® Pro™ strength conditioner is priced at a low \$699.95.\*\***

Find out how to get from "before" to "after" more effectively with isokinetics. Call **1-800-441-7890** for your **free video and brochure** on our whole line of **NordicFlex Gold** strength conditioners.

Call **1-800-441-7890** ext. 371/34 for a **FREE** video and brochure.

Or write: **NordicTrack, Dept. 87KB4**  
104 Peavey Road, Chaska, MN 55318-2355

Send me a **FREE** brochure  Also a **FREE** VHS videotape  
Name \_\_\_\_\_  
Street \_\_\_\_\_  
City \_\_\_\_\_ State \_\_\_\_\_ Zip \_\_\_\_\_  
Phone (\_\_\_\_) \_\_\_\_\_

©1994 NordicTrack, Inc. A CML Company • All rights reserved.

**ASK ABOUT OUR 30-DAY IN-HOME TRIAL!**

\* Individual results may vary.  
**The Isokinetic Advantage™**

**32**  
total-body  
exercises

Best of all, it's from **NordicTrack!**

**NORDIC FLEX Gold**

CIRCLE NO. 27

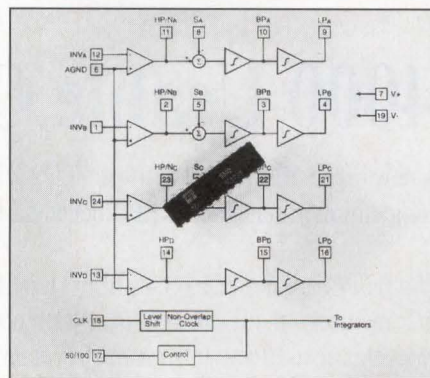

**Dual and quad switched-capacitor filters.** The SC64 and SC60 are 24-pin quad and dual second-order universal filter building blocks, respectively. The clock frequency and three to five external resistors control the center frequency, gain, and Q of each filter section. The supply voltage ranges from  $\pm 2.4$  to  $\pm 9V$ . The maximum clock frequency is 7 MHz. The SC64 (\$5.71, 100) is pin compatible with the LTC1064, and the SC60 (\$2.36) is compatible with the LTC1060 and MF10. **Electronic Technology Corp.**, Ames, IA. (515) 296-7000.

Circle No. 424

**Fiber-optic devices handle ATM.** Applicable to ATM and SONET networks, the ES-9304T transmitter and ES-9216R receiver work with data rates to 622 Mbps. The devices operate in the optical range over single-mode fiber and cost \$1300/pair. A related

\*\*NordicFlex Gold® Pro™ model not shown is priced at \$699.95 with 27 standard exercises. NordicFlex Gold® Medalist™ model shown is priced at \$999.95 with 32 standard exercises. NordicFlex Gold® World Class™ model not shown is priced at \$1,299.95 with 38 standard exercises.

NEW

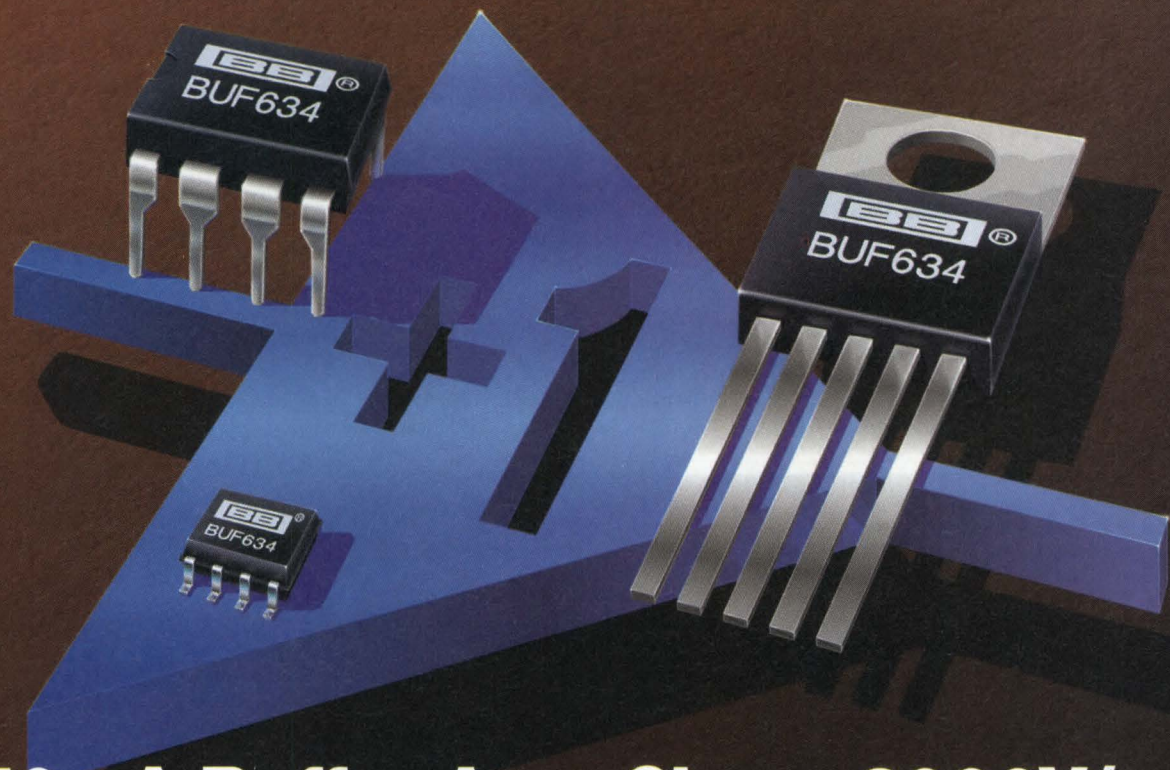

# 250mA Buffer Amp Slews 2000V/ $\mu$ s

## Small But Powerful

BUF634 is a high speed, unity-gain buffer amplifier that delivers 250mA output and 2000V/ $\mu$ s slew rate—all in a tiny SO-8 package. Its low price, high performance, and ease of use make BUF634 ideal for a wide range of applications. It's an excellent driver for valves, solenoids, video, and even headphones.

## Versatile Yet Simple

BUF634 can be used inside the feedback loop of op amps to increase output current, eliminate thermal feedback, and improve capacitive load drive. Its bandwidth can be pin-programmed for 30MHz with 1.5mA quiescent current or boosted to 180MHz with 15mA quiescent current. BUF634 is the simple solution for all your buffer needs.

## Easy And Rugged

BUF634's monolithic design is very rugged—its internal current limit and thermal shutdown protect it from extreme abuse. BUF634 withstands load faults and short-circuits with ease. It's virtually indestructible—you can design-in this device with confidence.

## BUF634 Key Specifications

- Output current..... 250mA
- Slew rate..... 2000V/ $\mu$ s
- Pin-selected bandwidth ..... 30MHz to 180MHz
- Quiescent current ..... 1.5mA (30MHz BW)
- Supply range.....  $\pm 2.25V$  to  $\pm 18V$
- Protection ..... internal current limit, thermal shut-down
- Packages: 8 pin-DIP and SOIC, TO-220, Dice
- From **\$2.60** in 100s

## First One's Free

Try our "worry-free" buffer!  
Call **1-800-548-6132**  
for your **FREE SAMPLE**,  
data sheets, & *High Voltage,*  
*High Current Amplifiers*  
brochure. Or, contact your  
local sales representative.

actual size

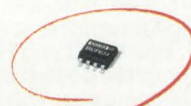

250 mA  
in SO-8!



device, the SDM4123-XC (\$210), combines transmit and receive functions for 155-Mbps applications. **Sumitomo Electric**, Tarrytown, NY. (914) 347-3770. **Circle No. 425**

**Lamp driver controls contrast.** The ML4864 backlight IC produces enough voltage to drive miniature cold-cathode fluorescent lamps and the contrast voltage to power LCDs. Using standard off-the-shelf external compo-

nents, you can set the device's input and output voltage to almost any level within the respective 40 to 20V and 100 to 2000V ranges. You can also set the dc contrast voltage to a positive or negative polarity. The IC features a power-down mode that independently shuts off the high-voltage lamp-drive circuits while maintaining the LCD contrast voltage. In a 20-pin shrink SOP, the device costs \$2.95 (1000). **Micro Linear Corp**, San Jose, CA. (408) 433-5200. **Circle No. 426**

## Low and high pass filters for real signals

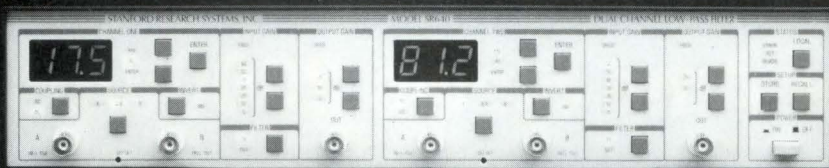

**SR640 dual channel low-pass filter**  
**SR645 dual channel high-pass filter**  
**SR650 combination high/low-pass filter**  
**Programmable, 115 dB/octave rolloff.**

**\$2990.**

The SR640, SR645 and SR650 offer unique combinations of filter specifications, preamplifier performance, and programmability at a price far less than other instruments. Featuring two fully independent 8-pole, 6-zero elliptic filters with less than 0.1 dB p-p passband ripple and 115 dB/octave rolloff, these filters are ideal for general purpose signal processing as well as anti-aliasing for digital signal processing systems.

The GPIB and RS232 interfaces allow complete control of all instrument settings via computer. The microprocessor components are optically isolated from the filter sections to provide optimum noise performance.

Whether your needs are for laboratory benchtop filters or signal conditioning filters in data acquisition systems, the SR640, SR645 and SR650 are the natural choices.

### SR640, SR645, SR650

1 Hz to 100 kHz cutoff frequency  
 3 digit frequency resolution  
 0.1 dB passband ripple  
 115 dB/octave rolloff  
 80 dB stopband attenuation  
 4 nV/√Hz input noise  
 ±0.5° phase match at  $f_c$   
 60 dB prefilter gain  
 20 dB postfilter gain  
 GPIB, RS232 interfaces standard



### Stanford Research Systems

1290 D Reamwood Avenue, Sunnyvale, CA 94089  
 TEL (408) 744-9040 FAX 4087449049  
 TLX 706891 SRS UD

CIRCLE NO. 28

## SHORTS

Semtech (Newbury Park, CA, (805) 498-2111) has upgraded its EZ Dropper line of dc/dc converters. The new ICs provide a wider current range—10 mA to 1A—than the original design's 200 mA to 1A. The company has also added a low-current—5- to 250-mA—version to the line.

**Circle No. 427**

The \$100 TB310I test board provides a quick way to evaluate Ericsson Components' (Richardson, TX, (214) 907-7911) PBL3774 and PBL3775 switch-mode (chopper) constant-current drive ICs. The board drives two bipolar stepper motors in full-, half-, and quarter-step modes. Advanced users can also implement one-third- and one-fifth-step modes. **Circle No. 428**

RF Monolithics Inc's (Dallas, TX, (214) 233-2903) family of single- and dual-port SAW resonators cover frequencies from 224.3 to 433.9 MHz. Nonlicensed wireless applications use these frequencies internationally. **Circle No. 429**

Analog Devices (Wilmington, MA, (617) 937-1428) is filling out its offerings of single-supply op amps. The OP-495 (\$3.95 (100)) rail-to-rail output amplifier is a quad version of the OP-295. The OP-113 (\$1.60 (100)) and -413 (\$5.35 (100)) are single and quad versions, respectively, of the OP-213 dual-precision amplifier. **Circle No. 430**

Logic Devices Inc has added the 10-nsec, 16-bit LPR200 8-level and LPR201 7-level pipeline registers to its product family (\$10). **Circle No. 431**

S-MOS Systems is offering its ASIC customers a quad flat-pack package with integral copper heat sink and heat spreader. The package handles 2.4W without airflow; 7W with. **Circle No. 432**

Semtech Corp now serves as an alternate source for select power ICs from Motorola, Unitrode, and Silicon General. **Circle No. 433**

Brooktree Corp is offering an \$1800 developer's kit for creating video capture, video playback, and graphics accelerator cards with its Bt885 CacheDAC and Bt812 video-decoder ICs. **Circle No. 434**

## KEYS TO SUCCESS

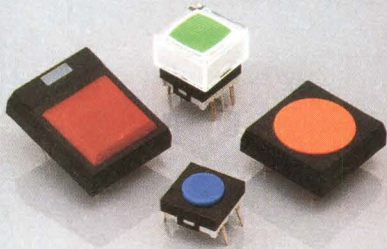

Dome contact, low profile keypad switches. Lighted & non-lighted, round & square. Sub-surface mounting types. Up to 5 million actuations.

## FLAWLESS LOGIC

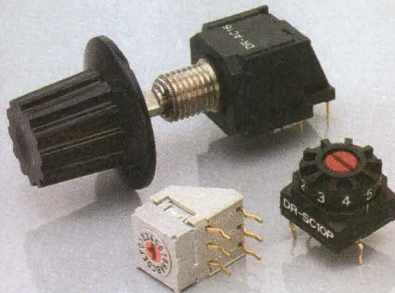

Real or complement coded, decimal or hexadecimal dip rotaries. Screwdriver, shaft or dial actuation. Washable.

## WASH AND GO

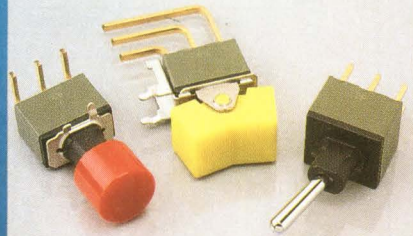

NKK washables lead the way with the industry's widest range of circuits, actuators, terminals & accessories. Micro thru std. sizes.

## LITTLE GIANTS

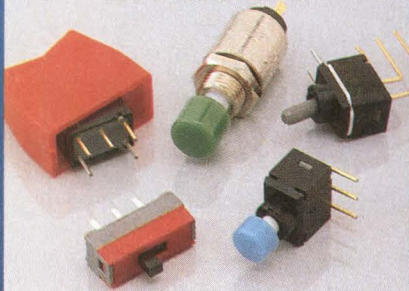

NKK pioneered the smallest. Toggles, rocker, pushbutton, slides. Washables, SMDs, anti-static & STC contacts available.

## FREE DESIGN TOOL

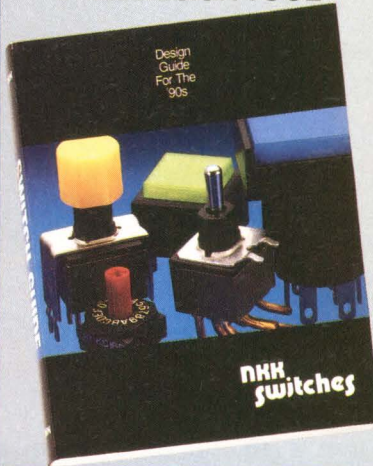

## LIGHT FANTASTICS

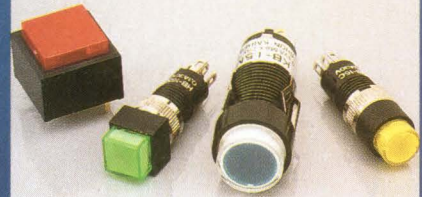

Tiny, but bright. Low-profile snap-in or panel mounting. Numerous actuators, circuits, ratings, terminals and colors.

## WAYS TO GLOW

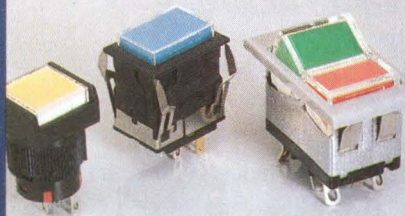

Round, square, rectangle shapes. In all popular colors. Wide choice of terminals, circuits, lamp types & accessories.

## POINTS OF LIGHT

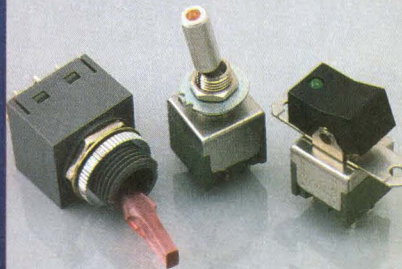

Lighted toggle and paddle tips add style and function to designs. Several actuator and circuit options.

## STAY ON TOP



The latest surface mount technology. Washable, vapor phase solderable toggles, pushbuttons and dip rotaries. Gull-winged terminals.

# DESIGN PARTNERS

We have exactly what every design engineer needs — over one million switch options and more than 40 years of switch know-how. Before you start your design-in, call for our 456-page Design Guide, then call on our experience. Make sure your design-ins go flawlessly. Make NKK your design partner right from the start. Call NKK Switches, (602) 991-0942 7850 E. Gelding Dr., Scottsdale, AZ 85260 FAX (602) 998-1435.

**NKK**<sup>®</sup>  
**switches**

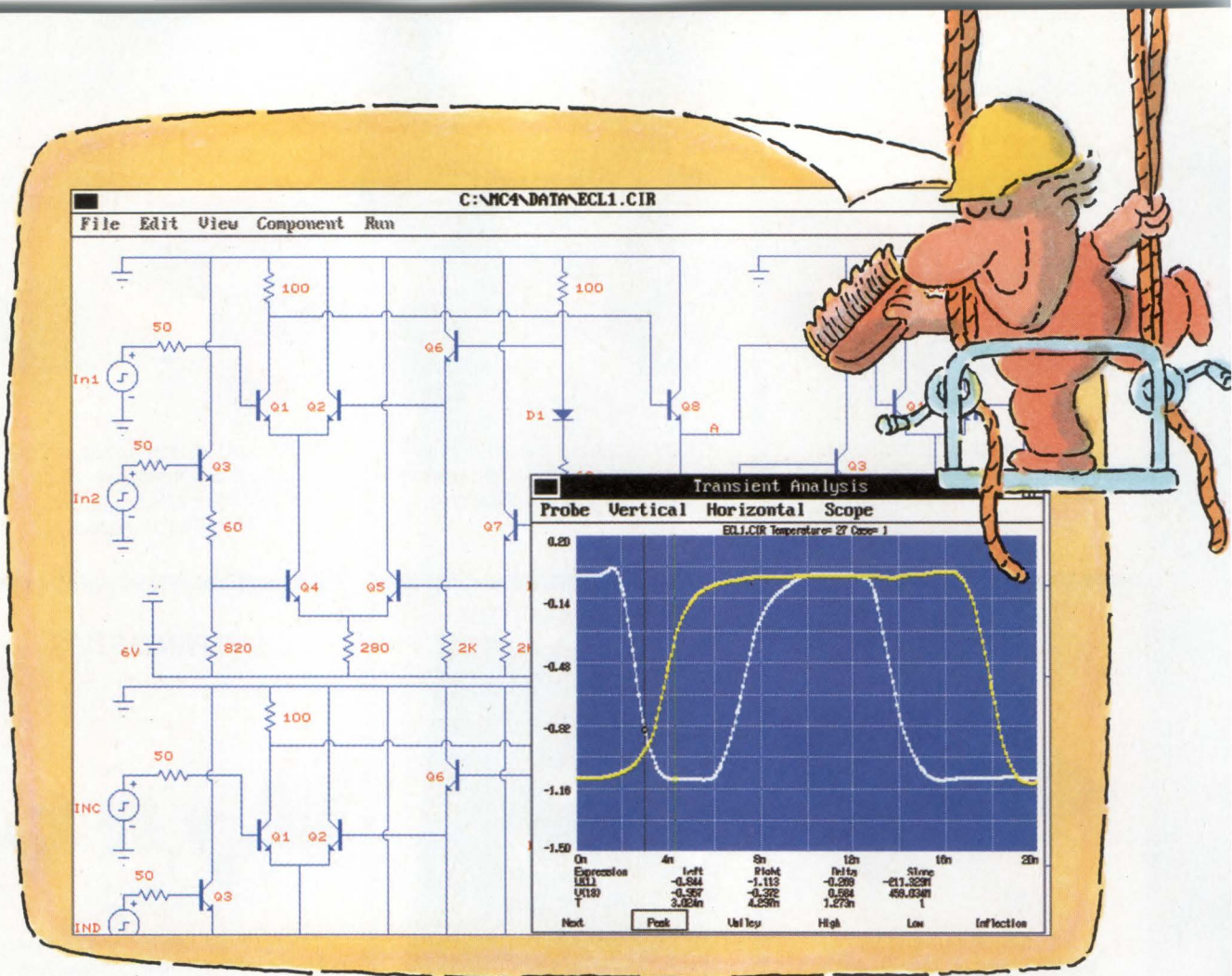

# INTRODUCING MICRO-CAP IV.™ MORE SPICE. MORE SPEED. MORE CIRCUIT.

PC-based circuit analysis just became faster. More powerful. And a lot easier. Because MICRO-CAP IV is here. And it continues a 12-year tradition of setting CAE price/performance standards.

Put our 386/486 MICRO-CAP IV to work, and you'll quickly streamline circuit creation, simulation and edit-simulate cycles — on circuits as large as 10,000 nodes. In fact, even our 286 version delivers a quantum leap upward in speed. Because, for one thing, MICRO-CAP IV ends SPICE-file-related slowdowns; it reads, writes and analyzes SPICE text files and MC4 schematic files. It also features fully integrated schematic and text editors. Plus an interactive graphical interface — windows, pull-down menus, mouse support, on-line HELP and documentation — that boosts speed even higher.

Now sample MICRO-CAP IV power. It comes, for example,

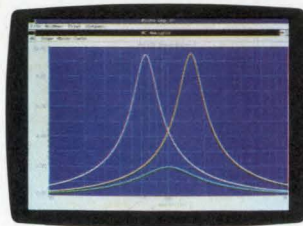

AC Analysis

from SPICE 2G.6 models plus extensions. Comprehensive analog behavioral modeling capabilities. A massive model library. Instant feedback plotting from real-time waveform displays. Direct schematic waveform probing. Support for both Super and Extended VGA.

And the best is still less. At \$2495, MICRO-CAP outperforms comparable PC-based analog simulators — even those \$5000+ packages — with power to spare. Further, it's available for Macintosh as well as for IBM PCs. Write or call for a brochure and demo disk. And experience firsthand added SPICE and higher speed — on larger circuits.

**spectrum**

1021 S. Wolfe Road  
Sunnyvale, CA 94086  
(408) 738-4387 FAX (408) 738-4702



## Mixed-signal simulator accepts multilevel models

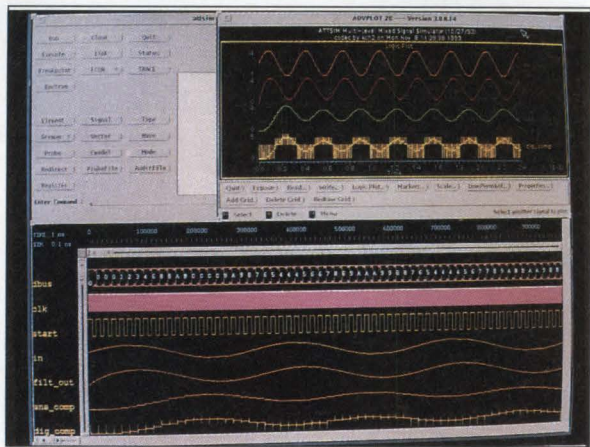

Using ATTSIM, designers can simulate complete mixed-signal systems by combining abstract behavioral models with detailed device models for the circuit's analog and digital portions.

The ATTSIM Multi Level Mixed Signal Simulator lets you simulate mixed analog-digital systems using any combination of Spice, VHDL (VHSIC Hardware Description Language), C, behavioral, and gate-level models. The simulator is equally capable of performing simulations of large analog or digital designs.

Because the simulator accepts all different levels of models, it suits both top-

down or bottom-up design methodologies. You can start at a high level of abstraction and gradually move down into more detailed logic descriptions; or you can opt to complete the detail design of a crucial subsystem and then simulate the remainder of the system around it. The simulator also offers the flexibility to use the modeling level that is most appropriate for speed vs accuracy as you simulate a system.

In addition to the company's model libraries,

the software supports Logic Modeling's Smart Models as well as the ATTSIM ModelWriter, which generates analog, digital, and mixed-signal models in C. The ATTSIM mixed-level simulator will be available in March. A single CPU license for Sun SPARC or HP 700 series systems costs \$65,000.—**Doug Conner**

*AT&T Design Automation, Murray Hill, NJ. (908) 582-4083. Circle No. 373*

## PLD design tool adds VHDL synthesis

Max+Plus II version 4 adds VHDL (VHSIC Hardware Description Language) synthesis to its PLD design capabilities. The new software takes advantage of 32-bit operating systems and runs on Windows 3.1, Windows NT, and Unix workstations. For engineers unfamiliar with VHDL, the software provides VHDL templates and integrated on-line help. When synthesizing logic from a VHDL description, the software uses different optimization techniques, depending on which family of the company's PLDs you have. The synthesis tool takes advantage of architectural features specific to the PLD you are using.

The new release also provides timing and area information to Synopsys synthesis tools; thus, users of the tools can opt to trade off speed

vs area to meet design requirements.

Max+Plus II version 4 is a free upgrade to users with maintenance agreements. VHDL synthesis (PLSM-VHDL) is not included in the upgrade; it costs \$3995 for PCs and \$6995 for Sun HP and DEC systems.—**Doug Conner**

*Altera Corp, San Jose, CA. (408) 894-7000. Circle No. 374*

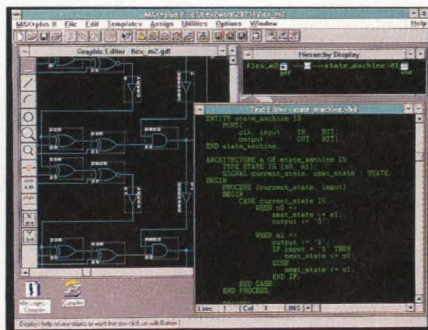

Max+Plus II software supports a hierarchical, top-down design methodology, integrating schematics and VHDL in a context-sensitive environment.

## FREE INFO, FREE POSTAGE

Use our postage-paid reader-service cards to get more information on any of these products.

**VHDL simulators offer presynthesis model development.** The VHDL System Simulator Family (VSS) includes the VSS Professional and VSS Expert simulators. VSS Professional for presynthesis-model VHDL development and system verification combines interpreted and compiled simulation engines. VSS Expert includes all the features of VSS Professional, plus a gate-level signoff simulation engine and system-level modeling capability. VSS Professional costs \$13,000, and VSS Expert costs \$24,000. **Synopsys Inc**, Mountain View, CA. (415) 962-5000.

Circle No. 375

**Digital circuit simulator finds minimum and maximum timing problems.** The PLogic simulator performs worst-case timing analysis using the range of delays specified by the IC manufacturer. This simulator finds problems that slip through simple single-delay analysis tools. The simulator also finds and flags setup and hold or worst-case timing violations. The software provides non-encrypted libraries of more than 1800 digital devices and lets you model devices directly from data-book specifications. Design Center with PLogic includes schematic capture and starts at \$3250 on PCs and \$14,000 on Sun workstations. **MicroSim Corp**, Irvine, CA. (714) 770-3022.

Circle No. 376

**Electromagnetic-analysis program simulates 3-D designs.** The EMC electromagnetic-analysis program simulates finite elements and predicts EMI, crosstalk, and coupled-eddy currents at any number of frequencies or for any time-domain problem. EMC runs on HP, IBM, SGI, and Sun workstations. The software costs \$19,950; you can lease it for \$950/month. **Aries Technology**, a division of MacNeal-Schwendler Corp, Lowell, MA. (508) 453-5310.

Circle No. 377

**VHDL-1076 simulator achieves high gate-level simulation performance.** The Vulcan simulator supports the IEEE VHDL-1076 and VHDL-VITAL ASIC modeling standards. VITAL defines a set of VHDL

# Birth of a Winner

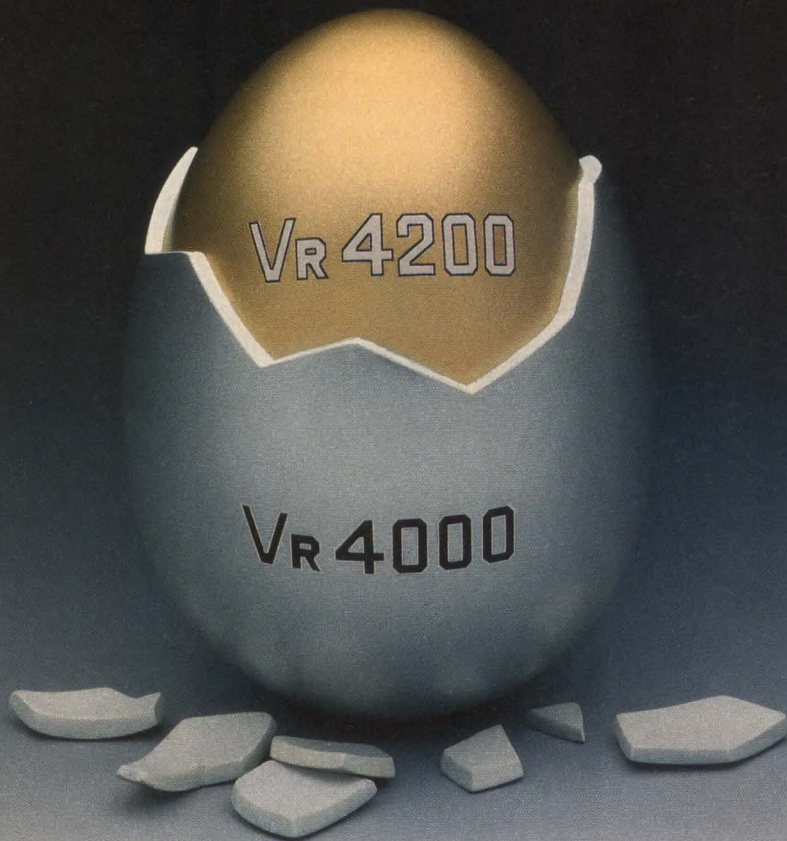

## **VR4000 performance at 1/5 the price.**

First we raised performance with the VR4000, the world's first 64-bit RISC microprocessor. Now we're slashing costs with the VR4200. A full-featured 64-bit RISC microprocessor at 1/5th the original cost, the VR4200 offers everything you need to be a winner in low-end workstations, X-terminals, Windows NT portable computers and embedded applications.

The VR4200 is paced by an 80MHz

internal clock. It delivers 55 SPECint92 and 30 SPECfp92. It incorporates a 16K-byte instruction cache and an 8K-byte data cache. Implemented with a 0.6µ triple-layer CMOS process and a smaller die, it runs on 3.3V and consumes only 1.5W. The VR4200 is available in a low-cost 208-pin plastic QFP or 179-pin ceramic PGA. It maintains hardware and software compatibility with the VR4000.

The VR4200 lets you build desktop capabilities into laptop and notebook computers. In combination with our RABBIT chip set (an I/O controller and memory controller for synchronous or Rambus DRAM), the VR4200 provides a cost-effective hardware platform for Windows NT.

For a winning combination of price, performance and power consumption, check out the VR4200, today.

\* The VR4200 was developed jointly with MIPS Technologies, Inc. Windows NT: Trademark of Microsoft Corp.

**For fast answers, call us at:** USA Tel:1-800-366-9782. Fax:1-800-729-9288. Germany Tel:0211-650302. Fax:0211-6503490. The Netherlands Tel:040-445-845. Fax:040-444-580. Sweden Tel:08-753-6020. Fax:08-755-3506. France Tel:1-3067-5800. Fax:1-3946-3663. Spain Tel:1-504-2787. Fax:1-504-2860. Italy Tel:02-6709108. Fax:02-66981329. UK Tel:0908-691133. Fax:0908-670290. Ireland Tel:01-6794200. Fax:01-6794081. Hong Kong Tel:886-9318. Fax:886-9022. Taiwan Tel:02-719-2377. Fax:02-719-5951. Korea Tel:02-551-0450. Fax:02-551-0451. Singapore Tel:253-8311. Fax:250-3583. Australia Tel:03-8878012. Fax:03-8878014. Japan Tel:03-3454-1111. Fax:03-3798-6059.

# NEC

# EDN-NEW PRODUCTS

## ELECTRONIC DESIGN AUTOMATION

primitives that are typically in ASIC cell libraries. It also defines a modeling style and a method for associating timing information with the cell primitives. The result is fast gate-level simulation that the company claims is comparable to Verilog-XL. Vulcan will be available initially on Sun and HP workstations starting at \$20,000. **GenRad Inc**, Concord, MA. (508) 369-4400. **Circle No. 378**

**Thermal models for Motorola components.** Motorola is creating 3-D thermal models of its components for use with Flowmerics Flowtherm computational-fluid-dynamics software. The models let you simulate and develop cooling methods before building the hardware. A Flowtherm software license costs \$11,000/year. **Flomerics Ltd**, Surrey, England. +44 (0)81-547 3373. **Circle No. 379**

**CAD system offers mechanical CAD compatibility.** The CADnexion software program offers support for electronic and mechanical CAD methods. It helps designers of high-fre-

quency circuits precisely define physical structure. CADnexion runs on PCs and starts at \$4995. **Bay Technology**, Aptos, CA. (408) 688-8919.

**Circle No. 380**

**System speeds prototyping for DSP designs.** The Paradigm RP modular system lets you use FPGAs, RAM, ROM, DSP, and microprocessor cores to emulate systems. The initial offering suits DSP systems but allows you to emulate other systems. Paradigm RP starts at \$60,000. **Zycad Corp**, Fremont, CA. (510) 623-4400.

**Circle No. 381**

**ECAD tool lets you graphically create Verilog models.** Working in a graphical design environment, you can create Verilog behavioral models by describing events and the corresponding reactions of a model. DesignVision graphically represents a behavioral model as a collection of threads. Each thread represents a series of events and actions. As each event occurs during simulation, the software performs a corresponding action. All threads are

active at once. The graphical-threads representation eases your ability to see separate operations that occur simultaneously. DesignVision is initially available on Sun Sparc systems for \$15,000. **Vista Technologies Inc**, Schaumburg, IL. (708) 706-9300 **Circle No. 382**

**Document-management system runs under Windows.** The AutoEDMS document-management system for Windows lets you find, store, manage, retrieve, view, and print virtually every type of drawing, document, and image. The software provides document tracking to meet ISO 9000 requirements. AutoEDMS for Windows starts at \$895. **ACS Telecom**, Lomita, CA. (310) 325-3055. **Circle No. 383**

**EPLD-design software costs \$89.95.** XEPLD version 4.1 is a design tool for Xilinx XC7000 family of erasable programmable logic devices (EPLDs). The software interfaces to logic compilers, such as ABEL, CUPL, and Palasm. **Xilinx, Inc**, San Jose, CA. (408) 559-7778. **Circle No. 384**

# POWR-LOK CONNECTION SYSTEMS

## POWER AMPEATER CONTACTS

5.0 Millimeter Contact Grid Pattern  
25 Amperes Continuous Load, All Contacts

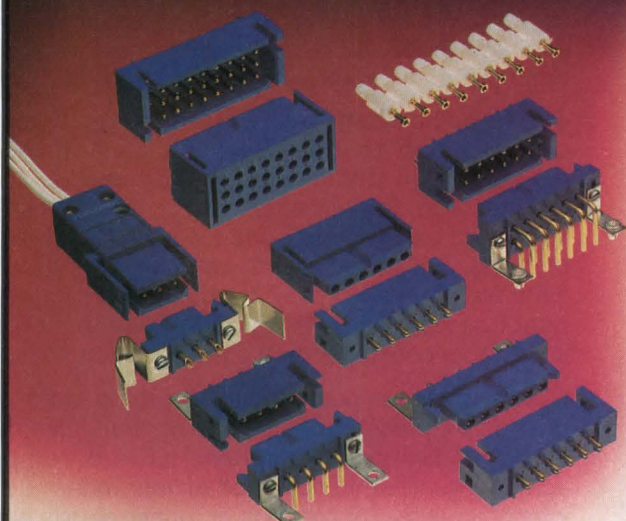

**POWER SOURCE TO PRINTED BOARD BUS with Minimum Heat generated at contact connection surfaces due to unique design of LARGE SURFACE AREA contact mating system.**

**CONTACTS:** Removable, machined of solid copper alloy. Male contacts can be varied to permit sequential mating to eliminate initial power overload. **PLATING:** Gold. **TERMINATIONS:** Crimp, Press-fit and solder style, 12 AWG (4.0mm<sup>2</sup>) wire maximum. Printed board mount, straight or 90° angled, mother-daughter board or board to board sandwich connection systems. **INSULATORS:** Glass filled polyester. Twelve contact variants, 3 through 24 contacts; one, two and three contact rows. **POLARIZATION:** Connector body keyed for alignment and correct coupling. **SHROUDS:** Male contacts protected with plastic shroud. **BLIND MATING:** Hardware option provides for 0.100 inch lead in. **LOCKING SYSTEM:** Powr-Lok system, easy to lock and unlock. **CABLE ADAPTORS:** Strain reliefs. **MOUNTING:** Panel and printed boards. **ENVIRONMENTAL SEALING:** Sealed connectors meet MIL-STD-810 immersion. **WORKING TEMPERATURE:** -55° C to +125° C. **CRIMPING TOOLS:** Automatic and manual. **NORMS:** U.L., CSA and Bauart Mart recognized.



**POSITRONIC INDUSTRIES, INC.**

423 No. Campbell Ave. • P.O. Box 8247 • Springfield, Mo. 65801  
Tel. 417-866-2322 • Fax 417-866-4115

**800-641-4054**

# EDN-NEW PRODUCTS

## ELECTRONIC DESIGN AUTOMATION

**Model simulates PowerPC.** This model of the PowerPC 603  $\mu$ P for Cadence's Verilog-XL and Leapfrog VHDL simulators, costs \$4900 and runs on IBM and Sun workstations. **Motorola**, Austin, TX. (512) 891-2839.

Circle No. 385

**VHDL simulator accepts Verilog models.** Cadence's Leapfrog VHDL simulator directly imports Verilog models. The option interfaces to Logic Modeling's SmartModels and hardware models. From \$12,000; Leapfrog 1.1 starts at \$20,000. **Cadence Design Systems**, San Jose, CA. (408) 943-1234.

Circle No. 386

**Windows-based tool offers drawing viewing and markup.** ForReview for Windows lets you view and mark up drawings. A limited version, ForView, does not let you save the drawing markups. ForReview costs \$495; ForView costs \$295. **Advanced Technology Center**, Laguna Hills, CA. (714) 583-9119

Circle No. 387

### SHORTS

Intusoft is offering a Spice bulletin-board service (BBS) on Compuserve. The BBS provides models, technical-application notes, software utilities, and demonstration software. It is under the CADD/CAM/CAE vendor forum. **Intusoft**, (310) 833-0710.

Circle No. 388

Model Technology's V-System/Workstation VHDL simulator supports Logic Modeling's SmartModel Library, which simplifies simulation of system-level designs. **Model Technology**, (503) 641-1340.

Circle No. 389

Harris EDA offers design kits for Texas Instruments' high-density-interconnect (HDI) MCM technology. **Harris EDA**, (716) 924-9303.

Circle No. 390

Mentor Graphics has introduced a high-speed board-design kit for Intel's Pentium processor chip set.

The kit includes logic symbols, mapping files, geometry, signal-integrity-I/O models, thermal models, reference layout for the core logic, and electrical rules. The design kit is free and works with the Mentor Graphics Board Station 500 timing-driven layout system. **Mentor Graphics**, (503) 690-2093.

Circle No. 391

OrCad is planning to act as an OEM for Model Technology's VHDL simulator for Windows. **OrCad**, (503) 671-9500.

Circle No. 392

Data I/O is offering users of the ABEL version 4 software a 60% discount to upgrade to the company's Synario universal-FPGA-design system. The discount applies to the base Synario product, which costs \$2995, and the PLD library kit, which costs \$995. ABEL version 3.2 or earlier users will receive a 40% discount. **Data I/O**, (206) 881-6444.

Circle No. 393

# Modular Keyboard Solutions



RK 90 short-travel keyboard with NEMA 13 sealing



RS 74/76 keyboard switch modules



RF 15/19 flat-panel switch and indicator modules



Industrial Electronic Engineers, Inc. has joined forces with Rafi GmbH & Co. to provide a unique modular approach to high performance data entry keyboards.

Our Keyboard Team offers a wide range of modular switches and keyboards with excellent design flexibility, high quality construction and reliability. We can provide cost-effective custom panels and keyboard assemblies based on standard switch modules and indicators. Whether you need sealed full-travel data entry type keyboards or rugged flat panel assemblies with selective illumination and interchangeable legends, we have the solutions.

IEE also provides completely integrated data entry and display assemblies utilizing our full line of standard flat panel displays. IEE is a company uniquely qualified to satisfy all of your man-machine interface needs. For catalogs or further details please call, fax or write to us.



INDUSTRIAL ELECTRONIC ENGINEERS, INC.  
7740 Lemona Avenue  
Van Nuys, California 91409-9234  
Tel (818) 787-0311 Ext. 418 • Fax (818) 901-9046

Immediate, Circle No. 30

Reference, Circle No. 120

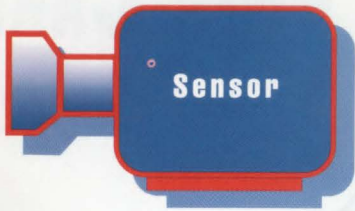

**THE BETTER  
WAY TO GET  
FROM HERE...**

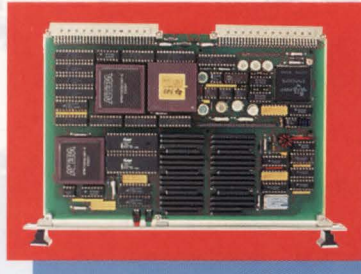
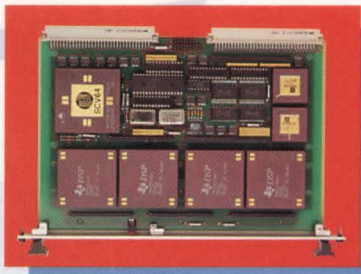
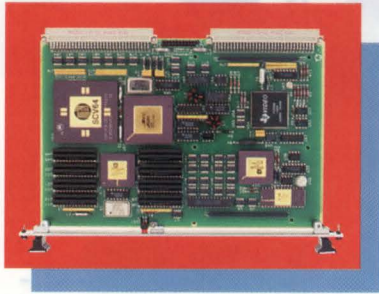

**TO HERE.**



DY 4 Systems Inc



# DY 4 INTRODUCES THREE VME CARDS

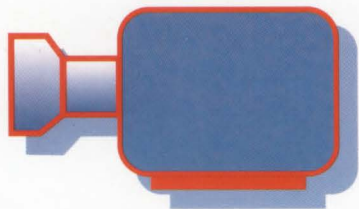

## SENSOR

- video
- radar
- sonar

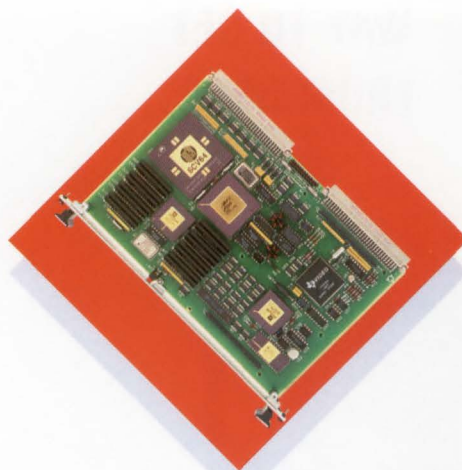

## 674 FRAME-GRABBER

- Frame capture/display
- Scan-rate conversion
- 35M samples/sec, 8 bits, 3 inputs
- Supports 16-bit digital video input
- Optional on-board TMS320C40
- RGB output to 1024 x 1024 x 8
- Built-In-Self-Test

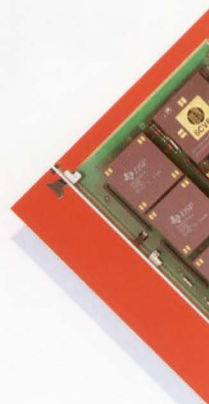

*DY 4 introduces an off-the-shelf integrated solution that can take data from sensors right through to a video display terminal. Our Frame Grabber, Quad 'C40 DSP and Graphics Controller work together seamlessly to capture*

*data from one or more sensors, process the findings and display them in real-time.*

## FRAME-GRABBER

The 674 frame-grabber, operates at 35M samples per second, and has its own C40 on board for extra processing power. Whether its grabbing video, radar or sonar data, the 674 offers high-performance signal data capture and manipulation in real-time.



## THREE CARDS = ONE INTEGRATED SUBSYSTEM.

By utilizing a high-speed 50M bytes/sec image bus, DY 4 delivers VMEbus integrated "vision processing" for multi-C40 and frame grabber applications. The benefit to you? With DY 4 resolving the hardware integration issues, you can concentrate on building a better application. Here are some of the features of this high-performance triple-card set.

## QUAD 320C40 DIGITAL SIGNAL PROCESSOR

A 50M bytes/sec image bus can link multiple frame grabbers to multiple 442 Quad 'C 40-based digital

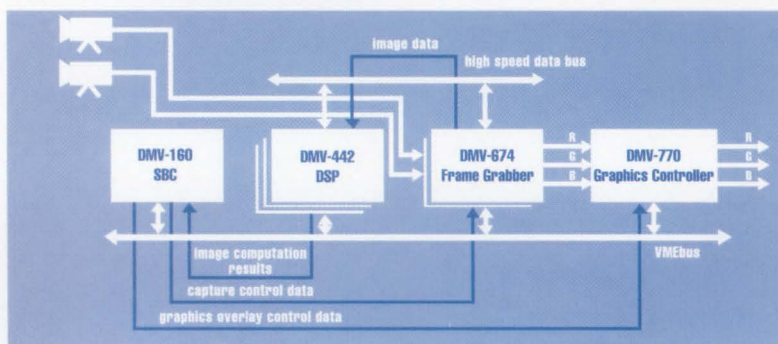

*Demonstration of complete image solution: 674 captures sensor video; 770 displays video within window on high-res display; imagebus link to 442 DSP used for real-time image analysis.*

signal processors. Using four Texas Instruments 320C40 DSP devices running at 40 MHz, the DY 4 Quad 'C40 has been designed with the military environment in mind. It's fast, cost-effective, reliable, and 100%

# THAT CAN DO WONDERS FOR YOUR IMAGE.

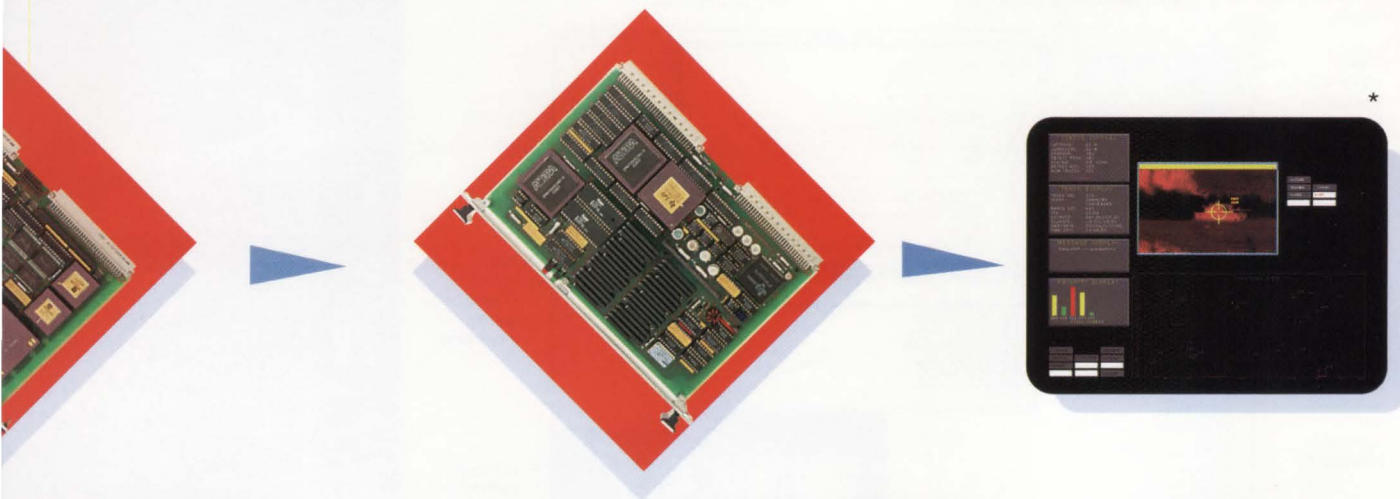

## 442 QUAD 'C40 DSP

- Four 40 MHz TMS320C40 digital signal processors
- 4M bytes to 16M bytes total SRAM
- High speed 50M bytes/sec multi-master image bus
- Inter-processor mailbox interrupts
- Externally accessible 'C40 Com ports
- Built-In-Self-Test

## 770 GRAPHICS CONTROLLER

- 34020 Graphics System Processor
- Color overlay on RGB or mono video input
- RGB output to 1280 x 1024 x 8
- Optional support for dual display or flat panel
- X-Windows, CGI, or RTGS graphics firmware
- Built-In-Self-Test

## VIDEO

- live video in a window
- color on color overlay
- X-windows

software compatible from commercial to Mil.

## 770 GRAPHICS CONTROLLER

The 770 Graphics Controller, offers single-board high-resolution graphics generation. Based on the 34020 Graphics System Processor, the card offers 1280 x 1024 resolution graphics on color analog overlay, and optional mezzanine cards for dual display or flat-panel display outputs.



## COMPREHENSIVE SOFTWARE DEVELOPMENT ENVIRONMENT

As you'd expect from DY 4, each card comes with a comprehensive set of card-level diagnostics and other commonly requested OS drivers and application software packages. The Quad 'C40 DSP also features Ada support from Tartan, C, C++, a set of optimized signal/vector processing libraries, and the Toolsmiths CASEworks™ development environment (more on CASEworks on the back of this insert!). The 770 graphics controller comes with a choice of graphics software: an Ada/C real-time driver RTGS, X-Windows, or CGI.

*DY 4 invites you to discover more about the better way to get your data from the sensor to the screen. All the technical details are just a phone call away. Call DY 4 Systems at:*

*USA (East) 603-595-2400; USA (West) 408-377-9822; Europe 0222-747927; Asia/Pacific and Canada 613-596-9911.*

## FROM COMMERCIAL TO MILITARY...

*As with all DY 4 VMEbus products, these three cards feature 100% software and electrical compatibility, from commercial right up to Mil spec. This ensures that the application software you design on our SVME commercial boards will work exactly as expected, no matter how far up the specification ladder your application needs to climb.*

**100% SOFTWARE COMPATIBILITY**

Mil

Rugged

Commercial

\* Application display provided by Gallium Software Inc.

## SOFTWARE DEVELOPMENT SUPPORT, WITH CASEworks™

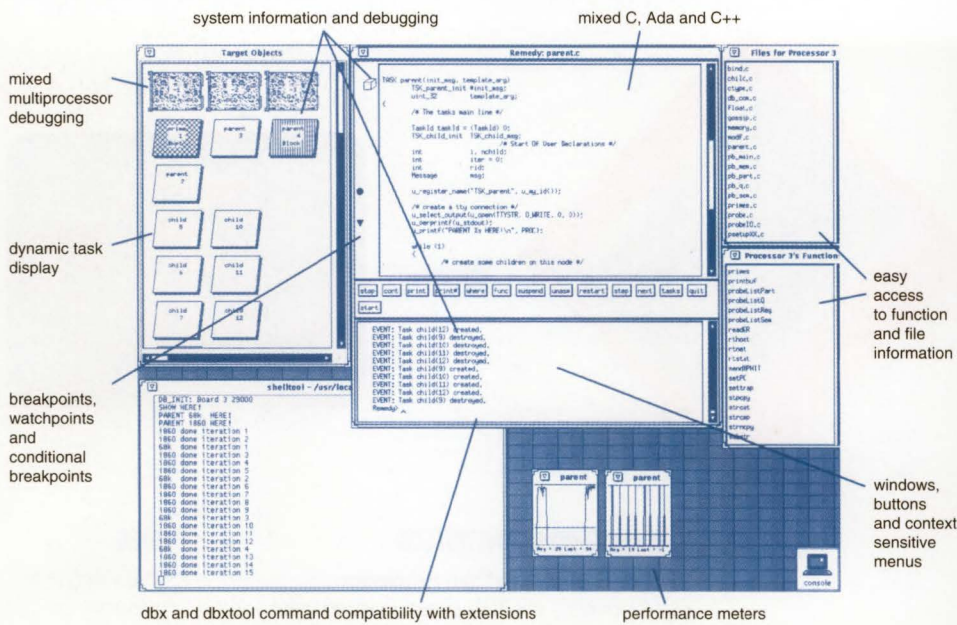

DY 4's Quad 'C40 DSP, the processor at the heart of our integrated three-card set, features Toolsmiths CASEworks™, a software development environment that helps you develop and produce better products faster, more easily, and at a lower cost. The CASEworks Remedy™ debugger, shown here, offers target debugging with dynamic displays, multiple windows, buttons, menus and mixed multiprocessor support. Fault isolation, diagnosis and system control have never been easier.

CASEworks is an example of DY 4's continuing commitment to software development support... and one more persuasive reason to make DY 4 your VME supplier of choice.

The DY 4 triple-card set has been designed to work with DY 4's broad product line:

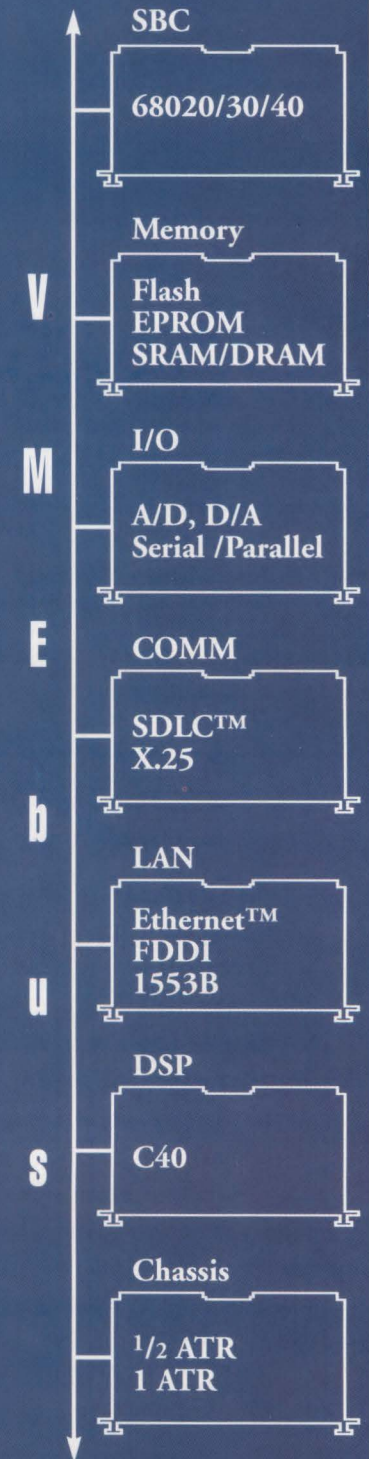

**DY 4 Systems Inc**  
**Customer First,**  
**Quality Always**

**DY 4 Systems Ltd.**  
 USA West: Tel: 408-377-9822  
 Fax: 408-377-4725  
 USA East: Tel: 603-595-2400  
 Fax: 603-595-4343

**DY 4 Europe**  
 Tel: 0222-747927  
 Fax: 0222-762060

**DY 4 Canada**  
 Tel: 613-596-9911  
 Fax: 613-596-0574

**DY 4 Asia/Pacific**  
 Tel: 613-596-9911  
 Fax: 613-596-0574

For more information about how we can help you, call the number of our office nearest you, or fill out the accompanying business reply card.





# If You're Looking For Product Acceptance In North America, UL Holds The Key.

THE BIG NEWS TODAY IS THAT UL IS ACCEPTED ALL ACROSS CANADA. AND WITH THE SIGNING OF A COOPERATIVE ASSISTANCE AGREEMENT WITH THE ASOCIACION NACIONAL DE NORMALIZACION Y CERTIFICACION DEL SECTOR ELECTRICO (ANCE), THE FIRST INDEPENDENT STANDARDS AND PRODUCT CERTIFICATION ORGANIZATION ACCREDITED BY THE MEXICAN GOVERNMENT — UL IS THE FIRST ORGANIZATION OF ITS KIND TO OFFER MANUFACTURERS ACCESS TO CERTIFICATIONS FOR ALL OF NORTH AMERICA.

AND SINCE UL PROVIDES CERTIFICATION THAT ALLOWS IMMEDIATE ACCEPTANCE ACROSS THE ENTIRE UNITED STATES, SAVING TIME AND MONEY TO GAIN ACCEPTANCE ACROSS NORTH AMERICA HAS NEVER BEEN EASIER.

IN FACT, NO OTHER SAFETY CERTIFICATION SERVICE CAN DELIVER WHAT UL PROVIDES. AND BECAUSE WE OPERATE AS A NOT-FOR-PROFIT ORGANIZATION, YOU CAN BE ASSURED THAT OUR PRIMARY OBJECTIVE REMAINS SAFETY.

SO IF YOU'RE LOOKING FOR ONE SOURCE THAT NOT ONLY HANDLES PRODUCT SAFETY CERTIFICATION ACROSS THE UNITED STATES, BUT ALSO FACILITATES EXPANDING YOUR PRODUCTS' ACCEPTANCE BEYOND THE BORDERS, WE CAN HAND YOU THE KEY.

U.S. HEADQUARTERS: BARBARA OLDS  
PHONE: 708-272-8800, EXT. 43319  
FAX: 708-272-9562

CANADA: JOHN WOODS  
PHONE: 819-671-0527  
FAX: 819-671-0527



**Underwriters Laboratories Inc.®**

ACCREDITED AS A CERTIFICATION ORGANIZATION BY THE STANDARDS COUNCIL OF CANADA.

SONY

## VISUALIZE WHAT YOUR PC CAN DO.

Video communications will be the hottest selling feature of tomorrow's PC's. The ingredients for which are available right now in packages as small as 1/4". Just add an optical system to Sony's CCD and supporting Chip Set for a first rate, on-board camera featuring high-quality Hyper HAD<sup>®</sup> technology. Formats are NTSC/PAL color and EIA/CCIR B&W. Supporting IC's for the CCD operating system include video signal processors in either color or B&W. Plus you get Sony's acknowledged expertise in video processing, just by calling 1-800-288-SONY.

It's a nice arrangement: We make the chips, you make the history.



©1993 Sony Electronics Inc. Sony and Hyper HAD are trademarks of Sony. Sony has a large selection of other CCD's available for immediate application in medical video cameras, surveillance cameras, 2D barcode readers, machine vision and B&W object or character recognition systems.

CIRCLE NO. 85

## IDE cache controller boosts disk-I/O rates

The BusLogic KT-410A, 910A, and 510A IDE cache controllers for the VL, PCI, and ISA buses, respectively, greatly increase the throughput of data between disk drives and a system processor. The PCI- and VL-bus versions transfer data at 5 Mbytes/sec on the disk side and 20 Mbytes/sec on the system side. The ISA version has a transfer rate of 5 Mbytes/sec on both sides.

Each controller connects a system to four IDE drives, each storing as much

as 4 Gbytes, and two floppy-disk drives. You can configure the controllers to provide disk mirroring or linking. The controllers require the addition of DRAM cache memory in 256-kbyte, 1-Mbyte, or 4-Mbyte SIMMs. You can mix and match different-capacity SIMMs for a total of 512 kbytes to 16 Mbytes of cache. The VL, PCI, and ISA versions cost \$175, \$255, and \$105, respectively.

—Gary Legg

*BusLogic Inc, Santa Clara, CA. (408) 492-9090.*

**Circle No. 369**

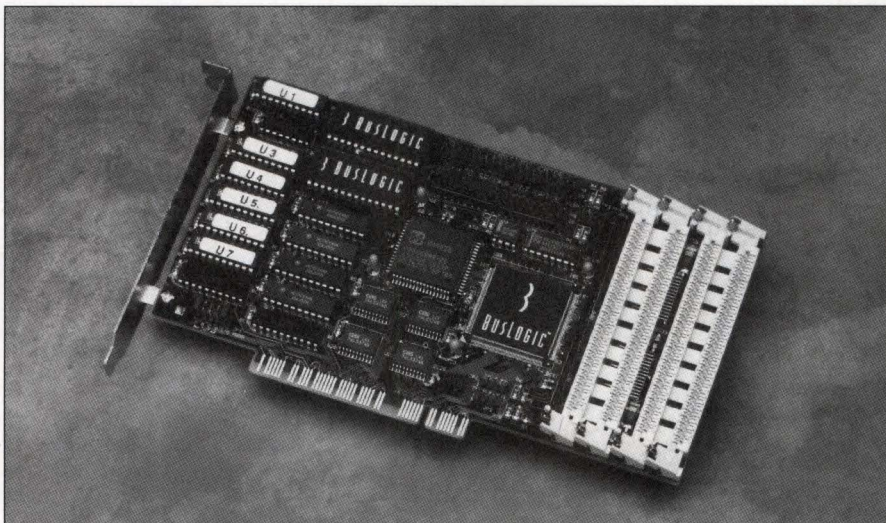

IDE cache controllers from BusLogic Inc increase disk-I/O rates to as much as 20 Mbytes/sec.

## SCSI adapter for PCI bus processes 2000 I/O requests/sec

QLogic's QLA1000-PI SCSI host-adaptor board for the PCI bus processes 2000 I/O requests/sec while queuing 1600 requests/sec. It provides burst data transfers at 132 Mbytes/sec and sustained transfers of 20 Mbytes/sec.

The board achieves its performance via the company's ISP1020 SCSI coprocessor that has dual on-chip processors. One processor controls SCSI-bus protocol; the other, a 16-bit RISC processor, handles data flow and

related commands. The board is ASPI- and CorelSCSI-compatible and is available with drivers for DOS, Windows, Windows NT, NetWare, SCO Unix, and OS/2. \$289 (1); <\$200 (OEM).

—Gary Legg

*QLogic Corp, Costa Mesa, CA. (714) 438-2200.*

**Circle No. 370**



## Quality Choices from Mueller

Now, Mueller gives you a choice of over 1000 test leads and accessories - over 100 brand new designs - and your choice of functionality. Choose test leads designed to meet your individual needs, offered in a wide range of constructions.

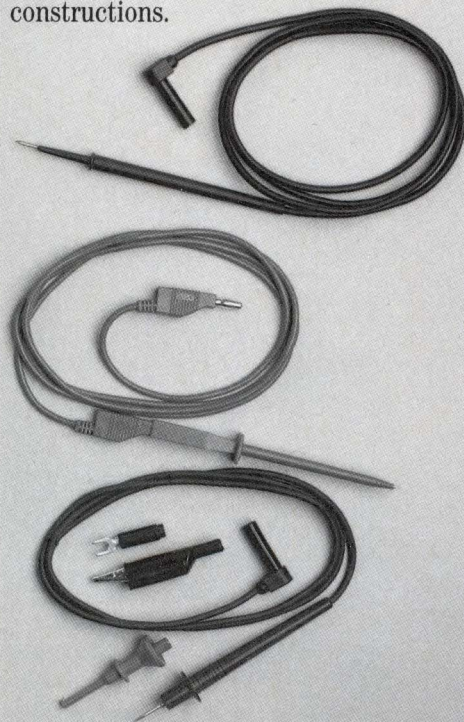

## Mueller

1583 East 31st. St., Cleveland, Ohio 44114  
Phone (216) 771-5225 • Fax (216) 771-3068

**FREE!** New, 72-page catalog includes over 100 new products, plus 1320 established items, all grouped by test application. For custom-designed test leads contact our Product Information Group.

**CIRCLE NO. 31**

**139**

# Our Power Module is Dual... theirs is only single output!

- **Low Cost DC-DC Converters**  
*Single Outputs \$104 / Dual Outputs \$149*
- **Dual Isolated Outputs**  
*28 Standard Models / Special Voltages Available*
- **Wide Input Voltage**  
*Four Series / 18-380 VDC Input*
- **Parallel Operation**  
*Fixed Frequency 100kHz  
True Redundancy Operation*
- **100 Watts**

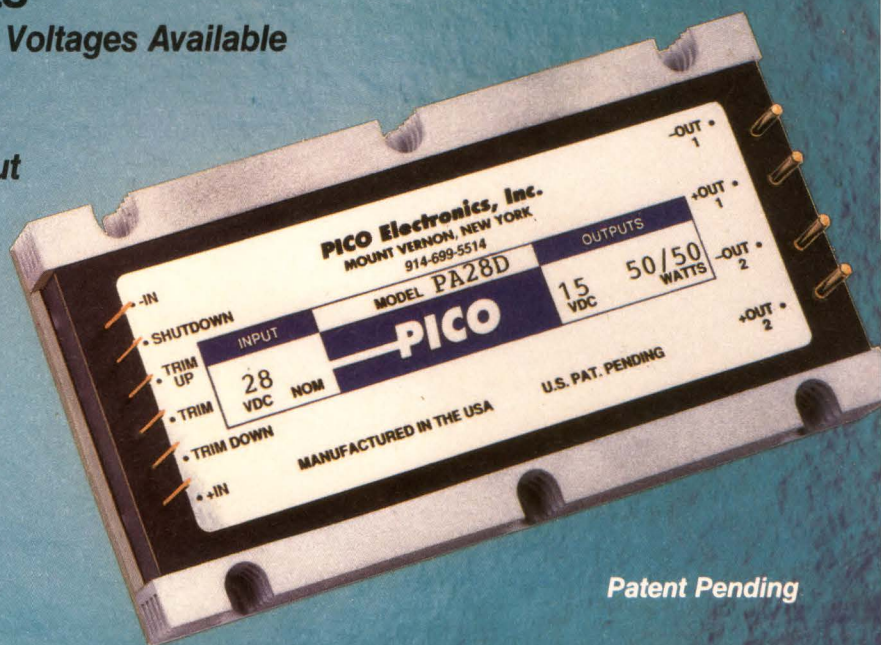

Patent Pending

The availability of DUAL ISOLATED OUTPUTS creates cost and space savings in many applications.

Fully safeguarded for over voltage, over temperature and continuous short circuit protection, these FIXED Hi-Frequency units minimize technical problems.

With output voltages from 3.3VDC to 100VDC, four distinct input ranges and the choice of single or dual outputs plus the capability of Parallel Operation, as standard features, your circuit designs can be optimized.

Assembled in the U.S.A. with PICO quality components, these hi density units allow the most stringent mechanical, electrical and environmental requirements.

FAX or call today for immediate engineering assistance, product information or FREE catalog.

**PICO Electronics, Inc.**

453 N. MacQuesten Pkwy., Mt. Vernon, N.Y. 10552

Call Toll Free

**800-431-1064**

in New York Phone 914-699-5514

FAX 914-699-5565

# EDN-NEW PRODUCTS

## COMPONENTS

**Protected quad high-side MOSFET driver operates from 8 to 60V.** The LT1161 quad MOSFET driver has four ruggedized n-Channel MOSFETs that have a 100% voltage margin in 24 and 28V systems. Each switch sports an internal charge pump, obviating external components to boost the MOSFET's gate 12V above the supply rail. Each channel has overcurrent protection and an internal reset timer. The device's current limit, delay time, and automatic restart period are externally programmable. \$3.15 to \$2.44. **Linear Technology Corp**, Milpitas, CA. (408) 432-1900. **Circle No. 439**

### FREE INFO, FREE POSTAGE

Use our postage-paid reader-service cards to get more information on any of these products.

and voltages range from 500 to 1.5 kV dc. \$0.15. **Cornell Dublier**, New Bedford, MA. (508) 996-8564. **Circle No. 441**

**Ultrafast power diodes switch in 30 nsec.** The HiPerFRED line of fast-recovery epitaxial diodes (FREDs) offers a 30-nsec switching speed and

guaranteed avalanche-power rating of 13 kW. These 1-kV devices exhibit 20- $\mu$ A leakage. The devices' soft-recovery factor is 1. These diodes combine elements of Schottky and PIN-diode construction. \$4.14 (1000). **IXYS Co**, Santa Clara, CA. (408) 962-0670. **Circle No. 442**

**Superflexible coaxial cables bend around 1-in. radius.** Three  $\frac{3}{8}$ -in., 50 $\Omega$  coaxial cables can carry high power around tight bends without losing their specified characteristic impedance. The jacketed ETS2-50T cable and unjacketed



**Thermocouple clamps directly around hot pipe.** The stainless-steel Pipe Clamp Sensor fits pipe diameters from 1 to 6 in. The sensor accepts common thermocouples that measure temperatures up to 1500°F. A connector allows you to leave the sensor in place between measurements. \$25. **Electronic Development Labs Inc**, Danville, VA. (800) 342-5335. **Circle No. 440**

**Silvered-mica snubbers quash 100,000V/ $\mu$ sec transients.** The Snubber Mike line of silvered-mica capacitors handle 3.7-kA peak currents and 8.7A steady state. These units exhibit unmeasurable changes in capacitance over frequency and temperature and withstand millions of "shots" without degrading. Capacitances range from 100 pF to 0.01  $\mu$ F,

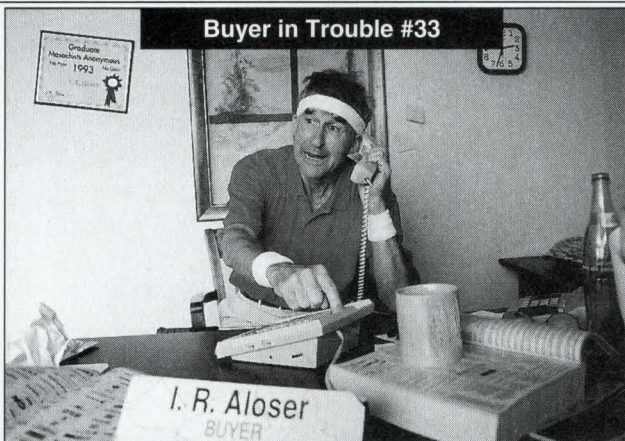

### "You're Gonna Deliver When?!!"

When is St. Patrick's Day? I promised Rocky in production they would be here last week!

(CLICK!) Hello...Hello...

I shoulda called Prem for pc power transformers. I hear they deliver when you need them,

I really shoulda called Prem.

You oughta call Prem!"



## PREM®

Where Quality Really Counts!

For Prem's new catalog or additional product information, call or write Prem Magnetics, Inc.  
3521 North Chapel Hill Road, McHenry, IL 60050.  
Phone: 815-385-2700. FAX: 815-385-8578.

CIRCLE NO. 32

# Sipex

SIGNAL PROCESSING EXCELLENCE

## Programmable PC/AppleTalk™ Multi-mode Transceiver

- Single Chip RS232 and AppleTalk
- Multiple Drivers and Receivers
- Driver Tri-state Control
- Software Selectable Modes
- 28-pin SOIC packaging

The **SP303** is the industry's first Programmable RS232/AppleTalk Serial Transceiver. Featuring Driver Tri-state Control, and software mode selection, the **SP303** is ideal for expanding interface capabilities for Printers, Modems, PCs....

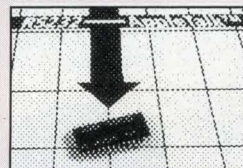

TM AppleTalk is a trademark of Apple Computer

Call for your Free Samples Today! (508)-667-8700

# Sipex

SIPEX Corporation • 22 Linnell Circle • Billerica MA 01821 • Tel: 508-667-8700 • Fax: 508-670-9001

CIRCLE NO. 33

EDN February 3, 1994 • 141

# EDN-NEW PRODUCTS

## COMPONENTS

ETS2-50 cable can carry over 1.15 kW at 1 GHz. The attenuation of the two is 4.24 dB/100 ft. Type FSJ2-50 has an attenuation of 4.09 dB/100 ft and can carry 0.452 kW at 1 GHz. The cables require a special N connector (\$35). FSJ2-50 \$2.64/ft., ETS2-50T \$11.14/ft. **Andrew Corp.**, Orland Park, IL. (708) 349-3300. **Circle No. 443**

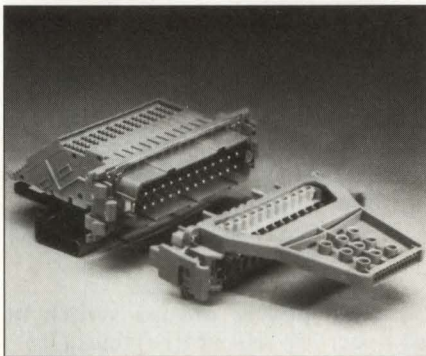

**Field wiring unplugs from connector block.** Rail-mounted, multipole connector blocks combine a multipin,

polarized connector with a terminal block. The blocks mount on TS32 and TS35 DIN rails and are certified to ISO 9001. Available versions accept screw terminals or crimps and can carry as much as 16A at 600V. Blocks feature 6, 10, 16, 24, 40, or 64 pins. \$17 to \$75. **Wieland Inc.**, Burgaw, NC. (919) 259-5050. **Circle No. 444**

**Dual, common-mode choke helps token-ring boards meet FCC EMI requirements.** The PE-67539 (surface-mount) and PE-65740 (through-hole) dual, common-mode chokes provide -40-dB performance from 5 to 200 MHz. The chokes help token-ring LAN pc boards meet EMI specs. \$2 (1000). **Pulse Engineering**, San Diego, CA. (619) 674-8100. **Circle No. 445**

**Insulation-displacement connector features 2x2-mm pitch.** The TCMD series of double-row connectors have 0.020-in. square, phosphor-bronze pins. The units' capacities range from two to 25 positions per row. Notch and position polarization are available. A resulting cable assembly is 0.20 in. tall and mates with the company's surface-mount and through-hole connectors. \$0.06/pin (1000); delivery, five days ARO. **Samtec Inc.**, New Albany, IN. (312) 944-6733. **Circle No. 446**

**Trimming capacitor has axial leads.** The 10-pF, half-turn RD10 trimming capacitor measures 0.14 in. in diameter and is 0.06 in. tall. Its dc working voltage is 25V, and its withstand voltage is 50V dc. The unit's Q at 1 MHz is 400, and its temperature coefficient is -50±100 ppm/°C. \$0.24 (100,000), delivery stock to five weeks. Sample kits available. **Voltronics International Corp.**, Denville, NJ. (201) 586-8585. **Circle No. 447**

**Sockets shrink spacing to 0.70 in.** A series of 0.070-in. pin-to-pin, shrink-DIP sockets suit lower cost, less-demanding applications. The sockets housings are UL94V-0 glass-filled thermoplastic. Contact pins are tin-plated phosphor bronze. The sockets are available with 16, 22, or 24 pins on 0.300-in. centers; 24, 28, or 30 pins on 0.400-in. centers; 40 or 42 pins on 0.600-in. centers; and 64 pins on 0.700-in. centers. The 64-pin socket costs \$0.40 (5000), delivery stock to six weeks ARO. **Aries Electronics Inc.**, Frenchtown, NJ. (908) 996-6841. **Circle No. 448**

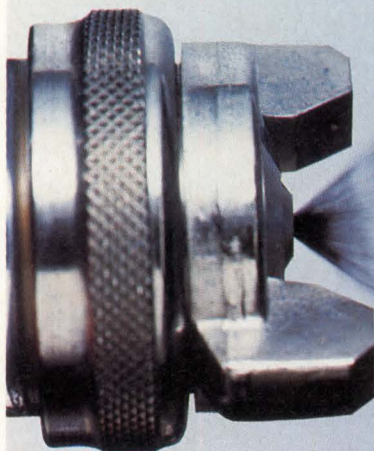
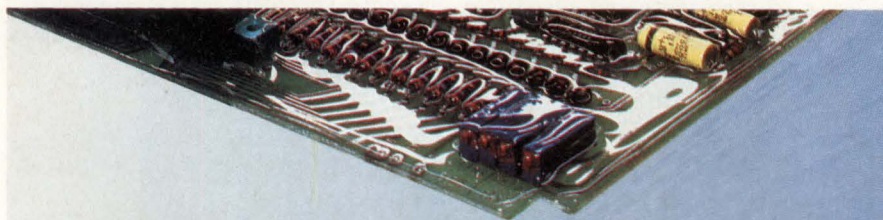

## ECCOCOAT® Conformal Coatings.

All the  
performance  
you need without  
all the solvents.

Everything you want in a one-component conformal coating is in the complete line of ECCOCOAT® products from Grace Specialty Polymers.

- Solvent free for low VOCs
- Easy to apply with dip, spray, flood or brush methods
- Complete line of chemistries and cure options
- MIL Spec listed and UL rated
- Reduced material and handling costs

Plus, ECCOCOAT UV-7900 is the only UV coating in the industry with a reliable secondary moisture cure — providing excellent cure under every component.

All you need to do now is call Grace Specialty Polymers — the company with a global perspective.



## GRACE Specialty Polymers

North America  
Woburn, MA  
(800) 832-4929

Europe  
Westerlo, Belgium  
+32-(0)14-57 56 11

Asia-Pacific  
Atsugi, Japan  
(81) 0462-25-8800

©1994, W.R. GRACE & Co. - Conn.

CIRCLE NO. 34

# Astronomical resolution

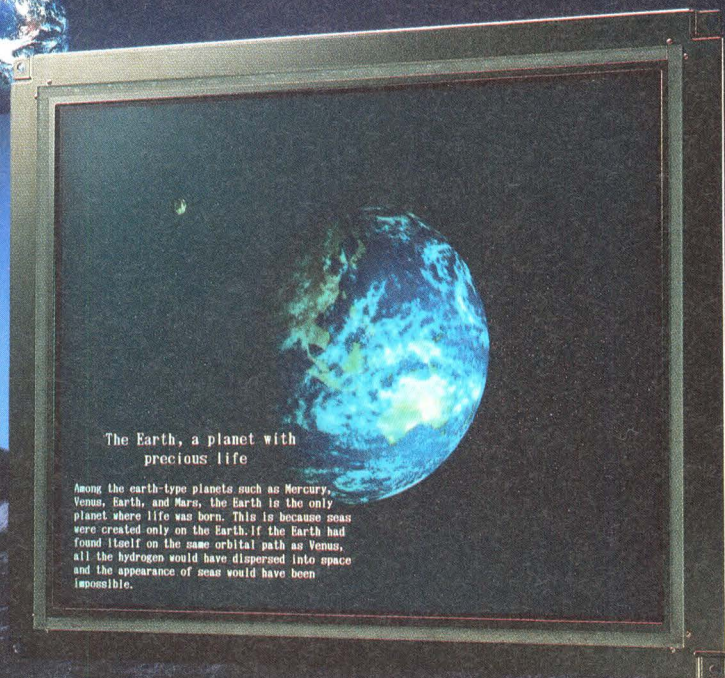

The Earth, a planet with  
precious life

Among the earth-type planets such as Mercury, Venus, Earth, and Mars, the Earth is the only planet where life was born. This is because seas were created only on the Earth. If the Earth had found itself on the same orbital path as Venus, all the hydrogen would have dispersed into space and the appearance of seas would have been impossible.

**For out-of-this-world resolution,  
explore the first 33cm color LCD with  
1,280 x 1,024 pixels.**

With almost four million transistors controlling each RGB dot, our new 33cm (13-inch) color LCD gives you resolution so high it's astronomical — 1,280 x 1,024 pixels arrayed at a 0.201mm pitch.

Higher resolution is just one result of NEC's leadership in thin-film-transistor (TFT), active-matrix-driven color LCDs. We're committed to this technology because it gives users a clear advantage in color, contrast, luminance, response and

viewing angle. As a major producer, we supply the OEM market with a wide choice of TFT color LCDs, including 640 x 480-pixel types.

Flat, lightweight, and low in power consumption, color LCDs are destined to dominate the display market. If you want to give your PC, workstation or multi-media terminal a visible advantage, take a good look at our TFT color LCD technology today.

**The right components to build your reputation.**

**For fast answers, call us at:** USA Tel:1-800-366-9782. Fax:1-800-729-9288. **Germany** Tel:0211-650302. Fax:0211-6503490.  
**The Netherlands** Tel:040-445-845. Fax:040-444-580. **Sweden** Tel:08-753-6020. Fax:08-755-3506. **France** Tel:1-3067-5800. Fax:1-3946-3663.  
**Spain** Tel:1-504-2787. Fax:1-504-2860. **Italy** Tel:02-6709108. Fax:02-66981329. **UK** Tel:0908-691133. Fax:0908-670290. **Ireland** Tel:01-6794200.  
**Singapore** Tel:253-8311. Fax:250-3583. **Australia** Tel:03-8878012. Fax:03-8878014. **Japan** Tel:03-3798-6148. Fax:03-3798-6149.

# NEC

# PICO

Free  
136 pg.  
catalog

SURFACE MOUNT  
& PLUG-IN  
TRANSFORMERS  
& INDUCTORS

## DC-DC CONVERTERS

- Surface Mount • PC Board Mount
- Low Profile • Single and Dual Output
- Isolated • Industrial to Military
- up to 1000 Volts

## AC-DC POWER SUPPLIES

- Linear • Switchers • Open Frame
- Low Profile • Up to 200 Watts

## New HIGH POWER DC-DC CONVERTERS

- New Isolated **DUAL** Outputs
- Wide Input Voltage Range
- Regulated 100 Watts

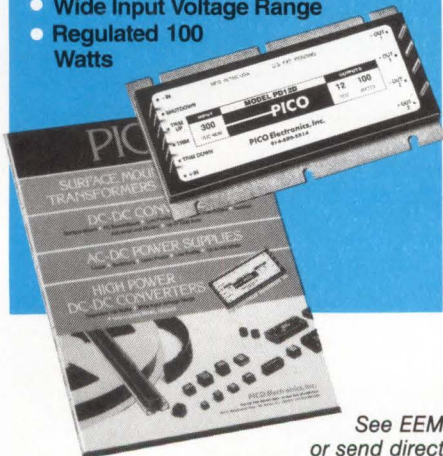

See EEM  
or send direct  
for **Free PICO Catalog**.  
Call toll free **800-431-1064**  
in NY call **914-699-5514**  
FAX **914-699-5565**

**PICO Electronics, Inc.**

453 N. MacQuesten Pkwy., Mt. Vernon, N.Y. 10552  
CIRCLE NO. 3

## EDN-NEW PRODUCTS COMPONENTS

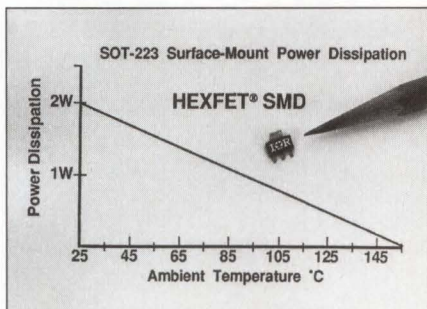

**Surface-mount package dissipates 1W optimally.** The SOT-223 surface-mount package occupies 30% less pc-board space and is 30% lower in height than other 1W packages. The package resembles a standard SOT package but has an enlarged drain connection. The company supplies power FETs in the SOT-223 package. The package lowers device prices by 10% compared with other packages. **International Rectifier**, El Segundo, CA. (315) 322-3331. **Circle No. 449**

**Resistor network surface mounts.** The Narrow Body Resistor Network model 4900P measures 0.150 in. wide. The surface-mount devices come in 8-, 14-, and 16-pin models. Both bused and isolated resistors are available. \$0.20. **Bournes Inc**, Riverside, CA. (909) 781-5140. **Circle No. 450**

**Snubber circuit's porcelain-on-steel substrate dissipates substantial heat.** Using an enameled-steel substrate, a snubber circuit dissipates 5W at 25°C (linearly derated to 0W at 105°C). Snubbers with chip capacitors can withstand 50V pk; units are available with disk capacitors having a 1000V-pk withstand voltage. (Plain power resistors made with the same porcelain-enamel-on-steel substrate are also available in 10, 15, 20, 50, and 100W ratings.) Snubber: \$0.47 (1000), delivery 10 to 12 weeks ARO. **Ohmite**, Skokie, IL. (708) 675-2600. **Circle No. 451**

**Low-cost 40-MHz converter draws 80 mW.** The model HI1171 40-MHz D/A converter's differential nonlinearity is 0.25 LSB, and integral nonlinearity is 1.3 LSB max. The device decodes and latches inputs before converting them. Glitch energy measures 30 pVsec. Differential gain and phase noise are 1.2 and 0.2% typ, respectively. \$3.86 in a 24-pin SOIC (1000). **Harris Semiconductor**, Melbourne, FL. (800) 427-7747, ext 7138. **Circle No. 452**

**WE'VE  
EXAGGERATED  
HOW MUCH  
CALCULATING  
POWER IS  
IN NEW  
MATHCAD PLUS 5.0.  
BUT ONLY  
SLIGHTLY.**

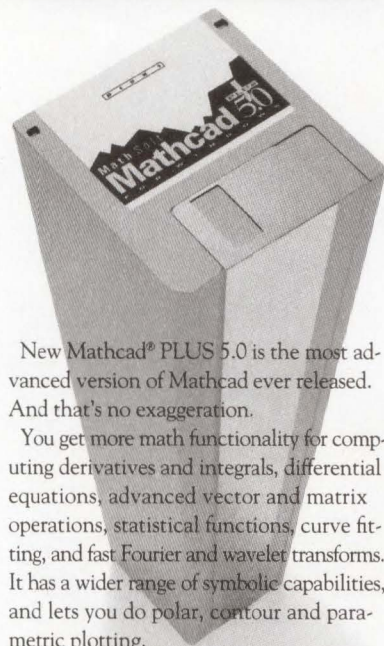

New Mathcad® PLUS 5.0 is the most advanced version of Mathcad ever released. And that's no exaggeration.

You get more math functionality for computing derivatives and integrals, differential equations, advanced vector and matrix operations, statistical functions, curve fitting, and fast Fourier and wavelet transforms. It has a wider range of symbolic capabilities, and lets you do polar, contour and parametric plotting.

Simply enter equations in real math notation anywhere in the on-screen worksheet. Add text and graphics, display results in 2-D and 3-D, change variables and instantly update answers. Then print your results in presentation-quality documents.

Best of all, Mathcad PLUS 5.0 is more powerful than spreadsheets or calculators and easier than programming languages. And that's no exaggeration, either.

Mathcad PLUS 5.0 is \$299.95\*. Call now for more information, or mail or fax the coupon below.

Call: 1-800-967-5075 • Fax: (716) 873-0906

**FREE MATHCAD PLUS 5.0 INFORMATION KIT**  
For more information on Mathcad PLUS 5.0,  
mail or fax this coupon.

Name \_\_\_\_\_ Title \_\_\_\_\_

Company \_\_\_\_\_

Address \_\_\_\_\_

City \_\_\_\_\_

State \_\_\_\_\_ Zip \_\_\_\_\_

Country \_\_\_\_\_ Phone \_\_\_\_\_

MathSoft, Inc. P.O. Box 1018, Cambridge, MA 02142-1519 USA  
Phone: 1-800-967-5075 • Fax: 716-873-0906  
MathSoft Europe, P.O. Box 58, Livingston, UK EH54 7AE  
Phone: +44 506 460373 • Fax: +44 506 460374

© 1994 MathSoft, Inc. TM and ® signify manufacturers trademark or registered trademark respectively. \* Dealer price may vary.

**CIRCLE NO. 36**



# HIGHER PERFORMANCE. NO WAITING.

## HARRIS DG400 SWITCHES AND MUXES ARE IN STOCK.

Upgrade the performance of your next design by using Harris DG400 switches and muxes. We're the only licensed alternate-source. And we've got the whole family in PDIP and SOIC packages. They're quality-built and spec-for-spec compatible with Siliconix. And you can get Harris parts right now. Off the shelf. Pronto. No waiting. Get your schedule back up to speed by selecting Harris DG400 switches and muxes.

### Compare. Then Make The Switch.

	SWITCHES		MUXES	
	The DG441 vs. The Old DG201A		The DG408 vs. The Old DG508A	
	DG441	DG201A	DG408	DG508A
$r_{DS(ON)}$	85 $\Omega$	175 $\Omega$	100 $\Omega$	400 $\Omega$
$t_{ON}$	250ns	600ns	150ns	1500ns
$P_D$	1.6mW	45mW	7.5mW	59mW

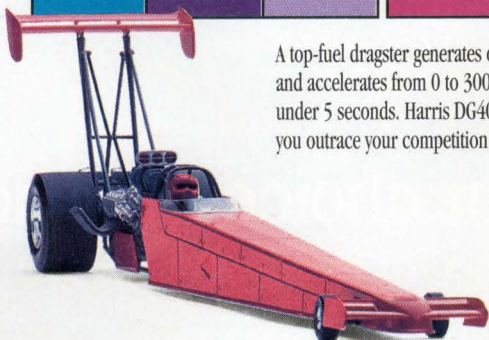

A top-fuel dragster generates over 5,000 HP and accelerates from 0 to 300 MPH in under 5 seconds. Harris DG400s will help you outrace your competition every time.

### Features

- High performance upgrades for DG2XX, HI-20X, DG50XA, HI050X
- Only licensed alternate source for Siliconix DG400

	DG441/2/4/5 Quad Switch	DG411/2/3 Precision Quad Switch	DG408/9 8-Channel/Diff. 4-Channel Mux
$r_{DS(ON)}$	85 $\Omega$	35 $\Omega$	100 $\Omega$
$t_{ON}$	250ns	175ns	150ns
$P_D$	1.6mW	0.035mW	7.5mW
Price (100s)	\$2.39	\$2.81	\$3.75

- Superior reliability
- Available in PDIP and SOIC packages



Try our AnswerFax service!  
Call 407-724-3818 and request document #7050.  
Or call 1-800-4-HARRIS, ext. 7142.  
CIRCLE NO. 88



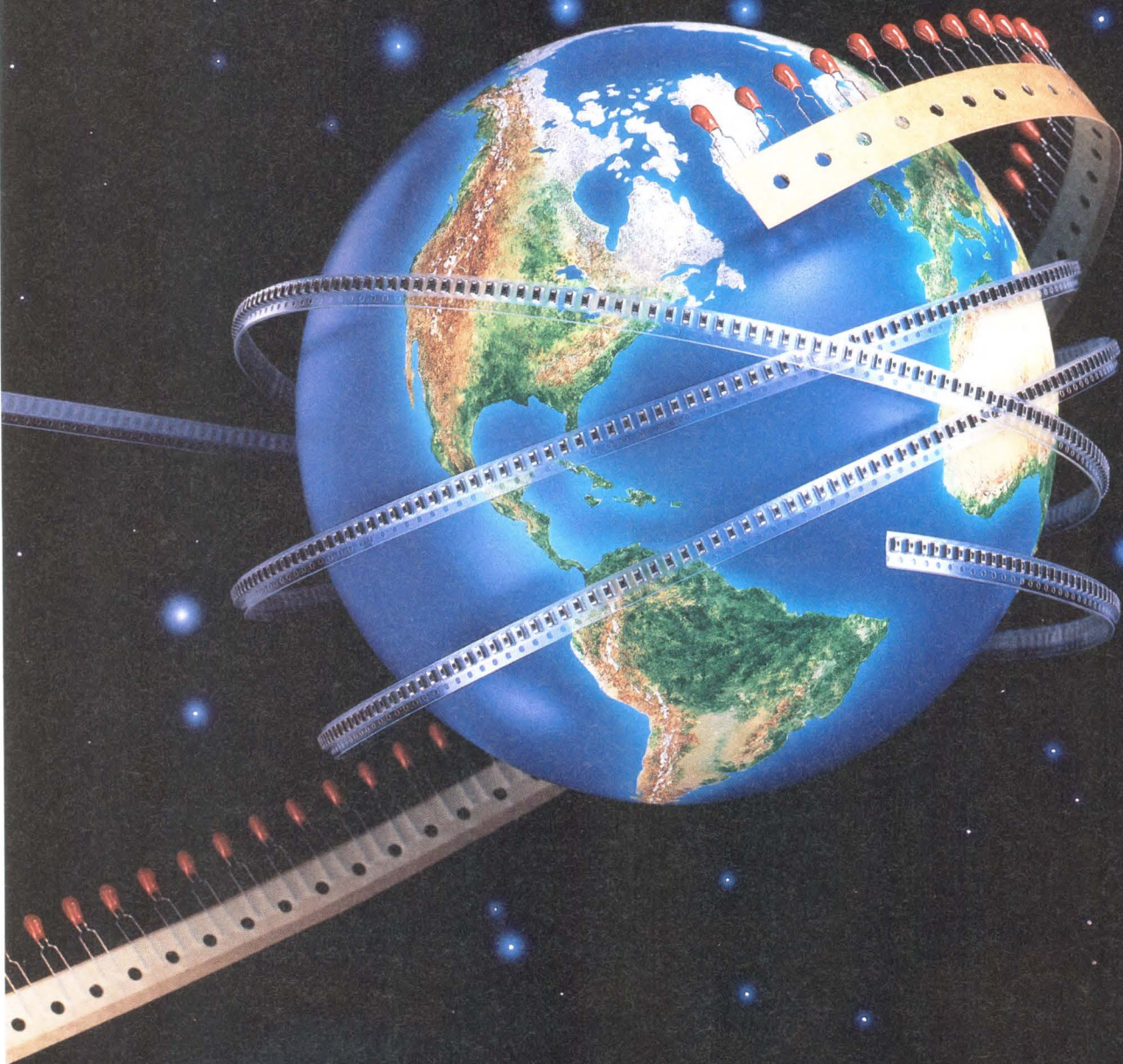

# Nichicon. Now the tantalum choice around the world.

Now you can get tantalum capacitors from Nichicon in the U.S. — and around the world. What makes that an earth-shaking event? Nichicon service. Nichicon flexibility. Nobody does what Nichicon does to get your problems solved. If you've got a question, we'll get an answer now. If you've got a requirement that's out of the ordinary — we'd like a chance to meet it. Our broad range will help you find a perfect fit. Call your Nichicon rep for a catalog today.

---

Chip-type surface mounts: 5 series.  
.1 $\mu$ F to 150 $\mu$ F/4 to 50 volts./ - 55°C to + 125°C.

---

Resin-dipped: 3 series — standard, hi-rel, ultra-miniature.  
.1 $\mu$ F to 150 $\mu$ F/4 to 35 volts./ - 55°C to + 125°C.

**nichicon**<sup>®</sup>  
**The capacitor choice.**  
708/843-7500 • FAX: 708/843-2798

### Module and bus bring 320-Mbyte/sec I/O to VME

SkyChannel bus architecture allows numerous processors to share access to system resources at data rates as fast as 320 Mbytes/sec. To maximize bus utilization, the synchronous 64-bit bus uses centrally arbitrated packetized data transfers with buffering at each end. This architecture has been proposed to VITA as an open standard.

Designed for multiprocessing applications, SkyChannel bus allows as many as 4096 processors to be interconnected. Each processor accesses memory and other system resources as part of a 16-Tbyte address space. Thus, the processors can share all memory, which simplifies data exchange. The bus can be used within a board, between boards, or between card cages. Multiple SkyChannels run in parallel with a crossbar switch between, which allows them to offer multiple independent paths between processor and resource when there are many resources to share.

Data traveling along the bus moves between units called Functional Modules in packets as large as 256 words, which are headed by a destination address. Each Functional Module uses FIFO buffering in both its input and output ports so that data transfers can occur at the maximum bus speed. A central arbiter controls access to the bus, granting Functional Modules use of the bus as requested.

Modules have three types of transfer: write, read, and compare and switch. The read and compare transfers use a split operation to reduce bus utilization. Both call for the reading module to provide a destination address to the module being read. The responding module then sends the requested data after it's queued in the FIFO.

A variety of SkyChannel products are available from the bus designers, including a multiprocessor VME card, a backplane bridge for VME systems, a complete VME system with SkyChannel embedded, and a stand-alone processing unit with SCSI interface. Each uses the Shamrock II compute daughter card as its basis.

The Shamrock II offers four i860 processors and 128 Mbytes of DRAM connected by a 4-channel bus with crossbar switch. A link to external SkyChannel buses is one of the card's

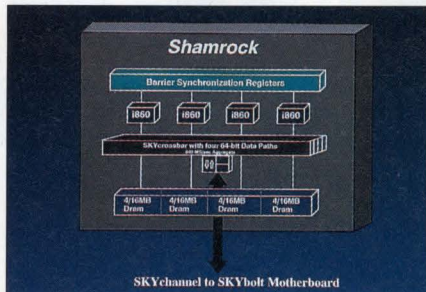

**Key to the SkyChannel system, the Shamrock II card uses the channel to connect four i860 processors to each other and off board.**

resources. The Skybolt II 6U VME card accepts one Shamrock daughter card and links the SkyChannel bus to the VME backplane's P2 connector. The 9U card accepts four daughter cards.

At the system level, the SkyStation II holds two daughter cards and provides them with 512 Mbytes of bulk memory, high-speed parallel I/O, and a SCSI-2 port. The SCSI-2 port links the SkyStation to a host processor, allowing the unit to function as a computa-

tion accelerator. Another system product, the SkySystem, is a 500W VME64 chassis with SkyBolt boards, tape, disk, and CD-ROM drives, color monitor, keyboard, and software tools. For designers building their own systems, the SkyBridge interconnect plugs onto the P2 connectors to provide a 4-channel bus between boards.

SkyChannel is supported by software tools that simplify multiprocessor computing. The compilers accept C, Fortran, and Ada code and automatically partition tasks among as many as four processors.

The Skybolt II 6U card and SkyStation II system are available now; each costs \$20,000. The SkyBridge, Skybolt II 9U cards, and SkySystem products will be available by the second quarter of 1994. The systems will cost \$30 to \$50k, depending on configuration. The SkyBridge interconnect will cost approximately \$600/board.—Richard A Quinnell

*Sky Computers Inc, Chelmsford, MA.*  
(508) 250-1920. **Circle No. 372**

## Full-Featured Fractional HP Motors and Controls at OEM Prices

by Japan Servo Company, Ltd.

### SERVEX Intelligent Controls/Stepper Motors

### Fans & Blowers



- Fully programmable intelligent controls
- Positioning & sequence controllers, driver, pulse generator and DC power supply in single unit

- AC, DC & Brushless models
- Wide range of sizes & air-flows
- Low & ultra-low noise levels

### AC Motors & DC Brushless/Permanent Magnet Motors

### Stepper Motors - Hybrid & Permanent Magnet

- Fixed & variable speeds
- Encoders & interchangeable gearheads
- Wide range of speeds & torques

- Step angles from 0.45° to 15° in half, full & micro-steps
- 50% more torque/size
- Encoders & gearheads with or without drivers
- Three-phase motors available

Distributed by:

**Japanese Products Corp.** Norwalk, CT 06851

**Call for Specs or Quote:**

**203/840-1590**

FAX: 203/840-1601

# Design INNOVATIONS

## TECKNIT FINGER STOCK ADAPTS TO WIDE RANGE OF LOW CLOSURE FORCE APPLICATIONS.

Tecknit has redesigned the geometry of industry standard Beryllium Copper strips to insure superior shielding performance in closure applications where wiping action and extremely low compression forces are required.

Beryllium Copper gaskets are tough and durable. They exhibit excellent fatigue strength and retain a constant

spring force — virtually eliminating compression set. And they perform flawlessly at extreme temperatures.

Top designers use Tecknit Finger Stock in a wide range of electronic applications from computers to radios, from military guidance systems to consumer products.

Call Tecknit Product Support people today for complete information on how Beryllium Copper can help solve your most difficult shielding problems.

CIRCLE NO. 91

## TECKSOF® COMMERCIAL SHIELDING GASKET... EASILY CONFORMS TO SURFACE IRREGULARITIES.

TECKSOF is a cost-effective shielding gasket designed to provide maximum EMI shielding effectiveness for applications where minimum closure force and unusually wide tolerance gaps exist. TECKSOF is constructed of silver-plated nylon thread over pliable urethane foam. This unique combination of materials ensures that the gasket will maintain close physical contact with even minute surface irregularities. Supplied in a wide range of sizes, in cut lengths or in continuous rolls, it can be installed around bends without wrinkling, creasing or cracking. Economical, TECKSOF supplies over 60dB shielding from 30MHz to 1GHz.

Call your Tecknit representative for complete information and design assistance.



## ORIENTED WIRES IN SILICONE. EXCELLENT SHIELDING IN ROUGH ENVIRONMENTS.

Tecknit Elastomet® and Elastofoam® solve EMI, static discharge and grounding problems where severe environmental conditions exist. Both patented

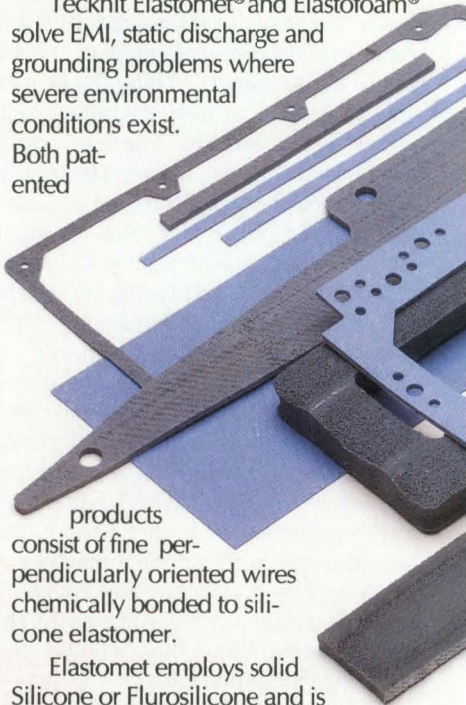

products consist of fine perpendicularly oriented wires chemically bonded to silicone elastomer.

Elastomet employs solid Silicone or Fluorosilicone and is most effective where medium or high closure forces are required. Elastofoam, made of a more pliable soft silicone sponge, is designed for applications where severe joint unevenness occurs and a low closure force is required.

Elastomet and Elastofoam meet the most demanding industrial, commercial and military requirements. Both products are available in sheets, strips to 9" wide or as die-cut finished gaskets. Tecknit will tailor designs to meet your needs. Call for information.

**TECKNIT®**

INNOVATION BY DESIGN

Call, fax or write for our complete shielding products catalog.

## BOARDS & BUSES

**Module provides controlled power-up sequence.** The Power Sequencing Module (PSM) staggers the turn-on and -off of supply voltages to the Futurebus+ backplane. PSM offers four voltage rails: 2.1, 3.3, 5, and 48V. The module connects in parallel with the ac's power input lines and the power supply. \$150. **Bicc-Vero Electronics Inc.**, Hamden, CT. (800) 242-2863.

Circle No. 353

**STD computer supplies extensive I/O.** The ZT 8802 is a V40-based STD-32 computer module that runs DOS software. In addition to the standard DOS serial port, the board offers two more RS-232C serial ports and 48 bidirectional digital I/O lines. The board also includes 1 Mbyte of RAM and 512 kbytes of ROM. An SBX expansion bus makes the module customizable. \$450. **Ziatech**, San Luis Obispo, CA. (805) 541-0488.

Circle No. 354

**Automation controller handles industrial environments.** Based on the 8086 processor, Hench Control automation controllers incorporate optical isolation, filtered power, and analog I/O filtering to withstand the rigors of the industrial environment. The modules are C-programmable and available as 11x7-in. boards or in NEMA-4 enclosures and offer 64 digital and 48 analog I/O channels. From \$3500 (unprogrammed). **Hench Control Corp.**, San Jose, CA. (408) 296-4600.

Circle No. 355

**Quad processor meets military needs.** The DMV-442 incorporates four 320C40 DSP devices—each with 4 Mbytes of RAM—onto a 6U VME board. The board makes four of the processors' 20-Mbyte/sec communications ports available on the backplane, offers a mailbox interrupt mechanism, and has an optional 500-Mbyte/sec I/O bus. The board is available in commercial, extended-temperature, and military-ruggedness configurations. From \$12,895. **Dy 4 Systems Inc.**, Campbell, CA. (408) 377-9822.

Circle No. 356

**VME board provides 32 analog output channels.** The MPV914 is a 6U slave VME board with as many as 32 channels of 12-bit DAC analog signals. The range for each signal is individually controllable and can be set for  $\pm 10$ ,  $\pm 5$ , 0 to 10, or 0 to 5V output. The digi-

### FREE INFO, FREE POSTAGE

Use our postage-paid reader-service cards to get more information on any of these products.

tal codes can be binary, offset binary, or 2's-complement. From \$4495. **Pentland Systems Ltd.**, Danville, CA. (510) 736-5113.

Circle No. 357

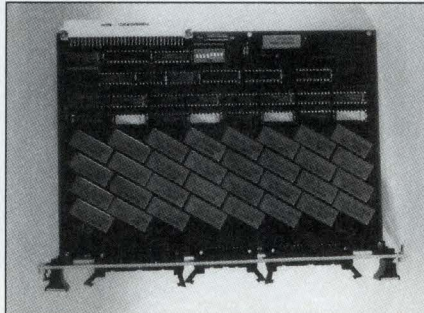

**VME modules offer switching options.** The VM series switch modules offer multiplexer, matrix, and discrete relay configurations in a 6U VME or B-size VXI board. The modules come with standard, mercury-wetted, or low-thermal relays and can be configured to handle as much as 8A. The coaxial relay matrix handles signals to 200 MHz. \$500 to \$1800. **Cytec Corp.**, Penfield, NY. (716) 381-4740.

Circle No. 358

**386 processor module fits small spaces.** The ESP 386SLV/486SLC module uses double-sided component placement to achieve minimum size while retaining full PC compatibility. It uses the VLSI Scamp chip set and the VL82C323 power-management chip to give software control of power usage. The board includes standard AT keyboard control, BIOS on boot-block flash EEPROM, and a coprocessor socket. \$302 (100). **Dovatron International**, Longmont, CO. (303) 772-5933.

Circle No. 359

**GPIO controllers mate with a variety of PCs.** Expanding beyond ISA-based machines, this GPIO controller family offers a variety of interfaces. The GPIO-232CT-A (\$495) is an RS232C-to-GPIO controller board that allows any serial port to become an IEEE-488.2 controller. The GPIO-ENET/Mac board (\$1095) connects Macintosh computers to the IEEE-488 bus via Ethernet. The TC-GPIO/OSF board kit (\$895) connects to DEC Alpha workstations. **National Semiconductor**, Austin, TX. (512) 794-0100.

Circle No. 360

**Board suits small industrial control.** The Puce board measures 250x140x44 mm and includes a 16-key keypad and a 2-line 16-character alphanumeric display. The eight digital-input, eight output, and eight analog lines are all power-surge protected. The board also offers an extension connector and a built-in beeper for audio alarms. **LEAS**, Grenoble, France. (33) 76 52 13 30.

Circle No. 361

**VME64 board utilizes RISC processor.** The HK80/V960D is based on a 30-MHz 80960CF processor with a 4-kbyte instruction and 1-kbyte data cache. The board also provides as much as 16 Mbytes of DRAM, 4 Mbytes of flash EEPROM, and sockets for 512 kbytes of ROM. Four serial ports, an Ethernet interface, a VME64 interface, and a 200-Mbyte/sec expansion bus handle board I/O needs. From \$4495. **Heurikon Corp.**, Madison, WI. (608) 831-0900.

Circle No. 362

**VME board accepts four PCMCIA cards.** The RM230 6U VME card accepts as many as four PCMCIA cards carrying I/O or as much as 256 Mbytes of memory. The board accepts the cards as two independent blocks—each block containing two cards. Memory and I/O cards are each address-selectable on 64-kbyte boundaries. \$580. **RAMix Inc.**, Chatsworth, CA. (818) 349-6772.

Circle No. 363

## SHORTS & REVISIONS

Beta Transformer Technology Corp now offers an application note on transformers for the MIL-STD-1553 data bus. (516) 567-5600, ext 7794.

Circle No. 364

The Model 467-1 Sbus-to-VMEbus adapter from Bit 3 Computer Corp now includes a slave DMA mode that handles sustained data transfer rates to 12 Mbytes/sec.

Circle No. 365

Texas Instruments has developed a low-cost version of its MVME162 embedded computer: the MVME-162LX. The \$1095 LX provides front-panel I/O access and error-correcting memory.

Circle No. 366

## Portable 500-MHz DSO stores 8M words in real time at 2G samples/sec

For reasons detailed in **Ref 1**, a real-time-sampling capability is a big deal in DSOs, and in real-time-sampling DSOs, deep memory is an even bigger deal. That explains the continuing increases in the memory depth of wideband DSOs whose real-time sampling rate is four or five times their  $-3$ -dB bandwidth. LeCroy Corp leads the industry in wideband DSOs that provide deep memory, but until now, the company has not had a real-time portable scope with 500-MHz bandwidth.

Now LeCroy has a family of six such scopes, the 9350 series. The top-of-the-line 9354L (\$24,490) offers an 8M-

sample memory. Other portable scopes that acquire 500-MHz signals at 4 samples/cycle offer less than 1% of that memory depth.

The 9350 series' versatility should win it the nickname of "the Swiss army knife" of DSOs. (Coincidentally, LeCroy manufactures its portable DSOs in Switzerland.) The 9354L achieves its 8M-sample memory depth and 2G-sample/sec acquisition speed when you use one channel. In this mode, it interleaves all four channels' 500M-sample/sec ADCs and 2M-sample memories. Although interleaving ADCs to achieve faster sampling is fairly common, only a few wideband scopes—none of them portable—interleave capture memory. Both time and numbers of stored samples are important in this case; failure to interleave memory reduces the captured signal's maximum duration.

The 9354L's long memory lets you capture 4 msec of data at 2G samples/sec. You can acquire signals at 2G samples/sec at sweep speeds as low as 400  $\mu$ sec/div. Under these conditions, even signals that contain 1-GHz components of significant amplitude do not cause aliasing. Moreover, you can zoom in on very short slices of the long records and view them at high sweep

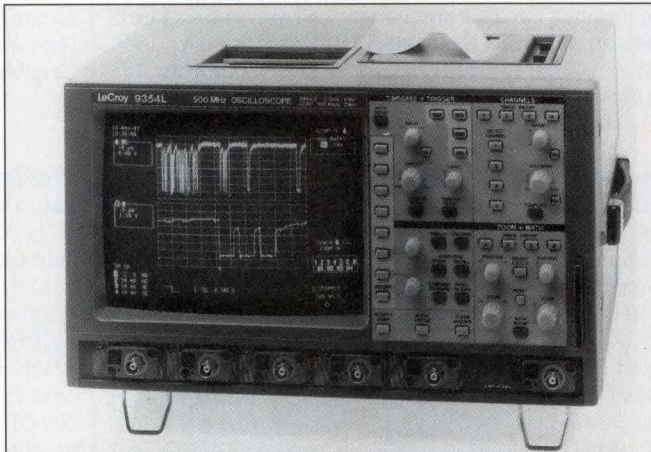

**The resemblance of LeCroy's 9354L to the company's other portable DSOs is striking, but the unit offers memory unmatched by any other wideband, portable DSO. The amber-phosphor CRT is bigger than some competitors', and the optional thermal printer can, in effect, give you a CRT many yards wide.**

speeds without reacquiring the data. Unlike some competitive units, the LeCroy scopes can simultaneously display the full signal and several expanded segments.

Some scopes with shorter memories offer a glitch-capture feature that, even at low sweep speeds, guarantees capturing narrow pulses. Glitch capture saves memory by processing the waveform data before it is stored. A scope with glitch capture tells you only roughly when a glitch occurs; all it says about the glitch width is that it didn't exceed some maximum. Even at fairly low sweep speeds, a scope with deep enough memory digitizes at its maximum rate and stores every acquired point. Unlike glitch capture, deep memory preserves all information about narrow glitches and portrays them more accurately.

One reason for the Swiss-army-knife label is that all of the 9350 units do both random equivalent-time sampling (useful with repetitive signals) and real-time sampling (useful with repetitive and 1-shot signals). The presence of this dual-mode capability pits the 9354 (\$13,990, 25k samples/channel, 100k-sample memory in 1-channel mode) and the 9354M (\$16,490, 100k samples/channel, 500k samples in

1-channel mode) against Tektronix's top-selling TDS 2540A (\$16,290 with optional 50k-sample/channel memory) and Hewlett-Packard's recently introduced 54540A (\$15,000, 32k samples/channel). In real-time mode, these HP and Tek units take 1G samples/sec on one channel, whereas the 9354, 9354M, and 9354L take 2G samples/sec on one channel.

Both HP and Tek offer portable DSOs that capture 2G samples/sec on up to four channels at once. HP's units store 32k samples/channel; Tek's store 2k samples/channel. Pricing of these real-time DSOs is roughly one-

third greater than that of the other HP and Tek scopes mentioned here.

Besides the 4-channel models, the 9350 series includes three 2-channel units. Their prices begin at \$9490. For \$590 more, you can equip the LeCroy scopes with a floppy-disk drive; for \$500, you can add a PCMCIA slot. A drive is standard on some competitive products, but the memory-card slot is not available. For \$890 extra, LeCroy equips its portable scopes with a thermal plotter, which does screen dumps and writes long records in uncompressed form. In effect, these records give you a "CRT" many yards wide. Tek offers a printer that you can attach to the top of its TDS scopes; the HP scopes use separate printers. FET probes for the LeCroy scopes cost \$990 each.

—Dan Strassberg

LeCroy Corp, Chestnut Ridge, NY.  
(800) 553-2769. **Circle No. 468**

Hewlett-Packard Co, Santa Clara, CA.  
(800) 452-4844. **Circle No. 469**

Tektronix Inc, Beaverton, OR. (800) 426-2200. **Circle No. 470**

### Reference

Strassberg, Dan, "Fast single-shot DSOs take varied design approaches," *EDN*, July 8, 1993, pg 47.

# EDN PRODUCT MART

This advertising is for new and current products.

Please circle Reader Service number for additional information from manufacturers.

## Low Cost Miniature Controllers

Save time.  
Save money.

Our wide range of C-programmable miniature controllers are ideal for control applications, data acquisition, and test and measurement. Compact and low in price (the Little PLC™ above is 2"x3" and \$195), these controllers are programmed with our easy-to-use Dynamic C™ development system. Our controllers feature digital I/O, ADCs and DACs, relays and solenoid drivers, RS232 and RS485 serial ports, battery-backed memory and time/date clock, LCDs, keypads, enclosures and more!

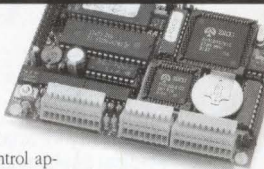

1724 Picasso Ave.

24-Hour AutoFax Davis, CA 95616  
916.753.0618. Call 916.757.3737  
from your FAX. 916.753.5141 FAX



CIRCLE NO. 230

NEW

## Ethernet

Development and  
Testing at full speed on:

- Multiport Devices ■ Bridges ■ Repeaters
- Ethernet Switches ■ Routers ■ Transceivers



### The ET-1000

An easy to use 2 port Ethernet test instrument for Design Engineers and Production Managers. Generate and capture Ethernet traffic, create and detect all possible packet errors, monitor accurately in real time all statistics. The ET-1000 is the most advanced physical and MAC layer tester / Simulator / Analyzer available! Attachment options include Jitter Simulator, Multiport device tester and a C/C++ Library. Call today for more information on this powerful tool.

21818 Lassen Street, Unit G  
Chatsworth, CA 91311  
(800) 531-6363 Fax (818) 709-7881



CIRCLE NO. 231

## DIRECT PLUG-IN ADAPTORS SOME EUROPEAN UNITS ARE NOW STOCKED!

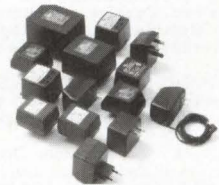

Hundreds of standard models available with AC or DC output, UL/CSA approval, regulation & other options. Many standard European, Asian, British, and Australian configurations also available with approvals. We now stock some European adaptors too!

For a catalog or a quotation, contact CUI Stack, Inc., 9640 SW Sunshine Ct., #700, Beaverton, OR 97005. 503/643-4899, FAX 503/643-6129.

CIRCLE NO. 232

## EXPRESS

Best Value in the World  
for

POLYIMIDE & FR4  
1 to 5 DAY TURN

1 to 12 Layers

PRINTED CIRCUIT PROTOTYPES

2 PIECE PRICES FOR FR4 .062 Th.

LAYERS	1	2	3&4	5&6	7&8
15	\$233	\$292	\$639	\$787	\$935
30	264	330	724	891	1059
60	311	389	853	1049	1137
90	358	448	980	1207	1434
120	385	486	1044	1311	1559

■ 5 PIECES x 1.34 ■ 5 DAY PRICES ABOVE  
■ 10 PIECES x 1.67 ■ UL LISTED

EXTRAS CAPABILITIES DISCOUNTS

- Photo Plotting
- Testing
- Gold Contacts - \$50
- 25% - Below 8 Mil Hole
- Below 15 Mil Hole
- SMOBC & LPI - \$50
- Buried & Blind Vias
- Polyimide Multilayer
- Full Body Gold
- Carbon Paste
- Tin nickel burn-in boards
- SMT-SMOBC
- Up to 22 layers
- Impedance control boards
- 5%
- COD
- 10%

FOR MORE INFORMATION CALL OR FAX

Ken Bahl ■ 1108 W. Evelyn Ave., Sunnyvale, CA 94086  
Phone (408)735-7137 FAX (408)735-1408 Modem (408)735-9842

CIRCLE NO. 233

## Advin

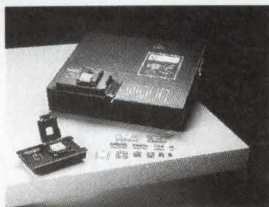

### PILOT-U84 Universal Programmer

#### The Leader in New FPGA Support

- Altera MAX 7064, 7128 • Xilinx 1736D, 1765D etc
- Intel FX-740, FX-780; 87C196 KD, KR, JR, MC etc
- Moto 68HC711D3, E9; 68HC705 C8, C9, P9 etc
- WSI PSD-4XX, -5XX, PAC, SAM • Atmel 29C040 etc
- AMD MACH435, 29F040, 16R8-4 • Lattice pLSI etc
- All packages to 256-pin: PLCC, PGA, QFP, TQFP, SOIC

For immediate support, please call  
800-627-2456 FAX: (408) 736-2503

CIRCLE NO. 234

## ROM-IT

EPROM EMULATION SYSTEM

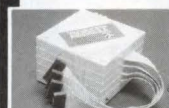

The Most Flexible  
EPROM Emulator  
You Can Get Today

- Emulates up to eight 4-Megabit EPROMs through one standard serial port.
- Downloads 2-Megabit programs in less than 23 seconds
- Examine and modify individual bytes or blocks.
- Accepts Intel Hex, Motorola S-Record and Binary files.
- Software available for IBM PC and compatibles.
- Base 27256 EPROM System \$395.00. Other configurations available.



Incredible Technologies, Inc.  
Visa, Mastercard and American Express Accepted

Order Now - It's Easy  
Call (708)670-7027 Or Fax (708)870-0120  
For More Information

CIRCLE NO. 235

To advertise in Product Mart, call Joanne Dorian, 212/463-6415

# COMMUNICATION BOARDS

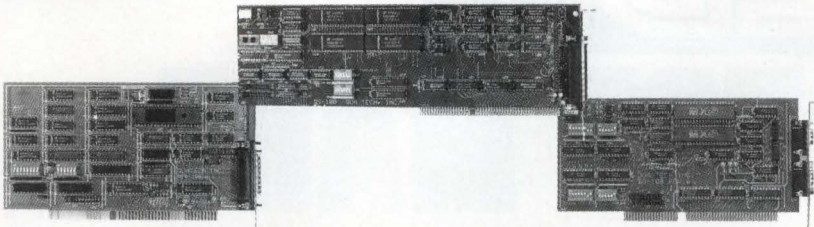

Quatech's synchronous/asynchronous serial boards for PC-AT and compatibles support RS-232, RS-422, and RS-485 communication.

Call for a free catalog  
**800-553-1170**



662 Wolf Ledges Parkway  
Akron, Ohio 44311

CIRCLE NO. 236

# Consistency is key



## to the power of EDN Product Mart

CIRCLE NO. 237

Tatum CAE Software!  
from \$49 to \$4190

- ✓ **ECA-2** Analog Circuit Simulation
  - Interactive • Fast, Complete • Realtime Graphics
  - Interface to Mfr's Spice models • Expanded user function and conditions list • Model the unusual •
- ✓ **SpiceAge for Windows**
  - Analog Circuit Simulation • Thorough • Powerful
  - Easy to use • Loaded with helps • Super Plots •
- ✓ **GESECA** Schematic Graphic Entry
  - Emphasis on circuit design rather than PCB layout
  - Ideal front end for ECA-2 and SpiceAge • Libraries
  - Pleasure to use • Ports to Tango, Racal, etc. PCB
- ✓ **SAUNA** 3D Thermal Analysis
  - PCB's, heatsinks, enclosures, complex thermal designs • Menu driven • All modes: conduction, convection, radiation • Full thermal/mat'l's library
  - The 'must-have' software for the package designer
- ✓ **+ More!** CAE Software
  - Active filter synthesis, Logic ckt design, Tutorial, Curve fitting, and more • Call for demos/catalog •

**Tatum Labs, Inc.**  
1287 N. Silo Ridge Dr. Ann Arbor MI 48108  
Tel: 313 663-8810 Fax: 313 663-3640

CIRCLE NO. 238

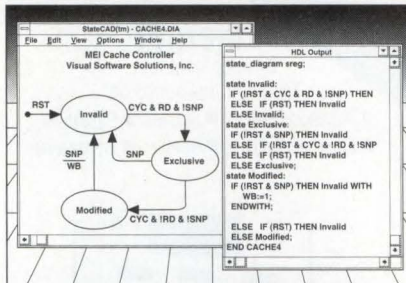

Wouldn't you rather draw HDL?  
With **StateCAD™** you can!

**StateCAD** enables you to draw state diagrams and automatically analyze them for design flaws. From state diagrams **StateCAD** produces synthesizable ABEL HDL and professional documentation.



**Visual Software Solutions**

3057 Coral Springs Dr. Suite 203  
Coral Springs, FL 33065  
Ph: (800) 208-1051 Fax: (305) 346-9394

StateCAD is a trademark of Visual Software Solutions, Inc.  
ABEL is a trademark of Data IO Corporation.

CIRCLE NO. 239



**High Density Circular Process and  
Medical Equipment Connectors**

D Series 7, 9 and 12 contact cable to cable and chassis connectors provide MIL quality contacts in impact resistant Polycarbonate housing. Keyed simple push button lock minimizes use problems. Solder cup or crimp contacts are useable in either housing.

**FOR ADDITIONAL INFORMATION, CONTACT:**  
**HYPERTRONICS CORPORATION**  
16 Brent Drive, Hudson, Massachusetts 01749  
(800) 225-9228 or (508) 568-0451  
FAX: (508) 568-0680

CIRCLE NO. 240

We speak your language!  
VHDL



Outsourcing Specialists

- Optimize time to market
- Cost effective designs
- Increase productivity

On-site or Off-site  
ASIC & FPGA Design & Training  
using VHDL & Synthesis

Tel: (408) 954-7370  
Fax: (408) 954-7372  
2880 Zanker Road, Suite 203  
San Jose, CA 95134, USA

CIRCLE NO. 241

## REMOVE HARDWARE LOCKS

**PROTECT YOUR INVESTMENT!  
MAINTAIN PRODUCTIVITY!**  
Software utility that allows for  
the removal of hardware locks.

Available for most major  
CAD/CAM and PCB  
software programs

*Easy - Simple - Guaranteed*

**Programs start at \$99.00 U.S.**

Visa and Mastercard Welcome  
Call or Fax for more Information

SafeSoft Systems Inc.  
201-1111 Munroe Ave. Phone (204) 669-4639  
Winnipeg, Mb. R2K 3Z5 FAX (204) 668-3566  
Canada

CIRCLE NO. 242

Combine your  
Product Mart ads in  
EDN Magazine and  
Products Editions  
for  
higher impact  
and a  
lower rate!

CIRCLE NO. 243



# MICROPROCESSOR EMULATORS

Zax provides a comprehensive series of real-time emulation support for Motorola, Intel, NEC, Zilog, and Hitachi microprocessors. Some of the highlighted features include source-level debug, real-time trace, and performance analysis.

Call now for more information:

(800) 421-0982  
(714) 474-1170 (Inside CA)  
(714) 474-0159 (Fax)

**ZAXTEK**

42 Corporate Park Irvine, CA 92714

CIRCLE NO. 244

You Don't Have  
To Burn Your  
Devices Like This!



## LOGICAL



Has a Full  
Range of  
High Quality  
Universal & Gang  
(EEPROMs, FLASH, PLD,  
& MICRO CONTROLLER)  
Programmable

**LOGICAL**  
DEVICES, INC. **digelec**  
TEL: (305) 428-6868  
FAX: (305) 428-1811

1 800 331-7766 Ext: 103

CIRCLE NO. 246

Communicate  
Weekly  
to the  
electronics OEM  
through EDN Magazine  
and Products Editions'  
Product Mart sections.

CIRCLE NO. 247

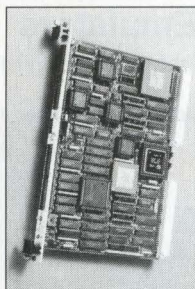

### VME to Encore HSD Data Link/ Emulation

Using our VMEHSD® card and file transfer software, files can be moved between a VME system and an Encore computer HSDII board. The

VMEHSD also emulates the HSDII; whereby, the VMEHSD can drive a HSDII compatible peripheral device. Test Program and UNIX drivers available for Motorola, Sun & SGI. This product provides an excellent data acquisition, monitoring or testing tool.

APPLIED DATA SCIENCES, INC.

P.O. Box 814209  
Dallas, TX 75381-4209  
(214) 243-0113  
FAX (214) 243-0217

CIRCLE NO. 248

## UNIVERSAL/GANG PROGRAMMERS

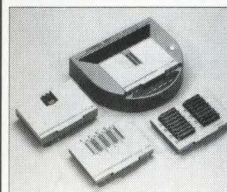

### FLEX-700

40 pins from \$845  
48 pins from \$945

TUP-400/300  
\$745/\$575

- Supports EPROM, FLASH, PLD, FPGA, GAL, MPU, ...in DIP, PLCC, SOP, QFP, PGA ...
- Expandable from 40 pins to 256 pins and to 4 or 8 sockets for gang programming.
- Universal 44, 68, & 84 pin PLCC modules.
- Free software updates via BBS.
- Programming algorithms approved by IC Manufacturers.

## 8051 IN-CIRCUIT EMULATORS

### NICE-51 SYSTEMS FROM \$795

- Supports 87(C)51 and many derivatives.
- Fully supports emulation of internal and external memory with no intrusion on user memory, I/O, stack, INT...
- Supports Archimedes, Franklin, Intel, IAR, KEIL, 2500AD.... C compilers and most assemblers.
- Single step, go slow, run in real time, set breakpoints and much much more...
- Complex trigger and filter functions let you record in real time all or any portion of program execution you desire (up to 16K 48bit words).



## ROM/RAM EMULATORS

### TRE/EML SYSTEMS FROM \$295

- Emulate up to two 27(C)64 - 27(C)010 devices at one time in independent or 16 bit even/odd mode.
- Emulate one 27C020, 27C1024, 27C2048.

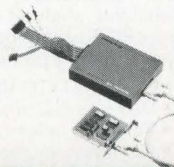

## EPROM/GANG PROGRAMMER

### TQP/QUICK-32 SYSTEMS FROM \$285



Tribal Microsystems Inc.  
44388 S. GRIMMER BLVD., FREMONT, CA 94538  
Tel: (510) 623-8859  
Fax: (510) 623-9925

CIRCLE NO. 251

## ASIC SOFTWARE

for PC, Sun, HP and Mac.



### Netlist Tools

- S-Edit: Schematic entry
- T-Spice: Circuit simulator
- GateSim: Logic simulator

### Layout Tools:

- L-Edit: Full-custom layout editor
- DRC: Design rule checker
- Extract: General device extractor
- LVS: Netlist comparison utility
- SPR: Standard cell place-&route

CMOS layout libraries for MOSIS & Orbit

**TANNER**  
RESEARCH

180 North Vinedo Ave  
Pasadena, CA 91107

CIRCLE NO. 249

8051 68HC11 68HC05 COP8

### Real-Time & Nonintrusive

- 64K Pgm Mem/  
64K Data Mem
- 128K Hardware  
Breakpoints
- 16K Frame Trace Buffer



- Symbolic & Source-  
Level Debug
- Complete 'C' Variable  
Support

### NEW, POWERFUL IN-CIRCUIT EMULATORS

8351FX/8052 \$1451.00  
8031/32 \$ 851.00  
83751/752 \$ 851.00

- Serial Link to any  
Dos PC, even Laptops!

Affordable MetaLink emulators support more than 100 derivatives of the microcontroller families listed above. 30-day money back guarantee, 10 day trials and monthly rentals. Prices above are U.S. list. Call today for FREE demo disk.



(800) 638-2423

**MetaLink**  
Corporation

MetaLink Corporation  
325 E. Elliot Road, Chandler, AZ 85225  
Phone: (602) 926-9797, Fax: (602) 926-1198

Westring 2, D-85614 Kirchseeon-Eggharling  
Telefon (08991) 2046, Telefax (08991) 2386

CIRCLE NO. 250

To advertise in Product Mart, call Joanne Dorian, 212/463-6415

EDN February 3, 1994 • 153

## Analog Circuit Simulation

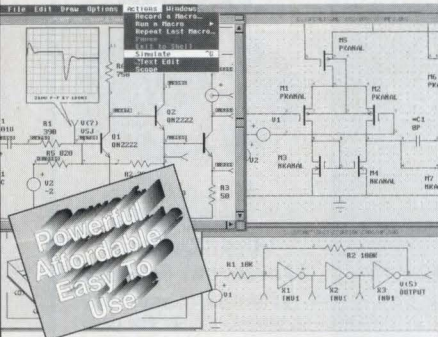

Powerful  
Affordable  
Easy To Use

- Schematic Entry
- ISpICE3 Simulator
- SPICE Models
- Real Time Graphics

Call or Write For Your FREE  
Demonstration and Information Kit!

Fax 310-833-9658  P.O. Box 710 San Pedro, CA 90733-0710  
Tel. 310-833-0710 **intusoft**

CIRCLE NO. 252

## 48 Channel 50MHz Logic Analyzer

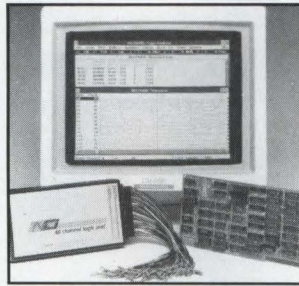

Complete System \$1495.00

New Windows 3.1 Compatible Software

- 48 Chnlns @ 50 MHzx 4K words deep
- 16 Trigger Words/16Level Trigger Sequence
- Storage and recall of traces/setups to disk
- Disassemblers available for: 68000,8088,8086, 6801, 6811, Z80, 8085, 6502, 6809, 6303, 8031, 64180

**NCI** □ 6438 UNIVERSITY DRIVE,  
HUNTSVILLE, AL 35806  
(205) 837-6667 FAX (205) 837-5221

CIRCLE NO. 253

# Consistency is key

## to the power of EDN Product Mart

CIRCLE NO. 254

## 200Ms Digital Oscilloscope

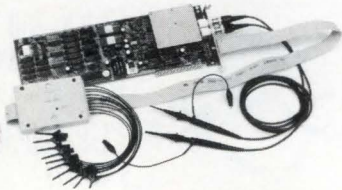

Starting at  
\$1799 With Probes &  
Software

- 200 MSa/s Sampling Rate
- up to 128K Samples/Channel
- PC-BASED INSTRUMENT
- 2 Analog Channels (2ch. Oscilloscope)
- 8 Digital Channels (8ch. Logic Analyzer)
- 125 MHz Single Shot Bandwidth

Call (201) 808-8990

 Link Instruments  
369 Passaic Ave, #100, Fairfield, NJ 07004 fax: 808-8786

CIRCLE NO. 255

## In-Circuit Emulators

Development tools for the most demanding

8051  
80196  
80186  
HPC +  
Z8  
8085  
DSP's

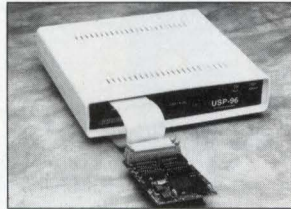

- Unparalleled features
- HLL debugger with locals support
- External unit, no plug-in cards !!!
- High speed download (64k in 12 sec)
- Banking support for > 64KB operation

see the difference - free 2 week trial

## SIGNUM SYSTEMS

Mountain View, CA / Thousand Oaks, CA.  
(415)903-2220 (805) 371-4608

CIRCLE NO. 256

## DECISION

IS YOURS!

as to who gives you the best value?

5 DAY TURN

PRINTED CIRCUIT BOARDS  
TWO-PIECE PRICES

LAYERS	1&2	3&4
SQUARE	60 \$300	\$725
INCH	90 \$350	\$800
UP TO	120 \$400	\$875

• 5 Pieces x 1.33 • 10 Pieces x 1.66  
EXTRAS: Photoplotting • Testing • Gold

SERVICES:

- 1 TO 5 DAY TURN
- UL Approved
- Single/Double/Multi-layer
- Prototype and Production
- Instant Quotes
- Gerber/AutoCAD/HPGL/P-CAD
- SMOBC and LPI
- Electrical Testing

DESIGN

- Extensive expertise in single, double & multi-layer circuit design
- Latest design tools and techniques to help you identify ways to reduce layers & simplify assembly
- Capability to suggest design alternatives to improve fabrication efficiency

PHOTOPLOTTING PRICES

FILMSIZE	MASTER
8 x 10	\$8
10 x 12	\$10
11 x 14	\$12
12 x 18	\$14
16 x 20	\$23
20 x 24	\$30
24 x 36	\$50

CALL US TODAY AT  
**Accutrace 1-800-600-6611**

SAVE EVEN MORE  
WITH FULL  
SERVICE

CIRCLE NO. 257

## RELIABILITY PREDICTION SOFTWARE

### ARE YOUR PRODUCTS RELIABLE?

The RelCalc 2 Software Package automates the reliability prediction procedure of MIL-HDBK-217, or Bellcore, allowing quick and easy reliability analysis of electronic products on your PC. Say goodbye to tedious, time consuming, and error prone manual methods!

- NEW UPDATE! VERSION 3.1 now available.
- User friendly: pop-up menus, hypertext help.
- Very easy to learn and use; quick data entry.
- Part library for rapid recall of part data.
- Global editing functions for what-if? trials.
- Reports which clearly organize results.
- Save time & money as you design for quality.
- Try our Demo Package today for \$25.

T-Cubed Systems, 31220 La Baya Drive,  
Suite 110, Westlake Village, CA 91362  
CALL: (818) 991-0057 FAX: (818) 991-1281

CIRCLE NO. 258

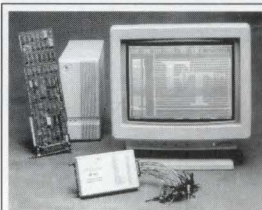

Rated #1  
for  
Ease-of-use  
by OEMs  
& end users

## Expandable Logic Analyzer plus

- ✓ 50 MHz and 25 MHz state and timing
- ✓ 32K sample depth, up to 192 channels
- ✓ Professional features in PC-based product
  - ✓ Easy-to-use, windows-like interface
- ✓ PC-based desktop and ISA bus versions
- ✓ Digital/analog pattern generator option



EMULATION TECHNOLOGY, INC.  
800.995.4381

CIRCLE NO. 259

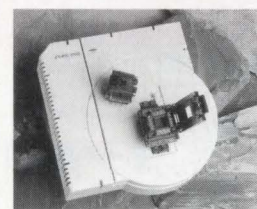

24-Hour  
7-Day  
Technical  
Support

## PC-based Programmer for over 1500 Devices

- ✓ Program PLDs, PROMs, EPROMs and MCUs
- ✓ Semiconductor manufacturer approved algorithms
- ✓ Wide choice of adapters: PLCC, SOIC, TSOP, etc.
- ✓ Immediate device list updates via BBS #408-982-9044
  - ✓ Trade-in discount offer (until 3/31/94)
  - ✓ Immediate delivery from stock



EMULATION TECHNOLOGY, INC.  
800.995.4381

For Our New PC-Based Development Tool Catalog

CIRCLE NO. 260

To advertise in Product Mart, call Joanne Dorian, 212/463-6415

Communicate  
Weekly  
to the  
electronics OEM  
through EDN Magazine  
and Products Editions'  
Product Mart sections.

CIRCLE NO. 261

### SM LAND/SOCKET

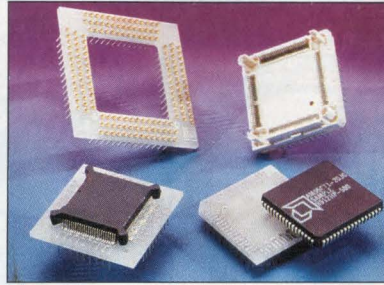

#### PLUGGABLE SURFACE MOUNT

The QFP and PLCCSM LAND/SOCKET provides a very reliable solution for socketing QFPs or PLCCs in production or ZIF (test/burn-in) patterns. The device is surface mounted to the SM LAND/SOCKET which converts the QFP or PLCC to a base pin array of the production or ZIP QFP socket and can then be soldered to target board or socketed using Ironwood's sockets receptacles. This results in a reliable connection at a reasonable cost. From \$20.

IRONWOOD ELECTRONICS  
P.O. BOX 21151, ST. PAUL, MN 55121  
(612) 431-7025 FAX (612) 432-8616

CIRCLE NO. 262

### FASTEST ALL PACKAGE-TYPE GANG & SET PROGRAMMER

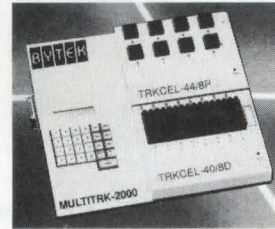

- ★ Prices from \$895 (USD)
- ★ Duplicate E/PROMs 8, 16 or 32 at a time.
- ★ Set Program to 8, 16 or 32 devices each with different data.

- ★ All Packages: DIP, PLCC, LCC, PSOP, PQFP.
- ★ Gang Motorola Micros (68xxx or 68HCxxx)
- ★ Free Lifetime Library Updates via 24 hr. BBS
- ★ Rapid Programming Speeds (Gang or Set)
- ★ 32 1Meg Devices: 17 seconds, 2Meg: 30 sec.

Call now: 800-523-1565

**BYTEK** Corporation  
Boca Raton, Florida - USA  
Tel: 407-994-3520  
Fax: 407-994-3615

CIRCLE NO. 263

### High-Resolution Medical Color Monitors



X-Med's 14" and 15" low-radiation super VGA monitors are listed to UL 544 medical standards, and feature patented low-leakage EMI filters. Other features include:

- Small footprint fits any desktop.
- Ergonomically designed screen controls with easy pincushion correction.
- Built-in autosizing and auto-centering.
- Multiscanning to maximize resolution, picture quality and graphics card compatibility.
- State-of-the-art surface mount technology.

Contact us today for additional information and specifications on these outstanding new monitors.

**X-MED**  
SYSTEMS

X-Med Systems Division of  
Condor D.C. Power Supplies, Inc.

2311 Statham Parkway, Oxnard, CA 93033  
(805) 486-4565 • FAX (805) 487-8911

CIRCLE NO. 264

**NEW**

### ChipLab™

- Programs PLDs, PROMs, and EPROMs and microcontrollers up to 48 pins
- Algorithm updates available via electronic bulletin board

To order, call:  
**1-800-3-DataIO, Ext. 901**  
(1-800-332-8246)

Also distributed by:  
**Promark Technology West**  
(1-800-227-3345)  
**JDR Microdevices**  
(1-800-538-5000)

**Special Introductory Price**  
**32-pin version: \$895**  
**48-pin version: \$1495**

**DATA I/O**

CIRCLE NO. 265

### HiWIRE II

Schematic and PCB Software

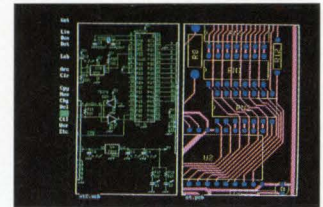

With support for expanded and extended memory, HiWIRE II can handle your most demanding schematic and PCB designs. The unique HiWIRE II editor allows you to display and edit schematics and PCBs simultaneously, using the same commands for each. HiWIRE II is \$995 and is guaranteed.



Wintek Corporation  
1801 South Street  
Lafayette, IN 47904  
Phone: (317) 448-1903

1 - 8 0 0 - 7 4 2 - 6 8 0 9

CIRCLE NO. 266

Combine your  
Product Mart ads in  
EDN Magazine and  
Products Editions  
for  
higher impact  
and a  
lower rate!

CIRCLE NO. 267

### ADVANCED™ SMT SOIC Sockets

SNAP ON  
COVER

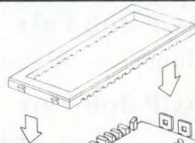

SMT SOIC  
Socket

- .050" (1.27mm) lead spacing.
- Molded locating ribs for fast device placement.
- Snap on cover retains device, maintains constant contact pressure.



ADVANCED INTERCONNECTIONS™  
5 Energy Way, P.O. Box 1019, W. Warwick, RI 02893 USA  
Tel. (401) 823-5200 Fax. (401) 823-8723

CIRCLE NO. 268

### PCMCIA (No Soap-on-a-Rope)



#### CH1827 PHONE INTERFACE

- Eliminates external DAA's — Fits Type II
- Works with all modem chip sets — V.32bis, V.TURBO
- Isolation included
- FCC Part 68 approvable
- Free Application Notes

Your Source for Modem Components



Tel: 408-752-5000  
Fax: 408-752-5004

Cermetek Microelectronics, Inc.  
1308 Borregas Ave. • Sunnyvale, CA 94089

CIRCLE NO. 269

To advertise in Product Mart, call Joanne Dorian, 212/463-6415

EDN February 3, 1994 • 155

# EDN-CAREER OPPORTUNITIES

## MANAGER PRODUCT DEVELOPMENT

Menomonee Falls, WI manufacturer of hybrid and resistor networks seeks individual to manage engineering staff in R&D of new products or extensive functional modification of existing standard lines in consumer telecommunications, power, and lighting products. Duties include: Originate basic scientific and engineering concepts of projects, evaluate findings of analytical studies to develop new products or to develop applications of findings to new uses; prepare and submit patent documents to supplement new findings; responsible for product material and manufacturing costs and quality of product, to reduce costs without impairment of quality and reliability standards; organize and formulate production operations for newly developed products; conduct complex R&D projects on specific components contributing to end product under development; evaluate feasibility of design, manufacturing, profitability, competitive product lines, marketing potential, and make recommendations; evaluate test results of pilot models and recommend changes to offset mechanical, electrical and other malfunctions; direct preparation of product layout, detailed drawings and schematics; direct and coordinate manufacture of prototype products; analyze test data and reports to determine if design meets functional and performance specifications; confer with outside academic research personnel to clarify and resolve problems and develop design; coordinate and manage technical collaboration with partners in India and Russia, including travel as required. Requires: M.S. (ABT) in Electrical and Computer Engineering and 6 yrs. experience in job offered or as Electrical Test/Design or Software Engineer in field of Telecommunications (may be concurrent), which must include following special requirements: 1 yr. experience in power supply and lighting engineering; 1 pending or approved patent in field of telecommunications, power supply or lighting; 3 yrs. experience in MASM808x, 80286, C, C++, Fortran, Cobol Basic computer programming languages; 3 yrs. experience with INTEL 8088, 68010, 68000, National COP822, COP88x, Z80 microprocessor based hardware. Salary \$39,600/yr, 40hr/wk; M-F. Send 2 copies of resume to: Gil Martinez at Waukesha Job Service Office, 141 N.W. Barstow, Waukesha, WI 53188 for Case No. 940057.

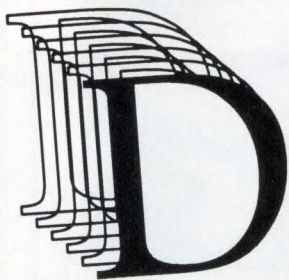
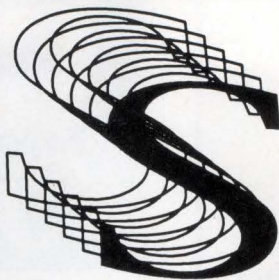
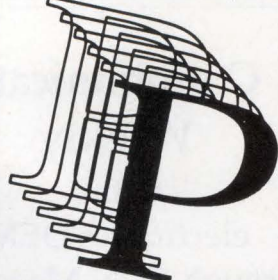
# Without Tears™

Learn DSP  
and Put your  
Knowledge to  
work  
immediately!

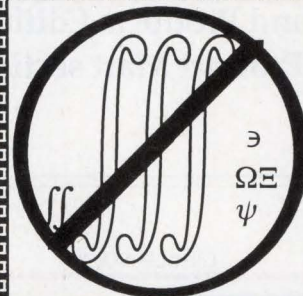

Coming to a  
Place Near You

Ft. Lauderdale  
Albuquerque  
Washington D.C.  
Chicago, Houston  
San Jose, Long Beach

Call Z Domain Technologies, Inc.  
(800)-967-5034  
(404)-664-6738

Call 9-5 EST. Ask for  
brochure.

Our 2-Day Advanced  
Course is ready. Call for  
info

By Taking This  
3-Day Course  
You will really  
learn DSP.  
Guaranteed!

## 1994 DIVERSITY/AFFIRMATIVE ACTION PROGRAM

### ISSUE DATE

### BONUS DISTRIBUTION

**March 3**

**NAACP Job Fair**

March 15 — Kansas City, MO

**National Society of Black Engineers**

National Meeting

March 16-20 — Pittsburgh, PA

**May 26**

**NAACP Job Fair**

June 7 — Atlanta, GA

**June 23**

**NAACP Job Fair**

July — Los Angeles, CA

**August 4**

**National Black Data Processing Association**

National Conference

August 17-21 — Cleveland, OH

**September 29**

**NAACP Job Fair**

October — Denver, CO

**October 27**

**American Indian Science & Engineering Society**

16th Annual National Conference

November 10-13 — San Jose, CA

**SOLID STATE  
DESIGNER/ENGINEER**

Northern New Jersey manufacturer of mechanical controls now developing complementary line of electronic products - primarily timing and light sensitive products - seeks experienced engineer on a project, freelance or consulting basis. Qualified individual must have a proven track record. Submit resume to:

EDN Magazine, 275 Washington Street, Box EDN - 2394, Newton, MA 02158-1630

**IOWA MIDWEST**

MIDWEST OPENINGS

**RF DESIGN ENGINEERS**

MSEE/BSEE. Experience levels to 10+ years. RF/Microwave circuit design, HF to 3.0 GHz. Areas of interest are: receivers, transmitters, power amplifiers, frequency synthesizers, modulation/demodulation, spread spectrum, DSP implementation of radio functions. Multiple openings with several of my Midwest client companies.

**DON GALLAGHER, MSEE**

Gallagher & Brei Associates

1145 Linn Ridge Rd., Mount Vernon, IA 52314  
(319) 895-8042 • Fax (319) 895-6455

**SOFTWARE ENGINEER**

Electrical Engineer with minimum five years experience in software design, strong background in C, assembler, 80188, TMS320, DSP operating systems and algorithms. Digital circuits. RF or video exp. a plus. Excellent opening at leading manufacturer of security scanners (since 1937). Northeastern New Jersey. Mail or fax resume and salary history to Brad Conway, Control Screening Corp., 234 Industrial Pk., Northvale, NJ 07647. Fax # 201-784-1583.

*For  
information  
on placing  
your  
advertisement in*

**CAREER**

**OPPORTUNITIES** for

**EDN Magazine**

*call:*

**Kim Fogarty  
Recruitment  
Account Executive  
1-800-603-4860**

**Knolls Atomic Power Laboratory**

**Senior Engineer  
Advanced Power Electronics**

Martin Marietta, Knolls Atomic Power Laboratory (KAPL) located in Schenectady, New York seeks experienced candidates to apply for a position as Senior Engineer, Advanced Power Electronics.

The individual in this position would be responsible for the circuit and packaging design, performance analysis and supervision of breadboard construction and testing. Specific applications to be developed and breadboarded will include: variable frequency/speed low noise AC and DC motor drives; medium current and voltage solid state circuit breakers; DC power distribution system control and conversion components; power factor correction equipment; harmonic correction/control equipment; DC power supplies.

Qualified candidates should possess either a PhD with a minimum of 5 years experience or MS with a minimum of 10 years experience specializing in power electronics. In addition, candidates should have working knowledge of SPICE and/or equivalent circuit modeling tool with desired experience using EMPT and CAD schematic capture tools.

KAPL offers a high level technical environment, competitive salary and company paid Martin Marietta benefits. Please submit your resume to: M. Englert-Walters, Program Manager, Staffing; Bldg A1, Room 161, Knolls Atomic Power Laboratory, P.O. Box 1072, Schenectady, NY 12301-1072. U.S. Citizenship is required. Equal Opportunity Employer M/F/D/V.

**MARTIN MARIETTA**

**ELECTRIC VEHICLE  
MOTOR CONTROL**

CURTIS/PMC, a division of Curtis Instruments, a small global company in business for over 30 years, is a world leader in transistorized and microcontroller based speed controllers for electric vehicles. Increased product demand has created a need for the following professionals:

**ENGINEER/RESEARCH**

We are seeking an engineer to research, build and test motor controller concepts. Candidates should have a strong generalist background having research design experience in magnetics (DC Permanent Magnet and Series Motors) and switchmode power supplies, a BSEE plus 5 years of hands-on commercial product design experience and basic principal understanding of thermal and mechanical properties related to electronic products. Please specify in a cover letter the development efforts you have undertaken related to motor design and power electronics.

**ENGINEER/R&D LAB**

Lead the centralized lab interfacing with manufacturing and R&D engineering. BSEE (or equivalent), 5-10 years' proven electronic construction, test, debug and prototyping experience, analog circuitry background, mechanical knowledge. People and project leadership strengths essential.

**ENGINEER/MECHANICAL**

Conceptualize, design, analyze, fabricate, test and assemble various mechanical and electromechanical assemblies, test fixtures and product packaging. BSME (or equivalent). Experience with stampings, extrusions, injection moldings, castings and electronics packaging required.

Located approximately one hour East of San Francisco (away from commuter congestion), we offer employer paid medical, dental, disability and life insurance, tuition assistance, profit sharing and 401(K) plan. Relocation assistance also provided. Send or fax resume INDICATING POSITION DESIRED, to: Human Resources Dept., CURTIS/PMC, 6591 Sierra Lane, Dublin, CA 94568. (FAX) 510-833-8777. Equal opportunity employer m/f/d/v.

**CURTIS PMC**  
A DIVISION OF CURTIS INSTRUMENTS, INC.

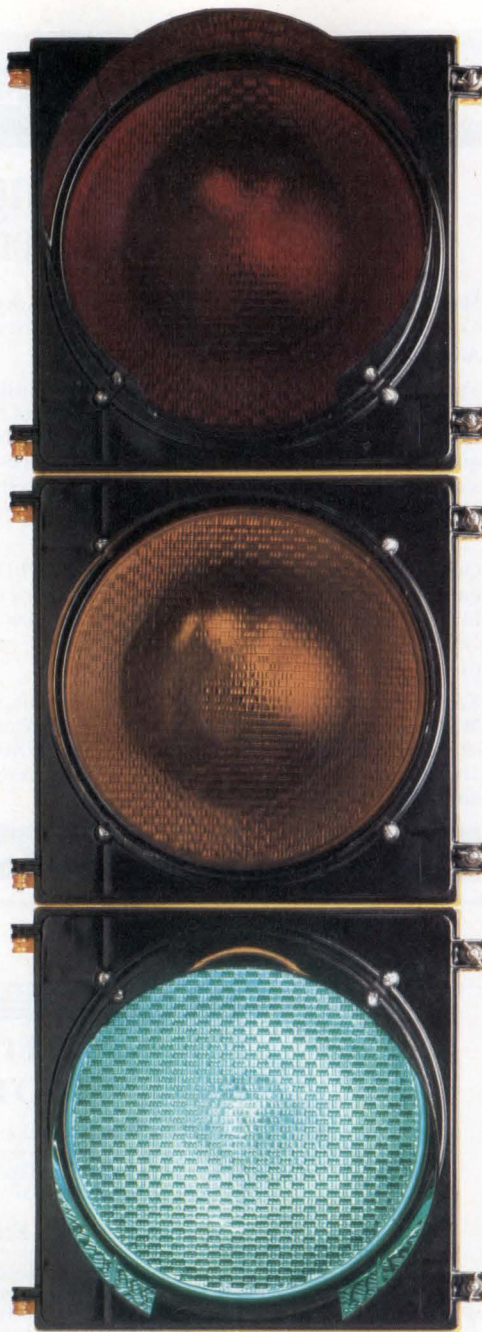

# Just to remind you that your project's a go.

When you can't afford to stop for downtime, GE Rental/Lease can keep you going. With over 120,000 pieces of the most advanced industrial and electronic test and measurement equipment and workstations in stock, we've got one of the largest equipment pools in the business. All available for rent, lease or purchase.

So you get the equipment you need, when you need it—backed by experienced Sales Specialists and our exclusive Customer Service Guarantee: *If for any reason you're unhappy with your rental, simply dial 1-800-GE-RENTS and ask for a Customer Service Representative. If we cannot make it right, your rental will be free.*

To give us the green light on

your next test equipment or workstation order, call **1-800-GE-RENTS** Monday through Friday 8 am to 8 pm, Saturday 8 am to 5 pm EST. We're ready to go.



**GE Rental/Lease**  
Test Equipment & Workstations

**EDN Headquarters**  
**275 Washington St**  
**Newton, MA 02158**  
**Fax: (617) 558-4470**

**Publisher**

Jeffrey Patterson  
 (617) 558-4454  
 Maria McGrath, Assistant  
 (617) 558-4346

**Advertising Sales Director**

Paul Rothkopf  
 (617) 558-4651

**Marketing/  
 Business Director**  
 Deborah Virtue  
 (617) 558-4779

**Custom Publishing Director**

Patricia Tyler  
 (617) 558-4526

**Promotion Assistant**

Jean Graham  
 (617) 558-4698

**Production Staff**

Andrew A Jantz, Group Product  
 Manager (617) 558-4372

Karen Banks, Manager  
 (617) 558-4441

Kelly Brashears, Assistant  
 (617) 558-4601

**Contracts**

Muriel Murphy, (617) 558-4451

**Circulation:** Denver, CO

(303) 388-4511

**Reprints of EDN arti-  
 cles are available on a  
 custom printing basis  
 at reasonable prices in  
 quantities of 500 or  
 more. For a quote,  
 phone Ellen Sandram,  
 Cahners Reprint Service  
 at (708) 390-2240.**

**NEW ENGLAND**

Chris Platt  
 Tel: (617) 964-3730  
 Fax: (617) 332-7128

**NEW YORK/NEW JERSEY  
 AND MID/SOUTH ATLANTIC**

John Maher  
 Tel: (215) 293-1212  
 Fax: (215) 293-0359

**IL, IN, KY, MI, OH, TN, TX,  
 OK**

JoAnn Cannon  
 Tel: (708) 635-8800  
 Fax: (708) 635-0929

**IL, MN, NE, IA, KS, ND, SD,  
 WI MO, AL, AR, MS, CANA-  
 DA**

Jack Johnson  
 Tel: (708) 635-8800  
 Fax: (708) 635-0929

**ARIZONA**

Donnie Jones Adams  
 Tel: (408) 243-8838  
 Fax: (408) 243-2144

**COLORADO/  
 WASHINGTON/  
 OREGON**

Frank Granzeier  
 Tel: (408) 243-8838  
 Fax: (408) 243-2144

**ORANGE/RIVERSIDE/  
 SAN DIEGO COUNTIES  
 LOS ANGELES/  
 SOUTHERN CA, NV**

Susan N Green  
 Tel: (714) 851-9422  
 Fax: (714) 752-6867

**NORTHERN CA/  
 SILICON VALLEY**

James W Graham  
 Frank Granzeier  
 Donnie Jones Adams  
 Tel: (408) 243-8838  
 Fax: (408) 243-2144

**EUROPEAN  
 OPERATIONS**

Tully Giacomazzi,  
 Managing Director  
 Tel: 49 89 769 02 391  
 Fax: 49 89 769 02 144

**UK**

John Waddell  
 Tel: 44-81-312-4696  
 Fax: 44-81-312-1078

**SWEDEN, NORWAY,  
 FINLAND**

Johan Fylking,  
 Lars Grunberger  
 Tel: 46 8702 1800  
 Fax: 46 8641 2032

**DENMARK**

Aase Kisborg  
 Tel: 45 33 14 9888  
 Fax: 4533149288

**GERMANY-NIELSEN 4/  
 BAVARIA**

Margarethe Munchmeier  
 Tel: (49-89) 22 20 15  
 Fax: (49-89) 299 160

**SPAIN**

Luis S Giner  
 Tel: 343-894-43-26  
 Fax: 343-894-88-37

**AUSTRIA**

Sven Kollensperger  
 Tel: 43-732-79-34-55  
 Fax: 43-732-79-34-58

**ISRAEL**

Asa Talbar  
 Tel: 972-35-223-621  
 Fax: 972-3-524-2177

**SWITZERLAND**

Roswitha N Briand  
 Tel: 41-1-261-4690  
 Fax: 41-1-251-45-42

**NETHERLANDS/  
 NORTHWEST GERMANY  
 (NIELSEN 1, 2, 5, 6, 7)**

Albert Ticheler  
 Tel: 31-40-41-37-27  
 Fax: 31-40-42-04-30

**CENTRAL/SOUTHWEST  
 GERMANY  
 (NIELSEN 3A, 3B)**

Franz Fleischmann  
 Tel: 4969-42-2951  
 Fax: 49-69-421-288

**FRANCE/BELGIUM**

Alain Faure  
 Tel: 33-1-4629-4629  
 Fax: 33-1-4093-0337

**HONG KONG**

Adonis Mak  
 Tel: 852-838-2666  
 Fax: 852 575 1690/852 575  
 1967

**JAPAN**

Kaoru Hara  
 Tel: (81-3) 3389-1822  
 Fax: (81-3) 3389-1761

**KOREA**

Jeong-gwon Seo  
 Tel: 82-2-752-4392  
 Fax: 82-2-752-4394

**SINGAPORE/MALAYSIA**

Hoo Siew Sai  
 Tel: 65-738-0122  
 Fax: 65-738-2108

**AUSTRALIA**

Alexandra Harris-Pearson  
 Tel: 61-2-299-5677  
 Fax: 61-2-299-6178

**TAIWAN**

Parson Lee, John Shih  
 Tel: 886-2-7114833  
 Fax: 886-2-7415110

**PRODUCT MART**

Joanne Dorian  
 Tel: (212) 463-6415  
 Fax: (212) 463-6404

**INFO CARDS/  
 LITERATURE LINK**

Melissa Bachman  
 Tel: (617) 558-4282  
 Fax: (617) 558-4328

**RECRUITMENT**

Kim Fogarty  
 Tel: (617) 558-4216  
 Fax: (617) 558-4328

**TELEMARKETING SALES**

Judy Telander  
 Tel: (310) 826-5818  
 Fax: (310) 207-1067

Direct Mail Service:  
 (708) 390-2361

**Cahners  
 Magazine Division**

Robert Krakoff,  
 President, CEO,  
 Cahners Publishing  
 Michael Wisner,  
 Senior VP/General Mgr,  
 Boston Div  
 Tom Dellamaria,  
 Senior VP/Production &  
 Manufacturing

**books that work the way you work**

*New edition!*

**Operational Amplifiers, 2e**

*Jiri Dostál, Research Institute for Mathematical  
 Machines, Czechoslovakia*

April 1993 500pp. cloth 0 7506 9317 7 \$59.95 (£46.00)

**Radio Frequency Transistors:  
 Principles and Practical Applications**

*Norman E. Dye and Helge O. Granberg, Motorola*  
 January 1993 288pp. cloth 0 7506 9059 3 \$39.95 (£40.00)

**EMC for Product Designers**

*Tim Williams*

1992 272 pp cloth 0 7506 9464 5 \$42.95 (£24.95)

**BUTTERWORTH-HEINEMANN**

80 Montvale Ave. Stoneham MA 02180

**1-800-366-2665**

M-F 8:30-4:30 ET

**FAX 617-438-1479**



**The EDN Series for Design Engineers**

*U.K. and Europe:*

Reed Book Services Ltd., Special Sales Department  
 P. O. Box 5, Rushden, Northants NN10 9YZ U.K.

TEL. 0933 58521 FAX 0933 50284

**SS089**

Cahners 16.89

# EDN-INTERNATIONAL ADVERTISERS INDEX

Company	Page	Circle	Company	Page	Circle	Company	Page	Circle
AMP	52-53	55	Intusoft	154	252	Siemens AG	50-51	54
Abbott Electronics	29	50	Ironwood Electronics	155	262	Siemens Matsushita Comp	68-69*	61
Accutrace	154	257	Japanese Products Corp	147	37	Sierra Circuits	151	233
Advanced Interconnection	154	259	Kikusui	78F	102	Signum Systems	154	25
Advin Systems	151	234	Linear Technology	70	62	Siliconix Inc	6	
Allegro Microsystems Inc	C2, 90	93, 71	Link	154	255	Sipex	141	33
Apex Microtechnology Corp	48	2,107	Logical Devices	153	246	Sony Semiconductor	138, 78E	85,101
Applied Data Sciences Inc	153	248	Mathsoft Inc	144	36	Spectrum Software	130	82
Ariel Corp	116	17	Maxim Integrated Products	83, 85	67, 68	Stanford Research Systems	130	28
Asahi Kasei	117	78		107, 109	75,76	Synopsys		27
Audio Precision	73	63	Metalink	153	250	T-Cubed Systems	154	258
Burr-Brown	129	81	MicroSim Corp	15	45	Tanner Research	153	249
Bytek Corp	155	26	Micron Semiconductor	122	79	Tatum Labs	152	238
Cermetek	155	269	Mini Circuits	3, 4	40, 41	Technit	148	91
Condor DC Power Supplies	155	264	Molex	75	64	Tektronix Inc	37-44,10-11	44
CuiStack Inc	151	232	Mueller	114	77	Texas Instruments	103, 78A	56
Cypress Semiconductor	12		NCI	139	31		61-63, 72	
DY4 Systems	137A-D		NCR Microelectronics	154	253		95-102	
	117A-D		NEC Corp	78	66		78G	
Data I/O Corp	155, C4	265,95		134, 143	83,87	Token Corp	89	70
Decision	116	19		86-87	69	Toshiba America	68-69	59, 60
Science Applications				78C	99	Electronics Comp		
Digi-Key Corp	1	38	NKK Switches	131		Tribal Microsystems	153	251
Diversified Technology	30-31	1	National Instruments	2	39	Trompeter	160	
Ecliptek Corp	76	4	National Semiconductor	19-21, 111		Underwriters Labs	137	84
Elantec Inc	88	106		113-114	96	Unitrode	145	89
Emulation Technology	155	267, 268	Netcom Systems	151	231	Viewpoint	152	241
Etal Ltd	159	117	Nichicon	146	90	Visual Software Solutions Inc	152	239
Fluke Corp	103	73	NordicTrack	128	27	W R Grace	142	34
Fujitsu	78H	104	Okii Electric Industry Co	78B	98	Westcor Corp	34	52
GE Rental & Lease	150	92	Omron	66-67	58	Wintek Corp	155	266
General Instruments	78D	100	OrCAD	49	53	Xilinx	32-33	51
Grayhill	124-125	20	Philips Semiconductors	64-65	57	Zaxtek	153	242
Hansen Corp	126	26	Pico Electronics	140	86	ZWorld Engineering	151	230
Harris Semiconductor	145	88		48, 144	3			
Hewlett-Packard	47		Positronic Industries Inc	135	29			
Corvallis Division			Power One	24	48			
Hewlett-Packard PMO	93	72	Prem Magnetics	141, 84	32, 9			
Hypertronics Corp	152	240	Protel	C3	94			
IEE	136	30	Quatech	152	236			
Incredible Technology	151	235	Quicklogic	127	80			
Integrated Device Technology	45		Raltron Electronics	84	16			
Intel Corp	8-9	43	Raytheon	16-17	46			
	118-121		Safe Soft	152	242			
International Rectifier	77	65	Samsung Semiconductor Inc	22-23	47			

## Recruitment Advertising

156

\*Advertiser in European edition

This index is provided as an additional service. The publisher does not assume any liability for errors or omissions.

## J24WHF Series Serial/Digital Patch Jacks

PREMIUM Normal-through video patch jacks that meet present and future broadcast standards!

Trompeter's J24WHF series 75Ω patch jacks provide an extended band width up to 360Mbits (720 MHz) with a typical return loss of ≥ 40dB through 720MHz. They meet and exceed present and proposed analog and digital standards.

J24WHF and J24WTHF-75 (self-terminating)



The J24WHF Series also offers:

- Greater reliability.
- 2.5 lbs. minimal withdrawal force to eliminate accidental removal.
- Long life, low contact resistance, consistent contact force.
- Superior dielectric and electrical contact properties.
- 100% compatibility with existing patch plugs, looping plugs and support equipment.

Trompeter's premium quality patching products and connectors are your best investment for ultra-high quality, reliable broadcast component performance.

Quality doesn't cost...  
It pays.



31186 La Baya Drive • Westlake Village CA 91362  
(818) 707-2020 • Fax (818) 706-1040

Contact your local representative or call us toll free - (800) 982-2629 for sales, service or technical support.



# THE FIRST WINDOWS™ EDA SYSTEM

Introducing the world's first electronic design automation system for Windows and the last EDA system you'll ever need to know. Protel Technology proudly presents the Protel Design System, the new standard for electronic design power and productivity on a PC.

New! *Advanced Schematic 2.0* This new release will take your designs anywhere you want to go and beyond, with integrated Engineering Change Order system, unlimited schematic design size, heads-up guided wiring and standard 15,000-part libraries, plus support for EEsof simulation products and EDIF netlists. *Advanced Schematic 2.0* provides direct loading of OrCAD SDT 3 & 4 files and libraries, just load your design files and keep working!

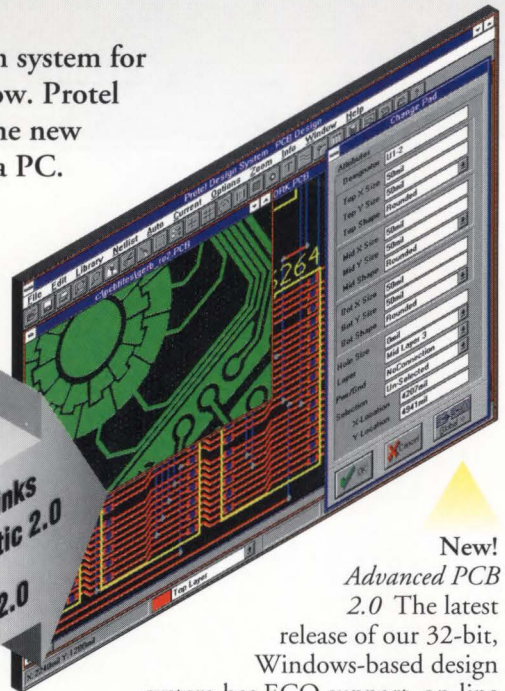
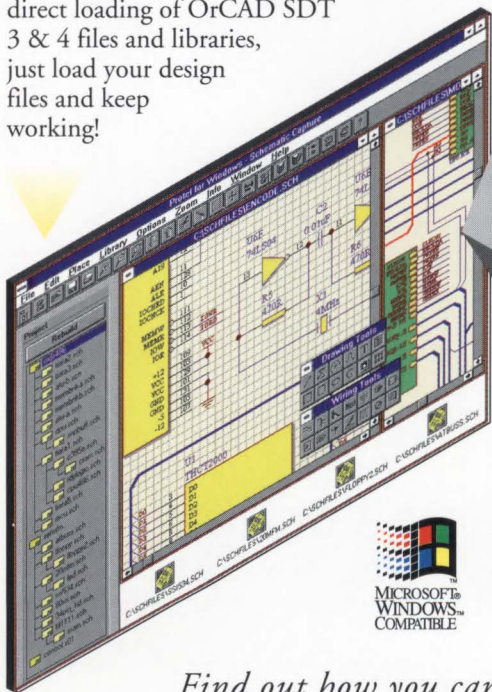

Cross Probing Links  
Advanced Schematic 2.0  
&  
Advanced PCB 2.0

New!  
*Advanced PCB 2.0* The latest release of our 32-bit, Windows-based design system has ECO support, on-line design rule checking, bi-directional cross probing with *Advanced Schematic*, unlimited object database and submicron resolution that eats high-density designs for lunch.

- New! *Advanced SB Route*, a gridless, shape based autorouter with the power to route your highest density designs in record time.
- New! *Advanced PLD Compiler*, a comprehensive tool for FPGA/PLD programming.\*
- New! *Advanced Digital Simulator*, your digital simulation solution.\*
- New! *Advanced Analog Simulator*, the analog simulator for Windows.\*



Find out how you can tap into the power of Windows EDA. Call today.

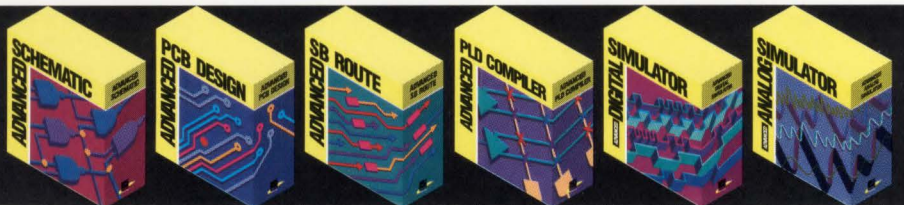

800-544-4186



FIRST IN WINDOWS EDA

## THE WINDOWS™ EDA SOLUTION

© 1993 Protel Technology, Inc. Prices and specifications subject to change without notice. \* FPGA/PLD, Digital Simulation and Analog Simulation modules will be available 1st quarter of '94. Protel and the Protel logo are registered trademarks of Protel Technology. Microsoft Windows is a trademark of Microsoft Corporation. All other products are trademarks of their respective manufacturers.

4675 Stevens Creek Boulevard, Suite 200 ■ Santa Clara, California 95051 ■ 408/243-8143 ■ Fax 408/243-8544



## You could even learn to like them.

Consider the FPGA. You want the density but you dread the complexity, and the cost and learning curve of the tools. Now consider Synario™. It's a universal toolset, yet it incorporates device-specific software from semiconductor vendors. And, this new design system is fully integrated, giving you schematic and behavioral entry, simulation, logic synthesis, and place-and-route in one, friendly Windows™-based environment. Even the price won't scare you. Learn how to face FPGAs – and CPLDs – fearlessly, call 1-800-332-8246, ext. 301.

# SYNARIO

Universal FPGA Design System  
*Synario is a Data I/O Product*

CIRCLE NO. 95



MICROSOFT  
WINDOWS  
COMPATIBLE