

Electronic Design 16

VOL. 24 NO.

FOR ENGINEERS AND ENGINEERING MANAGERS

AUG. 2, 1976

Analyzing the network analyzer.

As complex an instrument as you will ever find, the network analyzer needs care to produce best results. There are at least

half a dozen error sources that can assault accuracy. What the errors are and how they combine is up to you to find out. Dig into analyzers starting on p. 50.

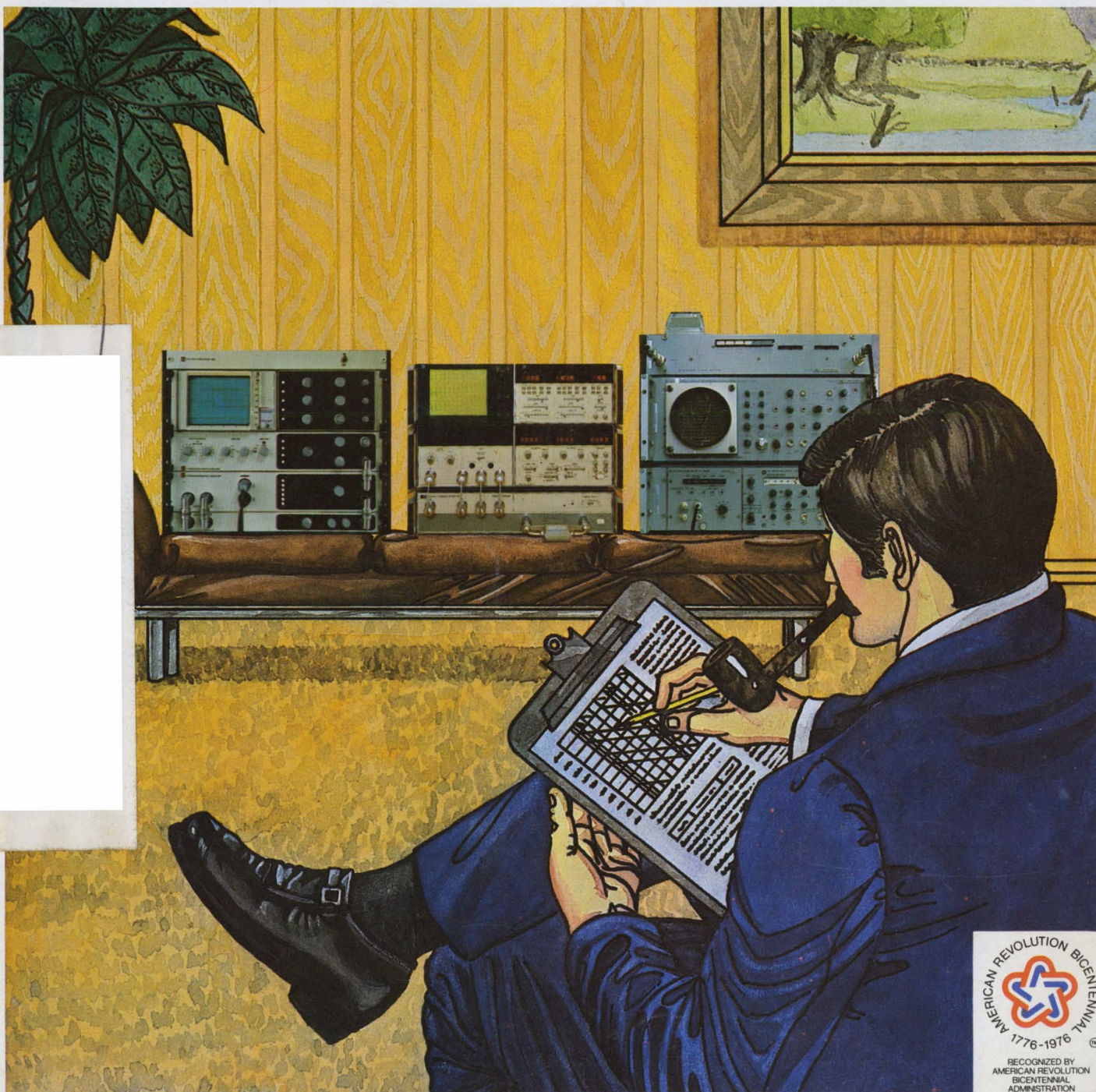

New Hybrid Potentiometer Combines the Best of Wirewound and Conductive Plastic— \$5³³*

New HYBRITRON™
resistance element . . .
conductive plastic
material on wirewound
mandrel.

The new BOURNS®
HYBRITRON™ resist-
ance element brings
you the best of both
worlds . . . the long life and
infinite resolution of con-
ductive plastic . . . plus the
tight linearity and low tem-
perature coefficient of a wire-
wound . . . at a new, low price.

You'll find this new element in
BOURNS® Model 3541 ten-turn
precision potentiometer . . . a new
member of BOURNS popular 3540
family of compact (7/8" dia., 3/4" deep),
low-cost multi-turn potentiometers.

Significant specifications of the Model
3541: service life of 5,000,000 shaft revo-
lutions; linearity 0.25%; temperature coef-
ficient of ± 100 ppm/°C maximum; reliable
SILVERWELD® direct terminal-to-element
bond; output smoothness of 0.015%; essentially
infinite resolution; rugged, mechanically locked
construction (no rear lid "pop-off"); special heat
resistant insert around terminals to prevent damage
during soldering.

If a low-cost wirewound satisfies your control requirement
. . . you can't do better than our Model 3540 ten-turn at \$3.97*.
Same quality construction features, same 0.25% linearity . . . with
rotational life of 1,000,000 revolutions. A wide range of standard and
custom options are available, including three- and five-turn versions.

FREE SAMPLE:

Write or phone the BOURNS PANEL POWER PEOPLE and tell us about your
application. We'll send you the Model 3540/41 that best suits your needs.

Available off-the-shelf from extensive factory stock and nearly 100 local distributor
inventories. TRIMPOT PRODUCTS DIVISION, BOURNS, INC., 1200 Columbia Avenue,
Riverside, California 92507. Telephone 714 684-1700. TWX 910 332-1252.

*1,000 pieces, same R.C., U.S. Dollars, F.O.B. Riverside, California



Gitchyseff an SFG.

**That's a synthesizer/
function generator, cousin—
the first one ever.**

Our new Model 171 combines the accuracy and stability of a synthesizer with the versatility of a function generator. This means you can generate sine, square, triangle, TTL pulse and dc outputs with synthesizer accuracy. Frequency range is 0.01 Hz to 2 MHz.

Sometimes all you'll need

to use is the generator dial, which is accurate to 3% of full scale. But for more precise operations, you'll want the synthesizer's 4½-digit accuracy which is 0.01% of setting. Synthesizer stability is $\pm 0.002\%$ from 0 to 50°C.

Now we all know that your average synthesizer goes for two grand or better. But the Model 171, which is also a function generator, goes for

just \$795*. Which means you could have two of our SFGs for the price of an ordinary synthesizer and have some bucks left over. Gitchyseff a couple. WAVETEK, P.O. Box 651, San Diego, California 92112. Phone (714) 279-2200, TWX 910-335-2007.

*US domestic price only

WAVETEK®

CIRCLE NUMBER 2

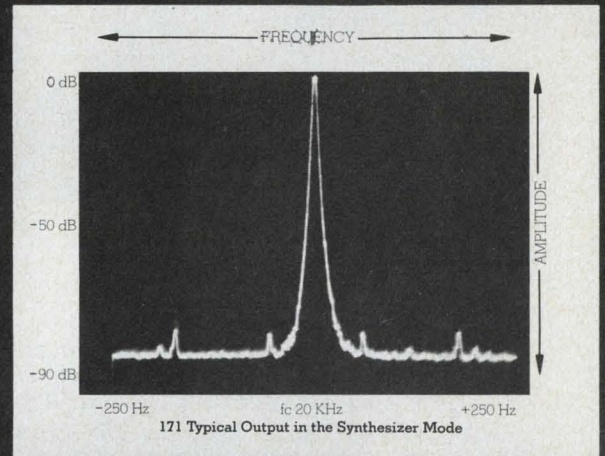
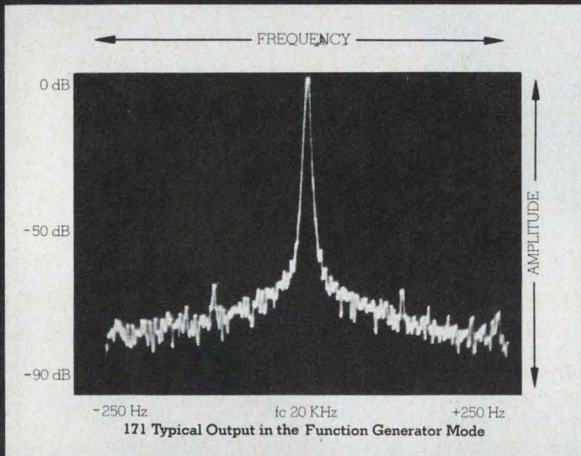

Actual spectrum analyzer photographs showing the improved waveform characteristics in the synthesizer mode.

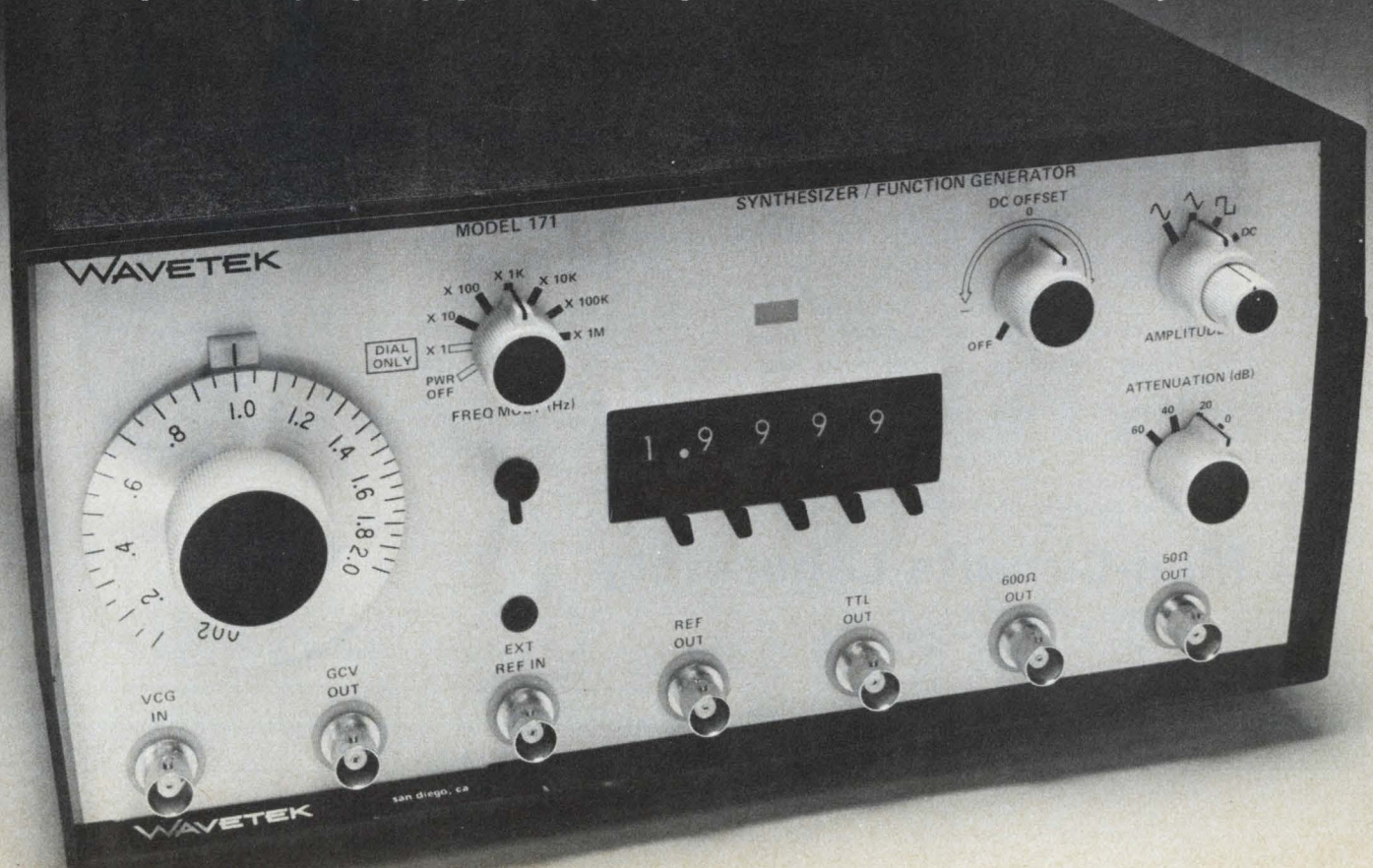

The only Double-Balanced Mixers with a 2-YEAR GUARANTEE*

featuring Hi-Rel tested diodes-

still only

\$7.95

(500 pieces)

\$9.95 (1-49)

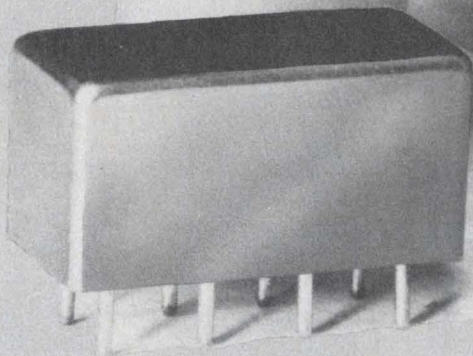

* including diodes!

Yes, a two-year guarantee for DBM's is now a reality . . . made possible by an accelerated-life diode screening program adopted at Mini-Circuits.

Each Schottky diode used in Mini-Circuits' SRA-1 mixers is now preconditioned by the HTRB (High Temperature Reverse Bias) technique, previously reserved almost exclusively for semiconductor applications assigned to space applications. With HTRB testing, each diode is operated for 168 hours at 150°C with one volt reverse bias applied.

To screen out "infant mortality", the diodes are deliberately stressed to accelerate aging and to force time-related failure modes to take their toll. In conventional testing or "baking", the diode does not experience anywhere near the stress encountered with the HTRB program. Hence, the ability at Mini-Circuits' to locate the potentially-unreliable diodes before they are assembled into SRA-1 units. And, with double-balanced mixers, the overall reliability hinges almost entirely on the diodes used.

Yes, the HTRB procedure costs us more and screens out more devices. But our goal is to improve reliability to a level unmatched for off-the-shelf DBM's at no increase in cost to our customers. You — our customers by your overwhelming confidence in our product line have made us the number one supplier of DBM's in the world.

To earn your continuing support, we are now employing HTRB Hi-Rel testing for every diode used in the SRA-1, at no increase in cost to you. So, for the same low price of \$7.95, you can purchase our SRA-1, with a two-year guarantee, including diodes.

To ensure highest system reliability demand highest quality diodes on your source-control drawings and purchase orders. Specify SRA-1 mixers, with HTRB tested diodes from Mini-Circuits'... where low price now goes hand-in-hand with unmatched quality.

MODEL SRA-1

Freq. range (MHz) LO - 0.5-500, RF 0.5-500, IF dc-500

Conversion loss (dB)	Typ.	Max.
One octave from band edge	5.5	7.5
Total range	6.5	8.5
Isolation (dB)	Typ.	Min.
Lower band edge to one decade higher	LO-RF 50	35
Mid range	LO-RF 45	30
Upper band edge to one octave lower	LO-RF 45	30
	LO-IF 40	25
	LO-IF 35	25
	LO-IF 30	20

Min. Electronic attenuation (20 mA) 3 dB

Signal, 1 dB compression level + 1 dBm

Impedance all ports 50 ohms



Mini-Circuits Laboratory

A Division Scientific Components Corp

837-843 Utica Avenue, Brooklyn, NY 11203
(212) 342-2500 Int'l Telex 620156
Domestic Telex 125460

International Representatives: AUSTRALIA General Electronics Services, 99 Alexander Street, New South Wales, Australia 2065. ENGLAND Dale Electronics, Dale House, Wharf Road, Frimley Green, Camberley Surrey. FRANCE S. C. I. E. - D. I. M. E. S., 31 Rue George Sand, 91120 Palaiseau, France. GERMANY, AUSTRIA, SWITZERLAND Industrial Electronics GmbH, Klüberstrasse 14, 6000 Frankfurt/Main, Germany. ISRAEL Vectronics, Ltd., 69 Gordon Street, Tel Aviv, Israel. JAPAN Denso Kaisha, Ltd., Eguchi Building, 8-1-1 Chome Hamamatsucho Minato-ku, Tokyo. EASTERN CANADA B. D. Hummel, 2224 Maynard Avenue, Utica, NY 13502 (315) 736-7821; NETHERLANDS, BELGIUM, LUXEMBOURG: Coimex, Veldweg 11, Hattem, Holland. NORWAY Datamatik AS, Ostensjoveien 62, Oslo 6, Norway

US DISTRIBUTORS: NORTHERN CALIFORNIA Cain White & Co., Foothill Office Center, 105 Fremont Avenue, Los Altos, CA 94022 (415) 948-6533; SOUTHERN CALIFORNIA, ARIZONA Crown Electronics, 11440 Collins Street, No. Hollywood, CA 91601 (213) 877-3550

For complete product specifications and U.S. Rep. listing see MicroWaves "Product Data Directory," Electronic Designs' "Gold Book" or Electronic Engineers Master "EEM"

NEWS

- 21 **News Scope**
- 26 **Scope in FM tuner** monitors quality of audio and rf reception.
- 28 **'Intelligent' turntable** contains μ P and LED in playback unit.
- 30 **Digital time-delay device** greatly enhances living room acoustics.
- 32 **Where is Natalia Makarova's tutu?** It was there a minute ago.
- 39 **Washington Report**

TECHNOLOGY

- 43 **MICROPROCESSOR DESIGN**
- 50 **FOCUS on Network Analyzers:** Unwrap the veil covering this most complex of instruments. Study the key elements in selection—accuracy, resolution, group delay—and make the choice easier.
- 58 **Put microprocessor software to work** by taking advantage of different addressing modes. Here are the basics of how these modes function.
- 66 **Use SOT-23 packaged components** in mass-produced hybrid circuits. They can cut size and cost while simplifying production and boosting over-all reliability.
- 72 **Isao Someya of Nippon Electric** speaks on educating engineers.
- 76 **Ideas for Design:**
Party-line intercom system needs only three wires.
Chopper amplifier for thermocouples has long-term drift of only $0.5 \mu\text{V}/\text{yr}$.
Logic circuit ensures definite break-before-make action for relay drive.
- 82 **International Technology**

PRODUCTS

- 85 **Modules & Subassemblies:** Inductosyn/digital converter modules offer top resolution.
- 100 **Power Sources:** Compact high-voltage supply stands tall in performance.
- 88 Instrumentation
- 92 Components
- 94 Integrated Circuits
- 96 Discrete Semiconductors
- 98 Data Processing
- 102 Packaging & Materials
- 104 Microwaves & Lasers

DEPARTMENTS

- 47 **Editorial:** Research it until you have the answer you want.
- 7 Across the Desk
- 106 Application Note
- 107 New Literature
- 112 Advertisers' Index
- 114 Product Index
- 114 Information Retrieval Card

Cover: Illustration by James Jany, network analyzers courtesy of Hewlett-Packard, GenRad and Rohde & Schwarz.

Our \$995* CPU is actually less than half the price of the 8080 or 6800 CPU.

And it's just the beginning of your saving. On-chip RAM, ROM and timers make an even bigger difference. Difference in cost. Difference in reliability and difference in manufacturing time. The following is the whole price/performance story of our F8 system, from minimum configurations to expanded systems.

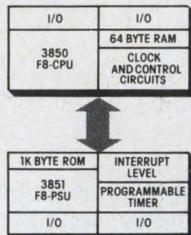

Lowest cost configuration

Our minimum configuration F8 is perfect for controlling home appliances, braking systems, vending machines, ignition systems and other uses with modest memory and I/O requirements.

Two chips do it all – a \$9.95 PSU (Program Storage Unit) and F8 CPU (Central Processing Unit) for \$9.95. The CPU is an 8-bit device, with a cycle time of 2 micro-seconds. It's the heart of all F8 microprocessors. It includes 70 instructions, 64-byte RAM (Random Access Memory), instruction register, accumulator, 16 individually controllable I/O lines, power-on reset, on-chip clock and control lines to other devices.

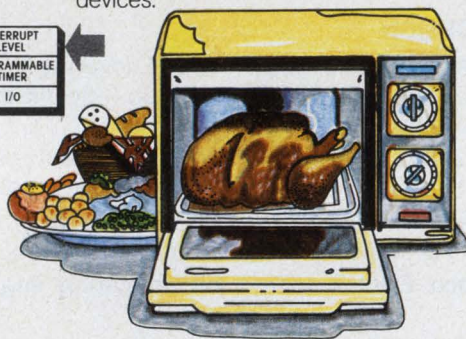

The PSU features a 1K byte ROM (Read Only Memory), program counter, 16 individually controllable I/O lines, 8-bit data port, stack register, incrementer/adder, and programmable timer and interrupt.

We're the only manufacturer in the world to offer this 2-chip performance. The 8080 requires 7 chips (9 chips with timer) to do the same thing.

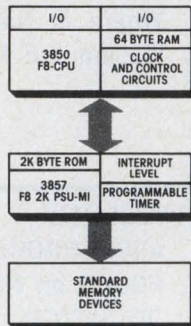

Double the program storage

If you need more program space, just substitute PSU's. Our new 2K byte PSU offers twice the ROM for only \$14.95.

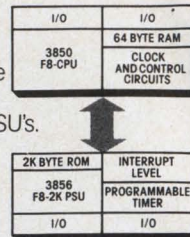

Built-in interface to external memory

But suppose you need a couple of RAM's added to your CPU and 2K/PSU. Again, substitute PSU's for one with a built in memory interface. Avoid paying for extra chips. Order our new 2K/PSU-MI for \$14.95. This is super microprocessor power on 4 chips.

The 8080 takes 10 chips (12 with timer) to do the same thing.

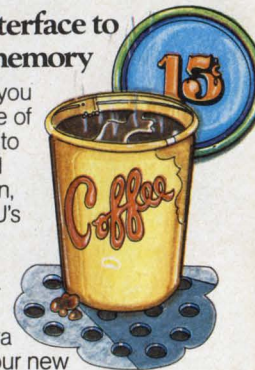

Fairchild's \$9.95 F8 Microprocessor

Half the Cost Twice the Versatility

A system that needs no ROM

If you don't want to commit to ROM, consider interfacing RAM and/or PROM (Programmable Read Only Memory) directly into the CPU. This approach is ideal when your production run is under 1,000 units, and for development prior to long production runs.

This F8 configuration uses only four chips: a CPU, a \$7.45 SMI (Static Memory Interface with interrupt and programmable timer) and two 2K PROMs. Competitors take twice as many chips to do the same thing.

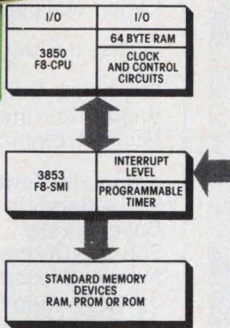

Where more I/O is needed

By adding our \$6.45 PIO (Parallel I/O) to this aforementioned configuration, you gain 16 I/O ports, another level of interrupt and a programmable timer. Now you have the perfect 5-chip microprocessor system for electronic scales, paper tape and cassette tape handlers, electronic games, traffic light control, cash register and similar applications.

Competitors take 10 chips to do the same thing.

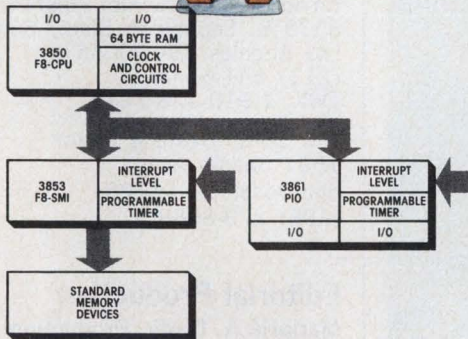

Memory intensive systems

In memory intensive applications like message concentrators, floppy disc controllers, and store-and-forward message switching you'll enjoy big benefits with the F8's DMI (Dynamic Memory Interface).



This \$7.45 device fits between your CPU and dynamic (or static) memory WITHOUT A MEMORY REFRESH CHIP.

Memory refresh logic is built into the DMI, and operates in sync with the CPU. Your CPU never stops. There's no cycle stealing. No performance degradation. We are the only manufacturer in the world to offer this advantage.

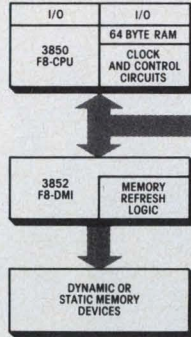

A supercharger for this memory intensive configuration is DMA (Direct Memory Access). This \$5.95 option comes in one chip. It creates a direct link between your memory and external data. All functional and internal system timing

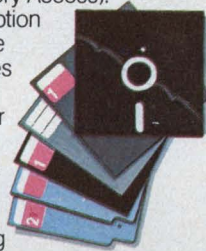

is built in. The DMA can run at 500K bytes/sec and never slows down the rest of the system.

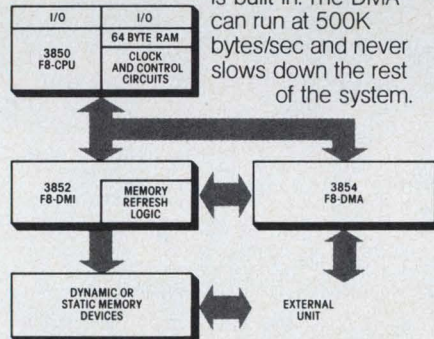

Expand your system

Interchangeability and compatibility are maximized for you. All inter-component timing is built in. Gang PSU's. Add PIO's. Daisy-chain multiprocessor systems.

To cut design time even more, you'll enjoy our Formulator.™ Think of it as an instant breadboard – a system developer, tester, debugger, and more. Of all hardware/software development aids on the market, this one is easiest to operate. Easiest to understand.

Discover how easy it is to assemble your own microprocessor. We provide a spectrum of hardware and software development aids. Everything you need including kits, hardware simulators and full program development support.

And then we will show you how to do it all, step by step in our brand new brochure, "THE PATHS OF LEAST RESISTANCE – Four Optimum Ways To Bring Your Microprocessor Product To Market". Write us now, your competitors probably will. We know ours will. Fairchild Micro Systems 1725 Technology Dr. San Jose, CA 95119 (408) 998-0123

FAIRCHILD

*All prices quoted are for 100 to 999 plastic packaged parts, effective Sept. 1, 1976

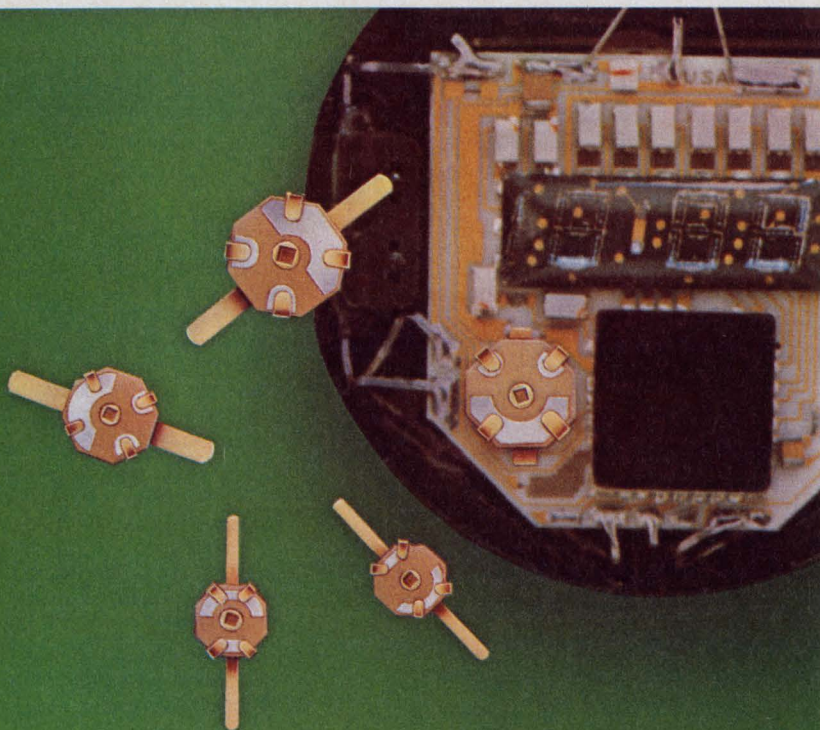

Thin-Trim[®] capacitors

Tucked in the corner of this Pulsar Watch is a miniature capacitor which is used to trim the crystal. This Thin-Trim capacitor is one of our 9410 series, has an adjustable range of 7 to 45 pf, and is .200" x .200" x .050" thick.

The Thin-Trim concept provides a variable device to replace fixed tuning techniques and cut-and-try methods of adjustment. Thin-Trim capacitors are available in a variety of lead configurations making them easy to mount.

A smaller version of the 9410 is the 9402 series with a maximum capacitance value of 25 pf. These are perfect for applications in sub-miniature circuits such as ladies' electronic wrist watches and phased array MIC's.

The logo for Johanson, featuring the name in a stylized, cursive script font enclosed within an oval border.

Johanson Manufacturing Corporation
Rockaway Valley Road
Boonton, New Jersey 07005
(201) 334-2676 TWX 710-987-8367

CIRCLE NUMBER 5

Sr. Vice President, Publisher
Peter Coley

Editors

Editorial Offices
50 Essex St.
Rochelle Park, NJ 07662
(201) 843-0550
TWX: 710-990-5071
Cable: Haydenpubs Rochellepark

Editor-in-Chief George Rostky

Managing Editors:

Ralph Dobriner
Michael Elphick

Associate Editors:

Sid Adlerstein
Dave Bursky
Samuel Derman
Morris Grossman
Jules H. Gilder
John F. Mason
Stanley Runyon
Michael Shunfenthal

Contributing Editors:

Peter N. Budzilovich, John Kessler
Alberto Socolovsky, Nathan Sussman

Editorial Field Offices

East

Jim McDermott, Eastern Editor
P.O. Box 272
Easthampton, MA 01027
(413) 527-3632

West

David N. Kaye, Senior Western Editor
8939 S. Sepulveda Blvd., Suite 510
Los Angeles, CA 90045
(213) 641-6544
TWX: 1-910-328-7240

Jim Gold, Western Editor
1537 Shasta Ave.
San Jose, CA 95128
(408) 279-8588

Editorial Production

Marjorie A. Duffy, Production Editor
Tom Collins, Copy Editor

Art

Art Director, William Kelly
Richard Luce, Anthony J. Fischetto

Production

Manager, Dollie S. Viebig
Helen De Polo, Anne Molfetas

Circulation

Director, Barbara Freundlich
Trish Edelmann, Gene M. Corrado

Information Retrieval

Peggy Long

Advertising Promotion

Susan G. Apolant

Across the Desk

Robot project arouses envy from a pioneer

The article, "Wanted: A Robot That Thinks For Itself," (ED No. 12, June 7, 1976, p. 67) arouses great envy in certain people. Those lucky fellows at JPL, NRL, and Tetra Tech are getting to do what a group at Applied Physics Laboratory—Johns Hopkins University (APL-JHU) tried to obtain funds to do 13 years and more ago.

The APL group proposed independent mobile automata for undersea, lunar, and planetary exploration, listing all the reasons given in your article. Alas, in those days manned space shots were the glamour projects, and no government funding could be found for unmanned "toys."

APL dipped into its own in-house budget to design and build two prototypes to test some of the concepts of self-sufficient robots. These automata were given the mission of surviving in the laboratory itself. Even this proved to be a harsher environment than first imagined, with stairwells, cul-de-sacs, floor level shifts between building sections, and hanging cables in the halls. When the silver-cadmium battery ran low, the automaton had to locate and plug into an AC wall outlet to recharge.

The MOD II robot's equipment was a sense of touch, sonar guidance, a vidicon eye for long range detection of outlets, a telemetry system for monitoring system states and issuing very general commands and a brain with discrete logic and a program patch panel. (Oh, to have had microprocessors, ROMs, RAMs, PROMs, and the like!) With a three-hour battery life, MOD II "lived" over

40 hours at a stretch before a mechanical failure disabled it.

Later models were to have been given useful tasks to perform in addition to simply surviving. (A leading soap manufacturer inquired about the economics of a robot floor-sweeper/waxer.) Planetary or aquatic models would, of course, need something like a solar or nuclear energy source. The problems of existing, moving, and working in alien environments were being tackled.

The two robots are now in APL's technical project museum. A couple of years ago someone gave MOD II a battery charge. It still worked.

The project received some publicity in the popular press at the time. There was a demonstration on NBC's "Today" show. There were articles in *Science Digest* (Aug., 1964), *Radio-TV Experimenter* (Oct.-Nov. 1964), *Parade* (Sept. 27, 1964), France's *Science et Vie*, and others. A short film-clip can still be seen in the film: *Future Shock*.

The JPL team, who were already developing many ideas of their own and who managed to come up with money, came to compare notes with the APL group, who were nearing the end of their funds. Judging from articles in the past few years and your article now, it appears that the JPL group has really been doing a great job.

Now they and NRL are ready to send their brain children into space and under the sea to prepare the path for man: One small step for a robot; one giant leap for automata.

George Carlton, John Chubbuck, Jim Jacques, Leonard Scheer, Lee

(continued on page 8)

Marcoflex. The switch that turns people on.

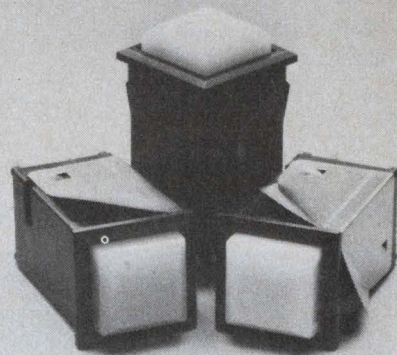

"... amazingly simple and reliable"
"Why didn't I think of it?"

People are really getting turned on by our new Marcoflex 650 switches.

Which doesn't surprise us. After all, its patented flexing spring action is something of a *break-through*.

An incredibly simple design gives you electrical and mechanical characteristics associated with larger switches in a miniature, .625-inch package at an economical price.

Features include wiping action, multiple-point (bifurcated) contact, true snap action, high contact force, and positive tactile feel.

Plus alternate or momentary action, and excellent reliability.

Get turned on by Marcoflex yourself. Contact us today for full details.

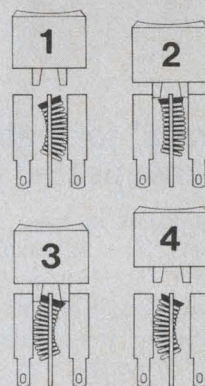

The patented Marcoflex mechanism.

ILLUMINATED PRODUCTS INC.

A subsidiary of OAK Industries Inc.
2620 South Susan St., P.O. Box 11930
Santa Ana, CA 92711
Telephone: 714/540-9471 TWX 910-595-1504

 COMPONENTS GROUP

CIRCLE NUMBER 6

Electronic Design welcomes the opinions of its readers on the issues raised in the magazine's editorial columns. Address letters to Managing Editor, *Electronic Design*, 50 Essex St. Rochelle Park, N.J. 07662. Try to keep letters under 200 words. Letters must be signed. Names will be withheld on request.

ACROSS THE DESK

(continued from page 7)
Spetner, Larry Viernstein, and the rest of us are watching.

Dr. Ronald C. McConnell
2255 Saddle Club Rd.
Burlington, NC 27215

Misplaced Caption Dept.

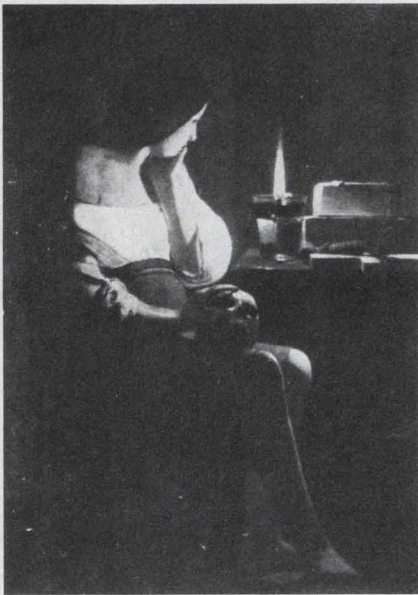

The standard candle has been carefully maintained for over 100 years in a basement at NBS.

Sorry. That's Georges de la Tour's "Magdalen with the Lamp," which hangs in The Louvre in Paris.

'Reward' for patent had unexpected result

With great interest I read your editorial "The Reward" (ED No. 6, March 15, 1976, p. 57). I think your engineer, Ken, hit the jackpot compared to the treatment that I received from the company I worked for several years ago. At least he got a dollar and a day off for his patent.

Here is what happened to me: An interface unit that I designed (subsequently patented) was material in giving my company the edge over competition in negotiating a very lucrative contract. While I was in San Francisco to

try out the prototype, about one half of my group was laid off, allegedly with my consent, and neither the president nor anybody else in the "top management" had the guts to call and inform me of their decision or action. Now, how is that for a reward?

Needless to say with such a bright leadership the company went broke a few years later.

Maybe, you can use this for a future editorial, but it is probably old hat for many engineers.

Gerhard T. Weiss
Senior Engineer

Yale University
School of Medicine Research
Facilities
34 Park St.
New Haven, CT 06508

Micron unit will not be a strapdown unit

In your April 26, 1976 issue, (ED No. 9, p. 16) an article was printed on our Micron strapdown inertial-navigation system, which is being developed under contract to the Air Force Avionics Laboratory at Wright-Patterson AFB. The article said the high-accuracy version of Micron "will not be a strapdown unit." That is not the case. Both the medium and the high-accuracy systems are strapdown, as opposed to gimbaled, systems.

The inertial instruments will be case-rotated about the "azimuth" axis to achieve the high-accuracy performance. This rotation does not constitute a stabilized axis, as it would for a gimbaled system. The rotation takes place for added accuracy.

J. A. Schwarz
Micron Program Manager
Autonetics Group
Rockwell International
3370 Miraloma Ave.
Anaheim, CA 92803

Magicam gives credit where credit is due

The article about Magicam ("Analog Servo System," ED No. 11, May 24, 1976, p. 30) states that Magicam developed the proportional

video matting process. This is not correct; the proportional process was invented independently by Petro Vlahos and Carl Hanseman, and developed by Image Transform, Inc. and Vidtronics, Inc. Magicam has used both systems.

John Gale

Technical Director

Magicam Inc.
5451 Marathon St.
Hollywood, CA 90038

Data on radar in our Bicentennial issue

Along with all the others, I too think your "200 Years of Progress" is tops. I'm saving my copy.

I saw one statement that I knew to be wrong, but who can be 100% correct in such a fine compilation? I did not intend to say anything but since others have cited what they believe to be errors, I thought I'd throw mine in.

You stated, "In 1943 the term 'Radar' was coined by Commander S. M. Tucker of the U.S. Navy." I was assigned as Personnel Officer of the Signal Corps General Development Laboratory in February 1942. Just prior to my assignment a section of the laboratory known as the RPF section (Radio Position Finder) was separated from the SCGDL and made a separate laboratory at Belmar, New Jersey. It was named the Signal Corps Radar Laboratory, Lt. Col. Rex Van Dam Corput commanding (later to become Brig. General).

In April 1942, I was recruiting civilian engineers for the SCGDL and a Major Bannister, was recruiting for the Radar Laboratory. While in California we received orders to discontinue the use of the word "Radar."

We joked about it, because we had already seen it in print in a trade magazine. We also joked that perhaps we should spell it backwards. Thousands of brochures had already been printed re the SC Radar Labs and a few hundred distributed.

Of course it's trivia, but nonetheless it's true.

John T. Freeman
Sr. Res. Engineer

E. I. DuPont De Nemours & Co.,
Inc.
Photo Products Department
Parlin, NJ 08859



MEASUREMENT COMPUTATION

innovations from Hewlett-Packard

NEWS

AUGUST 1976

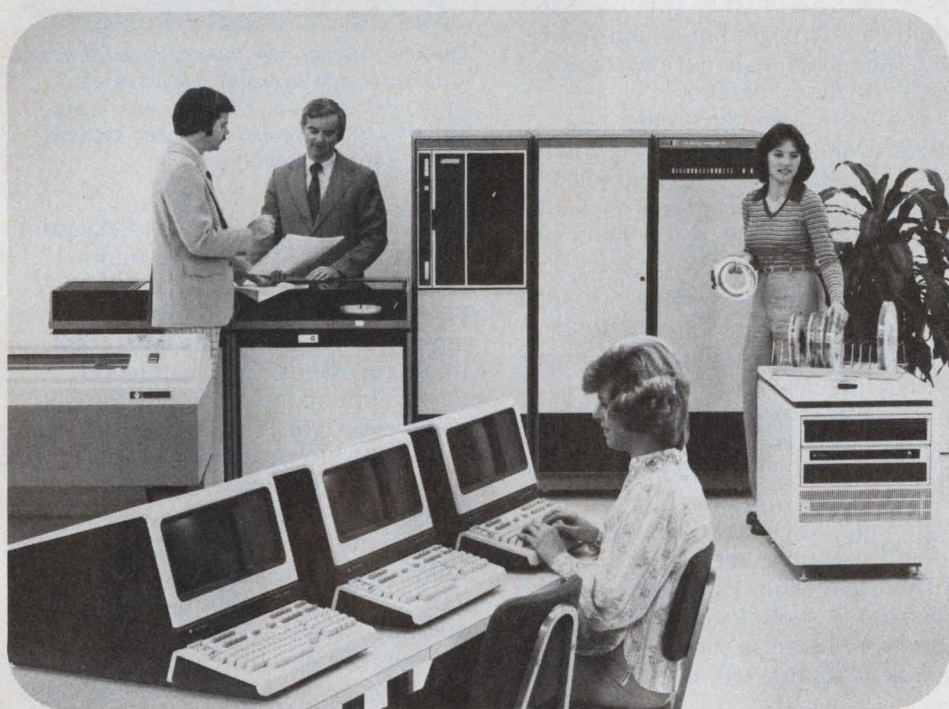

HP 3000 Series II systems are a powerful combination of software and hardware designed to deliver optimum performance.

Manage fast-growing data bases efficiently with new HP 3000 computer

As a terminal-oriented, general purpose computer, the new HP 3000 Series II is designed to operate in both batch and interactive terminal environments. Three compatible models allow you to select the configuration needed for present applications whether yours is a small or large organization or a corporate division. As your needs grow, the HP 3000 Series II can be upgraded—main memory can be expanded to 512K bytes.

Big system capabilities include:

- Fault control main memory—detect and correct memory errors with no reduction of speed
- Teleprocessing—data entry and processed-data-return via telephone lines
- Multi-terminal update and inquiry
- Data and file security
- On-line program development
- Job accounting
- Input and output spooling—for optimum use of peripherals
- Multiprogramming—for concurrent batch and terminal operations
- Remote job entry to large computers

in this issue

Instruments
“talk” and “listen”
with HP interface

Automatic RF network
measurements

New mini-processor board
for your instruments

- Five most popular commercial programming languages
- Data base management software (IMAGE/QUERY)
- Virtual memory

The HP 3000 Series II has been job-performance rated. Benchmark results are available to help you choose the proven capability that you need.

The HP 3000 Series II functions as a complete, independent data processing center, or as a satellite in a network of large computers.

If you plan to install a computer or upgrade your present system, you owe it to yourself to get all the facts. Check E on the HP Reply Card and we will send you a brochure with all the details.

High power pulse generator ideally suited for varied applications.



The highly flexible and carefully controlled output pulse characteristics of the Hewlett-Packard 214A make this pulse generator well suited to many applications. With output amplitude continuously variable from 80 mV to 100 V into a 50Ω load and fast (<15 ns) transition times, as well as minimum jitter, this pulse generator is particularly well suited for such applications as driving high-power modulators, semiconductor device testing, laser system testing, nuclear research and biomedical research.

Some of the more unusual applications of the 214A are:

1. A scientist at the University of California's Coastal Marine Laboratory used the 214A to measure the sound transmission in the head of a porpoise.
2. Engineers at the Convair Aerospace Division of General Dynamics in California used their 214A to find flaws in material by ultrasonic interference spectroscopy.
3. A French scientist used the 214A to measure the mobility of radioactive ions.

In addition to these applications, other engineers and scientists have used the 214A as a modulator driver in laser research and a pulse stimulus in basic material research. If you have an application for a pulse source that requires a high power signal, up to 200 watts, or a good, general purpose pulse generator for your lab, consider the HP 214A.

For additional details, check B on the HP Reply Card.

New multi-family logic clip speeds IC troubleshooting

Hewlett-Packard's new 548A logic clip troubleshoots IC digital logic circuits faster than ever:

- Its LEDs show logic states of 16 IC pins at once—a "truth table" display.
- It automatically adapts to TTL, DTL, RTL, CMOS and HTL circuits, and automatically seeks Vcc and ground.
- It's overload protected to 30V dc, to avoid damage from linear ICs.
- It draws <15 μA per pin—no circuit loading worries.

Use it with in-circuit stimuli or replace the system clock with our 546A Multi-Family Logic Pulser and slowly step sequential logic devices through a cycle to verify operation.

The 548A joins three other new HP IC troubleshooters to bring you the most modern set of handheld logic troubleshooting instruments available:

- **The 547A Current Tracer** lights up when held on or close to circuits carrying logic pulses from 1 mA to 1A. Troubleshoot wired-AND/OR busses, three-state busses, or pinpoint the one bad device on a stuck node.
- **The 546A Logic Pulser** is programmable to give one pulse per command, a 1, 10, or 100 Hz stream or a burst of 10 or 100 pulses. It drives TTL or CMOS high nodes low and low nodes high for stimulus/response testing.
- **The 545A Multi-Family Logic Probe** lights up to show logic highs, lows or bad level. Its pulse stretcher catches pulses as short as 10 ns.

Check C on the HP Reply Card.

The 548A logic clip is so easy to use that you can concentrate on the circuit under test instead of the test equipment.

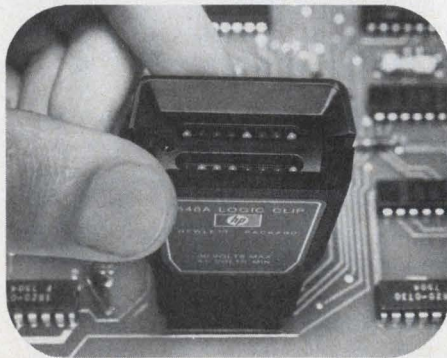

NEW "minicomputer on a board" is user programmable

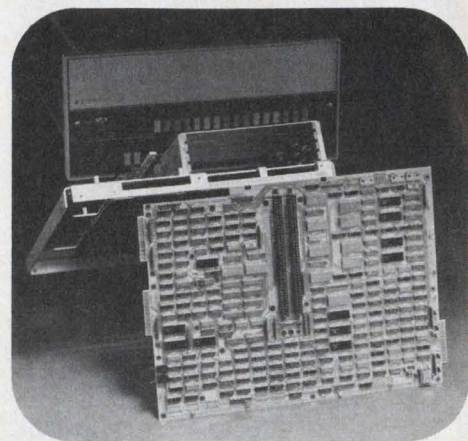

The new K-Series mini-processor board, which is hardware and software compatible with HP's 21MX Series of minicomputers, is supported by HP's powerful distributed systems software and hardware.

For the first time, Hewlett-Packard is offering the 21MX K-Series mini-processor components. Conveniently packaged for integration into your systems, the series includes the 2108K mini-processor board, instruction ROMs, front panel control assembly, and a choice of 18-slot or 8-slot cages.

As a 24-bit microprocessor, it is capable of performing a register-to-register add in one 325-ns cycle.

With the 12728E instruction set ROM, it becomes compatible with 21MX processor options, peripherals and operating systems.

Users can also benefit from the complete library of 21MX software systems for standard high level languages and microprogramming language, including the powerful new RTE-III Real-Time-Executive operating system.

Systems which could be designed around the HP processor include spectrometers, numerical control units, smart terminals, graphic display systems, medical diagnostic systems and other test equipment. A broad range of peripherals and instrumentation interfaces are available.

The 2108K gives you an opportunity to design high performance processing into your system. Accessories are priced separately. OEM discounts are available for quantity purchases.

For more information, circle A on the HP Reply Card.

Accurate measurements in hard-to-reach spots using touch-hold probe on new DMM

The touch-hold probe accessory for the new Hewlett-Packard 3½ digit, five-function autoranging digital multimeter allows the user to "freeze" the reading on the display—a convenience when probing closely-packed circuit boards.

Autoranging and manual modes: ac voltage, dc voltage and resistance can be measured either autorange or manually selected ranges. Select autorange to speed readings and minimize reading error—the LED readout always displays appropriate units. For repetitive readings, or ac and dc current measurements, use the manual mode, selecting from at least five ranges for each function...again the appropriate units will be automatically displayed on the high-efficiency LED annunciators.

Eliminate the need for both a high frequency ac voltmeter and a low-range ohmmeter inasmuch as the 3435A operates over a bandwidth five times greater than most comparably priced DMMs. Measure up to 1200V rms between 30 Hz and 100 kHz, with mid-band accuracy of 0.3% of reading plus three digits. Or, test resistance from a new low range of 20Ω full scale up to 20 MΩ. Dc voltages up to 1200V are

measured with a full-year best accuracy of 0.1% of reading plus one digit. Ac and dc current ranges extend from 20 μA to 2A. All inputs are protected; polarity is automatically sensed and displayed, and autozero occurs before each reading. Open circuit voltage on the ohm terminal, at its lowest range, does not exceed 5 volts, thus preventing damage to most solid-state devices.

Contact and transformer winding resistance are easily measured with 10 milliohm sensitivity. 100 μA sensitivity on the ac and dc ranges make the 3435A ideal for both bench and field applications.

An extensive line of accessories also includes probes for measuring ac voltages at frequencies as high as 700 MHz and dc voltage up to 40 kV.

The standard 3435A is ac line or battery operated and includes batteries and recharging circuitry. If you don't need battery operation, Option 001 gives you line operation only. A rack mounting model is also available. The touch-hold probe is an inexpensive accessory.

For more details, check F on the HP Reply Card.

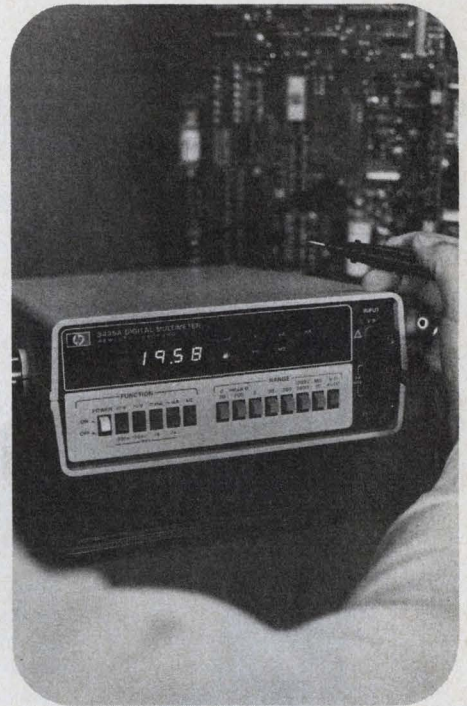

With new touch-hold probe, you can concentrate on your circuit, conveniently hold the measurement, and read the 3435's display after removing the probe. You are confident of measuring at the right point without accidentally shorting the circuit.

HP logic state analyzer speeds digital design and logic troubleshooting

In the TABLE mode, the 1600S displays up to 16 lines of code, and up to 32 bits wide, with their sequential relationships in familiar logic notation.



In the MAP mode, you can examine the unique "fingerprint" of every logic system.

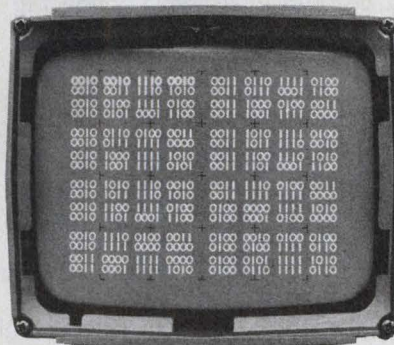

If you've ever spent more time than you care to account for in looking for the source of elusive digital problems, you will appreciate the effectiveness of using an HP logic state analyzer.

Look inside your operating circuit, right on the busses and qualifier lines. The HP 1600S logic state analyzer gives

you two ways to view system operation—**MAPPING** and **TABLE**.

MAPPING, which consists of a display of interconnected dots, offers a dynamic overall view of the program flow.

Each dot represents a specific data word with its position determined by the binary content of the word and its brightness indicates its relative frequency of occurrence. Once the suspected problem area is located, switch to the **TABLE** display mode.

Now, look at events leading up to, surrounding, or following the trigger word. Or, page through a program up to 99 999 clock cycles beyond your trigger point.

Circle D on the HP Reply Card for your copy of an 8-page brochure.

HP calculators control your instruments with easy do-it-yourself interfacing



Easily interface your instruments—scanners, counters, spectrometers, meters, converters and many others—with an HP calculator, thus achieving greater efficiency of the use of their outputs. An automated system giving you results and reports faster and easier will eliminate manual readings, adjustments and calculations, freeing you for creative project management.

HP-IB

The new HP 9815 and HP 9825 computing controllers make interfacing practical and inexpensive. Whether your interfacing application is simple data logging, dedicated instrument control, or large system integration, these controllers can save you time and money while increasing productivity.

Converting the signals from one device into signals the connecting device can use, or vice versa, is now simplified. You simply plug the correct interface card into the back of the controller that fits your need. Connect your instrument to the other end of the I/O card, program your controller with a few simple instructions, and you're ready to put your automated system to work.

Types of interfaces available for the 9815 and 9825 include:

HP-IB—Hewlett-Packard Interface Bus—up to 14 instruments with built-in HP-IB capability can be interconnected to a computing controller via this interface system, HP's implementation of IEEE Standard 488-1975. Bi-directional, asynchronous communication is now possible between many instruments.

BCD—The Instrumentation/Measurement Interface—the majority of instruments produced today output four-bit parallel BCD data.

Bit-Parallel—The General Purpose Interface—choose either 8 or 16-bit parallel input bus and an 8 or 16-bit parallel latched output bus combination. Use this interface to connect to HP devices such as plotters, tape readers, printers, or other equipment such as scanners, scanning electron microscopes, etc.

The HP 9815 calculator is an inexpensive alternative to manual monitoring of an instrument or small system.

For large complex instrumentation systems, the HP 9825 can interface to as many as 42 measuring instruments through its three I/O slots. The internal processing speed is so fast that transferring data and commands, accepting inputs, analyzing data, and printing or plotting results appear to happen simultaneously.

For additional details on selecting the calculator and/or the interface that will best meet your needs, check Q on the HP Reply Card.

NEW 4-channel tape recorder offers 32:1 time base expansion or compression plus remote control via HP-IB option

A new four-channel (0.6 cm) ¼-inch instrumentation tape recorder, the HP 3964A, has all of the standard features of the recently announced eight-channel HP 3968A ITR but at a much lower price.

Versatility, portability and durability are factors that will interest both the individual researcher and the OEM user, both for laboratory and field use.

Record at six tape speeds from 15/32 ips to 15 ips. Standard features include remote control, internal AC/DC calibrator, tape/tach servo mode and flutter compensation. Channel 2 may be interrupted for voice annotation; microphone and speaker are included.

FM recording is from DC to 5 kHz with a signal-to-noise ratio (SNR) of 48 dB at 15 ips. Direct recording is from 50 Hz to 64 kHz with SNR of 38 dB.

For additional information on additional features and options, check H on the HP Reply Card.



HP-IB

With increased time base expansion, rapidly changing signals can be slowed down and recorded by strip chart or oscillographic recorders for detailed analysis. Low frequency signals can be scaled up for observation on an oscilloscope.

How to make your spectrum analyzer measurements more accurate

Just published is a new application note, AN 150-8, a comprehensive discussion of spectrum analyzer accuracy considerations. Factors that determine amplitude and frequency accuracy are examined and procedures for obtaining the best accuracy are presented. Special cases such as swept measurements, low-level signals and closely spaced signals are described.

For your copy, check T on the HP Reply Card.

Boost low level signals with new 1300 MHz preamp

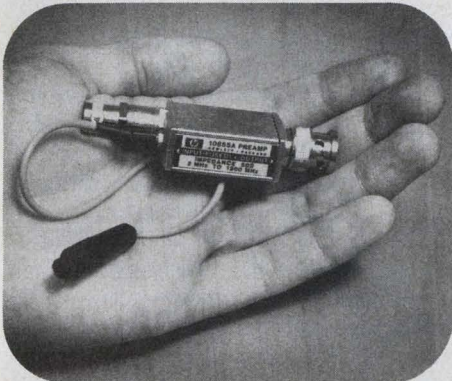

Noise figure of new preamp is less than 8.5 dB.

The new HP 10855A preamp enhances measurements of very low level signals by 22 dB minimum. Uses include amplifying "on-the-air" signals for measurement with counters or spectrum analyzers and restoring the loss of scope divider probes. The 10855A boosts the input sensitivity of HP counters by a factor of 10.

This preamp features ± 1 dB flat response from 2 MHz to 1300 MHz, with 50 Ω input and output impedances. This covers the VHF and UHF television, mobile communications and TACAN/DME bands. An input fuse prevents costly preamp damage.

The 10855A operates conveniently with HP measuring instruments having probe power outlets (see counter above right) or will work with a separate probe power supply such as the HP 1122A.

For more information, check R on the HP Reply Card.

Two HP-IB compatible counters measure UHF and TACAN/DME frequencies



The compact HP 5305B is designed for bench and portable applications in communications service; the HP 5328A is a full capability Universal Counter including precision frequency and time interval measurement for bench and systems use in laboratory or production test.

New capabilities extend two HP counters to 1300 MHz with 20 mV sensitivity to cover the VHF and UHF TV and mobile communications bands, TACAN/DME, and AM and FM broadcast bands. Each also includes a first for electronic counters—a probe power outlet to drive an accessory 22 dB ($\times 10$) preamp. The HP 10855A Preamp (plugged into 5328A counter above) enables the measurement of very low level signals. See article to the left.

Model 5305B operates with the 8-digit 5300B mainframe for frequency measurements from 50 Hz to 1300 MHz. A phase-locked multiplier gives $\times 1000$ resolution for rapid, accurate, automatic audio tone measurements to 10 kHz. With both extended high frequency range and improved audio range resolution, the 5305B is ideal for servicing mobile communications equipment that uses tone modulation for digital transmission.

The 5305B is one of eight snap-on modules for the 5300B measurement system. Any of seven other modules can be snapped onto the 5300B upper "readout module" in place of the 5305B in less than 30 seconds to convert the 5300B for other frequency or time interval measurements, or to a digi-

tal multimeter for ac/dc volts/ohms. Other accessories that snap between upper and lower halves include a battery pack and charger, a digital-to-analog converter for high resolution plots on analog recorders, and an HP-IB module for outputting digital data to the Hewlett-Packard Interface Bus.

With the HP 5328A Universal Counter, Option 031 adds 1300 MHz frequency measurement range to the extensive period, time interval, totalizing, ratio and voltage measurement capability of this 8-digit counter (9 digits optional).

The 5328A achieves its extended versatility by any of eight options which are either factory or field installable in about an hour. In addition to Option 031, there's: an ultra-stable time base option for higher accuracy, complete remote operation via the Hewlett-Packard Interface Bus, choice of two different built-in DVMs, a third frequency input channel up to 512 MHz with 9-digit display and a high performance time interval option.

For more information, check N on the HP Reply Card.

The HP 8640B now phase locks with 500 Hz resolution. Companion down converter extends output down to 5 kHz



Models 8640A/B signal generators are now offered with improvements in resolution, power, and modulation settability.

Some mobile FM receivers (especially in Europe) are now using channel spacing of 12.5 kHz to increase communications capacity. To meet this need, the HP 8640B signal generator now features an additional half digit of phase lock resolution across its entire band of 500 kHz to 1024 MHz. (500 Hz lock points from 100 MHz to 1 GHz).

Internal design changes provide simplified front panel operation for output power and modulation settings. New, low-power counter circuits and other component changes have reduced heat and component count for added reliability.

The same power and modulation changes have been made in the HP 8640A slide-rule-dial tuning signal generator.

For additional technical information on this increased capability of the 8640A/B signal generators and the 11710A down converter, check P on the HP Reply Card.



The model 11710A down converter extends the frequency range of the 8640A/B down to 5 kHz.

New 5 kHz to 550 kHz down converter

Design and service of AM-FM broadcast receivers often require test signals for both RF bands as well as the standard IF frequencies at 262 kHz and 455 kHz.

The HP 11710A down converter, as an accessory for the above-mentioned 8640A/B, provides a frequency range of 5 kHz to 500 kHz by mixing a 5.0 to 5.5 MHz carrier from the 8640 signal generator with a fixed 5 MHz oscillator in the 11710A.

Calibrated output level is preserved from 0 to -107 dBm, and the calibrated modulations may be set on the 8640. Intermixing spurious is more than 80 dBc (dB below carrier) and harmonics are more than 30 dB down. For user convenience, an RF switch bypasses the down converter and eliminates the need to switch cables when using the standard 8640 band.

New miniature 18 and 26.5 GHz microwave detectors ideal for designing into equipment

Equipment designers who require a broadband microwave detector with excellent performance and small dimensions now have an answer.

The HP 33330B detector covers the frequency range 0.010 to 18 GHz with excellent flatness (± 0.6 dB to 18 GHz). Package size is ideal for designing into small spaces. Total length of the package is 4.2 cm (1.70 in) and diameter is .97 cm (0.38 in). The model 33330C extends the frequency range to 26.5 GHz with reduced performance.

RF input is 50 Ω with an SWR of less than 1.5 to 18 GHz. The connector is the new APC-3.5 precision sub-miniature which exhibits outstanding reliability and repeatability even after 1000 connections. The APC-3.5 is fully compatible with the industry-standard 3.5 mm SMA series. The video output connector mates with the SMC series, which is especially well suited for the miniature cabling of modern equipment.

Models 33330B/C utilize the same field-replaceable diode module developed by Hewlett-Packard for measurement-quality microwave detectors and are specifically designed for use in rugged environmental conditions.

For more details, check K on the HP Reply Card.



HP 33330B microwave detector (.010 to 18 GHz) is of very small size for use in OEM equipment.

HEWLETT-PACKARD COMPONENT NEWS

New low loss absorptive modulators cut insertion loss 0.5 dB

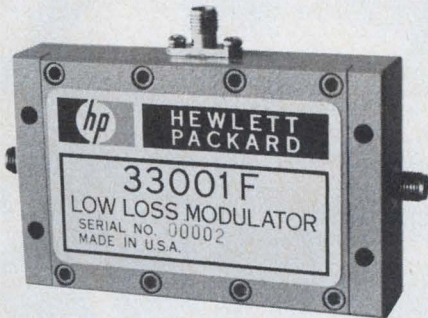

New hermetically sealed semiconductor devices in a rugged overall package are matched at all attenuation levels.

Three new HP absorptive modulators (33001E/F, 33008E) provide at least 0.5 dB improvement in insertion loss over previously available models. This improvement has been made possible by incorporating Hewlett-Packard low-loss PIN diodes into the modulators.

Absorptive modulator applications include level setting, wideband amplitude modulation, pulse modulation and switching. The absorptive modulators present constant impedance and therefore are useful where load sensitive sources are used.

These absorptive modulators are electronically controllable attenuators for the frequency range from 3.7 to 18 GHz. Each product covers greater than one octave and presents a good impedance match ($Z_0 = 50\Omega$) at both RF ports for all values of attenuation.

For technical data, check J on the HP Reply Card.

High reliability test programs for microwave transistors

If your procurement needs are immediate and you need microwave transistors screened by high-reliability test programs, Hewlett-Packard offers four levels of high-reliability testing patterned after MIL-S-19500.

Applications for these "off-the-shelf" microwave transistors include satellite equipment, avionics, radar, military radio and communications.

Four small-signal NPN transistors are presently offered: 35824A for general use to 1 GHz; 35826E for microstrip use to 4 GHz; 35829E optimized for high "tuned" gain at 2 GHz; and 35866E optimized for low noise at 4 GHz.

Details of these test programs are described in a new technical data sheet. For your copy, check I on the HP Reply Card.

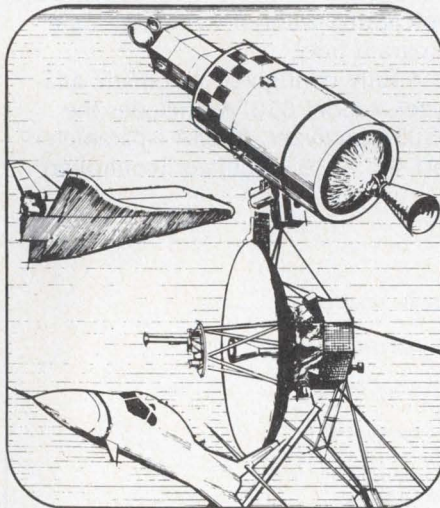

Four new .43" universal overflow digits

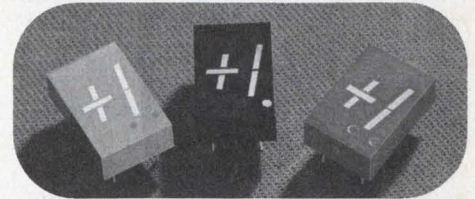

Overflow digits expand HP display family.

Available in red, high-efficiency red, yellow or green these devices can be driven common anode or common cathode because both leads of each LED are brought out to separate pins. Right-hand decimal point is a standard feature on this 5082-7756 series.

These devices are available from any franchised HP distributor.

For more information, check L on the HP Reply Card.

New microwave components short form catalog

Microwave circuit designers will want this new 4-page quick reference guide to Hewlett-Packard's line of diodes and transistors. A condensed review of the company's microwave components, this new brochure gives important specifications of HP's microwave transistors, and PIN, IMPATT, step recovery and Schottky diodes. Also included are condensed specifications of MIS capacitor chips and a printed circuit balanced mixer.

For your copy, check S on the HP Reply Card.

New low-power monolithic displays

Now available from Hewlett-Packard is a new series of large monolithic LED displays for instrument design. These magnified displays require only 1/3 the power of conventional seven-segment displays while offering excellent readability in high ambient light conditions.

Close digit-to-digit spacing allows over 4 digits per inch in a pre-aligned

multi-digit package.

The 5082-7265/75/85/95 series comes in 5 and 15-digit packages with centered or right-hand decimal points.

These devices are available from any franchised HP distributor.

For a technical data sheet, check M on the HP Reply Card.

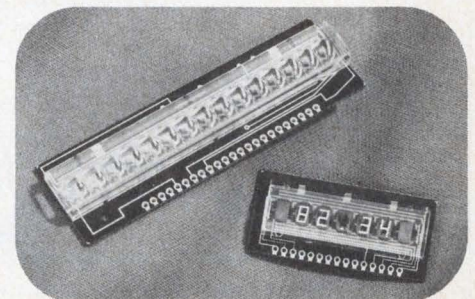

Make RF network measurements automatically— cassette programs simplify system start-up

Hewlett-Packard's new 1.3 GHz network analyzer, the 8505A, brings unprecedented capability to RF network characterization: 100 dB dynamic range, high-resolution digital data read-out with analog display, direct measurement of group delay, and a unique electronic line stretcher to measure deviation from linear phase.

The 8505A is also the most programmable network analyzer available today, permitting the analyzer to combine with the programmable HP 9830 calculator through the Hewlett-Packard Interface Bus (HP-IB) to become an immensely powerful *automatic* network analyzer.

Key advantages of automating the network analyzer include: extreme measurement accuracies (by virtue of the system's ability to measure, store, then subtract such vector errors as frequency response, directivity and source match) ability to make many measurements quickly, and the ability to manipulate data and format results in a suitable form.

Unique to this new automatic analyzer is its "**Learn Mode**" of operation which makes it possible to automate measurements *without programming*. A single key stroke can cause the calculator to store (Learn) the front-panel control settings of the network analyzer. These can later be recalled which re-



Model 8507A Automatic Network Analyzer, 500 kHz—1.3 GHz, dramatically reduces the time and cost of executing complicated tests.

turns the analyzer to its original test conditions. An entire test procedure can be created without writing a single program line!

A fully-configured automatic analyzer, Model 8507A, includes the 8505A analyzer, 8503A s-parameter test set, 9830 calculator (controller)

with printer, necessary interfaces, cables, calibration kit, table and cassette programs which permit you to start making measurements immediately.

For more details, check O on the HP Reply Card.

East-4 Choke Cherry Road, Rockville, MD 20850

Ph. (301) 948-6370.

South-P.O. Box 10505, Atlanta, GA 30348

Ph. (404) 434-4000.

Midwest-5500 Howard Street, Skokie, IL 60076,

Ph. (312) 677-0400.

West-3939 Lankershim Blvd, North Hollywood, CA

91604, Ph. (213) 877-1282.

Europe-7, rue du Bois-du-lan, P.O. Box, CH-1217, Meyrin-2,

Geneva, Switzerland, Ph. (022) 41 54 00.

Canada-6877 Goreway Drive, Mississauga, Ontario,

L4V 1M8, Ph. (416) 678-9430.

Japan-Yokogawa-Hewlett-Packard Ltd., Ohashi

Bldg., 1-59-1 Yoyogi, Shibuya-ku,

Tokyo 151, Ph. 03-370-2281/92.

HEWLETT  PACKARD

Sales and service from 172 offices in 65 countries.

 MEASUREMENT
COMPUTATION NEWS
innovations from Hewlett-Packard

July/August 1976

New product information from
HEWLETT-PACKARD

Editor: Iona M. Smith

Editorial Offices:
1507 Page Mill Road
Palo Alto, California, 94304 U.S.A.

THE LOGICAL CHOICE: Third in a series

SYMMETRICAL AND UNSYMMETRICAL PULSES
0.5Hz-5MHz.

CONTINUOUS, MANUAL ONE-SHOT & EXTERNAL TRIGGER OPERATION
External triggering to 10MHz

INDEPENDENTLY-CONTROLLABLE PULSE WIDTH & SPACING
100 nanosec-1 sec in 7 overlapping ranges 10⁷:1 duty cycle range



INDEPENDENT CMOS AND TTL OUTPUTS Fan-out to 40 TTL loads

SYNCHRONOUS OUTPUT GATING

100mV-10V POSITIVE OUTPUT Less than 30 nanosec rise/fall times

CSC'S DESIGN-MATE™ 4: \$124.95. NO OTHER DIGITAL PULSE GENERATOR GIVES YOU SO MUCH, FOR SO LITTLE.

Sounds hard to believe... but even a brief look at Design-Mate 4's specifications proves CSC's engineers have done it again. Whatever your application—whether you're looking for precision, flexibility or just plain economy—this compact source of fast, clean digital pulses offers the performance you need... at a price that discourages procrastination.

Use it as a clock source, delayed pulse generator, synchronous clock, manual system stepper, pulse stretcher, clock burst generator or in dozens of other applications. Use it alone or in tandem with other DM-4's for gated control. The

wide range of controls and multiple outputs give you enormous versatility... plus compatibility with all major logic families, for research, design, development, quality control, production testing, maintenance, troubleshooting... you name it.

Now, read the specs that follow... and check the price again. Or better yet, try DM-4 for yourself at your local CSC distributor. Once you do, we think you'll find it's as hard to do without as it is easy to own.

For more information about CSC's other fine products, and a list of distributors, please call or write.

DM-4 SPECIFICATIONS

Frequency Range: Pulse Width and Spacing Controls:	0.5 Hz to 5 MHz 100 nanosec to 1 sec. in 7 overlapping decade ranges. A single-turn vernier control provides continuous adjustment between ranges. 10 ⁷ :1 Range: adjustable over entire pulse width/spacing range. 100 nanosec "ON" 1 sec "OFF" to 1 sec "ON" and 100 nanosec "OFF".	ONE-SHOT	Pushbutton for single pulse. Output pulse occurs each time push-button is pressed.
Duty Cycle:	10 ⁷ :1 Range: adjustable over entire pulse width/spacing range. 100 nanosec "ON" 1 sec "OFF" to 1 sec "ON" and 100 nanosec "OFF".	OUTPUTS:	
Operating Modes: RUN	0.5 Hz to 5 MHz as per width/spacing and amplitude control settings.	VAR OUT	0.1-10 V positive Rise/fall time Less than 30 nanosec
TRIG Input requirements:	DC to approx. 10 MHz Sine waves 2 VP-P; pulses 1 V peak, >40 nanosec wide; maximum input ±10 V. (Input Impedance: Approx. 10KΩDC coupled.)	TTL OUT	400Ωmax. Fan-out 40 TTL Loads Sink 160 milliamps—0.8 V max. Rise/fall time Less than 20 nanosec
GATE Input requirements:	Synchronous gating. Leading edge of gate signal turns generator "ON". Last pulse is completed, even if gate ends during pulse. Same as "TRIG" Mode.	SYNC OUT	Pulse width Approx. 40 nanosec. Other sync pulse specs same as TTL out. Sync pulse leads outputs by approx. 20 nanosec
		POWER	117 VAC ±10%, 50/60 Hz, 5 watts (220 VAC, 50/60 Hz also available, at slightly higher cost.)
		SIZE (WxLxH)	7.5 x 6.5 x 3.25"
		WEIGHT	191 x 165 x 83 mm 2 lbs. (0.91 Kg)

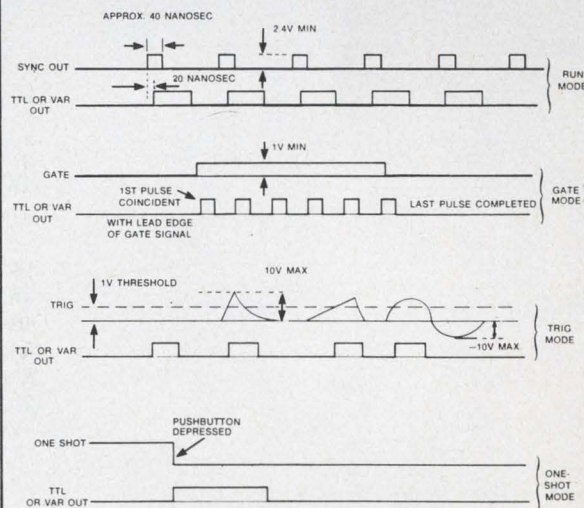

CONTINENTAL SPECIALTIES CORPORATION



EASY DOES IT

44 Kendall Street, Box 1942 New Haven, CT 06509 • 203-624-3103 TWX: 710-465-1227
West Coast office: Box 7809, San Francisco, CA 94119 • 415-421-8872 TWX: 910-372-7992
Canada: Len Finkler Ltd., Ontario

© 1976, Continental Specialties Corp.

CIRCLE NUMBER 7

**Who provides the
industry's broadest
line of electronic
packaging hardware
... including
Edgeboard Connectors?**

SAE does! Our injection molding equipment produces an almost endless variety of connector configurations.

You can choose between .100", .125", .150" or .156" contact spacings. Single or dual readouts. Pierced eyelet, dip solder or wire-wound terminations in one, two or three levels. Even right-angle terminals if that's what you need. You can pick either 10, 30 or 50 mils gold over nickel plating; thru-hole or tapped insert mounting styles; in-contact or between contact polarizing keys; and phenolic or thermoplastic housings.

And if we haven't described one you like, we'd be pleased to quote a custom connector to your specification! Our new 128 page packaging handbook gives complete details, and also describes our entire line of electronic packaging and interconnection hardware.

For an immediate reply, call the following toll-free "ZIP QUOTE" number at the factory ... 800-538-6843.

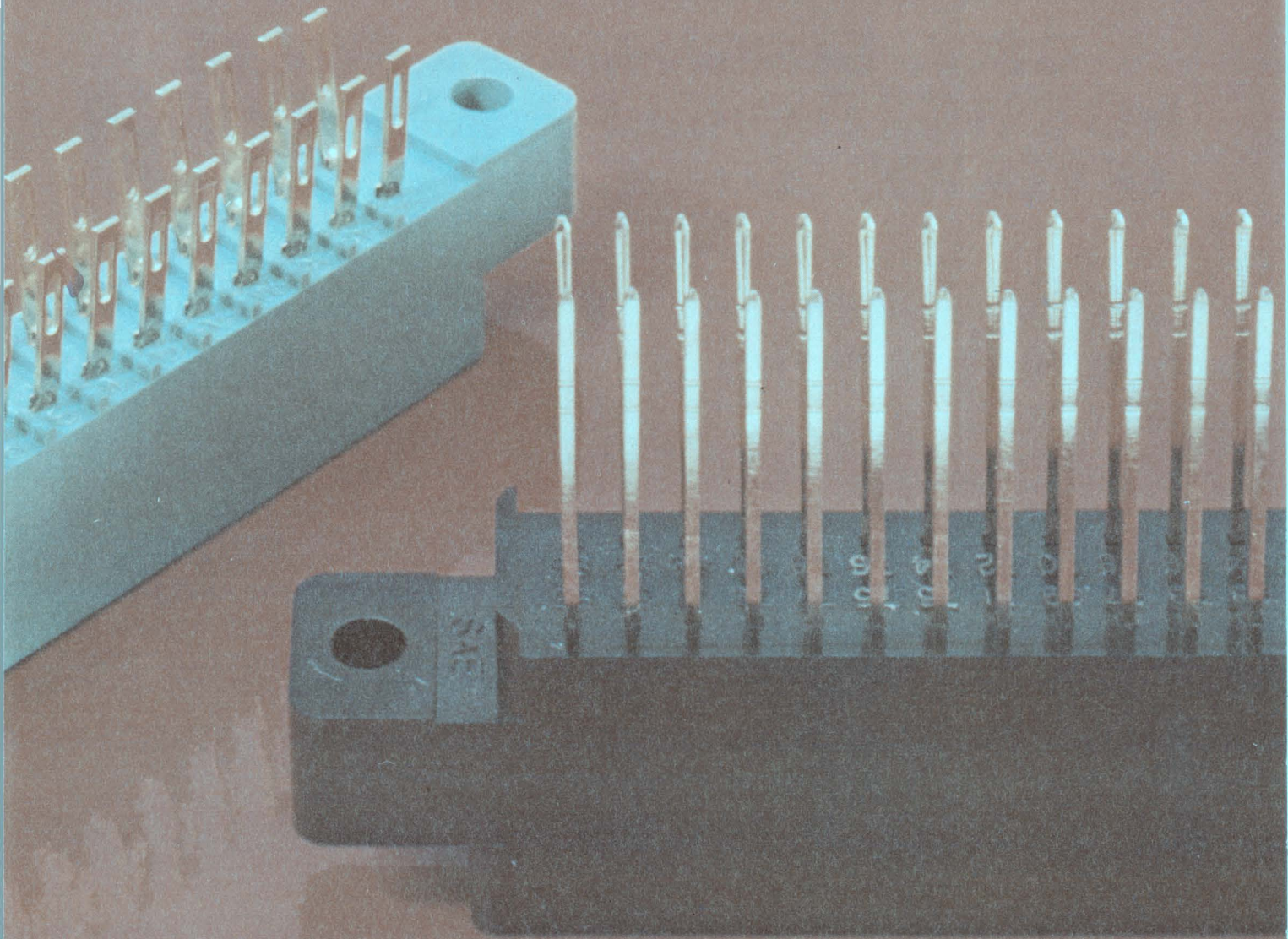

Stanford Applied Engineering, Inc.

340 Martin Ave., Santa Clara, CA 95050

(408) 243-9200 TWX 910-338-0132

CIRCLE NUMBER 8

AUGUST 2, 1976

Photovoltaic applications studied by NASA and ERDA

Sun-powered campers and electric cars with batteries recharged by sun power, are two ideas now being studied by the Photovoltaic Test and Demonstration Project under way at NASA's Lewis Research Center in Cleveland, OH. The project is a joint venture of NASA and ERDA (Energy Research and Development Agency).

A solar-powered camping refrigerator, to be tested at a remote trail-construction camp in Isle Royale National Park, MI, will be the project's first demonstration.

Battery chargers on electric vehicles will be the recipients of 1-1/2-kW arrays currently under study at Lewis.

All solar cells used by the Lewis group will be standard off-the-shelf photovoltaic cells that will be procured from several different sources, according to Robert Easter, assistant to the project manager at Lewis. The refrigerator project uses Type 785 silicon cells from Solarex, Rockville, MD.

To power the refrigerator, modules containing an array of 3×6 cells contained in a flat plate $10\text{-}1/4 \times 20$ in. are used. Each module produces a 6-V output with 9.2-W capacity. Since the refrigerator requires 12-V operation, the modules are connected in 2-module series pairs. Twelve of these series pairs are paralleled to provide 220 W of available power.

In addition to powering the refrigerator when the sun is out, the cells also charge six automotive lead-acid 100 A-h batteries, which power the refrigerator at night or during bad weather.

The Lewis group is currently designing a prototype residence with solar cells arrayed on the roof. They will provide up to 10 kW of power to get the residence

through peak usage periods. This prototype residence should be completed around January of 1977.

Photovoltaic arrays with 1 kW of output are now being designed into US Forest Service lookout towers. The first two prototype towers will be installed by September.

Weather reporting from remote locations will be eased by 200-W solar arrays being designed to go into remote weather stations by September, 1976.

Not to be outdone, the Dept. of Defense is in on the studies as well. Prototype completion by later this year is planned for arrays to be used in telephone vans, radio relays, remote radars, intrusion detection systems, battery chargers and water purification plants. Most of these systems will be tested at Fort Belvoir, VA.

Finally, Lewis is designing large demonstration panels for use in industry and shopping centers. By 1977 the panel will have a capacity of 100 kW. So far 2 kW are installed. By the end of August, 10 kW will be in place. And in a year, 40 kW will be in use.

Calculator remembers—even when turned off

The pocket calculator race continues at full gallop. Two new members of this ever-growing family were introduced last month, one from Hewlett-Packard and the other from Texas Instruments.

HP's offering is the addition of a nonvolatile memory to its model-25 programmable scientific calculator. Designated the model 25C, the new unit is identical to the older HP 25, with the added feature that information, once entered,

is retained even while the calculator is turned off. Program steps and data that are repeatedly used can thus be stored in the calculator. This storage results in the saving of operator time, and extends battery life.

Two data storage chips in the calculator use CMOS (complementary metal oxide semiconductor) technology to achieve continuous memory. Typically, the two chips require about $5 \mu\text{W}$ steady power drain to preserve the information. This figure represents about 1/80,000 of the 400 mW normally used when the machine is on. The model 25C is priced at \$200.

From Texas Instruments comes the model TI-30, a low-cost (\$24.95) unit aimed at the 15-million member high school student market.

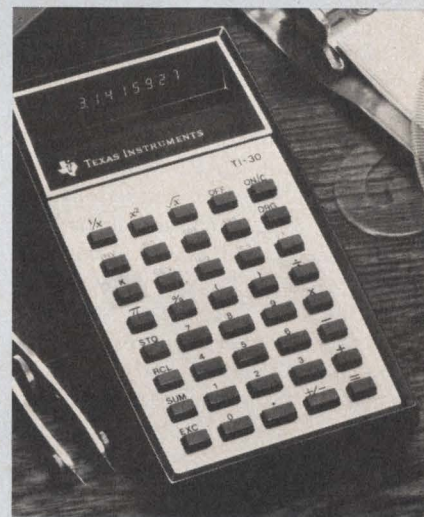

Texas Instruments' TI-30 scientific calculator retails for \$24.95.

Like its more expensive cousins, the SR-52, SR-56, and SR-60, the TI-30 features Texas Instruments' Algebraic Operating System (AOS), a method of solving algebraic equations through multiple parentheses. With AOS, equations are entered from left-to-right, following standard algebraic hierarchy. Powers and roots are computed first, then multiplication and division, and finally, addition and subtraction. The calculator "remembers" all entries and then acts on them using this hierarchy.

The TI-30, in addition to the usual four functions (+, -, \div , \times) includes, among other capabilities,

logarithms and trigonometric functions (in degrees, radians and grads).

For HP

CIRCLE NO. 318

For TI

CIRCLE NO. 319

Bell plans digital system to use occupied channels

The Bell System is testing a new digital system that takes advantage of normal pauses in telephone conversations to provide additional information-carrying capacity over an occupied communications channel.

Called TASI (Time Assignment Speech Interpolation), the system is being tested by Bell Telephone Laboratories and AT&T's Long Lines Dept. on Bell System microwave radio facilities between New York and Boston.

The new TASI is a modernized version of a system installed in 1960 in undersea cables between the United States and Europe and between Canada and Australia.

The earlier TASI worked with analog telephone transmissions. For each voice channel, individual speech detectors and speech-processing circuits were needed.

In the new TASI, the voice signals are converted into digital form, which allows single, high-speed digital circuits to perform



A digital system to use the gaps in voice communication is being tested for domestic telephone use.

speech-processing functions on a large number of channels.

The digitized speech can be sent directly to a distant location over a digital transmission system such as the T4M digital coaxial cable system. Or, the signal can be converted into its original analog form for transmission over conventional analog facilities.

The signal is transmitted via single-sideband using frequency-division multiplexing.

Sampling head measures electro-optic pulses

An oscilloscope sampling head has been built that measures both electrical and optical pulses with a potential resolution of 10 picoseconds.

The device's other advantages over conventional instruments: it has a broader bandwidth, greater dynamic range and it's free of sampling-pulse interference. The head was developed by the National Bureau of Standards, Boulder, CO.

Optical pulses, at present, are measured with a sampling oscilloscope whose sampling head uses a photodiode as an optical-to-electrical transducer. These oscilloscopes, however, distort the sampled pulse because of limited bandwidth in the detector circuits.

The NBS sampling head isolates sampling interference by optically sampling electrical pulses, and, conversely, electrically sampling optical pulses. The new head uses a gallium arsenide (GaAs) photoconductor—instead of a photodiode—as a transducer.

The photoconductor's output is the product of the optical and electrical waveforms, regardless of which is the sampling pulse and which is the sampled. This product-forming property, essential to the sampling operation, cannot be obtained with a photodiode in its normal reverse-biased mode.

The NBS sampling circuit uses the photoconductor shunt capacitance and stray-wiring capacitance as a sampling capacitor. Thus, unwanted and unavoidable effects are exploited to gain greater bandwidth in sampling optical waveforms.

By combining the detecting and

sampling functions in one GaAs chip and centralizing these and other original processing operations in the sampling head, the developers expect to attain greater fidelity in the scope's displayed waveform.

Cable TV firm installs first fiber-optic cable

Fiber optics is beginning to thread its way into the television industry.

Early this month, Teleprompter Manhattan Cable Co., a New York City home cable television firm, began using an 800 ft length of fiber-optic cable to carry signals from its receiving equipment atop a tall apartment building in Manhattan to its central processing offices, 34 floors below. Excellent quality of the transmitted picture was reported by William Bresnan, Teleprompter Cable's president.

The Teleprompter hookup is reported to be the first practical use of fiber optics in the television industry.

Only 90 microns (90×10^{-6} meter) in diameter, the fiber-optic cable replaces a conventional 3/4 inch coaxial cable that was used until now.

TV signals on the roof are first amplified, and then used to modulate a light-emitting diode. The resulting optical signal is carried down the length of fiber-optic cable.

Advantages of fiber-optic communications are by now well known. They include such benefits as:

- Conventional coaxial transmission requires the use of repeater amplifiers approximately every 1/3 mile. Using fiber optics, however, the number of such repeater stations is reduced to one every 1.5 miles.

- A single optical fiber can potentially carry many more TV and audio channels than a coaxial cable.

The new Teleprompter installation currently carries a single channel, that of Home Box Office, the pay-television service. However, by using a laser as the light source instead of the present LED, up to 167 TV channels could be transmitted on the single fiber cable.

Intro- ducing the amaz- ing EECO

machine: in one end you put your raw, un-annotated logic diagram, and out of the other comes your fully wire wrapped socket board/frame/drawer/system—your choice. Together with a *Final Exception Report*, a *Final String List*,

an IC Location List, *lists for IC Type and Socket Size*, *a Wire Loop List*, *a Pin Assignment List*, *an Unused Circuit Elements and Pins List*, *a Pin by Pin Wire List*, and your diagram back, fully annotated.

This machine uses a computer, and people, and hardware all under the same roof, and gives you a chance to correct or change your circuitry before we go to hardware. We deliver in as little as two weeks, including time for you to review.

We've been doing this for more than five years, almost in secret. Now we're telling you and the world because it's about time. Write or phone the keeper of the EECO machine, Dick Hunter.



EECO

PACKAGING/SWITCHES/READERS

1441 East Chestnut Avenue, Santa Ana, California 92701
Phone 714/835-6000

CIRCLE NUMBER 9

Motorola switches on SWITCHMODE II.*

The world's fastest Darlington.

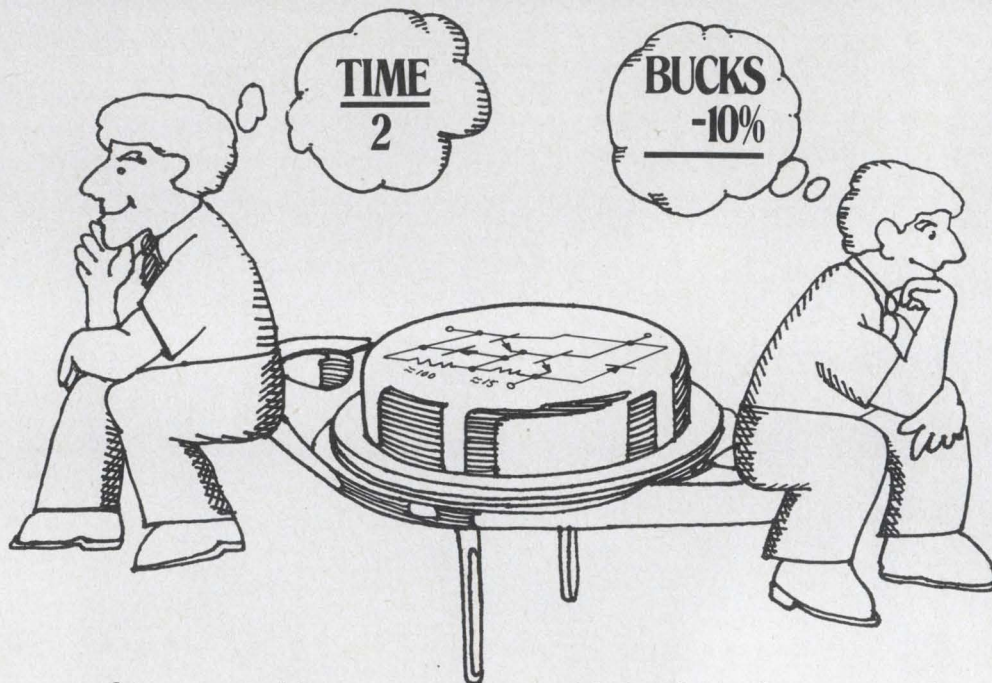

If you can't use the speed, think about the money.

When we say fast, we mean fast — like 40 nanosecond typical inductive fall time at 10 amps.

Switchmode II MJ10004-07 silicon power turns off twice as fast as any other high-current, high-voltage Darlington. Period.

The faster, the better — and at twice the speed, switching losses are cut in half. That's efficiency anyone can use.

It's all because of Motorola's recognized leadership in power Darlings. We introduced 'em, refined 'em and keep coming up with the right parts for today's applications.

The new 10 and 20 amp units are perfect examples.

Literally.

Besides offering up to 450-volt sustaining capability, they're true Switchmode devices with all the essentials for high-frequency, 200°C inductive use spelled out on Designers* Data Sheets. Up to 5,500-volt-ampere RBSOA capability. High-temperature, clamped inductive load switching specs. Switching times as functions of collector current and temperature. Spec'd limits for active region SOA. Maximized stability through high-performance glass passivation. Optimized B/E resistor values and current gain.

Switchmode II is the biggest story in years in switching Darlings.

You've got a chance to read it

in our special Switchmode literature package of Designers* Data Sheets, Selector Guide and application notes. Write Motorola Semiconductor Products, Inc., Box 20912, Phoenix, AZ 85036, or use your in-plant VSMF center.

Oh, yeah, the money. You pay less for the MJ10004 family. Right. Less than competitive parts. At up-to-999 prices of \$4.50 to \$9.50, you can save a bundle over parts that are microseconds slower.

Think about that on the way to the bank.

*Trademark Motorola Inc.

SUPERPOWER
unlimited



MOTOROLA Semiconductors

CIRCLE NUMBER 10

General Time's new DIGITAL Timers are changing the way equipment is being designed...

here's what you should know about them.

- Their low, low prices and high dependability enable them to replace both low and high accuracy analog timers as well as most electro-mechanical timers.
- Their digital circuitry provides exceptional $\pm 0.5\%$ repeat accuracy in all time ranges — even those as long as 60 minutes. Their short reset, recycle and abort times give you a new level of design flexibility.
- They're now *in stock* at all Distributors listed below. For complete information about General Time Q-20 Digital Timers use the reader service number provided.



AUTHORIZED STOCKING DISTRIBUTORS

ALABAMA

CRAMER
Huntsville (205) 539-5722

ARIZONA

CRAMER
Phoenix (602) 263-1112

METERMASTER
Phoenix (602) 273-7331

CALIFORNIA

CRAMER
Irvine (213) 771-8300
(714) 979-3000
San Diego (714) 565-1881
Sunnyvale (408) 739-3011

METERMASTER
Los Angeles (213) 685-4340
Palo Alto (415) 968-6292

NEWARK ELECTRONICS CO.
Inglewood (213) 678-0441

COLORADO

CRAMER
Denver (303) 758-2100
NEWARK ELECTRONICS
Denver (303) 757-3351

CONNECTICUT

ARROW ELECTRONICS, INC.
Hamden (203) 248-3801

CRAMER
No. Haven (203) 239-5641

HARTFORD, ELECTRIC SUPPLY
Hartford, CT. (203) 233-3694

NEWARK ELECTRONICS
Westport (203) 226-6921

DISTRICT OF COLUMBIA

CRAMER
Gaithersburg (301) 948-0110

FLORIDA

ARROW ELECTRONICS, INC.
Ft. Lauderdale (305) 776-7790

CRAMER
Orlando (305) 894-1511
Hollywood (305) 923-8181

NEWARK ELECTRONICS
Ft. Lauderdale (305) 587-2372

GEORGIA

CRAMER
Atlanta (404) 448-9050

ILLINOIS

ALLIED ELECTRONICS
Elgin (312) 697-8200

CRAMER
Mt. Prospect (312) 593-8230

METERMASTER
Elk Grove Village (312) 593-8650

NEWARK ELECTRONICS
Chicago (312) 638-4411
Hickory Hills (312) 599-2300

INDIANA

GRAHAM ELECTRONIC SUPPLY
Indianapolis (317) 634-8486

IOWA

NEWARK ELECTRONICS
Cedar Rapids (319) 362-1171

MARYLAND

ARROW ELECTRONICS, INC.
Baltimore (202) 737-1700
(301) 247-5200

CRAMER
Hanover (301) 796-5790

NEWARK ELECTRONICS
Beltsville (301) 937-5085

MASSACHUSETTS

ALLIED ELECTRONICS
Braintree (617) 848-4150
(800) 225-1890

ARROW ELECTRONICS, INC.
Burlington (617) 273-0100

CRAMER
Newton Centre (617) 969-7700

GRAYBAR ELECTRIC CO., INC.
Boston (617) 482-9320

NEWARK ELECTRONICS
Woburn (617) 935-8350

MICHIGAN

CRAMER
Livonia (313) 425-7000

NEWARK ELECTRONICS
Oak Park (313) 548-0250
Wyoming (616) 241-6681

MINNESOTA

ARROW ELECTRONICS, INC.
Bloomington (612) 888-5522

CRAMER
Edina (612) 835-7811

NEWARK ELECTRONICS
Minneapolis (612) 331-6350

MISSOURI

OLIVE INDUSTRIAL ELECTRONICS
St. Louis (314) 863-7800

NEW JERSEY

ARROW ELECTRONICS, INC.
Moorestown (609) 235-1900
Saddlebrook (201) 797-5800

BROWNELL ELECTRO INC.
South Plainfield, (201) 753-4600

CRAMER
Moonachie (201) 935-5600
Cherry Hill (609) 424-5993
(215) 923-5950

NEWARK ELECTRONICS
Kenilworth (201) 272-8410

NEW MEXICO

CRAMER
Albuquerque (505) 265-5767

NEW YORK

ARROW ELECTRONICS, INC.
Farmingdale (516) 694-6800
Fishkill (914) 896-7530

CRAMER
Endwell (607) 754-6661
Hauppauge (516) 231-5600
Rochester (716) 275-0300
E. Syracuse (315) 437-6671

NEWARK ELECTRONICS
Rochester (716) 473-6600
Plainview (516) 822-5000

NORTH CAROLINA

CRAMER
Raleigh (919) 876-2371
Winston-Salem (919) 725-8711

OHIO

ARROW ELECTRONICS, INC.
Cleveland (216) 464-2000
Kettering (513) 253-9176

CRAMER
Cleveland (216) 248-8400
Cincinnati (513) 771-6441

HUGHES-PETERS, INC.
Cincinnati (513) 351-2000
Columbus (614) 294-5351

NEWARK ELECTRONICS
Cleveland (216) 361-4700
Cincinnati (513) 874-5115

PIONEER
Cleveland (216) 587-3600

STOTTS-FRIEDMAN
Dayton (513) 224-1111

CLEVELAND TIME CLOCK
AND SERVICE CO.
Cleveland (216) 861-2496

OKLAHOMA

CRAMER
Tulsa (918) 836-3371

PENNSYLVANIA

WEST CHESTER ELECTRIC SUPPLY
West Chester (215) 696-7500

RHODE ISLAND

W. H. EDWARDS, INC.
Warwick (401) 781-8000

TEXAS

CRAMER
Dallas (214) 666-9300

NEWARK ELECTRONICS
Garland (214) 271-2511
Houston (713) 782-4800

UTAH

CRAMER
Salt Lake City (801) 487-4131

NEWARK ELECTRONICS
Salt Lake City (801) 486-1048

WASHINGTON

CRAMER
Seattle (206) 762-5755

WISCONSIN

ARROW ELECTRONICS, INC.
New Berlin (414) 782-2801

CRAMER
Oak Creek (414) 764-1700

NEWARK ELECTRONICS, INC.
Brookfield (414) 781-2450

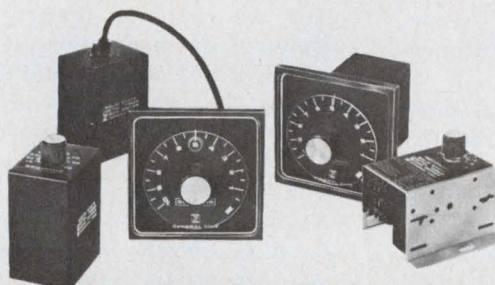

CIRCLE NUMBER 11

GENERAL TIME
A TALLEY INDUSTRIES COMPANY
INDUSTRIAL CONTROLS DIVISION
THOMASTON, CONNECTICUT 06787

At the Consumer Electronics Show

Scope built in FM tuner monitors quality of audio and rf reception

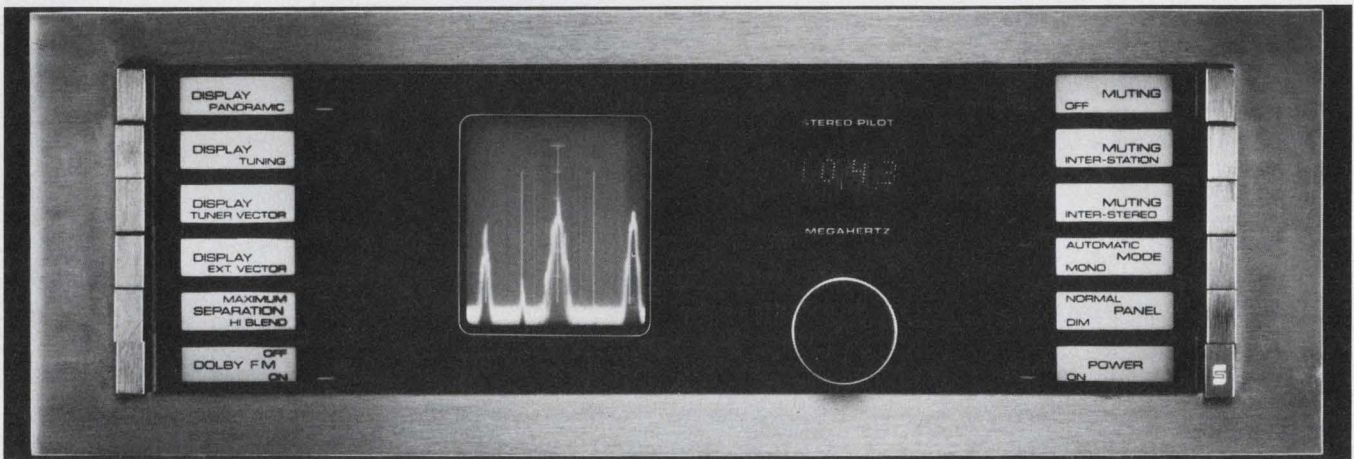

Visual checks of FM-station signal quality and receiver tuning, as well as analysis of stereo and quadraphonic signals, are provided by circuitry incorporated in the oscilloscope display of the Sequerra-1 FM tuner.

A unique FM tuner—the Sequerra 1—is the first consumer device to incorporate a multifunction oscilloscope for visual, as well as aural, evaluation of the rf input and of the demodulated stereo or quadraphonic audio of the station to which it is tuned.

A panoramic spectrum analyzer in the Sequerra 1, demonstrated at the recent Consumer Electronics Show in Chicago, provides a visual display of FM stations broadcasting a signal above the ambient interstation noise, which is represented by the scope base line. When the set is properly tuned to a particular frequency, the station is centered on the scope screen, as shown in the tuner photo.

The height of the vertical pips indicate relative signal strength. Alternate channel stations ap-

pear at 400-kHz intervals from the center frequency, and adjacent channel stations appear at a point 200-kHz away from the station tuned in.

The panoramic analyzer can be used to orient the FM antenna for greatest signal strength, and is also useful in detecting and identifying interference from other radio stations or from electrical devices.

Exact visual tuning possible

A tuning-signal-analyzer function provides precise visual tuning of the FM signal as well as indicating the rf-signal strength and percentage of modulation. It can also aid in antenna orientation by showing the best compromise of antenna position with respect to multipath reception and signal strength.

A typical selectivity response pattern is shown in Figure 1a, which displays the bandwidth, sig-

nal amplitude, threshold of noise level and noise density. A correctly tuned station is shown in 1b.

To analyze the separation, balance and phase characteristics of stereo program material, an internal vector separation circuit can be switched into the scope display.

For stereo broadcasts the instantaneous peak deviation of the right and left stereo channel information appears as in Figure 1c. The wider the angle of the display, the greater the separation; and the higher the trace the stronger the signal.

Audio signals from external sources can also be displayed. For example, with four-channel information, the left-rear vector is shown below the base line at 225° while the right rear vector is shown at 315°, as in Figure 1d.

Designers of the Sequerra 1, produced by the Sequerra Company, Inc., of Jamaica, NY for the audiophile who has everything—including the \$2995 to buy it—

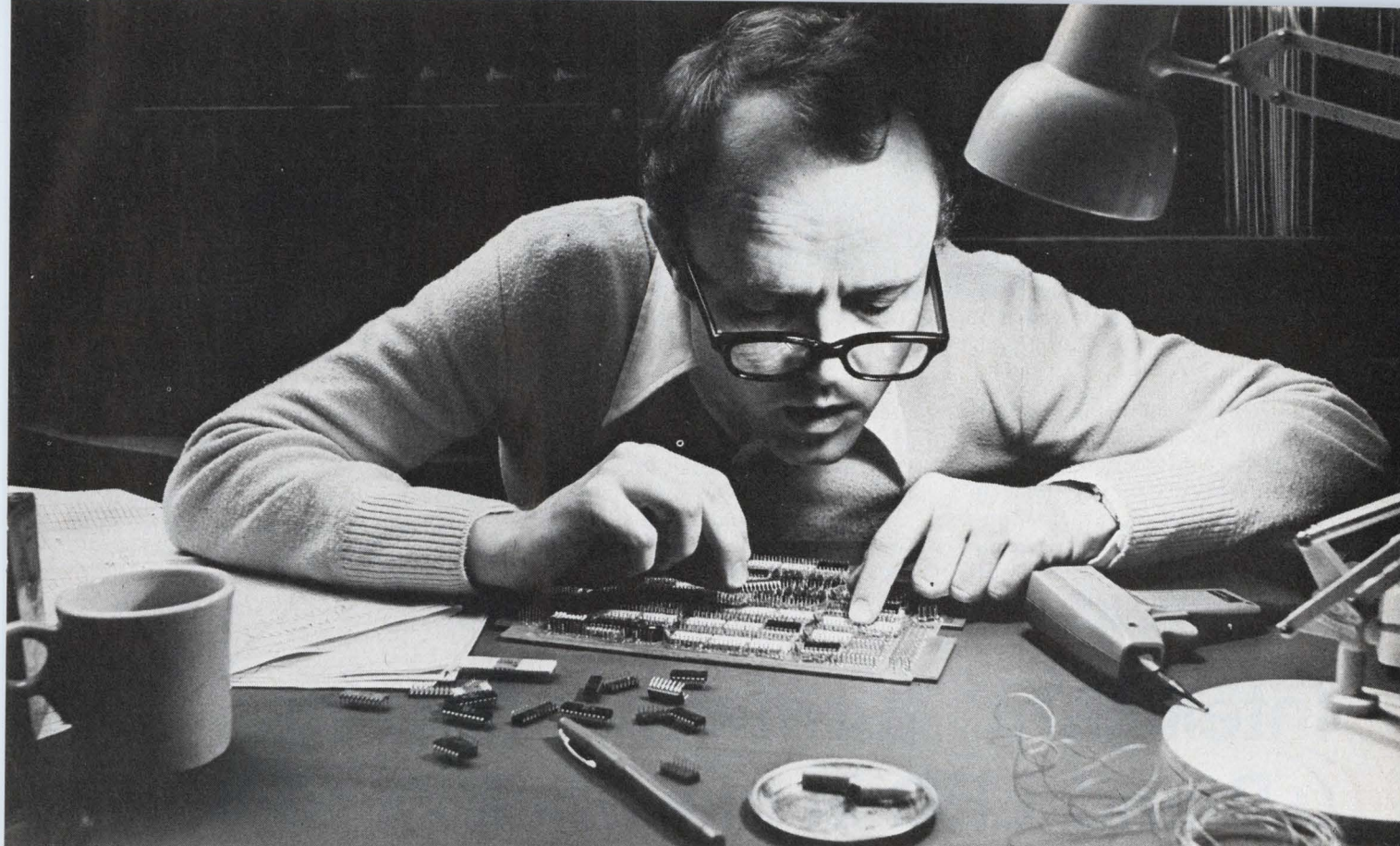

Buy our boards now if you want to stop buying them later.

If you're thinking of making your own micro-computer boards sometime in the future, ours are the only boards to buy right now.

Because the chips on our microNOVA boards are the same ones you can buy in the microNOVA chip set.

Which means you can switch from microNOVA boards to our microNOVA chips anytime you want.

The microNOVA board is a full 4K micro-computer. With a number of standard features. Like power-fail/auto-restart. Real-time clock. NOVA instruction set with hardware stack. Hardware multiply/divide. Data channel logic.

Yet all the above computer costs only \$589, in OEM quantities of 100.*

Which is a lot of computer for a little money.

Because it's a NOVA computer, the microNOVA board comes with powerful run-time software. Like

RTOS, our NOVA-compatible, field proven realtime executive. And it runs both Assembler and FORTRAN.

And because the microNOVA board comes from Data General, it comes with the manuals, technical publications, services, training courses and seminars you'd expect from a large minicomputer company.

Yet the microNOVA 4K board is only one member of an entire family. Besides the board (and all the supporting boards), you can get complete development systems. Or you can get completely packaged MOS minicomputers. Or chip sets that include the mN601 CPU, plus all the supporting chips.

So if you want to end up in the chips, call our toll free number, 800-225-9497. (Unless you're in Massachusetts. In which case, call 1-617-485-9100, EXT. 2509.)

microNOVA:

A giant reduction in the NOVA line.

DataGeneral

Data General, Route 9, Southboro, Mass. 01772 (617) 485-9100. Data General (Canada) Ltd., Ontario. Data General Europe, 15 Rue Le Sueur, Paris 75116, France. Data General Australia, Melbourne (03) 82-1361

*Prices quoted are FOB Southboro and apply to the U.S. Taxes excluded. NOVA is a registered trademark of Data General Corporation.

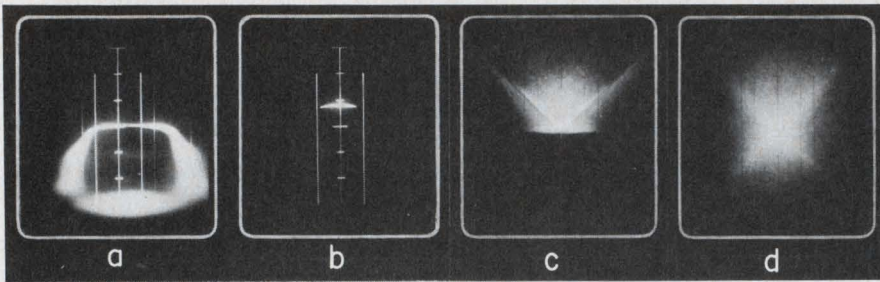

1. Tuner selectivity (a), station tuning (b), and separation of stereo and quadraphonic channels (c,d) are shown on the Sequerra scope monitor.

minimized the use of microcircuits to obtain the higher performance of discrete construction.

Other features in the tuner include the use of a varactor-tuner front end to minimize both packaging space and microphonics associated with standard gang-capacitor tuning. Also, n-channel FETs are

used in balanced push-pull stages of rf amplification to cancel out the even harmonics, which produce the highest level spurious response.

Another special circuit in the tuner varies the separation of the high frequencies in stereo broadcasts to suit the listener. A "Maximum" position provides the best

spatial and directional definition of the tuner's audio output. A "High Blend" position eliminates some high frequency noise under adverse listening conditions, such as excessive record hiss.

The station-frequency readout is a four-digit LED frequency counter that is controlled by the local oscillator. The use of a local oscillator rather than a frequency synthesizer was decided upon for two reasons.

First, although the synthesizer is inherently more accurate, there are stations abroad that do not fall at the equal frequency intervals to which it is programmed. Also it produces only even or odd frequency intervals, which would make it impossible to tune in some stations. ■■

'Intelligent' turntable contains μ P and LED in playback assembly

A combination of electro-optic, microprocessor and ultrasonic technologies has produced the first intelligent electronic turntable, the Accutrac 4000. It can select any or all of the dozen or more tracks on long-playing records, under programmed control.

The microprocessor specially designed for the turntable can store and execute up to 25 individual commands. Tracks can be played in any order the listener wants by inserting commands through program switches on the unit or by using a hand-held ultrasonic remote control with a similar keyboard. Tracks can also be skipped or repeated, according to Audio Dynamics, New Milford, CT, the turntable producer.

Electro-optics in the head of the playback assembly finds the individual tracks and also tells the microprocessor when the track has ended. A small infrared LED is built into the special cartridge. The beam from the LED is focused onto the record. Closely spaced grooves scatter this light (Fig. 1), but smooth surfaces between the recorded portions reflect the infrared energy back to a detector. The detector output then triggers the arm-lifting and moving servo and

is fed to the microprocessor, which then initiates the next command.

The integrated design of the Accutrac tone arm and cartridge results in an ideal tone-arm resonance between 8 and 10 Hz. Although the arm is raised, lowered and moved sideways automatically by its own servo motor, which is independent of the turntable drive. It instantly decouples from the system as soon as the needle touches the grooves. This prevents

unwanted groove wear.

The rate at which the playback head is lowered to the record is deliberately slower than with manual operation in order to extend record life.

A brushless, electronically controlled direct-drive turntable motor is used to eliminate the rumble, wow and flutter caused by the belts, wheels or pulleys of more conventional turntable drives.

The manufacturers of the new turntable say the system cuts record wear and avoids accidents—such as dropping the playback head on the record surface.

Direct-drive 12-V motor used

The electronically controlled, direct-drive turntable motor is a 12-V, brushless dc unit with speed-sensing circuitry, and Hall sensors for commutation. The speed of the motor, manufactured by Matsushita in Japan, is governed by the output of an RC oscillator. Speed-trimming controls, mounted on the turntable panel, permit locking the turntable speed to either 50 or 60 Hz of the local line frequency.

Pushbutton switches give the operator close to 33-1/3 or 45 rpm coarse speed. Two speed-trimming



A turntable with automatic track selection under microprocessor control, the Accutrac 4000, can be programmed using an ultrasonic remote control with keyboard.

Come up with an Optocoupler Application. And you might come up a winner. Announcing the Optocoupler Contest. Sponsored by Schweber.

Send us your unique optocoupler/ isolator application and you might win one of three terrific HP calculators. Winners will be selected on the basis of originality and workability of application.

ENTRY FORM: (Attach extra sheets if needed)

Description (50 words or less): _____

Circuit Diagram:

Mail to: Bill Gordon, Schweber Electronics, Westbury, N.Y. 11590

Name _____ Title _____
 Company _____
 Address _____
 City _____
 State _____ Zip _____

**Three winners
will receive
HP calculators
from Schweber.**

Deadline for entry is: September 30, 1976.



**1st
prize:**
HP 27 Calculator

**2nd
prize:**
HP 25 Calculator

**3rd
prize:**
HP 21 Calculator

If this offer is in any way contrary to you or your company's policies, disregard. If your company is engaged in military contracts this offer is void.

Westbury, N.Y: 516/334-7474 ■ Somerset, N.J: 201/469-6008 ■ Danbury, Conn: 203/792-3500 ■ Rochester, N.Y: 716/461-4000
 Waltham, Mass: 617/890-8484 ■ Rockville, Md: 301/881-3300 ■ Atlanta, Ga: 404/449-9170 ■ Hollywood, Fla: 305/927-0511
 Beachwood, Ohio: 216/464-2970 ■ Chicago, Ill: 312/593-2740 ■ Horsham, Pa: 215/441-0600 ■ Houston, Texas: 713/784-3600
 Eden Prairie, Minn: 612/941-5280 ■ Austin, Texas: 512/837-2890 ■ Dallas, Texas: 214/661-5010 ■ Detroit, Mich: 313/583-9242
 Toronto, Canada: 416/678-9050 ■ SchweberWest: 213/537-4321 714/556-3880

© 1976, SCHWEBER ELECTRONICS CORPORATION



controls with a $\pm 5\%$ range use stroboscopic patterns embossed on the turntable's rim to adjust the speed precisely.

The Accutracs' microprocessor is a two-chip system that was developed by General Instrument Microelectronics Ltd., in Scotland. One chip contains the microprocessor and its memory, and the second

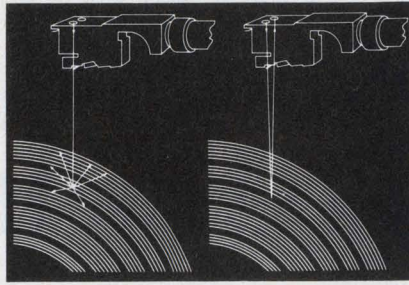

2. An infrared LED and detector in the Accutracs turntable pickup detects record grooves or spaces between.

chip contains the program instructions.

The same program chip is also packaged in the hand-held remote control. The remote unit transmits a coded serial-bit string at 40 kHz to the receiving unit (see photo). The bit string has the same encoding as that of the panel controls.

A LED on the receiver unit blinks to verify that the commands have been stored in the microprocessor memory. ■■

Digital time-delay device greatly enhances living room acoustics

A new stereo component can make the acoustics of a living room sound like those of a concert hall, a theatre or a cathedral. It's a 37-k-bit computer-like device programmed with an adjustable electronic model of acoustic space.

Called the Digital Time Delay System, the device synthesizes a live listening experience by digitizing stereo-channel audio signals and then adding multiple, continuous time delays to them. The signals are reconverted to analog audio voltages that contain echoes and reverberation.

The Digital Time Delay System, developed by Audio Pulse, Inc., Bedford, MA, overcomes mechanical resonances or electrical distortions of the signals that occur in the analog time delay systems used in other consumer stereo products.

With the Audio Pulse system, on the other hand, once the audio input is converted to its digital equivalent, time delays can be introduced without signal distortion.

The key to the wide-range delays—up to 94 ms in the Audio Pulse system—is two developments. One, called "Delta Modulation with Memory," permits time-delay enhancement of audio signals at moderate cost, according to Richard F. DeFreitas, vice president of Audio Pulse.

The second development is the design of an elaborate set of mixing, phase-shifting, filtering and recirculating circuits that enhance the delayed sounds with the reverberation qualities characteristic

of halls and auditoriums.

Delta modulation is not new, but this system includes an important new addition—a scratch-pad memory programmed to examine the recent history of the audio waveform and to predict what its slope will be during the next encoding interval.

Quadrupling the slew rate

Scratch-pad use has overcome the severe slew-rate limitations that restricted the high-frequency response of previous delta modulators. In the Audio Pulse system the encoder's slew rate has been quadrupled to provide a response of 8 kHz, thus providing an ample dynamic range for high-frequency transients. Since the cutoff of reverberation frequencies in real-life situations is an estimated 2 kHz, the available response is more than sufficient.

Conventional pulse-code modulation uses coded groups of pulses to represent the amplitude of the

audio signal at each sample. But with delta modulation, the encoding circuit generates a series of pulses whose rate reflects momentary changes in audio voltage.

This is more efficient than conventional PCM encoding because only about half as many pulses per second are required to reproduce a signal with equal fidelity. Consequently, only half as many shift registers are required to achieve a desired time delay.

With the Audio Pulse system the audio signal is encoded into digital pulses that are fed to a series of 37 shift registers of 1-k bit each. The encoding occurs at rates of either 400-k or 250-k pulse/s, as selected.

As the resulting pulses are loaded into the first register, its previous contents are shifted into the second. Simultaneously, the second register's contents are shifted into the third register, and so on. When the pulses emerge from the last shift register, they are decoded to recover the audio signal. The amount of time delay is proportional to the number of shift registers used.

In the Digital Time Delay system four different delays are obtained—two in each channel. In each channel the fully and partially delayed audio signals are fed to a variable mixer. Here, the relative proportions of the partial and full delays are controlled by Decay Time switches on the front panel. Discrete delays available are: 8, 12, 22, 36, 58 and 94 ms. ■■



A digital time-delay system using computer technology, by Audio Pulse, expands and varies the sense of acoustic space in a listening room.

We make your 16-pin 4K RAM business our business.

Our Austin plant has tripled volume production of the MCM6604.

Again.

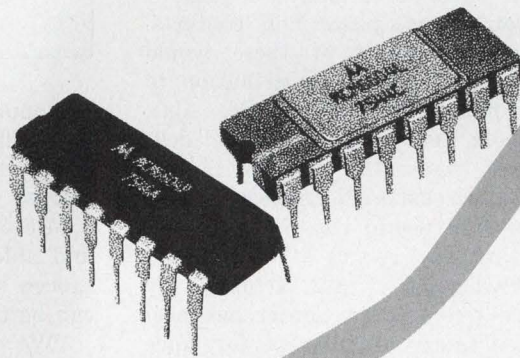

MOTOROLA
Semiconductors
MOTOROLA SEMICONDUCTOR PRODUCTS INC. • P.O. BOX 20912 • PHOENIX, AZ 85036

-still

the production house

By hundreds or by the hundreds of thousands, for 16-pin 4K RAM volume production needs, call your authorized Motorola distributor or Motorola sales office today.

ALABAMA, Huntsville	Hall-Mark Electronics	(205) 837-8700
ALABAMA, Huntsville	Hamilton/Avnet Electronics	(205) 533-1170
ARIZONA, Phoenix	Liberty Electronics/Arizona	(602) 275-7851
ARIZONA, Phoenix	Liberty Electronics/Arizona	(602) 257-1272
CALIFORNIA, El Segundo	Cramer/Los Angeles	(313) 332-8100
CALIFORNIA, Irvine	Cramer/Los Angeles	(714) 771-8300
CALIFORNIA, Los Angeles	Hamilton Electro Sales	(213) 558-2121
CALIFORNIA, Mountain View	Elmar Electronics, Inc.	(415) 961-3611
CALIFORNIA, Mountain View	Hamilton/Avnet Electronics	(415) 961-7000
CALIFORNIA, San Diego	Hamilton/Avnet Electronics	(714) 279-2421
CALIFORNIA, San Diego	Liberty Electronics/San Diego	(714) 565-9171
CALIFORNIA, Sunnyvale	Cramer/San Francisco	(408) 739-3011
COLORADO, Commerce City	Elmar Electronics, Inc.	(303) 287-9611
COLORADO, Denver	Hamilton/Avnet Electronics	(303) 534-1212
CONNECTICUT, Danbury	Schwaber Electronics	(203) 792-3500
CONNECTICUT, Georgetown	Hamilton/Avnet Electronics	(203) 762-0361
CONNECTICUT, North Haven	Cramer/Connecticut	(203) 239-5641
FLORIDA, Hollywood	Hamilton/Avnet Electronics	(305) 925-5401
FLORIDA, Hollywood	Schwaber Electronics	(305) 927-0511
FLORIDA, Orlando	Cramer/Sa	(407) 888-8900
FLORIDA, Orlando	Hall-Mark Electronics	(305) 855-4020
FLORIDA, Norcross	Hamilton/Avnet Electronics	(404) 448-0800
ILLINOIS, Chicago	Newark Electronics Corp.	(312) 638-4411
ILLINOIS, Chicago	Semiconductor Specialists, Inc.	(312) 279-1000
ILLINOIS, Elk Grove Village	Schwaber Electronics	(312) 593-2740
ILLINOIS, Mt. Prospect	Cramer/Chicago	(312) 593-8230
ILLINOIS, Schiller Park	Hamilton/Avnet Electronics	(312) 778-5130
INDIANA, Indianapolis	Graham Electronics Supply, Inc.	(317) 634-8202
INDIANA, Indianapolis	Pioneer/Indianapolis	(317) 849-7300
KANSAS, Lenexa	Hall-Mark Electronics	(913) 888-4747
KANSAS, Lenexa	Hamilton/Avnet Electronics	(913) 888-8900
MARYLAND, Rockville	Cramer/Washington	(301) 948-0110
MARYLAND, Gaithersburg	Pioneer/Washington Electronics	(301) 948-0710
MARYLAND, Hanover	Hamilton/Avnet Electronics	(301) 796-5000
MARYLAND, Rockville	Schwaber Electronics	(301) 851-3300
MARYLAND, Savage	Pytronic Industries, Inc.	(301) 792-7000
MASSACHUSETTS, Lexington	Harvey Electronics	(617) 861-9200
MASSACHUSETTS, Newton Centre	Cramer Electronics, Inc.	(617) 969-7700
MASSACHUSETTS, Waltham	Schwaber Electronics	(617) 890-8484
MASSACHUSETTS, Woburn	Hamilton/Avnet Electronics	(617) 933-8000
MICHIGAN, Detroit	RS Electronics	(313) 491-1012
MICHIGAN, Livonia	Hamilton/Avnet Electronics	(313) 522-4700
MICHIGAN, Livonia	Pioneer/Detroit	(313) 525-1800
MINNESOTA, Eden Prairie	Schwaber Electronics	(612) 941-5280
MINNESOTA, Edina	Cramer/Minneapolis	(612) 835-7811
MINNESOTA, Edina	Hamilton/Avnet Electronics	(612) 941-3800
MISSOURI, Hazelwood	Hamilton/Avnet Electronics	(314) 731-1144
MISSOURI, St. Louis	Hall-Mark Electronics	(314) 291-5350
NEW JERSEY, Cedar Grove	Hamilton/Avnet Electronics	(201) 239-0800
NEW JERSEY, Cherry Hill	Cramer/Pennsylvania	(609) 424-5983
NEW JERSEY, Mt. Laurel	Hamilton/Avnet Electronics	(609) 234-2133
NEW JERSEY, Moorestown	Arrow Electronics	(609) 235-1900
NEW JERSEY, Pennsauken	Radio Electric Service Co.	(609) 662-4000
NEW JERSEY, Saddle Brook	Arrow Electronics	(201) 799-5800
NEW JERSEY, Somerset	Schwaber Electronics	(201) 469-8008
NEW MEXICO, Albuquerque	Hamilton/Avnet Electronics	(505) 765-1500
NEW YORK, Farmingdale	Arrow Electronics	(516) 694-6800
NEW YORK, Hauppauge, L.I.	Cramer/Long Island	(516) 921-8700
NEW YORK, Rochester	Cramer/Rochester	(716) 275-0300
NEW YORK, Rochester	Hamilton/Avnet Electronics	(716) 442-7820
NEW YORK, Rochester	Schwaber Electronics	(716) 461-4000
NEW YORK, East Syracuse	Cramer/Syracuse	(315) 437-6671
NEW YORK, East Syracuse	Hamilton/Avnet Electronics	(315) 437-2642
NEW YORK, Westbury, L.I.	Hamilton/Avnet Electronics	(516) 333-5800
NEW YORK, Westbury, L.I.	Schwaber Electronics	(516) 334-7474
NEW YORK, Woodbury, L.I.	Harvey Electronics	(516) 921-8700
NORTH CAROLINA, Winston-Salem	Cramer/Winston-Salem	(919) 725-8711
OHIO, Beachwood	Schwaber Electronics	(216) 464-2970
OHIO, Cleveland	Hamilton/Avnet Electronics	(216) 461-1400
OHIO, Cleveland	Pioneer-Standard Electronics, Inc.	(216) 587-3600
OHIO, Dayton	Hamilton/Avnet Electronics	(513) 433-0610
OHIO, Dayton	Pioneer/Dayton	(513) 236-9900
OHIO, Solon	Cramer/Cleveland	(216) 248-8400
OKLAHOMA, Tulsa	Hall-Mark Electronics	(918) 855-8458
PENNSYLVANIA, Philadelphia	Pioneer/Philadelphia	(215) 674-5710
PENNSYLVANIA, Pittsburgh	Pioneer/Pittsburgh	(412) 782-2300
SOUTH CAROLINA, Columbia	Dixie Radio Supply Company, Inc.	(803) 779-5333
TEXAS, Austin	Sterling Electronics	(512) 838-1341
TEXAS, Dallas	Hall-Mark Electronics Corp.	(214) 231-6111
TEXAS, Dallas	Hamilton/Avnet Electronics	(214) 661-8661
TEXAS, Dallas	Schwaber Electronics	(214) 661-5010
TEXAS, Dallas	Sterling Electronics	(214) 357-9131
TEXAS, El Paso	Midland Speciality Co.	(915) 533-9555
TEXAS, Houston	Hall-Mark Electronics	(713) 781-6100
TEXAS, Houston	Hamilton/Avnet Electronics	(713) 526-4661
TEXAS, Houston	Sterling Electronics, Inc.	(713) 627-9800
UTAH, Salt Lake City	Hamilton/Avnet Electronics	(801) 262-8451
WASHINGTON, Bellevue	Almar/Avnet Electronics	(206) 748-8750
WASHINGTON, Seattle	Almar/Stroup Electronics	(206) 763-2300
WASHINGTON, Seattle	Liberty Electronics Corp.	(206) 763-8200
CALGARY, T2E 6L7, Alta.	Varah's	(403) 276-8818
EDMONTON, Alta.	Bowtek Electric	(403) 426-1072
LONDON, Ont.	ClM Peterson Co., Ltd.	(519) 434-3204
MISSISSAUGA, Ont.	Hamilton/Avnet	(416) 677-7432
OTTAWA, K2C 2B4, Ont.	Zentronics, Ltd.	(613) 238-6411
OTTAWA, K2C 2B4, Ont.	Hamilton/Avnet Int'l Ltd.	(613) 226-1700
ST. LAURENT, P.Q. H4S 1G2	Hamilton/Avnet	(514) 331-6443
TORONTO, Ont.	Zentronics, Ltd.	(416) 787-1271
TOWN OF MOUNT ROYAL, P.Q.	Zentronics, Ltd.	(514) 735-5361
VANCOUVER, B.C.	Bowtek Electric	(604) 736-1141
VANCOUVER, B.C.	Varah's	(604) 873-3211
WINNIPEG, Man.	Bowtek Electric	(204) 786-7521
CANADA		
ALABAMA, Huntsville 35805, 2608 Artie St., Suite 3		(205) 533-1650
ARIZONA, Phoenix 85008, 5005 E. McDowell Rd.		(602) 244-6900
ARIZONA, Phoenix 85018, 15720 Ventura Blvd., Suite 250F		(602) 994-6326
CALIFORNIA, Orange 92668, One City Blvd., West, Bank of America Tower Bldg., Suite 722		(714) 634-2844
CALIFORNIA, San Diego 92111, 7071 Conroy Court, Suite 210		(714) 560-4644
CALIFORNIA, San Jose 95117, 4020 Moorpark Ave., Suite 116		(408) 985-0510
COLORADO, Denver 80237, 3515 S. Tamarac, Suite 330		(303) 773-6800
CONNECTICUT, Hamden 06518, 3074 Whitney Ave., Bldg. C - Rm. 1		(203) 281-0771
FLORIDA, Ft. Lauderdale 33309, 1001 N.W. 62nd St.		(305) 491-8141
FLORIDA, Maitland 32751, 520 S. Maitland Ave.		(305) 644-3422
FLORIDA, Pompano Beach 33062, 1471 SW 12th Ave.		(305) 782-4464
FLORIDA, St. Petersburg 33702, 9720 Executive Center Dr., North		(813) 576-6300
GEORGIA, Atlanta 30328, 5825 Glenridge Dr. N.E. - Bldg. 2		(404) 255-2043
ILLINOIS, Schiller Park 60176, 4825 N. Scott St., Suite 300		(312) 678-7205
In Chicago		
INDIANA, Ft. Wayne 46805, 2777 Maplecrest Rd., Rm. 31		(317) 992-2320
INDIANA, Indianapolis 46250, 6525 East 82nd St., Suite 106		(317) 849-7060
IOWA, Cedar Rapids 52403, 4403 First Ave. S.E., Suite 304		(319) 393-8632
KANSAS, Mission 66202, 6700 W. Soubert Rd., Suite 104		(319) 384-3050
MARYLAND, Hyattsville 20782, 8525 Beltsford Rd.		(301) 779-1100
MARYLAND, Lanham 20801, 5900 Princess Garden Parkway, Suite 804		(301) 571-2600
MASSACHUSETTS, Lexington 02173, 2 Millis Dr.		(617) 861-1350
MICHIGAN, Garden City 48135, P.O. Box 355		(313) 261-6200
MICHIGAN, Douglas, 36 South Center		(616) 857-2159
Mail to: P.O. Box 567, Saugatuck, Michigan 49453		
MINNESOTA, Minneapolis 55426, 6950 Wayzata, Suite 424		(612) 545-0251
MISSOURI, St. Louis 63141, 760 Office Parkway		(314) 872-7681
NEW JERSEY, River Edge 07601, 937 Johnson Ave.		(201) 488-1200
NEW YORK, Fishkill 12524, Route 9		(914) 896-8970
NEW YORK, Hauppauge 11787, 350 Vanderbilt Motor Parkway		(516) 231-8000
NEW YORK, Rochester 14618, 3380 Monroe Ave.		(716) 381-7220
NEW YORK, Syracuse 13211, 123 Pickard Bldg., E. Molloy Rd.		(315) 454-8373
NORTH CAROLINA, Raleigh 27609, 4509 Creedmoor Rd., Suite 118		(919) 782-7604
OHIO, Cleveland 44143, 840 Brainard Rd.		(216) 461-3160
OHIO, Dayton 45439, 3480 S. Dixie Drive - Room 130		(513) 294-2231
OHIO, Worthington 43085, 5333 High Street		(614) 846-8460
OKLAHOMA, Tulsa 74145, 4833 S. Sheridan, Suite 406		(918) 664-5227
OREGON, Portland 97221, 1730 SW Skyline Blvd., Suite 203		(503) 297-2335
PENNSYLVANIA, Ft. Washington 19034, 501 Office Center Dr., Suite 128		(610) 643-4500
SOUTH CAROLINA, Columbia 29204, U.S. 1 North of I-20		(803) 788-0585
TENNESSEE, Knoxville 37919, 9041 Executive Park Dr., Bldg. 400		(615) 690-5592
TEXAS, Houston 77018, 2010 North Loop West, Suite 111		(713) 688-4583
TEXAS, Dallas 75224, 4825 LBJ Freeway, Suite L40		(214) 661-9829
WASHINGTON, Bellevue 98005, 300 120th Ave. N.E., Suite 202		(206) 455-3700
WISCONSIN, Wauwatosa 53226, 909 N. Mayfair Road		(414) 476-5554

Where is Natalia Makarova's tutu? It was there a minute ago....



Low-light and high-contrast conditions are problems that Lincoln Center must combat in the attempt to improve the quality of live telecasts such as this one, as shown in this photograph of a home set.

ON June 30, millions of Americans saw the American Ballet Theatre's "Swan Lake," on television. It was broadcast in color live from New York City's Lincoln Center. And if the viewers tuned in their FM stereo radios, they also heard Tchaikovsky's music—live—in living stereo.

Part of the miracle of this telecast was that it was done under existing performance conditions. There were no extra lights, obtrusive cameras or microphones to distract the audience—people who had paid up to \$10.95 a ticket to see one of the world's great ballets danced by two of the world's great dancers, Natalia Makarova and Ivan Nagy.

Instead, a van full of electronic equipment was used to overcome some of the staggering handicaps that "performance conditions" pose for televising video and sound. "One of the most obvious problems is poor lighting," says John

Goberman, director of the Lincoln Center Media Development Dept., which for the past two years has been experimenting with new techniques for televising Lincoln Center's performing arts.

"Television studios operate with 150 to 300 footcandles. We have to televise performances with light levels that range from less than one footcandle to roughly 25."

Goberman's group is motivated on several levels to solve this problem and the several others, even more difficult, that stand in the way of improving telecast quality.

"We are developing a television product for Lincoln Center," Goberman says. "The Center puts on some 3000 performances a year of ballet, opera, plays and concerts. Televising some of these would provide a cultural contribution to the nation and the world. Also, Lincoln Center has an annual deficit of some \$25 million. Selling these telecast performances to pay television would constitute an important new source of revenue."

"Swan Lake" is actually the third telecast the Center has produced under existing performance conditions. In January the New York Philharmonic was broadcast live, and in April, an opera—"The Ballad of Baby Doe."

"Besides having to televise in the dark, we have other problems to solve," says Mark Schubin, technological consultant for the department and technical producer of the telecasts.

"We have high contrast ratios to deal with—a soprano wears a white dress and the villain a black velvet suit: the soprano turns into a blob of white and the villain is so black you can't see him."



Nonuniform color is a problem, too. Different lights have different color temperatures, and often colored gels are used.

Microphones must be invisible, and able to pick up at great distances so that high-fidelity stereo can be transmitted nationwide.

"We've made great strides in solving the low-light-level problem," Schubin says, "but we've still got a long way to go."

One by-product of poor lighting is "lag," which occurs when the tube doesn't have enough light to refresh the information on it from a previous frame. "You have to remember," Schubin says, "that you can't make time exposures with TV cameras; the faceplate of the camera tube has roughly 1/30 of a second to integrate the light on its photosensitive surface."

Some cameras get around lag by using "bias light," an even projec-

Coming through...



with wire, cable and cord
that delivers quality,
performance, economy...

Belden has it: a total service capability. Extensive design and application know-how. What it takes to deliver complex cable configurations, special harnesses, cords, lead wires, and even special packages to fit your requirements.

Our specialists and engineers will meet with your people at your plant to discuss problems in processing, assembly, installation, ordering, human engineering, color coordination, physical and electrical parameters, opportunities for cost reduction. And when we can't help you using standard products, we'll innovate a solution to your problem.

Talk to a Belden specialist about your new applications, product ideas, processing problems—all your wire, cable and cord needs. He has thousands of standard items to draw from. And standard or special, he'll come through with the best wire buy around. For answers right now, phone:

317-966-6661 Electronic Div. or mark No. 400 on reader service card
312-986-1600 Electrical Div. or mark No. 401 on reader service card
312-887-1800 Transportation Div. or mark No. 402 on reader service card,
or write Belden Corporation, 2000 S. Batavia Ave., Geneva, IL 60134.

BELDEN 

Coming through...

with new ideas for moving electrical energy

tion of light directed on the faceplate of the camera tube to raise the input level above the threshold necessary for erasing the information that it had in the previous frame. Then, if the light projection is perfectly even, you can simply subtract it from the signal coming out of the camera.

In going to extremely low-light levels—down to 1 fc or less—the amplification system of the camera cannot raise the signal to a viewable level without producing a tremendous amount of noise, Schubin

says. To counter this, various noise-reduction techniques have been developed, and more are in the works. They include integration on a line-to-line or frame-to-frame basis, and noise coring. Noise coring is a process, somewhat like the Dolby method used for reducing audio noise. The portion of your signal that is most susceptible to noise is amplified when it's still noise free. The processed signal is then re-equalized to a flat signal that is still relatively noise free.

"We're not sure what the solution to this noise problem might be," Schubin says. "Noise reduction of an existing signal is one possibility. Noise coring is another. Or the answer might be a cooled amplifier or something of that nature. We've just started looking."

"We made one experiment with image-intensified tubes—a two-stage image intensifier in front of each tube in a 3-tube Philips camera. And while I'm sure it would be fine for the military—they could find a tank in the dark and even tell what color it was—the picture quality was very bad."

The group has also used cameras with secondary electron conduction (SEC) tubes, made by Westinghouse. The camera itself, made by Commercial Electronics, Inc., Mountain View, CA, "turned out to have more lag than ordinary bias-lit broadcast cameras."

The group is now looking at new tubes such as the silicon-intensified target tube (SIT) and the isocon tube. "Both of these tubes are supposed to be better than anything we're using today. Cohu has built a color camera using isocon tubes. It's a three-tube color camera that should be capable of perceiving a black cat in a coal mine at night. But whether it's going to have the commercial television quality we need is still a question."

Mark Schubin and his audio 'rack'

This transmission and stereo-control pick-up terminal is called "the rack" by its designer, Mark Schubin, who is standing to one side. It relays the sound from the theatre upstairs in Lincoln Center to the satellite and terrestrial transmission network.

The rack provides high-quality audio, compressed for portions of the networks that desire audio compression. And it provides dynamic-range compression for recordings so that the original dynamic range can be restored whenever tapes are played.

"The rack just makes life a lot easier," Schubin says. "With it we can put a show together in a matter of hours. Without it, it would take us a week."

Schubin, who is now technical consultant for Lincoln Center's Development Media Dept. and technical director of its telecasts, began his career as a chemical engineer. From there he became a newspaper publisher, then chief engineer for Computer Television, which was in the hotel pay-television business.

"Fortunately," Schubin recalls, "the company was small and we rented office space from Visual Information Systems, which ran a 24-hour-a-day tape-dubbing operation. I got interested, and every afternoon after work, at five, I'd wander in and ask questions. Now I have a patent on a pay-TV stereo television device I designed for Lincoln Center, and I have been nominated for



an Emmy for designing and developing a stereo network.

"I got to Lincoln Center via the pay-TV stereo device. Lincoln Center came to me for it and after I did it, I just stayed on as part of the staff."

Much of Lincoln Center's gap between box office receipts and costs is taken care of by donations from foundations. But individuals and companies also make tax-exempt gifts of services and money to the Center.

"We have lawyers and management consultants who donate their time, but no electronics companies. It would be a real shot in the arm for the performing arts—and for the electronic state-of-the-art—for an electronics company or laboratory to donate a development project for some of the breakthroughs we need.

"We can be reached at Lincoln Center, 1865 Broadway, New York, NY 10023."

Wanted: A good color camera

The Lincoln Center group is investigating color cameras built with SIT tubes and isocon tubes. "If someone has one with broadcast quality, we'd sure like to see it," Schubin says.

"In the long run, the trend may be toward solid-state imagers," Schubin says. "I think we'll get away from tubes altogether and go into charge-coupled devices and charge-injection devices. But no one has a broadcast-quality color camera yet that's ready for use. RCA is the only company we know of that's exhibited a color CCD camera intended to be used some day for broadcasting. Bell Labs has shown a low-resolution color camera for Picturephone service, but that's three to five years off.

"Worse than poor lighting, our most horrendous problem is the contrast ratio, which on stage

48-pin IC Tester: Total programming flexibility and no program boards put the IT-200 in a class by itself.

Here is an extremely flexible integrated circuit tester that can handle virtually all digital devices.

Its 100 kHz functional capability, coupled with a powerful DC parametric capability, allows testing of CMOS, NMOS, PMOS, ECL, and TTL devices of any complexity. The particularly powerful DC parametric test capacity provides current ranges from ± 200 na to ± 200 ma, and voltage ranges up to ± 20 V.

The versatile IT-200 operates under ROM or RAM program control (software load) and readily interfaces with handlers, probers and other instrumentation.

Check out the IT-200. You'll find the specs are truly in a class by themselves and the price is surprisingly low. For complete details, write or call: Siemens Corporation, Computest Products, 3 Computer Drive, Cherry Hill, New Jersey 08034 (609) 424-2400.



IT-200 is manufactured by Imperial Technology and marketed by Siemens

SIEMENS

CIRCLE NUMBER 201

The Adventures of Digital Don.

Once there was an engineer named Digital Don who was into gates and flops and stuff like that. Don was... well... he was consistent.



He wasn't like the guys down the hall who were into micro-programming—the ones with lots of technicians, three-piece suits, fancy new equipment and slinky secretaries.



GOSH, YOU'RE NEAT.

WAIT'LL YOU SEE MY PIPELINE REGISTER.

SIGH.

Don didn't know much about micro-programming. There was never an easy way to get into it. And besides, he always did things the way he always did them, so why should he change now?

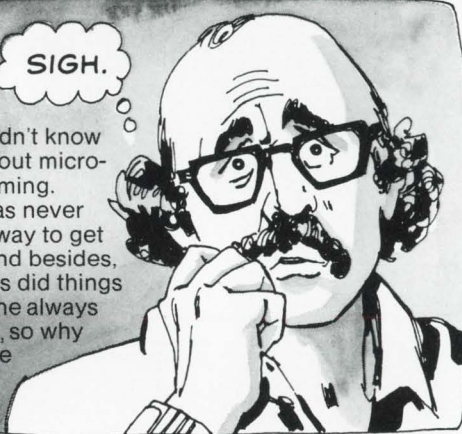

I'M REALLY WORRIED ABOUT HIM, GEORGE.

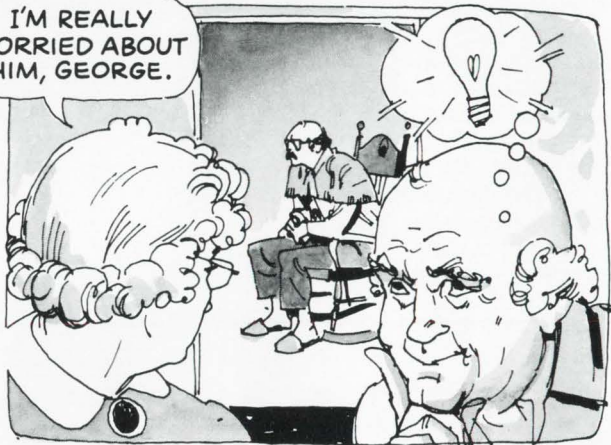

The Advanced Micro Devices' Learning and Evaluation Kit can teach Don how to configure a microprogrammed architecture using the industry standard Am2900 family. He'll be able to write and execute micro-instructions that will completely control an Am2901 microprocessor slice and Am2909 microprogram sequencer—just like a high-performance CPU.



GOLLY! FOR ME?!?!



The Am2900K1 Learning and Evaluation Kit.

It's terrific. For only \$289.00 you can master the basic theory and application of microprogramming. Here's what you get:

A read/write memory storing up to 16 microinstructions driving a pipeline register. From the pipeline register, the microinstructions control: an Am2901; circuits for logical and arithmetic shift and rotation; and the Am2909 sequencer that selects the next microinstruction address. Sixteen sequence control functions are built in, including conditional branch, loop, jump to subroutine and return. Built-in display logic

makes nearly every point in the system available at an LED display.

The Kit includes forty IC's, LED's, switches, resistors, decoupling capacitors, PC board and a really comprehensive manual covering assembly instructions, theory and experiments. The only thing you need to add is a 5-volt power supply.

Throw away your gates and flops. Get the Advanced Micro Devices Learning and Evaluation Kit from your AMD distributor. And become one of the really popular guys.



Advanced Microprocessors



Advanced Micro Devices • 901 Thompson Place, Sunnyvale, California 94086 • Telephone (408) 732-2400 • Distributed nationally by Hamilton/Avnet, Cramer and Schweber Electronics.

Get more for your money!

Use This New 3/8" Square Cermet Trimmer From Allen-Bradley

Our new TYPE E trimmer is a high performer with a realistic price. It has some important advantages: • Immersion seal is tested in 85°C water (not 50° or 70°). • Temperature characteristic is 100 PPM/°C for stability. • Multifingered contact for excellent adjustability. • \$0.49 each—1000 piece price. For more information call your A-B distributor or write for Publication 5219.

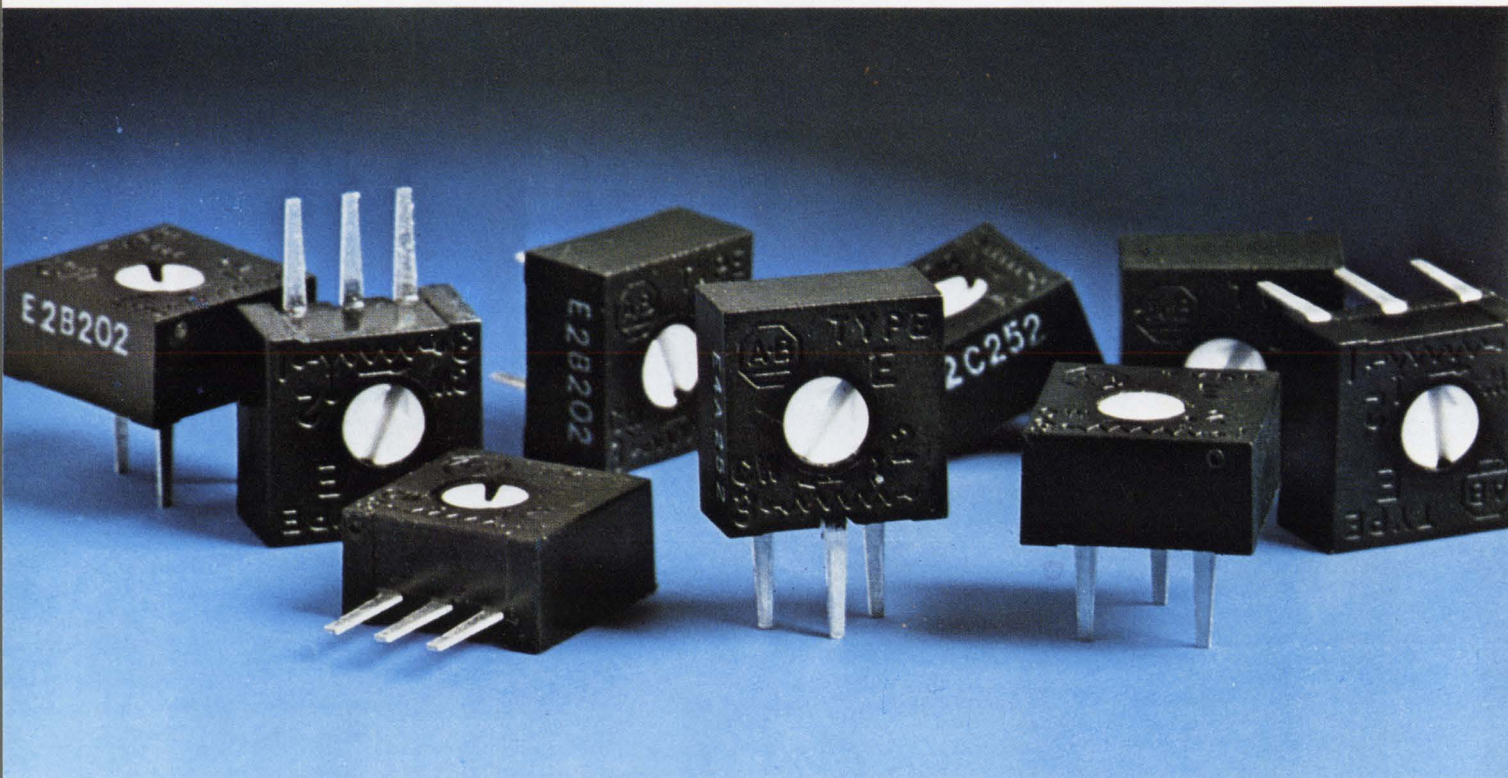
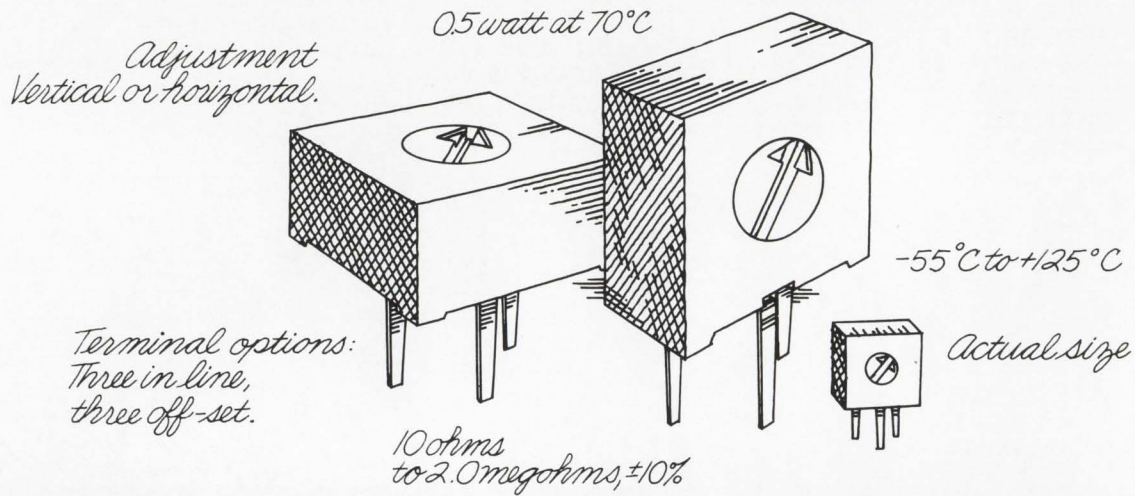

Quality in the best tradition.



ALLEN-BRADLEY

Electronics Division
Milwaukee, Wisconsin 53204

CIRCLE NUMBER 202

EC108

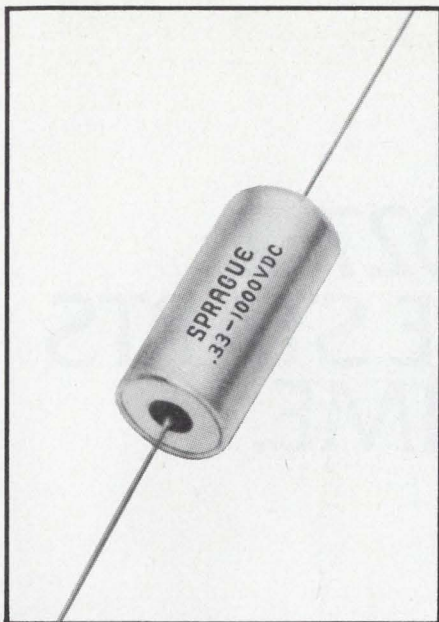

this capacitor is a natural for SCR snubber applications

Sprague Type 196P Vitamin Q® metal-clad paper capacitors, impregnated with an exclusive inert synthetic polymer, are well-qualified for high-current, high-voltage, high-repetition-rate a-c applications.

Conventional dry-construction film capacitors can't stand up to the 600-to-800 volts peak a-c generally encountered in SCR snubber applications. However, Type 196P hermetically-sealed capacitors are built to take even *greater* extremes, assuring exceptional performance and outstanding reliability.

For complete technical data, write for Engineering Bulletin 2110D to: Technical Literature Service, Sprague Electric Company, 347 Marshall Street, North Adams, Mass. 01247.

4SP-4146



*Sprague and ® are registered trademarks of the Sprague Electric Co.

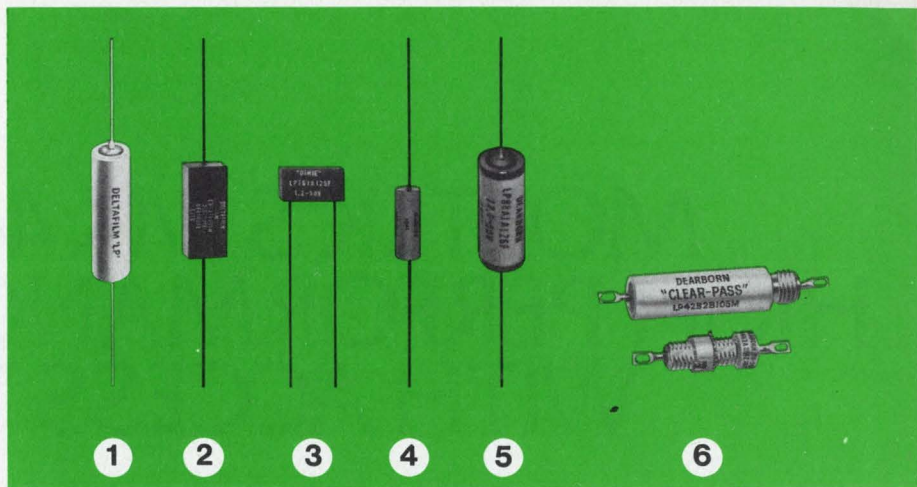

The Dearborn family of metallized polycarbonate film capacitors gives you excellent capacitance stability, low temperature coefficient, high insulation resistance...plus a choice of construction and styles.

1. **STYLES LP8, LP9** Hermetically-sealed metal-case tubular capacitors • LP8, bare case. LP9, insulating sleeve • Capacitance values from .01 to 100.0 μ F, voltage range from 50 to 400 WVDC • Also available as Styles CHR01 and CHR10 to MIL-C-39022.
2. **STYLE LP7A** Epoxy-case rectangular capacitors with axial leads • Capacitance values from .01 to 6.8 μ F, voltage range from 50 to 400 WVDC.
3. **STYLE LP7S** Epoxy-case rectangular capacitors with radial leads • Capacitance values from .01 to 18.0 μ F, voltage range from 50 to 400 WVDC.
4. **STYLE LP66** Wrap-and-fill miniature tubular capacitors • Capacitance values from .01 to 56.0 μ F, voltage range from 50 to 400 WVDC.
5. **STYLE LP88** FUZ-ION* SEALED tubular capacitors . . . epoxy end-seals fused to heat shrinkable plastic case • Capacitance values from .01 to 50.0 μ F, voltage range from 50 to 200 WVDC.
6. **STYLES LP42, LP44** CLEAR-PASS® feed-thru metal case capacitors for radio interference reduction • LP42, threaded neck . . . 10 and 15 amps. LP44, threaded case . . . 10 amps • Capacitance values from .01 to 27.0 μ F, voltage range from 50 to 400 WVDC.

*Trademark

Write for Engineering Bulletins on the Styles that meet your needs.

SPRAGUE ELECTRIC COMPANY

Dearborn electronics division LONGWOOD, FLA.



SALES OFFICES: 347 MARSHALL STREET, NORTH ADAMS, MASS. 01247

MOSTEK'S MK 4027-2. HIGH PERFORMANCE STARTS WITH ACCESS TIME.

150ns

With MOSTEK's new 4K RAM your system performance can match data sheet specs.

At 150 ns access time (worst case), the MK 4027-2 is the fastest 16-pin 4K RAM in the industry. It appears even faster when compared to 18 or 22-pin 4Ks that require high-level clocks and differential outputs. In this comparison, our 150ns is actually better than their 120ns.

But fast MOS memory can't be used efficiently unless you can surround it with high performance logic. You can with the MK 4027 because it's completely Schottky-TTL compatible with a max V_{IL} spec of .8 volts. And a wide $\pm 10\%$ tolerance on all power supplies is a standard feature from MOSTEK.

Gated \overline{CAS} , another new MK 4027 feature, provides an expanded timing window to compensate for timing skews encountered in the multiplexing operation. This window is a full 25% of overall access time.

The MK 4027 can further upgrade system performance with an improved output drive capability. It sources 5mA and sinks 3.2 mA while driving a 100 pF load. Other 4Ks drive only one TTL load and 50 pF.

By employing essentially all dynamic internal circuitry, the MK 4027 dissipates very little DC power. This allows the device to remain much cooler in operation than competitive products and is one reason for its outstanding reliability.

A new operating mode improves access time to 100ns.

It's called "page mode," an addition to the normal cycles of read, write, read-write, and read-modify-write. In a nutshell, page mode allows for successive memory operations at multiple column locations at the same row address with increased speed — 100ns — and decreased power.

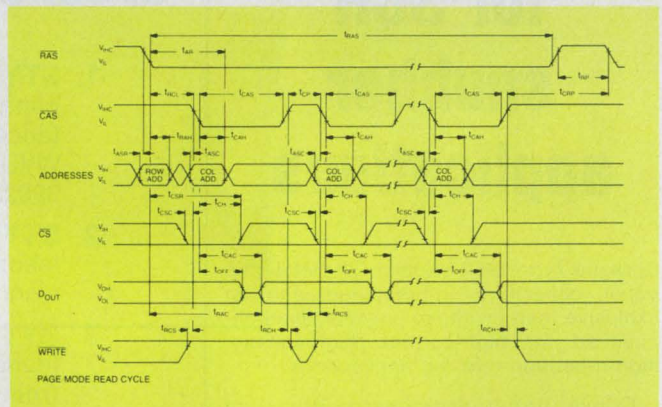

Page mode is not limited to any single chip. Since the \overline{CS} input can be used to select or disable any cycle(s) in a series of "page" cycles, the page boundary can be extended to multiple 4K memory blocks.



MOSTEK's 16-pin package reduces memory board size 50% over 22-pin packages.

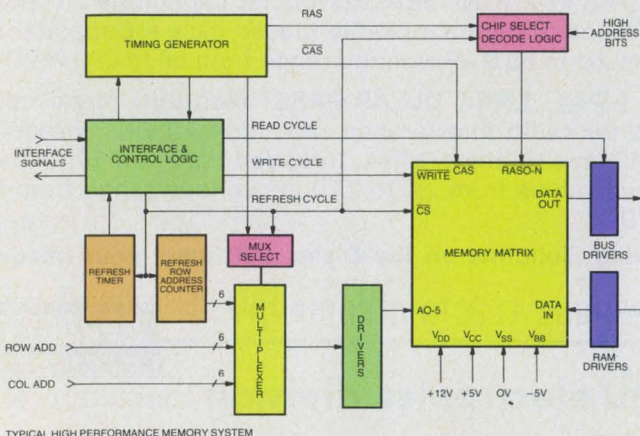

How about density — yours and ours?

As you might expect the MK 4027 is in the industry standard 16-pin package allowing the greatest possible density for your high performance memory system.

We've been working on our own density, too. At 104 mils x 140 mils the MK 4027-2 is the smallest 4K RAM in the industry.



Reliability? MOSTEK sets the standard.

The fastest, the smallest, the most versatile is not automatically the best. Not without MOSTEK quality. Every 4K RAM MOSTEK ships is subjected to these screens and stresses: pre-burn at high temperature, temperature cycling, centrifuge, dynamic burn-in at 125° C, and final test with wide guardbands.

High Performance 4K RAMs . . . Here's your choice?

	16-pin MK 4027-2	18-pin TI 4050-2	22-pin 2107B
FEATURES			
Access Time	150ns	200ns	200ns
Cycle Time	320ns	400ns	400ns
Read/Modify/Write	350ns	600ns	520ns
Worst Case Power			
Dissipation	462mw	478mw	680mw
V _{IL} (all inputs)	0.8v	0.6v	0.6v
V _{IH} (data, address)	2.2v	2.2v	2.4v
V _{IHC} (clocks)	2.4v	12.0v	12.0v
Clock Cap.	7pF (max)	33pF (max)	25pF
Power Supply Tol.	±10%	±5%	±5%
Page Mode	YES	NO	NO

MOSTEK's 16K RAM is coming soon.

In addition to an unlatched output, MOSTEK's 16K RAM will include all the features found in our high performance 4K. This means Schottky-TTL compatibility, ±10% tolerance on power supplies, page-mode, gated $\overline{\text{CAS}}$ and low power. Designing and testing with MOSTEK's MK 4027's in your production systems now is a logical "first step" toward an efficient 16K system.

Want more information? There's an application note and data sheet package that tells the complete MK 4027 story. Write on your letterhead to MS 402 for quick response. Or pick up the literature package and a sample at your local MOSTEK distributor.

MOSTEK

1215 West Crosby Road, Carrollton, Texas 75006
 (214) 242-0444
 In Europe, Contact:
 MOSTEK GmbH, TALSTR, 172, 7024 Filderstadt-1,
 West Germany
 Telephone: (0711) 701096

We've doubled our high voltage Power Transistor line.

Read what's in it for you.

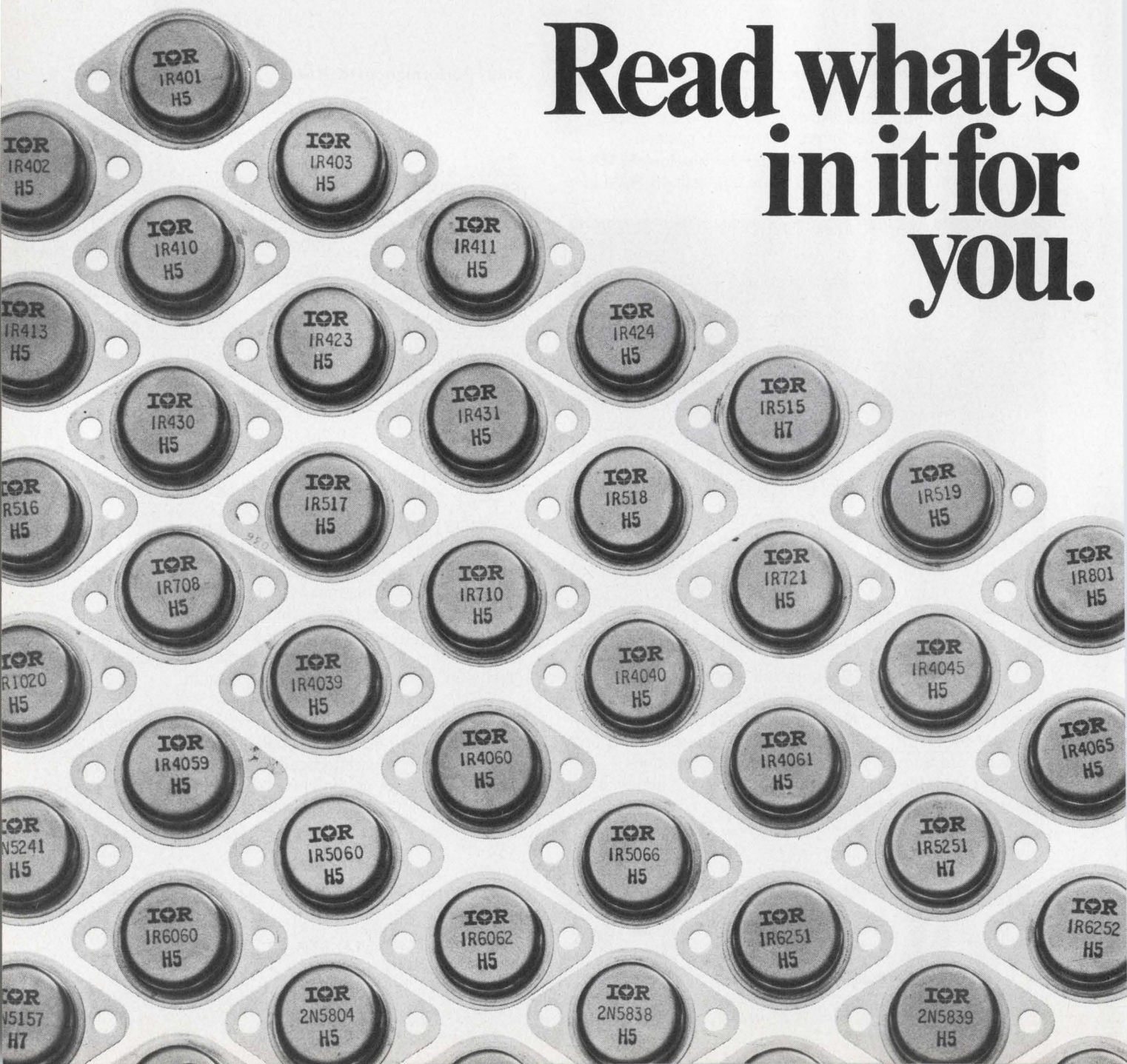

Our new, expanded line offers a lot more types than we could show here. But that isn't important to you. What is important is that now you can probably get a better device than you are now using, for these reasons.

All of the top power transistor companies make pretty good high voltage devices with low sats, broad operating areas, low switching losses. IR gives you that, and more.

For example, we use hard-glass passivation for our chips. That gives our devices longer life than those using organic passivating materials. It also gives a high-temperature stability that you can see in Figure 1, but may never see for other devices. It costs us more to apply. But it is far better for you in the long run.

We build and rate our devices to operate reliably and continuously at maximum rated junction temperatures. Other brands which come up short in high-temperature stability may require temperature derating. Check the performance of the ones you use.

Because we've specialized in "power" semiconductors for more than 28 years, we know the

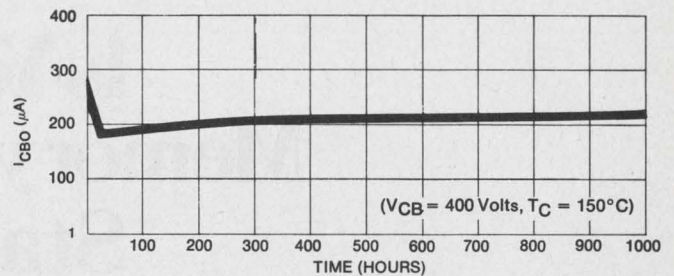

FIGURE 1 Typical High Temperature Reverse Bias Characteristics Vs. Time

importance of reliability testing. In addition to testing the 11 basic parameters of every device, we perform 100% tests on a curve tracer to make sure each part has a sharp high-voltage characteristic.

And there are other demands on power devices we've learned to handle over the years. Like mounting chips to the substrate so they stay there through years of temperature cycling. And making connections between the chip and case that last. Little things? No. They loom large when things go wrong on other devices.

In the case of chips to package yourself, you'll get a completely finished, fully protected and tested transistor for more flexibility in design and higher yields in your end product.

We offer the most popular types for the applications listed, so get our "Power Transistor Application Guide". Check it for our equivalents to the types you're using now. When you find them, you've found the way to add more stability and longer life to your product without adding to your costs.

That's what's in it for you!

Contact your local IR salesman, rep or distributor, or write to: International Rectifier, 233 Kansas Street, El Segundo, CA 90245. Call (213) 322-3331.

Our "Power Transistor Application Guide" gives the part numbers of types available for these applications. Get yours today.

Switching Power Supplies 64 Types
High Voltage Linear Regulators 30 Types
Auto Ignition Systems 22 Types
Ultrasonic Power Generators 13 Types
Vertical Deflection 17 Types
Horizontal Deflection 23 Types
Motor Drives 32 Types
High Frequency Lighting 11 Types

International Rectifier

... the innovative semiconductor people



CIRCLE NUMBER 132

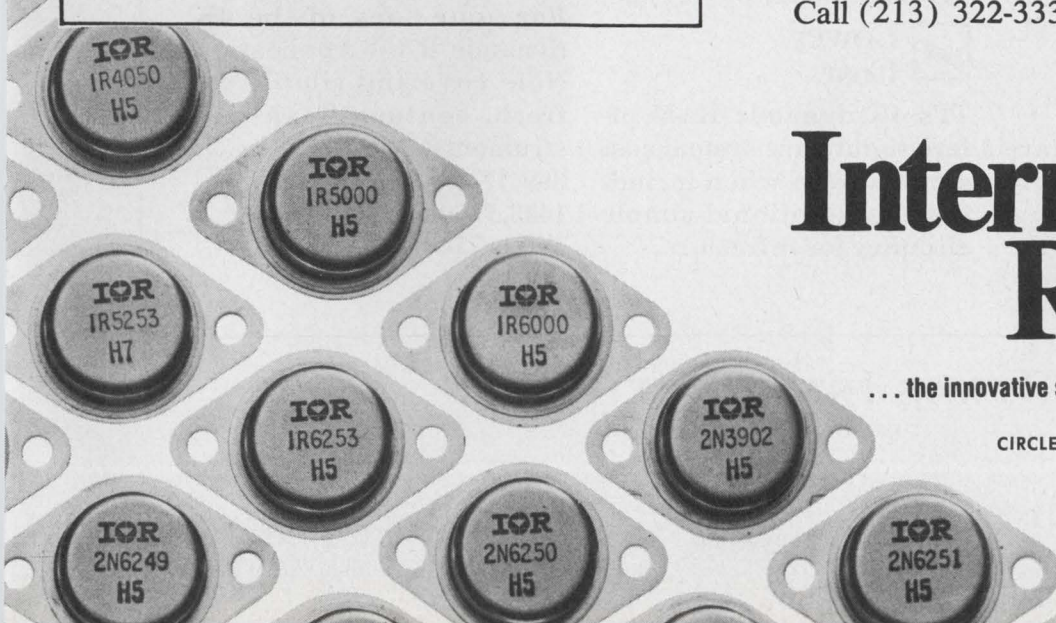

Is Your Memory Design Static?

Make Your Designs Dynamic.

Texas Instruments TTL Compatible 4K RAMs Make It Easy...

HERE'S WHY DYNAMIC DESIGNERS USE TI 4K RAMs.

36% Less Operating Power

Compare 1K low-power static RAMs with TI's TMS 4051 4K dynamic RAM. The table refers to maximum—not typical—values to provide a realistic comparison.

40% Less Standby Power

Low standby power is inherent in the 4K dynamic RAM operation—while static RAMs require extra circuitry to reduce V_{cc} to a low level.

Fully TTL Compatible

The TMS 4051 inputs and output (including clock) interface directly with TTL.

Fast Access Time

TI's 4K dynamic RAMs are fast. The TMS 4051-1 (with TTL clock) has a maximum access time of 250 ns, the

Parameter	Four 1K Static RAMs (2102 AL-2)	One 4K Dynamic RAM (TMS 4051-1)
Power (max.) operating	1368 mW	882 mW
standby	168 mW	101 mW
Access (max.)	250 ns	250 ns
Board area ratio	3.6	1.0
Fully TTL compatible	yes	yes
100 Pc prices	\$20.00	\$12.26

Based on published data

same as the 2102AL-2.

80% Less Board Area

You get almost four times the memory density by switching to TI 18-pin 4K RAMs. The reason? TI's compact 18-pin 300-mil-wide package—available in either plastic or ceramic.

Lower Cost

TI's 4K dynamic RAM offers significant system cost savings even when including the additional simple circuitry for refresh.

Simple Refresh

It's easy! Just 4-8 TTL packages per memory system are typically needed. To see how easy refresh can be, send for our Application Note.

Easy to Use

TI's 18-pin 4K RAMs feature simple 12-line non-multiplexed address and a single non-critical clock. Data input and output are multiplexed—ideal for use with microprocessor-based systems.

Applications Help

For your copy of the 4K dynamic RAM Application Note covering simple refresh, contact: Texas Instruments, M/S 669-4K, P.O. Box 1443, Houston, Texas 77001.



TEXAS INSTRUMENTS
INCORPORATED

We'll prove the reliability of our optoisolators. Just ask.

We want to prove the fact that Monsanto's advances in materials and processing technologies have significantly improved quality and reliability.

We'll send you a FREE COPY of our internal QA Report on our standard MCT2 device. It shows the requirements we place on our product before you even see it. It will prove that Monsanto means quality and reliability, which means cost savings and value to you.

We offer more choices of output configuration in standard products—to perform more functions—than any other manufacturer. Transistors. Darlingtons. Diodes. SCR's. Logic gates. We also have slotted limit switches and reflective sensor switches. And, there is immediate availability of most models.

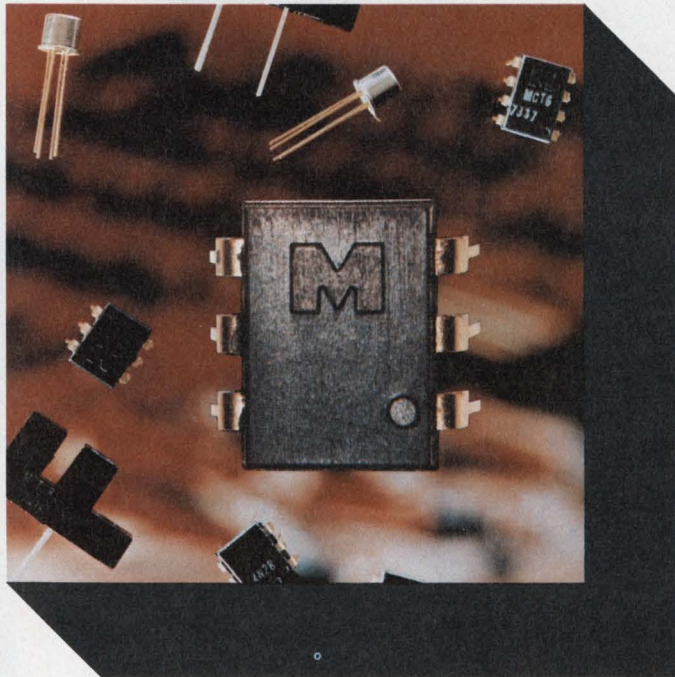

Output Format	Package Types	Min. Current Transfer Ratio	Min. DC Isolation Voltage (V)
Transistor	6 Lead Plastic DIP	6%-100%	1500-3550
Transistor	8 Lead Plastic DIP (Dual Channel)	6%-20%	1500
Transistor	TO-18 Metal Can	15%	1000
Darlington	6 Lead Plastic DIP	100%-200%	1500
Diode	6 Lead Plastic DIP	.15%	1500
Diode	TO-18 Metal Can	.10%	1000

Output Format	Package Types	Forward Blocking Voltages (VFXM)	Min. DC Isolation Voltage (V)
SCR	6 Lead Plastic DIP	200V-400V	1500
2 SCR's (Connected Anode to Cathode)	8 Lead Plastic DIP	200V	1500-2500

Output Format	Package Types	Typical Bandwidth	Min. DC Isolation Voltage (V)
Logic Gate	8 Lead Plastic DIP	0.1MHz-1.0MHz	2000

Output Format	Package Types	Collector Current (IC) @ (IF, VCE)
Transistor	Slotted Limit Switch	50 μ A @ 20mA, 10V 200 μ A @ 20mA, 10V
Darlington	Slotted Limit Switch	1.6mA @ 50mA, 1V 2.0mA @ 16mA, 1V
Darlington	Reflective Sensor Switch	50 μ A @ 50mA, 5V

Write now, on your company letterhead, for a copy of our MCT2 Reliability Evaluation Report. You can also get up-to-date information on our products. Or, contact your Monsanto representative or distributor for assistance or immediate delivery. Monsanto Electronics Division, 3400 Hillview Avenue, Palo Alto, California 94304. Phone: (415) 493-3300.

Putting Innovation to Work.

Monsanto:
the science
company.

Monolithic capacitors have been
our business for nearly three decades.

We build them better

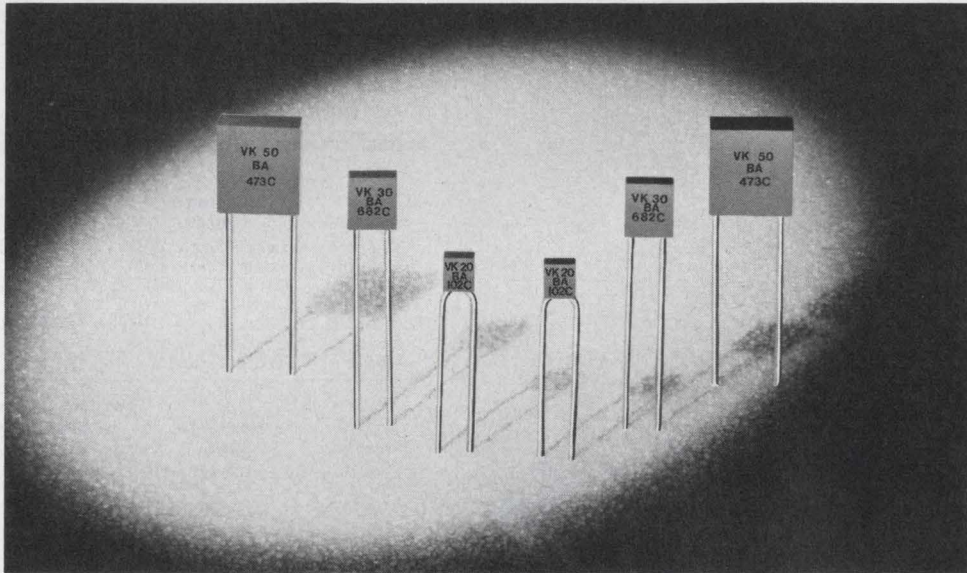

Our $\pm 0.25\%$ tolerance is low for any capacitor.

In short, our cased-radial NPO Ceramic Capacitors are unique.

They feature capacitance tolerances as low as $\pm 0.25\%$ — the tightest we've seen advertised — in all values from 10 pF to .051 μF .

Our other commercial and military ceramic capacitors are unique, too. They all bear the stamp of 'Vitramon' — a mark of high-quality capacitors and contemporary technology since we introduced the first 'VK' part (forerunner to all radial CK capaci-

tors), at WESCON in 1959.

Looking for high-quality CK and CKR military capacitors . . . a variety of commercial cased-radial components . . . dipped-radial parts in NPO, BX, X7R and Z5U dielectrics . . . values from 1.0 pF to 4.7 μF ?

We offer them all — as well as 29 styles of 'VY' Porcelain Capacitors that put the word monolithic into capacitor technology nearly three decades ago.

As important, we deliver what we offer. Call us at (203) 268-6261.

V[®]

Vitramon[®]

Vitramon North America
Division of Vitramon, Incorporated
Box 544, Bridgeport, Conn. 06601

Subsidiaries: Vitramon Limited (London) • Vitramon GmbH (Stuttgart) • Vitramon France S.A.R.L. (Paris) • Vitramon Pty. Limited (Sydney) • Vitramon Japan Limited (Tokyo)

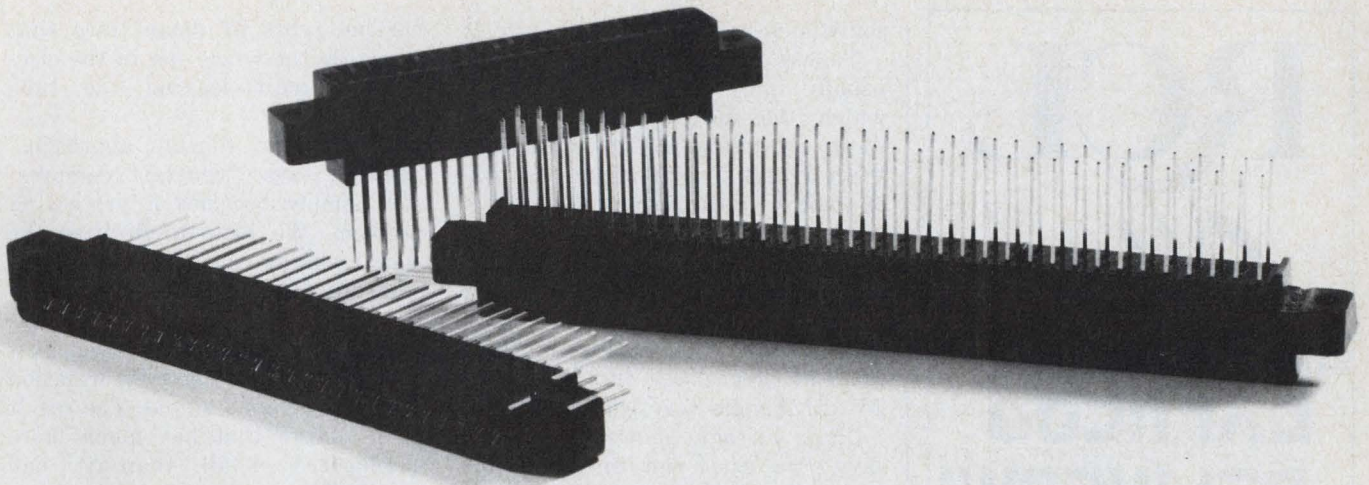

Presenting our better-mouse-trap line. No frills at all.

When you cut price without cutting quality, soon no one thinks of it as a cut price. That's where our Norsman line of Wire-Wrap* P/C connectors is headed. Here's why:

The insulator — it's tough, resilient, non-conductive — everything you need in a Wire-Wrap body. And it's made out of low cost phenolic, not the higher cost diallyl phthalate (if you need to meet mil specs, we have that in one of our other lines).

Contacts are semi-bellows and gold-plated — but

plated with our unique AuTac (TM) process. You get .000050" gold plate all along the mating surfaces for a sure, gouge-proof, pop-off-proof contact — but that's it. No wasted gold.

And you can find the size you need — Norsman is a full line from 15/30 to 50/100 contacts, in either .100 or .125 contact centers.

The whole Norsman idea is as simple as it is old: keep performance up and cost down. It works.

Send for details. We haven't told you everything.

*Wire-Wrap — registered trademark of Gardner-Denver Company.

Tell me everything. Send me detailed literature.

Name _____ Title _____

Company _____ Telephone _____

Address _____

City _____ State _____ Zip _____



Viking Industries, Inc./21001 Nordhoff St./Chatsworth, Calif. 91311/(213) 341-4330

CIRCLE NUMBER 16

RCL

Offers

"EXPRESS DELIVERY"

At Standard Pricing...

On Rotary & "PIP" Switches

Industry's Best Delivery at Non-Premium Prices.

PROTOTYPE OR PRODUCTION RUNS—ALL AT STANDARD PRICING

Send For New '76 Catalog Or Call our Hotline For Name Of Your Local Representative Or Stocking Distributor.

(201) 374-3311

AMF

RCL Electronics

General Sales Office:
700 So. 21st Street
Irvington, N. J. 07111

sometimes verges on the infinite."

Television studios, he explains, usually light on a 1:1 basis—in which the maximum amount of light is the same as the minimum. Within that 1:1 lighting ratio no one will be wearing a white shirt; white is too "hot" for TV. And no one will be wearing a black suit; it's too dark for TV. Given all the grays in between in a 1:1 lighting ratio, you wind up with a contrast ratio of maybe 5:1 or 8:1, which TV can handle very well.

"But in our shows," Schubin says, "we may run into lighting ratios of 100:1 or 1000:1."

In "Swan Lake" when Makarova's costume is white and the scenery dark, the television camera doesn't pick up the scenery and Makarova appears to be dancing in limbo. Then, when she dances in front of a white background, her tutu, as well as her torso, disappears (see photo).

Now, about all that's possible is "to play with the gamma of the system"—that is, to alter the curve of input brightness vs. output voltage. You can put more detail in the blacks, the whites or the grays—but not simultaneously. Those changes can be performed in any camera available today, but they're not entirely satisfactory.

Reducing the brightness

So the Media Development Dept. is working on a contrast-compression scheme that uses spatial frequency filtering. A picture that has many points in any given direction is said to have a high spatial frequency. One with few points has low spatial frequency. The spatial "high pass" filter lets detail through while reducing the amplitude of major brightness differences (low frequencies).

The National Aeronautics and Space Administration and a number of other groups have performed contrast compressions using spatial frequency filtering, but these experiments have usually involved the use of digital pictures.

Lincoln Center isn't trying to tell people how to solve the problem, but its engineers have considered the use of a scan-conversion tube for instantaneous x-y filtering. They've also considered using

various types of delay lines that might do the whole job in the electronic circuit—leaving the tube out of it.

"Using the digital approach," Schubin says, "contrast compression simply becomes a processing problem. We have to digitize the signal coming in and tell the processor to filter it in both x and y direction—that is, to do a low-pass filtering operation. Then we just subtract this low-pass information from the original signal. The result is a picture that has much more emphasized detail than it had originally.

A third problem is nonuniform color in lighting. Lights of different color temperatures change the lighting in video pictures as they do with color film. If you have a carbon spotlight and an incandescent light, the carbon is going to show up much bluer than the incandescent.

Another possibility: the carbon might have a blue filter on it and the incandescent a pink.

The nonuniform color problem is handled manually now, which isn't entirely satisfactory, Schubin says. The ideal solution would be to have some sort of device to tell all the cameras that a certain object is a certain color and to keep it that way. That would entail some sort of object-recognition system, perhaps based on contour detection.

Meanwhile Lincoln Center is working on automatic black-and-white balance and color-correction techniques.

The fourth problem—picking up voices at the other end of a long stage—is now handled fairly well with shotgun microphones, but eventually, some sort of ultra-directional microphones will probably be used.

The transmission of high-fidelity stereo sound nationwide is done now by the Center's patchwork network, which feeds into microwave links, land lines and satellites. Ultimately, there will be a network of broadband-satellite and terrestrial units, all using analog or digital techniques.

"People come to us with unusual ideas and we're always glad to hear them," Schubin says. "These include holographic scenery or props, three-dimensional television and anamorphic video projection." ■■

How to pick the right panel meter for your product.

The choice you make in panel meters can do a lot to help or hurt your product. Yet it's not all that difficult to pick the right one, even if panel meters aren't your specialty. Here are nine easy steps many experts follow to make sure they choose the right panel meter every time.

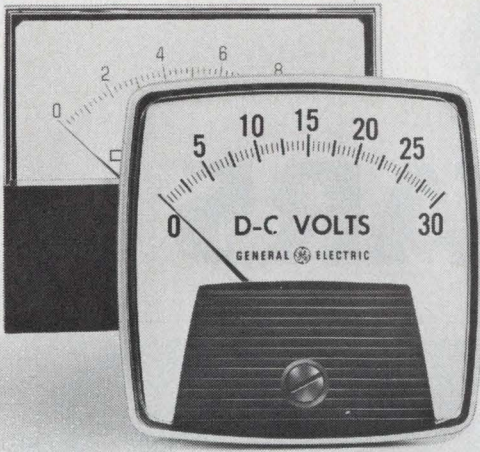

1 Make sure the panel meter will fit your exact mounting requirements.

Only those panel meters whose barrel diameters and mounting hole locations will match your panel cutout are worth considering. Otherwise, you'll get stuck later with costly drawing changes, new setups, and redrilling operations.

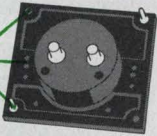

GE solves your mounting problems by ultrasonically placing studs to match your panel cutouts... for new or replacement meters.

2 Choose the scale you think your customers will find easiest to read.

Make sure the digits and subdivisions can be easily read from a reasonable distance. Check the shape of the pointer. Does it help or hurt readability?

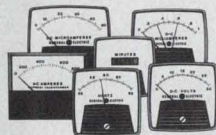

GE has BIG LOOK® and HORIZON LINE® styles in 1 1/2" to 4 1/2" cases. Front or rear mounting. Edgewise meters. Custom and optional features through GE Modification Centers, too.

3 Specify the style and size you think will work best and look best on your product.

Smart looks can sell. Your product's panel meters are often the very first "embellishments" your customer notices.

4 Determine what accuracy class you need.

Accuracy to $\pm 2\%$ of full scale is by far the most common. You can, of course, get cheaper, less accurate panel meters. Or pay a premium for higher accuracy when the application truly demands it.

5 Find out what the panel meter's loading effect will be on your product.

ANSI C39.1 Specs pretty well dictate these guidelines. But check them yourself to make sure the terminal resistance of your dc instrument, or the burden data of your ac instrument, won't overburden your circuit.

6 Choose between taut-band or pivot-&-jewel suspension.

Both have their advantages. Taut-band construction is extremely durable, friction-free and resistant to shock. Pivot-&-jewel instruments, on the other hand, have the inherent stability and strength to work best in most high vibration environments.



Taut-band

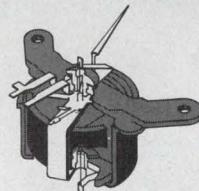

Pivot-&-jewel

GE makes both. We'll gladly help pick the right one for you.

7 Analog or digital?

You be the judge. Digital applications are hampered by power supplies and background signal "noise." They add more to the cost of your product. And it's next-to-impossible to quick-scan them or to monitor rapid change. Analog panel meters still outsell digitals by nearly 10 to 1.

8 Make sure it will work in dirty environments.

Since you can't control where your customer might use your product, you'd better make sure your panel meters are sealed in a good, tight case.

9 Then, if you're still undecided, consider the manufacturer's reputation.

Make sure your choices are reliable, that the manufacturer will stand behind them, and that the panel meters meet all ANSI specifications for performance.

Specify General Electric... just for good measure.

For a free guide entitled "Pick the Right Panel Meter" (GEA-10340) and our complete Catalog (GEP-307), write to General Electric Co., Section 592-65, Schenectady, N.Y. 12345.

592-65

GENERAL  ELECTRIC

CIRCLE NUMBER 18

LED SUPERSTARS

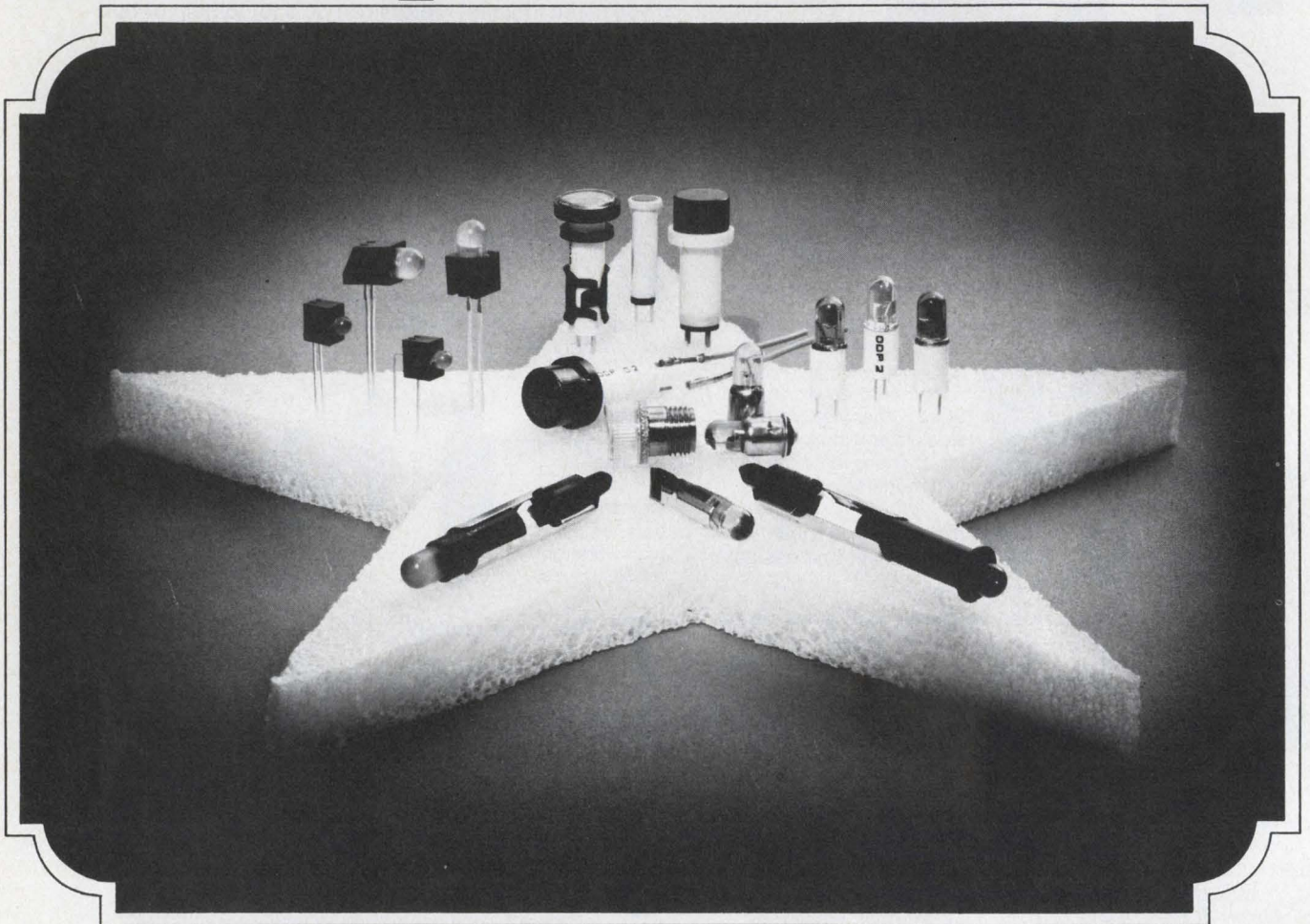

As bright as many incandescents!

Meet the LED Superstars . . . red, amber and green superbright panel and PCB lights. Their high brightness 50 MCD @ 20 MA (typical clear red) make them **the** perfect cost and power saving replacements for incandescents. Available with built-in resistors for all popular voltages.

Subminiature Panel LED's (also suitable for PCB mounting)—available in hundreds of sizes, shapes and styles.

PCB LED's—Horizontal or vertical viewing . . . optional built-in resistor for 5V applications.

Bi-Pin (T1- $\frac{3}{4}$) LED's—Ideal for dead front panel applications, e.g. DEC's PDP Series computers.

Midget-Flanged (T1- $\frac{3}{4}$) LED's—Direct replacements for incandescents in panel light and switch applications.

Replacement Lenses—Specifically designed for use with Midget-Flanged LED's.

Slide Base LED's—Direct replacements for incandescent types.

There's lots more too, and they're all Superstars! Send for our Catalog today: Data Display Products, P.O. Box 91072, Los Angeles, Ca. 90009, (213) 641-1232.

Produced by the original "little light" people.

DATA DISPLAY PRODUCTS

Washington Report

EIA projects government electronics growth

The electronics content of the Federal budget will rise steadily from \$19.1 billion for the new fiscal year beginning Oct. 1 to \$25.5 billion five years later in fiscal 1981, according to the new annual report of the Electronic Industries Assn.

The Defense Dept. will lead the growth, accounting for \$15.7 billion in fiscal 1977 and \$21.7 billion in fiscal 1981. Electronics spending will remain essentially level at the National Aeronautics and Space Administration and Dept. of Transportation, amounting to about a half billion dollars a year for each agency over the five-year period. Growth will be moderate at all other federal agencies—from \$2.3 billion next year to \$2.7 billion in fiscal 1981.

The EIA concedes that the actual electronics content of the budget is still a matter of debate within both government and industry, but maintains its projections are conservative because of the increasing application of high technology, particularly in the nondefense categories.

Science advisor post hit by politics

A political controversy has stalled the appointment of a new Presidential science advisor. President Ford wants National Science Foundation Director Dr. H. Guyford Stever for the post, but a group of conservative Republican senators opposes the nomination on the grounds that the NSF sponsored elementary and secondary-school courses in sex education.

The science advisor was an important White House post until President Nixon abolished it three years ago because he didn't like the advice he was getting. President Ford wanted it restored and worked closely with Congress in writing new legislation to create a permanent office of Science & Technology Policy. That legislation was signed into law May 11, but Ford has been careful not to alienate the conservative element of his party before the nominating convention later this month.

Stever has vocal support from science-oriented legislators, such as Sen. Frank Moss (D-UT), chairman of the Senate Space Committee, who called for "early action" on the appointment, and Sen. Edward Kennedy (D-MA), chairman of the subcommittee that oversees the NSF budget.

DOD to encourage plant modernization

Investing in new facilities will become more attractive for firms dealing with the DOD, if a recent ruling by the Cost Accounting Standards Board is put into effect.

Firms that borrow money to improve their facilities will be allowed to pass the interest expenses along as part of the cost of the contract—up to the rate approved by the Renegotiation Board, currently about 8%. This pass-along will improve profits by about 1%, if Deputy Defense Secretary William Clements decides to allow the increase.

Defense profits under negotiated contracts currently average about 8.8% of sales at the time contracts are written, but cost overruns—shared by the contractors and the government—have driven down actual profits to an average of 4.7%. The new formulas are intended to reduce this profit loss, and to reduce the overruns themselves, by making it more attractive for contractors to hold down their costs.

Under the present formula for determining profits the factors are weighted 65% for costs, 30% for risk, and 5% for other factors. The new plan would reduce cost to 45%, increase risk to 45%, and assign 10% to investment. Defense facilities, on the average, are twice as old—half as modern—as those of commercial manufacturers, according to Air Force Brig. Gen. James Stansberry, director of the Pentagon's year-long series of "Profit '76" studies, of which these recommendations form a part.

Air Force to finalize EF-111A design

The EF-111A, the Air Force's proposed \$586 million program to convert 40 surplus fighters into tactical jamming aircraft, is due to complete the final design phase this month. The program successfully passed critical design review in June at the Long Island facilities of prime contractor Grumman Aerospace Corp., and the results were reviewed by the Air Force Scientific Advisory Board.

The program involves installing electronic countermeasures (ECM) equipment in the weapons bays of surplus F-111s so they can neutralize enemy surface-to-air missile (SAM) radars during tactical air strikes. The equipment was originally developed by Grumman for the Navy's EA-6B ECM aircraft.

The major difference is that on the EF-111A the equipment will be carried below the fuselage in the weapons bay rather than on external wing-mounted pods. This is expected to increase reliability because operating temperature of the electronic equipment can be reduced from 160 to 40 F. The EF-111A is also expected to be more effective than the earlier EB-66 ECM aircraft, which were only partially successful in Vietnam.

Capital Capsules: A fully automatic system for classifying fingerprints has been demonstrated by Calspan Technology Products, Buffalo, NY. The prints are first converted to digital form with the company's Finder reader, now used by the FBI, and then classified according to fingerprint pattern by its new device . . . **The Naval Research Laboratory has devised an optical waveguide system for transforming the output of a phase modulator into an amplitude modulation.** Laser light is propagated in the waveguide system and forwarded into branches of the waveguide. Then an electro-optic material placed in one or more of the branches in the system is electrically controlled to vary the phase in each branch, causing different propagating modes . . . **How to use CB radios to promote public safety** is the prime subject of exploration during the 42nd annual conference of the Associated Public-Safety Communication Officers, Aug. 2 to 5, at New York City's Americana Hotel.

This Me Too 4K RAM Has Something Extra Going For It

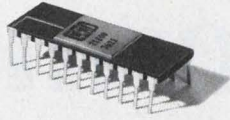

Like the fact that we've never made an MOS RAM before.

MMI 4K MOS RAMs INDUSTRY STANDARD 22-PIN DIP

Part No.	Pins	Temp.	Access Time	100 Qty. Price
2180	22	0-70°C	200 ns	\$15.00
2180-4	22	0-70°C	270 ns	\$10.00

For more information call,
TWX or write:

United States
Monolithic Memories, Inc.
1165 East Arques Avenue
Sunnyvale, CA 94086
Tel: (408) 739-3535
TWX: 910-339-9229

Europe
Monolithic Memories, GmbH
8000 Munich 80
Mauerkircherstr. 4
West Germany
Tel: (089) 982601, 02, 03, 04
Telex: (841) 524385

Far East
Monolithic Memories, Ltd.
Parkside-Flat Bldg
4-2-2, Sendagaya Shibuya-Ku
Tokyo 151, Japan
Tel: (3) 403-9061
Telex: (781) 26364

Think about it. Here we are the world's largest bipolar memory manufacturer coming out with the first device in a new MOS line. We can't afford a mistake.

So, to start things off, we build our RAMs better: to mil standard 883 to be exact. After we test them, we burn them all in dynamically, at 125°C.

Then we test them again. And we don't take any shortcuts. Every part is tested for DC parametrics and for dynamic functional pattern sensitivity at AC speeds. To guarantee that refresh sensitive soft failures are screened out, we perform all this testing at guard banded limits and at temperatures in excess of our published specs.

No price premium for quality.

Best of all, you can buy our 4K RAMs for the same price that you're now paying for someone else's run-of-the-mill parts.

Give us a call. We'll respond with parts for evaluation and all the documentation you need. Delivery, in quantity, is NOW.

Monolithic Memories

CIRCLE NUMBER 21

Designing broad band transformers?

Here
comes
help

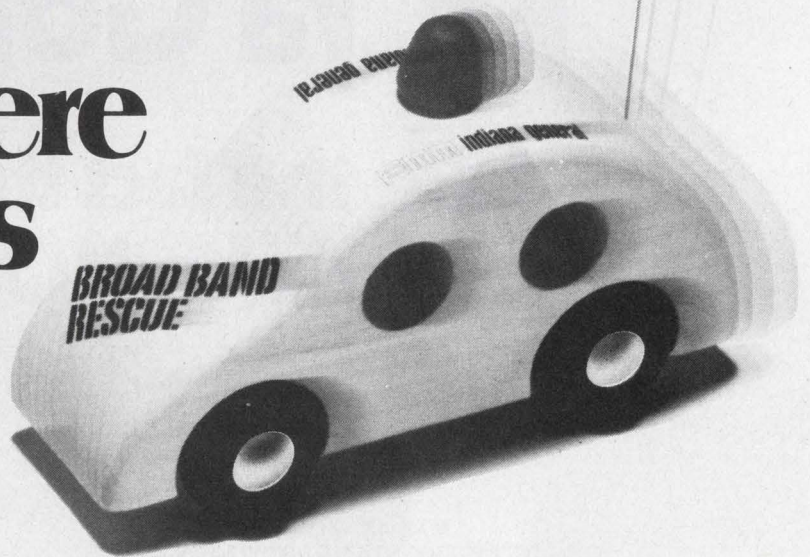

DESIGN DIRECTION — Tell us your application for broad band components. We'll send you complete design information on the only ferrites manufactured, tested and guaranteed for bandwidth performance. Your design will be easier and more precise with graphs of R_p and X_p vs. frequency and design examples that work.

COMPONENT SELECTION — Give us your circuit parameters and we will select a Broad Band-Rated[®] component with 16,000 perm to replace expensive metal laminations. Or give us your bandwidth requirements from 100 Hz to beyond 250 MHz and we'll choose from our complete range of toroids and mated parts in recommending a specific solution.

Call **APPLICATIONS ENGINEERING**, (201) 826-5100 or write: Indiana General, Keasbey, New Jersey 08832.

RESCUE VEHICLE — CREATIVE PLAYTHINGS

ENM indiana general
a division of Electronic Memories & Magnetics Corp.
Keasbey, N.J. 08832 • (201) 826-5100

CIRCLE NUMBER 22

Microprocessor Design

μ C board sizes will be standardized, provided that customers demand it

In the past year, several leading manufacturers such as Intel, National Semiconductor, DEC and Data General have introduced microcomputer boards with a variety of physical dimensions and pinouts. Bill Walkup of Cambridge, Thermionics Corp., Cambridge, MA, presents his views on board standardization.

There is no standard, military or otherwise, and there is no progress toward a standard, that I know of, and is my job to know. There is no real desire among the hardware industry to adopt one because then it becomes a business of buying on the basis of price, and not features. The price would go down, and the margins would go down, and nobody who is in this business wants this to happen. I don't see any trend developing or any standard emerging other than the so-called Universal Panel approach introduced by Augat, our competitor, 5 or 6 years ago and now manufactured by us and about 10 or 15 others. Universal Panels

(continued on page 44)

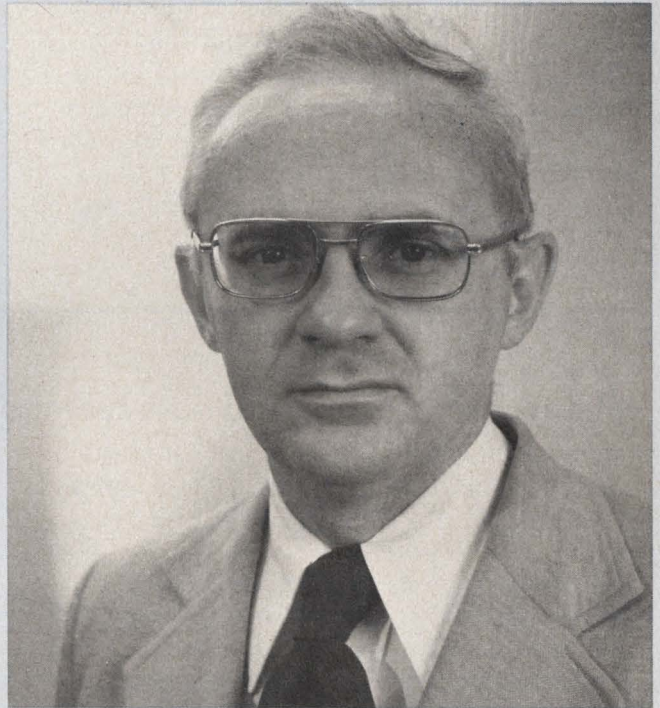

μ P prototyping board contains Basic interpreter

The EVK300 microprocessor prototyping board contains a Basic language interpreter, a debug program, and an EPROM programmer for the 6800 μ P.

The interpreter is supplied on 2-k words of EPROM and executes a subset of the full Basic language called Tiny Basic. It is less powerful than Basic because only integer numbers may be handled, variables must be identified by single letters, and no arrays or strings may be used.

The debug software is programmed into 2-k words of PROM. The program reads the teletypewriter, displays or changes the contents of a memory location or μ P register, and performs other functions.

Electronics for programming EPROMS is also on the card. A supply of -50 V is required, in addition to the 5 V, +12 V and -12 V required for the rest of the card. The board also contains 1-k words of RAM. Up to 56-k words of additional memory may be added externally.

The EVK300 costs \$950 (unit qty), measures 10.5×10.5 in. and has two 86-pin edge connectors for external interface.

AMI, 3800 Homestead Rd., Santa Clara, CA 95051. (408) 246-0330.

CIRCLE NO. 571

MICROPROCESSOR DESIGN

(continued from page 43)

are wire-wrapped together with no connectors used. Since the boards cannot be individually removed, all repairs are done at the component level.

However, I would like to see users get together and come up with a standard. This would be good for the industry although maybe not so good for my company. Users should get together and say to the manufacturers "this is what we want." It would take a few years probably, but standard could be developed. Then, the hard-ware card manufacturers would be forced to comply with the wishes of the marketplace.

The military and nuclear instrumentation industries have several standard function modules. These are not in wide use because of

their specialized requirements and are almost an order of magnitude more expensive than wrapped-wire boards with equivalent features. Since the modules specify particular functions to be performed, they are blocked into a format 6 to 8 years old and do not take advantage of the latest technology. The Standard Electronic Module (SEM), for example, started out as a generalized physical module, but it hasn't turned out that way.

By the way, Europe has a standard board size. Theirs is called Eurocard, and it has become quite popular. It was first developed in Germany around 1970 and subsequently adopted by the Common Market. The card has dimensions of 100 × 160 mm, and has a 64-pin male plug. It is produced presently by six or eight manufacturers and many more are very interested in making it. There are also double and triple-width sizes if more ICs must fit on the card. We ought to develop a similar standard.

μP improves accuracy of data-tablet digitizer

A magnetostrictive data-tablet digitizer improves point-location accuracy over similar systems by an order of magnitude through use of an 8080 microprocessor. The digitizer produces binary data that identifies the locations of X-Y coordinate intersections on the tablet. Magnetic pulses applied to X-Y wire ends drive strain-wave pulses down the wires. The pulses generate voltages in the cursor.

The 8080, in combination with a special ROM, provides the data tablet—called the Intelligent Digitizer by Summagraphics Corp., Fairfield, CT—with a software-based system that performs a ratiometric calculation for each point on the tablet selected by a stylus or cursor. This type of calculation gives an absolute, corrected value for each coordinate point anywhere on the tablet surface to within ±0.004-in. tolerance.

Nonlinearities inherent in the measuring system, which uses magnetostrictive ranging along an X-Y grid of wires underneath the tablet surface, are therefore cancelled out.

This improvement is in contrast to earlier Summagraphic systems in which the accuracy was specified as ±0.08% of the distance from the coordinate origin, which was located in the lower, left-hand corner. In the present case, the absolute accuracy remains the same with the distance from the origin.

For example, at a distance of 6-in. from the

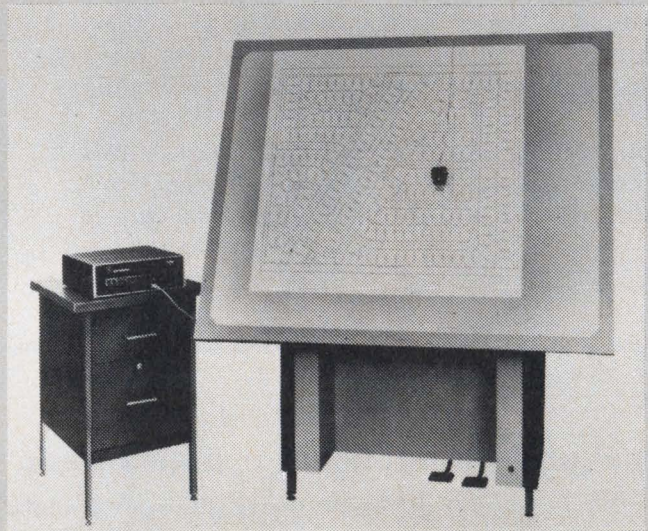

origin the absolute accuracy was about ±0.005-in., whereas 36-in. from the origin it was ±0.029 in.

Measurements of absolute accuracy over the entire tablet are produced by the Intelligent Digitizer, because, first, it makes two measurements for each coordinate intersection. That is, the intersection on the coordinate is measured first from the left (X_1) and then from the right (X_2); and the point on the Y coordinate is measured from the top (Y_1) and from the bottom (Y_2).

Second, these measurements are fed into the 8080, which corrects for nonlinearities in the

X and Y measurements by performing the the following calculations:

$$K_1 \left(\frac{X_1}{X_1 + X_2} \right) = X_{\text{TRUE}}; K_2 \left(\frac{Y_2}{Y_1 + Y_2} \right) = Y_{\text{TRUE}}$$

The μP in the Intelligent Digitizer also gives added functions not previously obtainable with a stand-alone tablet system. One function is the automatic correction of skew in a drawing that is not perfectly aligned on the tablet. Another is "floating origin"—the origin can be placed anywhere on the tablet that the operator desires.

A third feature is automatic scaling of

drawings in the ranges of 2, 5, 10 and 50 to 1. Also, the perimeters and areas of enclosures can be readily calculated by simply tracing the enclosure with the stylus or cursor.

The use of the 8080 also unburdens any host computer to which the digitized information is fed, thus saving central computer time. In addition the 8080 provides binary to BCD conversion for the tablet.

The Intelligent Digitizer has a 36 by 48-in. working surface and a resolution of 200 lines per inch. Specified accuracy is ± 0.004 -in., plus or minus one least significant bit.

Mini and microcomputers work together to lower heating costs

An automated energy-management can cut the cost of heating a building by as much as 25%. Further, the cost of such a system can be reduced by teaming up the minicomputer that controls the system with several microcomputers which gather and process sensor data. Such a system can reduce both normal and peak-power consumption loads.

The microcomputer, used by Systems Technology, Detroit, MI in their version of the automated energy conservation system described, is a standard MicroPac 80 manufactured by Process Computer Systems, Flint, MI. It works in conjunction with a minicomputer to automatically turn heating and cooling equipment on and off each day, and to minimize the use of this equipment when power consumption approaches a peak demand level. The new system can also be used to cycle ventilation equipment. By sensing outdoor temperatures and sending data to the computer, the system automatically determines when ventilation equipment can be shut off without any noticeable changes in temperature inside the building. Typically, whenever outside air is brought into a building, power is consumed both circulating it and heating or cooling it.

Sometimes it is desirable to circulate outside air because it can be used to achieve the same temperatures as that provided by air conditioning. Even when it is freezing outside, a concentration of people inside a building heats up the inside air. Outside air rather than air conditioning can then be used to cool down the building's interior. Since the computer constantly receives readings on inside and outside temperatures, it can determine when it is better to introduce outside air into a building.

Process Computer Systems, Inc., 5467 Hall 23 Dr., Flint, MI 48507. (313) 767-8920.

CIRCLE NO. 572

Nonvolatile memory available for the IMP-16P microcomputer

A nonvolatile core-memory card—one that will not lose data when power is removed—has been designed to mate with the IMP-16C microcomputer development system from National Semiconductor. The board, designated the MM16P, and offered by Micro Memory, Inc., stores $8\text{-k} \times 16$ words. It has a byte-control feature, and can be operated also as $16\text{-k} \times 8$ words.

The card contains timing, control, decode and drive circuits, and address and data registers. Access and cycle periods are 350 and 1000 ns, respectively.

Depending on the capacity of the development system, a separate supply of 12 V at 1 A might be required. The card dimensions are $8.5 \times 11 \times 1$ in. The board costs \$1500 in unit quantity.

Micro Memory, Inc., 9438 Irondale Ave., Chatsworth, CA 91311. (213) 998-0070.

CIRCLE NO. 573

DATEL



YOUR \$59* DPM

Choose Datel's DM-350 for your next design . . .
And take a look at these Datel Digital Panel Meters:

MODEL	NUMBER OF DIGITS	POWER SUPPLY	FEATURES	PRICE (1-9)
DM-350D1	3-1/2	+5VDC @ .3A	UNIPOLAR, LOW POWER, DISPLAY ONLY	\$69 (1-9) \$59 (100's)
DM-350D2	3-1/2	+5VDC @ .3A	BIPOLAR, LOW POWER, DISPLAY ONLY	\$75
DM-350A1	3-1/2	115/230 VAC	UNIPOLAR, XFMR-ISOLATED, DISPLAY ONLY	\$79
DM-350A2	3-1/2	115/230 VAC	BIPOLAR, XFMR-ISOLATED, DISPLAY ONLY	\$89
DM-4000	4-1/2	+5VDC @ .6A	OPTOISOLATED RATIO METRIC AUTO ZERO XTAL LINE FILTER	\$219 less BCD \$239 with BCD
DM-4300	4-3/4	+5VDC @ .6A	OPTOISOLATED RATIO METRIC AUTO ZERO XTAL LINE FILTER	\$235 less BCD \$255 with BCD
DM-2000AR	3-1/2 DIGITS AUTORANGING OVER 3 DECADES	+5VDC @ .8A	AUTOMATIC RANGING OVER $\pm 200\text{mV}$, $\pm 2\text{V}$ $\pm 20\text{V}$ FULL SCALE	\$169 less optoisolation \$218 with optoisolation



1020 Turnpike St., Canton, Ma 02021 • Phone (617) 828-8000
• Santa Ana, Calif. (714) 835-2751 • Santa Ana (L.A. Exchange) (213) 933-7256
• Sunnyvale, Calif. (408) 733-2424 • Gaithersburg, Md. (301) 840-9490

Research it till you have the answer you want

Jack was always right and he could prove it—with research. Mostly it was other people's research he used, but, if necessary, he would conduct his own. And it did become necessary—often—when he found that other research disproved his point.

Jack was always willing to research something till he got the right answer—the one he started with. Research that gave the wrong answers—"intermediate results," he called it—was discarded. And since he found that research always proved his initial assumptions he realized after a while that it wasn't necessary to waste so much of his time with it.

It was necessary, merely, to proclaim "the truth" to his subordinates, and to demand that they act on it. If his research—or instinct, which was just as good—showed that many people needed scopes, for example, he would set his people to designing scopes. His engineers might challenge his findings. They might say he had looked at only a small part of the situation and had seen only a limited "truth." They might, for example, suggest that other vendors had already discovered the widespread need for scopes.

For such carping, Jack was always ready. His engineers were being negative; they'd never get ahead with such negative thinking. They clearly needed the advantage of his forward thinking and, with it, some of his guidance on superior, innovative thought processes.

On more than one occasion Jack's projects were disasters. His engineers might develop a fine scope, for example, perhaps the best they could make with CRTs they could buy. But customers would stay away in droves.

The conclusion? Somebody had blundered—probably one of Jack's engineers. It couldn't have been Jack. He was always right.



RECOGNIZED BY
AMERICAN REVOLUTION
BICENTENNIAL
ADMINISTRATION

ELECTRONIC DESIGN[®] is deeply honored to have received official recognition as a participant in the American Revolution Bicentennial Celebration, with authority to display the Bicentennial Symbol.

A handwritten signature in cursive script, appearing to read "George Rostky".

GEORGE ROSTKY
Editor-in-Chief

All the people who bought our DUMB TERMINAL (the ADM-3) because of its low \$995* unit price didn't really expect a lot. But they hadn't counted on the 32 switches. Switches that let you turn the DUMB TERMINAL into a pretty clever animal.

Take the 20 switches under the LSI name plate, for example. Among them, 11 communication rate positive action switches that let you select bauds from 19200 to 75. Also an RS232 interface extension port switch. It allows you to connect the DUMB TERMINAL to all kinds of clever devices — to recorders, printers and smarter terminals. And switches for odd-even parity. Optional upper and lower case (the complete set of 128 USASCII characters) — plus a lot more.

Inside on the PC board, 12 more switches. More positive action types that instruct the DUMB TERMINAL how to behave. And for all those who bought the 24-line optional display, there's a switch to change over from the standard 12-line format. So instead of showing 960 standard characters in 12 rows, you have the option of displaying 1920

The 32 Switches

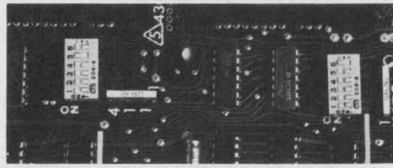

The 12 switches in the rear, on the PC board.

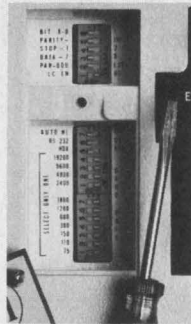

The 20 switches under the front name plate.

characters in 24 rows of 80 letters. And there are still more switches that make your terminal a cinch to operate.

Now people aren't sure what turns them on: the low price, the 32 switches, or the DUMB TERMINAL's standard features. Features like a full 12" diagonal screen. 59 data entry keys, arranged like on a typewriter. Compatibility with all popular computers. Simple, quiet operation. An optional numeric key pad. And fast data throughput. All features that make this terminal a perfect video replacement for the old teletypewriter.

The fact is, people keep finding more and more jobs for our DUMB TERMINAL. Because they can do anything within reason — with just a little switching and training. And that's why the DUMB TERMINAL really turns out to be a smart buy. Which may be the biggest switch of them all.

For full information, write: Lear Siegler, Inc., E. I. D./ Data Products, 714 N. Brookhurst St., Anaheim, CA 92803; Tel. (714) 774-1010.



**DUMB TERMINAL.
SMART BUY.**

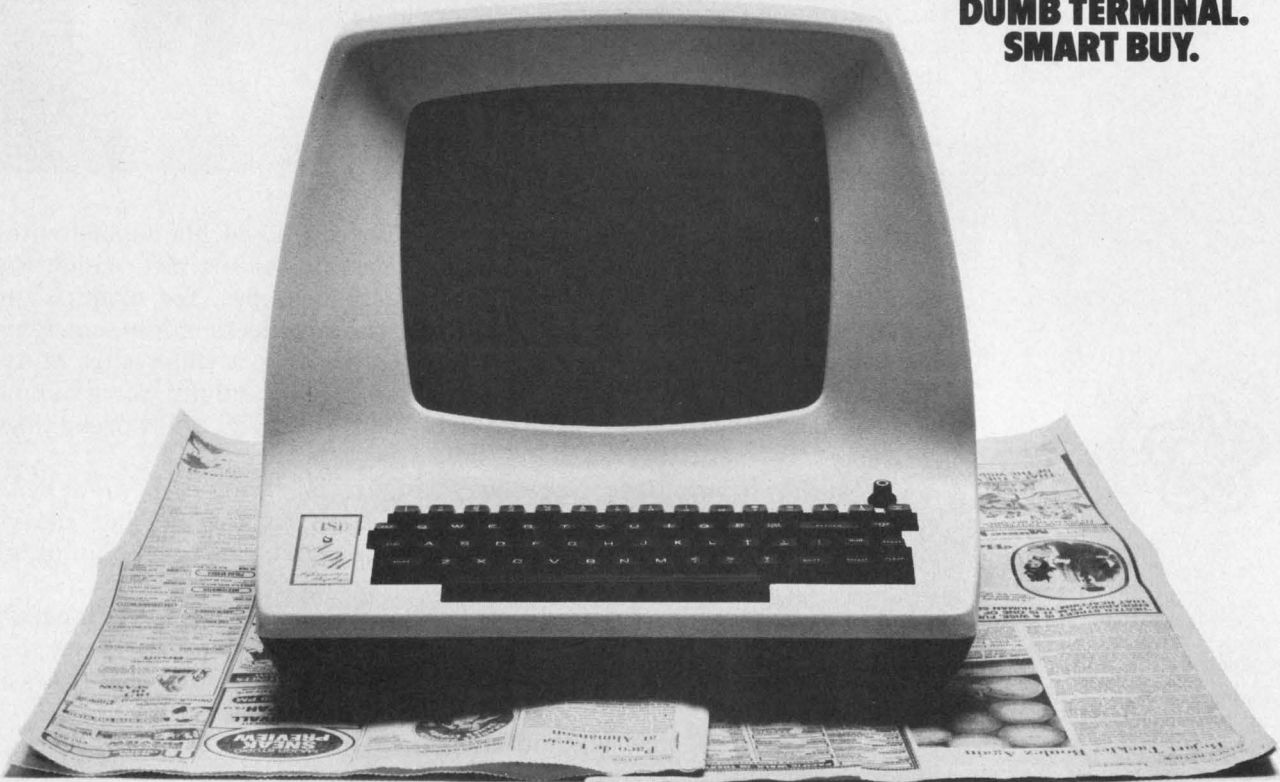

*U.S. domestic price

**THE \$995 DUMB
TERMINAL CAN BE TRAINED
TO DO PRACTICALLY
ANYTHING.**

BME™ Capacitors- Proven Reliability For Automotive Applications

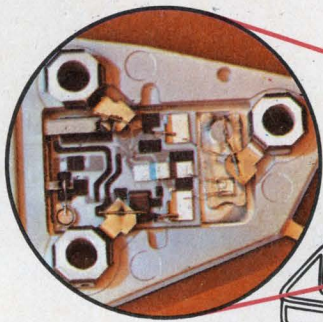

Voltage Regulators

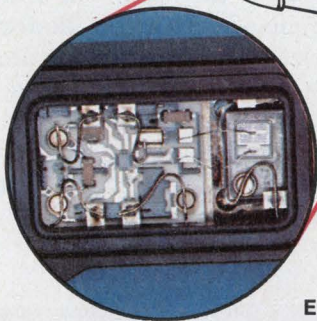
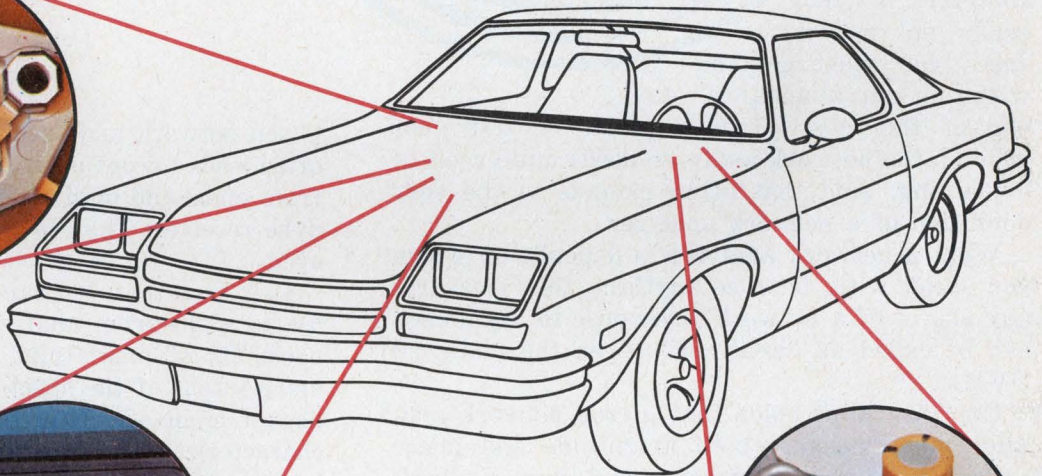

Electronic Ignition Systems

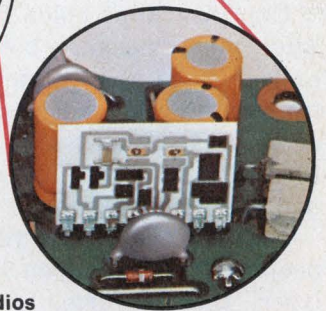

Radios

USCC/Centralab, the major supplier of monolithic ceramic capacitors to the largest manufacturers of automotive hybrid electronics.

The automotive environment can be considered the ultimate proving ground for component reliability. Under-the-hood systems provide a hostile environment where moisture, temperature extremes, shock and vibration are constant. It is a tremendous challenge to supply a component economical enough for an automotive application which can stand up to their rigorous specifications.

And Centralab is there, providing over 3.9 million BME-Chip™ Capacitors which are in 2.25 million domestic cars and light trucks. Over 11 billion unit life hours in ignition systems, voltage regulators and radios, without a single known failure. That's reliability! Compare your requirements with those of the automotive industry. We're sure you'll choose BME™ Capacitors . . . reliability and availability at a low cost.

Please write on company letterhead for complete technical test reports.



USCC/CENTRALAB Electronics • GLOBE-UNION INC.

4561 Colorado Boulevard • Los Angeles, Ca. 90039 • (213) 240-4880

FOR LITERATURE ONLY CIRCLE 251

FOR FREE SAMPLE, CIRCLE 252

Focus on Network Analyzers

In evaluating network analyzers, it's generally not a lack of specs you must contend with but an abundance. As

one of the most complex pieces of test gear around, the network analyzer needs quite a bit of explaining. And that often extends to the very definition of a network analyzer.

What a network analyzer is depends on whom you speak with, because anything that measures any aspect of a network's response to a stimulus can be called an "analyzer"—even the plain old DVM.

One viewpoint holds that a true network analyzer must measure both magnitude and phase and must be able to measure and display simultaneously both transmission and reflection characteristics. Others affix the label to equipment that can show just magnitude or that can measure only transmission.

Not surprisingly, you may find that the people you ask happen to manufacture an "analyzer" that conforms to their viewpoint.

Other equipment that loosely bears the title of network analyzer includes vector or phase-sensitive voltmeters; communications-link analyzers; data-link monitors that check data-comm networks for bit-error rate, bias distortion and other specs; tracking filters; and servomechanism analyzers.

Look alikes may not act alike

Whatever a network analyzer is, it's generally agreed that there are some things a network analyzer isn't: for instance, it's not a spectrum, wave or distortion analyzer.

Although the difference may seem rather obvious, there are some functional similarities be-

tween network and spectrum analyzers, and that often leads to confusion. Both analyzers use tuned front ends, and both are variations of the heterodyne receiver. The resemblance ends there, however.

It is true that you can add a tracking generator to a spectrum analyzer to make some measurements of magnitude. But that isn't the primary intent of the spectrum analyzer. Similarly, design trade-offs between distortion and phase characteristics in the network analyzer practically ensure that it will make a poor spectrum analyzer.

Thus the first question you should ask in analyzer selection is not: Spectrum or network? Rather ask: Which network analyzer? That



Add an S-parameter test set to a network analyzer and you can measure transistor forward and reverse gains or input/output impedances (Hewlett-Packard).

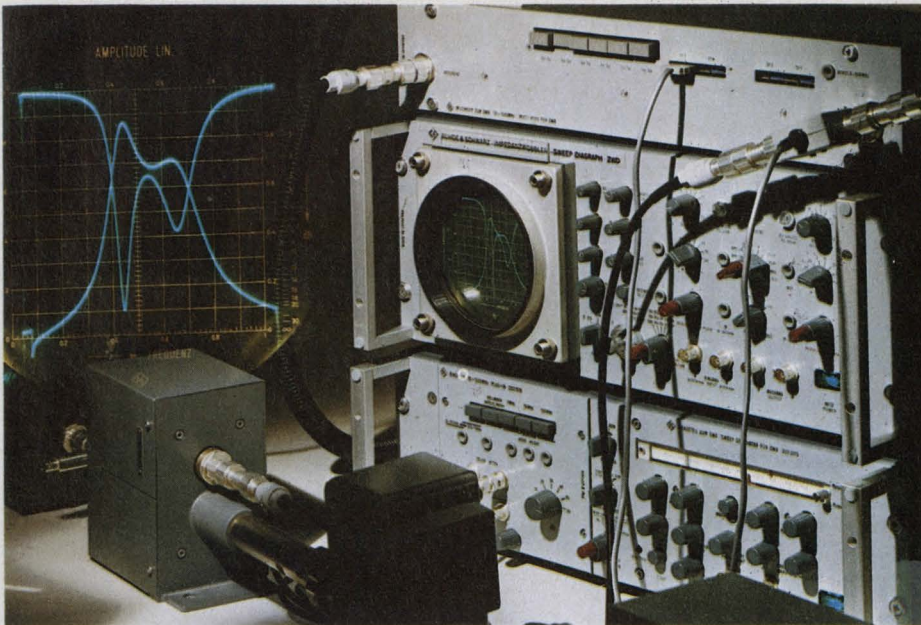

Exchangeable directional couplers provide a choice of three characteristic impedances, 50, 60 or 75 Ω , in the Rohde & Schwarz ZWD Sweep Diagraph. Crystal-controlled markers in the ZWD, with spacings of 1, 10 and 100 MHz, determine particular frequencies on the displayed curve.

question often boils down to: Do I really need phase information?

There's no question as to the usefulness of phase measurements. In many cases, knowledge of phase is a necessity. But the price of making complex (vector) measurements rings up as a steep cost differential—up to six to one over scalar units.

Where will you need phase? In general, if the performance of the circuit under test is phase sensitive; if phase response and magnitude response interact; if you must characterize phase variations with frequency (as in a filter); if phase is more sensitive than magnitude to changes in frequency (as phase often is at resonance)—then consider a vector analyzer.

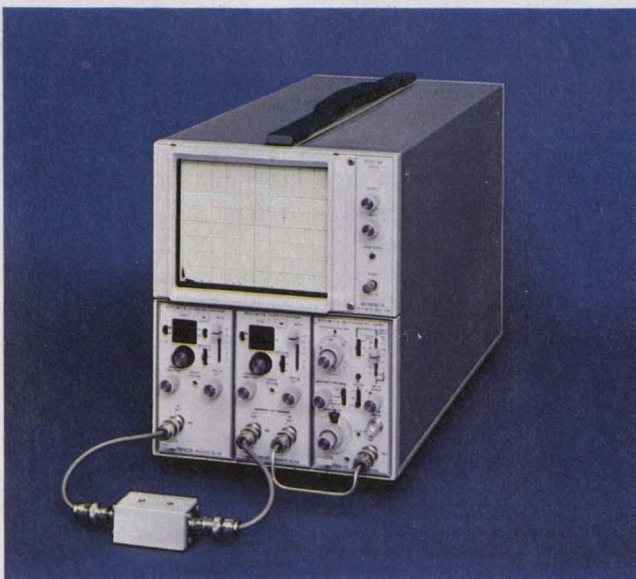

Simultaneous reflection and transmission measurements are possible up to 1500 MHz with this instrument from Wiltron. A 4 x 5-in. display shows frequency response.

A further implication of phase and magnitude interaction is the requirement for an analyzer with two measurement channels. With two channels you can simultaneously view phase and magnitude or transmission and reflection, and you can observe interactions while you tweak, tune or adjust the circuit under test.

Also, having two channels lets you look at both outputs of a diplexer as you adjust, lets you compare two devices or measure one device against a calibration standard.

Group 'therapy' reduces distortion

You might be interested in measuring group delay, a quantity related to phase. Sometimes called differential time delay or envelope delay, group delay is defined as the change in phase with frequency, $d\phi/d\omega$. It represents the relative delays of signals of different frequencies as the signals pass through a circuit.

Ideally, you'd like the relative delays to be zero, so that an original waveform will be reconstructed without distortion at an output. Of course, practical circuits exhibit some group delay. Just how much delay tells you what to expect in the way of, say, a network's pulse response or the color-reproduction quality of a TV i-f strip.

Although you can plot group delay on a point-by-point basis using a vector voltmeter or phase-meter, it is a tedious process. With the network analyzers that offer group delay, all you do is push a button or flip a few switches to display the delay as a function of frequency.

As you can with other network analyzer measurements, you can make adjustments while you watch. Consequently, you can tune a device for either constant delay or flat phase response.

Obviously, only you can judge your need for

phase or group-delay measurements. But one vendor—who doesn't offer those features—states that magnitude-only will satisfy 80% of network analyzer applications.

No matter what characteristics you elect to measure, one question will be uppermost in your mind: How well can I measure?

To tell the truth

When you spend up to \$25,000 for a network analyzer, you'd like to know a few things about what you're getting for your money. Like how much accuracy you can get, how much resolution, and how much sensitivity. The questions come easy. The answers don't.

The basic problem in pinning down a key spec like accuracy is that generally there's no one-number label that will do the job. In making transmission measurements, for example, up to six possible error sources can creep into your test setup to nibble away at accuracy.

What accuracy (really inaccuracy) you'll get depends on a number of things besides the accuracy of the basic analyzer itself: the kind of measurement (reflection or transmission), how well the device under test is matched to the source and detector, and what errors are contributed by external gear—power splitters, directional couplers, pads, terminations, transformers, and the like. And those factors aren't all.

Some vendors try to help by providing extensive data on all possible error terms, by offering error-analysis and interpretation techniques and by supporting applications with notes, seminars and technical papers. Other vendors lean on a far simpler solution—they just ignore the situation.

Sometimes "forgotten" is the fact that accuracy can deteriorate over the full dynamic or frequency range or in the presence of signal distortion. Signal amplitude, distortion and frequency can all team up to tear a hefty chunk out of accuracy.

Getting back to the source

Other memory lapses occur, perhaps provoked by the excitement of competitive skirmishes. Never mentioned, for instance, is the substantial role played by the source (usually a sweep generator), and how frequency stability, spurious responses, noise and other "garbage" in the source affect performance.

Often, the source is not integrated into the analyzer, but stands alone. In such a case you might decide to use an existing sweeper. If you do, you've got the responsibility for determining how clean the sweep is and how the measurement is affected.

At the very least the vendor should tell you

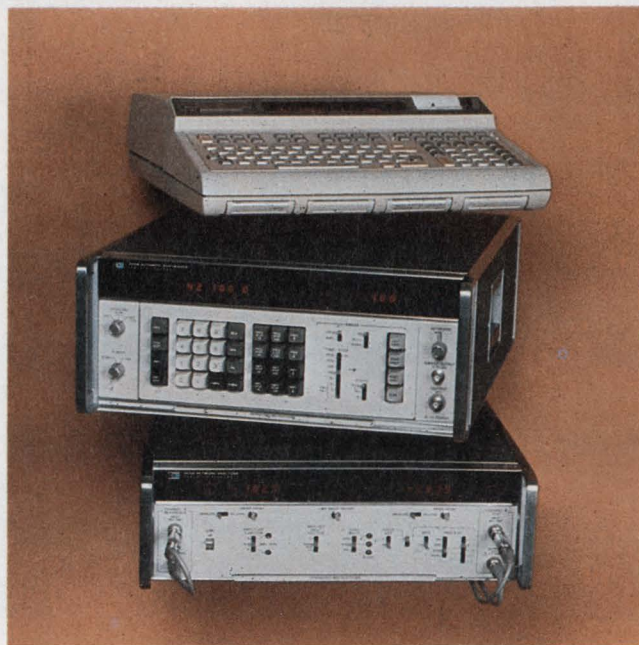

Calculator control of an analyzer enables a system to do more than just collect raw data. Applications programs can manipulate, calibrate and enhance accuracy. The system shown is the HP 3042A.

how well his equipment performs in the presence of harmonics and noise. Then you can "add up" all the individual errors in some manner to get an over-all number. Note: Every component must be considered as a possible error source.

When you are given an accuracy spec, be cautious. If the number is stated in decibels, remember that a seemingly small dB change can translate to a sizable swing when measured in volts.

Don't overlook the importance of high directivity in directional couplers to reduce errors in reflection measurements. To measure a standing-wave ratio (SWR) of 1.2 with ± 1 -dB accuracy, you'll need a directivity of 40 dB.

To keep mismatch errors down, look for source and detector matches of at least 20 dB, and preferably 30 dB.

You can squeeze better performance out of some analyzers by using a storage unit, calculator or computer to correct, compensate or subtract certain fixed errors.

You may well wonder how an analyzer's data sheet can shout a basic accuracy of 0.01 dB (or a resolution of 0.005 dB) on page one, yet quietly list on another page a magnitude or frequency-response error of ± 0.2 dB.

Smooth those troubles

Frequency-response error generally refers to a ripple in flatness caused by small mismatches within a system. You can get the lower spec of 0.01 dB all right. But you'll have to buy an optional error compensator to iron out the ripples.

(Bear in mind that external connectors can upset flatness to a greater extent than small internal mismatches.)

Fortunately, you can check out the response error and other important areas. For response, set the analyzer to its highest resolution to "magnify" the display. To verify accuracy or resolution, use traceable calibration standards—variable attenuators, and air lines to calibrate phase or absolute group delay.

One caution. In evaluating analyzers, be sure you don't confuse accuracy with resolution, a favorite trick of some vendors who try to blur true performance.

Source headaches—in stability, noise, spurious signals—can be spotted (maybe) with a spectrum analyzer.

Noise together with crosstalk (leakage between channels) limits dynamic range, another important analyzer spec. A wide dynamic range is desirable, for instance, to show filter reject bands and to measure isolation, crosstalk and attenuation.

The lower limit of the dynamic range—the measurement floor—is blurred by noise and crosstalk; the upper limit by the nonlinearities of overdriven stages. You can limit noise by narrowing bandwidth, but at the sacrifice of speed. Leakage isn't easy to keep out, requiring such measures as good shielding, or special rf connectors.

When you look into dynamic range, watch for statements like "displayed dynamic range," "rated range," and "over-all range." What they mean is that the instrument can't accommodate the entire range at once on the screen. To see across the range, you have to use switching or some substitution technique. The extra trouble may not faze you . . . if you know about it in advance.

Another aspect of dynamic range is how well the system measures phase or group delay under

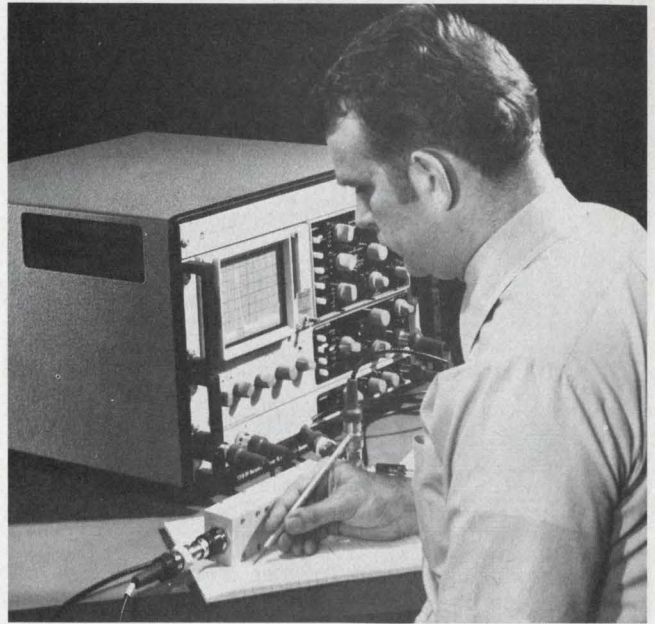

Push a button and see group delay displayed as a function of frequency in GenRad's 1710 rf network analyzer. The unit shows absolute levels.

various amounts of attenuation. It's tough to get accurate phase measurements with 100 dB of attenuation, but below about 50 or 60 dB, you can expect good results.

You can verify dynamic range by continuously adding attenuation while checking the response on the display.

Sometimes, being narrow is better

In general, greater dynamic range is achieved by going to a narrow-band system, an arrangement that also brings immunity to source harmonics, and provides greater resolution and other advantages over broad-band equipment.

If you're working with narrow-band devices—crystals, crystal filters and the like—you'll need

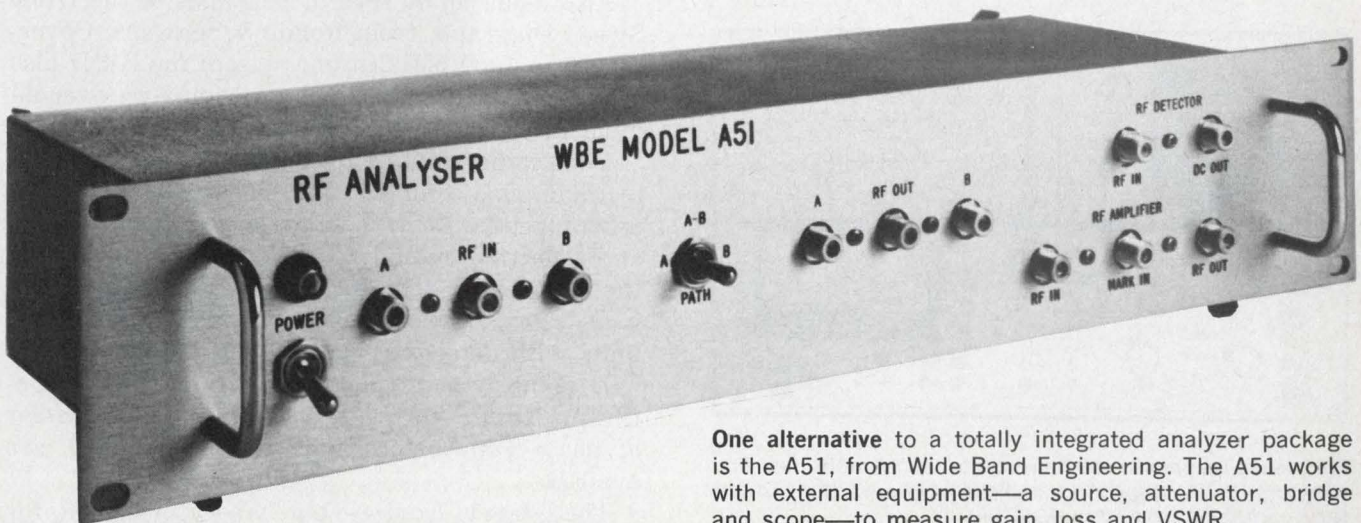

One alternative to a totally integrated analyzer package is the A51, from Wide Band Engineering. The A51 works with external equipment—a source, attenuator, bridge and scope—to measure gain, loss and VSWR.

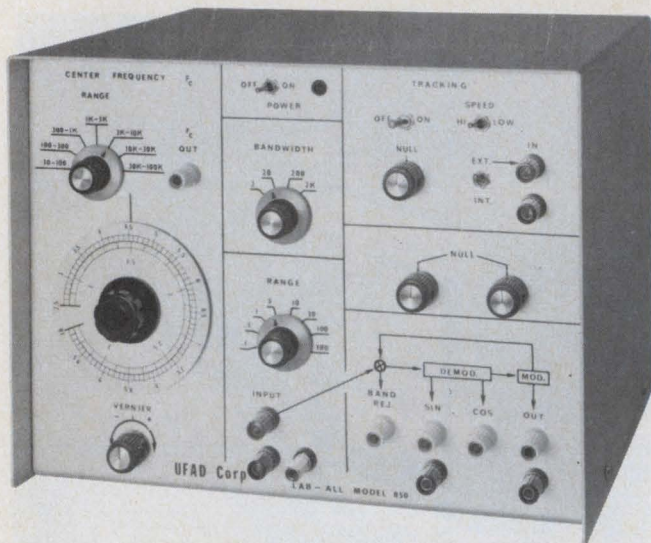

Besides producing network-transfer Nyquist plots on an external scope, the LAB-ALL functions as 10 or 11 other test instruments (UFAD Corp.).

test equipment with adequate signal purity and frequency stability. Most conventional sweepers can't meet these requirements. Only top-flight units or frequency synthesizers can do the job.

To resolve details requires a narrow bandwidth. But usually, the narrower the bandwidth, the slower you must sweep. The limitation results from the response time of the filters built into the analyzer.

Other points to keep in mind:

- Analyzers are linear instruments, designed for small-signal testing. Operation in a nonlinear region (large signals) will likely give unreliable results.
- Reflection measurements may be just as important as those for transmission.
- Accessories and options can eat into speed, accuracy or other basic specs.
- Most analyzers are ratio devices, that is, the analyzer compares the test-channel signal with a signal on a reference channel.

Again, the source can be a major trouble spot.

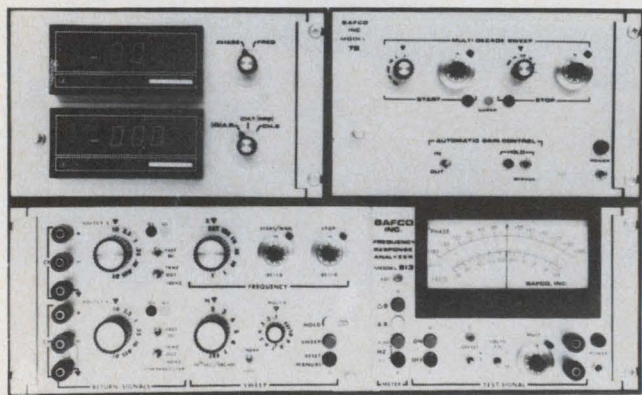

Frequency-response measurements of amplitude and phase shift in a feedback-control system are the forte of Bafco's Model 913/72 analyzer.

Take care to look over those specs that spell out signal purity and stability.

After you've sorted out the specs, what else should you look for in a network analyzer? Features, options and capabilities in analyzers are almost as diverse as those in the automotive industry.

Getting it all together

You might look for a unit that's totally integrated, with the stimulus, receiver or detector, display and all other necessary circuitry built in.

One such unit is Hewlett-Packard's 8505A, a 500 kHz-to-1.3-GHz analyzer with 100-dB of displayed dynamic range and a built-in 1.3-GHz counter that operates while the source sweeps. Along with the CRT, digital displays read out the measured parameters. A top-of-the-line analyzer like the 8505A doesn't come cheap. It will cost you about \$25,000.

Or you can start with a basic core—like the A51 from Wide Band Engineering—and surround the core with individual signal generators, bridges, oscilloscopes and other building blocks to form a complete analyzer.

The A51 provides 1-to-500-MHz swept or single-frequency measurements of gain, loss and VSWR on 50 and 75- Ω systems.

Somewhere between the "all-under-one-roof" and totally-individual-components approaches, you'll find semi-integrated packages, with perhaps the tracking receiver and display in one cabinet, the sweep generator in another, and so on.

GenRad's 1710 RF analyzer (to 500 MHz), for one, is composed of three or four 19-in. units in its basic form, and it measures the magnitude and phase of two signals relative to a reference. Thus you can make simultaneous transmission and reflection measurements with the 1710.

Basic price of the 1710 is \$9700. The group-delay option costs \$495, and the polar option another \$150.

Also made up of several packages is the ZWD Sweep Diagraph, from Rohde & Schwarz. Covering 10 to 1000 MHz in one sweep, the ZWD also offers two independent channels plus an over-all dynamic range of 120 dB (90 dB displayed).

Yet another way to go in analyzers is the plug-in route. One example: Wiltron's 640, a recently unwrapped system that measures transmission and reflection from 1 to 1500 MHz. Plug-ins for the 640—which sells for under \$4000 complete—include a sweeper and transmission/reflection units with detectors, bridges and log converters.

If point-by-point plotting—rather than a continuous sweep—is all you need, then a number of phase/gain meters, with digital displays, are available.

The Dranetz Engineering Laboratories 305, for



Digital readout of gain, phase and amplitude mark the Series 305, from Dranetz Engineering Laboratories. The autoranging unit works to 700 MHz.

example, digitally reads out gain and phase shift from 5 Hz to 700 kHz with the 305's PA-3009 plug-in. Besides several nice features, like autoranging and autocalibration, the 305 offers high phase accuracy— ± 0.1 degrees to 50 kHz.

Phase/gain meters, or vector voltmeters, are also marketed by HP, North Atlantic Industries and others.

Not quite a gain/phase meter, or a network analyzer for that matter, is an instrument called the LAB-ALL, built by UFAD Corp. Actually a multifunction instrument (12-in-one, says UFAD), the LAB-ALL (model 850) can, among other things, produce a Nyquist plot on an external oscilloscope.

The 850 rejects both even and odd harmonics to the tune of 55 dB, and offers $\pm 1\%$ phase accuracy, $\pm 2\%$ amplitude accuracy, from 30 Hz to 100 kHz.

Making things better

Accuracy, of course, is what you're after in a network analyzer. One way to enhance accuracy is to buy a programmable analyzer and store correction data in a calculator or computer.

HP's 3042A system does just that via the HP Interface Bus (HP-IB). With additional hardware, calculator enhancement routines can upgrade accuracy to 0.01 dB over 100 Hz to 10 MHz. The calculator can also manipulate data, make decisions based on test results and control other instruments at the same time.

Automatic analysis with a fast switching, synthesizer-based system is yet another option. One example is the GenRad 2261. Intended primarily for precision narrow-band measurements, the 2261 lets you work in frequency increments as narrow as 0.1 Hz.

A frequency programmer—rather than a calculator or computer—is used to enter sweep data in the GR unit.

Network analysis today extends into the microwave region. Microwave buffs will find the selection rather limited, however, because HP's 40-

GHz 8410B is virtually the only unit available that works at such lofty frequencies. With it, you can plot both magnitude and phase above 18 GHz, in coaxial and cable waveguides. And you can measure the S-parameters of microwave semiconductors.

Other commercial analyzers also offer attachments, or test sets, for S parameters and other capabilities. A sampling: calibration kits, biasing of active devices, polar displays (nice to have, but they offer less resolution than the rectilinear display), impedance attachments for non 50 or 75- Ω systems, Smith-Chart overlays.

Note that these and other features can be standard, optional or a mixture of both, depending on the unit. The price, of course, can soar when all options are added. The performance, unfortunately, can plunge when you add an option . . . and the spec sheet may not tell you. You'll have to ask. ■■

Need more information?

The products cited in this report don't represent the manufacturers' full lines. For additional details, circle the appropriate number on the Reader Service Card. For data sheets and more vendors, consult ELECTRONIC DESIGN's GOLD BOOK.

- Bafco, Inc., 717 Mearns Rd., Warminster, PA 18974. (215) 674-1700. **Circle No. 501**
- Dranetz Engineering Laboratories, Inc., 2385 South Clinton Ave., South Plainfield, NJ 07080. (201) 755-7080. (A. Ackerman). **Circle No. 502**
- EG & G Inc., Ortec Inc., 100 Midland Rd., Oak Ridge, TN 37830. (615) 482-4411. **Circle No. 503**
- EMR-Telemetry, P.O. Box 3041, Sarasota, FL 33578. (813) 371-0811. **Circle No. 504**
- Elsytec Div. of Compata Inc., 6150 Canoga Ave., Woodland Hills, CA 91364. ((213) 884-5200. **Circle No. 505**
- Frequency Engineering Labs, P. O. Box 527, Farmingdale, NJ 07727. (201) 938-9221. **Circle No. 506**
- GenRad, 300 Baker Ave., Concord, MA 01742. (617) 369-4400. (R. L. Moynihan). **Circle No. 507**
- Gulton Ind. Inc., Engineered Magnetics Div., 13041 Cerise Ave., Hawthorne, CA 90250. (213) 679-0111. **Circle No. 508**
- Hewlett-Packard, 1501 Page Mill Rd., Palo Alto, CA 94304. (415) 493-1501. **INQUIRE DIRECT**
- Hughes Aircraft Co., P.O. Box 92996 Los Angeles, CA 90009. (213) 670-1515. (Joe Jelinek). **Circle No. 510**
- Nationwide Electronics System Inc., 1536 Brandy Pkwy., Streamwood, IL 60103. (312) 289-8820. **Circle No. 511**
- NH Research Inc., 1510 S. Lyon St., Santa Ana, CA 92705. (714) 835-1616. **Circle No. 512**
- Quan-Tech Div., Scientific-Atlanta Inc., Randolph Pk. W, Rte. 10, Randolph Township, NJ 07801. (201) 361-3100. **Circle No. 513**
- Rohde & Schwarz, 14 Gloria Lane, Fairfield, NJ 07006. (201) 575-0750. (A. Freeland). **Circle No. 514**
- SE Labs (EMI) Ltd., North Feltham Trading Estate, Feltham, Middlesex TW14 0TD, England. **Circle No. 515**
- Siemens Corp., 186 Wood Ave. S., Iselin, NJ 08830. (201) 494-1000. **Circle No. 516**
- Sierra Electronics Operation Philco-Ford Corp., 3885 Bohannon Dr., Menlo Park, CA 94025. (415) 322-7222. **Circle No. 517**
- Singer Instrumentation, 5340 Alla Rd., Los Angeles, CA 90066. (213) 822-3061. **Circle No. 518**
- Spectral Dynamics Corp. of San Diego, 4255 Ruffin Rd., San Diego, CA 92123. (714) 565-8211. **Circle No. 519**
- UFAD Corp., 700 36th St., S. E., Grand Rapids, MI 49508. (616) 241-6000. (D. van Hartesveldt). **Circle No. 521**
- Vibration Instruments Co., 1614 Orangethorpe Way, Anaheim, CA 92801. (714) 879-6085. **Circle No. 522**
- Wide Band Engineering Co., Inc., P.O. Box 21652, Phoenix, AZ 85036. (602) 254-1570. (S. Ticknor). **Circle No. 524**
- Wiltron Co., 930 East Meadow Dr., Palo Alto, CA 94303. (415) 494-6666. (W. Baxter). **Circle No. 525**

CERBON™

TRIMMER RESISTORS

Affordable Stability

Centralab's new CERBON trimmers offer you stability approaching cermet at carbon prices... As little as 28¢ in distributor 1,000 quantities; as low as 10¢ in high volume orders.

Look at these performance

characteristics: • TCR less than -400 ppm/°C • CRV less than 2% of maximum resistance • Rotational life exceeds 500 cycles • Adjustability (typical) 0.05% of total voltage • High overload capability - 1 watt at 25°C ambient for 1,000 hours exhibits less than 2% cumulative resistance change • Maximum stability in humid environment - resistors exposed to an atmosphere of 40°C at 95% relative humidity for 300 hours return within four hours to +2.5% of their initial readings. Available now for delivery in any quantity. Write for technical data, or call (915) 779-3961 for a free evaluation sample.

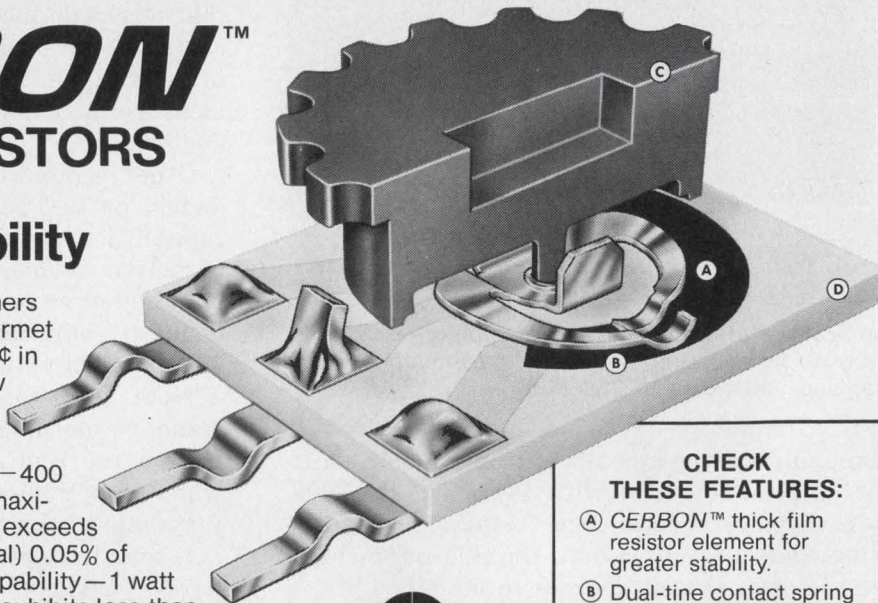

CHECK THESE FEATURES:

- Ⓐ CERBON™ thick film resistor element for greater stability.
- Ⓑ Dual-tine contact spring for low CRV and set-stability.
- Ⓒ Dust and solder protective thin-profile knob.
- Ⓓ Ceramic substrate resists solder flux; excellent thermal conductivity and dimensional stability.





CIRCLE NUMBER 26

Plan Now to Attend

The All-New
Electro/Optics/Laser
CONFERENCE & EXPOSITION

September 14-16, 1976 • New York Hilton

- Sponsored by Electro-Optical Systems Design Magazine
- Official Conference  Laser Institute of America
- Cooperating Societies  

The Largest Conference Program
in the E-O/Laser Industry

Over 150 Papers!

Learn the latest advances in E-O/Laser design and applications from the nation's top experts

The Largest Exhibition in the
E-O/Laser Industry in 5 Years

Over 150 Displays!

See the newest E-O/Laser components, subsystems, hardware, materials and test instruments displayed and demonstrated by leading manufacturers

MAIL TO: Donna Jernigan
INDUSTRIAL & SCIENTIFIC CONFERENCE MANAGEMENT, INC.
222 West Adams Street
Chicago, Illinois 60606 (Phone 312 - 263-4866)

I'm interested in
ATTENDING

Send complimentary ticket for FREE
ADMISSION TO EXHIBITS plus full
information on Conference Program

I'm interested in
EXHIBITING

Send complete details includ-
ing floor plan of exhibition hall

NAME _____
TITLE _____
COMPANY _____
ADDRESS _____
CITY/STATE/ZIP _____
PHONE _____
OUR BUSINESS _____ ED

CIRCLE NUMBER 27



Three times actual size.

New high ripple performance THF capacitors. One replaces up to four CSR types.

Here's a family of small, solid-tantalum capacitors with a per-unit substitution factor as high as one for four. To give you savings all the way in space, weight and cost.

Mallory THFs are specially designed for low impedance to ripple current at frequencies above 1kHz through 100kHz. Which makes them ideal for high-frequency power supply switching, or for regulator switching. Or for bypassing or filtering unwanted ripple currents.

ESR is low, so power losses are low. With the solid electrolyte and hermetic seal, long life is inherent. And electrical characteristics are very stable over a temperature range of -80°C through 125°C .

Mallory THF Spirit of '76 Capacitors come in a wide range of ratings; 5.6 to $330\mu\text{F}$, 6 to 50VDC. They're the result of our engineering program that's producing new high-performance types at less cost to you. Just ask your Mallory representative.

MALLORY

MALLORY CAPACITOR COMPANY

a division of P. R. MALLORY & CO. INC.

Box 372, Indianapolis, Indiana 46206; Telephone: 317-636-5353

Electrical and Electronic Components • Timing Devices and Motors • Metallurgical Products • Batteries

CIRCLE NUMBER 28

Put microprocessor software to work

by taking advantage of different addressing modes.

Here are the basics of how these modes function.

Get the most out of your microprocessor-based system by using the optimum addressing mode for each program step. Different addressing techniques—indexed, indirect, relative, paged and others—originally developed for use in large computers, can be used in μ P systems.

But beware—even though the technique may have the same name as in larger computers, the internal procedure performed by the μ P may be different. The short word lengths used in most μ P systems make it difficult to handle addresses. Common processors such as the 8080, 6800, F-8, PPS-8, CDP1802 or 2650 all have word lengths of only 8 bits, though some of these μ Ps simplify addressing by using 16-bit address busses.

Eight-bit busses are fine for handling 4-bit binary-coded decimal and 8-bit ASCII or EBCDIC characters, but they are not adequate for a viable memory address bus. A typical 8-bit μ P, when using direct addressing, needs three memory cycles to get the instruction and address into the processor. Only in the fourth cycle does the μ P actually do any useful work (Fig. 1). About 75 percent of all central processor (CPU) time is spent on overhead functions.

Know the different addressing modes

Obviously, a better way than simple direct addressing is needed. With an 8-bit μ P, the fewer 16-bit addresses you transfer, the more CPU time and memory space you save. For fixed-program applications, a ROM that holds the operating program would be the simplest solution. However, you cannot store subroutine return addresses in the ROM or modify its program instructions.

Data cannot be stored with the program either; temporary data must be placed in a separate part of memory. That also restricts the movement of the program and data in the memory unless special provisions have been made beforehand.

The limited chip size of μ Ps keeps the number of registers, busses and other elements minimal. Many signals may have to be generated external-

ly, thus adding to the system cost. Let's take a hard look at the different addressing methods to see how they can increase or decrease the complexity of the system.

Indexing is one of the most commonly used addressing modes. With this technique, the contents of the index register are added to the address supplied with the instruction (Fig. 2). The sum of the two is called the effective address, and is used to fetch the data.

The indexed instruction shown in Fig. 2 is Load Accumulator 300, X. (The , X indicates that indexed addressing is to be used.) If the index register contains the number 15, the indexed instruction has the same effect as a Load Accumulator 315 instruction. The contents of location 315 are fetched and placed in the accumulator. However, we can change the effective address of the indexed Load instruction by altering the contents of the index register. A Load Accumulator 315 instruction, though, is frozen for the life of the program.

Processing of data stored in arrays or tables is the usual application of indexed addressing. An entire array of data can be processed or moved with a simple program, just by starting the index register at a base number and incrementing it each time the program cycles through (Fig. 3a and 3b). Inside the program, indexed addressing is used to get the data. The address supplied with the instruction is the base address of the data stack. Indexing saves program memory space and adds flexibility. When you're only using one element at a time, though, indexing slightly slows down the program since you must add several instructions to increment the index register.

On the other hand, if several elements of an array are used each time the program cycles, indexing can speed things along. All the elements can be accessed just by changing the address that accompanies the instruction. Thus, each time the program cycles, the next six data elements can be accessed with the addresses:

BASE, X
BASE + 1, X

BASE + 5, X.

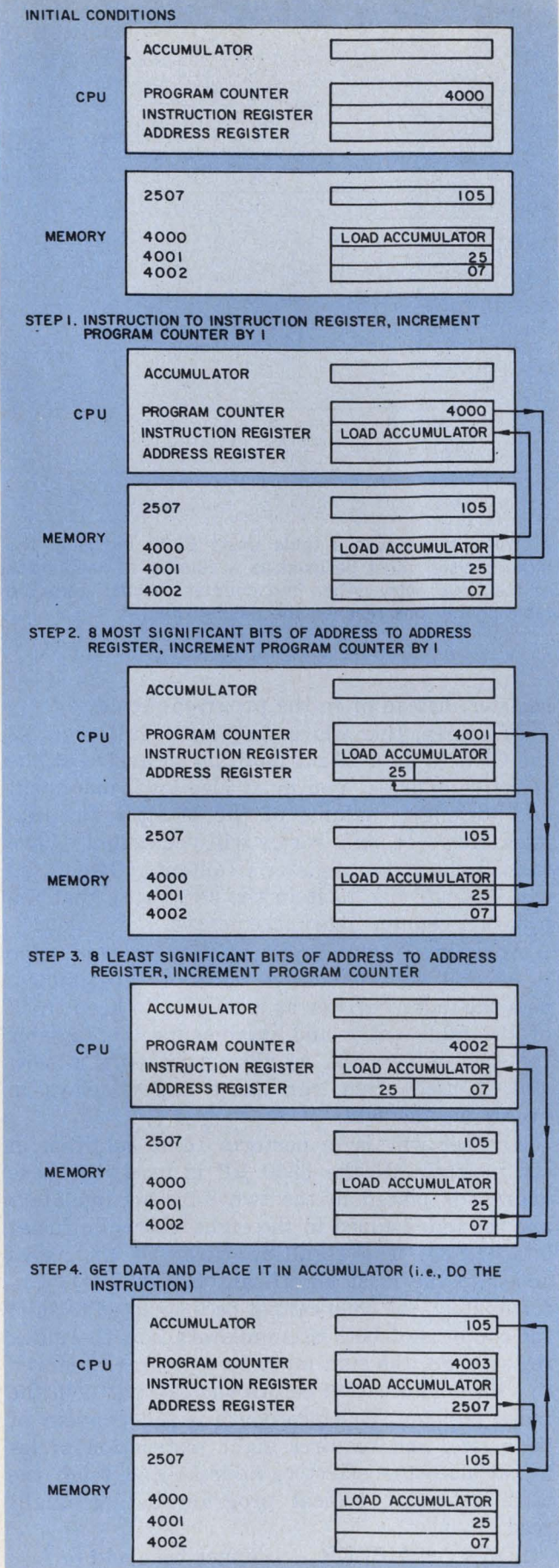

1. A simple instruction cycle, performed on an 8-bit μ P, requires four memory cycles if data must be fetched from memory. Three cycles are needed to get the instruction and data address and one cycle to actually do any processing.

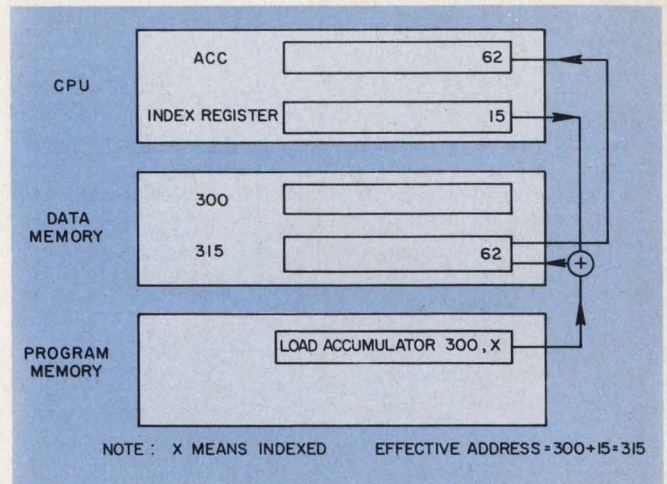

2. Getting information by indexing cuts the number of memory cycles needed by the processor, but slows down processing since the contents of the index register are added to the address supplied with the instruction.

For applications that require sorting, searching and editing, this accessing feature is very useful.

Several data arrays can be processed simultaneously if they are similarly structured. For instance, if one array contains names, one contains addresses and another contains Social Security numbers, once you locate a name you also have the location of all of the other data in the accompanying arrays.

Table access is simplified

When indexed addressing is applied to tables, you can simplify any look-up routines considerably. All that has to be done is to put the number of the desired element into the index register, then use the base address of the table as the fixed address.

The table of Fig. 3c shows how you can use a table to convert a number in the index register to a seven-segment code for display. The instruction—Load Accumulator 1000, X—does the conversion. The CPU obtains the seven-segment code from the effective address (1000 plus the decimal digit stored in the index register) and places it in the accumulator.

A microprocessor could do indexing in the same way as larger computers. However, the base address included in the instruction would have to be 16 bits long, and the CPU would have to perform a 16-bit addition of the base address and the index register. In an 8-bit CPU the arithmetic section would have to “double-up” to do the addition, thus slowing down the overall program.

Of course, you can save time and memory by limiting to 8 bits the address that is included with the instruction, and by using a 16-bit index register. The 6800 μ P does indexing that way, which is the reverse of normal indexing because the 16-bit base address is placed in the index

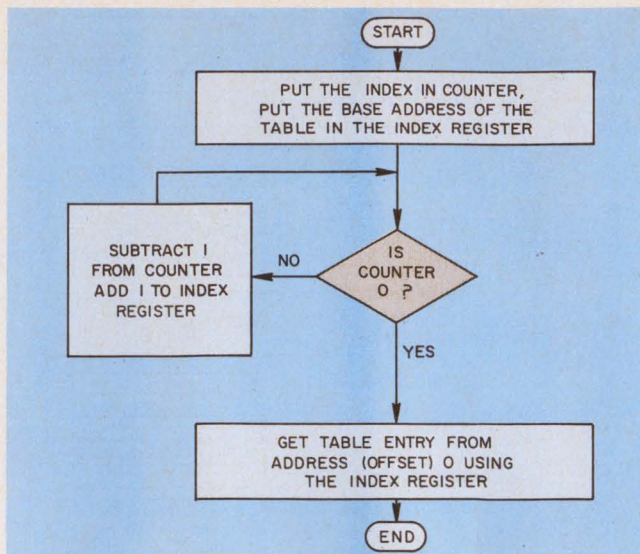
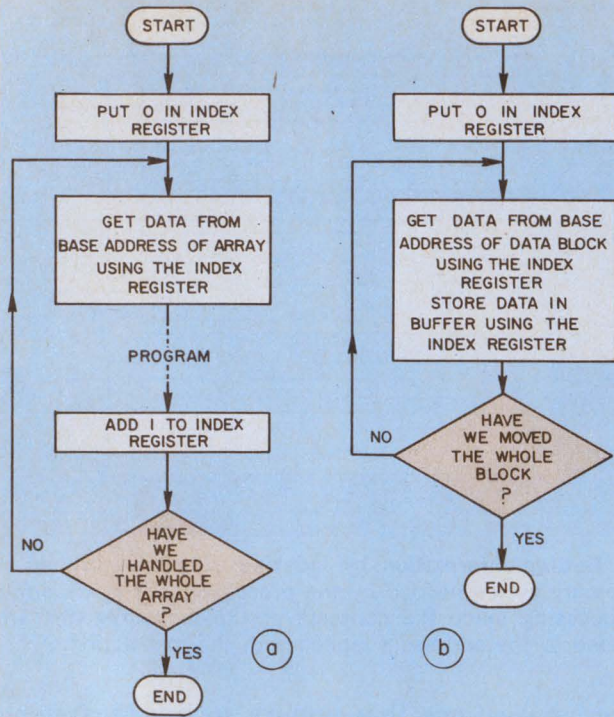

4. When you access a table using 6800 indexing, the index register must be used as a counter to keep track of the table entry. When the counter reaches zero the table pointer has reached the desired item.

USING INDEXING TO ACCESS A TABLE

INITIAL CONDITIONS

CPU	ACCUMULATOR	
	INDEX REGISTER	6

MEMORY

SEVEN-SEGMENT TABLE		
1000		3F
1001		06
1002		5B
1003		4F
1004		66
1005		6D
1006		7D
1007		07
1008		7F
1009		6F

NOTE: WE HAVE ORGANIZED THE SEVEN-SEGMENT TABLE WITH 0 IN THE MOST SIGNIFICANT BIT, FOLLOWED BY THE CODES FOR SEGMENTS G, F, E, D, C AND A; TABLE ENTRIES THUS CONSIST OF HEXADECIMAL DIGITS.

AFTER LOAD ACCUMULATOR 1000, X

CPU	ACCUMULATOR	7D
	INDEX REGISTER	6

MEMORY

1000		3F
1001		06
1002		5B
1003		4F
1004		66
1005		6D
1006		7D
1007		07
1008		7F
1009		6F

EFFECTIVE ADDRESS=1000+ CONTENTS OF INDEX REGISTER=1000+6=1006

3. You can easily use indexed addressing to process a data array (a), move data blocks from one area in memory to another (b) or to access a table for code conversion look-up (c).

register instead of in the program memory.

Of course, this addressing mode still requires the CPU to do a 16-bit addition to arrive at the effective address. You must also load, increment and store the contents of the 16-bit index register. However, only rarely will you actually have to load the index register's contents. Often, you can just add one to it in the same way that the program counter gets incremented.

Accessing a table to get an entry can be done in several different ways. One of the simplest uses the index register as a counter to keep track of the table entry and increments the register for each entry (Fig. 4). This procedure is slow and, if used often, can cause major delays in processing the data.

Another way is to perform 16-bit addition in the program. If the 6800 μ P is used, the base address is placed in the two 8-bit accumulators and the index added to the eight least-significant bits (LSB). The resulting carry, if any, gets added to the most significant bits (MSB). Unfortunately, the 6800 cannot be instructed to shift the contents of both accumulators into the index register. So, the sum must be temporarily stored in a memory location before you can put it in the index register. This procedure is independent of table size, and requires eight instruction cycles to calculate the effective address and fetch the table entry. A typical program listing might read:

```
LDAA # UPPER      upper base add to A
LDAB # LOWER      lower base add to B
ADDB INDEX        add index
ADCA # 0           and carry
STAB SUML         lower entry add.
STAA SUMU         upper entry add.
```

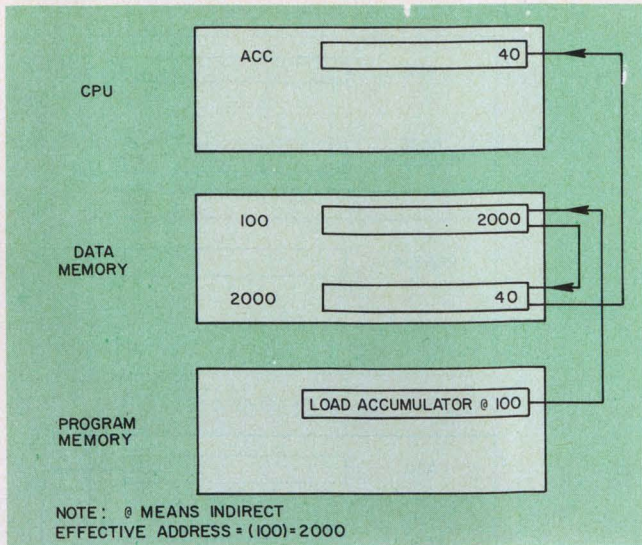
5. You can access the entire memory with indirect addressing but doing so can be confusing because the data byte or bytes fetched are used as the address of the actual data word.

```
LDX SUMU      get it to index reg.
LDAA X        get entry
```

Alternatively, you can set up the tables so that their starting addresses are always a multiple of 100 (hexadecimal). Then you can refer to any table by means of an 8-bit address. (An address of 4 means that the table starts at location 400 hex.) To get into the table, place the 8-bit table address in the eight MSBs of the index register and the 8-bit index in the eight LSBs of the index register.

In any of the methods just described, indexing is not really used to full advantage. The CPU does unnecessary 16-bit addition and time is lost for each indexing cycle that adds zero to the contents of the index register.

Get the addresses indirectly

If you can spare a memory cycle, indirect addressing can retrieve the full 64 kilobytes of available memory. When you use indirect addressing, the address supplied with the instruction is used to get the address of the data rather than the data itself (Fig. 5). The effective address is thus part of the data memory. Parentheses are used around an address to indicate that the contents of the location shown are what the CPU is after. Thus: ADDR is an address and (ADDR) represents the contents of that address.

Indirect addressing permits you to store a program in ROM, yet alter the contents of RAM locations called out from the ROM. Thus you can use the same instructions to process data anywhere in memory. All you do is put the starting address of the data into the RAM location specified by the program.

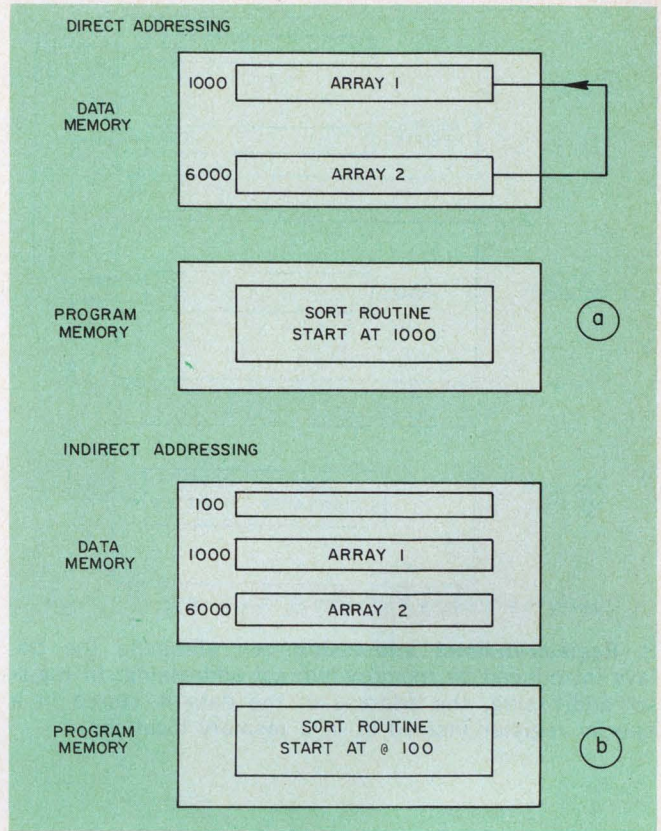

6. To do a sorting routine for an array that starts at an address other than that specified by the program, an extra program that first relocates the array must be included when direct addressing is used (a). Indirect addressing permits you to keep the program simple and start at any location (b).

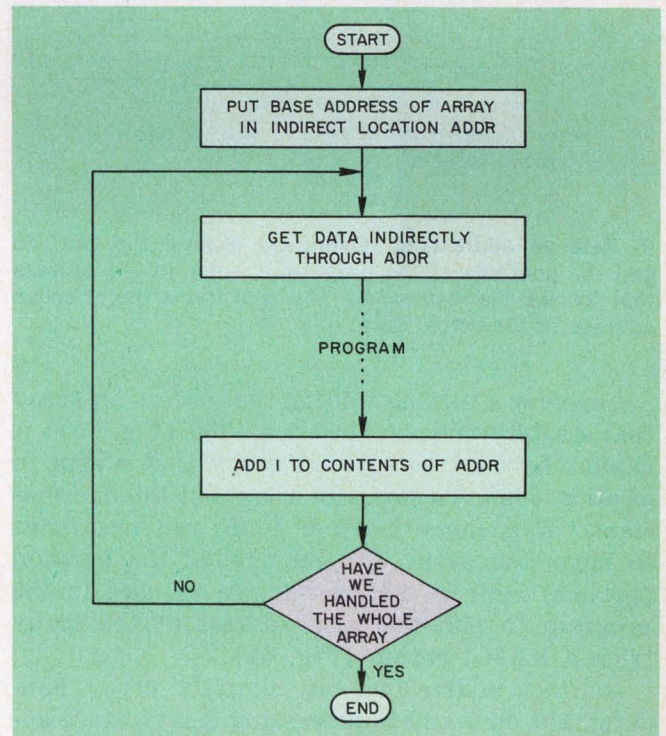

7. To process a data array, indirect addressing can be used, but it won't be the most efficient method because the memory must be accessed twice for each data word.

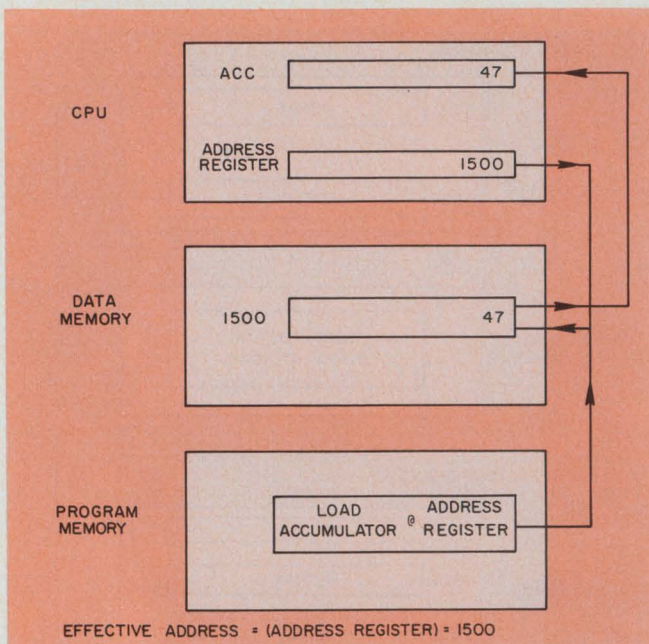

8. **Register-indirect addressing** can eliminate the delays introduced by memory-indirect addressing. In register addressing, the address of the data is stored in a special register instead of in a memory location.

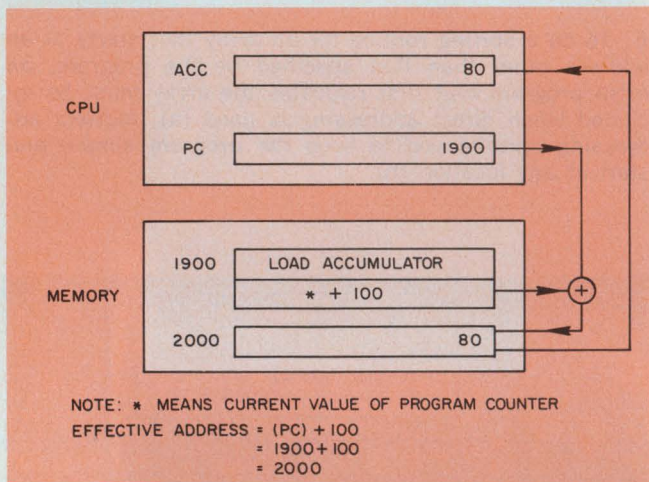

9. **Relative addressing techniques** require the CPU to add the contents of the program counter to the address that follows the instruction. The sum forms the effective address of the actual data.

Consider a sorting routine that orders an array that starts in memory location 1000 (Fig. 6a): it cannot be used to sort an array that starts in location 6000. To sort any array but the one that starts in memory location 1000, you first have to move the array. To get around the location problem, indirect addressing can be used in the program to pull the base address of the array from a RAM location (Fig. 6b).

Indirect addressing can simplify array handling, but does add to processing delays, since addresses must be pulled from memory locations. Further, you won't need the index register, and you'll eliminate the additions previously needed

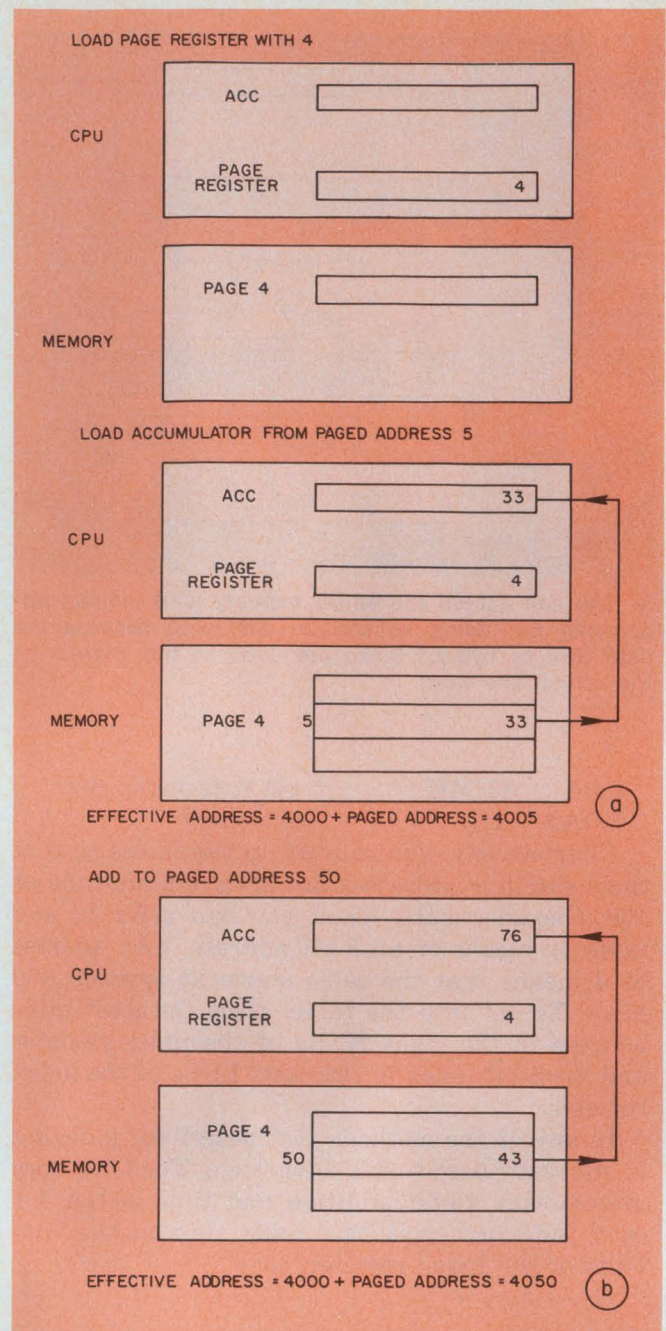

10. **When using page addressing**, you must first load the system's page register with the hex code for the desired page and refer to a specific address on that page. Then you can get the specific needed data.

to get the effective address.

When you must search a table or array for a particular element, indexing is the simplest method to use. Applications that use all or most of the array elements would probably do better with indirect addressing, though.

Many people find that indirect addressing is difficult to use, because the distinction between data and addresses can be confusing. Most of the popular microprocessors don't have true indirect addressing (as described) available to them, and would need an enormous number of cycles to get a 16-bit address from memory and then use it to get another 16-bit address. Even if some ad-

addresses were limited to 8 bits, too much time would be spent on overhead operations.

What some μ Ps (the 8080 and CDP1802, for example) use instead is "register indirect addressing," in which the address is stored in a register rather than in a memory location (Fig. 8). That eliminates the address fetch cycle. All you have to do to get the data is get the instruction from memory, then place the contents of the address register onto the address bus.

Register indirect addressing does have some advantages over indexing. You do not have to provide an offset as part of the instruction and you can eliminate the 16-bit addition to get the effective address. Thus, you save both program memory and time.

To process a data array, the same procedures used to perform the operations in Fig. 7 can be applied (Fig. 8). However, there is a restriction: you cannot reach any other elements in the array unless the program changes the address stored in the address register. If more than one array element is needed for a program, indexing may prove easier. Indirect addressing is ideal for processing single pieces of data.

Relative addressing keeps addresses short

By using relative addressing you can often keep addresses short and make programs easy to relocate in memory (Fig. 9). To get the effective address, the contents of the program counter are added to the address that is supplied along with the instruction. This procedure is similar to indexing, except that the contents of the program counter are used instead of the contents of the index register.

In Fig. 9, the flowchart shows a procedure that loads the accumulator with data from a memory location that is 100 words away from the instruction. The offset is usually interpreted as a signed two's-complement number so that locations in either direction can be accessed.

Relative addressing is particularly effective if the locations being addressed are very close to the program instruction. And moving programs around in memory won't cause any problems since relative addresses remain the same so you can put a program or subroutine in any unoccupied area of the memory.

Microprocessors can't take full advantage of relative addressing because they have short words and in many cases, read-only program memories. If 16-bit relative addresses are used, they must be stored as two memory words, with two memory cycles needed to recall them. On the other hand, if 8-bit relative addresses are used, you can save space and time but must use locations within ± 128 words of the instruction. In most programs, 128 words are not sufficient.

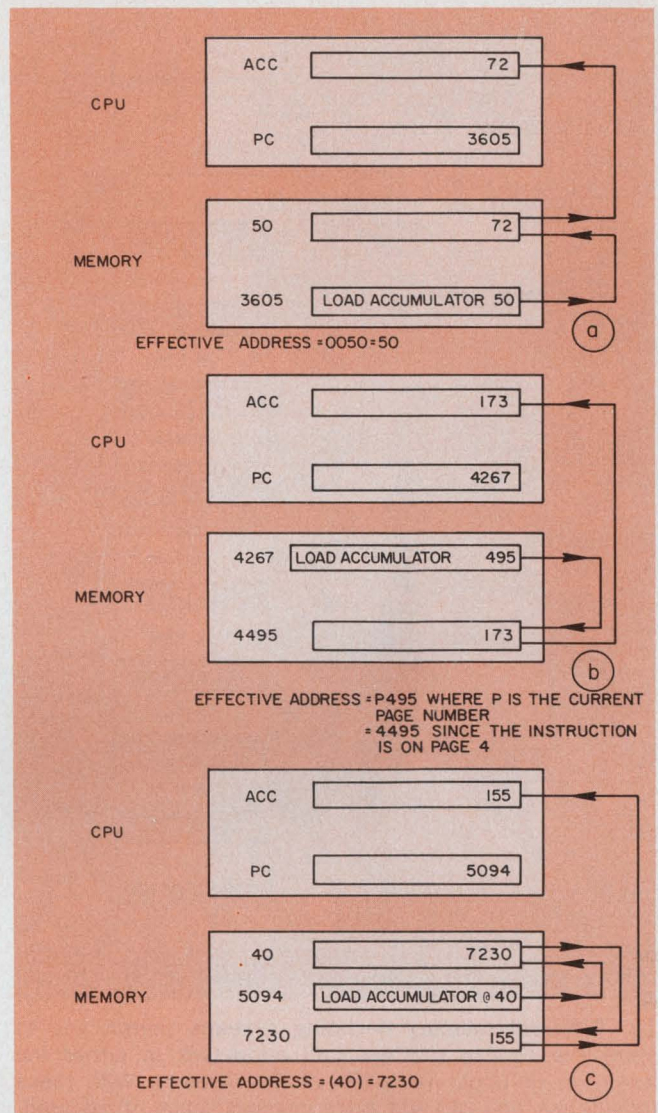

11. Page-zero addressing permits fast access of often used data, that are not on the current page, without an extra memory cycle (a). Current-page addressing can rapidly reach locations that are on the same page as the instruction (b). You can also use page-zero addressing indirectly to reach data on other pages (c).

The main advantage of relative addressing in μ Ps is the use of short offsets as jump addresses. However, just as with indexed addressing, the processor must perform a 16-bit addition to get the effective address each time the relative mode is used. So, slower execution time is traded for memory savings.

Turn the pages carefully

To avoid long addresses in computer programs, paging procedures can be used. Divide the memory into fixed-size sections called pages. You can then refer to a memory location by its page number and its address on that page. Often, the page number is put into a page register and then locations on the same page can be referenced with just the paged address (Fig. 10).

For small programs you can avoid using the

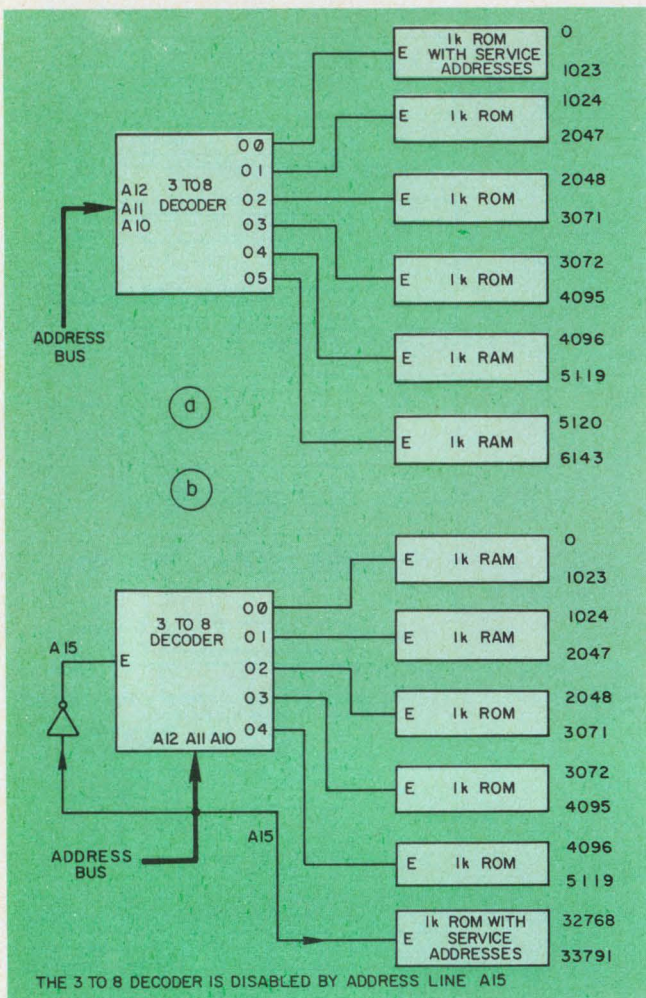

12. **Different memory decoding systems** permit you to store the service routines and addresses in either the lower (a) or upper (b) parts of the memory. With these techniques, you can add extra memory space, if required, up to the addressable maximum. However, memory system design is easier in case (a) since the lower memory configuration is continuous.

page register by limiting the pages that have to be addressed. If only addresses on the first page are used, the technique is called Page-Zero Addressing (Fig. 11a). When you can reach addresses that are on the same page as the current instruction, the technique is called Current-Page Addressing (Fig. 11b). Other pages can be addressed by using an indirect paging method, that is much like the indirect addressing mode (Fig. 11c). Many computers let you select current and zero-page addressing, with just a single bit change in the instruction.

For computers of 16 bits and larger, paging is a great solution to many of the processor limitations. Unfortunately, with μ Ps, page sizes must be kept to 256 words in order to get paged addresses into 8-bit words. Page zero is, in turn, restricted to 256 words—and there will be many page boundaries that must be handled.

As with relative addressing, you can't use current page addressing for anything except jump

instructions because in most cases data are not on the same page as the instructions. Current-page addressing does have the advantages of not requiring a 16-bit addition to get the effective address. The CPU gets the effective address from the eight MSBs of the program counter and the paged address.

If you use page-zero addressing, use a RAM for memory page zero. But remember that you don't want to put your interrupt and startup routines in the RAM, since you'll have to reload them each time the system is turned on. Thus the interrupt and startup service addresses must be stored on a page other than page zero.

However, the addresses on page zero are the easiest to generate since they're only 8 bits long. Additional circuitry, either internal or external, must be used to generate addresses on other pages. Furthermore, decoding is simple if you use a continuous memory that starts at location zero. If the service routines are put at fixed locations, either the memory will have to be divided into sections, or a complex decoding system must be used.

For example, assume you have a system with 6-k words of memory and the lowest 1-k are used to store the service addresses (Fig. 12a). In that case, additional memory can be added without causing any addressing problems. The 3-of-8 decoder can handle up to 8-k words. By using a 4-of-16 decoder you can address up to 16-k words.

A ROM with service addresses at the highest memory addresses can also be used (hexadecimal FF00 and up). The ROM that contains the service addresses must then be placed in a separate area of the memory so that additional memory can be added without moving that ROM (Fig. 12b). System design is made more difficult because the memory space must be divided into two sections.

If service addresses are externally generated to handle large interrupts, systems 8-bit addresses can be generated on page zero by using some encoders. Extra circuitry will be needed to generate 16-bit addresses and place them on the data bus in 8-bit sections.

Note: Some of the material in this article is based on sections of the author's forthcoming book on Microprocessors. ■■

Bibliography

- M6800 Microprocessor Applications Manual, Motorola, Inc., Phoenix, AZ, 1975, pp. 2-45 - 2-46.
- Nichols, A.J. and McKenzie, K., "Build a Compact Microcomputer," *Electronic Design*, Vol. 24, No. 10 (May 10, 1975), pp. 84-92.
- Torrero, E. A., "Focus on Microprocessors," *Electronic Design*, Vol. 22, No. 18 (September 1, 1974), pp. 52-69.
- Torrero, E.A., "An Introduction to Microprocessors," *Electronic Design*, Vol. 24, No. 9 (April 26, 1976), pp. 58-62.
- Vacroux, A.G., "Explore Microcomputer I/O Capabilities," *Electronic Design*, Vol. 23, No. 10 (May 10, 1975), pp. 114-119.

GR's Network Analyzer Costs Less and Performs Better

In the market for a high-performance network analyzer? The choice usually boils down to three instruments. All three are excellent products and the final selection typically centers around how important certain specifications are to one's applications. If *overall value* is the deciding criteria, then GR's widely used 1710 RF Network Analyzer has a definite edge. Here's why:

	GR 1710	HP 8407*	HP 8505*
Price	\$9,850	\$ 10,625	\$ 22,500
Frequency Range	0.4 to 500 MHz	0.1 to 110 MHz	0.5 to 1300 MHz
Polar Display	Yes	Yes	Yes
Group Delay	\$ 495 option	No Option	Yes
Dynamic Range	115 dB	80 dB	100 dB
Resolution	0.025dB	0.25 dB	0.1 dB

*Based on information contained in HP's 1976 Catalog

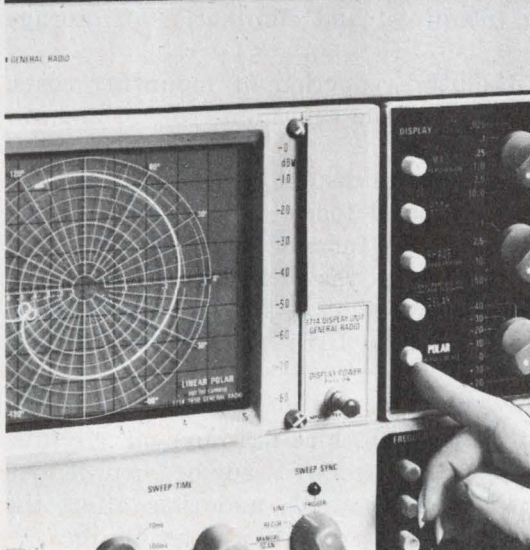
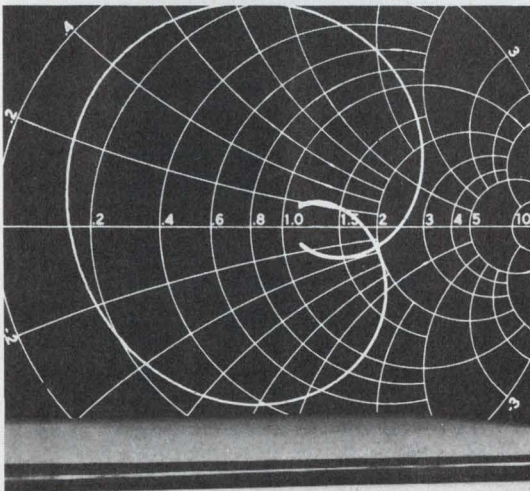

Now, of course, there are many more specs to compare and GR doesn't win in all areas, but the specs cited above are among the most important... including price. Unfortunately, one important feature of the GR 1710 that doesn't show up in the specs is its convenience of operation. Nothing can be more simple than GR's pushbutton switching from displays of magnitude to phase, or to both magnitude and phase, to delay, or to polar.

To get the full story on the capabilities of the GR 1710 request a copy of "RF Network Analysis", a 12-page brochure that describes the 1710 plus all its options and accessories. We'll also include a copy of Application Note 7, which describes how simple it is to make measurements with a GR 1710 at frequencies up to 2000 MHz or even higher.

Write to GenRad, 300 Baker Avenue, Concord MA 01742 or call one of the numbers listed below:

Atlanta 404 394-5380	New York (NY) 212 964-2722
Boston 617 646-0550	(NJ) 201 791-8990
Chicago 312 992-0800	San Francisco 408 985-0662
Dallas 214 234-3357	Washington, DC 301 948-7071
Dayton 513 294-1500	Toronto 416 252-3395
Los Angeles 714 540-9830	Zürich (01) 55 24 20

GR 1710 prices start at \$9700. Order now (after you make your own comparison, of course).



GenRad

Use SOT-23 packaged components in mass-produced hybrid circuits. They can cut size and cost while simplifying production and boosting over-all reliability.

Transistor chips for use in hybrid-circuits come in many sizes, but the unpackaged chips present both handling and connection problems. For better reliability and lower cost, consider using prepackaged chips in SOT-23 cases. The SOT-23 was originally developed in Europe but at least three international manufacturers are currently offering devices in that package.

As a designer of hybrid circuitry, you want as small a package as possible and a reliable bond between device and substrate. Equally important is cost. The attachment process used with the chip directly reflects the manufacturing cost and reliability of the hybrid assembly (see table). Although you can choose from such other packages as leadless inverted devices (LIDs), flip chips, or beam leads, only the SOT-23 can meet all of the above design requirements (Fig. 1).

The ribbon leads of the SOT-23 make it easy to handle during assembly. That includes positioning and mounting of the chip on its substrate, inspection of connections after the bond is made and the bonding technique itself. The SOT-23 can be bonded to the substrate either by the reflow soldering attachment technique or by dip soldering. This cuts costs since very little in the way of specialized equipment is needed to perform the assembly.

The triangular arrangement of the leads provides the package with excellent high-frequency response. Active devices in SOT-23 packages, including ICs, are available from the low to ultra-high frequency range. For example, Siemens recently introduced the popular 741 operational amplifier in a package similar to the SOT-23.

Ease assembly with SOT-23

Here are some benefits listed by manufacturers of the SOT-23:

- Technology: high reproducibility of device characteristics, and greatly reduced circuit volume.

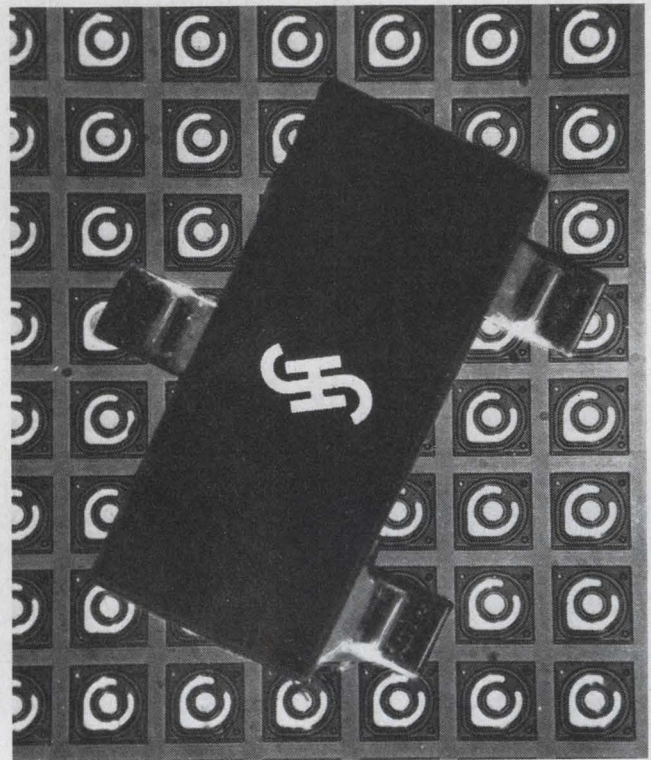

1. The SOT-23 packaged transistor requires only 1/30 the volume of a conventional transistor package and yet can contain a device with the same structure.

- Production: ease of attachment, suitable for automatic mounting, and elimination of storage problems.

- Profitability: reduction of mounting costs, testing costs, mounting times, line rejects and initial component cost.

The chip-and-wire technique is still the one most commonly used today, since wire bonding remains the cheapest form of assembly (Fig. 2a). But problems with the attachment technique spurred the development of the other methods—flip-chips, beam-leads, LIDs and, finally, SOT-23 devices.

The wire bond is one of the most common causes of failure in thick-film hybrid circuits. Weak bonds and overstressed or overbonded wires lead to malfunctions, and thus affect the product's over-all cost, quality and reliability.

Donald Epand, Product Marketing Manager, Siemens Corp., Iselin, NJ 08830.

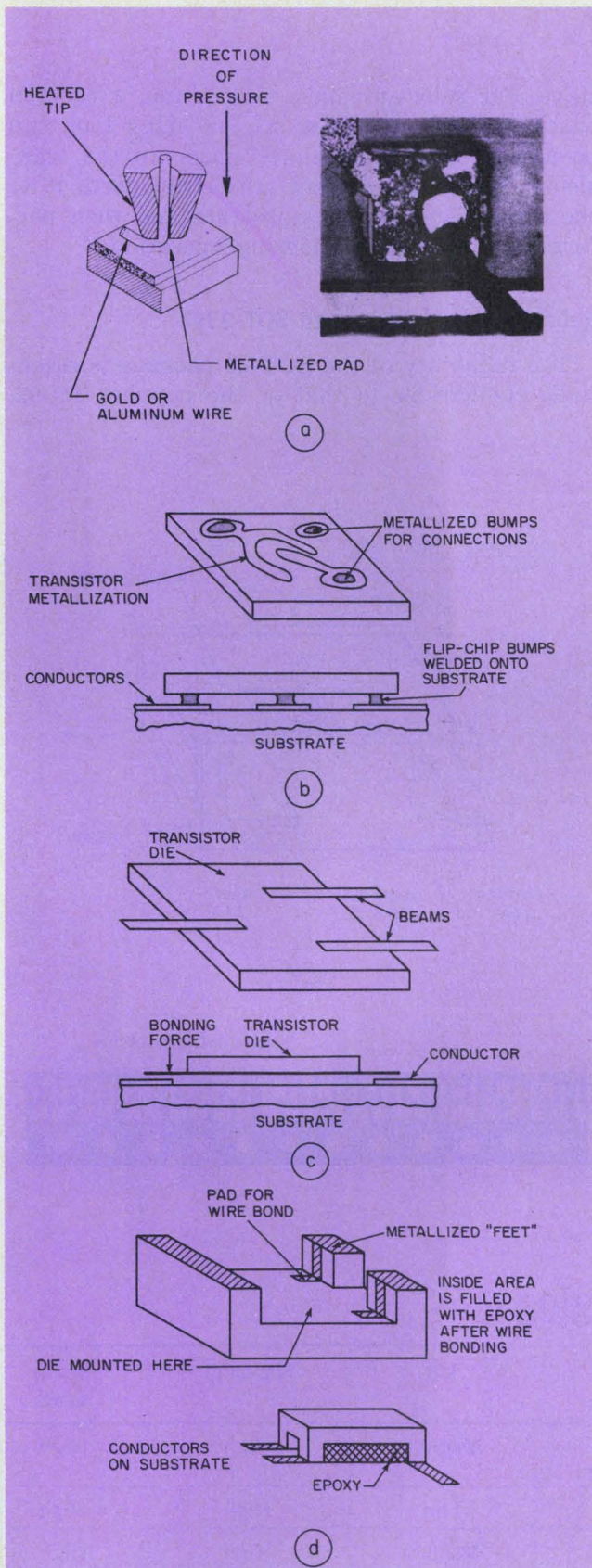

2. **There'll be problems** no matter how you mount an active device. Wire-bonding an active chip (a) is easy, but the bond isn't too reliable. A flip-chip (b) requires precise positioning and complex optics to inspect the bond. Beam-lead packages (c) relieve the inspection problem, but they still require precision bonding. LID packages (d) permit bonding by solder reflow, but inspection is still a problem.

The flip-chip bonding techniques totally eliminate wires and the die-attach step (Fig. 2b). Good bonds can be made if the bump's height and the substrate's flatness are accurately controlled to within a few microinches. All the bumps and their respective pads also have to be lined up accurately for the chip to be put down and bonded in place.

In a flip-chip arrangement, the operator must see the underside of the chip to observe the metallization pattern on the substrate. That requires sophisticated optics and greatly increases the cost of bonding. Another serious problem with the flip-chip is that there is no way to inspect the bond after it has been made.

On the other hand, beam-lead-mounted components (Fig. 2c) can be completely tested. But like flip-chip bonders, beam-lead bonders are expensive, because that process also requires the superimposed image of the beam and bonding pads. The cost of bonding and of associated equipment is the major disadvantage of the beam-lead attachment technique.

The LID, sometimes called the channel carrier, has a distinct advantage (Fig. 2d). It can be attached to a hybrid circuit by standard solder techniques without the high investment in die-bonding and wiring machines. Another advantage is the availability of a more diversified family of active devices than can be found in any other packaging format.

However, compared with the SOT-23, the LID has two disadvantages:

1. **Cost:** It requires a carrier, which adds to the initial price.
2. **Inspectability:** Pads are obscured by the body of the LID, thus making it hard to check for complete attachments.

Fig. 3 shows both the SOT-23 and LID packages. The same active device is used in both cases.

A choice of mounting methods

The SOT-23 packaging concept has been designed to give the hybrid manufacturer a choice of mounting techniques. The most popular and economical is reflow soldering, which uses a conveyor belt over a hot plate and does not require highly specialized equipment.

In that process the printed and fired substrates are dipped into a soldering bath kept at 220 to 230 C. The solder alloy must contain from 2 to 4% silver to prevent the conductor pattern from dissolving in liquid solder. The flux used is usually slightly activated.

The SOT-23s and other components are positioned on the substrate, their correct position secured by the adhesive force of the flux. The entire substrate is then dipped into the flux and

mounted on a heater plate. Soldering should be done as fast as possible—just enough for the solder in all locations to liquidize. A full soldering cycle depends on the equipment used and the size of the substrate. The soldering cycle time, placement and removal of the substrate are usually controlled automatically.

SOT-23 packages can also be attached using thermal compression techniques. With a low-wattage iron you can solder the SOT-23 directly to a circuit board during the preliminary design

stage. For fully automatic production, a vacuum chuck, acting as a resistance soldering tool, can be used. The vacuum chuck picks up the transistor from an alignment tray, transports it to the correct spot on the substrate and then performs the resistance-soldering operation.

Reliability: A problem with SOT-23s?

The reliability of the SOT-23 package is essentially comparable to that of the popular TO-92,

Inside the SOT-23 package

The SOT-23 package contains a wacon strip, a photoresist-coated, nitride-passivated chip, a piece of gold foil for alloying, and gold wires. Its body is made from molded plastic (Fig. A). The surface of the etched or stamped wacon strip (Fig. B) is first plated with 2 to 3- μm of gold. A piece of gold foil and the chip are then placed on the alloying point of the wacon strip.

Alloying is done in an inert atmosphere at about 460 C. The structure's emitter and base contact areas are connected to the transistors' leads with gold wires, 20- μm in diameter. The structure is next coated with photoresist to reduce photosensitivity and resist moisture, and then molded in plastic.

Next the transistors are tempered, and all plastic residue is removed. When the connections have been trimmed, they are stamped out and bent as required. Since the epoxy used on the Siemens transistors will withstand immersion in molten solder at 240 C for up to 5 s, these packages can be dip-soldered.

INTERNAL STRUCTURE

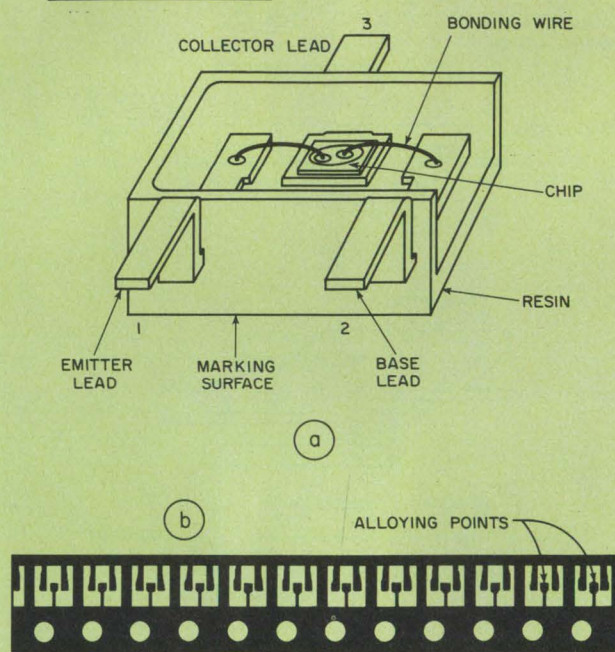

Comparison of active-chip prepackaging

Item	Wire & Chip	SOT-23	Lid	Flip-Chip	Beam Lead
I. Cost					
Finished product cost	High	Low to Medium	Medium	High	High
Cost per chip	Low	Low	Low	High	High
Wafer processing	Low	Medium	Medium	High	High
II. Product reliability					
Over-all	Low	High	High	Medium	High
Surface degradation	Medium	Medium	Medium	Medium	Low
Reliability of bond	Low	High	High	Medium	High
Inspectability of bond	High	High	Medium	Low	High

What makes the SOT-23 so small?

A line of active devices was developed at Siemens especially for the SOT-23 package. For example, the BCW60 silicon-planar epitaxial transistor in a SOT-23 case has the same characteristics as the conventional BC107 transistor housed in a TO-18 case, but is 30 times smaller and weighs only 7 mg. To accomplish that, the basic structure of the transistor had to be greatly improved. Siemens did so by adding a guard ring, shielding electrode and a silicon nitride passivation layer (Fig. A).

These changes were essential to account for certain properties in the silica film and the silica-silicon interface. Although use of a thermally grown silicon dioxide film to protect the pn junction improved the stability and quality to some degree, compared with that of the unprotected pn junction, more protection was still needed.

The oxide contains both mobile and stationary positive charges whose field acts upon the charge carriers in the silicon below. At temperatures around 200 C, ions of alkali metals (such as sodium) or of hydrogen act as mobile charges that can pass through the oxide. Ions travel not only within the oxide but also over the surface of the oxide film and change the characteristics of the pn junction.

The movement of the surface ions depends greatly on the relative humidity of the surrounding atmosphere. To make a stable transistor, it is necessary to grow a clean oxide and protect it from subsequent contamination and the influence of the surface ions.

The guard ring and shielding electrode prevent the uncontrolled spread of an inversion layer on the collector. The inversion layer could cause excessive leakage currents and eliminate the influence of surface ions. The silicon nitride layer prevents contaminants from entering the oxide. Silicon nitride is an effective insulator (resistivity is 10^{13} to $10^{14} \Omega/\text{cm}$) and is very hard (above 9 on the Mohs' scale).

The nitride's most important property, though, is its resistance to the passage of ions. If the transistor structure without a nitride passivating layer is coated with a substance containing sodium and then exposed to a temperature of 200 C, a considerable drop in the current gain occurs within a few hours. However, nitride-passivated transistors are unaffected by such treatment (Fig. B).

The excellent stability of nitride-passivated transistors is illustrated by the results of endurance tests performed with the BCW60 and BCW61. Fig. C shows the distribution of the drift coefficient of current-gain B. The drift coefficient is the reading taken after a 1000-hour endurance test, divided by the reading at the start of the test.

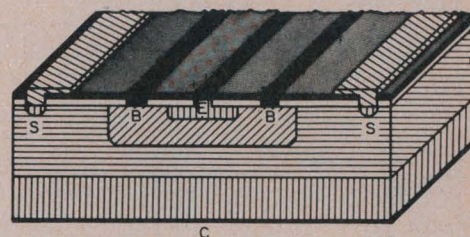

- P+ - TYPE CONDUCTION
 - P - TYPE CONDUCTION
 - N - TYPE CONDUCTION
 - SiO₂ LAYER
 - Si₃N₄ LAYER
 - SHIELDING ELECTRODE
 - CONTACT METAL
- S - GUARD B,C,E - BASE, COLLECTOR AND EMITTER CONNECTIONS

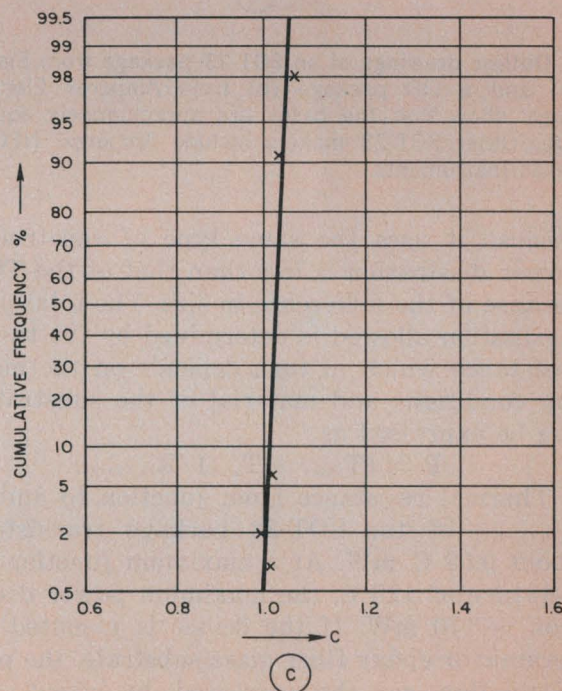
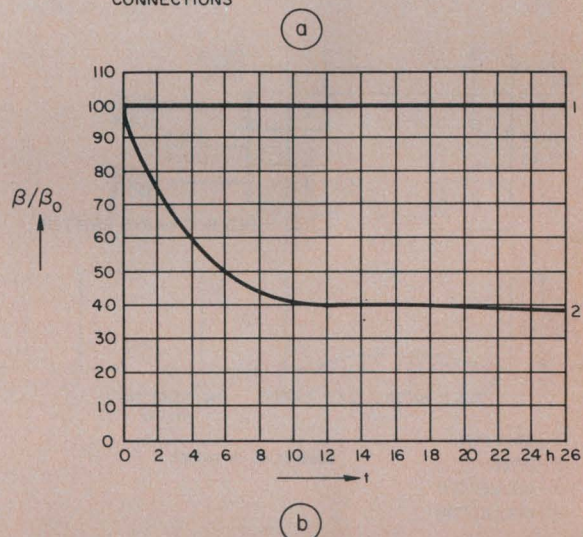

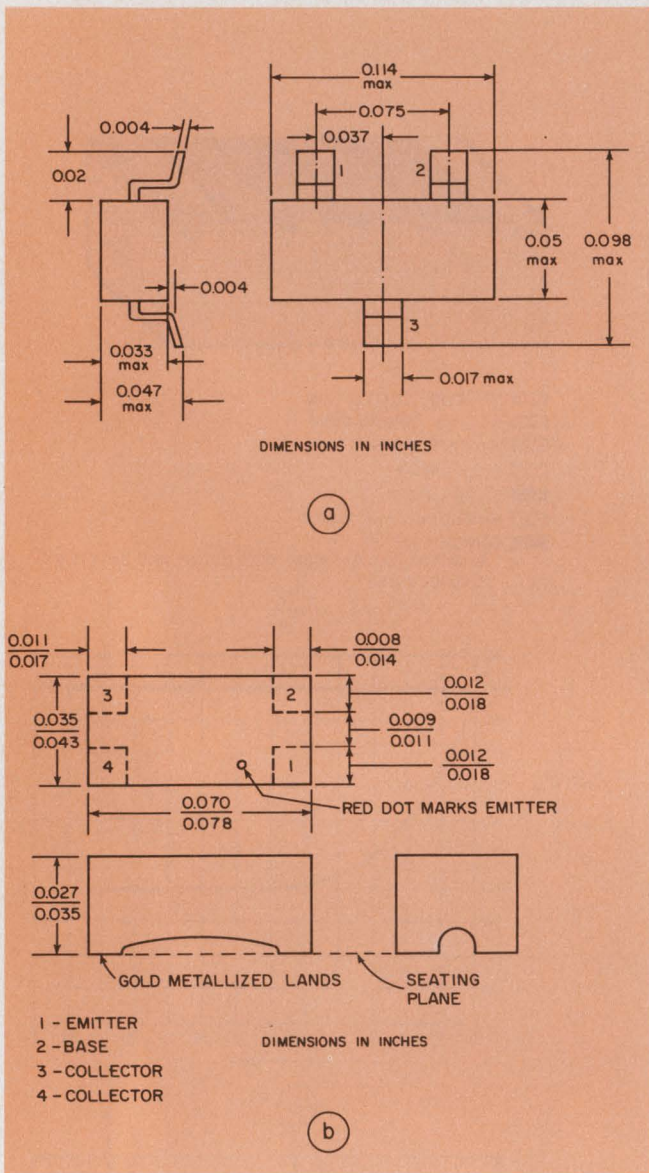

3. Outline drawings of an SOT-23 package from Siemens (a) and a LID package (b) from Amperex Electronic Corp. show that the cases are approximately equal in size. Other SOT-23 makers include Amperex, NEC and Texas Instruments.

because it uses the same type of construction. Power dissipation is less than that of the TO-92, because of the difference in size. The total power dissipation allowed is determined by the thermal resistance which in turn depends on the mounting conditions and material of the substrate. It can be expressed as

$$P = (T_{jmax} - T_{amb}) / R_{th(j-a)}$$

Thermal resistance from junction to ambient, $R_{th(j-a)}$, of the SOT-23 package transistor is about 0.58 C/mW. At a maximum junction temperature of 125 C, the maximum power dissipation is 170 mW. If the device is mounted on a ceramic or epoxy fiber glass substrate, the power dissipation can be increased by about 20%. Thus, power dissipation in excess of 200 mW is possible.

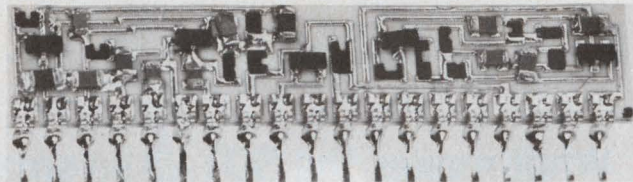

(a)

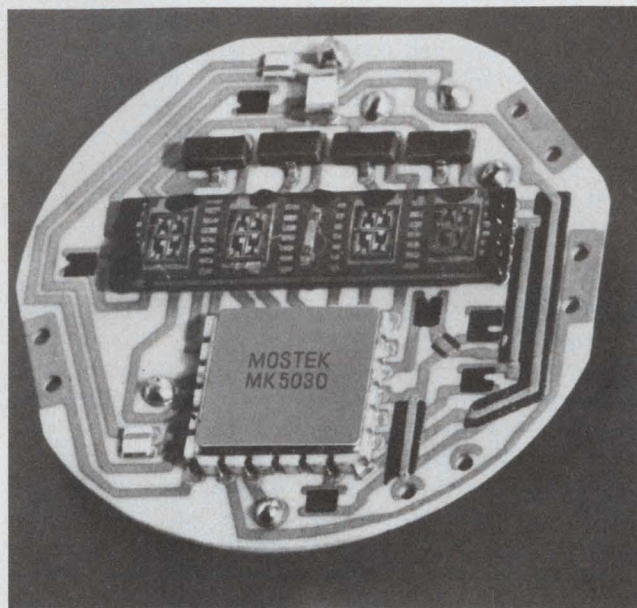

(b)

4. SOT-23-housed transistors and diodes are used in part of a hand-held communicator (a). Similarly housed transistors are used as LED drivers in a digital watch module (b). The transistors are mounted just above the digital LED display.

Fig. 4a shows a hybrid circuit manufactured by Pulse Engineering in San Diego. It is part of a subminiature module designed for hand-held communications equipment. The active devices used include vhf transistors, audio-frequency transistors and silicon diodes, all in SOT-23 packages.

Several other major original-equipment manufacturers of hand-held communications equipment are adopting SOT-23 packaged devices in their hybrid circuits. Fig. 4b shows SOT-23 packaged transistors used as LED drivers on a digital watch module. SOT-23 packaged phototransistors designed for cameras are finding use in digital watches as a sensor for ambient lighting; they regulate the LED drive current.

At least one major company that is in the telecommunications field had been using TO-18 devices in its equipment, but recently decided to hybridize its circuits by using SOT-23 packages. Tests conducted by that company showed the moisture resistance and reliability of the new package are about the same as for hermetically sealed devices. ■■

Amperex extends the range of microminiature components for your hybrid IC's with all-gold SOT-23's and SOT-89's.



The Amperex line of all-gold SOT-23 and SOT-89 plastic microminiature semiconductors consists of just about everything the hybrid IC maker needs, including several unique types that appreciably extend the range of applications for low cost hybrid IC's: Zener diodes, switching diodes, tuning diodes, Schottky mixers, general-purpose low-level transistors, fast-switching transistors, wideband amplifiers for IF and VHF, FET's, low-current/low noise transistors, UHF transistors, and even high voltage transistors that can handle up to 120 volts V_{CEO} .

In addition, we offer a whole series of drivers and switches that can dissipate up to 1 watt. These are available in the slightly larger SOT-89 plastic microminiature package and can be used on the same substrates as the SOT-23.

Both the SOT-23 and SOT-89 packages are suitable for either automated or manual mounting and for soldering by all the conventional methods, including

the popular reflow-soldering technique.

Intermetallic compound problems never strike Amperex SOT-23 or SOT-89 semiconductors because they contain no aluminum. We use a dual layer of Gold-over-Titanium at the contacts; we bond Gold wire directly to Gold surface; and we encapsulate the chip in a high-purity, neutral plastic which has no effect on semiconductor life.

The result: A more reliable, low cost microminiature package. The way is now open for the manufacture of high yield, high-reliability, low-cost hybrid integrated circuits...with Amperex SOT-23's and SOT-89's.

For data on the entire line of Amperex SOT-23's and SOT-89's, or for applications engineering assistance on any of your hybrid needs...from basic components to complete circuits (thick and thin film - custom or standard) ... contact: Amperex Electronic Corporation, Slatersville Division, Slatersville, R.I. 02876, Tel: 401-762-9000.

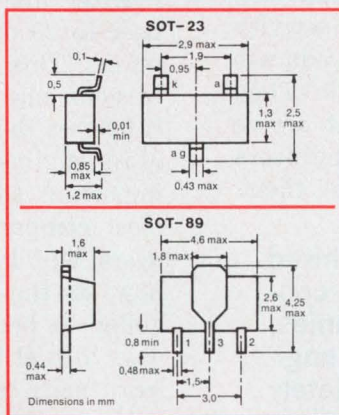

Amperex®

TOMORROW'S THINKING IN TODAY'S PRODUCTS

A NORTH AMERICAN PHILIPS COMPANY

Isao Someya of Nippon Electric Speaks On Educating Engineers

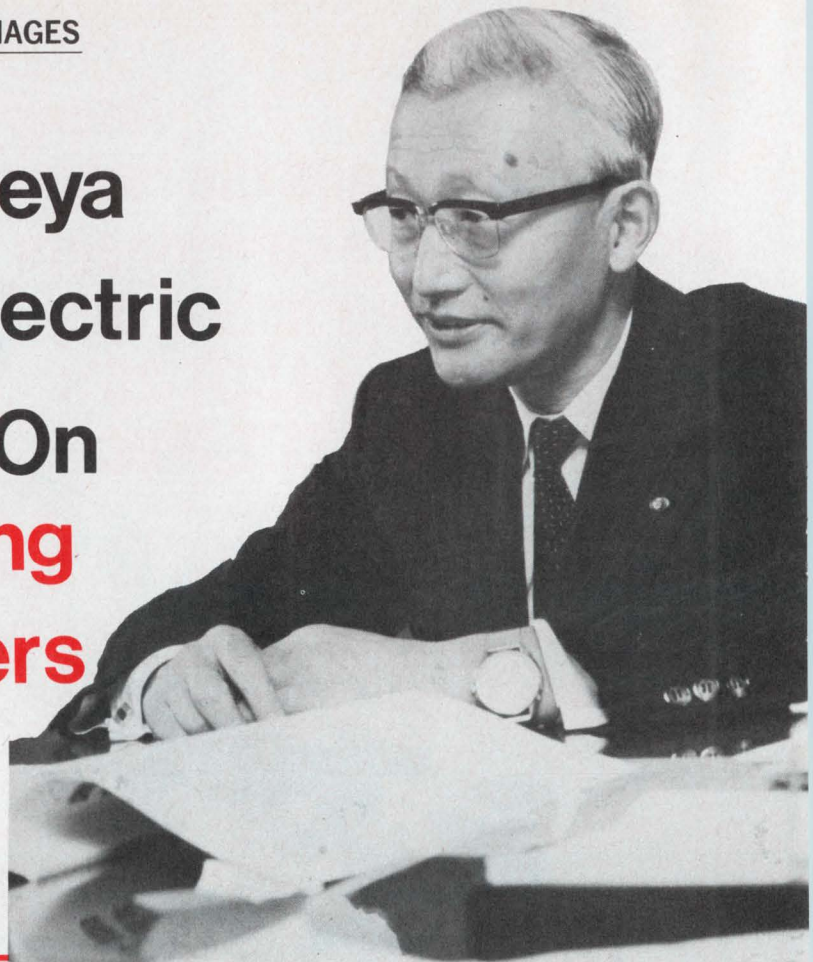

Too many of us take the education of our engineers for granted. When we hire an engineer, we assume that he's already been fully educated, that he has learned all there is to know at a university. If there is any further learning he needs, most of us feel that he'll learn what's needed on the job—by osmosis.

At Nippon Electric, we feel it's wise to make a positive commitment to educating our engineers—not only when they join the company but as they grow in the company as well. We feel the investment in educating engineers is paid back handsomely in greater engineering productivity and innovation. The techniques we use to educate our engineers are certainly not remarkable. They are the techniques almost anybody might arrive at if he sincerely felt that educating engineers was important. Let me show you some of them.

The first thing we do with a newly hired engineer is something you might consider elementary. Yet most companies, in their eagerness to plunge a new engineer into productive activity, completely neglect it. We give him an indoctrination.

Is that paternalistic? Not at all. Most engineers, like all other employees, welcome it. We

tell an engineer how our factory operates, what kinds of products we make, how we distribute our products, how we provide service to our customers, who our customers are, how we communicate with our customers, and how we communicate with each other.

This kind of indoctrination, which doesn't require more than a few hours, gives everybody a powerful start because it shows people where they fit into a large organization and helps show them their own importance.

After his indoctrination, we subject an engineer to 20 days of education in the use of computers. This has a double advantage. It familiarizes our engineers with some of our products and it teaches them how to use a powerful design tool. Most engineers and most companies know how important the computer is to engineering. Yet, most companies simply assume that their engineers will learn computer programming, somehow, on their own. Of course, an engineer isn't going to become an expert programmer in 20 days. But at least he gets the groundwork. He can learn more later.

Next, as a general policy, we encourage further education for our engineers even to the extent of sending them overseas for advanced specialized courses or post-graduate schooling.

But, in general, the engineer gets most of his specialized training in his own division. We feel that on-the-job training is extremely important for engineers as well as for others in the company. On-the-job training is not accidental with us; it's very deliberate and we spend a lot of time planning it.

A lot of this emphasis began three years ago when we started a program called Operation Quality, whose aim was to improve the quality of everything—management, engineering, manufacturing and, of course, products. As one might expect, education was an essential ingredient in this program.

In fact, part of the job of every section manager involves educating his engineers—not only for the immediate needs of their jobs—but for future requirements as well. One measure of the effectiveness of a section manager is how well he trains his engineers.

So the section managers train the engineers. Who trains the section managers? The department managers.

The question now is who trains the department managers. The answer is, largely, that they train themselves. Periodically, our department managers get together for brain-storming sessions. They discuss their failures and their successes. They trade ideas. They learn from each other. In addition, we often provide special courses, with guest experts invited to lecture at our plants. Further, we send our people to special seminars that might be given by institutes or universities. And, of course, department managers learn a great deal from division managers.

The division managers get most of the educational opportunities that are offered to the department managers. In addition, we periodically send them to a resort hotel where their minds are taken off the day-to-day activities. Here, we provide the division managers with five days of intensive study including brainstorming sessions. They hear lectures from outside experts, from our president, Mr. Koji Kobayashi, and from other NEC executives. We provide concentrated courses on subjects like developing a strategic philosophy. And we have sessions on accounting because we feel managers, especially engineering managers, should be able to understand accounting documents. We equip them to analyze investment decisions. And we involve them in computer-assisted management games.

In addition, for high-ranking division managers, we provide specialized education in things like managing multi-national companies. We operate dozens of foreign companies so we want our managers equipped to step into those situations when it is necessary.

Another element of education, not just for engineering managers but for engineers as well, involves training in foreign languages. English is the main language, of course, since information on new technology so often appears first in English. But we also provide courses in Spanish, Portuguese, French and German. In most cases the engineer selects the language he would like to study. But if we want to send an engineer to a foreign country, we'll insist that he learn the language of that country. We don't want our people to be total strangers in host nations.

Now all of this is part of the formalized train-

Who is Isao Someya?



In 1966, the year NEC established the basis for Japan's first time-sharing system, Isao Someya joined the firm. A graduate of Tokyo University, he received a doctor of engineering degree in 1952. In 1972 he was promoted to the post of senior vice president in charge of the R&D group. Although his particular interest is radio engineering, he provides direction in all R&D areas for the firm's 8500 engineers.

Nippon Electric Company was founded in 1899, and the following year began producing telephone sets and switchboards. NEC is today a company with 34,000 employees and an annual sales volume approaching \$2 billion. It is a leading installer of earth stations around the world and in communications satellites. NEC's other activities include microwaves, mobile radio communications, defense electronics, air navigation, radio, sonar and guided-missile electronic systems.

Someya's interests include classical music, golf, and the ancient game of "Go," a kind of Oriental chess game that combines the intricacy of chess with the simplicity of tic-tac-toe and the subtlety of Zen.

The M-600 amp works harder at 2.5 ohms

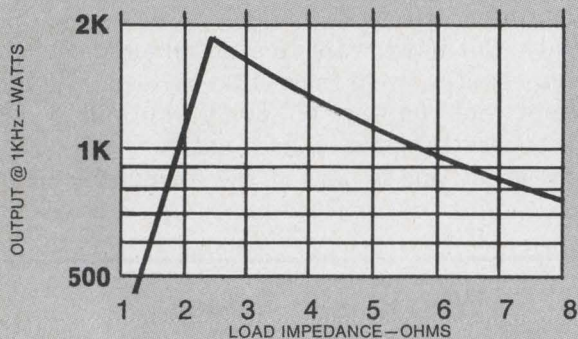

So each watt costs less

You get more watts per dollar from the Crown M-600 power amp if your circuit design lets it look at a 2.5Ω load.

The M-600 provides power from DC to 20KHz with complete protection against shorts, open circuits, mismatch, RF burnout and thermal overload. The M-600 will even drive a purely reactive load without overheating. Designed for continuous operation at full rated power, at any rated frequency.

One M-600 will cost you \$1,795. A copy of the spec sheet is free. Write today.

We'd also like to hear from you if you have any special amplification problems in the DC-20KHz range. We've already solved some tough, unique problems. We'd like to consider yours.

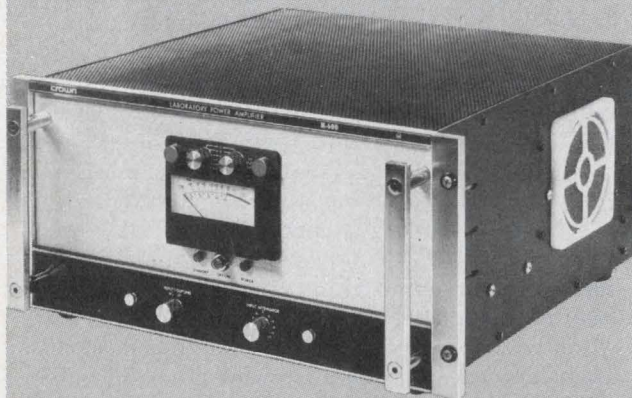

CROWN
INDUSTRIAL

1718 W. Mishawaka Road, Elkhart, Indiana 46514

219/294-5571

CIRCLE NUMBER 31

ing procedures that are part of the way of life for our engineers at NEC. In addition, we offer less-structured educational opportunities.

For example, we often provide financial help for engineers who want to take approved university courses or seminars outside working hours. We would approve courses in subjects like accounting, management techniques, management science. And we might select some engineers to take special courses on company time in subjects like economics and general technology. In most cases an engineer would have to apply to his supervisor for approval to take such courses at company expense.

As you can see, NEC is very much an education-oriented company. We even learn by teaching.

All of these courses are an addition to those given by company lecturers at our own facilities, usually in the evening. Further, we help our engineering departments by providing a good flow of technicians. We own a technical college in which we provide three-year evening education or one-year full-time education to employees who are high-school graduates who pass a qualifying examination. There's a secondary advantage here. Not only do we develop good technicians but we use our own engineers to teach these courses. And they educate themselves as they teach others. Everybody has heard the old maxim that the best way to learn something is to teach it.

We go still further with what we call our Career Development Assistance Program. We give young engineers aptitude tests to determine which phase of engineering they would be best at. We may find early in the game, for example, that one man may be a good circuit designer and another a good software designer.

So we want to help an engineer go down the path he is best suited for, though we don't want to lock him in. We want to broaden his horizons at the same time with everything else available to him in the company.

But since aptitude tests are not as perfect as we all wish they were, we allow room for modification. In the early years of a man's career at NEC, he might move around from job to job, spending perhaps three months in one specialty, then six months in another, until he finds the one that gives him maximum job satisfaction. That one will invariably be the one in which he is most productive for the company.

Engineering productivity is really what it's all about. Though we have intense devotion to education, an engineer, throughout his career, is expected to be a productive engineer—not merely a student. ■■

New Low Cost TIME CODE GENERATOR/READER



Time Code Reader \$890.
Generator/Reader \$1265.

The new LOW COST Series 9000 Time Code Units generate and read serial IRIG Time Codes used in analog magnetic tape instrumentation, hard wire transmission and telemetry systems. In addition, they provide buffered parallel BCD outputs, TTL compatible, for digital storage devices and computer inputs. Options include Multi-code units, Day-of-Year Calendars and Millisecond BCD outputs.

Write or call Chrono-log Corporation, 2 West Park Road, Havertown, Pa. 19083, (215) 853-1130



CIRCLE NUMBER 32

ONLY VISHAY GIVES YOU ALL SIX TOP SPECS IN RESISTOR PRECISION.

TCR to
 $0 \pm 1 \text{ ppm}/^\circ\text{C}$



TOLERANCE
to .001%

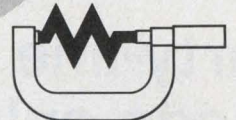

As low as 1-ns
RISE TIME- NO
INDUCTANCE



TRACKING
to $1/2 \text{ ppm}/^\circ\text{C}$



STABILITY
to 5 ppm/yr

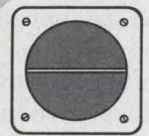

NO NOISE

Learn to make custom Vishay resistors in your prototype design lab. Call or write for information on our popular one-day training course. Vishay Resistive Systems Group of Vishay Intertechnology, 63 Lincoln Highway, Malvern, PA 19355; phone (215) 644-1300.



Vishay

6465

CIRCLE NUMBER 33

"CoBrush" Away Flux In Seconds!

MS-190 is also available in a heavy duty aerosol — MS-190HD.

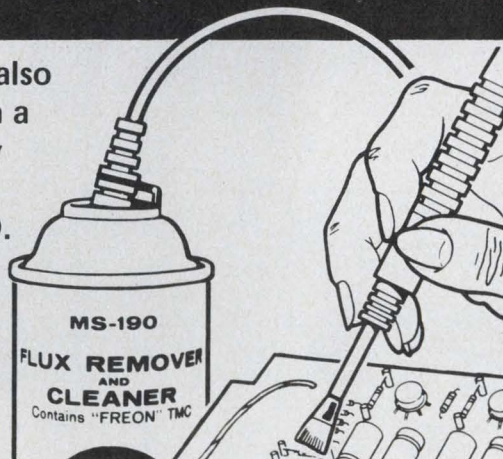

Send For
Trial Unit!

You've nothing to lose but your Flux Problems.
Money Back if not satisfied.

MS-190 Flux Remover and Cleaner, combined with the new "Cobra" Solvent Brush, guarantees fast, efficient removal of the most difficult flux accumulation.

"Two-Product Trial Unit" includes:

- One 16 oz. can of MS-190.
- One MS-226 Cobra Extension & Brush

miller-stephenson

ED-8U

Danbury, Connecticut 06810 • (203) 743-4447

- Enclosed is \$5.00, please send my "Two-Product Trial Unit" — (MS-190 and MS-226).
- Please send FREE literature and prices.

Name _____ Title/Dept. _____

Company _____

Address _____

CHICAGO • LOS ANGELES • TORONTO — Dist. in • ITALY • GERMANY • FRANCE
• GREAT BRITAIN • SWITZERLAND • LEBANON • SPAIN • NETHERLANDS

CIRCLE NUMBER 34

Party-line intercom system needs only three wires

A large number of intercom stations can be tied together, party-line style, with only three wires (Fig. 1). The wires can even be reduced to a single twisted pair between stations, if a separate ground system is used. All units are connected in parallel, and the entire system is buzzed by only one signalling circuit.

Each unit is shown powered individually from 1.5-V cells for redundancy. In the event of a line break, the stations on either side of the break can still function, though only the units on the side with the signalling circuit will be able to buzz each other. If desired, a fourth wire can be run to permit the entire system to function from a single 1.5-V source.

For greater signal volume, 3-V sources can be used for the supplies without changing any other parts of the system. When separate 1.5-V D cells

are used, they last approximately one year.

The carbon microphone of a standard telephone handset at each station feeds into a common-base amplifier, and a tandem high-gain common-emitter stage drives the intercom line. All the phone earpieces are in parallel across the line.

The signaling circuit, also connected across the line, is a simple oscillator that drives all the earpieces. Simple buzz codes can be used to reach the desired station.

Simplicity, ruggedness, redundancy and low-power consumption make this system well suited for use in the field or in underground mining applications.

Andrew M. Hudor Jr., Cosmic Ray Physics Group, Department of Physics, University of Arizona, Tucson, AZ 85721.

CIRCLE NO. 311

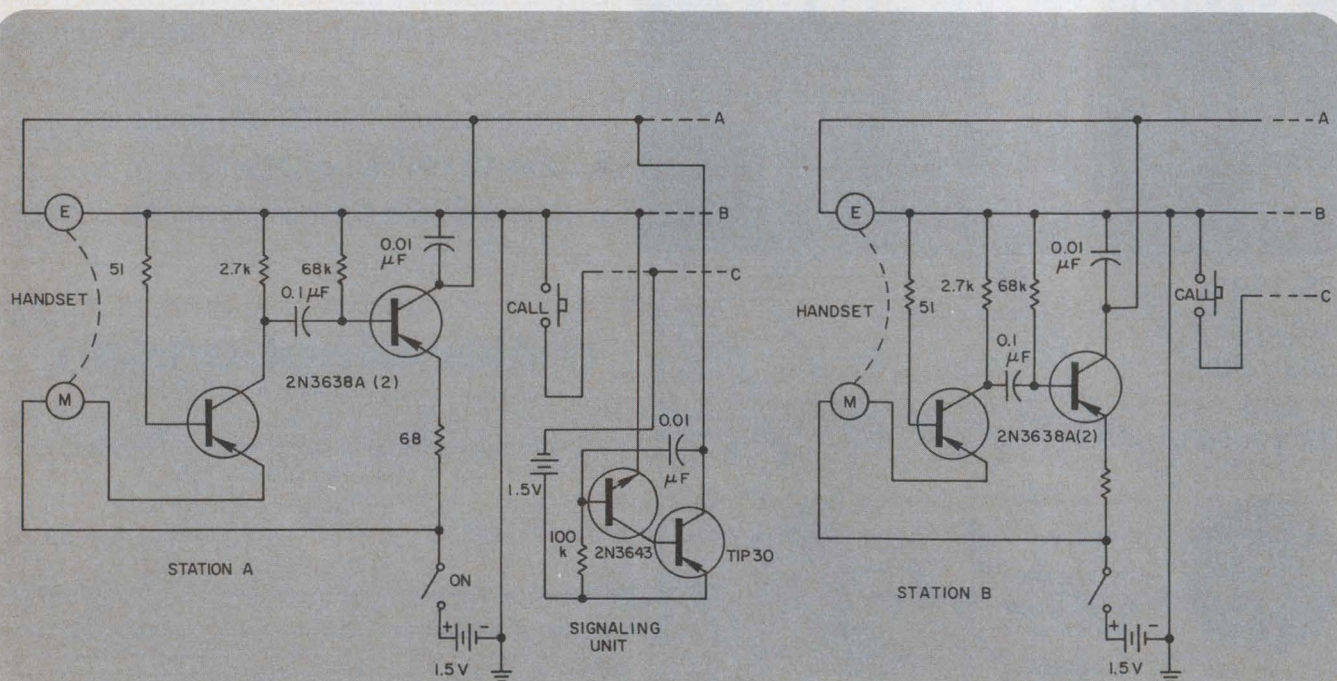

1. A large number of intercom stations can be added to the system by merely duplicating station

B and connecting each new station to the three-wire party line.

ANOTHER WINNER



QPS series
Power Supplies **\$21⁵⁰**

One year warranty.
From stock.
U.L. recognition.
Barrier block interface.

Socketed I.C.
regulator.
Crowbar
accessory.

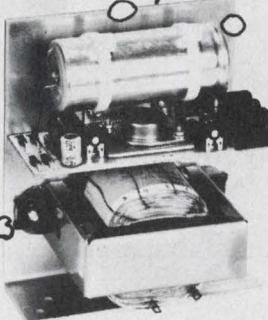

MODEL	QPS-1	QPS-2	QPS-3
RATINGS Volts/Amps	5/3 or 6/2.5	12/1.5 or 15/1.2	24/1
QTY.	1	100	250
PRICE	\$24.00	\$22.50	\$21.50

Deltron inc.

Wissahickon Avenue
North Wales, PA 19454

Tel: 215/699-9261 Twx: 510/661-8061

AC-10

POWER SUPPLY MAGIC



There's no trick! Get a full house everytime with Deltron's dual and triple power supplies.

U.L. recognized.
One year warranty.

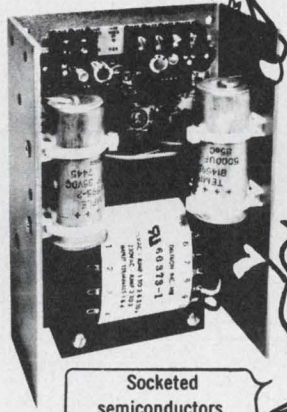

Socketed
semiconductors.
Barrier block interface.

MODEL	RATINGS volts/amps	PRICE		
		1	100	250
QD12/15-0.6	±12 to ±15/0.6	\$42	\$36	\$35
QD12/15-1.7	±12 to ±15/1.7	\$62	\$54	\$49
QD12/15-3.0	±12 to ±15/3.0	\$79	\$67	\$64
QT-1	5/3.0 ±12 to ±15/0.5	\$69	\$66	\$65
QT-2	5/6.0 ±12 to ±15/1.0	\$89	\$82	\$79

Deltron inc.

Wissahickon Avenue
North Wales, PA 19454

Tel: 215/699-9261 Twx: 510/661-8061

AC-12

OPEN FRAME POWER SUPPLY ELECTION

★ DELTRON PLATFORM ★

- ★ Competitive Prices.
- ★ Stock Delivery.
- ★ 1 yr. Warranty.
- ★ "Real" Specs.
- ★ User Designed.
- ★ Lowest Temp. Derating.

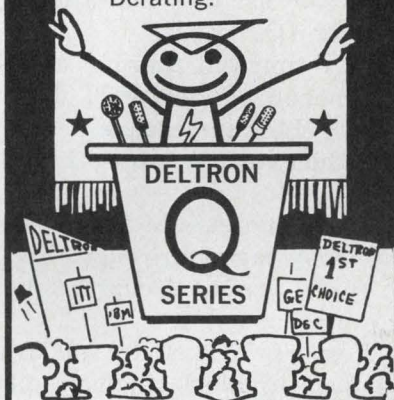

FROM THE "PRIMARY" ON...
IT'S "Q" SERIES
ALL THE WAY!

U. L.
Recognition.
Interchange-
able with
competitive
units.

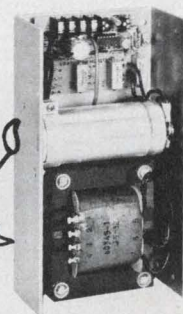

Size A Model No.	Size B Model No.	Size C Model No.	Size D Model No.	Size F Model No.
volts—amps Q 5—3.0 Q 6—3.0 Q 12—1.7 Q 15—1.5 Q 18—1.3 Q 20—1.3 Q 24—1.2 Q 28—1.0	volts—amps Q 5—6.0 Q 6—6.0 Q 12—3.4 Q 15—3.0 Q 18—2.6 Q 20—2.6 Q 24—2.4 Q 28—2.0	volts—amps Q 5—9.0 Q 6—9.0 Q 12—5.7 Q 15—4.8 Q 18—4.0 Q 20—4.0 Q 24—3.3 Q 28—3.1	volts—amps Q 5—12.0 Q 6—12.0 Q 12—7.0 Q 15—6.3 Q 18—5.2 Q 20—5.2 Q 24—4.8 Q 28—4.2	volts—amps Q 5—18.0 Q 6—18.0 Q 12—10.8 Q 15—9.5 Q 18—7.8 Q 20—7.8 Q 24—7.2 Q 28—6.0
Dimen. 4 7/8 x 4 1 3/8	Dimen. 5 3/4 x 4 7/8 x 2 1/2	Dimen. 7 x 4 7/8 x 2 3/4	Dimen. 9 x 4 7/8 x 2 3/4	Dimen. 14 x 4 7/8 x 2 3/4
Price: 1—\$32. 100—\$26. 250—\$24.	Price: 1—\$54. 100—\$44. 250—\$41.	Price: 1—\$67. 100—\$54. 250—\$51.	Price: 1—\$87. 100—\$70. 250—\$66.	Price: 1—\$113. 100—\$91. 250—\$85.

Deltron inc.

Wissahickon Avenue
North Wales, PA 19454

Tel: 215/699-9261 Twx: 510/661-8061

AC-13

Chopper amplifier for thermocouples has long-term drift of only $0.5 \mu\text{V}/\text{yr}$

The differential chopped-signal amp in Fig. 1 is designed for the amplification of low-level voltages from low-impedance sources such as thermocouples.

The extremely low input-offset voltage of about $2 \mu\text{V}$ without external trim over a -25 -to- 85 -C operating-temperature range results from five design features:

- (1.) Strict symmetry in all the switching circuits and use of a nonsaturating square-wave oscillator (Q_6, Q_7).
- (2.) Inherent thermal and dynamic balance of the monolithic dual-FET differential chopper, Q_1 .
- (3.) Low impedance of both the signal source and the external gain-setting divider resistors R_A and R_B .
- (4.) High gain of the carrier amplifier (Q_2, Q_4) as set by capacitors C_2, C_3 and C_4 .
- (5.) Careful circuit layout and low stand-by power consumption.

Features 1, 2 and 3 make the usual need for compensation of chopper-spikes entirely un-

necessary; features 2, 4 and 5 help in minimizing internally generated thermoelectric voltages.

The output op amp, Q_5 , contributes to the circuit's over-all open-loop gain of 10^6 , isolates the load, and, together with the external Miller-capacitor, C_F , establishes the desired closed-loop bandwidth and output noise.

Other circuit features include a long-term drift of $0.5 \mu\text{V}$ per year, an input-noise voltage of $0.2 \mu\text{V}$ peak to peak from 0.01 to 1 Hz, an input-bias current of 50 pA and a CMRR of 120 dB.

The circuit's common-mode input-voltage, though limited to a range of only $\pm 0.1 \text{ V}$, allows a very simple chopper drive that can be referenced to ground. The low input range is more than adequate for most thermocouple applications.

Jiri Dostal, Design Engineer, Research Institute for Mathematical Machines, Prague 5, Czechoslovakia.

CIRCLE No. 312

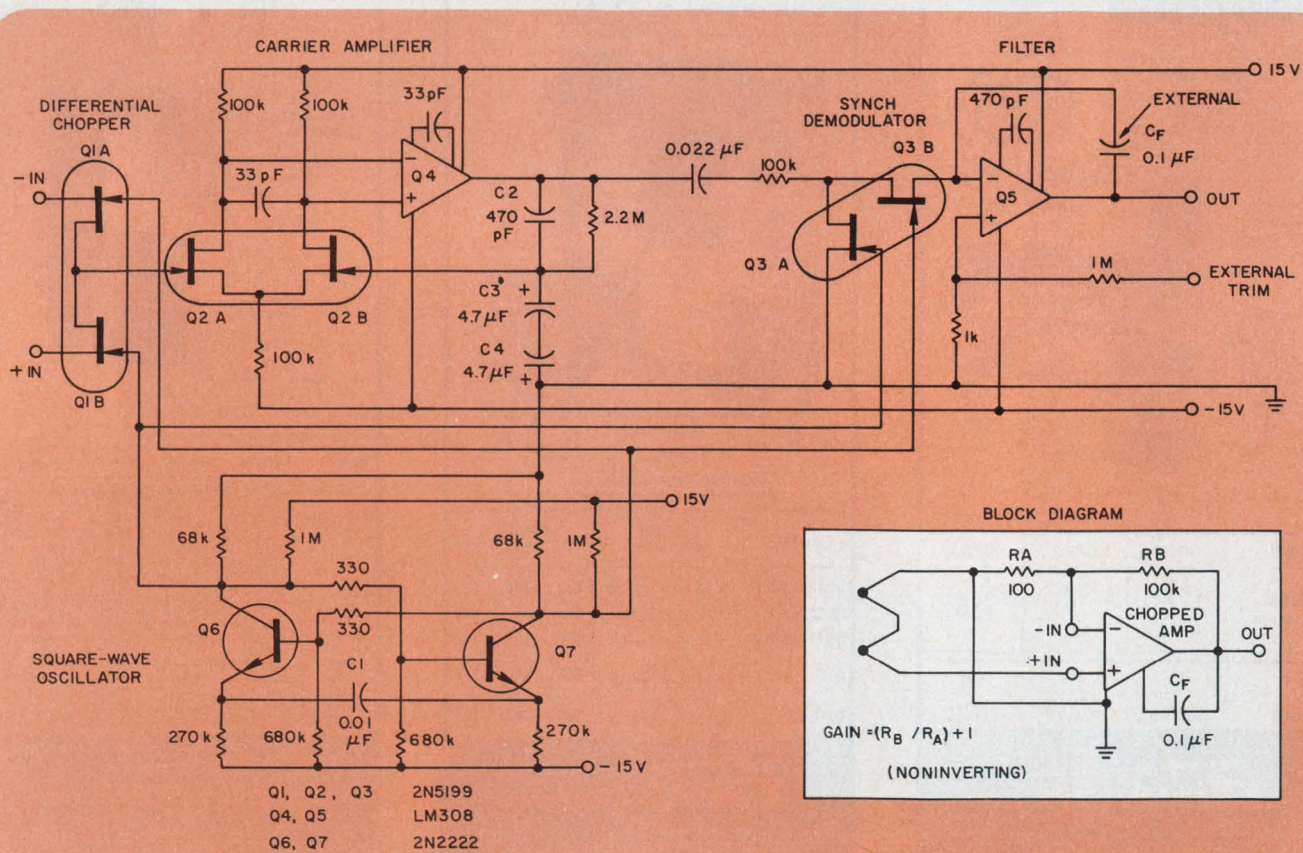

A thermocouple chopper amplifier needs no chopper-spike compensation because of the symmetry

of its switching circuits. External capacitor C_F determines the circuit's bandwidth.

Don't let offset voltage eat up your error budget!

Precision instrumentation can be only as precise as its components and the sum of their error specs. That's why we want you to consider specifying our monolithic OP-07—the industry's standard of Op Amp excellence—in your next system. Especially if you're working with low level (μV range) signals.

NO POT NEEDED! We zener-zap trim every OP-07 chip to give it the exact performance specs you find on the data sheet. There's no nulling, no trimming, and *no pot* to worry about. **SPECS?** Compare these to any real part:

V_{os} $10\mu\text{V}$
 TCV_{os} $0.2\mu\text{V}/^\circ\text{C}$
Stability..... $0.2\mu\text{V}/\text{mo.}$
Noise..... $0.35\mu\text{V}/\text{p-p}$

Precision Monolithics, Inc.
1500 Space Park Dr.
Santa Clara, CA 95050
(408) 246-9222
TWX: 910-338-0528
Cable MONO.



SECOND SOURCE? You'll find an "equivalent" data sheet on page 12-184 of the 1976 Fairchild catalog. Our price is \$7 (100's) and since we've been in high volume production for over two years, we deliver from stock. Send a P.O. Literature and application notes are yours by simply circling the reader card number; for a sample order, call your PMI distributor.



Logic circuit ensures definite break-before-make action for relay drive

The 4-bit-binary to 16-line decoder (Fig. 1) provides the definite break-before-make action that is usually needed when the circuit drives relays. If a logic circuit's turn-off time is equal to or slower than its turn-on time, the circuit can unintentionally produce two active ON positions at the same time. This may lead to welded relay contacts.

Under quiescent conditions, the same 4-bit binary number is present at both the input and output of the quad latch, IC₁. If the input changes, the 4-bit comparator output (pin 6 of IC₂) goes LOW. The negative transition triggers a one-shot, IC₄. One of the one-shot outputs temporarily in-

hibits outputs from the decoders (IC₅ and IC₆). The other enables a new binary input number to appear at the output of the quad latch. The decoders are again enabled when the one-shot resets.

The time interval between the circuit's release of one relay and actuation of a second is determined by the one-shot's pulse duration. This interval should be twice the relay's drop-out time, or for solid-state relays, two power cycles.

Thomas Neal, Test Engineer, Beckman Instruments Inc., 2500 N. Harbor Blvd., Fullerton, CA 92634.

CIRCLE No. 313

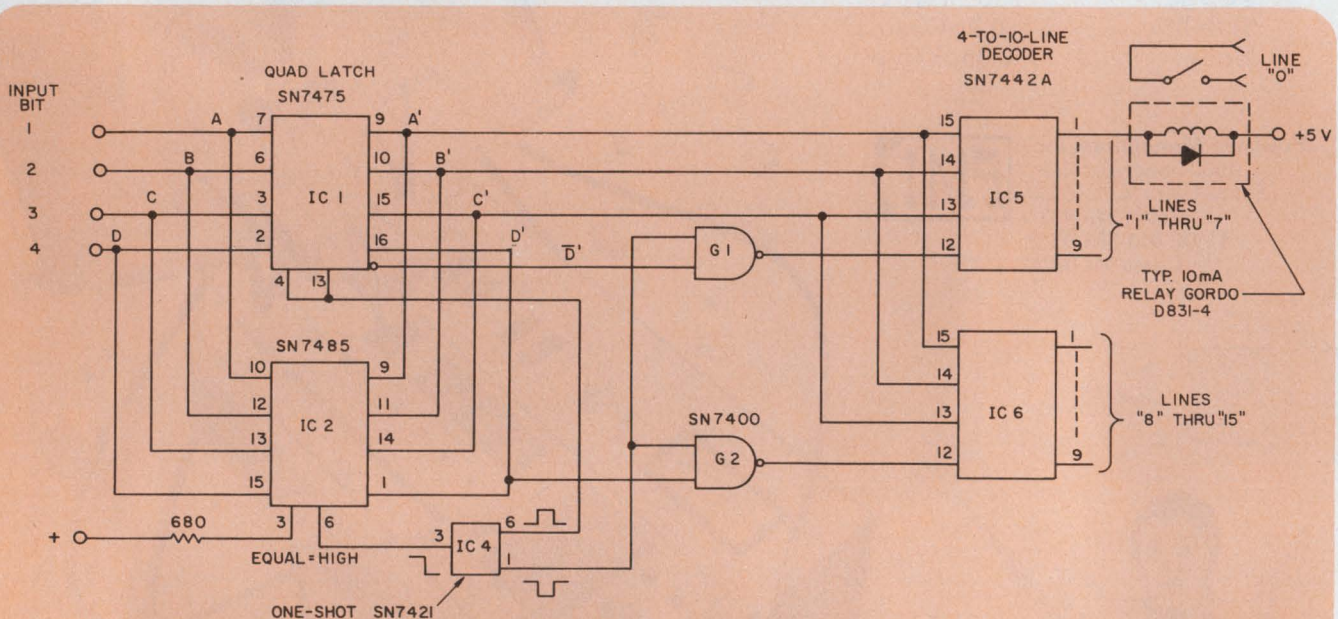

1. This circuit's break-before-make action ensures that no more than one relay is energized at any one

time by the 4-to-16-line decoder drive. The one shot determines the timing between activations.

IFD Winner of March 29, 1976

Gerald L. Vano, Systems Engineer, Alden Research Foundation, 117 N. Main St., Brockton, MA 02403. His idea, "Digital Frequency Doubler Works to 100 kHz" has been voted the Most Valuable of Issue Award.

Vote for the Best Idea in this issue by circling the number of your selection on the Reader Service Card at the back of this issue.

SEND US YOUR IDEAS FOR DESIGN. You may win a grand total of \$1050 (cash)! Here's how. Submit your IFD describing a new or important circuit or design technique, the clever use of a new component or test equipment, packaging tips, cost-saving ideas to our Ideas for Design editor. Ideas can only be considered for publication if they are submitted exclusively to ELECTRONIC DESIGN. You will receive \$20 for each published idea, \$30 more if it is voted best of issue by our readers. The best-of-issue winners become eligible for the Idea of the Year award of \$1000.

Which of these spring contacts can you get from Instrument Specialties?

None of them! (But we'll make some just for you!)

Sorry, we can't sell you any of the springs shown here. They're all proprietary. Each was designed for a specific application at a particular company. A very particular company. Which is why each one came to I/S!

But I/S can do the same *kind* of thing for you. Specialists in the design and manufacture of beryllium copper springs, we can create springs with your choice of many types of gold, silver, or other precious metal contacts.

Perhaps you require large welded contacts, with precious metal bonded to inexpensive base material. Or, small welded contacts in which precious metal is welded directly to the spring. Or, riveted contacts offering close tolerances with either single or double headed contacts. Instrument Specialties supplies all of them!

One other thought: Sometimes, you may *think* you need welded or riveted contacts. However, our engineers may feel that our CONTIP® bonding technique, or our gold selective plating process, or the use of inlay material, can meet your needs at considerably less cost. If so, we'll tell you that, too.

Our latest catalog contains complete information on all types of I/S spring contacts. For your free copy, circle the Reader Service Card or write us at Dept. ED-81.

Specialists in beryllium copper springs since 1938

CIRCLE NUMBER 39

INSTRUMENT SPECIALTIES CO., INC.
Little Falls, New Jersey
Phone 201-256-3500



Process boosts IC packing densities

Higher packing densities for integrated circuits may be possible through the use of a metal-removal developed by Siemens. The Siemens technique removes aluminum layers as thick as $1\ \mu\text{m}$ and gives conductor spacings of only $1.25\ \mu\text{m}$. These dimensions contrast with a minimum conductor spacing of the standard chemical etching process of $3\ \mu\text{m}$ and a maximum layer removal per etch of $0.25\ \mu\text{m}$.

In the Siemens process the substrate (a-1 in the photo) is first coated with an intermediate layer of aluminum $0.02\text{-}\mu\text{m}$ thick (a-2), on top of which the photoresist

mark (a-3) is applied. Those parts of the intermediate layer not covered with resist are then etched out, as in b.

Next, the substrate is coated with a $1\text{-}\mu\text{m}$ layer of aluminum (c-4), which forms on top of the remaining photoresist and also on the substrate from which the intermediate layer was removed. The photoresist is then dissolved, taking with it those portions of the $1\text{-}\mu\text{m}$ layer deposited upon it (d).

This leaves only the aluminum patterns of the $0.02\text{-}\mu\text{m}$ intermediate layer and the $1\text{-}\mu\text{m}$ final layer. The intermediate layer is then removed, leaving the final $1\text{-}\mu\text{m}$

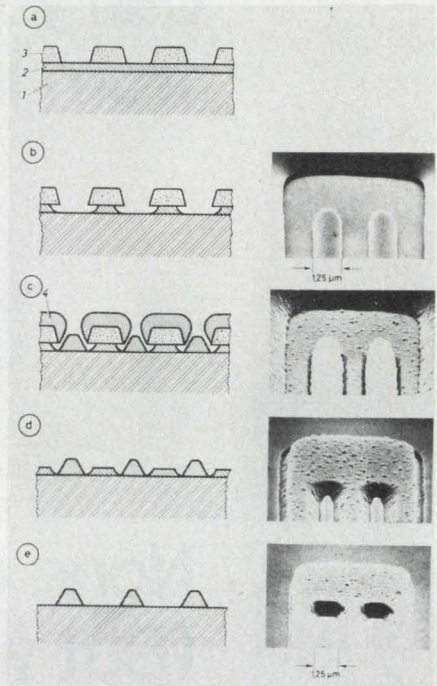

5V OR $\pm 15V$ POWER FOR PCB'S



Mount these mini power modules, as small as $2.3'' \times 1.8'' \times 1.0''$, directly on printed circuit boards to save space and simplify wiring. Ratings at 5 volts from .250 to 2.5 amps; at ± 15 volts from .025 to .5 amps. Short circuit protected. Prices start at \$24. Guaranteed 3-day shipment.

Acopian

Corp., Easton, Pa. 18042 Tel: (215) 258-5441

MATCHED OR DISSIMILAR DUAL OUTPUT



Select the combination of matched or dissimilar outputs that you require. Hundreds of ratings available, from 1.5 to 150 volts. Outputs are isolated, and may be used in the same or opposite polarities. Acopian's 3-day shipment promise applies for any combination.

Acopian

Corp., Easton, Pa. 18042 Tel: (215) 258-5441

thick conductor pattern.

The Siemens process results in slanting, conductor edges rather than vertical ones, and that facilitates the application of the additional coatings required for multi-layer devices.

Semi amplifier developed for IR thermal imagers

A single-chip semiconductor amplifier with a 15-GHz gain-bandwidth and a low noise-figure of $1 \text{ V/Hz}^{1/2}$ has been developed for infra-red thermal imagers that use cadmium-mercury-telluride detectors and serial CCD memories.

Produced by Ferranti Ltd., under a Ministry of Defense contract, the amplifier requires an external resistor to set the gain between 40 and 60 dB. The specified gain of 60 dB is accurate to within 1 dB for a 90% confidence level.

The high gain-bandwidth product, according to designer Stephen Harding, is due to the high-density CDI bipolar fabrication process

pioneered by Ferranti.

For higher than 60 dB gain, the amplifiers can be cascaded. Each device draws about 2 mA.

Ion implant equipment can handle 6-in. wafers

Ion-implantation equipment that can handle unusually large wafers—up to 6-in. in dia.—has been developed by Lintott Engineering in conjunction with the Harwell Research Laboratories in England. Lintott says that the equipment will have a higher throughput than any system currently available—typically 400 2-in. wafers or 200 3-in. wafers per hour. In addition, doping uniformity from wafer to wafer is better than 1%.

To conform to United States safety regulations, the target chamber is held at ground potential. The implantation accelerating potential is 160 kV. The control system uses optical-fiber links and servomechanisms for maximum isolation.

Present equipment operates auto-

matically except for specimen handling, and work is in progress to automate that.

New fail-safe method used in controller

A self-checking controller configuration for high-reliability systems uses a new approach—the dual fail-safe technique—that combines two fail-safe controllers. The dual system, according to Cambridge Consultants in Cambridge, England—the developers—is fully fault tolerant. (Conventional techniques such as triple modular redundancy were rejected as too expensive and inefficient.)

In each fail-safe controller every element is self-checking. The controllers react to an input signal by matching it with signal-verification data in a special memory.

A new memory architecture was devised to perform this verification function. The controller was developed as part of a study commissioned by the European Space Agency.

RACK MOUNT POWER ...TO 60 AMPS

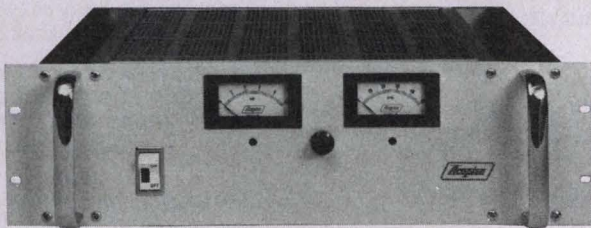

Designed for mounting in standard 19" RETMA cabinet racks, these power supplies are available in 76 different output ratings from 1 to 50 volts, and from 5 to 60 amps. Regulation, $\pm 0.05\%$ or better; ripple, 1 mV rms or better. Options include metering and overvoltage protection. Shipment, 9 days after receipt of your order.

Acopian

Corp., Easton, Pa. 18042 Tel: (215) 258-5441

GUARANTEED 3 DAY SHIPMENT

ACOPIAN

**POWER
SUPPLY
CATALOG
1976-1977**

Every power module listed in the Acopian 48-page catalog is shipped within 3 days of order. Guaranteed! Miniaturized supplies, narrow profile and plug-in modules, premium performance models, and a wide choice of other types are described in detail. Ask for your copy.

Acopian

Corp., Easton, Pa. 18042 Tel: (215) 258-5441

CIRCLE NUMBER 143

ELECTRONIC DESIGN 16, August 2, 1976

CIRCLE NUMBER 144

83

Arrow-M Amber Relays

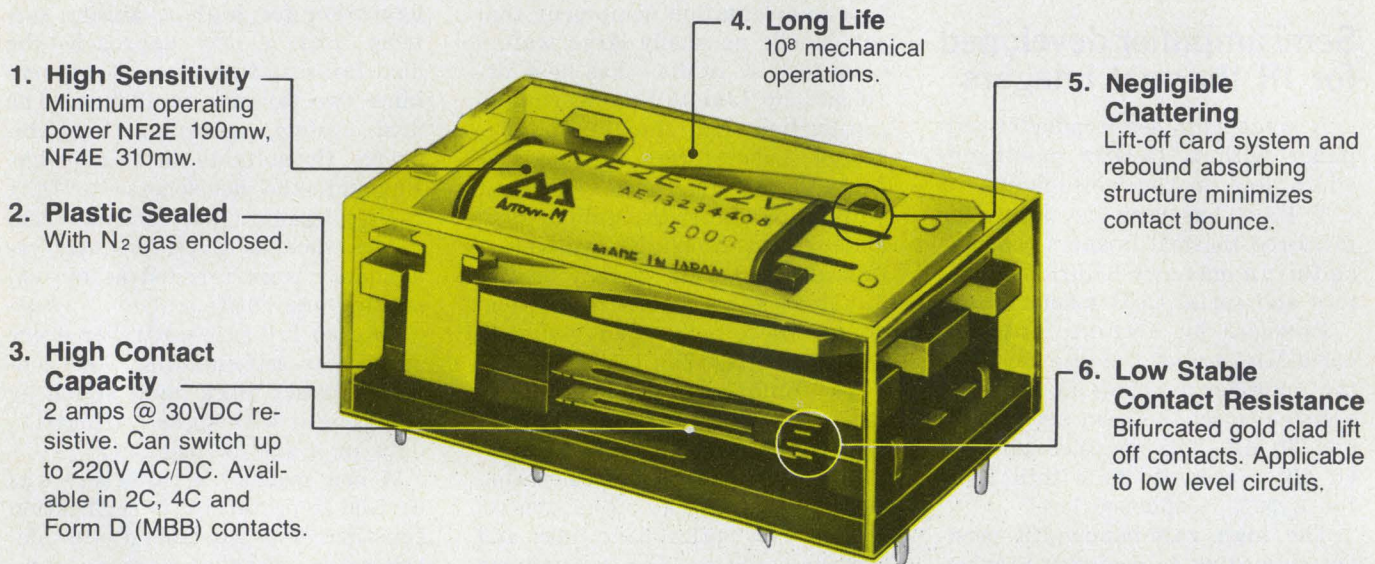

Sound advice for the alarm industry.

You know better components make a better alarm system. So it pays to install the most reliable relays available today: Arrow-M NFE Amber Relays . . . supported by our unique and advanced manufacturing techniques. They offer you:

Reliability — The secret is a unique automated modular assembly coupled with lift off bifurcated contacts and a rebound absorbing mechanism. Installed in a sensitive alarm, it can go unused for long periods of time and still work when needed.

Sensitivity — NFE Amber Relays use only half the power of ordinary relays.

Automatic Wave Soldering — NFE Amber Relays are plastic sealed with N₂ gas.

High Packaging Density PC Board Mounting — flatpack NFE Amber Relays are only 0.425 inches high.

The proven dependability and sensitivity of Arrow-M Amber Relays is based on more than 50 years of meeting the advancing needs of modern technology. So for relays that make it easier to make a better alarm, rely on Arrow-M NFE Amber Relays.

For evaluation samples, or for more information on exact specifications, write or call your nearest Arrow-M office.

Arrow-M Corporation
250 Sheffield Street
Mountainside, N.J. 07092
(201)232-4260

Western Office:
22010 S. Wilmington Ave.
Suites 300 & 301
Carson, Calif. 90745
(213) 775-3512



Member of Matsushita Group

Relays for Advanced Technology

CIRCLE NUMBER 40

New Products

Inductosyn/digital converter modules offer top resolution

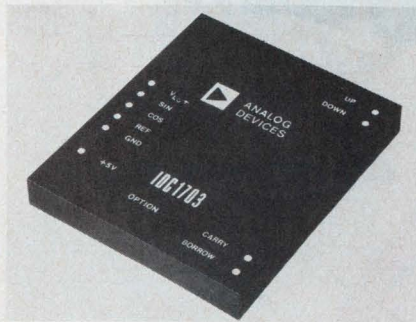

Analog Devices, Rte. 1 Industrial Park, P.O. Box 280, Norwood, MA 02062. (617) 329-4700. See text; stock (only available in U.S. and Canada).

Combining what is claimed to be the highest resolution and smallest size, the IDC1701 and IDC1703, Inductosyn-to-digital converters also offer the lowest cost—only \$350 in singles. The modules, made by Analog Devices, offer 12-bit resolution and a package size of $2.625 \times 3.125 \times 0.4$ in. ($29.3 \times 66.6 \times 10.2$ mm).

The Inductosyn, originally developed and patented by Farand (Valhalla, NY) is a linear distance transducer that uses air coupling between flat coil windings. The 1701 converter delivers a 12-bit parallel output and an up/down serial output. The 1703 only offers an up/down serial output that is scaled to 4000 pulses per period instead of 4096.

Both units have a tracking rate of 150 revolutions/s, which corresponds to a slew rate of 33.3 cm/s for an Inductosyn pitch of 2 mm. Any carrier frequency between 2 and 10 kHz can be used to excite the Inductosyn transducer. Accuracy of the converters is ± 9 arc minutes.

Only 400 mW at 5 V dc is required to power the converters over an operating range of 0 to 70 C. Two external differential amplifiers

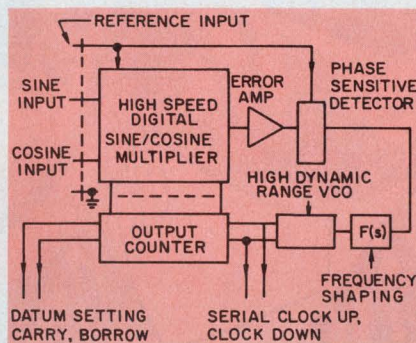

and a current amplifier are needed to complete the type II servo loop needed for operation.

Aside from complete Inductosyn systems such as offered by Farand for several thousand dollars, ILC Data Devices Corp. (Bohemia, NY) also produces Inductosyn-to-digital converter modules, the IDC101, and 102. The 101 produces 4000 pulses per cycle in a BCD output format while the 102 delivers 4096 pulses in a straight binary format. Both models cost \$495. The price, though, includes a second module with the necessary buffer amplifiers and isolation transformers.

The Analog Devices' modules and the DDC units use two different methods to arrive at equivalent digital outputs. The 1701 and 1703 from Analog Devices require a current generator op amp on the primary side of the Inductosyn and two differential amplifiers on the secondaries.

The 101 and 102, from DDC, on the other hand have two current drivers built into the main module that send signals into the Inductosyn secondaries and use a single amplifier on the primary side to pick up the difference signals. Both companies claim their method works best, so make your choice carefully.

Analog Devices **CIRCLE NO. 340**
 ILC Data Devices **CIRCLE NO. 341**
 Farand **CIRCLE NO. 342**

Photodetector/amplifier boasts 50-MHz BW

Applied Science Corp., 883 Commercial St., Palo Alto, CA 94303. (415) 494-6154. \$225 (unit qty.); stock.

Model DA-60 is a silicon photodetector/amplifier that has a bandwidth in excess of 50 MHz. Its responsivity is $3 \text{ mV}/\mu\text{W}$ at a wavelength of 900 nm. The DA-60 is housed in a metal enclosure that will fit standard 1.25 in. diameter optical eyepiece mounts. In addition, detector centering adjustment screws, input power filters and a coaxial output connector are provided.

CIRCLE NO. 343

Telephone-tone filters offer many options

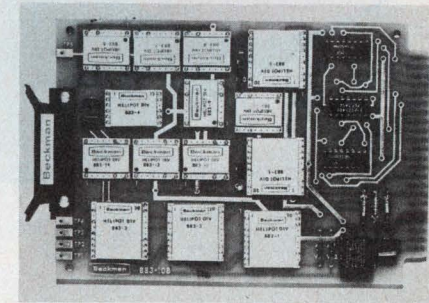

Beckman, 2500 Harbor Blvd., Fullerton, CA 92634. (914) 871-4848. 100-up prices: from \$8.20 to \$240.60; stock to 8 wks.

The series 883 hybrid tone-receiver circuits are available as individual modules or assembled on a completely pretested, ready-to-use card. Included are a dial-tone reject filter (883-1), a low-band filter (883-2), a high-band filter (883-3), a dual limiter (883-4), eight band-pass filters (883-6 to 16), and a quad tone detector (883-5). Two additional products, Models 883-107 and 883-108, are available as a set of series 883 hybrids together on PC boards with other required components forming a complete tone-decoder subsystem. The hybrids meet Bell System requirements for application in its central office equipment manufactured by Western Electric. They also satisfy the requirements of other major and independent manufacturers of telephone equipment in supporting their respective operating companies (e.g., GTE Automatic Electric).

CIRCLE NO. 344

SUPER ROM



Faster than a speeding MPU!

Here is the 16K ROM of the future.

With a maximum access time of 450 ns, the S6831 is ready for this generation of microprocessors—and the next! And it's an unbeatable ally of sophisticated calculators and other demanding applications.

Four versions of this speedy marvel give you pinout compatibility with all the slower 16K ROMs. And a turnaround time of eight weeks means you can improve your product in a hurry.

Whether you're building an AMI 6800 micro-computer or another powerful system that needs fast, low-power memory, our 16K ROM will give you:

Maximum access time of 450 ns

Low power of 150 mw average

S6831 is pinout similar to the S6830 (8K)

S6831A is pinout compatible with the Intel 2316A and 8316A

"SEE US AT BOOTH #1092-1094 AT THE WESCON SHOW"

S6831B is pinout compatible with the Intel 2316B and 8316B

S6831C is pinout compatible with the EA4600

N-Channel silicon gate depletion load technology

2K x 8 bit organization

Static operation

Three-state data output

Three chip enable inputs

Single 5-volt power supply

TTL compatible Input/Output

Want to get SuperROM on your side? Step into a phone booth and call your nearest AMI distributor or sales office. Or write to AMI, 3800 Homestead Road, Santa Clara CA 95051.

It's a sure way to fight obsolescence.

**it's
standard
at AMI.**

AMERICAN MICROSYSTEMS, INC.

Here's AMI:

SALES OFFICES

Long Beach CA • (213) 595-4768
 San Jose CA • (408) 249-4550
 Altamonte Springs FL • (305) 830-8889
 Elk Grove Village IL • (312) 437-6496
 Norwood MA • (617) 762-0726
 Livonia MI • (313) 478-9339
 Minneapolis MN • (612) 559-9004
 Monsey NY • (914) 352-5333
 Cleveland OH • (216) 292-6850
 Ambler PA • (215) 643-0217
 Richardson TX • (214) 231-5721

DISTRIBUTORS

ARROW ELECTRONICS:
 Minnesota—Bloomington (612) 888-5522
CENTURY ELECTRONICS:
 New Mexico—Albuquerque (505) 292-2700
 Utah—Salt Lake City (801) 487-8551
CESCO ELECTRONICS, LTD.:
 Canada—Montreal (514) 735-5511
COMPONENT SPECIALISTS, INC.:
 Texas—Dallas (214) 357-4576
 Houston (713) 771-7237
INTERMARK ELECTRONICS:
 Washington—Seattle (206) 767-3160
SCHWEBER ELECTRONICS:
 California—Costa Mesa (213) 924-5594
 and (714) 556-3880
 Connecticut—Danbury (203) 792-3500
 Florida—Hollywood (305) 927-0511
 Georgia—Atlanta (404) 449-9170
 Illinois—Elk Grove Village (312) 593-2740
 Iowa—Cedar Rapids "Lorenz Sales"
 (319) 393-6912
 Maryland—Rockville (301) 881-3300
 Massachusetts—Waltham (617) 890-8484
 Michigan—Troy (313) 583-9242
 Minnesota—Edina (612) 941-5280
 New Jersey—Somerset (201) 469-6008
 New York—Rochester (716) 461-4000
 Westbury (516) 334-7474
 Ohio—Beachwood (216) 464-2970
 Texas—Austin (512) 837-2890
 Dallas (214) 661-5010
 Houston (713) 784-3600
 Canada—Mississauga, Ont. (416) 678-9050
SEMICOMP CORP.:
 California—Newport Beach
 (213) 971-5253 and (714) 833-3070
STERLING ELECTRONICS:
 Arizona—Phoenix (602) 258-4531
 Louisiana—Metairie (504) 887-7610
 Massachusetts—Watertown (617) 926-9720
 New Jersey—Perth Amboy (201) 442-8000
 New Mexico—Albuquerque (505) 345-6601
 Texas—Dallas (214) 357-9131
 Houston (713) 627-9800
 Virginia—Richmond "Meridian Electronics"
 (804) 359-0221
R.V. WEATHERFORD CO.:
 Arizona—Phoenix (602) 272-7144
 California—Anaheim (714) 547-0891
 Glendale (213) 849-3451
 Palo Alto (415) 943-5373
 Pomona (714) 623-1261
 San Diego (714) 278-7400
 Colorado—Englewood (303) 761-5432
 New Mexico—Albuquerque (505) 842-0868
 Texas—Dallas (214) 243-1571
 Houston (713) 688-7406
 Washington—Seattle (206) 243-6340

REPRESENTATIVES
AMMON & RIZOS:
 Oklahoma—Oklahoma City (405) 373-2748
 Texas—Dallas (214) 233-5591
 Houston (713) 781-6240
BARNHILL FIVE:
 Colorado—Denver (303) 426-0222
BENEKE & McCALL:
 Missouri—Grandview (816) 765-2998
 St. Louis (314) 567-3399
CAN TEC REPRESENTATIVES, INC.:
 Ontario—Milton (416) 457-4455
 Ontario—Ottawa (613) 225-0363
 Quebec—Pierre Sonds (514) 620-3121
COULBOURN DEGREIF, INC.:
 Maryland—Baltimore (301) 247-4646
HADDEN ASSOCIATES:
 California—San Diego (714) 565-9445
HECHT, HENSCHEN & ASSOCIATES, INC.:
 Arizona—Phoenix (602) 275-4411
LOWREY & ASSOCIATES:
 Michigan—Brighton (313) 227-7067
MASIN-ESCO, INC.:
 New Jersey—North Caldwell (201) 226-2550
 New York—Syosset (516) 364-0310
NORTHWEST MARKETING ASSOCIATES:
 Washington—Bellevue (206) 455-5846
OASIS SALES, INC.:
 Illinois—Elk Grove Village (312) 640-1850
PRECISION SALES COMPANY:
 New York—Syracuse (315) 458-2223
REP. INC.:
 Alabama—Huntsville (205) 881-9270
 Georgia—Tucker (404) 938-4358
 North Carolina—Raleigh (919) 851-3007
TECHNICAL REPRESENTATIVES, INC.
 Indiana—Indianapolis (317) 849-6454

MODULES & SUBASSEMBLIES

Hybrid d/a converter takes 12-bits at 3 MHz

ILC Data Device Corp., Airport International Plaza, Boheima, N.Y. 11716. (516) 567-5600. From \$75 (1 to 9); stock.

The DAC-S, a 12-bit d/a converter can be clocked at throughput rates of 3 MHz. It is available in hermetically-sealed, 24-pin double DIPs. The unit is complete with its own temperature-compensated internal reference and output amplifier. The hybrid converted has pin-programmable voltage outputs of ± 2.5 , ± 5 , ± 10 , 0 to $+5$ or 0 to $+10$ V. Its gain temperature coefficient is ± 20 ppm/ $^{\circ}$ C (max.) and the offset drift is ± 10 ppm of full-scale reading/ $^{\circ}$ C. In the current-output mode, settling time is 300 ns, while voltage output units settle to within 0.1% in 5 μ s (for a full-scale change). Digital inputs are DTL/TTL compatible and are standard TTL one-unit load. For unipolar configurations, the coding is complementary straight binary or BCD; for bipolar it is complementary offset binary. Operating temperature ranges of 0 to 75 and -25 to $+85$ C are available.

CIRCLE NO. 345

Display assemblies have 0.6-in.-high characters

Instrument Displays, Div. of Keltron, 225 Crescent St., Waltham, MA 02154. (617) 894-1577. See text; stock.

From two to eight decades of numeric displays are available in the SD series of display assemblies. The LED numeric characters are 0.6 in. high and center-to-center mounting distances are only 0.6 in. A four-decade display typically can mount in a panel cutout of 3.25 \times 2.1 in., and has a depth of 3.2 in. Typical cost of a SD series four-digit display would be \$68 in quantities of 25 assemblies. There are four versions available: the SD, which has the decoder-driver and display; the SDM, which also includes a latch; the SDC, which has a unidirectional 15 MHz counter and display decoder-driver; and the SDCM, which has the counter, latches and decoder-driver.

CIRCLE NO. 346

SOMETIMES OUR STANDARD POWER SUPPLIES

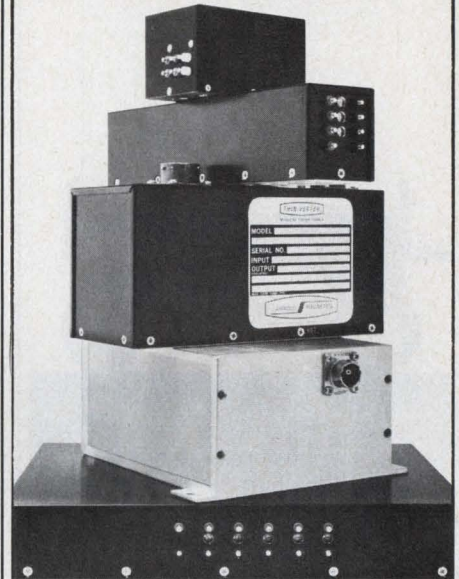

ARE A LITTLE SPECIAL!

For special electrical and/or mechanical power supply needs, Arnold Magnetics is hard to beat. Our unique modular concept allows us to mix our standard modules with specials to meet custom design requirements. The result is reduced engineering costs, fast deliveries and proven performance. And with over 1200 possible standard configurations a special from someone else may be just another standard for us.

- Single or dual inputs:
115 VAC, 47-500 Hz.
12, 18, 48, 115, 150 VDC.
- Multiple isolated and regulated DC outputs from 4.2 to 300 VDC.
- Line & load regulation to 0.1%.
- Up to 400 watts per output.
- Efficiencies to 85%.
- Completed units provided in tested and encapsulated, conduction cooled packages.

Call or write for more information today!



ARNOLD MAGNETICS CORPORATION

11520 W. Jefferson Blvd.
 Culver City, Ca. 90230 • (213) 870-7014

CIRCLE NUMBER 42

a little A-300 goes a long way.

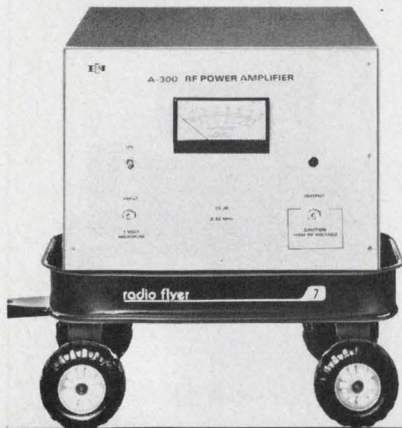

In high frequency transmission. RF power generation for industrial and research processes. RFI/EMI and general laboratory applications, too.

The Model A-300 is a totally solid state power amplifier, covering the frequency range of 0.3 to 35MHz with a gain of 55dB. Capable of delivering 300 watts of linear Class A power and up to 500 watts in the CW and pulse mode, the A-300 is the ultimate in reliability.

Although the unit is perfectly matched to a 50 ohm load, it will deliver its full output power to any load (from an open to a short circuit) without oscillation or damage.

Complete with power supply, RF output meter and rack mount, the A-300 weighs a mere 89 pounds and operates from ordinary single phase power.

High power portability goes a long way for \$5800.

For further information or a demonstration, contact ENI, 3000 Winton Road South, Rochester, New York 14623. Call 716-473-6900 or TELEX 97-8283 E N I ROC

ENI SEE Electronic Design's **GOLD BOOK** FOR COMPLETE PURCHASING INFORMATION.

The World's Leader in Power Amplifiers

CIRCLE NUMBER 43

INSTRUMENTATION

Linear IC tester uses program boards



Biomation/Sitek, 10411 Bubb Rd., Cupertino, CA 95014. (408) 255-9500. \$6850; 8 wks.

Model 1440 linear circuit tester uses dedicated program boards to perform large-signal dc tests on a wide range of circuits—both standard and special device types. The company offers a catalog of over 300 standard device numbers for which programs are available. Single, dual, triple and quad devices can be tested on the 1440 under the worst-case limits and conditions specified by the manufacturer. A multipass sequence option permits testing of all sections of multiple devices automatically.

CIRCLE NO. 349

Audio generator offers low distortion



Philips Test & Measuring Instruments, 400 Crossways Park Dr., Woodbury, NY 11797. (516) 921-8880. \$295.

A new low-frequency generator, the PM5107, features a typical distortion figure of 0.02%. The unit provides sine/square wave and TTL outputs in a compact package. Output frequency from 10 Hz to 100 kHz is set by a large fully variable control and range-multiplier pushbuttons to an accuracy better than 4%. Signal amplitudes to a maximum of 2 V for sine waves and 4 V for square waves are set by variable control and a fixed 20-dB attenuator can be pushbutton inserted to simulate output signals.

CIRCLE NO. 350

an investment in capitol buys rugged switch design and long, trouble-free life

For Example!
Our Extremely Dependable, Multiple-Position Push Button Strip Switches

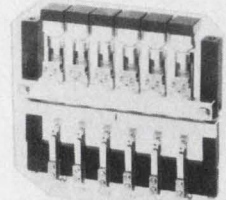

Basic frames are anodized aluminum. Plungers are 5/32" square brass with a nylon actuator molded on them. Hence, they will not bend or warp.

Mechanical linking of all switch positions prevents operation of more than one position at a time. A released button will return to the "up" position before the next button can be actuated. These switches can be illuminated either by an external circuit or directly from the switch. Lamps do not travel when positions are engaged, eliminating shock to the bulb.

Capitol switches are tested with 2 to 3 million operations to assure life-long, trouble-free performance.



Our 28-page catalog will give you all the "specs" on CAPITOL's entire line of quality switches.

CAPITOL manufactures a complete, high-quality line of push button and lever switches — illuminated if desired — standard and custom designs to fit your every need.

CAPITOL

The Capitol Machine and Switch Co.
87 Newtown Road, Danbury, Conn. 06810
Phone: 203-744-3300

CIRCLE NUMBER 44
ELECTRONIC DESIGN 16, August 2, 1976

Systems DMM takes 30 readings/s

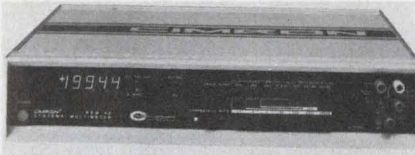

California Instruments, 5150 Convoy St., San Diego, CA 92111. (714) 279-8620. \$995; stock to 30 days.

DSM 44 4-1/2-digit systems multimeter offers noise rejection of 60 dB at dc reading rates of up to 30 per second. Also provided are five ranges of dc V and three-wire dc/dc ratios as standard. Optional are: Ac V (true rms or average reading), true four-wire resistance, bipolar four-wire dc/dc ratio, ac/ac ratio (true rms or average reading), ac/dc ratio and dc/ac ratio. System features include priority remote, data storage, self-programmed delays, gate line, false-program indication and more.

CIRCLE NO. 351

LRC meter uses μP to take on new look

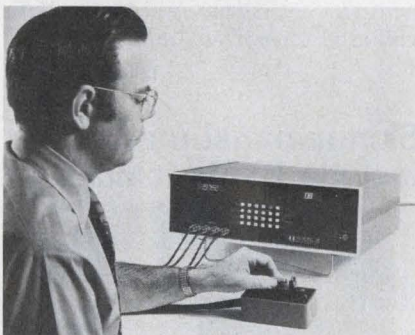

Electro Scientific Industries, 13900 NW Science Park Dr., Portland, OR 97229. (503) 646-4141. Under \$5000; 60-90 days.

Model 296 μP -controlled LRC meter measures R, L, C, G, and calculates D and Q. Programmable limits option allows up to 10 comparison values to be set for multi-band sorting. Deviations can be displayed in percentage or in units. The addition of the IEEE 488-1975 interface option modifies the unit for automatic component testing applications. Standard features include autoranging, dual frequency (1 kHz and 120 Hz), two selectable test voltage/current levels and two 4-1/2-digit readouts. Measurement speed is 70 to 300 ms.

CIRCLE NO. 352

ELECTRONIC DESIGN 16, August 2, 1976

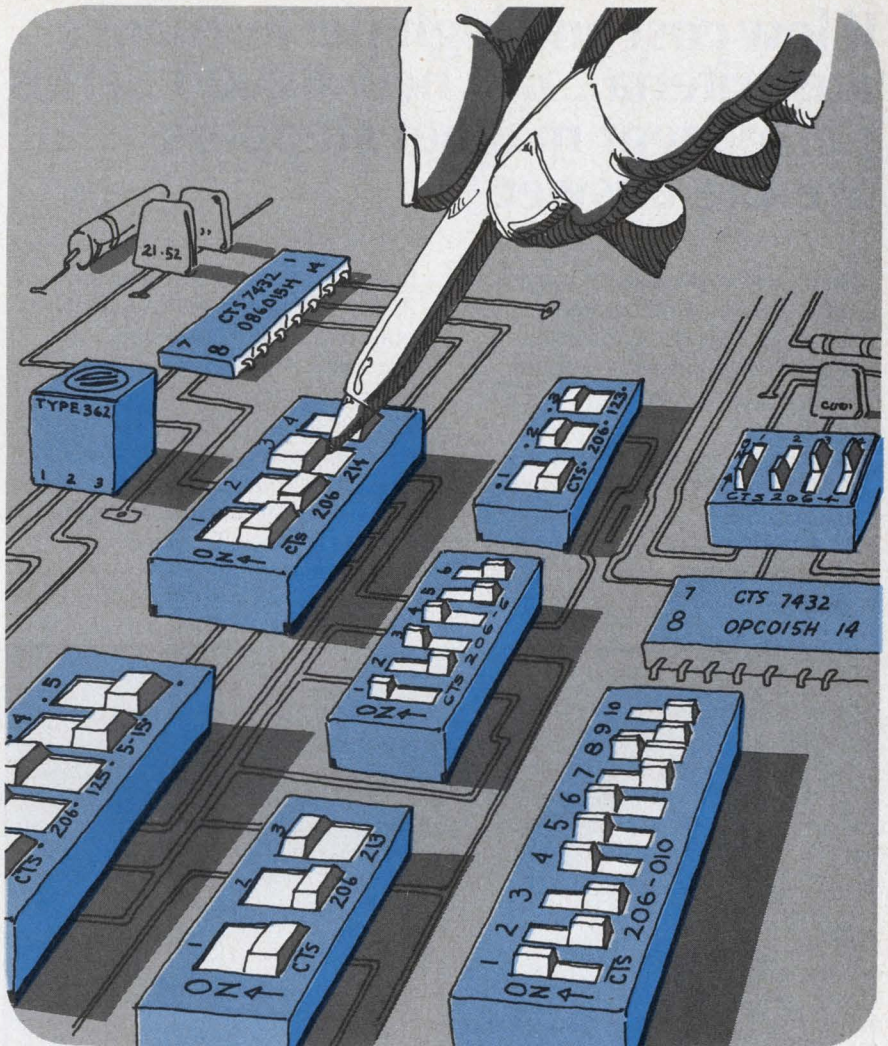

Take your pick... DPST, SPDT or SPST programmable DIP switches

CTS offers them all... with the addition of NEW 2, 3, 4 and 5 section SPDT and DPST switch styles.

A total of 15 Series 206 DIP switch packages are now available from CTS... 7 with SPST actuation, 4 with SPDT actuation and 4 with DPST actuation. All have .100" by .300" centers for PCB or standard DIP socket insertion. Gold plated contacts with nickel barrier assure lowest contact resistance throughout life.

All provide crisp slide actuation and reliable, positive contact wiping

action. Program up to 10 different logic functions with one compact SPST package or up to 5 SPDT or DPST functions with the identical size package.

Use the quality, reliable CTS Series 206 for your next computer, computer peripheral, communication or test equipment switch application. Available from the factory or off the shelf from CTS Distributors. For complete information, write CTS KEENE, INC., 3230 Riverside Avenue, Paso Robles, CA 93446. Phone: (805) 238-0350.

CTS CORPORATION
ELKHART, INDIANA
A world leader in cermet technology



CIRCLE NUMBER 45

If low cost and high performance are criteria... our new 82000 Series permanent magnet steppers are the answer.

Here's a new permanent magnet stepper motor line created to meet the design needs of analytical instrumentation and computer peripherals. Applications include tape drives, printer and chart drives and optical disc drives. Both 5 volt and 12 volt models are available.

All utilize 4-phase stators and permanent magnet rotors. Most

have 24-pole rotor construction. As a result, they offer excellent pull-in rates and good stepping accuracy. Another advantage is low temperature rise...over 50% lower than comparable variable reluctance stepper motors operating on a similar duty cycle. Gear boxes can be furnished to meet varying torque and speed requirements.

Write for information today!

Available pull-in torques from .750 oz-in. to 7.50 oz-in.
Available stepping rates from 210 steps/sec to 440 steps/sec.

Our 4-page *Permanent Magnet Logic Stepper Motor* catalog provides all basic details including performance data and charts, dimensional drawings, as well as electronic drive information. Send for a copy.

ES — 4-Phase Logic Drive
models for analytical
computer peripherals.

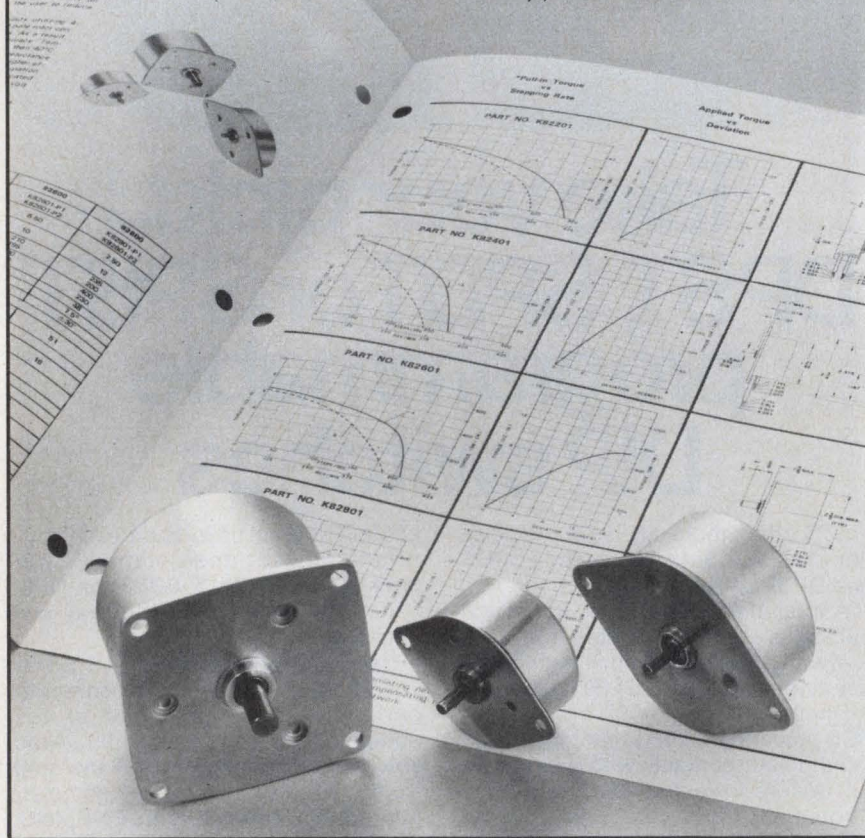

A. W. HAYDON CO. PRODUCTS

NORTH AMERICAN PHILIPS CONTROLS CORP.

Cheshire, Conn. 06410 • (203) 272-0301

CIRCLE NUMBER 46

INSTRUMENTATION

Benchtop tester handles mixed components



GenRad, 300 Baker Ave., Concord, MA 01742. (617) 369-4400. Starts at \$14,500.

The GR 2230 is a fully automated, user programmable, benchtop system for high-volume testing of multileaded devices. Using a powerful microcomputer, the DEC LSI-11, the 2230 evaluates, tests, and provides hard copy data for both discrete and hybrid networks. The unit performs mixed measurements on circuits containing resistors, capacitors, inductors, and diodes or transistors. Each component is measured against (individually) specified limits.

CIRCLE NO. 353

Skinny panel meters include DVMs, clocks



Nationwide Electronic Systems, 1536 Brandy Pkwy., Streamwood, IL 60103. (312) 289-8820. Start at \$76.

Clocks from \$76, dc voltmeters from \$87, transducer readouts from \$90: These are quantity-10 prices for the new Slimline indicator-only series. These instruments measure only 4-1/2 x 3-1/2 x 5/16 in. Displays are red-orange, seven-segment LEDs, 0.55-in. standard, 0.75-in. optional. Clocks are available in 4-digit (HR:MIN) or 6-digit (HR:MIN:SEC) models. The DVMs are 3-1/2 digits (1999 counts) with autopolarity and auto-zero. Four models cover from 199.9 mV to 199.9 V with an accuracy of $\pm 0.05\%$ of reading ± 1 count.

CIRCLE NO. 354

Synthesizer goes to 80 MHz in 1-Hz steps

PRD Electronics Div., 6801 Jericho Tpke., Syosset, L.I., NY 11791. (516) 364-0400. \$3498; 2 mos.

A new programmable frequency synthesizer, the PRD 7838, covers 1 kHz to 80 MHz in 1-Hz steps with an output level of 10 mV to 1 V rms into 50 Ω . Stability when locked to the internal frequency standard is 1 part in 10^6 per month, with an optional standard of 5 parts in 10^9 per day. Typical spurious outputs are 70-dB non-harmonic and 40-dB harmonic.

CIRCLE NO. 355

Events delay module spans digital & analog

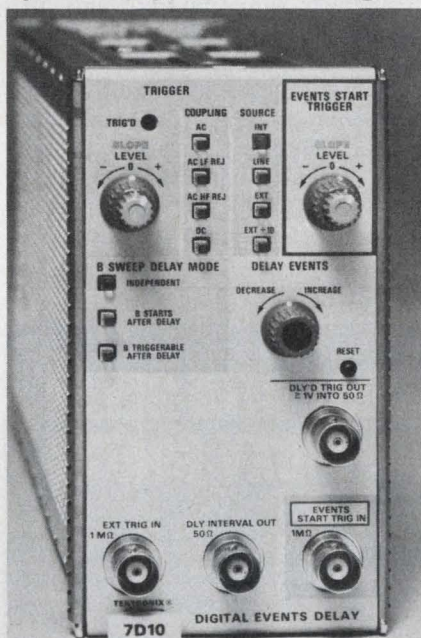

Tektronix, P.O. Box 500, Beaverton, OR 97077. (503) 644-0161. \$925; 10 wks.

With the 7D10 events-delay plug-in, you can verify or identify pulse or word timing in digital systems. The unit operates in both the digital and analog domain. In the digital domain, it identifies transient locations or incorrect logic-state locations. With the company's 7D10 logic analyzer, you can expand the effective memory or delay the memory by a specific number of digital words. In this delay-by-events mode, the 7D10 counts arbitrary trigger events and delivers an output after the preselected count has been reached.

CIRCLE NO. 356

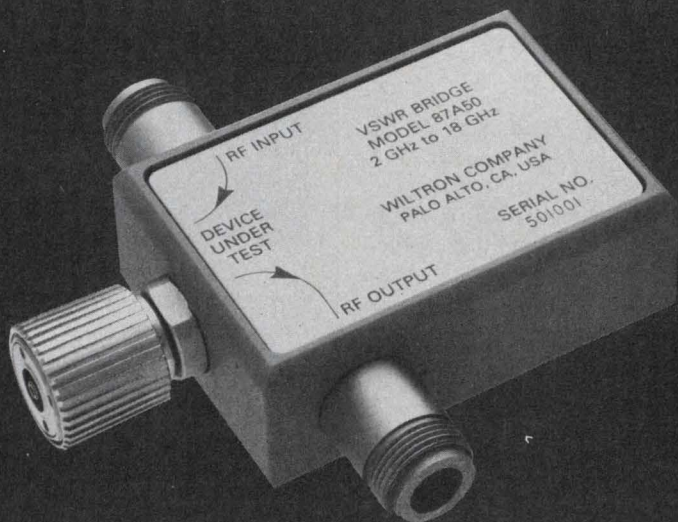

Measure SWR/return loss with 35 dB directivity from 2 to 18 GHz

Over the entire 2 to 18 GHz range, this one new WILTRON 87A50 SWR bridge gives you 35 dB directivity for SWR/return loss measurements.

That's much better than couplers — by about 10 dB.

WILTRON SWR bridges are the way to go. Not only for high directivity but also for coverage all the way down to 50 kHz if you wish.

(If you want the ultimate in swept measurement accuracy, check into our swept precision reflectometer using our Model 58A50 4-port bridge. It also covers 2 to 18 GHz.)

Call Walt Baxter and he'll rush you the literature on the industry's simplest and easiest way to measure SWR and return loss.

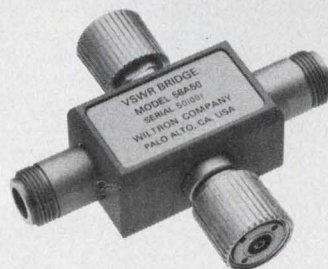

930 E. MEADOW DRIVE • PALO ALTO, CA. 94303 • (415) 494-6666 • TWX 910-373-1156
In Canada: WILTRON Instruments, Ltd.

CIRCLE NUMBER 47

Short 10-turn pots need less space

TRW Inc., 2801 72nd St. N., St. Petersburg, FL 33733. (813) 347-2181. \$4.65 (100 up); stock.

Type 6800 series of 7/8-in. diameter, 10-turn potentiometers, which features a shorter design than earlier units, projects only 11/16-in. behind the mounting panel. The units mount in standard 0.406-in. diameter holes and include integral locating keys that can be cut off if not needed. Construction features include brazed terminations, permanently sealed end lids and a flame-retardant case. Ten standard resistance values from 100 Ω to 100 k Ω have corresponding nominal resolutions from 0.031 to 0.007%. Resistance tolerance is $\pm 5\%$, and independent linearity is $\pm 0.25\%$. A 1% tolerance and 0.1% linearity are available on request. The units have a power rating of 2 W at 40 C and an operating temperature range of -55 to 105 C.

CIRCLE NO. 357

Metal-film resistors meet MIL qualifications

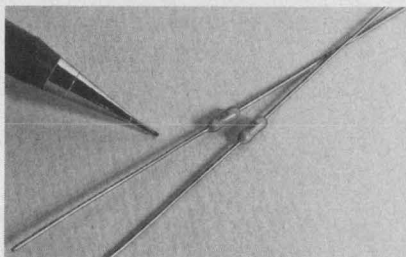

Dale Electronics Inc., Dept 860, Box 609, Columbus, NE 68601. (402) 371-0080.

New metal-film resistors, ERL07, are qualified as RLR07 types in accordance with MIL-R-39017. The new 1/4-W resistors provide an extended resistance range of 10 Ω to 1 M Ω (100 ppm/ $^{\circ}$ C) and tolerances of 1% and 2%. In contrast with competitive models, the ERL07 uses a welded-cap-and-lead assembly that is press-fitted onto each end of the resistor core. This provides both strength and heat resistance and eliminates potential disconnects which can occur on other types of construction, if production soldering is done close to the body, according to Dale.

CIRCLE NO. 358

Cermet trimmer features dust cover

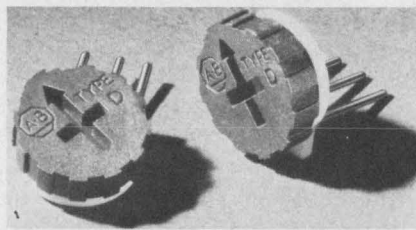

Allen-Bradley Co., 1201 South Second St., Milwaukee, WI 53204. (414) 671-2000. \$0.42 (1000 up); distributor stock.

Allen-Bradley's new Type D cermet trimmer is dust-covered, for use in applications where immersion-sealed types (such as Type E) are not required. It is approximately 3/8 in. in diameter, is rated at 0.5 W at 70 C and has a temperature range of -55 to 125 C. Resistance range is 10 Ω to 2 M Ω . Temperature coefficient is ± 100 ppm/ $^{\circ}$ C. A multifingered wiper provides greater adjustability and low contact-resistance variations. In six configurations, they provide three terminal spacings for top adjust and three for side adjust. Terminals are 0.025-in. dia.

CIRCLE NO. 359

SOLID STATE RELAYS WITH SOMETHING EXTRA

From Elec-Trol, a complete line of 3 to 45 Amp, 120 to 480 VAC output, AC or DC input Solid State Relays and custom designs to meet your needs. All feature: **Zero Crossover Switching** to eliminate RF noise and load current or voltage surges. **Photo Isolation between Input & Output.** **Input Current Limiter** on all DC models prevents relay closure by input transients & increases LED life. **Built-in Snubber Network in Output** prevents uncontrolled operation due to load-line transients. **IC Compatibility and Reverse Polarity Protection** on all DC models. Call or write for complete information today.

26477 N. Golden Valley Road • Saugus, Calif. 91350
(805) 252-8330 • (213) 788-7292 • TWX 910-336-1556

ELEC-TROL, INC.

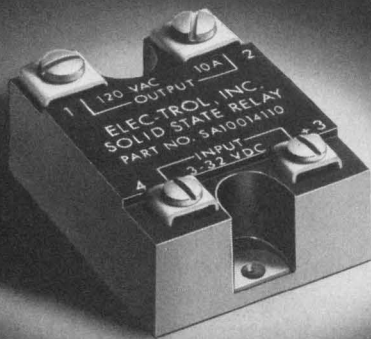

CIRCLE NUMBER 48

NEW LOW COST REED RELAY ROCK HARD EPOXY COATED

\$1.85 to 49¢

Depending on coil voltage, contact level and volume.

Blue Boy Reed Relays offer:

- Protection from handling, solvents, tough environments
- 1 pole normally open contacts up to 10 watts
- General purpose or logic level contacts
- Coil voltages 5 through 48 VDC; .35" H x 1" L

Available from distributors.

26477 Golden Valley Road • Saugus, California 91350
(805) 252-8330 • (213) 788-7292 • TWX 910-336-1556

ELEC-TROL, INC.

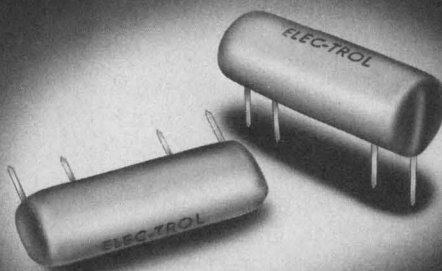

CIRCLE NUMBER 49

ELECTRONIC DESIGN 16, August 2, 1976

Chip capacitors designed for hf ICs

Hewlett Packard Co., 1501 Page Mill Rd., Palo Alto, CA 94304. (415) 493-1501. \$1.60 to \$1.75 (10-99); stock.

Series 5082-0900 MIS chip capacitors are intended for use in microwave ICs. Specific functions include shunt rf bypassing and series dc blocking. They can also be applied as series or shunt elements in filters. Eleven standard units are offered in the 0.5-to-45-pF range. Capacitance tolerance is $\pm 15\%$. Tolerances to $\pm 5\%$ and values in the 45-to-100-pF range are available on special order. Minimum breakdown voltage for units from 0.5 to 2.0 pF is 250 V. A breakdown voltage of 150 V is specified for units from 5.0 to 15 pF, and breakdown voltage for units from 20 to 45 pF is 100 V.

CIRCLE NO. 360

Plasma display provides 6 rows of 40 characters

Burroughs Corp., P. O. Box 1226, Plainfield, N.J. 07061. (201) 757-5000. \$170 (1000 up); First quarter 1977.

A flat-panel, 240-character, gas-plasma display, designed primarily for data terminals, provides six rows of 40 characters each. This addition to the SELF-SCAN II product line is compatible with presently available and proposed microprocessor terminal designs. The assembly measures 11×4 in. and is less than 1-1/4-in. thick including drive electronics, needing significantly less space and weighing less than CRT displays. Its 5×7 dot-matrix characters are 0.26-in. high by 0.14-in. wide. They are readable up to 18-ft away at horizontal viewing angles up to 120 degrees. The characters are uniform in size, brightness and contrast, with no fuzziness or distortion at the panel edges. Characters are jitter-and-flicker free; the neon-orange color minimizes eye fatigue. The panel can display ASCII, Cyrillic, Hebrew, and Katakana, as well as special symbols and characters. Power requirements are +5 V at 900 mA, -12 V at 200 mA and -250 V at 70 mA.

CIRCLE NO. 361

MEET OUR FAMILY of GRABBERS



MODEL 4233 MICRO GRABBER
Tests high density packaging



MODEL 3925 MINI GRABBER
Tests conventional packaging

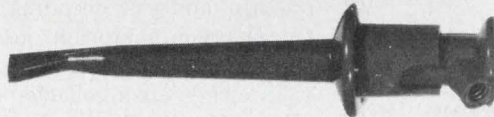

MODEL 4011 THREADED GRABBER
Accepts 6-32 threaded leads

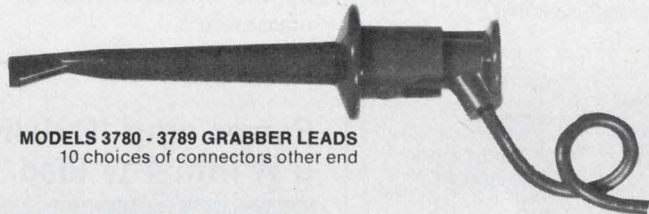

MODELS 3780 - 3789 GRABBER LEADS
10 choices of connectors other end

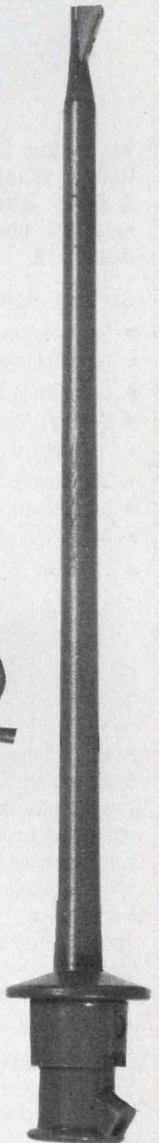

MODEL 4225 MAXI GRABBER
Tests high rise packaging

All Grabbers shown actual size

Our Grabber family is five years old now, and we're adding new members to keep pace with the complexities of state-of-the-art electronic packaging. Grabber is our name for a series of test clips designed to simplify testing of electronic packages from conventional components to maximum density DIP's. They're rugged, dependable, versatile, and very easy to use. Write for our catalog and get the complete story on the whole family of Grabbers. Find out why they are your best solution to your electronic testing problems.

AVAILABLE THROUGH YOUR
FAVORITE ELECTRONIC
PARTS DISTRIBUTOR

Booth 722 Wescon

ITT POMONA ELECTRONICS

1500 East Ninth St., Pomona, Calif. 91766
Telephone (714) 623-3463, TWX: 910-581-3822



CIRCLE NUMBER 50

1 Relay Miss every 2-Billion Cycles

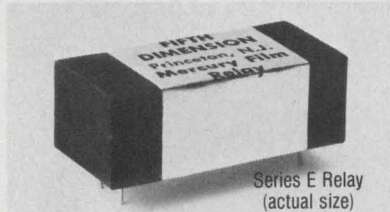

We tested 129 of our new Series E Relays at loads from dry circuits to 3 Amps. After 35-billion operations, only 10 single-cycle misses were monitored.

Series E Relays offer:

- Indefinite life
- No contact bounce
- Operation in all positions
- Contacts stable to ± 0.015 ohms over life
- Reliability at dry circuit or power loads
- Self-healing contacts
- Hermetically sealed contacts
- 1250V rms contact breakdown
- Low cost

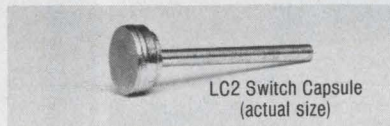

Series E Relay uses a rugged LC2 welded capsule rather than a fragile glass reed switch. This patented design holds a film of mercury securely to the metal walls of the capsule. With every operation, the mercury film renews the switch contacts. You get the reliability of mercury relays, but with complete freedom of mounting orientation. LC2 welded capsule reliability is proven by hundreds-of-thousands of units in the field, as well as billions of cycles under stringent laboratory conditions.

Send for a FREE SAMPLE of the LC2 welded capsule on your letterhead. Circle the reader service card number for Series E Relay information.

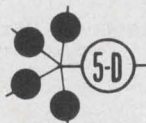

Fifth Dimension, Inc.

P.O. Box 483
Princeton, N.J. 08540
Tel: (609) 452-1200

CIRCLE NUMBER 51

INTEGRATED CIRCUITS

Bipolar Schottky ROM comes with 10-k storage

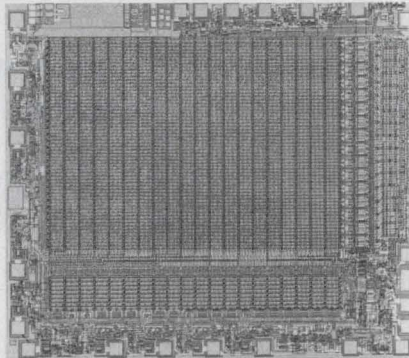

Intersil, 10900 N. Tantau Ave.,
Cupertino, CA 95014. (408) 996-
5000. From \$36 (100-up); stock.

The IM 53SXX family of Schottky bipolar ROMs is available with organizations of 1024 words by 8, 9 or 10 bits. Access time is 55 ns, typical, and maximum cycle times are under 100 ns. The ROMs are housed in 24-pin DIPs and have on-chip address decoding and optional on-chip storage latches. All chips have an OR-tie capability with either open collector or three-state outputs. Power dissipation is $65 \mu\text{W}/\text{bit}$ and the input current in the address lines is $250 \mu\text{A}$, maximum.

CIRCLE NO. 362

Power amp IC delivers 5 W into 4- Ω load



Siemens, 186 Wood Ave. S., Iselin,
NJ 08830. (201) 494-1000. Under
\$2 (1000-up).

The TDA-1037 power amplifier delivers 5 W at a 14-V bias and 4- Ω load resistance. The operating voltage range starts at 4 V and the amplifier has an input sensitivity of 150 mV at full load. The 9-pin single-in-line package simplifies mounting in a limited space. The thermal resistance between the chip and the plastic case is 12 K/W.

CIRCLE NO. 363

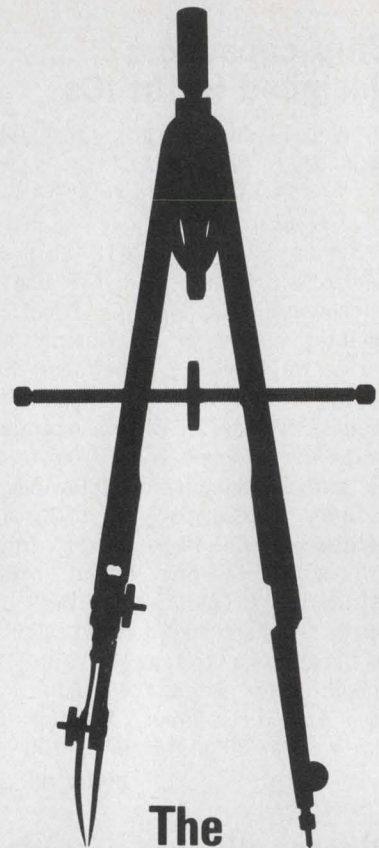

The Accuracy Policy of Electronic Design Is:

- To make diligent efforts to ensure the accuracy of editorial matter.
- To publish prompt corrections whenever inaccuracies are brought to our attention. Corrections appear in "Across the Desk."
- To encourage our readers as responsible members of our business community to report to us misleading or fraudulent advertising.
- To refuse any advertisement deemed to be misleading or fraudulent.

This statement of accuracy has appeared in every issue of *Electronic Design*, from the very first one. Staff members are imbued with it, from their very first day.

Electronic Design

50 Essex Street
Rochelle Park, New Jersey 07662
(201) 843-0550

High-speed comparator settles in 2 ns

Plessey Semiconductors, 1674 McGaw Ave., Irvine, CA 92714. (714) 540-9945. \$18 (100-up); stock.

The SP750B high-speed comparator has a maximum settling time of 2 ns and a propagation delay of just 3.5 ns. It can operate at rates of up to 10^8 samples per second. Input and output levels are ECL-compatible. In addition to the basic comparator function, the SP750B includes a latch function so that it can be used in the hold mode; integral gating for decoding comparator outputs in a multi-level comparator chain and wired-OR outputs to decode 4-bit lines.

CIRCLE NO. 364

Video game chip offers choice of six games

General Instrument, 600 W. John St., Hicksville, NY 11802. (516) 733-3107. \$6 to \$7 (lge qty.); stock.

The AY-3-8500 video game IC provides six switch-selectable games. The n-channel circuit is, in part, a dedicated microprocessor and can be set to play tennis, hockey, (soccer), squash, practise, rifle (skeet) shooting and rifle shooting with a random target. Each ball-and-paddle game can be played with a fast or slow ball speed, high or low ball angles and large or small bats. Various options for the circuit include four-player connection, full color display when color receivers are used, random ball speed and angle and black and white bats to ease player identification. Two versions of the circuit are available: The AY-3-8500-1 is designed for use in 525-line, 60 half-frame/s systems and the AY-3-8500 works with 625-line, 50 half-frame/s systems. Both circuits have automatic scoring and can display the scores (numbers up to 15) on the TV screen. A sound generator circuit on the chip creates realistic sound effects, depending upon the game selected. The game chips are housed in 28-pin DIPs and have an operating temperature range of 0 to 50 C. A 6 to 7 V supply that delivers 32 mA is required for the circuit.

CIRCLE NO. 365

2-k shift registers have 6-MHz data rates

Synertek, 3050 Coronado Dr., Santa Clara, CA 95051. (408) 241-4300. From \$15 (100-up); stock.

The SY2825A/26/27 family of p-channel dynamic shift registers can provide shift rates of up to 6 MHz. The 2048-bit units are available in three options: the SY2825A is a dual, 1024-bit register with

internal recirculating logic; the SY2826 is a dual, 1024-bit nonrecirculating register with dual-selectable data inputs; and the SY2827 has a single 2048-bit organization with internal recirculating logic. Required supply current is only 40 mA at 3 MHz—claimed to be the lowest available. The clock capacitance is also low—only 110 pF.

CIRCLE NO. 366

Q: Is there a recorder just for spectrum analyzers?

A:

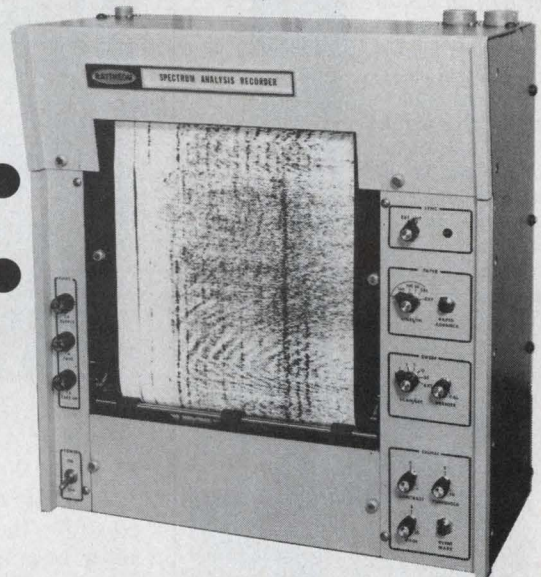

The new 19" rack-mounting SPECTRUM ANALYSIS RECORDER from Raytheon. It's the first dry paper line scanning recorder specifically developed for direct plug-in operation with commercially available spectrum analyzers.

Any new or existing spectrum analyzer equipped with the SAR-097 will have a lot more going for it. Like infinitely variable 100:1 speed range—5 sec/scan to 50 milliscan... stylus position encoder... automatic recorder synchronization... computer/analyzer compatibility... high resolution and dynamic range... all-electronic drive. And more.

If you design and build—or buy and use—spectrum analyzers, you don't have to settle for multi-purpose recorders any more. The SAR-097 is here. For full details write the Marketing Manager, Raytheon Company, Ocean Systems Center, Portsmouth, Rhode Island, 02871. U.S.A. (401) 847-8000.

RAYTHEON

CIRCLE NUMBER 52

Meet the First Opto-coupled Linear IC Amplifiers

Starting at \$26.50* each, and less than one cubic inch in volume, our 3650 and 3652 Isolation Amplifiers represent a major breakthrough in linear circuits.

Opto-Isolators have already made a name for themselves in digital designs but until now they weren't suitable for linear circuits. Trouble was, they were inherently non-linear. And the light source tended to degrade with age, which degraded gain accuracy. Temperature drifts, too, were a problem.

But we felt that opto-coupling held too much promise in linear applications to be discarded. Now those problems are solved. Look at the price and size reductions. Look at the splendid isolation they provide (1500V peak, continuous, 4000V peak for 10 seconds) without the cross-talk or EMI problems inherent in transformer isolators. And leakage is less than 0.5 microamp at 240VAC! Our 3650 transconductance amplifier (current-in, voltage-out) and buffered-input 3652 (voltage-in, voltage-out) let you use

isolation where you never could before. We know you will want more information on the new Burr-Brown Model 3650/3652 amplifiers and on our complete line of instrumentation amplifiers. Contact Burr-Brown, International Airport Industrial Park, Tucson, Arizona 85734. Telephone (602) 294-1431.

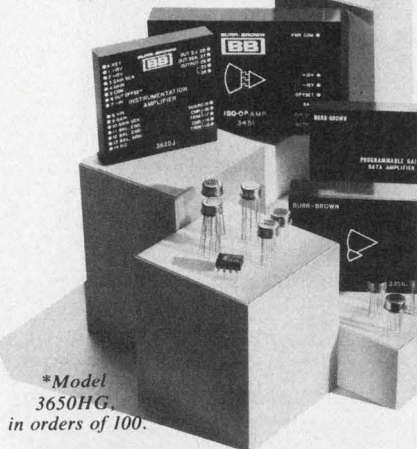

*Model 3650HG, in orders of 100.

BURR-BROWN



**A revolution
in price and size.**

CIRCLE NUMBER 54

DISCRETE SEMICONDUCTORS

JEDEC Schottky diodes switch supplies

International Rectifier, Semiconductor Division, 233 Kansas St., El Segundo, CA 90245. (213) 678-6281. \$8.60 to \$9.75 (1-100); stock.

A series of JEDEC registered Schottky diodes rated for 40 V operates at a junction temperature of 125 C. The units in DO-5 cases feature a nonrepetitive rating of 50 A. Units in the line designated 1N6097 are rated for 30-V and 1N6098 for 40-V operation. Chief application is in high-frequency switching power supplies operating at frequencies of 20 to 30 kHz.

CIRCLE NO. 367

LED alphanumeric display claimed lowest priced

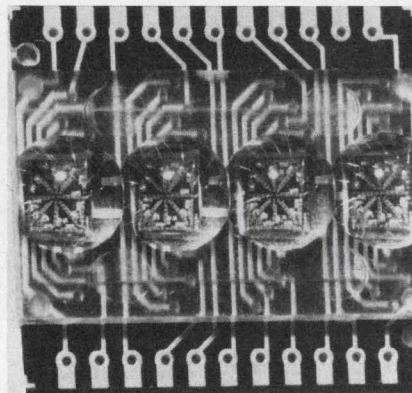

Litronix, 1900 Homestead Rd., Cupertino, CA 95014. (408) 257-7910. \$4 (1000 up); stock.

A LED-alphanumeric display provides the lowest price per character obtainable anywhere, according to Litronix. The DL-416 display has four 0.16-in.-high characters preassembled for multiplex operation on a PC board with pins on 0.075-in. centers. Boards may be stacked end to end to create a display with any number of characters, all evenly spaced on 0.260-in. centers. The high-contrast characters are readable in daylight at distances up to 5 ft, within a 20-degree half angle. Characters are formed with a 16-segment starburst pattern. Luminous intensity is 0.5 mcd/digit at 5 mA/segment.

CIRCLE NO. 368



use pressure sensitive
TEMP-R-TAPE of fiberglass
for quick relief.

Excellent electrical properties plus most anything else you want in fiberglass tapes like high tensile and tear strength, dimensional stability, good conformability, thermal endurance, abrasion resistance, non-corrosiveness, Temperature to 180°C. Available with several adhesive systems. Low unit cost.

Find your nearest Distributor in the Yellow Pages under "Tapes, Industrial" or in Industrial Directories or write for complete specification kit and sample offer. The Connecticut Hard Rubber Company, New Haven, Conn. 06509



an ARMCO company

CIRCLE NUMBER 55
ELECTRONIC DESIGN 16, August 2, 1976

HV rectifier meets magnetron power needs

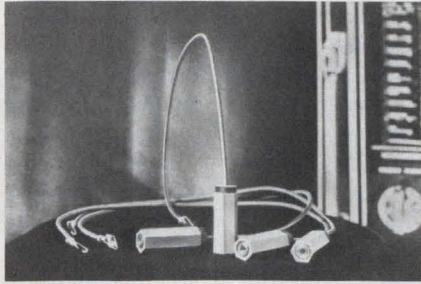

Semtech Corp., 652 Mitchell Rd., Newbury Park, CA 91320. (805) 498-2111. \$2.50 (1000 up) stock.

A new high-voltage rectifier, called KV-Stud, is specifically designed for microwave ovens. The rectifier's parameters meet the special characteristics of a magnetron power supply. This multi-junction silicon rectifier is encased in an aluminum hex rod to provide good heat dissipation, when properly mounted.

CIRCLE NO. 369

Avalanche photodiodes serve laser systems

RCA, Solid State Div., Box 3200, Somerville, N.J. 08876. (201) 685-6423. \$159 to \$475 (1-9) 60 days.

Four new silicon avalanche photodiodes are designed for a wide variety of applications including laser detection and ranging, optical communications and high-speed switching. Three of the devices, the C30817, C30884 and C30895, are supplied in low-profile TO-5 packages and have useful photosensitive areas of about 0.5 mm². The other—the C30872—is a large-area photodiode; its useful photosensitive area is about 7 mm². This diode is supplied in a low-profile TO-8 package. The C30817 and C30872 have a useful spectral range extending from about 400 to 1100 nm and rise and fall times of typically 2 ns. The C30884 has very high modulation capability, up to 400 MHz, and typical rise and fall times of 1 ns. Its spectral range is from 400 to 1100 nm. The C30895 is optimized for high responsivity and low noise at 1060 nm. Its spectral range extends from about 700 to 1100 nm. Rise and fall times are typically 2 ns. This device is also designed for use in adverse environments.

CIRCLE NO. 370

LED indicator contains red and green dies

IEE, 7740 Lemona Ave., Van Nuys, CA 91405. (213) 787-0311. \$0.97 (1000 up); stock.

Low cost red/green solid-state indicators, Model 232RG, in T-1-3/4 size use anode switching for single lamp go/no-go or on/off indications. A white, diffused-resin lens, three-lead capsule contains

both red and green LED dies of GaP light-emitting material for high brightness. If desired, both red and green dies can be energized simultaneously providing a trichromatic capability with the red and green combining to emit yellow. The viewing angle is 80-degrees with a 1.5-mcd typical luminous intensity at 10 mA (red) and 20 mA (green) forward current.

CIRCLE NO. 371



P/relTM

the programmable rotary encoded logic switch everyone will be talking about...

... because no other rotary switch has as much versatility with as low a cost as Standard Grigsby's P/rel switch!

The economy is twofold. This switch not only lends itself to full automation, but installed costs are lower by the use of our printed circuit terminals (solder terminals are also available).

A specially processed printed circuit disc is fully

programmable to the truth table of any code. We provide 100% program disc inspection to customer specifications. Up to 60 detent positions are available with our new double ball Dual FlexTM detent. And, the use of concentric shafts allows up to 120 detent positions from a single switch!

Everyone will be talking about P/rel . . . so will you!

Send for your free "Yes" button and literature.



standard grigsby, inc.

920 Rathbone Avenue, Aurora, Illinois 60507, Phone (312) 897-8417

CIRCLE NUMBER 56

DATA PROCESSING

Core-memory card plugs into Interdata 7/32

Pushpa Int'l Corp., 14142 Ipswich St., Westminster, CA 92683. (714) 898-5611. \$3200 (8 up).

The model 65-KB core memory card fits into the Interdata 7/32 main chassis. Eight such cards allow packaging 1/2 Mbytes of

memory into the Interdata computer. Each card presents one TTL load per input line. The 65-KB memory cards feature good thermal design with lower power consumption than comparable 32-kilobyte cards. Access period is 240 ns and cycle period is 650 ns. The manufacturer offers a lifetime warranty on parts and 2 years warranty on labor.

CIRCLE NO. 372

RS-232 modem works over short distances

Bo-sherrel Co., 36443 Shelley Court, Newark, CA 94560. (415) 792-0354. \$149 (unit qty). 4 wks.

The M-1 is a modem intended for use over short distances. The unit has full-duplex capability. The M-1 transmits according to EIA RS-232 and CCITT V24 specs. The unit can be used as a local communication link between computers, displays, printers, etc. Line driving is performed by a two-way, balanced current loop. Transmission speed goes up to 9600 baud. Dimensions of the M-1 are 3.2 × 6 × 2 in.

CIRCLE NO. 373

Unit adapts async to synchronous transmitter

Ark Electronic Products, Inc., 525 W. Nasa Blvd., Melbourne, FL 32901. (305) 724-5260.

Dubbed EASI-1A, for Elastic Asynchronous to Synchronous Interface, this device connects an asynchronous to a synchronous transmitting terminal where no absolute speed control is exercised between the two. The EASI contains an override feature that makes it capable of supporting a synchronous modem in a polled, switched or dedicated system environment. The input and output-data format are identical and consist of a start bit, eight data bits and one or more stop bits. The device functions by converting the input serial-data stream to parallel words and storing them in a memory. The output section of the EASI accesses the memory and shifts the words out serially under control of the modem clock signal. Should the input signal rate be faster than the output signal rate, the output section will fall behind the input and the memory will begin to fill. If the input rate is higher than the output rate by 0.02%, the maximum allowable, 20-k characters will be transmitted before the memory overflows. Should the speed difference be in the opposite direction, the EASI makes up the difference by inserting extra stop bits in the output stream when necessary. The input and output rates may be 2400, 4800, 9600 baud.

CIRCLE NO. 374

5½ DIGIT ACCURACY. 4½ DIGIT PRICE.

The 4600 is our brand new 4½ digit multimeter. It gives you the accuracy and resolution of typical 5½ digit multimeters. At half the cost.

And the 4600 stays accurate longer than other DVM's. DC accuracy stays within 0.01% ± one digit for six months at a time. We guarantee it.

80dB normal mode noise rejection produces a 10,000:1 reduction of excess noise. A full decade better than the 1,000:1 reduction of comparable instruments.

Loading errors are virtually eliminated by the 4600's 10,000MΩ input impedance on the two lowest DC voltage ranges.

There's a lot more. Send for a free catalog on our new

4½ digit 4600 multimeter. And find out how to get 5½ digit accuracy without paying for it.

Dana Laboratories, Inc.,
2401 Campus Drive, Irvine,
California 92715. 714/833-1234.



DANA

Others measure by us.

FOR PRODUCT DEMONSTRATION
CIRCLE # 80

FOR LITERATURE ONLY
CIRCLE # 81

Small-sized computer meets military specs

Rolm Corp., 18922 Forge Dr., Cupertino, CA 95014. (408) 257-6440. \$23,000 (20).

The Rolm Model 1650 computer provides the computing capability of the Model 1602 computer, but in a smaller package. The unit meets military specifications MIL-E-5400 and MIL-E-16400. It is a microprogrammed, general-purpose, 16-bit processor compatible with Data General's Nova series. The 1650 is packaged in a short 1/2-ATR chassis, measuring 7.62 × 4.9 × 12.56 in. It contains the CPU module, two 16-k core memory modules and a +28-V-dc power supply. You may choose conductive cooling, external forced-air or a Rolm-supplied forced-air unit. Some options available include floating-point firmware and ac power supply. A line of peripherals is also offered.

CIRCLE NO. 375

Graphics are digitized for under \$15,000

Instronics, Inc., 727 S. 23 St., Suite 215, Arlington, VA 22202. (703) 521-7130. \$15,000.

A digitizer that converts free form graphics sells for under \$15,000. The model GDC digitizer is designed to convert maps, drawings, photographs and other graphic material into digital form suitable for processing by a data-processing system. The unit consists of a 36 × 48 in. digitizing table, control electronics, and a pedestal-mounted X and Y axes readout display. The digitizing table features variable-intensity backlighting. It has a resolution and repeatability of ±0.001 in. and a point-to-point accuracy of ±0.004 in. A display provides a six-digit readout of cursor position on each axis, including sign and decimal point.

CIRCLE NO. 376

16-bit minicomputer has LSI bit-slice chips

Monolithic Memories, 1165 E. Arques Av, Sunnyvale, CA 94086. (408) 739-3535. See text. Stock.

The μ Mini-3 computer is built around bipolar LSI bit-slice chips. The 16-bit minicomputer features software and I/O compatibility with Data General's Nova. The μ Mini 3 is microprogrammed, with microded high-usage special functional, to achieve an operating speed that is faster than a stand-and minicomputer. These execute more efficiently than comparable software implementations. A 32-K word computer system fits on 15 × 15 in. PC boards. The μ Mini 3 will be offered as individual PC cards, or complete with a chassis, power supply and front panel. The price of the basic system with case, front panel and 8-K of memory is \$2500 (qty 50).

CIRCLE NO. 377

LOW NOISE MODULAR DESIGN

Switching Power Supplies!

A new line of compact, modular-design switchers that simplify design for 300-600 watt applications and sell for less than 90¢ per watt! End users benefit from low EMI noise levels and highly reliable operation plus easy add-on and maintenance features. Get everything you need to know to evaluate this high quality, money-saving line from:

Magnetic Components Group

GD CONTROL DATA
CORPORATION

7801 Computer Avenue South, Minneapolis, MN 55435
(612) 830-5800 TWX 910 576 2978

CIRCLE NUMBER 58

ELECTRONIC DESIGN 16, August 2, 1976

ONE-CHIP SYSTEM LOGIC #1. NEW AM/FM FREQUENCY SYNTHESIZER. ONE-CHIP ELECTRONIC TUNING.

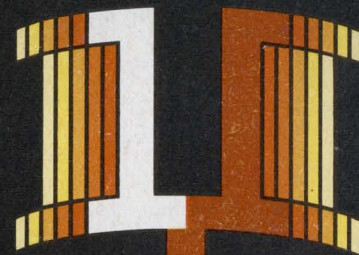

Now a single LSI chip that performs all digital control functions for generating AM/FM/CB radio freqs. Uses PLL techniques. Up to 2000 AM/FM channels possible. Simply order from stock: #8X08.

Send book titled *One-Chip System Logic*. Clip coupon to letterhead.

Name _____ Title _____

Tel. _____ M.S. _____

811 E. ARQUES, SUNNYVALE, CA. 94086

THINK
Signetics

a subsidiary of U.S. Philips Corporation

© 1976.

CIRCLE NUMBER 59

Compare Grayhill lighted switches!

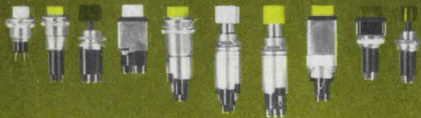

**Outstanding
performance
from logic levels to
1/4 amp**

- **Compare design**... Grayhill's self-cleaning wiping contacts outperform butt contact or snap action types.
- **Compare selection**... Grayhill has both momentary or alternate action; SPST, SPDT, and DPDT circuitry; front-panel bezel or sub-panel mounting; square or round button shapes in wide choice of colors.
- **Compare panel appearance**... Grayhill provides a compact, attractive panel... and a unique design-coordinated line of matching unlighted switches and indicator lights.
- **Compare service**... Grayhill's expert technical assistance, prompt quotations, and speedy deliveries save you time and money.
- **Compare price**... Grayhill lighted switches cost no more than other brands with equivalent ratings.

Start the comparison process NOW, by asking Grayhill for Lighted Switch Catalog #252 and information on our free sample offer.

Grayhill
INC. 561 Hillgrove Avenue
La Grange, Illinois 60525
(312) 354-1040

SEE US AT WESCON BOOTHS 825-827-829

CIRCLE NUMBER 60

POWER SOURCES

Compact high-voltage supply stands tall in performance

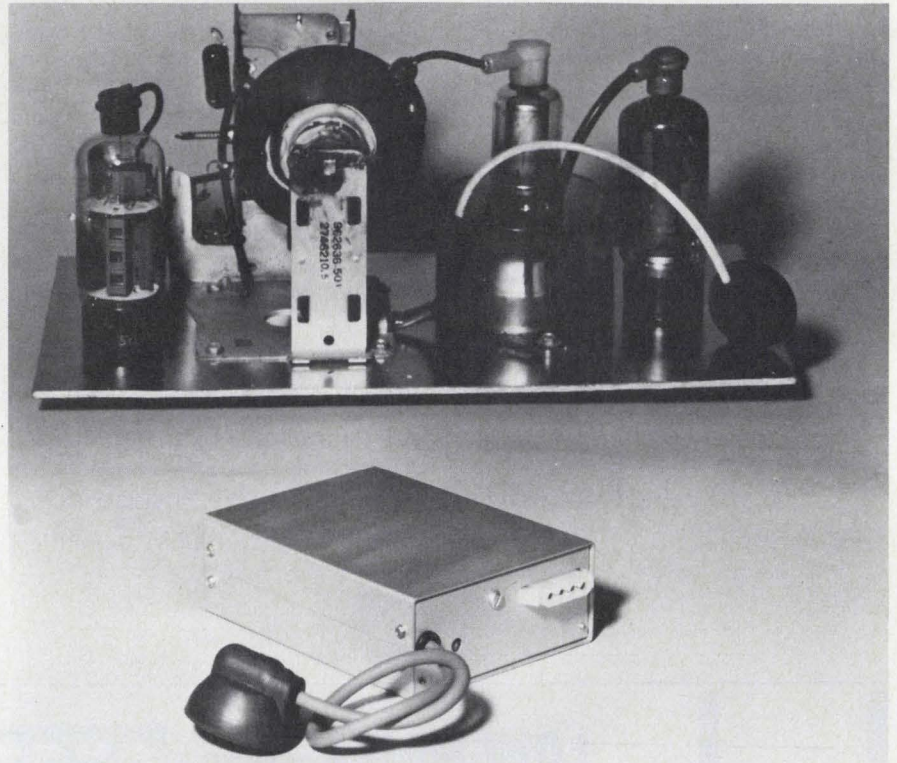

PTK Corp., 825 Capitolio Way, San Luis Obispo, CA 93401. (805) 544-7948. See text; stock-3 wks.

The 100-series high-voltage CRT supply, from PTK Corp., seems to support the old adage that nice things come in small packages. Out of the 100's volume of 18 cubic inches comes an impressive 10 W of power. Blow 10 cfm of air across the supply, and you can double that.

There are smaller high-voltage units, of course. But you'll be hard pressed to find one close to the PTK supply's price neighborhood. The top-of-the-line 100 sells for \$148; to get equal performance in a compact frame, you might have to spend five times more.

For instance, the petite MG-12 marketed by Venus Scientific, takes up a mere 6.4 cubic inches and delivers about the same power as the PTK unit. For the two-thirds reduction in size, you pay \$690, a \$542 differential. Another unit, the Lectrologic H series, is

packed into 19 cubic inches and costs even more—\$750.

All three competitors deliver a maximum current of 500 μ A at voltages ranging from 1 to 20 kV, depending on the model. Inputs for each are 28 V, nominal. Other specs—like regulation, ripple and those that spell out transient performance—aren't equal in the three.

The 100's performance line-up includes a load and line regulation of 0.05% (10 V), full-load ripple of 0.05%, tempco of 150 ppm/ $^{\circ}$ C max and a maximum transient of 5 V/100 μ A pk-pk. Operating temperature ranges from 10 to 60 C.

A number of circuits protect the PTK 100 (which comes in three versions) from shorts, arcs, over-temperature and reversed input voltage. All models are housed in a 6061 T6 aluminum case, 4.13 \times 3.16 \times 1.37 in., with 1/2-in. stainless steel studs for mounting.

PTK Corp.

Venus Scientific

Lectrologic

CIRCLE NO. 337

CIRCLE NO. 338

CIRCLE NO. 339

Switchers claim high MTBF at 80 C

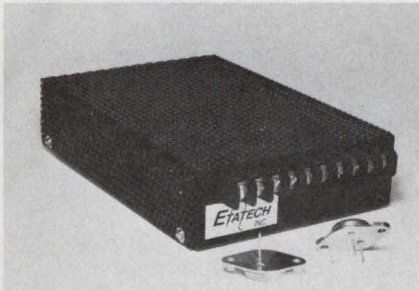

Etatech Inc., 187-MW, Orange-thorpe, Placentia, CA 92670. (714) 996-0981. \$145.

Series "B" 5-V, 10-A switching module (Model B5R00S10) comes complete with 5-year warranty, and features a 70,000-h MTBF at 80-C baseplate. Other specs are: 75% minimum efficiency, size of 4-7/8 x 1-3/4 in., weight of 2 lbs, remote sensing, and complete overload/short circuit and overvoltage protection, all with automatic recovery. The units provide ± 10 -mV max. line regulation, 10-mV max. load regulation and 250- μ s transient response.

CIRCLE NO. 378

Ac source packs 2500 VA into one case

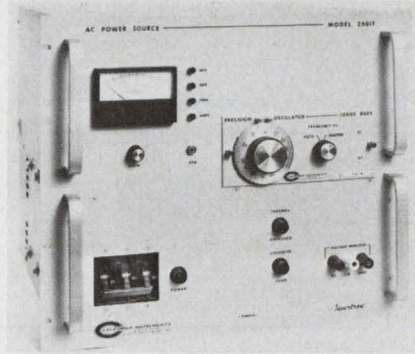

California Instruments, 5150 Con-vooy St., San Diego, CA 92111. (714) 279-8620. \$3995 w/o oscillator; 30 days.

Said to be the first time this much power—2500 VA—has been incorporated into a single unit using a linear amplifier, Model 2501T delivers 110 to 120 V rms (± 0.7 pF) of single-phase power from a three-phase input. Among its features is a selectable output of 0 to 30, 0 to 60, 0 to 120 or 0 to 240 V. Selection is by means of a rear-panel plug-in card.

CIRCLE NO. 379

Lab supply costs just \$76



Power/Mate, 514 S. River St., Hackensack, NJ 07601. (201) 343-6294. \$76; stock.

For those who need a bench-type laboratory supply at a low price, the BP-76 is a constant-voltage/constant-current unit that delivers full rated output voltage (10 V) at the maximum rated output current of 2 A. Key specs include: input of 105 to 125 V, 47-63 Hz, single phase; line and load regulation is less than 0.1% ± 4 mV; ripple is less than 1 mV rms; transient response is 50 ms from full to half load; tempo is better than 0.01%/°C.

CIRCLE NO. 380

NOW! PM and SHUNT-WOUND adjustable speed drive systems



CDC-PM describes PM systems, 1/12-1/4 Hp. 12 pages, 32 drawings, photos and tables.



CDC-SH describes shunt-wound systems, 1/50-1/4 Hp. 16 pages, 51 photos, drawings and tables.

... from Bodine and Bodine Distributors

Designed and built by Bodine to give you *perfectly matched* speed/torque control characteristics—provide reliability and performance you might expect only from far more costly and complex systems.

BODINE
ELECTRIC
COMPANY

BODINE MOTORS
GEAR MOTORS
SPEED CONTROLS

Send for catalogs today.

Bodine Electric Company, 2528 W. Bradley Place, Chicago, IL 60618
CIRCLE NUMBER 61

ELECTRONIC DESIGN 16, August 2, 1976

ONE-CHIP SYSTEM LOGIC #2. NEW DESKEW FIFO. ONE-CHIP PARALLEL DATA DESKEWING.

Breakthrough. Synchronize parallel data with 1 new LSI chip per track. 2 inputs for each track, 16 bits each input, all commonly clocked. 2 versions: #8X03 10V CMOS compatible; #8X04 T²L compatible. Both reduce costs in high performance peripheral controllers.



I want to read your book on *One-Chip System Logic*. Coupon's clipped to letterhead.

Name _____ Title _____
Tel. _____ M.S. _____
811 E. ARQUES, SUNNYVALE, CA. 94086

THINK

Signetics

a subsidiary of U.S. Philips Corporation

©1976.

CIRCLE NUMBER 62

Anodized heat sink clips onto transistor

Thermalloy, Inc., Dept. M, 2021 W. Valley View Lane, Dallas, TX 75234. \$0.06 (1000 up).

The 6046 Slip-Clip heat sink cools transistors that have TO-202, Motorola Case 152 or 306-02 device packages. The heat sink clips on

like a clothespin, and a specially designed locking tab provides positive retention. The 6046 can be installed after board assembly has been completed. No adhesives, mounting hardware or PC board drilling are necessary. The 6046 is available in black preanodized material. Typical thermal resistance is 25°C/W with natural convection cooling at 3 W heat dissipation. It weighs 1.45 gm.

CIRCLE NO. 381

**You know our Capacitors,
but have you seen our...**

EMI FILTERS

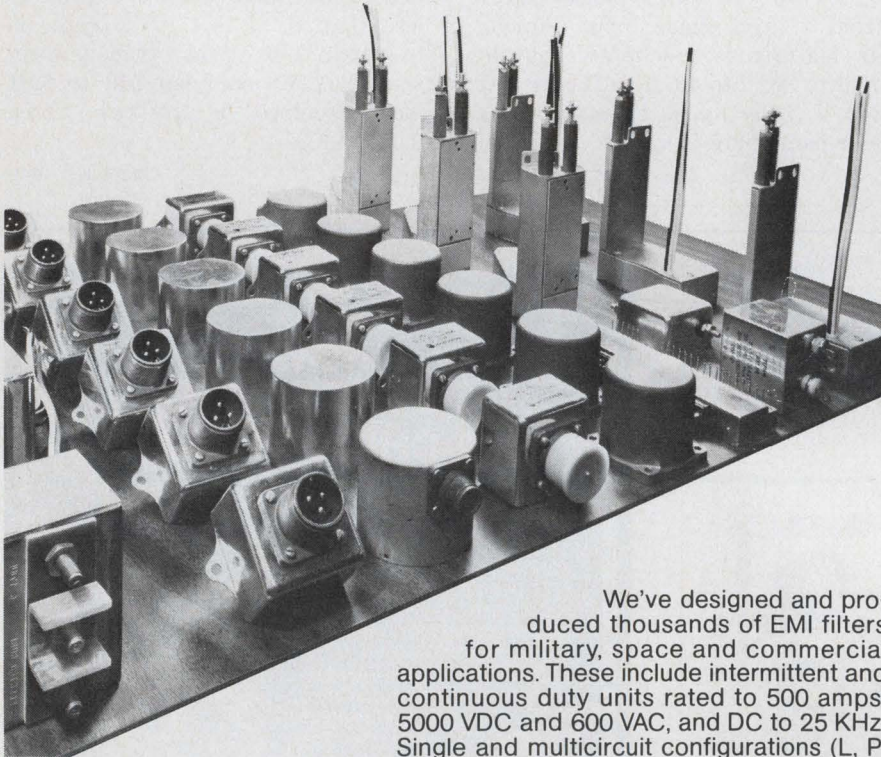

We've designed and produced thousands of EMI filters for military, space and commercial applications. These include intermittent and continuous duty units rated to 500 amps, 5000 VDC and 600 VAC, and DC to 25 KHz. Single and multicircuit configurations (L, Pi and T) are offered as low pass, electrical noise, line, screen room and heavy duty filters. Send us your circuit requirements—our extensive file of existing designs can probably provide the benefits of standardization to meet your non-standard needs. Get complete information today on our EMI Filters; write Electrocube, 1710 So. Del Mar Ave., San Gabriel, CA 91776; (213) 573-3300.



electrocube

CIRCLE NUMBER 63

Breadboard kit usable at high frequencies

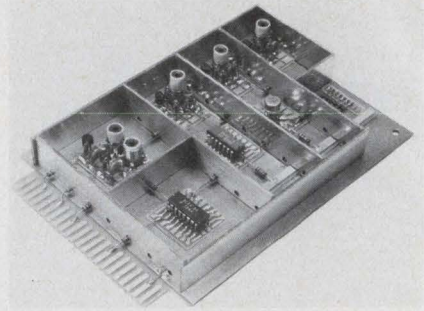

Christiansen Radio, Inc., 1950 San Remo, Laguna Beach, CA 92651. (714) 497-1506. \$60.00.

A breadboard kit with low-profile partitions accommodates rf circuits with high component density. The rf kit comes with component-mounting and partition hardware for circuits working into the GHz frequency range. Virtually all types of low-power packages may be mounted on a solid ground plane with no drilling. When used with an optional edge connector board and cover board, testing can be done directly in a card file. The kit comes complete with 100 component mounting pads, a storage box, a 10 × 20 cm solid ground plane, and a 1-m length of 18-mm high partitions.

CIRCLE NO. 382

Machine trims and forms axial lead parts

Fancort Industries Inc., 111 Clinton Rd., Fairfield, NJ 07006. (201) 575-0610. \$1395; stock, 6 wks.

The Model AX-1, the Axiform, automatically cuts and bends components that have axial leads. The components may be packed in cards, loose or taped together on reels. The Axiform is capable of processing up to 15,000 taped parts per hour. Optional templates for component-to-component spacing and lead length preset the adjustable dies in the machine. The Axiform contains stainless steel, tungsten carbide cutting dies and nitrided steel or nylon forming dies. The machine will accept components with body diameters to 1 in., body lengths to 2.125 in. and lead diameters to 0.045 in. Leads may be bent at distances from the component body of 0.075 in. to 0.500 in.

CIRCLE NO. 383

Service tool set contains 20 tools

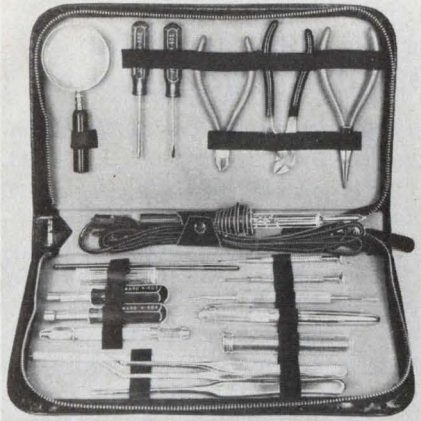

Jonard Industries Corp., Precision Tools Div., 134 Marbledale Rd., Tuckahoe, NY 10707. (914) 793-0700. \$45; single qty.

The Model K-600 consists of 20 different tools and a zippered carrying case. The leather case has dimensions of 11 x 6 in. and weighs 2 lb. The kit assortment consists of a soldering iron, solder aid, three pliers, four screwdrivers, two tweezers, two nutdrivers and an assortment of other tools.

CIRCLE NO. 384

IC socket presents a low-profile

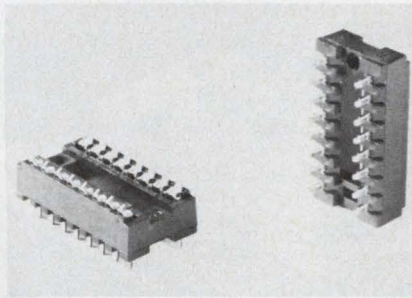

Molex, Inc., 2222 Wellington Court, Lisle, IL 60532. (312) 969-4550. 20¢ (low qty).

The LO PRO, Model 6197, is a low-profile, low-cost, integrated-circuit socket. This socket is available in 14 and 16-pin versions. The socket body has a locating/pick-up hole for automatic insertion equipment, beveled outside edges of the terminal channels, and a plastic barrier strip between each terminal. A small hole in the housing prevents solder-wicking and traps the terminals when soldered and is made of black polyester. The terminal pin, type 1938, features a wide-entry section for the IC lead.

CIRCLE NO. 385

Rugged system handles and ships PC boards

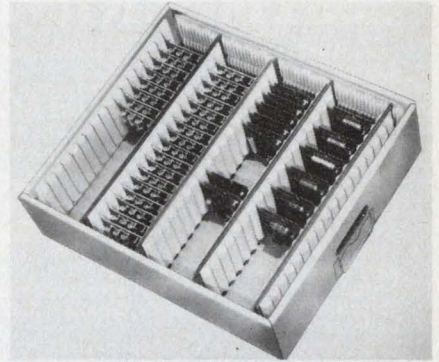

Shell Containers, Inc., Dept. P-2, Race and Ridge St., Ambler, PA 19002. (215) 643-2350.

A box with adjustable inserts, called Plasticor, positions, stores and ships printed circuit boards. The box is coated to provide a barrier to grease, moisture and sulphur. The boxes are available in nine sizes with matching adjustable inserts, product identification cardholders, and opaque and transparent covers. Plasticor may also be custom manufactured in quantities of 500 or more without a molding charge.

CIRCLE NO. 386

We started a counter revolution

... in 1964, when we introduced the Hecon line ... every kind of electro-mechanical, electronic and pneumatic/fluidic counter imaginable, from totalizing to predetermining to batching ... every single one tested before it leaves our plant.

Find out for yourself. Contact us for free catalog today.



HECON CORPORATION
P.O. Box 247
Tinton Falls, N.J. 07724
Phone (201) 542-9200

HECON CANADA INC.
80 Galaxy Blvd.
Rexdale, Ontario M9W-4Y8
Phone: (416) 678-2441



318

CIRCLE NUMBER 64

ELECTRONIC DESIGN 16, August 2, 1976

ONE-CHIP SYSTEM LOGIC #3

NEW CRC GENERATOR/CHECKER. ONE-CHIP ERROR-CHECKING.

Eight polynomials in one chip.
Detects serial digital data
errors including SDLC type.
I²L with on-chip TTL inter-
face. Order #8X01.

Need to know more on one-chip system logic. I've clipped coupon to letterhead.

Name Title

Tel. M.S.

811 E. ARQUES, SUNNYVALE, CA. 94086

THINK Signoties

a subsidiary of U.S. Philips Corporation

©1976

CIRCLE NUMBER 65

103

If you don't need it for forever, don't build it for forever.

Here's an application for our ACE solderless breadboards you may not have thought of.

Next time you only need a circuit for a little while, build it up on an ACE. There's an ACE the right size for almost any circuit you have to build. And ACE is a more reliable solderless breadboard, so your circuit can stay functional for as long as you need it together. Then, when your need for the circuit disappears, just disassemble it and use everything over again. It's all good as new.

And what's true for ACE is also true for our versatile A P Super-Strips™, Terminal and Distribution Strips.

So if you have a special application circuit that you won't need around forever—a test jig, a set-up-and-calibrate hookup, you name it—put ACE to work for you. The time you save may be your own. ACE. The All Circuit Evaluator from A P Products.

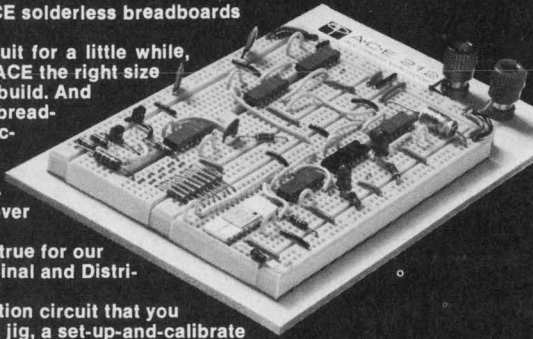

Part No.	ACE Model No.	Tie Points	DIP Capacity	No. Buses.	No. Posts	Board Size (inches)	Price Each
923333	200-K (kit)	728	8 (16's)	2	2	4-9/16x5-9/16	\$18.95
923332	208 (assem.)	872	8 (16's)	8	2	4-9/16x5-9/16	28.95
923334	201-K (kit)	1032	12 (14's)	2	2	4-9/16x7	24.95
923331	212 (assem.)	1224	12 (14's)	8	2	4-9/16x7	34.95
923326	218 (assem.)	1760	18 (14's)	10	2	6-1/2x7-1/8	46.95
923325	227 (assem.)	2712	27 (14's)	28	4	8x9-1/4	59.95
923324	236 (assem.)	3648	36 (14's)	36	4	10-1/4x9-1/4	79.95

Ohio and California Residents Add Sales Tax
All orders subject to acceptance at factory.

For quick phone service, call
the A P distributor nearest you:

Write us for the full line A P Products catalog.



A P PRODUCTS INCORPORATED
Box 110-F Painesville, OH 44077 (216) 354-2101
TWX: 810-425-2250

(201) 224-8032	(412) 782-2300	(612) 488-0201
(206) 682-5025	(415) 326-5432	(617) 237-6340
(213) 768-3800	(415) 969-9240	(617) 273-1860
(215) 698-4000	(513) 236-9900	(617) 879-0860
(216) 587-3600	(516) 483-9200	(713) 350-6771
(312) 298-8580	(516) 883-0999	(713) 777-1666
(313) 525-1800	(If no distributors in your area, call factory)	(803) 253-5333
(314) 863-7800		(914) 664-0088

CIRCLE NUMBER 66

MICROWAVES & LASERS

Four-port circulator handles high power

Trak Microwave Corp., 4726 Eisenhower Blvd., Tampa, FL 33614. (813) 884-1411. \$310 (10); 60-90 days.

Model 49A0031 microstrip four-port circulator can handle 200-W peak and 30-W average. Operating at 918 MHz \pm 20 MHz, the unit offers isolation of 20 dB minimum between all ports. Insertion loss is 0.3 dB maximum between ports 4 and 1; 0.6 dB maximum between ports 1 and 2. VSWR is 1.25 maximum. The circulators' impedance is 50 Ω nominal.

CIRCLE NO. 387

Measure frequencies automatically to 18 GHz

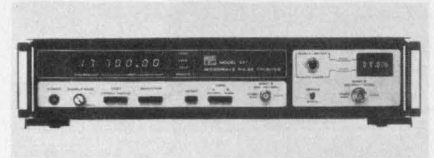

EIP, 3230 Scott Blvd., Santa Clara, CA 95051. (408) 244-7975. \$7700; 60-90 days.

Model 451 provides fully automatic frequency measurement of pulsed signals. Measurements cover the frequency range of 0.3 to 18 GHz, and pulse widths may be as narrow as 100 ns with no requirement for external gating or manual tuning. Replacing previously used pulse-measurement techniques such as the cavity wave-meter and transfer oscillator, the Model 451 eliminates the need for auxiliary equipment and highly skilled operators. Pulsed-frequency measurement is accomplished by simply connecting the input and reading the frequency on a direct reading 7-digit LED display. No manual switching is required to distinguish between cw or pulsed inputs; the counter will automatically measure either type of signal. The FM tolerance of the 451 allows for measurement of cw microwave carriers with up to 40-MHz pk-pk deviation at 10-MHz modulation rates.

CIRCLE NO. 388

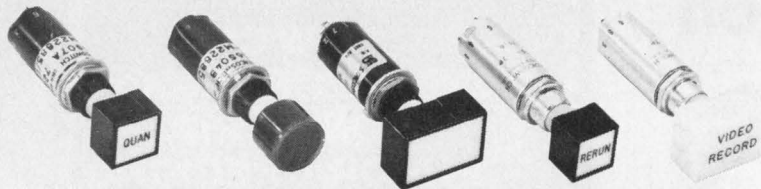

STACOSWITCH... dependability you can afford

SWITCHES Military or industrial/commercial single lamp switches built to exacting specifications for dependability and long service life. Choice of circuit control contact arrangement and solder or new PC terminations.

PUSHBUTTONS All sizes, styles, colors, and legend styles including new photographic film legends with visible or hidden messages. Color matched for visual recognition and operator convenience.

LOW COST Check the bottom line and you'll find Stacoswitch's low purchase price combined with quick and easy installation and maintenance make these your best buy in single lamp pushbutton switches. Write today for General Catalog giving complete description on single lamp and 4-lamp switches and indicators. When you think switch... think Stacoswitch.



STACOSWITCH
a STACO, INC. company
1139 BAKER STREET, COSTA MESA, CALIF. 92626
(714) 549-3041 TWX: 910/595-1507

Other STACO Company products:
Custom Transformers, STACO, INCORPORATED, Richmond, Indiana; Variable Transformers, STACO, INCORPORATED, Dayton, Ohio.

CIRCLE NUMBER 67

You can tune these mm-wave detectors

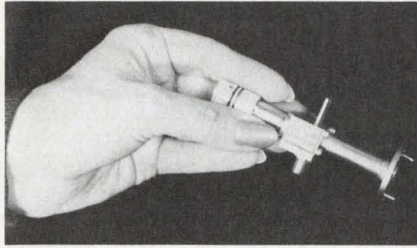

Hughes Aircraft Co. Electron Dynamics Div., 3100 West Lomita Blvd., Torrance, CA 90509. (213) 534-2121. Start at \$750; 60-90 days.

A new series of tunable millimeter-wave detectors feature full waveguide bandwidth tuning capability in each of six bands between 26.5 and 110 GHz. The solid-state detectors, designated 4483XH, consist of Schottky-barrier diodes mounted in a Sharpless wafer and tunable reduced-height waveguide cavity mount. Minimum sensitivities are 200 mV/mW to 75 GHz and 100 mV/mW to 110 GHz. Instantaneous 3-dB bandwidths of 5 GHz are typical.

CIRCLE NO. 389

Microwave receiver programs by computer

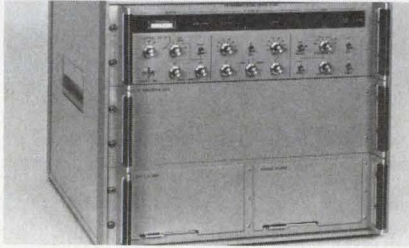

Scientific Atlanta, 3845 Pleasantdale Rd., Atlanta, GA 30340. (404) 440-2000. Approx. \$23,000.

Series 1770 programmable microwave receiver is for use in computer-controlled antenna measurement systems. The receiver covers the frequency range of 1 to 18 GHz in the automatic mode but can also be manually operated over the range of 1 to 90 GHz. An optional converter extends the frequency coverage down to 0.1 GHz. The 1770 has a 60-dB dynamic range and can be operated as a two-channel, separate mixer measurement system or as a three-channel system with two channels sharing a common mixer via an rf switch.

CIRCLE NO. 390

12-faced polygon offers adjustable mirrors

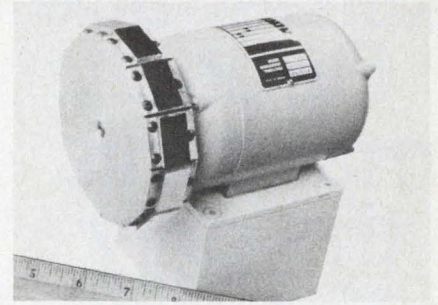

Scanco Inc., 145 Water St., S. Norwalk, CT 06854. (203) 846-2244. \$675; stock.

The first member of a family of polygonal scanners is Model 1812, a unit with 12 precision faces that can be rotated at 1800 rpm. Each PolyScan consists of a metal hub with the required number of faces. Mounted on each face is a 1 x 0.55-in. high-reflectivity mirror, supported by a 1 x 1-in. adjustable metal plate. The angle of each mirror is individually adjustable. Mirror reflectivity is 85% min and mirror alignment is 30 arc seconds standard.

CIRCLE NO. 391

MODEL SP-G11

SPEEDEX RECORDER

Model SP-G11 is equipped with a built-in A/D converter in addition to common analog recorder functions. Since output terminals are also provided. It can be readily used in computation and for connection to a printer or paper tape punch.

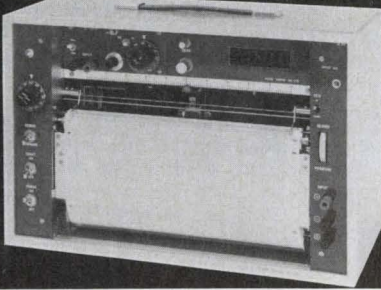

• FEATURES

- Digital output terminal (10-bit binary or 3-digit BCD)
- External clock terminal permits chart drive by external clock.

• SPECIFICATIONS

- Chart width 250mm
- Pen speed 0.8 secs full scale
- Measurement voltage 0.5, 1, 5, 10, 50, 100, 500mV, 1, 5, 10, 50, 100V full scale
- Chart speed 10, 20, 50, 100, 300, 600mm/hr
20, 50, 100, 300, 600mm/min
- Digital output (A or B) A...10-bit binary full scale at 1000 digit.
1 digit 0.1%
B...3-digits BCD 10²10¹10⁰ full scale 999

• Please write us on your letterhead for detailed information.



Riken Denshi Co., Ltd.
5-5-2, Yutenji, Meguro-ku, Tokyo, Japan.
TEL: 711-6656 TELEX: 0246-8107



CIRCLE NUMBER 68



ELECTRONIC DESIGN 16, August 2, 1976

ONE-CHIP SYSTEM LOGIC #4

NEW CONTROL STORE SEQUENCER. ONE-CHIP MICROINSTRUCTION SEQUENCING.

8 microfunctions — TSK, POP, RST, etc. in 52ns. All essential sequencing functions. 1K addressability, 4 level stack. Low power Schottky/LSI technology. Order #8X02.

Clip coupon to letterhead for book on this and all one-chip system logic products.

Name _____

Title _____

Tel. _____

M.S. _____

811 E. ARQUES, SUNNYVALE, CA. 94086

THINK signotics

a subsidiary of U.S. Philips Corporation

©1976.

CIRCLE NUMBER 69

Aerospace Optics make this the only miniature pushbutton switch that is Sunlight Readable

Patents in Process

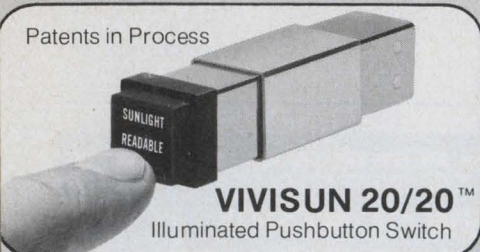

Tested and Proven

Only Vivisun 20/20 legends are readable in a light ambient of 10,000 foot-candles (sunlight). When the lamps are not energized the hidden legend characters are not discernable in a 10,000 foot-candle ambient (sunlight).

- Switches are designed in accordance with MIL-S-22885
- Single or multi-color legend option
- Individual unit or matrix mounting options
- Momentary or alternate pushbutton action available with SPDT, DPDT, or 3PDT switches
- Companion sunlight readable annunciator available (without switching)
- 1, 2, 3, or 4 separate messages
- Messages available in green, yellow, red, or white
- Designed for low power consumption (5, 12, 14, 18 or 28 volts available)
- Lamps replace from front without tools



AEROSPACE OPTICS INC.

7112 Burns Street, Dept. 33,
Fort Worth, Texas 76118

(817) 284-2293 (Ext 33) Telex 75-8461

Researchers, Designers and Manufacturers
of Sunlight Readable Lighted Displays

Application Notes

Semi status report

A major study that reports the current status and future prospects for semiconductor processing, fabrication, assembly and test equipment has been announced. It covers the period from 1974 to 1982, with detailed data and forecasts for 1975-1980. Gnostic Concepts and SEMI, Menlo Park, CA

CIRCLE NO. 329

Custom ICs

A 24-page pamphlet on custom ICs is available and has an actual IC chip on the front cover. A detailed description of integrated components is included, as well as 20 design examples. Interdesign, Sunnyvale, CA

CIRCLE NO. 330

Infrared microscopy

An illustrated folder on applications of infrared microscopy to solid-state devices is available. It covers instrument description, wavelength considerations, materials under study, and other topics. Research Devices, Berkeley Heights, NJ

CIRCLE NO. 331

Voltage suppressors

An eight-page report compares transient voltage suppressors. The report points out the key parameters designers should consider in specifying transient voltage suppressors, and defines these parameters. General Semiconductor Industries, Tempe, AZ

CIRCLE NO. 392

Motor starting capacitors

"Electrolytic Motor Starting Capacitors: Their Construction and Application," a 16-page booklet, features the history, assembly, dimensions, limitations, selection and use of electrolytic motor starting capacitors. Mallory Capacitor, Indianapolis, IN

CIRCLE NO. 393

Electronic Design

ELECTRONIC DESIGN's function is:

- To aid progress in the electronics manufacturing industry by promoting good design.
- To give the electronic design engineer concepts and ideas that make his job easier and more productive.
- To provide a central source of timely electronics information.
- To promote communication among members of the electronics engineering community.

Want a subscription? ELECTRONIC DESIGN is sent free to qualified engineers and engineering managers doing design work, supervising design or setting standards in the United States and Western Europe. For a free subscription, use the application form bound in the magazine. If none is included, write to us direct for an application form.

If you do not qualify, paid subscription rates are as follows: \$30.00 per year (26 issues) U.S., \$40.00 per year (26 issues) all other countries. Single copies are \$2.00 U.S., \$3.00 all other countries. The Gold Book (27th issue) may be purchased for \$30.00 U.S. and \$40.00 all other countries.

If you change your address, send us an old mailing label and your new address; there is generally a postcard for this bound in the magazine. You will have to requalify to continue receiving ELECTRONIC DESIGN free.

The accuracy policy of ELECTRONIC DESIGN is:

- To make diligent efforts to ensure the accuracy of editorial matter.
- To publish prompt corrections whenever inaccuracies are brought to our attention. Corrections appear in "Across the Desk."
- To encourage our readers as responsible members of our business community to report to us misleading or fraudulent advertising.
- To refuse any advertisement deemed to be misleading or fraudulent.

Microfilm copies are available of complete volumes of ELECTRONIC DESIGN at \$19 per volume, beginning with Volume 1, 1952 through Volume 20. Reprints of individual articles may be obtained for \$3.00 each, prepaid (\$.50 for each additional copy of the same article) no matter how long the article. For further details and to place orders, contact the Customer Services Department, University Microfilms, 300 North Zeeb Road, Ann Arbor, Michigan 48106 telephone (313) 761-4700.

Want to contact us? If you have any comments or wish to submit a manuscript or article outline, address your correspondence to:

Editor
ELECTRONIC DESIGN
50 Essex Street
Rochelle Park, N.J. 07662

New Literature

Electrical components

Proprietary and custom-made electrical and electronic components ranging from molded terminal blocks to sophisticated controls for public service utilities are covered in a six-page brochure. Curtis Industries, Milwaukee, WI

CIRCLE NO. 302

Power sources

Choosing a power source is easier with this four-page selection guide that describes nearly 150 off-the-shelf line operated power supplies and dc/dc converters. Two charts give specifications, features, prices and package/pinout index. Semiconductor Circuits, Haverhill, MA

CIRCLE NO. 303

Circuit breakers

Circuit breakers, which offer complete circuit protection in one molded-case breaker, are described in a 12-page brochure. Westinghouse Electric, Beaver, PA

CIRCLE NO. 304

IC packaging panels

Pluggable IC packaging panels—custom or standard—are featured in a short-form catalog. Excel Products, New Brunswick, NJ

CIRCLE NO. 305

Tubular solenoids

Complete specifications on tubular solenoids are given in a data sheet. North American Philips Controls, Frederick, MD

CIRCLE NO. 306

Readouts

LED, incandescent and neon readout devices are covered in a 56-page catalog. Specifications, applications, performance characteristics and schematics are included. Dialight, Brooklyn, NY

CIRCLE NO. 307

Electron tubes

The latest EEV/M-OV catalog describes professional electron tubes in Europe. Data are given for 1150 types, including 80 new tubes. An Equivalents Index lists almost 4000 internationally used tubes for which the company offers an equivalent. English Electric Valve, Chelmsford, CM1 2QU, England.

CIRCLE NO. 308

Digital interface ICs

A 464-page data handbook, "Interface Integrated Circuits," gives specifications on interface products such as: peripheral/power drivers, level translator/buffers, line drivers and receivers, memory and clock drivers, sense amps, display drivers and optocouplers. The text is supported by graphs, charts and diagrams. To purchase send a check for \$4 (CA residents add 6% sales tax) to Marketing Services Dept., National Semiconductor, 2900 Semiconductor Dr., Santa Clara, CA 95051.

INQUIRE DIRECT

tiny trimmers... tiny price!

MuRata's new line of subminiature trimmers has established a standard of performance in the economical trimmer field second to none . . . Alumina-base, non-combustible design, extreme resistance to solvents, and a wide 100 ohm to 2 megohm range of resistances. What's more, they are backed by MuRata's world-wide reputation for quality you can count on. Find out how these new pots can be put to work for you. Send for complete technical information today.

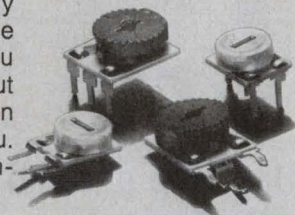

muRata
CORPORATION OF AMERICA
Rockmart Industrial Park, Rockmart, Georgia 30153
Phone: 404-684-7821/Telex: 54-2999/TWX: 810-766-1340

CIRCLE NUMBER 71

ELECTRONIC DESIGN 16, August 2, 1976

ONE-CHIP SYSTEM LOGIC #5 NEW 8-BIT INTERPRETER. ONE-CHIP CONTROLLER.

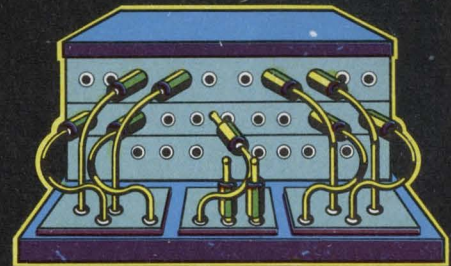

Finally, bipolar fixed instruction microcontroller on a single chip. Eliminates up to 150 SSI and MSI packages. Advanced Schottky LSI technology. 250 nanoseconds instruction cycle time. 8 powerful instructions. Order #8X300.

Coupon attached to my letterhead for One-Chip System Logic book.

Name _____ Title _____

Tel. _____ M.S. _____
811 E. ARQUES, SUNNYVALE, CA. 94086

THINK
Signetics

a subsidiary of U.S. Philips Corporation

©1976

CIRCLE NUMBER 72

107

Introducing One-Chip System Logic.

You get one-chip solutions to multiple-function problems!

Until now, when you wanted high-performance, you had to pay the high price. When you wanted low price, your performance options were limited.

That's exactly why Signetics has developed its line of "One-Chip System Logic" LSI products. To give you the best of both worlds. You get multiple functions on one chip. Great to build your own designs around. Great to upgrade from TTL and Schottky SSI and MSI. Great to save you time, hassle, board space, and reduce associated logic for overall lower systems cost.

"One-Chip System Logic" incorporated high-performance I²L and LS technologies and interfaces with TTL. The key is Signetics ¼ inch die capability which allows design and production of sophisticated LS building blocks.

System logic is one of the many LSI product families offered by Signetics including the MOS 2650 and bipolar 3000 series microprocessor.

Now, here are Signetics stock products:

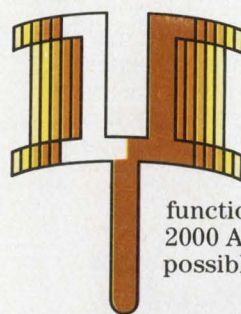

① One-chip electronic tuning

(#8X08 AM/FM Frequency Synthesizer).

Do away with mechanical tuning and frequency generation forever.

It performs all digital control

functions and gives you up to 2000 AM/FM/CB channels possible.

② One-chip parallel data deskewing

(#8X03 & 8X04 Deskew FIFO).

Now, one chip synchronizes parallel data on a per-track basis and offers lowest system cost. It's easy to design with and solves a lot of multiple circuit problems while you're at it.



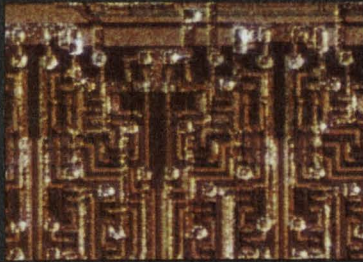

1. New AM/FM Frequency Synthesizer. 8X08

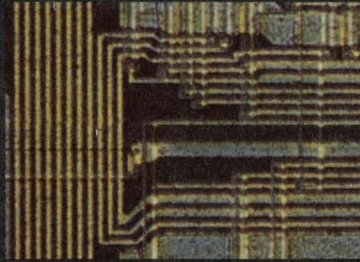

2. New Deskew FIFO. 8X03/04

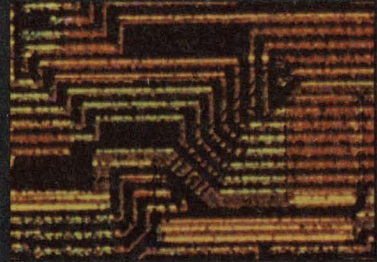

3. New CRC Generator/Checker. 8X01

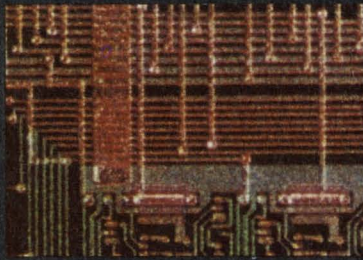

4. New Control Store Sequencer. 8X02

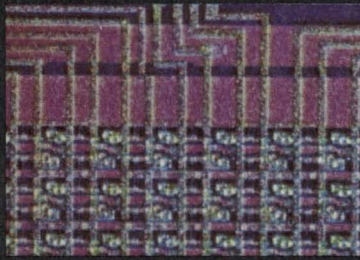

5. New 8 Bit Interpreter. 8X300



6. Your 1977 Solutions.

The only logical way to improve performance and save on systems cost.

3 One-chip error-checking

(#8X01 CRC Generator/Checker).

Eight polynomials for error detection of serial digital data. Detects SDLC type remainder. Easy-to-work with at an easier-to-live-with lower systems cost.



4 One-chip microinstruction sequencing

(#8X02 Control Store Sequencer).

You get 8 functions — everything you need for most

efficient microprogramming. With low power Schottky LSI technology, 28 pin DIP with 1024 word addressability, and more.



5 One-chip central controlling

(#8X300 8 Bit Interpreter)

Control oriented bipolar fixed instruction microprocessor on one LSI chip. Eliminates up to 150 discrete SSI/MSI chips. You get easy programming and fast processing — 250ns instruction cycle time.

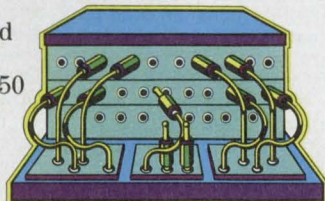

6 One-chip to solve your future needs.

Signetics has written a whole book detailing all of the instock standard products with a future products preview of "One-Chip System Logic." It shows you how Signetics is more responsive to your exact mixture of requirements. It includes a function/requirement questionnaire: tell us what you want us to develop as standard product in the system logic family for your next application. Read the book and send us the card.

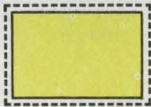

Attach this to your letterhead for fast response.

- Send me the whole book titled "One-Chip System Logic — Multiple Functions on One-Chip Now and in the Future."
- I have lots of questions. Please call me.
- Have a Field Applications Engineer make an appointment soon.

My application is _____

Name _____ Title _____

Telephone _____ Mail Stop _____

THINK signetics

811 E. Arques Ave., Sunnyvale, Ca. 94086

© 1976.

a subsidiary of U.S. Philips Corporation

CIRCLE NUMBER 73

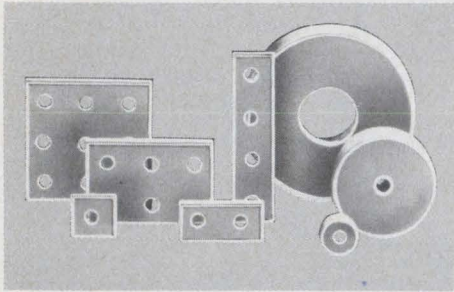

CIRCLE & MULTI-FEED-THRU CAPACITORS, available in a wide range of sizes and configurations, with NPO, BX, Z5U and Y5V characteristics. For use as feed-through elements, where volume efficiency of capacitance performance is required. Applications also include filter networks, pulse and logic circuitry, and signal bypass to ground elements in broadband circuits. Available in configurations suited to customer needs. Johanson/Dielectrics, Inc., Box 6456, Burbank, CA 91510 (213) 848-4465.

CIRCLE/MULTI-FEED CAPACITORS 181

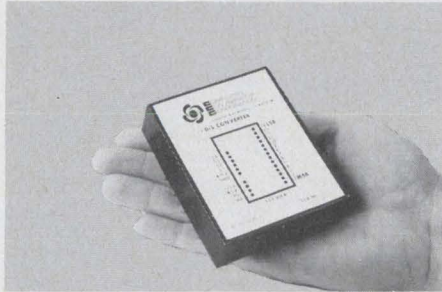

DIGITAL TO SYNCHRO CONVERTERS—14, 12 or 10 bit input, 11.8/90V, 400 or 60Hz transformer isolated output, accuracy ± 4 , ± 15 or ± 30 min. Driving 1VA, 2VA (2.6" x 3.1" x 82"H module) or 5 VA loads (4 1/2" x 9 1/4" PC card). Price from \$350 in qty. Other CCC products are Synchro to Digital or DC, and DC to Synchro Converters, Solid State C.T.'s or CDX's, and Absolute Encoders. Send for Free Catalog & Application Notes. Computer Conversions Corp., East Northport, N.Y. 11731 (516) 261-3300.

DIGITAL TO SYNCHRO 184

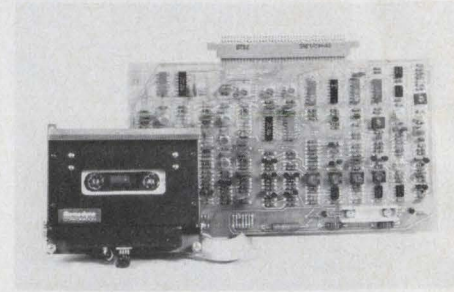

Memodyne Model 763 High Speed Magnetic Tape Cassette Recorder. For Computer or terminal peripheral storage. Records and playback at 20 IPS. Searches at 120 IPS. Uses patented servo system for constant speed. Has only two moving parts. For literature contact Memodyne Corporation, 385 Elliot Street, Newton, MA 02164.

CASSETTE RECORDER 187

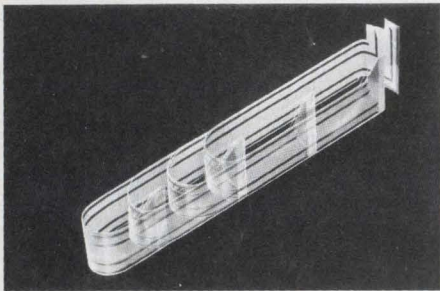

When you want a flexible circuit that doesn't just sit there, but really flexes—millions of times with complete reliability—then you want an R/flex flexible circuit from Rogers. Rogers has the know-how to make *flexible* flexible circuits to do your job. For help, write or call Rogers Corporation, Chandler, AZ 85224. Telephone: (602) 963-4584. (EUROPE: Mektron NV, Ghent Belgium; JAPAN: Nippon Mektron, Tokyo)

FLEXIBLE FLEXIBLE CIRCUITS 182

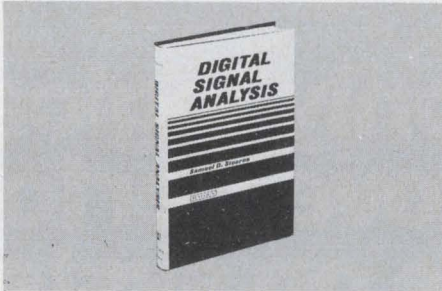

DIGITAL SIGNAL ANALYSIS, S. Stearns. Contains the most recent advances, brand-new design material, and a comparison between continuous and digital systems, making it an ideal master reference to today's signal processing techniques and systems. #5828-4, 288 pages, \$18.95. Circle the Info Retrieval Number to order 15-day exam copy. When billed, remit or return book with no obligation. Hayden Book Co., 50 Essex Street, Rochelle Park, N.J. 07662.

DIGITAL SIGNAL ANALYSIS 185

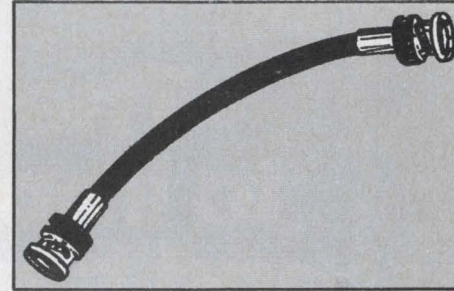

COAXIAL CABLE ASSEMBLIES. \$3.99 each. BNC Male to BNC Male coaxial cable assemblies. Model No. PE3067-12, 12"; PE3067-18, 18"; PE3067-24, 24"; PE3067-30, 30"; PE3067-36, 36"; PE3067-48, 48"; PE3067-60, 60"; PE3067-72, 72". Shipped same day order received. Types BNC, TNC, SMA, N, UHF are available on both flexible and semi-rigid cable. Custom made cable assemblies at competitive prices. For complete catalog: PASTERNAK ENTERPRISES, 8538 Hamilton Ave., Huntington Beach, CA 92646 (714) 536-7511.

COAXIAL CABLE ASSEMBLIES 188

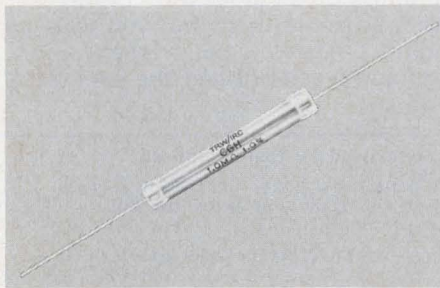

CGH Metal Glaze Resistors from TRW operate in high ambient temperatures with excellent high voltage load stability. These thick film resistors are particularly suited for precision high voltage and high impedance applications such as voltage multipliers, X-ray equipment, and high voltage power supplies where precision tolerances and TCs are required. TRW/IRC Resistors, an operation of TRW Electronic Components, 401 N. Broad St., Phila., Pa. 19108. (215) 922-8900.

CGH HIGH VOLTAGE 183

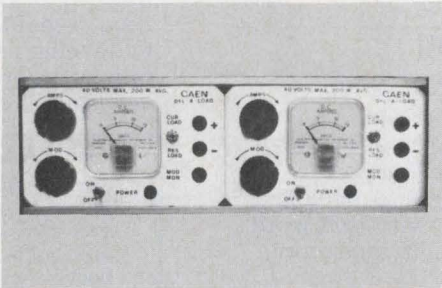

ELECTRONIC LOADS. Five different units available to test power supplies. Up to 25 amps in the single units and 50 amps in the dual by paralleling. Built in modulator for dynamic testing. Single units to 200 watts, dual units to 400 watts. Constant current or resistance selectable from front panel. "Quick," single turn controls for static and dynamic loading. Tests power supplies from 2-40 volts. Prices range from \$99.50-\$350. 30/60 days. CAEN ENGINEERING, 722B W. CHAPMAN, ORANGE, CA 92668 (714) 997-2751.

POWER SUPPLY TESTERS 186

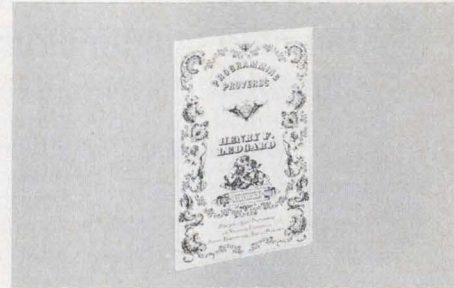

PROGRAMMING PROVERBS, H. F. Ledgard. A unique collection of "proverbs", or rules and guidelines, for upgrading the quality of your work, improving your skills in *program organization* and *logical thinking*. Sample programs in PL/1, ALGOL, and others. #5522-6, 144 pages, \$5.95. Circle the Info Retrieval Number to order 15-day exam copy. When billed, remit or return book with no obligation. Hayden Book Co., 50 Essex Street, Rochelle Park, N.J. 07662.

PROGRAMMING PROVERBS 189

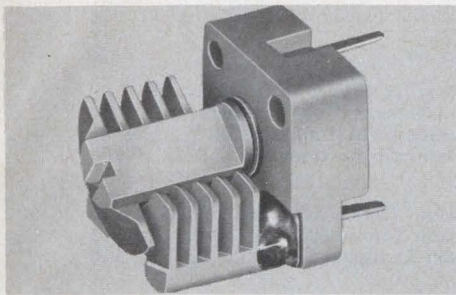

Miniature Type "U" air variable capacitors. Rotors and stators machined from solid brass extrusions offer excellent stability. High Q and low temperature coefficient (plus 45 ± 15 ppm/°C). Available in single section, differential and special order butterfly types. Choice of PC or discreet wiring terminals. E. F. Johnson Co., Waseca, MN., (507) 835-5222.

TYPE "U" CAPACITORS 190

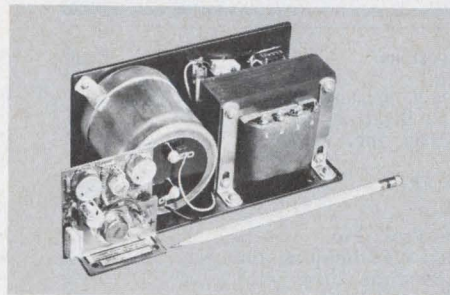

Cost-Saving "Blackline" Unregulated DC Supplies are reliable alternatives for many applications where regulation is a "frill," like powering solenoids, lamps, relays, latches, etc. When regulation is needed, Standard Power's new, compact "point-of-use" VCR Regulators can be added to provide $\pm 0.1\%$ regulation and simplify system packaging designs. They can be mounted anywhere that's convenient. For details, contact Standard Power, Inc., Santa Ana, CA 92705 (714) 558-8512.

DC POWER SUPPLIES 193

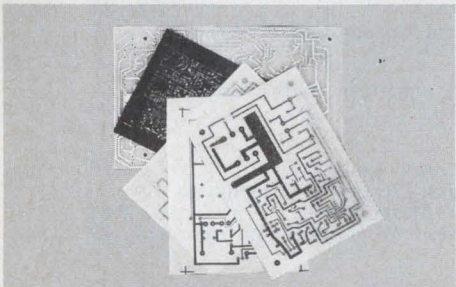

CUSTOM PC BOARDS AT LOW COST/FAST DELIVERY. No minimum order. Specialized service includes computer drilling, plated-through holes, tin or solder re-flow plating. Guaranteed delivery—3 days (single sided), 5 days (double), 1-24 pieces. All artwork services from schematic-to-proto available. Very competitive prices. WESTERN LABORATORIES, 110 South Rosemead Blvd., Pasadena, CA 91107 (213) 793-0148

CUSTOM PC BOARDS 191



FREE HIGH VOLTAGE CAPACITOR CATALOG. Complete source listings for over 1000 power, pulse, high voltage, and special purpose capacitors and high voltage power supplies in glass, plastic and CP72 styles. Special low inductance types for laser and high energy applications. Many "custom" designs are standard with us. High reliability, long life, moderate cost, and fast delivery assured. To get your catalog, just drop us a line. Condenser Products Corporation, P.O. Box 997, Brooksville, FL 33512.

HIGH VOLTAGE CAPACITOR CATALOG 194



NEW COMBO I, DIGITAL DIAL/POTENTIOMETER COMBINATION. Order it with our potentiometer or yours. Dial has precision, gear driven numbers with magnifying lens. Low cost Model 850 potentiometer (pictured), with gold terminals, resistance tolerance $\pm 5\%$; Ind. Linearity $\pm 25\%$; Life expectancy 500,000 shaft revolutions, minimum. ELECTRO TECHNIQUES, INC., 215 Via Del Norte, Ocean-side, CA 92054. (714) 757-7770. TWX: 910-322-1396.

DIGITAL DIAL/POTENTIOMETER 192

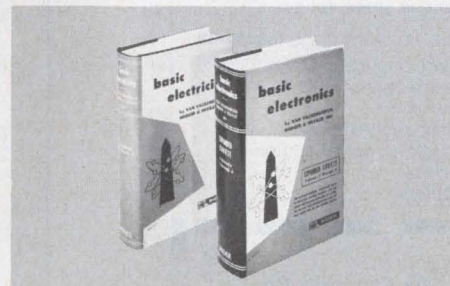

Basic Electricity & Basic Electronics by Van Valkenburgh, Nooger & Neville, Inc. Derived from the COMMON-CORE Training Program initially developed for the U.S. Navy. Thorough, comprehensive coverage. Available in separate paperbacks or cloth volume. Write for FREE brochure. Hayden Book Co., Inc., 50 Essex St., Rochelle Pk, N.J. 07662 (201) 843-0550.

TRAINING TEXT 195

Electronic Design

Advertising Sales Staff

Tom W. Carr, Sales Director
Jean Bunfield, Sales Coordinator
Rochelle Park, NJ 07662
Robert W. Gascoigne
Daniel J. Rowland
Thomas P. Barth
Stan Tessler
50 Essex St.
(201) 843-0550
TWX: 710-990-5071

Philadelphia

Thomas P. Barth
(201) 843-0550

Boston 02178

Gene Pritchard
P.O. Box 379
Belmont, MA 02178
(617) 489-2340

Chicago 60611

Thomas P. Kavooras
Berry Conner, Jr.
200 East Ontario
(312) 337-0588

Cleveland

Thomas P. Kavooras
(312) 337-0588

Los Angeles 90045

Stanley I. Ehrenclou
Burt Underwood
Neil Canavin
8939 Sepulveda Blvd.
(213) 641-6544

Texas

Burt Underwood
(213) 641-6544

San Francisco

Robert A. Lukas
3579 Cambridge Lane
Mountain View, CA 94040
(415) 965-2636

London

Constance McKinley
50 Essex St.
Rochelle Park, N.J. 07662
Phone: (201) 843-0550

Amsterdam, Tokyo, Seoul

Sanders, B. V.
Raadhuisstraat 24
Graft-De Ryp, Holland
Phone: 02997-1303
Telegrams: Euradteam-Amsterdam

Haruki Hirayama

Electronic Media Service
5th Floor, Lila Bldg.,
4-9-8 Roppongi
Minato-ku, Tokyo, Japan
Phone: 402-4556
Cable: Electronicmedia, Tokyo

Mr. O-kyu Park, President

Dongbo Intl Corp.—
World Marketing
C.P.O. Box 4010
Seoul, Korea
Tel. 76-3910/3911
Cable: DONGBO SEOUL
Telex: EBKOREA K27286

Advertiser's Index

Advertiser	Page	Advertiser	Page	Advertiser	Page
A P Products Incorporated.....	104	Data General Corporation.....	27	Industrial & Scientific Conference	
Acopian Corp.....	82, 83	Datel Systems, Inc.....	46	Management, Inc.....	56
Advanced Micro Devices.....	34 B-C	Deltron, Inc.....	77	Instruments for Industry, Inc.....	81
Aerospace Optics, Inc.....	106			International Rectifier.....	34H-I
Allen Bradley Co.....	34D	EECO.....	23		
American Microsystems, Inc.....	86, 87	Elec-Trol, Inc.....	92	Johanson Dielectrics, Inc.....	110
Amperex Electronics Corporation.....	71	Electro Techniques, Inc.....	111	Johanson Manufacturing Corp.....	6
Arnold Magnetics Corp.....	87	Electrocube Corp.....	102	Johnson Company, E. F.....	110
Arrow-M Corp.....	84	Electronic Design.....	94		
		Electronic Navigation Industries.....	88	Lear Siegler, Inc., E.I.D.	
Belden Corporation.....	33	Fairchild Systems Technology,		Data Products.....	48
Bodine Co., The.....	101	A Division of Fairchild Camera			
Bourns, Inc., Trimpot Products		and Instrument Corporation.....	4, 5	Mallory Capacitor Company.....	57
Division.....	Cover II	Fifth Dimension, Inc.....	94	*Membrain Ltd.....	34D
Burr-Brown Research Corporation....	96			Memodyne Corporation.....	110
		GenRad.....	65	Miller-Stephenson Chemical	
CTS Corporation.....	89	General Electric Company.....	37	Co., The.....	75
Caen Engineering.....	110	Gold Book, The.....	*82, *83, 113	Mini-Circuits Laboratory, A	
Capitol Machine & Switch Co.,		Grayhill, Inc.....	100	Division of Scientific	
Inc., The.....	88			Components Corp.....	2
Centralab, The Electronics		Hayden Book Company,		Monolithic Memories, Inc.....	41
Division of Globe-Union, Inc.....	56	Inc.....	34J, 110, 111	Monsanto Company.....	34K
Chrono-Log Corp.....	75	Hecon Corporation.....	103	Mostek Corporation.....	34F-G
Computer Conversions Corp.....	110	Heinemann Electric Company..	Cover III	Motorola Semiconductor Products,	
Condenser Products Corporation.....	111	Hewlett-Packard.....	9 thru 18	Inc.....	24, 31
Connecticut Hard Rubber				MuRata Corporation of America....	107
Company, The.....	96	ITT Pomona Electronics.....	93		
Continental Specialties Corporation..	19	Illuminated Products Co.....	7	North American Philips Controls	
Control Data Corporation,		Indiana General.....	42	Corp.....	90
Magnetic Components Division.....	99	Individualized Instruction Inc.....	112		
Crown International.....	74	International Rectifier.....	34 H-I	Pasternack Enterprises.....	110
		Industrial Controls Division,		*Philips Electronic Components	
Dana Laboratories, Inc.....	98	General Time.....	25	and Materials.....	34A
Data Display Products.....	38			Precision Monolithics, Incorporated..	79

All-new Phi-Deck,[®] precision remote controlled cassette transports starting at under \$100!

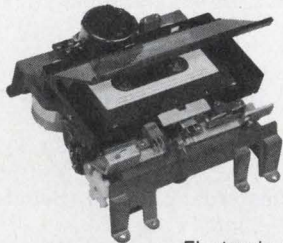

- Featuring:
- Re-engineered precision parts
 - New cast frames
 - 4 motor reliability
 - Remotely controlled
 - Precise, fast head engage/disengage
 - Quick braking
 - Various speed ranges

Electronic packages for control or read/write

- For application in:
- | | |
|-----------------------------------|---------------------------------------|
| 1. Micro processing | 6. Data duplicating |
| 2. Data recording/logging/storage | 7. Security/automatic warning systems |
| 3. Programming | 8. Test applications |
| 4. Instrumentation | 9. Audio visual/education |
| 5. Industrial Control | 10. Hi-Fi |
| | 11. Others |



Triple I A Division of The Economy Co.

1901 North Walnut P.O. Box 25308
Oklahoma City, Oklahoma 73125 (405) 521-9000

- I am interested in application no. _____
 Have Representative call Send application notes

Name _____ Title _____
Company Name _____
Address _____
City _____ State _____ Zip _____
Phone Number _____

CIRCLE NUMBER 74

RCA Solid State.....Cover 1V
RCL Electronics, Inc..... 36
Raytheon Company, Ocean
Systems Center..... 95
Riken Denshi Co., Ltd.....105
Rogers Corporation.....110

Sabor Electronics.....114
Schweber Electronics..... 29
Siemens Corporation.....34A
Signetics Corporation.....99, 101, 103,
105, 107, 108, 109
Sprague Electric Company.....34E
Stacoswitch, A Staco Inc. Company..104
Standard Grigsby, Inc..... 97
Standard Power, Inc.....111
Stanford Applied Engineering, Inc... 20

TRW/IRC Resistors, an Electronic
Components Division of
TRW, Inc.....110
Texas Instruments Incorporated.....34J
Triple I, A Division of the
Soconomy Co.....112

USCC/Centralab Electronics
Division, Globe-Union, Inc..... 49

Viking Industries, Inc..... 35
Vitramon North America Division
of Vitramon Incorporation.....34J
Vishay Resistive Systems Group..... 75

Wavetek San Diego, Inc..... 1
Western Laboratories.....111
Wiltron Company..... 91

*Advertisers in non-U.S. edition

"Our catalog in the GOLD BOOK paid for itself on the very FIRST DAY!"



Len Kornfeld
Executive Vice President

Len Kornfeld is Executive Vice President of U.S. Box Crafts, Inc., Brooklyn, NY manufacturer of paper, plastic and cardboard boxes and containers. Mr. Kornfeld writes:

"The very first day the GOLD BOOK came out we received inquiries which are converting to orders that will more than pay for our advertising costs. These inquiries are still coming in steadily.

"This was our first try in the electronics industry. The results are extremely gratifying."

The company normally directs its advertising to the general manufacturing industry. When GOLD BOOK representatives prepared a mock-up, U.S. Box Crafts decided to give it a try.

Mr. Kornfeld adds: **"We wouldn't have gone into the GOLD BOOK at all if you hadn't shown us what we could do. Now we're glad we did."**

Because the GOLD BOOK goes primarily to *Electronic Design's* audience of specifiers, U.S. Box Crafts gets the benefit of 78,000 engineers, engineering managers and purchasing agents throughout the U.S.A., not to mention 13,000 overseas. These are the men who are ready to talk packaging—the men who have the authority to *buy*.

**THE ELECTRONIC DESIGN AUDIENCE IS WORKING
FOR U.S. BOX CRAFTS, INC. ...IT CAN
WORK FOR YOU**

Electronic Design / GOLD BOOK

HAYDEN PUBLISHING COMPANY, INC.

50 Essex Street, Rochelle Park, New Jersey 07662. Tel: 201-843-0550

Sabor presents the **SONY**[®] Instrumentation Cassette Recorder

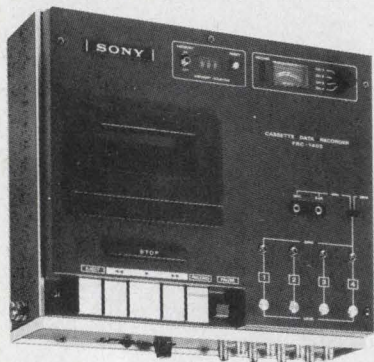

The SONY FRC-1402 provides 4 FM data channels with a frequency response of DC to 625 Hz. S/N ratio is 45dB (rms) minimum. Tape speed is 1-7/8 ips with recording time up to 45 minutes.

Priced from \$1990.

12597 Crenshaw Blvd.
Hawthorne, CA 90250
(213) 644-8689

Sabor corporation

CIRCLE NUMBER 76

classified ads

Biomedical Electronics Engineer position available as in-house consultant to researchers in Life Sciences investigating sensory mechanisms. Masters degree required. Salary open to \$17,000 commensurate with experience. Call or write direct to Dr. Daniel R. Kenshalo, Codirector, Psychobiology Research Center, Florida State University, Tallahassee, FL 32306 (904) 644-4416 or 644-5741.

WYOMING RANCH LAND

Wild horses, antelope, deer, elk. 10 acres \$30 down, \$30 month. FREE maps - photos - info. Owner - Dr. Michael Gauthier, 9550N Gallatin Rd, Downey, CA. 90240

CIRCUIT DESIGN ENGR:

Mfr. of mobile radio access. equipment seeks ckt. design engr. with experience in RF and Audio circuitry. Req'ts: BSEE and min. one year ckt. design experience. Send resume and salary history to Box CY, Electronic Design Magazine.

Product Index

Information Retrieval Service. New Products, Evaluation Samples (ES), Design Aids (DA), Application Notes (AN), and New Literature (NL) in this issue are listed here with page and Information Retrieval numbers. Reader requests will be promptly processed by computer and mailed to the manufacturer within three days.

Category	Page	IRN	Category	Page	IRN
Components			microprocessors	101	62
capacitors	6	5	microprocessors	103	65
capacitors	24	10	microprocessors	105	68
capacitors	31	251	microprocessors	107	72
capacitors, chip	93	360	microprocessors	109	73
DIP switches	89	45	μC board	45	571
motors	101	61	μC system	45	572
plasma display	93	361	Microwaves & Lasers		
potentiometers	92	357	circulator	104	387
potentiometers	11	281	detectors	105	389
pushbutton switch	106	70	electron tubes (NL)	107	308
reed relay	92	49	receiver	105	390
relays	94	51	scanner	105	391
resistors	56	26	tester	104	388
resistors	75	33	Modules & Subassemblies		
resistors, metal film	92	358	amp, instrumentation	87	347
rotary switch	97	56	amplifier, light	85	343
solid state relay	92	48	clock, digital	87	348
switches	36	17	converter, d/a	87	345
switches	88	44	converters, l/d	85	340
switches	104	67	displays, numeric	87	346
transformers	42		filters, tone	85	344
trimmer, cermet	92	359	Packaging & Materials		
Data Processing			breadboard, rf	102	382
core memory card	98	372	breadboards	104	66
digitizer, free form	99	376	connectors	35	16
minicomputer	99	377	flux remover & cleaner	75	34
minicomputer, rugged	99	375	heat sink clip	102	381
modem, RS-232C	98	373	IC packaging panels (NL)	107	305
modem adaptor	98	374	machine, trim and form	102	383
Discrete Semiconductors			PC board container	103	386
diodes, Schottky	96	367	socket, IC	103	385
display, alphanumeric	96	368	spring contacts	81	39
indicators, LED	97	371	temp-R-tape	96	55
photodiodes, avalanche	97	370	test clips	93	50
rectifier, HV	97	369	tool set and case	103	384
Instrumentation			wire, cable & cord	33	400
analysis recorder	95	52	Power Sources		
component tester	90	353	ac source	101	379
DMM	89	351	HV supply	100	337
DPM	46	23	lab supply	101	380
delay module	90	356	power sources (NL)	107	303
generator	88	350	power supplies	77	35
generator/recorder	75	32	power supplies	82	141
IC tester	88	349	power supplies	90	46
LRC meter	89	352	power supplies	99	58
network analyzer	65	29	switcher	101	378
panel meters	90	354	new literature		
power amp	74	31	circuit breakers	107	304
recorder	105	68	electrical components	107	302
synthesizer	90	355	electron tube catalog	107	308
Integrated Circuits			IC packaging panels	107	305
amplifier, power	94	363	power sources	107	303
chip, video game	95	365	readouts	107	307
comparator, high-speed	95	364	tubular solenoids	107	306
ROM, bipolar	94	362			
registers, shift	95	366			
Microprocessor Design					
core memory board	45	573			
microprocessor	99	59			

THE UP-FRONT BREAKER

PRECISE PROTECTION IN A PRETTY PACKAGE—AND A POWER SWITCH FOR YOUR FRONT PANEL.

Put a Heinemann Type J breaker on your front panel, and you get a power switch for free. An ingeniously simple way to cut component and assembly costs. There's just no reason to keep your protection under cover when you can get such good-looking breakers, with a choice of handle types, colors, and mounting arrangements.

Maybe you think a fuse and a switch would be cheaper. But did you ever stop to think how much it costs when your technician makes a service call just to replace a blown fuse? An easily resettable Heinemann circuit breaker can keep that from happening. Saves you money and enhances your product's reliability reputation.

Remember, too, that nothing works like a hydraulic-magnetic circuit breaker—close-tolerance protection and freedom from temperature-caused nuisance tripping. Our Type J can be custom-tailored to your circuit requirements in any integral or fractional rating from 0.020A to 30A at 240V 60 Hz or 400 Hz, or

65V dc. In a choice of four time-delay ranges and seven special-function internal circuits.

Values like the Type J have helped make Heinemann the world's most respected name in OEM circuit breakers. Only Heinemann gives you such a complete selection of sizes and ratings. And now we offer you a choice of protection: electro-mechanical, hybrid, or all solid-state. Backed up with Quick-Draw delivery (most popular styles and ratings shipped in a day or two); the exclusive Heinemann five-year warranty; and manufacturing facilities in the U.S., Canada, West Germany, South Africa, and Australia.

We want to help you get the most for your protection dollar. Call us or your nearby Heinemann representative for knowledgeable applications assistance. For starters request our Type J bulletin. Heinemann Electric Company, Trenton, NJ 08602. Phone (609) 882-4800.



HEINEMANN

We keep you out of trouble.

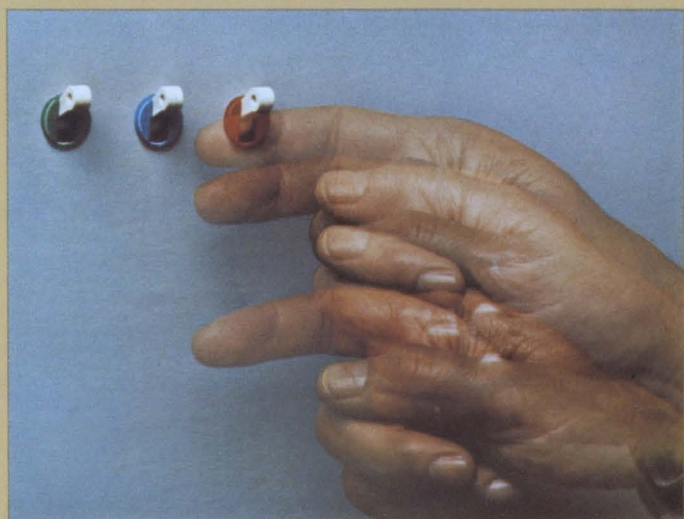
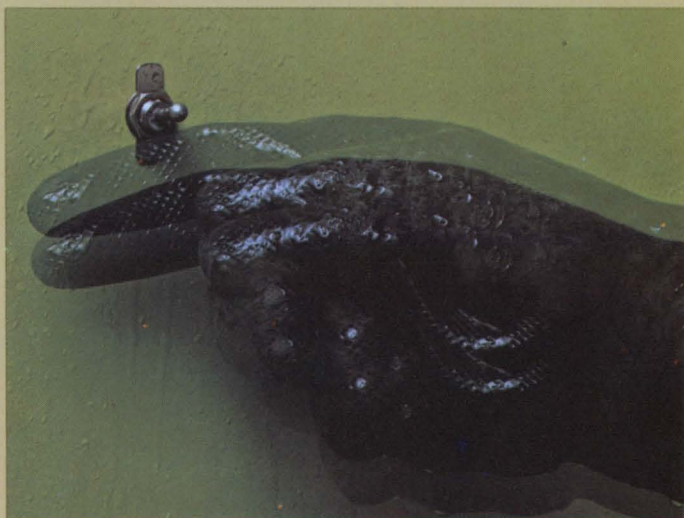
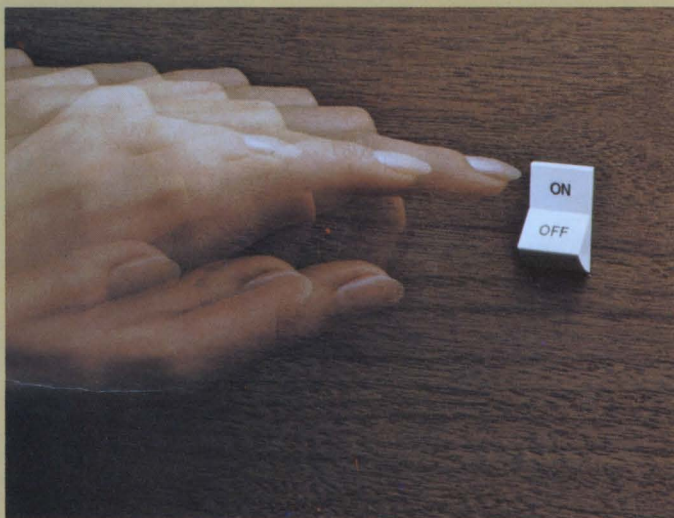

What's new in solid state . . .

RCA high-voltage power transistors made our special way.



You already know RCA transistors for reliability and performance. But maybe you didn't know about our high-voltage, high-current, fast switching 2N6513, 2N6308 and 2N6251 families. Available off-the-

shelf, they're made with the special brand of advanced technology, process controls, device characterization and circuit performance you expect from RCA. Inventors of the workhorse 2N3055.

Our special way

These transistors have multiple epitaxial base structure and 4-layer pi-nu construction, for high voltage and energy-handling capabilities. Rugged clip-lead connections for reliability and high current-

handling. Plus a thermal cycling rating that helps you design for optimum reliability vs. cost. All of which makes these devices excellent choices for 20 kHz switching regulators and inverters. Motor switches. TV monitors. Hammer, solenoid and relay drivers. Electronic ignition.

Check the specs and competitive prices below. Contact your local RCA Solid State distributor. Or RCA. Write: RCA Solid State. Box 3200, Somerville, New Jersey 08876; Ste. Anne de Bellevue 810, Canada; Sunbury-on-Thames, U.K.; Fuji Bldg., Tokyo, Japan.

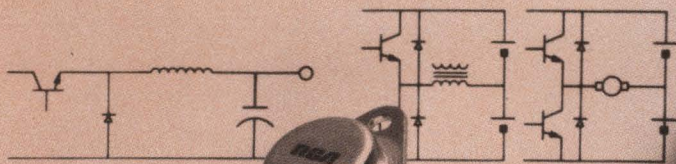

Switching regulator

Switching inverters

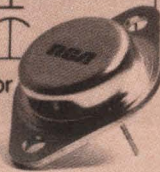

Coming soon.
A Super Switch.
 $t_r = < 200 \text{ nsec}@6 \text{ amps.}$

	I_C amps	V_{CER} volts	V_{CBO} volts	V_{CEO} (sus) volts	P_T watts	V_{CE} (sat) volts	t_r nsec	t_s μsec	t_f nsec	100+ price
2N6513	7	400	400	350	120	1.5@4A	700@4A	3@4A	500@4A	\$4.44
2N6308	8	450	700	350	175	1.5@3A	600@3A	1.6@3A	400@3A	\$5.09
2N6251	10	375	450	350	175	1.5@10A	800@10A	1.8@10A	500@10A	\$6.84

RCA. Powerhouse in Transistors.