

Electronic Design[®] 12

VOL. 25 NO.

FOR ENGINEERS AND ENGINEERING MANAGERS

JUNE 7, 1977

Computers talk with the world, but not always with ease. The main problem lies in nonstandard standards. But there are other problems — and advances. That's

true, also, for semi memories, cassette and cartridge recorders, PROM programmers and CAD programs for circuit design. For late developments, see p. 36.



A New Dial Design...

... beautiful
from any angle.

Any way you look at it, there's beauty and reliability at a low cost in our new Model H-1400 turns-counting dial. From the smooth, high impact tapered plastic design . . . to the big, bold legible numbers . . . this dial will add to the aesthetics of any control panel. But, with beauty being only skin deep, we've put durable long-lasting metal inside where it counts — including the gears and set-screw thread insert. And, the price is just as attractive — only \$4.26* in production quantities!

Send today for complete technical data and discover a beautiful new angle in turns-counting dials — from Bourns, naturally! Direct or through your local distributor.

TRIMPOT PRODUCTS DIVISION, BOURNS, INC. 1200 Columbia Ave.,
Riverside, CA 92507 Phone: 714 781-5123. TWX: 910 332-1252

*Domestic U.S.A. price only, H1411, without brake.



International Marketing Offices: European Headquarters — Switzerland 042/23 22 42 • Belgium 02/218 2005 • France 01/2039633 • Germany 0711/24 29 36 • Italy 02/32 56 88 • Netherlands 70/87 44 00 • United Kingdom 01/572 6531 • Norway 2/71 18 72 • Sweden 764/20 110 • Japan 075/921 9111 • Australia 02/55-0411 03/95-9566 • Israel 77 71 15/6/7

For Immediate Application — Circle 130
or for Future Application — Circle 230

When we surveyed the pulse generator market, we discovered that what many of you wanted was unavailable: a Wavetek pulse generator.

Model 801 takes care of that.

It's a 50 MHz pulse generator with independent width, rate, and delay controls. It's a versatile instrument, with double pulse

capability, a pulse burst mode, and a pulse reconstruction feature. But above all, it's a Wavetek, as you can see, and as you can tell by the low price (just \$995).

We could go on about the fixed ECL, TTL, and ECL outputs, and the variable outputs up to plus and minus 20 volts. Or the adjustable rise/fall from less

than 5 nanoseconds. But this is an ad, not a data sheet. So why not circle our reader service number and get all the specs on Wavetek's first pulse generator: WAVETEK, 9045 Balboa Avenue, P.O. Box 651, San Diego, CA 92112. Telephone: (714) 279-2200, TWX 910-335-2007.

WAVETEK®

CIRCLE NUMBER 2

Nobody ever put one of these on a pulse generator before.



RF TRANSFORMERS

\$ **2.95**
(10-49)
Model T 1-1T

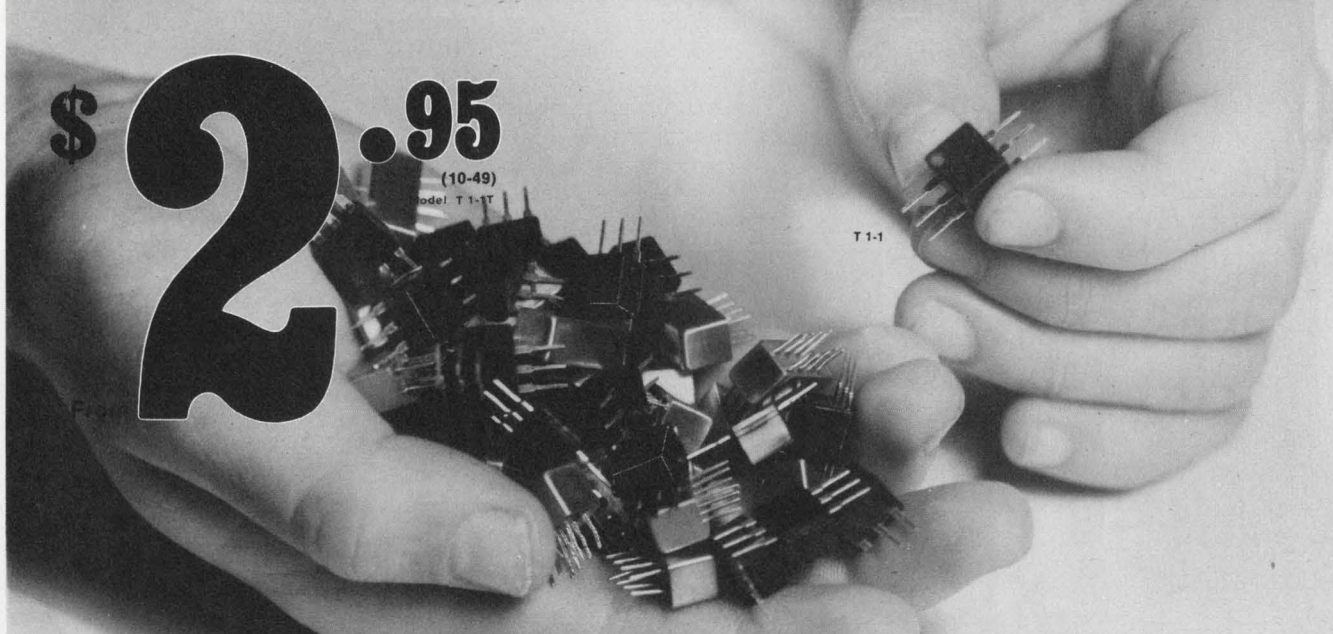

Have it your way!

36 models to choose from, 10KHz-800MHz

It costs less to buy Mini-Circuits wideband RF transformers. The T-series (plastic case) and TMO series (hermetically sealed metal case) RF transformers

operate with impedance levels from 12.5 ohms to 800 ohms and have low insertion loss, 0.5 dB typ. High reliability is associated with every transformer. Every

production run is 100% tested, and every unit must pass our rigid inspection and high quality standards. Of course, our one-year guarantee applies to these units.

DC ISOLATED PRIMARY & SECONDARY						
Model						
Metal Case	TMO 1-1	TMO 1.5-1	TMO 2.5-6	TMO 4-6	TMO 9-1	TMO 16-1
Plastic Case	T 1-1	T 1.5-1	T 2.5-6	T 4-6	T 9-1	T 16-1
Freq. Range, MHz	.15-400	.1-300	.01-100	.02-200	.15-200	.3-120
Impedance Ratio	1	1.5	2.5	4	9	16
Max. Insertion Loss	3 dB	2 dB	1 dB	3 dB	2 dB	1 dB
Price, Model TMO	\$4.95	\$6.25	\$5.95	\$5.95	\$5.45	\$5.95
(10-49) Model T	\$2.95	\$3.95	\$3.95	\$3.95	\$3.45	\$3.95

UNBALANCED PRIMARY & SECONDARY					
Model					
Metal Case	TMO 2-1	TMO 3-1	TMO 4-2	TMO 8-1	TMO 14-1
Plastic Case	T 2-1	T 3-1	T 4-2	T 8-1	T 14-1
Freq. Range, MHz	.015-600	.5-800	.5-600	.15-250	.2-150
Impedance Ratio	2	3	4	8	14
Max. Insertion Loss	3 dB	2 dB	1 dB	3 dB	2 dB
Price, Model TMO	\$5.45	\$6.25	\$5.45	\$5.45	\$6.25
(10-49) Model T	\$3.45	\$4.25	\$3.45	\$3.45	\$4.25

DC ISOLATED PRIMARY & SECONDARY CENTER-TAP SECONDARY									
Model									
Metal Case	TMO 1-1T	TMO 2-1T	TMO 2.5-6T	TMO 3-1T	TMO 4-1	TMO 5-1T	TMO 13-1T	TMO 13-1T	TMO 13-1T
Plastic Case	T 1-1T	T 2-1T	T 2.5-6T	T 3-1T	T 4-1	T 5-1T	T 13-1T	T 13-1T	T 13-1T
Freq. Range, MHz	.05-200	.07-200	.01-100	.05-250	2-350	3-300	3-120	3-120	3-120
Impedance Ratio	1	2	2.5	3	4	5	13	13	13
Max. Insertion Loss	3 dB	2 dB	1 dB	3 dB	2 dB	1 dB	3 dB	2 dB	1 dB
Price (10-49)	\$5.95	\$6.25	\$6.25	\$5.95	\$4.95	\$6.25	\$6.25	\$6.25	\$6.25
Model T	\$3.95	\$4.25	\$4.25	\$3.95	\$2.95	\$4.25	\$4.25	\$4.25	\$4.25

Designers Kit Available		
(TK-1) — 2 transformers of each type T1-1, T2-1, T4-1, T9-1, T16-1	\$32.00	(TMK-2) — 2 transformers of each type TMO1-1, TMO2-1, TMO4-1, TMO9-1, TMO16-1
		\$49.50

International Representatives: **AUSTRALIA:** General Electronic Services, 99 Alexander Street, New South Wales, Australia 2065. **ENGLAND:** Dale Electronics, Dale House, Wharf Road, Firmley Green, Camberley Surrey. **FRANCE:** S.C.I.E. - D.I.M.E.S. 31 Rue George - Sand 91120 Palaiseau, France. **GERMANY, AUSTRIA, SWITZERLAND:** Industrial Electronics GMBH, Klüberstrasse 14, 6000 Frankfurt/Main, Germany. **ISRAEL:** Vecronics, Ltd. 69 Gordon Street, Tel-Aviv, Israel. **JAPAN:** Densho Kaisha, Ltd. Eguchi Building, 8-1 Chome Hamamatsucho Minato-ku, Tokyo. **EASTERN CANADA:** B.D. Hummel, 2224 Maynard Avenue, Utica, NY 13502 (315) 736-7821. **NETHERLANDS, BELGIUM, LUXEMBOURG:** Coimex, Veldweg 11, Hattem, Holland. **NORWAY:** Datamatik AS, Ostensjoveien 62, Oslo 6, Norway. **AFRICA:** Alitra (PTY) Ltd., P.O. 9813, Johannesburg 2000. **SINGAPORE, MALAYSIA:** Electronics Trading Company, 87, Bukit Timah Road, Singapore, 9. **SWEDEN:** Intergeard Elektronik, Box 43 S-1, B2 51 Djursholm, Sweden.

U.S. Distributors: **NORTHERN CALIFORNIA:** Cain-White & Co., Foothill Office Center, 105 Fremont Avenue, Los Altos, CA 94022 (415) 948-6533. **SOUTHERN CALIFORNIA, ARIZONA:** Crown Electronics, 11440 Collins Street, No. Hollywood, CA 91601 (213) 877-3550.

World's largest manufacturer of Double-Balanced Mixers
Mini-Circuits
 Mini-Circuits Laboratory A Division Scientific Components Corp.
 837-843 Utica Avenue, Brooklyn, NY 11203
 (212) 342-2500 Int'l Telex 620156 Domestic Telex 125460

22 Rev A

CIRCLE NUMBER 3

ELECTRONIC DESIGN 12, June 7, 1977

NEWS

- 21 **News Scope**
- 29 **Washington Report**
- 36 **Bit-oriented protocols** plus standard interfaces are helping ease data communications.
- 44 **Computer-aided design** beats the trial and error method—just find the software.
- 52 **Kenneth Iverson:** from a symbolic notation to A programming language.
- 58 **PROM programmers** have grown quite a bit—some have brains and 'personality.'

TECHNOLOGY

- 66 **FOCUS on cassette and cartridge recorders.** Faced with an abundance of choices, you may find that such crucial specs as those for capacity, compatibility and coding tend to cloud rather than clarify.
- 84 **Get the best processor performance** by building it from ECL bit slices. The 10800 family offers versatility as well as cycle times of less than 100 ns.
- 96 **Getting the bugs out of your software** can be harrowing and costly. But if you have done a top-down design, systematic testing minimizes agony.
- 104 **Build a μ P-based simulator and learn** elementary programming. The unit executes 16 instructions. The parts fit on one board and cost under \$100.
- 116 **Ideas for Design:**
Timing circuit burps battery to improve charging efficiency.
Digitally programmable clock source built with a d/a and v/f converter.
Interface circuit teams cassette recorder with a CRT to replace TTY unit.
- 122 **International Technology**

PRODUCTS

- 125 **Modules & Subassemblies:** Hybrid amplifiers deliver premium performance at low cost.
- 132 **Instrumentation:** Synthesized signal generator tunes with spin wheel.
- 140 Packaging & Materials
- 146 Components
- 148 Micro/Mini Computing
- 162 Microwaves & Lasers
- 164 ICs & Semiconductors
- 174 Data Processing
- 178 Power Sources

DEPARTMENTS

- 81 **Editorial:** Attacking the problem
- 7 Across the Desk
- 182 Evaluation Samples
- 182 Application Notes
- 184 Vendors Report
- 186 New Literature
- 192 Product Index
- 194 Advertisers' Index
- 194 Information Retrieval Card

Cover: Photo by Steve Grohe, courtesy of Data General Corporation

ELECTRONIC DESIGN is published biweekly except 3 issues in July by Hayden Publishing Company, Inc., 50 Essex St., Rochelle Park, NJ 07662. James S. Mulholland Jr., President. Printed at Brown Printing Co., Waseca, MN. Controlled circulation postage paid at Waseca, MN and New York, NY, postage pending Rochelle Park, NJ, Atlanta, GA. Copyright© 1977. Hayden Publishing Company, Inc. All rights reserved. POSTMASTER: Please send form 3579 to ELECTRONIC DESIGN, P.O. Box 13803, Philadelphia, PA 19101.

64-bit RAMs without aspirin.

Advanced Micro Devices, Inc. • 901 Thompson Place, Sunnyvale, California 94086 • Telephone (408) 732-2400 •
Distributed nationally by Hamilton/Avnet, Cramer and Schweber Electronics and regionally by Arrow, Bell,
Century Electronics, Future Electronics and RAE Electronics.

Advanced Micro Devices announces brand new, trouble-free 64-bit RAM's. Am27S02A/3A, the world's fastest. Am27LS02/03, the world's best low-power, high-speed combination. And Am29700/01, the world's only non-inverting 64-bit RAM.

They're a whole new 64-bit RAM family. Rebuilt from top to bottom. No re-hash of eight-year-old designs. Internally compensated ECL circuitry. Optimum speed/power performance.

Modern LSI process techniques: Two-layer metalization. Ion-implantation. Three-micron EPI. Washed emitters. It's today's TTL RAM technology — designed to run extremely well over military specs. And even better over commercial.

They're cooler and faster.

Cooler and faster than the part has ever been. They're designed with a

temperature-compensated regulator system built in for stable performance over supply and temperature variations.

A transparent option is also available at no extra cost. It'll allow you to see the complement of the data in during the write cycle without lowering the part's overall speed.

Everything but the glitch.

The output circuitry is pre-conditioned so that true data is present at the outputs when the write cycle is completed. There's no "write/recovery glitch."

We don't take data sheets lightly.

Our new 64-bit RAM's will meet every single spec on those data sheets. And we mean every one.

Here's what you do: Send us your name on your letterhead and the part number you're interested in. We send you two free parts. You throw away the aspirin.

The specs.	THEIR LOW POWER COM'L/MIL	OUR LOW- POWER 27LS02* & 27LS03 COM'L/MIL	THEIR HIGH- SPEED COM'L/MIL	OUR HIGH- SPEED 27S02A* & 27S03A COM'L/MIL
MAX ADDRESS ACCESS tAA	80ns/100ns	55ns/65ns	35ns/50ns	25ns/30ns
MAX CHIP SELECT ACCESS tpZH/L (CS)	60ns/80ns	30ns/35ns	17ns/25ns	15ns/20ns
MIN WRITE PULSE WIDTH tpw (WE)	80ns/100ns	45ns/55ns	25ns/25ns	20ns/25ns
MAX WRITE RECOVERY tpZH/L (WE)	80ns/100ns	30ns/35ns	35ns/40ns	20/ns25ns
MAX POWER SUPPLY CURRENT	25mA/25mA	35mA/38mA	110mA/110mA	100mA/105mA

NOTES: COM'L = 0°C to 75°C V_{cc} = 5v ± 5%
MIL = -55°C to 125°C V_{cc} = 5v ± 10%

*open collector output

Advanced Micro Devices

Bipolar LSI. N-channel, silicon gate MOS. Low-power Schottky.
Multiple technologies. One product: excellence.



+1 1.008 mV 240.5 ACV
 198.4 PSI 139.45 GPM
 -180.0 °C +1084.5 °F
 1.386 AMPS 2570.85 RPM
 220.0 OZ/SEC 1303 LBS

United Systems' Indicators Will:

- MEASURE voltage and current; ac, true rms or dc.
- CONVERT the output of any transducer/transmitter to display in engineering units.
- DISPLAY temperature (C or F) directly from thermocouple, RTD, or thermistor sensors.
- INTERFACE readily into your system by optional "single line enable" parallel BCD output.
- INDICATE when a predetermined limit is exceeded, through relay closure or logic level output from optional internal comparator alarm.

And with United Systems' exclusive adaptors these indicators change, in the field, to perform any measurement listed above and more!

For additional information contact your United Systems Representative or call the factory (513) 254-6251.

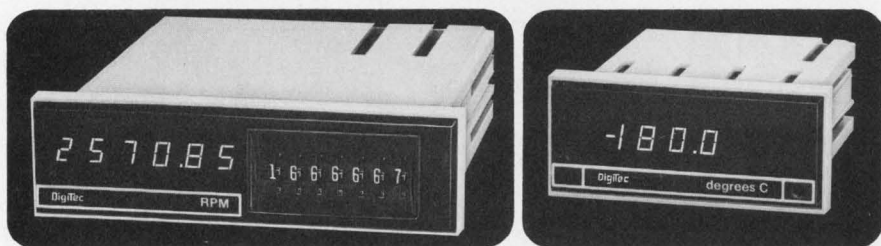

Digitec. UNITED SYSTEMS CORPORATION

918 Woodley Road, Dayton, Ohio 45403
(513) 254-6251. TWX (810) 459-1728

United Systems Corp: Precision measurements to count on

FOR INFORMATION ONLY CIRCLE #158

FOR DEMONSTRATION ONLY CIRCLE #239

Sr. Vice President, Publisher

Peter Coley

Editors

Editorial Offices
50 Essex St.
Rochelle Park, NJ 07662
(201) 843-0550
TWX: 710-990-5071
(HAYDENPUB ROPK)
Cable: Haydenpubs Rochellepark

Editor-in-Chief George Rostky

Managing Editors:

Ralph Dobriner
Michael Elphick

Senior Associate Editor

Stanley Runyon

Associate Editors:

Sid Adlerstein
Dave Bursky
Morris Grossman
John F. Mason
Andy Santoni
Max Schindler

Contributing Editors:

Peter N. Budzilovich, Jules H. Gilder,
John Kessler, Alberto Socolovsky,
Nathan Sussman

Editorial Field Offices

East

Jim McDermott, Eastern Editor
P.O. Box 272
Easthampton, MA 01027
(413) 527-3632

West

Dick Hackmeister, Western Editor
8939 S. Sepulveda Blvd., Suite 414
Los Angeles, CA 90045
(213) 641-6544
TWX: 1-910-328-7240
Dave Barnes, Western Editor
844 Duncardine Way
Sunnyvale, CA 94087
(408) 736-6667

Editorial Production

Marjorie A. Duffy, Production Editor
James Keane, Copy Editor

Art

Art Director, William Kelly
Richard Luce, Anthony J. Fischetto

Production

Manager, Dollie S. Viebig
Helen De Polo, Nancy Hurey

Circulation

Director, Barbara Freundlich

Information Retrieval

Paula Greenleaf

Advertising Promotion

Susan G. Apolant

Reprints

Maxine Correal

Wage busting: more than a matter of perspective

Assuming you have quoted Edward Leeson accurately in your article on wage busting (ED No. 4, Feb. 15, 1977, p. 26), I find it inconceivable that Leeson would be appointed executive director of any organization more prestigious than, perhaps, a motorcycle gang.

His inappropriate language notwithstanding, Leeson's mind deviates down curious paths of logic. He faults the concerned engineer because "they can't seem to live in a free enterprise system." Yet, he seems to find nothing at fault with 16 industrial organizations, which supposedly compete within the same system, finding it necessary to form an industrial union that parades under the flag of an "industrial council"—the National Council of Technical Service Industries. Evidently, a need was felt to unite in order to agree privately on the best way to do business with the Government.

Leeson has also concluded that loss of respect for engineers who want to organize might be forthcoming. The companies have already telegraphed their "respect" in no uncertain way. Leeson throws in the matter of seniority. According to your article, that word seems to be quite elastic and, under the circumstances, little more than amusing.

It would be interesting to have Leeson explain exactly why a floor sweeper is entitled to less respect than an engineer—or for that matter himself.

The best way to keep the Government out of the wage picture is to eliminate the conditions that would make this solution attractive—conditions created by the members of NCTSI that they knew, when they bid, are patently unfair and totally unconscionable. But it is highly doubtful that the chief executive officers of the firms mentioned are aware of all the details

of the existing problem and even more doubtful that they are aware of the official position of the NCTSI, as expressed by Leeson.

Peter L. Krohn

170 Shawnee Ave.
Easton, PA 18042

Wage busting not limited to a few companies

Thank you for your timely article on wage busting. It was comprehensive, and portrayed the plight of many engineers in service contracts. However, I feel that using company names rather than simply "contractor" did not enhance the article, but made it appear that the problem rests with a few particular companies. This is eminently untrue, and the sole purpose of the movement started by the coalition of Aerospace Professional Employees, and subsequently joined by IEEE, is to correct the problem by legislation in Washington, and was never intended to denigrate employers.

I purposely avoided company names when testifying before the Senate hearings last May at Merritt Island, FL, but substituted "previous contractor" and "present contractor," which were duly recorded in the Congressional record.

Alleviating the wage-busting problem transcends companies, or even NASA and the Air Force, since the practice of awarding contracts to the low bidder is a dictate they all must follow—and companies must bid low to win, as pointed out in your article.

Charles O' Neal
Senior Engineer

Planning Research Corp.
Kennedy Space Center, FL 32925

Wage busting is not the real issue. . .

Your article on wage busting correctly points out that wage busting has

(continued on page 8)

Single Source? Not the Mona Lisa!



She smiles like that whenever they give her a lot of general data about only buying her peripherals from the mainframe manufacturer. But she's never decked by it because she knows about buying tape and disk systems. She knows that, at DATUM, she can get immediate delivery of controllers for a wider variety of peripherals... and save a lot of money, too.

Only DATUM has designed, built and installed over 7000 controllers and systems for so many different minicomputers to interface with such a variety of peripheral devices.

Check these tape-controller features: Triple-density NRZI formatting. Dual-density PE/NRZI formatting. 200 ips for all existing interfaces. Single-source responsibility for all major tape drives.

For that Mona Lisa smile, write DATUM now for specifications and prices.

Datum also manufactures cassette and rotating memories, data acquisition systems and timing instrumentation.

Peripheral Products Division
1363 S. State College Blvd., Anaheim, CA
92806 • 714/533-6333 EUROPE: Datum
House, Cranford Lane, Harlington, Middlesex,
UK • 01-897-0456

datum inc

Electronic Design welcomes the opinions of its readers on the issues raised in the magazine's editorial columns. Address letters to Managing Editor, Electronic Design, 50 Essex St., Rochelle Park, NJ 07662. Try to keep letters under 200 words. Letters must be signed. Names will be withheld upon request.

Across the desk

(continued from page 7)

occurred among professionals. However, an important point not stated is that forced reduction of the salaries of professional persons performing essentially the same duties (as the result of recompetition) has not occurred on service contracts in several years. While I cannot speak for the federal government, my discussions with federal officials assures me that wage busting of professionals in any future recompetitions will not be tolerated. Therefore, it would seem that anti-wage-busting legislation is the right issue but at the wrong time.

A natural retort to this statement might be, "If wage busting is wrong, why not outlaw it, whether or not it is likely to happen?" Unfortunately, HR 314, the proposed bill to bring professionals under the Service Contract Act of 1965, does not simply outlaw wage busting. Instead, HR 314 requires salaries be regulated by the U.S. Department of Labor. Many knowledgeable people on Capitol Hill believe that wage busting is only the emotional, "up front" issue, with the real goal of HR 314 being to raise service-contract salary costs enough to equal the salary costs of civil servants if they were doing the same work. From there, it is a relatively easy step to terminate all service contracting in favor of a total in-house effort by "big government."

Just as I cannot speak for the government, I cannot speak for all contractors. However, the major push for HR 314 is coming from Brevard County, Florida. My company, PRC Systems Services Company, is a major employer of professionals under service contracts in that county, with a major design-engineering contract at Kennedy Space Center. We recruit nationwide for our Florida project, and we pay professional salaries that compare favorably with data published by such prestigious bodies as the Engineers Joint Council.

Although we pay nationally competitive salaries, it would be unrealistic to expect that every one of our engineers considers himself fairly compensated. Indeed, we know that a few of our employees are not paid at the level they commanded in the halcyon days of Apollo. We believe that, compared with others on the basis of rela-

tive productivity, they simply are not worth their former salaries. It would be naive to expect them to agree.

A most unfortunate result can be predicted from HR 314 if it becomes law. If a company must pay a salary to any individual that is higher than management believes he or she is worth, then the company is going to look for a replacement it considers effective at the legislated salary level. The end effect will be that, in the main, those individuals who are pushing for HR 314 will be laid off precisely because of HR 314.

I, for one, find it difficult to see the positive contribution of a law that forces unemployment among the lesser qualified, less effective engineers in Brevard County, who will be replaced by technical expertise imported from out of the state.

If wage busting is the real issue, then we are prepared to support an executive order or, if need be, legislation that outlaws wage busting. In fact, we heartily endorse HR 4873, proposed by the National Society of Professional Engineers, which, if it became law, would accomplish that end.

*George E. Monroe
President*

PRC Systems Services Co.
7600 Old Springhouse Rd.
McLean, VA 22101

Wage busting is the real issue

Mr. Monroe states incorrectly that if bill HR 314 is passed, the Department of Labor will then regulate the salaries of professionals. The Department of Labor Survey, a survey of professional, administrative, technical and clerical pay, better known as the PATC, lists the salaries of over 340,000 engineers who are employed by "free enterprise" firms throughout the United States. The PATC survey has been described as excellent by the Chairman of Surveys of the Engineering Manpower Commission, an "industry management"-dominated commission of the Engineers Joint Council.

Another myth is that engineers' salary costs would become equal to the costs for civil servants. This is absolute nonsense! The fringe benefits for government employees lie in the area of 70% of their salaries while the national norm for private industry lies in the area of 30%. What's more, contracts becoming an in-house effort by "big government" is a myth as well. Private

industry has more flexibility in coping with changing work situations than the government. Work efficiency is higher in private industry than in government—it is next to impossible to fire an incompetent civil servant. The Office of Management and Budget's policy, OMB A-76, is to rely on private enterprise to perform service contracts.

As to the claim by Mr. Monroe that his company's wages are competitive, I ask him to tell how many of his senior engineers are making \$13,500 to \$16,500 per year. With over 10 years' experience, they should be making \$23,000 or better.

If, as Mr. Monroe states, he is employing incompetent engineers, I must express my outraged indignation as a taxpayer.

As for the NSPE bill, HR 4873, IEEE lawyers have examined it and recommended that IEEE not support it in its present form—it doesn't employ a third party to see that engineers are being paid their proper worth. Engineers can still be paid low salaries on a new contract. The bill has absolutely no teeth to enforce the proper payment to engineers, because it leaves the wage decision to the procurement officer.

Mr. Monroe states that the major push for HR 314 is coming from Brevard County, Florida—my colleagues from Huntsville, Alabama would disagree, I am sure. Wage busting is going on throughout the country on service contracts. In fact, the most recent instance to come to our attention is at Fort Huachuca, Arizona.

The knowledgeable people on the Hill know that by Mr. Monroe's definition, an engineer who is laid off when the contract runs out and then rehired by a new contractor for substantially the same work for less money is not considered wage-busted. These fair-minded people say it is wage busting.

The IEEE has informed me that Mr. Monroe has submitted a bill to them that will amend the Service Contract Act of 1965 by extending its coverage to professional employees. A clause would give the Secretary of Labor the same authority to enforce the provisions of the new bill as he has in the "blue collar" and "white collar" bill. This is indeed encouraging, for I have no desire to be in an adversary position with any contractor. I am certain we can accomplish much more if we work together.

I conclude by pointing out that everyone is covered by the umbrella of the Service Contract Act except the

(continued on page 19)

hp MEASUREMENT COMPUTATION **NEWS**

product advances from Hewlett-Packard

JUNE 1977

in this issue

New memory offers lightning fast retrieval

An HP first—6-pin optocouplers

New 22 GHz spectrum analyzer



The new 5004A Signature Analyzer displays a hexadecimal signature unique to a data node in one of HP's new products designed for troubleshooting using the signature analysis technique. This technique allows building economical component-level servicing into new products.

Signature analyzer simplifies microprocessor system servicing

Few, indeed, are the electronic product areas untouched by the microprocessor revolution. But despite the benefits of microprocessors, the question arises, "How will the products be serviced?" Swapping defective modules for good ones creates inventory and handling costs. HP now offers a timely, more economical alternative—**signature analysis**, for servicing down to the component level. It even eliminates the need to design the product as a modularized one, in some cases.

(continued on third page)

Trace serial data with parallel-mode logic analyzer

A new serial-to-parallel converter now makes it possible to use the measurement capabilities of HP's 1600A and 1607A Logic State Analyzers for the serial data domain. This accessory, the 10254A, accepts data in serial form and formats it into a parallel word for presentation as one line on the logic state analyzer's tabular display. Just as with parallel data, the logic state analyzer can be set to capture and display the data sequence beginning with a particular word, or data leading up to the word, or data at some point downstream from the word, enabling the user to find the part of the program where malfunctions occur.

If both the 1600A and 1607A are being used at the same time, with the 10254A converter, both serial and parallel data can be displayed in two tables on the 1600A display.

For more details, check B on the HP Reply Card.



The 10254A serial-to-parallel converter (lower unit) interfaces the HP 1600A logic state analyzer (upper unit) to serial data streams so serial data flow occurring at a node or on a bus can be presented as a table of binary words on the logic analyzer's display.

Cache speed memories at semiconductor prices

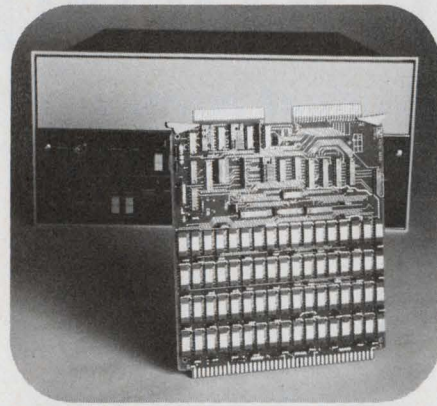

The addition of high-speed semiconductor memory options to the 21MX-E Series computer results in up to 30% overall system performance increase over previous memory modules.

In the time it takes light to travel 100 meters, an HP 21MX E-series computer with new high-speed memory can retrieve information and be ready for another access!

A major contribution to this speed is the new N-Channel MOS/RAM memory. New 4K RAMs cycle in 320ns.

The new structure of the HP 2102E controller has almost eliminated its time overhead. Cycle time of the system then is 350ns, almost equivalent to that of the chips.

To ensure reliability, all memory parts and boards undergo vigorous burn-in and proprietary diagnostic tests to discover and correct faults that would not have otherwise been detected.

The new HP 12741A memory modules meet stringent environmental specifications, i.e., 0-55°C, up to 95% humidity, plus tough shock and vibration tests.

Available in 32-kbyte modules, the new 350ns memory may be ordered with 21MX E-Series computers, all HP 1000 Systems and 2126A DisComputers. Because HP offers full asynchronous interface with memory, field retrofit is possible; a change of controller is necessary.

With a memory cycle time at 350ns, the new memory exceeds that of many cache memory schemes, without the usual associated high cost.

Check D on the HP Reply Card for further information.

HP 7920—the disc that doesn't keep your CPU waiting

The new 50 megabyte (formatted) HP 7920 disc has some of the fastest access times in the minicomputer industry. Seek times—track to track—are 5 ms, averaging 25 ms, worst case is only 45 ms.

Designed with a light carriage/rail system for lower mass, and a linear voice coil motor with high force inputs, higher accelerations are possible and therefore greater speed.

Speed in stopping and accurately positioning the head is equally important. High-speed feedback circuitry, deriving a signal directly from the surface of the disc, allows optimization of over-shoot and settling times.

Reliability is also designed into the discs. The Error Correction Code hardware and algorithm are together capable of correcting one single-burst data error per sector, if the error is of length ≤ 32 bits. For burst errors of > 48 bits, 99.999% are detected.

A dual filtration system of the HP 7920 contributes to reliability by removing 99% of particles 0.3 microns or larger. Also, in the event of a blackout or circuit break, an emergency head retract prevents head crashes.

For further information, check O on the HP Reply Card.



The addition of the high-speed HP 7920 disc to a 256k byte HP 3000 Series II computer results in a 20% improvement in system response time in interactive sessions and a 30% improvement in throughput.

Enhance swept measurements with digital storage and normalization

Understanding and measuring phase noise in the frequency domain

Hewlett-Packard's new Application Note 207 describes the theory and practice of making phase noise measurements from 5 Hz to 13 MHz from the carrier. Emphasis is placed on the correction factors required for making noise power spectral density measurements with wave and spectrum analyzers. Examples are given for both manual and automatic measurements.

For your free copy, check S on the HP Reply Card.

Troubleshoot complex microprocessor-based circuits

(continued from first page)

Signature analysis is based on the time-honored technique of signal tracing. HP's Model 5004A Signature Analyzer converts lengthy bit streams in the product into short, four-digit hexadecimal "signatures" when its requirements are designed into a product. By tracing signatures—good and bad—through the circuits, the faulty component can be isolated rapidly.

Here are some benefits:

- Increases product's value to user by lowering cost of ownership.
- Lowers warranty costs.
- Lowers material costs since product needs not be modularized for servicing purposes.

We've made a major commitment to this time and money-saving technique ourselves: the majority of HP's new microprocessor-based products are being designed for service using signature analysis, and several of them are already on the market.

Look into the 5004A signature analyzer's cost savings now. Check H on the HP Reply Card.

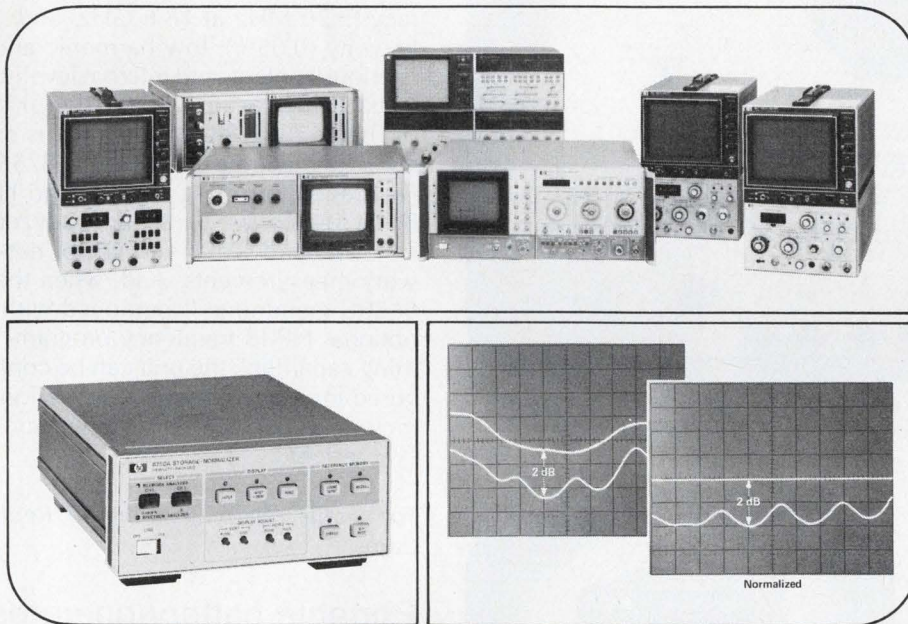

HP network and spectrum analyzers (top) gain additional accuracy, measurement speed and operational simplicity when the HP 8750A storage-normalizer (lower left) is used with them. In the example shown, test system frequency response variations are easily removed through normalization.

Here are some advantages the new HP 8750A Storage-Normalizer, a versatile accessory instrument for HP network and spectrum analyzers, can bring to swept measurement applications:

Remove frequency response errors—calibrate the test system's response and store it in the 8750A's memory. Then, subtract it from the measured data for increased display accuracy (i.e., a "normalized" measurement). *Flicker-free slow sweep measurements*—response of narrowband devices requiring very slow sweeps is displayed fully and brightly because measurement data are displayed from memory at a fast rate with continuous memory refresh.

Direct comparison measurements—instead of having to scale deviations between two traces, the deviation itself can be displayed in a single, calibrated trace.

The 8750A is directly compatible with current model HP network analyzers and several HP spectrum analyzers, (existing models can be retrofitted). Even instruments not directly compatible, such as HP 140 series spectrum analyzers, can be used by adding a simple low-frequency oscilloscope for the digitally stored and/or normalized display.

The 8750A can "freeze" CRT displays for simplified photography. X-Y recordings are also easily made because plots all made at an automatic 30 second rate, independent of actual test system sweep speed.

Performance details, applications ideas, and instrument compatibility information are all in the 8750A data sheet. For your copy, check R on the HP Reply Card.

New triple output power supplies for use in microprocessor systems

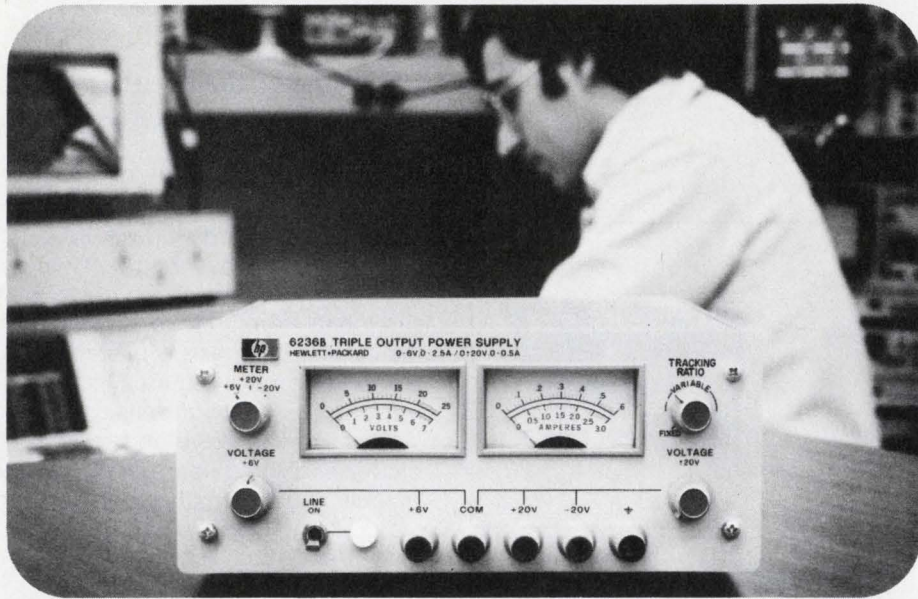

New power supplies include the 6236B and 6237B (above) for operating microprocessor systems during the product design stage, and (shown below) the 62312D OEM modular supply for equipment component use.

Triple output supplies give you operating voltages for most microprocessor systems in one convenient package. HP offers two new triple output laboratory supplies for your system development work, and a new triple output OEM modular power supply for use in end-product equipment.

Models 6236B and 6237B, designed for lab use, offer fully metered, adjustable wide-range outputs with convenient operating controls. The 6236B main output is 0 to +6V at up to 2.5A, while the 6237B is 0 to +18V, at 1.0A. Both have adjustable plus and minus outputs of 0 to 20V at 0.5A.

When operated in the fixed tracking mode, the dual outputs match within 1% as a single voltage control sets both. Switching to the variable tracking mode allows the negative output to be separately set lower than the positive one, yielding three different output voltages. All three outputs are fixed current limit protected.

The new HP 62312D triple output OEM modular Supply is specifically designed as a complete component unit for powering microprocessor systems in end products. All outputs are independently adjustable and isolated from each other and the chassis, providing a wide selection of voltages and



polarities from one basic model for a variety of systems. The main output is rated at 4.75V to 5.25V at 3A, while the other two each range from 4.75V at 0.38A to 12.6V at 0.6A at up to 40°C. The supply may be operated up to a 70°C ambient with current derating. It also features remote programming terminals to control the main 5V output for margin testing.

Protection features include an internal AC fuse, fixed foldback current limit and standard over-voltage protection on the main 5V output (optional on the other two outputs).

For more information on triple output laboratory supplies, check M on the HP Reply Card.

For information on the OEM Modular supplies, check L on the card.

Higher power, wider coverage with new microwave sweeper plug-in

At least 10 milliwatts of leveled output power over the frequency range from 2 to 18.6 GHz is what you get with the new HP 86290B RF plug-in for the HP 8620C Sweep Oscillator. You also get excellent frequency accuracy (± 20 MHz at 18.6 GHz) and linearity (0.05%), low harmonic and spurious content, and internal leveling to ± 0.9 dB over the full 2 to 18.6 GHz.

The 86290B/8620C Sweeper is directly compatible with the HP 8755 Frequency Response Test Set and HP 8410 Microwave Network Analyzer for wideband scalar and vector network measurements. And, when the 8620C mainframe is equipped with optional HP-IB frequency programming capability, the unit can be configured for many versatile applications, including a 2-18.6 GHz frequency synthesizer.

For details, check Q on the HP Reply Card.

Portable battery-operated calculator delivers a printed record

The HP-91 scientific printing calculator provides you with a full range of scientific and arithmetic functions—complete with a printed record—all in one compact calculator. And because the HP-91 prints and operates on AC or its own built-in batteries, you can use it anywhere—in the office or the remotest field locations.

For more information, check A on the HP Reply Card.



Thermal printing system can print—with labels—statistical summations, contents of the operational stack, or the contents of all sixteen addressable memories.

Two compact quartz oscillators rival performance of lab units

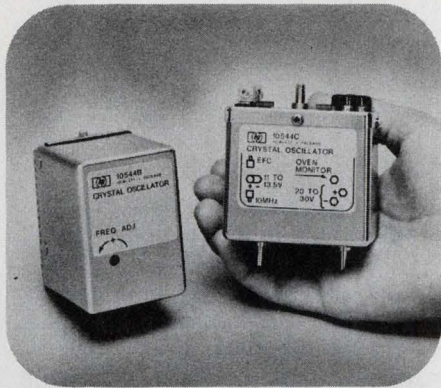

HP's new oscillators are particularly useful in communication and navigation systems and instruments such as counters, synthesizers and analyzers.

Two new 10 MHz compact component oscillators offer outstanding frequency stability, spectral purity and aging rate as well as ruggedness and fast warm-up at moderate prices.

They were designed to meet the high performance standards and time base requirements of several new HP instruments.

Key specifications include:

Aging rate: <math><5</math> parts in Phase noise: >150 dB for > 1 kHz offset

Warm-up:

Temperature co-efficient:

Short term stability	Averaging time
<math>1 10^{-8}<="" \times="" math><="" td=""> <td><math>10^{-4}< math>="" sec.<="" td=""> </math>10^{-4}<></td></math>1>	<math>10^{-4}< math>="" sec.<="" td=""> </math>10^{-4}<>
<math>1 10^{-9}<="" \times="" math><="" td=""> <td><math>10^{-3}< math>="" sec.<="" td=""> </math>10^{-3}<></td></math>1>	<math>10^{-3}< math>="" sec.<="" td=""> </math>10^{-3}<>
<math>1 10^{-10}<="" \times="" math><="" td=""> <td><math>10^{-2}< math>="" sec.<="" td=""> </math>10^{-2}<></td></math>1>	<math>10^{-2}< math>="" sec.<="" td=""> </math>10^{-2}<>
<math>1 10^{-11}<="" \times="" math><="" td=""> <td><math>10^{-1}< <math>10^1<="" math>="" sec.<="" td="" to=""> </math>10^{-1}<></td></math>1>	<math>10^{-1}< <math>10^1<="" math>="" sec.<="" td="" to=""> </math>10^{-1}<>

Size: 72x52x62 mm

Magnetic and gravitational field performance are also specified.

The two models are 10544B and C. The main difference is the connectors: Model B has a printed circuit connector board; C has filter feed-thru terminals for power connections and a snap-on RF connector for the 10 MHz output. Model C also has provision for shock mounting.

Check C on the HP Reply Card.

New Coaxial and Waveguide Catalog and Microwave Measurement Handbook

The new 1977-78 edition of the popular **MICROWAVE CATALOG** is now ready for RF and Microwave engineers. Intended for design engineers, production test personnel, quality assurance and metrology labs, the catalog contains 84 pages of product descriptions on over 300 microwave measurement accessories. Product sections include attenuators, detectors, couplers, filters, power sensors and many more.

Over 20 pages are devoted to a **MICROWAVE MEASUREMENT HANDBOOK SECTION**, summarizing common scalar measurement techniques of attenuation, impedance, power, frequency, and noise figure in coaxial and waveguide systems. Measurement tables offer comparison of accuracy vs cost for common measurements; equipment selection tables list model numbers needed for specific measurements by band, and important characteristics of products are described.

For your free copy, check U on the HP Reply Card.



Fast, on-line capacitor testing in inspection and manufacturing



With front-panel thumbwheel switches, high and low limits can be set for fast testing of capacitors.

For high-speed GO/NO GO measurements on the production line or during inspection, two new C meters check capacitors to 0.1% accuracy.

Both the 1 MHz Model 4272A and the 1 kHz Model 4273A are capable of 8 measurements per second.

With the 4272A, capacitors from 10 pF to 1000 pF full scale are measured to 0.001 pF resolution. Using the 4273A, capacitors from 100 pF to 10 μF full scale are measured to a resolution of 0.01 pF.

Go/no-go indications on the front panel are also available at reed relay and TTL outputs on the rear panel. A digital output for digital printers is also available for hard copy.

For more information, check F on the HP Reply Card.

of Hertz and Gigahertz

...part 3 in a series

The super performance counter

When your needs exceed the capabilities of the best of universal counters, consider a super performance unit such as HP's 5345A. It has a range of dc to 500 MHz, 20 mV sensitivity, sub-nanosecond gating throughout, and also gives you:

- reciprocal counting for greatest resolution per given gate time.
- time resolution of 2 ns for single shot events and 1 ps for repetitive events via time interval averaging. HP's unique jittered clock ensures accurate averaging for all input repetition rates.
- external gate times down to 20 ns. This, plus the 5345's high accuracy for brief gates, permits frequency profiling within a burst or characterizing rapidly swept cw signals.
- frequency averaging for greatly increased pulsed RF resolution.
- superb measurements to 4 GHz with the 5354A Auto Frequency Converter. It acquires in <2 ms, tolerates up to 500 MHz p-p deviation, measures RF pulses down to 250 ns. (100 ns manually). With frequency averaging, short microwave pulses can be measured about 100 times more precisely than with any conventional counter.
- HP Interface Bus option for easier, more economical systems design.

For the 20-page data sheet, check I on the HP Reply Card.

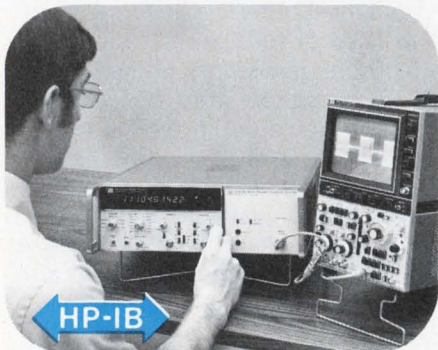

The HP 5345A super performance counter can accurately measure short RF pulses or rapidly swept signals.

No need for add-on options with NEW full capability X-Y recorder

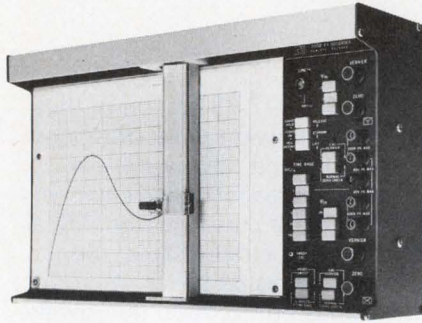

The 7015B lab X-Y recorder is a low cost, one-open instrument that features maximum electrical and mechanical flexibility to fit many and varied applications.

A new low-cost FULL CAPABILITY X-Y recorder, the HP 7015B, offers full capability recording without the need for costly add-on options or external equipment. The single, all inclusive price provides these four full capability features:

Internal Time Base can be slowed to ¼ hour sweep and has automatic pen control and remote triggering for sweep start and reset.

Matched Input Filters eliminate or reduce the always present signal noise. (Noise of less than 0.1% of full scale can start degrading the trace!)

Remote Pen Lift can mean the difference—during a quick plot—between an acceptable graph and one that must be redrawn by hand.

TTL Level Remote Control provides an easy interface with external equipment or systems.

Attention OEMs

To bring recording quality to your systems, consider HP recorders. We support worldwide what we sell.

The 7015B also offers top-of-the-line quality in its disposable pen writing system and continuous duty servo motors for operator convenience and low cost of ownership. It has sensitivities from 5mV/cm or 10mV/in on charts up to A4 or 8½ × 11".

For more information, check N on the HP Reply Card.

New microwave coaxial switch has 50 dB isolation at 26.5 GHz

A dc to 26.5 GHz coaxial microwave switch is now available. The HP 33311C is a SPDT switch which features all-matched ports by using internally switched 50Ω loads to terminate the unused secondary port and improve the isolation. Isolation is >85 dB at 18 GHz, >50 dB at 26.5 GHz.

Excellent repeatability results from use of "edge-line" design which switches only the center conductor. After 1,000,000 switchings, repeatability is typically 0.03 dB. APC-3.5 connectors allow operation to 26.5 GHz and are fully SMA compatible. SWR is <1.5 to 16 GHz, <2.3 to 26.5 GHz. Insertion loss at 16 GHz is <0.8 dB, <1.4 dB at 26.5 GHz. The switch will handle 1W average and 100W peak.

The 33311C is electrically switched and self-latching. Coils draw 3W at 24 VDC and automatically disconnect after the 30 ms switching time.

The small size (5.5 × 7 × 1.5 cm) and environmentally rugged construction makes the 33311C ideal for designing into microwave systems.

For more technical data, check E on the HP Reply Card.



Internally switched 50Ω loads in this SPDT switch provide all-matched ports to 26.5 GHz.

New HP-IB brochure cites more than 58 interfaceable products

The recent development of a standardized interface enables engineers to create flexible, cost-effective systems quickly and easily.

The Hewlett-Packard Interface Bus (HP-IB) is our implementation of IEEE standard 488, and it is also in accord with the main IEC document approved by member nations during 1976. With the bus, you can link instruments to perform automatic measuring and test-

ing. Under management of a computing controller, an HP-IB system virtually runs itself.

Now, a new 12-page brochure is available, covering:

- Evolution and benefits of the standard interface
- How HP-IB operates
- Typical applications
- A list of more than 58 HP-IB products currently available for "do-it-yourself" systems
- Selecting a computing controller
- Preassembled HP-IB systems

For a copy of this informative and helpful brochure, check T on the HP Reply Card.

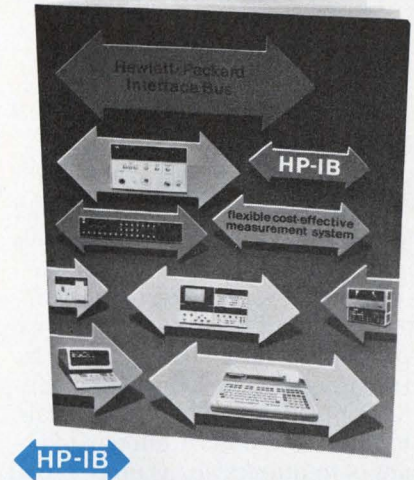

HEWLETT-PACKARD COMPONENT NEWS

Simplified optical design and higher channel density with new high radiant intensity emitter

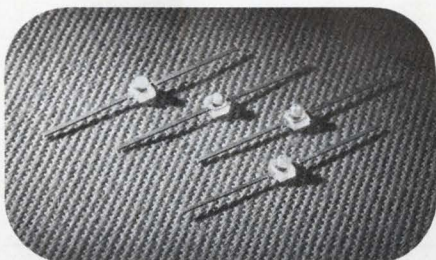

The clear optical port and offset wire bond also allow the HEMT-6000 to function as a photodiode. The typical responsivity is 0.35 amps/watt centered at 700 nanometers.

Designed for maximum efficiency at 700 nm wavelength, this visible, near-IR source is low cost and easy to align. The HEMT-6000 uses a GaAsP chip designed for optimum trade-off between speed and quantum efficiency. Axial radiant intensity is typically 250 microwatts/steradian. Bandwidth is dc to 5 MHz.

Applications for the HEMT-6000 include bar code readers, optical mark sensors, optical scanners, safety interlocks, tape sensing systems and fiber optic drivers.

For details, check J on the HP Reply Card.

New 6-pin optical couplers available for first time

Two photodarlington devices are announced from Hewlett-Packard. These Models 4N45 and 4N46 optocouplers feature low input current with high gain. Current transfer ratio (CTR) is typically 1000%.

The 4N46 has a 20V minimum output voltage rating and a 350% minimum CTR at an input current of only 0.5mA making it ideal for use in low input current applications such as MOS, CMOS and low power logic interfacing. The 4N45 has a 250% minimum CTR at 1.0mA input current and a 7V minimum output voltage rating.

Applications include uses as telephone ring detectors, digital logic ground isolation, low input current line receivers, line voltage status indicators or logic to reed relay interface.

For additional details, check G on the HP Reply Card.

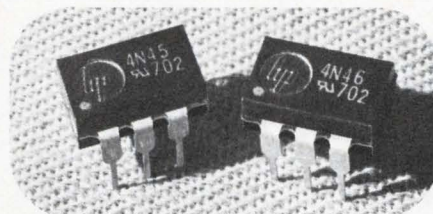

The 4N45/46 optocouplers contain a GaAsP light emitting diode optically coupled to a high gain photodetector IC.

HP microwave transistors now registered with EIA

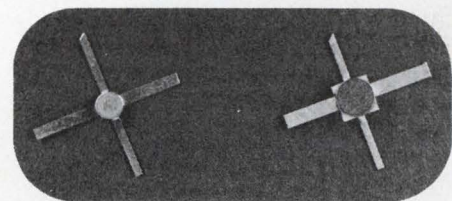

2N6617 has been assigned by the Electronic Industries Association to Hewlett-Packard's HXTR-6101 low noise transistor. Specified at 3.0 dB noise figure at 4 GHz with 8 dB minimum associated gain, it is packaged in a 1.8 mm (0.070 in) diameter hermetic metal/ceramic package.

2N6618 has been assigned to the recently introduced HP HXTR-6103. Noise figure is 2.2 dB maximum at 2 GHz with 11 dB minimum associated gain. The 2N6618 is supplied in a 2.5 mm x 2.5 mm (0.1 in x 0.1 in) hermetic metal/ceramic package.

These transistors are intended for use in radar, EW and communications systems in the 1 to 6 GHz range.

For additional details, check K on the HP Reply Card.

Measure to 22 GHz with new easy-to-use spectrum analyzer

HP's new microwave spectrum analyzer, model 8565A, combines wideband performance (10 MHz to 22 GHz frequency coverage) with greatly simplified operation and unambiguous displays. The analyzer features absolute amplitude calibration, automatic preselection from 1.7 to 22 GHz, and flat frequency response for meaningful comparisons of multiple signals. In addition, the 8565A offers wide ranges of frequency spans (from broad spectra to close-in analysis), resolution bandwidths (from 1 kHz to a wide 3 MHz), and amplitude scale factors that provide from coarse to fine resolution.

Even with this breadth of performance capabilities, operation of the 8565A is remarkably straightforward. Most measurements are a simple 3-knob sequence. With a wide span selected, pick out the signal of interest with the TUNING control. Then zoom in on it with the FREQUENCY SPAN/DIV control. As you narrow the span, the resolution bandwidth, sweep time and video filtering are all automatically set to keep the display calibrated. Then set the signal amplitude to full deflection with the REFERENCE LEVEL control, which then indicates the signal's power level.

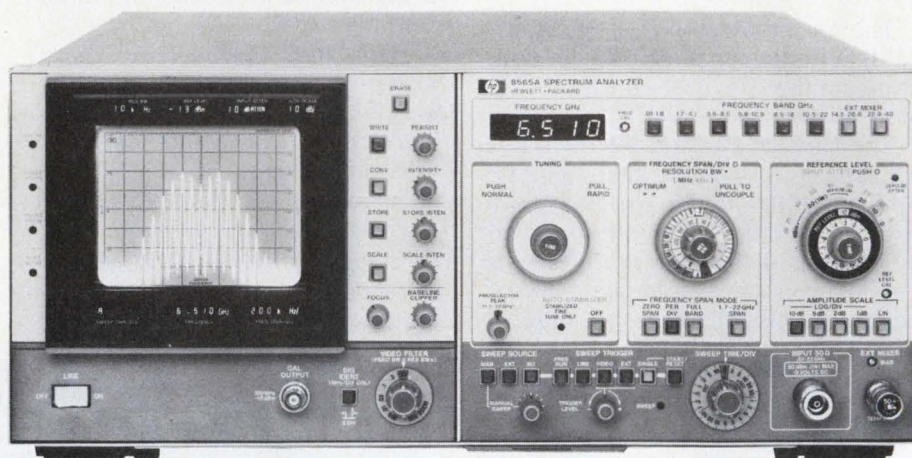

Wide range, spurious-free displays plus simple operation and digital display of control settings all contribute to the HP 8565A Spectrum Analyzer's usefulness in microwave applications.

To add to the operator's convenience and confidence, the value of each pertinent parameter—even the ones automatically established—is digitally displayed on readouts in the CRT bezel assembly. These data are captured when using a scope camera.

The 8565A Analyzer can measure to 40 GHz using the HP 11517A Waveguide Mixer. And the analyzer can be used with the HP 8444A Opt 058 Tracking Generator to make >90 dB swept response measurements in

the 10 to 1300 MHz range. A useful complement to the 8565A is the new HP 8750A Storage Normalizer (described elsewhere in this issue). The 8750A can digitally store a reference signal which can then be compared to a later input signal.

For more information about this versatile microwave instrument, check P on the HP Reply Card.

East-4 Choke Cherry Road, Rockville, MD 20850,
Ph. (301) 948-6370.
South-P.O. Box 10505, Atlanta, GA 30348,
Ph. (404) 434-4000.
Midwest-5201 Tollview Dr., Rolling Meadows, IL 60008,
Ph. (312) 255-9800.
West-3939 Lankershim Blvd, North Hollywood, CA
91604, Ph. (213) 877-1282.
Europe-7, rue du Bois-du-lan, P.O. Box, CH-1217, Meyrin-2,
Geneva, Switzerland, Ph. (022) 41 54 00.
Japan-Yokogawa-Hewlett-Packard Ltd., Ohashi
Bldg., 1-59-1 Yoyogi, Shibuya-ku,
Tokyo 151, Ph. 03-370-2281/92.

HEWLETT  PACKARD

 MEASUREMENT **news**
COMPUTATION
product advances from Hewlett-Packard

May/June 1977

New product information from
HEWLETT-PACKARD

Editor: Iona M. Smith

Editorial Offices:
1507 Page Mill Road
Palo Alto, California, 94304 U.S.A.

Across the desk

(continued from page 8)

engineer. This is the injustice that must be corrected.

John L. Alexander
President

Coalition of Aerospace
Professional Employees, Inc.
P.O. Box 2251
Satellite Beach, FL 32937

Ed. Note: Subsequent to writing his letter, George E. Monroe submitted to the IEEE a proposed amendment to the Service Contract Act. His proposal does not attempt to raise what many engineers at Cape Kennedy consider "depressed salaries," but it does propose provisions that would prevent these salaries from being "busted" in the future.

Me an editor?

Maybe. If you would enjoy interviewing industry authorities, and writing and editing articles on the latest technological developments, you might enjoy being an editor.

We have openings at our home office in New Jersey. Write to Mike Elphick, Managing Editor, Electronic Design, 50 Essex St., Rochelle Park, NJ 07662.

Power supply, not case is doubly insulated

You were quite right to focus attention on safety (ED No. 24, Nov. 22, 1976, p. 114). This is a subject that we have been giving a lot of attention. So much so that we incorporated double insulation into one of our latest oscilloscopes. You made this point in the article but unfortunately the caption on p. 116, which says that doubly insulated cases make battery-operated instruments safer is misleading.

The case is not "double-insulated." In fact, this feature applies to the power supply according to International Electrotechnical Commission Standard 348 for metal-encased Safety Class II equipment. Such an instrument is, of course, intrinsically safe with respect to line-voltage accidents and can be compared with a battery-operated instrument in this respect.

This feature does indeed permit the user to "float the instrument,"

as you say, but the same care should be observed when measuring "signals riding on high voltages" as in all circumstances where such voltages are involved.

We do want to stress that the feature does not give immunity from the need to take such normal precautions and is not claimed to do so.

A. S. Lodder
Press Officer

Science & Industry Division

N.V. Philips
Gloeilampenfabrieken
Eindhoven
the Netherlands

Misplaced Caption Dept.

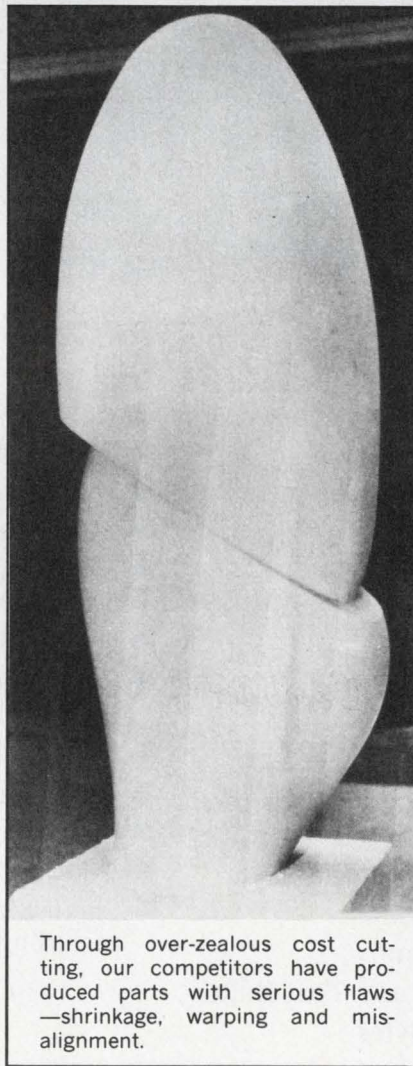

Through over-zealous cost cutting, our competitors have produced parts with serious flaws—shrinkage, warping and misalignment.

Sorry. That's Hans Jean Arp's sculpture "Coupes Superposées," which stands in the Isaac Delgado Museum of Art, New Orleans.

giga-trim capacitors for microcircuit designers

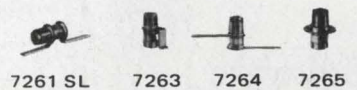
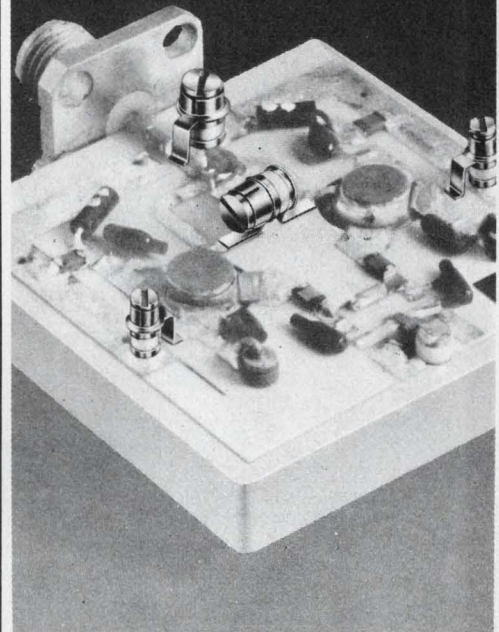

Giga-Trim® (gigahertz-trimmers) are tiny variable capacitors which provide a beautifully straight forward technique to fine tune RF hybrid circuits and MIC's into proper behavior. They replace time consuming cut-and-try adjustment techniques and trimming by interchange of fixed capacitors.

Applications include impedance matching of GHz transistor circuits, series or shunt "gap-trimming" of microstrips, external tweaking of cavities, and fine tuning of crystal oscillators.

Johanson

MANUFACTURING CORPORATION

BOONTON, NEW JERSEY 07005

201 / 334-2676

CIRCLE NUMBER 7

Multi-User/Multi-Task DOS COMMAND PERFORMANCE



muPro-80D Multi-User, Multi-Task Disk System

Software

- Concurrent Multiple Terminal Operation
- Multiple Task Real-Time Operating System
 - Supports up to 256 concurrent tasks
 - Provides 64 priority levels
- Program Overlay Capability
- Comprehensive File Management
 - List File Directory
 - Add, Delete, Rename, Append File
 - Run-Time file definition
- File Utilities: Copy File
 - Copy and Compress Disk
 - Format Disk
- I/O Device Characteristics transparent to user
- Concurrent Interrupt-Driven I/O
- Calendar Maintenance - Date, Time
- Supports BSAL-80, Linking loader and Text Editor
- Operating System Requires 16K Bytes

Hardware

- Dual Diskette Drive - 512K Bytes
- Soft Sektored - IBM 3740 compatible
- High Speed Seek - 76 track seek in 100mSec.
- Single Card Controller installs directly into muPro-80 chassis
- Double-Sided Recording - Optional
- Controller accomodates up to two dual drives (four diskettes), or four single drives
- Real Time Clock
- Write Protect
- Manual or Processor controlled diskette eject
- Data transfer via DMA
- Small Size - 4.6"H x 10.0"W x 21"D including power supply. 32 lbs.

Available in OEM and End User Configurations

Manufacturers of Innovative OEM and End User Microcomputer Systems

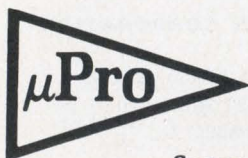

muPro Inc. ■ 424 Oakmead Pkwy ■ Sunnyvale, CA 94086 ■ (408) 737-0500

See us at NCC (Dallas) Booths 1143/1145

Circle 215 for Demonstration

Circle 216 for Literature

JUNE 7, 1977

Laser radar lets copters track tiny obstacles

A 2.5-W CO₂ laser radar enables helicopters to detect wire and other obstacles and to follow terrain. But before it could be used in helicopters, some tough design problems had to be solved, including:

- **Stabilizing the 10.6- μ m laser frequency against the severe vibrational environment of a helicopter. Generating circularly polarized transmissions to improve the detectability of small obstacles like one-eighth-inch wire strung across helicopter paths.**

- **Providing an electronically programmable scanner that can instantly switch from identification to ranging modes.**

- **Incorporating a digital signal-analysis system to identify the nature of target returns.**

- **With just 2.5-W average power, the 10.6- μ m radar system can detect a one-eighth-in. field wire at a range of 1500 ft, according to its designer, Dr. Robert Mongeon of United Technologies Research Center, East Hartford, CT. Moreover, degradation of frequency stability in flight is negligible, Mongeon reported at last week's Laser Engineering and Applications Conference in Washington, DC.**

Stabilization-system requirements were demanding because the components for the laser radar are all hard-mounted—no springs or cushions—in the helicopter. In the stabilization system, an electronic servo system controls the length of the laser cavity by expanding or contracting piezo-electric elements that hold the cavity mirrors. This compensates for detuning due to linear displacement of the mirrors. In addition, angular detuning of the laser is rejected and discrimination of the lowest-order transverse mode from competing higher-order modes is improved by the laser's "hybrid unstable resonator configuration." Pioneered by United Technologies, the technique is very important to maintaining frequency stability, Mongeon points out.

In typical unstable resonator de-

signs, laser efficiency is reduced because part of the laser beam is allowed to leak out of the main laser path. In Mongeon's design, a weak-waveguide effect is used to recapture parts of these losses.

Circularly polarized radiation is incorporated in the laser to improve the reliability of returns despite the angle of a target, such as a wire, to the helicopter beam. It is provided by using a germanium plate set at Brewster's angle in the path of the transmitted and received radar-beam optics.

An electronically programmed scanner with two motor-driven prisms permits the system to first perform a line-scan in a terrain-avoidance ranging mode, then to go into a log-spiral scan to detect obstacles.

Targets are distinguished from background returns by a digital signal processor. A system of logic determinants in the processor instantly evaluates the probability of the returns being from a wire. Moreover, the system is configured to detect the more complicated cases where the background returns merge with wires.

The transmitter-receiver has an optical-heterodyne design; a second CO₂ laser is included as the local oscillator. The detector has over 100-MHz bandwidth and doppler tracking electronics in the receiver compensate for velocities of a few hundred knots, and also the scan angle in use.

Printer-calculator combo plots graphs, writes words

Plugged into one of Texas Instruments two new calculator models, a thermal printer produces hard-copy records more graphic and more comprehensible than current printer/calculator combinations. These conventional systems can only print numbers. But with either the Programmable 58 or the Programmable 59, the PC-100A, also from TI, can print out headings,

prompting messages, and program codes, as well as plot data. Yet the price—as little as \$324.90 for the printer and the less expensive of the two calculators—is much lower than that of computer systems or time-shared terminals usually used for graph plotting.

Combined with either the SR-52 or SR-56 calculators—to be discontinued this month—the PC-100A, which replaces the PC-100 and costs \$199.95 adds no new features. But a system consisting of the PC-100A and one of the new calculator modes is powerful enough to replace batch processing or time-sharing on computers, and thereby eliminate both the wait for and expense of computer time, says Peter Bonfield, product manager in TI's Calculator Products Division in Dallas. In fact, so dedicated is the company to replacing a single central computer with separate calculators that it is giving the more expensive Programmable 59 to each of its engineers, as well as to each new engineer that joins the company. The cost of the TI 59—which retails for \$299.95—should be more than covered by increased productivity, Bonfield explains.

The TI 59 (TI has dropped the "SR" designation on its programmables because it considers the "slide rule" reference obsolete) can store 480 program steps and has 60 data memories in its standard format. The memory space can be reconfigured for up to 960 program steps with no memory space or as few as 160 program steps with 100 memory spaces. The allocation can be made from the keyboard or in a program.

The TI 59's magnetic card programmer is like that of the SR-52, with an added wrinkle that ensures confidentiality. A flag at the beginning of the program allows normal operation, but prevents the program from being listed on paper tape. Such a requirement is paramount for some military applications as well as for such fields as insurance and stock brokerage, says Bonfield.

The less expensive TI 58 lists for \$124.95 and has all the features of the 59 except the mag-card programmer; it also has less memory space. The standard configuration, 240 program steps and 30 memories, can be changed to as many as 480 program steps and no memory spaces or 60 memory spaces and no program steps. By comparison, the SR-52 has 224 program steps, 20 memory locations, and goes for \$249.95. Using what TI calls "solid-state software," off-the-shelf pro-

grams from the TI library can often be run in either new calculator without taking any program steps. Stock programs are stored in read-only memories encapsulated in plastic modules that plug into the back of the machine.

This technique is a refinement of one used by Sharp Corp., which had ROMs in dual-in-line packages to configure its calculator to specific applications, such as engineering, surveying, and navigation.

Now four memory chips can be tested at once

A test system for 16-k memory chips exercises four devices at the same time and cuts test time from 18 s to 7 s per part or less, depending on the yield and number of bins. The system consists of the 5581 Parallel-Memory Tester from Fairchild-Xincom, Chatsworth, CA, and the 7194 four-station environmental handler from Sym-Tek, San Diego, CA.

Recently introduced at the Semicon West Show in San Mateo, CA, Fairchild-Xincom's 5581 Parallel-Memory Tester features dual-head operation, with each head testing two parts. When testing for pattern sensitivity, all four sockets are active at once.

As long as the addresses are multiplexed, the 5581 can test RAM or ROM parts that have up to eight data lines and 65-k addresses.

Because of their many discrete address pins, nonmultiplexed parts are generally limited to one test head.

The 5581 works with Sym-Tek's temperature chamber/handler which is configured as four individual, asynchronous handlers sharing a common temperature chamber. Two small, cylindrical test heads from the 5581 interface to the front of the Sym-Tek handler and provide four test sockets. "Soaking" at temperature, four columns of parts to be tested, are gravity-fed to the sockets from the top of the chamber. The 5581 then checks each part in turn for dc parametrics and basic functionality.

Once each socket holds a potentially good part, the algorithmic pattern generator creates a number of test patterns. The same pattern is applied to all four parts. A range of access times is used to select devices of different grades, and tested parts go to one of the four bins.

The Fairchild-Xincom 5581 Parallel Memory Tester, together with Sym-

Tek's 7194 Multi-Station Handler will sell for less than \$200,000.

CIRCLE NO. 319

Microcomputer with 8085 is the lowest priced, yet

The first microcomputer board to use the 8085 microprocessor is less than 40% of the price of previous boards capable of operating in multiprocessor systems. Complete with RAM and ROM, system clock, serial and parallel I/O and programmable timer, the 80/05 goes for under \$200 in OEM quantities.

Developed by Intel Corp., Santa Clara, CA, the 80/05 plugs into the same bus as the SBC 80/20 single-board computer, and, like it, can be joined with several other microcomputers or controllers that logically share system tasks. Its low price, just over a third that of the 80/20, may spur designers to apply multiprocessor solutions to a wider range of computing and control problems, says George Adams, Intel's SBC 80 product manager.

Bus capacity is up to four 80/05s or high-speed controllers. When an external-priority network is added, up to 16 masters can share the bus.

The 80/05 contains 512 bytes of low-power static RAM and two sockets for up to 4 kbytes of 8716 EPROM or 8316 masked ROM. Software, which is compatible with the 80/20 and other 8080-based systems, configures the 22 parallel I/O lines by assigning two 8-bit and two 3-bit ports to input or output uses as needed. Sockets permit I/O line drivers appropriate to the application to be used.

Shareable plug-in boards that can operate from the SBC 80 bus—which has a maximum data transfer rate of 5 Mbytes/s—include the SBC 310 high-

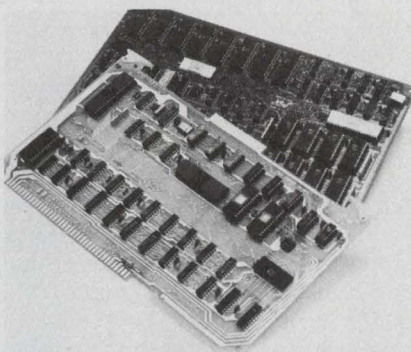

Intel's SBC 80/05 μ C board (bottom) is shown with SBC 310 plug-in, high-speed math unit.

speed math unit (see photo). Using Intel's 3000-series bipolar microprocessor, the SBC 310 can do floating-point 32-bit multiplication in 91 μ s and division in 102 μ s maximum. The SBC 732 analog I/O board performs 16,000 12-bit a/d conversions per second on 16 differential or 32 single-ended inputs, and also contains two d/a channels.

A number of additional boards are under development at Intel: a double-density diskette controller, a four-port programmable communications interface card for RS232 serial I/O and parallel interface to the Bell 801 automatic calling unit, and an opto-isolated digital I/O card.

Rugged minicomputer is conduction-cooled

A fully enclosed minicomputer for harsh environments cools itself by an unusual thermal conduction technique rather than forced air. It can also run any program written for a DEC PDP-11/34.

Implemented in TTL/MSI, the rugged SECS-11 from EM&M's Severe Environment Products Division, Chatsworth, CA, gets rid of internally generated heat by using a distributed heat sink, ICs are mounted atop a heavy copper bus that conducts heat away from the devices to the PC card's edge.

In the card cage, thermally conductive pressure plates route heat from the bus into heavy metal plates at the top and bottom of the cage, then to radiating fins at the front and rear of the enclosure. No fans are used, and no switches protrude through the enclosure.

Emulating both the instruction set and I/O scheme of the DEC machine, the SECS-11 gives access to all the software for the 11/34 and can replace it in any configuration of peripherals. The mini's architecture decodes the DEC instruction set in ROM. Internal microcodes then control the machine at a 10-MHz rate. In fact, many of the DEC instructions are executed faster than the 11/34—users can expect a 20 to 30% improvement in throughput, according to new-products manager, Bill Mandl.

With a 1024×32 capacity that allows for an extended instruction set, SECS-11's decoder ROMs permit hardware single-precision floating point, and double-precision fixed point arithmetic to be performed.



Introducing the hungry ECLIPSE.

Data General's new ECLIPSE S/130 computer has a bigger appetite for work than any other mid-range mini. And enough speed and versatility to wolf down any kind of data you have to dish out.

The hungry ECLIPSE computer is built around the same powerful architecture as our super high-speed ECLIPSE S/230. Added to that is a host of special features that make the hungry ECLIPSE unique. Like our fast micro-coded floating point and efficient character string instruction sets. And our second-generation WCS general-purpose user microprogramming ability that results in unmatched throughput in demanding applications. To top it off it also includes AOS, our amazing new heuristic multi-programming advanced operating system, and of course the full range of Data General's economi-

cal big-computer peripherals, software and worldwide support.

Now, you don't have to skimp along with an undernourished mini that's too limited for your work. Or splurge on one that's too fat just to get the performance you need. Just order an ECLIPSE S/130 computer. It will make your work load a lot leaner. Want more food for thought? Send for our brochure.

- Send your S/130 brochure.
 Send your S/130 brochure and have your sales representative call.

Mail to: Data General, Westboro, MA 01581

Name _____

Title _____

Company _____

Address _____ Tel. _____

City _____ State _____ Zip _____

ECLIPSE is a registered trademark of Data General Corporation.

© Data General Corporation, 1977

 **Data General**
 It's smart business.

Data General, Westboro, MA 01581, (617) 366-8911. Data General (Canada) Ltd., Ontario.
 Data General Europe, 15 Rue Le Sueur, Paris 75116, France. Data General Australia, Melbourne (03) 82-1361.

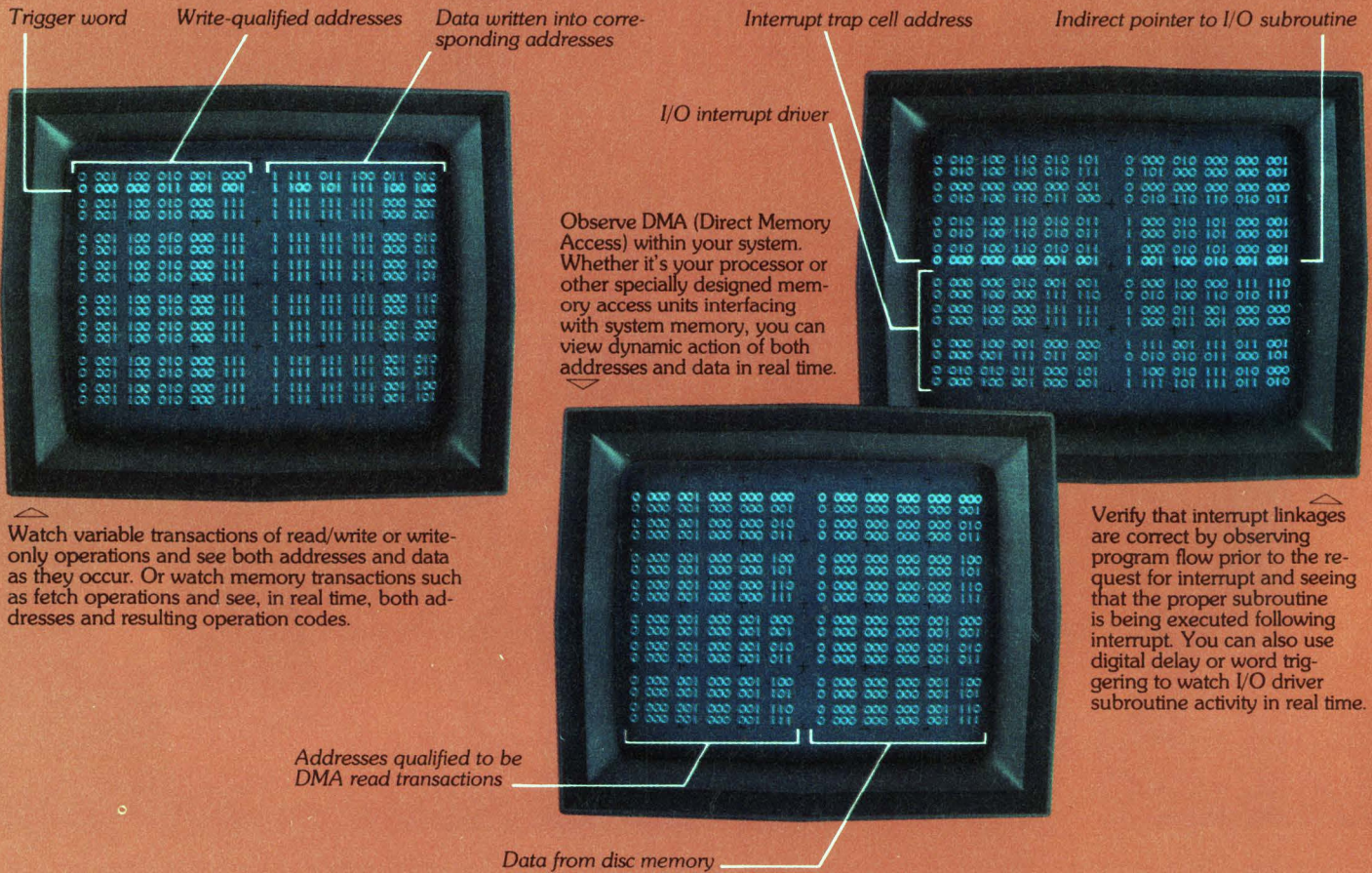

If you're designing minicomputer based systems, only HP Logic State Analyzers show you real time like this.

Logic State Analyzers effectively put you inside your operating minicomputer system for faster design and debugging. Here's the difference HP's real-time view makes.

HP's 1600S Logic State Analyzer (priced at \$7100*) plus 10254A Serial-to-Parallel Converter (priced at \$975*) gives you a better way to spot and diagnose intermittent system operation. They give you greater insight for better understanding of your system's capability. The combination can mean earlier product introduction, lower development costs, a faster return on the development investment.

Your local HP field engineer has all the technical details. Give him a call today. And also ask him about HP's FREE seminars—An Introduction to the Data Domain.

*Domestic U.S.A. prices only

Cursor

Dynamic real time photograph (time exposed) of incrementing counter used as system clock

Get a system overview with this memory map. It shows how your memory is being utilized in an operating program. If you know how your memory is organized, the map tells you at a glance what your program is doing and the relative time being spent in any one memory location. That makes it easy to spot things that shouldn't be happening, or to determine that part of your program isn't being implemented.

Disc address (cylinder, head, sector)

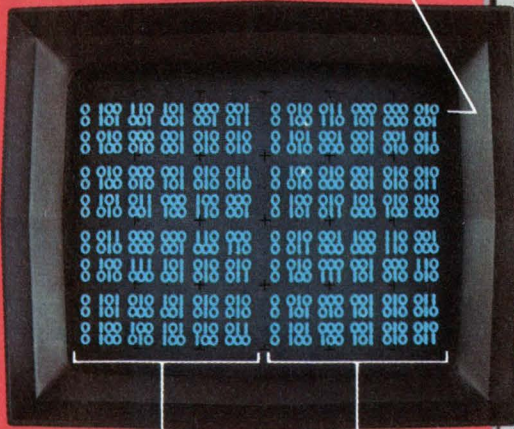

Parallel data inside computer

Serial data from 10254A

ASCII code

View I/O transactions in real time. Straddle an interface with the 1600S and you can evaluate handshake signals and compare input and output data directly—even if the clock rates differ and you're comparing serial data to parallel.

Qualifiers, digital delay and various local or bus-triggering modes give you pinpoint selection of data flow for effective program tracing.

Output triggers drive your scope—at the right instant—for making electrical measurements in the time domain.

Up to 32 channels let you see all the action on a 16-bit system main bus plus 16 bits in the control section, I/O, or any other logic section in your minicomputer system.

Dual clock means you can easily relate bus activity to events occurring elsewhere at a different clock rate—in system peripherals, for example.

Serial-to-Parallel Converter (HP's 10254A) lets you directly view serial data in relation to parallel data on the system bus.

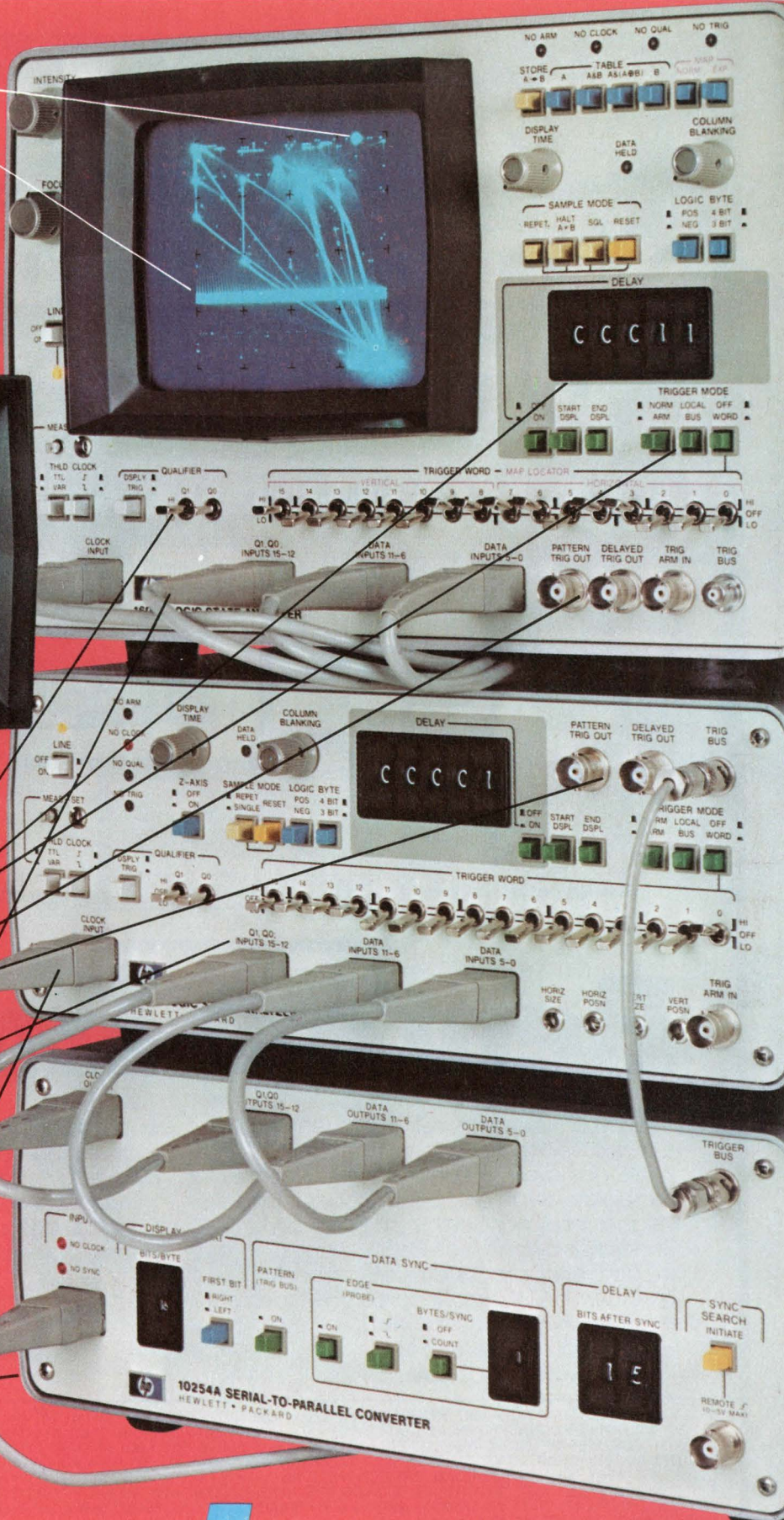

FREE DATA DOMAIN SEMINAR

Find out for yourself how HP Logic State Analyzers can broaden your view of the data domain and speed digital design and debugging.

Seminars are scheduled in a number of cities throughout the country. Ask your HP field engineer about specific details on seminars in your area.



1507 Page Mill Road, Palo Alto, California 94304

For assistance call: Washington (301) 948-6370, Chicago (312) 255-9800, Atlanta (404) 955-1500, Los Angeles (213) 877-1282

You Don't Have To Beg, Borrow Or Buy...

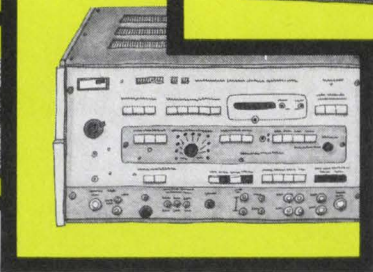
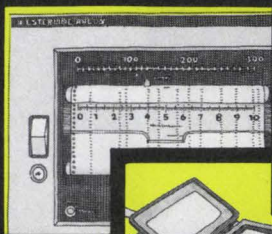
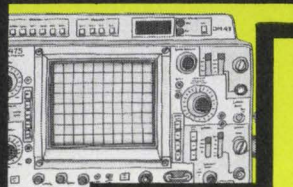
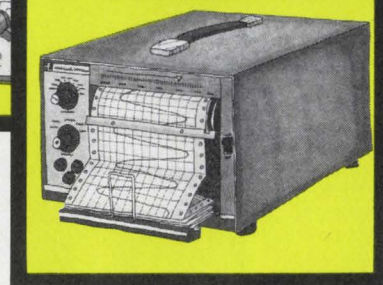
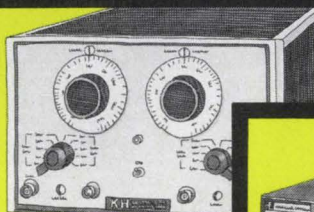
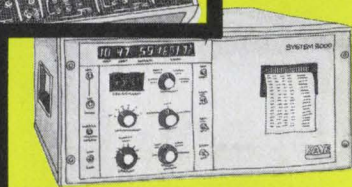
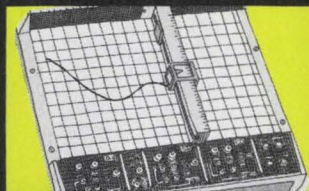

Rent'em From GE

Short or long-term instrument rentals give you flexibility and economy.

GE has over 9,000 instruments available for immediate shipment: □ Tek Scopes □ Biddle Megger Insulation Testers □ H-P Signal Generators □ Honeywell Oscillographs □ Complete Data Systems □ Esterline Angus Recorders □ GE Chart Recorders □ Modems □ Communication Terminals . . . all calibrated to the manufacturer's specs.

We have over 100 Sales/Service Centers,

and one of them is near you. In addition to maintaining our Rental Inventory, they can also repair and calibrate your own equipment.

Don't borrow someone else's GE Rental Catalog. **Call collect (518) 372-9900** or your nearest Sales/Service Center.

Quick-rental[®] instruments

ALA. BIRMINGHAM (205) 925-3101 • **ARIZ.** PHOENIX (602) 278-8515 or 8516, TUCSON (602) 294-3139 • **CAL.** LOS ANGELES (213) 642-5350, SAN FRANCISCO (415) 436-9260 • **COL.** DENVER (303) 371-1260 • **CONN.** SOUTHINGTON (203) 621-4059 • **FLA.** JACKSONVILLE (904) 751-0610 • **GA.** ATLANTA (404) 457-5563 • **ILL.** CHICAGO (219) 933-4500 • **IND.** INDIANAPOLIS (317) 639-1565 • **KY.** LOUISVILLE (502) 452-3311 • **LA.** NEW ORLEANS (504) 367-6528 • **MD.** BALTIMORE (301) 332-4700 • **MASS.** BOSTON (617) 396-9600 Ext. 160, SPRINGFIELD (413) 781-1111 • **MICH.** DETROIT (313) 285-6700 Ext. 208 • **MINN.** MINNEAPOLIS (612) 522-4396 • **MO.** KANSAS CITY (816) 231-4377, ST. LOUIS (314) 965-7115 • **N.J.** CLIFTON (201) 471-6556 • **N.Y.** BUFFALO (716) 876-1200, SCHENECTADY (518) 385-2195 • **N.Y.C.** CLIFTON, N.J. (201) 471-6556 • **N.C.** CHARLOTTE (704) 525-0311 • **OH.** CINCINNATI (513) 874-8512, CLEVELAND (216) 523-6382, TOLEDO (419) 691-3501 • **OR.** PORTLAND (503) 221-5101 • **PA.** PHILADELPHIA (609) 424-4450, PITTSBURGH (412) 462-7400 • **TEX.** DALLAS (214) 357-7341, HOUSTON (713) 672-3570 • **VA.** RICHMOND (804) 232-6733 • **WASH.** SEATTLE (206) 854-0211 • **W.V.** CHARLESTON (304) 345-0920 • **WISC.** MILWAUKEE (414) 744-0110 • **PUERTO RICO** PONCE (809) 843-4225.

GENERAL  ELECTRIC

Important news for Intel SBC 80 users:

The RTI-1200 solves your real-time analog I/O subsystem problems.

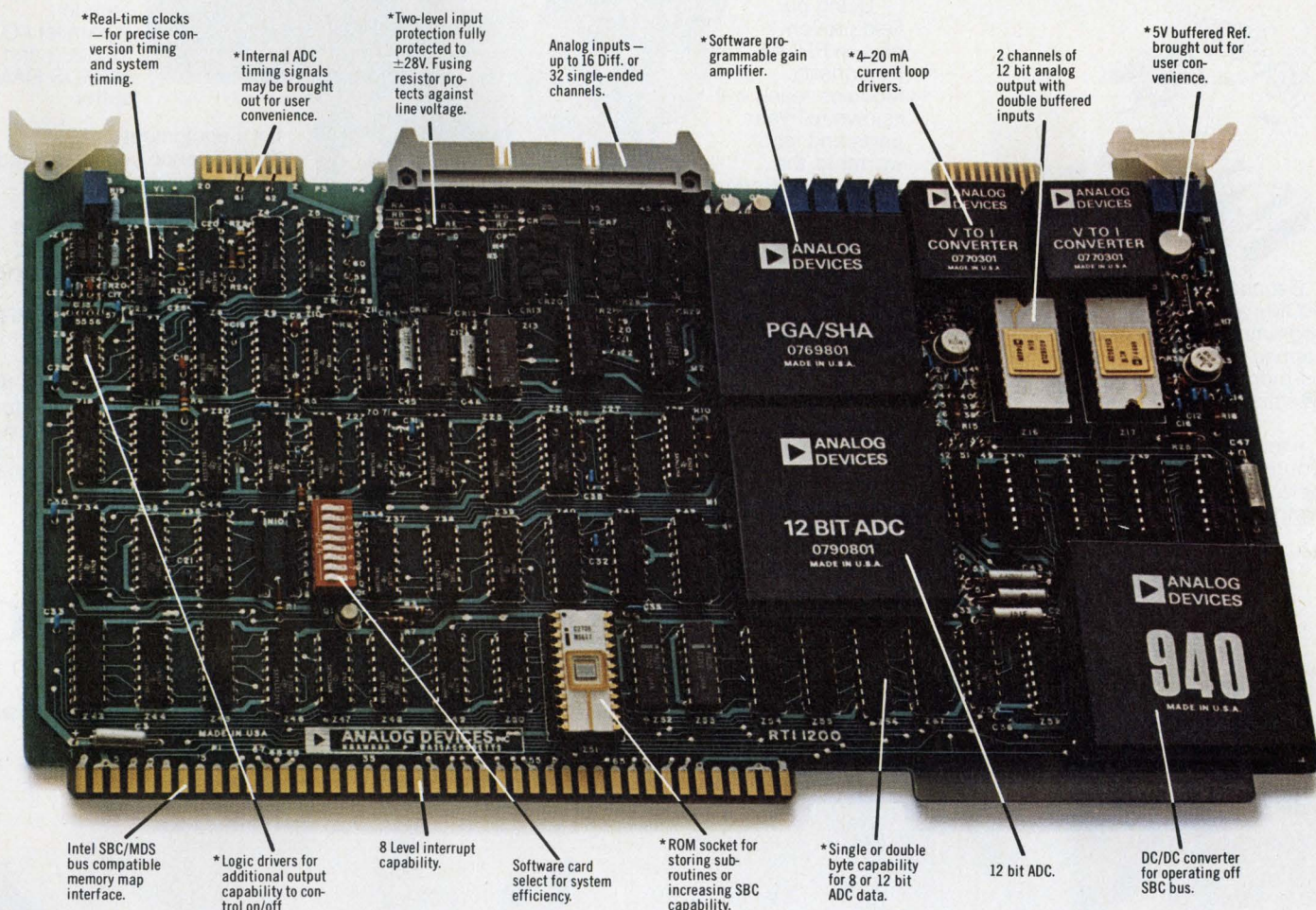

Now Intel SBC 80 users have the most complete, most versatile and easiest-to-use input card for the acquisition and control of analog signals.

What you don't see here are all the other significant RTI-1200 features that enhance its maximum convenience and versatility. One of the most impressive is our User's Guide. It doesn't just tell you how to hook up jumpers. It does tell you how to write programs that optimize throughput rates, how to use the 8080's instruction set to take advantage of the RTI-1200's capabilities and a whole lot more.

If you're looking for the solution to your analog I/O interface problems, the Analog Devices' RTI-

*Exclusive features of Analog Devices' RTI-1200.

1200 is it. Single prices range from \$629 to \$979 depending on options (quantity discounts are available). The Analog Devices' RTI-1200, the first in a family of analog subsystems from the market leaders in analog products for signal conditioning, converting and control.

Send for the complete RTI-1200 Technical Information Package.

ANALOG DEVICES

The real company in analog μ peripherals

Analog Devices, Inc., Box 280, Norwood, Massachusetts 02062 East Coast: (617) 329-4700, Midwest: (312) 894-3300, West Coast: (213) 595-1783, Texas: (214) 231-5094, Belgium: 031 38 27 07, Denmark: 02/84 58 00, England: 01/94 10 46 6, France: 686-77 60, Germany: 089/53 03 19, Japan: 03/26 36 82 6, Netherlands: 076 879251, Switzerland: 022/319704 and representatives around the world.

Pro-Log taught the PROM programmer to think so you can relax.

Way back in 1973, Pro-Log revolutionized PROM programming with a microprocessor-based programmer that simplifies programming and lets you relax.

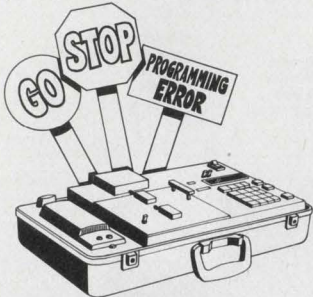

Because it analyzes PROMs as they're being programmed, it minimizes dropped data and mis-programming, and maximizes PROM yield.

It leads you step by step through each programming operation to lessen the chance of mistakes.

Our microprocessor-based control unit is so reliable we back it with the industry's longest warranty, 2 full years parts and labor.

Using our field proven plug-in PROM Personality Modules, each with its own full-year parts and labor warranty, the stand-alone Series 90 PROM Programmer programs, lists, duplicates and verifies every major MOS and bipolar PROM. Its master control unit costs only \$1,800.

The single-button Series 92 Peripheral PROM Programmer/Duplicator control unit, including a TTY interface, is \$995.

PROM Personality Modules cost from \$360 to \$450 and plug into either control unit.

Pro-Log routinely submits PROM Programmers and PROM Personality Modules to PROM manufacturers for evaluation and approval. Contact us for approval status on the PROM Personality Module you want.

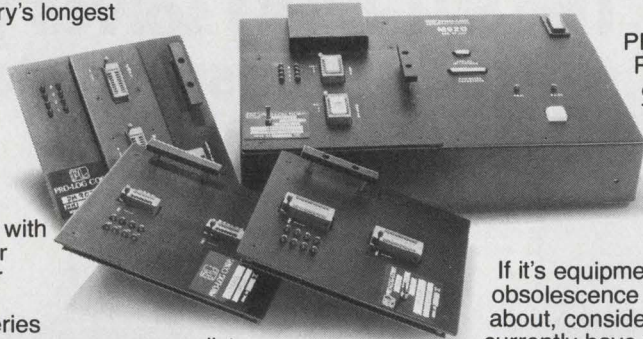

PROM Programmer options include TTY, paper tape reader, parallel I/O, RS232 and CMOS RAM buffer.

If it's equipment obsolescence you're worried about, consider this. We currently have about 2,000

Series 90 PROM Programmers in use worldwide. And every one, oldest and newest alike, accommodates every one of our field-proven PROM Personality Modules including our new Generic PROM Personality Modules.

Try programming your next PROM the relaxing way. For a demonstration or for the latest version of our 48-page PROM User's Guide, contact Pro-Log Corporation, 2411 Garden Road, Monterey, CA 93940. Phone (408) 372-4593.

 **PRO-LOG**
CORPORATION

Microprocessors at your fingertips.

CIRCLE NUMBER 13



Washington report

Navy lukewarm about British missile seeker

Although the U.S. Navy has agreed to evaluate a new British guidance system for its Sparrow air-to-air missile, chances of acceptance have dimmed considerably since the British decided not to participate in the NATO Airborne Warning and Control System (AWACS). Both the Navy and the Air Force are seeking a more effective guidance system than the current pulsed-doppler seeker, which is susceptible to ground clutter and electronic countermeasures.

The British Sky Flash missile, a short-range version of the Sparrow, solves this problem by using a monopulse seeker developed by Marconi Ltd. In 17 tests conducted to date by the Navy for the British Ministry of Defense at Pt. Mugu, CA, Sky Flash scored eight direct hits against low-flying targets, came within 1 meter seven times, and missed the target twice. Five more tests are planned under the cooperative program, and then the Navy is slated to test the missile about 10 more times for possible American use.

Before pulling out of the AWACS, the British had hoped to sell the monopulse seeker. But now, the U.S. will probably initiate a competition among American firms to develop a whole new monopulse system. General Dynamics and Raytheon are expected to bid on the program.

Air Force pushing avionics reliability in rocket

A "pair-and-spare with cross-strapping" approach to avionics redundancy will be applied by the Air Force to its Interim Upper Stage (IUS), which will launch space payloads from the Space Shuttle. This is expected to improve reliability from 0.81 to 0.983. The new approach will mean "losing one or two spacecraft out of 100 instead of one or two out of 10," explains Lt. Col. Joel M. Rosenzweig, Air Force IUS program manager.

In the past, the Air Force has used "single-string" avionics—essentially one of each subsystem—in its launch vehicles. But this has turned out to be the most expensive approach in terms of losing spacecraft. "Triple-string" systems (three of each) are cheaper, but the pair-and-spare method is the most effective. The Air Force estimates IUS avionics costs (including development and 10 years of operation) would be \$1.1-billion for single-string and \$348-million for triple-string. Pair-and-spare should cost \$254-million.

NASA, GAO quarrel over space-telescope costs

The National Aeronautics and Space Administration is at logger-heads with the General Accounting Office over the proposed 2.4-m Space Telescope, which is now due to be launched in late 1983 by the Space Shuttle.

The GAO, which studied the program at the request of Congress, says that it would cost nearly \$1.4-billion to develop and operate for 15 years. NASA says that this estimate "is based on incomplete program definition and erroneous costing and could result in providing misinformation to the Congress."

Both organizations agree that the development will cost at least \$435-million. The disagreement is over the operating costs. GAO estimates these at \$470-million over 15 years plus \$210-million for the nine Space Shuttle flights needed to service the telescope and more than \$200-million in such hidden costs as inflation, government workers' salaries and tracking. NASA maintains that annual operating costs would only be \$10-million to \$15-million, so operating costs for 15 years would total no more than \$225-million.

Air Force optimistic about digital phase-lock loop

As a result of favorable acceptance by systems manufacturers, the Air Force reports, a digital phase-lock loop designed by the Air Force's Avionics Laboratory in Dayton, OH, may be available within a year as a standard catalog item, cost less than \$4, and still satisfy military specifications. Under Air Force contract, 150 chips were produced by RCA, then sent in February to 45 qualified systems manufacturers for evaluation.

The digital PLL, which has a complexity of 270 equivalent gates, contains transistors and resistors that can be connected to create such diverse circuits as radar-signal processors and encrypted speech coders.

The advantage of the digital design over analog PLLs is its ability to change frequency and bandwidth instantaneously, according to designer Gary Gangler of the Laboratory's Electronic Technology Div.

The new loop is being considered for frequency tracking, bit timing and data recovery in 5 navigation systems, and as a synchro/resolver to digital conversion in aircraft flight controls.

Capital capsules: Raytheon and Ford Aerospace are expected to compete for the \$119-million worth of AIM-9L Sidewinder missiles to be sold to Britain under a letter of offer submitted to congress by the Defense Department. Britain will receive 1709 of the missiles for its F-4, Multirole Combat Aircraft (MRCA) and Sea Harrier fighters....A \$56-billion market for commercial aircraft is projected by industry executives over the next decade with the largest market segment, \$36-billion, earmarked for replacing current short and medium-range transports. Boeing, Lockheed and McDonnell Douglas all have begun working on new aircraft that will carry less than 200 passengers in the range of 2000 miles....The Air Force has begun flight testing of the No. 2 development aircraft in the EF-111A electronic warfare program following rollout ceremonies May 20 at the Calverton, NY, plant of prime contractor Grumman Aerospace Corp. The aircraft carries internal electronic countermeasures to jam enemy radars, and the No. 2 vehicle is the first with a full avionics suite....Due to Congressional budget cuts, a delay of at least five months is anticipated in the development of a new forward-looking infrared (FLIR) system to permit night operations of the Army's Advanced Attack Helicopter. The two competing contractors, Martin Marietta and Northrop, are due to deliver their prototype systems in 1978 for a fly-off scheduled for late 1979....

The Defense Dept. estimates that an unusual energy monitoring instrument now being tested at the Naval Construction Battalion Center, Port Hueneme, CA could save \$ 1 million annually in energy consumption costs per military installation. Developed by Franklin Electric Co., Bluffton, IN, the Model 30 Energy monitor keeps track of electrical energy consumption at any branch or load circuit rather than only at the main feeder. As a result, data can be collected and analyzed relative to specific loads, as opposed to watt-hour meters which are connected to a whole plant or installation....Northrop Corp. will present a panel discussion on the future of wideband data transmission at this year's convention of the Armed Forces Communications and Electronics Association (AFCEA) to be held June 21-23 at the Sheraton Park Hotel in Washington, DC.

You design the system. We'll display your solutions.

Together we make each other look better than ever. Because our specialty is taking your system's output and displaying it as concepts that any user quickly understands.

Tektronix has made graphics desirable and affordable

worldwide. Our components can give your system the same universal acceptance and versatility. Our capabilities complement your needs: including graphic and alphanumeric terminals and monitors. Plotters. Hard copiers. Combined refresh and storage technology.

We'll work as your partners. We'll provide modular display components you can stake your reputation on, with prices and quantity

discounts that put it all together. You've got high standards for your OEM suppliers: we stack up to them. Give us a call soon.

Tektronix
Information Display Group
OEM Components
P.O. Box 500
Beaverton, Oregon 97077

**Tektronix
OEM components:
the perfect fit.**

CIRCLE NUMBER 15





About that 'new' kid on the block...

Actually, he's not that new. He's been around for quite a while now. Other vendors keep announcing miniature cylindrical ceramic capacitor 'innovations', but Sprague Electric, the pioneer in layer-built ceramics, can state with pride that this type of capacitor was introduced by Sprague more than ten years ago.

Sprague Type 292C MONOLYTHIC® Capacitors are the industry's best-constructed axial-lead capacitors, thanks to MFT*, a closely-monitored material modification of electrode metal and ceramic reacted with glass. The result—less capacitance change with temperature change, improved stability with life, and improved impedance with frequency characteristic.

These low-cost miniature capacitors feature a dimensionally-precise molded construction and can be ordered taped and reeled for automatic insertion. They are available in body formulations to meet characteristics Z5U (general-application), X7R (semi-stable), and C0G (NP0).

For complete technical data, write for Engineering Bulletin 6250B to: Technical Literature Service, Sprague Electric Co., 347 Marshall St., North Adams, Mass. 01247.

4SZ-7103

Illustrated approx.
4x actual size

MINIATURE MOLDED
AXIAL-LEAD
CERAMIC
CAPACITOR

* Modified Formulation Technology

THE BROAD-LINE PRODUCER OF ELECTRONIC PARTS

CIRCLE NUMBER 16

SPRAGUE®

THE MARK OF RELIABILITY

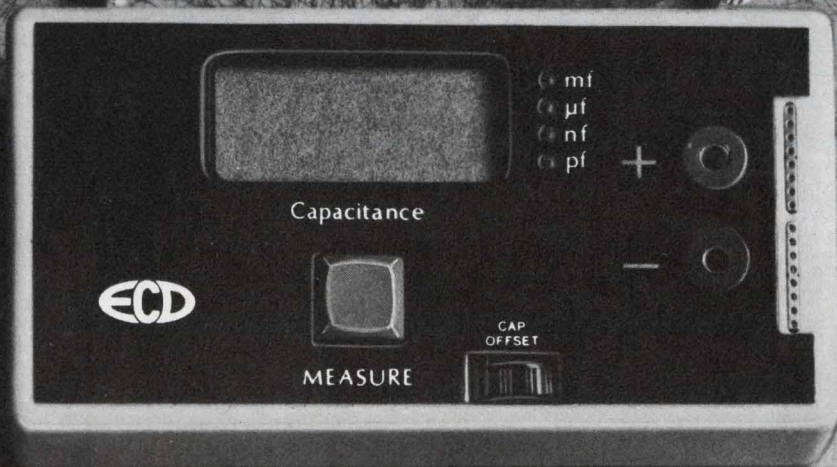

My shirt, yes...my C-Meter, no.

Test the kind of guy who'll give you the shirt off his back: ask him for his C-Meter.[®]

He knows that his C-Meter gives him a definite edge. It exposes an obvious efficiency: capacitors are easier to measure than resistors.

No more twiddling and nulling. No need for expensive, tight-tolerance capacitors or tweak pots. With its pushbutton speed, high accuracy (0.1%), small size

and versatility (0.1 pf to 0.2 farads), the C-Meter makes you a more productive engineer.

You owe it to yourself to try one on. It'll cost no more than a fine suit: stocked locally at only **\$289.00**.

ECD CORP.
196 Broadway, Cambridge
Mass. 02139 (617) 661-4400



CIRCLE NUMBER 17

SALES OFFICES: AL, Huntsville (205) 533-5896; AZ, Scottsdale (602) 947-7841; CA, Costa Mesa (714) 540-7160; CA, Sunnyvale (408) 733-8690; CO, Denver (303) 750-1222; FL, Winter Haven (813) 294-5815; GA, Chamblee (404) 457-7117; IL, Elk Grove Vill (312) 593-0282; IN, Indianapolis (317) 293-9827; MD, Silver Spring (301) 622-4200; MA, Burlington (617) 273-0198; MN, Minneapolis (612) 781-1611; MO, Kansas City (816) 358-7272; NJ, Camden (215) 925-8711; NM, Albuquerque (505) 299-7658; NY, Great Neck (516) 482-3500, (212) 895-7177, Syracuse (315) 446-0220; NC, Raleigh (919) 787-5818; OH, Centerville (513) 433-8171; TX, Houston (713) 688-9971; TX, Richardson (214) 231-2573.

FOR UNDER \$2000, YOU CAN BUY A 300 LPM PRINTER THAT PRINTS FASTER THAN 300 LPM. MAYBE EVEN 50% FASTER.

While the Teletype[®] model 40
132-column
printers are rated
at 300 lpm
(monocase), that
figure is somewhat
misleading.

Actually,
that's quite an
understatement
since the real
printing speed
lies somewhere

between 300 and 500 lpm. We wish we could pin our speed down
tighter, but throughput takes into consideration a couple of variables.
Like different character type belts and an almost infinite number
of data patterns.

But speed isn't all we offer for less than \$2000. Because for that
money you also get a printer that's completely
operational. All you furnish is 115 VAC power and
the serial signal source and you're ready to
go on-line.

For more information about
Teletype model 40 OEM
printers, write: Teletype,
Dept. 89-P,
5555 Touhy Ave.,
Skokie, IL 60076.
Or call:
312/982-2000.



THE TELETYPE[®]
MODEL 40 OEM PRINTER.
NOTHING EVEN COMES CLOSE.

Teletype is a trademark and service mark registered
in the United States Patent and Trademark Office.

CIRCLE NUMBER 18

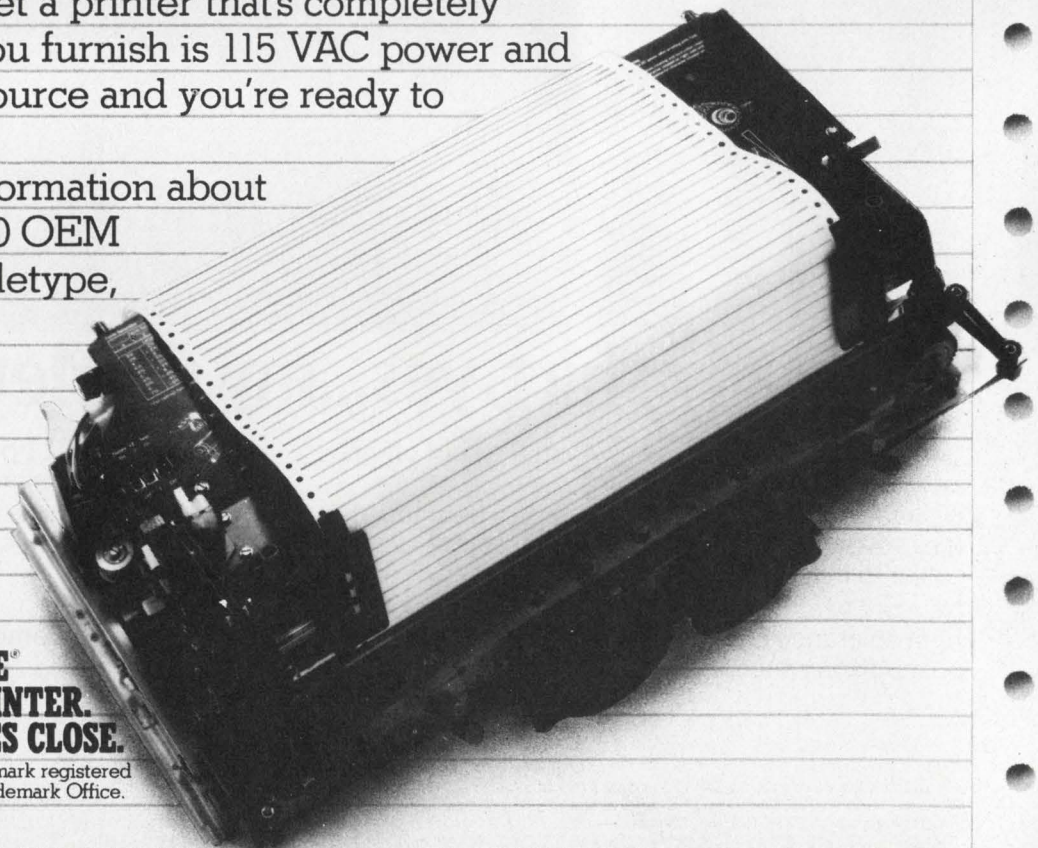

GE puts it on the line with a new family of TermiNet[®] line printers

Four value-packed true line printers
with real 90-340 lines per minute
throughput at practical, low prices

Small size. Compact design. Modern styling.
Quiet operation. Low prices.

At the same time this new space-saving
family of GE TermiNet line printers is big on
throughput. Gives you a range of speeds from 90
lpm to 340 lpm, depending on the number of
printable characters per line and the size (64 or 96)
of the ASCII subset. And that's *real* throughput.

They're big on reliability backed by years of
proven electronics and rotating belt technology.
(Over 75,000 GE belt printers installed
worldwide.)

Big on quiteness. They're a welcomed
addition to any office or computer room. Big on
value-packed features. 132 columns. Original and
5 copies. A unique ribbon cartridge. With a life
span of 50 million print characters.

The only thing you'll find small about this
new family of true line printers is their size and
price. In these days of spiraling costs, GE is
putting it on the line with practical, low prices.
From \$3900 for the TermiNet 310 printer to \$5130
for the TermiNet 340 printer (user quantity 1).

Let us prove it. Write General Electric
Company, TermiNet 794-17A, Waynesboro, VA
22980.

For your special kind of needs-
a special kind of printer

GENERAL  ELECTRIC

CIRCLE NUMBER 221



IT'S A TOUGH WORLD OUT THERE.

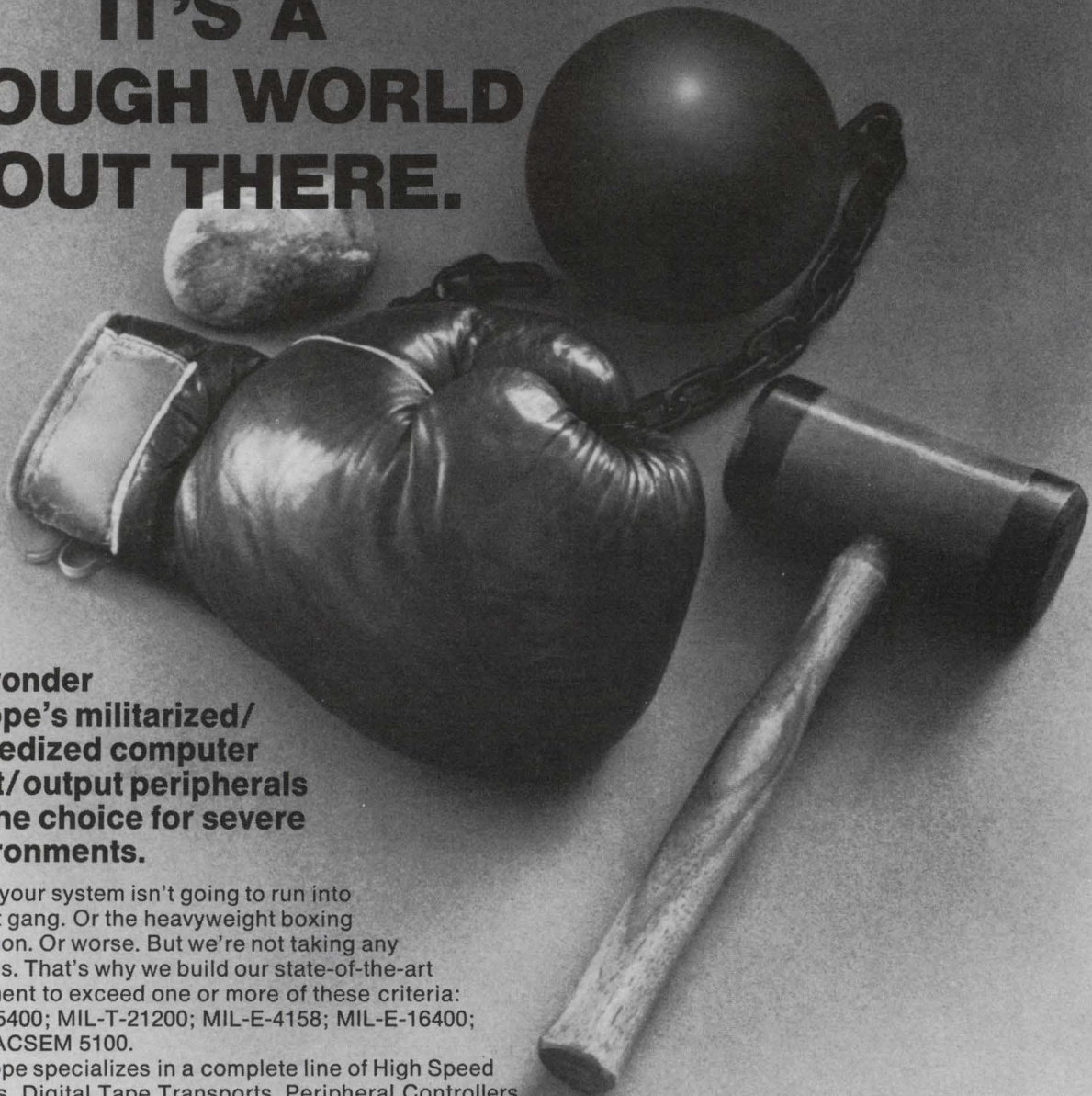

**No wonder
Miltope's militarized/
ruggedized computer
input/output peripherals
are the choice for severe
environments.**

Maybe your system isn't going to run into a street gang. Or the heavyweight boxing champion. Or worse. But we're not taking any chances. That's why we build our state-of-the-art equipment to exceed one or more of these criteria: MIL-E-5400; MIL-T-21200; MIL-E-4158; MIL-E-16400; and NACSEM 5100.

Miltope specializes in a complete line of High Speed Printers, Digital Tape Transports, Peripheral Controllers, Floppy Disc Drives, Tape Cartridge Recorders and Keyboard Printer I/O display terminals.

All designed to assure you of exceptional reliability for just about any tactical or ruggedized application your system encounters. So, if you're interested in computer input/output peripherals that are tough enough to take anywhere, call Miltope.

MILTOPE MAKES IT EASIER.

MILTOPE

CORPORATION

NINE FAIRCHILD AVENUE • PLAINVIEW, N.Y. 11803 TEL: 516-938-9500 TWX: 510-221-1803

TAPE TRANSPORTS

- IBM Compatible, 7 or 9 track • 800 and/or 1600 BPI Format • Speeds to 125 IPS
- Withstand High Altitudes



HIGH SPEED PRINTERS

- 33, 80, 132 column formats • Up to 400 lines per minute • Built-in test equipment • 4 copies • Serial keyboard option



TAPE CONTROLLERS

- Compatible with PDP-11, Honeywell 316/516, MIL-STD-1397, NOVA Series
- Built-in test capability
- Error Correction

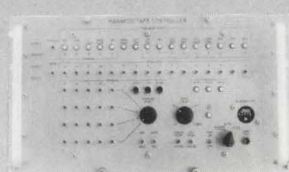

FLEXIBLE DISK DRIVES

- Over 6 million bits of on line storage • 77 Data track, 6400 bits per inch • Random Access • 500 KC Data transfer rate

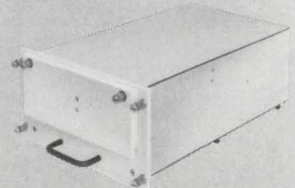

Here's the extra microcomputer power and speed you need in today's engineering

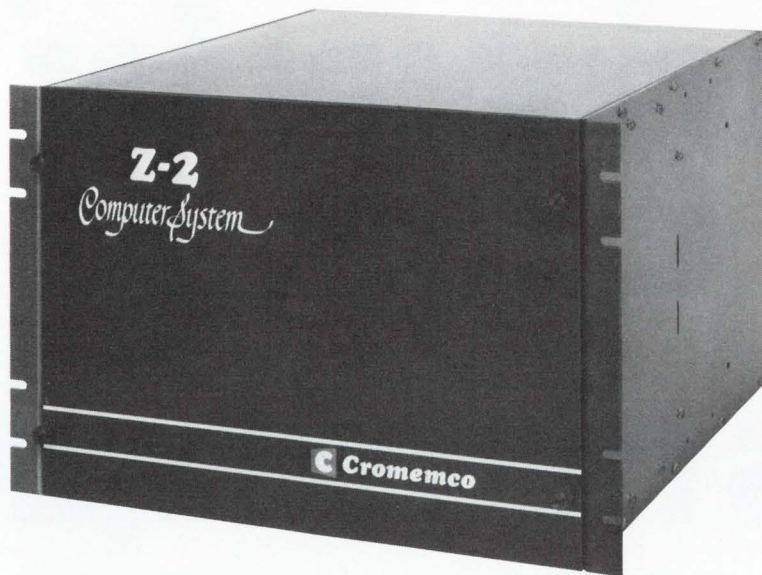

Z-80 BASED COMPUTER

You see here one of the industry's fastest and most powerful microcomputers.

It's our advanced Model Z-2, designed for dedicated work.

Its power comes from using the Z-80 μ P with its powerful 158-instruction set.

Its speed comes from using a special version of the Z-80 that operates at a 4 MHz clock rate.

So with our Z-2 you not only can do more, you can do it faster. You get extra flexibility, too, because of the Z-2's S-100 bus.

ADAPTABLE TO YOUR JOB

Further, the Z-2 is arranged so you can tailor it to your job. It has a 21-slot motherboard accessible from the front. You can quickly and easily plug in an almost endless variety of additional memory, I/O, or whatever you need for your project.

BROAD SUPPORT

Cromemco also gives you the kind of support you need. Analog I/O, for example. And high-speed 4 MHz memory in the form of 4-kilobyte and 16-kilobyte RAM cards with a bank-select feature. Our bank-select lets you organize memory into as many as 8 banks of 64K each.

You can also have a color-graphics interface, a highly-flexible TU-ART which interfaces two terminals, PROM cards with inexpensive PROM programmer, and a joystick console with self-contained speaker for audio effects.

INDUSTRY-STANDARD BUS

The Z-2 is designed around the industry-standard S-100 bus. That means you can plug in not only Cromemco circuit cards but those from dozens of manufacturers that support the S-100 bus.

HEAVY DUTY

The Z-2 is ideal for engineering, production, lab, business, and educational applications. The front panel is entirely free of controls or switches (no accidental memory losses or wipe-outs).

The unit is designed for rack mount-

ing and is totally enclosed in heavy sheet metal — no plastic.

Even the power supply has the extra measure of quality Cromemco is known for — it provides 30A from +8V and 15A from +18 and -18 V. That's more than adequate for a full set of 21 circuit boards and other peripherals.

LOW PRICE

You get the Z-2 for only \$995 (or only \$595 in kit). That includes the 4 MHz Z-80 μ P board, power supply, and full-length motherboard. You have the fast, powerful basics to supplement with whatever circuit cards your project requires.

Contact Cromemco today for the literature on this powerful and practical computer. It's already one of the industry's best-known units.

Ask, too, for our new 20-page catalog.

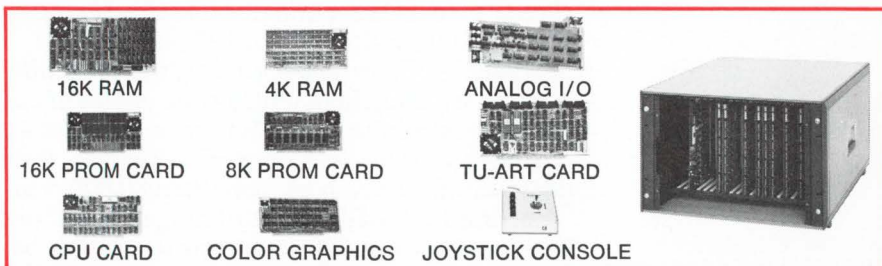

Cromemco

incorporated

Specialists in computers and peripherals

2400 CHARLESTON RD., MOUNTAIN VIEW, CA 94043 • (415) 964-7400

CIRCLE NUMBER 223

You won't find a better family of printers for the price. It's that simple.

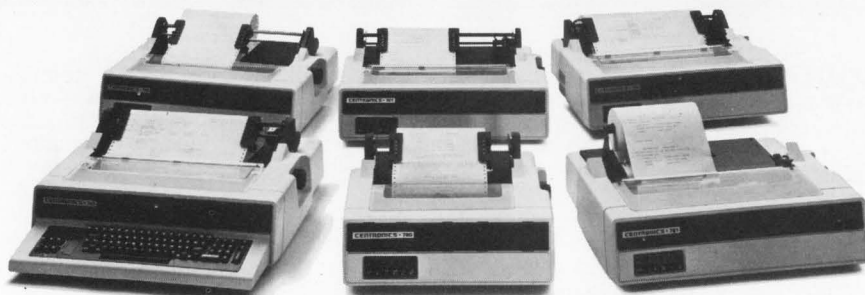

The New Centronics 700 Series.

Now, the features that make our model 700 the best, lowest-priced serial printer are available in a *family of seven* models: uncomplicated modular construction; the reliability of fewer moving parts; high parts commonality; and low price. All of which means a lower cost of ownership.

The new 700 family covers a full range of serial printer requirements: 80- and 132-column format; 60 to 180 cps speed range; bi-directional and logic-seeking operations; and 110-300 baud KSR and RO teleprinters.

Like all Centronics printers, the 700 family is better because we back them with a wide choice of customizing options and accessories. More than 100 sales and service locations worldwide. Centronics' financial stability, and dependability proven by more than 80,000 printers installed.

Simplicity of design, full range capabilities, and better back-up make our 700 series printers simply better.

Centronics Data Computer Corp., Hudson, N.H. 03051, Tel. (603) 883-0111. Or Centronics Offices in Canada and throughout the world.

CENTRONICS® PRINTERS
Simply Better

CIRCLE NUMBER 224

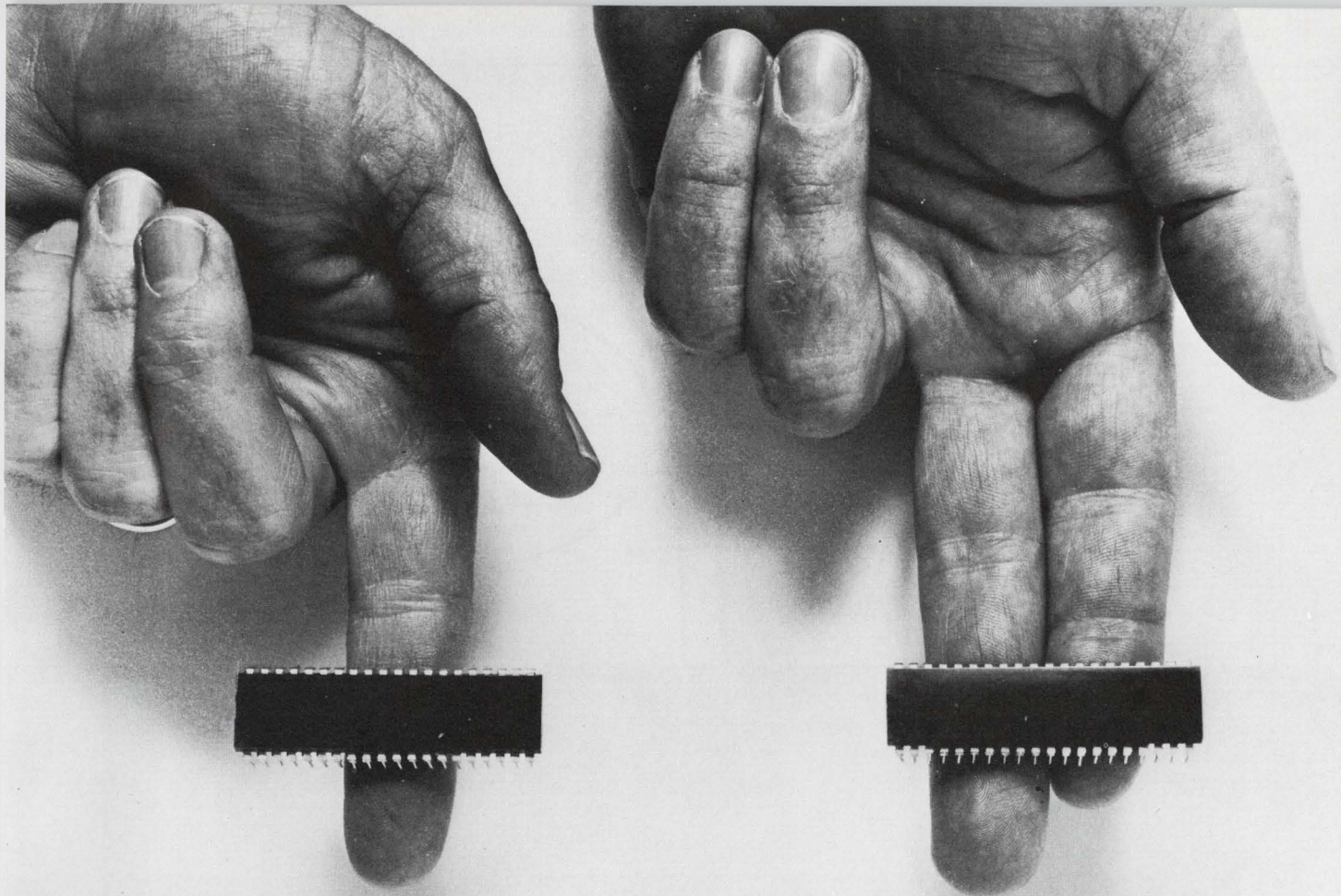

Announcing the 1800 CMOS microprocessor.

Again.

Hughes now has, off the shelf, second-source availability of RCA's 1802 CPU, 1824 RAM and 1852 I/O devices. And very soon, for the entire standard 1800 microprocessor family.

The advantages of CMOS microprocessors? Low-power dissipation, single wide-range power supply; high noise immunity; single-phase clock; full operating temperature range, -55°C to 125°C and dc-to-6.4 MHz operation.

And this is only the beginning. You'll soon be able to get the 1800 series ROMs from us.

Why Hughes? It makes sense. We were one of the pioneers in CMOS technology. We are the largest producer of digital watch modules. We have the experience, the production capability, and the necessary resources to turn out high-quality devices in large volume.

For full information, contact Hughes Solid State Products Division, 500 Superior Avenue, Newport Beach, California 92663 (714) 548-0671.

Availability Schedule

HCMP 1802 CPU	Now
HCMP 1824 RAM	Now
HCMP 1852 I/O Port	Now
HCMP 1831 4k ROM	3rd Qtr.
HCMP 1854 UART	3rd Qtr.
HCMP 1833 8k ROM	4th Qtr.
HCMP 1853 N Bit Decoder	4th Qtr.
HCMP 1856/57 Buffer	4th Qtr.
HCMP 1858/59 Add. Latch Decoder	4th Qtr.

HUGHES

HUGHES AIRCRAFT COMPANY
SOLID STATE PRODUCTS DIVISION

WHAT'S NEW
IN IC
MEMORIES?

I DON'T
KNOW...I'VE
JUST BEEN
HATCHED.

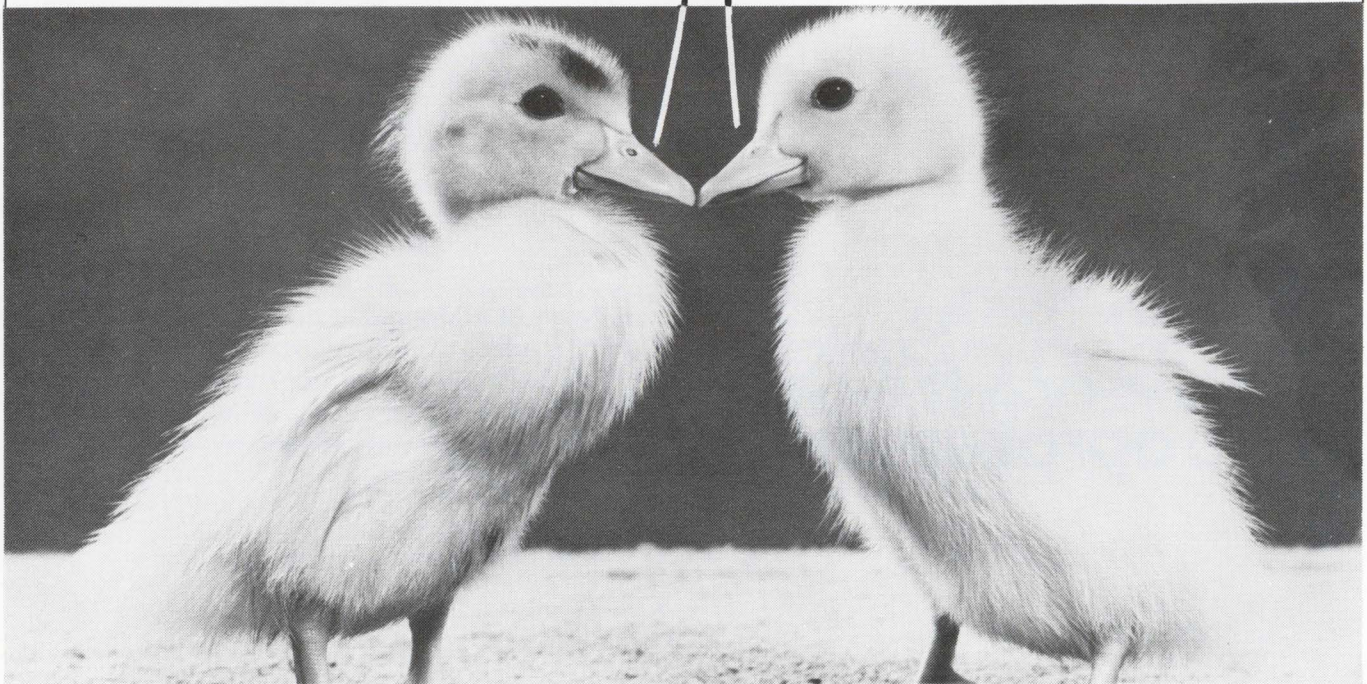

Semiconductor memories are without a doubt one of the fastest evolving products anywhere. Five years of product lifetime is a real accomplishment — many products don't make it beyond a year or so.

Where does the technology stand today? What products are becoming obsolete? What will replace them? What must a designer consider before he commits his firm to a component that could grow up to be a Dodo?

**FIND OUT ON AUG. 16 IN
Electronic Design's FOCUS REPORT
"INTEGRATED CIRCUIT MEMORIES"**

16K ROM'S: 8316E. TWO WEEK DELIVERY.

We're the ROM's specialists.

That means we can offer you a lot of things that non-specialists can't. Things like two week delivery on prototype quantities of 8316E's.

Your language. Our ROM's.

Send us your programmed EPROM's, (we might modestly suggest our EA2708's,) or your codes on tape, punched tape, cards... even on a competitors ROM. We'll program your code and have your ROM's on the way in two weeks.

Here's our little zinger

When you're ready to produce, we're ready to produce. Big. Every month, we deliver over a billion bits in 19 separate ROM's. But we'll start you off with a prototype run of fifty or less.

Swell, but what about production quantities?

Your ROM's are in inventory now. All they need is your program and our final mask. That means we can give you your prototype ROM's in a hurry.

Prices?

Call us. We'll put both our products and prices up against anybody in the business. And because we're still somewhat smaller than those big guys, we'll bust our humps to see that you get your ROM's... your way... on your schedule. Worldwide.

Any questions?

Call ROM Country. Here's our number: Toll Free: (800) 227-9962. Or, (415) 964-4321.

EXPECT IT FROM ROM COUNTRY



**ELECTRONIC
ARRAYS, INC.**

CIRCLE NUMBER 227

ELECTRONIC ARRAYS, INC., 550 MIDDLEFIELD ROAD, MOUNTAIN VIEW, CA 94043 (U.S.A.)

Tell me more about your capabilities in ROM's EPROM's. Also, please send me your Application Notes on ROM's EPROM's. Please send me the name of my nearest EA representative. Add me to your mailing list.

Name _____
Company _____
Address _____
City _____ State _____ Zip (Postal Code) _____
Country _____ Telephone _____

HOW TO FIND OUT ALL ABOUT THE NEW U.S. AND WORLDWIDE DEVELOPMENTS IN COMPUTER TECHNOLOGY

SUBSCRIBE TO COMPUTER DECISIONS!

COMPUTER DECISIONS is the monthly magazine that tells you how to get the most value from your existing computer system as well as tested methods for effectively improving your system or even changing it. COMPUTER DECISIONS brings you depth feature articles, software and hardware surveys . . . columns written by experts in the areas of software, minicomputers, computer technology, data communications and other subjects. COMPUTER DECISIONS is an easy means of staying abreast of U.S. and world technology in the ever-expanding industry. Whether you are responsible for development programs that apply to manufacturing, to government, utilities, banking, publishing, education or in other areas, you will find COMPUTER DECISIONS brings practical ideas, tested plans, facts and suggestions direct from industry leaders in the U.S. and around the world. Subscribe today!

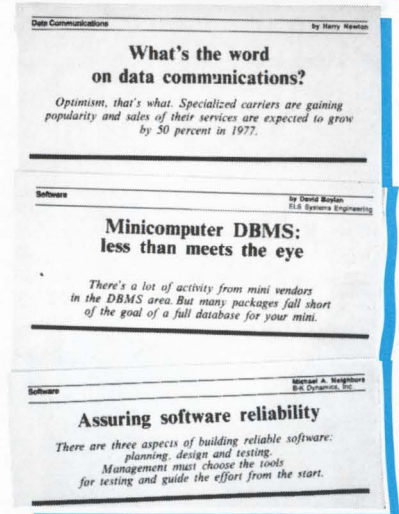
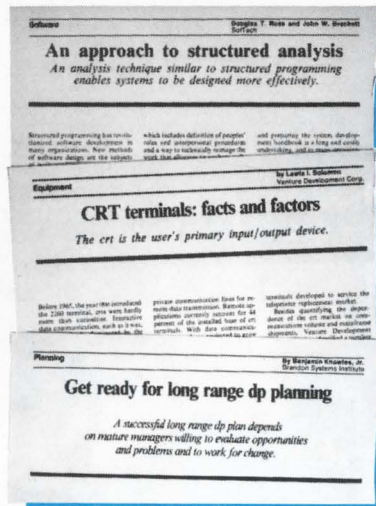

Reproduced in miniature above is a small cross-section of content found in a typical issue of COMPUTER DECISIONS . . . to help you use data processing systems for maximum potential. Everything is written in clear English, COMPUTER DECISIONS also uses plenty of graphics, charts, diagrams

and color in its pages to make everything easy to grasp and understand. Each feature article is summarized on the Contents page of every issue so you may quickly notice and turn to the matters which most concern you.

Computer Decisions

104R

Hayden Publishing Company Inc., P.O. Box 13802, Philadelphia, PA. 19101

Please RUSH me my subscription to COMPUTER DECISIONS.

1 Yr. @ \$30.

2 Yrs. @ \$45.

3 Yrs. @ \$60.

Check enclosed.

Purchase order enclosed
(we will bill you later).

Fill in grid completely for best service!

1st Initial	2nd Initial	Last Name	
Company Name (Do not abbreviate if possible)		Division	
Address			
County/Province			
State/Country		Zip Code/Postal Code	

MOLDED TANTALUMS:

KEMET Precision-Molded, Solid Tantalum Capacitors with axial leads are tailor-made for your high-speed, automatic insertion operations.

Their self-insulating epoxy cases are distinctively shaped for positive polarity identification, and provide unexcelled dimensional stability and lead concentricity.

You get extremely high capacitance-to-volume ratio, excellent performance characteristics from -55°C to +85°C, and solid KEMET quality throughout. At a surprisingly low in-place cost.

Specify the T320 Series for sub-miniature, extended-range units in three tubular case sizes, and CV range from 0.1 to 68 μF , 6 to 50 volts. Or the KEMET "Bullet" T310 Series in four standard cases, and CV range from 0.1 to 330 μF , 6 to 50 volts. Write for complete data.

Components Department, Union Carbide Corporation, P.O. Box 5928, Greenville, SC 29606; phone: (803) 963-6300; TWX: 810-287-2536; Telex: 57-0496.

Or see your local KEMET Capacitors Distributor.

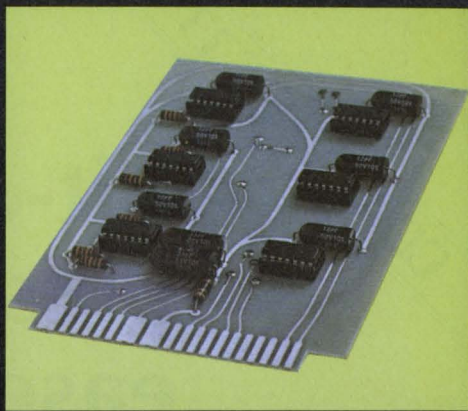

KEMET® OFFERS YOU MORE.

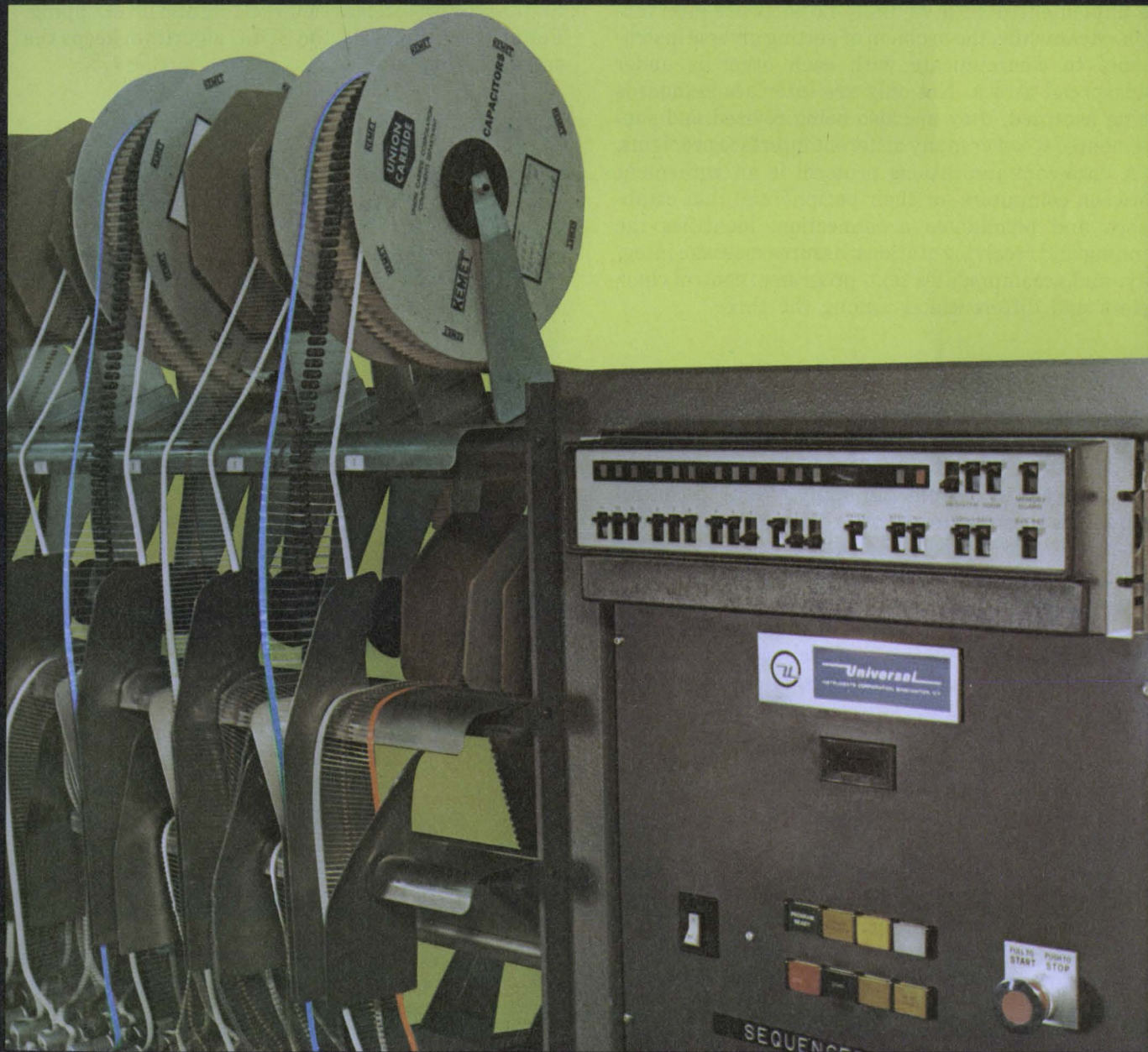

UNION CARBIDE COMPONENTS DEPARTMENT

KEMET is a registered trademark of Union Carbide Corporation

CIRCLE NUMBER 19

In Europe: Union Carbide Europe, S.A. 5, Rue Pedro-Meylan,
Geneva 17, Switzerland Phone: 022/47 4411 Telex: 845-22253

Bit-oriented protocols plus standard interfaces ease data communication

A fundamental shift is gradually taking hold in data communications—software-intensive byte-oriented protocols are destined to give way to simpler, more efficient synchronous data-link control protocols. SDLC protocols are bit-oriented and can be implemented with virtually no software intervention. Meanwhile, the problem of getting diverse instruments to communicate with each other is under widespread attack. Not only are interface standards being accepted, they are also being revised and supplemented to cover many different interface problems.

A data-communications protocol is an agreement between computers (or their peripherals) that establishes and terminates a connection; identifies the sending and receiving stations; assures message integrity; and accommodates text, programs, control characters and differentiates among the three.

Software is a problem

The byte-oriented protocols used today, including IBM's de facto-standard Bisync, Burroughs' Basic and DEC's DDCMP, need complex software to differentiate message text from the many overhead control characters these protocols need. In addition, they are severely limited to half-duplex operation.

Bit-oriented protocols, on the other hand, need recognize only two special characters—the flag pattern 0111 1110 ($7E_x$), which identifies the beginning and the end of a transmission frame, and an abort signal which is simply a sequence of seven or more consecutive ones. Other advantages include

- Full-duplex operation.
- LSI implementation.
- Fewer line turnarounds.
- Error checking over the entire transmission frame.

"Synchronous data link control" is another de facto IBM standard protocol. However, SDLC is also a type name for two similar, bit-oriented protocols that are destined to become standards. "Advanced data communications control procedure" (ADCCP) is now in

the final stages of development and will become the standard protocol of ANSI (American National Standards Institute). "High-level data-link control (HDLC) will become the ISO (International Standards Organization) protocol. The major features of these three SDLC-type protocols are bit stuffing and bit stripping. For all three protocols, the SDLC algorithm keeps the software simple.

An eloquent algorithm

In SDLC, the number of consecutive ONEs in the bit stream is never allowed to exceed five. The protocol



Data-communications equipment includes (clockwise from top) General Electric Terminet 30 teleprinter, which gives hard copy; Livermore acoustic coupler, which brings a telephone handset to computers; ADDS CRT terminal, which gives soft copy; Vadic VA3400 full-duplex modem (MOdulator-DEModulator), which operates at 1200 bits/s; and the Terminet 300 and acoustic coupler.

sub-system (either hardware or software) at the transmitting station imbeds an extra ZERO after the fifth ONE—neither the flag pattern (0111 1110) nor the abort pattern (1111 111X) is ever duplicated by data.

At the receiving station, the protocol sub-system reverses the algorithm, and strips away the first ZERO after a string of five ONES. The buffered data are then passed on to the receiver. The whole process is transparent to the computers involved.

Transmission in bit-oriented protocol occurs in frames. Each frame has two flags and four fields—address, control, information (which may be empty) and check. The frame is bracketed by identical opening and closing flags. Flags are considered part of the frame. When not actually busy, stations in an SDLC network are kept in an “idle” state. But when an opening flag is detected, the receiving station becomes active.

One of the big differences among mainframe manufacturers’ protocols is that the address field can vary in length—larger networks have more sophisticated addressing capability. An 8-bit control field defines how the information field is to be interpreted by the receiver.

The information field is any integral number of bytes long—its only limit is storage capacity. If the control field specifies a “management” or a “supervisory” frame, this field may be empty.

At this point comes a number, a 16-bit check field, constructed from all the data transmitted thus far, including the address and control fields. This check field is generated by the transmitter’s protocol sub-system—if the receiver’s sub-system constructs the same value, the message is considered error free. After recognizing the closing flag, the receiving station returns to its “idle” state.

The future is bit-oriented

Although IBM’s SDLC is the current bit-oriented standard protocol, Saroj Kar, an independent communications consultant and ANSI committee member, predicts that HDLC will become the protocol in use after the turn of the century. But the shift from byte to bit will not be complete for quite some time and protocol chip designers are keeping one foot in the present and one in the future.

“Eighty to ninety percent of all the data communications taking place today is in byte-oriented Bisync—it dates from 1968, and it will be a long time before its sphere of application is exceeded,” says Al Weissberger, an applications engineer who helped

Vadic VA3400, the first full-duplex, 1200-bps modem operates on dial-up or two-wire leased lines.

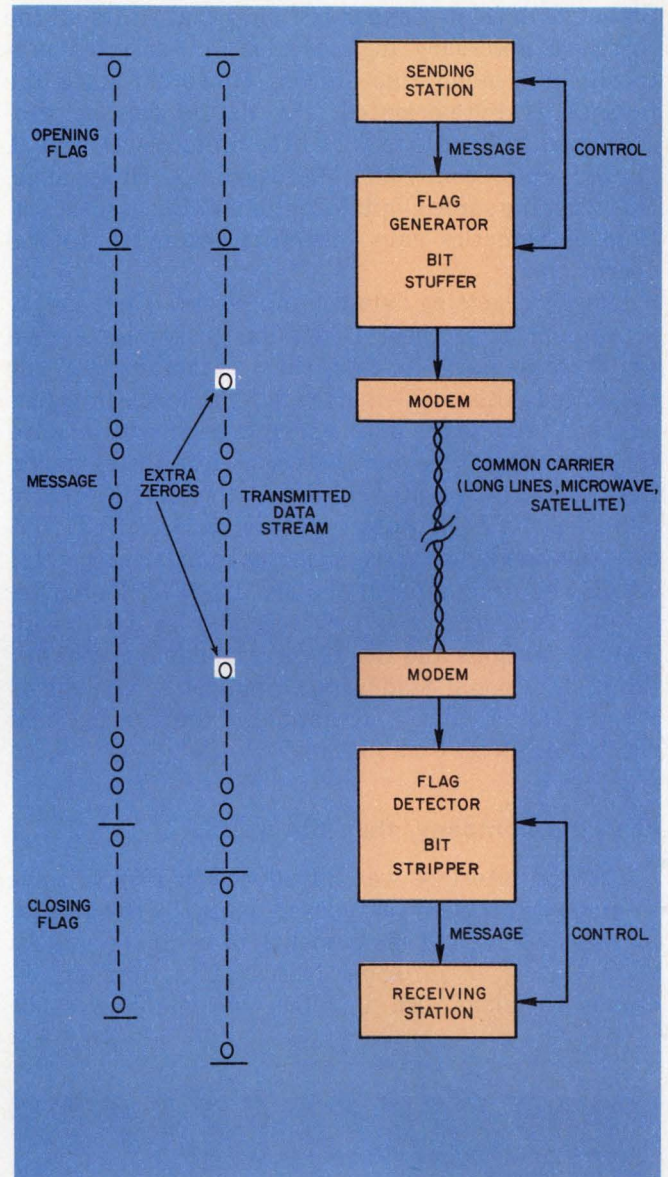

Bit stuffing (and bit stripping) is the key to bit-oriented protocols. A flag generator/bit stuffer is normally part of the computer’s software system, but new protocol chips will make this overhead invisible to processors at both ends of the data-communication link.

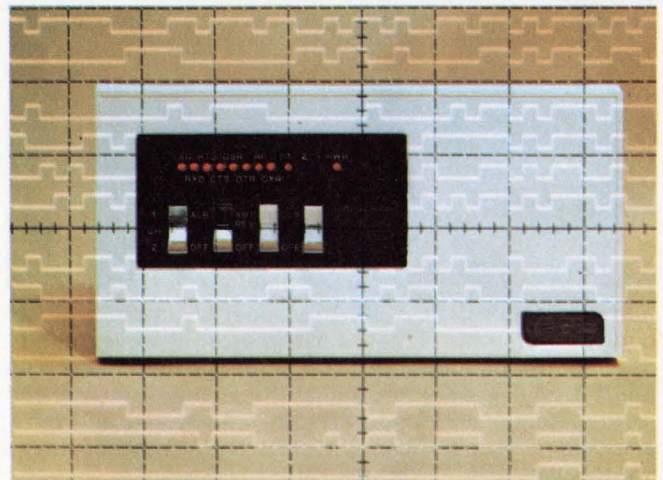

Signetics develop a super-LSI chip that shifts all the software necessary to implement bit-oriented protocols into monolithic silicon. However, since the present is byte-oriented, the device can be programmed to handle today's byte protocols as well. A similar chip from SMC Microsystems, Hauppauge, NY, with the same Digital Equipment Corp. specifications as Signetics' chip—also features multi-protocol operation.

However, getting data communicated is not simply a problem of protocol. Dissimilar instruments need an "intermediary" to help them communicate. One response to this problem, Hewlett-Packard's interface bus, has become the most widely recognized standard for communicating data between close instruments. Besides being accepted by the Institute of Electrical and Electronics Engineers and designated IEEE STD 488, the bus is now recognized as standard by ANSI which has designated it the MC 1.1-1975. Moreover, its interface scheme is now accepted by the 62 full-member nations and the 19 correspondent nations of the International Standards Organization and the 44 Western and Eastern-bloc nations of the International Electrotechnical Commission.

First the company, then the world

The HP interface was introduced in 1973 to solve a company problem that closely parallels the general problem of getting instruments to communicate—a wide variety of differing instruments from autonomous divisions. An interface scheme had to be

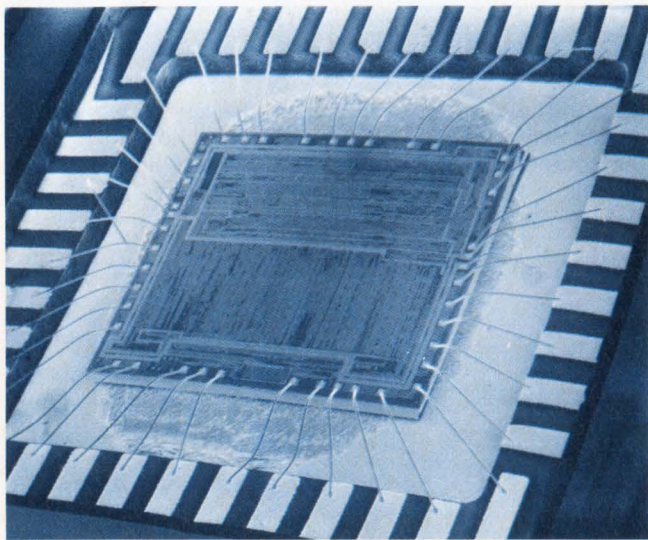

More complex than a μP , this super-LSI multi-protocol control chip from Signetics assumes all the overhead of data-communications protocol management: Flag and abort signal generation, bit stuffing and stripping and error detection. It supports both bit-oriented and byte-oriented protocols. (Scanning-electron-microscope image courtesy of The Aerospace Corp., El Segundo, CA)

developed to incorporate all these diverse devices into unique, individual, and functional systems.

"We wanted an approach that would standardize the mechanical, functional and electrical interface considerations, yet leave the instruments' operational characteristics (programming) free to vary from device to device," recalls Don Loughery, HP's computer interface engineer, who helped develop the interface bus. As a result, not only can each device on the bus retain its particular control commands, but also five broad categories of instruments—stimulus, measurement, storage, display and control—can be connected. In addition, the HP bus can be converted to other interface schemes as well, such as the RS-232 bit-serial interface.

Sixteen active signal lines comprise the bus—8 bidirectional data lines, 5 general interface-management lines and 3 byte-transfer-control lines.

Each station on the bus can work as a "controller," a "talker" or a "listener." Some devices can assume

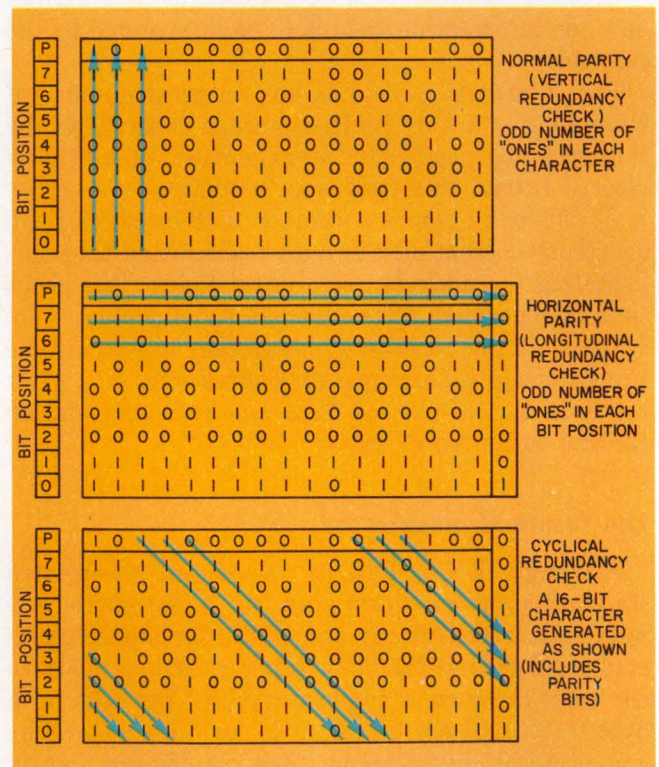

Bit-oriented protocols use three types of error checking to ensure message integrity from transmitting station to receiving station: Vertical parity, horizontal parity and cyclical redundancy checks. The two parity schemes generate an odd (or even) number of ONEs for each byte and for each bit position in the message; cyclical redundancy is an arithmetic operation performed on the data in a wraparound fashion. A 16-bit number is generated from the data and appended to the message. If the data are transmitted correctly, the receiving station duplicates the CRC character and accepts the message. If not, another transmission is requested.

multiple roles, such as a calculator (control, talk and listen) or a digital multimeter (talk and listen). Other instruments like counters and signal generators are not as versatile.

Many stations can listen

The 488 can be configured for as few as two stations (a single talker and a single listener) or as many as 15 (a controller with 14 talker/listeners). Because certain control lines are wire-ORed, many stations can listen at the same time; the bus will accommodate the slowest of them. In addition, the 488 can operate up to 1 Mbyte/s, although most users' data rates lie in the range of a few thousand bytes/s or less.

One byte of data is transferred at a time—completely asynchronously, and without strobes. An "interlocked handshake protocol" between bytes prevents a new transfer from occurring before the current transfer is completed. Two levels of protocol are



The Hewlett-Packard Interface Bus, also known as HPIB, GPIB and IEEE Standard 488, is the standard data-communications scheme for instrumentation systems. Here, it interconnects a Tektronix 4051 calculator, a Dana 5900 digital multimeter and a Dana 9000 timer/counter. A single cable carries 8 bidirectional data lines, 5 general-

involved—initial and repetitive.

First, the control station sets the attention line (one of five general interface-management lines) true, and sends out the addresses of all the stations to be involved in the upcoming data transfer. In turn, each station recognizes its address on the data bus and prepares to listen or talk. Only one station, however, may talk at a time. The byte-transfer control lines then support the per-byte handshake protocol.

The 488 operates much like a computer intra-system data bus (except for the absence of a Direct Memory Access function)—in addition to byte oriented, asynchronous data transfer, cables are passive, and the devices they interface are parallel.

But no single solution can satisfy every interface

problem. For example, computer automated measurement and control (CAMAC)—a backplane interconnect system for open-instrumentation modules—is widely recognized in Europe and accepted to a lesser extent in the U.S.

Developed by the Committee of European Laboratories in collaboration with the Energy Research and Development Administration (ERDA) and normally used to implement nuclear instruments, CAMAC is recognized as a standard by the IEEE and designated STD 583. Elements connected into a CAMAC system are called crates, and its 24-bit bus structure is called a highway.

Although not exactly standardized, Serial ASCII and Parallel BCD (binary-coded decimal) data-communication schemes are also widely used by instrument manufacturers. Used for instrumentation outputs exclusively (such as IEEE 488 talkers), these interfaces typically output measurements to hard copy, display units or data acquisition systems. Par-



interface-management lines and 3 byte-transfer control lines. The basic ground rules for system integration are not more than 20 meters of cable in any one system, a load every 2 meters, and an address for each "box" on the bus. The 488 can operate up to 1 Mbyte/s. (Photo courtesy Dana Laboratories, Irvine, CA).

allel BCD uses parallel lines to describe a value (measurement result) in a 4-bit scale-of-10. The bus structure typically includes a print-command line and other simple control functions.

Serial ASCII is used for the same purpose, but describes measured values in terms of the standard ASCII character set, and presents them serially to the outside world on a single pair of wires. As a result, instruments can interface directly to a teleprinter, data logger or data-acquisition network.

This kind of bit-serial data communication, which is called RS232C by the Electronics Industries Association, is the latest revision of RS232, EIA's description of an interface between data-terminal equipment and data-communication equipment employing

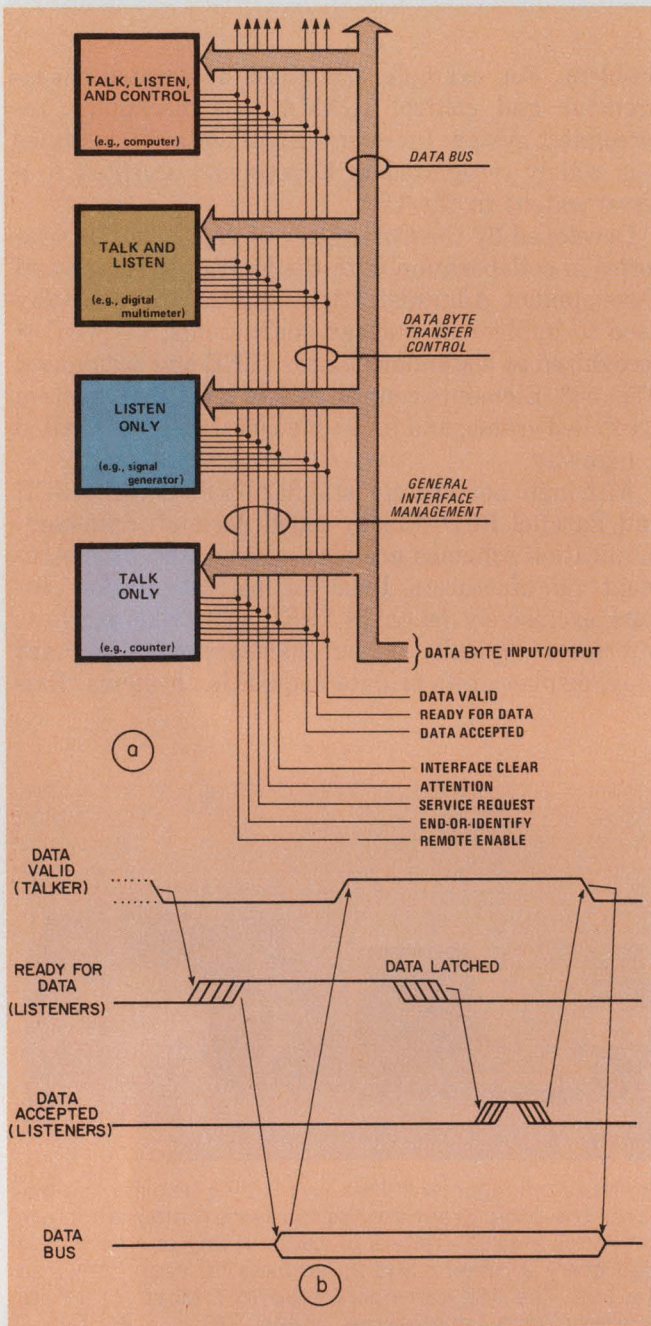

The HP interface bus's 16 signal lines interconnect an instrumentation system with as few as two and as many as 15 independent "boxes". Byte-wise data communication takes place with the patented, three-wire handshake protocol shown.

serial binary-data interchange. However, this "C" version is just about nine years old (Aug., 1969). Small wonder, then, that EIA has supplemented RS232C with updated interface standards in RS422 and RS423, which apply to integrated circuit implementations of bit-serial interfaces. RS422 describes a balanced line standard that overcomes noise problems; RS423 covers the "unbalanced" version. While RS232C's maximum line length is 50 ft, both RS422 and RS423 are useful up to 4000 ft between devices. And whereas RS232C is slow—it is limited to 20 kbits/s—RS422

operates up to 10 Mbits/s.

A family of devices has been introduced by Motorola Semiconductor, Mesa, AZ, to support the new EIA bit-serial standards. This MC-3480 series provides balanced and unbalanced drivers and receivers in dual and quad packages. In addition, Motorola plans to introduce a monolithic device to support the HP bus's handshake protocol this fall. It will be designated MC-68488.

Datacom: a universal concern

Data communications is an ongoing concern of several organizations, both here and abroad. The father of international technical organizations, the International Electrotechnical Commission, spawned the International Standards Organization. The ISO group most concerned with data communications is Technical Committee 97, Subcommittee 6—ISO TC 97/SC6 for short. The American National Standards Institute is the U.S. representative to ISO.

ANSI's standards are widely used by U.S. firms as guides, and often modified. At least nine different standards come from ANSI, ranging from the definition of ASCII to the determination of over-all datacom system performance. Many have been adopted by the Government, are called FIPS (federal information-processing standards), and are mandatory for the Department of Defense.

The Electronics Industries Association publishes standards, too, some of which duplicate ANSI standards. The 14 EIA standards carry an "RS" prefix, and the most popular is probably RS232. These standards are updated periodically. (Designers of any type datacom system should become familiar with EIA's new RS422/423 interface standards—they describe balanced and unbalanced updates for RS232C bit-serial lines.)

The Institute of Electrical and Electronics Engineers publishes standards, but only reluctantly. IEEE publications come in three degrees of importance: mandatory "standards," recommended "preferred procedures" and suggested "guides."

Technical organizations aren't the only standard makers. The Bell System, Data Transmission Co., MCI and American Telephone and Telegraph Co. all have similar "common carrier" standards. These standards have a common prefix, "PUB," and standardize such considerations as a 30-baud private line channel interface (PUB41001) and connector requirements for automatic dialers (PUB41601). Over 30 common-carrier standards are available from AT&T alone.

One government program currently underway is the Federal Communications Standards Program (FCSP), which is developing the National Communications System (NCS). The standards developed by this agency will overlay a number of ANSI standards and will be published by the National Bureau of Standards (NBS). They, too, will be FIPS. ■■

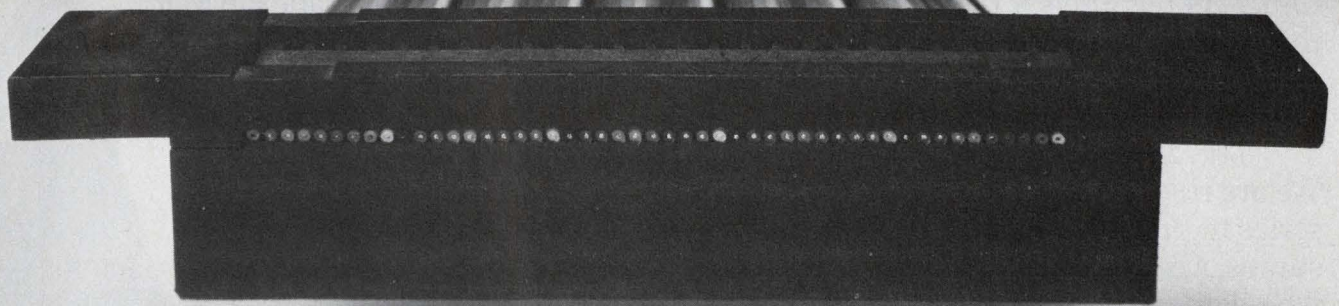

MULTI-TERM: HAPPY ENDING

Putting together a system that uses flat flexible cable? Watch out for these five key factors.

1. Cable Contacts

Insulation displacement requires a sharp edge. Any roughness or irregularity can nick the conductor and weaken it. Only SAE uses precision coining to produce a perfect contact surface.

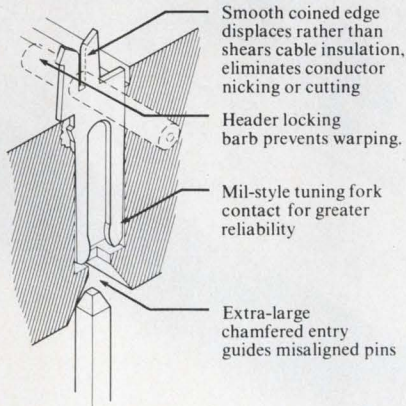

2. Mating Contacts

A lot of systems use a beam-type contact. SAE uses a military-type tuning fork configuration. It grabs the pin and produces maximum electrical reliability.

3. Header Security

Only MULTI-TERM™ contacts have locking barbs that bite into the header at every conductor position. Built-in pre-retention keeps header, contact and conductor securely mated. Vibration resistance is superior, and headers won't warp or bow.

4. Cable Quality

The best termination system in the world can't overcome irregular cable. Specify SAE ribbon cable as part of your system and you'll get more than just economy. You'll get dimensional stability.

5. Production Tooling

MULTI-TERM tooling speeds

production. Alignment is automatic, cuts and terminations are square, and the final result is as pleasing to the eye as it is effective and reliable.

SAE manufactures all the parts. PC connectors, header connectors, I/O headers, 14 and 16 pin DIP connectors and socket connectors. Tooling. Fixtures. Cable. You can buy any component you need.

Better yet, call SAE during your design phase. Let our engineers help work out a complete MULTI-TERM System for your flat cable runs. Your project, and your cable, will have a happy ending.



The OEM Connection

Stanford Applied Engineering, 340 Martin Avenue, Santa Clara, CA 95050. (408) 243-9200. TWX 910-338-0132

Intel delivers the growing

Our 2114 has already become the most widely second-sourced 4K static RAM for the same reason Intel's 2102A is the industry standard 1K static RAM. The 2114 simplifies system design, like the 2102A, and provides the highest possible density and modularity in static memories.

The 2114 is the first of several new generation Intel static 4K RAMs. We are now delivering both the standard 2114 series and the low-power 2114L series in production volumes. The 2114L is just as fast as the 2114 but consumes 30 percent less power. We will soon be shipping the 2142 to designers who want an extra chip select and output disable control inputs. Next, we'll add the super high-speed 2147.

This new generation assures a continuing reduction in static RAM costs. We fabricate the 4K chips with an evolution of our 2102A technology. At 181 mils square area, the 2114/2114L packs four times the bits in only twice the silicon area. The chips fit into standard 18-pin plastic or ceramic packages, keeping volume production costs low.

Our 4K RAMs also inherit the 2102A's ease of use and low overhead. You don't need a clock, address setup timing, or refreshing. You don't even need pullup resistors or output gating. These RAMs operate at TTL levels on a single

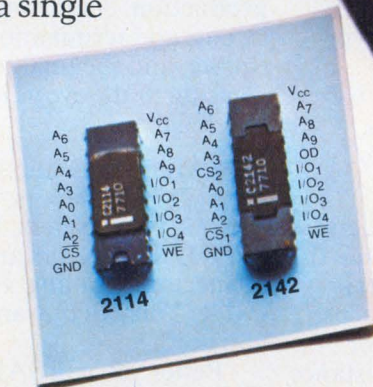

+ 5v supply and have buffered, three-state outputs. We guarantee identical access and cycle times, so you can surpass the performance of clocked RAMs. For instance, you can achieve a data rate of 20 million bits a second with our 200-nanosecond parts. That's up to twice the rate of clocked RAMs with 200-ns access time. Intel specs also guarantee that even at such high throughput you'll need only 25 to 50 percent of the power of first-generation static RAMs.



4K static RAM family.

As for board density, look at the pinouts. The 18-pin 2114/2114L configuration provides the highest density possible in 4K static RAMs.

Our 20-pin 2142 adds a second chip select — so you can go to 4K without external decoders — and an output disable for direct control of the output buffers. And since it is a simple modification of the 2114, it promises similar production economies.

You can minimize package count at any number of kilobytes since these new RAMs store 1Kx4 bits. With our compatible 256x4-bit static RAMs, you now have the widest range of modular design options. They are all listed in our new Static RAM Family Album.

Intel's 4K Static RAMs		
1K x 4	Access Time (max) Cycle Time (min) 0-70°C	I _{cc} (max) 0-70°C
2114-2 2114L2 2142-2	200 ns	100 mA 70 mA 100 mA
2114-3 2114L3 2142-3	300 ns	100 mA 70 mA 100 mA
2114 2114L 2142	450 ns	100 mA 70 mA 100 mA
4K x 1 with low power standby		
2147	70 ns	160 mA Active 20 mA Deselected

The 2114/2114L series is already as easy to get from stock as the 2102A. The 2142 soon will be. Contact any Intel franchised distributor: Almac Stroum, Component Specialties, Cramer, Elmar, Hamilton/Avnet, Harvey Electronics,

Industrial Components, Liberty, Pioneer, Sheridan, L. A. Varah or Zentronics.

For your copy of our Static RAM Family Album, write:
Intel Corporation, Literature Department, 3065 Bowers Avenue, Santa Clara, California 95051.

In Europe, contact Intel International Corporation S.A., Rue du Moulin a Papier, 51-Boite 1, B-1160, Brussels, Belgium. Telex 24814. In Japan, contact Intel Japan Corporation, Flower Hill-Shinmachi East Building 1-23-9, Shinmachi, Setagaya-ku, Tokyo 154.

intel® delivers.

Computer-aided design beats trial-and-error —just find the software

Computer-aided design is the most powerful engineering tool today, and is used extensively in many high-technology industries. With CAD, for example, you can optimize the design of a complex filter network in minutes. And yet, many thousands of engineers are hanging on to the wasteful "trial and error" method. Why?

Cost and scanty information about CAD software have restricted the use of CAD. Yet for most applications that would benefit from CAD, hardware cost is no longer an obstacle. Over the past decade, mini-computers have reduced hardware cost by a factor of 10, and now microcomputers are lopping off another order of magnitude. And as more CAD software is being developed, its cost is also coming down.

But you still have a rough time finding out what's available and where. Why have repeated efforts to compile CAD libraries failed?

Much of the existing CAD software has been developed in industry for internal use, and is not available to the public. The rest is also proprietary to a large extent, but can be rented or purchased from software houses. There is one notable exception: About 1600 programs, developed under NASA funding, are accessible through Cosmic, a software library in Athens, GA (for full address, see Table 1). Brief program descriptions are sent on request. You can purchase documentation at roughly \$.07 per page, and the program itself for \$.10 to \$.50 per line of code, depending on the length of the program and your selection of a transfer medium.

Computer manufacturers can be a source for applications software, but their programs are mostly math or graphics packages, and tailored for use on their own hardware. There *are* exceptions, such as IBM's circuit-analysis program, ECAP,¹ which is used worldwide on many different computers.

Chances are, you won't find the exact program you need in the "public" sector. Even if you do, you probably will have to modify it for your application, and adapt it to your computer. Since these costs can

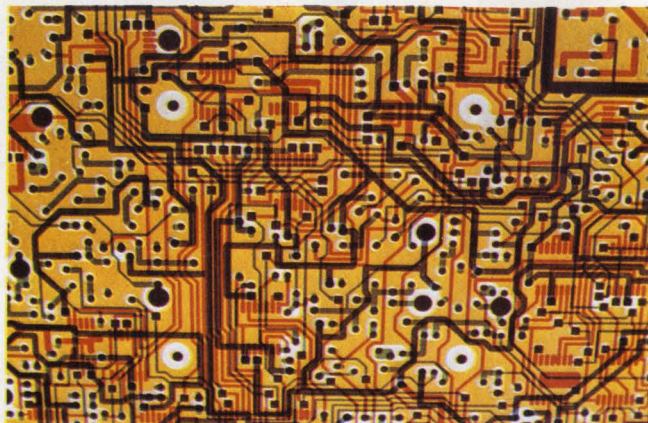

Computers generate the artwork for complex ICs or PC boards. In this composite photo from Markrevel, each color represents a different layer of a PC board for the space shuttle.

be very substantial, you may prefer to buy a packaged CAD program from a software house, even though that price may go into five digits. In addition to the program itself, the package contains full documentation, and helps you get started.

\$30,000 can be cheap

These expensive programs can save you a bundle. A few years ago, two companies obtained contracts to build 10 prototypes of a very sophisticated traveling-wave tube. One company designed the tube with about \$30,000 worth of CAD programs. It assembled 15 tubes, and qualified 10 prototypes in six months. The other company, staying with the trial and error method, built well over 100 tubes (at about \$3000 each), and after a year was still trying to qualify prototypes.

But before you commit yourself to a \$10,000 program, make doubly sure it's the right one. Get an opinion other than the vendor's. Consult a member of a growing profession—a software consultant who does not offer any programs of his own. You should contact professional societies or universities active in your field, suggests Dr. William van Cleemput of Stanford University, himself a highly reputable consultant in logic simulation and artwork generation.

But even if you have found the best program, and have properly debugged it, you have covered only part of the total expense—possibly even a minor one. Software maintenance is the biggest cost item (70%), according to Barry Boehm of TRW, followed by design and test (12% each), and coding (6%).

And even though some published surveys show that purchased software often saves 90% of the installed cost,² make sure you actually receive all the support you are expecting. Software houses form a very volatile industry. Of 2800 companies active during the late Sixties, only 800 survived the 1969-to-1971 pinch. But lately, they have jumped to well over 3000. In fact, the 1974 recession proved somewhat beneficial because many companies pruned their in-house EDP personnel sharply.

Before buying software, consult an EDP information service like Datapro, Delran, NJ, even though not too many technical programs are included in its program list or user ratings.³ For EDP software in general, a Datapro survey reveals that 63% of the programs purchased in 1976 required no modification, 19% were modified by the vendor, and 23% by the user. For technical software, which is much less standardized than financial programs, the modification rate is bound to be much higher.

There are technical pitfalls, too

But you still aren't home-free. Say you obtain a medium-sized program on paper tape. Though written in "standard" Fortran IV, if developed on Digital Equipment's PDP11, it will probably not run on Data General's Nova, or vice versa. In fact, you may not even be able to feed the tape in. While a short program can always be keyed-in by hand, you don't want to try that with even a moderately complex program. Several typing errors per page are practically guaranteed, and that means hours of troubleshooting.

Large programs are frequently installed from IBM cards, which are accepted by most computers—provided you have a card reader. But even if you do get the program up and running, your troubles are far from over.

Dollars in—garbage out

Costly or not, the program you acquire will probably not run on the first try—or it will output "garbage." A reputable software house certainly will not leave you hanging with a \$10,000 inoperative program, but neither will it compensate you for your (and your computer's) time—unless the contract says so. And even if the program runs, debugging can cost you real money.

In fact, one of the most agonizing experiences is to struggle with a program that works well with the vendor's own set of parameters, but gives wrong answers to *your* inputs. Since the canned program you acquire must use your computer's own math library

—which often differs from the vendor's—weird things can happen.

In one case, a problem was caused by the host computer's algorithm for a Bessel function, which would not converge beyond a certain value of the argument. The question is, how much time and money will your company expend before it stops "throwing good money after bad," and aborts the whole mission?

If you don't have access to adequate computer facilities, you will be restricted in your CAD efforts, but by no means excluded. Time-sharing services may come to your rescue. The larger ones offer a number of technical packages. Rapidata, Fairfield, NJ, for instance, has libraries for Math, Statistics, General Engineering and Applied Science. National CSS in Norwalk, CT, and Boeing Computer Services in Seattle, WA, are also technically oriented. Look for their branch offices, as well as other companies, in your phone book.

The CAD tree grows branches

To many, CAD has come to mean circuit analysis, and the large number of such programs may be confusing. A recent Air Force study of 16 circuit-analysis programs can help you choose the right one for your application.⁴

Several types of programs have evolved from circuit-analysis and have established a number of well-defined "branches" on the CAD "tree." One rather straightforward development carries the frequency range up to microwaves, even millimeter waves. Here, distributed components (primarily transmission lines) become very important, while transients are usually of little interest at such high frequencies.



When you design circuits with a computer, you can change the performance with the stroke of a pen, as on this Sanders console. The computer may even display the revised schematic.

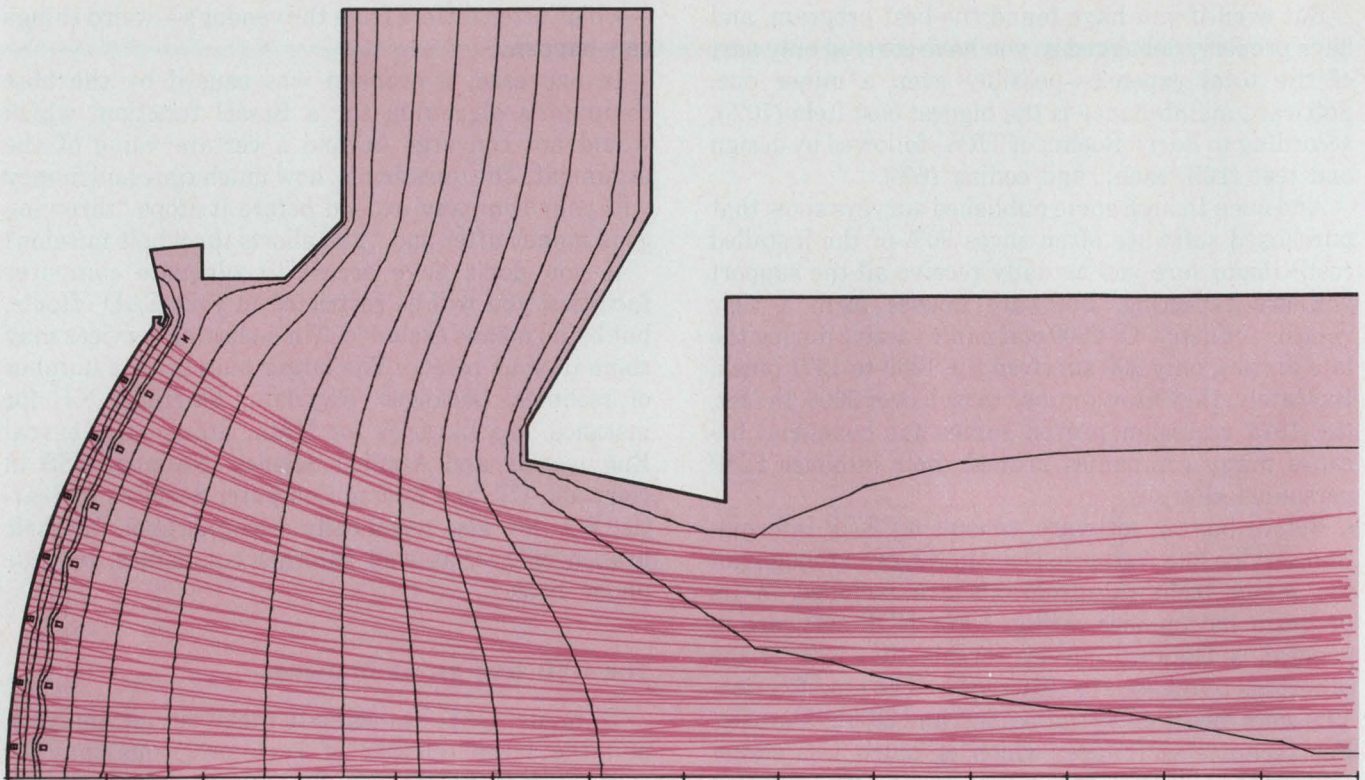

After calculating the equipotential lines (black) of a traveling-wave tube gun, a program from Shared Applica-

tions plots the electron trajectories (color) accounting for space charge.

As a result, the preferred model for such circuits is no longer a loop/node algorithm. Instead of solving simultaneous equations as a time function, circuit elements are now described by steady-state parameters. These can be scattering (S-) parameters, chain (ABCD-) parameters, or hybrids. Reasonably large networks can be strung together from such elements, but they rarely reach into the hundreds of branches that are typical of ECAP-type circuit-analysis routines.

As soon as computer-aided circuit analysis was established, engineers began to look for ways to have the computer automatically change circuit parameters until the outputs came as close to the design goal as possible. Now, optimization is almost a discipline in its own right, and is often listed as a mathematical routine.

Solid-state technology has stimulated several other major limbs on the CAD tree. For example, since the nonlinear transistor is not easily represented by one equation, or even a few, transistor modeling can be credited with putting solid-state circuitry within the grasp of network analysis.

Next, a logical development

While analog circuits usually require less than a dozen transistors, digital circuits consume transistors now by the thousands—and pretty soon by the millions. No wonder that logic-design programs represent a major CAD branch. Aside from transient analysis,

logic CAD is only marginally related to the network-solving algorithms of analog-circuit design.

Another digital branch may even be regarded as a separate tree. As circuit integration has mushroomed from small to medium to large-scale, the routing of interconnections on a chip (or PC board) has surpassed human patience. Only a dumb but dedicated servant like the computer has the perseverance to try thousands, even millions, of combinations to find the best solution.

Once the computer has found the ideal interconnections for 50,000 transistors to fit into a few mm², you might as well have it draw the masks. So, automatic artwork generation has become widespread and automatic drafting, another outgrowth of IC technology, is becoming increasingly popular.

A picture may be worth 1000 dollars

An offshoot of automatic drafting is the entire field of computer graphics. Today, you can feed a rough circuit sketch into a terminal, then modify your computer's interpretation. You can move connecting points, change components, and add elements—all with the stroke of a light pen.

Computer graphics lets you turn a three-dimensional object to any desired view, and even figure out how your prototype can best be assembled, without ever having to build one.

The future development of CAD will be deeply affected by the microprocessor. As more affordable

How computers optimize

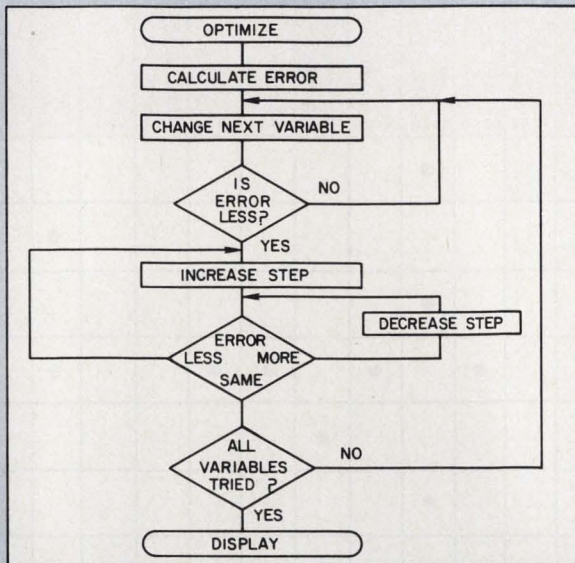

Self-optimization routines are sometimes very complex, for example using derivatives and Monte Carlo techniques. But often a simple algorithm like the one roughly flow-charted above will suffice.

In any case, the user must first define an "error function," which contains all important circuit characteristics, like gain, flatness, etc. The computer then varies circuit elements until this error can no longer be reduced.

In a small circuit, the computer can simply change one variable at a time. Starting with a small change, the program increases the step size if the error gets smaller, and then backtracks when the lowest error value has been passed.

If the circuit elements interact with each other, the algorithm shown may not find a global minimum. Rather, the process must be repeated until new iterations yield no further improvement. An element of randomness is usually introduced to avoid retracing the same change sequence.

microcomputers with more peripherals get into more engineering labs, CAD programs will become more and more available. And hopefully CAD will benefit as microcomputers proliferate in the home as well as the office—better methods for transferring computer programs will be developed.

At present, paper tape is used widely to transfer small programs. The tape is cheap enough, but readers and punches aren't. And paper tape isn't adequately standardized.

Many "hobby" programs are now available on inex-

Choose your favorite model

To work in computer-aided design, you must start with a mathematical model that translates the physical world into equations or tables with which your computer can work. No model—no CAD. Consequently, modeling has become a discipline in its own right.

In electronics, an ideal model would require that you give the computer the location of every electron (and hole) in your device, as well as all boundaries and applied voltages. Then you would feed-in the force equations, and watch the electrons move. However, for any practical device, such a model is still ages away.

But computers *can* solve differential equations (Laplace's or Poisson's) and thus calculate the field in relatively simple geometries, such as electron guns. Once you have the fields, electron trajectories in a vacuum can be determined (and plotted) easily.

Because the "trial and error" approach is terribly expensive for sophisticated electron-beam devices, CAD holds an unchallenged position here. Thermal, stress and hydrodynamic problems can be solved with similar algorithms.

Most engineers, however, work with circuits. Here, too, fields move electrons, but the geometries are far too involved to use electron motion as a model. So you must resort to solving node and loop equations for large networks. For pure dc analysis, that's rather simple. Computers are especially good at solving linear, simultaneous equations that are far too unwieldy to be tackled by hand. Ac and transient analysis add only a time axis to the process.

Keep in mind, also, that nonelectrical problems can often be expressed by electrical analogs. Heat flow, permanent-magnet circuits, and mechanical systems can all be analyzed with network algorithms.

pensive audio cassettes. One manufacturer is rumored to have put his operating system and program library on LP records. But neither of these media can even approach the ultimate bargain in information transfer—printer's ink.

No wonder experiments are already underway to input programs from printed bar code—the lines you find on soup cans and cereal boxes. With a ruler and a light pen, you can read-in small programs in less than a minute, and new programs can be mailed to you by vendors or clubs for pennies. This "paper tiger" may start a new era in computer-aided design. ■

References

1. Jensen, R.W., Lieberman, M.D., *IBM Electronic Circuit Design Program*, Prentice Hall, Englewood Cliffs, NJ 07632.
2. "The Industry—Reflections on a Prophecy," *Interface*, International Computer Programs, Inc., 1119 Keystone Way, Carmel, IN 46032, Spring, 1977, p. 3.
3. *Datapro Directory of Software*, Datapro Research Corp., 1805 Underwood Blvd., Delran, NJ 08075.
4. Blattner, D.J., "Choosing the Right Programs for Computer-aided Design," *Electronics*, April 29, 1976, pp. 102-105.

(Continued on page 48)

Software vendors for different CAD categories

	Artwork Generation	Beam Tube Simulation	Circuit Design	Graphic Display	Logic Simulation	Mathematics Libraries	Mechanical Thermal	Nonlinear Modelling	Optimization Algorithms	Statistics Programs	Test Automation	Other technical Programs
Application Consultants, Inc. , 5555 W. Loop South, Belair, TX 77401. (713) 666-1777.				•								
A.R.A.P. , 50 Washington Rd., P.O. Box 2229, Princeton, NJ 08540. (609) 452-2950.											•	
Bancroft Computer Systems , 405 Wheelis St., Box 1533, W. Monroe, LA 71291. (318) 388-2236.				•								
Berne Electronics, Inc. , 28 Havilands Lane, White Plains, NY 10605. (914) 946-7950.			•		•		•	•			•	
Bonner & Moore Software Systems , 500 Jefferson Ave., Suite 1124, Houston, TX 77002. (713) 659-1871.						•						
California Computer Products, Inc. , 2411 W. LaPalma Ave., Anaheim, CA 92801. (714) 821-2011.				•								
Cambridge Computer Associates, Inc. , 222 Alewife Brook Parkway, Cambridge, MA 02138. (617) 868-1111.				•								
Cambridge Telecommunications Inc. , 41 North Rd., Bedford, MA 01730. (617) 275-1383.										•		
Chi Corp. , 11000 Cedar Ave., Cleveland, OH 44106. (216) 229-6400.										•		
Compact Engineering , 1651 Jolly Ct., Los Altos, CA 94022. (415) 968-7025.			•					•				
Computer Aided Design Centre , 25 Kensington Gore, London, SW7 2EP, England (01) 589-7496.				•								
Computer Inst. for Social Science Res. , 505 Computer Ctr., East Lansing, MI 48824. (517) 353-2040.										•		
Cosmic , University of Georgia, Barrow Hall, Suite 112, Athens, GA 30602. (404) 542-3265.	•	•	•	•	•	•	•	•		•	•	•
Digital Equipment Corp. , 146 Main St., Maynard, MA 01754. (617) 897-5111.						•					•	
Electronic Calculus Inc. , 468 Park Ave. South, New York, NY 10016. (212) 532-1545.							•					
Harvard University Lab for Computer Graphics , 48 Quincy St., Cambridge, MA 02138. (617) 495-2526.				•								
Henco, Inc. , 215 Oak St., Natick, MA 01760. (617) 653-4323.						•						
Hewlett-Packard Co. , 1501 Page Mill Rd., Palo Alto, CA 94304. (415) 493-1501.			•			•				•	•	
IBM Corp. , Data Processing Div., 1133 Westchester Ave., White Plains, NY 10604. (914) 696-1900.			•	•		•	•	•		•		•
Internat. Mathemat. & Statist. Libraries, Inc. , 7500 Bellaire Blvd., Houston, TX 77001. (713) 772-1927.						•		•		•		
Katcard Systems, Ltd. 376 Churchill Ave., Ste. 306, Ottawa, Ont. 1Z 5C3, Canada. (613) 725-3061.				•								
M & S Computing, Inc. , P.O. Box 5183, Huntsville, AL 35805. (205) 772-3411.				•								
MarKrevel Inc. , 7895 Conway Ct., San Diego, CA 92111. (714) 565-0252.	•											
Micro Computer Machines , 133 Dalton St., Box 310, Kingston, Ont. K7L 4W2, Canada. (613) 544-9860.						•						
Mitchell & Gauthier Assoc. , P.O. Box 685, Concord, MA 01742. (617) 369-5115.												•

	Artwork Generation	Beam Tube Simulation	Circuit Design	Graphic Display	Logic Simulation	Mathematics Libraries	Mechanical Thermal	Nonlinear Modelling	Optimization Algorithms	Statistics Programs	Test Automation	Other technical Programs
Multiple Access Computer Group , 885 Don Mills Rd., Don Mills, Ont. M3C 1W2, Canada. (416) 443-3900.							•					
National CSS Inc. , 542 Westport Ave., Norwalk, CT 06851. (212) 686-6452.			•		•				•			
Olivetti Corporation of America , 500 Park Ave., New York, NY 10022. (212) 372-5500.						•			•	•		•
Omni Systems , Div. of Mnemonics, Inc., 280 Connecticut Ave., Norwalk, CT 06854. (203) 853-7511.										•		
Optimal Systems Research, Inc. , 200 Atlantic Ave., Box 458, Manasquan, NJ 08736. (201) 223-1131.			•						•			
Physics International Co. , 2700 Merced St., San Leandro, CA 94577. (415) 357-4610.				•		•				•		
Proprietary Computer Systems, Inc. , 16625 Saticoy ST., Van Nuys, CA 91406. (213) 781-8221.											•	
RRC International, Inc. , 24 Wade Rd., Latham, NY 12110. (518) 783-9003.					•						•	
SAS Institute, Inc. , P.O. Box 10066, Raleigh, NC 27605. (919) 834-4381.										•		
Scientific Computing Consulting Services , Box 335, Manhattan, KS 66502. (913) 539-5735.						•						
Scientific Process & Research, Inc. , 400 Cleveland Ave., Highland Park, N.J. 08904. (201) 846-3477.				•								
Shared Applications, Inc. , 611 Church St., Ann Arbor, MI 48104. (313) 761-8612.		•	•			•						
Software Products Company , 1567 E. Curtis Rd., Hope, MI 48628. (517) 689-4539.					•							
SPSS, Inc. , 111 E. Wacker Dr., Suite 1234, Chicago, IL 60601. (312) 861-0933.										•		
Synercom Technology, Inc. , 6300 Hillcroft, Suite 303, Houston, TX 77081. (713) 772-1991.				•								
Systems Consultants, Inc. , 1054 31st St. N.W., Washington, DC 20007. (202) 333-6800.											•	•
Technical Economics, Inc. , 573 The Alameda, Berkeley, CA 94707. (415) 525-7774.										•		
Technical Systems Consultants , Box 2574, W. Lafayette, IN 47906.						•						
Tektronix, Inc. , P.O. Box 500, Beaverton, OR 97077. (503) 638-3411.				•								
Unitech, Inc. , 2005 E. Saint Elmo Road, Austin, TX 78704. (512) 444-0541.				•								
University Software Systems , 250 North Nash St., El Segundo, CA 90245. (213) 640-0576.							•					
Varian Graphics Div. , 611 Hansen Way, Palo Alto, CA 94303. (415) 494-3004.				•								
Verified Software Products Co. , 207 Rose Marie Dr., R.D. 1, Linwood, NJ 08221. (609) 653-1391.				•								
Wang Laboratories, Inc. , One Industrial Avenue, Lowell, MA 01851. (617) 851-4111.				•		•				•		
Western Electric , P.O. Box 25000, Greensboro, NC 27420. (919) 697-2000.						•						

CLIFTON PRECISION

More and more O.E.M.'s are changing to Clifton. They know that Clifton offers the finest motor technology, versatility and a responsiveness to customer's needs that is unmatched

in the industry. Clifton designers have demonstrated an ability to solve seemingly impossible problems. Why not put Clifton technology to work for you?

FRACTIONAL HP DC PM

APPLICATIONS

TAPE TRANSPORT DRIVES
DISK MEMORY DRIVES
PRINTER CARRIAGE DRIVES
MACHINE TOOL DRIVES
CONVEYOR DRIVES

FEATURES

Torques from 10 to 120 lb-ft
2 inch to 5.5 inch O.D.
Advanced magnetic materials
Cartridge brushes

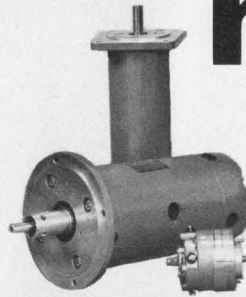

motors

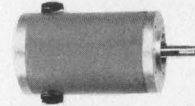

MINIATURE DC PM INSTRUMENT

APPLICATIONS

DAISY WHEEL DRIVES
PRINT HEAD DRIVES
INSTRUMENT RECORDERS
LABORATORY INSTRUMENTS

FEATURES

Torques from 2 to 50oz-in.
.75 inch cube to 1.25 inch O.D.
Cartridge brushes
Alnico or rare earth magnets

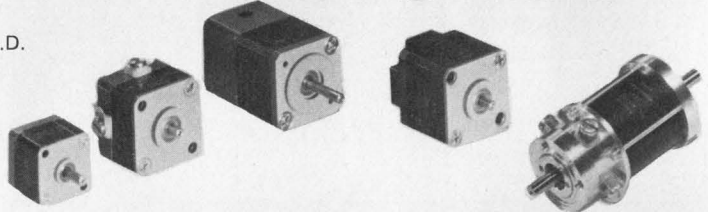

motors

APPLICATIONS

PRINTER RIBBON DRIVES
PRINTER PLATTEN DRIVES
CARD SORTERS
OFFICE COPIERS

FEATURES

Step angles 7.5°, 15°, 30°, 45°, 90°
1.1 inch to 2.8 inch O.D.
Ceramic or rare earth magnets



PM STEPPER

motors

APPLICATIONS

PRINTER CARRIAGE DRIVES
COPYING MACHINES
SPEED CONTROLS
MACHINE TOOL CONTROLS

FEATURES

Optical encoder resolution to 1000 cycles
Solid state gallium arsenide light source
Integral assemblies — no assembly or alignment necessary
Single source for motor/encoders eliminates costly assembly & simplifies service

INTEGRAL ENCODER AND

motors

MOTOR-TACHOMETER ASSEMBLIES

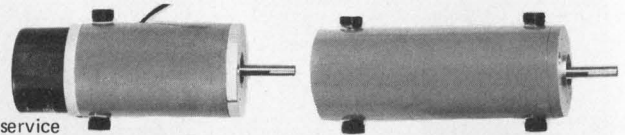

DC PM HOLLOW SHAFT TORQUE

APPLICATIONS

INERTIAL NAVIGATION
PLATFORMS
AIRCRAFT INSTRUMENTS
AIRCRAFT CONTROLS

FEATURES

Torques from 6 to 500oz-in.
1.1 inch to 5.2 inch O.D.
Precision tolerances
Gold commutators
High reliability

motors



CLIFTON PRECISION

for further information, call John Staiber,
(215) 622-1000

MARPLE & BROADWAY, CLIFTON HEIGHTS, PA. 19018

A revolutionary idea. Stackpole "top-hat" networks prove you can get more resistance on less real estate.

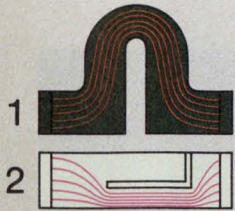

Compare (1) our "top hat" to (2) a standard "L"-cut and you see why ours dissipates more heat, faster. On a much longer resistance path.

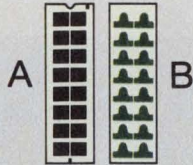

(A) Standard thick-film networks have more hot spots, current crowding higher capacitance than (B) our "top-hat" network.

Flip our network's lid and you can see why. It's revolutionary.

The more our unit is trimmed, the better your resistance. So ratings of 200 watts/in² are very realistic.

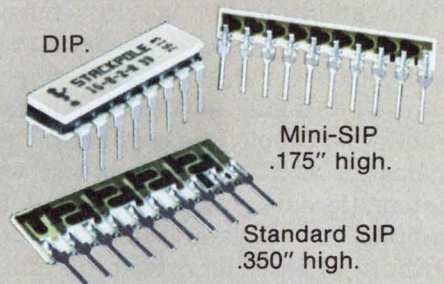

The secret is in the simple laser cut in the middle of each "hat." In this and its horizontal geometry you get lower capacitance without hot spots, current crowding, or the other power-robbing things built into conventional networks.

Now you can get equal resistance in less space. Or greater resistor network performance in the same space.

We're out to tip our "hat" to you. With a full range of values, tolerances, sizes. In single or dual in-line networks, custom designs and even mini-SIPs that are only .175 inch high.

Ask for a free sample of a revolutionary idea. Stackpole Components Company, P.O. Box 14466, Raleigh, N.C. 27610. (919) 828-6201.

 **STACKPOLE**
The revolutionary resistor people.

CIRCLE NUMBER 23

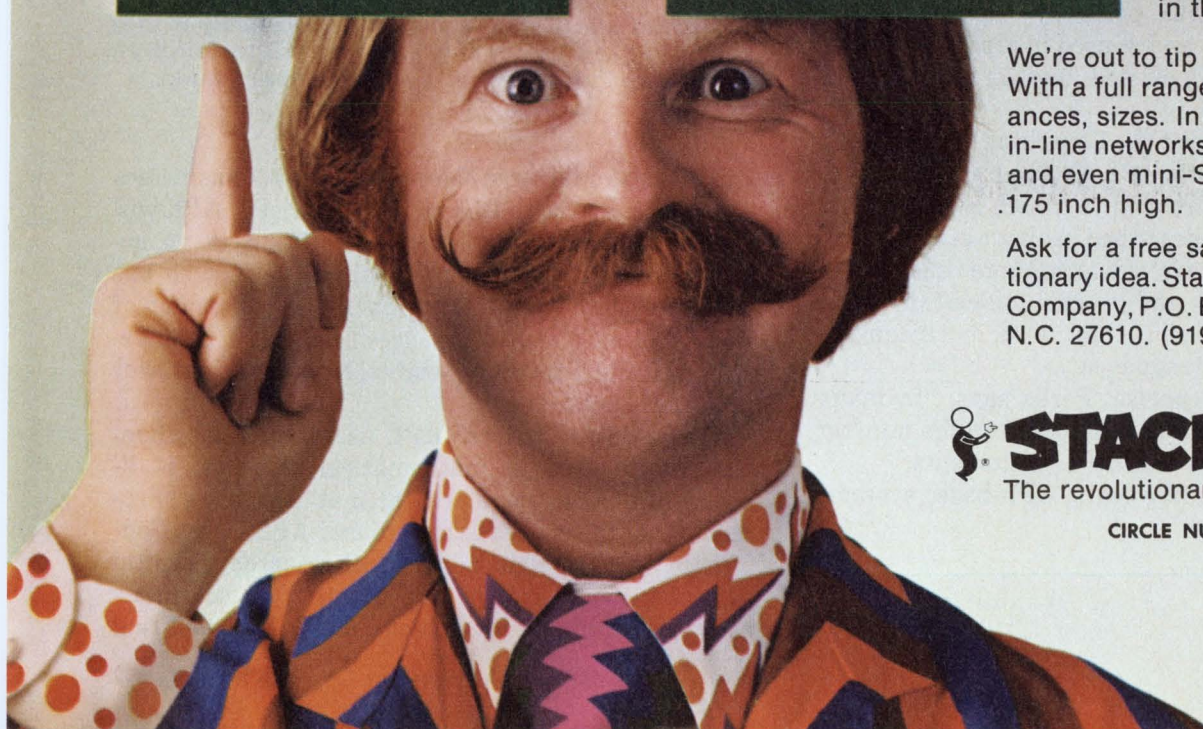

Kenneth Iverson: from a symbolic notation to A Programming Language

“I never really sat down and said ‘I’m going to develop a computer language,’” Kenneth E. Iverson says, thoughtfully, as he reaches over to a small computer-terminal on his desk and types an instruction in APL—the computer language he invented in 1957 while trying to devise a new system of conveying information to people.

“I wasn’t thinking about communication between machines and people,” he continues. “While teaching mathematics at Harvard I was also writing a book on automatic data processing. And I found that in attempting to explain things, such as sorting algorithms, I needed an expanded system of notation—a system both simpler and more general than conventional mathematical notation provides.”

Iverson turned for help to the computer languages available at the time—Flowmatic, Fortran and others. But he found them useless for his purposes—mainly because they didn’t recognize the importance of arrays, or lists (vectors), and tables (matrices).

So Iverson decided to develop a system of his own, basing it on conventional mathematical notation and enriching it with symbols he created himself. “When I started I had no intention of creating anything that wasn’t needed. I used accepted mathematical notations unchanged. I was perfectly happy with the conventional +, -, ×, and ÷ used in grade school and up.” Where no symbols existed, Iverson invented new ones.

Alan Perlis, director of the Computer Science Dept. of Yale University, calls APL (A Programming Language) “a kind of shorthand in which complex data manipulations can be described in single statements.” Perlis’s students, he says, advance three times faster in programming skills and general understanding of electronic data processing than with more conventional programming languages.

APL is also more concise, Perlis says. “In many cases, there is a 10 to one ratio between the number of Fortran statements and APL statements.”

“In another three to five years, APL-based systems



Photos by John F. Mason

“Designers are missing a fantastic opportunity if they don’t take a serious look at APL,” Kenneth E. Iverson says. “Working with it ushers in a whole different world.”

will be a major factor in the management of businesses worldwide, and with this as the spearhead, APL will penetrate all aspects of data processing at an accelerated rate,” according to Adin Falkoff, who has worked closely with Iverson on the development of APL at the Computer Sciences Dept. of IBM’s Research Div. in Yorktown Heights, New York, and later in Philadelphia.

The variety of current APL users, most of whom are not involved in mathematical pursuits, is illustrated by the papers presented at last year’s “Proceedings of the Eighth International APL Users Conference.” Topics included medical research, hospital administration, a system for evaluating projects in the petroleum industry, investment analysis, text editing



Kenneth Iverson invented "a kind of shorthand in which complex data manipulations can be described in single

and on-line interactive collection and analysis of scores at gymnastics competitions.

Once a mathematician. . .

Iverson began his career as a mathematician, and in spite of having invented a highly successful computer language and becoming manager of IBM's APL Design Group, he still thinks of himself as such. "Computers," he explains, "are just a mathematical tool."

Iverson's identification with mathematics includes a B.A. in mathematics from Queen's University, Kingston, Canada, in 1950; an M.A. in mathematics from Harvard University in 1951; and a Ph.D. from Harvard in applied mathematics in 1954. He discovered the relatively new world of computers in *Giant Brains*, by Edmund Berkley. Subsequently, he took a course in computer design at Harvard given by Prof. Howard Aiken, the originator (in 1937) of Harvard's famous Mark I built by IBM and completed in 1944.

Iverson became so intrigued by the potential he saw in computers that he transferred out of the mathematics department and into Engineering and Applied Physics. He completed his thesis on computer solutions of an economic model under Professors Aiken and Wassily Leontief (who would win the 1973 Nobel Prize in economics). Then in 1955 Aiken ex-

statements. In many cases a 10-line statement in Fortran becomes one statement in APL."

panded his faculty to develop a curriculum in automatic data processing, and Iverson became one of the newly appointed instructors.

"That's really where I did the early work on APL," Iverson recalls. While teaching, he found, somewhat to his surprise, that many of the notational facilities that he had introduced for the treatment of sorting methods were virtually what he needed for treating things like the simplex method in linear programming.

"As I went from one application to another," Iverson remembers, "I found new needs, and for each one I introduced additional notation. For the first two or three years, each new application called for new symbols. The language was getting much too complicated and I was beginning to despair."

Iverson then made an important observation.

"I realized the value of generalizations: one symbol could be used to express a number of things, depending on how it was used." From then on, the key to developing APL was to recognize generalizations.

First commercial work

Iverson continued to augment and refine his growing system of notation while teaching and writing at Harvard. In 1957 he spent six months with McKinsey and Co., in New York, on a computer model of a transportation problem for one of its clients. This

A Programming Language

APL is a general-purpose language that is used extensively in such diverse applications as commercial data processing, system design, mathematical and scientific computation, and the teaching of mathematics and other subjects. It has proved particularly useful in data-base applications, where its computational power and communication facilities combine to enhance the productivity of both application programmers and end users.

When implemented as a computing system, APL is used from a typewriter-like keyboard. Statements that specify the work to be done are typed in, and the computer responds by displaying the result of the computation. The result appears at a device accompanying the keyboard, such as a printer, or video display. In addition, entries may also invoke the use of printers, disc files, tapes or other remote devices.

work broadened the range of applications being considered in the development of APL.

In 1960, Iverson went to work for IBM. But he didn't start thinking seriously about implementing his computer notation until 1964.

Why did it take so long?

"Benign neglect, I suppose," says Iverson. "If there'd been more interest in the company, we'd have implemented it sooner.

"APL may have lacked backers because it was so different. It was hard for traditional computer people

to grasp, and they didn't appreciate its possibilities at first."

The delay was actually beneficial in the long run, Iverson believes. "It's one reason APL is so bug-free. If a language is designed for a machine, built into it right away and sold to hundreds of people who from then on don't want it to change, you will have some uncorrectable weak spots.

"We had years to work on APL before anyone got interested in implementing it on a computer."

Once the decision was made to implement APL, the first step was to design a typing element, like those used on IBM Selectric typewriters, except that this one contained symbols for APL. Iverson and his colleagues then wrote software to run the language on an IBM 360 computer.

"By 1966, we had a time-sharing system, and by 1967, APL on the IBM 1130 was available to users outside IBM."

In 1968, IBM put out an APL program for the 360, and in 1973 produced the APLSV (SV means "shared variables"). "This enabled us to use a larger data base than for previous systems, which opened the door to applications requiring extensive engineering calculations.

"The use of APLSV has grown rapidly," Iverson reports. "Most of our divisions now use the machines in their commercial data processing."

More than mathematical

But somehow, the idea persists that APL is just a mathematical language for mathematical applications

APL: A powerful shorthand

```
B←26 13 17 28 41
+/B×B>25
```

95

```
X←1 2 3 4 5
4⌈B⊖X∘.*0 1 2
41.0000 20.7857 4.2143
```

In the first example above, the APL expression $+/B \times B > 25$ yields the sum of all balances B which exceed 25; the second example yields the four-digit approximation to the coefficients of the polynomial which best fits the function values B for arguments X .

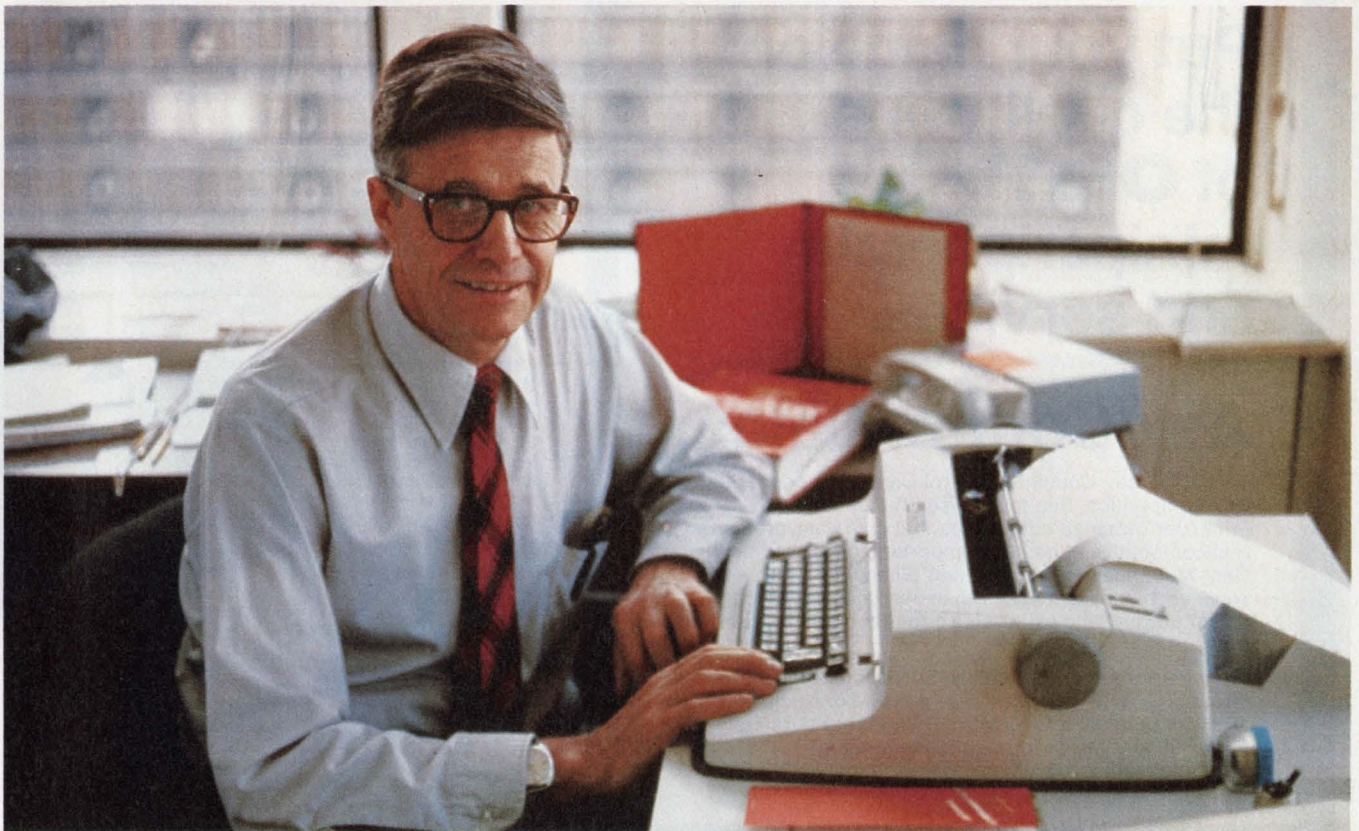

Iverson began his career as a mathematician and in spite of having invented a highly successful computer language

and becoming manager of IBM's APL Design Group, he still thinks of himself as a mathematician.

—an erroneous impression, insists mathematician Iverson. "Ninety per cent of APL used, inside and outside IBM, is for commercial data processing. It's also used successfully by design engineers. We use APL to design APL machines."

Indeed, Iverson likes to point out the ease with which anyone can use APL. "You don't need to be a programmer or to know anything about computers. It's like driving a car: You don't need to know anything about the internal combustion engine to drive. You just need to know what language the automobile speaks.

"With APL, every mathematician and every engineer is a programmer." What's more, the language can be easily mastered by non-English-speaking users. Geneticist Dr. Marcos Rico, of the Universidad Politécnica de Valencia (Spain), for example, has used it comfortably and successfully in simulating genetic models.

The absence of natural language is an advantage, Iverson feels. "For example, 'or' is an ambiguous word. Does it mean 'either but not both' or 'either as well as both'? In APL, we have an 'inclusive or' and an 'exclusive or'."

Iverson, who is now an IBM Fellow, is interested in expanding the language with more operators and with further exploitation of shared variables. Currently, APL has five different operators ("one of the most

important characteristics of the language," Iverson says), and the plan is to create "a lot more." (An Operator, incidentally, he explains, is *not* something that applies to numbers; it applies to a function that produces a new function. APL's five operators are scan, reduction, axis operator, outer product and inner product.) The next addition could be a derivative operator.

Two interacting programs

"The shared variable is a general notion," Iverson goes on, "which allows us to have two interacting programs—both in APL or one in another language. Essentially, the way they interact is by sharing a name. If we both use "X," for example, then X must mean the same to both of us."

Does he have any plans for leaving APL and starting something else?

"What else is there?" Iverson responds with a look of surprise. "APL is simply *the* language. It's as if I were asked: 'When are you going to drop English and start speaking something else?'"

Designers are missing a fantastic opportunity, Iverson believes, if they don't take a serious look at APL. "Working with this language," Iverson concludes, "ushers in a whole different world." ■■

Put your name on the quality line of **oem** miniperipherals and services.

Ask Control Data.

Test. Evaluate. Compare Control Data Miniperipherals with competition. See for yourself the definite CDC price/performance advantages that give your product a real competitive edge. Most important, check our new OEM Maintenance Program and Financing Plans — two services that make it easier than ever to put your logo on our product and establish a stronger marketing position for your entire line.

Price. Performance. Reliability. Service. **Quality** throughout. Whether you're a large OEM or small, you get all these benefits from Control Data OEM Peripherals — both mini and maxi. For detailed information . . . for evaluation units . . . call our OEM Hot Line: (612) 853-7600.



PRINTERS

300-600-900 lpm HORIZONTAL FONT BAND PRINTERS

Offer your customer reduced paper and total life cycle costs through exclusive choice of 10 and 15 cpi bands. Unique removable 15 cpi band prints 132-character line on 11" paper . . . can be operator-exchanged with 10 cpi band in 30 seconds. Multiple options practically permit you to custom-tailor the printer for your customer's needs. Eleven interchangeable bands, identical spare parts kits. Full, solid stroke characters, top to bottom; print quality never before available in a medium-to-high-speed line printer at its price! Print speeds with 48 character set: 360, 720 and 1130 lpm.

MATRIX PRINTER

For 70 to 200 lpm print requirements, the multi-optioned companion to the Band Printer features bi-directional printing under microprocessor control. Models 9317, 9318

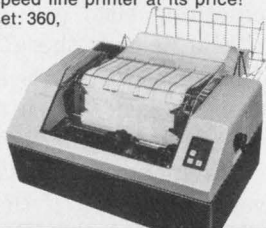

CIRCLE NUMBER 261

ROTATING MEMORY

Get built-in reliability from Control Data's advanced total technology that produces all three parts — heads, disks, drives — and makes them work as a winning team.

INTERCHANGEABLE WITHOUT CHANGING YOUR DESIGN:

Storage Module Drives. The industry standard. Offers easy system integration through common interface software and firmware. So you can select the best drive for any purpose without costly design modification.

High Technology Mini Module Drives. High-reliability, sealed-media companion to CDC's Storage Module Drive family — SMD interface and format compatible. Fixed, sealed module includes rotary actuator and head-per-track option.

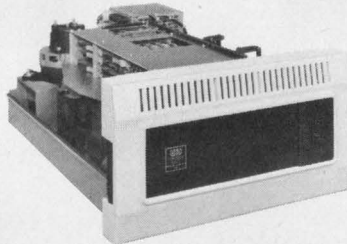

TYPE	CAPACITY	MODEL	MEDIA	INTERFACE
MMD	12 MB	9730-12	Fixed, Sealed	Industry std. SMD I/O format and interface common to all models.
	24 MB	9730-24		
	48 MB	9730-48		
SMD	40 MB	9760	Removable	
	80 MB	9762		
	150 MB	9764		
	300 MB	9766		

CIRCLE NUMBER 264

DISK PACKS & CARTRIDGES

Get rotating media from the same production line as the end user packs we label with our name and guarantee for the life of the pack. The differences: your specifications and packaging; your private label and color; your shipping container. Packs are offered for all of our OEM drives.

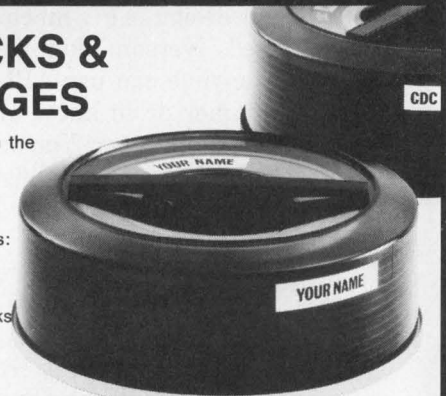

PRODUCT	DATA PACK		DRIVE TYPE	ALIGNMENT PACK	
	CDC Model No.	IBM Model No.	IBM Drive No.	CDC Pack Model No.	IBM Model No.
Diskettes	9821-60W	3740	3740		
Disk Cartridge	9846	2315	2310	9846-51	2315CE
	9847	5440	5444	9847-51	5440CE
Disk Packs	9849	1316	1311/2311	9850-52	1316CE
	9876			9876-51	
	9877			9877-51	
Data Modules	9778-70	3348-70	3340-70		
	9778-70F		3340-70F		

CIRCLE NUMBER 262
ELECTRONIC DESIGN 12, June 7, 1977



CARTRIDGE DISK DRIVE

Updated, simplified, field-tested and proven for twice-the-reliability of previous models. Versatile, modular, easy to maintain. 12 MByte standard; 6 and 3 MByte optional. Average access 35 ms. Model 9427H

NON-REMOVABLE "CARTRIDGE MEDIA" DISK DRIVE

The new low-cost, problem-free fixed media companion to Cartridge Disk Drives. Offers the best MTBF rating in the industry. No operator intervention or electrical adjustments needed. Model 9414: 12 or 6 MByte capacity. Cartridge Disk Drive interface.

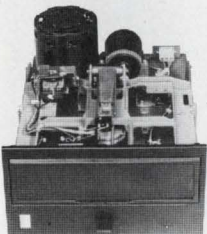

FLEXIBLE DISK DRIVE

Updated version of the drive specified by more major OEM's than any other. Single or double density capability, ceramic head, daisy chain interface. Current switching, ready interrupt, power reduction and a wide range of options allow tailoring to unique applications. Model 9404

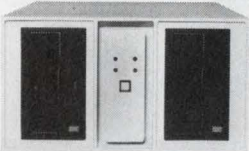

FLEXIBLE DISK DRIVE SUBSYSTEM

Ready made package contains formatter, microprocessor based controller, power supply and drives in a finished table-top or rack-mount package. Model 9472

COMPUTER MEMORY PRODUCTS

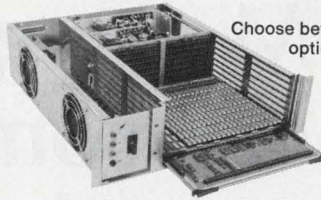

Choose between reliable core memory modules optimized for cost, speed, size. Or select from advanced semi-conductor memory systems. Custom or off-the-shelf standard configurations.

Model No.	Feature	Density	Enclosure 5 1/4" High	Capacity 10 1/2" High	Performance
94200	Cost-optimized	16K x 36 32K x 18	256 KB	512 KB	350 ns. Access 850 ns. Cycle
94300	Speed-optimized	16K x 16 16K x 18 16K x 20	128 KB	256 KB	250 ns. Access 650 ns. Cycle
94320	Ampex 1620 compatible	16K x 16 16K x 18 16K x 20	128 KB	256 KB	275 ns. Access 750 ns. Cycle
94322	Double density	32K x 16 32K x 18 32K x 20	256 KB	512 KB	350 ns. Access 830 ns. Cycle
94400	Size-optimized	4K x 8/9 8K x 8/9 16K x 8/9			300 ns. Access 1000 ns. Cycle
94405	Single (+5) voltage	4K x 9 8K x 9			350 ns. Access 1250 ns. Cycle
94500	4K MOS RAM	32K x 18 32K x 20	512 KB		325 ns. Access 450 ns. Cycle
94501	Low-cost version	32K x 18 32K x 20	512 KB		450 ns. Access 600 ns. Cycle
94550	Double density	64K x 20	1024 KB		325 ns. Access 450 ns. Cycle

Also available:

Loose UNITEMP core. In 18-mil and new 13-mil sizes. UNITEMP is the temperature-independent magnetic ferrite core stable over the entire MT temperature range (0°-90° C).

Enclosures. Two enclosures are available for mounting core or semiconductor modules in a standard EIA 19" rack. Cabinet measures 5 1/4" or 10 1/2" high, 20" deep; cards mount horizontally. Self-contained cooling fans direct air horizontally across the modules. Both core and semiconductor modules can be incorporated to a maximum of 1 megabyte.

CIRCLE NUMBER 265

TERMINALS

DISPLAY TERMINALS

A family of Conversational, Edit and High Performance Intelligent Displays, offering a wide range of features for data entry, console, other display applications. High quality construction backed by a full one year warranty. Trouble-free convection cooling replaces noisy, worrisome fans and filters. Communications to 9600 baud. Detachable keyboards.

INTELLIGENT DISPLAY

Powerful microprocessor can be programmed to control operations between operator, peripherals and communication lines. Built-in self-test diagnostic feature. Capacity: 1920 characters. Edit feature. Optional Bulk Storage, Paging. Hardcopy and polling. Cursor Position and Read. Model 92451

CONVERSATIONAL DISPLAY

Keyboard/display terminal with 1920-character display of 96 or 64 characters. Features built-in printer interface and X-Y cursor addressing. For high-speed data entry, a keyboard with optional numeric cluster is available. Model 92452

EDIT DISPLAY

Edit Display Terminal with 1920 characters. Features microprocessor control, built-in printer interface, function keys, and editing. Unique diagnostic checks readiness of terminal. Model 92456

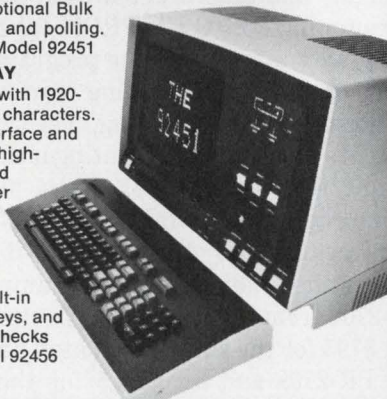

oem SERVICES

NEW! OEM Maintenance Services. Now, Control Data can offer you and your customers maintenance on certain specified Control Data peripherals. This service can be provided both scheduled and on-call, in a dozen major U.S. metropolitan areas. You reduce your need to familiarize your maintenance staff with Control Data equipment; to document reliability and maintenance; to capitalize test equipment; to carry spares. Most important, it can free your people and dollar resources for other needs.

OEM Financial Services. Through its Commercial Credit subsidiary, Control Data can now assist with the financial planning of your OEM peripherals purchases, or even provide lease programs for your customers. Your Control Data OEM Representative has complete details.

Ask our **oem** people

GD CONTROL DATA CORPORATION

CIRCLE NUMBER 263

ELECTRONIC DESIGN 12, June 7, 1977

PROM programmers have grown—some have both brains and 'personality'

Originally designed to be a secondary piece of equipment for system development, the PROM programmer is becoming smarter and much more flexible. In fact, recently introduced models employ microprocessor-based controllers to simplify their interfacing with over 200 available PROMs. In addition, selecting the right programmer for any of the many programmable read-only memories, logic arrays and gate arrays has become one big tradeoff of capabilities.

You can select a programmer with varying degrees of flexibility and performance, from over 15 companies. Or you can go to a microprocessor vendor who also offers some form of programmer for use in his program-development system.

Available models now range from simple, dedicated units that can program only one type or generic family of arrays to a "universal" programmer that can handle any array with changeable "personality" cards that control all programming voltages, currents and timing relationships. Prices start as low as \$250 for dedicated programmers and can reach \$10,000 for a universal model with a full compliment of personality cards.

Whether the programmer is dedicated or universal, many system-like features now come with it. Most vendors, for instance, offer interfaces to terminals so that programs can be written on the terminal and transferred directly to the programmer. Often, the programmer has a RAM storage buffer that holds the data to be programmed into the array and a keyboard that permits you to access the data and alter them before the code is burned into the array.

Dedicated programmers help cut corners

Since the dedicated PROM programmer costs well under \$1000, you can purchase several units for the price of one universal programmer. And, some of the more recent dedicated programmers include "smart" interfaces as well as serial communications ports. For example, the Model 2708 programmer from



Able to program any bipolar or MOS PROM, the IM1000 programmer from International Microsystems includes a TTY interface as well as two RS-232 ports as standard.

Shepardson Microsystems, designed specifically for the 2708 and 2704 ultraviolet-erasable PROMs, includes both an RS-232 interface and a 20-mA current-loop port.

Using a built-in microprocessor-based controller and a 1-k \times 8 RAM buffer, the 2708 programmer can accept BNPF or BHLF-coded paper-tape inputs and program any manufacturer's 2704 or 2708 UV PROM.

Programming a 2708 UV PROM takes 130 s. When operating with a terminal, the programmer offers 17 different operations, including various single key instructions for programming, verifying, inverting the contents of the buffer, printing a checksum of the buffer and reading a PROM into a buffer.

Other programmers for the 2704/08 family of PROMs include the 1007K made by Technitrol, benchtop units from PROM Programmers Inc., and the PR-2708 from Curtis Electro Devices. These units start at \$795 for the simple benchtop units, go to \$998 for the PR-2708 and hit \$1185 for the 1007K.

The dedicated units from Curtis are intended for manual programming, but data can be entered either

by 8-bit switches or by a cable connecting a computer to the internal RAM of the programmer/simulator. And with its $1\text{-k} \times 8$ RAM, the PR-2708 can simulate the PROM it is designed to program—and provide simple PROM emulation for program development. You can also use it to duplicate PROMs by inserting a master PROM into the test socket and reading its contents into the internal RAM. Then when you plug an unprogrammed unit into the socket, the RAM contents are read out to program the unit.

A similar concept is available in Technitrol's 1007K. Housed in a 5 in. thick attaché case, the programmer includes a keyboard and LED display. For options,

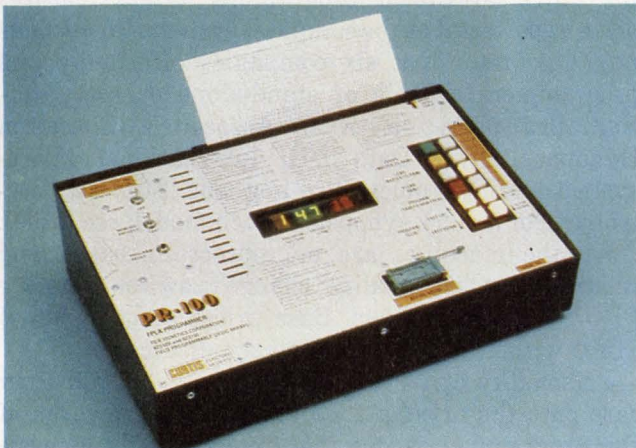

Designed to automatically program the 82S100/101 PLA, the PR-100 made by Curtis Electro Devices provides you with seven different operating modes.

you can choose from a hex display (\$150), a serial or parallel interface (\$250), or a paper-tape reader (\$875). Other dedicated models are available for the 1702 PROM or the National Semiconductor 5302/03/04 PROMs.

The benchtop units from PROM Programmers come in $2.5 \times 6 \times 8$ in. cabinets and allow for entering data via the keyboard, copying a master PROM, or parallel-inputting program data with a computer. You can add on a hex keyboard and display for \$95 or get a dual serial interface controlled by a μP for both an RS-232 and a 20-mA loop for \$350.

Many of these same companies offer programmers for the bipolar PROMs and include most of the same features. But the lowest-cost programmers come from Curtis Electro Devices—its PM-3000 series units cost just \$479.50 plus \$75 to \$120 for every socket adapter for generic family PROMs. These units are intended for manual operation and have no interfaces for any equipment. For more capability, Technitrol offers bipolar-PROM-programming versions of its 1007K.

For the not-so-common memory array, Curtis offers the PR-10139, a programmer dedicated for the 10139 ECL PROM; it costs \$279.50. And, should you use PLAs, Curtis has the PR-100 an automatic programmer for the 82S100/101 PLA—for a hefty \$1299. This



With an RS-232 interface, the series 90 PROM programmer from Pro-Log lets you enter programs from a CRT terminal directly into the PROM to be programmed or into an optional RAM workspace.



Complete with a portable RAM-pak, DATA I/O's Model IX programmer can program or emulate any type of bipolar PROM array available.

unit has seven operating modes: manual data loading into internal RAM, automatic data loading into RAM from master PLA, manual editing of preloaded data, programming from preloaded data into blank PLA, clearing of internal RAM to match blank PLA, program verification of programmed blank vs RAM contents, and PLA blank checking.

Data I/O also offers a universal programmer for PLAs—Model X. The programmer includes a CRT display to simplify formatting, and can accept inputs from paper tape, mark-sense cards or a master PLA. It costs a whopping \$8000.

Some dedication is limited

Many of the programmers offered by the micro-processor vendors are also dedicated, but more often than not they're dedicated to the system they can be used in—not to the PROM types they can program. For example, Fairchild's F8 95086001 board mounts in its Formulator development system. Intel offers the UPP-1 and UPP-2 programmers that interface to its Intellec system or the Prompt stand-alone units. Motorola makes a board that plugs into its EXORciser card cage, and Texas Instruments has a PROM-programmer box that connects to its 990 mini.

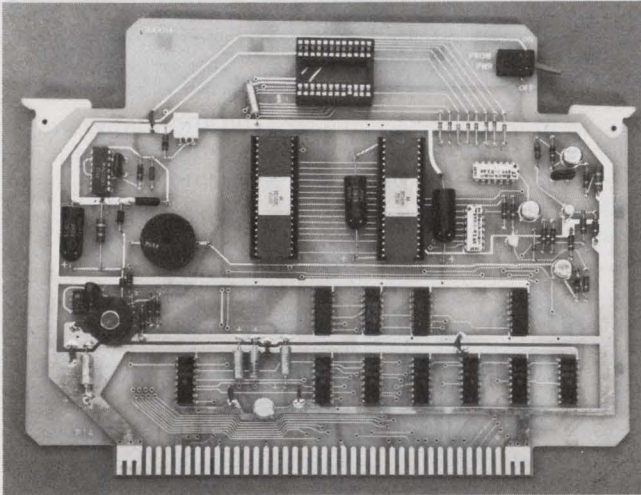
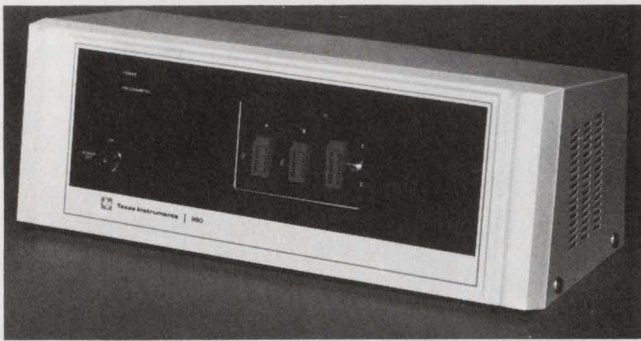

"Dedicated" programmers, such as the universal unit from Texas Instruments for the 890 minicomputer (top) or the single-card UV PROM programmer board from Motorola for the EXORciser (bottom), are designed specifically for one type of development system.

Many microcomputer companies also offer boards that plug into their own computers—MITS, for example, has a board that programs 2708-type PROMs and is controlled by software from its Altair computer.

To get past the limitations of fixed-hardware programmers, some microcomputer and microprocessor vendors have put all the timing control information into software. As a result, their programming boards can handle almost any PROM—which, of course, has cleared the way for microprocessor-based universal programmers.

Universal units take all comers

Operating in either a stand-alone or system mode, the universal PROM programmer offers features often as powerful as the computer systems the PROMs might go into. Just six companies offer universal programmers capable of stand-alone or computer-controlled operation—Adar Associates (Spectrum Dynamics Div.), Data I/O, International Microsystems, MilerTronics, Pro-Log and Sunrise Electronics (for a quick synopsis of each model, see table).

All the machines are microprocessor-based and require just a "personality" change to switch from one PROM type to another. Base prices start at about \$1500 without options and personality cards.

Personality cards can add about \$250 to \$600 per card onto the price of the programmer. However, if the programmer is designed to handle the generic PROM families, costs can be trimmed since only one

Universal-programmer performance synopsis

Features \ Model*	Adar 550	Data I/O Model V	Data I/O Model VII	Data I/O Model IX	Int'l Microsys. IM 1000	Miler-Tronics ¹ P-8000	Pro-Log Series 90	Pro-Log Series 92
Keyboard input	Yes	Yes	Opt.	Yes	Yes	Yes	Yes	No
Selectable address field	Yes	No	Opt.	Opt.	Yes	Yes	Yes	Yes
Visual display	Yes	Yes	Opt.	Yes	Yes	Yes	Yes	Yes
Editing capability	Yes	Yes	Opt.	Yes	Yes	Yes	Yes	Yes
Internal RAM size (bytes)	512	1 k	1 k	1 k	4 k	4 k	0	0
TTY interface (20 mA)	No	Yes	Opt.	Opt.	Yes	Opt.	Opt.	Yes
RS-232 interface	No	Yes	Opt.	Opt.	Yes (2)	Opt.	Opt.	Opt.
Baud rates	No	■	■	■	■	■	▲	▲
Parity check	Yes	Yes	Yes	Yes	Yes	Yes	No	No
Papertape reader	Opt.	Yes	No	No	Opt.	Opt.	Opt.	Opt.
Parametric testing	No	Yes	Yes	Yes	Opt.	No	Opt.	No
Operate in terminal mode	Opt.	Yes	Opt.	Opt.	Yes	Opt.	Opt.	Yes
Interface to μ P development system	Opt.	No	Opt.	Opt.	Opt.	Opt.	Opt.	Opt.
Programmer base price	\$2300	\$3750	\$1095	\$1975	\$1495	\$1495	\$1800	\$995
Personality modules	\$500 to \$750	\$400	\$400	\$400	\$250 to \$295	\$250 to \$550	\$325 to \$450	\$325 to \$450
Generic adapters	\$100	\$50	\$50	\$50	\$60	\$50	\$100	\$100

■ = 110 to 9600 baud; ▲ = 110 to 1200 baud.
 All units have a duplication capability, can handle MOS & bipolar PROMs, program generic families, have expandable RAM options and operate as stand-alone systems.

1. Will not be available until Fall, 1977.

*Details for the model from Sunrise Electronics not available at press time.

Don't forget the UV light box

With all the discussion about PROMs and their programmers, don't overlook the ultraviolet light box needed to erase the UV PROMs. Typical units are the S-52T and UVS-54T made by Ultra-Violet Products.

The S-52T can erase up to 16 PROMs at once in about seven minutes with an intensity of 6 watt-seconds/cm² at a distance of 1 in. It comes with a removable base that can have a built-in timer to shut the lamp off after a preset period. The price with timer is \$209.

For less than half the price of the S-52T, the company offers the UVS-54T at only \$99. It provides about half the performance too—and takes about twice the time to erase, and holds only half as many PROMs.

Of course, when you use any of the UV light products, make sure to take all the safety precautions recommended by the manufacturers. Never look directly into a lighted lamp, and avoid shining the lamp on reflective surfaces.

For small or large UV-PROM-erasing applications, light boxes such as the 2537 from Technitrol (top) or the UVS-54 and S-52T (bottom) from Ultra-Violet Products are an absolute necessity for fast turnaround.

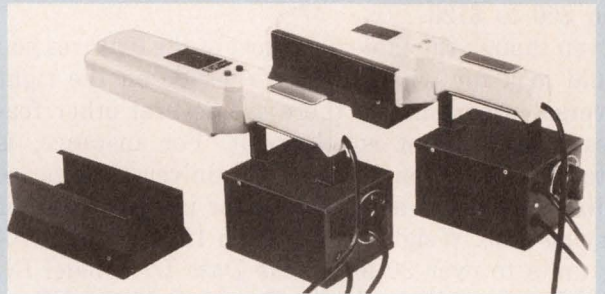

A primer on PROMs, PLAs and PGAs

Programmable memory products are available in three major forms—the programmable read-only memory, the programmable logic array and the programmable gate array. The PROM is a special form of read-only memory that can be purchased unprogrammed, then programmed in just a minute or two. The PLA and PGA can be user-programmed as well, which cuts out the lengthy turn-around times of two to 12 weeks for custom-programmed circuits.

PROMs are available in three technologies. The two most common are the fused-link bipolar PROM and the ultraviolet-erasable MOS PROM.

Nichrome links (fuses) are commonly used within the bipolar PROM for each memory cell in the array. During programming, a link is either blown open or left intact to indicate a bit's value. Other types of fuses are used—PROMs from Intel have a polycrystal silicon link, while avalanche-induced migrations are used by Intersil to short back-biased junctions.

UV PROMs, on the other hand, use MOSFET cells that are programmed by injecting a charge with an avalanche technique. An ultraviolet light source can remove the charge by causing photocurrent to flow between the gate and the silicon substrate. However, when you use a UV light, you cannot erase selectively. The entire array must be wiped out and then totally reprogrammed.

Many PROM manufacturers have developed what they call "generic families" of PROMs. Since units within a family require the same programming voltages, currents and timing relationships, they can usually be programmed by one programmer with a change of socket. Currently, nine manufacturers offer generic PROM families—Fairchild, Harris, Intel, Intersil, Mitsubishi, Monolithic Memories, National Semiconductor, Signetics and Texas Instruments.

Another technology just starting to appear in PROM form is the electrically alterable, metal-nitride MOS array. It can be electrically programmed in much the same way as UV PROMs—but you can erase either the entire array or just one word, then rewrite the word without using any light sources.

Current PLAs and PGAs are available only in the bipolar fused-link technology. A PLA is basically an array of logic gates (ANDs, ORs, NANDs, NORs, etc.) that can be set up to form any combinatorial logic function you desire. The most common array is an AND/OR or NAND/NOR arrangement. For more on PLAs, see ED No. 18, Sept. 1, 1976, p. 24.

The PGA is a bit simpler than the PLA—it has only one level of logic interconnect—such as an all AND or NAND arrangement for multiple input lines and multiple outputs. For more information about PGAs, see ED No. 2, Jan. 18, 1977, p. 101.

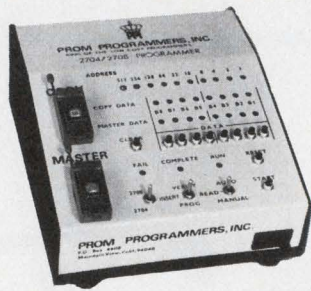
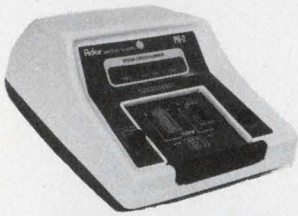

Use of dedicated programmers like the PR-2 from Adar (left) and the 2704/2708 from PROM Programmers (right) can help keep capital costs down if only a few types of PROMs are used.

personality card is needed for each family; you still need adapter sockets to route the signals properly for arrays within the family. Adapter-socket prices range from \$50 to \$120.

Even though the table lists most of the features you should look for when trying to decide on the right universal programmer, there are several other features that are not so clear-cut. For instance, is portability important? Most of the universal units are available in either attache cases or in some form of carrying case. Weights range from 15 lb for the Pro-Log units to over 30 lb for the Data I/O Model IX.

Editing capabilities in the Data I/O Model VII or IX let you alter the contents of any location, and even insert or delete words. The system will automatically make room by shifting the rest of the memory up or down.

Meanwhile, specifications for programming parameters are changed so often by the IC manufacturers that the support provided by the PROM-programmer manufacturers has become an important factor in selecting a programmer. Once you buy a programmer, how well will the vendor keep you informed of

hardware updates and changes to the programming algorithm?

And, to guarantee correct performance to the original purchase specifications some self-test and diagnostic capability is another must. Most Data I/O programmers have test circuitry on an optional calibration card. By plugging the card into the unit and using a meter and a scope, you can run a full calibration cycle without returning anything to the manufacturer. Pro-Log, on the other hand, provides a total guarantee that its programmers will remain calibrated. Unlike Data I/O, which uses a programmable power supply, Pro-Log puts all the specialized voltages for a particular PROM on personality cards, to make sure that the voltages remain stable.

In addition, Pro-Log builds some self-checks into the programmer to make sure it doesn't make the entire PROM go up in smoke. Warning indicators alert the operator to a malfunction.

Once a microprocessor is built into a PROM programmer, there are all sorts of wonderful things you can do. For instance, various parametric tests can be performed on unprogrammed or programmed units to make sure they are fully functional before being installed in a system. Almost all programmers include some sort of indicator that lets you know if the PROM has been programmed and if the code matches the code held in the RAM buffer or in the master PROM.

However, there's more to testing—under actual load conditions, some blown fuses in bipolar PROMs can appear to reform and thus cause incorrect bit patterns that are almost impossible to track down. And, with MOS PROMs, charge migration within cells or incomplete erasure of cells can show up as errors in the final assembly.

Both the Data I/O and Pro-Log programmers offer a range of parametric tests that can help spot faulty units before they get put on boards. ■■

Need more information?

For further information on PROM programmers, you may wish to consult the manufacturers listed here by circling the appropriate numbers on the reader service card. More vendors and information can be found in ELECTRONIC DESIGN's GOLD BOOK under Lamps, ultraviolet; ICs, central processing unit; ICs, programmable logic array; ICs, programmable read-only memory; and Computers, digital, micro.

Adar Associates, Spectrum Dynamics Div., 11B North Ave., Burlington, MA 01803. (617) 273-1850. (R. O'Leary) **Circle No. 551**
 Accutest Corp., 25 Industrial Ave., Chelmsford, MA 01824. (617) 256-8124. (R. Therrian) **Circle No. 552**
 Applied Systems Corp., 26401 Harper Ave., St. Clair Shores, MI 48081. (313) 779-8700. (M. Wyrod) **Circle No. 553**
 Aquarius Electronics, 32191 Albion Ridge Rd., Albion, CA 95410. (707) 937-0064. (R. Coppeck) **Circle No. 554**
 Curtis Electro Devices, Box 4090, Mountain View, CA 94040. (415) 964-3136. (J. Curtis) **Circle No. 555**
 DAI, Dreve Des Renards 6, Bte 8, 1180 Brussels, Belgium. Tel. 375 11 14 Telex: 61 067 DAIBRU **Circle No. 556**
 Data I/O Corp., P.O. Box 308, Issaquah, WA 98027. (206) 455-3990. (B. Gronquist) **Circle No. 557**
 Electro Design Inc., 8141 Engineer Rd., San Diego, CA 92111. (714) 277-2471. (Mr. Davenport) **Circle No. 558**

Fairchild Micro Systems, 1725 Technology Dr., San Jose, CA 95110. (408) 998-0123. (J. Katsaros) **Circle No. 559**
 Gulf & Western Co., Eagle Signal Div., 73 Federal St., Davenport, IA 52803. (319) 326-8111. (E. Weaver) **Circle No. 560**
 Intel Corp., 3065 Bowers Ave., Santa Clara, CA 95051. (408) 246-7501. (R. Walker) **Circle No. 561**
 International Microsystems Inc., 4900 Auburn Ave., Bethesda, MD 20014. (301) 657-3993. (Mr. Sage) **Circle No. 562**
 Microkit Inc., 2180 Colorado Ave., Santa Monica, CA 90404. (213) 828-8539. (R. Schaff) **Circle No. 563**
 MilerTronics, 525A Airport Rd., Greenville, SC 29607. (803) 242-9232. (T. Brown) **Circle No. 564**
 Motorola Semiconductor Products, Box 20912, Phoenix, AZ 85036. (602) 244-6900. (T. Mazur) **Circle No. 565**
 Pro-Log Corp., 2411 Garden Rd., Monterey, CA 93940. (408) 372-4593. (S. Noble) **Circle No. 566**
 PROM Programmers Inc., P.O. Box 4608, Mountain View, CA 94040. (415) 948-0450. (J. Rampelberg) **Circle No. 567**
 Shepardson Microsystems Inc., 20823 Stevens Creek Blvd., Cupertino, CA 95014. (408) 257-9900. (R. Shepardson) **Circle No. 568**
 Sunrise Electronics, 228 N. El Molino, Pasadena, CA 91101. (213) 963-8775. (R. Erickson) **Circle No. 499**
 Technitrol Inc., 1954 E. Allegheny Ave., Philadelphia, PA 19134. (215) 426-9105. (W. Chamberlin) **Circle No. 569**
 Texas Instruments, Digital Systems Div., P.O. Box 1444, M/S 784, Houston, TX 77001. (714) 494-5115. **Circle No. 570**
 Ultra-Violet Products, 5100 Walnut Grove Ave., San Gabriel, CA 91778. (213) 285-3123. (L. Wasserkrug) **Circle No. 571**

10 μ volt sensitivity, 10 nanoAmp sensitivity, and True RMS measurement in a 4 $\frac{1}{2}$ -digit portable DMM... \$345.*

The Model 248's exceptional sensitivity and accuracy is only the beginning. Data Precision has utilized proven circuit design techniques plus LSI/MOS chip economy and dependability to ensure outstanding reliability.

The result: a truly portable, high-performance, full-function instrument that provides sensitivity to 10 microvolts and 10 nanoAmps DC and AC, unsurpassed $\pm 0.05\%$ basic accuracy, and true RMS measurement for AC... with all specifications guaranteed for a full year.

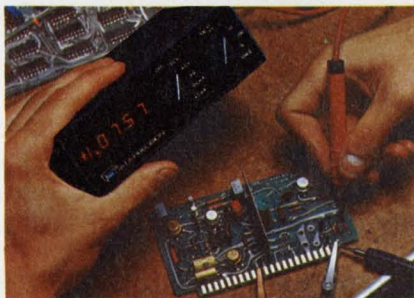

Measuring just 5 $\frac{1}{2}$ " x 1 $\frac{3}{4}$ " x 3 $\frac{1}{2}$ ", and weighing only 1.3 pounds, our 248 is the only rechargeable portable, 4 $\frac{1}{2}$ -digit DMM that brings you the advantage of True RMS voltage measurements. And with full 4 $\frac{1}{2}$ -digit resolution on all parameters, you'll have lab performance in the field or on the bench.

Exceptional Reliability

Model 248's sensitivity, accuracy, and portability place it in a class by itself, and its reliability is just as impressive. Its extremely low component count and optimal use of advanced chip technology and design makes Model 248 by far the most dependable True RMS 4 $\frac{1}{2}$ -digit portable

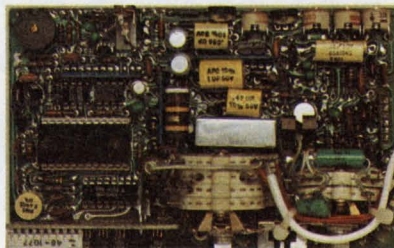

multimeter available (all the way down to 10 μ Volts). In fact, it's so reliable we guarantee its accuracy for a full year.

With only two controls — Function and Range — and the bright 0.33" LED display for easy reading in any light, you'll save time on every job. And Data Precision's overload protection



circuits make it forgiving of mistakes on all functions.

\$345.* Complete

Charger, NiCd battery, input leads and carrying case are supplied with the instrument. Model 248 is available throughout the world from Data Precision representatives, and service is available from any of our world-wide service centers.

Data Precision Corporation,
Audubon Road, Wakefield, MA.
01880, USA, (617) 246-1600.
TELEX (0650) 949341.



*price U.S.A.

Sensitivity.

DATA PRECISION[®]
...years ahead

For Demonstration Circle 241
For Additional Information Circle 242

International Rectifier "Function Fit" Power Transistors will enhance your circuit design and increase its reliability.

It's unlikely that you'll find a Power Transistor line with as many types as ours, or with functional characteristics that fit specific applications so well . . . to improve reliability.

For example, for **Switching Power Supplies**, our 2N6542-2N6547 and IR6002's will switch up to 600V $V_{CEX(sus)}$ with optimum t_r and E_s/b .

For **Display Terminal** horizontal and vertical deflection, you can get up to 900V V_{CBO} with a sharp breakdown (from hard-glass passivation) for added reliability . . . coupled with low $V_{CE(s)}$.

For **Automotive Ignition**, count on higher $V_{CEO(sus)}$ and higher inductive energy capability with the reliability you need. Clamped or unclamped performance in a TO-3 package, on a chip, or a chip on a Beryllia substrate.

For **High Current Applications** our BUX-20 not only switches 125V and 50A at 20KHz, but does it at commercial prices. Also try our 2N6274-2N6277.

For **Amplifiers**, try our high energy EPI base discretes and Darlington. You'll get the SOA you need plus better frequency response than you'll find in other companies' diffused types.

For **Motor Drives**, our rugged Darlington will provide the inductive energy, high $V_{CEO(sus)}$, and high gain needed for reliability in these tough applications.

Whatever your application, chances are good that we have a "Function Fit" Power Transistor that will give you extra-margin reliability without changing your circuit . . . or costs!

Contact your local IR Sales Office or Distributor for data or write to
International Rectifier,
 233 Kansas Street,
 El Segundo, CA 90245
 (213) 322-3331, Telex 67-4464

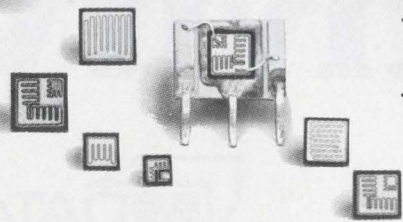

International Rectifier

... the innovative semiconductor people





**Whatever
your
shielding
problem,
Metex can
stop it.**

Metex has pioneered the broadest range of conventional and special-purpose shielding materials, components and techniques to prevent EMI/RFI problems wherever they occur in EDP systems.

Our shielding products in these EDP systems apply to mainframes, CPU's, printers, and other peripherals. They exclude external interference as well as contain interference sources within enclosures of systems equipment.

We've packed a wealth of EMI/RFI shielding information into an application brief covering practical solutions to all electromagnetic interference problems. For your free copy, including a Design Kit of shielding samples, or for practical engineering help, call or write: Metex Corporation, Electronic Shielding Group, Edison, N.J. 08817, (201) 287-0800; or Cal-Metex Corporation, Torrance, Calif. 90501, (213) 320-8910.

the glitch grabbers



Cable Shielding

Air Filter Panels

Shielded Windows

Conductive Compounds

Strip Gasketing

Conduit Fittings

Gaskets

METEX
ELECTRONIC SHIELDING GROUP

Grounding Buttons

CIRCLE NUMBER 26

FOCUS

on Cassette and Cartridge Recorders

The magazine-loaded, digital tape recorder has matured to the point where you have too many choices. The line-up includes cassettes, cartridges, single-track or multiples, drives of various kinds, and at least 10 encoding schemes. And rather loose specifications for cartridge and cassette recorders cloud the picture even more.

Probably your most important decision in specifying any storage device involves capacity. With cassette and cartridge recorders, the problem of deciding is compounded by the real difference between actual and theoretical capacity.

Don't fall into the capacity trap

Although the theoretical storage capacity (bit density \times tape length) for a cartridge or cassette seems adequate at first glance, a large part of the "capacity" can be eaten up by starting and stopping.

Consider, for example, a recorder with a 50-ms start time, a 30-ms stop time, and recording at 400 bits per in. (bpi) with the tape moving at 10 in. per second (ips). Starting takes 0.5 in., writing an 8-bit character takes 0.02 in., and stopping takes 0.15 in. So for a common 300-ft cassette, the number of 8-bit characters you can store is only $3600 \div 0.67$ (5380). That's a far cry from the theoretical 180,000 characters.

So much space is dedicated to nondata functions that each character can be written five times and affect total storage by only 10%. And increasing the bit density from 400 to 800 bpi changes the character count only from 5380 to 5460—in most cases hardly worth the effort.

Buffering data into blocks helps spread the nondata portions over more characters. Thus, by writing blocks, rather than individual characters, you can make as many as 1000 characters share one start-stop space. Buffering, then, increases actual capacity.

Sid Adlerstein
Associate Editor

Cartridges clearly have more capacity than cassettes. Although the most commonly used media, Philips-type cassettes and 3M-type cartridges, can both accommodate from one to four recorded tracks, the most data a cassette can pack is 1.44×10^6 eight-bit bytes. By contrast, some cartridge systems can cram as much as 11.5×10^6 bytes into one package.

But the high data capacity that multitrack units offer may not fit into your automatic system. Find out: Will you have to remove the media pack and turn it around to access all tracks? Or are the tracks accessible in some predetermined order? The most versatile units let you access any track in either the



The DC-300 cartridge is electromechanically locked into Kennedy Co.'s Model 331 drive, until its release by an Unload command. All four of the serially sequential tracks can be accessed without turning the tape.

forward or reverse motion of the tape.

Be careful when figuring multitrack capacity. Some systems use a track for a prerecorded clock, to either synchronize the data or control tape speed. This is a nondata track and should not be counted in total capacity. However, some systems using a clock track for data synchronization have more actual capacity than systems in which all tracks contain data. The clock validates data recorded on much of the usually wasted start-stop space.

Another pebble that can ripple the already muddy waters of tape capacity is specifying in bits rather than in the standard 8-bit bytes. So keep a sharp lookout and divide by eight.

Need capacity? Look at density

When you are concerned about capacity, you have to be concerned about density. Most cartridge systems use the American National Standards Institute (ANSI) specification for density—1600 bpi, while most cassettes commonly use the ANSI density of 800 bpi. However, with so many cassette units on the market, packing densities of 333, 430, 518, 556, 615, 960, 1000 and even 1600 bpi are available.

Packing density aggravates the sore spot of obsolete standards in packaged-media recording. Shortly after digital data were first recorded on crude audio cassettes, standards became necessary. Data taken on one machine wouldn't play back on others, and finding the right interface was a little too exciting. But by the time the first "standard" for recording digital data on a cassette was ready for publication, it was already obsolete. This was the Kansas City (KC) process that dealt with recording bits as tone bursts.



Data are crammed onto four serial tracks at 6400 bpi in Microdata's Lodestar cartridge recorder. To ensure compatibility between the recorder and the medium, cartridges are certified for this high density.

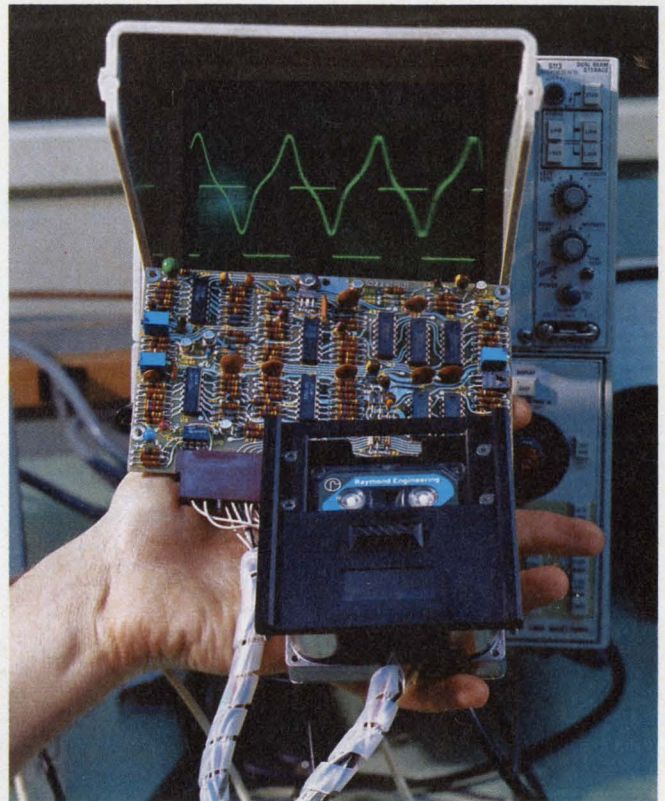

The Model 6409 Mini-Raycorder fits into your hand. This 17-in.³ unit from Raymond Engineering draws 1.5 W at 5 V. All its electronics come on just one PC board, and the tiny device uses ANSI-proposed minicassettes.

The standards are lagging again. ANSI and the European Computer Manufacturers' Association (ECMA) have instituted cassette-tape standards that specify a width of 0.15 in. and a length of at least 282 ft. These standards are almost universally adhered to. So watch out when a manufacturer boasts that his system produces up to 150,000 characters. He may mean for 450 ft, when the usual capacity specification uses 300 ft.

For cartridge tape, ANSI has proposed that 282 ft be the minimum length, and 0.25 in. the standard width.

One problem with yet another standard—recording density—is the rapid change in performance. The approved cassette standard requires phase-encoded data at 800 bpi. The proposed standards for cartridge drives ANSI X3B5/75-44 and -53 for serial and parallel data, respectively, require 1600-bpi density. But some units have already surpassed this level of performance. Commercially available systems pack data into cassettes at 1600 bpi, and at least two units can operate a standard 3M cartridge at 6400 bpi—four times the standard. And the cartridge-recording standard isn't even approved yet.

Try specials when standards won't do

Standards, even if scrupulously updated, can't cover all situations. Therefore, don't be surprised to find a variety of nonstandard media and special systems.

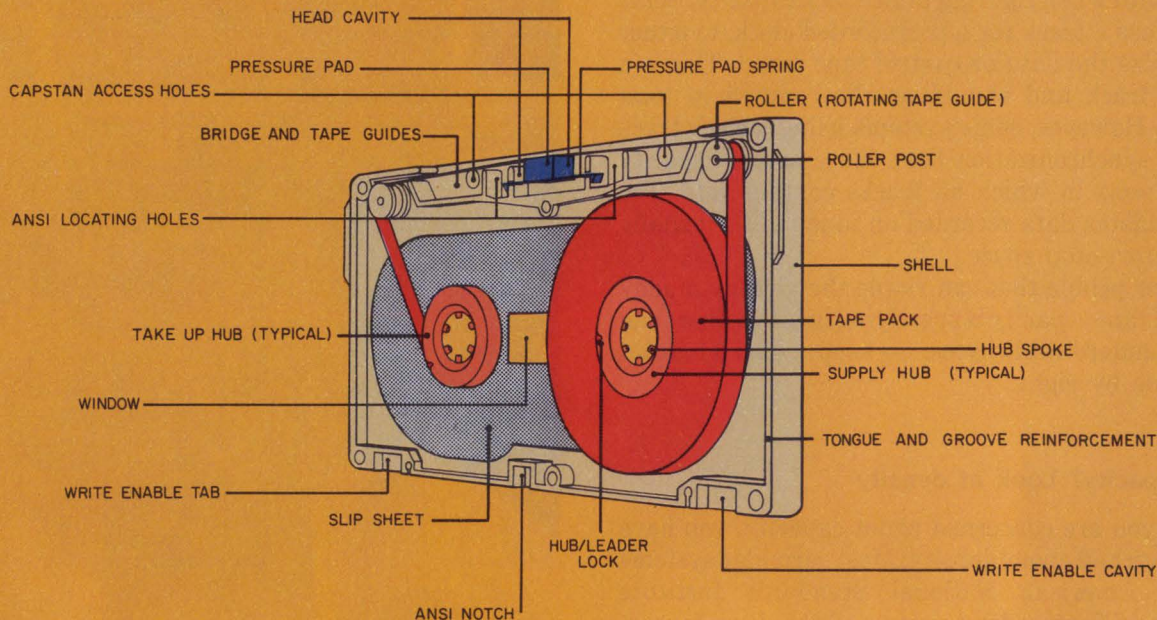

The digital cassette (top) holds at least 282 ft of 0.15-in. tape. Differences between digital and most audio cassettes include an ANSI locating notch, reusable write-enable tabs, pullout-proof leaders, and holes at the tape's beginning and end. The recording qualities of the two types also differ. A flat belt provides built-in direct drive and tensioning for the 0.25-in.-wide recording tape in a 3M-type cartridge (bottom). Internal guides align the tape.

Tape packs made for special drives offer up to 17×10^6 byte capacities, up to nine tracks, 1600 bpi and speeds varying from a barely visible crawl to a zippy 60 ips.

While nonstandard media offer large capacities, the standard units have the edge in speed, with ranges from 0.08 to 90 ips. However, the variety of speeds is rivaled by the variety of drives and guiding systems that move and tension tape.

Guiding and tensioning the tape is more of a problem in cassette drives than in cartridge units. Whereas in a cartridge, tape guiding and tensioning are already built in, each cassette drive must supply its own. Some of the common methods by which cassette drives align the tape across a head are

- A finger guide on one side of the head.
 - Rails across the head surface.
 - Grooves near the head.
 - Spring-loaded guides near both sides of the head.
- Any of these methods can skew a tape.

Generally, the more moving parts a system has, the better the guiding. But moving parts are failure-prone, and every additional moving part decreases reliability. And reliability figures, usually expressed as mean time between failures (MTBF), are the most elusive specifications. MTBFs for recorders are usually

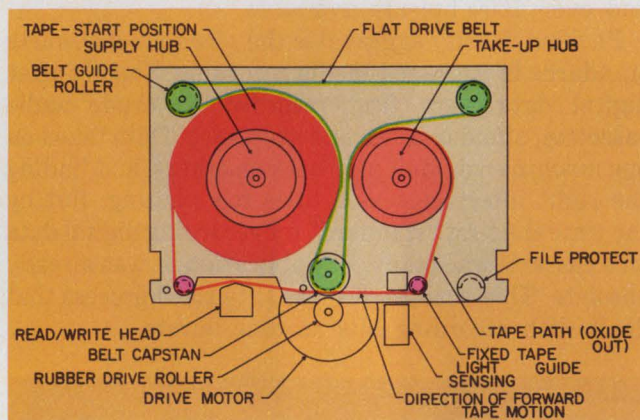

quoted anywhere from 1000 to 20,000 hours. But these figures are usually based on calculations rather than actual field reports. And some manufacturers can't supply the calculations.

But one thing that every manufacturer will supply is a justification for his tape-moving scheme—particularly for cassettes. The basic methods are reel-to-reel and capstan-drive.

In cassettes, the drive's the thing

The capstan and pinch-roller drives that are so useful for audio recorders, where speed tolerances of 1% may be unacceptable, have stirred a hornet's nest in the digital cassette world, where speed tolerances of 20% are sometimes adequate.

The trouble is that with the start-stop operation common in digital recording, pinch rollers can jam dirt into the tape. While this isn't the end of the world in audio use, it can result in intolerable dropouts in

digital recording. Then again, capstans and pinch rollers are a pretty good way to move tape accurately. So the pro and con discussions go on.

Meanwhile, alternatives to capstans emerge. For example, you can move and tension cassette tape via the supply and take-up reels by connecting motors to the hubs. But while these reel-to-reel drives may increase tape life up to five times, at a constant motor speed, tape speed past the head (where it counts) will vary by 2.3:1 over 282 ft of tape. Consequently, you won't be able to record 800 bpi. Controlling the motor speed—thereby the tape speed—is costly and a source of errors.

Controlling tape speed by servo motors, steppers, tachometers and prerecorded clock tracks—all have their champions and their places in digital recording. Their defenders are usually hair-trigger fast in quoting the 1 to 2% short-term speed tolerances you can expect with their particular controls. Data on long-term speed variation sometimes take a little longer to get at—like never.

Also, you will have to prod cassette and cartridge-recorder manufacturers to determine if you need external equipment and what kind. Is the speed control contained entirely in the unit? What is standard equipment? What is optional? When considering any drive, ask what comes with it to move the tape as accurately as you need.

Cherchez le format

Other useful questions: What format capabilities does a given recording unit provide? Do you need any external circuitry to format the data usefully?

As an example of the capability you might look for consider the ANSI standard for cartridge recorders. This specifies that blocks of data be bracketed by known bit patterns.

First comes a 16-bit preamble, followed by a data block of up to 2048 eight-bit bytes. A 16-bit cyclic-redundancy check and a 16-bit postamble follow the data block.

The preamble has 15 ZEROs followed by a ONE. Preambles establish timing for reading data when the tape moves forward. The postamble, a ONE followed by 15 ZEROs, sets the timing for reading data in reverse.

Note that for both directions of tape travel, data are preceded by a string of 15 ZEROs and a ONE. This pattern can be used to locate data in a de-skewing register.

No matter what the format, arranged data must be encoded magnetically onto the tape. Check that the system you buy can encode data. Some systems require optional boards to give you common data-encoding schemes. Others require an external oscillator. And many do not provide common encoding methods—even as options. Then you must design your own encoder.

All data encoding is either clocked or self-clocking.



Data-Logger-2 can record 64 analog channels as a string of 14-bit words. This battery-powered, cassette, weather-proof data-acquisition and recording system, from Datel, can run for up to a year on one charge.

Return-to-ZERO (RZ) and nonreturn-to-ZERO (NRZ) are primary examples of encoding that require a separate but synchronized clock to recover data.

In RZ coding, a half-bit-wide pulse represents a ONE. No pulse is a ZERO. NRZ-coding schemes, on the other hand, have three common variations: level, mark or IBM, and space.

Complementary-NRZ coding uses two tracks. ONEs are recorded as a flux change on one of the tracks and ZEROs by flux changes on the other—obviously a redundant coding technique.

In NRZ-level coding, the high level represents ONE, the low level ZERO. One problem with NRZ-level coding is that a missing bit ruins all subsequent data.

The problem is cured in NRZ-mark or IBM coding. A change in level is a ONE, while no change is a ZERO. NRZ-space coding is the inverse of mark; that is, a change denotes ZERO and no change denotes ONE.

With level-type encoding, bit density is equal to flux changes per inch (fci). So NRZ has the capacity for dense recording.

But this quality doesn't come free. Level (clocked) recording requires that the data-recovery amplifiers respond to dc and show phase linearity. The result is a high signal-to-noise ratio (s/n). Also, pulse-to-pulse jitter and timing errors must be held to half a bit cell. Furthermore, data synchronization is difficult because two tracks are required—one for data, the other for clock. Beware of skewing between tracks.

Self-clocking encoding, on the other hand, uses flux change in every bit time. Therefore, a data-

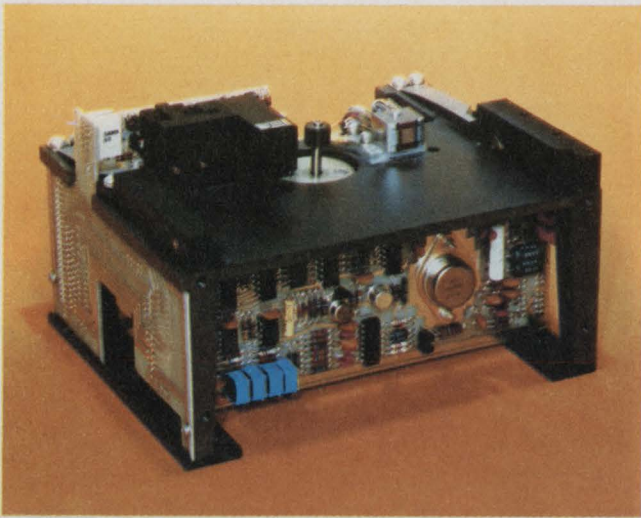

The 3000-S2 drive meets ANSI standards for processing data on X3B5/75-43 type cartridges. The Data Electronics unit reads and records per standards X3B5/75-44 (serial) and X3B5/75-53 (parallel).

synchronized clock is inherent in the record on the data track. Skewing between tracks isn't a factor.

Since information is put down at precise intervals, just two frequencies matter for data recovery: either f_{ci} or $f_{ci}/2 \times$ the tape speed. The data can thus be bandpassed with a resulting increase in s/n. Phase-encoded data are particularly suitable to detection because phase errors are minimized in a differentiator (slope detector) operating in a narrow-frequency band.

The simplest self-clocking code is Bi-phase-mark (Bi- Φ -M), or Manchester I. The mark version uses a flux change (fc) at the start of each bit space. For a ONE, there is another fc at the middle of the bit space; a ZERO gets no fc.

Either Bi-phase-level (Bi- Φ -L) or Split- Φ (also called Manchester-II +180°) recording has an fc at the middle of every bit. The fc is toward north for a ONE and away from north for a ZERO. Of course, the appropriate fc must be made at the start of each bit to establish the proper polarity state for the bit to come. A peculiar requirement of Bi- Φ -L is that a ZERO must precede data whose first bit is ONE.

Although more complex than Bi- Φ -M, level recording is often recommended because of the following advantages:

- Writing always begins and ends at the same flux level, north, because no matter what the bit pattern is, there is always an even number of fc's in Bi- Φ -L recording.
- The noise sensitivity of Bi- Φ -L is one-third that of the mark method.
- It is the ANSI-ECMA standard (ANSI Std BSR X 3.48).

At a maximum density of 500 bpi, however, Bi- Φ -L recording is usually recommended for high data reliability.

The Bi-Phase-clock technique is similar to the Bi- Φ -M except that it requires two tracks, one for data recorded like Bi- Φ -M and the other for a prerecorded

clock. The obvious disadvantage is loss of a complete track to the nondata clock, but this can be overshadowed by the ability to read and write without the tape attaining constant speed.

This capability can be valuable in incremental operation, especially when the records are short. Data can be transferred almost instantly at start, which saves the tape space ordinarily allotted for start time.

Usually, at block sizes larger than 32 characters, a cassette provides more actual storage capacity with Level or Mark recording than with Clock. The starting-stopping time space is then just wasted.

Recording with the Bi- Φ -C method does carry the burden of a high error rate. The number of clock pulses that can be missed without affecting data recovery is $n/3-1$, where n is the number of clock pulses used to write a single data bit.

Divide a bit cell for ratio recording

Another phase-encoding scheme, the three-clock bit-cell method, or ratio recording, divides each bit space into three sections, dedicated to synchronization, data, and reset.

The first transition establishes the beginning of the cell and alerts the system that a bit is about to come. The second transition, timed with the next clock after the synchronization pulse, indicates a ONE; no transition in this slot indicates a ZERO. The third transition space in the cell establishes the reset time and, like the first transition, has no data content.

The most complex phase-encoding method for



Forms are retrieved selectively in seconds from the mini-cartridge storage in Hewlett-Packard's 2644A Mini Data Station. The terminal uses HP's own drive, which is not yet available by itself.



A 32-Mbyte capacity is featured in the 5200 carousel-handling and drive system, in which 16 cartridges can be accessed four at a time. The National Computer Systems unit meets ANSI X3.56-1976.

digital recorders is Miller coding. In this scheme, a ONE is represented by an fc in either direction at the middle of the bit cell. Two adjacent ZEROS are coded as one fc in either direction at the end of the cell containing the first ZERO. Since Miller coding is self-clocking and requires only narrowband recovery amplifiers, the s/n is high.

The main disadvantage is that phasing the clock for data recovery in the decoder requires that either the frame or word-synchronizing fields contain a 101 sequence. In addition, because there is a transition for each clock, you must consider pulse-to-pulse jitter.

Another encoding method, modified frequency modulation, is often used in disc recording and is now being applied to tapes. This method provides two times more density per fc than other recording methods.

The medium is crucial

But no matter how carefully you select your drive, encoding scheme or data format, your system is going to have strange outputs unless the recording medium itself performs properly. Although they look similar, audio and digital cassettes are totally different.

Don't try to capture digital data on your old audio cassettes. Originally, digital recording was done on audio cassettes because the convenience and price of cassette recording were irresistible—and digital cassettes weren't available.

The most pronounced difference between audio and digital tape is the frequency range. But, you say, "the wider the frequency response of anything, the better."

Untrue. While audio-tape manufacturers do strive for bandwidths exceeding 20 kHz, one measure of digital-tape quality is that its bandpass be just wide enough to pass the data and cut off sharply to eliminate noise.

Next to bandwidth, the most important difference between tapes meant for pulse recording and those for storing continuous signals is the curve of magnetization vs write current. Whereas an ideal audio tape boasts unbounded magnetization linearity, in the ideal digital tape relatively small currents can switch the magnetization between two saturated states with no stopovers along the way. In other words, audio recording requires linear tape, while digital tape should be nonlinear.

Moreover, in high-quality digital tapes, electrical conductivity is controlled so that static charge doesn't build up, especially at high speed. The uncoated portion's transparency to light is controlled so that clear tape leaders can be detected by beginning and end-of-tape photo-electric sensors.

Furthermore, the tape surface must be uniform and tough enough to stand up to thousands of passes at up to 120 ips. And that's not the worst of it. Many systems require that a small length of tape "shoe-shine," or read/rewind/read, for many passes. Low-quality tapes can be deformed by the rapid tension changes and tape heating that are inherent in this demanding mode of operation.

Digital media: the better choice

What's more, tape isn't the only difference between audio and digital cassettes—the housings are usually different. Often, audio cassettes don't have such features as an ANSI locating notch, reusable write-enable devices, a pressure pad for read-after-write heads, pullout-proof leader attachment, and end-of-tape and beginning-of-tape holes. Even the storage box for a digital cassette is different—with dust flanges so the cassette can't get dusty in its box.

Once you know you should use digital, not audio, media, how do you know how good it is? After all,



Drawing only 50 μ W in standby, Memodyne's Model 3243 data-logging system uses the company's Model 208 cassette drive and real-time clock. Separate readers mate the write-only machine with popular computers.

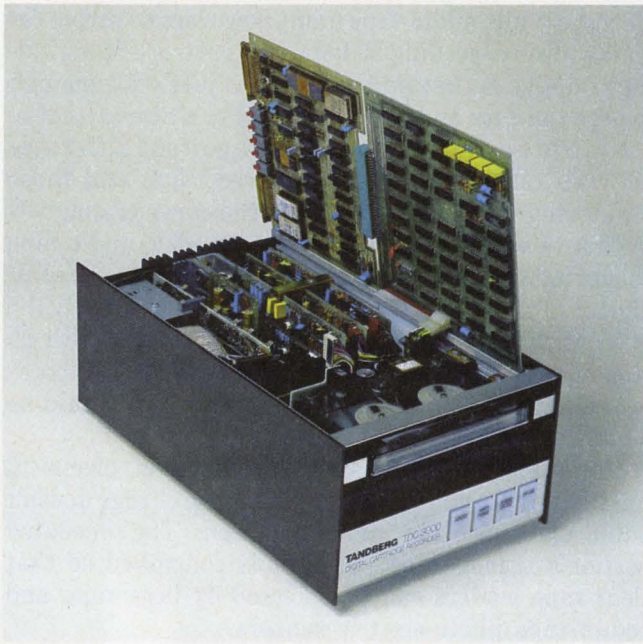

Spring-loaded arms hold the cartridge with high retention force in the rugged TDC-3000 recorder, a Tandberg Data product. The replaceable head doesn't require shimming, azimuth or tilt adjustment. An optical encoder on the capstan-motor shaft measures velocity, direction and displacement of the drive tape.

everything is subject to quality variations. So you go all the way with a manufacturer-certified unit. But it's never that easy! There are also statistical, bulk and post-assembly certifications to choose from.

Statistical certification is performed by testing a sample of the media used in a production run. Some lots of statistically certified tapes have as many as 8% defective units. In bulk certification, the tape is tested before it is loaded into the cartridge or cassette. Defect rates of 4% are common. Obviously, you've got the best shot at an error-free medium when it is 100% post-assembly certified.

To get the best results from your tape, be sure the drive is doing a proper job. Dirt, worn or badly adjusted guides or head, improper tensioning and poor speed control all contribute to the early demise of your recording medium.

How long will the tape live?

At least one media vendor, Information Terminals, expects its series R, T and H cassettes to stand up with a properly maintained drive for an average of two, three and four thousand passes, respectively. The average error rate for these units per million readings is 0.1, 0.01 and 0.005. But this level of performance is only for room temperature at 50% relative humidity in a dust-free environment.

Warped, stretched and sticky tapes all stem from high temperatures. So make sure you don't leave cassettes in a car parked in direct sunlight. The car's interior temperature can hit 60 C, and that's enough to damage most tape.

Low-humidity operation can also cause trouble. As tape travels in dry operating environments, electrostatic attraction due to charge build-up can pick up dust and fine particles, which can cause dropouts if they become imbedded in the tape. In addition, abrasion from foreign matter on the tape can wear out the head.

A cassette's conductive slip sheet helps repel pickup, which is most pronounced at relative humidities lower than 40%. Also, back-coated tape is often recommended for operation in dry places. At the damp end, 80% humidity combined with 60 C temperature will wear the tape out very quickly.

No matter how well tape is treated, its life is limited. Many drives offer heads with read-after-write capability. For the best error detection—reading and checking data while writing—get a read-after-write head.

Cassettes are still the most widely used medium for digital recording. Although many cassette recorders boast various encoding, formatting, buffering and density characteristics, the most distinguishing feature of all these units is the drive.

Cassette drives vary

In one drive, the Model 250B from MFE, two reel motors are servoed to a prerecorded clock track. With only two moving parts, the unit requires no maintenance or adjustments. Just keep the head clean and the tape zips along at up to 120 ips.

The only two moving parts in Datum's Model 4200 are also the reel motors. In this unit, however, circuitry senses speed-related parameters in the mo-

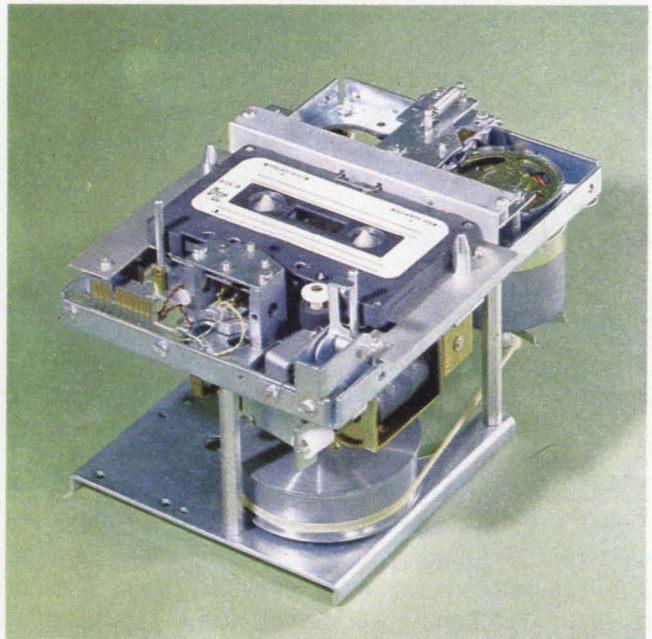

Tape-speed drift is held to within 2% by a synchronous-motor capstan drive in Amilon's Model A7 cassette transport. For high-inertia driving, the unit uses one reel motor and a second capstan motor.

tors so that control needs no tachometers or a clock track.

In another approach, used in the Model 172 transport by Dicom, a tachometer controls dc servo motors driving the capstan and reels. A special feature of this drive, its cam-loaded head actuator, provides precise head-to-tape alignment. The 172 transport is a component of the Model 176 digital cassette subsystem, which includes a servo drive, a μ P controller, a data formatter, a character buffer and an interface.

By using simple synchronous ac motors to drive the capstan and only one reel in the Model A7, Amilon maintains almost constant tape speed (within 2%) without external circuitry. This high-inertia drive system holds pulse-to-pulse jitter to 1%. Lower-inertia drives usually hold jitter to 3 to 5%. In addition, the Amilon drive at \$102.50 in 1000 qty. is among the least expensive of the ANSI-compatible units.

Wasted space in starting and stopping gaps is greatly reduced by the speed tolerant recording technique used in the STR-150, from Electronic Processors. The self-clocking unit includes an 8-bit interface that easily connects with bus-oriented μ Ps.

Four ac motors control the fixed-speed Phi-Deck Model 4 μ P cassette deck from Tripple i. A separate motor controls takeup, rewind, play or record, and head engagement. Because the capstan motor is dedicated to just moving the capstan, flutter, wow and jitter are kept low.

The established technique of capstan and pinch roller is the heart of the single drive in Anderson-Jacobson's Model AJ 730, a cassette recorder system featuring editing and searching capability. The block-recording unit interfaces directly with terminals specializing in word processing, data collecting and communicating with computers.

Another cassette recorder intended for minicomputer interfacing is used in GE's Terminet terminal. In this desk-top system, block recording increases tape use and eases editing. Block lengths of 88, 144 or 166 characters are strap-selectable. Data-storage capacity ranges from 100,000 to 125,000 characters per cassette with the block format.

Cassette units log data

Cassette recorders are particularly useful for logging data. Datel's LPS-16, a data-logging system for remote locations, operates from a 12-V source and draws a mere 900 mW while recording and "micro-watts" during standby. The system accepts up to 16 analog inputs or any number of 16-bit serial bytes. A companion reader transcribes the cassette's data to computer-compatible media.

Another 16-channel data logger, the cassette data acquisition system from Climatronics, can record for up to 240 days. The unit records data and time. The companion reader offers either an RS232 or a parallel-computer interface.

Using a high-resolution stepping motor and eight-

phase driver, the Series 1200 all-weather data logger, from Sea Data, samples up to 32 times in one second. On a single battery charge, the unit can record 536,000 12-bit words plus 67,000 36-bit headers, including elapsed time.

Two independent channels can record the history of events on EDMAC's Model 2043A recorder. In this device, single pulses mark occurrences. The spacing between pulses must be decoded to determine the time at which an event occurred.

Cartridges store more

When cassettes fall short on capacity or recording density, use standard 3M cartridges. The Series 4000, from Kennedy, phase-encodes 1600 bpi, at 5000 bytes/s, into the ANSI format. These recorders use an isoelastic drive that controls tape tension and motion with a single servoed motor. Total storage is 2.875 Mbytes on a cartridge.

In the CMTD-3000S1 ANSI/ECMA tape drive, Data Electronics Inc. uses a servo motor containing an integral tachometer to drive the cartridge's band. Speeds of up to 120 ips for the bidirectional search and rewind are available.

Microdata's Lodestar stores 11.5 unformatted

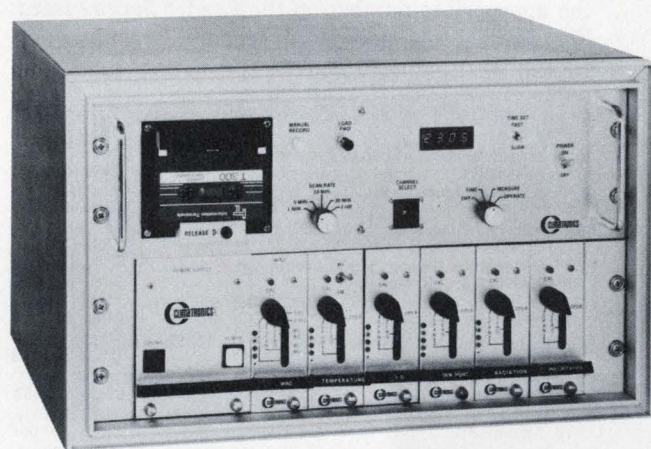

Scan, record and time 16 channels for 240 days with a cassette data-acquisition system from Climatronics.



Hardware and software control 3M's DCD-100 mini-cartridge drive in Gnat Computers' μ P-based MC-200.



Information Terminals 100% certifies Verbatim storage units—cassettes, mini cassettes and cartridges.

Mbytes onto a 3M type cartridge. Data are recorded at 6400 bpi on each of four serial tracks.

Software, in the form of stand-alone dump-restore utilities, operates from either a preestablished command file or a Run command in the 4455 drive, an

optional part of SYCOR's 440 system. To get 3200 bpi, the drive uses a double-density encoder and a phase-locked data separator.

Other systems that record on 3M cassettes are offered by Telemetry Systems Engineering (using a transport from Genisco), Epicom (with a Kennedy transport), Tandberg Data, Penny & Giles, and Spec-tron (in its datascopes).

A carousel-type system that holds 16 cartridges and includes a dual- μ P formatter is offered by National Computer Systems. The Model 5200 stores 32 Mbytes.

With a 3M DC100 mini cartridge, Hewlett-Packard's drive is used in its interactive CRT terminals in the 12645A display station and 2641A APL terminal.

Additional drives and systems using plug-in media other than standard cassettes and cartridges are produced by Genisco Technology, Raymond Engineering, Interdyne, Memodyne, Micro Communications, Braemar Computer Devices and Gnat Computers. ■■

Need more information?

The products cited in this report don't represent the manufacturers' full lines. For additional details, circle the appropriate number on the Reader Service Card. For data sheets and more vendors, consult ELECTRONIC DESIGN'S Gold Book.

Amilon Corp., 49-12 30 Ave., Woodside, NY 11377. (212) 274-1794. (L. Rosenblatt) **Circle No. 500**
Anderson-Jacobson, 521 Charcot Ave., San Jose, CA 95131. (408) 263-8520. (D. LeVesque) **Circle No. 501**
Applied Data Communications, 1509 E. McFadden, Santa Ana, CA 92705. (714) 547-6954. **Circle No. 502**
Bison Instrument Inc., 5708 W. 36 St., Minneapolis, MN 55416. (612) 926-1846. (F. Schwartz) **Circle No. 503**
Braemer Computer Devices, 11950 Twelfth Ave., South Burnsville, MN 55337. (612) 890-5135. (R. Morris) **Circle No. 504**
Cipher Data Products Inc., 5630 Kern Mesa Rd., San Diego, CA 92111. (714) 279-6550. (W. Otterson) **Circle No. 505**
Climatronics, 1324 Motor Pkwy., Hauppauge, NY 11787. (516) 234-2772. (T. Schreiber) **Circle No. 506**
Computer Operations, 9700-B George Palmer Hwy., Lanham, MD 20801. (301) 459-2100. (M. Keating) **Circle No. 497**
Data Electronics Inc., 370 N. Halstead St., Pasadena, CA 91107. (213) 351-8991. (S. Thompson) **Circle No. 507**
Datel Systems, 120 Turnpike St., Canton, MA 02021. (617) 828-8000. (L. Copeland) **Circle No. 508**
Datum Inc., 1363 S. State College Blvd., Anaheim, CA 92806. (714) 533-6333. (K. Lowe) **Circle No. 509**
Dicom Industries, 715 N. Pastoria Ave., Sunnyvale, CA 94086. (408) 732-1060. (A. Roberts) **Circle No. 510**
Digital Equipment Corp., 146 Main St., Maynard, MA 01754. (617) 897-5111. **Circle No. 511**
EDMAC Associates Inc., 333 W. Commercial, East Rochester, NY 14445. (716) 385-1440. (R. Reynolds) **Circle No. 512**
Electronic Processors, 1265 W. Dartmouth Ave., Englewood, CO 80110. (303) 761-8540. (J. Voelker) **Circle No. 513**
Emerson Electric Co., Industrial Controls Div., 3300 S. Standard St., Santa Ana, CA 92702. (714) 545-5884. (J. Coolidge) **Circle No. 514**
Epicom, 592 N. Douglas Ave., Mount Laurel, NJ 08057. (609) 234-5700. (B. Adams) **Circle No. 515**
Facit-Addo Inc., 501 Winsor Dr., Secaucus, NJ 07094. (201) 866-5111. (O. Bjerkmann) **Circle No. 516**
General Electric, Data Communications Prods., GE Dr., Waynesboro, VA 22980. (703) 942-8161. (R. Hoffman) **Circle No. 517**
Genisco Technology Corp., Tape Recorders Div., 18435 Susana Rd., Compton, CA 90221. (213) 537-4750. (P. Godinez) **Circle No. 518**
Gnat Computers, 7895 Convoy Ct., Unit 6, San Diego, CA 92111. (714) 560-0433. (F. Adams) **Circle No. 519**
Hewlett-Packard Data Terminals, P.O. Box 1559, 11000 Wolfe Rd., Cupertino, CA 95014. (408) 257-7000. (T. Anderson) **Circle No. 520**
Information Terminals, 323 Sequel Way, Sunnyvale, CA 94086. (408) 245-4400. (G. Newton) **Circle No. 521**
Interdyne Inc., 14761 Califa St., Van Nuys, CA 91411. (213) 787-6800. (B. Geist) **Circle No. 522**

International Computer Products, 2529 Merrell Rd., Dallas, TX 75229. (214) 350-6951. (C. Bishop) **Circle No. 498**
Kennedy Co., 540 W. Woodbury Rd., Altadena, CA 91001. (213) 798-0953. (R. Bartholomew) **Circle No. 523**
Kybe Corp., 132 Calvary St., Waltham, MA 02154. (617) 899-0012. (P. Garland) **Circle No. 524**
Magnetic Information Systems, 25 Dock St., Mount Vernon, NY 10550. (914) 699-7050. (M. Kane) **Circle No. 525**
Memodyne Corp., 375 Elliot St., Newton Upper Falls, MA 02164. (617) 527-6600. (K. Corbett) **Circle No. 526**
MFE Corp., Keewaydin Dr., Salem, NH 03079. (603) 893-1921. (J. Saret) **Circle No. 527**
Micro Communications Corp., 80 Bacon St., Waltham, MA 02154. (617) 899-8111. (I. Johnson) **Circle No. 528**
Microdata Inc., P.O. Box 19501, Irvine, CA 92713. (714) 540-6730. (J. Ramsey) **Circle No. 529**
Mohawk Data Sciences Corp., Administrative Headquarters, Palisade St., Herkimer, NY 13350. (315) 867-6000. (F. Graziano) **Circle No. 530**
3M Co., Mincon Div., 3M Center, St Paul, MN 55101. (612) 733-8863. (R. Swart) **Circle No. 531**
National Computer Systems, 4401 W. 76th St., Minneapolis, MN 55435. (612) 831-4100. (T. Probst) **Circle No. 532**
NCR Corp., Dayton, OH 45479. (513) 449-4522. (L. Tribby) **Circle No. 533**
Penny & Giles, Mudeford, Christchurch, Dorset BH23 4AT. Phone: Highcliffe (042-52) 71511. Telex: 41266 **Circle No. 534**
Percom, 4021 Windsor, Garland, TX 75042. (214) 276-1968. (H. Mauch) **Circle No. 535**
Percor Corp., Peripheral Equipment Div., 9600 Irondale Ave., Chatsworth, CA 91311. (213) 882-9222. (N. McElwee) **Circle No. 536**
Quantex Div., North Atlantic Inds., 200 Terminal Dr., Plainville, NY 11803. (516) 681-8350. (L. Malmeld) **Circle No. 537**
Raymond Engineering Inc., 217 Smith St., Middletown, CT 06457. (203) 632-1000. (R. Duffy) **Circle No. 538**
Redactor Corp., 100 Pkwy. Dr. S., Hauppauge, NY 11787. (516) 543-8700. (T. Reantillo) **Circle No. 539**
Robins Industries, 75 Austin Blvd., Commack, NY 11725. (516) 543-5200. (S. Jones) **Circle No. 540**
Sea Data Corp., 153 California St., Newton, MA 02158. (617) 244-3216. **Circle No. 541**
Spectron, Church Rd. and Roland Ave., Mount Laurel, NJ 08057. (609) 234-5700. (B. Adams) **Circle No. 542**
SYCOR Inc., 100 Phoenix Dr., Ann Arbor, MI 48104. (313) 971-0900. (M. Sidowski) **Circle No. 543**
Tandberg of America Inc., P.O. Box 321, Ramsey, NJ 07446. (201) 825-7640. (B. Greenfield) **Circle No. 544**
Telemetry Systems Engineering, P.O. Box 750, Andover, MA 01810. (617) 475-4086. (A. Petrella) **Circle No. 545**
Telxon, 7280 Wynnwood, Suite 350, Houston, TX 77008. (713) 868-5511. (J. Westfall) **Circle No. 546**
Three Phoenix Co., 10632 N. 21 Ave., Phoenix, AZ 85029. (602) 944-2221. (J. Dahl) **Circle No. 547**
Triple I, 1901 N. Walnut, P.O. Box 25308, Oklahoma City, OK 73125. (405) 521-9000. **Circle No. 548**
Univac Div. of Sperry Rand, 322 N. 2200 W., Salt Lake City, UT 84110. (801) 328-8066. (S. Dunn) **Circle No. 549**
Wangco Inc., 5404 Jandy Pl., Los Angeles, CA 90066. (213) 390-8081. (D. Barnes) **Circle No. 550**

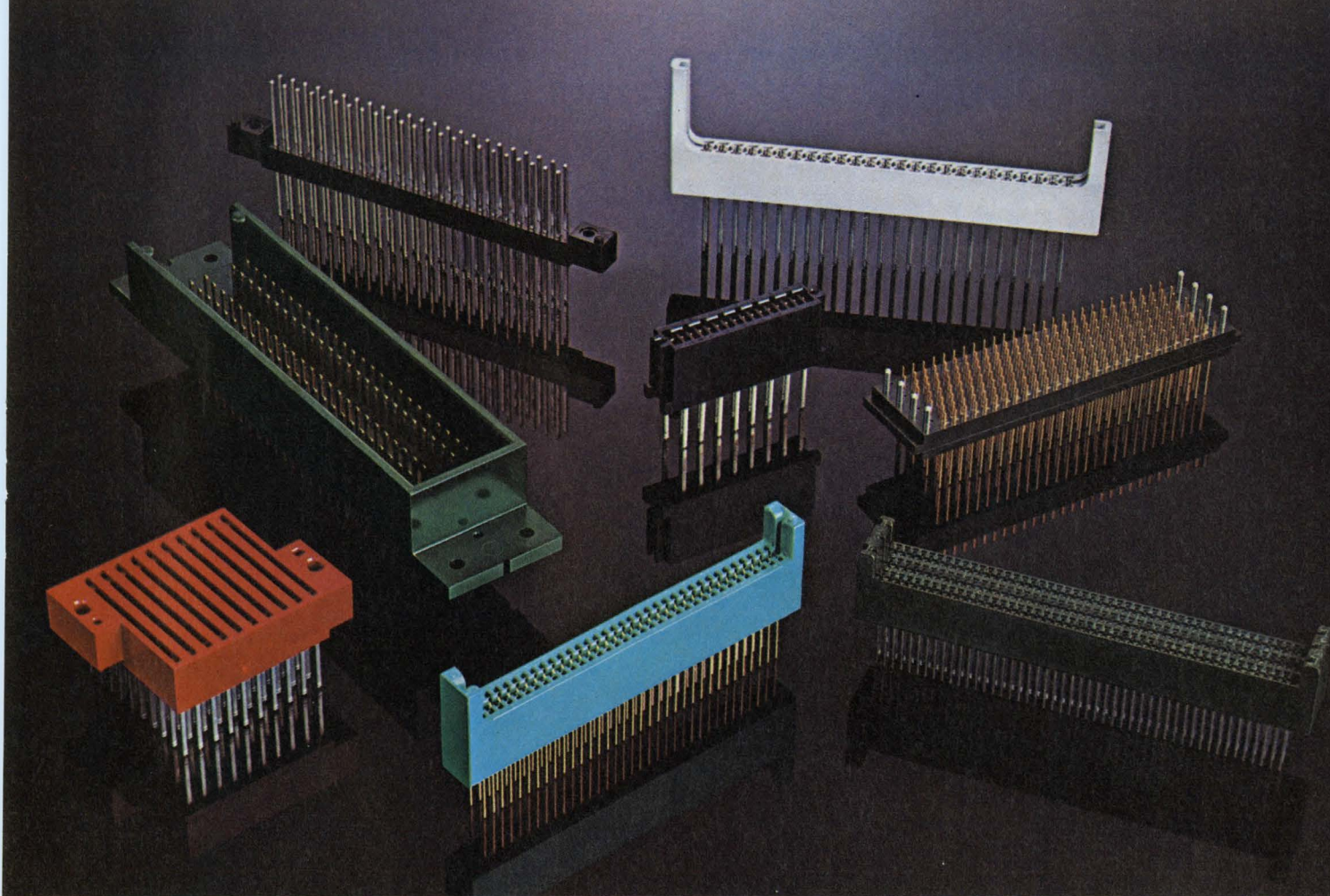

Special connectors are an old family custom.

We've been designing and manufacturing connectors for special custom applications for a long time. In fact, that's how we started in the business.

Over the years we've built up the special tooling skills and design expertise needed to produce the best connector at competitive prices.

Our in-house manufacturing capability makes for tight quality control. We can produce every part in-house—from the plastic body to the gold dot on the contact.

And we know our gold dots. We're the people who developed the most reliable system on the market.

We're not limited to any one design or manufacturing approach, either. We've made them all—bifurcated bellows, cantilever, single-beam contacts, thermoplastic or thermoset plastic.

But don't wait until after you've firmed up your design to call us. Our engineers and toolmakers show you ways to save money while getting a more reliable product.

They might even be able to fill your needs with a member of our off-the-shelf connector family.

Contact GTE Sylvania, CPO, Titusville, Pa. 16354. Phone 814-589-7071.

Good connections run in our family.

GTE SYLVANIA

The \$99.95 mystery...



B&K-PRECISION's new 3½ digit DMM

For over two years, our competition has been trying to figure out how B&K-PRECISION could sell a full-feature 3-digit DMM for only \$99.95. They've dissected it, analyzed it, and some even asked us how we did it. Well, they can start all over because we did it again!

B&K-PRECISION's new Model 2800 portable DMM features 3-1/2 digit display, auto-zeroing and 100% overrange reading for only \$99.95. Basic DC accuracy is 1%. Twenty-two ranges read up to 1000 volts DC or AC, 1000mA and 10 megohms.

All ranges are well protected against overloads. Even if you should accidentally apply +1000VDC to the 2800 while switched to an ohms range, no instrument damage will result. All DC and AC voltage ranges are protected up to ± 1000 volts DC or AC. The current ranges receive the double protection of diodes and a series fuse.

For accurate in-circuit resistance measurements, the 2800 measures with high- or low-power ohms ranges. At low-power ohms, less than 0.2 volt is developed across the measured resistance. To forward bias semiconductor junctions, the high-power ohms ranges develop about 2 volts.

B&K-PRECISION also has a full complement of optional accessories for the 2800. Accessories include a carrying case, wire tilt stand, AC adapter/charger, high-voltage probe, direct/isolation probe NiCad Batteries and 10-amp current shunt.

The B&K-PRECISION 2800 may be a mystery to our competitors, but for you—it takes all the mystery out of which DMM to buy.

See your local distributor for immediate delivery.

B&K PRECISION **DYNASCAN CORPORATION**

6460 West Cortland Avenue, Chicago, Illinois 60635 • 312/889-9087

In Canada: Atlas Electronics, Ontario • International Sales: Empire Exporters, Inc., 270 Newtown Road, Plainview, LI, NY 11803



So what?
So OEM's are dancing in the streets, that's so what. At least the pros are.

And what makes it such a big deal is the magnitude of the cost savings—possibly 20% or more per computer system.

One reason is that interfaces are generally long on duplication and short on common sense. Most interfaces, for example, faithfully repeat half or more of the circuitry on all the other interfaces. And with multiple interfaces, that gets to be a pretty expensive proposition.

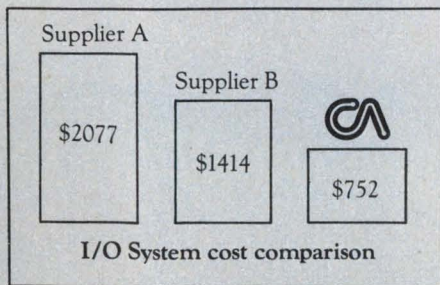

So we came up with the solution you see here: The Distributed I/O System. Designed to work specifically with our line of NAKED MINI® computers.

We figured a way to cut the cost of interface in half.

And once you get by its unorthodox appearance, the logic of it becomes pretty appealing. As do the cost savings.

All the basic circuitry is located on a single half-card I/O

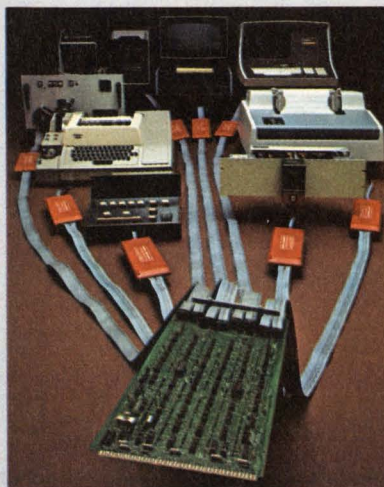

The Distributed I/O System

Distributor, which can be shared by as many as eight "Intelligent Cables." Packaged into every cable is an integral PicoProcessor, which handles the functional control for each interface.

This arrangement allows much smaller computer packages, since only one I/O

board is housed inside the computer cabinet.

And along with a smaller package, comes a smaller price.

The I/O cost comparison at left shows the savings on a typical four-interface system (2 CRT's, 1 line printer and 1 card reader). And since our System handles up to eight interfaces, imagine your savings using its full capability.

Consider ComputerAutomation's Distributed I/O System. It's an uncommonly sensible solution to a commonplace problem. From the price/performance people who brought you the NAKED MINI®



ComputerAutomation
NAKED MINI® Division
18651 Von Karman, Irvine,
California 92713, (714) 833-8830

THESE LOW-COST CASSETTE PROGRAM LOADERS DELIVER TOP PERFORMANCE FOR YOUR MICROPROCESSOR BASED SYSTEMS.

All four of these program loaders use EPI's patented Speed Tolerant Recording (STR®) technique to give you bit error rates of less than 1 soft error in 10^7 bits and less than 1 hard error in 10^8 bits. With STR, you get high data reliability in read and write modes while using a relatively low-cost recorder

and inexpensive tape cassettes.

Interfacing is similar to most paper-tape reader/punch units now in use. And with better data reliability, faster loading, more storage, lower price, and briefcase or rack mounting, EPI cassette program loaders make sense for both the

end user and OEM.

For more information on these low-cost alternatives to paper tape loading, contact Electronic Processors Inc., 1265 West Dartmouth Ave., Englewood, Colorado 80110. Phone (303) 761-8540.

**ELECTRONIC PROCESSORS
INCORPORATED**

Custom designs, like this STR-110T for the Texas Instruments 5TI Programmable Control System, can handle your special loader needs. You can get an intelligent loader... automatic verification in both read and write modes... remote control. Tell us what you need. Chances are an EPI STR loader can handle it.



8-bit parallel loading at standard TTL levels and at transfer rates to 125 characters per second is provided by the STR-210. Its high speed and storage capacity of 100,000 characters on a 300-foot cassette makes it ideal for memory dumps as well as program loading. Priced at just \$700.

OEM systems recorder, the STR-100, is a complete tape-drive unit that provides full remote signal or character control of all transport functions. It includes read-write electronics, control and timing logic, and motor-control logic. All you need to supply is a mounting location, power supply, and an interface with the controlling I/O device and you have a reliable unit for program storage and retrieval.

8-bit serial loading with switch-selectable rates to 1,200 baud are provided by the STR-LINK. The transmission mode (half or full duplex) is also switch selectable for maximum flexibility. Data capacity is 100,000 characters on a 300-foot cassette. Priced at \$1,190.

Coming through...

with a vital part in product design

It's what's up front that counts. That's why it pays off to involve Belden in the early stages of a project.

We know the codes, specs and electrical/environmental parameters your faced with. We've come through with answers to some extraordinary new applications.

As much as any component, wire, cable and cord, can make a critical difference in your product's performance. And your costs. By drawing on thousands of high-quality standards—and a wealth of custom engineering knowhow—we can tailor an answer to fit your needs. Exactly.

We can even help you cope with the economics of wire processing, assembly and installation. Our problem solving experience ranges from innovative

packaging to total manufacturing analysis.

Whether you need cord sets, special harnesses, shielded cable construction, flat cable—or help putting it all together, involve a Belden Wire Specialist. He'll come through with everything we've got. For answers right now, phone:

317-966-6661 Electronic Division or mark 400 on reader service card.

312-986-1600 Electrical Division or mark 401 on reader service card.

312-887-1800 Transportation Division or mark 402 on reader service card.

Or write Belden Corporation, 2000 S. Batavia Ave., Geneva, IL 60134

BELDEN



Coming through...
with new ideas for moving electrical energy

FEATHERWEIGHT MINIATURE PANEL MOUNT THERMAL PRINTER!!



Datel's new model DPP-7 Digital Panel Printer uses only 2 moving parts for OEM reliability. At only 2.3 Lbs. (1,1Kg) it is one of the lightest panel-mounting recording instruments available.

Includes all electronics.

The \$475* single quantity price includes everything required for full parallel BCD/TTL data inputs *plus* an input storage register for multiplexed bus applications *plus* an AC power supply! There are no extra boards to design or bulky cables and power supplies needed. The DPP-7 is ready to use.

Thermal printing means no messy inks, banging hammers or twirling print-wheels. Nothing to jam or run-out of ink.

Use the miniature DPP-7 for simple data logging systems, automatic test fixtures or with a digital panel meter for accurate unattended data measurement.

The **small size** of the DPP-7 makes it ideal for panel-mounting in analytical instruments and compact data systems. Up to six digits and sign may be printed to identify channel number and data.

The DPP-7 uses +5VDC power in a very short 6.2" (158mm) deep version or 100, 115 or 230 VAC or +12V or +28VDC power in an 8.7" (221mm) deep version.

DPP-7 QUICK SPECS

Printing Rate:

3 lines per second

Inputs

Full parallel BCD
TTL logic inputs, selectable positive or negative true

Printouts:

Six digits and sign, 99±9999, ±999999 or 9±99999 (Hexadecimal optional)

Input Storage

BCD data must be valid only 1.5 microseconds during print command

Data Capacity

9000 lines on 150 foot x 1.75 inch (44.5mm x 45m) thermal paper rolls

Power Supply:

Choice of: +5VDC, +12VDC, or +28VDC, or 100, 115 or 230VAC, 47 to 440 Hz.

Size Case:

4.50" wide x 2.72" high (115mm x 69mm)

Depth:

5V Models
6.2" (158mm)
28V, 12V, or
AC Models: 8.7" (221mm)

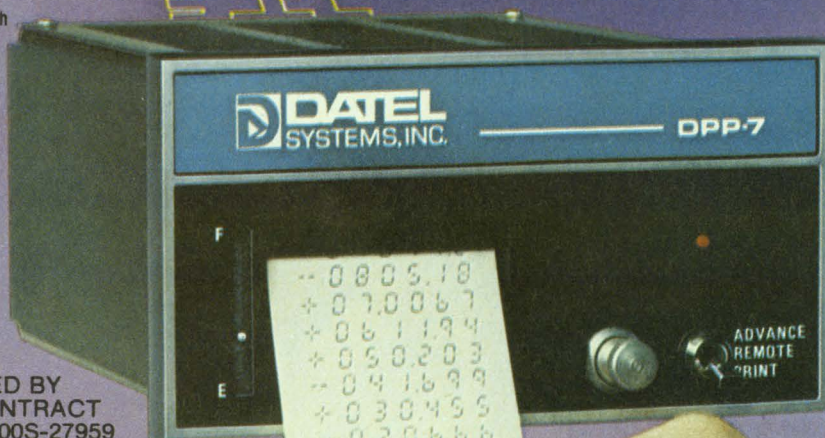

COVERED BY
GSA CONTRACT
NO. GS-00S-27959



Send for your FREE Brochure
1020 Turnpike St., Canton, MA 02021
Phone: (617) 828-8000

- Santa Ana, CA (714) 835-2751
- Santa Ana, (L.A. Exchange) (213) 933-7256
- Sunnyvale, CA (408) 733-2424
- Gaithersburg, MD (301) 840-9490

*U.S.A. domestic price only.

CIRCLE NUMBER 31

Attacking the problem

Charlie had a problem and he knew it. His counter sales were declining sharply and he knew he would have to make a decision to cope with that problem pretty quickly. Fortunately, he knew the reasons for the problem: his sales people weren't selling properly and his engineers weren't designing imaginatively.

This was particularly irritating because Charlie had already improved the counter with a redesign he had ordered—though his sales and engineering people objected to it and the customers didn't like it either. And because he had improved the counter, Charlie had raised the price—while competitors had lowered theirs.

Cynical Jack, the sales manager, suggested that they redesign the counter to give customers what they wanted rather than what Charlie felt they should have. Charlie's anger was understandable. After all, he reasoned, if the engineers were any good they could refine his redesign so that customers could see that the product merited the price increase. And if the salesmen were any good, they could demonstrate the product's superiority, which should have been obvious anyway.

So Charlie took action. "Straighten out your sales department," he told Jack. "That's where the problem is. Stop looking for excuses." So Jack tried to improve the sales department, which had previously been fine until the counter was redesigned and the price increased. But that didn't help.

So Charlie told the chief engineer to modify the front panel. And that didn't help either.

How could he ever have hired such incompetent managers, Charlie asked himself. And finally he saw the obvious solution to the problem. He fired the chief engineer and sales manager. Any day now, he told himself, those customers should be flocking back.



A handwritten signature in dark ink, appearing to read "George Rostky". The signature is fluid and cursive, written in a professional style.

GEORGE ROSTKY
Editor-in-Chief

There's a world of difference in Sensors.

The difference is Elmwood. Sensitive fast-response snap-acting thermostats for a world of applications, designed to meet the world's needs.

Difference in design. Models that meet U.L., C.S.A. and European requirements, and conform to DIN norms. Wide or narrow differentials and tolerances that match your high limit or control applications perfectly, while keeping your costs to a minimum.

Difference in performance, with each unit factory pre-set then 100% tested for a lifetime of dependable operation. Choose from ratings to 15 amps, and exposures from -65°F to 550°F (-54°C to 288°C).

Ask for prototypes. See the difference in Sensors for yourself.

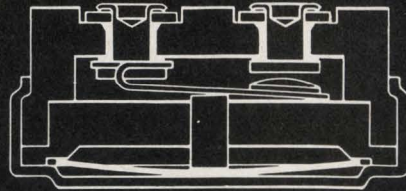

Elmwood Sensors, Inc. 1655 Elmwood Avenue, Cranston, R. I. 02907

Ph 401/781-6500. Twx 710-381-6413

European Div., Elmwood Sensors Ltd., North Shields, Tyne and Wear, NE29 8SA England Ph(089) 45-82821. Telex: 53284



Elmwood Sensors

Elmwood makes Sense

CIRCLE NUMBER 32



THERE'S A WHOLE FAMILY OF LOGIC* DESIGNED TO SOLVE YOUR NOISE PROBLEMS.

HERE'S ONE:

THE 367 QUAD SCHMITT TRIGGER

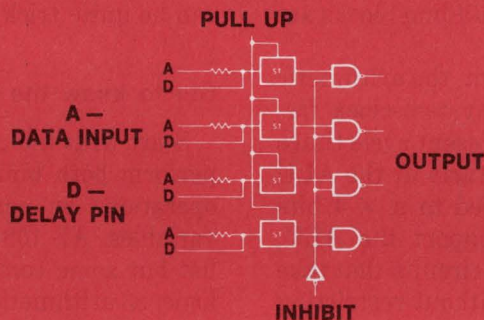

- 4.5V typ hysteresis
- 5.5V typ DC noise immunity
- Delay pin feature
- Dual truth table
- Withstands $\pm 100V$ $1\mu s$ spike

* HIGH NOISE IMMUNITY LOGIC (HiNIL)

is designed to make logic systems virtually immune to voltage transients and other sources of electrical noise. Typically it provides a noise immunity about 10 times better than conventional logic, such as TTL — even under worst-case conditions. HiNIL is most effective in control applications where high electric currents are present and a severe electro-mechanical interface exists.

With the family of HiNIL devices constantly growing, you can design entirely with HiNIL, or you can use it in place of your conventional I/O logic to protect and interface reliably with CMOS, TTL, or MOS circuits without resorting to special filtering, shielding or power supply regulation.

Get details on the full family of HiNIL logic circuits from your local Teledyne rep or distributor. Or contact us at the address below.

HiNIL CIRCUITS

One Shots/Timers

- 342 Dual Monostable Multivibrator
- 346 Retriggerable Monostable Multivibrator
- 347 Dual Retriggerable Monostable Multivibrator
- 348 Retriggerable Pulse Stretcher
- 349 Dual Retriggerable Pulse Stretcher
- 355 HiNIL Timer

MSI Circuits

- 343 4-bit Digital Comparator
- 361 Dual HiNIL to 5 Volt Interface
- 362 Dual 5 Volt to HiNIL Interface
- 363 Quad 5 Volt to HiNIL Interface
- 367 Quad Schmitt Trigger/Line Receiver
- 368 Quad Schmitt Trigger/Line Receiver (Open Collector)

Interface Buffers

- 390 Dual 4-Input AND
- 391 Dual AND
- 392 Dual NAND
- 393 Dual OR
- 394 Dual NOR
- 395 Dual 4-Input NAND
- 396 Dual Line Driver/Receiver

Gates

- 301 Dual 5-Input Power NAND
- 302 Quad 2-Input Power NAND (Open Collector)
- 303 Quad 2-Input Power NAND (Passive Pullup)
- 304 Triple 4, 3, 4-Input Power NAND (Passive Pullup)
- 306 Quad 2, 2, 2, 3-Input NOR
- 307 Quad 2, 2, 2, 3-Input NOR (Open Collector)
- 321 Quad 2-Input NAND
- 322 Dual 5-Input NAND
- 323 Quad 2-Input NAND (Open Collector)
- 324 Quad 2-Input NAND (Passive Pullup)
- 325 2, 2, 3, 3-Input NAND
- 326 2, 2, 3, 3-Input NAND (Passive Pullup)
- 331 Dual 5-Input Gate Expander
- 332 Hex Inverter (Open Collector)
- 333 Hex Inverter (Passive Pullup)
- 334 Strobed Hex Inverter (Open Collector)
- 335 Strobed Hex Inverter (Passive Pullup)
- 341 Dual 2-Input AND-OR-INVERT
- 344 Dual Expandable AND-NOR

Flip Flops

- 311 Master/Slave RST
- 312 Dual J-K Edge Triggered
- 313 Dual J-K Master/Slave
- 370 Quad D (Passive Pullup)
- 375 4-bit Shift Register

Counters

- 371 Decade (Passive Pullup)
- 372 Hexadecimal (Passive Pullup)
- 373 Up/Down Decade
- 374 Up/Down Hexadecimal

Decoders/Multiplexers

- 350 8-bit Multiplexer
- 351 Dual 4-bit Multiplexer
- 380 BCD to Decade Decoder/Lamp Driver (Open Collector)
- 381 BCD to Decade Decoder/Logic Driver (Open Collector)
- 382 BCD to Decade Decoder/Gas Discharge Driver
- 383 BCD to Seven Segment Decoder/Driver
- 384 BCD to Seven Segment Decoder/Gas Discharge Driver

TELEDYNE SEMICONDUCTOR

1300 Terra Bella Avenue, Mountain View, California 94043 Tel: (415) 968-9241 TWX: 910-379-6494 Telex: 34-8416

SALES OFFICES:

DOMESTIC: Salem, N.H. (603) 893-9551; Stony Brook, N.Y. (516) 751-5640; Des Plaines, IL (312) 299-6196; Los Angeles, CA (213) 826-6639; Mountain View, CA (415) 968-9241 • INTERNATIONAL: Hounslow, Middlesex, England (44) 01-897-2503; Tiengen, West Germany 7741-5066; Kowloon, Hong Kong 3-240122; Tokyo, Japan 03-405-5738.

CIRCLE NUMBER 33

Get the best processor performance

by building it from ECL bit slices. The 10800 family offers versatility as well as cycle times of less than 100 ns.

Offering the fastest cycle times of any available bit-slice processor family, the 10800 series of ECL 4-bit processor slices permits you to design high-speed computer systems. Each 10800 circuit is completely expandable, and the major system building blocks are either available or being designed.

The core of any 10800-based system, the arithmetic and logic unit (ALU), operates at system-clock frequencies of 10 to 15 MHz, which represent cycle times of 60 to 100 ns. System word size starts at the ALU width of 4 bits, but can be expanded to $n \times 4$ bits by cascading ALU sections. To support the ALU, Motorola has developed several ECL circuits that take care of most of the housekeeping without restricting the processor design.

Intended to address the instructions stored in the microprogram memory, the 10801 microprogram controller provides a 4-bit address that can be expanded to any size by cascading controllers. A memory interface circuit, the 10803, also has a cascadable 4-bit output bus, but it connects to the address bus of the main memory and supplies all the read and write addresses.

Acting as a register file, stack or I/O buffer, the 10806 dual-port memory provides 32 words \times 9 bits of temporary storage and can be accessed through either of its ports. For high-speed mathematical operations, the 10808 multibit shifter can handle up to 16 bits and, under software control, can do left-shift, right-shift or rotate operations. Additional 10808s can be cascaded for larger word lengths.

Other support circuits include the 10802 timing generator and clock controller, the 10804 and 10805 bidirectional bus translators (ECL to TTL and vice-versa) and all of the MECL 10,000 series of logic circuits. (All 10800 series circuits and some of the most commonly used 10,000-series units are listed in Table 1.)

A basic processor, built from 10800-series circuits, is outlined in Fig. 1. With a 16-bit word length, the processor would typically consist of four 10800s, two or more 10801s, one 10802, four 10803s, one 10179

(look-ahead carry generator), several 10145s or 10143s for a register file, some microprogram and main memory, and of course some logic glue (SSI and MSI packages). But getting all the parts to work in unison can be quite tricky unless you know how they work.

Get to know the ALU

Start with the core. The 10800 4-bit ALU slice can perform both binary and BCD arithmetic and logic operations on combinations of one, two or three variables. All 10800 operations are too numerous to list but some commonly used commands include 28 logic, 23 arithmetic and 16 data-routing combinations

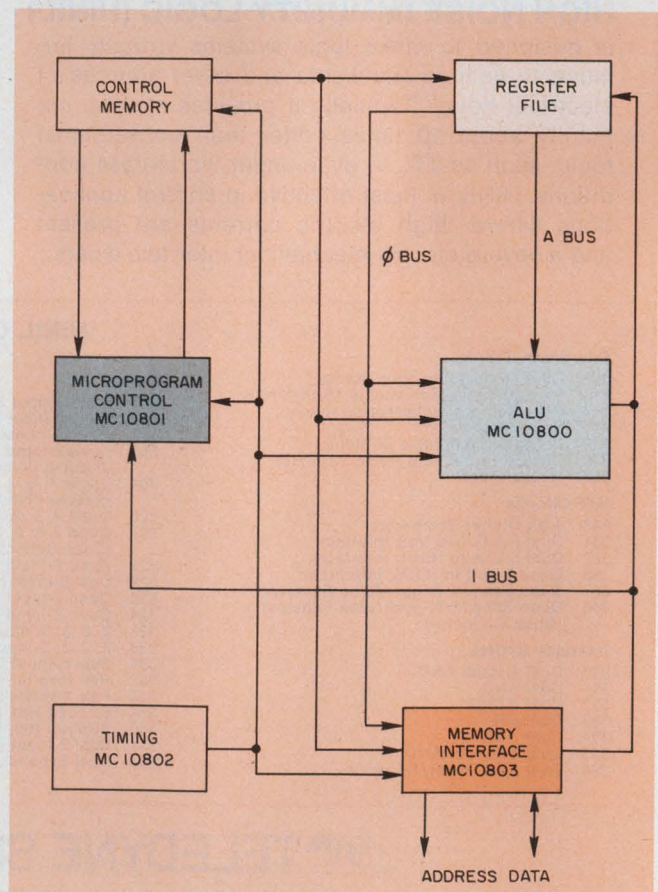

1. With the 10800 series of bit slices, you can build a high-performance microprogrammable processor with instruction times of less than 100 ns.

Tom Balph, Applications Engineer, and Bill Blood, Manager, Bipolar LSI System Engineering, Motorola Semiconductor, Inc., 5005 E. McDowell Rd., Phoenix, AZ 85036.

as shown in Tables 2, 3 and 4, respectively. Housed in a 48-pin quad-in-line package (QUIL), the ALU slice offers a flexible organization (Fig. 2).

There are three 4-bit ports on the 10800: an input-only data bus (A bus) and two bidirectional buses (\emptyset and I buses). The A and \emptyset buses are the primary data-entry ports, and the I bus is the main output bus. Accepting data from the A bus, \emptyset bus and/or the internal accumulator, the ALU performs its operations under the direction of 17 selection and control lines.

The three buses and select lines account for 29 pins on the 10800. Another eight pins are required for power (four for grounds, two for -2 V and two for -5.2 V). Five additional lines provide ALU-status outputs, another line is for the clock input, one more for the carry input, and two for parity outputs (one for the carry parity and one for the result parity). And two more control the shift-left/shift-right operation of the ALU's output-shift register. Shifting is possible for the A or \emptyset bus as well as the accumulator. Also various add or subtract/shift combinations can be performed by using the shift network with the ALU.

Whether the ALU does binary or BCD arithmetic, the speed of the operation remains the same: A 9's-complement circuit is built in and automatically

enabled whenever BCD operations are performed. In addition, only one line, AS11, must change state to switch operating modes (see Table 2).

A masking multiplexer on the chip precedes the ALU and performs bit manipulations on incoming data. An on-chip accumulator can hold data for ALU

Table 1. M10800 components & support

Part number	Description	100-qty prices
M10800	Arithmetic and logic unit	\$30.00
M10801	Microprogram sequencer	50.00
M10802	Timing function and clock controller	15.00
M10803	Memory-interface circuit	40.00
M10804	Bidirectional bus translator (ECL/TTL)	3.75
M10805	Bidirectional bus translator (ECL/TTL)	4.50
M10806	Dual-port address register (32 x 9)	62.00
M10808	Multibit shifter	25.00
MCM10143	Multiport RAM (8 x 2)	9.90
MCM10145	Single-port RAM (16 x 4)	5.90
MCM10146	Single-port RAM (1 k x 1)	15.60
MCM10149	ECL PROM (256 x 4)	22.00
MC10176	Hex. master-slave flip-flop	4.70
MC10179	Look-ahead carry generator	3.30

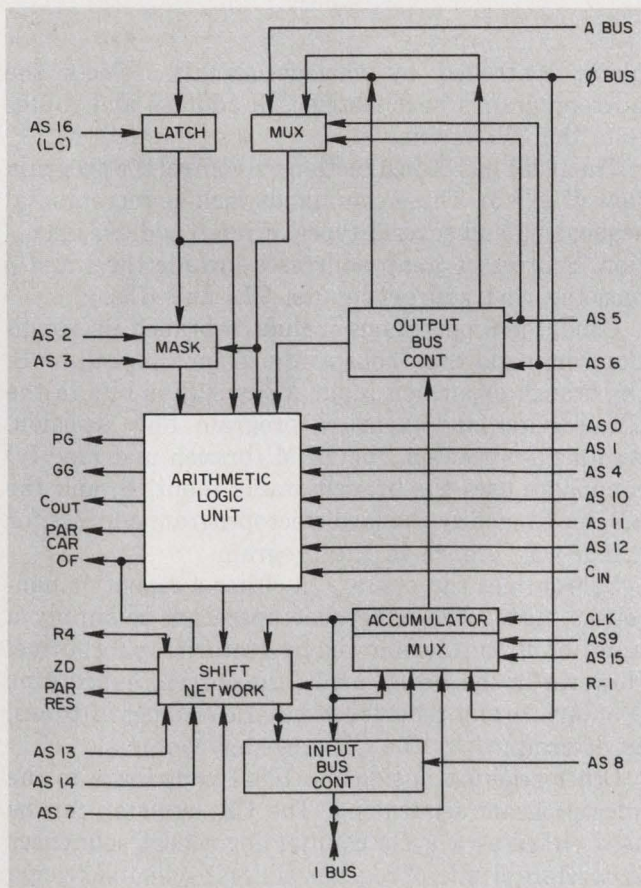

2. Capable of 28 logic and 23 arithmetic operations as well as 16-data-routing options, the M10800 4-bit ALU slice can form the heart of a flexible computer system.

Table 2. Basic ALU logic commands

Y MUX		X MUX		INV	ACC	Function
AS0	AS1	AS2	AS3	AS10	AS5-AS6	
0	1	0	1	1	0	Logic 0
0	0	1	0	1	0	A
0	0	0	1	1	0	\emptyset
0	0	1	0	0	0	\bar{A}
0	0	0	1	0	0	$\bar{\emptyset}$
0	0	1	1	1	0	$A + \emptyset$
0	1	0	0	0	0	$A + \bar{\emptyset}$
1	0	0	0	0	0	$\bar{A} + \emptyset$
0	0	0	0	1	0	$A \cdot \emptyset$
0	1	1	1	1	0	$A \cdot \bar{\emptyset}$
0	1	0	0	1	0	$\bar{A} \cdot \emptyset$
0	1	1	0	1	0	$A \oplus \emptyset$
0	1	1	0	0	0	$\bar{A} \oplus \emptyset$
0	0	0	0	0	0	$\bar{A} \cdot \bar{\emptyset}$
0	0	1	1	0	0	$A + \emptyset$
0	1	0	1	0	0	Logic 1
1	0	1	0	1	1	$ACC \cdot \bar{A}$
0	1	0	1	1	1	$ACC \cdot \bar{\emptyset}$
1	0	1	0	0	1	$ACC + A$
0	1	0	1	0	1	$ACC + \emptyset$
0	0	1	0	1	1	$ACC \oplus A$
0	0	1	0	0	1	$ACC \oplus \bar{A}$
0	0	0	1	1	1	$ACC \oplus \emptyset$
0	0	0	1	0	1	$ACC \oplus \bar{\emptyset}$
0	0	0	0	1	1	$ACC \oplus A \cdot \emptyset$
0	0	0	0	0	1	$ACC \oplus \bar{A} \cdot \bar{\emptyset}$
0	0	1	1	1	1	$ACC \oplus A + \emptyset$
0	0	1	1	0	1	$ACC \oplus A + \bar{\emptyset}$

Table 3. ALU arithmetic operations

Y MUX		X MUX		± 2	Comple- ment	ACC	Binary function (plus C_{IN})	BCD function (plus C_{IN})
AS0	AS1	AS2	AS3	AS4	AS10	AS5-AS6	AS11 = 1	AS11 = 0
1	0	0	1	1	1	0	A plus \emptyset	A plus \emptyset
1	0	0	1	1	0	0	A plus $\overline{\emptyset}$	A plus 9's comp. \emptyset
0	1	1	0	1	0	0	\emptyset plus \overline{A}	\emptyset plus 9's comp. A
0	0	1	0	1	1	0	A	A
0	0	0	1	1	1	0	\emptyset	\emptyset
0	0	1	0	1	0	0	\overline{A}	9's comp. A
0	0	0	1	1	0	0	$\overline{\emptyset}$	9's comp. \emptyset
1	1	1	0	1	1	0	-1 plus A	*
1	1	0	1	1	1	0	-1 plus \emptyset	*
1	1	1	0	0	1	0	-2 plus A	*
1	1	0	1	0	1	0	-2 plus \emptyset	*
0	0	1	0	0	1	0	+2 plus A	+2 plus A
0	0	0	1	0	1	0	+2 plus \emptyset	+2 plus \emptyset
1	0	1	0	1	1	0	A plus A	A plus A
0	1	0	1	1	1	0	\emptyset plus \emptyset	\emptyset plus \emptyset
0	0	1	0	1	1	1	ACC plus A	ACC plus A
0	0	0	1	1	1	1	ACC plus \emptyset	ACC plus \emptyset
0	0	1	0	1	0	1	ACC plus \overline{A}	ACC plus 9's comp. A
0	0	0	1	1	0	1	ACC plus $\overline{\emptyset}$	ACC plus 9's comp. \emptyset
0	0	0	0	1	1	1	ACC plus A· \emptyset	ACC plus A· \emptyset
0	0	0	0	1	0	1	ACC plus \overline{A} · \emptyset	ACC plus 9's Comp. A· \emptyset
0	0	1	1	1	1	1	ACC plus A+ \emptyset	*
0	0	1	1	1	0	1	ACC plus \overline{A} + \emptyset	*

*Not defined in BCD

operations. The I and \emptyset ports are connected to both the ALU and accumulator thus increasing data processing flexibility. With the accumulator, A bus and \emptyset bus as operands, any of the functions listed in Tables 2, 3 or 4 can be performed in one pass through the circuit.

The status-output lines from the 10800 include the carry-propagate and carry-generate signals for look-ahead carry operations. A carry-output signal is available when slices are cascaded, without carry look ahead. And also available are an overflow output used only for binary operations for indicating when the maximum output from the ALU has been exceeded, and a zero-detect line for indicating when an all-zero condition exists in the output of the ALU shift network. The overflow output can also be used to detect sign changes that stem from a shift operation.

Manipulate the ALU with the microprogram

When a processor is built from 10800 ALU slices, a microprogram selects an ALU operation every clock cycle. The 10801 controller (Fig. 3) determines the next microprogram memory location to be addressed. It performs incremental sequencing, handles jumps, conditional branches, subroutines and repeat loops.

Inside the chip, the control-memory-address register (CR₀) holds the microprogram address that accesses the next instruction. A next-address logic

block, controlled by various signals, selects the microprogram's next instruction address and routes it to the CR₀ inputs.

The 10801 has 16 instructions to control the program flow (Table 5). These commands include incremental sequencing and several types of jump address operation. Sources of jump addresses include the I and \emptyset bus, the next address inputs, CR₁ and CR₂.

Conditional operations include a branch on condition command that looks at the branch input line B, the branch expansion input \overline{XB} or status bits in the CR₃ register and makes a program flow decision. Another instruction, the BRM (branch and modify) command, uses the branch status input, B, and the \overline{XB} line to modify the next microprogram address for a four-way branch in the program.

Subroutines can operate in either a repeat or non-repeat mode. The nonrepeat operation is simply a jump to subroutine followed by a return to subroutine. However in the repeat mode, the current subroutine is automatically repeated a specific number of times, as determined by the CR₁ register contents.

Other registers inside the 10801 contribute to the microprogram sequencing. The CR₁ register can be used either as a cycle counter for repeat sequences or to store a microprogram address when servicing interrupts. Register CR₂ can hold a machine-instruction starting address or an interrupt vector for microprogram flow jumps.

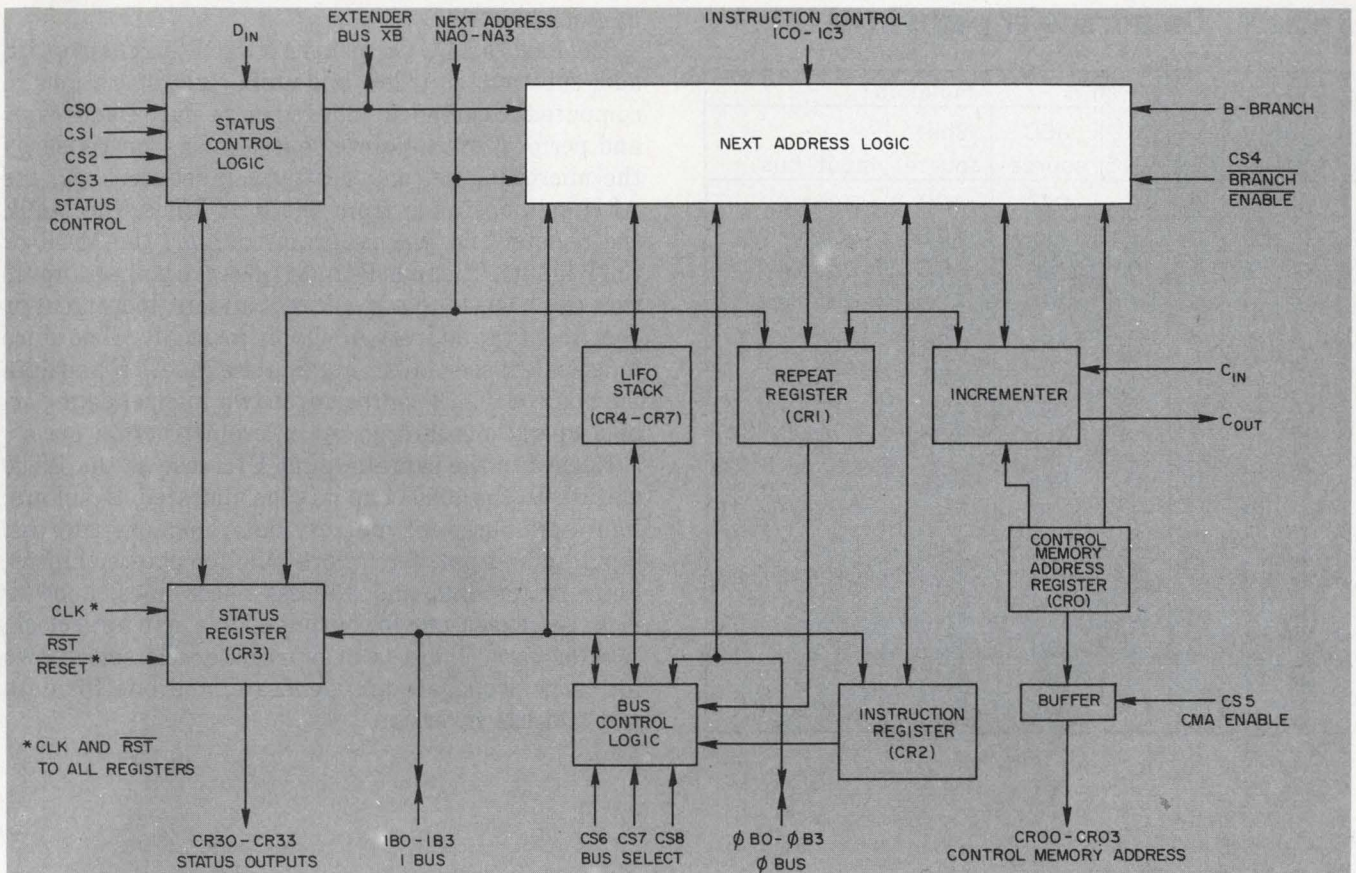

3. Controlling the microprogram addressing, the M10801 microprogram sequencer generates the next address and

has a repertoire of 16 program-flow commands. It provides a 4-bit section of the address.

The CR₃ register stores the status bits for conditional program jumps. These bits are most often external signal lines, such as interrupts or test points.

Sometimes, the ALU's condition-code bits are held in CR₃, but usually they are stored in a separate register controlled by the microprogram. Select lines CS₀, CS₁, CS₂ and CS₃ control the CR₃ status register and permit it to store or read individual bits. All status conditions are available as outputs.

Another bank of four registers, CR₄ to CR₇, forms a last-in, first-out (LIFO) stack to next subroutines. Controlled by the next-address logic block, the stack can be extended through the \emptyset port bus with external memory. Also, should an emergency power-down or priority interrupt be signaled, all the register's contents can be "dumped" through the \emptyset or I bus ports. The reverse data flow is also possible—all registers can be loaded through the same ports.

The 10801 provides a 4-bit section of the microprogram address, and any number of controllers can be cascaded. For instance, two 10801s can control 16 pages of 256 words. One of the available CR₃ registers makes a handy page-address register while the other available CR₃ register can be used to hold status information. Larger systems might use three 10801s to address up to 4096 words directly or 16 pages of 4096 words each.

The 10801 has five I/O ports—the CR₀, CR₃, I bus, \emptyset bus and NA inputs—which account for 20 of the

48 pins on the QUIL package. Another nine pins are used for the select lines, four more are the instruction inputs, and eight are needed for power and ground. Two more pins form the carry-in and carry-out lines for cascading, one is for the clock input and four take care of other control functions.

Main memory also needs a controller

To generate main memory addresses for any 10800-based system, the 10803 I/O controller interfaces to the main memory and peripherals via the address and data buses. I and \emptyset bus ports interface to the other system components. A memory-data register inside the 10803 chip (Fig. 4) holds incoming or outgoing data, and a memory-address register (MAR) holds outgoing information. A 4 × 4 register file can be used as a program counter, a stack pointer, an index register or other related functions. Its output feeds into the simple ALU or into the multiplexer input to the memory-address register.

A data-matrix block controls the transfer of data between various internal registers and I/O ports. Seventeen data-transfer operations are possible (Table 6a and b), and they are controlled by inputs MS₀ to MS₃, MS₅ and MS₁₄. The MS₁₄ line permits any combination of positive and negative logic formats by inverting any data on the data and address buses. Once selected, any transfer can be performed within one

Table 4. Data-transfer paths in ALU

AS7	AS8	AS9	AS15	Function		
				ACC source	Shift source	Input bus
0	0	0	0	RES	ACC	Disable
0	0	0	1	ØB	ACC	Disable
0	0	1	0	IB	ACC	Disable
0	0	1	1	ACC	ACC	Disable
0	1	0	0	RES	ACC	ACC
0	1	0	1	ØB	ACC	RES
0	1	1	0	IB	ACC	RES
0	1	1	1	ACC	ACC	RES
1	0	0	0	RES	F _{OUT}	Disable
1	0	0	1	ØB	F _{OUT}	Disable
1	0	1	0	IB	F _{OUT}	Disable
1	0	1	1	ACC	F _{OUT}	Disable
1	1	0	0	RES	F _{OUT}	ACC
1	1	0	1	ØB	F _{OUT}	RES
1	1	1	0	IB	F _{OUT}	RES
1	1	1	1	ACC	F _{OUT}	RES

microinstruction.

The 10803's ALU performs AND, OR, Exclusive-OR, add, subtract, shift-left and shift-right operations to compute the extended, indexed and relative addresses and perform stack-pointer operations. Controlled by the microfunction and destination-decode logic, the ALU gets operands from the Ø or I bus, the MDR, the register file, the program counter, the MAR or the P inputs. The four P-input lines are pointer inputs that can be used to add address offsets, increment or decrement the address, or supply mask bits. And since independent select lines manipulate the ALU and data matrix, the 10803 can perform two independent parallel operations during one microinstruction cycle.

Housed in the same 48-pin QUIL case as the 10800 and 10801, the 10803 has its pins allocated as follows: four 4-pin buses for memory data, memory address, input and output, four more pins for pointer inputs, 11 more for data and address-select lines, another eight for power, one for output enable, one for a clock, two for carry lines, two for register-file select, two for carry propagate and generate, and one for data and address inversion.

Table 5. Program-flow commands for the 10801 controller

Mnem	Code				Description	Reset RST	Branch or repeat condition	CRO	CR1	CR2	LIFO stack CR4-CR7
	IC3	IC2	IC1	IC0							
X	X	X	X	X	Reset condition	0	X	0	0	0	"Push" CRO to stack
INC	1	1	0	0	Increment	1	X	CRO plus C _{in}	—	—	—
JMP	0	0	1	0	Jump to next address	1	X	NA	—	—	—
JIB	1	0	0	0	Jump to I Bus	1	X	IB-NA	—	—	—
JIN	1	0	0	1	Jump to I Bus & Load CR2	1	X	IB-NA	—	IB	—
JPI	1	0	1	0	Jump to primary inst.	1	X	CR2-NA	—	—	—
JEP	1	1	1	0	Jump to external port	1	X	ØB-NA	—	—	—
JL2	0	0	0	1	Jump & load CR2	1	X	NA	—	IB	—
JLA	0	0	1	1	Jump & load address	1	X	NA	CRO plus C _{in}	—	—
JSR	0	0	0	0	Jump to subroutine	1	Repeat	NA	—	—	"Push" CRO to stack
						1	Nonrepeat	NA	—	—	"Push" CRO plus C _{in}
RTN	1	1	1	1	Return from subroutine	1	Repeat	CR4	CR1 plus C _{in}	—	"Pop" stack to CRO
						1	Nonrepeat	CR4	—	—	"Pop" stack to CRO
RSR	1	1	0	1	Repeat subroutine	1	X	CRO plus C _{in}	NA	—	—
RPI	1	0	1	1	Repeat instruction	1	Repeat	—	CR1 plus C _{in}	—	—
						1	Nonrepeat	CR1-NA	—	—	—
BRC	0	1	0	1	Branch on condition	1	Branch = 1	NA	—	—	—
						1	Branch = 0	CRO plus C _{in}	—	—	—
BSR	0	1	0	0	Branch to subroutine	1	Branch = 1	NA	—	—	"Push" CRO plus C _{in}
						1	Branch = 0	CRO plus C _{in}	—	—	—
ROC	0	1	1	1	Return on condition	1	Branch = 1	CR4	—	—	"Pop" stack to CRO
						1	Branch = 0	NA	—	—	—
BRM	0	1	1	0	Branch & modify	1	CS4=1	NA	—	—	—
						1	CS4=0	CRO=NA0-B CRO1=NA1-XB CRO2=NA2 CRO3=NA3	—	—	—

To get all the blocks to work in unison, the 10802 timing function circuit generates up to four clock phases from a single-phase oscillator input. It also allows for system starts and stops, and has a single-step control for diagnostic purposes. Both the number of clock phases and their duration are programmable through seven select lines.

Synchronize all the logic blocks

The 10802 is housed in a 24-pin DIP with seven pins for the select inputs, four for the phase outputs, three for power, one for the clock input and nine for controls. Several timing circuits can be cascaded if more than four clock phases are needed. The 10802 can also be programmed to compensate for one slow path without slowing down the faster sections by doubling the duration of any clock phase.

At this point, getting all the parts to work together is a matter deciding on word length, system architecture and microprogramming structure. A generalized 16-bit minicomputer architecture, based on the 10800 series, is shown in Fig. 5. The system uses a pipelined architecture to keep the cycle time as fast as possible.

The actual fetch and execution of a microinstruction are accomplished in two clock cycles. The next instruction is being fetched while the current instruction is being executed.

A microprogram control cycle consists of addressing the microprogram memory, setting up a new address (through the I and NA fields) and clocking the new address to the 10801's CR₀ register, which starts the cycle all over again. During the control cycle, new data-processing and memory interface operations are accessed and clocked into the pipeline register. A status-field, also held in the pipeline register, is used to select branch conditions, update interrupt status, and reset the system, among other functions. The number of microprogram memory bits is minimized by decoding the various fields from the microprogram memory.

Before setting up a microcode to control all these operations, a system architecture and instruction set must be defined. Look at a master-slave system that uses a 6800 microprocessor as a controller and an 8-bit, 10800-based processor to rapidly perform complex mathematical operations (Fig. 6). For more about the 6800, see "Microprocessor Basics: Part 5," ED No. 15,

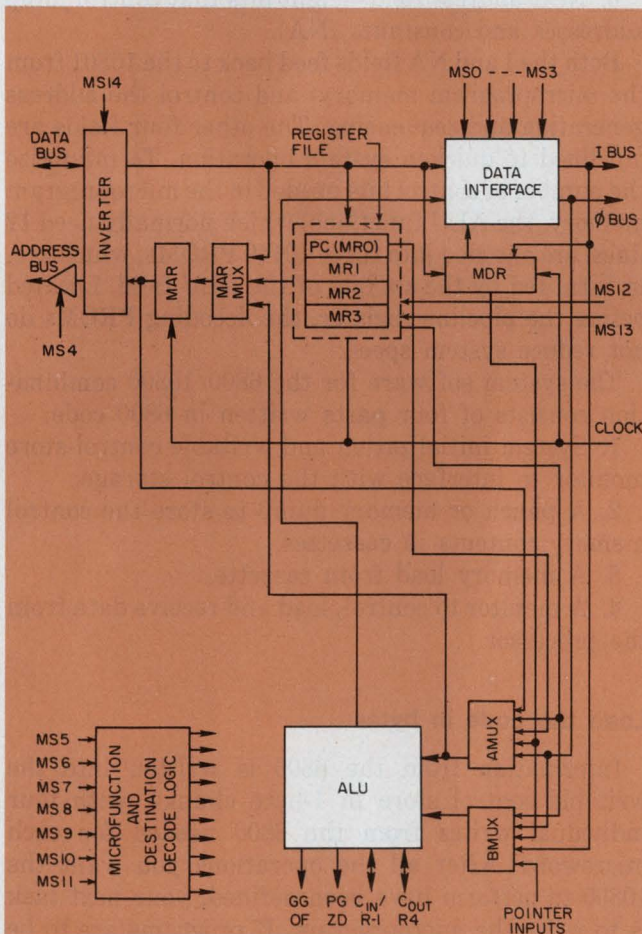

4. Built with five I/O ports, the M10803 memory interface circuit offers very flexible operation along with 17 different data-routing instructions.

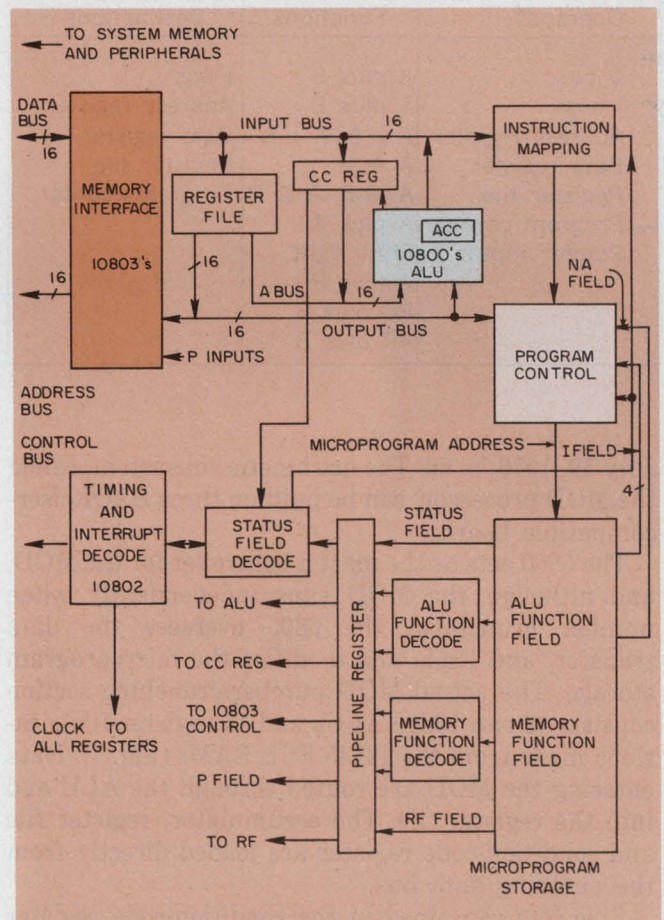

5. A generalized 16-bit minicomputer can be based on the 10800 bit slices. Its pipelined architecture offers the best performance technology can provide.

Table 6. Memory-controller commands

MS 3 2 1 0	MS 5 1 4	Mne- monic	Operation
0 0 0 0	- -	NOP	No operation
0 0 0 1	- -	AIB	ALU to IB
0 0 1 0	- -	ODR	$\overline{\text{DB}}$ to data register
0 0 1 1	- -	ADR	ALU to data register
0 1 0 0	0 0	BRF	$\overline{\text{DB}}$ to register file
	0 1		DB to register file
	1 0	BAR	$\overline{\text{DB}}$ to address register
	1 1		DB to address register
0 1 0 1	- 0	BIB	$\overline{\text{DB}}$ to IB
	- 1		DB to IB
0 1 1 0	- 0	BDR	$\overline{\text{DB}}$ to data register
	- 1		DB to data register
0 1 1 1	- -	IDR	IB to data register
1 0 0 0	- 0	FDB	Register file to DB
	- 1		Register file to DB
1 0 0 1	- 0	RDB	Data register to DB
	- 1		Data register to DB
1 0 1 0	- 0	ODB	$\overline{\text{DB}}$ to DB
	- 1		$\overline{\text{DB}}$ to DB
1 0 1 1	- 0	PTB	Data register to DB; IB to DR
	- 1		Data register to DB; IB to DR
1 1 0 0	- -	FOB	Register file to $\overline{\text{DB}}$
1 1 0 1	- -	ROB	Data register to $\overline{\text{DB}}$
1 1 1 0	- 0	PFB	Data register to $\overline{\text{DB}}$; $\overline{\text{DB}}$ to DR
	- 1		Data register to $\overline{\text{DB}}$; DB to DR
1 1 1 1	- -	MOR	Data register to $\overline{\text{DB}}$; IB to DR

Operands	Functions	Destinations
\emptyset bus	A plus B	I bus
I bus	A plus $\overline{\text{B}}$	Address register
Address register	A · B, A · P	Data register
Data register	A + B	Register file
Register file	A ⊕ B, A ⊕ P	Program counter
Program counter	A plus A	
Pointer inputs	Shift right	
	A plus P	
	PC plus B	
	AR plus B	

July 19, 1976, p. 66. The arithmetic subsystem, called the MOD processor, can be built on three EXORciser-compatible boards.

The 6800 acts as the master controller for the MOD, and although the MOD runs independently when number crunching, the 6800 oversees the data transfer, and loads and modifies the microprogram storage. The actual MOD number-crunching section consists of two 10800 ALUs and 16 register-file locations made from the 10145 ECL RAMs (Fig. 7). Data entering the MOD are routed through the ALU and into the register file. The accumulator, register file and condition-code register are loaded directly from the outgoing data bus.

Five bits contained in the condition-code register are used to indicate the following:

1. Carry output from the most-significant bit of the ALU (C).

2. Two's complement arithmetic overflow (V).
3. Zero detect output of the result (Z).
4. Sign of the result (N).
5. Link bit for shifting (L).

Two 10801s are used to sequence through the microprogram storage. When cascaded, they are connected to generate both an 8-bit word address and a 2-bit page address. The memory is thus organized as four pages of 256 words each. The microprogram memory for the MOD consists of 1024 words of RAM, each 32-bits wide.

This writable control store is built from 32 1-k RAMs (10146s) and is loaded with instructions by the 6800 controller. Each 32-bit word is divided into six fields (Fig. 8):

1. ALU field—six bits that control 61 ALU operations (ALU).
2. Condition-code field—three bits that control eight functions (CC).
3. Register-file field—six bits that hold the register-file address, the register-file write enable and the accumulator write enable (RF).
4. Status field—five bits that contain 31 operations to control branch operations for the 10801, the CR₃ register and page addressing (S).
5. Instruction field—four bits that handle microprogram address functions (I).
6. Next-address field—eight bits that control jump addresses and constants (NA).

Both the I and NA fields feed back to the 10801 from the microprogram memory, and control the address generation and sequencing. The other four fields are pipelined to quicken system operation. To minimize the number of control bits needed in the microprogram memory, the ALU functions, which normally need 12 lines, are encoded into three 10149 PROMs, which are, in turn, fed by the six bits of the ALU field. Located before the pipeline register, the decoding PROMs do not reduce system speed.

The system software for the 6800/10800 combination consists of four parts written in 6800 code:

1. System initialization and writable control-store monitor to interface with the control storage.
2. A punch or memory dump to store the control memory contents in cassettes.
3. A memory load from cassette.
4. A monitor to control, load and receive data from the processor.

Load the code in bytes

Information from the 6800 is written into the writable control store in 1-byte chunks, with four individual writes from the 6800 needed for each microword. After all the operations you want the 10800 to perform have been defined, your next task is to write the microprogram. If programs are to be written by hand, a tabular listing, as shown in Table 7, can simplify the procedures.

Line (1) represents a complete microinstruction in

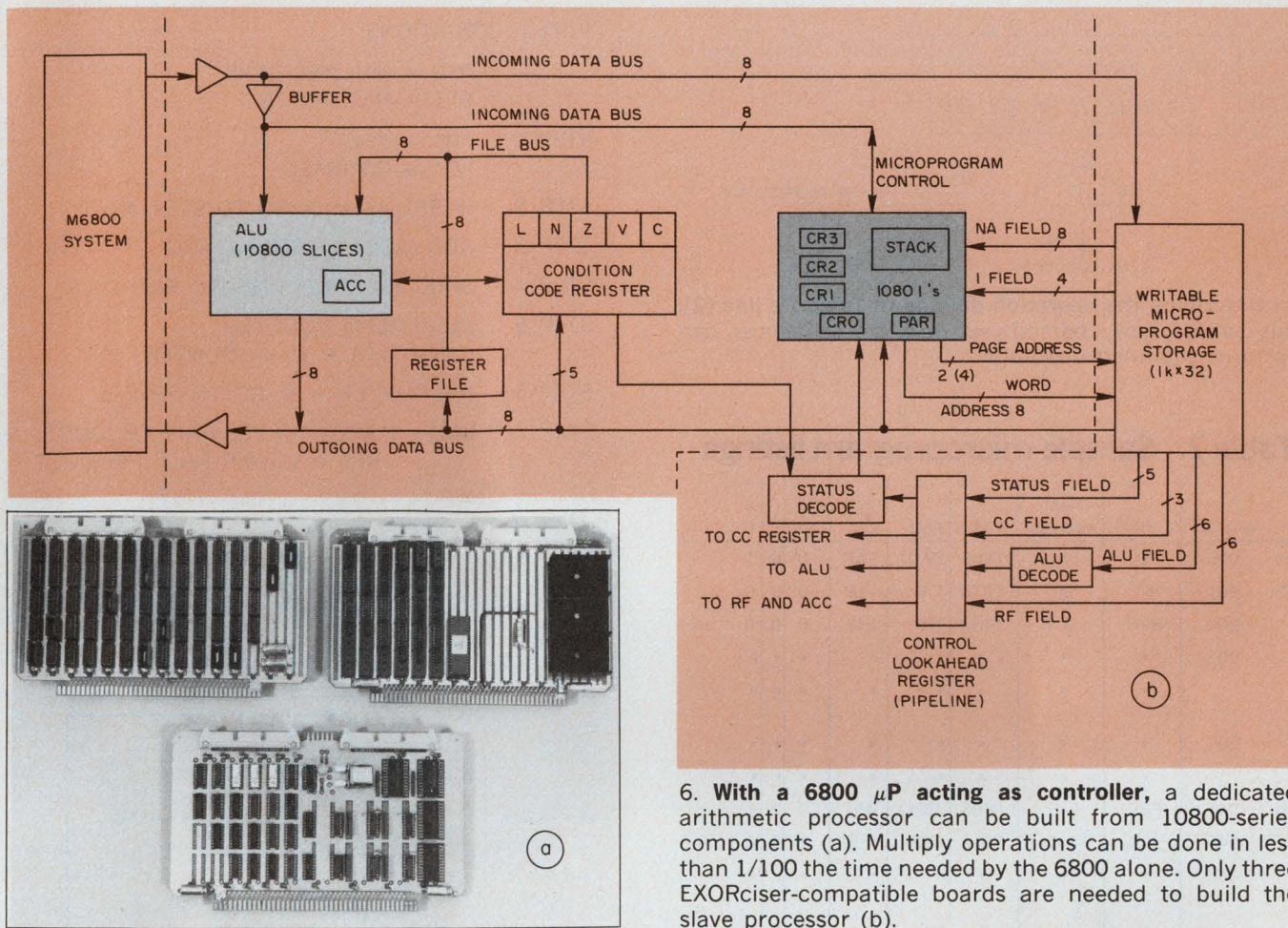

6. With a 6800 μ P acting as controller, a dedicated arithmetic processor can be built from 10800-series components (a). Multiply operations can be done in less than 1/100 the time needed by the 6800 alone. Only three EXORciser-compatible boards are needed to build the slave processor (b).

mnemonic form. Each of the field columns defines an operation performed by the microword: INC—increment address; X—don't care for next address; INHS—inhibit status; BADA—binary-add register field and accumulator; LAR—load Z, N, C and V condition-code bits; RFB—register B; FE=0—disable register-file write; and AE=1—enable accumulator write. In “English” the microword tells the machine to increment the address, add register B to the accumulator with the result returned to the accumulator, and load all condition-code bits except the link bit.

The second line of the program, (2), continues the instruction at address 000 to the instructions at addresses 001 and 002. A register-file-add-to-accumulator instruction given in address 000 is followed by a branch operation at address 002 (Fig. 9). The I-field address advances to 002. If N equals 1 the branch occurs, and advances the address to 00F, as specified by the NA field. If N equals 0, a simple increment instruction is performed.

A more complex example is an 8 x 8-bit binary magnitude multiply. For this example let the contents of RF₀ be the multiplicand and RF₁ be the multiplier. The 16-bit product will be stored with the eight MSBs in the accumulator and the lower eight bits in RF₁. To perform the multiplication, use an add-shift algorithm that repeats eight times (Fig. 12). The initial

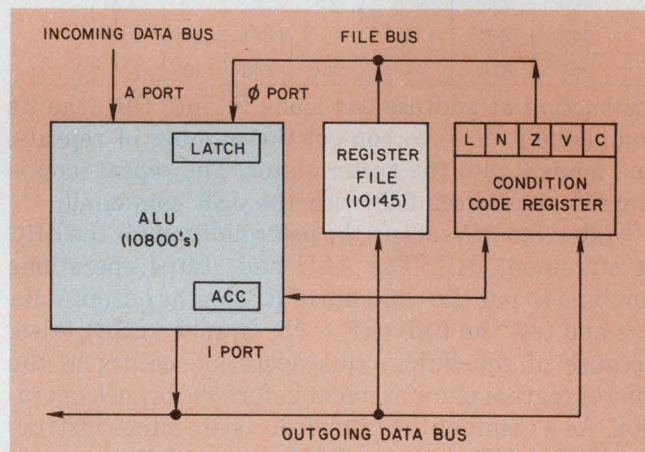

7. The data-processing section of the MOD boards consists of an 8-bit ALU, a 16 x 8 register file and a condition-code register.

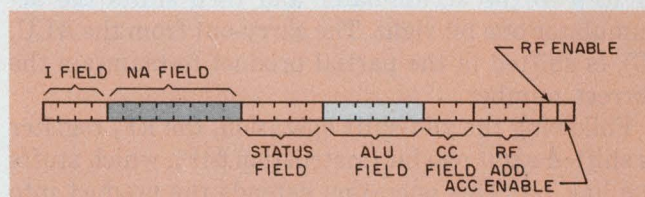

8. The microinstruction that controls MOD operation is subdivided into six fields that control smaller sections of the processor.

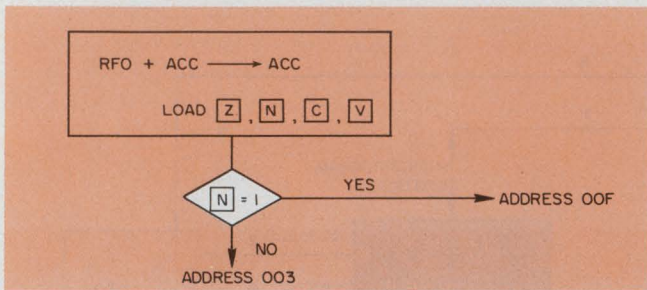

9. Describing the operation defined in Table 7's line (2), this simple flow chart shows how the sequencer can perform a branch operation.

Table 7. Sample microprogram listings

A d d ₁₆	I. field	Next address	Status	ALU	CC	RF add	F E	A E
(1) 000	INC	X	INHS	BADA	LAR	B 0	0 1	
(2) 001	INC	X	TSTN	TIB	IHB	0 0	0 0	
002	BRC	∅ F	INHS	TIB	IHB	0 0	0 0	
003
00F
(3) 044	RSR	F 8	INHS	ZERO	IHB	0 0	0 1	
045	JSR	4 C	TSLs	TRF	IHB	1 0	0 0	
046
04C	BRC	4 E	INHS	TIB	IHB	0 0	0 0	
04D	JMP	4 F	INHS	LSRA	LDA	0 0	0 1	
04E	INC	X	INHS	ACSR	LDA	0 0	0 1	
04F	RTN	X	INHS	RORF	IHB	1 1	0 0	

instruction at address 044 loads F8 into CR₁ (the 2's complement of 8) to control the number of repeats, and loads 0 into the accumulator. The repeat loop is started at address 045 with the JSR command.

Statement 045 sets up the test condition for the BRC at statement 04C. The ALU and status operations combine to put the contents of RF₁ on the output-data bus and test the LSB (RF₁ → ∅B, Branch=LSB). Also, because of pipelining, this operation occurs in the microprogram one statement before the branch operation. As a result of the branch decision, either instruction 04D or 04E is executed. If 04D is used, the contents of the accumulator are shifted one bit to the right, which is the same as adding zero to the accumulator and then shifting. Instruction 04E adds the contents of RF₀ to the accumulator and then shifts the accumulator one bit right. The carry-out from the ALU, (C), is shifted in the partial product to maintain the correct number.

Following the add-shift operation, the RF₁ register is shifted right one bit (instruction 04F), which stuffs the link bit. This operation extends the product into RF₁ by one bit and moves the next multiplier bit into position for the next iteration. After the final iteration, the program jumps to 046. A more complex

INITIAL CONDITIONS:

RF0 = MULTIPLICAND
RF1 = MULTIPLIER

- STEP 1 "0" → ACC
"0" → COUNTER
- STEP 2 IF RF₁LSB = 0, GO TO STEP 4
- STEP 3 ADD (ACC) + (RF0) → ACC
- STEP 4 SHIFT (ACCRF1) ONE BIT RIGHT
- STEP 5 INCREMENT COUNTER,
(COUNTER) + 1 → COUNTER
- STEP 6 IF COUNTER ≠ 8, GO TO STEP 2
- STEP 7 END | ACC = UPPER HALF PRODUCT
RF1 = LOWER HALF PRODUCT

(a)

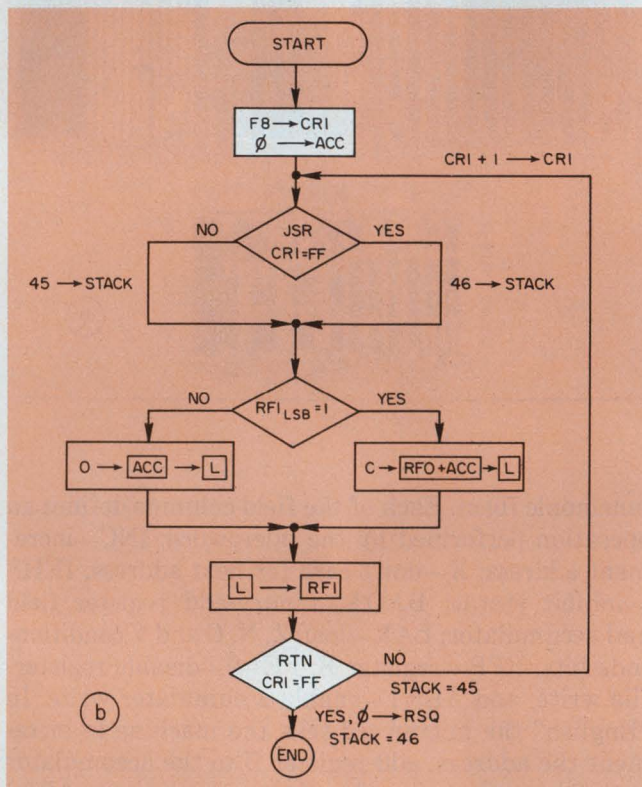

(b)

10. To perform an 8 × 8-bit multiply operation, a simple add and shift routine can be written and iterated eight times (a). The same routine can be expressed in flow-chart form (b).

example is a full floating-point, single-precision multiply operation with two 32-bit numbers that have an 8-bit sign and exponent and a 24-bit mantissa. With a 10 MHz clock the MOD processor needs 37.6 μs to perform the operation—less than 1/100 the time of an equivalent software multiply in the 6800. ■■

Previous articles in this series discussed the 8080, F8, 6800, 2650, 1802, 6100, PACE, SC/MP, Series 3000 and Series 2900. The next article in the series will cover the Z80.

The Mallory Capacitor Help-Force.

Everything to make buying easier for you.

The Help-Force is what we call our expanded product, sales and full-service organization. It's organized to make your job easier and free you from time-consuming details in getting the capacitors you need.

Now you can place your large or customized orders with our OEM direct sales force. Or get immediate off-the-shelf delivery through our authorized Mallory distributors.

Whichever way you choose, use our

headquarters services, too, to get the status of your production order at the same time; or on-the-phone price and delivery quotations. And if you have unusual applications, call our product managers. They can recommend the right capacitors to meet your needs.

The Mallory Help-Force can help you on a worldwide basis, too. We have distributors almost everywhere. So if you buy capacitors for overseas manufacturing, let us fill your needs either by direct shipment or through an authorized Mallory distributor.

Let the Mallory Help-Force take some of the weight off your shoulders. Call your local Mallory sales representative. Or Help-Force headquarters at (317) 856-3731.

Mallory Capacitor Company, a division of P. R. Mallory & Co. Inc. Box 1284, Indianapolis, Indiana 46206.



MALLORY

We not only wrote the book,

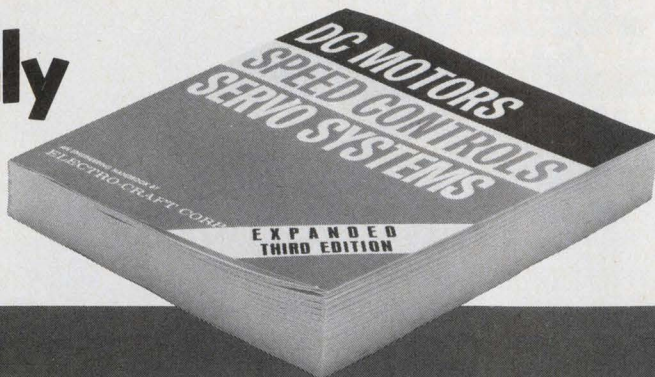

SPEED CONTROLS

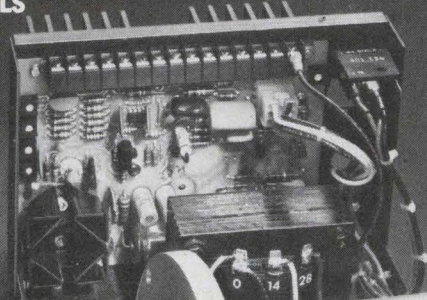
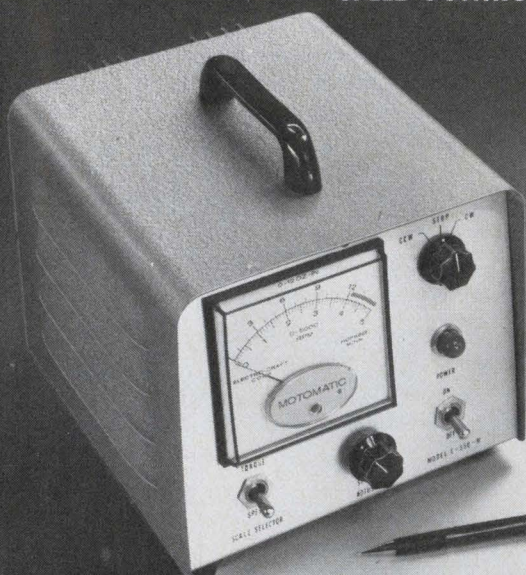

DC MOTORS

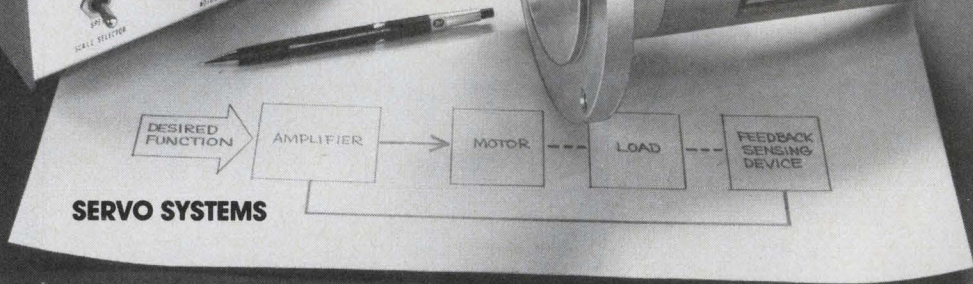
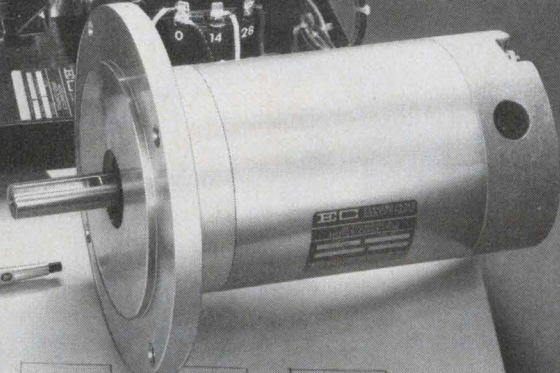

SERVO SYSTEMS

we make the products, too.

The "bible" of the industry. Over 35,000 now out in use. In its third edition. And Electro-Craft wrote the book.

That's expertise. And our products reflect it. Over 100 different products. And 300 different applications that we know of for sure. We stake our reputation on every product. A reputation earned by 16 years of innovation, reliability and integrity. That's a lot of years of experience in a

young dynamic industry like ours.

You can put this expertise to work for you. In custom designs or off-the-shelf standards. One unit or thousands. You get our service both ways. Just give us a call at (612) 935-8226.

If by chance you don't have the Electro-Craft Handbook shown here, a \$10.00 value, just send us your business card and \$1.00 to cover handling and postage. (Overseas \$5.00)



ELECTRO-CRAFT CORPORATION

1608 Second Street South, Hopkins, Minn. 55343 • Tel. (612) 935-8226

ANOTHER VINTAGE YEAR FOR CHERRYS

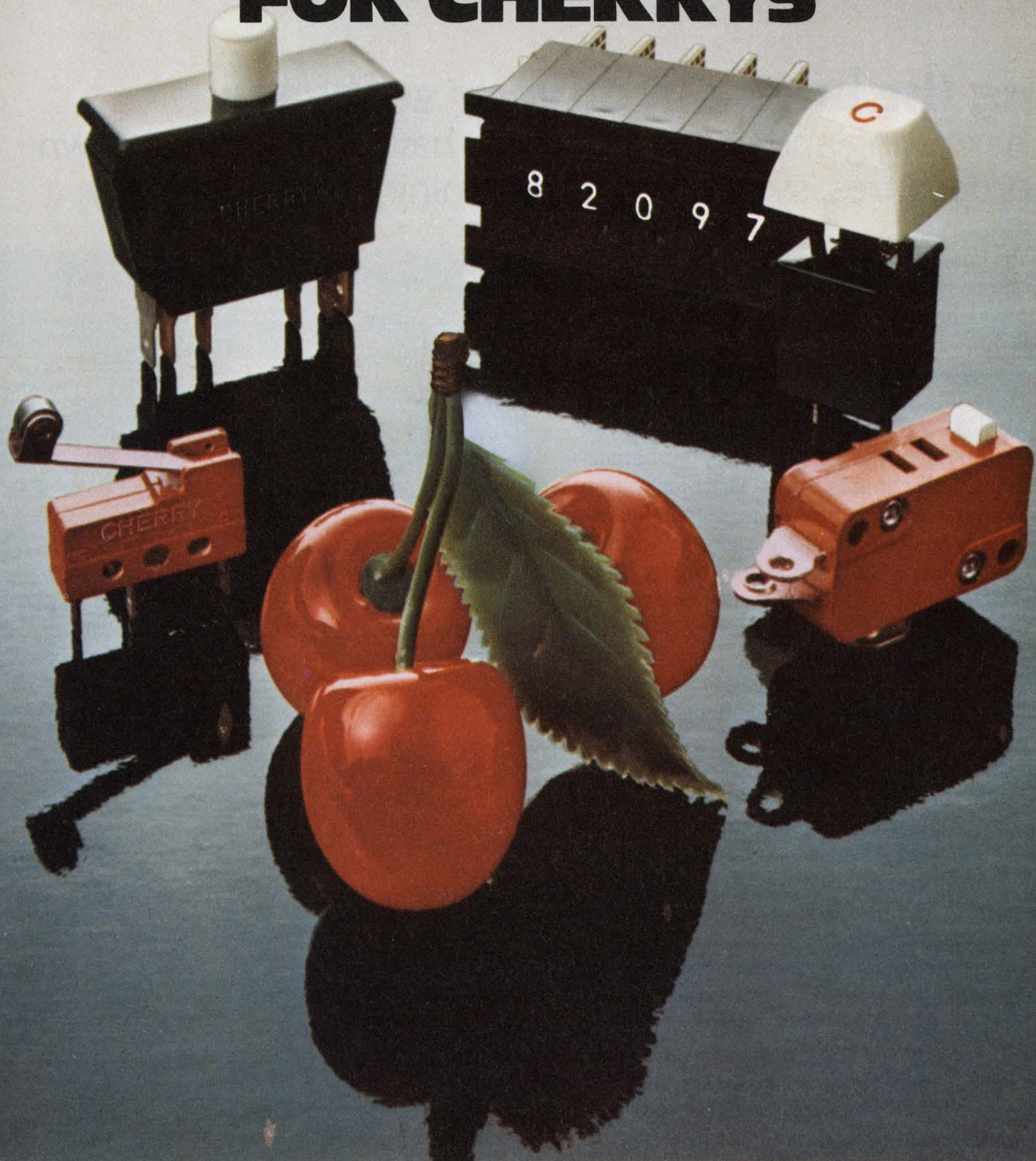

We planted the seeds for these Cherrys 25 years ago. Today they're the pick of the switching crop. Good, sturdy, hardworking switches with years of know-how, experience and refinement behind them . . . and a bright future ahead.

What kinds of switches? You name it, Cherry's got it. Snap-action switches with unique Cherry coil spring mechanism for long mechanical life. Gold crosspoint contact switches for low energy solid state circuits. Thumbwheel switches in a full range of alphanumeric readouts and output codes. Individual keyboard switches and complete keyboard assemblies with electronics. Rotocode® switches . . . a new rotary switch with coded electrical output.

If your products are made or sold overseas you'll be glad to know that Cherry's switches are available worldwide from our modern manufacturing plants in the USA, England, Germany and Japan and a licensee in Australia. All our switches have passed rigid performance requirements of independent testing laboratories. Many of our switches have been listed, certified or approved by various international testing and approval agencies.

Check the complete crop of Cherry switches. Ask for our latest 84 page catalog. For immediate action just phone (312) 689-7700.

CHERRY



CHERRY ELECTRICAL PRODUCTS CORP.
3609 Sunset Avenue, Waukegan, Illinois 60085

CIRCLE NUMBER 36

SWITCHES and KEYBOARDS — Available locally from authorized distributors.

See Us At NCC/Dallas, June 13-16, Booths 1768-1774



Getting the bugs out of your software

can be harrowing and costly. But if you have followed top-down design procedures, systematic testing minimizes your agony.

You have designed a software system, including its algorithms, subroutines, I/O routines and interrupt services. All you have to do now is put it together.

All? Knock on wood. The final steps, testing and debugging, are often blamed for schedule slips and cost overruns. Sometimes it seems as if the last 5% of the job takes 95% of the effort. However, if you have used the top-down design procedure and structured programming techniques (Fig. 1), your system should go together with few problems. Nevertheless, even the best planned design will have some bugs, and you must eliminate them by systematically synthesizing, testing and documenting your program.

A good layout is half the battle

A well written program is recognizable by its looks. When all the modular blocks and subroutines are arranged in the final program ("source listing"), it should resemble the format shown in Fig. 2. The program header is a comment field that summarizes the program's vital statistics. It includes the name of the program, the date and current revision status, where the program is to be used, and comments on memory and I/O requirements.

Symbolic constants follow the header. They include pseudo-instructions that define immediate data, memory reference addresses, and I/O port names. Next come the storage definitions for reserved program storage, followed by branch isolation tables that define jumps to internal branches and I/O routines.

The main program follows, but in modular-design it often contains nothing but initialization and a bunch of subroutine calls. The main program's subroutines are arranged in order of decreasing complexity. Routines called by the main program should come first, then routines called by the first set and so on, down to the most elementary blocks. The organization of the program proper (main program plus subroutines) establishes the order for testing and debugging. After the program, data tables are listed and identified.

When laying out a source program, use comments liberally so that you can instantly identify any pro-

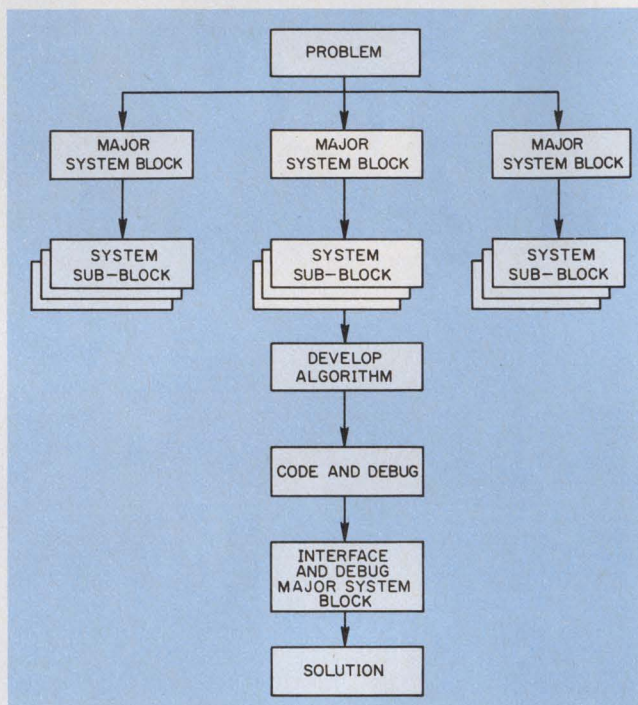

1. In top-down design the complete program is broken down into blocks and sub-blocks that can be coded and tested easily.

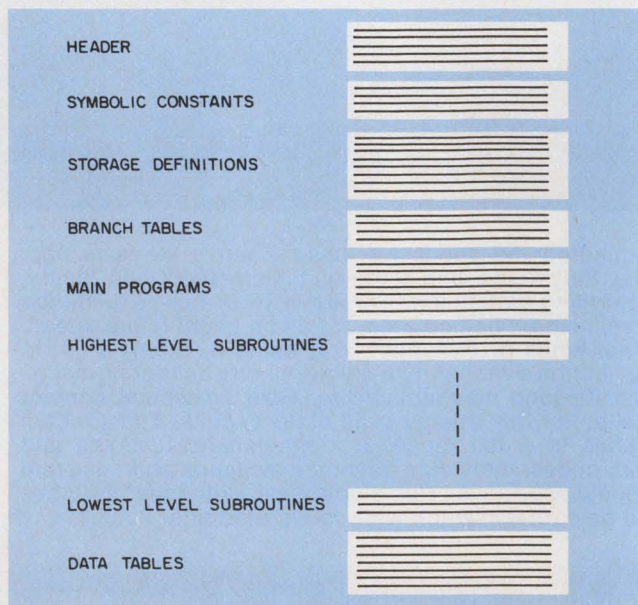

2. A well written program follows an established layout, like the courses in a menu.

Robert W. Ulrickson, President, Logical Services Inc., 711 Stierlin Rd., Mountain View, CA 94043.

0000		
00FF	R/W	CPU INTERRUPTS AND RESERVED AREAS
0100		
01FF	R/W	RESERVED STORAGE AREA
0200		
03FF	R/W	SCRATCH STORAGE AREA
0400		
0400	R/W	TRANSIENT PROGRAMS
3FFF		
BFFF	NOT USED	
C000		
FFFF	R/O	RESIDENT PROGRAMS

0000		
00FF	R/W	CPU INTERRUPTS AND RESERVED AREAS
0100		
01FF	R/W	RESERVED STORAGE AREA
0200		
03FF	R/W	SCRATCH STORAGE AREA
0400		
0400	R/W	TRANSIENT PROGRAMS
3FFF		
4000		
6FFF	R/W	RESIDENT PROGRAMS
7000		
FFFF	NOT USED	

0000		
00FF	R/O	CPU INTERRUPTS AND RESERVED AREAS
0100		
0100	R/O	RESIDENT PROGRAM
3FFF		
4000		
40FF	R/W	RESERVED STORAGE AREAS
4100		
4100	R/W	SCRATCH STORAGE AREAS
43FF		

3. **Memory maps stake out the needs** of various program segments (top). Maps for systems without read-only memory (center), or production-oriented systems (bottom) are two possible variants.

gram area by scanning the source listing. The following skeleton of a source listing in 8080A assembly language is laid out according to the format just described.

HEADER

```
;SAMPLE PROGRAM STRUCTURE, REV. 0.0
```

```
;RELEASE DATE:
;PROGRAMMER:
```

```
;SYMBOLIC CONSTANTS
```

```
;ASCII CHARACTERS
```

```
CR      EQU 0DH      ;ASCII CARRIAGE RETURN
LF      EQU 0AH      ;ASCII LINE FEED
```

CONSTANT DEFINITIONS

```
;I/O ASSIGNMENTS
```

```
DATINO  EQU 1 0H     ;DATA INPUT PORT
DATOUT  EQU 1 0H     ;DATA OUTPUT PORT
```

```
;MEMORY ASSIGNMENTS
```

```
IOTBL   EQU 60H     ;SYSTEM IOTABLE
```

STORAGE DEFINITIONS

```
;RESERVED STORAGE AREAS
```

```
NAME:   ORG 100H     ;BUFFER STARTS AT 100H
        DS 2         ;NAME BUFFER ADDRESS
BUFFIN: DS 80       ;INPUT BUFFER
BUFOUT: DS 80       ;OUTPUT BUFFER
```

BRANCH TABLES

```
;BRANCH ISOLATION TABLES
```

```
;INCOMING — BRANCHES TO INTERNAL ROUTINES
```

```
ORG 400H
```

```
JMP MAIN ;BRANCH TO MAIN PROGRAM
JMP RTE  ;BRANCH TO INT. ROUTINE
```

```
;OUTGOING — BRANCHES TO EXTERNAL ROUTINES
```

```

CI:      JMP IOTBL   ;SYSTEM CONSOLE INPUT
CO:      JMP IOTBL+3 ;SYSTEM CONSOLE OUTPUT

```

PROGRAM ORGANIZATION

```

;MAIN PROGRAM
MAIN:   -           ;START OF MAIN PROGRAM
.
.
;HIGH LEVEL SUBROUTINES
SUBH:   -           ;FIRST HIGH LEVEL SUBR.
.
.
;ELEMENTAL SUBROUTINES
LOWST:  -           ;LOWEST LEVEL ROUTINES

```

PROGRAM DATA AREAS

```

;DATA TABLES
.
.      ORG 1000H
;MESSAGES
HELLO:  DB          'HELLO THERE'.CR,LF
GOODBYE:DB         'SEE YOU LATER'.CR,LF
.
.
;TABLES
.
VTBLE   VTBLE—VOLTAGE TABLE
        DB 10
        DW 1000H
        DB 11
        DW 1001H
.
.
END

```

Chart your memory, or else

Each program module must reside somewhere in memory. The plan for locating your program in the available system memory is called a memory map. Its major sections are:

1. CPU-dependent storage
2. Reserved program storage
3. Scratch program storage
4. Resident program storage
5. Transient program storage
6. I/O port storage

CPU-dependent storage for microprocessors is usually a small number of memory locations for interrupt or I/O functions. The 8080A, for example, reserves the first 64 bytes of memory (0 to 3FH) for eight restart blocks. Interrupting devices use these locations to vector control to the appropriate I/O driver routines. When laying out your memory map, mark these locations and avoid using them for anything else.

Reserved and scratch storage occupy one or more small memory areas set aside for branch tables, I/O images, I/O-driver vectors, subroutine-pass parameters, stack pointers, character buffers and operational

constants. These areas should be large enough to handle expansion. When using RAM, follow your plan strictly to make sure data are not modified unintentionally in these areas. Record these values by name, size and location in your memory map to make them available to any program segments that need them for temporary storage.

In scratch memory you are not concerned about destroying or restoring the stored values. So don't use scratch memory for passing parameters.

You can manage the use of reserved and scratch storage space with a routine that keeps track of available storage. Space can be dynamically allocated to whatever programs need it, then released when no longer needed. You can, for instance, create a FIFO stack in memory, and keep track of available space with a pointer—in other words, make a "list of available space" (LAS). More sophisticated routines use linked lists to allocate memory space dynamically. But regardless of your approach, you must note the limits of variable storage in your memory map to prevent one memory area from eating into another.

Resident-program storage typically serves such systems programs as supervisors and monitors. These programs are often stored in ROM so that they never have to be loaded. Dedicated microcomputer systems in control and measurement applications often use nothing but resident programs. At the very least, you should include a resident bootstrap loader in ROM, to help you load the operating system.

Transient program storage is needed whenever the available RAM is limited. You must then store programs off-line and load them only when they are needed. Temporary storage space may be the largest area in your memory map.

I/O port storage must be set aside for all I/O ports if your system uses memory-mapped I/O—i.e., the I/O devices are addressed as memory locations. A graphic representation of your memory map (Fig. 3) is a valuable piece of documentation that you will use every time you modify or update your programs.

Pass that parameter, please

Two of the most important considerations in putting together your programs are that parameters pass properly to subroutines, and that all working registers be restored when a routine is completed. Parameters can be passed to and returned from subroutines through the working registers, or through memory. Decide on a fixed convention for passing parameters, and stick with it. You can use working registers, and always pass the first parameter in a certain register, the second in the next available register, and so on.

By sticking to a convention, you can design software modules with the confidence that the passed parameters will always match up. One such convention is to use the least versatile registers for passing parameters. For example, the 8080A has seven registers. The B and C registers are the weakest, the D and E

registers are slightly more versatile, while H and L are the most versatile after the Accumulator (A register). A good convention, then, is to pass the first parameter in register C and the second in B. Two more 8-bit parameters or one single 16-bit parameter can be passed in DE.

The result of a subroutine operation is often passed back in the accumulator (register A) because it can be treated along with the status or flag register. Be sure that the registers used for passing parameters are restored before being used for other purposes by the calling program, especially if subroutines are to be interruptible and re-entrant.

If your computer does not have enough registers for passing parameters, or if it's inconvenient to use,

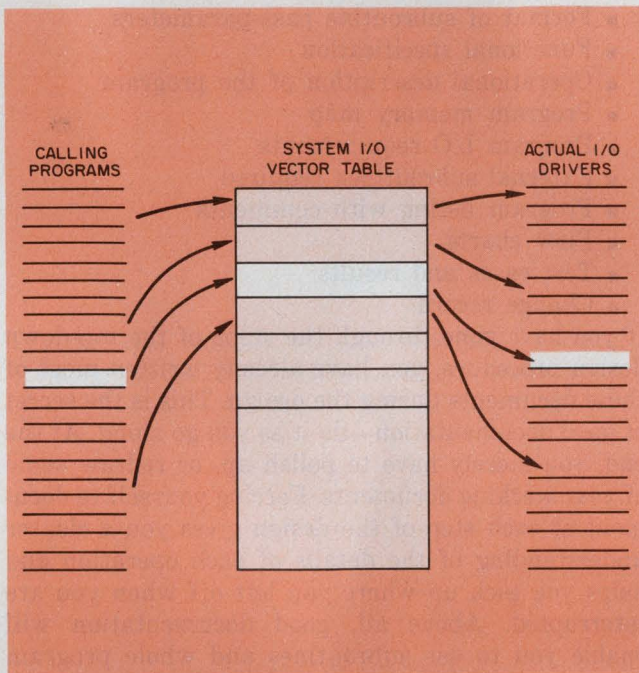

4. Table-isolated I/O assignments have the advantage of being easy to modify.

you can pass parameters in memory. However, fixed memory areas are undesirable for this purpose because nested subroutine calls can easily destroy parameters passed from a previous routine. A software FIFO stack can get you around this problem. The called program pushes pass-parameters onto the stack; the subroutine pops them off the stack, performs its computations, and pushes the results back onto the stack where the calling program can pop them back. But take care to balance the stack: An imbalance between pushes and pops can cause the stack to creep higher or lower in memory until it mysteriously eats another part of the program.

Like memory, the system I/O ports must be assigned in a definite way. It is often useful to isolate the I/O driver routines from the physical I/O ports. You obtain greater design flexibility, and don't have to change all references to a particular I/O driver

when it is moved to another location in memory. Fig. 4 shows a "table-isolated" I/O scheme. The memory locations of currently used I/O drivers are stored in the table. Calling programs jump indirectly to the appropriate driver routines via the table. You can then relocate drivers simply by updating the table. I/O isolation prolongs the life of your program, making it much easier to debug and to transfer to other computer systems.

Some bugs are real pests

Debugging is the process of removing mistakes (bugs) from programs. Testing is the means by which these bugs are found. Experience indicates that most programmers spend more time debugging their programs than designing them. Systematic and consistent design techniques help to prevent bugs in the design phase—not exorcize them after the fact. But, in spite of all efforts to prevent them, bugs creep into all but the most trivial programs.

Before you can debug a program, you must test it. But don't load the whole program all at once and "smoke-test" it by throwing the "on" switch. Begin testing with a careful review of the source program. Start with the most elemental routines, those that do not call other routines. Make sure that the coding conforms to the logic of your flow charts and that loops are properly initialized and terminated. Check for correct data values. Look for missing instructions. Cover all the details, and never, never, *assume* that something is right.

Next, devise test cases to check the functioning of each routine. Plug-in worst-case or extreme data values and be sure the routine handles these correctly. Once you have tested and debugged the simplest routines, you can move up to the level of the calling routines. You know now that the elementary routines are correct, so concentrate on testing calling-program operation and parameter passing. Work your way up to the highest-level subroutines, then to the main program itself, repeating the test/debug cycle until each module operates correctly. Then—proceed to the next level (Fig. 5).

Where you have branches, make sure all paths get tested, and check initialization and termination of all operations. Make sure that no routine inadvertently modifies another routine's data. Check structures carefully for both format and contents. Be careful with all pointers, delimiters, and terminators. If you get no output, the computer may be stuck in a loop. Insert print instructions in strategic locations.

But are the answers true?

When all parts of the program have been tested, and the bugs you found have been corrected, are you finished? No. When the program appears to be working properly, debugging begins in earnest.

(continued on page 100)

(continued from page 99)

Load the program, and begin assembling or compiling the object code that the computer will execute. Most language processors assist you by flagging syntax errors you overlooked while testing the source program. Syntax errors stem from typing errors, format errors, or transpositions that produce illegal character strings. Correct them before you go on: Syntax errors can cause the language processor to generate erroneous code.

Now attempt to run small portions of the program. If the results don't come out right, look for valid, but

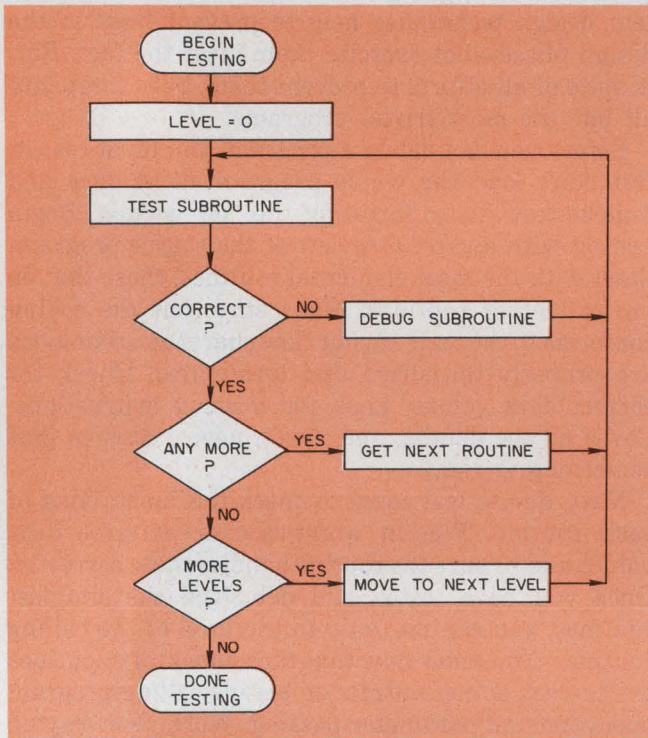

5. A good debug plan tests the lowest-level program modules first, then proceeds upward.

incorrect, instructions, transposed variable names, and incorrect data. The machine is a very harsh judge of your work and it will keep sending you back until you fix every detail. After pinpointing a bug to a small section of code, you can single-step through the program and carefully evaluate the results of each step. Debug monitors or similar system programs can be very helpful at this stage.

Once you are convinced that the program operates properly, you can begin looking for the toughest of bugs: faulty algorithms. Algorithm bugs often creep in at parameter extremes. The program may work fine for typical data, but break down for very small, very large, or limiting-data values. If this happens, you may have to change your algorithm or add range tests on the input data before processing it. Be sure that

the algorithm you designed provides the speed and accuracy required by the application. You must, of course, know some of the answers beforehand—how else could you be sure your program really works?

Without documentation, you're dead

Documentation consists of all information necessary to understand, modify, or use your program as executed on the computer you selected, such as:

- Computer type and serial number
- Memory size
- Master memory map
- I/O port assignments
- Format of subroutine pass-parameters
- Functional specification
- Operational description of the program
- Program memory map
- Program I/O requirements
- External subroutines required
- Program listing with comments
- Flow charts
- Test cases and results
- Change record

If you have gone through the steps of the top-down design procedure, you have already written most of these documents during the design. This is the secret of good documentation—do it as you go along. At the end, you merely have to polish up, or redraw some of your working documents. Forcing yourself to document at each step of the design gives you a clearer understanding of the details of each operation and helps you pick up where you left off when you are interrupted. Above all, good documentation will enable you to use subroutines and whole program segments over again in future software projects.

By the time your program is debugged and operating, you have probably thought of many ways to improve the job you did. Unless you have some very good reasons, don't. Otherwise, you will produce more bugs, and little else.

On the other hand, if the system doesn't run fast enough, exceeds its production-cost goals, uses more memory than you have available, or is just too difficult to use, you may have to optimize. Usually, this means trading off one feature for another. Memory size can be traded for speed; hardware for software; higher development cost for lower production cost. And don't expect much improvement from more efficient coding. If really significant improvements are needed, find a better algorithm.■

This article concludes the sequence of articles on the fundamentals of μ P programming. Future articles in this series will cover higher-level programming languages.

Acknowledgement

Portions of these articles were excerpted with permission from the Modu-Learn Microcomputer Software Course, © 1976 and 1977, Logical Services Incorporated.

WHEN IT'S FINALLY ON THE SCREEN, YOU DESERVE FAST HARD COPY.

Gould's electrostatic printer/plotter is the fastest graphic hard copy peripheral available today for your Tektronix 4000 Series interactive graphic terminal. You get permanent graphics direct from the

terminal in as little as 4 seconds, regardless of image complexity. In an on-line CPU configuration, you can plot at up to 3.25 paper in./sec. and print at up to 1600 lines per minute.

Yet Gould's hard copy still possesses exceptional resolution and extremely high contrast. Only Gould offers you both unmatched speed and unsurpassed image quality.

And Gould lets you select a 0° or 90° image orientation at will. In 90° mode, images are enlarged

up to 72%. You are able to select 1024 or 2048 point sampling and high or low speed graphic operation, letting you optimize image size, resolution and speed.

As with all Gould systems, your software is all-Gould. You never need worry about third party variables.

Gould images don't deteriorate. The system requires no warm-up. Gould paper costs a fraction of silver paper. Up to 2 interfaces are accommodated in the plotter, allowing you to use it with up to 8 Tektronix terminals or 4 terminals and a minicomputer, or 2 mini-computer CPU's.

Your CRT work deserves the best hard copy you can get. You get it from Gould.



For more information and a sample graphic output, contact Gould Inc., Instrument Systems Division, 3631 Perkins Ave., Cleveland, Ohio 44114. Or Gould Advance Ltd., Raynham Road, Bishop Stortford, Herts, United Kingdom.

FOR FREE BROCHURE CALL GOULD
TOLL-FREE AT (800) 325-6400 Ext. 77.
In Missouri: (800) 342-6600

 **GOULD**
The product development company

**Need an industrial version
of our famous DOT and DIT
military transformer?
TRW/UTC has a stock answer.**

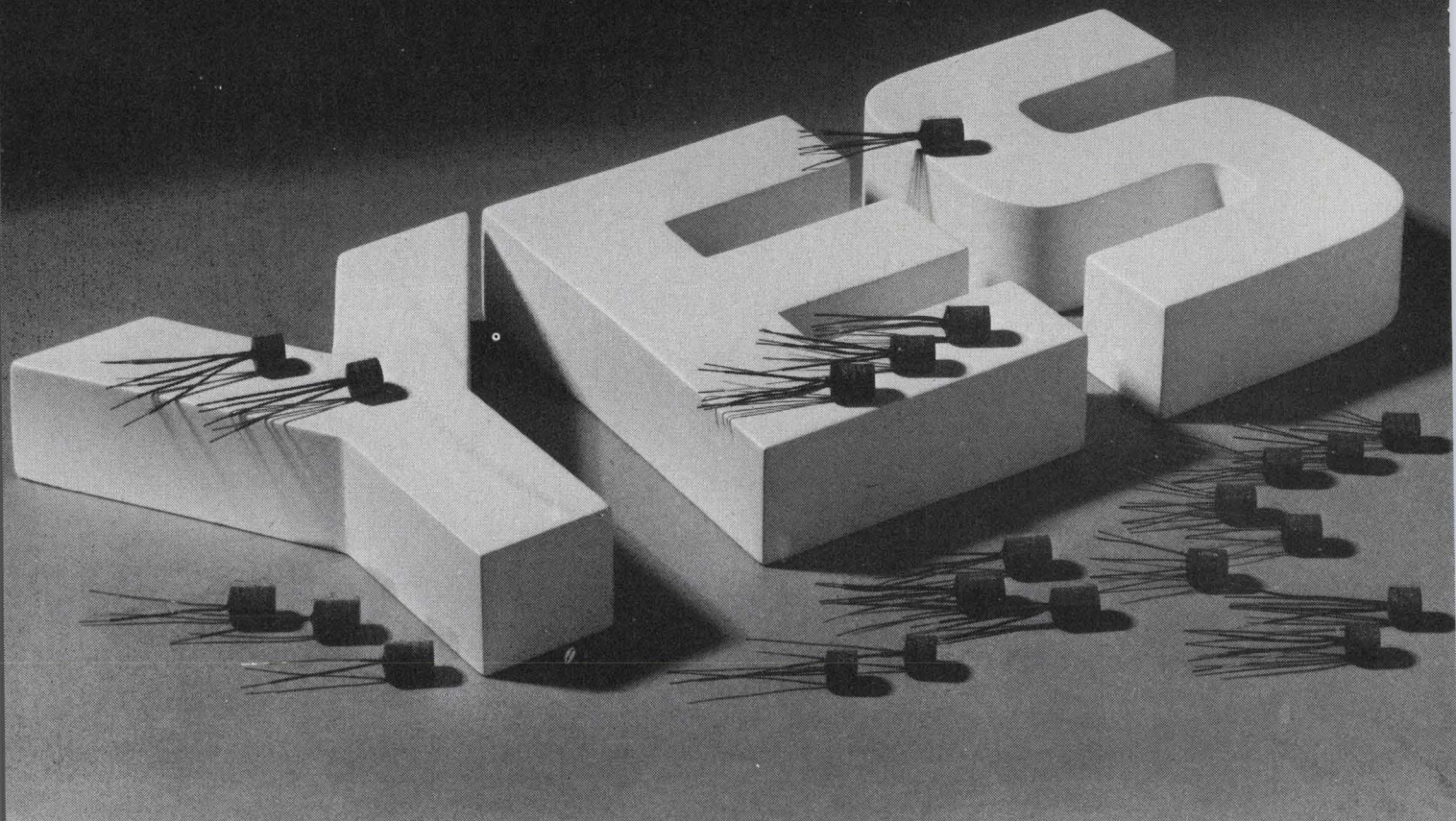

Now industrial users of transformers who need the space/performance of a high grade well tested product can choose from the I-DOT and I-DIT line of audio, signal, pulse or power transformers and inductors.

You see, we relaxed some of the environmental specifications of our prominent line of Mil spec DOT and DIT transformers, but kept the identical excellent electrical performance. Only the cost was reduced.

And the nice part, this industrial counterpart to the world renowned military line is a stock product available now at your authorized TRW/UTC distributor.

The I-DOT family has a frequency response of ± 3 db, 300 hertz to 20K hertz. The I-DIT has a ± 3 db, 400 hertz to 100K hertz, and is available both with flexible leads and with uninsulated dumet wire leads for printed circuit board mounting.

Check your authorized TRW/UTC local distributor for immediate off-the-shelf delivery or contact TRW/UTC Transformers, an Operation of TRW Electronic Components, 150 Varick Street, New York, N.Y. 10013. Area code: 212-255-3500.

TRW UTC TRANSFORMERS

ANOTHER PRODUCT OF A COMPANY CALLED TRW

CIRCLE NUMBER 38

Varian's new mainframe-on-a-board: What you do with it is your business.

Whether your systems business is scientific, instrument control, or data communications, know this:

Our new V77-200 delivers more computing power than any other computer-on-a-board you can buy. Handling up to 32K/16-bit words of 660ns MOS memory.

Reason enough to call it the world's first mainframe-on-a-board. But there's more.

Because our new V77-200 comes loaded with "big machine" features. Like 8 programmable registers with byte, word and double word manipulation. Up to 32-bits of arithmetic precision. A powerful set of 187 instructions. Hardware multiply/divide. Direct memory access. Programed I/O. Multi-device automatic program loaders. A real-time clock. And a teletype/CRT controller. All standard. And all on a single 10.8" x 17" board.

There's even Virtual Console Logic that eliminates the need for a programmer's console by allowing you to control the V77-200 from a teletype or CRT keyboard.

You get "big machine" performance, too. Example: a microinstruction cycle time of 165ns that allows multiplication functions to be handled in just 4.9 microseconds — divide in just 8.

Plus your choice of OEM-tailored options. Like a variety of connector planes and general purpose interface boards for custom I/O designs. Three different 660ns memory boards (in 8K, 16K, and 32K-word modules). An operator's console. Power-fail detect and data save. Memory parity. Hardware for up to 64 priority vectored interrupts. An integral or modular power supply. And, of course, a system chassis. All the "unbundled" pieces you need for quick and easy system integrations.

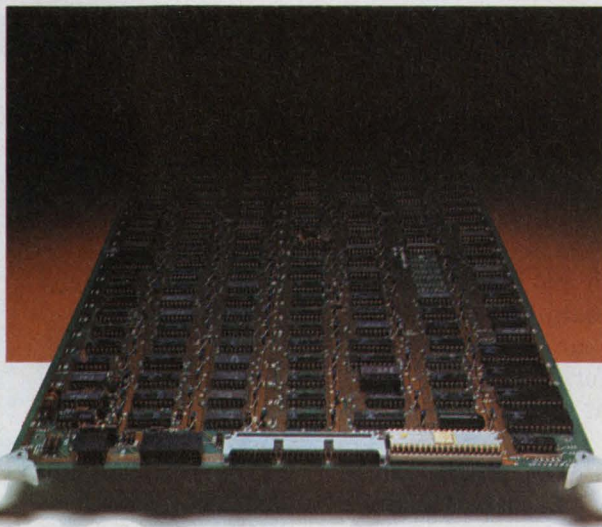

The new V77-200 also saves you time and money by allowing you to use Varian's well-established floppy or disk-based VORTEX real-time operating system. In effect, allowing you to concentrate on the development of your application software.

And giving you access to Varian's extensive library of software subsystems, language processors, and system utilities.

Best of all, the world's first mainframe-on-a-board has a base price of just \$1200. Plus a discount plan designed to give even modest-volume OEM buyers a big break. And you can take delivery in a matter of days — not months.

No matter how you configure it, the new V77-200 is the most economical Varian yet. Delivering the kind of price/performance value that just makes good sense. No matter what business your systems are in.

For more information on the world's first mainframe-on-a-board, please contact: Varian Data Machines, 2722 Michelson Drive, P.O. Box C-19504, Irvine, California 92713, Telephone (714) 833-2400. In Europe, please contact: Varian Associates, Ltd., Molesey Road, Walton-on-Thames, Surrey, England, Telephone 28971.



Mini's that think like mainframes.

CIRCLE NUMBER 39

Build a μ P-based simulator and learn elementary programming. The unit executes 16 instructions. The parts fit on one punched board and cost under \$100.

If you aren't designing with a microprocessor yet, you should be. Microprocessors usually make a system cheaper, easier to modify, and quicker to develop than dedicated-logic circuits. You'll learn quickly with a μ P-based simulator, just as you learned by tinkering with your first one-transistor circuit.

With the simulator pictured in Fig. 1 you can become familiar with the hardware and instruction set, both deliberately restricted so that you can focus on the fundamentals. When you outgrow the limited capabilities of this system, you can reprogram it.

You can make the simulator for under \$100, plus the power supply cost, with a kit of ICs from Intel and additional parts (Table 1).

You also need access to an EPROM programmer capable of programming the kit's 4702 erasable memory. The EPROM memory chip must be programmed with instructions listed in Table 2. Plugged into the simulator, the programmed EPROM creates an abbreviated instruction set that you use. Fig. 2 shows the schematic of the system.

Understanding the microprocessor

This instructional unit uses the Intel 4004 4-bit μ P, chosen because it is the oldest, most popular and most completely debugged of the available chips. Any microprocessor operates in a timed sequence. Instructions entered by the user are first stored in the unit's memory by the programmer. The μ P executes these instructions when told to do so.

There is no hidden trick in learning how to use the simulator. First, the hardware has been configured, by the software stored in the EPROM, to look as shown in Fig. 3. It has

- Instruction storage
- Data-input switches
- Data-output lights
- A register (where data are stored)
- An accumulator (where data can be manipulated)
- An instruction-address counter, which tells the address of the next instruction.

Everything else is lumped into the instruction-

W. C. Blanchard, Project Engineer, Bendix Environmental and Process Instrument Div., 1400 Taylor Ave., Baltimore, MD 21204.

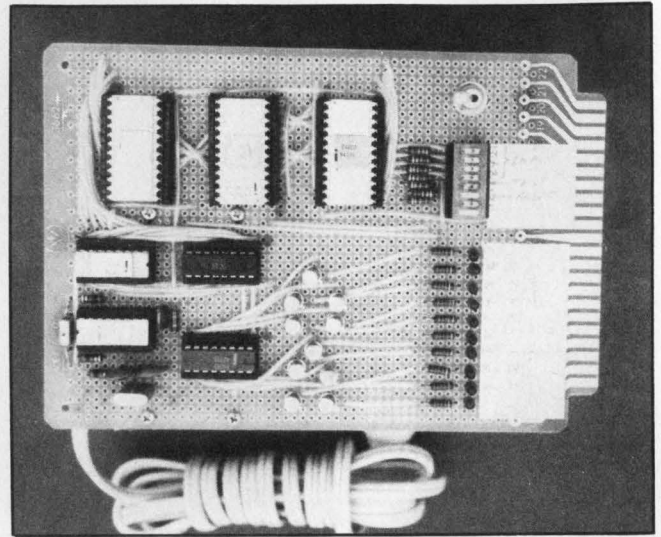

1. The simulator fits on one punched board with integral power supply. To minimize external wiring, board-mounted DIP switches control the simulator.

Table 1. Simulator parts list

Quantity	Type	Description	Manufacturer
1	MSC-4A	Chip set	Intel
1	4201	Clock	Intel
1	CY3A 4 MHz	Xtal	Crystex
2	33 pF, mica	Capacitors	
1	1 μ F, 25 V	Capacitor	
1	15 μ F, 25 V	Capacitor	
1	10 μ F, 25 V	Capacitor	
10	CM-73A	LED	
3	100 Ω , 1/4 W	Resistors	
10	1.2 k, 1/4 W	Resistors	
5	4.7 k, 1/4 W	Resistors	
1	1 M, 1/4 W	Resistors	
6	spst	Switch	
3	16-pin DIP	Sockets	
3	24-pin DIP	Sockets	
10	2N2907	Transistors	
1	15 V at 150 mA	Power supply	
Miscellaneous: solder, punched board, wire, labels			

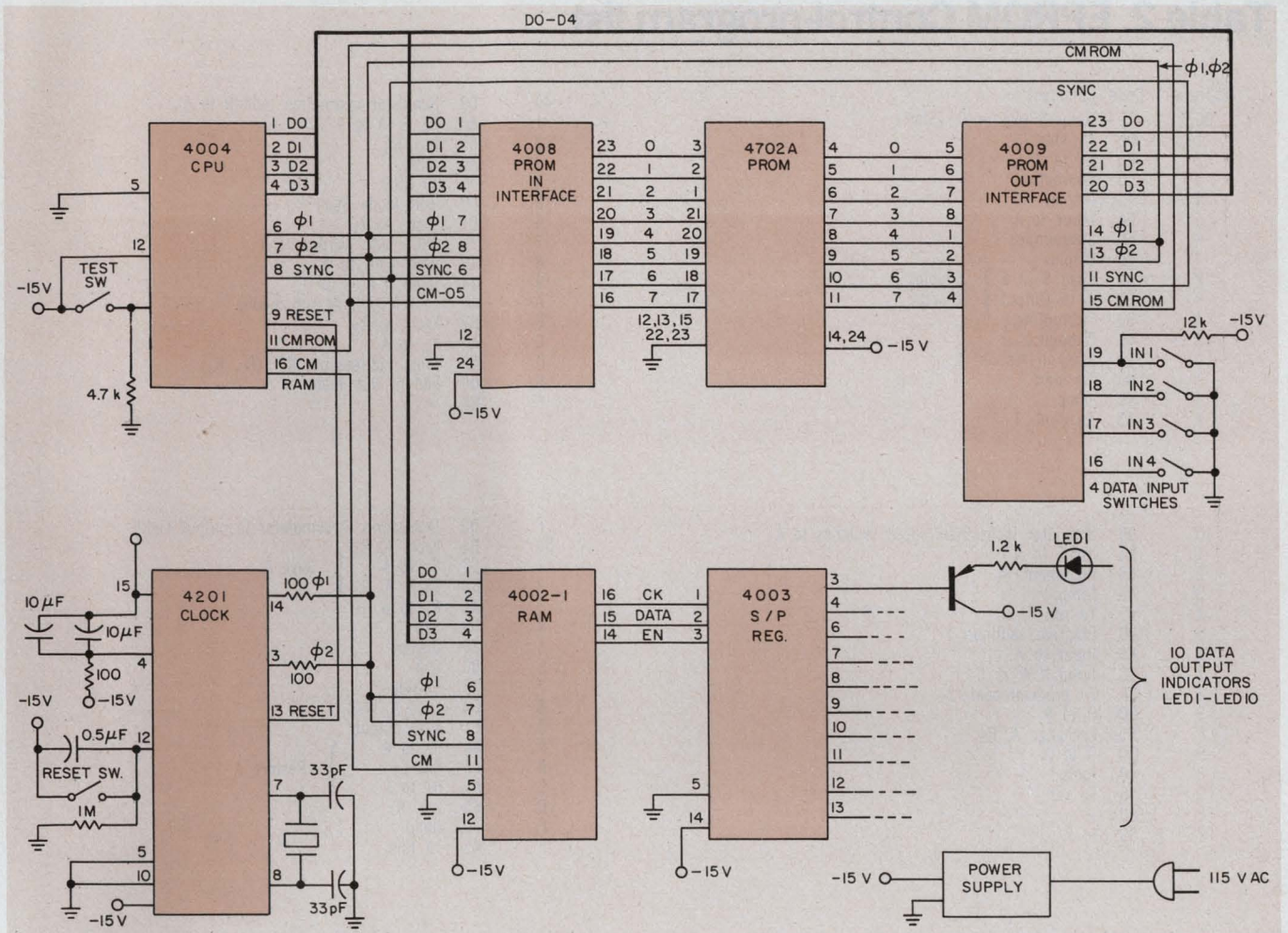

2. The schematic is uncluttered by discrete components, except for the decoupling capacitors and a few resistors.

interpretation and execution hardware, which is not under your control.

There are two modes of hardware operation: program and run. When the power is turned on and the system reset, the hardware is in the program mode. The system will run after 16 instructions are programmed or a Run instruction is entered.

Second, you should learn what the microprocessor can be instructed to do:

- Look at the input lines and copy their HIGH and LOW states in its accumulator.
- Copy the accumulator's HIGH and LOW states on the output lines.
- Increment, decrement, store or clear the accumulator.
- Jump to a different instruction under certain conditions—for example, when the accumulator bits are all ZERO or when an external condition is satisfied.

The programs that you write can use up to 16 instructions and are stored in memory (Table 3). Most instructions occupy one address location, but some occupy two. Instructions taking up two locations contain either data or another address, which is stored in the second location. The addresses are identified

by numbers that start at ZERO for the first address and continue in hexadecimal sequence.

Operating the unit

To load a program into the computer, apply power, turn the Test switch on the input switches off, and push the Reset button. The system acknowledges by extinguishing all address and instruction LEDs—indicating that it is at address 0000. Then, enter the machine code for the first instruction.

For example, set IN4 through IN1, respectively, to 0, 0, 0, 1, or off, off, off, on, to transfer the contents of the input switches to the accumulator when the program is run. The instruction LEDs show what has been entered. Then, set the Test switch off to store the instruction in the simulator's memory.

To enter the next instruction or the second part of an instruction that takes up to two locations, turn on the Test switch again. The address lights show that the computer has incremented the address by 1. Set the IN4-through-IN1 switches for the machine code for the next instruction, then again turn off the Test switch. Repeat the procedure for each instruction you want to enter.

Table 2. EPROM Control-program list

Address	Code	Comment
00	11	Jump if test = 0, (Start)
1	00	To start
2	A5	R ₅ to A
3	50	Subroutine,
4	75	Display
5	EA	Input to A
6	50	Subroutine,
7	75	Display
8	D4	Load 4 in A
9	E1	A to Output
A	50	Subroutine,
B	65	Debounce
C	11	Jump if test = 1,
D	00	To start
E	40	Jump,
F	15	To Cont. 1

40	00	Simulator instruction: Add R to A
1	80	R ₀ + A to A
2	65	Inc. R ₅
3	40	Jump,
4	45	To RUN
5	00	RUN Mode Start
6	B1	Exch. A, R ₁
7	25	SRC ¹ RAM word # (R ₅)
8	E9	RAM word to A
9	14	Jump if A = 0
A	49	To self (ending run mode)
B	B2	Exch. A, R ₂
C	A1	R ₁ to A
D	33	Jump Indirect per RPI (R ₂ , R ₃)
E	00	End of Run Mode
F	00	—

10	00	Simulator instruction: Input switches to A
1	EA	Input to A
2	65	Increment R ₅
3	40	Jump,
4	45	To run
5	00	Program continue 1
6	EA	Input to A
7	1C	Jump if A = 0
8	2A	To program cont. 2
9	DO	0 to A
A	B5	Exchange A, R ₅
B	DO	0 to A
6	40	Jump,
D	45	To run
E	00	—
F	00	—

F	00	Instruction: Accumulator to output Light
50	B1	Exch. A, R ₁
1	F7	Cy to A
2	BD	Exch. A, R _D
3	A1	R ₁ to A
4	50	Sub
5	75	Display
6	50	Sub
7	75	Display
8	D4	Load A, W/4
9	E1	A to output
A	AD	R _D to A
B	F6	Rat Cy
C	A1	R ₁ to A
D	65	Inc. R ₅
E	40	Jump
F	45	To Run

20	00	Instruction: Subtract from A
1	90	A - R ₀ to A
2	65	Inc. R ₅
3	40	Jump
4	45	To run
5	00	—
6	00	—
7	00	—
8	00	—
9	00	—
A	00	Program Cont.
B	25	SRC ¹ RAM word # (R ₅)
C	E0	A to RAM word
D	00	—
E	40	Jump
F	35	To Prog. Cont. 3

60	00	Simulator instruction: Clear A and Carry Bit
1	F0	0 to A, 0 to Carry Bit
2	65	Inc. R ₅
3	40	Jump
4	45	To run
5	00	Sub: Debounce
6	76	ISZ ² , R ₆
7	65	To 65
8	77	ISZ ² , R ₇
9	65	To 65
A	C0	Return
B	00	—
C	00	—
D	00	—
E	00	—
F	00	—

30	00	Simulator instruction: Exchange R and A
1	B0	Exchange R ₀ , A
2	65	Inc. R ₅
3	40	Jump
4	45	To run
5	00	Program, Cont. 3
6	50	Subroutine
7	65	Debounce
8	11	Jump if Test = 0
9	36	To -4 addresses
A	75	ISZ ² , R ₅
B	02	To start plus 2
C	00	End of Program Mode
D	0	—
E	40	Jump
F	45	To run

70	00	Simulator instruction: Set Carry Bit
1	FA	1 to Carry Bit
2	65	Inc. R ₅
3	40	Jump
4	45	To run
5	00	Sub Display Start
6	BA	Exch. A, R _A
7	DC	C to A
8	BB	Exch. A, R _B
9	F0	0 to A, Carry Bit
A	BA	Exch. R _A , A
B	F5	Rot L; MSB to Carry Bit
C	BA	Exch A, R _A
D	F7	Carry Bit to A
E	40	Jump
F	87	To Display Cont

80	00	Simulator instruction: Load A with XXXX
1	65	Inc. R ₅
2	25	SRC RAM word # (R ₅)
3	E9	RAM to A
4	65	Inc. R ₅
5	40	Jump,
6	45	To RUN
7	00	Sub: Display, Cont. 1
8	F5	Rot L
9	F2	Inc. A 00 X 1
A	E1	A to out
B	00	0 to A
C	E1	A to out
D	00	—
E	40	Jump
F	95	To Cont. 2

C0	00	Instr: Jump if T = 1 to XXXX
1	19	Jump if T = 1
2	B0	To Jump Inst. (B)
3	65	Inc. R ₅
4	65	Inc. R ₅
5	40	Jump
6	45	To RUN
7	00	—
8	00	—
9	00	—
A	00	—
B	00	—
C	00	—
D	00	—
E	00	—
F	00	—

90	00	Simulator instruction; Increment A
1	F2	Inc. A
2	65	Inc. R ₅
3	40	Jump,
4	45	To RUN
5	00	Sub: Display Cont. 2
6	7B	ISZ, R _B
7	79	To Address 79
8	D1	1 to A
9	E1	A to out
A	D0	0 to A
B	E1	A to out
C	C0	Return
D	00	End of Sub: Display
E	00	—
F	00	—

D0	00	—
1	14	Jump if A = 0
2	B0	To Jump Inst. (B)
3	65	Inc. R ₅
4	65	Inc. R ₅
5	40	Jump
6	46	To RUN
7	00	—
8	00	—
9	00	—
A	00	—
B	00	—
C	00	—
D	00	—
E	00	—
F	00	—

A0	00	Simulator instruction: Decrement A
1	F8	Dec. A
2	65	Inc. R ₅
3	40	Jump
4	45	To RUN
5	00	—
6	00	—
7	00	—
8	00	—
9	00	—
A	00	—
B	00	—
C	00	—
D	00	—
E	00	—
F	00	—

E0	00	Simulator instruction: Carry Bit to out clocked
1	B1	Exch. A, R ₁
2	12	Jump if Carry Bit equals 1
3	EB	To EB
4	D1	1 to A
5	E1	A to out
6	D4	4 to A
7	E1	A to out
8	65	Inc. R ₅
9	40	Jump,
A	45	To Run
B	D3	3 to A
C	E1	A to out
D	40	Jump,
E	E6	To E6
F	00	—

B0	00	Simulator instruction: Jump to Inst. XXXX
1	65	Inc. R ₅
2	25	SRC RAM word # (R ₅)
3	B1	Exch. A, R ₁
4	E9	RAM word to A
5	B5	Exch. A, R ₅
6	D0	0 to A
7	B1	Exch. A, R ₁
8	40	Jump,
9	45	To RUN
A	00	—
B	00	—
C	00	—
D	00	—
E	00	—
F	00	—

F0	00	Simulator instruction: Delay = 1.5 s
1	76	ISZ, R ₆
2	F0	To F ₀
3	77	ISZ, R ₅
4	F0	To F ₀
5	78	ISZ, R ₈
6	F0	To F ₀
7	79	ISZ, R ₉
8	F0	To F ₀
9	65	Inc. R ₅
A	40	Jump
B	45	To RUN
C	00	—
D	00	—
E	00	—
F	00	—

Note 1: SRC—Send Register Control

Note 2: ISZ—Increment register, if it is then not zero, then jump to address.

(continued on page 108)

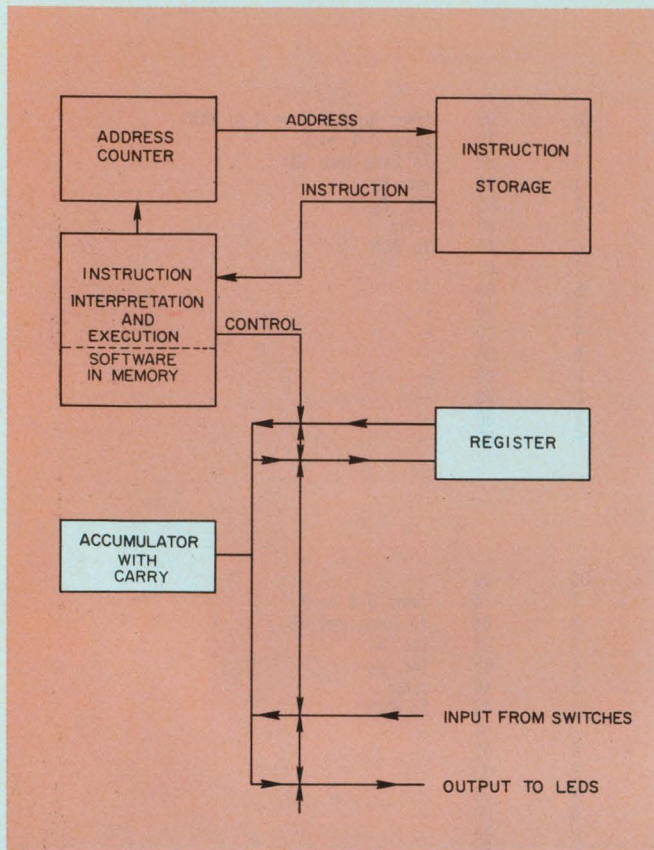

3. The hardware contains an accumulator to operate on data and a register to hold data temporarily.

Table 3. Instruction set for the microcomputer simulator

Instruction Machine Code		Description (A = Accumulator, R = Register)
Binary value	Hexadecimal value	
0000	0	Initiate Run mode from Program mode. In run mode it terminates run
0001	1	Input Switch to A
0010	2	Subtract R from A
0011	3	Exchange A and R
0100	4	Add R to A
0101	5	A to Output Light
0110	6	Clear A and Carry Bit
0111	7	Set Carry Bit to 1
1000	8	Load A with data contained in the next location
1001	9	Increment A by 1
1010	A	Decrement A by 1
1011	B	Jump to the address contained in the next location
1100	C	Jump if test is 1 to the address contained in the next location
1101	D	Jump if A is zero to the address
1110	E	Display Clocked, Carry Bit to output, Light 1
1111	F	Delay \approx 3 seconds

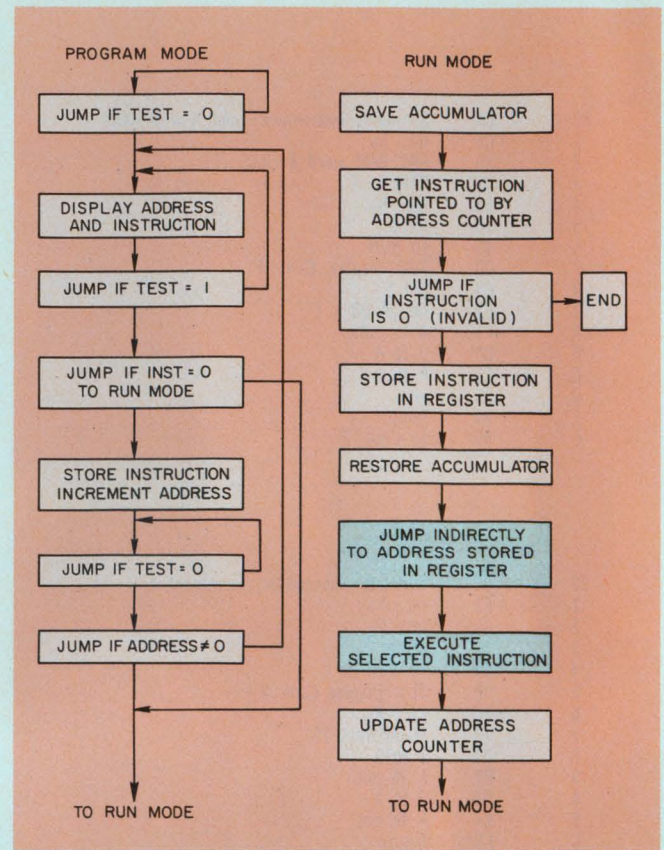

4. The control program executes each simulator-program instruction and manipulates the μ P's registers.

Table 4. The flow chart for a programming example

Flow chart	Additional remarks	Program listing in hexadecimal	
		Address	Instruction
<pre> START LOAD A WITH 6 EXCHANGE A WITH R LOAD A WITH SWITCH DATA ADD A AND R, PUT RESULT IN A DISPLAY A JUMP BACK RUN </pre>	Two-location instruction	0 1	8 6
	R contains 6	2	3
	A contains the number on the switches	3	1
	A contains the sum of the switch number and 6	4	4
		5	5
	Two location instruction	6 7	B 3
	The program executes this instruction once to start.	8	0

Table 5. Programming the simulator

Operating Procedure	Address Lights		Instruction Lights		Address (Hex)	Instruction (Hex)	Comments
	10987	6	5432	1			
Power on	0000	0	0000	0			} Initializing procedure common to all programs.
Input switches off	Don't know						
Test switch on	Don't know						} Ready to input inst. at address 0
Reset on then off	0000	0	0000	0	0	0	
Input switches to 1000	0000	0	1000	0	0	8	Load accumulator instruction
Test switch off	0000	0	1000	0	0	8	Instruction stored
Test switch on	0001	0	1000	0	1	8	Ready to input data at address 1
Input switches to 0110	0001	0	0110	0	1	6	Second word of load inst.; the load value
Test sw. off then on	0010	0	0110	0	2	6	Inst. loaded & ready for inst. at add. 2
Input switches to 0011	0010	0	0011	0	2	3	Exchange accum. & register instruction
Test sw. off then on	0011	0	0011	0	3	3	Inst. loaded & ready for inst. at add. 3
Input switches to 0001	0011	0	0001	0	3	1	Input switches to accumulator instruction
Test sw. off then on	0100	0	0001	0	4	1	Inst. loaded & ready for inst. at add. 4
Input switches to 0100	0100	0	0100	0	4	4	Add register to accumulator instruction
Test sw. off then on	0101	0	0100	0	5	4	Inst. loaded & ready for inst. at add. 5
Input switches to 0010	0101	0	0101	0	5	5	Accumulator to output light instruction
Test sw. off then on	0110	0	0101	0	6	5	Inst. loaded & ready for inst. at add. 6
Input switches to 1011	0110	0	1011	0	6	B	Jump instruction
Test sw. off then on	0111	0	1011	0	7	B	Inst. loaded & ready for add. at add. 7
Input switches to 0011	0111	0	0011	0	7	3	Second word of jump inst.; the address
Test sw. off then on	1000	0	0011	0	8	3	Inst. loaded & ready for inst. at add. 8
Input switch to 0000	1000	0	0000	0	8	0	Run instruction
Test switch off	0110	0	0000	0			Inst. loaded & executed, program running & displaying input +6 = 0+6 = 6 Display gives input +6 = 1+6 = 7 Display gives input +6 = 10+6 = 16 = 0 Display gives input +6 = 3+6 = 9
Input switches to 0001	0111	0	0000	0			
Input switches to 1010	0000	0	0000	0			
Input switches to 0011	1001	0	0000	0			
	Data Output Lights						

In the run mode, the instructions are executed sequentially. The instruction starting at address zero is fetched and executed by the instruction-interpretation and execution hardware. The instruction-address counter is incremented, and the machine fetches the next instruction.

The simulator follows a procedure similar to the one for instructions that take up two locations, except that both halves of the simulator's instruction are fetched before it is executed.

If the first half of an instruction is, for example, "Jump to a new address," the second word is loaded into the instruction-address counter so that the next executed instruction will be called from that address. Or, if the first half of a two-location instruction says, "Load the second location into the accumulator," then the hardware will do so.

However, a two-word instruction is restricted two ways. First, the second word cannot be ZERO. If it were, the hardware would immediately run the program, instead of loading the program in memory.

Second, jump instructions cannot specify the second half of another instruction location. If they did, that data or address would be interpreted as the first half of an instruction. Then the instruction would be executed improperly.

Solving a problem

The procedure for using the hardware is illustrated by the following problem: All input data from the keyboard must be incremented by 6, then displayed on the output LEDs.

First, make a flow chart—a list of required operations in the order they have to be done. Second, substitute one or more instructions for each operation in the flow chart (Table 4).

When you are satisfied that the flow chart and the instructions are correct, load the program on the simulator and run it. Table 5 shows the sequence of steps for the operate and run mode.

Once you master the instructions that the simulator

Dialight sees a need:

(Need: The widest choice for your every application.)

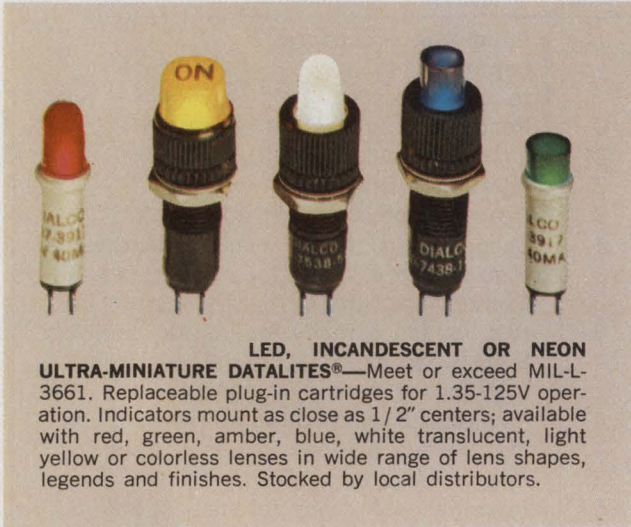

LED, INCANDESCENT OR NEON ULTRA-MINIATURE DATALITES—Meet or exceed MIL-L-3661. Replaceable plug-in cartridges for 1.35-125V operation. Indicators mount as close as 1/2" centers; available with red, green, amber, blue, white translucent, light yellow or colorless lenses in wide range of lens shapes, legends and finishes. Stocked by local distributors.

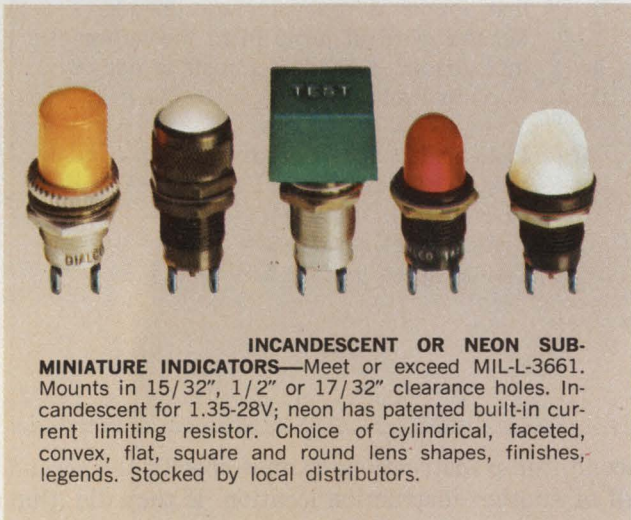

INCANDESCENT OR NEON SUB-MINIATURE INDICATORS—Meet or exceed MIL-L-3661. Mounts in 15/32", 1/2" or 17/32" clearance holes. Incandescent for 1.35-28V; neon has patented built-in current limiting resistor. Choice of cylindrical, faceted, convex, flat, square and round lens shapes, finishes, legends. Stocked by local distributors.



Dialight, the company with the widest choice in switches, LEDs, indicator lights and readouts, looks for needs . . . your needs . . . and then they develop solutions for your every application. No other company offers you one-stop shopping in all these product areas. And no other company has more experience in the visual display field. Dialight helps you do more

with these products than any other company in the business, because we are specialists that have done more with them. Talk to the specialists at Dialight first. You won't have to talk to anyone else. Send for your free new copy of Dialight's current catalog.

DIALIGHT

Dialight, A North American Philips Company
203 Harrison Place, Brooklyn, N. Y. 11237
(212) 497-7600

See Dialight.

CIRCLE NUMBER 40

Table 6. The control program's use of the μ P registers

Register Pair No.	Index Register No.	Use	Index Register No.	Use
0	0	Reserved for user	1	Temporary A storage
1	2	Indirect jump address	3	0, second half of indirect-jump address
2	4	0, first half of Send Register Control (SRC)	5	Counter No., Second Half of SRC
3	6	0, for Delay and Debounce	7	0, for Delay and Debounce
4	8	0, for Delay	9	0, for Delay
5	A	Rotated A for Display	B	C, Counter for Display
6	C	Not used	D	Temporary storage of the Carry Bit
7	E	Not used	F	Not used

is capable of executing, you can learn a program that controls the simulator. This control program is stored in an erasable, programmable, read-only memory (EPROM). The program then controls the execution of each simulator instruction.

The simulator instruction is initially stored in RAM when the simulator is in the program mode, then fetched in the run mode. The simulator instruction becomes an indirect-jump address, the address of a series of instructions in EPROM that executes the simulator instruction.

Display has a separate subroutine

The output display is handled by a subroutine that uses the system's serial/parallel register. This register accepts data via the RAM-output ports from the accumulator. The data have the following format: Bit 1 is the register clock, Bit 2 is the data, Bit 3 is the register enable and Bit 4 is not used. The display is enabled by the calling routine.

The software for the program and run modes is too long for any single place in the programmable memory, so it is stored between the simulator-execution set of instructions.

The control-program flow chart is shown in Fig. 4, along with the hexadecimal program listings. Table 6 is a register map showing the control program's use of the CPU. The instruction set can be changed, of course, by reprogramming the PROM. ■■

References

1. *Intel Memory Design Handbook*, Intel Corp., 1976: Santa Clara, CA.
2. *Intel MCS-40 User's Manual for Logic Designers*, Intel Corp., 1976: Santa Clara, CA.

Discover the limitless universe of optoelectronics.



We'll help you see the light.

After all, HEI introduced the first optical switch and is the innovative leader in the world of optoelectronics. A world limited only by your imagination.

Match that imagination with our unique ability to combine optoelectronics and hybrid circuitry. The result: a creatively engineered, custom assembly that can set new standards of speed, precision and quality for you.

We're already doing it in applications for:

• **limit switches** • **TTL compatible card and paper**

tape readers • **light pens** • **direction and position sensors** • **encoders** • **and much more.**

For simple or complex applications of optoelectronic technology, let HEI shine a little light for you.

Just give us a call.

 **HEI inc.**

Jonathan Industrial Center • Chaska, MN 55318 • 612/448-3510

MIL/NASA QUALIFIED RECTIFIERS

WE HELPED WRITE THE "BOOK"!

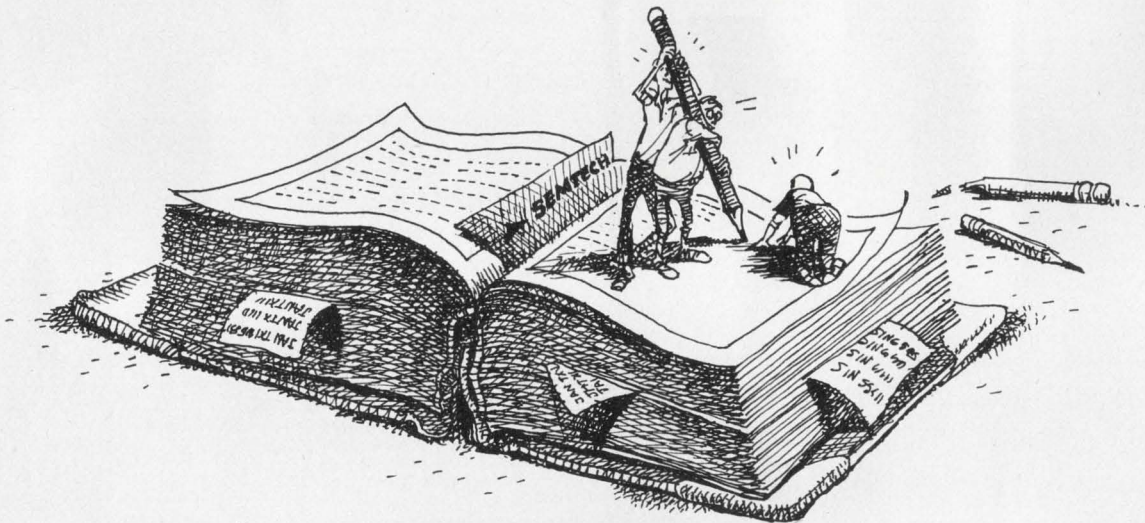

What's in a Number ?

For over a decade Military Specifications have been written around Semtech E.I.A. registered medium power rectifiers.

Many suppliers can provide parts with the same JAN, JANTX or JANTXV label. Although these devices may comply with the appropriate military specification, there can be significant differences in the design and manufacture that may affect the reliability; such as, different lead materials, pin materials, body materials, junction types and junction areas. Devices of one manufacturer are not necessarily the same as those of another, even though they are labeled with the same part number.

Semtech Corporation is one of the few manufacturers in the industry that has its own government approved Qualification Test Facilities equipped to perform tests that meet the requirements of Military and Space programs. A NASA approved Radiographic Inspection (X-Ray) facility rounds out the total capability of Semtech's environmental and test facilities.

We have earned the confidence of the Military establishment by supplying reliable devices to government specifications throughout our history.



Military Specifications

MIL-S-19500/2400

JAN, JANTX, JANTXV 1N645*-1
JAN, JANTX, JANTXV 1N647*-1
JAN, JANTX, JANTXV 1N649*-1

MIL-S-19500/279C (NAVY)

JAN, JANTX 1N3644*
JAN, JANTX 1N3645*
JAN, JANTX 1N3646*
JAN, JANTX 1N3647*

MIL-S-19500/286C

JAN, JANTX, JANTXV 1N4245
JAN, JANTX, JANTXV 1N4246
JAN, JANTX, JANTXV 1N4247
JAN, JANTX, JANTXV 1N4248
JAN, JANTX, JANTXV 1N4249

MIL-S-19500/359B

JAN, JANTX, JANTXV 1N4942
JAN, JANTX, JANTXV 1N4944
JAN, JANTX, JANTXV 1N4946
JAN, JANTX, JANTXV 1N4947
JAN, JANTX, JANTXV 1N4948

MIL-S-19500/411C

JAN, JANTX, JANTXV 1N5415
JAN, JANTX, JANTXV 1N5416
JAN, JANTX, JANTXV 1N5417
JAN, JANTX, JANTXV 1N5418
JAN, JANTX, JANTXV 1N5419

MIL-S-19500/420A

JAN, JANTX, JANTXV 1N5550
JAN, JANTX, JANTXV 1N5551
JAN, JANTX, JANTXV 1N5552
JAN, JANTX, JANTXV 1N5553
JAN, JANTX, JANTXV 1N5554

MIL-S-19500/427B

JAN, JANTX, JANTXV 1N5614
JAN, JANTX, JANTXV 1N5616
JAN, JANTX, JANTXV 1N5618
JAN, JANTX, JANTXV 1N5620
JAN, JANTX, JANTXV 1N5622

MIL-S-19500/429B

JAN, JANTX, JANTXV 1N5615
JAN, JANTX, JANTXV 1N5617
JAN, JANTX, JANTXV 1N5619
JAN, JANTX, JANTXV 1N5621
JAN, JANTX, JANTXV 1N5623

*Not E.I.A. registered by Semtech Corporation.

MIL-S-19500/484(EL)

JAN, JANTX 1N5835
JAN, JANTX 1N5836

MIL-S-19500/503(EL)

JAN, JANTX, JANTXV 1N6073
JAN, JANTX, JANTXV 1N6074
JAN, JANTX, JANTXV 1N6075
JAN, JANTX, JANTXV 1N6076
JAN, JANTX, JANTXV 1N6077
JAN, JANTX, JANTXV 1N6078
JAN, JANTX, JANTXV 1N6079
JAN, JANTX, JANTXV 1N6080
JAN, JANTX, JANTXV 1N6081

NEW! Transient Voltage Suppressors

MIL-S-19500/516(EL)

JAN, JANTX, JANTXV 1N6102 thru 1N6137
JAN, JANTX, JANTXV 1N6102A thru 1N6137A
JAN, JANTX, JANTXV 1N6138 thru 1N6173
JAN, JANTX, JANTXV 1N6138A thru 1N6173A

NASA (MSFC) Approvals

85M01645 (NASA) S1N645S & S1N649S

85M03895 (NASA) S1N4245-1, S1N4247-1, S1N4249-1,
S1N4942-1, S1N4946-1 & S1N4948-1

85M03896 (NASA) S1N5199, S1N5201, S1N5417-1 &
S1N5419-1

RELIABILITY COSTS LESS !

1975 NATIONAL SBA SUBCONTRACTOR OF THE YEAR



652 Mitchell Road, Newbury Park, California 91320
(805) 498-2111 • (213) 628-5392 • TWX: 910-336-1264
CHICAGO: (312) 352-3227 • DALLAS: (214) 234-6523
FLORIDA: (305) 644-5404 • MARYLAND: (301) 937-0070
NEW JERSEY: (201) 654-4884 • SAN FRANCISCO: (415) 494-0113
CANADIAN SALES: (416) 844-2121
EUROPEAN SALES: Bourns AG Zug, Switzerland (042) 232-242

YOU CHOOSE THE WINNER

PROCESSOR	6/16	NOVA 3/4	PDP-11/04
Data Type Lengths (bits)	4,8,16,	16	1,8,16
Instruction Word Length (bits)	16,32	16	16,32,48
General-Purpose Registers	16	4	8
Hardware Index Registers	15	2	8
Maximum Memory Available (KB)	64	64	56
Directly Addressable Memory(KB)	64	2	56
Automatic Interrupt Vectoring	Standard	N/A	Standard
Parity	Optional	Optional	N/A
Cycle Time (nanoseconds)	600	800	725

PRICE	6/16	NOVA 3/4	PDP-11/04
8KB Processor	\$2200	\$2600	N/A
16KB Processor	\$2800	\$3200	\$3795
32KB Processor	\$4000	\$4400	\$4995
Multiply/Divide Hardware	\$ 950	\$1400	\$1820

Interdata's 6/16 wins the battle of the specs.

Not only do we cost less than the Nova 3/4 and the PDP-11/04, we have more features. Just compare: 16 general purpose registers on the 6/16 to simplify programming and reduce fetches . . . only 4 in the Nova and 8 in the 11/04; 15 hardware index registers on the 6/16 against 2 for the Nova and 8 for the 11/04; 64 KB of directly addressable memory instead of just 2 KB for the Nova 3/4 and 56 KB for the PDP11/04.

What's more; all these hardware features enhance the nimble 6/16's performance. Its cycle time is only 600 nanoseconds, compared to 800 for the Nova and 725 for the 11/04.

Interdata's comprehensive software drives this powerful hardware full out. You get the field-proven OS/16 MT2, a real-time, multi-tasking operating system providing instantaneous response to events, while allowing the user to minimize memory by storing non-critical functions on disks. And the 6/16 can be programmed in your choice of FORTRAN, BASIC or MACRO CAL.

All this and save money too, as much as one-third less than a PDP-11/04 and substantially less on a Nova 3/4 . . . with OEM discounts saving even more.

Get the whole story. Just fill in the coupon or call (201) 229-4040.

Send me 1977 specs on your Model 6/16

NAME _____ TITLE _____

COMPANY _____

ADDRESS _____

CITY _____ STATE _____ ZIP _____

PHONE _____

 **INTERDATA®**

A UNIT OF
PERKIN-ELMER DATA SYSTEMS
 Oceanport, New Jersey 07757, U.S.A.

Low-leakage current for half the currency.

Replaces expensive tantalum and film capacitors. Our new Low-Leakage Series of Aluminum Electrolytic Capacitors have been specifically designed to meet the most stringent low-leakage design specifications. Yet they cost up to **50% less** than tantalum or film-type capacitors. These V Series radial type capacitors offer a maximum leakage of .002 CV or 0.4 μ A (whichever is greater) with a capacitance range from 0.1 μ F to 100 μ F. It's operating temperature range is -40°C through $+85^{\circ}\text{C}$. Low-Leakage Aluminum Electrolytics



nichicon

The pulse of the industry.

NICHICON (AMERICA) CORPORATION
6435 N. Proesel Ave. • Chicago, IL 60645 • (312) 679-6530
Division of NICHICON CAPACITOR LTD., Kyoto, Japan

are just one example of our continuing emphasis on reliability as the dominant design criterion. We manufacture every type of capacitor including other types of aluminum electrolytics, ceramic discs, film, oil filled—without PCB's, metallized paper and wax paper capacitors for standard or specialized applications.

Send for your free catalog and engineering samples today. Simply write to us on your company letterhead.

You'll hear from us soon.

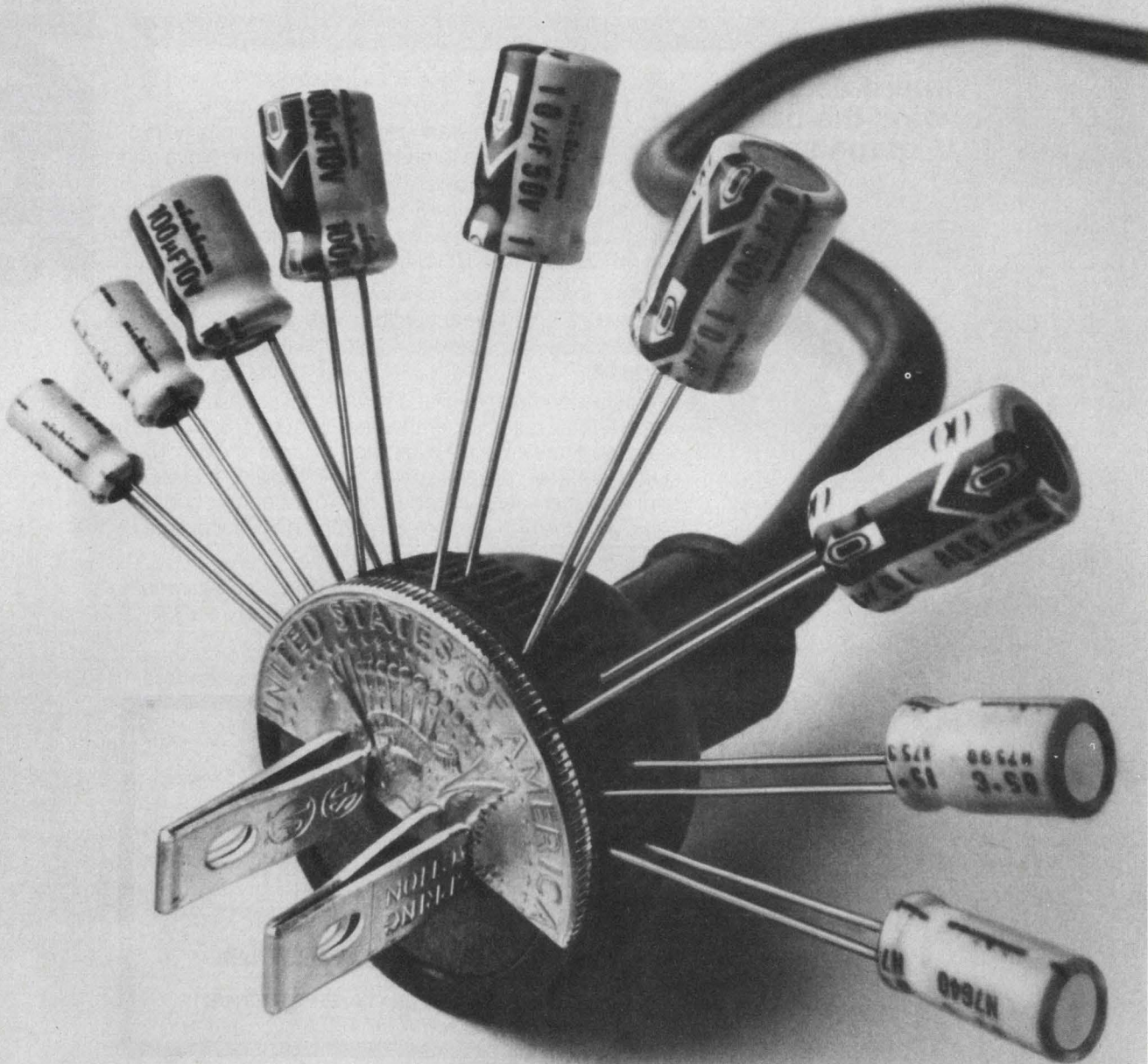

The CONTEMPO SERIES from Bud.



A new line of enclosures styled and designed to house new ideas.

There are scores of applications for Bud's new Contempo Series. And their versatility is equalled by their clean, contemporary design. Four styles come in 22 sizes with either a woodgrain and eggshell or black pebble and smooth gray finish. Whatever the size or finish you choose, the Contempo Series is immediately available from your authorized Bud distributor. For literature, phone Bud toll free: (800) 321-1764; in Ohio, (800) 362-2265.

Additional top support is provided by a tie-bar secured to end panels.

Enclosure body, made from .062" aluminum, comes in either eggshell white or gray baked enamel finish.

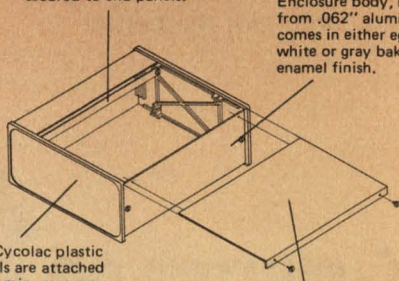

Molded Cyclocac plastic end panels are attached to the aluminum wrap-around body and are available with either woodgrain or black pebble.

Aluminum top slides into grooves in end panels and is secured with two screws. Top comes with woodgrain or gray enamel finish.

BUD INDUSTRIES, INC.
4605 East 355th Street
Willoughby, Ohio 44094

BUD WEST, INC.
3838 North 36th Avenue
Phoenix, Arizona 85019

try us...



MAXI IS A SWITCH FOR THE BETTER!

Tired of supplier hassles? Shipping delays? Promises that don't pan out? Maybe you should try Maxi-Switch keyboards for your next project. We're in business to do business on your schedule, and that's good business for both of us. Maxi is big enough to handle your largest keyboard project, and small enough to appreciate your business.

The Maxi line of standard keyboards will meet just about any conventional keyboard requirement. They include mechanical contacts, reed switches, and solid-state design in all the popular layouts and formats. If it's an industry standard,

we've already built it. Button styles and colors? Name your choices.

Custom keyboards are big business at Maxi too. We work to your layout, logic specifications, and encoding parameters, and help devise the most efficient design for your application. Need special purpose strip switches or numeric blocks? They're in the Maxi bag too.

It's all here at Maxi, including competitive pricing, and our pledge for responsive service, every time. So try us. Contact your Maxi-Switch representative, and make a switch for the better!

THE *Maxi*-SWITCH CO.

9697 EAST RIVER ROAD • MINNEAPOLIS, MINNESOTA 55433

(612) 755-7660



SIEMENS

Cost-Effective Solutions to Semiconductor Test Problems

APPLICATION:

Verification of semiconductor memory performance from device to system level.

WHAT TO LOOK FOR IN A TESTER:

High speed microprocessor.
Independent X & Y addressing.
Off-the-shelf device interface.

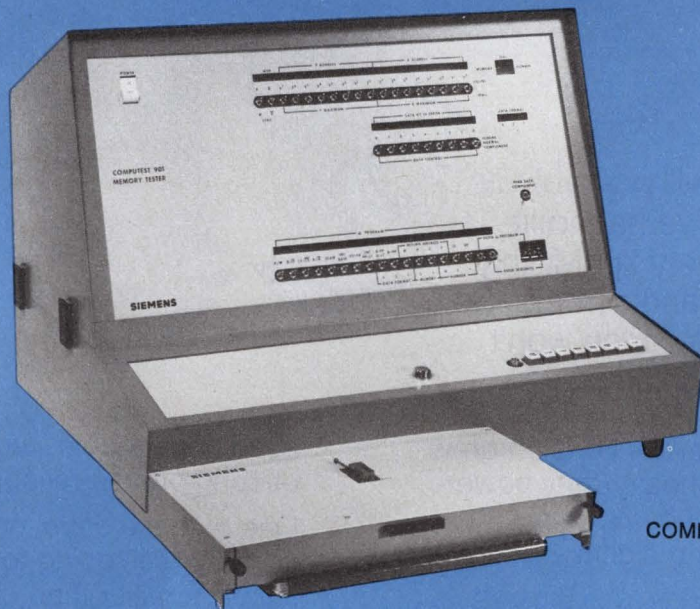

COMPUTEST MODEL 901

Semiconductor testing demands a practical low-cost solution. To check performance of semiconductor memory from the device through the system level requires memory-oriented addressing capability, a stable clock system, performance compatible device interface and real-time error detection. It's all found in the Computest Model 901 benchtop memory tester.

The Computest 901 has an easy-to-use, 10 MHz microprocessor, independent X & Y address generator, and a flexible, multi-channel clock. A com-

plete inventory of RAM/ROM interface modules puts the 901 to work for you immediately.

The Computest 901—flexible, versatile, tailored in price and performance for semiconductor memory testing from device to system level.

For additional information contact Cliff Small.

Siemens Corporation
Measurement Systems Division

3 Computer Drive, Cherry Hill, N.J. 08034 (609) 424-2400

WHOEVER HEARD OF A POWER SUPPLY IN AN EGG CARTON?

It Could
Happen.

If it ever happens, it will probably be at Keltec Florida. We've had to fit power supplies into very tight-fitting, oddly shaped nooks and corners. So fitting one into an egg carton won't present much of a problem.

Keltec Florida's Commercial Division grew from demand for small heavy-duty power supplies to operate mini-computers, tele-communications and digital processing equipment.

Commercial people with power supply problems heard of the powerful dependable small-sized units we've been building for the military for the past 15 years.

They convinced us we should build power supplies especially for their unique requirements. . . as well as for the military.

Now we supply the best of two worlds. At the Commercial Division, we handle only commercial power supplies and solve only commercial problems for the people who

need dependable, rugged, low-cost units utilizing proven reliability circuits.

One of these days, one of our commercial customers is going to ask us for a power supply smaller than one section of an egg carton. . . we'll supply it!

Keltec's Commercial Division.
We make it happen.

Aiken Industries
Keltec Florida Division

P. O. Drawer 1348
Fort Walton Beach, Florida 32548
(904) 651-1210 • TWX 510-730-7775

If your Christmas delivery of indicator lights arrived in time for Valentine's Day, you need Littelfuse.



It can happen any time of the year. Broken delivery dates. Long lead times. Production downtime.

But not with Littelfuse! Our indicator lights are more than just top quality—they're available—fast. From a nationwide network of Littelfuse Littelites distributors or from Littelfuse direct in large volume orders.

All Littelites are U.L. Recognized and Certified by C.S.A. And they sell at better than competitive prices.

Quality. Attractive Pricing. Unmatched delivery. We think



CIRCLE NUMBER 165

you'll find Littelites offer an unbeatable combination. For more information, send for our Littelites Product Guide or give us a call—today!

LITTELFUSE[®]
 SUBSIDIARY OF
Tracor

800 EAST NORTHWEST HIGHWAY
 DES PLAINES, ILLINOIS 60016 • 312/824-1188

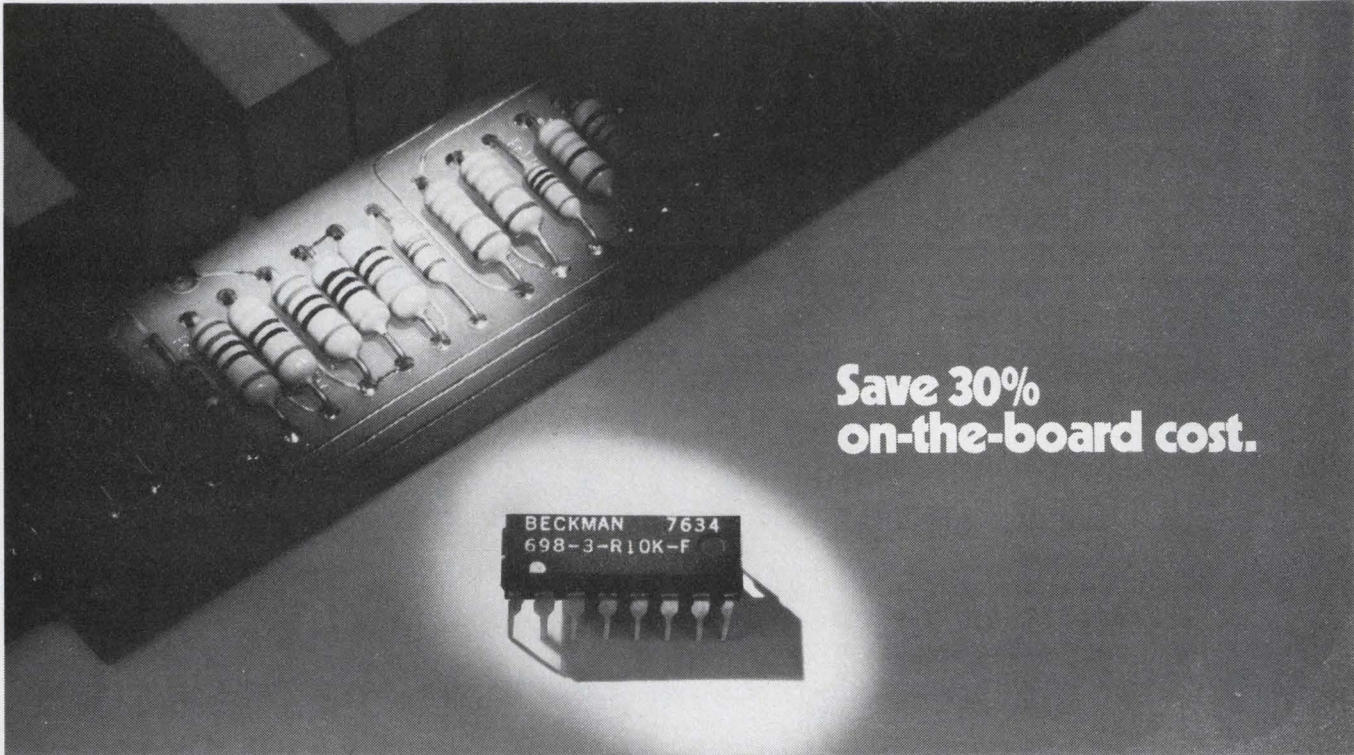

**Save 30%
on-the-board cost.**

Now, an alternative in the precision resistor world.

Beckman introduces precision film networks.

The board geography savings are obvious.

But our standard, 16-pin Series 698 Precision Film Resistor Networks mean much more. First, they're competitive in purchase cost with thin film discrete resistors. And, when you consider inventory and handling costs, lead bending, QC and other factors, they mean about a 30% savings in "on-the-board" costs.

That isn't all. Beckman precision networks have better performance and stability than unmatched discrettes. With ± 5 ppm/ $^{\circ}$ C tracking, the matched resistors in our dual in-line packages feature (1) absolute 1% resistance tolerance ratioed to 0.5%, and (2) ± 50 ppm/ $^{\circ}$ C tempo.

The two models (see schematics) are standard size and pin-spaced for automatic insertion. Series 698-1 comes in 17 stock resistance

values; Series 698-3 in 20 stock values. And these parts can be coupled, in series or parallel, to obtain other values in gain-setting, summing and feedback circuit applications.

The 1,000-piece price: just 65¢ for the 698-3 (8 resistors), 81¢ for the 698-1 (15 resistors). Compare with discrettes!

And remember: they're standard... for quick delivery, off the shelf through our widespread distribution.

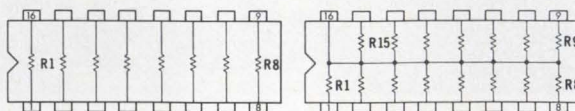

Get into the world of precision resistor networks. For more data, and applications information, contact your local distributor or Beckman Helipot today at (714) 871-4848, Extension 1776.

BECKMAN®

HELIPOT DIVISION

CIRCLE NUMBER 166

FOR RENT... the most advanced new products from Intel's Intellec[®] Microcomputer Development System family, including the exciting new 888...

You can take delivery now at low monthly rental rates on these ready-to-use products from 10 fully-stocked U.S. and Canadian instant inventory centers.

The Intellec System 888 is the new development package which provides all the resources necessary to develop microcomputer system software in assembly language or in Intel's high level programming language, PL/M-80. Included in the system are the MDS-800 with 64k bytes of RAM and resident PL/M-80 high-level language compiler, the new MDS-DDS 1-million byte capacity Dual Drive Double Density Diskette Operating System, and the MDS-CRT. It's available now.

The Intellec MDS-800 supports the development and implementation of Intel 8080, 8085, 8748, 8048, 8035 and Series 3000 microcomputers. It includes an 8080A CPU, a universal bus with multiprocessor and DMA capability, an 8-level maskable priority interrupt structure, a real-time clock, 256-byte bootstrap loader, 2k bytes of ROM memory, 16k bytes of RAM, and interfaces for a teletypewriter, CRT, high-speed paper tape reader, high-speed paper punch, line printer and Universal PROM programmer. Standard software includes a ROM-resident system monitor, a RAM-resident 8080/8085 assembler and a text editor. It's available now.

The Intellec MDS-016 is a 16k RAM option, consisting of a model 2107 N-Channel dynamic RAM. It's available now.

The Intellec MDS-PTR is a High-Speed Paper Tape Reader peripheral, including a cable assembly and featuring a transfer rate of 200 cps. It's available now.

The Intellec MDS-PRN is a High-Speed Printer peripheral. The 5x7 matrix line buffered printer operates at a maximum of 165 cps. Line width is switch-selectable from 80 columns at 10 characters/inch to 132 columns at 16.5 characters/inch. The printer produces an original plus four copies and includes a tabletop cabinet, power supply, interface cable, operator lights, automatic on-off motor control and a 2-channel VFU control. It's available now.

The Intellec MDS-DDS is a Dual Drive Double Density Diskette Operating System for MDS-800 direct access bulk storage. It includes an intelligent controller and two Diskette Drive Units (each with 500,000 byte capacity), a cabinet, power supplies, cable assemblies and two ISIS-II system software Diskettes. ISIS-II includes a Relocating Macro-Assembler, Linker, Object Locator, Text Editor and Library Manager. The DDS is expandable to 2-million bytes. It's available now.

The Intellec MDS-CRT is a Keyboard Display Unit providing total user communication with all Intellec Diskette software and peripherals. The keyboard is detachable, and the RS232C-compatible CRT provides asynchronous data transfer rates of up to 9600 baud and features cursor positioning and cursor homing capability. It's available now.

The Intellec MDS-80-ICE is the famous In-Circuit Emulator which allows the design, development and debugging of a product in its own real-time operating environment. The ICE module consists of an 8080 CPU In-Circuit Emulator and includes a cable assembly and interactive software. It's available now.

The Intellec UPP-101 is a Universal PROM Programmer, including a cabinet, software, power supplies, cable and one 16/24-pin zero insertion force PROM programming socket pair. At least one "personality card" is required. It's available now.

The Intellec UPP-816 is a Personality Card for the 2716 2k x 8 EPROM, which features a 450 nanosecond access. It's available now.

The Intellec UPP-848 is a Personality Card for the new 8748 single-chip LSI microcomputer. The card includes an adaptor socket. It's available now.

The Intellec UPP-855 is a Personality Card for the new 8755 PROM (a pin-for-pin equivalent of the 8355 ROM) which contains 2k bytes of program memory, an address latch and two 8-bit general purpose I/O ports (one of which may be used to address external memory). It's available now.

The Intellec MDS-PLM is a Resident Compiler for Intel's High Level Programming Language, PL/M. It translates a source program written in PL/M into machine code for the 8080A and 8085 microcomputers. An MDS-DDS and 64k bytes of RAM are required. It's available now.

The Intellec MDS-D48 is a Support Package for assembling 8748, 8048 and 8035 single chip microcomputer programs on the MDS-800. It's available now.

The Intellec PROMPT-48™ is a Personal Programming Tool for the 8748 and 8048. It runs programs in real-time, with multiple breakpoints, or with single-stepping. PROMPT-48 includes both 8748 and 8035 CPUs, an EPROM Programmer, an integral keyboard, displays and system monitor in ROM. The system provides 64 bytes of RAM register memory, 1k bytes of EPROM program memory, 256 bytes of RAM data memory and 1k bytes of RAM program memory. System I/O, bus and memory can be expanded or directly interfaced to a user prototype. It can be used as a stand-alone system, or it can work with any terminal. It may be connected to the MDS-800 for direct program downloading and includes I/O ports, a bus cable and comprehensive documentation. It's available now.

The Intellec PROMPT-SER is a serial cable for connecting PROMPT-48 to a TTY or CRT. It's available now.

The Intellec PROMPT-SPP is a Specialized EPROM Programmer Kit which allows PROMPT-48 to be connected to the MDS-800 as a specialized EPROM programmer peripheral or debugging station. It's available now.

You can rent any of these products—from stock, immediately—by contacting

Rental Electronics, Inc.

Another of the **AMERICAL** companies

Anaheim, Calif. (714) 879-0561
Mountain View, Calif. (415) 968-8845
Northridge, Calif. (213) 993-RENT (7368)
Fort Lauderdale, Fla. (305) 771-3500

Des Plaines, Ill. (312) 827-6670
Burlington, Mass. (617) 273-2770
Gaithersburg, Md. (301) 948-0620
Dallas, Texas (214) 661-8082
Oakland, N.J. (201) 337-3757
Rexdale, Ontario, Canada (416) 667-7513

CIRCLE NUMBER 167



From REI... off-the-shelf,
throughout North America.

NEC IS BULLISH ON

1. WE'RE THE COMPANY WITH ALL FOUR KINDS.

Now with the introduction of these four new families, we're the company with every kind of dynamic RAM you could need:

The μ PD414 Series — 4K, 16-pin, 200-350ns.

The μ PD418 Series — 4K, 18-pin, 150-300ns.

The μ PD411A Series — 4K, 22-pin, 200-350ns.

The μ PD416 Series — 16K, 16-pin, 150-300ns.

2. WE GIVE YOU A $\pm 10\%$ OPERATING MARGIN.

In all four families. Compare that with other people's margins of $\pm 5\%$. Imagine the manufacturing care that takes. And the added flexibility you get.

3. WE DESIGN THEM TO USE LESS POWER.

Our μ PD414's and 416's have as low a power dissipation as any comparable product in the industry.

And our μ PD418's and 411A's actually use less power than any other standard 18- or 22-pin 4K RAMs on the market. In fact, our 18-pin uses 60% less power.

And with this kind of power dissipation, we can offer all our RAMs in plastic, as well as cerdip, packages.

4. WE'LL EVEN PUT THEM ON A BOARD.

If you want any of our products on a board, we'll gladly design and build it for you. However you like. In whatever quantity you need.

So next time you're in the market for dynamic RAMs, why not contact one of our reps or distributors. They've got everything you need. And that's no bull.

NEC Microcomputers, Inc., Five Militia Dr.
Lexington, MA 02173, 617-862-6410.

NEC microcomputers, inc.

REPS: East — C&D Sales 301-296-4306, Contact Sales 617-273-1520, Harry Nash Assoc. 215-657-2213, Tech-Mark 607-748-7473, 716-223-1252, 315-652-6229, Trionic Assoc. 516-466-2300; South — Perrott Assoc. 305-792-2211, 813-585-3327, 305-275-1132, Wolfs Sales Serv. Co. 919-781-0164; Midwest — Electronic Innovators 612-884-7471, W. Pat Fralia Co. 817-640-9101, 817-649-8981, 713-772-1572, K-MAR Eng. & Sales 816-763-5385, R.C. Nordstrom & Co. 313-559-7373, 616-429-8560, Technology Sales 312-438-3300; West — Mike Duffy Assoc. 303-934-7392, Electronic Component Marketing 714-524-9899, 213-649-5374, Spedden Assoc. 714-295-6122, Summit Sales 602-994-4587, Trident Assoc. 408-734-5900, Tri Tronix 206-232-4993, 505-265-8409; Canada — R.F.Q. Ltd. 416-626-1445, 514-626-8324.

DISTRIBUTORS: Century Electronics (Albuquerque, Salt Lake City, Wheatridge CO), Diplomat (Chicopee Falls MA, Clearwater FL, Elk Grove Village IL, Farmington MI, Minneapolis, Mt. Laurel NJ, Salt Lake City, St. Louis, Sunnyvale, Totowa NJ, Woodbury NY), Future Electronics (Montreal, Ottawa, Rexdale, Canada), Harvey Electronics (Fairfield NJ, Lexington MA, Norwalk CT, Woodbury NY), Intermark Electronics (San Diego, Santa Ana, Sunnyvale), Lionex (Burlington MA), G.S. Marshall (Sunnyvale), Mirco Electronics (Phoenix), Resco (Raleigh), R-M Electronic (Kentwood MI, Madison Hgts MI), Semicomp (Newport Beach CA), Semiconductor Specialists (Burlington MA, Chicago, Dallas, Dayton, Farmington MI, Hazelwood MO, Indianapolis, Kansas City, Milwaukee, Minneapolis, Pittsburgh, St. Louis; Malton Canada), Sterling Electronics (Albuquerque, Dallas, Houston, New Orleans, Phoenix, San Diego, Seattle, Sun Valley CA, Watertown MA), Technico (Columbia MD, Roanoke VA), Zeus Components (Elmsford NY).



DYNAMIC RAMS.



Touch and Trigger

Stable, Automatic displays without fiddling

As shown, the PM 3212 has an impressive combination of features that add up to unbeatable all around performance. 25 MHz/2mV, comprehensive triggering, brightness and portability add up to an impressive value at \$ 1155.00 including probes.

And more . . . a sharp display, double insulated power supply, battery option, versatile X-Y operation, Auto, AC, DC, TV, Level Control and Composite Triggering, and the usual Philips plus; a front panel layout based on user efficiency.

Bright display with small spot size through 10 kV CRT. Continuously variable illumination of internal graticule.

Auto triggering provides a baseline in the absence of a signal and derives trigger from pk-pk signal amplitude to insure stable triggering from a variety of signal and gain setting conditions.

DC coupled triggering prevents loss of display under varying duty cycle signals. Vital for digital measurements.

Add function for A-B displays with composite triggering on A-B signal to display signals with high offsets.

Solid TV triggering at the touch of a button. Automatic line or frame sync down to max. sensitivity.



PM 3212 priced at \$ 1155.00 includes cover and probes. Pouch shown is optional.

Time base vernier overlaps range settings to avoid double writing of digital signals.

20 nS maximum sweep speed with 10x magnifier.

Separate source triggering and composite for phase and timing measurements on asynchronous signals and no probe switching.

Full level of control of trigger point.

All trigger sources can be used for the horizontal channel for versatile X-Y displays.

Philips Test & Measuring Instruments, Inc.
A NORTH AMERICAN PHILIPS COMPANY

In the United States:
85 McKee Drive
Mahwah, New Jersey 07430
(201) 529-3800

In Canada:
6 Leswyn Road
Toronto, Ontario Canada M6A 1K2
(416) 789-7188

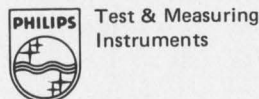

PHILIPS

CIRCLE NUMBER 170

ELECTRONIC DESIGN 12, June 7, 1977

THE MOLEX 4850 IS THE MOST VERSATILE FLAT CONDUCTOR CONNECTOR TODAY!

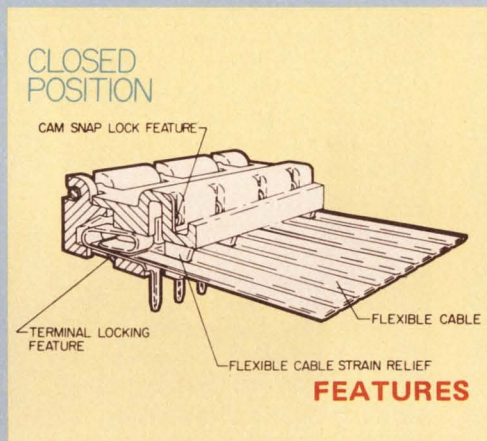
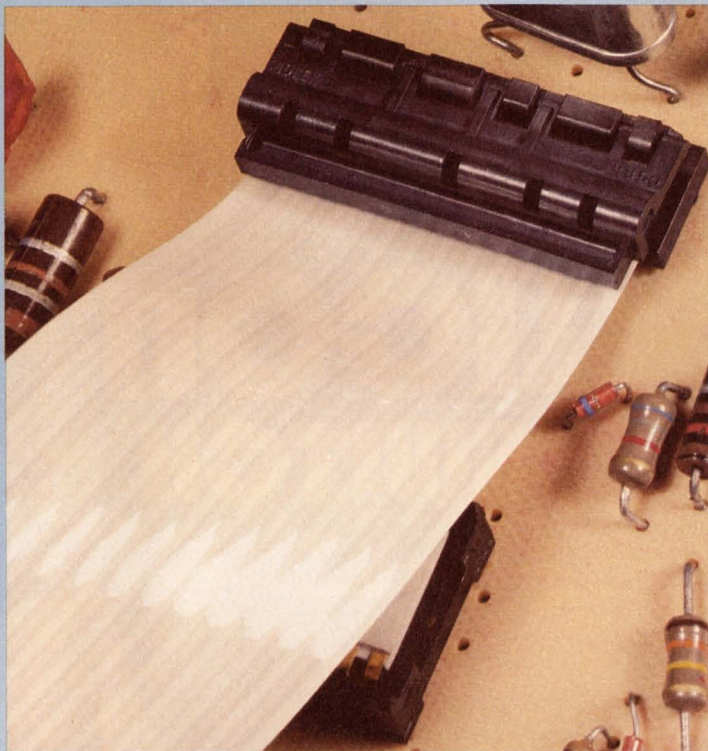

MOLEX 4850 FEATURES

- High reliability.
- Designed for cable or flexible etched circuits.
- Zero insertion/extraction force.
- Unique two-piece housing with a snap-on hinge cam.
- Numerous insertion and withdrawals without damage to plating or flat conductors.
- Strain relief.
- Connector locks to printed board for soldering and use.
- Eliminates soldering to flat conductor cables or circuitry.
- Available in 5 through 25 circuit sizes, inclusive.
- 94V-O, U.L. rated, polyester.
- Simple assembly, no learning curve.
- Tin or gold-plated solder tail terminals.

Another example of Molex "Affordable Technology". For complete details and options available call (312) 969-4550 or write MOLEX INCORPORATED, 2222 Wellington Court, Lisle, Illinois 60532.

molex [®] ... Affordable Technology

Your LICON distributor invites you to

We've made it easy for you to experience the unique design, production, pricing and customer service benefits other Licon switch users have enjoyed for years. Free of charge... without any strings of any kind!

Here's all you need to do. Ask your nearby Licon distributor (he's listed below) for a copy of the New Licon Switch Selection Guide. Pick out the model you'd like from the list of Licon lighted and non-lighted pushbutton switches and single and double break basic switches. Fill out the postage-paid card that's enclosed... and we'll take it from there!

We'll rush you the Licon switch you choose.

You can weigh it, measure it, plug it into your product or prototype, bite it, kick it, sniff it, life test it... do whatever you want. It's yours.

You've nothing to lose. So call or write for a test drive today. Offer good in the U.S.A. only. Licon, A Division of Illinois Tool Works Inc., 6615 West Irving Park Road, Chicago, Illinois 60634. Phone: (312) 282-4040. TWX 910-221-0275.

TEST DRIVE



LICON[®] SWITCH



LICON

A DIVISION OF ILLINOIS TOOL WORKS INC.

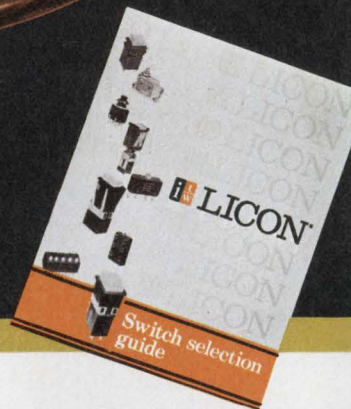

Call your LICON distributor for a TEST DRIVE

ARIZONA
Phoenix/Cramer Electronics
(602) 267-7321

CALIFORNIA
Burlingame/Rose Electronics Distributing
Co.
(415) 692-5700

Los Angeles/Electric Switches, Inc.
(213) 660-1310

Los Angeles/Kierulff Airline Supply
(213) 724-6600

Santa Clara/Fisher Brownell
(408) 244-6182

Sun Valley/Richey Electronics
(213) 768-3800

COLORADO
Denver/Cramer Electronics
(303) 758-2100

CONNECTICUT
Hartford/L. E. Whelan Company
(203) 246-5694

FLORIDA
Orlando/Cramer Electronics
(305) 894-1511

ILLINOIS
Chicago/Newark Electronics Corp.
(312) 638-4411
Chicago/Electronic Expeditors
(312) 236-1088

INDIANA
Indianapolis/RA DIS Co.
(317) 637-5571

KANSAS
Wichita/Radio Supply Company Inc.
(316) 267-5214

MARYLAND
Kensington/Marine Air Supply
(301) 949-1353

MASSACHUSETTS
Newton/Cramer Electronics
(617) 969-7700
West Springfield/Tectrol Associates
(413) 733-3695
Watertown/Sterling Electronics
(617) 926-9720

CIRCLE NUMBER 172

MICHIGAN
Detroit/Fife Electric Supply Company
(313) 963-1160
Wyoming/Newark Industrial Electronics
(616) 241-6681

MINNESOTA
Minneapolis/Stark Electronics Supply
(612) 332-1325

NEBRASKA
Lincoln/Scott Electronics Supply
(402) 466-8221

NEW JERSEY
Hackensack/Nassor Electrical Supply Co.
(201) 342-3737

NEW YORK
Binghamton/ASI Electronics Inc.
(607) 723-6326
Buffalo/Summit Distributors Inc.
(716) 884-3450
Farmingdale/Iris Electronics, Inc.
(516) 420-8400

NORTH CAROLINA
Winston-Salem/Kirkman Electronics
(919) 722-9131

OHIO
Akron/Akron Electronics Supply
(216) 762-8816
Dayton/Esco Electronics Inc.
(513) 226-1133

PENNSYLVANIA
McKeesport/Barno Radio
(412) 751-5966
Philadelphia/Pytronics Industries
(215) 643-2850

TEXAS
Houston/Lenert Company, Inc.
(713) 225-1465
Dallas/Wholesale Electronics Supply
(214) 824-3001

WASHINGTON
Bellevue/Bell Industries
(206) 747-1515

WISCONSIN
Milwaukee/Electronic Expeditors
(414) 228-8100

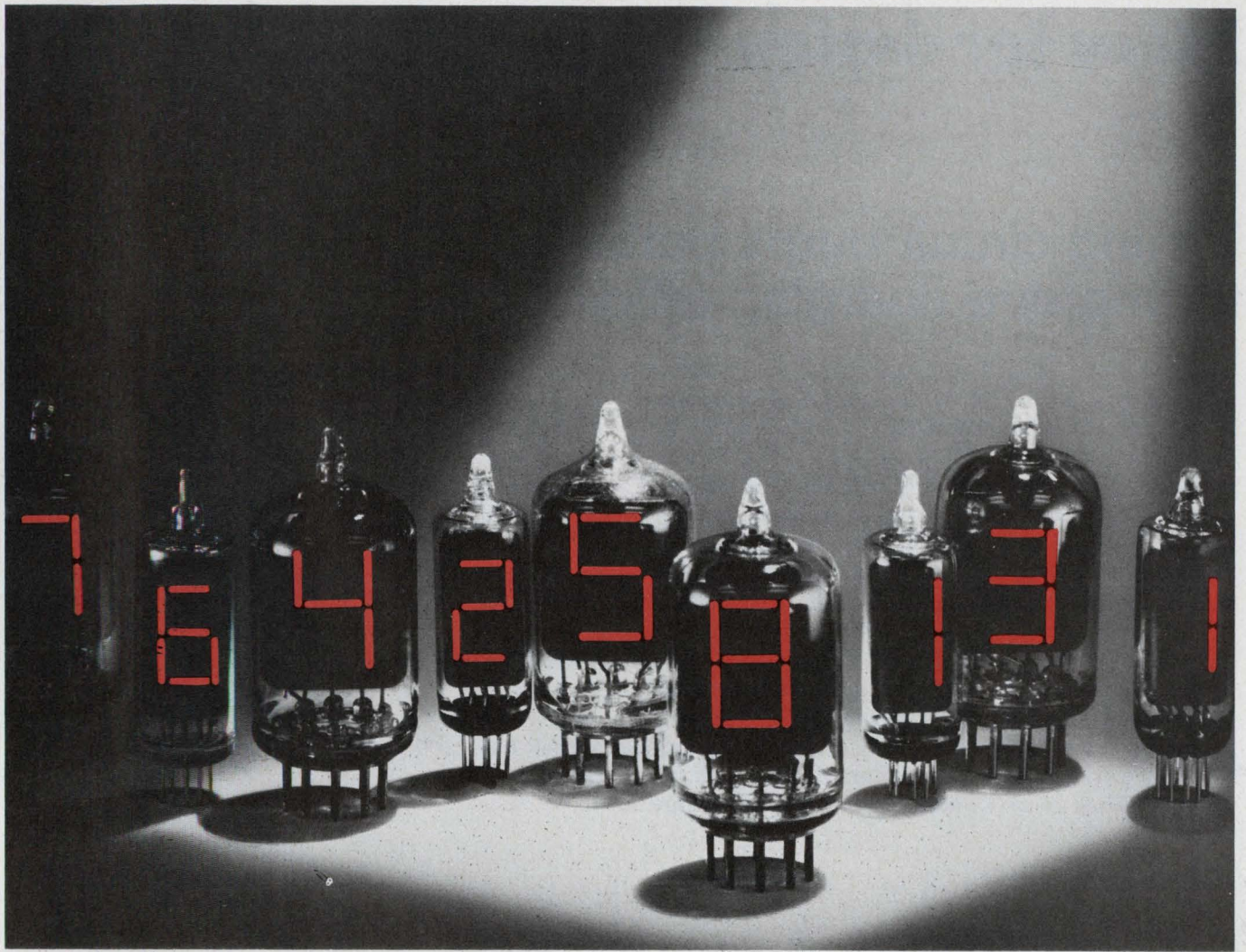

RCA NUMITRON Digital Display Devices - Retain brightness even in direct sunlight.

RCA Numitron Digital Display Devices are the designer's answer to high ambient light conditions. And, with normal indoor lighting, numerals are legible to 40 feet or more with almost any color filter desired.

In addition to their astonishing brightness, they offer equipment designers the following unique benefits:

- Color filter selection is practically unlimited since the output spectrum is broad and continuous.
- Brightness is completely controllable. Numitrons maintain uniform brightness from segment to segment, even at reduced voltages.
- High reliability and rugged construction provide a mean life expectancy of more than 100,000 hours.
- Low voltage operation (4.5 volts nominal).
- Compatible with IC decoder/drivers such as the RCA CD2500E family.
- Freedom from induced or radiated interference.

- Planar construction gives uncluttered wide-angle viewing.
- Ambient operating temperatures range from -50°C to $+125^{\circ}\text{C}$.

RCA Numitrons will open new markets for your products. Their applications keep growing throughout industry. Remember, Numitrons are designed and manufactured by RCA . . . the quality and ruggedness are built-in.

Get your free copy of "RCA NUMITRON Display Devices" containing complete technical information. Contact your RCA District Manager or Numitron Distributor or write RCA Numitron Merchandising, RCA Distributor and Special Products Division, 2000 Clements Bridge Road, Deptford, N.J. 08096.

RCA NUMITRON
Display Devices

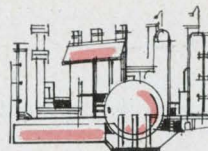
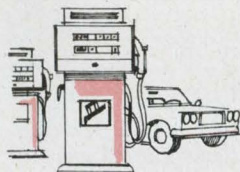

Timing circuit burps battery to improve charging efficiency

The circuit in the figure is an improved storage-battery charger that uses a 555 timer to "burp" the battery—to apply a 20-V pulse across the battery periodically, while it's being charged. This process tends to shake gas molecules loose from the battery plates. The molecules insulate portions of the battery plates from the electrolyte, which reduces the effective charging current by raising the internal resistance.

This burp-control circuit can be added to just about any existing automobile-battery (12-V) charger. The 555 timer is connected in a free-running mode and has independent on and off times. The time between burps is controlled by the variable pot, R₁₀, from once every 2 s to once every 2½ min. Capacitors C₂ and C₃ charge to 20 V. When relay K₁ activates, a negative charge

is dumped into the battery.

Burping continues after the battery is fully charged. But the time between burps should be adjusted to correspond to the chemical activity in the battery—a short time for high activity when the battery charge is low, and long when near full charge. The duration of the negative pulse is short, so it won't harm the battery. But be careful—with the battery mounted in an automobile, the alternator rectifiers can be damaged if the positive cable to the battery isn't removed.

John Okolowicz, Senior Electrical Engineer, Honeywell Inc., 1100 Virginia Dr., Fort Washington, PA 19034.

CIRCLE NO. 311

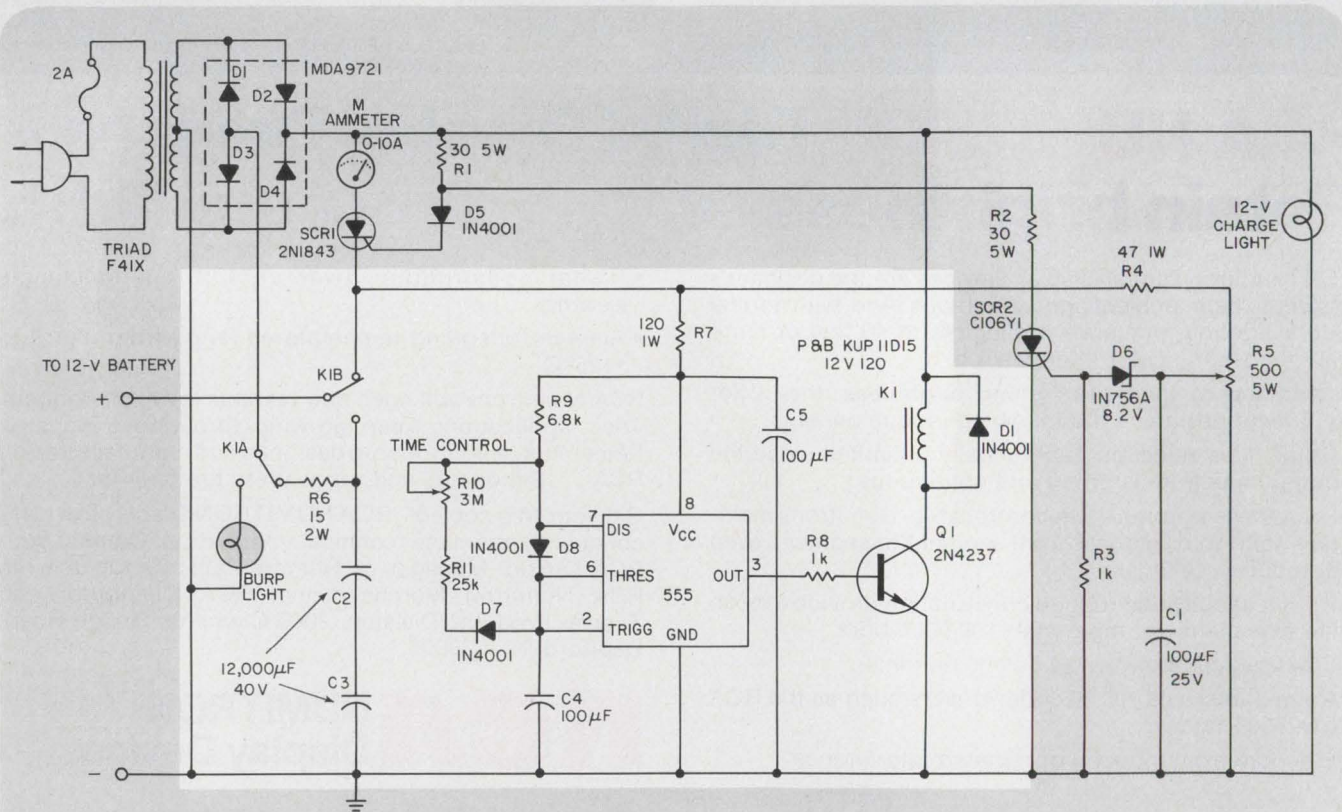

The burp-control circuit shown within the outline applies a 20-V pulse to a charging battery at intervals

of 2 s to 2-1/2 min, determined by the setting of time-control resistor R₁₀.

Group portrait: The Class of '77



Guardian solenoids are made in all sizes and shapes: Box frame, U-frame, laminated and tubular . . . push 'n pull . . . AC 'n DC. But, it's the WAY they're made that puts them in a class by themselves.

Example: Uni-Guard® II molded bobbin and coil covers are now standard on our box frame and U-frame solenoids. This one design feature alone gives you cost savings of up to 25% . . . with at least 25% longer life.

Example: Our tubular solenoids are made in two basic versions . . . and hundreds of variations. There are the built-to-take it traditional tubulars. Plus, long-life tubulars that survive 100 million operations.

Example: We have more types available from stock than anyone else: A special? You spec it and Guardian's ready to produce it. Return springs, special plunger configurations, terminations, mountings, coil finishes, thermal cutouts, dual windings, external switches . . .

Let your Guardian Angel show you why Guardian is No. 1 in its solenoid class.



 Recognized under the component program of Underwriters Laboratories, Inc.

GUARDIAN®

GUARDIAN ELECTRIC MANUFACTURING CO. • 1572 West Carroll Ave. • Chicago, Illinois 60607 • 312/243-1100

CIRCLE NUMBER 46

Digitally programmable clock source built with a d/a and v/f converter

An accurate programmable frequency source can be easily constructed by using a d/a converter to drive a v/f converter (see figure). The frequency can be set either with thumbswitches or from any source of BCD or straight-binary data. With the components shown, the maximum frequency is about 100 kHz. The AD537 output can easily drive TTL or CMOS logic, or even directly sink a current of 20 mA in the LOW state and put out 36 V in the HIGH state.

The AD562 delivers an output current that the AD537 uses directly without intermediate circuitry. A further simplification results from the +1.00-V reference-voltage output of the AD537. The v/f converter uses this voltage as its reference, so the circuit works in a ratiometric mode that contributes to overall accuracy.

Note that the AD562 exhibits a maximum current-gain from the input at pin 4 to the output at pin 9 of 2.5, so the 160- μ A current in the scaling resistors, R_1 and R_2 , becomes nearly 400 μ A. If a straight binary-coded AD562 is substituted, the full-scale output current is 640 μ A, and the timing capacitor, C, should be increased by a factor of 1.6.

Calibration is straightforward: with the thumbswitches set to 999, adjust R_2 to read the corresponding frequency, that is 99.9 kHz, on a counter.

The linearity of the system ensures that all other settings of the frequency are correct within the three-digit window. A fourth decade can be added in the LSD position with an external current feed to pin 4 of the AD537, which is very close to ground potential. This voltage may be trimmed to exactly zero with a pot connected between pins 9 and 10.

In addition to the square-wave output from its pin 13, the AD537 also generates a symmetrical triangular voltage across the capacitor, which may be used as an alternative output if buffered by a differential-input amplifier.

The use of a d/a converter may seem extravagant, since a Kelvin-Varley voltage divider can be used to energize the +1.00-V reference output, having its final decade connected to the voltage input of the AD537. However, such components with guaranteed $\pm 0.03\%$ accuracy are very expensive.

A helical pot with a digital dial is another possibility, but this usually offers only $\pm 0.25\%$ linearity, and more linear pots are both costly and not readily available.

Barrie Gilbert, IC Design Engineer, Analog Devices Inc., Route 1 Industrial Park, P.O. Box 280, Norwood, MA 02062.

CIRCLE NO. 312

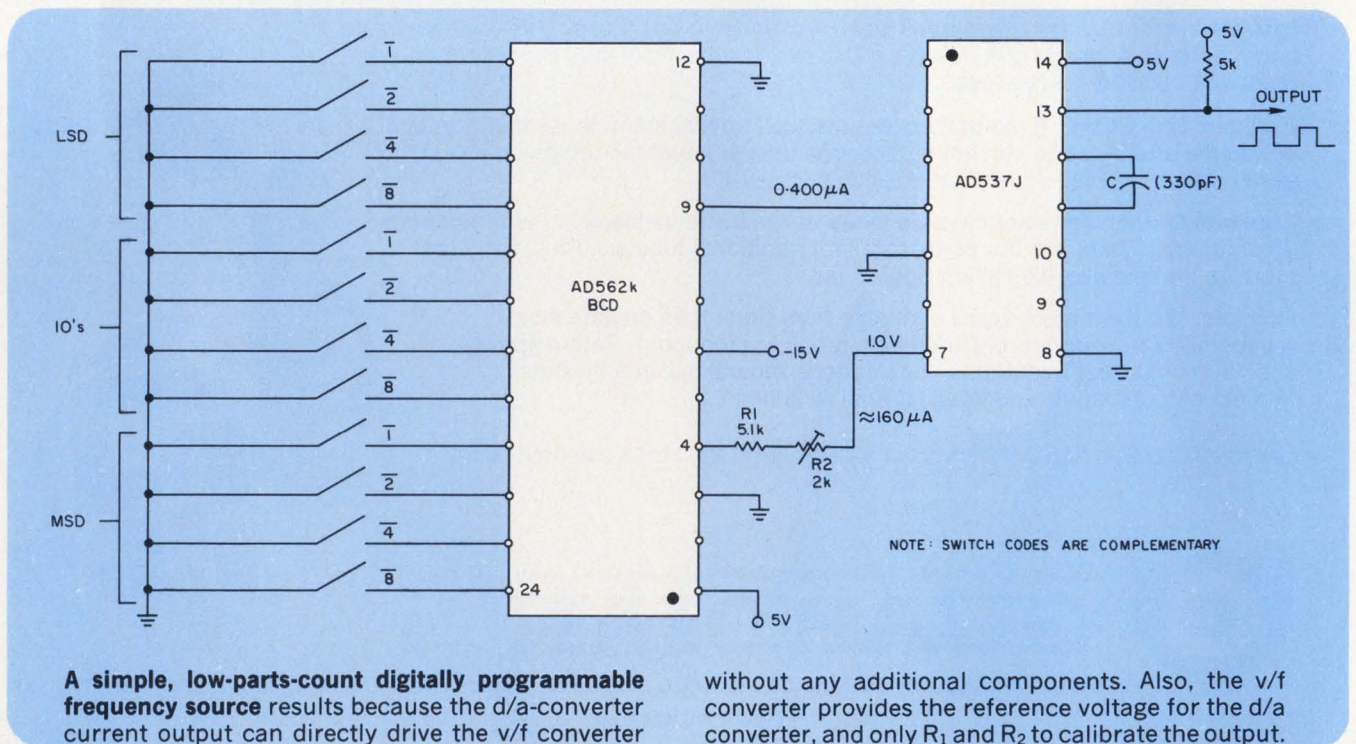

Just as you can count on 24 hours in a day,



you can count on Synchron[®] motors.

We custom-make every Synchron motor. Every one. Because it's almost impossible to stock ready-made synchronous motors exactly right for your needs.

Perhaps the motor you need for your product calls for a little more speed than the motor that's letter perfect for someone else. Or you need a little less torque. Or a threaded output shaft instead of a knurled one.

If we say we'll ship in 5 weeks, we'll do it. At a fair price.



And if we've approved your application we'll stand behind our motor 100%.

Stated simply: You can rely on Synchron motors to be designed and built right, to do the job right. That's the only way we do business.

Call or write for our specification sheets and the name and location of our representative in your area.

Choose from five principal styles of Synchron motors—60 or 50 Hz—from one revolution per week to 900 rpm—from 8 thru 98 oz-in torque at 1 rpm—from hundreds of different outputs.



HANSEN MANUFACTURING CO., INC.

Princeton, Indiana 47670

a subsidiary of IMC MAGNETICS CORP.

We make every Synchron motor as if our name were on your product

Interface circuit teams cassette recorder with a CRT to work as a TTY/paper-tape unit

Use the cassette-recorder, CRT and computer interface circuit in the figure so the assembly can work like a TTY with its paper-tape reader. The interface circuit allows operation in local and remote modes.

When switch S is in the local position, the keyboard of the CRT can transfer data to the cassette-recorder interface, and also to the CRT display. In addition, data from the cassette recorder can be displayed on the CRT. In the local mode, no data paths exist between the computer and either the CRT, keyboard or cassette-recorder.

When switch S is in the remote position, data from the CRT keyboard or the cassette recorder are applied to the computer, and data from the computer are available to the cassette recorder interface and the CRT display.

Level-changing gates 1488 and 1489 translate between TTL and RS232C levels; the 7400 gates allow data from both the CRT keyboard and the cassette recorder to be ORed into the computer input; and the selector/multiplexer, IC₁, in conjunction with the OR gate acts as a data-transfer switch for the local/remote selection.

Of course, where TTL levels or 20-mA current loops instead of RS232 levels are present, the level-changing gates can be appropriately replaced without sacrifice of circuit performance.

Ban Bong, Senior Technical Staff Engineer, Advanced Technology & Engineering, Collins Government Telecommunications Div., Rockwell International, Cedar Rapids, IA 52406. CIRCLE NO. 313

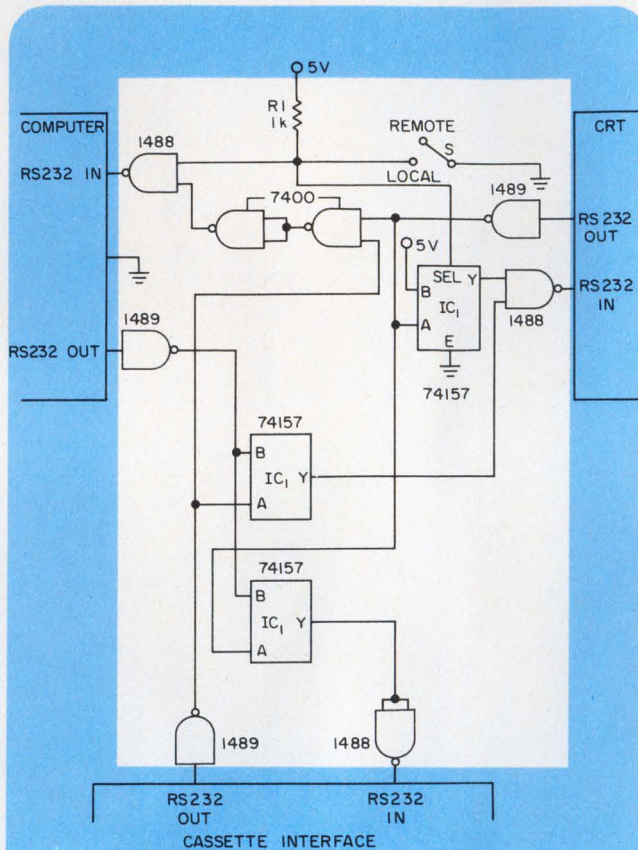

A cassette recorder/CRT system can be made to do the work of a TTY/paper-tape combination with this simple interfacing circuit.

IFD Winner for February 1, 1977

Peter Ole Jensen, Applied Computer Technology, Lindevangshusene 19, DK-2630 Taastrup, Denmark. His idea "Implement a Lab-scope Data Display with μ P Software" has been voted the most valuable of Issue Award.

Vote for the Best Idea in this issue by circling the number of your selection on the Reader Service Card at the back of this issue.

SEND US YOUR IDEAS FOR DESIGN. You may win a grand total of \$1050 (cash)! Here's how. Submit your IFD describing a new or important circuit or design technique, the clever use of a new component or test equipment, packaging tips, cost-saving ideas to our Ideas for Design editor. Ideas can only be considered for publication if they are submitted exclusively to ELECTRONIC DESIGN. You will receive \$20 for each published idea, \$30 more if it is voted best of issue by our readers. The best-of-issue winners become eligible for the Idea of the Year award of \$1000.

Need a 2-digit BCD DAC?

Our DAC-20 is the world's first monolithic 2-digit BCD-coded DAC. Gives you very high speed performance (85nsec settling, typ.) with very low power consumption (37mW), terrific nonlinearity ($\pm 1/4$ LSB Max. over temp.)—all for **very low cost**.

It's simple to use. Provides a universal logic interface for TTL, CMOS, ECL, or any other logic. Full noise immunity is provided by high swing adjustable threshold logic inputs. And dual complementary current outputs with $-10V$ to $+18V$ compliance give you a voltage output with only a resistive termination. No speed-limiting output op amp needed.

Just ask . . .

Applications for our DAC-20 series range from audio attenuators and analog meters to modems and micro-processors. We'll be glad to send you a data sheet full of these and other application ideas

using the DAC-20 in such things as reference amplifiers, logic threshold controls, and multiplying circuits with bipolar or pulsed references.

Just circle the reader service number for a copy. And if you would like a free sample DAC-20, write us on your letterhead and tell us what application you're thinking about. We'll be glad to help you get going. Write DAC-20 at the address below.

Thank you.



Precision Monolithics, Inc.,
1500 Space Park Drive,
Santa Clara, CA 95050
(408) 246-9222. TWX 910-
338-0528.

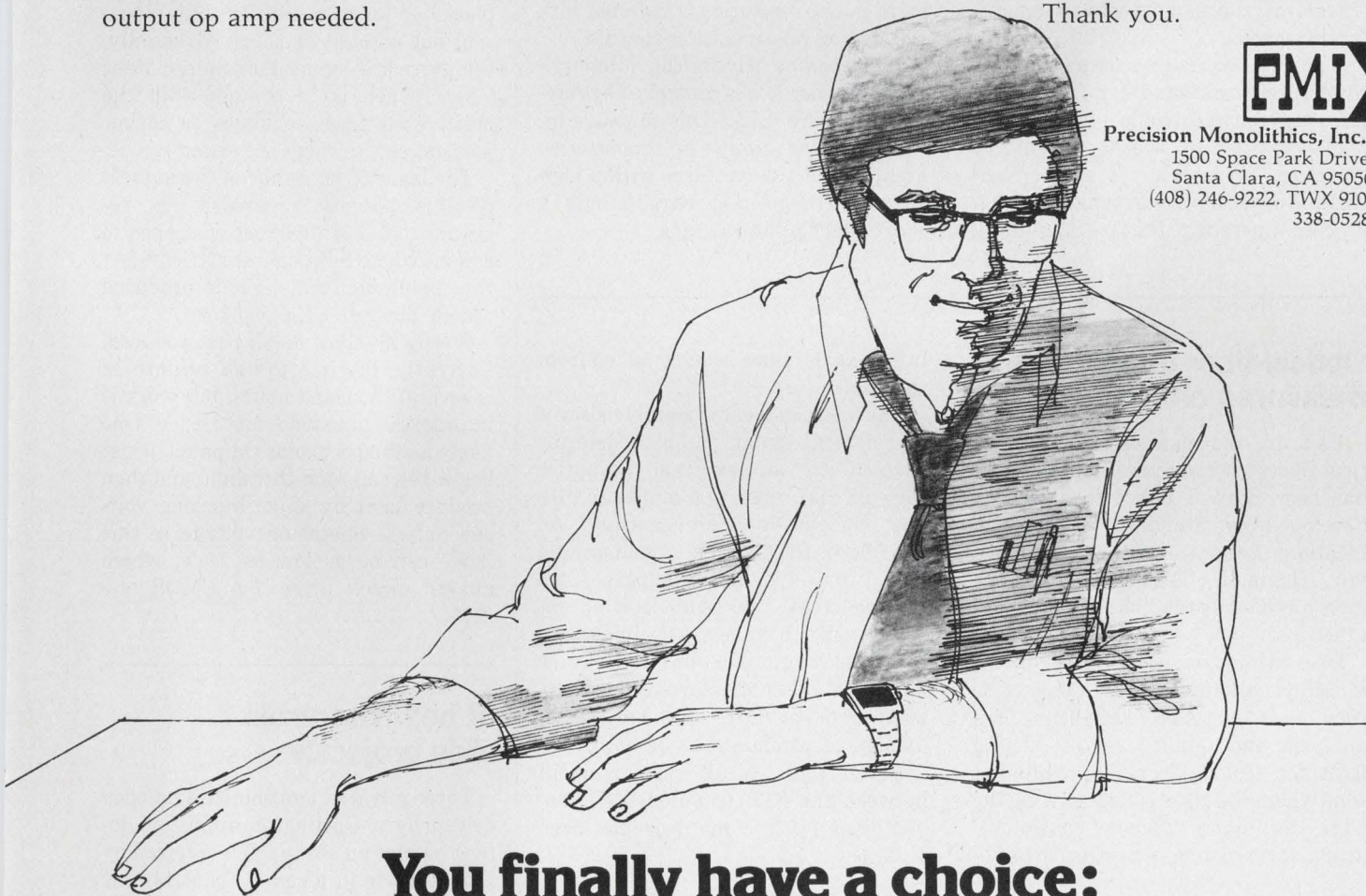

You finally have a choice:

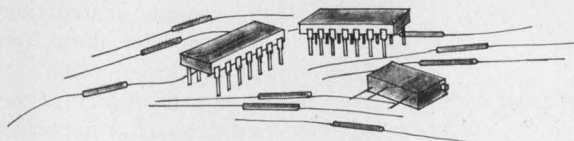

Make

Buy

CIRCLE NUMBER 48

Pattern maker's masks are big and sharp

A computer-controlled pattern generator can produce masks with large-area patterns and fine-line definition. Developed at the University of Edinburgh, Scotland, it can draw patterns over areas as large as 300 × 300 mm (11.8 × 11.8 in.). Image placements are accurate to a few micrometers, with even closer accuracy claimed for repeatability and the ensuing registration of the same patterns on different masks.

Suitable for such components as SAW filters, thick and thin-film hybrid circuits, optoelectronic devices and high-resolution PC boards, the pattern generator is superior to the conventional Rubylith photographic emulsion process. Currently, the largest reduced

image available is about 1/2 × 1/2 in. However, the Edinburgh pattern generator can photocompose over a 4 × 4-in. area with half-micro X and Y-axis steps and ±0.2 μm repeatability at any X, Y point.

Line resolutions are restricted to the 2.5 to 3-μm level because of the limiting resolution of the photo-emulsions that have to be used. But further improvement in line resolution is expected with the use of photoresist materials.

The machine drive of the Edinburgh pattern generator is controlled by complex software. Since this software includes nested groups of subpatterns, highly repetitive patterns with a high degree of repetition require only a short description on tape.

Optical-fiber quality measured on-line

Usually, the characteristics of optical fibers are measured after the fiber has been drawn. But with a method developed by Standard Telecommunications Laboratories (STL) of Harlow, England, fiber quality can be monitored while the fiber is being manufactured.

Discontinuities in the fiber-transmission characteristics are detected as they occur, which simplifies loss analysis and quality control. Using light for testing from the white-hot zone where the glass is first melted, the STL technique allows continuous attenuation-vs-length profiles to be ob-

tained as the fiber is being pulled from the melt.

The measurement system consists of a rotating drum, a photodetector coupled to an external amplifier through slip rings, and an 890 to 910-nm bandpass-interference filter. As the fiber is formed, it is wound around the drum, and the bandpass filter ensures that the photodetector responds only to wavelengths important to optical communication. The detector output is either displayed on a chart recorder or converted to a direct digital display of attenuation—or both.

Better than ±1-dB/km agreement between the STL technique and conventional off-line methods has been obtained.

Panel production simpler with dc phosphors

Depositing phosphors on large-area, electroluminescent (EL) ac panels requires careful and costly control. But now phosphors can be applied with a much simpler, low-cost dip-coating dc

process that eliminates the need for expensive control.

Constant light can be produced over ac panels only if the bulk uniformity of the phosphors is high. The dc-phos-

phor technology developed by Phosphor Products, Dorset, England, requires no uniformity to produce constant light.

The new phosphor particles consist of an insulating core of zinc sulfide surrounded by a conducting layer of copper manganese. Particle diameter is about 1 μm.

The phosphor is mixed with only 5% of binder, not the conventional 40%, so that when the mixture is coated onto a panel electrode, the phosphor particles are in close electrical contact with each other.

A forming voltage applied across the phosphor layer results in a high current but no light emission. Gradually, the particle's copper-manganese outer layer, which is in contact with the positive electrode, changes as copper ions migrate towards the negative side.

The layer of phosphor at the highest positive potential increases in resistance as it is depleted of copper to a point where light emission occurs. At that point, uniform light is produced across the full EL-panel area.

A bright yellow display is produced. Currently, lifetime to half brightness is several thousand hours, but work is in progress to extend this period. One likely method is to bias the panel to just below the emission threshold and then produce light by superimposing voltage pulses. Operating voltage in this mode can be as low as 15 V, which allows direct drive by CMOS devices.

IR beam controls slide projector

Three infrared light-emitting diodes driven by a Darlington amplifier deliver carrier pulses that are received by a photodiode in a remote control unit developed for slide projectors by Siemens AG in Germany. Instructions for room lights, projector lamp, and forward and backward motion are transmitted in sequential form, time-encoded by simple capacitor networks. The receiver decodes the pulses through a tuning circuit and a low-cost video i-f amplifier IC.



It also comes assembled.

If you need dials, we have dials. If you need handsets, we have handsets. If you need Touch Calling keysets, we've got 'em by the thousands. Ringers and hookswitches, too. Or, if you need complete telephones, we have them for you in all the latest styles and colors.

You get communications components faster from GTE Automatic Electric because, outside of the Bell System, we're the largest manufacturer of telephone equipment in the U.S. If you need it, we have it.

Use the coupon below for a complete

catalog. Or if you're in a real hurry, call John Ashby at (312) 562-7100, extension 250.

When it comes to quality components, call THE SOURCE: GTE Automatic Electric.



- Please send your catalog of communications components.
- Please send more information and prices on _____ of _____ (Quantity) (Product)

Name _____ Title _____

Company _____

Address _____

City _____ State _____ Zip _____

Telephone _____

Mail to: Mr. J. D. Ashby, B-4, GTE Automatic Electric, Northlake, Illinois 60164.

GTE AUTOMATIC ELECTRIC

Arrow-M Amber Relays

solve PC board cleaning problems.



Arrow-M's leak-free Amber Relays are N₂ gas-filled and sealed in plastic so they're simple to clean with most de-greasers and detergent cleaners, without affecting the maximum contact reliability of the relays.

And, Arrow-M can help you substantially reduce your labor costs! Just use Arrow-M Amber Relays on your PC board in conjunction with automatic wave soldering, instead of costly hand soldering.

The total savings are even greater when you use Arrow-M Amber Relays. Arrow-M Amber

Relay prices are right in line with standard non-seal types.

Arrow-M Amber Relays. When you want maximum reliability and maximum savings. And only Arrow-M makes them.

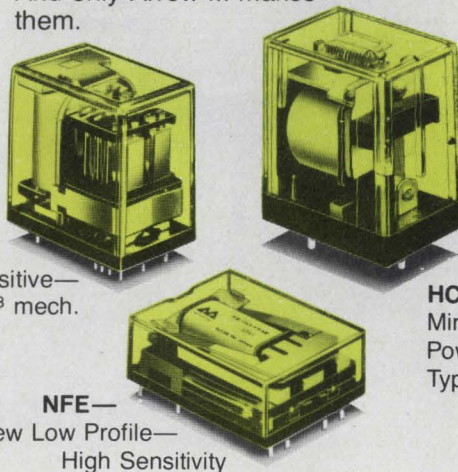

KE—Sensitive—
Long Life—10⁸ mech.

NFE—
New Low Profile—
High Sensitivity

HCE—
Miniature
Power
Type.

For more information on exact specifications, write or call your nearest Arrow-M office.

Arrow-M Corporation
250 Sheffield Street
Mountainside, N.J. 07092
(201) 232-4260

Western Office:
22010 South Wilmington Ave.
Suites 300 & 301
Carson, California 90745
(213) 775-3512



New products

Hybrid amplifiers deliver premium specs at low cost

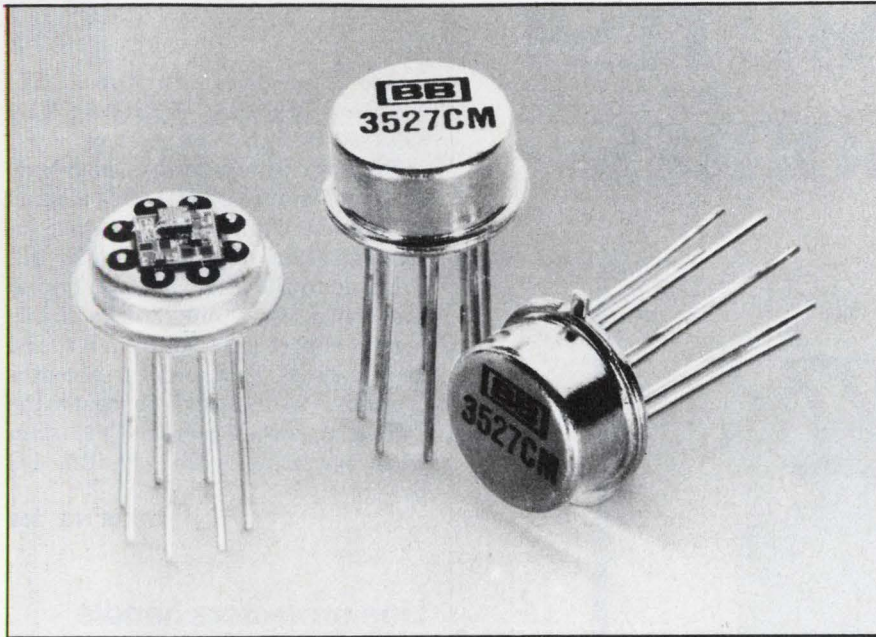

Burr-Brown, International Airport Industrial Park, Tucson, AZ 85734. G. Athey (602) 294-1431. P&A: See text.

The 3527 series of hybrid op amps has input bias currents of 5 pA or less, voltage offsets of under 0.5 mV, and offset drifts no worse than 10 $\mu\text{V}/^\circ\text{C}$. What's more, prices for the series of FET-input op amps start at \$7.95 for the 3527A, rise to \$10.35 for the 3527B and finish at \$19.40 for the 3527C, all in 100-qty lots.

However, to get input specs that are better than those of most other op amps, Burr-Brown had to make a small compromise in amplifier response—the slew rate is just 0.6 V/ μs . Each model offers a different combination of bias current, offset and drift. The A version has a 5-pA bias, a 0.5 mV offset and a 10 $\mu\text{V}/^\circ\text{C}$ drift. Both the B and C versions have a 0.25-mV offset, but the B has a 2-pA bias and a 5- $\mu\text{V}/^\circ\text{C}$ drift. The C has a 5-pA bias and a 2- $\mu\text{V}/^\circ\text{C}$ drift.

All 3527s have a 100-dB minimum open-loop gain, a 10-kHz frequency response, minimum, typical input impedances of $10^{12} \Omega$ (differential) and $10^{15} \Omega$ (common-mode), and a typical input noise of 25 nV/ $\sqrt{\text{Hz}}$ at 10 kHz

and 75 nV/ $\sqrt{\text{Hz}}$ at 10 Hz. Each unit is capable of delivering $\pm 10\text{ V}$ at $\pm 10\text{ mA}$, min, when operated from $\pm 15\text{ V}$ supplies, but can operate over ± 5 to $\pm 20\text{ V}$. When the op amps are powered by $\pm 15\text{ V}$ lines, the quiescent current is 2.6 mA.

Housed in eight-pin TO-99 packages, all versions are specified for operation over -25 to $+85^\circ\text{C}$. As with many FET-input op amps, bias current doubles for every 10 C increase above 25 C.

This 3527 series faces some pretty stiff competition—in both price and performance. Starting at under \$1, the 3130 or 3140 series of monolithic op amps from RCA (Somerville, NJ) come close in performance: Input-bias currents are 50 pA for the inexpensive models and 20 pA for the best (\$12). Voltage-offset span is 2 to 15 mV, and drifts range from 10 to 20 $\mu\text{V}/^\circ\text{C}$.

The LF355 series of monolithic BiFET amplifiers developed by National Semiconductor (Santa Clara, CA) have bias currents of 50 to 200 pA but slew at up to 50 V/ μs and cost anywhere from about \$2.50 to \$17. Also from National are the LH0052 and 0022 hybrid amplifiers, which have bias currents of 5 to 25 pA, respectively. The

AD506 and 503 series from Analog Devices (Norwood, MA) have better frequency response than the Burr-Brown series, with slew rates from 1 to 50 V/ μs . However, their bias currents and drifts are much higher than those of the 3527 series.

Burr-Brown	CIRCLE NO. 302
Analog Devices	CIRCLE NO. 303
National Semiconductor	CIRCLE NO. 304
RCA	CIRCLE NO. 305

Multiplex and convert 16 analog channels

Zeltex, 940 Detroit Ave., Concord, CA 94518. R. Terry (415) 686-6660. \$300 (100 qty.); stock to 30 days.

The ZMP-1000 data acquisition system converts 16 analog channels to a multiplexed 12-bit output. The system features monotonicity over 0 to 70 C, max conversion time of 12 μs , adjustable throughput rates of up to 50-k channels/s and differential linearity of ± 1 LSB with no missing codes. The unit is $3 \times 4.6 \times 0.375$ in.

CIRCLE NO. 306

Analog interface plugs into PACE microcomputer

Data Translation, 23 Strathmore Rd., Natick, MA 01760. F. Molinari (617) 655-5300. \$395 (1 qty.); stock.

The DT1723 data-acquisition system is plug-compatible with National Semiconductor's PACE μC application card series. The single-board system fits in a slot of the PACE and requires no additional interfacing. With 16 single-ended or 8 differential channels, the system's front end has an overvoltage-protected multiplexer, a high input-impedance instrumentation amp, a fast sample-and-hold amp, and a 12-bit a/d converter. Standard throughput rate is 35 kHz, with 100 kHz optional. Features include 12-bit resolution, $\pm 0.03\%$ accuracy, $\pm 1/2$ -LSB linearity, and ± 25 ppm/ $^\circ\text{C}$ tempco. Address selection is fully user selectable at the 72-pin backplane connector. In addition to analog input ranges of ± 10 , ± 5 and 0 to 10 V, the system accepts 4 to 20-mA signals.

CIRCLE NO. 307

MEET OUR FAMILY OF ELECTRONIC TEST ACCESSORIES

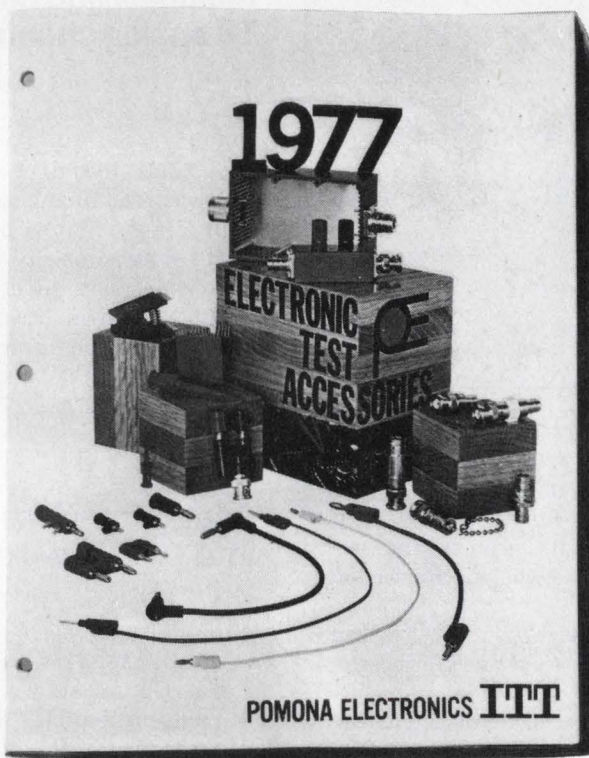

The 1977 edition of our family album of electronic test accessories (illustrated above) is yours for the asking.

Our new general catalog has grown to 82 pages. It describes and illustrates every one of the 600-plus members of the ITT Pomona Electronics family, including 28 new items that have been added for the first time this year.

You'll find this comprehensive catalog will be your best single source for high quality test accessories in every phase of electronic testing. For your free copy, circle the reader service number listed below, or write:

ITT POMONA ELECTRONICS

1500 East Ninth St., Pomona, Calif. 91766
Telephone (714) 623-3463. TWX: 910-581-3822



CIRCLE NUMBER 51

MODULES & SUBASSEMBLIES

Double-balanced mixer dumps distortion

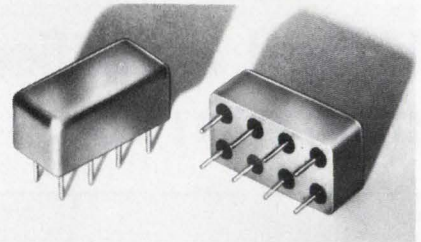

Anzac Electronics, 39 Green St., Waltham, MA 02154. J. Leonard (617) 899-1900. \$25 (1-50 qty.); stock.

Even in systems with a high-level local oscillator (LO), MD-151 balanced mixers reject third-order two-tone intermodulation distortion by 15 dB. From dc to 500 MHz (i-f port) typical conversion loss is only 8 dB and LO-port to rf-port isolation from 5 to 200 MHz is 30 dB. Third-order intercept is typically -23 dBm, and rf output to the 1-dB compression point is +13 dBm when operating with +17-dBm LO power.

CIRCLE NO. 308

Line protectors handle high-current blasts

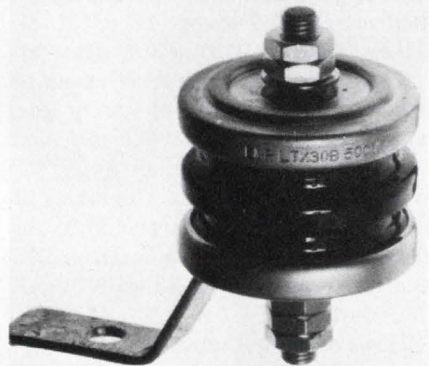

TII Corp., 100 N. Strong Ave., Lindenhurst, NY 11757. J. Kent (516) 842-5000. From \$30 (13-25 qty.); 60 days.

Surge protectors for 440-V-ac power lines, one to three phase, Models TII-485 and TII-486, ground 65-kA spikes and 1 ms, 75-A surges. Model 485 is a 1-lb axial unit with a terminal at either end; the 2-lb Model 486 includes a mounting strap, ground lug and pigtail. Both units use porcelain gap-spacers, mica separators and heavy-gauge copper electrodes. For three-phase systems connect an arrester from each phase to ground.

CIRCLE NO. 309

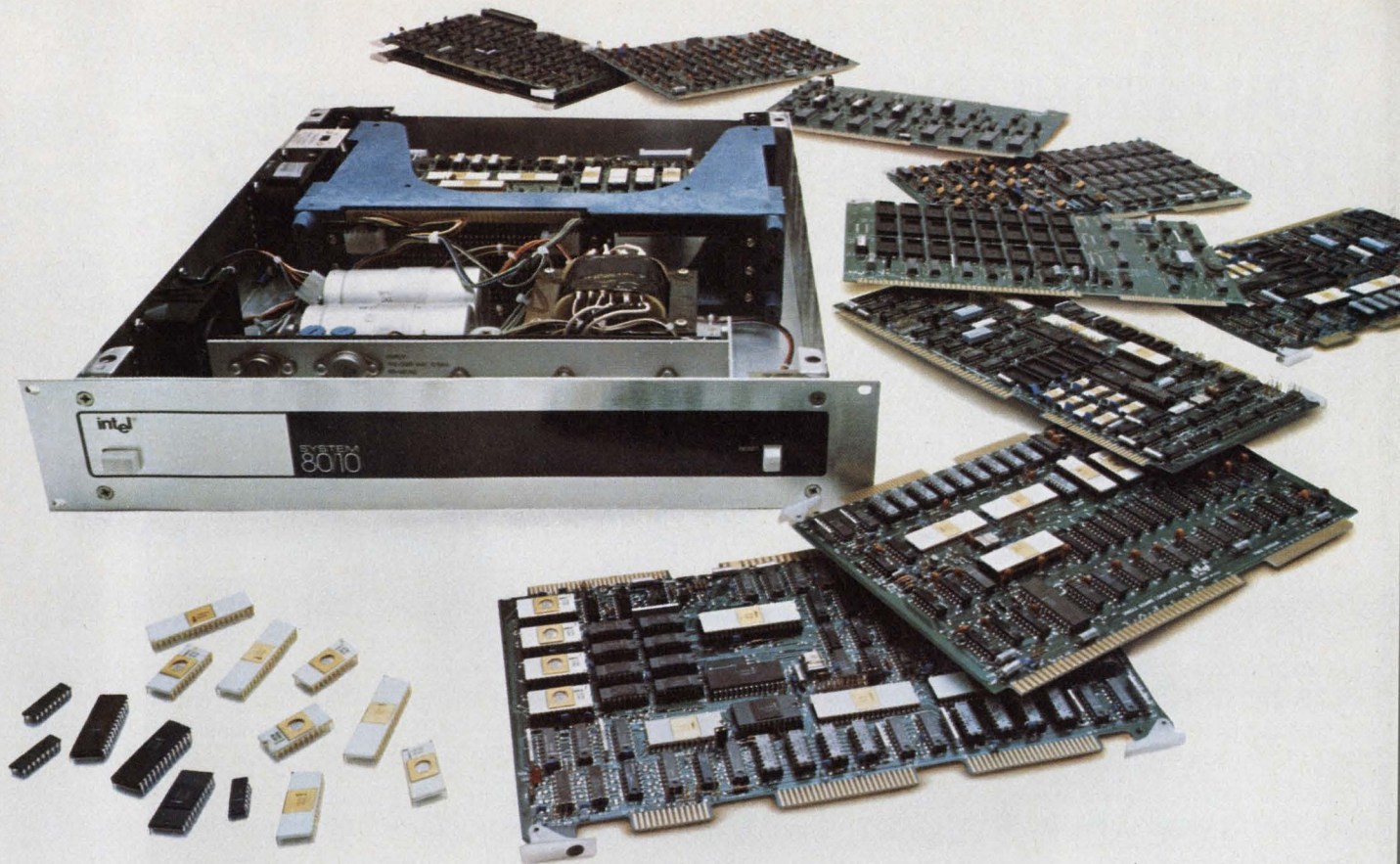

Intel delivers microcomputer systems that take the risk out of becoming successful.

Intel takes the risk out of becoming successful by providing economic, flexible and reliable microcomputer hardware and software solutions for your moderate and high volume requirements.

For most moderate volume microcomputer applications, it makes economic sense to buy an assembled and tested microcomputer system. That's why we offer two Single Board Computers (SBC 80/10, SBC 80/20) and two packaged systems (System 80/10, System 80/20). When you decide it's more economical to do the job "in-house," we'll make arrangements for you to use our bill of material, fab and assembly drawings, and artwork. And since we manufacture *all* the essential components—CPU, EPROMs, ROMs, RAMs, programmable I/O, and other LSI devices in volume, you can order the components from us and continue to take advantage of quantity discounts. *No penalty for success.*

Intel® microcomputer systems are flexible and easily configured to your specific needs. Expanding your system or reconfiguring the I/O is easy. All Intel microcomputer systems are supported by a complete line of I/O and memory expansion boards, diskette and DMA controllers, power supplies, card cages, and accessories. And since I/O, communications, timer and interrupt control functions are programmable, you can reconfigure the system to match your application by altering a few bytes of memory instead of redesigning system hardware.

And Intel delivers more than microcomputer systems that give you the cost/performance advantage. In addition we provide Intellec® Microcomputer Development System support to get you to market sooner. Intellec resident PL/M, the high level microcomputer language, can cut man months off your software development schedule. Intellec ISIS-II Diskette Operating Software, with

linkage and relocation capabilities, will save more programming time. Develop programs in small manageable modules—then link them together or link them with general purpose subroutines from a software library. Reduce system integration and checkout time with the Intellec resident ICE-80™ In-Circuit Emulator. Develop, symbolically debug and execute high level and assembly language programs directly on your System 80 or SBC 80 based prototype.

From hardware and software development all the way through production, Intel gives you the competitive advantage. For a copy of our new 24-page brochure or a demonstration contact your local Intel representative, use the reader service card, or write: Intel Corporation, 3065 Bowers Avenue, Santa Clara, California 95051.

intel® delivers.

You eliminate short circuits and reduce costs with these AMP connectors.

Unique, low-cost, all-plastic AMP straight posted and right-angle headers.

Now circuit paths can be located directly under the connector without shorting. Because AMP 94V-O rated AMPLIMITE headers are of all-plastic construction. These low-cost high-density headers intermate with standard AMPLIMITE connectors, other similar designs and those meeting EIA specification RS-232-C. Housings have built-in stand-off relief and are available in 5 popular right-angle versions, and a new 25-position low profile straight posted version.

A better way to terminate flat-cable fast.

We put teeth in low-cost mass termination with 25-position HDF AMPLIMITE plugs and receptacles. A simple, miniature press is all that's needed. Fork-like teeth penetrate the cable, make electrical contact with each conductor and interlock with the housing.

Accommodate any 26-position solid or stranded round-conductor flexible cable on 0.050" centers—with no preparation other than

squaring the end. The HDF connector is the one to use for highest production rates and lowest applied cost.

And AMP's unique technical service is the one to use, too. It's in-depth help that's yours for the asking even if you are only in the product planning stage. In fact, we prefer to be involved early. Because it lets you take full advantage of the capabilities and willingness of AMP people to search out better ways for better products.

For further details on the unique AMPLIMITE all-plastic or HDF connectors, call Customer Service at (717) 564-0100. Or write AMP Incorporated, Harrisburg, PA 17105.

AMP has a better way.

AMP

INCORPORATED

CIRCLE NUMBER 53

AMP EUROPE

Austria — AMP Austria. Branch of AMP Deutschland GmbH. Markgraf-Ruediger Str. 6-8, 1150 Vienna. Phone: 924191/92

Belgium — AMP Belgium. Branch of AMP-Holland B.V., Rue de Brabant 62-66, Brussels. Phone: 322.17.55.17

Finland — AMP Finland OY Postilokero 3, 00401 Helsinki 40 Phone: 90/584122

France — AMP de France. 29 Chaussée Jules-César. Boite Postale No. 39. 95301 Pontoise France. Phone: 030 82 20, 030 92 30

Germany — AMP Deutschland GmbH. Ampèrestrasse 7-11, 607 Langen, B. FFM., West Germany. Phone: (06103) 7091

Great Britain — AMP of Great Britain Limited, Terminal House, Stanmore, Middlesex, England. Phone: 01-954-2356

Holland — AMP Holland B.V., Papierstraat 2-4 's-Hertogenbosch, Holland. Phone: (04100) 25221

Italy — AMP Italia S.p.A., Via Fratelli Cervi 15, 10093 Collegno (Torino), Italy. Phone: 785-656

Spain — AMP Española, S.A., Apartado 5294. Pedro IV, 491, 495, Barcelona 5, Spain. Phone: 307-75-50

Sweden — AMP Scandinavia AB, Datavägen 5, 17500 Jakobsberg, Sweden, Mailing Address: Fack S-175 20 JARFALLA 1, Sweden. Phone: 0758/10400

Switzerland — AMP AG, Haldenstrasse 11, 6006 Luzern, Switzerland. Phone: (414) 235421, 235422, 235423

AMP NORTH AMERICA

Canada — AMP OF CANADA LTD., 20 Esna Park Drive, Markham, Ontario, Ph: 416-499-1251

Mexico — AMP de Mexico, S.A., Apartado Postal 179, Naucalpan de Juarez, Edo, de Mexico, Phone: Mexico City 576-41-55

Puerto Rico — AMP OF CANADA LTD., 677 Calé de Diego, Rio Piedras, Puerto Rico 00924, Phone: (809) 766-2346

United States — AMP Incorporated, Harrisburg, Pa. 17105, Phone: 717-564-0100

AMP SOUTH AMERICA

Argentina — AMP S.A. Argentina 4 de Febrero, 76 Villa Zagla — SAN MARTIN, Buenos Aires, Argentina, Phone: 752-4612

Brazil — AMP do Brasil Ltda., AV Comendador Martinelli 185, Lapa, Sao Paulo, Phone: 262-4353

AMP PACIFIC

Australia — Australian AMP Pty. Limited, 155 Briens Road, Northmead, N.S.W. 2152 Australia, Mailing Address: P.O. Box 194, Baulkham Hills, N.S.W. 2153 Aus. Ph: 630-7377

Japan — AMP (Japan), Ltd., No. 15-14, 7-Chome, Roppongi Minato-Ku, Tokyo, Japan, Ph: 404-7171

Products and services for many specialized industries are provided by the AMPLIVERSAL Division. In the United States, this division is known as AMP Special Industries.

For Amp products and services in other countries, write: AMP International Division, Harrisburg, PA 17105, USA.

MODULES & SUBASSEMBLIES

Filters eliminate dual-tone errors

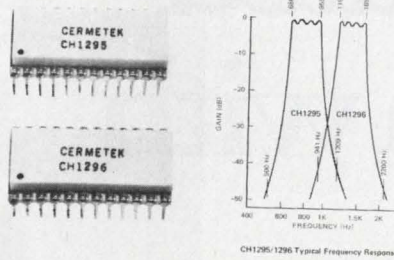

Cermetek Microelectronics, 660 National Ave., Mountain View, CA 94043. (415) 969-9433. \$16.50 (1000 qty.); stock to 4 wks.

CH-1295 and 1296 band splitters eliminate crosstalk, interference and distortion associated with dual-tone multifrequency (DTMF) signaling. The filters can be the front end of a DTMF tone receiver; or with a limiter and digital filter/DTMF IC, the filters complete a DTMF receiver. Model 1295 covers the 686 to 955-Hz low band and the 1296 covers the 1191 to 1657-Hz high band. The units provide 40-dB attenuation, unity gain, and accept inputs up to +10 dBm without clipping.

CIRCLE NO. 310

Fast warm-up modules pour out pure 10 MHz

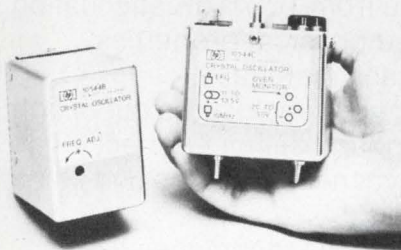

Hewlett-Packard, 1501 Page Mill Rd., Palo Alto, CA 94304. (415) 493-1501. From \$690; 90 days.

Two crystal oscillators supply 10-MHz outputs featuring an aging rate of 5 parts in 10^{10} per day, spurious phase noise of 150 dB for more than 1-kHz offset, and warm up to within 5×10^{-9} of final value in 20 min. Model 10544B uses a printed-circuit board connector; Model 10544C has filter feed-through terminals, a snap-on rf connector and provision for shock mounting. Both oscillators are rugged enough for field equipment. These 11 oz modules are $2.8 \times 2.03 \times 2.44$ in.

CIRCLE NO. 320

Thermocouple junction compensator acts fast



Hades Manufacturing, 151A Verdi St., Farmingdale, NY 11735. E. Brand (516) 249-4244. \$69 (1-24 qty.); stock to 4 wks.

Self-powered thermocouple reference-junction compensators of the NC420 series require no warm-up time. Just connect the external leads and the unit's self-contained battery gives you 5000-h continuous use or 3-yr intermittent use. Standard reference-temperature setting is 0 C with other references available for all thermocouple materials. Compensation accuracies are typically $\pm 1/4^\circ\text{C}$ at 25 C to $\pm 3/4^\circ\text{C}$ from 0 to 50 C. Output impedance is less than 250 Ω . The cylindrical compensator is 3 (L) \times 0.625 (D) in.

CIRCLE NO. 321

Instrumentation amp gains CMR & CMV

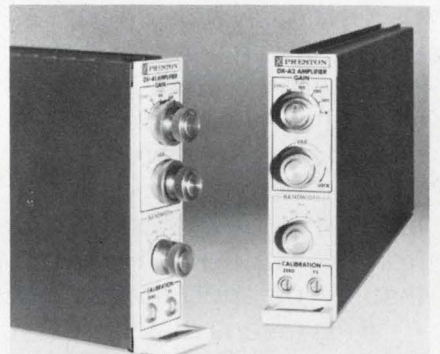

Preston Scientific, 805 E. Cerritos Ave., Anaheim, CA 92805. B. Spear (714) 776-6400. From \$335 (1-10 qty.); stock.

The common-mode rating for the DX-A2 Series of instrumentation amps is 30-V dc or pk ac—a threefold increase over the standard DX-A1 amps. The common-mode rejection ratio has also been increased to 120 dB at 60 Hz for a gain setting of 1000; and 100 dB at a gain setting of 10. Seven switch-selectable gain levels between 10 and 1000 are available on the front panel, and a variable gain control selects any gain between the fixed-gain steps, up to 3000. Additional features include six-month isothermal gain stability of 0.01%, 30-day isothermal and zero stability of $\pm 5 \mu\text{V}$ (rti) and ± 0.1 mV (rto).

CIRCLE NO. 322



If you've got a complicated problem with EMI we've got a simple solution

Electromagnetic Interference. It shows up as static on radio and snow on TV. It can make computer terminals register input error. Make a pacemaker or an EKG malfunction. And interfere with sensitive navigation equipment.

Obviously, you've got to shield your equipment against EMI. You can use sheet metal. Or foil. Or a plating process. These are fine for small enclosures with flat surfaces. But when it comes to large cases and complex shapes, you need a better solution.

And here it is. Electrodag® coatings. We've engineered a whole range of them. To give you from 10-70 dB attenuation, from 1 MHz to 10 GHz. With varied physical properties that let you apply them to almost any material.

This means that you can build your enclosures out of light plastic, coat them with Electrodag, and still get perfect skintight shielding. Even on honeycomb structures and flexible parts made from foamed resins.

And you can forget about expensive techniques like plating, metallizing and vacuum deposition. With Electrodag, all you need is a spray gun, a simple dipping technique, or a paintbrush.

You can use these new coatings for everything from CB radios and EKG units to data terminals and microphones.

This is a new field, but we're the oldest company in it. With the greatest experience, the biggest R&D staff and the most EMI coatings. For technical advice on specific applications, write: Acheson Colloids Company, Electrical Products, Port Huron, Michigan 48060. Or call (313) 984-5581.

 **Acheson**
high technology coatings

CIRCLE NUMBER 54

© AC Co., 1976

MODULES & SUBASSEMBLIES

Accurate attenuator steps with 64 digits



Applied Research, 76 S. Bayles Ave., Port Washington, NY 11050. A. Scandurra (516) 883-5700. From \$450; 45 days.

A digital attenuator, Model 7581-004, operates in 0.5-dB steps to 31.5 dB and in 1-dB steps to 63 dB. Accuracy is ± 0.25 dB up to 100 MHz. Between 0.5 to 8 dB, accuracy is 0.15 dB. Insertion loss is 1 dB at the zero setting. The phase difference between attenuation settings is $\pm 0.4^\circ$ from 20 to 90 MHz.

CIRCLE NO. 323

Tiny elapsed timer boasts crystal control



Veeder-Root, 70 Sargeant St., Hartford, CT 06102. A. Patricelli (203) 527-7201. \$160; stock.

Using MOS-LSI circuitry, the 7971 Minicounter Indicator measures and displays elapsed time to $\pm 0.01\%$ and ± 1 count. A quartz oscillator provides stability. Models are available with 0.01, 0.1 or 1 s resolution for 12 to 15-V-dc operation. The five LED digits are 0.375 in. The crystal is gasketed for splash and dust resistance. The case, only 1×1.93 in., clip-mounts without screws into a standard 25×50 -mm panel cutout. The device displays the measured time between externally applied start and stop signals received from relays, switches or open-collector transistors. It can be reset by an external command after each reading or can accumulate the total time for a number of operations.

CIRCLE NO. 324

DELETE DISCRETES

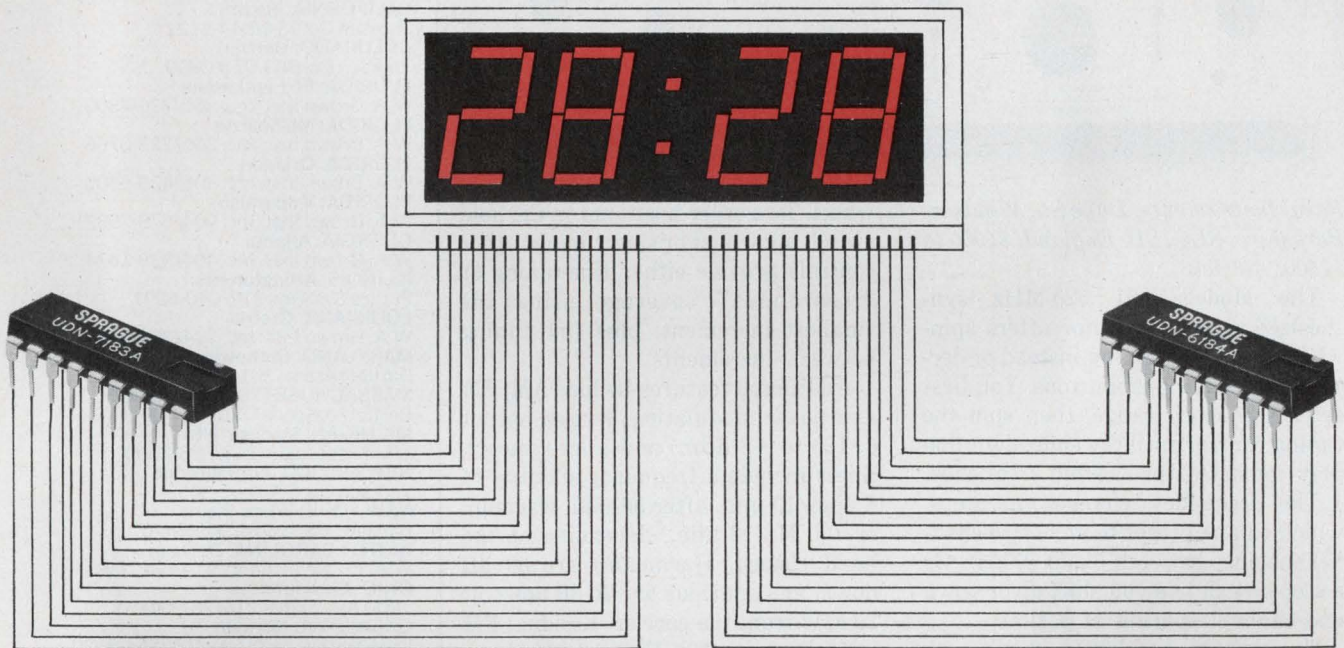

Now... A Series of Sprague ICs that simplify gas discharge display interface

Sprague Series UDN-6100/7100 Display Drivers offer the systems designer a simplified, low-cost interface with planar gas discharge displays that essentially eliminate the need for discrete components. Designers can now take advantage of the superior aesthetics of gas discharge panels with their low power consumption, relative ease in customizing, and large digit capability without the need to use large quantities of discrete components.

With broad commercial/industrial applications, these unique drivers find wide usage in business calculators, POS systems, cash registers, scales, appliances, clocks, electronic games, instrumentation, computer peripherals, industrial controls, avionics, and a variety of other display products.

Series UDN-6100 Digit (anode) Drivers are rated with a supply voltage of +120 V max. and an output current of 70 mA max. They are available with 4, 6, or 8 drivers per device, in 14, 16, and 18 pin plastic and hermetic DIP packages, respectively.

Series UDN-7100 Segment (cathode) Drivers operate at a max. supply voltage of -120 V. Circuits are available with nominal output current ratings from 0.6 mA to 14 mA. Each device has 8 drivers and is available in an 18-pin plastic or hermetic DIP package.

For complete data, write for Engineering Bulletins 29311 and 29312, as well as WR-172 "Quick Guide to Interface Circuits" to: Technical Literature Service, Sprague Electric Company, 509 Marshall Street, North Adams, Mass. 01247.

FOR FAST INFORMATION, CALL YOUR NEAREST SPRAGUE SALES OFFICE:

ALABAMA, Sprague Electric Co., 205/883-0520 • ARIZONA, Sprague Electric Co., 602/279-5435 • CALIFORNIA, Sprague Electric Co., 213/649-2600. Wm. J. Purdy Co., 415/347-7701. KCE Corp., 714/278-7640 • COLORADO, Wm. J. Purdy Co., 303/777-1411 • CONNECTICUT, Sprague Electric Co., 203/261-2551 • DIST. OF COLUMBIA, Sprague Electric Co. (Govt. sales only), 202/244-6006 • FLORIDA, Sprague Electric Co., 305/831-3636 • ILLINOIS, Sprague Electric Co., 312/678-2262 • INDIANA, Sprague Electric Co., 317/253-4247 • MASSACHUSETTS, Sprague Electric Co., 617/899-9100. Sprague Electric Co., 413/664-4411 • MICHIGAN, Sprague Electric Co., 517/787-3934 • MINNESOTA, HMR Inc., 612/920-8200 • MISSOURI, Sprague Electric Co., 314/781-2420 • NEW JERSEY, Sprague Electric Co., 201/696-8200. Sprague Electric Co., 609/795-2299. Trinkle Sales Inc., 609/795-4200 • NEW MEXICO, Wm. J. Purdy Co., 505/266-7959 • NEW YORK, Sprague Electric Co., 516/549-4141. Wm. Rutt Inc., 914/698-8600. Sprague Electric Co., 315/437-7311. Mar-Com Associates, 315/437-2843 • NORTH CAROLINA, Electronic Marketing Associates, 919/722-5151 • OHIO, Electronic Salesmasters Inc., 800/362-2616. Sprague Electric Co., 513/278-0781 • PENNSYLVANIA, Sprague Electric Co., 215/467-5252. Trinkle Sales Inc., 215/922-2080 • TEXAS, Sprague Electric Co., 214/235-1256 • VERMONT, Ray Perron & Co. Inc., 617/762-8114 • VIRGINIA, Sprague Electric Co., 703/463-9161 • WASHINGTON, Sprague Electric Co., 206/632-7761 • CANADA (Ontario), Sprague Electric of Canada Ltd., 416/766-6123 • CANADA (Quebec), Sprague Electric of Canada Ltd., 514/683-9220

4SS-7114



... and you thought we
only make great capacitors.

Synthesized signal gen tunes with spin wheel

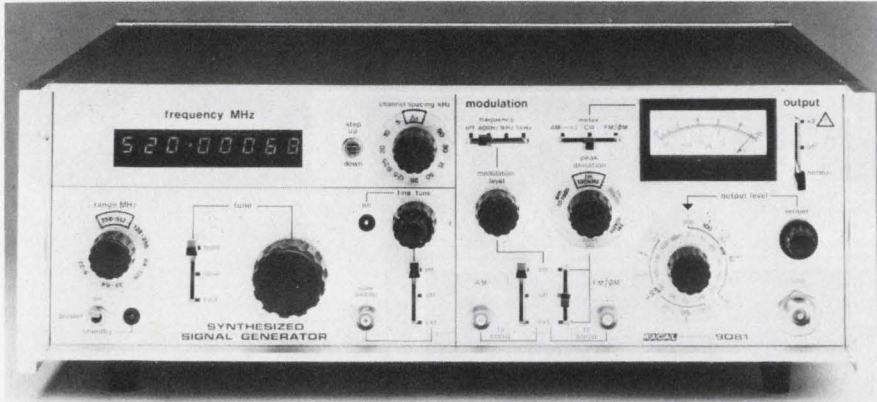

Racal Instruments, Duke St., Windsor, Berkshire, SL4 1SB, England. \$4000 to \$4500; 4-6 wk.

The Model 9081 520-MHz synthesized signal generator offers spin-wheel electronic tuning instead of decade switches or pushbuttons. You first set a frequency range, then spin the tuning control until the eight-digit display indicates the desired frequency.

The frequency changes in steps, which can be preset to any of 10 channel spacings between 5 and 60 kHz. Or a step switch lets you shift up or down one channel spacing at a time.

To prevent accidental changes, a "hold" switch can disconnect the spin

wheel. Two other positions on the hold switch allow fast or slow tuning. Other controls provide either fine-tuning or "continuous" coverage using the smallest increment, plus fine tuning between increments.

Additional features include AM, FM and phase modulation, leveled output (-130 to +3 dBm) and a level meter. Specs include a frequency stability of 1 ppm/10 min. after 30-min. warmup, or 100 Hz/10 min., depending on the band chosen. Harmonics are 30 dB down, and spurious are 70 dB down at 20 kHz from the carrier. Residual FM is 50 Hz rms (300 Hz to 3 kHz bw).

CIRCLE NO. 301

Test station aims at page-mode memories

Teradyne, 183 Essex St., Boston, MA 02111. (617) 482-2700. J387 with H712, \$107,000.

H712 is a major station for testing 4-k and 16-k page-mode memories on the company's J387 memory test system. In addition to address multiplexed devices, the H712 station tests page-mode memories with multiplexed input and output terminals. The basic H712 includes nine independently programmable, double-edge clock phases, 16 address drivers, four data drivers, and four dual-limit comparators. These can be expanded. A new Auto-Vector software package is included, which eliminates the need for an external time reference.

CIRCLE NO. 325

Plug-in performs multichannel averaging

Norland Instruments, Route 4, Norland Dr., Fort Atkins, WI 53538. (414) 563-8456. \$3500; June, 1977.

Model 2301 signal averager plug-in expands the capability of the company's 2001A waveform and data analysis system by adding the software and hardware needed for high-speed, multichannel signal averaging. The 2301 can provide up to four channels of simultaneous signal averaging depending on plug-in selection. Both the raw (noisy) input and the averaged waveform can be displayed. The display reads out in user defined units, not counts. Data can be acquired at a 1 μ s/s sample rate, with throughput as high as 200,000 sample/second.

CIRCLE NO. 326

Call your nearest ISC sales representative.

ALABAMA: Huntsville
W. A. Brown Inst. Inc. 205/539-4411
ARIZONA: Phoenix
Thorson Co. 602/956-5300
CALIFORNIA: Goleta
Thorson Co. 805/964-8751
CALIFORNIA: Los Angeles
Thorson Co. 213/476-1241
CALIFORNIA: Mountain View
Thorson Co. 415/964-9300
CALIFORNIA: San Diego
Thorson Co. 714/298-8385
CALIFORNIA: Tustin
Thorson Co. 714/544-5121
COLORADO: Denver
Thorson Co. 303/759-0809
FLORIDA: Ft. Lauderdale
W. A. Brown Inst. Inc. 305/776-4800
FLORIDA: Melbourne
W. A. Brown Inst. Inc. 305/723-0766
FLORIDA: Orlando
W. A. Brown Inst. Inc. 305/425-5505
FLORIDA: Valparaiso
W. A. Brown Inst. Inc. 904/678-7932
GEORGIA: Atlanta
W. A. Brown Inst. Inc. 404/939-1674
ILLINOIS: Arlington Hts.
Future Systems 312/640-6091
LOUISIANA: Gretna
W. A. Brown Inst. Inc. 504/366-5766
MARYLAND: Bethesda
Bartlett Assoc. 301/656-3061
MASSACHUSETTS: Framingham
Bartlett Assoc. 617/879-7530
MICHIGAN: Madison Hts.
WKM Associates 313/588-2300
NEW MEXICO: Albuquerque
Thorson Co. 505/265-5655
NEW YORK: White Plains
Bartlett Assoc. 914/949-6476
NORTH CAROLINA: Durham
W. A. Brown Inst. Inc. 919/682-2383
OHIO: Cleveland
WKM Associates 216/267-0445
OKLAHOMA: Norman
Data Marketing Assoc. 405/364-8320
PENNSYLVANIA: Pittsburgh
WKM Associates 412/892-2953
PENNSYLVANIA: Wayne
Bartlett Assoc. 215/688-7325
SOUTH CAROLINA: Columbia
W. A. Brown Inst. Inc. 803/798-3297
TENNESSEE: Knoxville
McCain Elec. Equip. 615/584-8411
TEXAS: Austin
Data Marketing Assoc. 512/451-5174
TEXAS: Dallas
Data Marketing Assoc. 214/661-0300
TEXAS: Houston
Data Marketing Assoc. 713/780-2511
TEXAS: San Antonio
Data Marketing Assoc. 512/828-0937
WASHINGTON: Bellevue
Thorson Co. 206/455-9180
AUSTRALIA: Mt. Waverly, Victoria
Anderson Digital Elec. 03-543-2077
CANADA: Montreal
Cantec Rep. 514/620-3121
CANADA: Ottawa
Cantec Rep. 613/225-0363
CANADA: Toronto
Cantec Rep. 416/624-9696
EUROPE: England
Techex, Ltd. 0202-293-115
EUROPE: France
Peritex 749-40-37
EUROPE: Switzerland
Interest, AG 031-224481
JAPAN: Tokyo
Munzing International 586-2701



Intelligent Systems Corp.

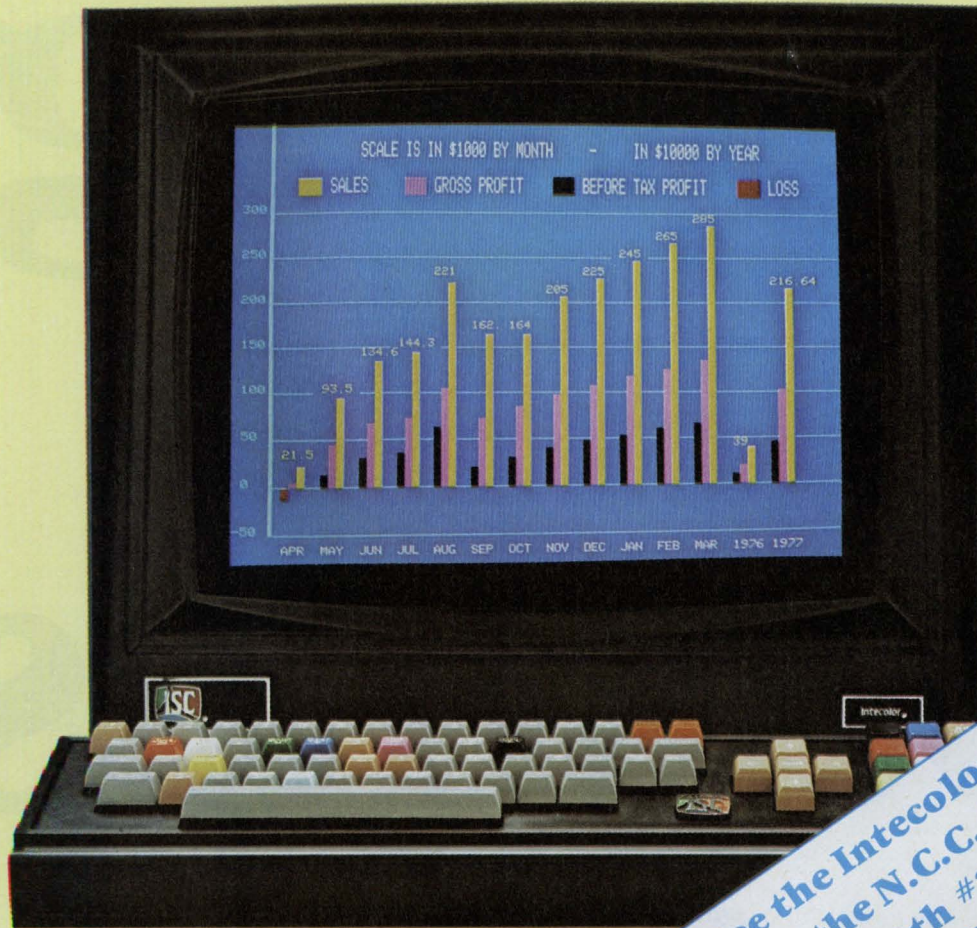

Unretouched photograph of screen.

See the Intecolor 8001
at the N.C.C. Show
Booth #2067

The Intecolor 8001 CRT. Buy One or Buy One Hundred. Just \$1495*.

That's the price tag we'll put on the Intecolor 8001 if you place your order right now for 100 or more units. \$1495. That's also the price we'll give you on a one-shot cash basis on an Intecolor 8001 CRT evaluation unit. Now, we'll never get rich with a price structure like that, but we look at it this way. That price is an investment in your future. We know that once you get your hands on the Intecolor 8001, once you see what it can do, you'll be back for more.

And it's because you'll be getting an Intelligent, 8-Color CRT that'll outperform any CRT on the market on a dollar for dollar and character for character basis. And it's complete. You won't have to lay out more cash for a keyboard, or 8080 CPU, or any of the standard features you'd expect to find on a good color CRT. It'll be ready to go. You can put it to work as a stand-alone CRT, incorporate it into your present system, or use it to upgrade the CRT's in the systems you're currently marketing. Whatever your application, it'll work for you.

But if your needs call for a more sophisticated CRT, a CRT that'll give you higher-level functions — no problem. We'll be glad to work with you to help you come up with an options package to fit your requirements. Like additional RAM to 32K, Roll, Background Color, Light pens, Graphics, 48 Line X 80 Characters/Line and up to 64 Special Graphics Characters. You define your needs, and we'll give you the capabilities to get the job done. It's that simple.

But if you'd like to see for yourself, look over our rep list on the adjacent page and ask the rep in your area for a demonstration. Whatever your application, he can show you the right Intecolor 8001 CRT at just the right price.



Intelligent Systems Corp.®
5965 Peachtree Corners East
Norcross, Georgia 30071
(404) 449-5961

*Quantity 100 price — \$1495 each, net 20 Days
Evaluation unit price — \$1495, Limit one to a customer, cash with order
Domestic U.S.A. prices

CIRCLE NUMBER 56

Going into business sale.

National Semiconductor is going into the microcomputer business.

And to celebrate, we're having a "sale."

10% off the Intel 80/10.

To get 10% off Intel's 80/10, don't buy Intel's 80/10. Buy National's 80/10.

We're able to sell the 80/10 for less because of our improved board layout which permits automated assembly (such as using axial leaded components)...the fact that we make not only the 8080, but also—unlike Intel—most of the rest of the ICs on the board...and, of course, National's

legendary competence in efficient manufacturing doesn't hurt either.

The industry standard.

Our second-sourcing of the 80/10 clears the way for the 80/10 to be the clear-cut standard of the microcomputer industry.

You can't effectively have an industry-standard without a second-source. Having two suppliers is a healthier competitive situation for you, the customer, and you have the security—and abuse-protection—of an alternate source.

What we make and how we make it.

What we're making is this:

Series/80 Cards:

BLC 80/10 BLC 104*
BLC 016 BLC 508*
BLC 406 BLC 416*
BLC 905

*Available 3rd quarter '77

Series/80 Systems:

BLC 80P BLC 614 BLC 604

Series/80 Firmware:

BLC 910

(With more, much more, to come
in the future.)

And how we're making them is this:

We're putting out the finest
quality available. A cleaner board—
better layout, all axial components,
plug selectable options rather
than wire wrap.

We "burn in" every board at
elevated temperature, and run
computer diagnostics during burn-in.

Think we're kidding about quality?
We're offering a one year warranty.
Which is just about four times longer
than Intel's warranty period.

A microcomputer company small enough to do business with.

We're not dummies.

We know that to break into a field
that somebody else has a lock on, we've
got to offer something extra.

And extra quality for less money
ain't a bad start.

But we're offering something else
extra, too.

Desire.

As the little guy we can't afford
a fat cat attitude.

We'll do our best to meet
impossible deadlines.

Our phone won't be busy. Etc.

In the microcomputer arena we're
young, small, and hungry.

So if you'd like to see what
you've been missing in 80/10's, see your

local distributor or use this coupon to
get our literature.

Help us celebrate our going into
business sale by helping us *stay* in
business.

See us at NCC Booth 1565.

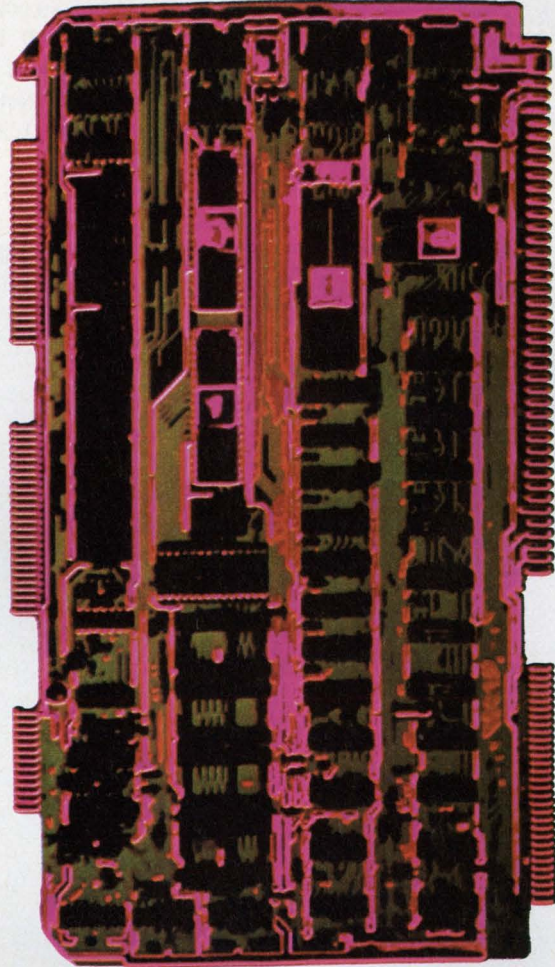

National Semiconductor Corporation
2900 Semiconductor Drive, Santa Clara, CA 95051

Gentlemen: You've got my interest. Please send me more
information on National's SERIES/80.

I'm so turned on, I can't wait. Please have a
salesman call me immediately.

Name _____ Title _____

Company _____

Address _____

City _____ State _____ Zip _____

Telephone _____

My application is _____

- I'm presently using the other guy's 80/10.
 I'm not up to the 80/10 yet but I'm using the 8080.
 I have an 8080 software development system.
 Your BLC 80/10 will be used in house.
 I'm an OEM. Your BLC 80/10 will be shipped out as part of
my equipment.

 **National Semiconductor**

INSTRUMENTATION

Calibrator extends measurement accuracy



Rotech, 220 Grove St., Waltham, MA

02154. (617) 899-4611. Approx. \$9000; July.

Model 610 ac/dc standard provides a dc voltage accuracy of 0.002% setting +0.001% range from 1 to 500 V, and 0.002% setting +0.0015% range +2 μ V below 1 V. The ac voltage accuracy is 0.025% setting +0.0025% range +10 μ V from 400 to 1000 Hz with reduced accuracies from 40 to 400 and 1000 to 50 kHz. Outputs range from 1 mV to 1000 V, 1 μ A to 1 A, and 1 Ω to 10 M Ω .

CIRCLE NO. 327

After you look at the specs, look how long they're guaranteed.

The accuracy specs for the Dana 5100 5½ digit multimeter are guaranteed for a full year. Not 90 days. Not 6 months. That means you only have to calibrate it once a year.

All other multimeters have to be calibrated an average of three times a year. At about \$75 a pop. Which makes their \$995 units a lot more expensive to own than the Dana 5100 at \$1145*.

Instead of sitting in the shop for six weeks over the course of the year, the Dana 5100 will stay right where you are. Measuring AC, DC, Ohms and frequency (yes, frequency too) with very high accuracy. Just like the specs say. For a year at a time.

When you look at it that way, one thing becomes obvious. The cost of owning a multimeter is a lot more important than the price.

Write Dana Laboratories, Inc., 2401 Campus Drive, Irvine, CA 92715 for all the specs. And take a good look. With specs that good, you'll be glad you only have to give it up once a year.

DANA

Others measure by us.

*U.S. domestic prices.



Dana 5100.

Ask for a free demonstration before you consider anything less.

Personality module analyzes 6502 μ Ps

Biomation, 10411 Bubb Rd., Cupertino, CA 95014. (408) 255-9500. \$300; 60 days.

A plug-in "personality module" to analyze the MOS Technology 6502 extends the capabilities of the company's Model 168-D microprocessor analyzer beyond the previously announced 8080A and 6800 personality modules. The company will also build to order personality modules for specific microprocessors, including RCA COSMAC 1802, Zilog Z80, Signetics 2650, Rockwell PPS-8, Intel 8085, National SC/MP, and Electronic Arrays 9002.

CIRCLE NO. 328

Smart counter/timer tops out at 1 GHz



Ballantine Laboratories, P.O. Box 97, Boonton, NJ 07005. (201) 335-0900. \$1050; 30 days.

Model 5500B-Opt. 35 universal counter/timer extends frequency measurement capability to 1 GHz. The 8-digit instrument's ROM-controlled circuitry permits automatic resolution and autoranging in all ten operating modes. Featured on the front panel is a resolution control that guarantees full use of the most significant digit in any measurement, ensuring against overflow or loss of data.

CIRCLE NO. 329

Software package generates test program

Teradyne, 183 Essex St., Boston, MA 02111. (617) 482-2700. Starter package, \$8000.

Once a circuit has been described to the P400—a new software system for the company's L100-series of PC-board testers—the software system produces a program that includes the basic input and output test patterns and diagnostic data, as well as the introductory interfacing information and initializing patterns. The program is produced in the symbolic language of the test system on a ready-to-be-loaded tape cartridge.

CIRCLE NO. 330

NEW 1978 PROMS!



IF YOU CHANGE TO A NEW TYPE OF PROM TODAY, WILL YOUR PROM PROGRAMMER BE OBSOLETE TOMORROW?

When you program your PROMs on a Data I/O programmer you don't have to worry about obsolescence.

Data I/O programmers are universal. They program all 200 plus commercially available PROMs. This gives you maximum design and production flexibility.

With one Data I/O generic program card set you can program an entire PROM family simply by changing socket adapters. **You'll always have current PROM programming specifications.** Data I/O program

card sets are tested and certified by the PROM manufacturers themselves before we approve them for manufacturing and distribution to our customers.

If manufacturers change PROM programming specifications, we provide you with all the information you need to update your card sets. And, by making periodic tests with the Data I/O Universal Calibrator, you have the guarantee that you're always programming within exacting PROM and programmer specifications to help you reach maximum PROM yields.



Programmers from \$1095.00

HOW TO SELECT THE RIGHT PROM PROGRAMMER FOR YOUR NEEDS.

We'd like to tell you more.

This fact filled tabloid gives you valuable information about PROM programming technology. To get your copy, circle reader service number or contact Data I/O Corporation, P.O. Box 308, Issaquah, WA 98027. Phone 206/455-3990.

DATA I/O

THE PROM PROGRAMMER PEOPLE.

INSTRUMENTATION

Pulse generator gives varied outputs

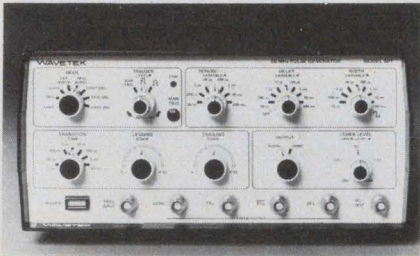

Wavetek, P.O. Box 651, San Diego, CA 92112. (714) 279-2200. \$995; 30 days.

Model 801 50-MHz pulse generator provides continuous, triggered, gated or burst pulse outputs with normal, delayed or double pulses. Pulse period, delay and width are independently adjustable with front-panel controls. The primary output pulse is shaped by independent rise and fall controls with a 50:1 range. Fixed ECL and TTL levels and their complements, are available from front-panel outputs, and another output has independently adjustable positive and negative limits from +20 to -20 V.

CIRCLE NO. 331

Logic analyzer comes in a suitcase



Yucca International, 14415 N. Scottsdale Rd., Scottsdale, AZ 85260. (602) 991-1491. \$1790 with probe for M6800 or 8080; 30 days.

Model YA-I portable MPU logic analyzer checks 6800 and 8080 μ Ps in operation. The unit does not take control while monitoring MPU hardware/software. Its speed is controlled by the MPU clock. Special interfacing or additional programming is not required. YA-I traps 128, 32-bit data words at any preselected point in the program, at any address or at any user input. Instructions (32 words back, 96 words forward) are read, a data word at a time, on hexadecimal displays.

CIRCLE NO. 332

'Pocket' thermometer resolves 0.1 C

Extech International, 177 State St., Boston, MA 02109. (617) 227-7090. \$174.50.

Series 2400 portable digital thermometer and interchangeable thermistor probes cover -30 to 100 C, reading in 0.1° increments on red LED displays. Accuracy is $\pm 0.4\%$ \pm one digit at 23 C ± 5 C. The meter is powered by standard AA batteries or works from either the 115 or 230-V line with a plug-in ac adapter. Series 2400 thermometer kits include meter, batteries, ac adapter, stand and carrying case.

CIRCLE NO. 333

Oscillator kit offers pushbutton operation



Heath Co., Dept. 350-20, Benton Harbor, MI 49022. (616) 982-3417. Kit, \$129.95; assembled, \$190.

Model IG-1272 oscillator kit provides a low-distortion sine-wave output from less than 5 Hz to 100 kHz. Unusual is the ability to offer both pushbutton and variable-frequency operation. Attenuation accuracy is ± 0.2 dB. Hum and noise are rated at 0.01% or less. The IG-1272 also comes fully assembled and tested (SG-1272).

CIRCLE NO. 334

Line analyzer memorizes and compares readings

Power-Science, Inc., 8076 Engineer Rd., San Diego, CA 92111. (714) 292-4422. \$545.

Line-voltage analyzer, Model LVA-110, offers high-speed ac measurements; the instrument can monitor line voltage with either a 1/2, 1 or 2-cycle time base. Each measurement is analyzed and compared against two memories that store the highest and lowest line voltage readings. An additional power-fail memory lights an indicator when power returns after an interruption. The dynamic input range is 0 to 199 V, and the analyzer can operate continuously over inputs from 50 to 160 V.

CIRCLE NO. 335

HARRIS OEM

SALES OFFICES:

CALIFORNIA: Long Beach (213)426-7687; Palo Alto (415)964-6443
FLORIDA: Fort Lauderdale (305)971-3200; Melbourne (305)724-7430
ILLINOIS: Hinsdale (312)325-4242
MASSACHUSETTS: Wellesley Hills (617)237-5430
MINNESOTA: Minneapolis (612)835-2505
NEW YORK: Melville, L.I. (516)249-4500
OHIO: Dayton (513)226-0636
PENNSYLVANIA: Wayne (215)687-6680
TEXAS: Richardson (214)231-9031

HARRIS SALES

REPRESENTATIVES:

ALABAMA: Huntsville (205)533-3620
ARIZONA: Phoenix (602)971-6250
CALIFORNIA: Goleta (805)964-8751; Mountain View (415)961-8121; San Diego (714)565-9444
COLORADO: Denver (303)759-0809
CONNECTICUT: East Norwalk (203)838-1493
FLORIDA: Boca Raton (305)395-6108; Oviedo (305)365-3283; Tampa (813)933-1759
ILLINOIS: Elk Grove Village (312)640-1850
INDIANA: Fort Wayne (219)484-1432; Indianapolis (317)849-6454
IOWA: Cedar Rapids (319)377-8275
MARYLAND: Lanham (301)459-1556
MASSACHUSETTS: Burlington (617)273-1313
MICHIGAN: Farmington (313)476-2446
MISSOURI: Hazelwood (314)731-5799; Independence (816)737-1100
NEW JERSEY: Keasbey (516)567-5900; West Caldwell (516)567-5900
NEW MEXICO: Albuquerque (505)265-5655
NEW YORK: Albany (518)489-7408 or 4777; Huntington Station (516)567-5900
NORTH CAROLINA: Winston-Salem (919)722-5151
OHIO: Cleveland (216)831-8292; Dayton (513)890-2150; Worthington (614)888-0483
OREGON: Beaverton (503)643-1644
PENNSYLVANIA: Allison Park (412)487-4300; King of Prussia (215)265-0634
SOUTH CAROLINA: Greenville (803)268-1125
TEXAS: Dallas (214)691-4592; Houston (713)780-9710
VIRGINIA: Charlottesville (804)973-6672
WASHINGTON: Bellevue (206)454-0300
CANADA: Mississauga (Toronto) (416)676-1042; Montreal (514)626-6723; Ottawa (613)729-1831

HARRIS NATIONAL

DISTRIBUTORS:

Hamilton/Avnet; The Harvey Group, Inc.; Kent Electronics; Schweber Electronics; R. V. Weatherford Company
CANADA: Preleo Electronics Ltd.

HARRIS COMMITMENT:



NOW UNDER CONSTRUCTION ... the most advanced fully automated CMOS production facility in the industry. A \$7.5 million commitment by Harris to meeting industry demands.

Designers arise!

HARRIS introduces the largest family of CMOS memories in the industry. With the very first CMOS PROMs.



Harris has the answer in CMOS RAMs, ROMs, and PROMs. Count 'em. 10 distinctively different memories, including three exclusive new CMOS PROMs...first in the industry...giving you the widest range of design options ever available. Harris CMOS Memories have the kind of high performance features you can design around. Like extremely low power requirements in both active and standby conditions. Fast access times. High noise immunity. TTL compatibility in/out. With temperature ranges for military (-55°C to +125°C), industrial (-40°C to +85°C) and commercial (0°C to +70°C) usage. Features that can help you simplify your designs while improving performance. Reduce part count. Save money.

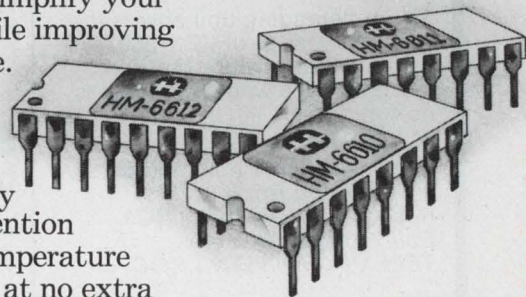

And every device is pretested to guarantee data retention down to 2.0 volts over rated temperature

range — at no extra cost to you. If you want to free yourself from the ordinary, add a new dimension to your designs, check the Harris CMOS Memory family. It's the biggest in the business. The quality is there. And the price is right. For complete specifications call your nearby Harris sales location, or write **Harris Semiconductor, P.O. Box 883, Melbourne, FL 32901**

USE THIS CHART TO HELP YOU SELECT THE CMOS MEMORY BEST SUITED FOR YOUR DESIGNS.

TYPE NO.	ORGANIZATION	PINS	SPEED	FEATURES
HM-6610 PROM	256x4	16	450 ns	Industry's first CMOS PROM. Combines
HM-6611 PROM	256x4	16	450 ns	benefits of low active and standby
HM-6612 PROM	256x4	18	450 ns	power, high noise immunity and fast access time.
HM-6312 ROM	1024x12	18	350 ns	Highest density CMOS ROM available. Ideal for 12 bit microprocessor systems.
HM-6508 RAM	1024x1	16	290 ns	Bipolar RAM pinout
HM-6518 RAM	1024x1	18	290 ns	6100 uP compatible
HM-6501 RAM	256x4	22	285 ns	Popular 5101 pinout
HM-6551 RAM	256x4	22	285 ns	Latched chip select
HM-6561 RAM	256x4	18	285 ns	6100 uP compatible
HM-6562 RAM	256x4	16	285 ns	Smallest 256x4 RAM available.



HARRIS SEMICONDUCTOR
A DIVISION OF HARRIS CORPORATION

RF power

We've made the most of it... You can, too!!

All wrapped up in a neat little package, our Model 510L is an ultra-wideband RF power amplifier whose wide range of frequency coverage and power output provide the user with the ultimate in flexibility and versatility in a laboratory instrument. Easily mated with any signal generator, this completely solid state unit amplifies AM, FM, SSB, TV, pulse and other complex modulations with a minimum of distortion.

Constant forward power is continuously available regardless of the output load impedance match making the 510L ideal for driving highly reactive loads.

Unconditional stability and instantaneous fail-safe provisions in the unit provide absolute protection from damage due to transients and overloads.

This outstanding unit covers the frequency range of 1.7 to 500 MHz with a linear power output of more than 9.5 watts and there is no tuning.

For further information or a demonstration, contact ENI, 3000 Winton Road South, Rochester, New York 14623. Call 716-473-6900 or TELEX 97-8283 ENIROC

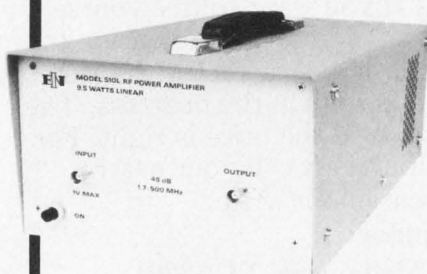

ENI

The world's leader in solid state power amplifiers

SEE ELECTRONIC DESIGN'S GOLD BOOK FOR COMPLETE PURCHASING INFORMATION

CIRCLE NUMBER 61

PACKAGING & MATERIALS

Ground people with a wrist band

Walter G. Legge Co., Inc., 101 Park Ave., New York, NY 10017. (212) 689-3083.

Wristat, an anti-static device worn around the wrist, grounds production, assembly and service employees without restricting arm movement. A flexible double conductor cable connected to an alligator clamp can be grounded to machinery or equipment.

CIRCLE NO. 336

Male and female contacts served by wrapped pin

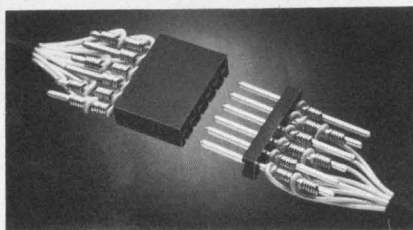

Method Electronics, Inc., 1700 Hicks Rd., Rolling Meadows, IL 60008. (312) 392-3500.

The Happy-Wrapper connector is a 0.045-in.-square pin joined to a sturdy female or other male contact. Insulators are injection molded on a nylon base. The Happy-Wrapper method connects leads with hand wire-wrapping terminations. Also a male header element can attach to a bulkhead or circuit board.

CIRCLE NO. 337

Self-contained torch burns 30 min/refill

Ungar, Div. of Eldon Industries, Inc., 233 E. Manville, P.O. Box 6005, Compton, CA 90220. (213) 774-5950.

The Versa Torch 5001 is a self-contained, pocket-sized torch and soldering iron that provides total freedom and portability for heating and soldering. It refills in seconds from standard propane or MAPP gas cylinders, provides up to 30 min of continuous heating per refill and weighs only 11 oz. A special adapter allows the torch to be fitted with any Ungar 1/4-in. tip. And a pinpoint burner tip for conventional flame heating solders copper tubing, welds and bends PVC plastics, and performs an endless list of other jobs. A detachable stand locks the torch into two positions—vertical and horizontal.

CIRCLE NO. 338

Adapter plugs come in many styles and sizes

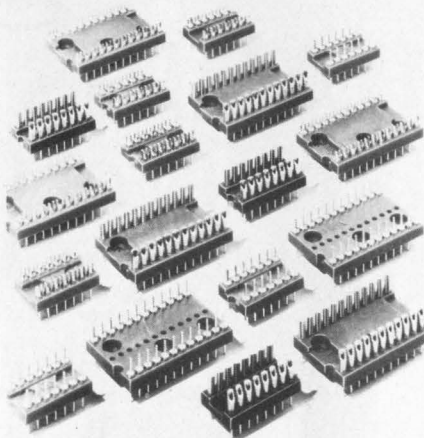

Samtec Electronic Hardware, 810 Progress Blvd., New Albany, IN 47150. (812) 944-6733. From \$0.35 ea.

DIP adapter plugs are available in seven sizes with three terminal styles for interfacing all component leads to DIP pin-out patterns. Terminals are precision-machined brass in either gold or tin finish with a choice of solder-pin, solder-pot, or slotted-head styles. Body is 1/8-in. thick glass-filled polyester U.L. rated 94V-0. All adapters feature pin-1 orientation and counter-bored thru-mounting holes.

CIRCLE NO. 339

Weary of static? This handy meter helps



Anderson Effects, Inc., P.O. Box 657, Mentone, CA 92359. (714) 794-3792. \$250.

A static meter that fits the shirt pocket and weighs only 8 oz is designed for simple one-hand operation. The meter reads the static charge on test surfaces without touching them, showing both polarity and charge in kV. Tote boxes, clothing, and the skin of ungrounded personnel can be checked to prevent electrostatic damage to ICs.

CIRCLE NO. 340

Announcing the first major advance in magnetic shielding in 50 years.

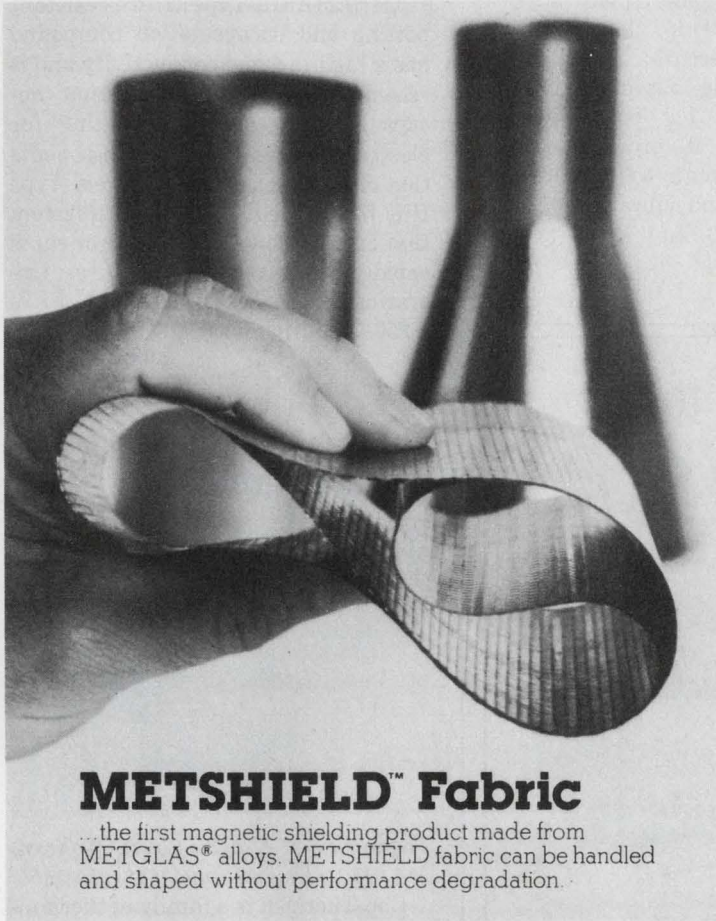

METSHIELD™ Fabric

... the first magnetic shielding product made from METGLAS® alloys. METSHIELD fabric can be handled and shaped without performance degradation.

Now you have such a shielding. It's METSHIELD™ magnetic shielding fabric—a wholly new flexible product made from Allied Chemical's METGLAS® amorphous metal alloys.

Because of its exceptional strength and flexibility, METSHIELD fabric retains its full shielding effectiveness during fabrication and use.

This reliability of performance—plus the ease with which METSHIELD fabric can be handled and shaped—promises you a significant reduction in the overall cost of shielding.

You can use METSHIELD fabric for a variety of applications, including cathode ray, photomultiplier, vidicon, and image tubes.

To find out how METSHIELD fabric can help solve your shielding problems, phone John Dismukes at 201-455-4031 or Jack Thorp at 201-455-3306. Or send in the coupon.

The time is right for a revolutionary concept in magnetic shielding.

Increased sales of electronic equipment, a trend toward miniaturization, and intensified regulatory considerations have put increased emphasis on electromagnetic compatibility.

Consequently, electronics manufacturers need cost-effective magnetic shielding not plagued by fabrication problems and use limitations associated with conventional nickel alloys.

Send me information on METGLAS® alloys and METSHIELD™ fabric.

Name/Title _____

Company _____

City/State/Zip _____

Mail to: Metglas Products, Allied Chemical Corporation
7 Vreeland Road, Florham Park, NJ 07932

 **Allied
Chemical**
Metglas Products

PACKAGING & MATERIALS

Are you using LCDs? Then mount a Zebra!

Tecknit Corp., 129 Dermody St., Cranford, NJ 07016. R. Ventimiglia (201) 272-5500. \$1.20 (5000); 2 wks.

Mounting LCDs at a right angle to PC boards is a snap with a Zebra connector assembly. It consists of a dielectric holder with a metal clip and a Zebra 1010

Elastomeric Connector. The Zebra 1010 is made of alternating layers of conductive and nonconductive silicone rubber and makes 50 electrical contacts per inch. You position it in the holder, place an LCD of up to 2.760 in. length in the holder, and secure it with the metal clip. The assembly is then bolted to the PC board without any soldering; it provides an environmental seal and protection against shock and vibration.

CIRCLE NO. 341

Potting compound resists fires

Transene Co., Route One, Rowley, MA 01969. (617) 948-2501. \$5/lb (qty).

THERMASIL-Type II fire-resistant potting and encapsulation compound has a high thermal conductivity and is recommended as a protective encapsulant or conformal coating for electronic circuits and components that operate at high power levels. Type II is formulated as a two-part system that cures at low temperature or cures rapidly at elevated temperatures. Operating temperature range is -50 to +250-C continuous.

CIRCLE NO. 342

Thermal conductor needs no grease



Chomerics, 77 Dragon Court, Woburn, MA 01801. Kevin Dunne (617) 935-4850.

Cho-Therm-R is a family of thermally conductive, electrically isolating silicone materials reinforced with glass cloth to resist tears and punctures. The material is available in three grades to provide thermal-transfer equivalents ranging from that of greased mica to greased beryllium, but Cho-Therm-R does not require grease.

CIRCLE NO. 343

Axial fan helps you save energy

Howard Industries, One North Dixie Highway, Milford, IL 60953. L. Lewis (815) 889-4105. \$30 (unit qty); stock-14 wks.

10-in. axial fans of the 5-50-series deliver from 590 ft³/min at zero static pressure to 55 ft³/min at 0.35 static pressure and draw approximately 0.35 A—half as much as comparable fans. This ball bearing equipped fan is powered by a permanent split-capacitor motor, rather than the normally used, less efficient, shaded pole motor. Available with solder terminals or cord sets.

CIRCLE NO. 344

Here are the latest additions to the **Par.Metal** line of modern electronic housings!

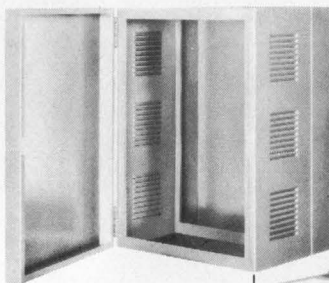

new... sectional wall cabinets

WC SERIES

Made of 3 sections —

- Wall mounted rear unit — 4" deep
- Center body section — 12" deep
- Front door — 2" deep



new... mod-cab welded desk cabinets

DC SERIES

- Panel heights from 3½" to 21"
- Two panel widths 9½" and 19"
- Three depths — 12", 18" and 22"
- Choice of 10 colors with walnut or black vinyl aluminum trim

new... low silhouette console cabinets

MODEL FS-21

Designed for any control requirement

- Provides unobstructed views
- Modular units for grouping
- 21" wide x 44" high x 24" deep

SEND FOR COMPLETE LITERATURE
OF PAR-METAL'S PACKAGING SYSTEMS

Par.Metal PRODUCTS, INC.

1260 Atlantic Ave., Brooklyn, N.Y. 11216
(212) 772-5800

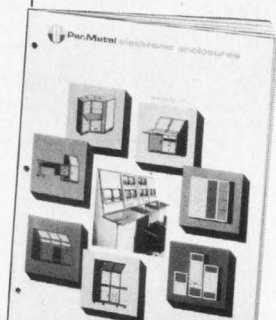

CIRCLE NUMBER 63



**“THE GOLDBOOK IS ONE SOURCE
I CAN COUNT ON NOT TO WASTE MY TIME.”**

Mark A. Edwards is President of Edwards Industries, Reno, Nevada. His company designs and manufactures CATV-telephone equipment and provides consulting services. In addition to corporate management, Mr. Edwards is design supervisor. His directory? *Electronic Design's* GOLD BOOK.

“The GOLD BOOK is the most comprehensive and accurate publication of its kind. The great number of headings and listings along with the in-depth cross referencing make it a pleasure to use. As a matter of policy, Edwards Industries does not endorse products or services. In this case, however, an exception is warranted. I've used the GOLD BOOK countless times. It's without question the finest directory I've used.”

Mr. Edwards has specified relays, transformers, ICs, transistors and design aids for purchase directly from the GOLD BOOK.

The GOLD BOOK is working for advertisers because it's working for 90,000 engineers, engineering managers and specifiers — like Mr. Edwards, throughout the U.S. and overseas.

IF IT'S ELECTRONIC...IT'S IN THE GOLD BOOK



Triad Transformers

Dependable Control For A Better Control Circuit

If you're designing a new control circuit — or upgrading an old one — specify Triad control transformers. Triad gives you a choice of 6, 12, 24 and 48 volt secondaries for series or parallel operation; dual primaries, and open construction with U-bracket or mounting straps. All have been proven rugged and reliable in hundreds of critical applications.

Your Triad distributor already has them in stock for your short-run needs so you won't have to wait for them to be built to order. And if he doesn't have enough for your longer runs, we back him up with large bulk quantities at our plant.

If you're designing magnetic components of any type into your system or device, you'll probably find just the transformer or inductor you need in the Triad catalog. So see your Triad distributor today, or send for a copy.

Type No.	Primary	Secondary		VA Rating
		Parallel	Series	
F-105Z		6V @ 2A	12V @ 1A	12
F-106Z	115V/230V	6V @ 4A	12V @ 2A	24
F-107Z	50/ 60 CPS	12V @ 4A	24V @ 2A	48
F-108U	on all	12V @ 8A	24V @ 4A	96
F-109U		12V @ 16A	24V @ 8A	192
F-211Z		24V @ .5A	48V @ .25A	12
F-212Z		24V @ 1.0A	48V @ .50A	24
F-213Z		24V @ 2.0A	48V @ 1.0A	48
F-214U		24V @ 4.0A	48V @ 2.0A	96
F-215U		24V @ 8.0A	48V @ 4.0A	192



TRIAD-UTRAD

Litton Distributor Services

305 North Briant Street, Huntington, Indiana 46750

CIRCLE NUMBER 65

PACKAGING & MATERIALS

Free-standing pinsockets cool, allow inspection

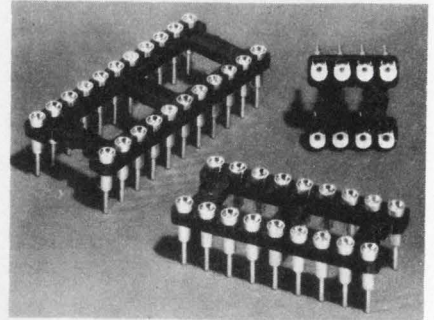

Robinson-Nugent, 800 E. Eighth St., New Albany, IN 47150. Don Fleming (812) 945-0211.

The ICT Series DIP socket reduces assembly time without special equipment, yet provides the same cooling advantages as ordinary free-standing pinsocket contacts. Each pinsocket, precisely set in a carrier, ends difficult and time-consuming assembly alignment. Also, each socket stands free above the PC board, simplifying solder inspection. The socket is available with from 8 to 40 pinsocket contacts.

CIRCLE NO. 345

Two-pair data bus cable carries long distances

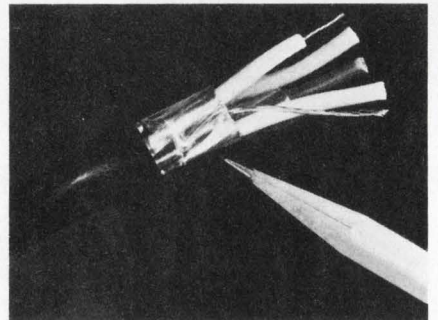

Belden Corp., 2000 S. Batavia Ave., Geneva, IL 60134. (312) 565-1200.

Two-pair 150-Ω data-bus cable, YRS-15250, carries data over long distances. The twisted pairs in an overall Duofoil (aluminum-polyester-aluminum laminate) shield are covered with a black polyvinylchloride jacket. Shield termination, a 22-gauge stranded tinned-copper drain wire, is kept in constant contact with the shield. Overall cable diameter is 0.42 in. Capacitance between a conductor pair is 9 pF/ft, and attenuation is 1 dB/100 ft at 10 MHz. The cable complies with UL Style No. 2772.

CIRCLE NO. 346

BIPOLAR MEMORIES

FAIRCHILD INTRODUCES PLASTIC PROMS THAT WILL LIVE TO A RIPE OLD AGE.

While many of our competitors are still trying to figure out how to put PROMs in plastic, we've taken another giant step forward: Plastic packages with silicon nitride protection to make the longest lasting PROMs in the industry about six times longer lasting.

That's because silicon nitride inhibits latent device failure by holding out moisture and ionic

contamination. In fact, in accelerated tests such as biased 85/85, MTBF on industry standard plastic PROMs was 2,000 hours, while MTBF on our plastic PROMs was 13,000 hours. And, in the real world of systems applications, they're equivalent to hermetic packages.

WE HOLD ALL THE RECORDS FOR FAST.

For all their reliability, Fairchild PROMs don't sacrifice a nanosecond in speed. They're still the fastest on the market. Up to 30% faster than most.

And the simplest to program. The breadth of our line pretty much speaks for itself, so we'll let it:

PROM Part No.	Organization	Output	0-70°C TAA
93417	256 x 4	0C	45 ns
93427	256 x 4	3S	45 ns
93436	512 x 4	0C	50 ns
93446	512 x 4	3S	50 ns
93438	512 x 8	0C	55 ns
93448	512 x 8	3S	55 ns
93452	1024 x 4	0C	55 ns
93453	1024 x 4	3S	55 ns

STEP RIGHT UP, THERE'S NO WAITING.

If you need fast, reliable, simple-to-program PROMs, and you need them now, you're in luck. Because all ours are available now.

To place an order, or to learn more, write or call your Fairchild sales office, distributor or representative today.

Or use the direct line at the bottom of this ad to call our BIPOLAR MEMORY people direct. Fairchild Camera and Instrument Corporation, 464 Ellis St., Mountain View, California 94042. Tel: (415) 962-3951. TWX: 910-373-1227.



FAIRCHILD

**CALL US ON IT.
(415) 962-3951**

COMPONENTS

LEDs directly replace phone incandescents

Data Display Products, P.O. Box 91072, Los Angeles, CA 90009. (213) 677-6166. \$0.80 (OEM qty.); stock to 6 wks.

The first LEDs that directly replace incandescent lights in standard telephone pushbutton sockets, type 55BS, are mounted in a short No. 5 base. They

are produced in red, amber and green. With a drive current of 20 mA, output is typically 50 mcd (red), 35 mcd (amber) and 24 mcd (green) with clear tinted encapsulation. Diffusive encapsulation also is available. A built-in resistor allows operation from 5 to 48 V dc. For ac operation over 12 V, a built-in rectifier is used. The cathode is marked with a green dot; however, units with built-in resistors are not damaged if they are operated momentarily in the wrong direction.

CIRCLE NO. 347

Relays show low profile for PC-board mounting

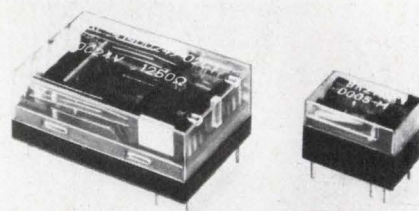

Impact Electrical Products, Inc., 7 Westchester Plaza, Elmsford, NY 10523. Harry Hopper (914) 592-2880. \$1.96 (1000 qty.).

Low-profile PC-board relays, less than 0.5-in. high, feature bifurcated contacts, a life of more than 1-million operations at 1 A, 30 V dc and a mechanical life of more than 30-million operations. The relays are available as DPDT and 4PDT and consume low power—approximately 0.45 W for DPDT and 0.6 W for 4PDT.

CIRCLE NO. 348

STOP

WAITING ON OUTPUT FROM YOUR μP DEVELOPMENT SYSTEMS

You Are Wasting More In Program Development
Costs Than This LINE PRINTER Sells For

2400 LPM - 80 COL.
MODEL 8210 - \$3450*

1400 LPM - 132 COL.
MODEL 8230 - \$3785*

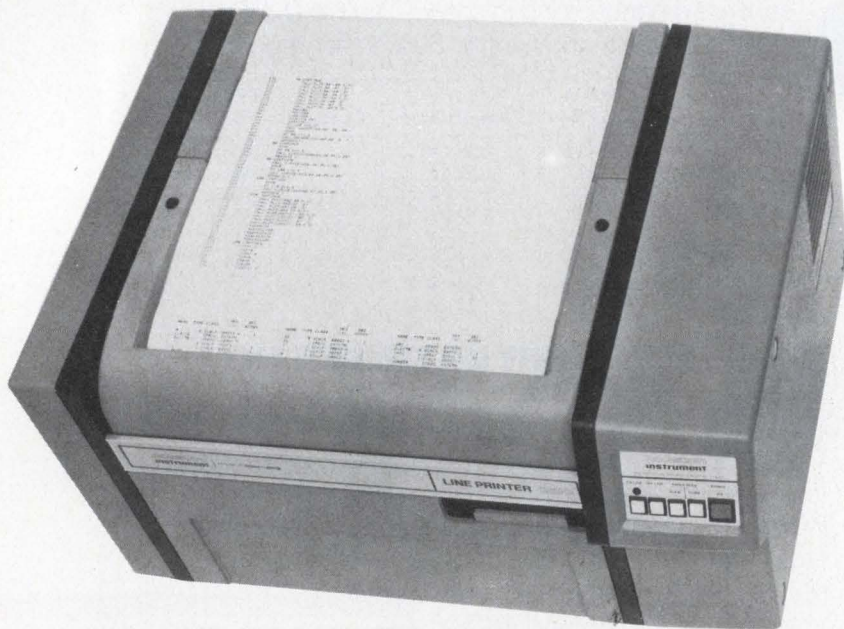

FOR ORDERING INFORMATION CALL OR WRITE:

**houston
instrument**

DIVISION OF BAUSCH & LOMB

ONE HOUSTON SQUARE (at 8500 Cameron Road) AUSTIN, TEXAS 78753
(512) 837-2820 TWX 910-874-2022 cable HOINCO

TELECOPIER

ROCHESTERIAN 6 8240 Gistel Belgium
EUROPEAN OFFICE Phone 059/277445 Telex Bausch 19399

"the recorder company"

* Domestic USA Prices, Qty 1, End User

CIRCLE NUMBER 67

Modular PB switches employ reed contacts

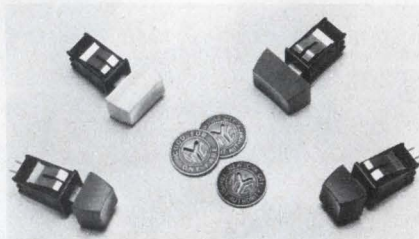

Dialight, 203 Harrison Pl., Brooklyn, NY 11237. (212) 497-7600. \$1.10 (1000 up); stock.

Modular pushbutton reed switches, the 541 Series, are designed for reliability and long life with electrical characteristics especially suited to interface semiconductor circuits. A reed element is hermetically sealed in a capsule to isolate contacts from contamination. For impact and vibration resistance, the switches are resiliently mounted in a high-impact glass-reinforced plastic housing, and all internal connections are welded. Electrical specifications include 50-V-dc max. at 20 mA max. of switched current, resistive load; 1000-MΩ min. insulation resistance; and initial contact resistance 0.5 Ω max., rising to no more than 1.25 Ω at the end of switch life. Contact configurations is SPST NO. Terminals are designed for PC boards, wire-wrapping or hand soldering.

CIRCLE NO. 349

COMPONENTS

PC-mountable SS relay receives UL recognition

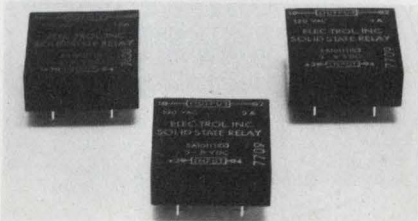

Elec-Trol, Inc., 26477 N. Golden Valley Rd., Saugus, CA 91350. (213) 788-7292. \$5.79: 3 A, 120 V (1000 qty); 6 to 8 wks.

Miniature solid-state relays, Model SA 1011 series, have received UL recognition, Bulletin 508 under file E-58275. With a small "footprint"—only 1.27 in.²—they can still switch up to 3 A at 120 or 240 V ac with 3-to-8, 8-to-18 or 18-to-32-V-dc inputs. The units offer zero-crossover switching, photoisolation, total epoxy encapsulation, IC compatibility, long life and immunity to shock and vibration.

CIRCLE NO. 350

Smoke detector senses with two ion chambers

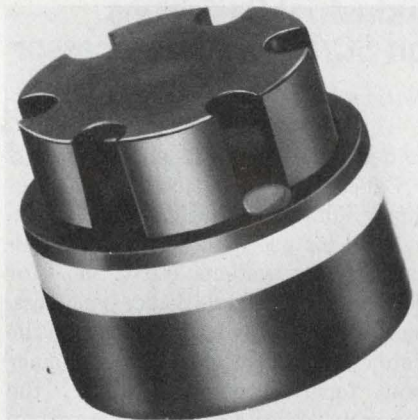

Electrometer Corp., 600 Sonora Ave., Glendale, CA 91201. (213) 240-2010.

Battery-operated type DSID smoke detectors trigger alarms when smoke concentrations as low as 1% aerosols enter the chamber. Two ionization chambers—one sealed, the other open to the atmosphere—provide compensation for changes in barometric pressure, temperature, and humidity without giving false alarms. A minute amount of radioactive material ionizes the air in the chambers setting up a current flow when a voltage potential is applied. Smoke entering the chamber neutralizes the ions before they can be collected, causing the current to drop. A buffer amplifier sets off an alarm.

CIRCLE NO. 356

DATASTAR

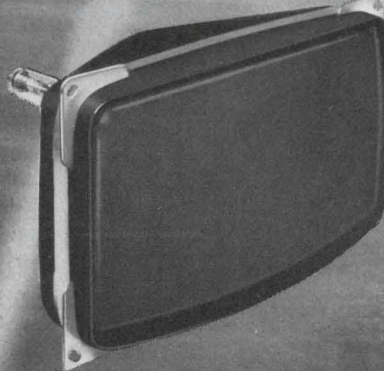

the bright new answer to data viewing problems, available only from CLINTON . . . THE ANSWER PEOPLE IN CRT'S. Clinton's new DATASTAR high Contrast Phosphors (available in versions of P-4 and P-31) are the first and only phosphors developed specifically for information display applications.

With Clinton's new DATASTAR high contrast phosphors the operator does not have to adjust the tube to a high brightness level in order to achieve good readability under high ambient light conditions. This also means less spot distortion and delayed screen/phosphor discoloration, common to alpha-numeric displays. In addition, DATASTAR phosphors are significantly more resistant to discoloration, therefore the Clinton CRT has a longer useful field life.

Combine the advantages of DATASTAR phosphors with Clinton's high resolution SUPER-TUBES, and you have a CRT display unequaled in quality and performance. DATASTAR . . . Just one more innovation from CLINTON . . . THE ANSWER PEOPLE IN CRT'S. See the DATASTAR phosphors in operation in booth 1149 at the N.C.C.



**CLINTON
ELECTRONICS
CORPORATION**

6701 Clinton Rd., Rockford, Ill. 61111 Phone 815-633-1444 Telex 257-484

CIRCLE NUMBER 68

Available Now!



□ MICROPROCESSOR

BASICS, edited by Michael S. Elphick. Here's the nitty-gritty on design selected from *Electronic Design* for the eight currently popular microprocessors: 8080, 6800, F8, PACE, IMP, 2650, 1802, and 6100. Each chapter discusses one model, detailing its advantages, disadvantages, architecture, capabilities, and includes many illustrations of its applications. #5763-6 paper 224 pp., \$9.95

□ ORGANIZING AND DOCUMENTING DATA PROCESSING INFORMATION,

by Thomas R. Gildersleeve. Write sharp, precise DP documents that command attention. This book will show you how to... prepare a first draft... shape your sentences for reading ease... organize a document for quick study. Filled with examples of great DP writing and scores of exercises for practice. #5739-3 paper, 160 pp., \$7.95

Please send the book(s) checked on 15-day examination. At the end of that time, I will send payment, plus postage and handling, or return the book(s) and owe nothing. On all prepaid orders, publisher pays postage. Prices are subject to change without notice. Offer good in U.S.A. and Canada only.

NAME _____

COMPANY _____

ADDRESS _____

CITY _____

STATE/ZIP _____

Send to:

Hayden Book Company, Inc.
50 Essex Street, Rochelle Park
New Jersey 07662

#77-62

MICRO/MINI COMPUTING

Interface mates LSI-11s to instrument buses

Digital Components Group, One Iron Way, Marlborough, MA 01752. Robert Brick (617) 481-7400. \$750; stock.

Connecting up to 15 instruments to an LSI-11 microcomputer, the IBV11-A interface conforms to the IEEE standard 488-1975. The instrument-bus portion of the interface will support a total cable length of 65.6 ft, and is hardware-compatible with any system using the LSI-11 as a component. Contained on a single printed-circuit board assembly, the IBV11 plugs directly into any LSI-11 bus-structured system backplane.

CIRCLE NO. 357

Single-chip μ Cs come in wide choice of models

Rockwell International, 3310 Miraloma Ave., P.O. Box 3669, Anaheim, CA 92803. (714) 632-3729. Under \$10.

Six single-chip microcomputers have become members of the PPS-4/1 family by the Microelectronic Device Division of Rockwell International. Two of the chips, the MM76 and MM78, join the already introduced MM77 single-chip microcomputer. All three are now available. The other four μ Cs are slated for introduction later this year. On-chip ROM and RAM size is the main differentiating characteristic of the three available microcomputers. The MM76 has a 640 \times 8 ROM and a 48 \times 4 RAM; the MM77 has a 1344 \times 8 ROM and a 96 \times 4 RAM; and the MM78 has a 2048 \times 8 ROM and a 128 \times 4 RAM. Three of the four chips scheduled for volume production later in the year are identical to the MM76 except for minor additions: The MM76C has a high-speed counter (either one 16-bit presetable up/down counter or two 8-bit counters) with 8 control lines; the MM76D features a 12-bit a/d converter and six additional I/O lines; and the MM76E provides an expanded ROM capability of 1024 \times 8. An economy single-chip computer, designated the MM75, will be available, too. Identical to the MM76 in ROM and RAM capacity, the MM75 has fewer I/O lines: 22, not 31. And whereas the other five come in 42 or 52-pin quad in-line packages, the MM75 is packaged in a 28-pin DIP.

CIRCLE NO. 358

Cassette interface card mates with 680b bus

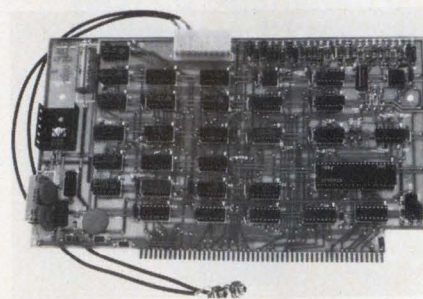

MITS, 2450 Alamo S. E., Albuquerque, NM 87106. (505) 243-7821. Contact local distributor; stock.

Designed for use with inexpensive audio-cassette recorders, the 680b KCACR interface board permits mass data storage and retrieval. Using the "Kansas City Standard" for data recording the board fits in the company's 680b microcomputer mainframe (the 680b is a 6800-based machine). Included on the board are a digital demodulator, a motor control circuit and sockets for all ICs.

CIRCLE NO. 359

Industrial Basic runs on SC/MP microprocessor

National Semiconductor, 2900 Semiconductor Dr., Santa Clara, CA 95051. Phil Roybal (408) 737-5000. See text.

Called NIBL, a microcomputer language similar to Basic, has been developed for use with 8-bit SC/MP microprocessor systems. NIBL, short for National Industrial Basic Language, has been placed, without charge, in the public domain. It is available in paper tape form through Compute, the company's microprocessor users group newsletter. In preparation is a self-teaching manual for NIBL and the SC/MP low-cost development system and a soon-to-be-released NIBL firmware package in ROM. Although NIBL was originally conceived to operate on the SC/MP LCDS, the minimum hardware required to handle NIBL is the SC/MP μ P, crystal and support logic; a 110 baud ASCII terminal interface; 4096 \times 8 bits of ROM for NIBL; 2048 \times 8 bits of RAM user space (allows about 60 average NIBL statements); a teletypewriter or similar terminal and a power supply. Two versions of NIBL are available, one written for the PMOS SC/MP operating with a 2-MHz clock and one for the new NMOS SC/MP II, with a 4-MHz clock.

CIRCLE NO. 360

COULD A \$3 RESISTOR SAVE YOU A \$300 FIELD SERVICE CALL?

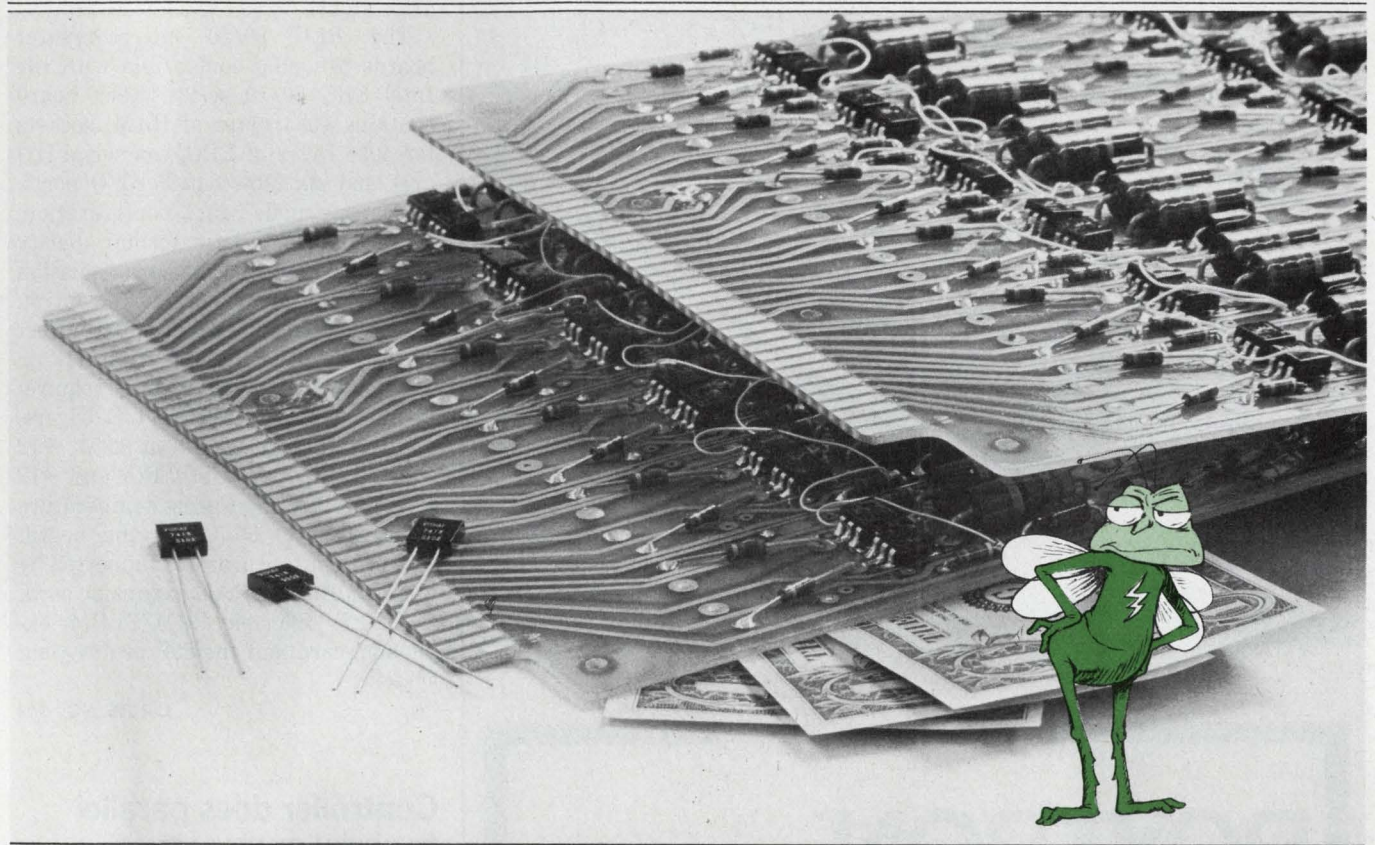

It sure could.

When the equipment you've built fails at the worst possible moment in the field, you may suddenly learn just how expensive a mere resistor can be. You may learn the hard way that the dollar or two you saved at the drawing board has cost you hundreds or even thousands in warranty service. And quite possibly even cost you a customer.

Not every resistance application cries out for Vishay quality. You may often do without this quality and still suffer no dire consequences.

But when you need a precision resistor or trimmer for rock-solid stability and reliability, think of this:

Some precision resistors offer you tight tolerance at the expense of poor frequency response. Others offer low inductance and fast rise at the expense of poor temperature characteristics. Only Vishay Bulk Metal[®] resistors offer you the *complete set* of top performance characteristics, including TCR as low as $0 \pm 1 \text{ ppm}/^\circ\text{C}$, a combination that will most often free your equipment from that tormenting bug.

And now Vishay offers you the chance to *make your own* custom bulk-metal resistors for breadboard, prototype, or even production use. Call or write for information on the simple calibration and encapsulation of Vishay resistors in your own plant. Vishay Resistive Systems Group, 63 Lincoln Highway, Malvern, PA 19355; phone (215) 644-1300; TWX 510-688-8944.



Only Vishay resistors give you all six top performance specs.

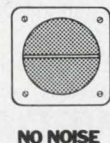

Bliley

first name in frequency control

We have a reputation that can mean as much to you as it does to us. Here's why.

By manufacturing our own crystals and growing and sweeping our own quartz, we control product quality from raw material to finished unit.

Next, we specialize in the design and production of units whose level of precision is difficult—if not impossible—to find elsewhere.

Finally, our total commitment to quality makes us the preferred supplier to the more sophisticated levels of electronics.

If that's *your* level, you've found your peer in Bliley. Tell us about your present requirements or, simply request our catalog of complete product information and call later when you need us.

QUARTZ CRYSTALS • CRYSTAL OSCILLATORS • CRYSTAL FILTERS •

BLILEY ELECTRIC COMPANY

2545 West Grandview Boulevard,
P.O. Box 3428, Erie, PA. 16508
Tel. (814) 838-3571 TWX 510-696-6886

CIRCLE NUMBER 71



MICRO/MINI COMPUTING

Microcomputer board fits in SBC 80/10 slots

National Semiconductor, 2900 Semiconductor Dr., Santa Clara, CA 95051. Don Schare (408) 737-5000. \$265 (100 qty); stock.

The BLC 80/10 microcomputer boards are plug compatible with the Intel SBC 80/10 series. Each board contains 1024 bytes of RAM, sockets for 4096 bytes of PROM, a serial I/O port and six 8-bit parallel I/O ports. Operating mode, data configuration, control characteristic format, parity checks and synchronous transmission rate are all under program control. Easily visible blue jumper plugs select synchronous data rates from 110 to 4800 baud. Maximum supply requirements exclusive of PROM, I/O drivers, and terminators are 5 V at 2.9 A, +12 V at 150 mA, -5 V at 2 mA and -12 V at 150 mA. Operating temperature range is 0 to 55 C for the board. Microcomputer cards are supported by the BLC 016 16-k RAM expansion card, the BLC 406 6-k ROM/PROM expansion card and the 80P prototyping system.

CIRCLE NO. 361

ROYTRON™ plug-compatible reader/punch

Designed to operate with a Keyboard/Printer or CRT connected to a modem or common serial port of a mini-computer.

Punch accommodates all varieties of commercial tape including mylar and mylar composites from 5 through 8 channels. Baud rate is selectable from 50 to 600 baud.

Photoelectric reader has a stepping motor tape transport and LED phototransistor tape sensing system for reliable operation. Baud rate is selectable from 50 to 2400 baud independent of punch baud rate.

Panel switches control operation of reader, punch and associated device. Tape duplication feature is provided by setting unit to LOCAL mode. All made in U.S.A.

NCC—BOOTHS # 1000-1002

for full details, write or call

 **SWEDA INTERNATIONAL**
Litton OEM Products

34 Maple Avenue, Pine Brook, N.J. 07058/(201) 575-8100

IN U.K. — ADLER BUS. SYSTEMS/OEM PRODS., Airport House, Purley Way, Croyden, Surrey, England

IN FRANCE — SWEDA INTERNATIONAL/OEM, 103-107 Rue de Tocqueville, 75017 Paris, France

CIRCLE NUMBER 72



MODEL 1560-S
with Serial Interface
High-speed, compact, with self-contained electronics and power supply. Complete in attractive noise dampening housing.

Controller does parallel to serial or vice versa

Fairchild Camera and Instrument, Instrumentation and Systems Group, 1725 Technology Dr., San Jose, CA 95110. Gordon Dagg (408) 998-0123. \$595 (one port), \$695 (dual port); stock.

The Model 6600 general-purpose interface takes data from a 16-line RS-232C link (eight control lines, nine data lines) and converts them into 8-bit parallel signals. Conversely, the device will take 8-bit parallel data words and convert them to the RS-232C standard. Also operating as a peripheral controller, the 6600 accepts asynchronous commands and generates the required reader or punch on or off, forward or reverse, etc., commands. Front panel controls are used to select the data path to the local terminal or modem, turn on or off the punch or reader, advance or rewind the tape and select a local or remote command mode. Internal switch selection permits speeds up to 9600 bps, parity character, stop bits and character size.

CIRCLE NO. 362

Multibase calculator also has logic functions

Texas Instruments, P.O. Box 5012, Dallas, TX 75222. (214) 238-2011. \$49.95; stock.

Called the TI Programmer, the handheld calculator does arithmetic in three different number bases and performs conversions to and from those bases. The number bases include hexadecimal, decimal and octal. The calculator represents negative numbers with a two's-complement code in both the hexadecimal and octal bases. A one's-complement key on the calculator also simplifies working with computers that use one's-complement arithmetic. The calculator can perform bit-by-bit logic operations on numbers in hexadecimal or octal. Included are AND, OR, Exclusive-OR and shift operations.

CIRCLE NO. 363

Development software cuts Z-80 system design

Technical Design Labs, Research Park Bldg. H, 1101 State Rd., Princeton, NJ 08540. Chris Rutkowski (609) 921-0321. \$150/program (including manuals), 30 days.

Developed to simplify the writing of Z-80 programs, the Zapple line of μ P software is relocatable, and except for the macroassembler, is ROMable (may be placed in ROM and operated from ROM without first being moved into RAM memory). The I/O drivers for all programs are contained only in the monitor program. Thus, once the monitor is configured for any particular hardware I/O configuration, all other programs are immediately compatible with that system. The five software packages are (1) a Zapple Monitor, which occupies 2 k of RAM and offers 27 instructions; (2) a Text Editor, which occupies 3 k of RAM and is both line and character-oriented; (3) a Relocating macroassembler, which occupies 8 k of RAM and can generate fully relocatable object code; (4) Zapple Basic, which occupies 8 k of RAM and, according to the company, packs more command versatility into 8 k than any other Basic ever written; and (5) SCRIPT, a word-processor program that occupies 3 k of RAM or ROM and allows complete word-processing capability, including automatic paging, justification, concatenation, spacing, titling and subtitling.

CIRCLE NO. 364

Selection Guide for Ending Surge & Lightning Troublespots

APPLICATIONS	TII-317 (and TII-352)	TII-710-025	TII-410 (and TII-411)	TII-425
Key Systems				Yes
Carrier Communications		Yes	Yes	Yes
PBX		Yes	Yes	
AC Power Input Lines			Yes	Yes
Test Equipment	Yes			Yes
Computers		Yes		Yes
Control Lines	Yes	Yes		
Security Systems	Yes			Yes
Base Station & Radio	317 only	Yes		Yes
Antenna (Microwave & RF)	Yes	Yes		

Also TII-300 Failsafe Protector for Telephone Station applications.

TII 3-Electrode Heavy-Duty Gas Tube Surge Arresters reduce maintenance, protect equipment and personnel. The packages shown are most often used for retro-fit applications in existing equipment. New equipment manufacturers can choose from more than 60 standard TII packages, all designed for 20-year service life. Call or write for new booklet entitled "Surge Protection for Sensitive Electronic Equipment."

TII-317 & TII-352 Heavy-Duty & Standard Duty spade-ended primary arresters are simple to install.

TII-710-025 handles up to 10 balanced line pairs in a single unit.



TII-425 offers direct plug-in convenience plus the additional protection of a circuit breaker.

TII-410 & TII-411 Powerline Surge Protectors complete with covers, with line cord (TII-411) and without (TII-410) for 115 VAC application.



TII CORPORATION
TELECOMMUNICATIONS DIVISION

100 North Strong Avenue, Lindenhurst, New York 11757
(516) 842-5000 • Telex: 144631

Licensed by Western Electric Co. and M-O Valve Co., Ltd.

MICRO/MINI COMPUTING

Add-on memory boards support Series 80 micros

National Semiconductor, 2900 Semiconductor Dr., Santa Clara, CA 95051. Don Schare (408) 737-5000. Unit qty. prices: \$878 (016), \$315 (406); stock.

Two plug-compatible memory boards, the BLC 016 and BLC 406, provide memory expansion for any Series/80 microcomputer. The BLC 016 contains 16 k × 8 of RAM with built-in refreshing. Typical read cycle times are 735 ns; write cycle times are 1360 ns. The refresh cycle requires 735 ns. Maximum power requirements for the RAM board are 5 V at 1.5 A, 12 V at 1 A and -5 V at 3.2 mA. The BLC 406 has 24 sockets for up to 6 k × 8 of UV PROM or mask ROM. Switches and plug-programmable jumper terminals set independent base addresses for 2-kbyte blocks and a 4-kbyte block at any 2-kbyte boundary. Other switches enable or disable memory blocks and set access times from 1 μs to 2.5 μs.

CIRCLE NO. 365

Microcomputer adapter upgrades 8080 to Z80

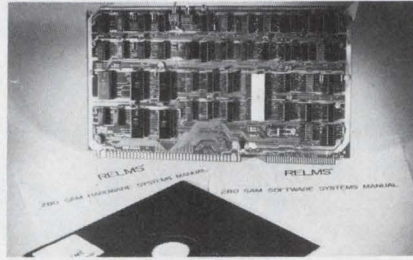

Relational Memory Systems, P. O. Box 6714, Santa Clara, CA 95150. Douglas Kelley (408) 248-6356. \$1495; stock.

The Z80-SAM adapter module can update any MDS-800 development system from the 8080 or 8085 to the Z80. Besides the hardware board, a Z80-SAM system monitor in firmware PROM replaces corresponding MDS-800 ROM firmware (on monitor ROM board). Software consists of a 16-k DOS assembler and a 32-k DOS assembler. The Z80 SAM assembler operates four times as fast as the 8080 assembler on the MDS-800. Moreover, the user can patch Z80 code into existing 8080 code.

CIRCLE NO. 366

Static RAM board holds 8 k, accesses in 530 ns

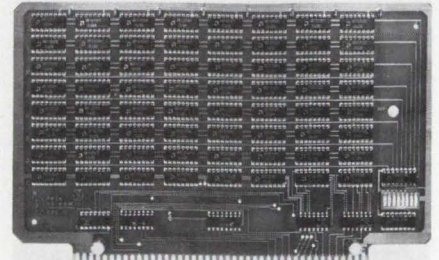

Creative Micro Systems, 6773 Westminster Ave., Westminster, CA 92683. (714) 892-2859. \$210 (100 qty); stock.

A fully static RAM board, the 9626, holds 8 kbytes of storage and is compatible with Motorola's EXORciser and Micromodule bus. The RAM card has an access speed of 530 ns, maximum, a power dissipation of 8.5 W, maximum, and a switch selectable operating region. Also compatible with Motorola's MEK6800D1 and D2 systems, the card has full 16-bit address decoding and requires a 5-V supply. The card measures 9.75 × 6.05 × 0.6 in. and operates over 0 to 70 C.

CIRCLE NO. 367

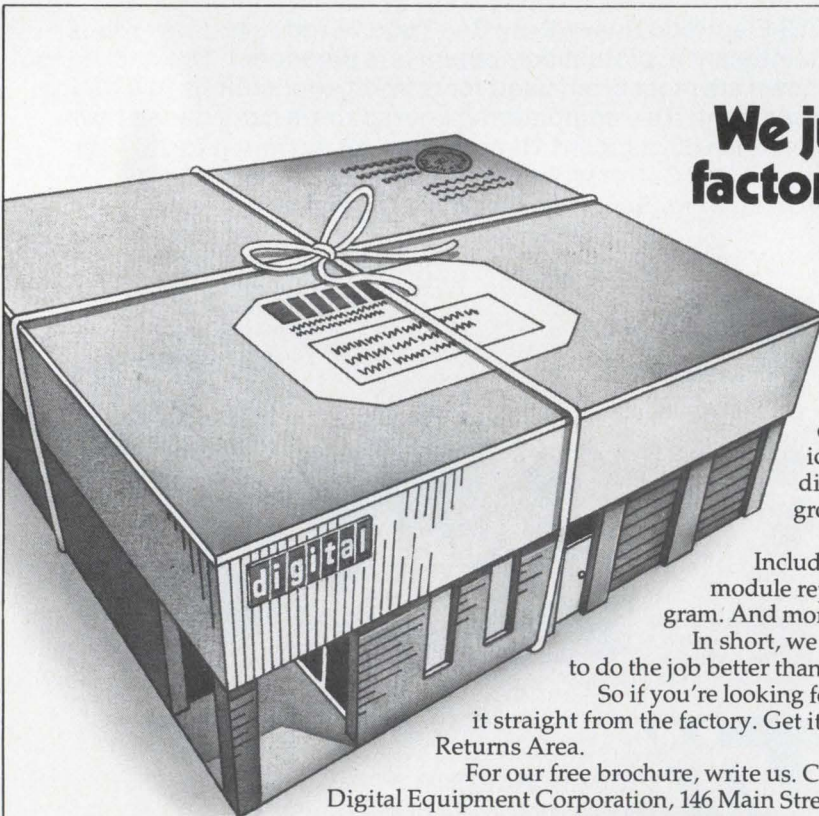

We just brought Digital factory service one step closer to the field.

Announcing the Customer Returns Area. The major off-site repair center for Digital Equipment Corporation.

The Customer Returns Area offers all our customers direct access to factory service. We have our own parts inventory, diagnostic and test center, and engineering group.

We also have a number of service plans. Including subassembly contracts, individual module repair, our unique Module Mailer™ program. And more.

In short, we have everything it takes to do the job better than anyone else.

So if you're looking for off-site service, get it straight from the factory. Get it from the Customer Returns Area.

For our free brochure, write us. Customer Returns Area, Digital Equipment Corporation, 146 Main Street, Maynard, MA 01754.

digital

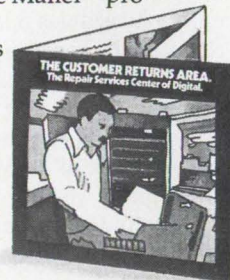

Power supplies.

The HE200 Series Power Supplies offer the design engineer a low-cost, highly efficient alternative to the size, weight and heat generation problems normally associated with series-pass regulated supplies. Using state-of-the-art switching techniques and CMOS logic, the HE200 Series Supplies achieve 75% efficiency at full load.

All models in the HE200 Series have the "footprint" and mounting dimensions of the Lambda package size "B" supplies...a feature that allows the engineer to experiment with high-efficiency techniques in existing designs. In new designs, the engineer can take advantage of

the small size (1.2 watts per cubic inch) and light weight (1/2 ounce per watt) of the HE200 Series Supplies.

The highly reliable HE200 Series Supplies are all short-circuit proof, over-voltage protected, available in 115 and 230 VAC input models, and backed by a full two-year warranty.

Finally, the HE200 Series offers the design engineer considerable savings: 5 volts, 10 amps for \$195; 5 volts, 20 amps for \$295; and ± 15 volts, 1.5 amps for \$195 in single quantities.

 **Computer Products, inc.**

Distributors: Los Angeles 213-877-5518/
Dallas: 214-341-8311 • Houston: 713-780-2220

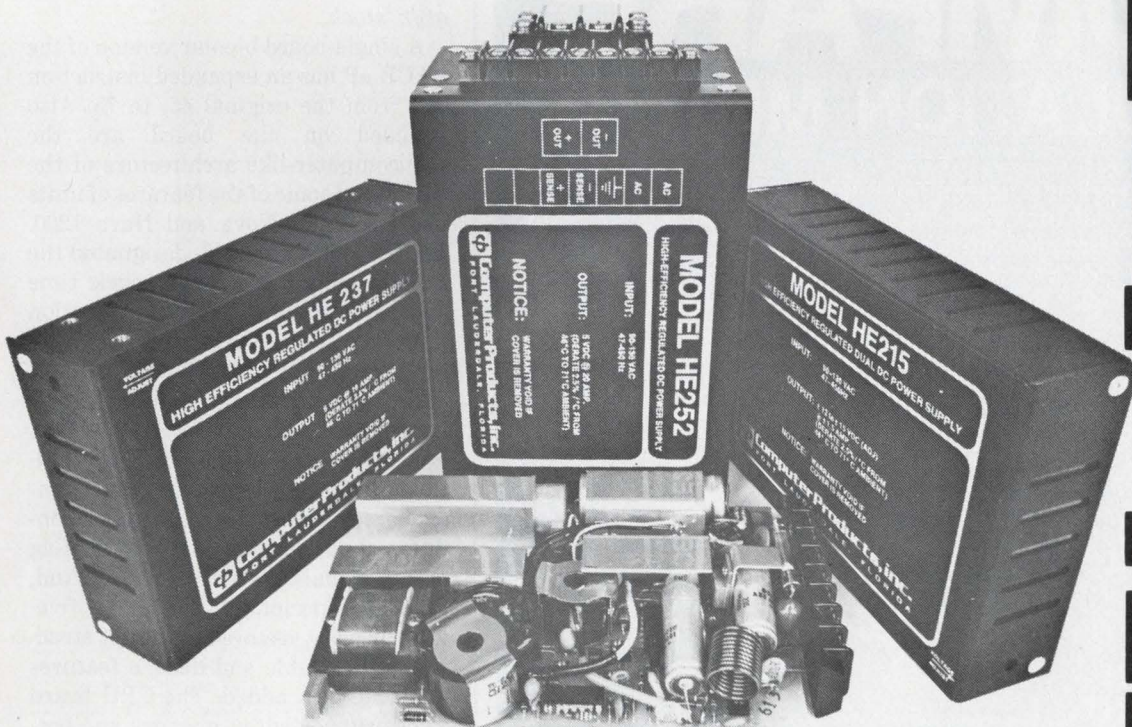

1400 N.W. 70th Street, Fort Lauderdale, Florida 33309 (305) 974-5500, TWX (510) 956-9895

CIRCLE NUMBER 75

High Efficiency



Now...Quiet Numeric Printing With Special Data Identification Characters

No more writing data identification on tape ... no more transcription errors
... no unidentified numbers

New Gulston ANP-9 non-impact thermal numeric printer gives you seven columns of numbers (or six with \pm sign) and two columns of data identification characters, either before or after the numeric entry. A standard 32 character set of data identification characters is provided. However, any special characters that can be formed by a 5x7 dot matrix are available.

Gulston offers a full line of alphanumeric, numeric and special character printers. Write or call today for technical data.

gulston[®]

Measurement & Control Systems Division

Gulston Industries Inc., East Greenwich, Rhode Island 02818
401-884-6800 • TWX 710-387-1500

CIRCLE NUMBER 76

Before you buy

COMPARE MODULATION METERS

We invite you to use Radiometer's Type AFM2 or AFM3 in your laboratory on a 10 day trial. Check features, specifications and especially performance in your own precise measurements of FM deviation and AM modulation on carriers from 5 MHz to over 1 GHz. Determine distortion levels of signal generators or transmitters and make sensitive measurements of incidental AM or incremental FM on carriers.

You can check all these and more.

For details contact us at
811 Sharon Drive,
Cleveland, Ohio 44145
Phone 216/871-8900

 **THE
LONDON
COMPANY**

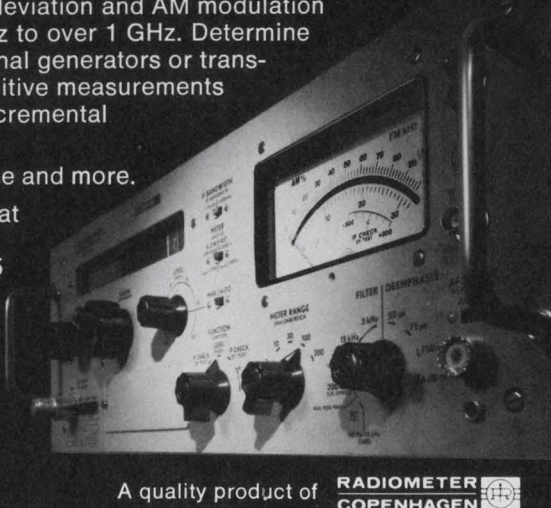

A quality product of **RADIOMETER
COPENHAGEN**

CIRCLE NUMBER 77

MICRO/MINI COMPUTING

Dual floppy-disc system mates to EXORciser bus

Motorola Microsystems, P.O. Box 2094,
Phoenix, AZ 85036. (602) 244-6900.
\$3300; stock.

A floppy-disc system, the EX-ORDisk II, consists of a dual side-by-side diskette drive unit. Included with the drive is a controller module, a software package called MDOS (Motorla disc operating system), a cable assembly and support documentation. The controller module is bus-compatible with an EXORciser or a Micromodule-based system. Data recording format is compatible with the IBM 3740 format. Intended for tabletop use, or optionally, for rack-mounted installation, the drive units are available for either 110-V-ac, 60-Hz or 220-V-ac, 50-Hz operation. Random or sequential file organization is permissible with MDOS, as is multiple I/O file activity. Eighteen MDOS commands provide the user with a comprehensive means to rapidly develop or modify software. **CIRCLE NO. 368**

Bipolar PACE equivalent offers 30 extra commands

National Semiconductor, 2900 Semiconductor Dr., Santa Clara, CA 95051.
Bob Pecotich (408) 737-5000. \$831 (unit
qty); stock.

A single-board bipolar version of the PACE μ P has an expanded instruction set, from the original 45, to 75. Also included on the board are the minicomputer-like architecture of the PACE and some of the features of units like the Micro-Nova and Nova 1200. The 8.5 x 11-in. board, designated the IPS-16C/100, has a 220-ns cycle time and an average instruction execution interval of 1 ns. On the board are a 16-bit address bus and a separate 16-bit bidirectional data bus. Among the new instructions added to the Super-PACE are double word/double precision, multiply, divide, block transfers and memory search. Interface signals, jump condition input signals and control flag output signals are also provided. And, for easier peripheral control, a five-level priority vectored interrupt structure with enable and disable features has also been added. The CPU board comes supported by memory and peripheral boards as well as software and programming aids. **CIRCLE NO. 369**

Number 1 doubles the floppy.

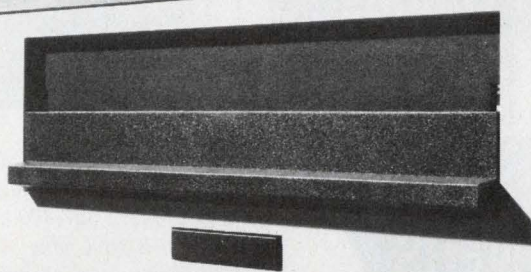
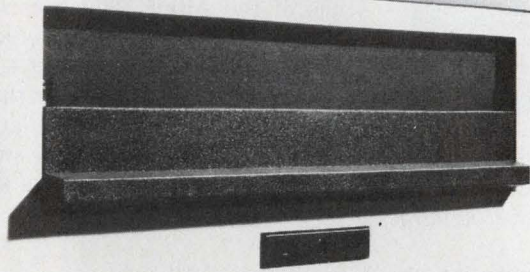

Doubled data storage capacity. Doubled access speed. Doubled floppy media selection. Get it all with the new Shugart double-sided single/double density floppy disk drive. All this for only 25% more than a single-sided floppy.

Data. Data. The new SA850 double-sided floppy packs twice as much data as a standard unit—up to 1600 Kbytes (unformatted). Yet the SA850 is identical in physical interface, mechanical outline and package size to the industry-standard—our SA800/801. It's plug-compatible, cabinet-compatible.

Faster. Faster. Access time is more than twice as fast. The SA850 moves from track-to-track in 3 milliseconds, with an average access time of less than 100 milliseconds. The secret is a proprietary Fasflex™ actuator that delivers positive, low-friction head movement.

Media. Media. One drive reads and writes them all. Single or double density. Single or double-sided disks. Industry standard diskettes and IBM Diskette 2, too.

Features. Features. The head carriage assembly allows loading of the two read/write heads simultaneously on both sides of the disk. (No more head load pads!) Plus this head can be replaced without an alignment disk, scope, or special tool—and it's totally self-aligning.

Lower heat dissipation and better PCB packaging promise even better reliability. A new I/O controlled programmable door lock strengthens data security.

And there's more, more. So before you look at another floppy, see the SA850 twice. See it in our brochure. Then watch it perform in a demonstration with your own system.

The SA850. The doubled floppy from number 1.

Corporate Headquarters –
415 Oakmead Pkwy. Sunnyvale, CA 94086

Phone (408) 733-0100
Eastern Region Sales/Service –
Phone (617) 890-0808

Western Region Sales/Service –
Phone (408) 252-6860

Europe Sales/Service –
3, Place Gustave Eiffel, Silic 311
94588 Rungis, France Phone (1) 686-00-85

™Fasflex is a Shugart Trademark

Number 1 in low cost disk storage.

 **Shugart Associates**

CIRCLE NUMBER 78

ALONE AGAIN

in low cost 1-watt
Zener Diodes

SCHAUER

"Z" SERIES ZENERS

DO-41 epoxy
molded case

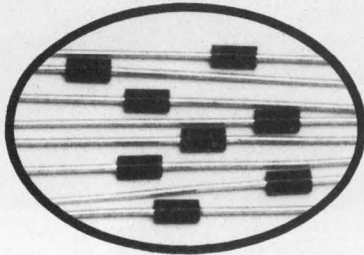

ANY VOLTAGE

2.6 to 34.0

ANY TOLERANCE

1% 2% 5% 10%

At Any Test Current

Compare These Prices

On 1% Tolerance Diodes

Quantity	Price each
1-99	91¢
100-499	83¢
500-999	77¢
1000 up	73¢

**LARGE STOCK
GOOD DELIVERIES**

Send for complete rating data
and other tolerance prices.

Semiconductor Division

SCHAUER

MANUFACTURING CORP.

4511 Alpine Ave., Cincinnati, OH 45242
Telephone 513-791-3030 Telex 21-4576

CIRCLE NUMBER 79

MICRO/MINI COMPUTING

Compact tape transport writes at 32 kbits/s

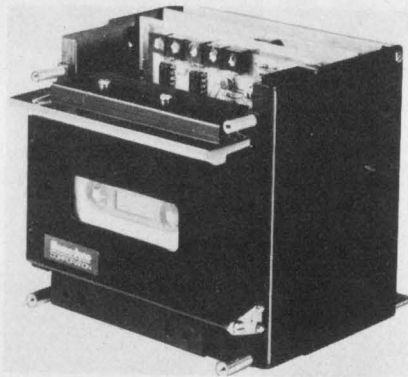

Memodyne Corp., 385 Elliot St., Newton Upper Falls, MA 02164. Kevin Corbett (617) 527-6600. Under \$500 (large qty); 2 to 4 wks.

Using a reel driven transport, the Model 764 digital cassette recorder moves the tape at constant speed. The 764 consists of the transport to which is attached a card cage containing a servo control card and a read-while-write electronics card. Measuring only 4.75 x 5 x 5.2 in., the entire package weighs less than 3 lb. Up to 32 kbits/s can be written or read, searches can be done in either direction at 100 ips, and the start-stop-settle time is 200 ms. The drive has only two moving parts and a soft-error rate of 1 in 10⁷. Up to 5 x 10⁶ bits can be stored on a standard Philips cassette.

CIRCLE NO. 370

PROM/RAM board holds 1 k RAM & 2 k of PROM

Vector Graphic, 717 Lakefield Rd., Suite F, Westlake Village, CA 91361. Carole Ely (805) 497-0733. See text.

Able to hold 1024 bytes of RAM and 2048 bytes of PROM, the PROM/RAM board is compatible with microcomputers using the Altair bus structure. The PROM sockets are laid out for 1702A memories, which can be used to hold monitors, bootstrap loaders and video drivers. A jump-on-reset feature permits a PROM program to be executed at any location in memory without interfering with any other portion of memory. The board has its own regulators, and has optional firmware available for use with Altair, Imsai or Polymorphic I/O boards. Available from stock, the PROM/RAM board costs start at \$89 as a kit without the PROMs and goes to \$199, maximum (assembled), including PROMs.

CIRCLE NO. 371

Auto-load board replaces Altair front panel

RMQ Systems, 1044 University Ave., Berkeley, CA 94710. Pete Roberts (415) 845-5300. From \$165 (kit); stock.

An auto-load board, compatible with Altair 8800 systems, eliminates the keying in of bootstrap programs and the need to reset sense switches. The board, called the Power-Start, fits in one of the Altair 100-pin card slots. Once set it can automatically load the computer from disc, cassette, paper tape, or any other devices. On the board are switches that simulate the computer's front panel sense switches.

CIRCLE NO. 372

16-bit microcomputer permits 16 Mb/s DMA

National Semiconductor, 2900 Semiconductor Dr., Santa Clara, CA 95051. Bob Pecotich (408) 737-5000. From \$825; stock.

The IMP-16L, a 16-bit microcomputer, has a high-speed asynchronous bus and data controller that allow DMA data transfers at rates to 16 Mb/s. Fully assembled, the microcomputer includes an IMP-16 CPU board with DMA control, 4 k x 16 bits of RAM (expandable to 64 k), a standard TTY interface module and complete program control panel. Optional cards provide interfaces for a Centronics 306 printer, a Documation 300 card reader and a National IMP-16/805 PROM programmer card. The microcomputer has 60 general-purpose instructions which include single-word commands such as multiply, divide, double precision add, double-precision subtract and many bit or byte oriented instructions. With a 1.4-μs microcycle time, the IMP-16L has typical register-to-register addition times of 8.4 μs. A DMA transfer requires 1.05 μs. Software support includes CPU, memory and peripheral diagnostic routines; software Debug, resident assembler; IMP-16 to Pace or SC/MP cross assemblers; absolute and linking loaders; and an IMP/Fortran cross assembler. The 12 x 17 x 24-in. unit has 12 slots for CPU, memory and interface cards and requires 105 to 125 V at 60 Hz. For expansion, additional six-slot card cages may be installed.

CIRCLE NO. 373

The Facit 4555 Page Printer.

Fewer moving parts are a moving argument.

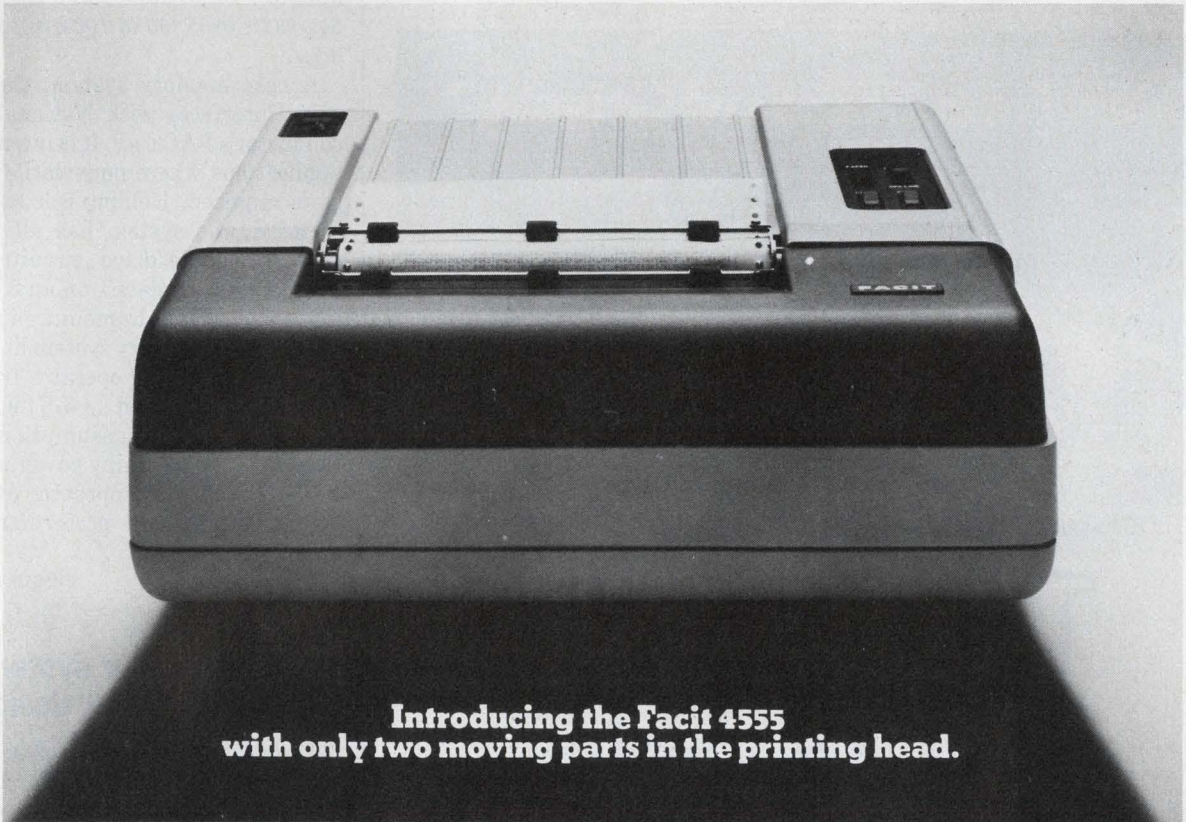

**Introducing the Facit 4555
with only two moving parts in the printing head.**

The rationale: fewer parts moving around means fewer parts wearing out.

But we didn't stop there.

We also gave considerable thought as to how well our page printer should produce a print-out.

So, unlike most page printers, our 4555 uses a character by character (asynchronous) print-out and an automatic ribbon

control to give you big, easy-to-read characters at 6 or 60 characters per second.

And whether you need one, two or even three copies, your print-out will always come out crystal clear.

Our 4555 is even less trouble to hook up than most page printers. That's because we give you several interface versions. Among them are: The Facit SPI interface for bit parallel data transfer, and the EIA, RS 232C.

All things considered, the Facit 4555 page printer is one of those rare instances where less for your money is really more for your money.

Facit-OEM Division,
66 Field Point Road,
Greenwich, Connecticut
06830.

 **FACIT**
Dedicated to Efficiency

See us at the N.C.C. Show in Dallas, Booths 1670-72-74.

CIRCLE NUMBER 80

Upgrade SC/MP systems with SC/MP-II μ P

National Semiconductor, 2900 Semiconductor Dr., Santa Clara, CA 95051. Hashmukh Patel (408) 737-5000. \$18.50 (unit qty.); stock.

A retrofit kit for owners of the PMOS SC/MP kit permits an upgrade to the NMOS SC/MP II. The NMOS processor requires only a +5-V supply, and operates at twice the speed. Power dissipation is just 200 mW and because of the +5-V operation, the SC/MP-II can be easily interfaced to other logic families. The retrofit kit includes the SC/MP-II CPU, a 2-MHz crystal, a users manual, an applications handbook and a SC/MP-II data sheet.

CIRCLE NO. 374

Core memory board mates with PACE μ P system

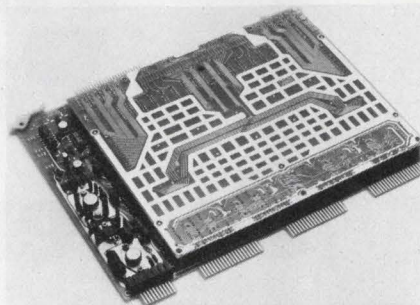

Electronic Memories & Magnetics, 12621 Chadron Ave., Hawthorne, CA 90250. Lawrence Treglia (213) 644-9881. \$895 (50 to 100 qty); 45 to 60 days.

A core memory system, the Micro 3800, interfaces with National Semiconductor's PACE μ P. It is intended for applications where nonvolatile memory is required. Holding 8 k \times 16 bits of RAM, the system has all timing, control, decode/drive circuitry, and address/data registers on an 8.5 \times 11-in. card designed to mount on 0.75-in. centers. The memory system has a 400-ns access time, and operates from unregulated ± 15 and +5-V supplies. Worst-case power consumption is less than 40 W, and standby power is under 10 W. The memory operates over 0 to 50 C without any performance degradation.

CIRCLE NO. 375



P/rel ^{TM.}

the programmable rotary encoded logic switch everyone will be talking about...

... because no other rotary switch has as much versatility with as low a cost as Standard Grigsby's P/rel switch!

The economy is twofold. This switch not only lends itself to full automation, but installed costs are lower by the use of our printed circuit terminals (solder terminals are also available).

A specially processed printed circuit disc is fully

programmable to the truth table of any code. We provide 100% program disc inspection to customer specifications. Up to 60 detent positions are available with our new double ball Dual Flex detent. And, the use of concentric shafts allows up to 120 detent positions from a single switch!

Everyone will be talking about P/rel . . . so will you!

Send for your free "Yes" button and literature.



standard grigsby, inc.

920 Rathbone Avenue, Aurora, Illinois 60507. Phone (312) 844-4300

CIRCLE NUMBER 81

Microcomputer system permits modular design

Omnibyte Corp., 900 Jorie Blvd., Suite 192, Oak Brook, IL 60521. (312) 986-1401. From \$80 to \$595 for cards, \$5500 for full system; stock.

Available either as individual cards or housed in a system crate, the Omnibyte series of microcomputer products are based around the 6800 microprocessor. The system crate has 16 card slots and requires an external supply. Cards for the system include the CPU card, the crate controller card, a ROM/RAM card, a PIA card, an ACIA card and a breadboard card. Soon to come are a 16-channel data-acquisition card, a PROM programmer card (for 2708 or 2704 PROMs), an 8-k RAM card and a quad 8-bit d/a converter card. Also available is a dual floppy-disc subsystem and Omnibug—a TTY monitor routine. All cards measure 4.5 \times 6.5 in. and the crate size is 5.2 \times 10.27 \times 8.58 in.

CIRCLE NO. 376

Opening new frontiers with electro optics

PMT with big new "teacup" dynode gives scintillation counters better PHR.

We expect quite a tempest over this teacup. It's a radically different RCA approach to large-diameter PMT's: The teacup is a large, cup-shaped first dynode that is an improvement over conventional venetian-blind types. It has better spatial uniformity and better off-axis uniformity. As a result, PHR (Pulse Height Resolution) is improved by 0.3% for Cs^{137} [NaI (TI)] and 0.7% for Co^{57} [NaI (TI)].

RCA 4900 is the first in a whole new family of 2" to 5" circular and hexagonal face PMT's with teacup first dynodes. It has a 3" diameter, 10 stages, and "blue" cathode responsivity of $10 \mu\text{A}/\text{blue lm}$ minimum, $10.5 \mu\text{A}/\text{blue lm}$ typical. Available with voltage divider network.

High performance in exacting applications

Besides scintillation counting, the teacup PMT can also be useful in gamma ray spectroscopy

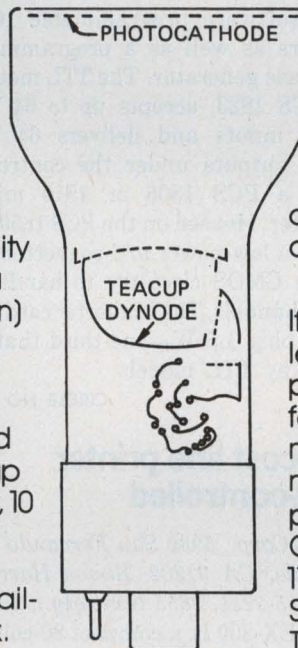

for medical applications. Several leading manufacturers of medical diagnostic equipment recently conducted their own tests on these gamma-camera type tubes, and pronounced them a giant step forward in improving camera performance.

If electro optics can solve your problem, remember: EO and RCA are practically synonymous. No one offers a broader product spectrum. Or more success in meeting special needs. Call on us for design help or product information. RCA Electro Optics, Lancaster, Pennsylvania 17604. Telephone 717-397-7661. Sunbury-on-Thames, Middlesex TW16 7HW, England; Ste.-Anne-de-Bellevue, Quebec, Canada; Belo Horizonte, Brazil; Hong Kong.

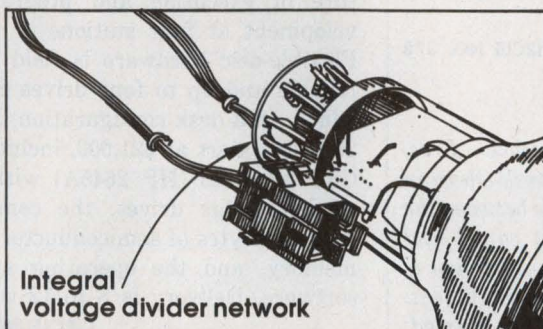
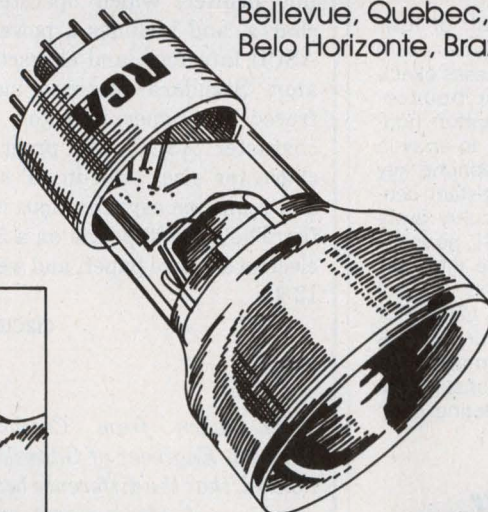

RCA

Grayhill coded output switch modules stack up!

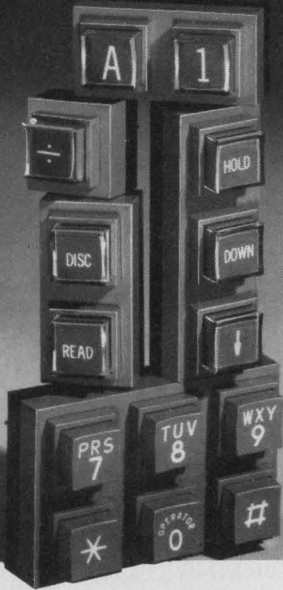

**new performance
standards...
1,500,000 cycles
with less than
10 milliseconds bounce**

- Self-generated logic...7 wire coding capability
- Can be stacked in any array
- Telephone array will provide standard frequency selection

This "second generation" of low-profile Grayhill pc mountable push-button switch modules passes exacting test for life and for bounce. Choose 6-, 3-, 2- and 1-button horizontal or vertical modules, to array in any format, including telephone key set, while maintaining constant center-to-center spacing! Circuitry available as SPST through 4 PST, normally open, or the poles can be internally shorted so several terminals connect when button is actuated. Choice of colors, with hot stamped or molded-in legends. For more information on these Series 82 modules, consult EEM or ask Grayhill for engineering data.



561 Hillgrove Avenue • LaGrange, Illinois 60525
(312) 354-1040

CIRCLE NUMBER 83

MICRO/MINI COMPUTING

Interface cards simplify connections

Process Computer Systems, 5467 Hill 23 Dr., Flint, MI 48507. Gary Johnson (313) 767-8920. From \$285; stock.

A line of I/O modules has been developed to simplify interfaces for the 180 microcomputer series. The PCS 1804 ac/dc card accepts up to eight ac inputs and eight high-level digital inputs. It provides optical isolation and delivers eight ac outputs and eight high-level digital outputs. Up to 32 digital inputs are accepted and 16 digital outputs controlled by either a PCS 1806 or 1810 microcomputer are delivered by the PCS 1820 multi-function card. It also accepts up to eight priority-interrupt inputs and has three software programmable 16-bit counters as well as a programmable time-base generator. The TTL module, the PCS 1823, accepts up to 64 TTL digital inputs and delivers 64 TTL digital outputs under the control of either a PCS 1806 or 1810 microcomputer. Housed on the PCS 1850 a/d card is a low-power a/d converter and enough CMOS circuitry to handle 16 input channels. The converter card consumes only 1.5 W—one-third that required by TTL models.

CIRCLE NO. 377

Low-cost line printer is μ P-controlled

Axiom Corp., 5932 San Fernando Rd., Glendale, CA 91202. Simon Harrison (213) 245-9244. \$655 (unit qty.); 4 wks.

The EX-800 is a compact 80-column line printer, which operates at 160 char/s, and includes a power supply, ASCII interface, and character generator. Standard features include infrared low-paper detector, bell, 96-character ASCII set, programmable character size, built-in μ P self-tester and multiline asynchronous input buffer. The EX-800 prints on a 5-in. wide electrosensitive paper, and weighs only 12 lb.

CIRCLE NO. 378

Filler

We learn from Czeslaw Frac, Diploma Engineer of Gdansk-Oliwa in Poland, that the difference between the one-humped (dromedary) camel and the two-humped (Bactrian) version is simply a matter of coupling coefficient. The former is undercritically coupled.

6502 resident assembler package comes in 2 ROMs

Microcomputer Associates, 2589 Scott Blvd., Santa Clara CA 95050. Darrell Crow (408) 247-8940. \$200 (ROM), \$295 (PROM); 30 days.

Stored in two 2 k \times 8 ROMs, the SW101 RAP resident assembler program and a tiny Basic interpretive program are both designed to run on the 6502 μ P. Formerly contained in seven 1702A PROMs, the SW200 RAP is claimed to be the only single-pass resident 6502 assembler available. Statements are entered either from paper tape or directly from a terminal keyboard. RAP generates a listing and places object code into RAM for immediate execution. A minimum of 4 k \times 8 RAM is needed. Following assembly the programs can be debugged using the debugging facilities of DEMON, the company's DE-bug MONitor program, housed in the 1 k ROM section of an optional ROM/RAM-I/O-interval timer circuit.

CIRCLE NO. 379

Mini with resident OS handles up to 608 kbytes

Hewlett-Packard, 1501 Page Mill Rd., Palo Alto, CA 94304. (415) 493-1501. See text.

With a new operating system resident in main memory, rather than disc, the HP/1000 Model 20 is compatible with the disc systems but has a starting price of \$20,000 instead of \$35,000. RTE-M, the operating system for Model 20, uses calls and file structure identical with those of RTE-II and RTE-III, the disc-based systems used in larger models. The Model 20 is available with main semiconductor memory up to 608 kbytes and can support concurrent program execution and program development on four terminals or more. With the addition of the flexible disc, the system will handle any mixture of execution and program-development at four stations or more. Flexible-disc hardware is field retrofittable and up to four drives can be added. In a desk configuration, Model 20 prices start at \$21,000, including a CRT terminal (HP 2645A) with two mini-cartridge drives, the computer with 64 kbytes of semiconductor main memory, and the operating system software. Delivery is 8 to 12 weeks.

CIRCLE NO. 380

Same great name. Same great color.

And now a neat new way to definitive display performance.

DOT MATRIX

Consider the new Noritake-Ise dot-matrix line-up—
9, 10, 16, 20 and 40-character line displays.
Variety aimed at giving you more design potential.
Or consider our unique 400-dot graphics display
with 17m/m depth and low 35V drive rating.
It's aimed at helping you think low voltage,
portability and economy all at the same time.

In short, consider Noritake-Ise period
for dot matrix (or segmental) displays.
Itrons always help you design more competitively.

itron®



DC209A2

Dimension: 41(H) × 208(W) × 10.5(D)mm Character Size: 9.0(H) × 6.3(W)mm

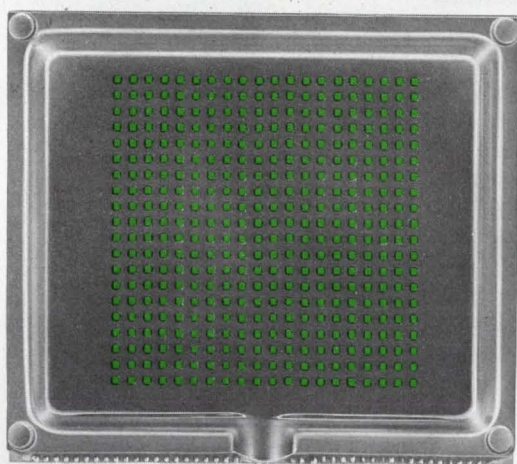

FG400DA1

Dimension: 114(H) × 130(W) × 17(D)mm

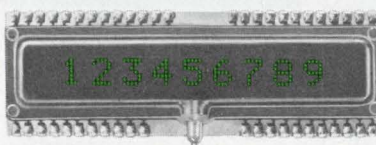

DC95A2

Dimension:
24(H) × 75(W) × 7.2(D)mm
Character Size:
5.05(H) × 3.55(W)mm



FG48D6

Dimension:
25.5(H) × 56.5(W) × 7(D)mm
Character Size:
8.0(H) × 4.2(W)mm

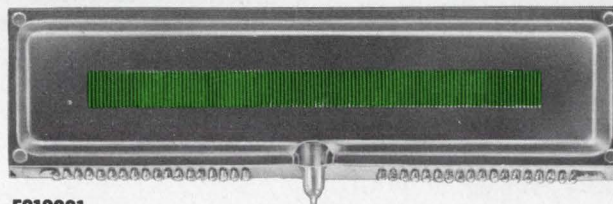

FG120S1

Dimension: 39(H) × 138(W) × 12.5(D)mm



FG209M2

Dimension: 41(H) × 208(W) × 10.5(D)mm Character Size: 9.0(H) × 5.4(W)mm

NORITAKE CO., LTD.

Electronics Division
1-1, Noritake-Shinmachi, Nishi-ku,
Nagoya-Shi, Japan
Phone: NAGOYA (052) 561-7111
Telex: J59738 NORITAKE

Electronics Office (U.S.A.)
22410 Hawthorne Blvd.
Torrance California 90505, U.S.A.
Phone: (213) 373-6704
Telex: 230674910

F.R. Germany
NEUMULLER GmbH 8 Muenchen 2.
Karlstrasse 55, F.R. Germany
Phone: 592-421
Telex: 522106

U.K.
ITT Component Service
Refuge House, River Front,
Enfield, Middx, England
Phone: 01-363 7459
Telex: 21637

Hong Kong
Room 1403 Shing Loon Bldg.
24-26 Stanley Street, Hong Kong
Phone: 5-232420 Telex: HX83151
Taipei
72-9 SEC 2, JEN AI RD., Taipei
Phone: 351-0293 Telex: 11176

Manufacturer:
ISE ELECTRONICS CORP.
P.O. Box 46, Ise-shi,
Mie-Pref., Japan
Phone: (05963) 5-2121 to 4
Telex: 4969523

Fiber-optic data link bridges up to 2 km

Meret, Inc., 1815 24th St., Santa Monica, CA 90404. (213) 828-7496.

By combining a high-performance infrared LED with a low-noise receiver, the MDL4577-SF transmitter/receiver communicates digital data over 2 km. The receiver uses a transimpedance amplifier and a voltage comparator for TTL-compatible output, and the transmitter can be driven with a pulsed signal of 0.8/2.5 V. Frequency range is dc to 20 MHz, rise and fall time 15 ns. Connectors are designed for coupling to single fibers.

CIRCLE NO. 381

Coax terminations jacked up to mm-range

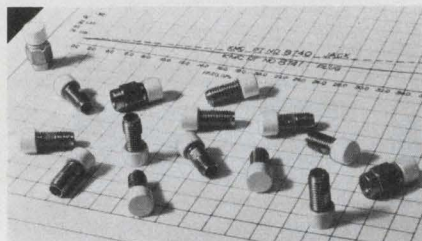

Kevin Manufacturing Co., 26 Conn St., Woburn, MA 01801. Ernest Lattanzi (617) 935-4800. \$59 (1-9); stock.

Dc-to-40-GHz subminiature terminations incorporating a new SMA connector design are available in both jack (Model 8740) and plug (Model 8741) configurations. The loads handle 0.1 W; VSWR ranges from 1.05 at 1 GHz to 1.28 (jack) or 1.25 (plug) at 40 GHz.

CIRCLE NO. 382

Gunn oscillators relay fast computer talk

Narda Microwave Corp., Plainview, NY 11803. J. P. Schindler (516) 433-9000.

A low-noise Gunn oscillator for use in high data-rate communication systems is mechanically tunable from 10.7 to 11.7 GHz, with 1-GHz bandwidth. A built-in varactor permits fine-tuning and frequency modulation. Power output is typically 50 mW, and tuning sensitivity 2 to 4 MHz/V.

CIRCLE NO. 383

Low-pass filter hides inside UT-250 coax

Uniform Tubes, Inc., Collegetown, PA 19426. (215) 539-0700.

Low-pass filters packaged inside semi-rigid coaxial cables have several advantages: The monolithically sealed filters are more reliable, and four connectors can be eliminated. In the VT-250A, the cutoff of the 15-section Chebyshev filter is 2 GHz, with a rejection at 2.7 GHz of 60 dB, a VSWR of 1.5, and 0.01-dB ripple.

CIRCLE NO. 384

Small monitor sounds off at low radiation



Cicoil Corp., 70945 Plummer St., Chatsworth, CA 91311. (213) 882-2021. \$34.95; 4 wks.

If you work around microwave power sources, the Micro Guard 100 radiation detector offers inexpensive protection. It senses radiation in the 0.5-to-13-GHz range. The trigger level is normally set to 2 mW/cm², but Cicoil will adjust it from 0.5 to 10 mW/cm². When activated, the 4-oz detector sounds a loud 1300-Hz tone. The Model 100 runs 500 h with a 9-V transistor battery, and is no larger than a pack of cigarettes.

CIRCLE NO. 385

Quiet isolator has low loss

Aercom Industries, Inc., 405 Tasman Dr., Sunnyvale, CA 94086. James E. Mitchell (408) 736-7600. \$145 (1-4 qty.); 4 wks.

Low-loss isolators for applications in the 3.7 to 4.2-GHz range provide a matched load for input to low-noise amplifiers, while adding only slightly to the noise level. Typical specs include 23-dB isolation, 0.15-dB loss, and a VSWR of 1.15:1. Operating temperature range is -30 C to +75 C, and size is 1 × 1 × 0.5 in.

CIRCLE NO. 386

Flat Gunn VCOs work up to 40 GHz

Alpha Industries Inc., 20 Sylvan Rd., Woburn, MA 01801. (617) 935-5150.

With a flat 100-mW ±0.5-dB output over a 100-MHz bandwidth, varactor-tuned oscillators in the TRG A9500 series provide relatively high power around 35 GHz. The rugged Gunn-effect devices are available for frequencies from 26.5 to 40 GHz, with a tuning rate of 8 MHz/V, and a temperature range of -10 to 55 C.

CIRCLE NO. 387

Dual-quad mixers come in small packages

Watkins-Johnson Co., 3333 Hillview Ave., Palo Alto, CA 94304. W. A. Green (415) 493-4141. \$155 and \$199.

Dual-quad, eight-diode, high-level mixers, Models WJ-M1P and M5R, cover frequencies of 40 MUz to 4.5 GHz. They can be used as up or down-converters. They feature high intercept points, a 0.005-to-3-GHz flat i-f response, and good two-tone performance. The M1P is housed in an SMA connector package, while the M5R comes in a 3-pin PC package.

CIRCLE NO. 388

Hybrid mixer loses little in translation

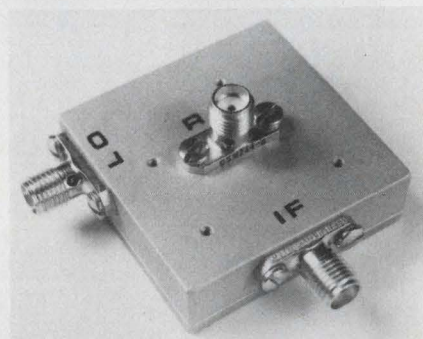

SED Systems Ltd., P.O. Box 1464, Saskatoon, Sask., Canada S7K 3P7. (306) 244-3633.

Series-72525 single-balanced, 90° hybrid mixers are optimized for low conversion loss. Five models cover 3.7 to 15.35 GHz. Conversion loss at 30 MHz i-f is 6-dB max, and local oscillator isolation is 6-dB min at 7-mW drive. While the 3-dB i-f bandwidth normally covers dc to 150 MHz, options go up to 1 GHz.

CIRCLE NO. 389

now there is one... in signal processing

IF and Microwave Components From One Source.

At Merrimac we have over 750 standard catalog items from DC to 18GHz with lumped elements, stripline or ferrites. If these standard units don't meet your requirements we pride ourselves in designing and producing custom or special components. . . in fact specials are over 50% of our business.

Additionally, we can design and manufacture Sub-Systems and Integrated Packages of active and passive IF, RF and Microwave components within an IF Processing Chain, Microwave sub-system or the combination of both. NOW THERE IS ONE IN SIGNAL PROCESSING. . . MERRIMAC with over 750 standard units, Custom components and Sub-system capability.

SPORTS ILLUSTRATIONS SUITABLE FOR FRAMING.



Football, Basketball, Soccer and Hockey,
Two Color reproductions FREE on request.

CIRCLE NUMBER 85

AUDIO, VHF AND UHF IN-PHASE, REACTIVE LUMPED ELEMENT POWER DIVIDERS/ COMBINERS

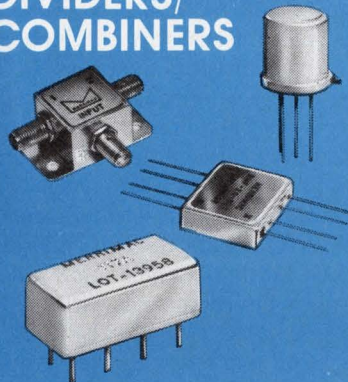

50 kHz to 2 GHz

The winning combination is 83 different standard catalog 2, 3, 4, 6, 8, 12 and 16 way Power Dividers in TO-5, FLAT PACK, RELAY HEADER, LOW PROFILE PC PLUG-IN, SMA, BNC, TNC AND "N" CONNECTOR PACKAGES. Newest models feature ultra-broadband, multi-decade frequency ranges within the range of 50 kHz to over 1 GHz, at low costs.

Following are 4 standard low cost, ultra broadband, 2-way Dividers which demonstrate Merrimac's variety of different packages available off the shelf.

Frequency range (all models) 5 (or 10) to 500 MHz

PACKAGE	MODEL NO.	PRICE	ISOLATION dB	PHASE BALANCE
TO-5 (0.3" high)	P-110	\$12.00	25 TYP. 20 MIN.	2°
RELAY HEADER	113-C	\$ 9.00	30TYP. 25 MIN.	1° TYP. 2° MAX.
FLAT PACK	PDF-2A-250	\$17.00	30TYP. 25 MIN.	1°
WITH SMA CONNECTORS	PDM-20-250	\$35.00	30 MIN.	1°

For complete detailed specifications on the above 4 models as well as our other 79 standard IF power dividers:

**Send for our
NEW '77 CATALOG
OF IF SIGNAL PROCESSING
COMPONENTS.**

CIRCLE NUMBER 86

MICROWAVE IN-PHASE, STRIPLINE BINARY POWER DIVIDERS/ COMBINERS

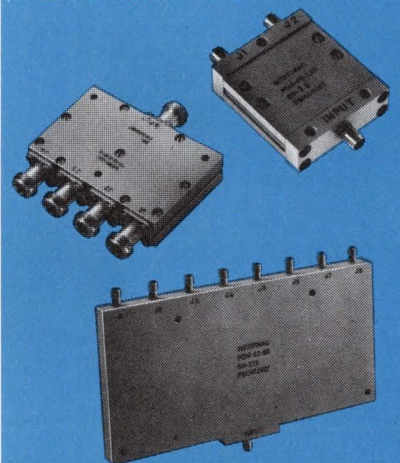

.5 to 18.0 GHz

The winning combination is 58 different standard catalog 2, 4, and 8 way Power Dividers with SMA and TYPE N, in octave, multi-octave and straddle bands from 500 MHz to 18 GHz with in-line and angled output configurations.

Following are 4 standard models which are typical of the other 54 standard items: prices from \$85.00 for 2-ways to \$265.00 for 8-ways.

MODEL No.	POWER DIVISION	FREQUENCY RANGE (GHz)	ISOLATION dB(MIN)	INSERTION LOSS dB(MAX)
PDM-22-75G	2:1	.50-1.0	20	.30
PDM-42-3.95GA	4:1	3.7-4.2	18	.50
PDM-82-6GA	8:1	4.0-8.0	17	1.0
PDM-22-15G	2:1	12.4-18	14	1.0

For complete detailed specifications on the above 4 models as well as our other 54 Standard Microwave Power Dividers:

**Send for our
NEW '77 MICROWAVE
CATALOG**

CIRCLE NUMBER 87

now there is one...in signal processing

EXPORT REPRESENTATIVES DAGE CORP.
STAMFORD, CONNECTICUT 06902
(203) 324-3123 TWX 710-474-2490 Telex: 96-5928

Merrimac
INDUSTRIES, INCORPORATED
POST OFFICE BOX 986, 41 FAIRFIELD PL., W. CALDWELL, N.J. 07006
• 201 575-1300 • TWX 710-734-4314

"VISIT US AT MCA REPCO BOOTH #53 AT THE MTT SAN DIEGO SHOW".

FINALLY.

A State-of-the-Art Tool For Learning Software Design.

And at an affordable price. The Modu-Learn™ home study course from Logical Services. You read about it starting in ED #1 this year.

Now you can learn microcomputer programming in ten comprehensible lessons. At home. In your own time. At your own pace.

You learn to solve complex problems by breaking them down into easily programmed modules. Prepared by professional design engineers, the Modu-Learn™ course presents systematic software design techniques, structured program design, and practical examples from real 8080A micro-computer applications. All in a modular sequence of 10 lessons ... more than 500 pages, bound into one practical notebook for easy reference.

You get diverse examples, problems, and solutions. With thorough background material on micro-computer architecture, hardware/software trade-offs, and useful reference tables. All for only \$49.95

For \$49.95 you learn design techniques that make software work for you. Modu-Learn™ starts with the basics. Our problem-solution approach enables you to "graduate" as a programmer.

Please send the Modu-Learn™ course for me to examine. Enclosed is \$49.95 (plus \$2.00 postage and handling) or my Mastercharge/BankAmericard authorization.

Name: _____
 Address: _____
 City: _____ State: _____ Zip: _____
 Card # _____
 Expiration date: _____
 Signature: _____

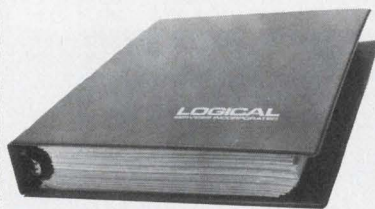

711 Stierlin Road
 Mountain View, CA. 54043
 (415) 965-8365

LOGICAL

SERVICES INCORPORATED

CIRCLE NUMBER 88

MOS ROM stores 32 kbits and accesses in 450 ns

Texas Instruments, P.O. Box 5012, Dallas, TX 75222. (214) 238-2011. \$20 (1000-up).

Designated the TMS 4732, a 32,768-bit MOS ROM organized as 4096 words × 8 bits, is available in a 24-pin DIP. The fully static ROM has a maximum access time of 450 ns, a maximum cycle time of 450 ns and a typical power dissipation of 450 mW. All inputs can be driven directly by series 74 TTL circuits, each output can drive two series 74 TTL circuits and all data outputs are three-state for OR-tying of multiple devices to a common bus. Two programmable chip select controls are provided for data readout and system decode flexibility. The TMS 4732 is upwards pin-compatible with the TMS 4700 ROM, the TMS 2708 EPROM, and the 8316B and operates over 0 to 70 C.

CIRCLE NO. 390

IR sensor and emitter made for audio & control

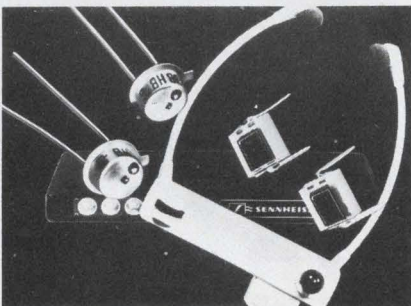

AEG Telefunken, Englewood Cliffs, NJ 07632. Manfred Duebner (201) 568-8570. 1000 qty. prices: \$0.50 (emitter), \$1.95 (detector); 6 to 8 wks.

An infrared emitter and detection pair, the CQY-99 and BPW-34, respectively, are designed for audio and control applications. The CQY-99 IR emitter delivers 14 mW/steradian at a wavelength of 925 nm and has a total radiated power of 15 mW. It requires 100 mA of forward current and dissipates 210 mW in its T-1-3/4 plastic or T0-18 metal package. The BPW-34 p-i-n photodiode detector has a sensitivity of 85 nA/lux up to a maximum of 85 μA of output current. Its open circuit output voltage is 400 mV and the dark current is 30 nA. The detector is housed in a 2-pin clear plastic DIP-like case and has a 120° light angle.

CIRCLE NO. 391

FET power drivers handle loads of up to 2 A

Siliconix, 2201 Laurelwood Rd., Santa Clara, CA 95054. Jim Graham (408) 246-8000. From \$3.06 (100 qty); stock.

The S55V01/S75V01 and S55V02/S75V02 series of power peripheral driver transistors offer 12 models to choose from. They provide continuous current ratings up to 2 A, standoff voltages to 90 V and power dissipation ratings of 4 or 25 W in both military and commercial temperature ranges. All S55V/S75V drivers are directly compatible with CMOS. A VMOS input has megohms of impedance and requires only nanoamperes of input current. CMOS fanouts to over 100 drivers are possible. Maximum propagation delays with CMOS inputs are 10 ns for both turn-on and turn-off. With TTL inputs, typical propagation delays are 8 ns for turn-on and 5 ns for turn-off. The S55V01, 11 and 12 handle 2 A, have breakdown voltages of 60, 35 and 90 V, and come in T0-3 packages capable of handling 25 W. The S55V02, 21 and 22 handle 1.5 A, have the same breakdown ratings and are available in T0-39 packages for 4-W applications. All S55V devices operate over -55 to +125 C. The S75V series provides the same six parts specified for 0 to 70-C operation.

CIRCLE NO. 392

Single-chip a/d converts signals to 2-1/2 digits

National Semiconductor, 2900 Semiconductor Dr., Santa Clara, CA 95051. Dennis Dauenhauer (408) 737-5000. From \$9.85 (100-up); stock.

Known as the DM8700, the single-chip a/d converter forms a 2-1/2-digit panel meter when connected to a LED display. The converter includes autopolarity, overrange indication, a temperature-compensated reference, an internal clock, and digit-select and current-controlled segment drivers for a LED display. Requiring +5 and -15-V supplies the converter needs 1 s for each conversion. Input impedance is 500 kΩ and conversion accuracy is 1%. The DM8700 is specified for operation over a 0-to-70-C range and comes in a 24-pin epoxy or ceramic DIP.

CIRCLE NO. 393

LOW NOISE MODULAR DESIGN

Switching Power Supplies!

A new line of compact, modular-design switchers that simplify design for 300-600 watt applications and sell for less than 90¢ per watt! End users benefit from low EMI noise levels and highly reliable operation plus easy add-on and maintenance features. Get everything you need to know to evaluate this high quality, money-saving line from:

Jim Daly
phone (612) 830-5800
TWX 910 576 2978
or write: 7801
Computer Ave. So.
Minneapolis, MN 55435.

**GD CONTROL DATA
CORPORATION**

CIRCLE NUMBER 89

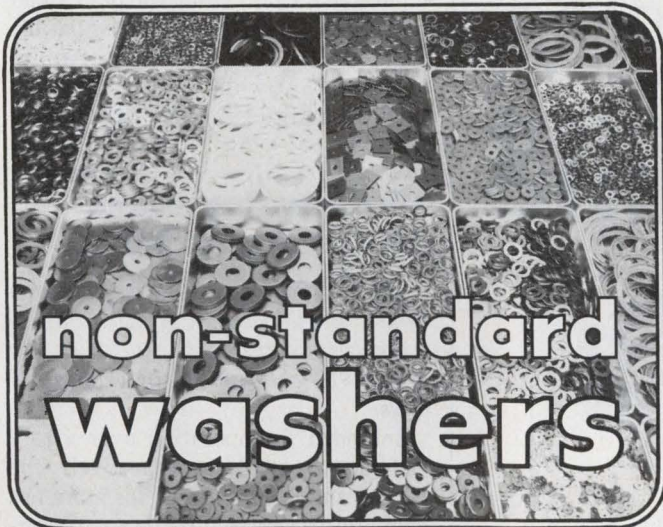
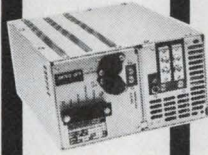
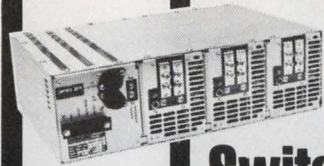

non-standard washers

Our NEW CATALOG lists 3000 non-standard washers and spacers. Circle the number of this ad for your free copy.

SIZE RANGE:

OD: .086" to 1.935"

ID: .027" to 1.637"

Thickness: .005" to .125"

Available without die charge from any stampable material. Metal washers are tumble deburred.

For your convenience our complete catalog is now reprinted in ThoMcat. Look under Boker's in Volume 9.

BOKER'S, INC.

Stamping Specialists since 1919.

3104 Snelling Avenue South, Minneapolis, Minn. 55406

CIRCLE NUMBER 90

ELECTRONIC DESIGN 12, June 7, 1977

The M-600 amp works harder at 2.5 ohms

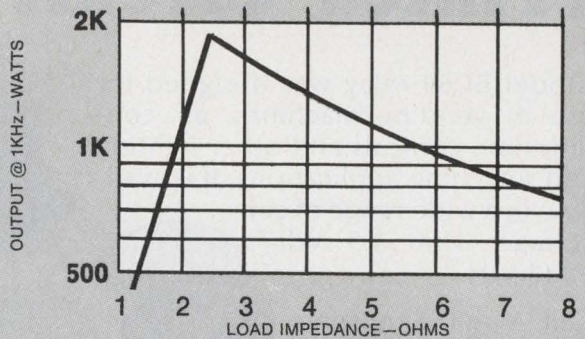

So each watt costs less

You get more watts per dollar from the Crown M-600 power amp if your circuit design lets it look at a 2.5Ω load.

The M-600 provides power from DC to 20KHz with complete protection against shorts, open circuits, mismatch, RF burnout and thermal overload. The M-600 will even drive a purely reactive load without overheating. Designed for continuous operation at full rated power, at any rated frequency.

One M-600 will cost you \$1,795. A copy of the spec sheet is free. Write today.

We'd also like to hear from you if you have any special amplification problems in the DC-20KHz range. We've already solved some tough, unique problems. We'd like to consider yours.



**CROWN
INDUSTRIAL**

1718 W. Mishawaka Road, Elkhart, Indiana 46514

219 / 294-5571

CIRCLE NUMBER 91

LOW COST... UL approved, 6 amp, SPDT, Printed Circuit Relay

Model BC69 relay was designed for use in vending machines, air conditioning controls and other lighting and switching applications. It is available in a wide range of coil voltage from 1.5 Vdc to 48 Vdc.

Call Virgil Simpson, Mike Altman or write for a data sheet and free samples.

Available from stock at Hamilton-Avnet.



The way to say Quality Relay... BABCOCK Military/Aerospace/Commercial

BABCOCK RELAYS

E **ESTERLINE ELECTRONICS**
AN ESTERLINE COMPANY
3501 Harbor Blvd., Costa Mesa, California 92626
(714) 540-1234 TWX 910-595-1517

CIRCLE NUMBER 92

HOOK-UP WIRE WIRE STRIPPERS

Carpenters Swing Blade wire strippers were designed expressly for clean and quick end stripping of all types of solid and stranded wire construction. Will not disturb lay of stranded wire... a common problem with other stripping methods.

FREE WIRE STRIPPING SERVICE

All we require is a 3-5 ft. sample of your wire and strip specifications. Your sample will be returned to you stripped, together with a complete report as to unusual characteristics of the wire and recommendations as to what equipment will best serve in stripping that particular wire.

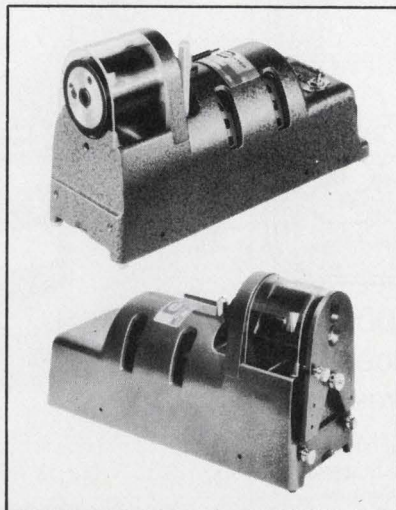

CARPENTER MFG. CO., INC.
Fairgrounds Drive, Manlius, N.Y. 13104
Phone 315/682-9176

CIRCLE NUMBER 93

ICs & SEMICONDUCTORS

4-k dynamic RAMs access as fast as 100 ns

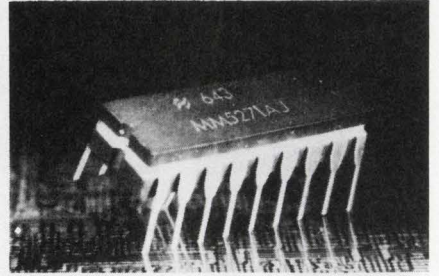

National Semiconductor, 2900 Semiconductor Dr., Santa Clara, CA 95051. Ron Livingston (408) 737-5000. \$15 (100 qty); stock.

An "A" version of the MM5270, MM5271, MM5280 and MM5281, 4-k dynamic RAMs offers access time selections down to 100 ns. The MM5270A and MM5280A have a cycle time of only 210 ns. The A versions offer a two-to-one speed-power improvement over the original MM5270, 71, 80 and 81s. The 5270A is an 18-pin device that uses a high-level chip enable and has a Trishare common I/O port. The 5280A uses the same clock level, but has 22 pins and a separate input and output, while the 5271A and 5281A both have the TTL-compatible chip enable. All 18-pin devices require +12 and -5 V, while the 22-pin devices need an additional +5-V supply.

CIRCLE NO. 394

Microwave transistors operate at up to 6 GHz

California Eastern Labs, One Edwards Court, Burlingame, CA 94010. Jerry Arden (415) 342-7744. 10 to 99 qty prices: \$17 (chip), \$54.50 (packaged); 30 days.

Intended for operation over 4 to 6 GHz or 0.5 to 3 GHz, respectively, the NE644 and 645 bipolar transistors use a unique process that reduces collector-to-base and parasitic capacitance to 50% of previously attainable values. The NE644 has a typical noise figure of 2.7 dB at 4 GHz, while the 645 has a 1.6-dB figure at 2 GHz and 7-mA bias. Typical power gain is 11 dB for the NE645 and drops to 9 dB for the 644. Both devices have a V_{CE0} of 12 V, an I_C of 40 mA, a P_T of 300 mW and an f_T of 8.5 GHz. Either transistor comes in chip form or in an 80-mil-square, hermetically sealed Kovar-ceramic package.

CIRCLE NO. 395

Photo-Darlington couplers provide CTRs of 1000%

Hewlett-Packard, 1501 Page Mill Rd., Palo Alto, CA 94304. Inquiries Manager (415) 493-1501. 1000-qty prices: \$1.50 (4N45); \$1.60 (4N46); stock.

The 4N45 and 4N46 photo-Darlington optocouplers offer a current transfer ratio of typically 1000%. Input current at a 350% CTR for the Model 4N46 can be as low as 0.5 mA and the output voltage can range from -0.5 to 20 V. The 4N45 has a minimum CTR of 250% at 1 mA of input current. Its output voltage spans -0.5 to 7 V. A gain-bandwidth adjustment pin allows an external resistor to be added to adjust gain bandwidth or input current threshold. Performance is guaranteed over a range of 0 to 70 C. Both models are housed in 6-pin mini-DIPs.

CIRCLE NO. 396

Rf power transistors span 100 to 500 MHz

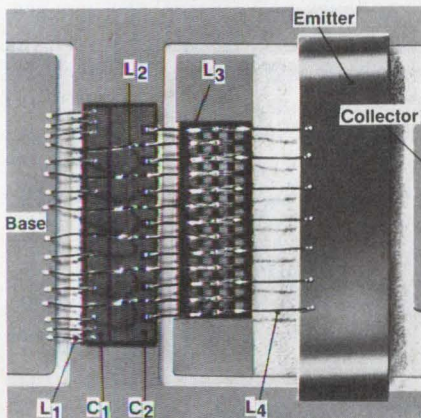

Motorola Semiconductor Products, P.O. Box 20912, Phoenix, AZ 85036. Lothar Stern (602) 244-6900. From \$8.95 to \$55 (100 qty.); stock.

Capable of delivering up to 80 W of rf, the MRF 321 series of transistors operate at frequencies from 100 to 500 MHz. The rf transistors are designed for class A, AB, B or C use in equipment operating from 12-to-28-V supplies. Units in the series include the MRF 321, 323, 325, 326 and 327 and have outputs of 10, 20, 30, 40 and 80 W, respectively, at 28 V and 400 MHz. Minimum gains at the same bias and frequency are 12, 10, 8.5, 8.5 and 7.3 dB, respectively. All transistors can withstand a 30:1 output load VSWR at rated power and load. The MRF 321 comes in a 0.205 SOE package, the 323 in a 0.28 SOE and the 325, 326 and 327 in 0.5 CQ cases.

CIRCLE NO. 397

Touch plate sensors scan six or eight channels

Plessey Semiconductors, 1674 McGaw Ave., Irvine, CA 92714. Dennis Chant (714) 540-9945. 100 qty. prices: \$4.89 (six channel); \$6.52 (eight channel); stock.

Four electronic switch circuits, designed to replace mechanical switches in tuners with touch plates, are available in two six or two eight-channel versions. The ICs can be driven directly from two-terminal touch plates and

provide direct neon drive; low impedance drive to tuning Varicaps; remote control stepping; sound muting during channel selection; and operation from 0 to +65 C. Of the two six channel models, the 24-pin ML236 is cascadable and has positive channel selection, while the 16-pin ML237 offers negative channel selection. The eight-channel ML238 and ML239 select channel 1 on power-up, with the 238 providing for positive channel selection, the ML239 for negative channel selection.

CIRCLE NO. 398



CTS matches crystal specs to your microprocessor.

And no waiting. CTS Industrial Distributors supply a perfectly matched crystal at the same time you buy the microprocessor, because CTS carefully checks the crystal requirements with each semiconductor manufacturer before writing crystal specs.

CTS now has a full line of standard crystals for microprocessors and clock IC's. CTS Knights crystals feature low start-up resistance, reliable CTS mil-approved manufacturing processes and gold and silver frequency calibration for long term stability. Available in 17 standard frequencies, 1.0 to 22.1184 MHz. Other frequencies available on special order.

CTS Knights crystals are available **off the shelf** at these typical 100-piece prices: from \$5.50 each (1.0 MHz) to \$2.75 each (18.432 MHz).

See your nearest CTS distributor for full information, or write **CTS Knights, Inc.**, 400 Reimann Ave., Sandwich, IL 60548, phone: (815) 786-8411.

CTS Knights.
The frequency specialists.

CTS CORPORATION
Elkhart, Indiana 

CIRCLE NUMBER 94

spill- proof power



for
every
stand-by
emer-
gency
need



Our batteries are truly Carefree. They won't spill, never require maintenance, built with dual covers and they're completely rechargeable. We've got practically all sizes, but if you need a unique configuration that isn't on our shelf, we can probably build it for you. Call us. We're prompt and we're Carefree.

EAGLE P ICHER
SINCE 1843

EAGLE-PICHER INDUSTRIES, INC.
Commercial Products Department ED
P.O. Box 130, Seneca, Mo. 64865
Telephone (417) 776-2258

CIRCLE NUMBER 95

ICs & SEMICONDUCTORS

Power transistors handle high voltage or current

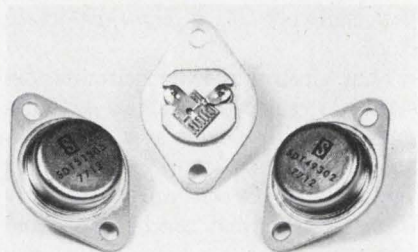

Solitron Devices, 1177 Blue Heron Blvd., Riviera Beach, FL 33404. (305) 848-4311. From \$3.25 (100 qty.); 4 to 6 wks.

Two families of homotaxial single-diffused npn power transistors, one designed for high voltage and one for high current linear applications are both available in TO-3 cases. The high voltage devices, the SDT 31303, 05, 07 have $V_{CE(sus)}$ ratings of 200, 250 and 300 V, h_{FE} of 10 to 50 at an I_C of 2 A, and V_{CE} sats of 0.5 V min at 2 A. The $I_{s/b}$ for the SDT 31303 at an I_C of 1.25 A, a V_{CE} of 200 V, and a pulse of 1 s is 250 W; $I_{s/b}$ for the SDT 31305 and 07 at an I_C of 1 A, a V_{CE} of 250 V, and a pulse of 1 s is also 250 W. The high current family consists of the SDT 49302 and 04. Typical specifications include $V_{CE(sus)}$ ranges of 50 and 70 V, and V_{CE} sats of 1.9 V at 60 A (SDT 49302) and 1.4 V at 40 A (SDT 49304). The $I_{s/b}$ for the SDT 49302 at an I_C of 6 A, a V_{CE} of 50 V and a pulse of 1 s is 300 W; and for the SDT 49304 at an I_C of 4.3 A, a V_{CE} of 70 V, and a pulse of 1 s, it is also 300 W.

CIRCLE NO. 399

Multiplying d/a settles in 85 ns, delivers 2 mA

Precision Monolithics, 1500 Space Park Dr., Santa Clara, CA 95050. Donn Soderquist (408) 246-9222. From \$2.95 (100 qty.); stock.

Capable of multiplying a two-digit BCD input with a reference in just 85 ns, d/a converters in the DAC-20 series have nonlinearities of 1/2 or 1/4 LSB. Models are available with guaranteed performance over 0 to 70 or -55 to 125 C and can deliver 2 mA, maximum. Housed in 16-pin DIPs, the multiplying converters have a compliance voltage swing of -10 to +18 V and can operate with ± 4.5 to ± 18 V supplies, dissipating 37 mW with ± 5 -V supplies.

CIRCLE NO. 404

Rectifier assemblies handle up to 100 A

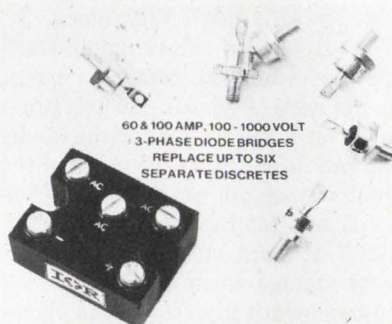

60 & 100 AMP, 100-1000 VOLT
3-PHASE DIODE BRIDGES
REPLACE UP TO SIX
SEPARATE DISCRETES

International Rectifier, 233 Kansas St., El Segundo, CA 90245. (213) 322-3331. From \$39 (100 qty); stock.

Designated 600HT for 60 A and 1000HT for 100 A, a series of molded bridge assemblies comes in molded packages with screw-on terminals that measure just 2.25 x 1.75 x 1.07 in. Units in each line are available for three-phase operation with peak reverse ratings of 100, 200, 300, 400, 600, 800 and 1000 V. Isolation between the base plate and terminals is 1500 V for units rated up to 600 V and 2000 V for units rated for 800 and 1000 V. All specified ratings are at full rated current and 150 C operating junction temperature. Maximum peak surge current is 500 A for 600HT models and 800 A for 1000HT units. Thermal resistance case-to-heat sink is 0.07 C/W.

CIRCLE NO. 406

CRT controller circuit provides any format

SMC Microsystems, 35 Marcus Blvd., Hauppauge, NY 11787. (516) 273-3100. \$32 (100 qty); stock.

Capable of providing programmable display formats, the CRT 5027 video-timer/controller circuit can drive interlaced and noninterlaced CRT monitors. Programming is done by loading seven 8-bit control registers from a bidirectional data bus. Display formats can be modified for the number of characters per row, rows per frame, scans per row, scans per frame, scrolling or nonscrolling, video cursor generation, vertical data positioning and synchronization—horizontal, vertical or composite. The NMOS circuit, housed in a 40-pin DIP, requires +5 and +12 V and operates over 0 to 70 C.

CIRCLE NO. 407

DIGITAL RECORDER

- Low cost, high reliability, compact
- One supply, 2 moving parts, excellent speed control
- Full electronics, TTL I/O, Auto-Sync® phase encode/decode
- Short IRG, 5.7 megabits, 8K Baud



Model CS-400A

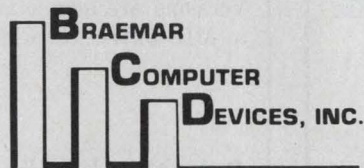

11950 TWELFTH AVENUE SOUTH
BURNSVILLE, MINNESOTA 55337
(612) 890-5135

CIRCLE NUMBER 96

PROM ERASER

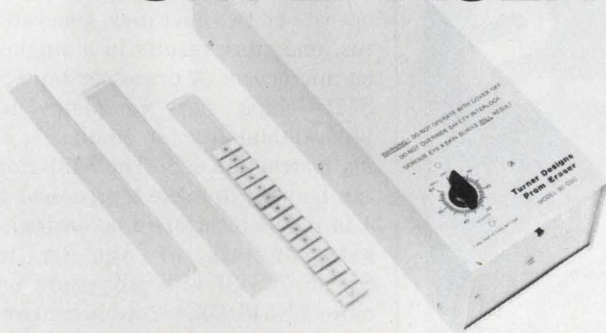

Designed specifically to deliver a calibrated dose of ultraviolet at the correct wavelength and intensity to assure long-term data retention. Tested by leading manufacturers of EPROMS, it meets data-sheet requirements of Intel, National, AMD, AMI, Mostek and others.

- SAFE - Operator protected against uv and ozone
- SMALL - 7 in. wide, front loading
- AUTOMATIC lamp start and timer
- CONVENIENT - Metal-tray loading
- FLEXIBLE - One to 60 PROMS per cycle
- AVAILABLE from current stock

Write or call for further data, or to order

TURNER
2247A Old Middlefield
Telephone



DESIGNS
Mountain View, CA 94043
415/965-9800

CIRCLE NUMBER 97

Design it for safety!

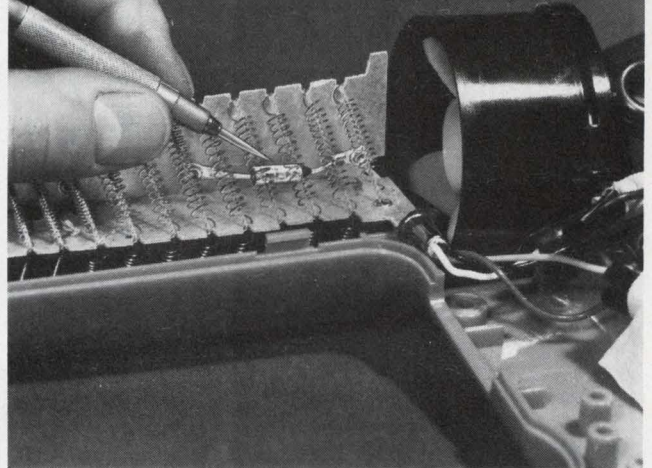

4000 Series MICROTEMP® Thermal cutoff in electric hair dryer

Guard your products and profits with MICROTEMP® thermal cutoffs

This hair dryer is protected by our 4000 Series MICROTEMP® thermal cutoff. Those who use this product, and those who make and sell it, are likewise protected by the precise, yet low-cost MICROTEMP®.

Millions of MICROTEMP® thermal cutoffs are now being used on hundreds of successful OEM applications. Write or call us for data and test samples.

If the hair dryer overheats, for any reason, the MICROTEMP® promptly cuts off the power. The fault must be corrected and the MICROTEMP® cutoff replaced before the appliance can be used again.

Accuracy of operation is within $\pm 3^\circ\text{F}$. You can choose from a wide range of cutoff temperatures (136 to 468°F), terminals and mounting packages to best meet your design/production requirements.

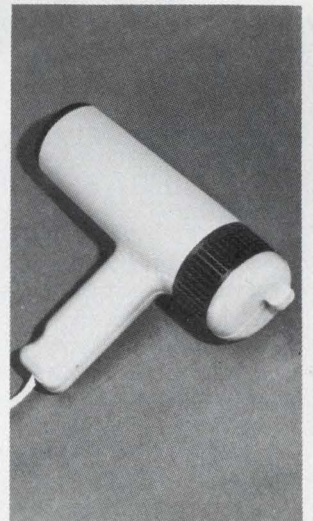

MICRO DEVICES



DIVISION OF EMERSON ELECTRIC CO.
1881 SOUTHTOWN BLVD.
DAYTON OH 45439 513-294-0581

CIRCLE NUMBER 98

MAGNETICALLY SHIELDED TAPE DATA PRESERVERS

Protect your magnetic tapes from degradation and physical damage. Designed for storage, shipment and hand carrying. A wide choice of models and capacities available for standard reels, discs, disk packs, flexible disks and standard cassettes. Immediate shipment from stock.



MAGNETIC SHIELD DIV.



PERFECTION MICA CO.
740 North Thomas Drive
Bensenville, Ill. 60106, USA
Phone 312 / 766-7800
TWX 910-256-4815

SEND FOR NEW
TP-5 CATALOG

CIRCLE NUMBER 99

CRITICAL CRYSTALS

come from M-tron

M-Tron specializes in providing quality crystals and design assistance with maximum economy. Complete facilities for production of AT Cut crystals for commercial and military applications from 800 KHz to 200 MHz. Computer-aided design program speeds sample delivery for all types of precision, industrial and commercial applications.

Phone 800-843-6842 or write

M-tron INDUSTRIES, INC.

Box 630, Yankton, South Dakota 57078 A Div. of Lynch Corp.

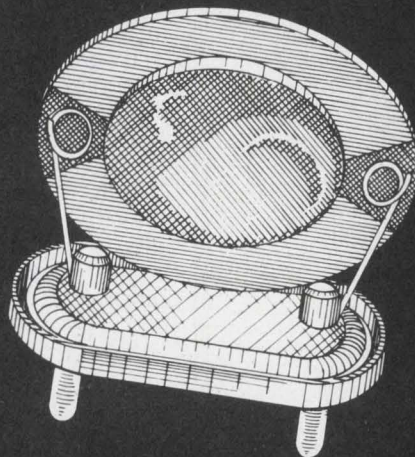

CIRCLE NUMBER 100

ICs & SEMICONDUCTORS

Complete d/a converters deliver 10 bits & sign

Precision Monolithics, 1500 Space Park Dr., Santa Clara, CA 95050. Donn Soderquist (408) 246-9222. From \$15 (100 qty); stock.

The DAC-05, a monolithic 10-bit plus sign d/a converter, comes complete with voltage output and internal reference. Settling in 1.5 μ s, there are two voltage-output versions, a ± 10 -V and ± 5 -V model. Housed in 18-pin hermetic DIPs, the converters come with a monotonicity specification of 8, 9 or 10 bits over 0 to 70 or -55 to 125 C. Versions are also available processed to MIL-STD-883A Class B.

CIRCLE NO. 408

Schottky bit slices cycle in just 100 ns

Texas Instruments, P. O. Box 5012, Dallas, TX 75222. (214) 238-2011. From \$2.25 to \$29.25 (100 qty); stock.

The S481 chip set is a series of Schottky TTL microprogrammable building blocks that provide up to 10 times the throughput of conventional microprocessors. Available in both commercial and military temperature ranges, the S481 chip set can select and operate on two operands, generate status, and store results in a single 100-ns microcycle. A processor built from S481 chips has complete microprogrammability for emulating existing instruction sets. The S481 chip set can be used to make a processor from 4 to $n \times 4$ bit system as desired. The set consists of one or more SN54S/74S481 4-bit processors, one or more SN54S/74S482 4-bit controllers, an appropriate number of either the SN54S/74S330 or 331 field programmable logic arrays, and various PROMs, RAMs and logic circuits. Able to recognize, decode and execute any of 24,780 instructions within a single 100-ns clock cycle, the S481 slice has hardwired algorithms for automatically sequenced iterative, signed or unsigned multiplies and divides, as well as for cyclical redundancy character calculations. The S482 control element combines a full adder, four-word push-pop stack, source select multiplexer and address register.

CIRCLE NO. 409

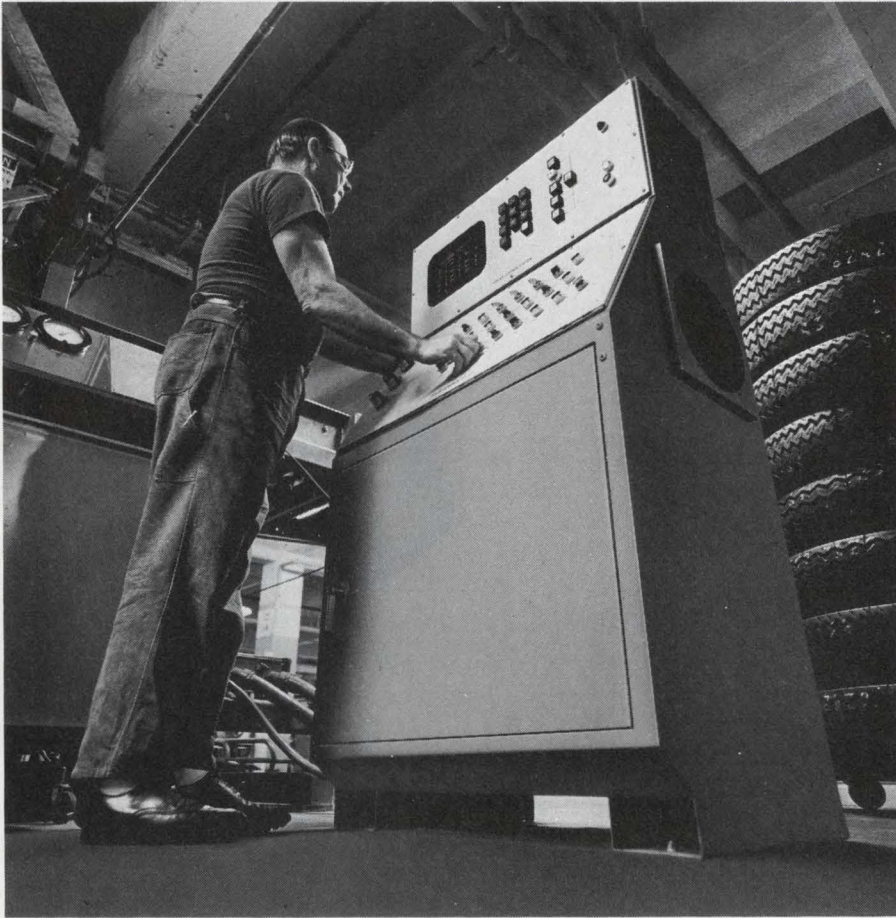

There's a Hoffman enclosure for almost every electronic application you can think of.

Case in point: our consoles. They're designed to rigidly controlled parameters, so they can meet your exacting specifications. They answer your requirements for electronic enclosure applications in dust-filled industrial environments, including process-control computers.

They're components of a 1700-product Hoffman line, including free-standing enclosures, consoles, instrument boxes, and new electronic rack enclosures, in an extensive array of materials and sizes.

There is a Hoffman enclosure for almost every electronic application you can think of. All you need to do is think of us. Check with your local Hoffman distributor, or write directly for detailed specifications. Then see how well Hoffman quality will perform for you.

For complete data write:
HOFFMAN ENGINEERING COMPANY
 Division of Federal Cartridge Corporation
 DEPT. ED652, ANOKA MN 55303

Hoffman[®]
 ELECTRICAL ENCLOSURES

CIRCLE NUMBER 101

AUTHOR'S GUIDE

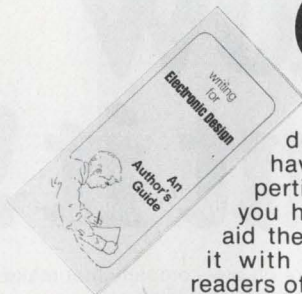

If you've solved a tricky design problem, if you have developed special expertise in a specific area, if you have information that will aid the design process... share it with your fellow engineer-readers of *Electronic Design*.

Articles you have authored not only raise your own professional status, but help build your company image as well. The readers benefit, your company benefits.

To help you prepare material that meets *Electronic Design's* high editorial standards, our editors have prepared a special author's guide entitled "Writing for Electronic Design." It covers criteria for acceptability, form, length, writing tips, illustrations, and payment for articles published. It's available without cost.

It's easy to write for *Electronic Design*, but it's often hard to get started. Send for your copy of our Author's Guide today.

Circle No.
250

The Protector Selector

This guide tells you what protectors to choose to guard against overvoltage, overcurrent, undervoltage, or even some completely external condition (such as high or low tank level or pressure) that could damage your equipment or your process.

It's a little introduction to the world of circuit protection in which Heinemann is No. 1. A copy awaits your request. Heinemann Electric Company, Brunswick Pike, Trenton, NJ 08602.

HEINEMANN
 Protection that adds value.

* Heinemann

6518

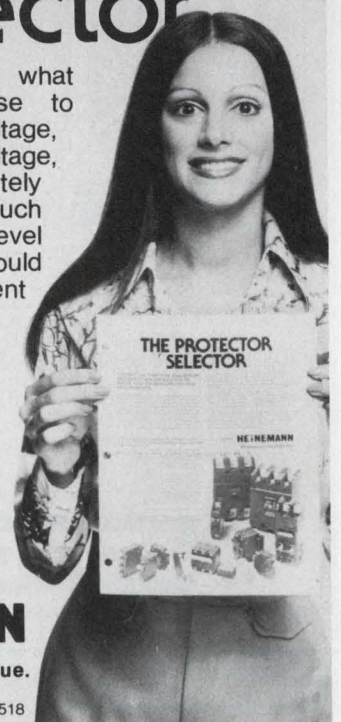

CIRCLE NUMBER 102

JFD *where it's at!*

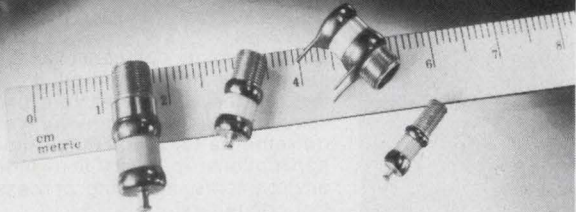

MVM®/AIR VARIABLE CAPACITORS

JFD air variable capacitors are specially designed for high frequency applications that demand extreme stability, small size and high Q—greater than 5000 measured at 10 pf and 100 MHz. These rugged, miniature units are offered in both printed circuit and panel mounting models in capacitance ranges of 0.35-3.5 pf; 0.4-6 pf; 0.8-10 pf; and 1-20 pf measured at 1 MHz. These units which measure less than 1/2" in length are completely interchangeable with competitive devices.

JFD where the miniature precision capacitor began . . . and where it's at!

JFD ELECTRONICS COMPONENTS CORPORATION

15th Avenue at 62nd Street, Brooklyn, N. Y. 11219
212-331-1000 TWX 710-584-2462

CIRCLE NUMBER 105

Join the IMC Book Club*



Free 24 page catalog contains facts on IMC's Off-The-Shelf precision cooling devices.

This airmover catalog is devoted to technical information and illustrations on the full line of Tubaxial Fans, Propeller Fans and Centrifugal Blowers. IMC Boxer®, Fulmar®, Condor® and IMCair® airmovers are featured.

For immediate service please call Fred Taylor, Sales Manager-603/332-5300

*Product Literature Broadside and request card will be sent to you along with this catalog

SERVING INDUSTRY OVER 25 YEARS



IMC MAGNETICS CORP.

NEW HAMPSHIRE DIVISION
ROUTE 16B, ROCHESTER, NEW HAMPSHIRE 03867

CIRCLE NUMBER 106

have a gripe?



let us know about it!

We'll help you put pressure on any company that makes promises in its ads . . . then fails to deliver.

Electronic Design refuses to run advertisements deemed to be misleading or fraudulent.

ACCURACY is everybody's business. So if you have a gripe about a misstatement or inaccuracy in either editorial or advertising material in *Electronic Design* . . . tell us about it. We'll do everything we can to find out what happened and see that it's corrected. Notify . . .

George Rostky

Editor-in-Chief

Electronic Design

50 Essex Street
Rochelle Park, New Jersey 07662

ICs & SEMICONDUCTORS

Tuning diodes offer a 4:1 tuning range

MSI Electronics, 34-32 57 St., Woodside, NY 11377. A. Lederman (212) 672-6500. \$10 (100 qty); 2 wks.

With reverse capacitances of 200 pF at a 1-V bias, the HA1850A varactor diode provides a tuning ratio of 4:1. The reverse capacitance drops to 50 pF at a 28 V bias. At 1 V, the Q is greater than 200 and increases with bias voltage. Rated for a 30-V breakdown, the diode comes in a DO-7 glass case.

CIRCLE NO. 410

Power transistors handle 40 A at up to 180 V



NPN Silicon Power Transistors 2N6046, 2N6047, 2N6048 and SSDI Type 1748

For Switching, Amplifier and Regulator Applications
40 Amperes Peak Collector Current
Gain Rated at 20 and 30 Amperes
Dimensions in Inches (And Millimeters)

Solid State Devices, 14830 Valley View Ave., La Mirada, CA 90638. Arnold Applebaum (213) 921-9660. From \$25 to \$40 (100 qty.); stock.

The 2N6046, 6047, 6048 and 1748 npn power transistors offer peak collector currents of 40 A. Their V_{CE0} 's are 60, 100, 140 and 180 V, respectively. Maximum dissipation is 200 W at 25 C and the collector-emitter and base-emitter saturation voltages are 2 V. The transistors have maximum rise and fall times of 600 and 350 ns, respectively, and a typical gain bandwidth of 40 MHz. All units come in TO-63 cases and have a linear power derating of 1.13 W/°C above 25 C.

CIRCLE NO. 411

Power transistor handles up to 2 A at 80 V

General Transistor Corp., 12591 Crenshaw Blvd., Hawthorne, CA 90250. (213) 679-9721. \$0.95 (1000 qty); stock.

Able to handle 2 A of collector current, the GT 200 npn transistor can dissipate up to 12 W. The transistor, housed in a TO-220AB case has a typical f_T of 150 MHz at a V_{CE} of 5 V and an I_C of 500 mA. Reverse collector-emitter voltage is 80 V, as is the reverse collector base voltage. The minimum h_{FE} is 30 at a V_{CE} of 5 V and an I_C of 1 A.

CIRCLE NO. 412

HOW DO YOU GET ANALOG SIGNALS INTO YOUR COMPUTER?

Using the new RAMP/Scanner, you can connect any combination of thermocouples, voltage signals or current transmitter signals directly to the input panel. Use two sets of twisted pair wires to tie the RAMP/Scanner into your computer's standard 20 ma current-loop or RS232 port. You'll now have two-way communication between the RAMP/Scanner and your computer in ASCII code. What could be simpler?

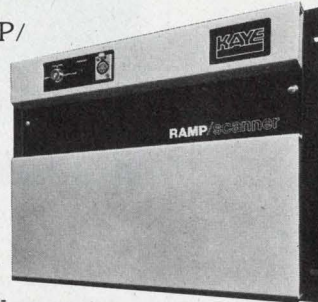

The new RAMP/Scanner features a solid-state scanning breakthrough, providing common mode voltage capability in excess of 250Vrms continuous or 600V peak • an auto-ranging dual-slope integrating DVM for high noise rejection • selectable

serial transmission rates from 150 to 19,200 baud — and more!

Write or call Newell Tillman at (617) 275-0300.



15 DeAngelo Drive, Bedford, Massachusetts 01730

CIRCLE NUMBER 108

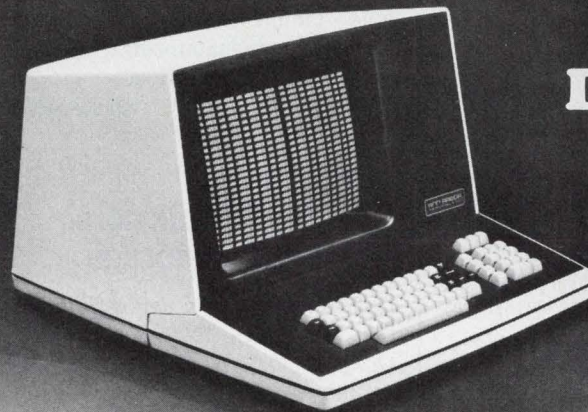

Data Display: YOUR Way

Ann Arbor makes over 1000 standard RO and KSR display terminal models. Alphanumeric. Graphics. Or both.

We also thrive on tough CRT display applications. Unique character sets. Unusual graphics. Difficult interfacing. Custom keyboards. Special packaging. You name it.

Standard or custom, every terminal produced is based on a field-proven Ann Arbor engineering concept. DESIGN III desktop terminals to complement any office decor. Compact, rugged Series 200 modular terminals that defy industrial environments. Or barebones board sets for OEMs who prefer to roll their own.

Many companies sell CRT terminals. But Ann Arbor sells creative solutions to CRT display problems, as well.

Probably at lower cost than anyone else in the business.

Contact us at 6107 Jackson Road, Ann Arbor, MI 48103. Tel: 313-769-0926 or TWX: 810-223-6033. Or see our catalog in EEM, Volume One.

ANN ARBOR
TERMINALS, INC

... creating new ways to communicate

CIRCLE NUMBER 109

Miniature BITE Indicators Qualified to Mil-I-83287

BUILT-IN TEST
EQUIPMENT



Widest selection of Bite Indicators. Select from QPL listings to MIL-I-83287/1, /2, /3 or /4. Units provide reliable fault detection or circuit condition indication with minimal power drain (low as 50 milliwatts). All models display positive color contrast with excellent visibility under extreme environmental conditions, temperatures -65°C to $+125^{\circ}\text{C}$ and vibration to 2,000 Hz 20G. Units are available to operate at 1.5, 3, 5, 6, 12, or 28 volts, with manual or electrical reset as desired. Typical applications include high performance aircraft, computers, communications systems and ground test equipment.

Sudden Service on Small Quantities!

PROTOTYPES

available on phone or letterhead request

MINELCO

A  TALLEY INDUSTRIES COMPANY

135 South Main St., Thomaston, Conn. 06787
Phone 203-283-8261

...from **Minelco**

CIRCLE NUMBER 110

DATA PROCESSING

Large-screen CRT display gives fine resolution

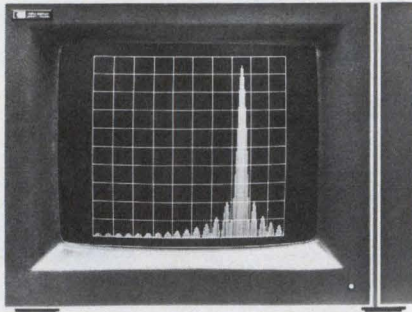

Hewlett-Packard, 1501 Page Mill Rd., Palo Alto, CA 94304. (415) 493-1501. \$2400; 8-12 wks.

A 20 x 25-cm (nearly 8 x 10 in.) CRT display, Model 1304A, provides the high resolution needed to display 2000 alphanumeric characters in normal room lighting. The electrostatic tube has a spot size of 0.5 mm. A system power consumption of only 60 W enhances reliability. Dynamic focus keeps the spot sharp at all intensity levels. X and Y-axis amplifiers of the 1304A have a settling time of less than 300 ns, and the linear writing speed is better than 25 cm/ μs . Z-axis rise time is less than 25 ns, cw bandwidth more than 5 MHz. A range of options tailors the display to special situations. Available mounting hardware includes standard rack-mountings, slide, and slide-and tilt mountings.

CIRCLE NO. 413

Stationary 'bulk core' mimics disc storage

Dataram Corp., Princeton-Hightstown Rd., Cranbury, NJ 08512. John F. Gilligan (609) 799-0071. \$9700; 12 wks.

Bulk Core, introduced early last year, is now available with complete interfaces to emulate DEC and Data General fixed-head disc systems. The 15-3/4-in.-high rack-mountable chassis can hold up to eight 128-k word modules, for a maximum capacity of one megaword (two Mbytes). The Models BC-201 and BC-202 emulate DEC's RC-11/RS-64 and RF-11/RS-11, respectively, and the BC-301 mimics Data General's 4019 Controller and Novadisc. Access time for the μP -controlled units is 750 ns to 2.0 μs —5000 times faster than comparable fixed-head discs.

CIRCLE NO. 414

Rugged mini won't mind tortures

Electronic Memories and Magnetics, 20630 Plummer St., Chatsworth, CA 91311. (213) 998-9090. See text.

SECS-11I stands for Severe Environment Controller System-11, Industrial. The rugged minicomputer has been programmed to emulate all functions of the DEC PDP-11/34 or PDP-11/35. The SECS-11I consists of four multi-layer board logic modules, power supply, chassis and control panel. Additional board positions provide space for up to 128-k RAM semiconductor or core memory. The chassis can be completely sealed, providing protection against hostile atmospheres. Cards are rigidly mounted and supported to prevent damage from high-level vibration. Prices are slightly higher than for equivalent commercial units.

CIRCLE NO. 415

Modem doubles reach of data transmission

Gandalf Data Inc., 190 Shepard Ave., Wheeling, IL 60090. Alan Melkerson (312) 541-6060. \$1500 (unit qty.); 4-8 wks.

The LDM 404 transmits data up to 20 miles at a speed of 4800 bits/s over standard 3002 unconditioned data lines, twice the distance of its predecessor. While the 300 Series required "non-loaded" circuits which cannot always be readily prepared, the 400 Series uses the more easily obtainable "loaded" facility. This is especially valuable in larger cities where "nonloaded" circuits are at a premium.

CIRCLE NO. 416

Line printers get more competition

Centronics Data Computer Corp., Hudson, NH 03051. Chuck Clemente (603) 883-0111. From \$4050; October, 1977.

With the 6000 Series, Centronics enters the field of fully formed-character line printers, at prices up to 40% lower than comparable printers. The four models in the series provide speeds of 75, 150, 300, and 600 lines/min, and share 85% common parts. The use of μPs provides simple operator controls and increased flexibility. Each model accommodates 1 to 6-part forms (width 4 to 19 in.) and prints 132 char/line at six lines/in.

CIRCLE NO. 417



A new source for your custom hybrid needs.



Hydrelco is ready to turn your designs into quick reality. We can do big orders. We can do small ones. We can do complex multilayers. We can do trimmers. We can do assemblies. And we can do them all fast, at a price you'll like. Next time you have a hybrid question, call Hydrelco - we'll give you a high-quality answer!

HYDELCO INC.
Manufacturer of Hybrid Microcircuits

3481 Old Conejo Rd., Suite A-3, Newbury Park, Ca 91320 • (805) 498-3688

CIRCLE NUMBER 111

50 Million operations

With TTL loads, our new reed relay offers maximum contact resistance of 0.12 ohms, after more than 50 million operations. And a contact resistance delta



of 0.01 ohms, maximum. Sticking and missed operations are essentially eliminated.

Call or write for information on the RX-1.

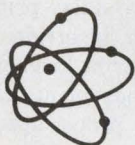

EAC Electronic Applications Company

4918 Santa Anita Ave., El Monte, CA 91734
213/442-3212 TWX 910/587-3351

CIRCLE NUMBER 112

ELECTRONIC DESIGN 12, June 7, 1977

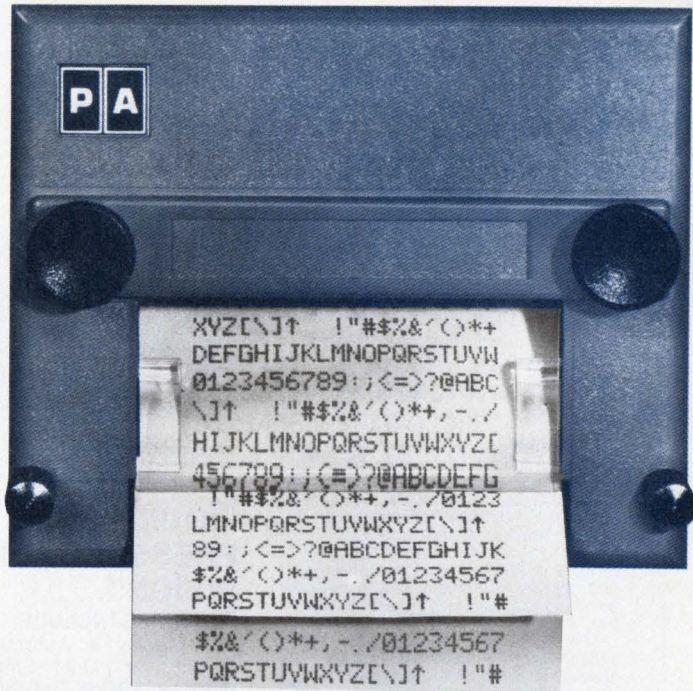

Name one other printer this small that prints multiple copies using standard paper

Don't even bother trying; only our DMPT-3 Miniature Alphanumeric Printer puts it all together like this. Granted, our 20-column workhorse is the industry's smallest alphanumeric impact printer. Granted, it packs the versatility of both "first line up" text and "first line down" print formats. Even so, that's just the beginning for the DMPT-3.

The truth is, you not only get multiple-copy capabilities, but you can use ordinary adding machine rolls instead of the special paper thermal printers require. You not only get a full alphanumeric capability, but enhanced characters and high 120 cps speeds as well. You'll graduate from messy ribbons to a drop-in ink platen with a 75,000-line life. And you can move up to microprocessor compatibility by putting our programmable control option between the DMPT-3 and the outside world. You get it all, but only in the DMPT-3.

For more details, call or write today.

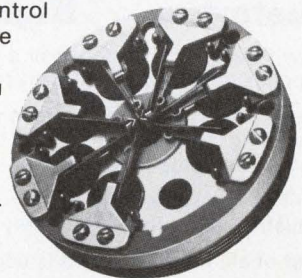

PRACTICAL AUTOMATION, INC.

Trap Falls Road
Shelton, Connecticut 06484
Tel.: (203) 929-5381

CIRCLE NUMBER 113

THIS PROCESS MONITOR MEETS YOUR EXACT NEEDS FOR \$145⁰⁰

IT'S THE UNIVERSAL RECEIVER FOR PROCESS TRANSMITTERS

These easy-to-install digital process monitors will change the way you think digital systems should perform. They substantially cut costs and can build a whole new flexibility into your process control or test system.

A full range of options include: true RMS; non-functional zero; suppression of negative polarity sign at zero; buffered isolated gated and stored parallel BCD output; linearized analog output; digital set point; orange LED display; extended range of 4999 or 5999 counts; zero offset and scaling for virtually any transducer input; and count by one, two, or five.

The Model 204 with 4000 counts sells for only \$145.00. The photo is shown with extended range and extra zero options.

At these prices you can't afford to miss getting all the facts.

For Immediate Response:

Call or write us and we'll provide a process monitor for your evaluation.



DISPLAYS YOUR DATA IN ENGINEERING UNITS

LIQUID LEVEL, PRESSURE, FLOW, WEIGHT...

FEATURES INCLUDE: 13mm (1/2 in.) LED Display • Automatic Zero and Polarity • Dual Slope, Average Value • 120dB CMR up to 500 V • V, I, and Ratio Measurements • Parallel BCD Output • Standard DIN Case

Newport Labs
630 East Young Street,
Santa Ana, California 92705
Phone (714) 540-4914
In Europe—Tele Amsterdam 20-452052

NEWPORT

CIRCLE NUMBER 114

MICROPROCESSOR POWER SUPPLIES

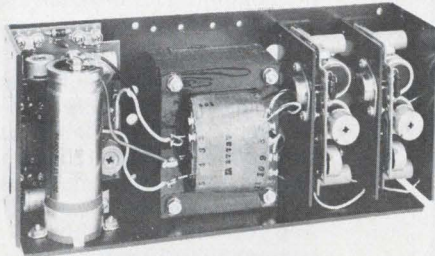

Featuring . . . High Reliability and Low Cost

Now Power/Mate introduces a series of triple output, open frame power supplies designed specifically for microprocessor users.

Based on a rugged, field proven design, the ETR series of microprocessor power supplies features Dual AC Input, remote sensing, adjustable current limiting and plug-in IC regulation throughout the line.

Built to the same rigid quality standards that have made Power/Mate the industry leader, they offer a very impressive 100,000 hour MTBF.

Best of all, the ETR series is economical and in stock. Call or write for our free brochure.

PMC

POWER/MATE CORP.

World's largest manufacturer of quality power supplies.

514 South River Street/Hackensack, N.J. 07601/Phone (201) 343-6294 TWX 710-990-5023

CIRCLE NUMBER 115

DATA PROCESSING

Quiet line printer churns out 33 ft/min

Houston Instrument, One Houston Square, Austin, TX 78753. Tom Hall (512) 837-2820. \$3450; 4 wks.

The nearly noiseless Model 8210 printer has 80 print columns (10 char/in.) and is capable of speeds up to 2400 lines/min at 6 lines/in. The interface signals allow easy connection to the Intel MDS System. A 132-column version is available at \$3785.

CIRCLE NO. 418

Quiet teleprinter has 50 built-in options

Siemens Corp., 186 Wood Ave. S., Iselin, NJ 08830. Martin Weitzner (201) 494-1000.

The T-1000 teleprinter uses MOS and LSI chips to achieve high typing speeds and reliable transmission at low noise levels. The lightweight printer uses a plastic disc, which carries the individual letters and symbols on 56 points. A special feature of the T-1000 is the "variant module" group which permits selection of more than 50 pre-programmed additional functions such as character feed suppression, special symbols, paper monitor, printout stop, etc. A built-in diagnostic unit aids in finding the source of defects.

CIRCLE NO. 419

Two-headed printer writes simultaneous translations

Qume Corp., 2323 Industrial Parkway, West Hayward, CA 94545. (415) 783-6100. \$2725 (unit qty); 90 days.

The Micro 3 TwinTrack character printer is useful in situations where two heads are better than one. For example, a word-processing system could print a simultaneous translation. The two-headed printer gives 192 on-line characters—twice the number available on a standard 96-character printwheel. Up to 75 char/s can be printed in parallel columns or as solid text. Also the use of two daisy printwheels eliminates hand insertion of special characters. One print head can type text while the other prints the required symbols in the proper space.

CIRCLE NO. 420

Colorful graphics brighten terminals

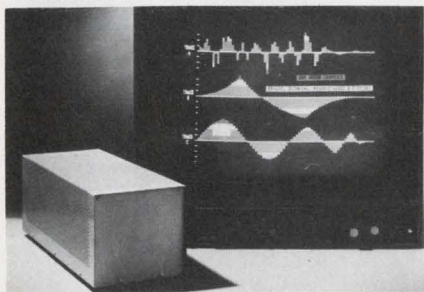

Ann Arbor Terminals, 6107 Jackson Rd., Ann Arbor, MI 48103. Sarah J. Freeman (313) 769-0926. \$1395; 12 wks.

The 2480 controller displays graphics symbols, 8 dots wide and from 0 to 10 TV-lines high, in any one of seven colors, plus blinking red on RGB-color monitors. It also displays in normal (white), bright or blinking bright on black-and-white monitors. The terminal displays 24 lines of ASCII alphanumeric, as well as the graphics symbols. The characters can be displayed as white, black or blinking on any one of seven background colors. RS232 interface is standard, as are baud rates from 110 to 9600.

CIRCLE NO. 421

Versatile terminal uses plasma display



Applications Group, Div. of Eprad, Inc., Box 4712, Toledo, OH 43620. A. H. Rotsinger (419) 243-8106.

The AG-60 graphics/alphanumeric terminal offers three character sets (5 × 7, 7 × 9, and user-programmable 8 × 16), two graphics sets (incremental and vector) and alphanumeric cursor. Other functional capabilities may be added. The AG-60's 12-in. diagonal plasma panel has a 512 × 512 dot matrix that presents a clear, bright display, free from flicker, jitter and distortion. Input devices include two keyboards, touch panel or sonic pen.

CIRCLE NO. 422

Low-cost disc drive packs up to 70 Mbytes



Kennedy Co., 540 W. Woodbury Rd., Altadena, CA 91001. Russell Bartholomew (213) 798-0953. From \$2500; 12 wks.

Fixed-cartridge, moving-head disc drives store up to 70 Mbytes of data at rates of 1 Mbyte/s—25 to 50% more than similar units. The Series 5300 drives have unformatted capacities ranging from 14 Mbytes in the single-disc version to 70 Mbytes in the three-disc model. MFM recording technique is used for high-speed, and maximum frame definition. Power supply and all electronics are included in a single, easily serviced assembly. Standard power requirements are 120 V at 60 Hz, with 230 V at 50 Hz optional.

CIRCLE NO. 423

THICK FILM RESISTOR

CUSTOM DIP NETWORKS

Our computer controlled laser has solved thousands of custom designed dip and sip networks ... use it to solve yours!

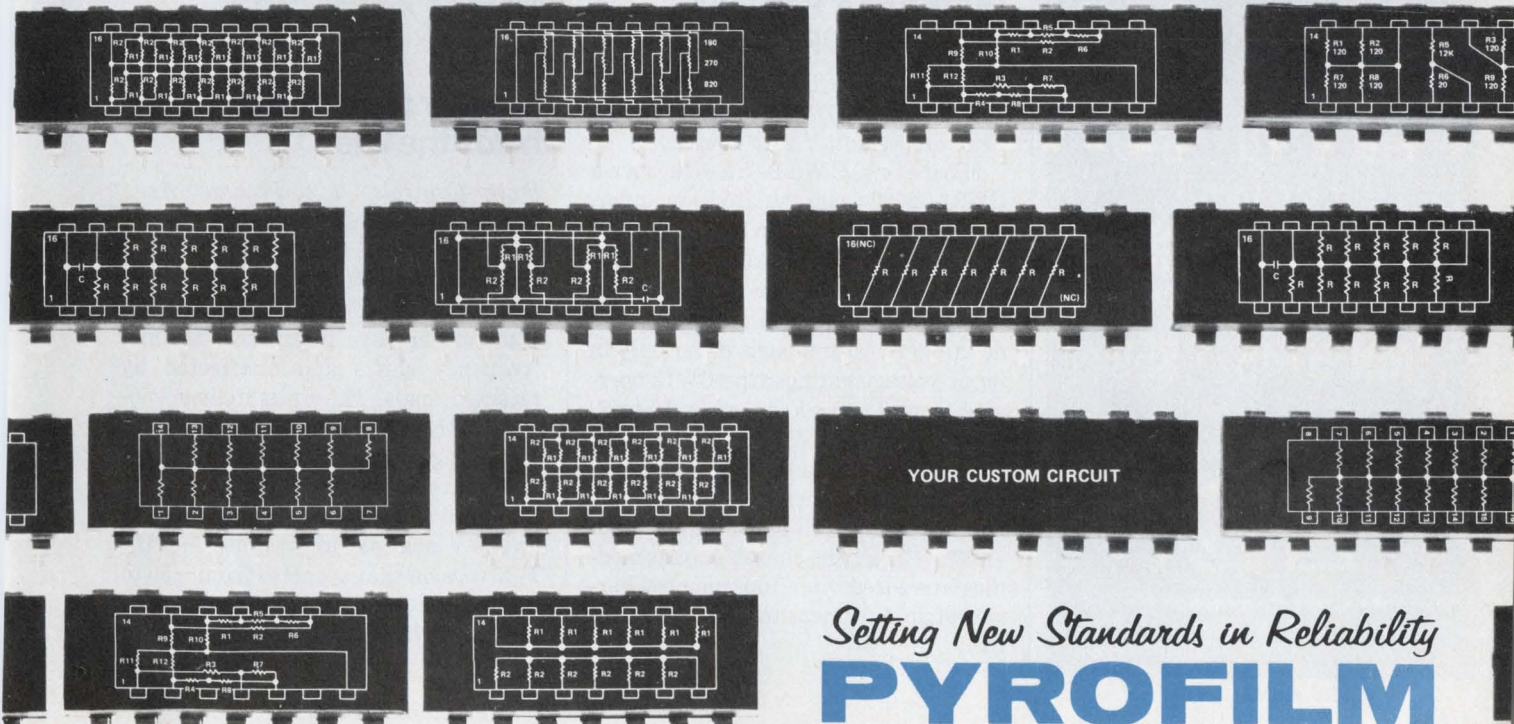

YOUR CUSTOM CIRCUIT

Setting New Standards in Reliability
PYROFILM

60 S. Jefferson Road • Whippany, N. J. 07981 • (201) 887-8100

Designers Choice In Low-Cost 8-Bit A/Ds

3 New Series In Dual In-Line Packages

Provide choice of

- Input ranges
+10V, -10V, ±5V, ±10V
- Power supplies
±12V or ±15V
- Conversion time
2.5 or 6 μsec max.
- Operating temperature
-0° to 70°C
-55° to +125°C
- Mil-Std 883
processing

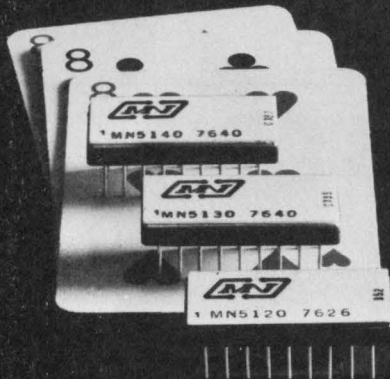

MN 5120 *\$49
(± 15V 6 μsec)

MN 5130 *\$59
(± 15V 2.5 μsec)

MN 5140 *\$59
(± 12V 2.5 μsec)

* (1 to 24 units)



Micro Networks Corporation
324 Clark Street, Worcester, MA 01601
(617) 852-5400 TWX 710-340-0064

CIRCLE NUMBER 117

POWER SOURCES

High-voltage dc/dc maintains accuracy

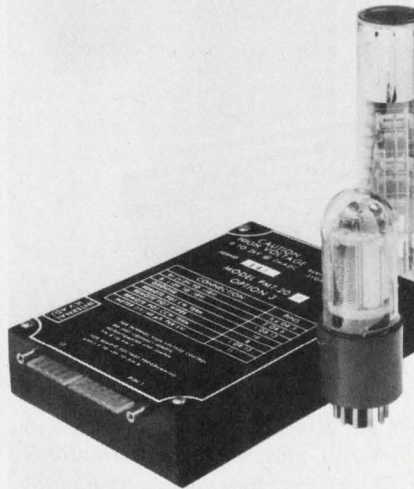

Bertan Associates, 3 Aerial Way,
Syosset, NY 11791. L. Bertan (516)
433-3110. \$175 (1 qty.); stock.

Model PMT-20, a dc/dc converter module, powers photomultiplier tubes with adjustable or programmable 0 to 2000 V at 0 to 2 mA. Features include line and load regulation of 0.001%, ripple of 2-mV pk-pk and short-term stability of 0.005%. Both positive and negative polarities are available and the module operates from various dc inputs. A low-level output-voltage monitor is included in the short-circuit and arc-protected unit.

CIRCLE NO. 424

Converters stay cool over wide input dc

Semiconductor Circuits, 306 River St.,
Haverhill, MA 01830. (617) 373-9104.
From 100 (1 qty); 2 to 4 wks.

Models CW12-5S600 and CW24-5S600 encapsulated, modular, ripple-regulator, dc/dc converters feature 60 to 70% operating efficiencies over a 2:1 input-voltage range. Delivering foldback-protected outputs of 5 V dc at 6.5 A, both models differ only in input voltage ratings; the CW12 operates from 9 to 18 V dc, while 18 to 32 V dc powers the CW24. Features of the converters include 0.5% line and load regulation, 13 mV rms of output ripple and noise, and full-rated output from -25 to +71 C. The chassis-mount modules are wired via a top-mounted barrier strip and measure 3.5 × 2.5 × 2 in.

CIRCLE NO. 425

Switcher family spans 5 to 24-V outputs

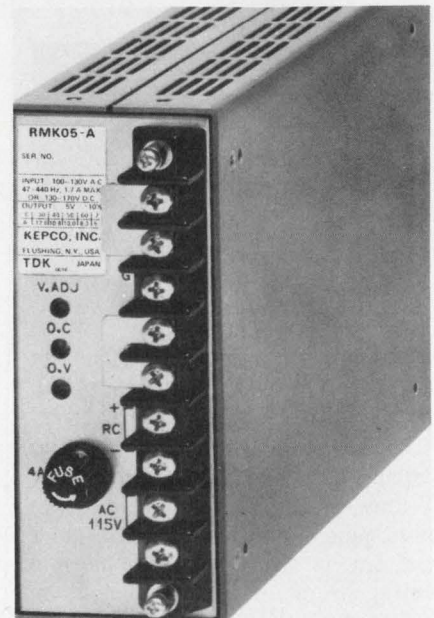

Kepeco, 131-38 Sanford Ave., Flushing,
NY 11352. (212) 461-7000. \$179 (unit
qty).

Series A of the RMK switching mode power supplies contains five models whose outputs are: 5 V at 0 to 12 A, 9 V at 0 to 7.6 A, 12 V at 0 to 6.3 A, 15 V at 0 to 5 A and 24 V at 0 to 3.2 A. All models can be factory-set at -30% to +10% of nominal voltage. Their operating temperature is 0 to +71 C. Features include 25-kHz switching (for a 68% typical efficiency) and a five-year warranty. The units also have remote error sensing, adjustable current limiting, logic-level turn-on and turn-off and both ac and dc power input. The 3-lb modules are 2.19 × 5.1 × 7.5 in.

CIRCLE NO. 426

Smaller transformer holds the line

Power-Controls, 142 Peconic Ave.,
Medford, NY 11763. (516) 654-2084. \$39
(500 qty.); stock to 4 wks.

Smaller by 50% than ferroresonant regulators, Mini-Reg line-regulation transformers are insensitive to line-frequency shifts and unaffected by rectified loads. The units deliver 250-VA of 115-V, 60-Hz output power with 1% voltage regulation from an input line that varies from 105 to 125 V. Standard units operate from either 115 or 230-V nominal input lines. A MIL-T-27 version that operates from -55 to +125 C and weighs 2 lb, comes in a can that is 2.375 × 2.75 × 3.875 in.

CIRCLE NO. 427

TRUE POWER MEASUREMENT



PC5 SERIES OSI WATT TRANSDUCERS

- Easy installation
- For power (E-I-Cos θ) monitoring and control
- Proven reliability, repeatability, long life
- Specified by Government Agencies, Industry and Public Utilities

FOR APPLICATION ASSISTANCE
WRITE OR CALL GARY CLAGETT



PIONEER IN SOLID STATE TECHNOLOGY FOR
ENERGY CONVERSION AND POWER MONITORING

OHIO SEMITRONICS, INC.
1205 CHESAPEAKE AVE., COL.'S. O. 43212
PHONE 614/486-9561

CIRCLE NUMBER 118

NEW LOW PROFILE LSI SOCKETS FROM SMK

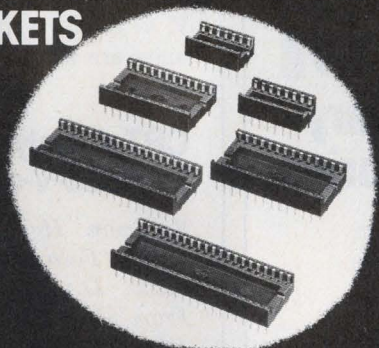

The **SI-2440 Series** complete line of new LSI Sockets, including 14, 16, 24, 28, 40 and 42 pin versions on 0.1" centers are designed so that they can be flush mounted end-to-end maintaining the 0.1" center-to-center pin spacing. For example, two 24 pin LSI Sockets can be mounted end-to-end to accommodate the latest 48 pin ROM.

The glass-filled Nylon bodies (66% Nylon) are designed to withstand soldering temperatures to +350°C for 3 seconds and are available with either tin plating, selective gold contact plating or gold flash.

Typical 100 piece price for the fourteen pin unit, tinned plated, is \$3.11 each.



SMK Electronics Corporation
of America

118 East Savarona Way Carson, California 90746
Tel: (213) 770-8915

CIRCLE NUMBER 119

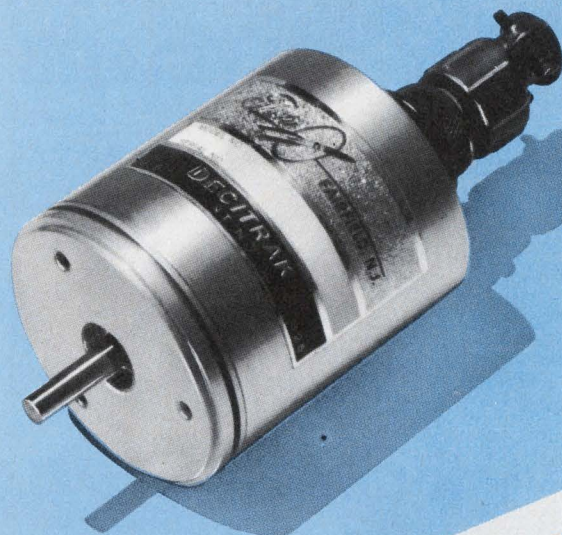

decittrak[®] decit

OPTICAL INCREMENTAL SHAFT ENCODER

**Low,
Low Cost...
Rugged Industrial
Design... Wide Ranges
Available Up To 14,400
Counts...**

The ideal, low cost incremental encoder to digitize rotary motion for display and control...up to 14,400 counts per turn...ultra reliable LED light source...only 5VDC required for operation...Bi-directional outputs in sine wave, square wave or pulse format...heavy duty industrial design...And...if you need additional electronics or a system, you can rely on Theta. Our application engineers are ready to help.

LITERATURE:

Write for descriptive literature and your free copy of Digital Solutions to Automatic Control

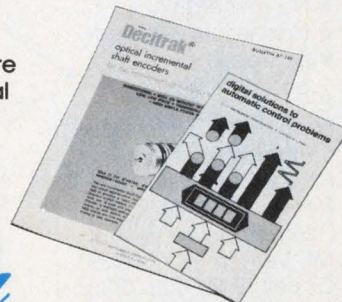

Theta

INSTRUMENT CORPORATION

Fairfield, New Jersey 07006 • Phone: 201-227-1700
CIRCLE NUMBER 120

3000



electrocube solutions...

POLYCARB

for INSTANT RELIEF

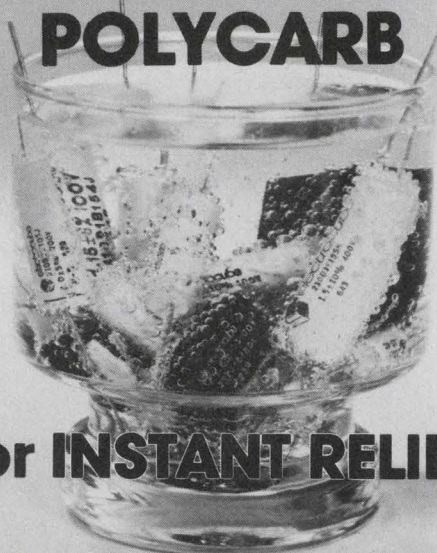

If capacitor performance and delivery are giving you problems, our reliable metallized polycarbonate Series 650 could be the solution. More than the 1100 miniature units, in 6 case styles, rated to 50 mfd and 600 VDC — all extremely stable over a wide temperature range. **And they're available in reel and un-reel packaging.** For instant relief, contact Electrocube, 1710 So. Del Mar Ave., San Gabriel, CA 91776; Tel.: (213) 573-3300.

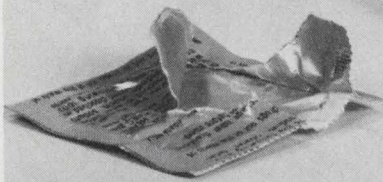

CIRCLE NUMBER 121

Memory Power

Eternacell® 10 year lithium primary battery for semiconductor memories

Don't risk memory failure. Eternacell® high reliability, lithium primary batteries are the ideal standby power source for all types of volatile memory applications. The reasons:

- Steady voltage (2.9 volts per cell) at low continuous current
- Shelf life of up to 10 years
- Highest energy per unit weight and volume
- No recharging
- Hermetically sealed
- Designed for pc board mounting

For complete information and pricing write:
Power Conversion, Inc.,
70 MacQuesten
Parkway South,
Mt. Vernon, N.Y. 10550.
Or call (914) 699-7333

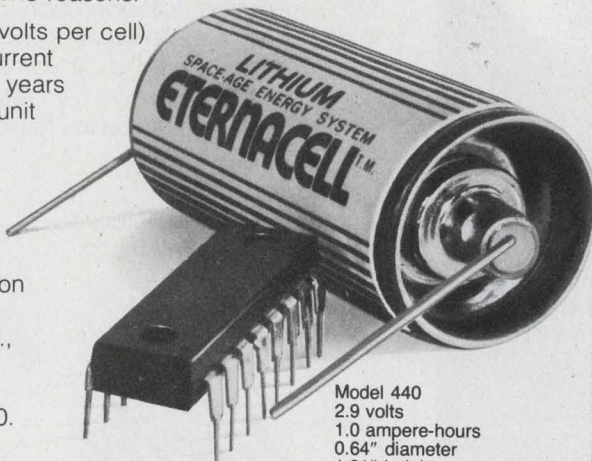

Model 440
2.9 volts
1.0 ampere-hours
0.64" diameter
1.31" height

Power Conversion

CIRCLE NUMBER 122

POWER SOURCES

Three-output switchers deliver 172 W

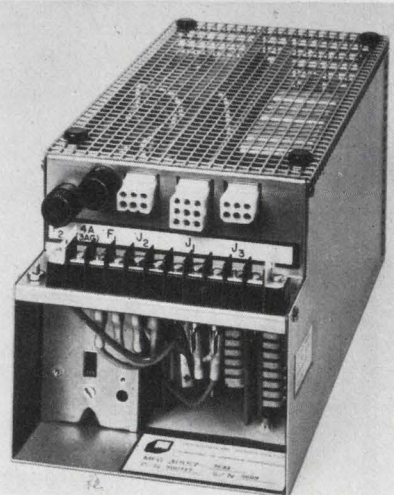

Powercube Corp., 214 Calvary Street, Waltham, MA 02154. J. Prestidge (617) 891-1830. \$300 (1000 qty.); 8-10 wks.

OLS switching power supplies offer three regulated outputs: +5 V at 24 A and ± 12 V at 4 A each up to a 172-W total. Outputs of ± 15 V are optionally available at the same power level. Each output has overvoltage and short-circuit protection, and holds up for 50 ms during power failure at full load. The supplies feature plug-in card construction and are designed for high-temperature operation with forced-air cooling. They operate from 115 or 230-V, 47 to 63-Hz, input power. The 9 lb units are 5.5 x 5.5 x 11 in.

CIRCLE NO. 428

CRT supply operates from 28-V-dc input

Spellman High-Voltage Electronics Corp., 7 Fairchild Ave., Plainview, NY 11803. D. Galluzzo (516) 822-2130. From \$300; stock to 10 wks.

Operating from a 28-V-dc input and drawing 300 mA max, the RMX810 provides high-voltage dc outputs for a CRT. You get -3 kV for the anode, -1 kV for the cathode and a floating -1 kV for the grid. Load and line regulation of these voltages is 0.01%. You can modulate a CRT either through grid bias or in the Z-axis mode via an input on the supply. The supply is enabled through an energized relay. Ground-referenced, low-level test points provide monitoring for all outputs. The self-restoring unit is arc-over and short-circuit protected. The design complies environmentally with MIL-E-16400.

CIRCLE NO. 429

SWITCHES FOR KEYBOARDS

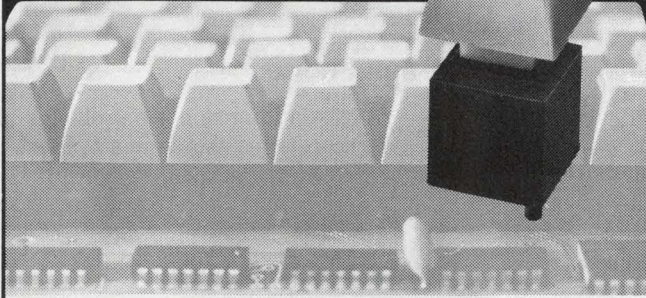

We offer the following for OEM's producing their own keyboards.

- Keyswitch sizes for 5/8" or 3/4" centers
- Gold Bar mechanical contacts or sealed contacts
- Front panel relampable lighted models
- Single and double pole contacts including NC
- Alternate action models
- Doubleshot molded keytops for 3/4" or 5/8" mounting
- Easy change legend systems
- 100,000 pc. quantity prices as low as \$0.21 each

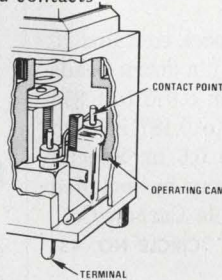

Letterhead request or phone call brings free sample switch w/keytop.



MECHANICAL ENTERPRISES, INC.
8000 Forbes Place Springfield, Virginia 22151
(703) 321-8282 TWX 710-832-0942

In Germany - NEUMÜLLER GMBH, MUNICH
In U. K. - TEKDATA Ltd., STOKE-ON-TRENT

CIRCLE NUMBER 123

Full Size Hexadecimal Encoded Keyboards



\$12.95
1000 - UP

FEATURES

- FULL C-MOS ENCODED (3 TO 30 VOLT)
- 4 BITS AND STROBE W/2 KEY ROLLOVER
- BOTH CARD EDGE & DIP TERMINATION
- GRAY DOUBLE SHOT MOLDED KEYTOPS
- SWITCH LIFE - 20 x 10⁶ OPERATIONS

1 - 100 \$17.75 100 - 1000 \$15.50



Mechanical Enterprises, Inc.
8000 Forbes Place Springfield, Virginia 22151
(703) 321-8282 TWX 710-832-0942

Germany - NEUMULLER GMBH, MUNICH
U.K. - DEVLIN ELECTRONICS, LTD., BASINGSTOKE, HANTS
France - TEKELEC AIRTRONIC, SEVRES
Switzerland - DIMOS, AG ZURICH

CIRCLE NUMBER 124

COST - CUTTING WESTON BREAKTHROUGH!

3/8" MULTITURN CERMET TRIMMER

FOR ONLY **99¢** (1,000-Pc. Price)

Same High Weston Quality At A Real Savings In Price!



Weston has done it with the new #850! We took this widely used square multiturn trimmer, and by radically improving manufacturing techniques have been able to trim the price without sacrificing quality, performance or uniformity. It can give you an important new competitive edge.

WRITE FOR SPECS AND DETAILED PRICE INFORMATION.

SANGAMO WESTON
Schlumberger

WESTON COMPONENTS & CONTROLS
A Division of Sangamo Weston, Inc.
Archbald, Pa. 18403
Tel. (717) 876-1500
TWX 510 656-2902
Telex 83-1873

CIRCLE NUMBER 125

ELECTRONIC DESIGN 12, June 7, 1977

Buzzzz.

(Write for new catalog.)



Solid state electronic MICRO-BUZZER from CITIZEN: High reliability, competitively priced with immediate delivery.

A complete range: **SMB** 1.5, 6, 12, 24, VDC
RMB 3, 6, 12, 24, VDC
IMB (Intermittent) 6, 12, VDC

CITIZEN

CITIZEN AMERICA CORPORATION
1710 - 22nd St.
Santa Monica,
CA 90404

Toll Free (800) 421-6516
In Calif. (213) 829-3541
TWX: (910) 343-6450

Name _____
Company _____
Address _____
City _____ State _____
Zip _____ Phone _____

CIRCLE NUMBER 126

Circuit Savers

NEW

AC POWER LINE PROTECTOR



Protects
110, 220, 380,
440 VAC line
1 ϕ , 3 ϕ - 50/60/400 Hz

The **Series P** operates rapidly to prevent damage to equipment operating on the AC power lines, by switching rapidly to a clamping state whenever a transient exceeds the clamping threshold. The units operate on overvoltages of either polarity, on 1 ϕ and 3 ϕ lines and recover automatically when the transient expires. Severe transient conditions cause the protector to switch to a crowbar mode and cause an external fuse or circuit breaker to operate.

CATALOG 801

Full line of protection modules for every hi-lo voltage/current requirement. Write or call for data.

160 Brook Ave., Deer Park, N.Y. 11729
Telephone: 516-586-5125

MCG Electronics

CIRCLE NUMBER 127

**"If you're
really minding
your own
business,
you're giving
more to
higher
education."**

John T. Connor
Chairman and Chief Executive Officer
Allied Chemical Corporation



**Make America smarter.
Give to the college
of your choice.**

**CE
AE**

Council for Financial Aid to Education, Inc.
680 Fifth Avenue, New York, N.Y. 10019

**Ad
COUNCIL**

A Public Service of This Magazine
& The Advertising Council.

Evaluation samples

Containers

Containers come in nine standard sizes, each equipped with standard slotting layouts. By adding adjustable inserts, containers allow the positioning of more than one size PC board. Shell Containers Systems.

CIRCLE NO. 430

Soft ferrite beads

A soft ferrite bead pack contains 10 items of approximately a dozen beads each. O.D.s range from 0.073 to 0.375 in.; I.D.s from 0.038 to 0.187 in. and lengths from 0.085 to 0.6 in. Special sizes and materials may be included upon request. Stackpole Carbon Co.

CIRCLE NO. 431

Potentiometers

Conductive-plastic, semi-precision, industrial-grade potentiometers feature 1% linearity, 5-million cycle rotational life and low noise (0.25% output smoothness). For more information, circle the reader service number. New England Instrument

CIRCLE NO. 432

Oxide-free solder cream

Solder creams require low heat, short dwell time and low soldering temperatures, and are virtually oxide-free. The creams come in a variety of tinlead as well as silver bearing alloys with either an active or mildly active rosin-base flux. The flux residue is light and clear in color. Multicore Solders.

CIRCLE NO. 433

Reed relays

The RX-1 relay operates at 5, 6 and 12 V dc. When the RX-1 is used at TTL switching levels, it provides 50-million switching operations without discernable deviations in performance. Send a letterhead request for a free sample, stating in minor detail how the relay will be used. Electronic Applications, 4918 Santa Anita Ave., El Monte, CA 91734

INQUIRE DIRECT

Application notes

Input noise

How to minimize noise problems in X-Y recorders is shown in a four-page note. Hewlett-Packard, Palo Alto, CA

CIRCLE NO. 434

Alarm sensing circuit

Design and performance of an alarm sensing circuit is described in an application note. All element values, layout and characteristics over the military temperature range are included. Interdesign, Sunnyvale, CA

CIRCLE NO. 435

Instrumentation quarterly

The first issue of an applications engineering quarterly describes use of digital instruments in trip-point testing of protective relays. Dranetz Engineering Laboratories, South Plainfield, NJ

CIRCLE NO. 436

Timing measurements

A better approach to pulse and digital timing measurements based on the Delta Time measurement package (7B80 and 7B85 plug-ins) for 7000-Series Oscilloscopes is described in an application note. Tektronix, Beaverton, OR

CIRCLE NO. 437

Encoders, decoders

How to implement highly noise-immune, remote supervisory control systems using commercially available tone-encoder and decoder modules are described in an eight-page reprint. Frequency Devices, Haverhill, MA

CIRCLE NO. 438

7-digit LED counter

A battery-operated, low-cost counter is described in a six-page bulletin. With frequent references to design drawings, the bulletin discusses circuit design considerations, display requirements, the power-supply requirement, hardware and the basic system accuracy as a function of the oscillator and mode selected. Intersil, Cupertino, CA

CIRCLE NO. 439

WE KNOW A LOT ABOUT A LITTLE.

Nickel cut cores, for instance.

If you need nickel-iron cores with low losses and high efficiency in small sizes, our nickel cut cores will do the job for you. Designed for high saturation flux densities, our Supermendur types make possible a 30% weight reduction over conventional silicon-iron cores. Our Permalloy 80 cores provide a core loss approximately one-tenth that of a silicon-iron core of equal thickness. Our Orthonol® cores have a flux density of 15,000 gauss, with a core loss about one-half that of a silicon-iron C core of the same thickness. For more information, write Magnetics, Components Division, Butler PA 16001.

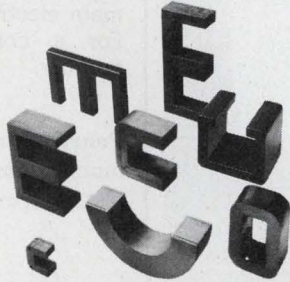

Very special specialists in nickel cut cores.



CIRCLE NUMBER 131

WE KNOW A LOT ABOUT A LITTLE.

Tape cores, for instance.

When it comes to tape wound cores, we offer thousands of choices—900 sizes, eight materials, seven gauges. Our Supermalloy tape cores feature high permeability and low loss for such applications as precision current and ratio transformers, high-perm inductors, bridge lifters, etc.

We also make bobbin cores from Permalloy 80 and Orthonol® ultra-thin tape. These cores are wound on nonmagnetic stainless steel bobbins, with core diameters down to 0.050".

For more information on tape or bobbin cores, write Magnetics, Components Division, Butler PA 16001.



In addition to catalog items, we offer a custom core service.

Very special specialists in tape wound cores.



CIRCLE NUMBER 132

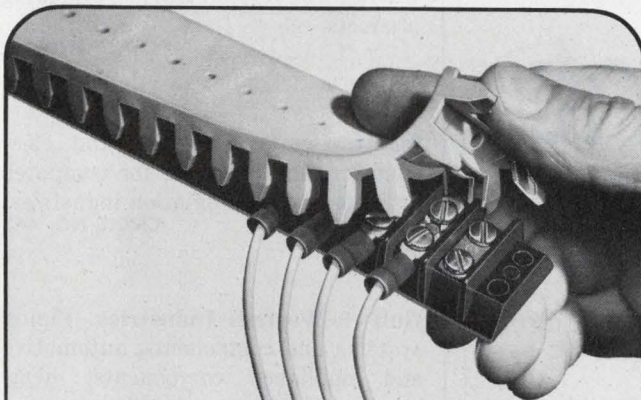

NEW SAFE-TI CAPS™

Protect your terminal board connections by covering them with Kulka's non-flammable, rubber Safe-Ti Caps™. These unique covers guard against spills, dirt and accidental short circuits from dropped tools. Available in all the popular sizes. Be sure to send for Kulka's free catalog.

Kulka®

A NORTH AMERICAN PHILIPS COMPANY

520 S. Fulton Ave., Mt. Vernon, NY 10551 Tel: 914 664 4024

CIRCLE NUMBER 133

ELECTRONIC DESIGN 12, June 7, 1977

Fast start/stop... positive directional stability



It's great on torque and price, too! The compact 81700 synchronous motor.

High torque-to-frame size ratio, superior performance characteristics and attractive low price make the 81700 synchronous motor ideal for computer peripherals, business machines and home entertainment equipment. Included are turntables, remote tuners, credit card readers and facsimile transmission equipment.

The motor's inherent reliability and 6 oz. in. @ 300 rpm are key factors. Instantaneous start/stop eliminates clutching and prestarting. Directional stability and low cost are other important advantages. A permanently lubricated bearing prolongs motor life and minimizes maintenance.

Write for information today!

NORTH AMERICAN PHILIPS CONTROLS CORP.

Cheshire, Conn. 06410 • (203) 272-0301
CIRCLE NUMBER 134

WATERS OFFERS the best answer to your servo feedback problem

Designed with computer programmed correction, Waters conductive plastic pots and elements are the answer to your most difficult servo feedback application. They offer long rotational life, low output smoothness, low static noise, and infinite resolution in rotaries from 1/2" to 2" diameters with accuracy to 0.1% terminal linearity. Elements are built to your specifications from 1/2" to 40" in length to almost any resistance value.

Waters customer service team includes an engineering services group which processes every customer inquiry and will consult with you to review existing applications and provide assistance on new ones.

Call Bob Waters at 617-358-2777 or circle reader service card for complete catalog.

We're ready to serve you.



**WATERS
MANUFACTURING,
INC.**

Longfellow Center
Wayland, MA 01778 617-358-2777

CIRCLE NUMBER 135

Vendors report

Annual and interim reports can provide much more than financial position information. They often include the first public disclosure of new products, new techniques and new directions of our vendors and customers. Further, they often contain superb analyses of segments of industry that a company serves.

Selected companies with recent reports are listed here with their main electronic products or services. For a copy, circle the indicated number.

Penril Corp. Business, data-communications products and electronic test instruments.

CIRCLE NO. 440

Computer Automation. Computer and computer-related products, software and computerized systems.

CIRCLE NO. 441

Energy Conversion Devices. Imaging products.

CIRCLE NO. 442

Electro-Craft. Electronic and electromechanical products for computer peripheral and automation industries.

CIRCLE NO. 443

Gulf + Western Industries. Piping systems and components; automotive and appliance components; heat-transfer equipment; electronic supplies; wire and cable; traffic-control systems; natural resources and automotive replacement parts.

CIRCLE NO. 444

Polarad Electronics. Commercial and military electronic equipment and systems; microwave signal generators and receivers; spectrum analyzers, and electronic navigation instruments.

CIRCLE NO. 445

Harris Corp. Communication and information-handling systems and equipment; ICs.

CIRCLE NO. 446

To The Point

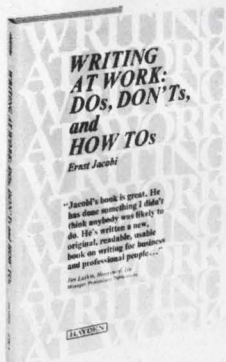

WRITING AT WORK. DOs, DON'Ts, and HOW TOs

by Ernst Jacobi, Xerox Corporation.

"Jacobi's book is great . . .

He's written a new, original, readable, usable book on writing for business and professional people. . . ." Jim Lufkin, Manager, Professional Publications, Honeywell.

*The book on writing for
business and professional
people!*

#5730-X, cloth,
208 pp., \$10.95.

Order your
15-day exam
copy today!

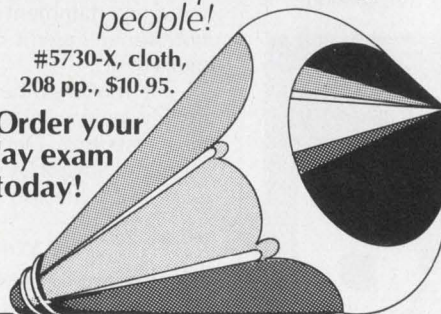

Rid yourself of stiff, awkward writing with this lively, easy-to-read guide. No pat rules or formulas here. Instead, you get practical advice and sound wisdom to help you make your reports and proposals sharper, more interesting, and informative.



**Hayden Book
Company**

50 Essex Street
Rochelle Park, N.J. 07662

Itel. Leasing of data-processing equipment.

CIRCLE NO. 464

EG&G. Instruments; components; environmental and biomedical services; custom services and systems.

CIRCLE NO. 465

Threshold Technology. Automatic voice-recognition systems.

CIRCLE NO. 466

Data 100. Data-processing terminal systems. A separate corporate profile is available.

CIRCLE NO. 467

Computer Communications. Equipment and systems for processing and switching of data transmitted between computers and remote locations.

CIRCLE NO. 468

SGL Industries. Batteries, spark plugs and igniters; magnetic transformer components; PCs and specialty plastics.

CIRCLE NO. 469

Datapoint Corp. Data-processing equipment.

CIRCLE NO. 470

Bio-Medicus. Medical products and devices.

CIRCLE NO. 471

Lafayette Radio Electronics. Consumer electronics.

CIRCLE NO. 472

Tandy Corp. Consumer electronics.

CIRCLE NO. 473

Dataram Corp. Memory systems.

CIRCLE NO. 474

Zero Manufacturing. Cases, cabinets and specialized cabinets.

CIRCLE NO. 475

Scientific-Atlanta. Satellite-communications systems; microwave test equipment.

CIRCLE NO. 476

Pentron Industries. Coils, extruded and molded plastic parts and electronic distance measuring instruments.

CIRCLE NO. 477



Everything in Fail-Proof Drum-Impact Digital Printers.

Used by the world's leaders in cash registers, instrument data loggers, and all print-out applications.

Whatever your hard-copy need—alpha-numeric/digital printout; multi-copy; multi-color; ordinary calculator label, fan-folded forms, sales slip—one of our 12 basic field-proven impact printers will suit you perfectly.

Choose up to 21 columns, up to 42 characters/column, 3.4 lines/sec printing speed. Lowest sample prices.

Products of Shinshu-Seiki, world-famous for a decade of reliability. Represented and guaranteed by C. Itoh Electronics—part of the 117-year C. Itoh & Co., Ltd. world-wide trading organization.

C. Itoh Electronics, Inc.

East: 280 Park Ave New York, NY 10017	West: 5301 Beethoven St. Los Angeles, CA 90066	C. ITOH & CO. LTD. London Inter- national Press Centre 76 Shoe Lane; London EC4A, 3JB; England Call Mr. Walker 01-353-6090
---	---	---

Call 212-682-0420. Telex WUD 12-5059

Call 213-390-7778. Telex WU 65-2451

C. Itoh means excellence in Digital Printermatics.

CIRCLE NUMBER 136



Compact Cooling

When you need high performance, low profile cooling for .500" centerline board spacing, the compact 6060 heat sink will do the job. The total height is only .375", and there is sufficient clearance under the fins to mount small components. 6060 is the highest performance low profile heat sink on the market with a thermal resistance of only 6.5°C/watt. The universal hole pattern of the 6060 accepts TO-3, TO-66, and plastic devices.

Thermalloy, Inc.

Post Office Box 34829
2021 West Valley View Lane
Dallas, TX 75234 • (214) 243-4321

Free sample and all products catalog with your response

Number one in Semiconductor Accessories

CIRCLE NUMBER 137

New literature



CMOS

Specifications, functional and pinout information on 98 different SCL-4000B series CMOS devices as well as standard CMOS memory and time-keeping circuits are given in a 12-page catalog. Solid State Scientific, Montgomeryville, PA

CIRCLE NO. 447

Bridge rectifiers

Full specifications and dimensional drawings of bridge rectifiers are shown in a four-page brochure. Electronic Devices, Yonkers, NY

CIRCLE NO. 448

Wire-wrapping

Solderless wire-wrapping production techniques and practices are described in a 34-page manual. Amphenol Connector, Oak Brook, IL

CIRCLE NO. 449

Thick-film hybrids

Custom thick-film hybrid products are covered in a 4-page brochure. Parlex Corp., Methuen, MA

CIRCLE NO. 450

Peripheral driver ICs

A 120-page peripheral-driver IC catalog provides comprehensive information on 46 peripheral-driver ICs. Featured are function tables, schematics, pin configurations and parametric measurement information. Texas Instruments, Dallas, TX

CIRCLE NO. 451

CAMAC equipment

An introduction to IEEE Standard 583, "IEEE Standard Modular Instrumentation and Digital Interface System (CAMAC)" and descriptions of over 90 products conforming to this standard, are included in a 224-page catalog. Kinetic Systems, Lockport, IL

CIRCLE NO. 452

Spectrum analyzer

A 12-page brochure shows how to apply real-time spectrum analysis to acoustic, vibration and transient problems with the Model 444 FFT computing spectrum analyzer. Nicolet Scientific, Northvale, NJ

CIRCLE NO. 453

Splicing products

Modular-system splicing products are described in a 24-page booklet. 3M TelComm Products, St. Paul, MN

CIRCLE NO. 454

Thyristors

Data sheets describe converter-grade thyristors, types N007, N010, N013 and N023. Rating information, performance curves and characteristics at specified case temperatures are given. Westcode Semiconductors, Chippenham, Wilts, SN15 1JD England

CIRCLE NO. 455

Microwave tubes, diodes

"Microwave Tubes and Diodes" contains data on lighthouse tubes, reflex klystrons, TWTs, magnetrons and microwave silicon diodes. The 500-page book is printed in English and German. AEG-Telefunken, D-7900 Ulm, West Germany

CIRCLE NO. 456

8-bit MOS μ P

The 320-page 8080A/9080A Handbook describes the 8-bit MOS microprocessor and major support circuits. The publication includes detailed timing diagrams, memory and interface circuit descriptions and an applications section. For more information regarding the \$7.95 book, circle the number. Advanced Micro Devices (Library), Sunnyvale, CA

CIRCLE NO. 457

Switches

Single and double-break, lighted or nonlighted PB, DIP LED-indicator PB, industrial and sealed actuators are covered in a 36-page guide. Engineering and specification data, switch dimensions and electrical ratings are included. Licon, Illinois Tool Works, Chicago, IL

CIRCLE NO. 458

Function circuits

"Function Circuits, Design and Applications" deals with the multifaceted area of analog function circuits. Numerous graphs and formulas are presented in the 300-page book. The book costs \$18.50 postpaid. For more information, circle the reader service number. Burr-Brown Research, Tucson, AZ

CIRCLE NO. 459

Engineering encyclopedia

"The Reston Encyclopedia of Biomedical Engineering Terms" is a comprehensive dictionary of medical and electronic terms. The book costs \$29.95. For more information, circle the number. Prentice-Hall, Englewood Cliffs, NJ

CIRCLE NO. 460

Power sources

Performance and specifications, ratings, prices, options and accessories for a family of digitally controlled power sources are given in a 12-page catalog. Hewlett-Packard, Palo Alto, CA

CIRCLE NO. 461

Communication components

Over 500 communication components are featured in a 36-page catalog. Schematics, specifications, selection charts, product descriptions and photos are included. ADC Products, Minneapolis, MN

CIRCLE NO. 462

Solid-state relays

Application data, charts and graphs provide specifications and design data on ac and dc-controlled, triac and SCR solid-state relays. Also included in the 20-page catalog is information on heat sinks, solid-state hybrid power relays and sockets. Magnecraft Electric, Chicago, IL

CIRCLE NO. 463

**The original
economy
power supply.**

Proven reliable 125,000 times.

More than 125,000 DPS supplies have been sold to OEM's and it's still a best seller. That's your assurance of quality ...reliability ...cost effectiveness.

Models available to supply 5 volts at 3 amps to 24 volts at 0.8 amp. Each is a U.L. listed recognized component.

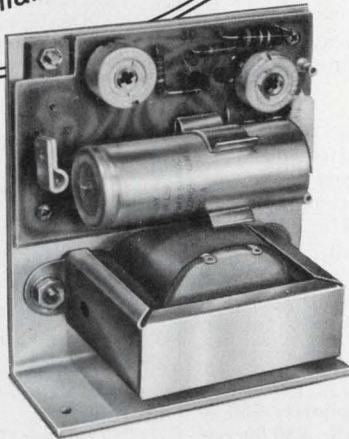

Write or call for additional data.

TELE-DYNAMICS

DIVISION OF **AMBAC**

525 Virginia Drive, Fort Washington, Pa. 19034 • 215-643-3900

A STEP AHEAD IN QUALITY

CIRCLE NUMBER 139

**CHOCKED FULL OF
TECHNOLOGY!!**

**Model D-72C
Two Element X-Y, T
Recorder**

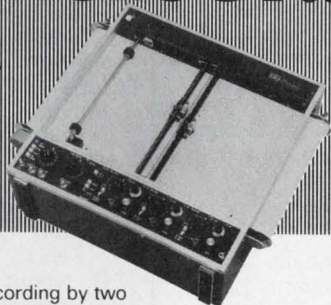

Features

1. Two element time axis

Model D-72C permits time recording by two systems; mechanical recording chart feed and time axis sweep by time.

2. High performance chart attraction

Troubles due to faulty attraction of the chart due to friction during chart feed has been completely eliminated regardless of the temperature or feed rate.

3. Automatic chart replacement in XY recording

The chart can be automatically fed and stopped at the end of chart replacement with one touch by loading roll chart.

4. Remote control terminals

- Pen up-down
 - X-axis electronic time sweep trigger
 - Mechanical time feed recording chart start/stop
 - XY chart automatic replacement feed trigger
- 5. Easy-to-install optional chart take-up device (Optional)**
6. Felt tip pen (Optional)
7. High input impedance 10MΩ fixed (Optional)

• For further information, please contact:

Riken Denshi Co., Ltd.

5-5-2, Yutenji, Meguro-ku, Tokyo, Japan. TELEX: 0246-8107

CIRCLE NUMBER 140

ELECTRONIC DESIGN 12, June 7, 1977

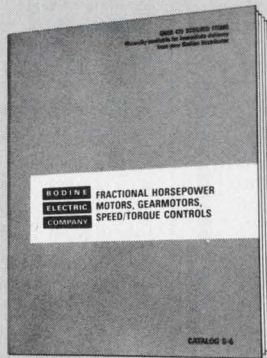

**NEW!
CATALOG**

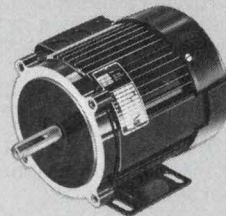

**NEW!
MOTORS**

*Higher Hp.
[up to 1/2]*

425 STOCK fhp (1/2000 to 1/2 Hp) motors, gearmotors, and speed/torque controls listed. Included are Bodine's new TEFC 48 frame A-C induction motors and gearmotors. Also new 32 and 42 frame PM D-C motors, gearmotors and speed controls.

32 pages packed with over 150 photos, charts, diagrams and graphs. Plus helpful information on proper selection and application, mounting, performance, safety, custom designing... Send for Catalog S-6, or see your Bodine Distributor (your now source for all items in Catalog S-6).

**BODINE
ELECTRIC
COMPANY**

Bodine Electric Co., 2500 W. Bradley Pl., Chicago, IL 60618

CIRCLE NUMBER 141

The
fabulous Phi-Deck® family
of 5 cassette transports
under \$100 in quantities of 10

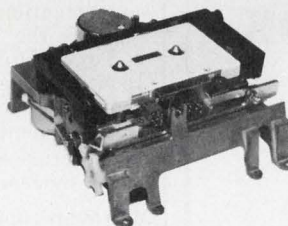

Featuring:

- Die-cast frames
- Remote controllable
- Precise, fast head engage/disengage
- Quick braking
- Search FF/rewind 120 ips
- Speed ranges from .4 to 20 ips

Electronic packages and mag heads for most applications

For application in:

- | | |
|-----------------------------------|---------------------------------------|
| 1. Micro processing | 7. Security/automatic warning systems |
| 2. Data recording/logging/storage | 8. Test applications |
| 3. Programming | 9. Audio visual/education |
| 4. Instrumentation | 10. Telephone interconnect |
| 5. Industrial Control | 11. Hi-Fi |
| 6. RS-232 Data storage | 12. Point of sale |



Triple I Incorporated

4605 N. Stiles P.O. Box 18209
Oklahoma City, Oklahoma 73118 (405) 521-9000

- I am interested in application no. _____
 Have Representative call Send application notes

Name _____ Title _____
 Company Name _____
 Address _____
 City _____ State _____ Zip _____
 Phone Number _____

CIRCLE NUMBER 142

R&D ENGINEERS

THE COMPANY Waters Associates, the leader in Liquid Chromatography, the most rapidly expanding field in analytical instrumentation, is a dynamic and growing company with a sustained record of profitable expansion. As part of our planned growth, we are seeking several outstanding individuals.

THE OPPORTUNITY Research, development and design of sophisticated commercial instrumentation.

EDUCATION EE, ME, Electro-Mechanical, or Electro-Optics at the BS or MS level.

ESSENTIAL BACKGROUND 3 or more years of research, development and design in a commercial environment with one or more of the following technologies. Microprocessor hardware and software, UV optics and detectors, thermal printers, chart recorders, I/O devices, fluids or high pressure pumping systems.

We offer a challenging environment, excellent salaries, competitive benefits and a chance to be in an unusual growth environment. Please send resume and salary history to W. J. Hecht.

WATERS ASSOCIATES

34 Maple Street, Milford, MA 01757
An Equal Opportunity Employer

KEEP

Electronic Design's

GOLD BOOK

HANDY

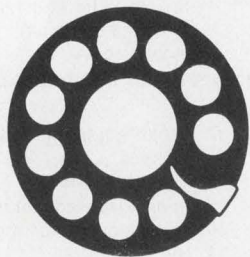

When You Call

Save time when you contact suppliers. Check their catalog pages first in *Electronic Design's* GOLD BOOK. Maybe the information you need is right at your fingertips.

Electronic Design

ELECTRONIC DESIGN's function is:

- To aid progress in the electronics manufacturing industry by promoting good design.
- To give the electronic design engineer concepts and ideas that make his job easier and more productive.
- To provide a central source of timely electronics information.
- To promote communication among members of the electronics engineering community.

Want a subscription? ELECTRONIC DESIGN is sent free to qualified engineers and engineering managers doing design work, supervising design or setting standards in the United States and Western Europe. For a free subscription, use the application form bound in the magazine. If none is included, write to us direct for an application form.

If you do not qualify, paid subscription rates are as follows: \$30.00 per year (26 issues) U.S., \$40.00 per year (26 issues) all other countries. Single copies are \$2.00 U.S., \$3.00 all other countries. The Gold Book (27th issue) may be purchased for \$30.00 U.S. and \$40.00 all other countries.

If you change your address, send us an old mailing label and your new address; there is generally a postcard for this bound in the magazine. You will have to requalify to continue receiving ELECTRONIC DESIGN free.

The accuracy policy of ELECTRONIC DESIGN is:

- To make diligent efforts to ensure the accuracy of editorial matter.
- To publish prompt corrections whenever inaccuracies are brought to our attention. Corrections appear in "Across the Desk."
- To encourage our readers as responsible members of our business community to report to us misleading or fraudulent advertising.
- To refuse any advertisement deemed to be misleading or fraudulent.

Microfilm copies are available of complete volumes of ELECTRONIC DESIGN at \$19 per volume, beginning with Volume 1, 1952 through Volume 20. Reprints of individual articles may be obtained for \$3.00 each, prepaid (\$.50 for each additional copy of the same article) no matter how long the article. For further details and to place orders, contact the Customer Services Department, University Microfilms, 300 North Zeeb Road, Ann Arbor, Michigan 48106 telephone (313) 761-4700.

Want to contact us? If you have any comments or wish to submit a manuscript or article outline, address your correspondence to:

Editor
ELECTRONIC DESIGN
50 Essex Street
Rochelle Park, N.J. 07662

Electronic Design

Advertising Sales Staff

Tom W. Carr, Sales Director
Robert M. Lepore,
Sales Coordinator

Rochelle Park, NJ 07662

Robert W. Gascoigne
Thomas P. Barth
Stan Tessler
50 Essex St.
(201) 843-0550
TWX: 710-990-5071
(HAYDENPUB ROPK)

Philadelphia

Thomas P. Barth
(201) 843-0550

Boston 02178

Gene Pritchard
P.O. Box 379
Belmont, MA 02178
(617) 489-2340

Chicago 60611

Thomas P. Kavooras
Berry Conner, Jr.
200 East Ontario
(312) 337-0588

Cleveland

Thomas P. Kavooras
(312) 337-0588

Los Angeles 90045

Stanley I. Ehrenclou
Burt Underwood
8939 Sepulveda Blvd.
(213) 641-6544

Texas

Burt Underwood
(213) 641-6544

San Francisco

Robert A. Lukas
3579 Cambridge Lane
Mountain View, CA 94040
(415) 965-2636

England

Constance McKinley
50 Essex St.
Rochelle Park, N.J. 07662
Phone: (201) 843-0550

Europe

Sanders, W. J. M.
Raadhuisstraat 24
Graft-De Ryp, Holland
Phone: 02997-1303
Telegrams: Euradteam-Amsterdam
Telex: 13039-SIPAS

G. Nebut

Promotion Presse Internationale
7 ter Cour des Petites Ecuries
75010 Paris, France
Telephone: 5231917, 1918, 1919

Dieter Wollenberg

Erikastrasse 8
D-8011 Baldham/Muenchen
Germany
Telephone: 0 8106/4541

Tokyo

Haruki Hirayama
EMS, Inc.
5th Floor, Lila Bldg.,
4-9-8 Roppongi
Minato-ku, Tokyo, Japan
Phone: 402-4556
Cable: EMSINCPERIOD, Tokyo



quick ads

New and current products
for the electronic designer
presented by their manufacturers.

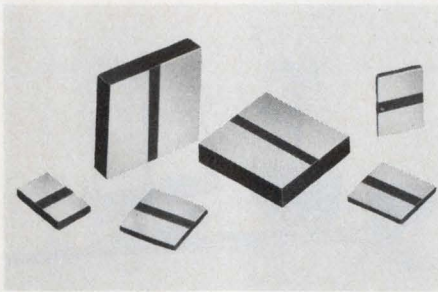

CERAMIC CHIP CAPACITORS. SPLIT-CHIP, is a new concept in ceramic chip capacitor technology. These new units have two broad electrodes on one face and eliminate conventional wrap-around end terminations. This new concept provides lower cost and easier assembly. SPLIT-CHIPS are available in five standard sizes from .040" x .030" to .130" x .090" and .015" thick and in all popular dielectrics and capacitance ranges. JOHANSON DIELECTRICS, INC., Box 6456, Burbank, Ca. 91510 213-848-4465

CERAMIC CHIP CAPACITORS

181

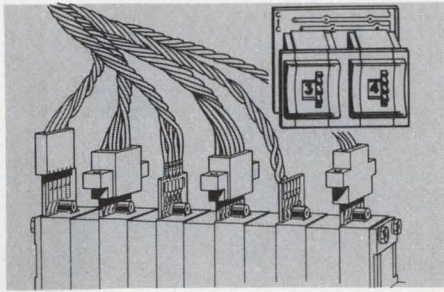

Versatile Thumbwheel Switches from AMP snap, plug or wire in and save you time, money and solder, too. Or you can still solder to them. Just choose the one that fits your needs. You'll get traditional AMP quality plus full engineering backup. For more information, call Customer Service at (717) 564-0100. Or write AMP Incorporated, Harrisburg, PA 17105.

THUMBWHEEL SWITCHES

184

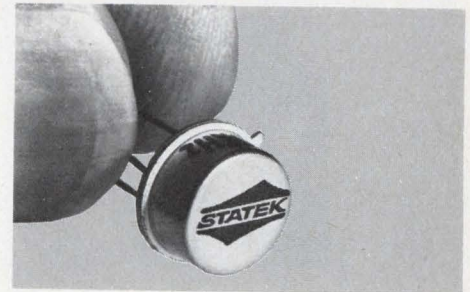

LOW COST QUARTZ CRYSTALS Use Statek 10 to 300 kHz quartz crystals in TO-5s . . . they eliminate count down for oscillators, filters, tone generators, timers . . . They're rugged, accurate & resistant to high vibration and shock. Prices low as \$1.70 ea. in 1000 qty. Send your written application & we'll send you a sample. Call or write for literature. Details in Gold Book and EEM * STATEK CORP. * 512 N. Main, Orange, Ca. 92668 * (714) 639-7810 * Telex 67-8394

QUARTZ CRYSTALS

187



MAY I HELP SPEED LEAD BENDING OPERATIONS? Cut costs by 50%! Fast, exact, thumbwheel control adjusts to precise measurements. Match pointers with eyelet holes in circuit boards by adjusting knurled wheel with thumb, automatically spacing bends for insertion of component into boards. All axial lead components accommodated. From 1/2" x 1 1/2" long with max. distance between inside of bends of 1.725". Harwil Co., 1548 17th Street, Santa Monica, CA. 90404. (213) 829-2310

COMPONENT LEAD BENDER

182



MAGNETIC SHIELDING Take advantage of Eagle's 23-year background in shield design and production. Custom and standard models. Full service includes design, engineering, fabrication, heat treating, finishing, testing. Also wide selection of sheet and foil so you can form your own shields. For helpful design and cost data, request Bulletin E-77. Eagle Magnetic Co., Inc., Box 24283, Indianapolis, IN 46224, 317-297-1030.

MAGNETIC SHIELDING

185

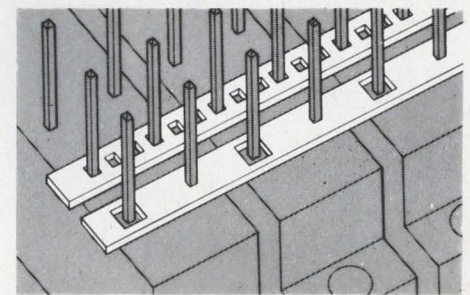

STRIP/BUS BY ROGERS. Low Cost Busing Systems; easy installation, reliable solder joints; greater pin exposure. Write or call for details. Rogers Corporation, Chandler, AZ 85224. Phone (602) 963-4584. (EUROPE: Mektron NV, Ghent, Belgium; JAPAN: Nippon Mektron, Tokyo)

STRIP/BUS

188

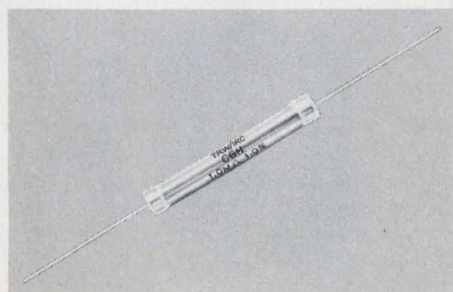

CGH Metal Glaze Resistors from TRW operate in high ambient temperatures with excellent high voltage load stability. These thick film resistors are particularly suited for precision high voltage and high impedance applications such as voltage multipliers, X-ray equipment, and high voltage power supplies where precision tolerances and TCs are required. TRW/IRC Resistors, an operation of TRW Electronic Components, 401 N. Broad St., Phila., Pa. 19108. (215) 922-8900.

CGH HIGH VOLTAGE

183

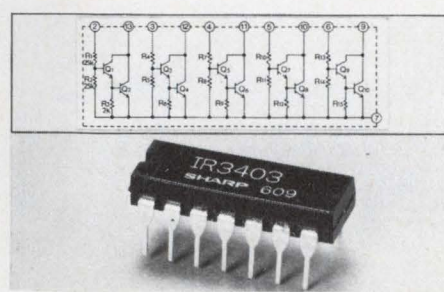

DUAL IN-LINE HIGH CURRENT DRIVER BLOCK • Special driver for Seiko 310, extra versatile. • 5 Darlington's with 350 mA output current each. • 26V supply voltage. • 14 pins. • Off-the-shelf sales. • 45 cents each for 50K FOB Japan. Contact: Sharp Corporation, Semiconductor Div., 2613-1 Ichinomoto, Tenri City, Nara 632, Japan. Phone: (07436) 5-1321. Tel: 5522364 SHAPEL J

DARLINGTON ICs

186

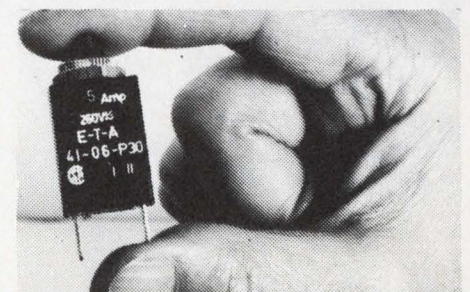

Overcurrent Protector, manual reset eliminates fuse replacement. Convenient panel mounting. 19 fractional ratings from 0.1 to 5 amp. Other models up to 400 amp. Trip-free and fool-proof, UL and CSA approved. High quality, low cost \$1.39 ea. in 1000 lots. E-T-A Products Co. of America, 7400 N. Crounace Rd., Chicago, Ill. 60648. Tel: (312) 647-8303. Telex: 253780.

CIRCUIT BREAKER

189

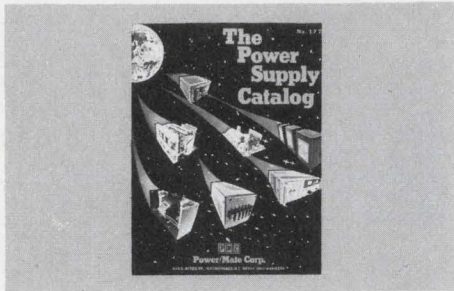

Free New '77 catalog contains over 34,500 quality power supplies from the world's largest manufacturer, Power/Mate Corp. Power Supplies for every application including submodulars, open frame, variorated, encapsulated, laboratory & system. All units UL approved and meet most military and commercial specs for industrial and computer uses. Power/Mate Corp., 514 S. River St., Hackensack, NJ 07601 (201) 343-6294

POWER SUPPLIES

190

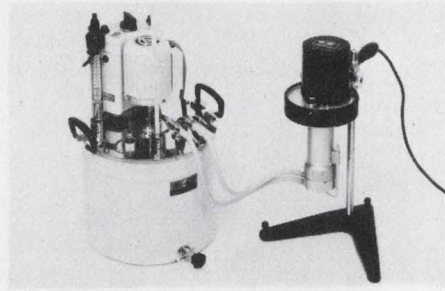

Wells-Brookfield Cone/Plate Viscometer fits the higher shear rates needed for evaluation of thick film inks, routinely develops viscosity data required with excellent precision and reproducibility. Ideal instrument for research and economical quality control procedures. Requires less than 1/2 cc of sample. Under \$1800 complete with constant temperature bath. Applications include ink formulations, quality control and batch tests. Brookfield Engineering Laboratories, Inc. 240 Cushing Street, Stoughton, MA 02072

THICK FILM INK VISCOMETERS

193

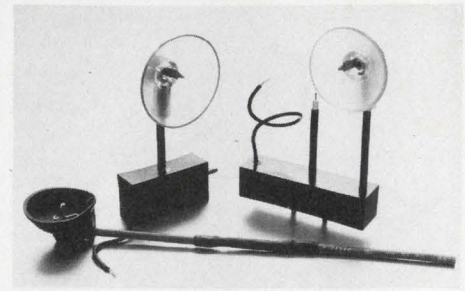

HIGH VOLTAGE RECTIFIER ASSEMBLIES FOR CRT DISPLAYS. • Inline 5-40 KV Rectifier Assemblies. • 5-20 KV Rectifier Bleeder Assemblies. • 5-90 KV Voltage Multipliers. • Tailored Circuit Designs. • Custom Mechanical Configurations. • Corona-free Assemblies. • For all types of high voltage rectifiers, diodes or assemblies, call or write: Galileo Electro-Optics Corporation, Galileo Park, Sturbridge, MA 01518. 617-347-9191.

RECTIFIER ASSEMBLIES

196

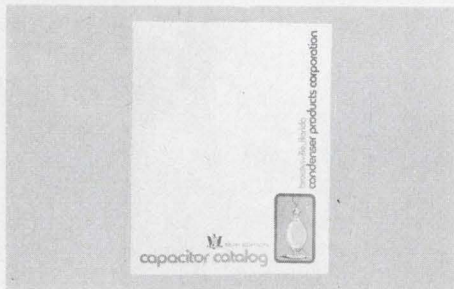

FREE HIGH VOLTAGE CAPACITOR CATALOG. Complete source listings for over 1000 power, pulse, high voltage, and special purpose capacitors and high voltage power supplies in glass, plastic and CP72 styles. Special low inductance types for laser and high energy applications. Many "custom" designs are standard with us. High reliability, long life, moderate cost, and fast delivery assured. To get your catalog, just drop us a line. Condenser Products Corporation, P.O. Box 997, Brooksville, FL 33512.

HIGH VOLTAGE CAPACITOR CATALOG 191

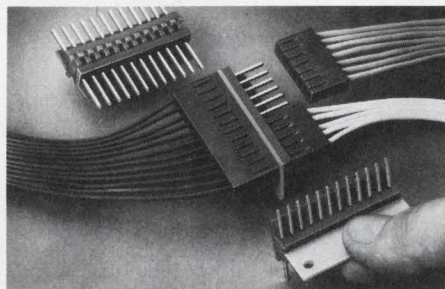

NEW "DOUBLE-HEADER" MINIATURE CONNECTOR ANSWER TO MYRIAD OF CONNECTION PROBLEMS. Have dual set of pins that interface with DIFFERENT SIZE crimp contact receptacles. In-line or right angle configurations with screw, rivet or snap-in PC board bulkhead mounts available. Permits identification of each pin with permanent legend on connector. Great for flying interconnects. METHODE ELECTRONICS, INC. 1700 Hicks Road, Dept. PR., Rolling Meadows, Illinois 60008. (312) 392-3500.

DOUBLE-HEADER CONNECTORS

194

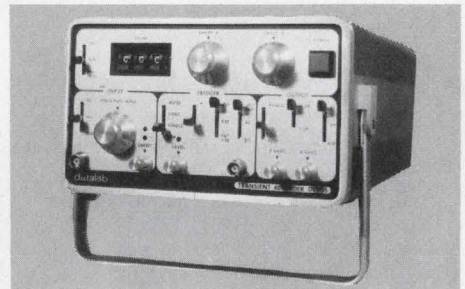

TRANSIENT RECORDER: Single voltage transients, repetitive waveforms, or very slowly changing signals can all be recorded by the DL905 Transient Recorder in its digital memory. The Captured signal may be viewed on an oscilloscope, a permanent record produced on a chart recorder and a digital readout obtained to feed a digital recording device or general use computer. Four models available, DL905 price \$3100, 4-6 wks. Call Bob Merritt, New Process 5529 N. Figueroa St. Los Angeles Ca 90042 (213) 258-6264.

TRANSIENT RECORDER

197

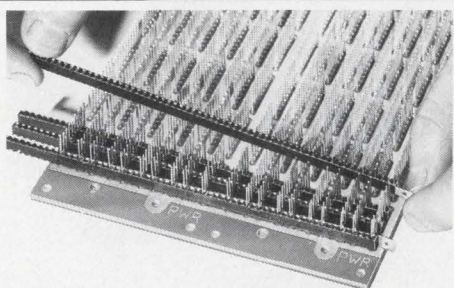

QUIK/STRIP BY ROGERS. Fast, low-cost system for connecting in-line pins on DIP socket boards and connector arrays. Shock and vibration resistant. 18 gauge current capacity. Can be used on pin densities as high as .100" x .100" and be stacked two or more high. Write or call for details. Rogers Corporation, Chandler, AZ 85224. Phone: (602) 963-4584. (EUROPE: Mektron NV, Gent, Belgium; JAPAN: Nippon Mektron, Tokyo.)

QUIK/STRIP

192

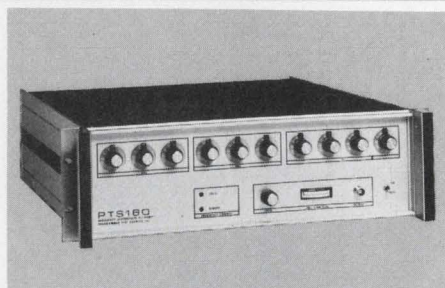

PROGRAMMABLE 160 MHz SIGNAL SOURCE. The PTS 160 offers steps as fine as 0.1 Hz from 100 KHz-160 MHz with local or remote control. Fast switching, low noise/spurs make this the best source for ATE, resonance studies, sat-com or lab needs: 1 V into 50 Ω 75 dB spurs, 66 dB phase noise, 3×10^{-9} /D, low power drain, high reliability. Options: Resolution, freq. standard, controls. Prices: \$3250 to \$4800 PROGRAMMED TEST SOURCES INC. LITTLETON, MA 01460; (617)-486-3731

FREQUENCY SYNTHESIZER

195

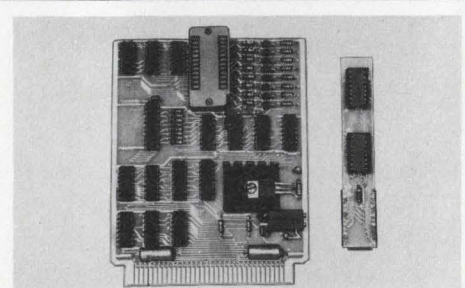

Low-cost bipolar PROM programmer plugs directly in National Semiconductor's LC/DS. Functions: initial verification of PROMs, programming PROMs, verification of programmed data against source data, duplication of PROMs, copy PROM into RAM, full error checking. Executes from LC/DS panel or from TTY. Software runs from MM5204Q on CPU card. Integrated Logic Systems, 17B Culbo Drive, West Hartford, CT 06110, (203) 525-5318. A division of The Guest Corporation.

PROM PROGRAMMER

198

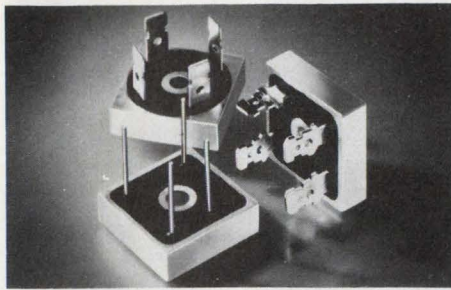

AVALANCHE SILICON BRIDGE RECTIFIER ASSEMBLIES. Sarkes Tarzian produces the industry's broadest line of standard bridge rectifier assemblies in designs from 1.8 to 500 amps and up to 1400 PIV. Available with positive or negative centertap or doubler circuits. Assemblies also available with controlled avalanche and fast recovery. Full design service for custom-built specials. Sarkes Tarzian, Inc., Semiconductor Division, 415 No. College Avenue, Bloomington, IN 47401; (812) 332-1435.

BRIDGE RECTIFIER ASSEMBLIES

199

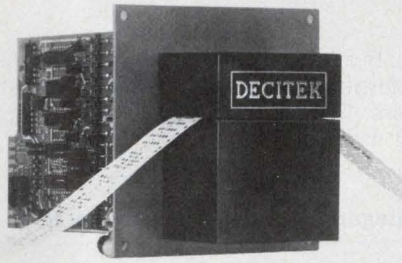

Low-cost tape reader is fast—up to 300 cps—and quality-built. Dual sprocket drive, a state-of-the-art fiber optic light source and photo transistor read head. Simplicity of design makes it easy to adapt to specific OEM requirements. Decitek, 250 Chandler Street, Worcester, MA 01602 (617) 798-8731

SAM[®] TAPE READER

201

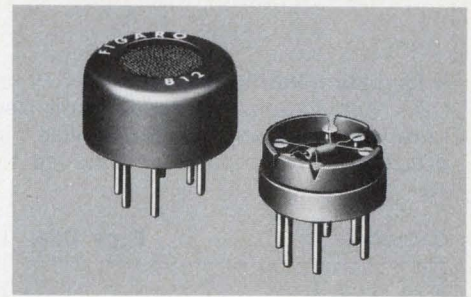

FIGARO GAS SENSOR TGS is a gas sensitive semiconductor. When combustible gas is absorbed on the sensor surface, a marked decrease of electrical resistance occurs. Major features of the sensor include high sensitivity, long term reliability and low cost. The applications are: GAS-LEAK ALARM, AUTOMATIC FAN CONTROL, FIRE ALARM, ALCOHOL DETECTOR, etc. Figaro Engineering Inc., North America Office-3303 Harbor Boulevard, Suite D-8, Costa Mesa, Calif. 92626 Tel: (714) 751-4103 Telex: 678396

GAS SENSOR

204

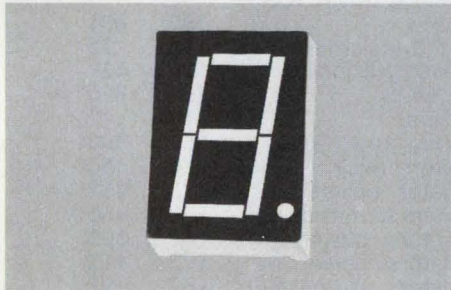

1" RED LED DISPLAYS AVAILABLE FROM IEE. In stock - In production - Series 1720 has bright red characters readable up to 60 feet and at angles of more than 160°. This KING-SIZE 1 inch LED comes in either 0-9 or ± 1 , common anode or common cathode configurations with 14-pin DIP connections. Typical 20mA per segment/3.3V_F power provides 500 μ cd of high contrast brightness. Available OFF-THE-SHELF at \$2.75 in 500-piece quantities. IEE, 7740 Lemona Avenue, Van Nuys, CA 91405, (213) 787-0311, ext. 268.

1" LEDS

200

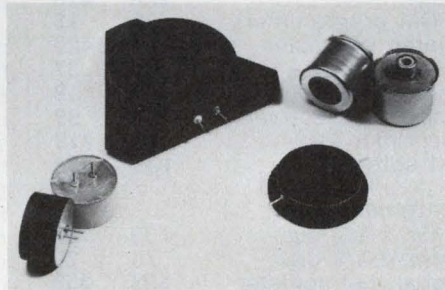

LOW COST AIR ACOUSTIC TRANSDUCERS. Extremely sensitive transmitting/receiving devices are available at low cost from Linden. These ultrasonic air transducers are single frequency devices utilizing a piezoelectric ceramic element. Transducers are available in standard models and custom designs to meet your specification. Write for a free catalog. LINDEN LABORATORIES, INC., Box 920, State College, PA 16801, 814-355-5491. A RESOURCE MANAGEMENT CORPORATION SUBSIDIARY.

ULTRASONIC TRANSDUCERS

202

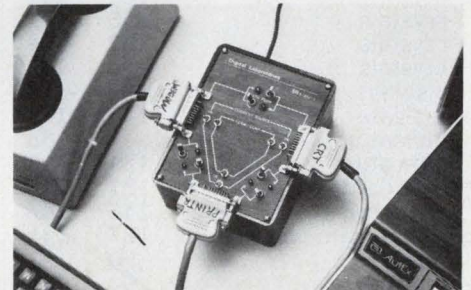

UNIVERSAL JUNCTION UNIT . . . for three devices, RS232C or current loop.

. . . Six switches provide all 63 interconnects that are possible between three I-O devices. LED's indicate data flow. . . . Designed to provide circuit compatibility and easy data routing between different manufacturer's devices. . . . \$350 (1-4) from DIGITAL LABORATORIES, 600 Pleasant St., Watertown, MA 02172 (617) 924-1680

3 PORT RS232 & 20 MA LOOP

205

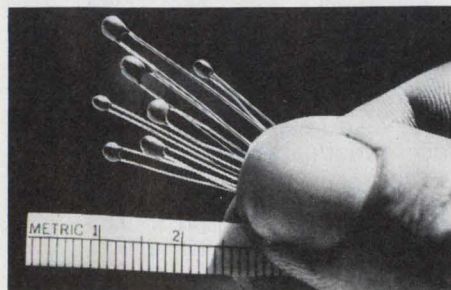

THERMISTORS with leads and coating are highly reliable low cost components in small dimensions more compatible with modern circuit design. R @ 25°C 100 Ω to 1 meg Ω $\pm 10\%$ to $\pm 1\%$. CURVE MATCHED INTERCHANGEABLES to $\pm .25^\circ\text{C}$. POINT MATCHED INTERCHANGEABLES to $\pm .2^\circ\text{C}$. Call or write for HP97 or TI SR52 THERMISTOR LINEARIZATION PROGRAM. WESTERN THERMISTOR CORPORATION, 403 Via El Centro, Oceanside, CA 92054. (714) 433-4484.

THERMISTOR



COMPUTER SYSTEM BUILDERS' CATALOG 48 pages packed with descriptions of micro kits, software, and peripherals such as video monitors, terminals, printers, and disk drives. Includes special report "All about Hobby Microcomputer Systems" with a comparison chart between 5 popular microcomputers. Also reviews of over 100 books—the largest selection of computer titles ever assembled. Send \$1 to COMPUTER WAREHOUSE STORE, Dept C, PO box 69, Kenmore Sta, Boston, MA 02215

SYSTEM BUILDERS' CATALOG

203

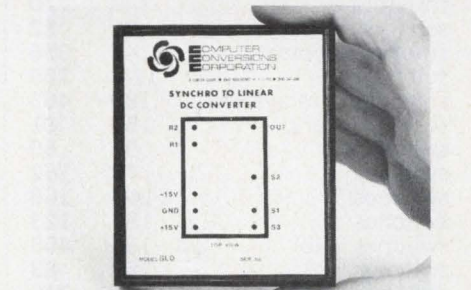

Synchro to Linear DC Converter: Infinite Resolution. Full ($\pm 180^\circ$) or Limited Angle DC Output ($\pm 90^\circ$), ± 6 or ± 15 minute accuracy at input rates up to 1440°/sec., 60 or 400 Hz input. Custom Output scaling available. Module 2.6" x 3.1" x .82" H. Price from \$350 in quantity. Other CCC Products are Synchro to Digital, Digital to DC, Solid State C.T.'s or CDX's, and Absolute Encoders. Send for Free Catalog & Application Notes. Computer Conversions Corp., East Northport, N.Y. 11731—(516-261-3300).

SYNCHRO TO LINEAR DC

206

Category	Page	RSN
8-bit MOS μ P (NL)	186	457
Microwaves & Lasers		
components, microwave	163	86
fiber-optic datalink	162	381
filter, low-pass	162	384
Gunn oscillator	162	383
isolator	162	386
microwave tubes, diodes (NL)	186	456
mixer, high-level	162	388
oscillator, v.c.	162	387
radiation monitor	162	385
single-balanced mixer	162	389
termination	162	382
Modules & Subassemblies		
alarm-sensing circuit (AN)	182	435
amp, instrumentation	129	322
amplifier, FET	125	304
attenuator, digital	130	323
communication components (NL)	186	462
compensator, tc	129	321
converters, a/d	178	117
data acquisition	125	306
data acquisition	125	307
encoders, decoders (AN)	182	438
filter, DTMS	129	310
function circuits (NL)	186	459
indicators	6	168
mixer, double-balanced	126	308
oscillators, crystal	129	320
power amplifiers	140	61
power amplifier	165	91
shaft encoder	179	120
solid-state relays (NL)	186	463
surge protectors	126	309
thick-film hybrids	186	450
timer	130	324
7-digit LED counter (AN)	182	439
Packaging & Materials		
adapter plugs	140	339
axial fan	142	344
cable, two-pair bus	144	346
cap, safety	183	133
coatings	130	54
communication com- ponents (NL)	186	462
connectors	75	27
connectors	128	53
connectors, flat	114K	171
connectors, wire-wrapped	140	337
custom hybrids	175	111
electronic housings	142	63
enclosures	114A	161
enclosures	171	101
LCD mount	142	341
magnetic shielding	141	62
oxide-free solder cream (ES)	182	433

Category	Page	RSN
personnel grounder	140	336
pinsockets	144	345
potting compound	142	342
shielding	65	26
sockets, LSI	179	119
static meter	140	340
test accessories	126	51
thermal-conductor	142	343
torch, soldering	140	338
wire strippers	166	93
Power Sources		
batteries	168	95
batteries	180	122
converter, dc/dc	178	425
converter, dc/dc, HV	178	424
power supplies	114D	164
power supplies	153	75
power supplies	165	89
power supplies, μ P	176	115
power supply	187	139
power supply, CRT	180	429
power supply, dc	178	426
power supply, dc	180	428
surge arresters	151	73
transformer, reg.	178	427
new literature		
bridge rectifiers	186	448
CAMAC equipment	186	452
CMOS	186	447
catalog	152	74
catalog, DIP	III	245
communication components	186	462
engineering encyclopedia	186	460
function circuits	186	459
microwave tubes	186	456
motor catalog	187	141
peripheral driver ICs	186	451
power sources	186	461
solid-state relays	186	463
spectrum analyzer	186	453
splicing products	186	454
switches	186	458
thick-film hybrids	186	450
thyristors	186	455
wire-wrapping	186	449
8-bit MOS μ P	186	457
application notes		
alarm sensing circuit	182	435
encoders, decoders	182	438
input noise	182	434
instrumentation	182	436
timing measurements	182	437
7-digit LED counter	182	439
evaluation samples		
containers	182	430
oxide-free solder cream	182	433
potentiometers	182	432
soft ferrite beads	182	431

GOOD BOOKS ARE HARD TO FIND.



WHY HIDE YOURS?

We are always looking for well-written manuscripts, or book proposals, for works on topics of interest to professional engineers that will advance their understanding of the state of their art.

What have you been working on?

What can we do for each other?

Let me know.

S. WILLIAM COOK
EDITORIAL DIRECTOR



Hayden Book Co., Inc.
50 ESSEX STREET
ROCHELLE PARK, N.J. 07662

Advertiser's index

Advertiser	Page	Advertiser	Page	Advertiser	Page
AMP, Incorporated.....	128, 129, 189	Galileo Electro-Optics Corp.....	190	NEC Microcomputers, Inc.....	114H-I
Acheson Colloids Company, Electrical Products.....	130	General Electric Company.....	34A	National Semiconductor Corporation.....	134, 135
Advanced Micro Devices.....	4, 5	General Electric Company, Instrument Rentals.....	26	New Process Metrology.....	190
Advertising Council.....	182	Gold Book, The.....	143, 188	Newport Laboratories, Inc.....	176
Allied Chemical, Metglas Products.....	141	Gould, Inc., Instrument Systems Division.....	101	Nichicon (America) Corporation.....	114
Analog Devices, Inc.....	27	Grayhill, Inc.....	160	Noritake Co., Ltd.....	161
Ann Arbor Terminals, Inc.....	173	Guardian Electric Manufacturing Company.....	117	North American Philips Controls Corp.....	183
Arrow-M Corp.....	124	Gulton Industries, Inc., Measurement & Control System Division.....	154	Ohio Semitronics.....	179
B & K Products of Dynascan Corporation.....	76	HEI, Inc.....	111	Par-Metal Products, Inc.....	142
Beckman/Helipot Division.....	114F	Hansen Manufacturing Co.....	119	*Philips Test & Measuring Instruments.....	123
Belden Corporation.....	79	Harris Semiconductor, A Division of Harris Corporation.....	138, 139	Philips Test & Measuring Instruments, Inc.....	114J
Bliley Electric Co.....	150	Harlow Co.....	189	Power Conversion, Inc.....	180
Bodine Electric Company.....	187	Hayden Book Company, Inc.....	148, 182, 184, 193	Power/Mate Corp.....	176, 190
Boker's, Inc.....	165	Heinemann Electric Company.....	171	Practical Automation Inc.....	175
Bourns, Inc., Trimpot Products Division.....	Cover II	Hewlett-Packard.....	9 thru 18, 24, 25	Precision Monolithics, Incorporated.....	121
Braemar Computer Devices, Inc.....	169	Hoffman Engineering Company.....	171	Programmed Test Sources, Inc.....	190
Brookfield Engineering Labs, Inc.....	190	Houston Instrument, A Division of Bausch & Lomb.....	146	Pro-Log Corporation.....	28
Bud Industries, Inc.....	114A	Hughes Aircraft Company, Div. Solid State.....	34E	Pyrofilm Corporation.....	177
CTS Corporation.....	167	Hydelco, Inc.....	175	RCA Distributor & Special Products Division, Sales Promotion Services.....	115
Carpenter Mfg. Co., Inc.....	166	IEE.....	191	RCA Electro Optics.....	159
Centronics.....	34D	IMC Magnetics Corporation.....	172	RCA Solid State.....	Cover IV
Cherry Electrical Products Corp.....	95	ITT Pomona Electronics.....	126	Rental Electronics, Inc.....	114G
Citizen America Corporation.....	181	Intel Corporation.....	42, 43	Riken Denshi Co., Ltd.....	187
Clifton Precision.....	50	Intel Memory Systems.....	127	Rogers Corporation.....	189, 190
Clinton Electronics Corporation.....	147	Intelligent Systems, Inc.....	132, 133	SMK Electronics Corporation of America.....	179
Computer Automation Inc.....	77	Interdata, Inc.....	113	Sarkes-Tarzian, Inc.....	191
Computer Conversions Corp.....	191	Integrated Logic Systems.....	190	Schauer Manufacturing Corp.....	156
Computer Decisions.....	34H, 146A-B	International Rectifier.....	64	Semtech Corporation.....	112
Computer Products, Inc.....	153	Itoh Electronics, Inc., C.....	185	Sharp Electronics Corporation.....	189
Computer Survey Card.....	50A-B	JFD Electronics Corporation.....	172	Shugart Associates.....	155
Computer Warehouse Store.....	191	Johanson/Dielectrics, Inc.....	189	Siemens Corporation.....	114C
Condenser Products Corporation.....	190	Johanson Manufacturing Corp.....	19	Sprague Electric Company.....	32, 131
Control Data Corporation.....	56, 57	Kaye Instruments.....	173	Stackpole Components Company.....	51
Control Data Corporation, Magnetic Components Division.....	165	Keltec Florida Division, Aiken Industries.....	114D	Standard Grigsby, Inc.....	158
Cromenco.....	34C	Kulka Electric Corp.....	183	Stanford Applied Engineering, Inc.....	41
Crown Industrial.....	165	Licon, Division of Illinois Tool Works, Inc.....	114L	Statek Corp.....	189
Dana Laboratories, Inc.....	136	Linden Laboratories, Inc.....	191	Sweda International OEM Products.....	150
Data General Corporation.....	23	Littelfuse, Subsidiary of Tracor.....	114E	TII Corporation, Telecommunications Division.....	151
Data I/O Corporation.....	137	Logical Services Incorporated.....	164	TRW/IRC Resistors.....	189
Data Precision Corporation.....	63	London Company, The.....	154	TRW/UTC Transformers, an Electronic Components Division of TRW, Inc.....	102
Datel Systems, Inc.....	8	MCG Electronics.....	182	Tektronix, Inc.....	31
Datum, Inc.....	7	M-Tron Industries, Inc.....	170	Teledyne Semiconductor.....	83
Decitek.....	191	Magnecraft Electric Company..	Cover III	Tele-Dynamics, Division of Ambac.....	187
Dialight, A North American Philips Company.....	110	Magnetic Shield Division, Perfection Mica Company.....	170	Teletype Corporation.....	34
Digital Equipment Corporation.....	152	Magnetics, Inc.....	183	Thermalloy Company.....	185
Digital Laboratories.....	191	Mallory Capacitor Company.....	93	Theta Instrument Corp.....	179
ECD Corporation.....	33	*Matsuo Electric Co., Ltd.....	144	Triad/Utrad.....	144
*EMI Ltd. SE Labs.....	117	Maxi-Switch Co.....	114B	Triple I, A division of the Economy Co.....	187
E-T-A Products Co. of America.....	189	Mechanical Enterprises, Inc.....	181	Turner Designs.....	169
Eagle Magnetic Co., Inc.....	189	Merrimac Industries, Incorporated.....	163	Union Carbide Corporation, Components Department.....	35
Eagle-Picher Industries, Inc.....	168	Metex Corporation.....	65	United Systems Corporation.....	6
Electro-Craft Corporation.....	94	Methode Electronics, Inc.....	190	Varian Data Machines.....	103
Electrocube Corp.....	180	Micro Devices Corp.....	169	Vishay Resistive Systems Group.....	149
Electronic Applications Corp.....	175	Micro Networks Corporation.....	178	Waters Manufacturing Inc.....	184
Electronic Arrays, Inc.....	34G	Miltape.....	34B	Wavetek San Diego, Inc.....	2
Electronic Design.....	34F, 171, 172	Minelco, a Talley Industries Company.....	174	Western Thermistor Corporation.....	191
Electronic Navigation Industries.....	140	Mini-Circuits Laboratory, A Division of Scientific Components Corp.....	2	Weston Components.....	181
Electronic Processors Incorporated.....	78	Molex, Incorporated.....	114K		
Elmwood Sensors, Inc.....	82	MuPro Associates.....	20		
Esterline Electronics, an Esterline Company.....	166				
Facit-Addo, Inc.....	157				
Fairchild Semiconductor, A Division of Fairchild Camera and Instrument Corporation.....	145				
Figaro Engineering, Inc.....	191				
GTE Automatic Electric.....	123				
GTE Sylvania, Parts Division.....	75				

*Advertisers in non-U.S. edition

**Workers. They've always been with us.
But Magnecraft has a colony of DIPs
that really perform dependably.**

Write for our new DIP Catalog

Magnecraft[®] 5575 North Lynch Avenue, Chicago, IL 60630 312/282-5500
ELECTRIC COMPANY

CIRCLE NUMBER 245



In high-voltage CMOS designs...

To B or to UB? RCA COS/MOS helps with the answer.

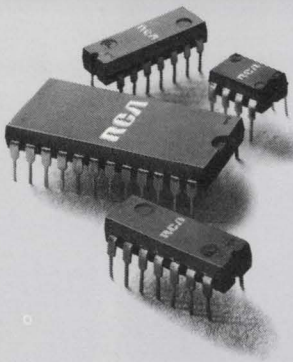

Not all B-Series CMOS is buffered — that's why there's a UB suffix. RCA experience shows that certain designs call for a buffered gate, but in others, unbuffered is better. Only the designer is in a position to decide.

That's why we offer you both. To JEDEC specs. With COS/MOS you don't have to worry about non-interchangeability of "B" devices in applications where speed, noise immunity, output impedance and linear gain-bandwidth characteristics are critical. As the table shows, you can select the COS/MOS option that does what you want in the environment to be faced — without having to add components or compromise on system performance.

Get the RCA B-Series Product Guide from your Solid State distributor. Or RCA.

Which COS/MOS option is best for your design?

Requirement/environment	Buffered	Unbuffered
High speed		x
Ultra-low frequency		x
High freq., moderate gain, linear amplification		x
High-noise environment, low-speed system	x	
Constant output impedance	x	
Low freq., high gain, linear amplification	x	

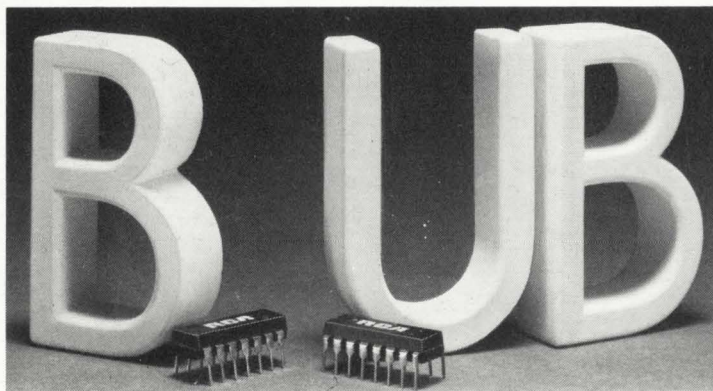

Buffered B

Unbuffered B

CD4000B
CD4001B
CD4002B
CD4011B
CD4012B
CD4023B
CD4025B

CD4000UB
CD4001UB
CD4002UB
CD4011UB
CD4012UB
CD4023UB
CD4025UB

Write: RCA Solid State, Box 3200, Somerville, NJ 08876; Sunbury-on-Thames, Middlesex TW16 7HW, England; Ste-Anne-de-Bellevue, Quebec, Canada; Fuji Bldg., Tokyo, Japan.

RCA COS/MOS experience is working for you.