

▲ **PART II: ALISA SYSTEM REVIEW**
PRICE WATERHOUSE'S ALEN DARR MAKES THE
FINAL MAC-TO-VAX CONNECTION PAGE 54

**HC/WG LABS
FIRST KIT:
AN OPUS
WORKSTATION**

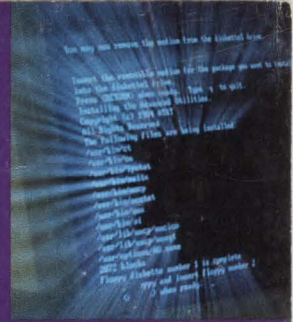

HARDcopy®

NEED TO KNOW™ SOLUTIONS FOR DEC COMPUTING

APRIL 15, 1988, VOL.8, NO.3 \$3.00

REPORT 4 OPERATING SYSTEMS PAGE 32

PLAYING YOUR TUNE

- ▲ **DEC'S LICENSING:** A POLICY TO FIT YOU...OR A BENEFIT TO THEM? PAGE 15
- ▲ **SAA:** UNIFORMITY ACROSS APPLICATIONS AND NETWORKS PAGE 22



A Classic Approach to Mass Storage! Optical Disk Jukebox for VAX/VMS™

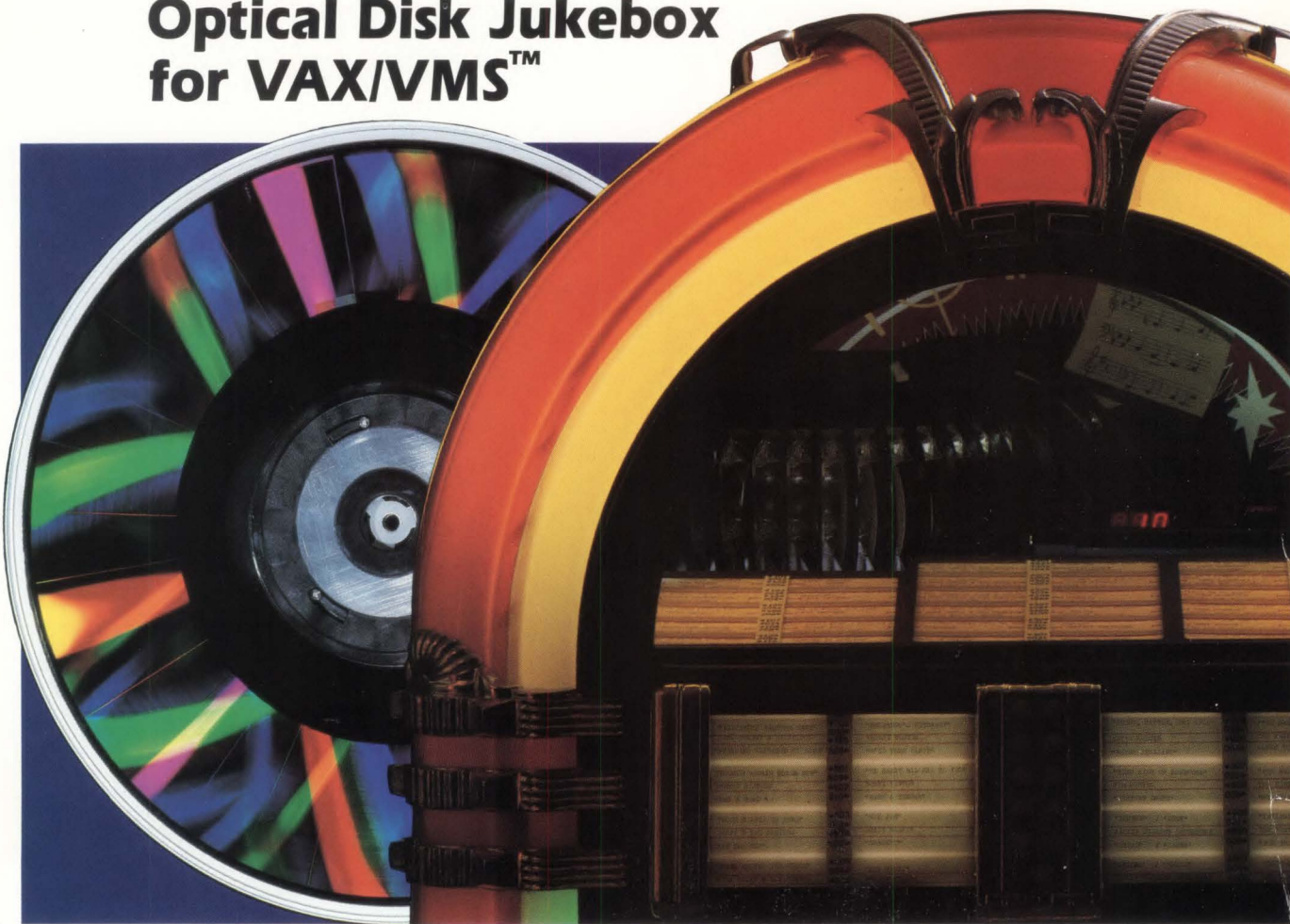

Introducing LaserStar™, a complete optical disk jukebox subsystem.

Perceptics' LaserStar brings the massive storage capacity of optical disk jukeboxes to the fingertips of VAX/VMS users. Combining the latest in optical storage technology with the classic "jukebox" concept of disk handling, LaserStar provides convenient, on-line storage and retrieval of vast amounts of data using write-once optical disks.

The LaserStar jukebox consists of a robotic disk handling mechanism, a media storage unit, and one or more optical disk drives. The system also includes a host adapter, Perceptics LaserStar software, and installation. Optional items

include 12-inch double-sided media and on-site maintenance. A variety of drive/media configurations are available to meet your specific budget and performance requirements, with total on-line storage capacities ranging from tens to hundreds of gigabytes. Media are fully compatible with Perceptics' LaserSystem™ optical disk subsystem.

LaserStar software provides automatic, VMS-transparent access to the jukebox optical

disk library. Based upon Perceptics' industry standard LaserWare™ software, LaserStar is completely compatible with VMS utilities and applications. Thus, each optical disk volume in the jukebox may be accessed with **no changes** to your existing software.

**Contact us for your
custom system
requirements!**

perceptics

Perceptics Corporation
Pellissippi Corporate Center
Knoxville, TN 37933-0991, USA
(615) 966-9200
FAX (615) 966-9330

Codonics brings you the first affordable graphics terminal without the jaggies

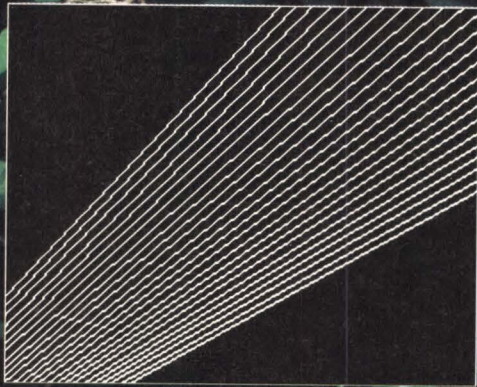

The competition's 1024 x 780 pixel display

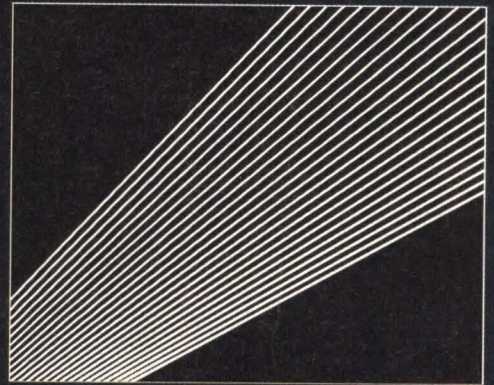

Codonics' true-line™ display

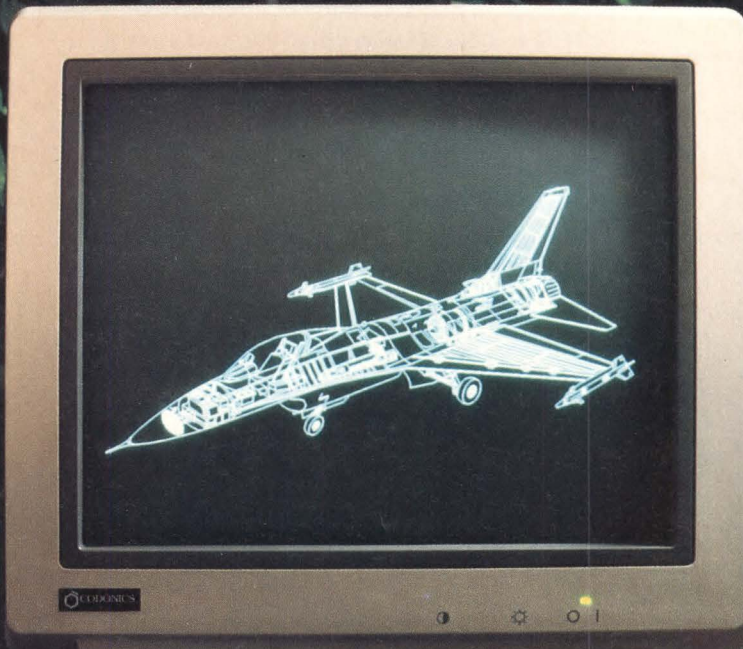

The Codonics 4096. Finally, a graphics terminal with Tektronix 4010/4014 emulation, DEC VT320/220/100 alphanumerics and no jaggies.

A few features:

- ▶ 16,000 x 12,000 effective resolution, utilizing Codonics' true-line™ beam geometry hardware
- ▶ True 4096 x 4096 sub-pixel addressability
- ▶ DEC VT320/220/100 emulation with high definition fonts
- ▶ Flawless Tektronix 4010/4014 emulation
- ▶ True pan and zoom with display list cache
- ▶ 73 Hz non-interlaced flickerless display
- ▶ Built in hardcopy support utilizing Codonics' true-line™ technology
- ▶ Mouse included as a standard feature

Our team of sales engineers are awaiting your call. 1-800-444-1198



CODONICS

We bring the Future into Focus

Computer Graphics Division
18001 Englewood Drive
Middleburg Hts., Ohio 44130
Telephone (216) 243-1198
Telex 650-292-8429

Codonics and true-line are trademarks of Cleveland Codonics, Inc.
DEC VT320/220/100 are trademarks of Digital Equipment Corporation.
Tektronix is a trademark of Tektronix, Inc.

See us at DEXPO/Spring '88—Booth # 1241

CIRCLE 376 ON READER CARD

FROM THE BLUE LINE

April is the beginning of spring and an excellent time for us to reflect on how well we have served you as a publication. We believe that *Hardcopy* serves up the best editorial package available in the Digital Equipment Corp. marketplace. But we need to know how well you think we've done; especially during the first three months of this year. Now is your chance to step up to the mike, in this case, the bingo-card number, and have your say.

The process is simple. Below are a number of questions with various answers. Circle the number on the reader service card that corresponds to the answer that best reflects how you feel about *Hardcopy*.

If you have more to say, don't be shy. You can write to us at *Hardcopy* Magazine, 1061 S. Melrose Ave., Ste. D., Placentia, CA 92670-7180, 714-632-6924 (inside CA), 800-247-7930, or MCI-Mail: 252-1932.

Carl Warren
Editor In Chief

1. *Hardcopy's* new editorial look is:

125 Excellent 126 Average 127 Needs Improvement

2. The section I like the most is:

128 Tech Focus 129 Feature Reports 130 HOW Reviews
131 Product Focus 132 Product News 133 Bus Stop
134 StorAGE

3. Rate the following columns:

VAX/VMS Toolbox:

135 Excellent 136 Average 137 Needs Improvement

PDP Perspective . . . RSX:

138 Excellent 139 Average 140 Needs Improvement

PDP Perspective . . . RT-11:

141 Excellent 142 Average 143 Needs Improvement

Graphics Notes:

144 Excellent 145 Average 146 Needs Improvement

PDP Perspective . . . RSTS:

195 Excellent 196 Average 197 Needs Improvement

Mass. Report:

198 Excellent 199 Average 200 Needs Improvement

4. Tech Focus

147 Provides me with information I can't get elsewhere

148 Is a fair mix of market and trend information

149 Not of very much value

5. In Tech Focus I would like to see:

150 More people-related stories and pictures

151 Interviews with key DEC personnel

152 A balanced mix of market and technology trends

153 Less analysis and marketing information

6. Should *Hardcopy* have interviews with key DEC personnel?

154 No, it's a waste of my time

155 Yes, I am interested in their perspective

156 No, I get that from other publications

157 Yes, I like interview articles

158 It has no place in *Hardcopy*

7. *Hardcopy* is a: (circle all that are appropriate)

159 News magazine

160 Feature magazine

161 Hardware magazine

162 Software magazine

163 Workstation magazine

8. I would prefer to see:

164 More tutorial articles

165 Fewer tutorial articles

166 More system integration articles

167 More application software articles

168 More development-tool software articles

169 The current article mix is just right

170 More emphasis on DEC-to-DEC

171 Less emphasis on DEC-to-DEC

172 More emphasis on multi-vendor connectivity

173 Less emphasis on multi-vendor connectivity

174 Only DEC-specific products

175 Fewer DEC-specific products

9. I read *Hardcopy* for:

176 News

177 New products

178 Highly focused, feature-level, HOW-to articles

179 The HOW reports and reviews

10. I am:

180 An OEM

181 A system integrator

182 A VAR or VAD

183 A large-scale end user

11. If I was the editor of *Hardcopy*, I would put more emphasis on:

184 Personal computers (including the Apple Macintosh)

185 Workstations

186 Apple computer products

187 Backplane issues

188 Networking issues

189 Application software

190 Development software

191 DEC-only products

12. How do you feel about articles on alternative buses such as Multibus, NuBus, VME, and Microchannel?

192 I want more coverage

193 They have no business in *Hardcopy*

194 I want more, but in relationship to the DEC environment



Closer to Genius

Introducing PowerHouse PC™, the most powerful 4GL for serious application development on a personal computer.

PowerHouse PC delivers more power than any other PC application development product. It gives you OS/2™ performance and integrated communications. And it gives you all of this — today.

PowerHouse now lets you prototype and build serious business applications on your PC in addition to HP, Digital and DG mid-range computers. The simplicity of one language across architectures gives you the flexibility of choosing the production environment that best suits your needs.

Use PowerHouse PC as a *development workstation* to develop applications for your mini, as a *host extension* to offload processing, or for *stand-alone* applications. Complete with a communications facility, PowerHouse PC makes the most of your resources by allowing you to share applications and data between architectures. What makes PowerHouse PC even smarter is that it runs under both *DOS and OS/2*.

When you're ready for serious application development on a personal computer, you're ready for PowerHouse PC.

COGNOS

OS/2 is a trademark of International Business Machines Corporation. The Cognos logo and PowerHouse are registered trademarks of Cognos Incorporated. PowerHouse PC is a Cognos trademark.

Cognos Corporation, 2 Corporate Place, 1-95, Peabody, MA, USA 01960, (800) 4-COGNOS. Cognos Incorporated, 3755 Riverside Drive, P.O. Box 9707, Ottawa, Ontario, Canada, K1G 3Z4, (613) 738-1440, Telex: 053-3836. Cognos Limited, Westerly Point, Market Street, Bracknell, Berkshire RG12 1QB, United Kingdom, National (0344) 486668, International +44 344 486668, Telex: 846337 Cognos G.

Introducing PVCS for VAX/VMS

The Leading Configuration Management System.



Unmatched Flexibility and Price/Performance Now Available for VAX Software Projects

The POLYTRON Version Control System (PVCS) simplifies and automates Configuration Management so programmers and managers can effectively control the revisions and versions of source code. Compare PVCS to DEC's CMS and Softool's CCC. You will see why PVCS is the most widely used change control product and is used by the leading software, aerospace, manufacturing and service companies.

Project Control

PVCS provides functions in five key areas: Management Control, Security and Access Control, Version Control, Project Reporting and Integration with PolyMake, the leading Make utility from POLYTRON. PVCS maintains a history of revisions to a source document and allows prior versions to be recreated very quickly at any time. The "source document" can be any file, which means program source code, object code, libraries and project documentation can each be stored and maintained in an individual PVCS "archive." These "source documents" can be written in any language or multiple languages.

Unmatched Flexibility

- Storage & Retrieval of Multiple Revisions of Source Code
- Maintenance of a Complete History of Changes
- Control of Separate Lines of Development (Branching)
- Resolution of Access Conflicts
- Optional Merging of Simultaneous Changes
- Release and Configuration Control
- Project Activity Reports
- Management Reports

"In terms of features, PVCS provides everything necessary to a large multiprogrammer project — more than any other package reviewed. No restrictions are placed in the development environment and all aspects of operation can be customized for specific project needs."

PC Tech Journal
September 1987

Fast Retrieval of Revisions

PVCS uses "reverse delta storage" which saves disk space and speeds retrieval of versions of any file in the project database. A delta is the set of differences between any revision and the previous revision. PVCS can rapidly recreate complete versions of any file whether it is the most recent revision of a module or the original version of the entire project. Differences are automatically detected and stored.

A Practical Necessity for Workgroups

While important for single-programmer projects, PVCS is absolutely essential for multiple-programmer projects where files are simply too easy to change. Because any change to any file can have major ramifications, coordinating and keeping a record of changes is critical. Project leaders can determine, on a module-by-module basis, which programmers can access or modify source files, libraries, object code and other files. The levels of security can be tailored to meet the needs of nearly every project.

Adopt PVCS on Your Existing Projects

You can obtain the benefits for your current project without disrupting development, regardless of how long your project has been underway. You can build PVCS archives from revisions stored in your present files or simply adopt PVCS from the current date.

Personal PVCS (MS-DOS) — Offers most of the power of Corporate PVCS, but excludes features necessary for multiple-programmer projects. \$149

Corporate PVCS (MS-DOS) — For managing large, multiple-programmer projects. \$395

Network PVCS (MS-DOS) File locking and security levels can be tailored for each project. \$995 for a 5 station LAN

PVCS for VAX/VMS — Uses same archive format and interface as MS-DOS versions and manages large, multiple-programmer projects. MicroVAX \$4,950, VAX 7XX \$9,500, VAX 8xxx \$10,500+

TO ORDER:

1-800-547-4000

Dept. HCY

Oregon & Outside USA

Call (503) 645-1150

Send Checks, P.O.s to:
POLYTRON Corporation
1700 NW 167th Place
Beaverton, OR 97006

HARDcopy

NEED TO KNOW™ SOLUTIONS FOR DEC COMPUTING

PUBLISHER George R. Seldin
ASSOCIATE PUBLISHER Susan R. Francis

EDITOR IN CHIEF Carl Warren
MANAGING EDITOR Catherine Semar
MIDWEST EDITOR Brad Harrison, 500 W. Prospect, Ste. 111,
N. Aggie Village, Fort Collins, CO 80526, 303-491-8963
EAST COAST EDITOR Lynn Haber, 6 Funewil Hall
Marketplace, Boston, MA 02109, 617-723-2477

SENIOR COPY EDITOR Bonnie Brisson
ASSISTANT COPY EDITOR Sean Smithson
ASSOCIATE EDITOR Kimberly Schulze
EDITORIAL ASSISTANT Cindy Grant-Thurman
SENIOR STAFF CONSULTANT Robert Peterson
SENIOR EDITOR Edith Myers

CONTRIBUTING AUTHOR David Spencer
COLUMNISTS Milton Campbell, Steve Davis, Robert
Gezelter, Mark Hartman, Matthew Owen,
Edward R. Teja

TECHNOLOGY EDITORS

COMMUNICATIONS EDITOR Robert Pap
INTERFACE/CONTROLLER AND STANDARDS EDITORS I. Dal Allan,
Kenneth J. Hallam
MAGNETIC STORAGE EDITOR Tom Gardner
OPTICAL STORAGE EDITOR George Langworthy
STORAGE MARKET EDITOR Phil Devin

DEC/WG LABS PERSONNEL

SENIOR SCIENTIST AND LAB MANAGER Steve Bostwick
SENIOR RESPONDENT—HARDWARE Richard Stencross
SENIOR RESPONDENT—SOFTWARE Chris Serrano

EXECUTIVE DESIGN DIRECTOR Roger L. Morrison
PRODUCTION MANAGER Dave Dalmas
ASSISTANT ART DIRECTOR Marianne Weldon

NATIONAL SALES MANAGER Cal James Franklin, 1061 S.
Melrose Ave., Ste. D, Placentia, CA 92670-7180,
714-632-6924

CIRCULATION DIRECTOR Dianne Hoff
MARKETING MANAGER Renee P. Brown

ADMINISTRATIVE SERVICES Wendy R. May
ADMINISTRATIVE SECRETARY Andrea Bolander
ACCOUNTING MANAGER Otto Ingram, Jr.

POSTMASTER: Send address changes WITHIN USA to: Hardcopy magazine, P.O. Box 759, Brea, CA 92621-0759. Send changes of address OUTSIDE USA to: Hardcopy, Seldin Publishing Inc., c/o PDS, European Circulation Center, Radlett Rd., Colney St., St. Albans Herts, AL2 2EG, England. Hardcopy magazine ISSN 0279-8123 is published monthly by Seldin Publishing Inc., 1061 S. Melrose Ave., Ste. D, Placentia, CA 92670-7180. Subscriptions are complimentary to qualified sites in the U.S., Canada, and Mexico; foreign air mail \$100. All orders must be prepaid. Hardcopy magazine is an independent journal, not affiliated in any way with Digital Equipment Corp. Hardcopy® is a registered trademark of Seldin Publishing Inc. StorAGE®, SofCopy®, and SoftCopy® are trademarks of Seldin Publishing Inc. Adobe® and PostScript® are trademarks of Adobe Systems Inc. DEC is a registered trademark of Digital Equipment Corp. The term "UNIX" is the trademark of AT&T. Entire contents © 1988 Seldin Publishing Inc. All rights reserved; material in this publication may not be reproduced in any form without permission. Second-class postage paid at Placentia, CA 92670 and additional mailing offices.

ddb DIGITAL DEALERS ASSOCIATION

BPA

POLYTRON

High Quality Software Since 1982 CIRCLE 432 ON READER CARD



Two jams Welch Foods will never get into – Payroll and Human Resource Management

The people at Welch Foods know that home-grown payroll and human resource management systems are not the answer. There are just so many administrative and legislative updates, that reprogramming becomes a real problem. That's one of the reasons why Welch Foods has chosen the Cyborg Payroll and Human Resource Management Systems. We offer enough flexibility to react to most any user-situation without program changes. And, we offer you total support.

The Cyborg Support Team helps you out of maintenance jams by supplying you with all government-dictated changes. We also give you convenient methods for implementing your own payroll/personnel updates, including a vehicle for mass changes. Plus, help is always just a phone call away.

There's always a support-specialist available to help you through a difficult problem or to just answer a question on simple procedures. We're here to help you 24 hours a day. Which just goes to show that Cyborg Support knows almost as much about jams as Welch Foods.

Call today for information on Cyborg's Payroll and Human Resource Management software. Our software runs on all leading mainframe and mini computers.

The Solution Series™
SOFTWARE BY CYBORG

From what they say, you'd think that all terminal manufacturers are industry leaders. And that their terminals provide unmatched performance, emulation, reliability, value, and just about anything else you could want. We say all that too, about GraphOn. And about our terminals. So we're not surprised that the other guys say it. They're not about to say that their terminals are almost as good as ours. But the fact is that people *are buying* terminals that are almost as good as ours. We know you want the best DEC and Tek emulations you can get—along with all the other features of a top terminal. So we're happy to send you specifications and other information about GraphOn monochrome and color terminals, but... It's one thing to read about all the features and benefits of a terminal. It's another thing to actually experience them. Face it. There's really only one way to judge a terminal. And that's to see it at work on your own applications, in your own environment. Phone us today for your special hands-on demonstration. 1-800-GRAPHON.



GraphOn

A black and white photograph showing a group of people in a dark room. In the foreground, a woman on the left and a man on the right, both wearing white lab coats, are looking intently at a computer terminal. The woman has her hand to her mouth in a surprised expression, and the man has a wide, open-mouthed smile. In the background, two other men in suits are also looking towards the terminal. The scene is lit with dramatic, low-key lighting, creating a sense of mystery and excitement.

**Face it.
There's really only one way
to judge a terminal.**

TECH FOCUS

- 15 Beware! Read the Fine Print Before You Sign on the Dotted Line** One customer of a third-party vendor didn't even know he'd paid for VMS until he was asked for \$7,500 when he added one user
by Edith Myers

- 17 Bargains Galore! Computer Graphics Within Your Financial Reach***/by Brad Harrison*

- 22 DEC Takes Cue From Big Blue***/by Robert Pap*

- 26 Desktop Publishing Moves from 2nd Ave. to Madison Ave.*/by Lynn Haber***



HC/WG Labs reads the Traverse menu—page 48

FEATURES

HC/WG Labs drives through the plethora of operating systems—page 32



- 32 Report 4: Operating Systems—The Medusa Within** Serving as system overseer and encapsulating umbrella for applications, today's operating systems offer multiuser and multitasking capability plus network management while providing commonality of operation regardless of whether it's a PDP-, VAX-, or microprocessor-based system*/by the HC/WG Laboratory Staff*

- 43 IBM PC/AT = UNIX Workstation. Believe it or Not!** If you're thinking about attaching a workstation to increase the distributed processing power of your VAX, the HC/WG Lab Staff shows you how to turn an IBM PC/AT into a powerful UNIX workstation without losing the use of your DOS-based applications*/by the HC/WG Laboratory Staff*

CONTENTS CONTINUED ON PAGE 10

STORAGE

- 8** **Winchesters 'To Go'** Although disk pack technology is all but gone, users are still looking for removability for security purposes, as well as to extend the storage capability of the system/by *Tom Gardner*
- 4** **I. Dal Allan and Ken Hallam's I/O Update** Optical standards . . . Why bother? After all, aren't they still trying to make that stuff work?
- 14** **George Langworthy's Insights to Optical Storage** Some interactive thoughts
- 18** **Phil Devin's Rotations** Maybe there really is a subsystem market



Graphics galore (and affordable, too!)—page 17

HOW REVIEW

- 48** **Now You Can Traverse the VMS Menu**/by the *HC/WG Laboratory Staff*

HC/WG LABS HOW REPORT

- 54** **Here it is! Part II of the HC/WG Lab AlisaTalk Evaluation**/by *Alen Darr and Paul Morrin*

PRODUCT FOCUS

- 93** **Put Away Your Bifocals and Search and Scroll** No More Moniterm Corp.'s Models VY1962 and VL2462 monochrome monitors

HC/WG Labs turns an IBM PC/AT into a powerful UNIX workstation—page 43



- 94** **You Beta Use VHS** Digi-Data Corp.'s Gigastore

DEPARTMENTS

From the Blue Line	4
Letters	12
Who to Contact at <i>Hardcopy</i>	12
In the Queue	50
Product News	97
Mini Mart	117
New/Used Equipment	118
Calendar	129
Bus Stop	130

COLUMNS

The Mass. Report	30
VAX/VMS Toolbox by <i>Steve Davis and Matthew Owen</i>	83
PDP Perspective . . . RT-11 by <i>Milton Campbell</i>	87
Graphics Notes by <i>Edward Teja</i>	89



Providing multiuser and multitasking capability, XENIX offers you the benefit of being able to define the application environment, thus letting you play your application tune your way. The notion of jukebox environment was art directed and designed by Bruce Steinberg, vice president of marketing communications, Santa Cruz Operations (Santa Cruz, CA), exclusively for *Hardcopy* magazine. Photography by Tony Grant; production assistant Kathleen Roberts.

We can integrate Digital's networking VAXmate into a total information system for you.



Digital's VAXmate desktop computer with Digital LA75 companion printer

As an Authorized Distributor for Digital Equipment Corp., MTI has an extensive background with Digital's network products, including second generation Thinwire Ethernet, DEConnect cabling system, and DECnet networking software. We can integrate VAXmate desktop computers into a high-speed information exchange with other personal computers as well as Digital's VAX, MicroVAX and VAXcluster systems, and even IBM mainframes.

We are also a full service distributor. In addition to our networking expertise, MTI is your source for all computer and data communications equipment. We offer sales, leases, or rental plans, service contracts and

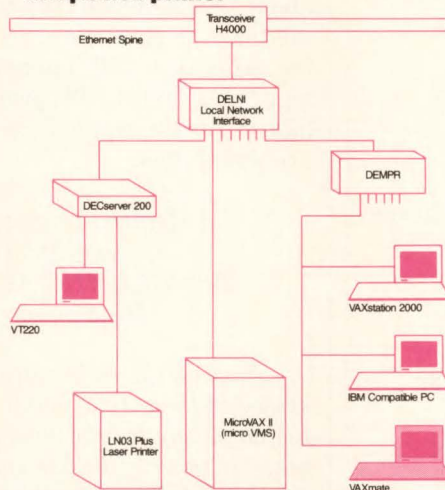

The key to VAXmate's network capabilities is VAX/VMS services for MS™-DOS.

supplies and accessories. Our prices are very, competitive, too. Call us today.

The following are registered trademarks for Digital Equipment Corp: VAXmate, DEConnect, DECnet, VAX, MicroVAX, VAXcluster, VAX/VMS, VT220, LN03, and VAXstation 2000. MS-DOS is a trademark of Microsoft Corporation. IBM is a trademark of International Business Machines, Inc. Ethernet is a trademark of Xerox Corporation.

For more information on the VAXmate, call our toll free number or the MTI office nearest you.

800/645-6530

New York:

718/767-0677

516/621-6200

518/449-5959

212/226-2337

New Jersey:

201/227-5552

Massachusetts:

617/270-9890

Connecticut:

203/284-8109

Pennsylvania:

412/931-9351

Ohio:

216/464-6688

513/531-0688

Illinois:

312/773-2300

Kentucky:

502/426-7696

Georgia:

404/447-6662

Florida:

813/874-6444

305/486-4004

Alabama:

205/830-9526

Wisconsin:

414/785-5500

Colorado:

303/799-8525

Arizona:

602/431-0016

Utah:

801/485-4900

California:

818/718-0073

714/220-6487

619/268-4730

408/947-3588



Celebrating our 20th year!

MTI SYSTEMS CORP.

Where service and support make the difference.

CIRCLE 416 ON READER CARD

digital™
Authorized Distributor

WHO TO CONTACT AT HARDCOPY

If you have questions regarding *Hardcopy* editorial, feel free to contact the appropriate *Hardcopy* editor/author.

I. Dal Allan & Ken Hallam, I/O
ENDL Consulting
14426 Black Walnut Ct.
Saratoga, CA 95070
408-867-6630

Steve Bostwick, Senior Scientist
HC/WG Labs
1061 S. Melrose Ave., Ste. D
Placentia, CA 92670-7180
714-632-6924

Milton Campbell, RT-11
Talisman Systems
Drawer CP255
Manhattan Beach, CA 92503
213-318-2206

Steve Davis/Matthew Owen,
VAX/VMS Toolbox
Owen + Davis Systems
3100 Airway Ave. #116
Costa Mesa, CA 92626
714-540-8878

Phil Devin, Rotations
1290 Ridder Park Rd.
San Jose, CA 95131
408-437-8211

Tom Gardner, Magnetic Storage
14469 Manuella Rd.
Los Altos, CA 94022
415-941-5324

Robert Gezelter, RSX
27-42 168th St. #312
Flushing, NY 11358-1130
718-463-1079

Mark Hartman, RSTS
2404 E. Nutwood #E23
Fullerton, CA 92631
714-738-8300

George Langworthy,
Optical Storage
6025 Martway #111
Mission, KS 66202
913-268-8775

Robert Pap, Communications
Sheraton Office Center #A180
409 Chestnut St.
Chattanooga, TN 37402
615-267-5959

David Spencer, Review Support
2600 V St.
Sacramento, CA 95818
916-456-7000

Edward Teja, Graphics Notes
704 N.E. 61st Ave.
Portland, OR 97213
503-231-9914

LETTERS

TONER PROBLEM IS MESSY

In reading Renee P. Brown's article "Consumables Eat Up Majority of Laser Printer Maintenance Expense," *Hardcopy*, February 1988, page 28, I was shocked to find a glaring error in regards to toner replacement for DEC's LN03 laser printer.

In actuality, the \$83 toner maintenance kit contains enough toner to print 6000+ pages. The maintenance kit must be applied every 10,000+ pages, *not* every time you have to replace toner.

Please be careful in little things like this, as I tend to disregard anything else an author may have to say about "costs" when they make such mistakes. If Brown overestimated the general cost of toner replacement on a DEC LN03, perhaps the figures for the Apple LaserWriter are wrong, too.

David Meile
Health Computer Sciences
University of Minnesota
Box 511 UMHC, 420 Delaware
Minneapolis, MN 55455

Since all the information presented in the article was accurate, we see no reason for the comments you made in your letter. You should read more carefully before you point out errors. Nowhere in Brown's article does she state that you must use an LN03 maintenance kit every time you replace a toner cartridge in the printer.

The amount of toner used in a laser printer depends on printer usage, which is different at every site. The article explains that for proper maintenance of LN03 printers, DEC requires the purchase of both kits. It gives no time frame as to when or how often either kit should be used. This information was supplied by sources at DEC and an independent third-party printing supplies dealer. The pricing of both kits is listed in DEC's supply catalogue DECdirect Plus.

The article was written to supply our readers with a basic understand-

ing of the cost of ownership of a laser printer, quoting suggested list prices of consumables and parts. Statistics in the article were supplied by industry analysts who follow the market and are considered experts in the field. If you disagree with their findings, we suggest you become a printer analyst and conduct your own study.—Ed.

GREMLINS IN THE VMS TOOLBOX

It would appear that more than one gremlin found their way into the February VAX/VMS Toolbox, page 83.

Rather than having logical data and time functions, a nice notion, the authors were referring to the so-called lexical functions of DATE AND TIME, found in VMS. Additionally, we seemed to have added a few extra spaces for SHOW DAY-TIME. According to authors Steve Davis and Matthew Owen, entering it as we showed, SHOW DAY TIME, will cause an error. And typing DATE at the VMS \$ prompt will not yield the current system date and time in standard notation. It will yield the message: "%DCL-W-IVVERB, unrecognized command verb—check validity and spelling"

Entering DAY:==@PRINT—DAY.COM into the login command file will not cause the current system date to be displayed at log-in. What it does do is to create the symbol DAY so that if you type DAY at the dollar sign, it will activate the procedure.

Although we seem to have created a little havoc, the CODE as shown does work.—Ed.

We welcome your comments . . .

Send letters to:

Letters

Hardcopy Magazine

1061 S. Melrose, Ste. D

Placentia, CA 92670-7180

All letters should be signed and include a phone number where you can be reached during the day. We reserve the right to edit letters for style, space, and clarity.

When Used Isn't Good Enough

Sometimes NEW is too much and USED isn't good enough. Our REMANUFACTURED DEC* computer equipment fills this void and offers the best of both worlds.



Quality Equipment

- CAD/CAM Diagnostics
- Fully Inspected for Wear
- Six- Month Warranty
- Lease/Finance Options

Depot Repair

- Repair/Exchange Service
- Complete Testing
- Volume Discounting
- Six- Month Warranty

Call for a price list



RESTOR
a Cincinnati Bell company

7880 Foundation Drive
Florence, Kentucky 41042
800-722-477

*DEC Registered Trademark

CIRCLE 411 ON READER CARD

We set out to do for the VAX what Lotus did for the PC.



Introducing abc, THE spreadsheet for VAX computers.

Feature-for-Feature, AOK.abc is the spreadsheet for you.

Because if you know 1-2-3, the industry spreadsheet standard, you know abc.

And when you can save the cost of retraining your 1-2-3 users, you've saved time AND money!

If you could work with a familiar spreadsheet AND have access to your database files, what more could you ask?

Ask for a spreadsheet with more features than any of the others!

If you bought any other VAX spreadsheet, would it...

Feature eight presentation-quality graph types?

Read and write all Lotus files and execute 1-2-3 macros?

Provide Macro-Journaling and Auto-Recovery?

Have 150+ Built-in, Programmable and String functions?

Link and Consolidate spreadsheets?

Run on over 45 types of terminals?

And when you can pay a lower price for a better spreadsheet than the others, what more could you ask?

Ask for a demo today!

30-day evaluation copies include all spreadsheet functions and features. All demo fees are credited upon purchase.

Call today, or write to find out more about AOK.abc.

(312) 884-7123



AOK Software Products, Inc.
1305 Wiley Rd., Ste. 102
Schaumburg, IL 60173

CIRCLE 437 ON READER CARD

USER-BASED LICENSE FEES FOR VMS CAN BRING SURPRISES

One customer of a third-party vendor didn't even know he'd paid for VMS until he was asked for \$7,500 when he added one user

by Edith Myers, Senior Editor

Is Digital Equipment Corp. becoming another IBM? Many have said so. Some think this is good and some aren't so sure. Those who think it's a good thing point to increasing customer sensitivity as the company becomes more marketing oriented. Those who think it's bad, suggests Alan Clifford of Jager Computer Systems (Calgary, Alberta, Canada), a DEC software developer, go so far as to say, "The world doesn't need two IBMs," and he, too, is talking about marketing.

His particular concern is DEC's licensing policies for the VMS operating system on the MicroVAX. "It doesn't cost them any more if we have 40 users or eight at one time," says Clifford.

DEC does have a multiple-user licensing plan for the MicroVAX that differs from what it offers on its bigger machines. Dave Chase, business manager for DEC's systems software group, calls it "two different licensing methodologies: user-based and machine-dependent."

Picking Up Slack

Jager's Clifford calls DEC's licensing policy "a [stone in the shoe] and a marketing ploy on the part of Digital to get more out of the customer. It's logical that DEC is playing hardball with software licensing. Indeed, hardware prices are coming down and they need something to pick up the slack."

DEC's Chase explains the MicroVAX licensing policy: "The methodology we use for the MicroVAX is user based. You buy a li-

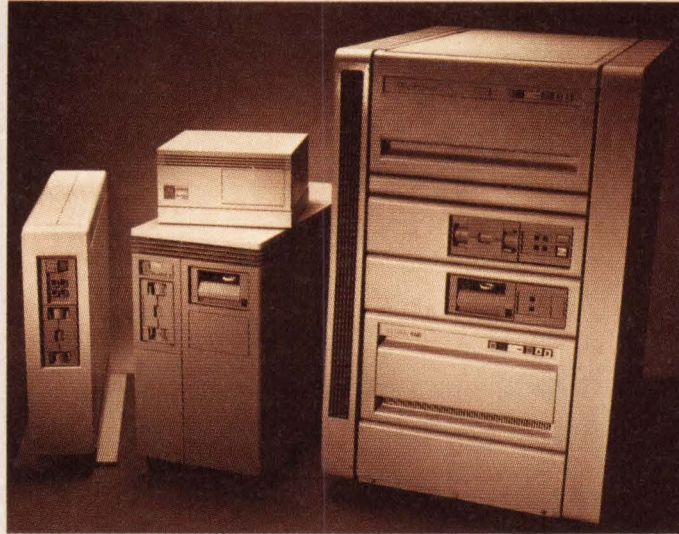

DEC's licensing policy for its MicroVAX family of computers has been termed by some users as a "marketing ploy to get more out of the customer." Others see it as a need for DEC to maintain profitability. Whatever the reason, costs are clearly being passed on to the users.

cense based on the number of users logging onto a system." He notes that pricing starts at \$2,100 for a two-user system license for the MicroVAX II (he notes similar price structures apply to the MicroVAX 2000, 3500, and 3600) then goes to \$6,300 for an eight-user license. A 16-user license, however, goes for \$13,650. But, if you elect to add even one more user, the price zooms to \$18,980.

By contrast, the machine-dependent VMS license for a VAX 8200 is \$21,000 and, for the largest processor in the VAX class, the VAX 8800, \$73,500—regardless of the number of users.

OS/2 Policy

Machine-dependent licensing is more typical; user-sensitive licensing is not prevalent. IBM's licensing policy for OS/2, for example, is bundled with the hardware. The license is per-machine and the ap-

proximate cost is \$290. Moreover, this varies with volume discounts. The price gives you the right to make backup copies of the operating system—a notion that is not clear for DEC users.

OS/2 Standard Edition isn't in widespread use. But, with databases and other applications forthcoming from companies like Ashton-Tate Corp. (Torrance, CA) and Lotus Development Corp. (Cambridge, MA), it is viewed as a potential threat to DEC's hold on the mid-range computer world. Additionally, some industry observers believe OS/2 may further stifle DEC's attempts to expand onto the desk top.

Although OS/2 provides multitasking capability and LAN links, IBM is quick to point out that OS/2 is not a multiuser operating system. But, with the networking hooks built in, OS/2 allows access to multiple devices and other users.

The Pick operating sys-

tem, on the other hand, is a multiuser system. Monica Giobbi of International Spectrum, a San Diego-based organization that sponsors Pick-oriented conferences, says that all Pick licensees charge their customers on a per-machine rather than a per-user basis for their licenses. Thus, licensees aren't burdened with new changes every time a user is added.

A Bit of a Shock

As a MicroVAX user, you possibly aren't even aware that you have a user-based license—particularly if you bought from a third party. Bruce Biller, president of Information Concepts Inc. (City of Industry, CA), a DEC value added reseller (VAR), cites one such tale. "We have a customer who has an eight-user license. When they added a ninth user, DEC made them cough up an additional \$7,500 for a 16-user license—that came as a little bit of a shock," remembers Biller.

Biller says that it's difficult for companies to guess how fast or how big they're going to grow: "Deciding on the right license is pure guesswork."

Since most businesses do have ups and downs, Biller thinks DEC should reconsider its licensing/pricing policy: "The smaller user is really hard pressed." He suggests that DEC should consider some form of incremental pricing "... for the smaller account."

Cluster Licenses

Besides the user-based license fees for VMS, there are objections to DEC's cluster licenses for applications such as All-In-1,

continued on page 16

continued from page 15
DEC's multifunction business information application program. "We have one customer," says Biller, "a large health network, who would love to use All-In-1. The problem is that only a few people would be using it. But this company has a cluster, thus forcing an expensive cluster license. They're not going to do it."

Not That Unhappy

Even though Biller is vocal about DEC's disparities in licensing, he isn't unhappy. "They have treated us right for the past couple of years [the amount of time Biller has been a DEC VAR] and we've gotten excellent support," says Biller.

Not everyone is so optimistic. Jager's Clifford, for one, foresees an adoption of user-based pricing on DEC's bigger machines. "It's a logical follow-on, particularly as hardware sales are increasingly a smaller portion of their total revenue," says Clifford.

DEC is clearly motivated by profit, and Bob Ran-

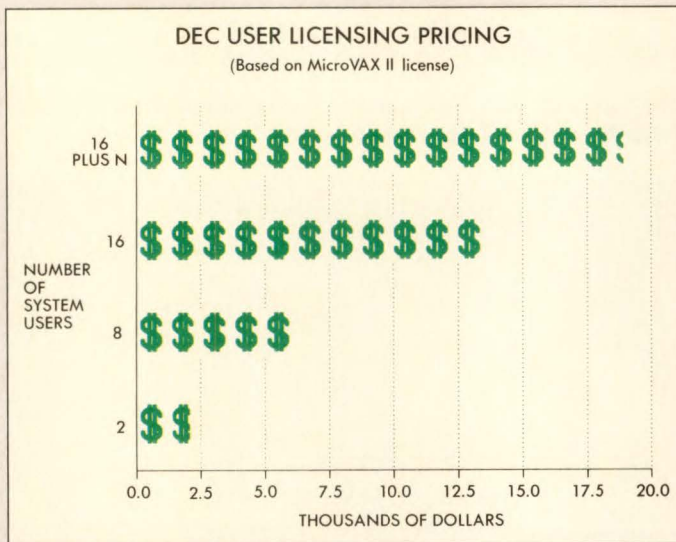

MicroVAX II license pricing starts at \$2,100 for a two-user system license, then increases to \$6,300 for an eight-user system license. More than double this price, and you've got the cost of a 16-user license: \$13,650. If you add even one more user beyond 16, the price soars to \$18,980.

dolph, an analyst with International Data Corp. (Framingham, MA), sees the user-based licensing practice as a reflection of a need to show profit. "Software pricing has always been a problem for hardware vendors. Everyone's experimenting. DEC has

moved from the early mini-computer thought process that held that software wasn't very valuable and could be given away, to a realization that it needs to make money from software," explains Randolph.

Software currently represents the highest profit

margin available to computer makers. Randolph says that "it can represent as big a margin as 70-80%. Hardware margins, on the other hand, have dipped to 20 or 30%."

DEC is indeed spending a tremendous amount of money to gain market share against IBM. Industry analysts estimate that DEC's administrative costs increased by 35% last year. As a consequence, to maintain profitability they need to create higher margins to offset the higher cost of doing business. Unfortunately, the costs are passed on to the users.

The reason other computer manufacturers aren't using user-based license pricing is, in Randolph's estimation, "... because they haven't thought of it or they didn't think they could get away with it." Now that DEC is doing it, Randolph suspects that others will follow suit. "That's what software pricing is all about. You look at the competition and try to adopt a similar strategy," says Randolph.

Loss at the Network

Another factor that Randolph and others believe DEC is facing is concern with how to get paid for use of software on a network. Most companies contend that when you put software in a server environment, control is lost over the machines and users. The result is a perceived loss of revenue.

User-based license pricing is a way hardware vendors are ensuring that you pay your fair share for software use—not necessarily fair to the user but certainly profitable to the hardware vendor. The incremental structure used by DEC may be the fairest approach. Typically, users are added in groups, and, says Randolph, DEC appears to have established reasonable ranges. ■

THE SHOT HEARD 'ROUND THE WORLD

Operating system licensing problems aren't new in the Digital Equipment Corp. world.

In late 1986, DEC announced that it would no longer allow the transfer of a VMS license from one machine to another or from one owner of a given machine to another owner of the same machine. This was like "the shot heard 'round the world," because of the hue and cry raised by DEC users and dealers.

"It's too expensive to upgrade," they (users) lamented.

"It's impossible to sell in the used market," complained DEC's dealers.

Objections to this policy evidently carried sufficient weight with DEC to cause

this policy to be reversed in March 1987. However, not all problems associated with the transfer policy have disappeared.

Disappearing Paperwork

C.D. Smith, president of C.D. Smith & Assoc. (Houston, TX), a company that buys and resells used DEC systems, says it's hard to track licenses for older systems. "The new paperwork is different and much of the old paperwork has been lost. If I acquire a system that was sold in 1985, and the seller never went back to DEC for an upgrade, it's hard to transfer the license because I can't track it," says Smith.

In contrast, Jack Clinton, president of Clinton

Digital (Framingham, MA), a DEC systems integrator, says he has had tracking problems but, "it's getting better since they [DEC] gave that responsibility to Field Service."

Not everyone is convinced that the restrictions have been relaxed. Smith says, "Many DEC salesmen don't know about the changed policy. They've interfered with our license transfers and held things up."

The problem may be geographical, suggests IDC analyst Bob Randolph. "Consistency of sales operations has always been a problem for DEC," says Randolph, "they haven't got an institutionalized effort the way IBM has." ■

GRAPHICS DEVICES CHEAP ON PRICE, NOT ON PERFORMANCE

by Brad Harrison,
Midwest Editor

Desktop graphics devices, CRTs, and printers are getting cheaper. But don't mistake low cost for lack of performance. Indeed, just the opposite is true. The latest round of CRTs and printers are sporting high-resolution graphics and speedy output. For example, alphanumeric terminals are being cast aside in favor of a new generation of monochrome and color graphics equipment, such as that offered by Monterm Corp. (see Product Focus page 93), which provides plug-compatible 19- and 24-in. monochrome monitors throughout the industry.

DEC Graphics

Digital Equipment Corp. is clearly aware of this trend. The VT330 and VT340 advanced graphics workstation terminals, introduced within the past year, sport full graphics functionality to take advantage of powerful software tools that are becoming available.

Some manufacturers, such as Human Designed Systems Inc., a manufacturer of low-cost monochrome terminals, are moving to a combination alphanumeric/graphics terminal: "There's a growing base of software that requires graphics capabilities," says Mike Kantrowitz, director of marketing. He suspects that alphanumeric-only terminals are dead.

Kantrowitz and others contend that graphics is more than just a buzzword normally associated with engineering. "Graphics is encompassing much more than engineering. Business presentation graphics and desktop publishing are putting big demands on the pe-



With a price tag of \$1,200, Human Designed Systems Inc.'s HDS3200 Model 30 Image Leader monochrome terminal provides affordable 1056 x 800 resolution for a wide variety of graphics applications.

ripherals," says Kantrowitz. Agreeing is market research firm Dataquest Inc.'s (San Jose, CA) Mike Tyler: "Users want powerful graphics devices at their fingertips." He explains that the PC opened the graphics doorway "... and for a very few dollars. So it's natural to assume that it will migrate upward."

Because of the availability of powerful processing engines, creating a distributed graphics workcluster has become amazingly cheap, says Kantrowitz. For example, for less than \$6,000, you can buy an Intel 80386-based machine running UNIX, a 20-Mbyte hard disk, and four HDS3200 Model 10 monochrome terminals (at \$700 each). This system will support graphics applications ranging from spreadsheet graphics to elementary CAD/CAM—capabilities that used to come with a price tag many times greater. Another company offering multiple emulations in a low-cost graphics terminal is Modgraph; its Model

GX2000 is a \$1,500 monochrome terminal that can work as either a DEC VT220/100/52 or a Tektronix Inc. 4010/4014.

Not Really Dead

Not everyone is conceding the death of monographic terminals, however. Tyler's associate, Greg

Blatnik, for one, agrees that, although terminals are incorporating many of the elements of the PC, the alphanumeric base is still the largest. "This may change significantly in the future, but for now the core of the terminal business is still alphanumeric," says Blatnik.

Tyler believes all that's really holding back mass migration to graphics is the cost difference and some performance issues. His contention is that companies buy according to the bottom line and alphanumeric terminals are still the least expensive. He adds, "It's also performance. A serial RS-232C connection is a small pipe to be pushing graphics data through." Newer graphics terminals are using RS-422 and video interfaces. But, even though they move throughput, "it isn't for free, ..." warns Tyler.

Color graphics terminal emulation on a PC brings many capabilities to the desk top or engineering design center at a refreshing-
continued on page 18

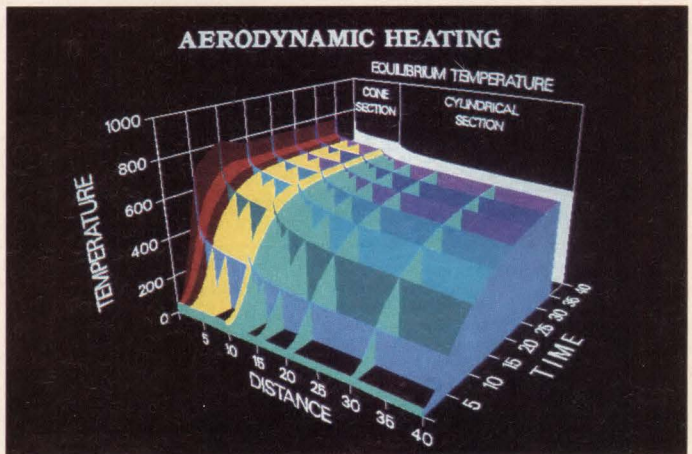

For less than \$4,000, the Tektronix Inc. 4207 terminal provides high resolution (640 x 480), 64 colors (16 displayable at any given time), and pan and zoom. The full image stored by the terminal is actually 4096 x 4096 pixels, allowing the user to view the different parts of a much larger image without requiring host intervention.

continued from page 17
ly low cost. With the almost ridiculously cheap price of PC hardware—in some cases less than \$1,000 for a fully equipped system—which has resulted from the very competitive PC marketplace, DEC users can equip their installations with full-color VT alphanumeric and Tektronix graphics emulation for less than the cost of the lowest-priced color graphics terminals, plus get all the advantages of having a PC.

For example, consider using TGRAF emulation software on a PC outfitted with EGA card, DOS, and color monitor. This emulation package lets you access any Tektronix-compatible graphics application running on a VAX or PDP host.

But graphics emulation often doesn't meet expectations. To this end, Grafpoint's 715 hardware-software emulation product is a terminal enhancement board that's connected to the EGA card in the PC. The company claims significant increases in speed and resolution, but be aware that the 715 carries a hefty price tag—\$1,495.

For \$1,000 more, you can have the real thing—a color Tektronix graphics terminal, the Tek-4205. That's Tektronix' lowest-priced terminal, but the company has a marketing agreement with Grafpoint to sell the TGRAF emulation software to customers who don't want to spend the \$2,495.

A Graphics Challenge

The competition for low-cost color graphics terminals is heating up. Companies such as Colorgraphic Communications Corp., Graph-On Corp., Pericom Inc., and Visual Technology Inc. are challenging Tektronix' low-end products with high-quality color terminals that act just like their Tektronix counterparts.

Taking advantage of graphics terminal functions is Access Technology Inc. Its 20/20 spreadsheet application package supports Tektronix protocols, DEC's ReGIS, and Sun and Apollo

workstations.

20/20 is a classic example of the drift in application software toward support for graphics—and with low-cost color terminals, the trend is gaining mo-

mentum and now color printers are making their contribution as well.

Much like terminals, output devices such as printers are starting to fit
continued on page 20

Table—Economical Color Printers

Company	Product Name	Technology	Speed	Interface	Emulation	Price
Advanced Matrix Technology Inc. 1157 Tourmaline Dr. Newbury Park, CA 91320 805-499-8741 Circle No. 212	AMT Office Printer Plus	Dot-matrix	250 cps	Parallel or serial	LQP02, LA120, LA210, Tektronix 4696 Inkjet	\$1,845
Brother Int'l. Corp. 8 Corporate Pl. Piscataway, NJ 08854 201-981-0300 Circle No. 226	M-2518	18-pin dot-matrix	360 cps	Parallel serial (opt.)	Epson, EX + FX, IBM Pro-Printer XL	\$1,295
Canon U.S.A. Inc. One Canon Plaza Lake Success, NY 11042 516-488-6700 Circle No. 227	PJ-1080A	Ink-jet	37 cps	Parallel	Epson	\$699
Digital Equipment Corp. Maynard, MA 01754 800-343-4040 Circle No. 228	LJ250	Ink-jet	167 cps	Parallel or serial	ReGIS, SIXEL, HP-PCL	\$1,695
Hewlett-Packard Inc. 16399 W. Bernardo Dr. San Diego, CA 92127 619-592-8010 Circle No. 229	PaintJet	Thermal ink-jet	30–40 seconds per page (text), 4 minutes per page (graphics)	Parallel or serial	Hewlett-Packard	\$1,395
IBM Corp. Direct Response Mktg. 101 Paragon Dr. Montvale, NJ 07645 800-IBM-2468 Circle No. 230	Model 3852 Jetprinter	Color ink-jet	20 cps (letter quality), 50 cps (draft)	Parallel	IBM	\$745
Infoscribe Inc. 11507 Sunset Hills Rd. Reston, VA 22090 703-689-2805 Circle No. 231	1200-DP	Dot-matrix	200 cps (text), 12.5 or 6.25 ips (graphics)	Parallel or serial	IBM Graphics, Prism, Epson, Diablo 630, Anadex	\$1,995
Printronix Inc. P.O. Box 19559 Irvine, CA 92713 714-863-1900 Circle No. 232	S7024C	Dot-matrix	240 cps	Parallel or serial	IBM ProPrinter, IBM 3287, IBM 5225	\$1,490
Tektronix Inc. Info. Display Group P.O. Box 15273 Portland, OR 97215 Circle No. 233	4696	Ink-jet	0.47 square inches per second (graphics)	Parallel	Tektronix	\$1,795
Toshiba America Inc. Info. Systems Div. 9740 Irvine Blvd. Irvine, CA 92718 Circle No. 234	P351C	24-pin dot-matrix	300 cps	Parallel or serial	Qume Sprint 11, IBM Color, IBM Graphics	\$1,599
	P321SLC	24-pin dot-matrix	216 cps	Parallel or serial	Qume, IBM ProPrinter, IBM Graphics, IBM Color, Epson LQ, Epson JX-80	\$949

BACK TO THE FUTURE!

WITH ~~UNIVERSE BASIC~~

UNIX

universe Basic

DataVISION

Saver Computer Systems

GOULD Electronics

BASIC plus APPLICATIONS

4GL's

Databases

Spreadsheets

DEC

RSTS

FUTURE PROOF COMPUTING

UNIVERSE BASIC is the route to safeguarding your investment in DEC BASIC plus and BASIC plus II software.

UNIVERSE BASIC allows you to avoid the DEC route where the **Road Stops Too Soon** by offering you the new road to UNIX, and the very latest hardware and software technology available from the many **UNIVERSE BASIC** authorised distributors.

With its Interpreter, Translator/Compiler and C-ISAM Interface

UNIVERSE BASIC

- SECURES YOUR** Investment in existing applications
- EXTENDS YOUR** Choice of available hardware
- MINIMISES** Implementation costs and time scales
- PROVIDES** Protection from dependency on any one

For more information on how your company can acquire 'future-proof' computing, please contact the **UNIVERSE BASIC** product manager for details of authorised UNIVERSE



Tim Fitzpatrick
57 North Main St.
Suite E
Hartford,
Wisconsin 53027
Tel: (414) 673-7041

Saver Computer Systems
1750 South Brentwood
St. Louis, Missouri
63144
(314) 962-0382

continued from page 18 into the graphics picture (see Table).

With steady improvements and lower prices in ink-jet and thermal transfer technologies, desktop graphics output is an affordable reality. Peter Testan, director of color hardcopy services at CAP International Inc. (Marshfield, MA), estimates that the color *Hardcopy* output device will reach 2.1 million products by 1991—generating revenues of \$4.7 billion.

Moreover, the development of low-cost, high-quality, color ink and wire-dot-matrix printers, as well as high-resolution (600 dpi and above), you can expect to see an onslaught of new devices, possibly by year end.

For output, a whole slew of low-cost laser printers are available that support popular graphics protocols. (See "Inside and Out, Newest Laser Printers Sport More for Less," *Hardcopy*, page 19, January 1988.) "The quality of today's laser printers," says Dataquest's Tyler, "is so great that many users aren't even considering the current generation of color printers."

Print It Cheap

There does appear to be a demand, albeit small, for cheap color *Hardcopy* output.

For those waiting for a cheap color laser printer, "You might end up waiting an eternity," according to CAP's Testan, "There have been color laser printer rumors floating around for years, and one or two printers will probably surface this year, but these most likely will be very expensive and slow."

In the meantime, ink-jet, wire dot-matrix, and thermal transfer devices are stealing the show (and the dollars) by delivering a wide variety of quality, low-cost, color output devices.

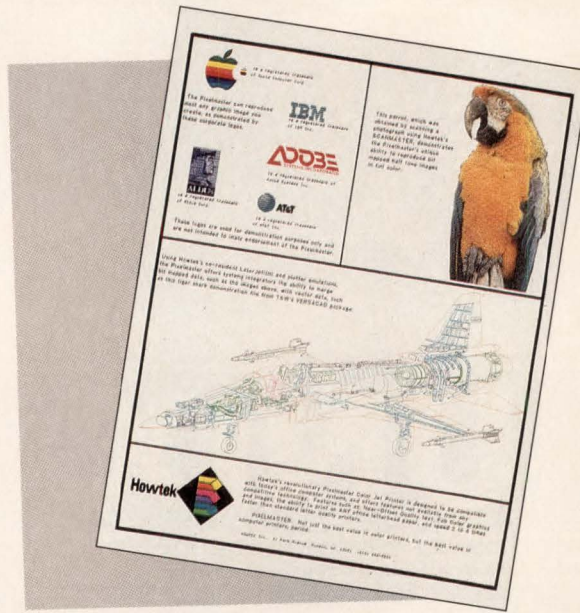

Though it's expensive compared to the new generation of low-cost ink-jet printers, Howtek Inc.'s Pixelmaster yields high-quality color output on any type of paper and has a low consumables cost. The Pixelmaster is able to print bit-mapped images and vector data on the same page. To touch, output from the Pixelmaster is rough—the ink builds up on the paper rather than being absorbed by it.

Dot-matrix impact devices continue to make a strong showing as well, with improved resolution, by using 24-wire print heads in place of the older, nine-wire design. But, Testan says, the wire dot-matrix business is flat. He contends that the average price per printer is even increasing. Color printing has moved to non-impact technologies, such as thermal and ink-jet.

Reliable Jets

Ink-jet technology, once thought to be doomed because of nozzle clogging problems and unbelievably slow speed, is making a comeback. Indeed, products from Hewlett-Packard Inc., DEC, and Tektronix are delivering quality output at a low cost. The key to success with this technology has been the use of throw-away

UNRAVELING THE JUMBLE OF GRAPHICS PROTOCOLS

How can you be sure that the graphics hardware you buy today will be compatible with tomorrow's software? Or, conversely, how can you be sure that the graphics software you buy today will work with tomorrow's hardware? With the grab-bag of graphics protocols that seem to be invading the industry, the question is: Will the protocol I choose be around tomorrow?

Actually, it doesn't matter. "Customers can be reasonably sure that whatever graphics equipment they invest in, it will continue to receive support," says Sandy Friedman at Digital Equipment Corp. The trend, he points out, is toward hardware independence, and companies such as DEC, Sun, and Tektronix Inc. are providing support for multiple protocols.

Additionally, there exists plenty of protocol conversion software. Examples are White Pine Software Inc.'s Reggie, which makes Apple Macintosh graphics displayable on equipment supporting ReGIS or ANSI/SIXEL, and DEC's Retos, which converts ReGIS to SIXEL.

DEC Stays Loose

Currently, DEC is showing its greatest support for GKS because of the protocol's device independence, but the company supports the Tektronix, SIXEL, and Hewlett-Packard Inc. (HP) protocols as well. DEC offers a wide variety of conversion—or translator—utilities to move between protocols. The company's support of X Windows is in addition to all this—the nature of X Windows is that it provides a device-independent interface to the hard-

ware and co-exists with the specific graphics protocols.

It's Everywhere

The most widely supported protocols are Tektronix protocols. Tektronix 4010/4014 provides the foundation—they get the monochrome lines on the screen. The 41xx protocols then move one step further: 4105 adds color, and 4107 and 4125 specify the more complicated segment graphics protocols.

But other standards such as GKS and PHIGS are hot on Tektronix' heels. In addition, HP's GL is widely implemented. HP-GL has been around for 12 years, specifying polygon and wedge-area fill, arc and circle generation, line types, and character fonts. DEC's ReGIS, though DEC has been supporting it for a long time, is receiving less and less attention as GKS moves forward. ■

cartridges that contain both the ink and the nozzles.

But disposable parts result in a higher cost of ownership. Howtek Inc.'s Pixelmaster printer, which uses a spin-off of ink-jet technology called thermo-jet, takes a different tack. The Pixelmaster avoids clogging problems via the use of solid wax/ink rods that are melted when applied to paper. No carrier is used, freeing users to print on almost any type of paper they choose. This results in a price per page of just \$.05-\$.08, compared to about \$.25 for the cartridge ink-jet technology (\$.19 for the cartridge and ink, \$.06 for the paper).

The price tag for the new technology, however, is high—\$6,000. But so is the quality. As this technology matures, it may offer the greatest hope for high-quality, cheap, color *Hardcopy* output.

Heat It Up

Another relatively new printer technology is currently receiving considerable attention—thermal transfer. Thermal transfer uses a hot element to melt a



Access Technology Inc.'s 20/20 spreadsheet product includes graphics capabilities to produce X-Y, line, bar, pie, comparison, and stacked graphs. Up to four graphs can be viewed simultaneously.

wax-based ink from a mylar ribbon onto the paper. This technology has resulted in color printers that cost as little as the \$268 Okimate 20 from Okidata, and as much as \$4,500-\$5,000 in the more expensive ColorMaster and PlotMaster products from CalComp. According to Testan, thermal transfer technology will find its greatest use in engineering environments, whereas ink-jet tends to be more suitable to the office because of its higher quality. ■

Additional information about the products or services described in this article can be obtained by contacting the company directly or circling the appropriate reader service number.

Access Technology Inc.
6 Pleasant St.
S. Natick, MA 01760
617-655-9191
Circle No. 210

CalComp
2411 W. La Palma Ave.
Anaheim, CA 92803
714-821-2000
Circle No. 211

Colorgraphic Communications Corp.
5388 New Peachtree Rd.
P.O. Box 80448
Atlanta, GA 30366
404-455-3921
Circle No. 225

Grafpoint
1485 Saratoga Ave.
San Jose, CA 95129-4934
408-446-1919
Circle No. 213

Graph-On Corp.
1901 S. Bascom Ave.
Campbell, CA 95008
408-371-8500
Circle No. 214

Hewlett-Packard Inc.
16399 W. Bernardo Dr.
San Diego, CA 92127
619-592-8010
Circle No. 224

Howtek Inc.
21 Park Ave.
Hudson, NH 03051
603-882-5200
Circle No. 215

Human Designed Systems Inc.
3440 Market St.

Philadelphia, PA 19104
800-HDS-1551
Circle No. 216

Modgraph Inc.
149 Middlesex Turnpike
Burlington, MA 01803
617-229-4800
Circle No. 217

Monitem Corp.
5740 Green Circle Dr.
Minnetonka, MN 55343
612-935-4152
Circle No. 218

Okidata
532 Fellowship Rd.
Mt. Laurel, NJ 08054
609-235-2600
Circle No. 219

Pericom Inc.
2291 205th St., Ste. 103
Torrance, CA 90501
213-618-9190
Circle No. 220

Tektronix Inc.
P.O. Box 15273
Portland, OR 97215
800-225-5434
Circle No. 221

Visual Technology Inc.
1703 Middlesex St.
Lowell, MA 01851
617-459-4903
Circle No. 222

White Pine Software Inc.
94 Rte. 101A
P.O. Box 1108
Amherst, NH 03031
603-886-9050
Circle No. 223



Bright, multicolor printing on paper or overhead transparency film for the slim price of \$1,395 can be achieved with the Hewlett-Packard Inc. PaintJet ink-jet printer. The printer uses disposable cartridges that contain both the ink-jet nozzles and the ink. Two disposable cartridges are required—one black and one color. A total of 60 nozzles are required to produce full-color Hardcopy.

IBM's SAA: COMMONALITY AT THE SYSTEM AND APPLICATION LEVEL

by Robert Pap,
Communications Editor

The growing demand for diverse systems to communicate at a variety of levels has spanned the establishment of a common method of interfacing systems. To this end, IBM Corp. is developing the notion of the Systems Applications Architecture (SAA).

The underlying goal of SAA is to provide a common method of system-to-system communication, and establish a level of interoperability at the application level, regardless of vendor equipment.

Besides a technical specification that links environments, there's some commonality to Digital Equipment Corp.'s approach as well.

DEC, unlike other system vendors, understands the need for both upward and downward commonality of software and operation across the entire product line. Moreover, DEC is demonstrating a desire to be considered part of the world (multi-vendor) environment by opening up links to its VAX systems via various communications environments.

Even though IBM is considered the standards maker, and has laid the groundwork for system-to-system links via its Systems Network Architecture (SNA), the company has failed to provide easy migration paths across its own equipment architectures and foreign equipment—at least with commonality of spirit and interoperability.

Consequently, SAA takes on a bigger role and serves to put the rest of the industry, specifically DEC, on notice that IBM intends to be the great unifier.

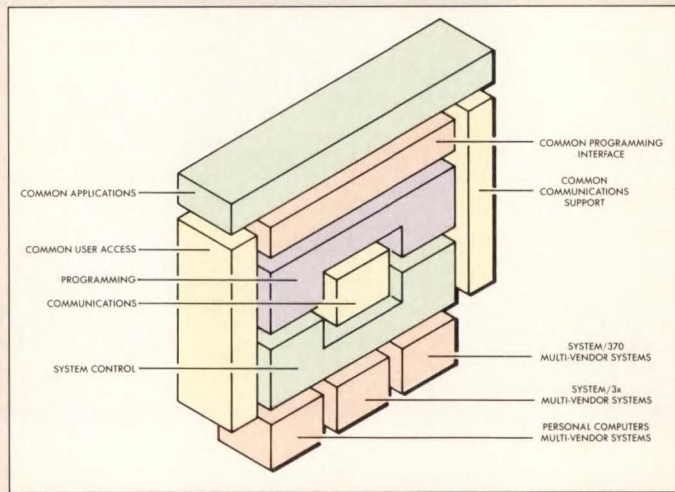

Figure 1—If conceptualized as a series of building blocks, IBM's systems application architecture (SAA) is a series of four base modules that define the interfaces for user access, programming, communication, and applications. Notably, each module is built on the notion of commonality of operation within its own level with common attachments to the associative or supporting module.

Defining the Goal

IBM's method for establishing a common approach involves defining four common interfaces (Figure 1), which it hopes will serve as the industry blueprint for linking systems and applications under the SAA banner.

No matter what the technical goals are, the basic precept behind SAA is to help you, the user.

Regardless of what happens in the system, you interact with the screen. And IBM's approach with the common user access definition in SAA is to provide a basis for making programs look consistent.

The presentation services under the so-called presentation manager—the interactive part of SAA—provide you with a set of programming functions for windowing software, the keyboard, and pointers, all aimed at supporting your access to graphics functions, fonts, images, terminals, plotters, printers, and

communications.

The model used for the presentation manager, like many portions of SAA, isn't new. Rather, it's based on the mainframe (370) graphical data display manager that users of 3780-type display terminals are familiar with.

Common Programming

The common programming interface module of SAA is based on higher-level languages, including C, COBOL, and FORTRAN; procedure languages; and an application generator.

The majority of interface elements for the smaller personal computers are available in the EZ-Run feature, running in PC-DOS compatibility mode of Microsoft Corp.'s (Redmond, WA) OS/2. Essentially, this feature makes it possible for an application on a PC to look and act the same as one on a 370 mainframe under MVS or VM operating environments. The functional definition for the programming interface,

however, is intended to go far beyond the IBM environment. Speculation is that IBM will be providing tools that make applications on DEC and other vendor's equipment have similarities to MVS and VM applications. This solves at least one level of the interoperability disparities.

Missing Links

While IBM's PS/2 personal computer and 370 mainframe architectures are moving closer together, some question still lingers as to the status of providing a more tightly coupled relationship with other IBM systems.

What seems clear, at the PS/2 level, is that Microsoft's OS/2 operating environment—at least the version from IBM—will embody many of the attributes defined under SAA.

For example, the languages available in the OS/2 environment include C, COBOL, FORTRAN, BASIC, Pascal, and assembler—very similar to those defined by SAA. Thus, it appears that the commonality of all the languages among the SAA processors will be one way to make your applications work with other implemented systems.

Vendors are expected to begin offering bridges to VAX applications. Currently, Apple Computer Corp. (Cupertino, CA) is making noises that it will serve as the common bridge between IBM and DEC via a combination of hardware and software. A variety of vendors (see "Third-Party Developers Make the Mac-to-VAX Connection," *Hardcopy*, page 17, February 1988) offer possible solutions that may help a VAX application be considered.

continued on page 24

COLORSCAN[®]/2 Workstation

*VAX access
and PC applications.
Hmmm!*

One big idea in one small space.

The COLORSCAN/2 color graphics workstation "is an idea whose time has come," reported *Digital Review*. It fits two capabilities - VAX[™] access and the ability to run PC applications - into one very small, low-profile enclosure with quiet, diskless operation.

It's a built-in plug-compatible VT[™]200 text/color graphics terminal for all your VMS[™] and UNIX[®] information access. And it's a high-performance MS-DOS[®] personal computer for today's business applications. All in one sleek ergonomically-designed desktop workstation.

There's more, too. Parallel VT200 and MS-DOS operations. ReGIS[™], Sixel, Tektronix[™] and EGA plus-compatible color graphics (640 × 480 × 16 resolution). Built-in cut and paste. Full 132-column display.

In other words, "The COLORSCAN/2," according to Frank J. Derfler, Jr., editor of *PC Magazine*, "is an excellent solution to desktop clutter for any combination of PC, LAN-based and host-based applications."

To find out more, call Datamedia at 1-800-DMC-INFO.

Unretouched screen
10 × 15 × 2.5-inch base unit

COLORSCAN is a registered trademark of Datamedia Corporation. VAX, VT, VMS and ReGIS are trademarks of Digital Equipment Corporation. UNIX is a registered trademark of AT&T Bell Laboratories. MS-DOS is a registered trademark of Microsoft Corporation. Tektronix is a trademark of Tektronix, Inc.

DMC
DATAMEDIA CORPORATION
The Positive Response™

11 Trafalgar Square, Nashua, NH 03063

CIRCLE 407 ON READER CARD

continued from page 22

Even though a commonality of languages and operating system equivalents should offer a logical (device-to-device) bridge in the same product family, some disparities currently exist. For instance, IBM's PS/2 COBOL isn't up to System 370 COBOL under MVS. Interestingly, PS/2 FORTRAN is identical to the mainframe version.

Another confusing point in the SAA specification is the procedure language interface. Although loosely based on a command structure used on 370 mainframes, no definition or implementations exist for it at other levels. This seems a paradox since it appears the procedure language should be the glue that holds the building blocks of SAA together. As defined, however, it's similar to VM system interpreter.

Database Interface

Because data handling is the key function of any system, SAA defines access to relational databases through the non-procedural Structured Query Language (SQL). This implementation is based on DB2 and SQL/DS—both IBM mainframe tools. Since IBM developed SQL—now ANSI X.135-1986—it's more than familiar with the concepts. In fact, IBM has helped Microsoft meld it into OS/2 as the Database Manager Query Language. With Ingres by Relational Technology Inc. (Alameda, CA), Focus by Information Builders Inc. (New York, NY), and Oracle by Oracle Corp. (Belmont, CA) already available for a VAX, common databases can easily be implemented today. For example, this SAA portion is easier to do on a VAX today than on the System/3x. Interestingly, the VAX SQL databases can work with PC and System 370 products already if the data is structured properly.

Comm. Support

SAA communications support includes the notion of data streams—the method of passing information—applications services, sessions services, networking, data link controls, and current products such as network control programs. With its Open Communication Announcement of September 16, 1987, IBM claims that SNA will be the vehicle for connecting applications, systems, networks, and devices in the future. Even though IBM appears to have put most of its emphasis on communications, the final decision on where ASCII-to-EBCDIC will take place hasn't been made; however, indications are that IBM favors its own mainframe environment. Most likely, DEC and third-party VAX software developers will concur since this eliminates a tricky conversion from the development puzzle.

Among the communication building blocks included in SAA are data streams like 3270 and 5250 (System/3x), document content, and intelligent printer data. The application services include the SNA distribution services and network management as well as document

interchange. Interprogram communications will be via LU Type 6.2. and low-entry networking nodes that support peer-to-peer communications using type 2.1 nodes. The data communications are planned to use synchronous data-link control protocol for synchronous, code-transparent, serial-by-bit information transfer. The token ring network (based on IEEE 802.2 and 802.5) is provided in OS/2 by the PC-LAN 1.3 support due in July and the OS/2 LAN Server V. 1.0, providing resources-sharing service for administration and the sharing of service.

The CCITT packet protocol X.25 for attaching data terminal equipment with its support for physical, data, and network layers is also to be supported.

In addition, various mainframe services such as virtual telecommunication access method, advanced control function/network control program, and network—all upper-level mainframe communications control functions—are part of the SAA communications interface. And, you can expect the extended edition of the communications manager for OS/2 to embody

some, if not all, of these links.

DEC isn't sitting back on its haunches either. It recently made the interface with SAA easier by announcing the DECnet/SNA Gateway V. 1.4 that includes a number of SAA functions including 3270 data stream, professional office systems (PROFS) and system network architecture distributed server mail and document exchange, and advanced program-to-program communications (APPC—LU 6.2) programming interface. DEC is also supporting a number of the IBM SAA planned operating systems. The DEC Mailbus (Figure 2) should allow easy interconnection in the future.

The Final Connection

The SAA concept, if properly implemented by IBM, will facilitate movement between systems and allow IBM to add to its product base. It will also allow, by its open concept, the attachment of VAX systems to networks of SAA computers.

Other companies are ready to climb on the bandwagon. Hitachi Tokyo has already announced an SAA look-alike with a DEC interface.

With this movement toward a common ground, user access to data will be easier across hardware architectures and applications.

Furthermore, as the specifications from IBM are implemented in the near future, expect to see a mating of IBM-to-IBM and seamless transparent IBM-to-multi-vendor connections. The care and details of the cross product attachment most likely will allow the same implementation for DEC users. It's unlikely DEC will embrace an IBM architecture without a fight, however. But SAA will be a reality as SNA is today. ■

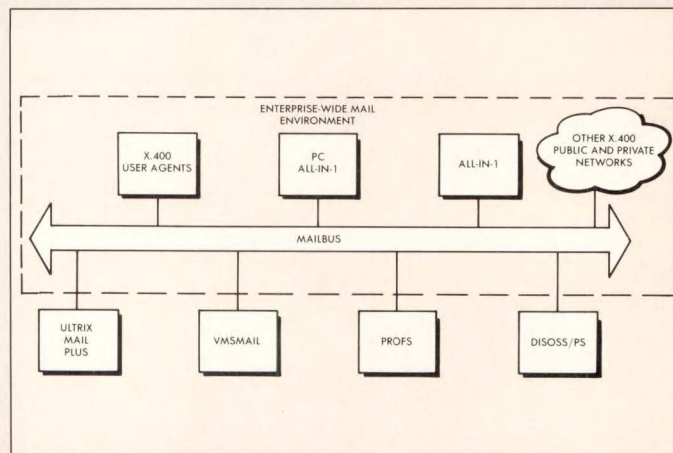

Figure 2—DEC's Mailbus is a comprehensive method of delivery of services throughout an enterprise—all functions and systems—using gateway and message routers to transfer information throughout various systems, nodes, and networks with a cohesive transparent operation.

THE MASS STORAGE WORLD OF CMS ENHANCEMENTS



CMS understands that enhancing your personal computer can make a world of difference! That's why we offer personal computer users a complete line of enhancement products. Our superior quality and exceptionally low prices are unparalleled anywhere on the globe—we're even confident enough to stand behind every product we sell with a full one year warranty.

Whether you use Apple, Compaq, DEC, IBM including PS/2, AT&T, any of the laptops or their compatibles, our state-of-the-art line of hard disk drives can provide anywhere from 20MB to an unbelievable 2.6 Gigabytes of additional storage.

And the world of CMS doesn't stop spinning there. Because we've put ourselves on the map by providing a full range of products to meet any of your enhancement needs. We've got you covered with everything from floppy disk drives and tape back-ups to add-in boards, surge suppressors and

media. We've got it all! And you can count on CMS to continue bringing you the best today as well as tomorrow, with the same commitment to excellence that has made us a leader worldwide.

So call one of our dealers today, or phone CMS directly at 714-259-9555 for more information or the dealer nearest you. And remember. When it comes to your mass storage needs... we can give you the world.

CMS Enhancements, Inc.



COMDEX/Spring
Atlanta, GA Booth #3602

1372 Valencia Avenue, Tustin, CA 92680 (714) 259-9555
Telex (023) 371-8711 FAX (714) 549-4004

CORPORATE ELECTRONIC PUBLISHING: MOVING BEYOND THE DESKTOP

by Lynn Haber, East Coast Editor

Desktop publishing systems have allowed organizations to take control of some of their publishing requirements and, as a result, have sparked an awareness that is precipitating greater visibility of, and demand for, networked enterprise-wide, corporate electronic publishing systems (CEPS)—and vendors are responding.

Digital Equipment Corp., for example, has targeted electronic publishing as a strategic network application (Figure 1) that spans across industries and the company is positioning itself as a systems integrator by enlisting the support of third-party suppliers.

"Electronic publishing won't be isolated in the publishing department but will be a distributed application that shows up everywhere in the organization," says Jackie Kahle, marketing manager for electronic publishing systems at DEC. And furthermore, she adds, "We don't believe that one vendor alone can provide all the solutions."

Via the company's Systems Cooperative Marketing Programs, DEC works with third-party product suppliers to design application solutions.

In the area of electronic publishing, DEC has such agreements with Interleaf Inc., Datalogics, Aldus Corp., Microtek Lab Inc., and Eastman Kodak Co.

According to Woodrow Vandever, executive vice president of InterConsult Inc., a Cambridge, MA-based consulting company that focuses on electronic publishing, by 1990 the electronic publishing market, in the United States, will reach \$7 billion, up from \$5.5 billion in 1987.

"The long truth is," says Vandever, "once people start to buy desktop publishing systems, they'll want greater electronic exchange of documents and the next question will be, 'How do I integrate my system?'"

At that point, suggest industry participants, electronic publishing applications capable of producing a variety of documents including sales proposals and presentations, product and user manuals, business forms, catalogs, and directories will no longer be specific to a particular desktop device.

A key element of enterprise-wide electronic publishing is that its a multi-person activity. Therefore, it requires a networked solution capable of integrating a variety of technologies including personal computers (PCs), workstations, minicomputers, mainframe computers, input devices such as scan-

ners, and output devices such as printers.

Additionally, the integration of various electronic technologies and the fact that electronic publishing runs on a distributed platform, as opposed to a stand-alone platform application such as desktop publishing, means that such systems must incorporate complex methods of document management.

Today, says InterConsult's Vandever, electronic information is textual, graphics, or numeric. He suggests that, in the future, electronic information will include voice and animation. Print on paper will be one option for information delivery. Electronic delivery systems such as electronic mail and videotex will be others.

What users will end up with, then, is an electronic database of a variety of information that will require *StorAGE*, security, manipulation, access rights,

(U.S. Market) Total Revenue Desktop Publishing

Year	Revenue
1985	\$200-\$300 million
1986	\$450-\$500 million
1987	\$900 million
1988	\$1.2 billion
1989	\$1.6 billion
1990	\$1.9 billion

Source: InterConsult Inc., Cambridge, MA

networking, and distribution.

DEC's Kahle calls document management one of the hidden aspects of electronic publishing. "At DEC, we're trying to address some of the behind-the-scenes issues such as document management, security, output, and distribution," she says. "We call it WYDSIWYN—what you don't see, is what you need."

The Problem

According to Vandever, recent studies suggest that corporations spend 6-10% of their gross revenue on publishing and printing. Because expenditures for publishing and printing activities do not show up as a single, budgetary line item, corporations are often unaware of how great their publishing needs are.

Vendors of electronic publishing systems, such as Interleaf, Textet Corp. and Xyvision Inc., recognize that duplication of efforts is commonplace within companies.

Additionally, with the advent of desktop publishing, many organizations are purchasing locally—for example, marketing buys a system, engineering buys a system, etc.—and are now recognizing the need for integration and information flow.

continued on page 28

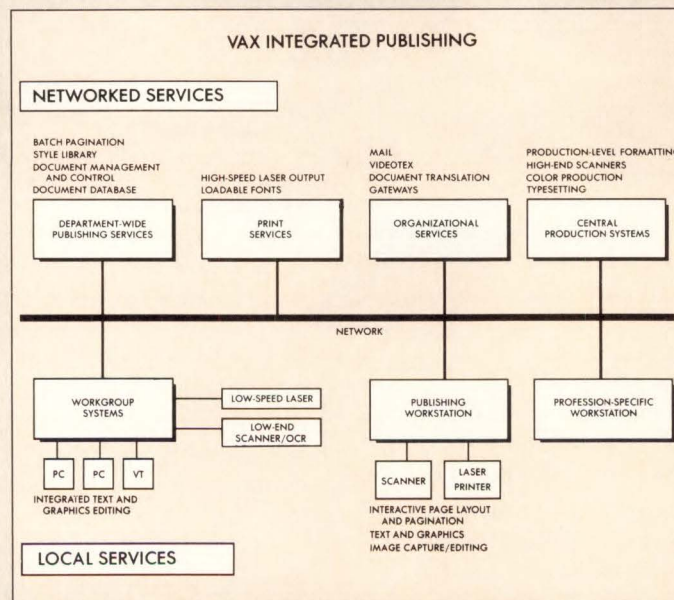

Figure 1—DEC's approach to enterprise-wide electronic publishing is designed to allow input of information from anywhere on the network, publication in a variety of ways, information access to any user on the network, and integration of publishing applications with other business applications.

MORE THAN A DATABASE FOR THE DEPARTMENT COMPUTER

Over the noise of corporate issues, your department's computing needs are not always heard. In the stack of things to do, they often wait at the bottom of the pile.

RDM is the ONLY application developer designed specifically to get department software development done. More than just a database, **RDM** is a complete application development system AND full relational database — integrated into one flexible, table-driven tool.

RDM's table-driven technology is a generation beyond conventional database development. **RDM** supplies all the parameters that shape standard application components. You add your own custom-designed specifics. **RDM** eliminates the need to code and recode routine application features.

RDM is nonlanguage, fill-in-the-form application development. With no programming code to analyze, the learning curve is short and productivity increases. With or without software development specialists, you create the entire application: data input forms, summaries and reports, command menus, on-line help files and processes to validate and manipulate data. You'll implement even the most procedural tasks — without procedural language syntax.

After initial software development — your department's needs will evolve. **RDM** makes system modification and maintenance easy. You add new forms and reports — when you need to. You create new files or change data relationships — quickly. And without any change or rewrite, **RDM** applications will transfer and share data across 10 different operating systems. You save time and money with one software product for your VAX, PDP11 and IBM-PC.

Since 1980, **RDM** has been the choice of more than 2500 departmental application developers. For quick application development and easy maintenance, for increased productivity and extended portability, for stand-alone, integrated, distributed or networked systems . . . there's no better software solution than **RDM**.

Find out how your applications can rise to the top of the stack. Call today.

800-362-6203

In Canada, call 800-255-6378



Interactive Technology, Inc.
460 Park Plaza West
10700 SW Beaverton-Hillsdale Highway
Beaverton, OR 97005
503-644-0111
TLX 703920

RDM[®]

continued from page 26

Publishing, as users are learning, is a content-driven application that requires a document to pass through a number of hands—for creation, composition, formatting, review, editing, output, and distribution—to complete the loop.

DEC's Kahle reports, for example, that the company is seeing a demand from customers to add publishing applications to DEC's All-In-1 integrated office information system.

Electronic publishing is the coming together of hardware and software features and capabilities that InterConsult's Vandever classifies as follows:

- Level one—Black and white, monotone, pagination systems characterized by short documents; used by one or two people; the documents have a short life cycle; the system requires few interfaces; and the output is low-resolution. Product examples include Aldus' Pagemaker software and Ventura Publisher, marketed by Xerox Corp.

- Level two—Also black and white systems; lengthier documents and document life cycle is longer; the need to modify and update information; many people are involved in document production and their jobs are defined; interfaces to other systems such as CAD/CAM for technical information or to minicomputer or mainframe computer databases for technical information are required; and output is of higher resolution. Systems include Interleaf, Textet, and Xyvision.

A key difference between level one and level two is that level one is page oriented whereas level two is document oriented. Desktop publishing is a level one application whereas technical publishing falls into level two.

- Level three—In addition to level two features,

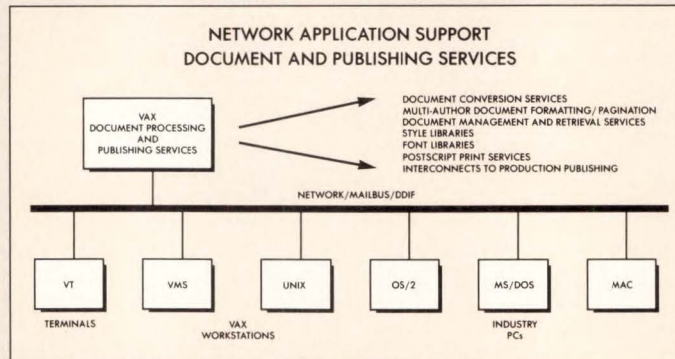

Figure 2—DEC's strategy for electronic publishing is based on a networked approach that will link the desktop, workgroup, and department into the organization's office information system.

systems include color capability in both the process and the output; presentation graphics, slides, or spot type color.

- Level four—Includes processed color separations.

Vandever points out that today's CEPS represent level-one- and two-type features and functionality. He adds that the visibility of level-three-type products will increase this year.

For example, Apple Computer Corp.'s desktop presentation marketing strategy includes products that utilize color slides. Additionally, Interleaf offers spot color capability and Adobe Systems Inc.'s Illustrator product has color capability.

Level-four-type products will not reach the market for another few years, he contends.

Vendors recognize that no single product or set of tools will satisfy everyone and, therefore, notes Sharon Pruss, an industry analyst at CAP International, a market-research company located in Marshfield, MA, we are seeing a repackaging trend among vendors.

"Vendors are now offering system configurations targeted to niche applications," she says. "This approach allows vendors to offer lower priced, modular solutions by pulling together only the pieces that an

organization needs."

Interleaf, for example, offers product solutions that run on workstations from Sun Microsystems Inc., IBM Corp., Apollo Computer Inc., DEC, and, most recently, Apple's Macintosh II, and the company reports that in April they will have beta installation of mainframe publishing software.

DEC has also targeted

three publishing solution areas: desktop workgroup publishing, departmental publishing, and production publishing (Figure 2).

Issues on the Forefront

While many of the elements necessary to make electronic publishing a reality are being put in place—networks, shared peripherals, multiuser application software, and document management features, for example—the industry is still in its infancy and obstacles remain.

Issues to be addressed include the need for industry standards to enable multi-vendor interoperability, the need for greater network bandwidth such as scanning—a memory-intensive application that requires a more efficient transmission vehicle than today's office networks can provide—increased *Storage* capability, higher resolution displays, and lower system cost. ■

Additional information about the products or services described in this article can be obtained by contacting the company directly or circling the appropriate reader service number.

Adobe Systems Inc.
1585 Charleston Rd.
Mountain View,
CA 94039-4400
415-961-4400
Circle No. 104

Aldus Corp.
411 1st Ave. S., Ste. 200
Seattle, WA 98104
206-622-5500
Circle No. 105

Apollo Computer Inc.
330 Billerica Rd.
Chelmsford, MA 01824
617-256-6600
Circle No. 107

Apple Computer Corp.
20525 Mariani Ave.
Cupertino, CA 95014
408-996-1010
Circle No. 106

Datalogics
411 W. Huron
Chicago, IL 60610
312-266-4444
Circle No. 108

Digital Equipment Corp.
Corporate Headquarters
146 Main St.
Maynard, MA 01754
617-897-5111
Circle No. 109

Eastman Kodak Co.
434 State St.
Rochester, NY 14650
716-724-4000
Circle No. 110

IBM Corp.
Old Orchard Rd.
Armonk, NY
914-765-1900
Circle No. 112

Interleaf Inc.
10 Canal Pk.
Cambridge, MA 02141
617-577-9800
Circle No. 111

Microtek Lab Inc.
16901 S. Weston Ave.
Gardena, CA 90247
213-538-5369
Circle No. 113

Sun Microsystems Inc.
2550 Garcia Ave.
Mountain View, CA 94043
415-960-1300
Circle No. 115

Textet Corp.
37 Broadway
Arlington, MA 02174
617-641-2900
Circle No. 116

Xerox Corp.
101 Continental Blvd.
El Segundo, CA 90245
213-536-7000
Circle No. 117

Xyvision Inc.
101 Edgewater Dr.
Wakefield, MA 01880
617-245-4100
Circle No. 114

EXCLUSIVE FROM MILTOPE!

Continuous Printing at 37/54/90 Pages per Minute

Cut sheet printers available at 30/45/60/75 ppm

“WE CONNECT TO DEC”

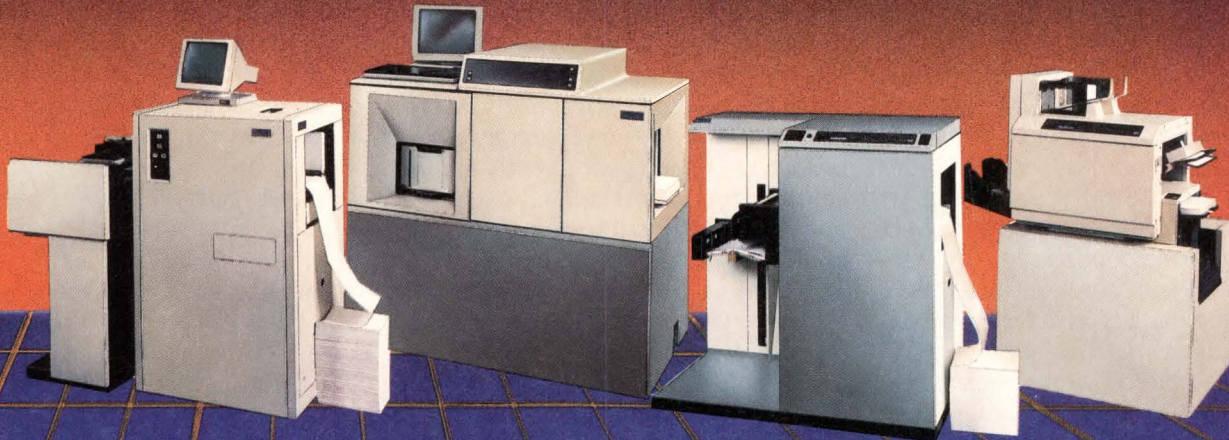

Miltope's FAMILY of Non-Impact 'ion' deposition page printers affords letter quality printing at 'less than a penny' per page.

Miltope provides multifont alpha/numeric printout, "true" electronic forms overlay plus sophisticated graphics for generation of signatures, logos, bar codes, OCR and special characters.

Miltope's page printers eliminate time-consuming bottlenecks by combining speed, high-duty cycle, reliability and versatility in electronic printing systems that are plug-to-plug compatible and fully emulate:

- Xerox 3700/2700
- HP LaserJet Plus
- HPGL
- HASP
- QMS® MAGNUM®
(Printronic Graphics)
- Standard Interfaces: Dataproducts or Centronics
- DEC Interfaces:
DEC UNIBUS-PDP11 and VAX11 Series
DEC Q BUS — LSI11, MICRO PDP 11 and MICROVAX
DEC X —DMF-32 Equivalent
- IBM Interfaces: 3211 — 3287 — System 3X
2780/3780 — 3270 — 3770 etc.

The choice is YOURS!

MODEL	SPEED	FORMAT	RESOLUTION	MONTHLY VOLUME
3801	90 PPM	Continuous Form	240 × 240 DPI	Over 1 Million Pages
SERIES 75	75 PPM	Cut Sheet	240 × 240 DPI	Up to 1 Million Pages
SERIES 60	60 PPM	Cut Sheet	240 × 240 DPI	Up to 1 Million Pages
SERIES 54	54 PPM	Continuous Form	300 × 300 DPI	Over 250,000 Pages
SERIES 45	45 PPM	Cut Sheet	300 × 300 DPI	Up to 250,000 Pages
SERIES 37	37 PPM	Continuous Form	300 × 300 DPI	Over 250,000 Pages
SERIES 30	30 PPM	Cut Sheet	300 × 300 DPI	Up to 250,000 Pages

Cost Effective Printing and Dependable Nationwide Field Service have made Miltope the "Source" for ALL ion deposition printing systems.

“IMAGINE YOUR IMAGE”

MILTOPE Business Products, Inc.

1770 WALT WHITMAN ROAD • MELVILLE, NY 11747 • (516) 420-0200

Miltope Printers use Delphax Ion deposition engines.

QMS and MAGNUM are registered trademarks of QMS, Inc.

CIRCLE 439 ON READER CARD

THE MASS. REPORT

Technological Lag

My neighbors up the road are preparing to tap their maples. For my West Coast friends, that's how we get our maple syrup. My neighbors enlist the help of dozens of children. The older children tap the trees and hang the buckets; the younger children collect the buckets and pour the sap into vessels carried in a horse-drawn sleigh. Some years ago I took my then-seven-year-old daughter to a "sugaring-off" to see how the sap is boiled-off into syrup. The residual syrup is then poured onto the snow where the children can scoop it up and eat it, often with fresh cornbread, ginger cookies, and hot cider supplied by the parents. It's a wonderful, happy time—full of dogs barking, horses neighing, children laughing, and delicious smells. I hope we never lose the process to automation.

There are, however, new technologies I find no less magical. More to the point, I am as concerned when some of these newer technologies are *not* used to replace older processes as I am when certain older processes (like maple sugaring) *are* replaced by new technologies. It pains me to learn that Ray Bradbury, one of my favorite authors, continues to use a typewriter. Or that our local accountant doesn't use a spreadsheet.

I can think of many explanations for these examples of what sociologists call *technological lag*—the time that elapses from when new technologies become available to when they become accepted. But the truth is that I really don't know. Perhaps someone reading this column can direct me to studies that attempt to explain why so many intelligent people ignore the many new computer tools that promise to make their lives so much more productive, rewarding, and enjoyable.

Without scientifically acquired data, however, I'd like to offer some personal observations from working

with "holdouts." Then I'd like to suggest what you and I can do about it. First, we should recognize that the scope of the problem includes computer users—and even consultants.

Item: A well-known computer retailing and business applications consultant from New England once told me that "until I put your business card in my Rolodex you don't exist." Translation: "I don't use a database."

Item: Of the three most popular female consultants on office computer and communications technologies, only one (Jan Lewis) uses electronic mail. One subscribes but never uses the service, while the other doesn't even subscribe. I suspect the breakdown among male consultants is worse, but the numbers are less apparent.

Item: A Boston-based business consultant who specializes in critiquing the business plans of high-technology companies refuses to use a spreadsheet or computer.

The point is, of course, that if even the people constantly exposed to computer products are not themselves using the products they describe, or in some cases even the computerware they recommend(!), how can we begin to get at "the masses"? How can we reach the people who use typewriters to write long reports? Or the people who record their research on hundreds of 3 x 5 cards?

Again, I don't know the answer and would appreciate any help that you, our readers, can provide. But, for the moment, let me list the three most common responses I get from such hold-outs: 1) don't need one (*one* being computer, or spreadsheet, or database, or communications, etc.); 2) too expensive; 3) don't have time to learn.

My experience has been that all these objections can be overcome simply by the right kind of exposure. When I find someone I believe could benefit from an application, I try to sit down with that person and dem-

onstrate not just the application, but *their* application. In other words, my objective isn't to demonstrate abstract spreadsheets or databases, but to bring up *their* company's figures, project *their* estimates, graph *their* results, and retrieve names from *their* files. Sure, it takes a half-hour or so to enter the data, and sometimes that much time just to get the prospective user to agree that real, rather than hypothetical, data might make a difference. But believe me, it does make a difference! Once a prospective user sees how he or she can *actually* use the demonstrated application, it frequently becomes a "must-have".

It's unfortunate that three-quarters of a generation since personal computers were introduced, it's still necessary to play this game, which is a bit like reading racy novels aloud to motivate people to learn to read. Sadly, our secondary schools, for whatever reasons, do an abominable job explaining horizontal applications. There are courses in BASIC and Pascal for future programmers, and there are courses in only dBase or only Lotus 1-2-3, but to the best of my knowledge, there isn't a curriculum in the entire country that offers, in one course, an overview of all major personal computer applications. Consequently, even those personal computers purchased for experimentation often languish in closets because their owners lack applications knowledge. Until we can depend on schools to provide an awareness of the general benefits of horizontal applications, it's necessary for us to generate motivation for specific applications. And the reason for using actual data is to make those specific applications as specific as possible. ■

Reader Interest Level

High	Circle No. 356
Medium	Circle No. 358
Low	Circle No. 345

"I just recovered 20 percent of my disk space with PAKMANAGER™"

PAKMANAGER saves disk space by pinpointing space wastage. There's no VMS utility like it.

PAKMANAGER gives you an instant detailed report of disk space usage and identifies specific "space stealers" such as:

- unnecessary duplicate files
- aged files
- excessive multiversion files
- overallocated blocks
- expired files

PAKMANAGER gives you the vital information you need to zero in on disk space wastage and identifies performance problems such as wrong cluster factor, excessive directory nesting, or disk fragmentation.

Cost Effective

PAKMANAGER, like other DEMAC software, is priced to allow you to recover the cost quickly. It enables you to postpone the acquisition of expensive hardware by allowing better use of existing resources. PAKMANAGER also saves money by increasing system efficiency and eliminating tedious hours of effort by system support staff.



Safe

PAKMANAGER is completely safe to use. No special privileges are required. In fact, no user files are ever accessed while PAKMANAGER'S reports are being generated. PAKMANAGER works in VAXclusters, shadowsets, and over networks.

Powerful

Reports that now take days to compile using standard VMS tools, will be generated in seconds. PAKMANAGER identifies culprit files, and gives you an efficient method to deal with those files, and recover valuable space immediately.

Free Trial

Call us today, or use the coupon to find out more about the new way to manage your disk resources. We're so confident you'll realize the tremendous benefits that PAKMANAGER can bring to your site that we're offering you a

FREE NO-HASSLE TRIAL! Call us, or write today, for more information.

DEMAC
SOFTWARE LTD.

Name _____
Title _____
Organization _____
Address _____
City _____ State _____
Zip _____ Phone _____

Call toll free at
1-800-267-3862
In California 1-714-553-8683
Canada and international
613-748-0209

VAX and VMS are trademarks of Digital Equipment Corporation. PAKMANAGER is a trademark of DEMAC Software Limited. SQUEEZPAK is a trademark of DEMAC Software Limited.

Mail to:
Demac Software Limited
Suite 103
Bridge Plaza
Ogdensburg, New York 13669

MICRO TO VAX OPERATING SYSTEMS PART 1:

MEETING THE APPLICATION NEED



SERVING AS SYSTEM OVERSEER AND ENCAPSULATING UMBRELLA FOR APPLICATIONS, TODAY'S OPERATING SYSTEMS OFFER MULTIUSER AND MULTITASKING CAPABILITY PLUS NETWORK MANAGEMENT WHILE PROVIDING COMMONALITY OF OPERATION REGARDLESS OF WHETHER IT'S A PDP-, VAX-, OR MICROPROCESSOR-BASED SYSTEM

by the HC/WG Laboratory Staff

Finding your way through the jungle of processing hardware can be difficult. But choosing the right operating system may prove equally puzzling. Part of the frustration in choosing hardware is determining which operating system is ideal for the task at hand. A year ago, if your needs involved multitasking and multiprocessing, your choices were fairly limited—buy a VAX with VMS and be done with it. Today, that is no longer the obvious choice, nor is it necessarily the right one.

Due to the emergence of the Intel 80386 and the Motorola 68020 and 68030 microprocessors, desktop computer systems offer processing power previously available only with PDP- or VAX-class equipment. But, sheer horsepower is only part of the story. Until recently, these desktop systems

Coordinated by Carl Warren, Editor-in-Chief; responded to by Steve Bostwick, Senior Scientist; Steve Davis, VMS Columnist; Milton Campbell, RT-11 Columnist; Mark Hartman, RSTS Columnist; Bob Gezelter, RSX Columnist; and John Schimpf, UNIX Respondent.

Finding your way through the forest of operating systems can be difficult without the proper road signs. This art, prepared specifically for Hardcopy magazine by Pick Systems, denotes that no single operating system can meet every application need, and even those that promise robust environments often serve up more than is needed. Art work designed by Glenn Herbert and Kevin Schroeder, LeAnce and Herbert (Irvine, CA).



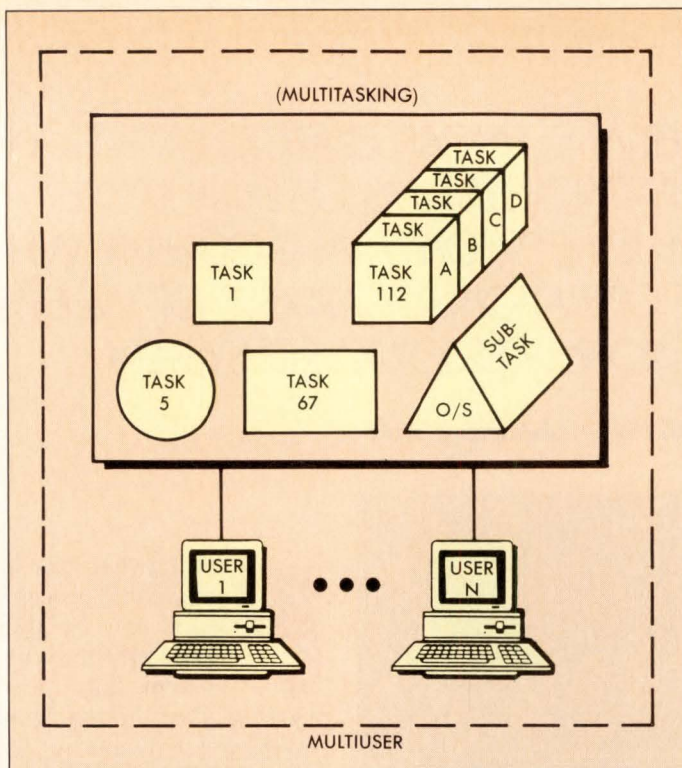

Figure 1—Within a multiprocessing system, the multiuser function makes use of the multitasking concept. In operating, a task request is made by a user or another task. While the requested task is operating, another task may be started by the running task or by another user. The operating system, such as VMS, creates a control environment that measures the needs of each task and user and slices up the CPU time. A multiuser system makes use of the notion of multitasking by using some of the processing time to service requests from users. In reality, the user request is treated in exactly the same way as a task request and processing time is provided.

have been limited by the available operating systems.

This three-part report examines what's available to make your desktop, PDP, or VAX system operate at its best, and explores the basics of operating environments. In this context, the following operating systems/environments are explored:

- microprocessor systems: MS-DOS, OS/2, Pick, and XENIX;
- systems for VAX-class machines: Pick, UNIX, and XENIX; and
- systems for PDP-class machines: RSTS, RT-11, and RSX.

Establishing Environments

You can argue that the hardware does indeed determine the operating environment. But, the applications and what you hope to achieve with them serve as the basic underpinnings of the operation of the environment. For example, a single user with a personal computer is only interested in working on one task at a time.

As your needs change and the processing environment grows, so does

the complexity of the system. For example, multitasking and support of many users is proving to be a necessary requirement in most business applications. Digital Equipment Corp. has always offered these solutions in both hardware and software; today, powerful desktop systems using Intel's 80386 and Motorola's 68000 series of processors offer equal versatility and might. And, as this report will show, the operating environments do exist to support a wide variety of system architectures and application functions.

Multitasking

Multiuser capability is a function of multitasking (Figure 1). A user is just another task within the environment. There are indeed operating systems, such as Microsoft Corp.'s OS/2, that manage multitasking but don't handle multiple users, but they do provide support for networking—a form of multiuser capability (Figure 2).

The Pick operating system, on the

other hand, supports multiple users and tasks but isn't easily integrated into a network environment. The Pick system is a specialized environment that is used on VAX and PC systems. Its purpose is to provide a rich database environment as its core. The system functions, tasking, user support, and peripheral control, are incidentals of the system. The other operating systems/environments discussed in this report tend to work from the hardware out rather than the data in—as Pick does.

Managing multiple functions is indeed important, but so are factors dealing with real time. Most data collection activities rely on the ability of the system to absorb and manipulate data in current or real time. To this end, operating systems such as RSX are powerful tools for those applications—and sufficiently unique to warrant special attention (Part III [June] of this report).

Starting With Singular Tasks

Not all applications demand or require the control of multiple functions. Indeed, single-user and single-tasking operating systems (as opposed to environments) are far more pervasive today than their more robust big brothers.

Currently, Microsoft's MS-DOS is the most widely used operating system for personal computers, but sheer numbers don't necessarily make it the most robust. Clearly MS-DOS is limited when compared with any of the operating systems available for DEC equipment (see Table).

Although it can be argued that MS-DOS is more substantial than some operating systems offered on minicomputers in the past, there are still some who insist that it's not an operating system at all. Rather, it is characterized more as a system executive—the definition of which is quite broad and an academic fine point. Basically, MS-DOS provides the minimum number of features needed to make it useful in a single-user/single-tasking environment.

Managing DOS Files

An important area for you to examine when selecting an operating system is the manner in which files are handled. This is one of the primary purposes of an operating system. There was a time, not very long ago,

There's A Whole Lot Of Shakin' Going On!

Why? Because Sigma set out to make the most rugged, versatile Q-bus enclosure we could. We shook, baked, and bounced our unit until we were confident it would protect your computer system under the most severe work conditions. Not only did we design the SA-H169 to withstand adverse work environments, but we also created an enclosure that's completely adaptable to your specific needs. Note the following features, then call us.

- The backplane, power supply, and disk drives are independently shock isolated.
- Chassis construction is of .090", 6061 aluminum, with a heavy aluminum front bezel, and dowel-pin receptacles for weight distribution in the rack.
- Front inlet filtered air cools the power supply, drives, and backplane at 300 CFM.
- The chassis has been specifically designed to meet MIL-STD-461B; TEMPEST options include EMI and RFI gaskets, EMI honeycomb air vents, and TEMPEST line filter.
- Room for up to four removable shock isolated disk drives to meet your storage needs, with low insertion force, high reliability docking connectors.
- Automatic drive select provides complete interchangeability of drives between slots.
- Front control panel features high visibility indicators, switches for drive write protect, Q-bus control, and power ON/OFF.

Plan to protect your computer system with our Q-bus enclosure.

Call your SIGMA representative today.

Q-bus is a registered trademark of Digital Equipment Corporation.

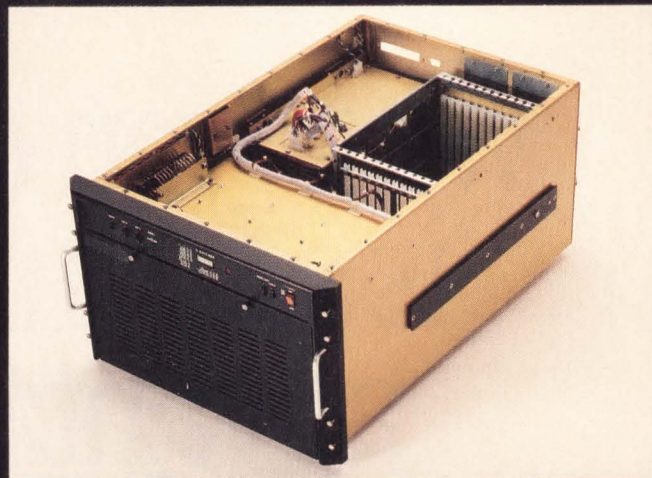

See us at DEXPO/Spring—Booth #237

**Sigma
Information
Systems**

3401 East La Palma Avenue, Anaheim, California 92806
(714) 630-6553 TLX 298607 SGMA FAX (714) 630-5417

CA (714) 633-0652	MA (617) 938-6400	TX (713) 690-8011
(714) 771-7320	MD (301) 921-8898	(214) 790-2777
(408) 241-3770	MN (612) 435-6550	UT (800) 521-3007
CO (719) 528-8893	MT (800) 521-3007	WA (408) 241-3770
ID (800) 521-3007	NM (800) 521-3007	WY (800) 521-3007

Belgium (02)7209038	Holland (03404)27211	Sweden (08)7680540
Denmark (06)848300	Italy (02)4459351	Switzerland (038)514353
Finland (00)52711	N. Zealand (09)590249	U. Kingdom (0372)378811
France (01)47862504	Norway (02)685230	W. Germany (02202)52042
Greece (01)9514944		

Table—Operating Systems at a Glance

Features	MS-DOS	OS/2	XENIX	Pick	VMS	UNIX	System V	Ultrix-32**	RSX	RSTS	RT-11
Multitasking	No	Yes	Yes	Yes	Yes	Yes	Yes	Yes	Yes	Yes	Yes
Multiuuser	No	No	Yes	Yes	Yes	Yes	Yes	Yes	Yes	Yes	No
Networking	Opt.	Opt.	Opt.	No	Yes	Yes	Yes	Yes	Yes	Yes	No
Line Editor	Yes	Yes	Yes	Yes	Yes	Yes	Yes	Yes	Yes	Yes	Yes
Full-Screen Editor	No	Opt.	Yes	Opt.	Yes	Yes	Yes	Yes	Yes	Yes	Yes
C	Opt.	Opt.	Opt.	No	Opt.	Opt.	Opt.	Opt.	Opt.	Opt.	Opt.
FORTRAN-77	Opt.	No*	Opt.	No	Opt.	Opt.	Opt.	Yes	Opt.	Opt.	Opt.
COBOL	Opt.	No*	Opt.	No	Opt.	Opt.	Opt.	Yes	Opt.	Opt.	Opt.
Pascal	Opt.	No*	Opt.	No	Opt.	No	Opt.	Opt.	Opt.	Opt.	Opt.
BASIC	Yes	Yes	Yes	Yes	Opt.	Opt.	Opt.	Opt.	Opt.	Yes	Opt.
Assembler	Opt.	Opt.	Opt.	Yes	Yes	Yes	Yes	No	Yes	Opt.	Yes
Debugger	Yes	Yes	Yes	Yes	Yes	Yes	Yes	Yes	Yes	Yes	Yes
Database Manager	No	No	No	Yes	Opt.	No	Opt.	Opt.	Opt.	Opt.	Opt.

Manufacturer-supplied operating systems only

*Real mode only in current release

**Berkeley Standard 4.2 System V Ethernet

left by deleted files. MS-DOS is more sophisticated than this.

MS-DOS divides the disk volume into small chunks called clusters. Clusters usually range in size from 512 bytes to 4096 bytes. The granularity of the clusters is a function of the density of the recording medium being used and is most often a multiple of the physical sector size. The allocation of clusters to files is controlled by the File Allocation Table (FAT). The FAT has one entry for each cluster on the disk. The index of an entry is used to determine the physical cylinder, track, and sector location of the cluster. FAT entries are either unallocated or part of a linked list of clusters for a file. The FAT entry for the first cluster in a file is in another table called the Directory. To read a file, the system finds the file's name in the Directory, reads the first cluster, goes to the FAT entry for that cluster and obtains the next cluster, and continues reading until the FAT entry indicates the end of the list. When files are written, the system creates a Directory entry, searches

when an operating system required you to allocate absolute track and sector extents to a file. Other operating systems would automatically al-

locate space on a disk, but would not remove deleted files. These systems required the user to repack the disk by copying all the files into the holes

What you don't need
is a lecture on the
advantages of a
spreadsheet designed
for VAX™ computers.

the FAT for the first available entry, writes to that cluster, and continues writing to available clusters, chaining them together until the write is complete.

The MS-DOS file system is generally efficient and flexible. It does, however, have three problems—one minor, one major, and one esoteric. The minor problem has to do with the cluster size. The smallest file you can write is one cluster. While it may irk the more thrifty user that he must use 4096 bytes to hold his 100-byte file, this is not usually a problem. Most users don't have numerous small files and the percentage of waste is generally not large.

The major problem with MS-DOS is file fragmentation. As you can see from the previous discussion of the FAT, MS-DOS does not necessarily write files to sequential locations on the disk. When a disk is new or freshly formatted, files are written sequentially. This means that head movement when writing or reading is minimized. Minimized head movement means maximized data transfer

speeds. As the disk is used and files are deleted, the large areas of contiguous sectors begin to disappear. With a heavily used disk, it's not uncommon to have the disk only half full, but to have data written to every track on the disk. When the free space gets divided into small clumps, new files written to the disk are also broken up. Such files are said to be fragmented. The additional head movement required for processing fragmented files can significantly degrade the performance of a program using those files. There are ways to correct a fragmented disk. Several utility programs exist that will safely reorder the files on a disk so that they are sequential. This reordering is also a by-product of some file backup restoration programs, thus killing two birds with one stone. The potential system degradation due to disk fragmentation is principally of concern to users with programs that constantly read and write large files. Such users might include large database systems, commercial programs such as payrolls, and scientific users

with programs that use large data files.

The esoteric problem has to do with a limitation imposed by MS-DOS' FAT system—no volume may exceed 32 Mbytes. Until two years ago, very few users would have found this a limitation as 32 Mbytes of data is a lot of data. (When computers were young, the popular press liked to describe computer *StorAGE* in Encyclopaedia Britannicas [EBs]. The exact value of an EB has been lost in antiquity, but assuming that it's about eight million characters, a 32-Mbyte disk will hold four EBs!) When the standard hard disk drive held 10 or even 20 Mbytes, the 32-Mbyte limit seemed more than enough.

Now, the standard disk drive is 40 Mbytes and drives with capacities in the hundreds of megabytes are not uncommon. The 32-Mbyte limit requires that these large drives be treated as several volumes and limits the largest possible file to 32 Mbytes. This may not be a large enough file for some giant databases and for some scientific files such as star cata-

What you do need is proof.

Order a 20/20 Evaluation Kit and you'll get a full working program, documentation and Evaluator's Guide. 20/20 is the leading integrated spreadsheet for VAX™ computers. 75% of everyone who tries 20/20, buys 20/20. Once you see what it can do for you, we think you will, too.

Attached is my business card or letterhead. Please send:

- Information on ordering a 20/20 Evaluation Kit.
- Information on 20/20.
- Information on your reseller program.
Computer Model _____

Access Technology, 6 Pleasant Street, South Natick, MA
01760/617-655-9191. In Europe: 66-68 Chapel Street, Marlow, Bucks
SL71DE, England (0628)890345 Telex: 848138 HCA488

20/20 by Access Technology

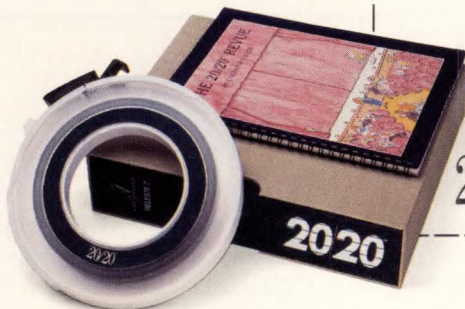

CIRCLE 444 ON READER CARD

logs that carry stellar data at very high precision. This limitation is, however, being removed from MS-DOS. The current version of Compaq DOS (3.31) and the next version of MS-DOS (3.4) have this restriction removed.

Large disks have added another consideration to be examined when selecting an operating system: directory structure. With a 32-Mbyte drive, it's easy to have hundreds of files. A directory listing could take a long time and be so long that you couldn't find your file. For that reason, MS-DOS supports the subdirectory concept. This allows a hierarchical division of the volumes files into smaller, logical groupings. Since subdirectories may themselves have subdirectories, a complete tree-structured directory system can be created.

MS-DOS File Utilities

MS-DOS has all the usual file utilities and commands. You can copy files, delete files, rename files, rename volumes, etc. It has a mediocre file backup system that most people avoid. The only really elegant file utility is XCOPY, which allows whole subdirectories to be copied to another volume. Aside from this routine, the file utilities are very pedestrian. Several fancy file utilities are, however, available from third-party vendors.

MS-DOS multiuser and multitasking is easy to describe—there's no such thing. The only way for more than one user to access files and other resources is through a network. Although networking works with MS-DOS, it was an afterthought and is not well integrated into the operating system. MS-DOS doesn't have real multitasking facilities built into it. A

task can suspend itself and start a subtask, but simultaneous execution of tasks requires that the system be tricked. MS-DOS has one multitasking utility, PRINT, which prints files as a background task. Other background-type utilities are available from third-party software suppliers. Microsoft offers a multitasking option for MS-DOS called Windows.

MS-DOS Tools Its Strength

The great strength of MS-DOS is the plethora of available editors, compilers, linkers, spreadsheet programs, word processors, and other productivity aids.

For program editors, MS-DOS comes with EDLIN, a line editor. This program, although usable, is limited and you're better off using an optional program or word processor.

Included with MS-DOS is the Mi-

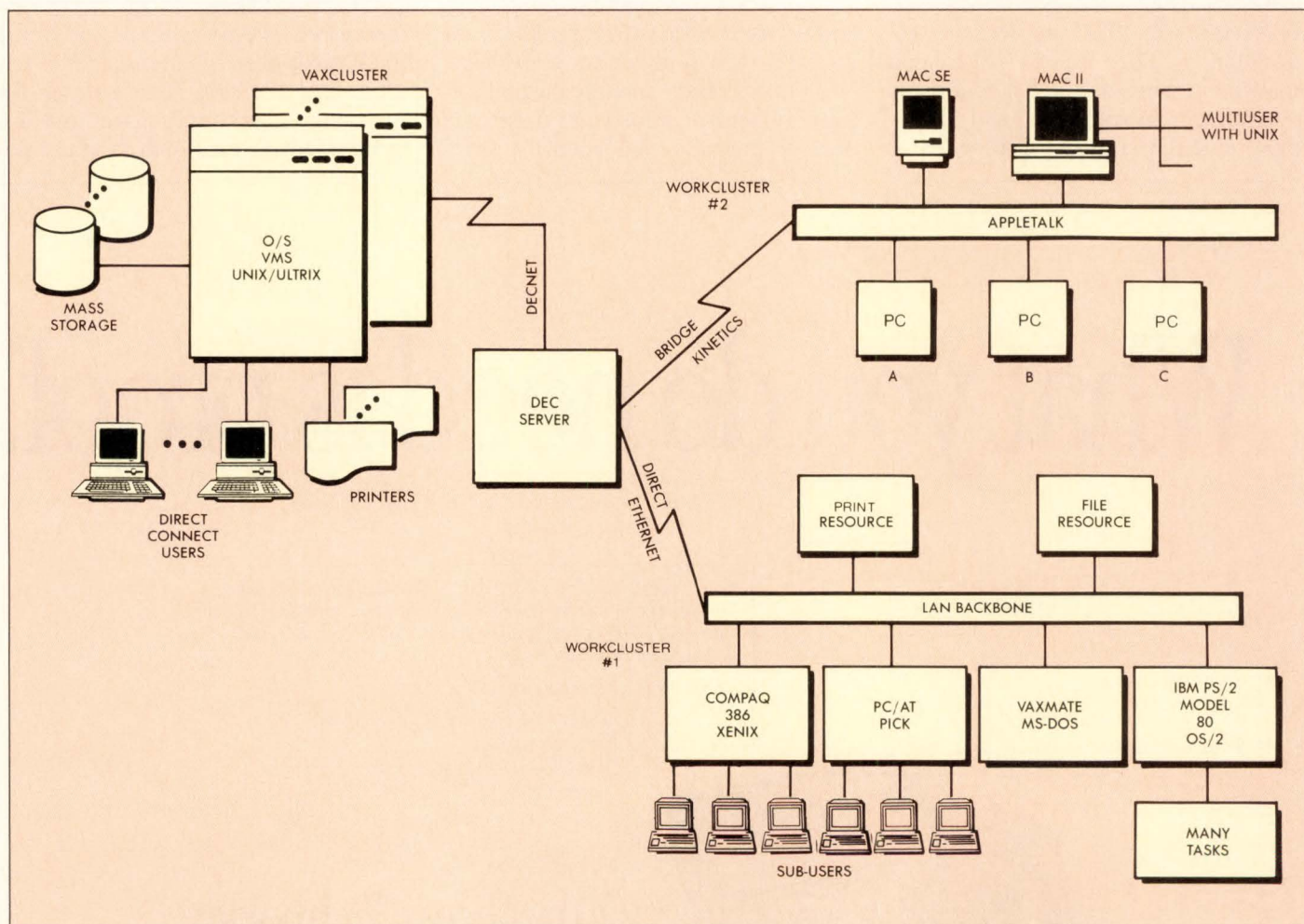

Figure 2—One of the clear advantages of tying diverse workclusters together with networks is the commonality of resources. A node on cluster 1, for example, has access to any resource within the matrix as if it were a local device. Thus, a terminal user (sub-user) attached to the Compaq 386 running XENIX and attached to an Excelan Ethernet backbone can access any of the resources or files available on that network or those on the VAXcluster. One factor that makes the idea of diverse workstation clusters workable is the idea of common files within diverse environments. For example, a file on the VAXcluster will look the same to the user of the VAXmate running MS-DOS.

icrosoft BASIC Interpreter. This is a very good BASIC and has become the industry-standard BASIC. In addition to BASIC, Microsoft has a very strong selection of optional language processors ranging from the QuickBASIC compiler to a powerful LISP compiler. Notably, the Microsoft C for microprocessors is the same C the company offers for the VAX.

There are some similarities between Microsoft tools and those supplied with VMS. For example, all Microsoft compilers come with an excellent linker. The latest versions of the C, FORTRAN, QuickBASIC, and Pascal compilers allow their object code to be linked together along with assembler routines. Pascal main routines can call C subroutines and FORTRAN can call C or QuickBASIC routines, etc. These compilers and assemblers now also come with CodeView, Microsoft's excellent source line debugger.

But microprocessor systems are no longer limited to minimal operating environments. Indeed, there are four other alternatives, Microsoft's OS/2, Pick, UNIX, and XENIX, that you can choose from, especially if multiprocessing capability is needed.

Microsoft Multitasking

Taking the cue from multitasking operating systems like VMS, Microsoft has developed OS/2. By combining the flexible file structure of MS-DOS with modern operating system concepts, OS/2 maintains downward compatibility to older MS-DOS applications.

Since both MS-DOS and OS/2 operating systems come from a common manufacturer, you would expect them to bear a resemblance to each other and, in fact, they do. Microsoft refers to both operating systems as the MS-DOS/OS/2 family and there is a family resemblance. Both systems share a common file structure and system functions. There are improvements over MS-DOS, however. These include:

- Device-independent graphics drivers—better access to high-bandwidth peripherals while maintaining the ability to virtualize the peripheral. There's no longer a need to access BIOS routines or hardware directly to obtain good performance with high-speed peripherals.

```
@echo off
rem
rem Set real mode program path and data path
path c:\os2;c:\rbin;c:\bin;c:\os2\install;c:\;c:\brief
append c:\rbin;c:\bin
rem
rem Set prompt to identify real mode and current directory path
prompt=$e[37;41m$x[Real $P]$e[37;40m
rem
rem Set pathnames for compilers, assemblers, and linkers
set init=c:\init
set include=c:.;c:\include;c:\lanman\netsrc\h
set lib=c:.;c:\lib;c:\lanman\netsrc\lib
set tmp=c:\tmp
rem
rem Set BRIEF environment control variables
set bpath=c:\brief\macros
set bhelp=c:\brief\help
set bbackup=.
set bflags=-ail20r -mSJB
rem
rem Install public domain dos command line editor
ced
a)
```

```
@echo off
rem
rem Set protected mode program path and data path
path c:\os2;c:\pbin;c:\bin;c:\lanman\netprog;c:\
dpath c:\pbin;c:\bin
rem
rem Set prompt to identify protected mode and current directory path
prompt $e[37;44m[$P]$e[37;40m
rem
rem Set pathnames for compilers, assemblers, and linkers
set init=c:\init
set include=c:.;c:\include;c:\lanman\netsrc\h
set lib=c:.;c:\lib;c:\lanman\netsrc\lib
set tmp=c:\tmp
rem
rem Turn on ANSI escape sequence support
ansi on
b)
```

To maintain upward and downward compatibility, command file verbs used by MS-DOS, and the newer OS/2 from Microsoft Corp., are similar in operation but, as would be expected, the newer generation is more robust. For example, MS-DOS requires that an ANSI device driver be loaded, but OS/2 has a syntax switch that allows you to make use of the industry-standard terminal escape sequences.

- Multitasking with little or no loss of response and performance from single-tasking systems.

- A separate, customizable environment for each program.

- A protected environment to ensure system stability.

- A fully integrated network manager.

MS-DOS and OS/2 are closely related. Applications can be written to run under either by restricting the Application Program Interface (API) calls to a common subset called the Family API. OS/2 has also taken great pains to ensure that older programs can run under OS/2. New pro-

grams run as tasks in "protected" mode, a mode where application programs and the operating system are protected from other applications running at the same time.

The converse of protected mode is real mode; older MS-DOS programs must run in the real mode. OS/2 provides one task that is capable of accepting older, real-mode programs. This task is called the "real box" or "compatibility box." Most MS-DOS programs that do not harm the system hardware or software will run in the real box. This does not affect other, protected-mode tasks, which may run simultaneously.

OS/2 Files and File Utilities

OS/2 uses exactly the same file structure as MS-DOS. OS/2 and MS-DOS may, in fact, coexist on the same system and share files. All of the MS-DOS file utilities and commands are available under OS/2. OS/2 has the same 32-Mbyte maximum volume size that MS-DOS has, but it will be revised soon.

Unlike MS-DOS, OS/2 has multitasking support. Like MS-DOS, OS/2 is not a multiuser operating system. Like MS-DOS, networking provides multiuser capabilities. Unlike MS-DOS, OS/2 has a fully integrated network manager that provides safe and efficient access to the network's resources—easing integration tasks.

OS/2 is a true multitasking operating system. Many tasks can be run simultaneously and in complete isolation. Even older MS-DOS applications can be run as one of the tasks. From the user's point of view, the system provides the convenience of running several jobs at once. The advantages to the program developer are more profound. You can now build sophisticated, multi-threaded applications using standard operating system features. Thus, OS/2 applications are more robust than their MS-DOS counterparts.

Tools As Good As VMS

OS/2 still provides the offensive EDLIN editor. Since it only runs in the real (compatibility) mode, it's probably the same exact editor provided with MS-DOS. Microsoft does provide a much better editor with its OS/2 Software Development Kit (SDK). This editor, called SDKED, is a full-screen editor and runs in either real or protected mode.

All of the compilers available for MS-DOS run under OS/2 in real or compatibility mode, limiting the resulting application to run only in real mode as well.

In the SDK, Microsoft provides modified versions of two of its compilers, Macro Assembler and the Microsoft C Optimizing Compiler, which produce code that runs in protected mode. As with MS-DOS, these compilers include a copy of CodeView that has been modified for OS/2.

Color Me XENIX

XENIX System V is a fully li-

censed implementation of AT&T's UNIX System V with enhancements for the microcomputer environment. XENIX was originally developed by Microsoft. It has become the standard microcomputer UNIX system and 85% of all microcomputers, worldwide, that are running any form of UNIX are running XENIX. The Santa Cruz Operation Inc. (SCO) and Microsoft have an exclusive joint agreement for the cooperative development and marketing of XENIX. This working relationship has produced a complete UNIX that runs well in the PC environment and cohabitates with MS-DOS.

XENIX System V is a powerful multiuser and multitasking operating system. There are versions of XENIX for microcomputers based on the 8088/8086, 80286, and 80386 processor.

Files Like to Share

Files under XENIX share the same physical media as MS-DOS and OS/2 files, but their format is completely different. The directory structure used by XENIX is similar to the subdirectory structure of MS-DOS, but references to specific physical drives are not explicitly used.

XENIX has all the standard file utilities and commands found in any operating system. It also has a rich set of commands that can best be described as nice. The ability to search files for a pattern or to compress files are the types of services XENIX is famous for.

More Than One Function

XENIX is a full multiuser and multitasking operating system. It allows file sharing between independent terminal operators or between application programs under the control of one or more users. Networking is also available as an option.

Like the other systems, XENIX has a rich set of editors, compilers, and other development tools. XENIX provides several editors. The standard UNIX line editor, ed, is provided. Another editor, vi (which stands for "visual"), is also provided; this editor combines both line- and screen-oriented features. vi is powerful, but it is also fairly complicated. It has commands and features to satisfy the most jaded text-editor junkie.

SCO provides two language processors—C and assembler. Along with these processors, SCO provides all the development facilities for which UNIX is famous, such as a comprehensive source code control system and an interactive symbolic debugger. In addition, the following Microsoft compilers are available in XENIX versions: Microsoft BASIC Interpreter, Microsoft FORTRAN Compiler, Microsoft COBOL Compiler, Microsoft Pascal Compiler.

XENIX is the most commonly chosen multitasking operating system for microcomputers. This is partly because of the popularity of UNIX, but more due to the support available from the large UNIX community. XENIX is a good choice for a multitasking microcomputer operating system, especially if the user wants to maintain compatibility with a UNIX or Ultrix system running on a VAX.

Part II of this report, which will appear next month, delves into the Pick, UNIX/Ultrix, and VMS operating systems. In the June issue, the final installment of this three-part report appears wherein HC/WG Labs Software Respondent Mark Duvall shows you how to install and manage a XENIX environment with a 386 workstation. ■

Reader Interest Level

High	Circle No. 291
Medium	Circle No. 293
Low	Circle No. 295

For additional information about the products discussed in this article, please contact the company directly or circle the appropriate reader service number.

Accusoft Enterprises
8041 Foothill Blvd., Ste. A
Sunland, CA 91040
818-951-1891
Circle No. 242

Digital Equipment Corp.
Maynard,
MA 07154-2571
617-490-8365
Circle No. 243

Microsoft Corp.
16011 N.E. 36th Way
P.O. Box 97017
Redmond,
WA 98073-9717
206-882-8080
Circle No. 244

Pick Systems Inc.
1691 Browning St.
Irvine, CA 92714
714-261-7425
Circle No. 245

**Santa Cruz
Operation Inc.**
400 Encinal St.
Santa Cruz, CA 95060

VMEbus and MicroVAX imaging subsystems from Imaging Technology. Advanced vision for advanced architectures.

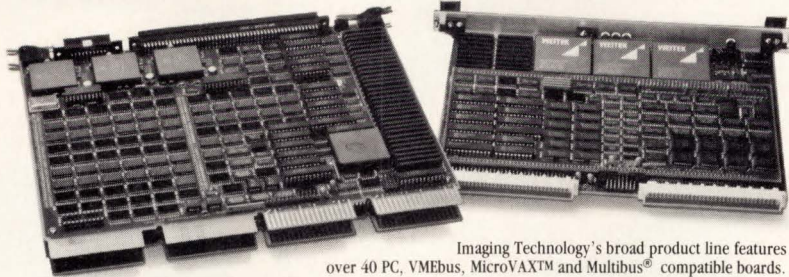

Imaging Technology's broad product line features over 40 PC, VMEbus, MicroVAX™ and Multibus® compatible boards.

Imaging Technology supplies high-powered image processing hardware and software for MicroVAX and VMEbus-based computers and workstations, including Sun Microsystems.

Our Series 100™ single-board image processor incorporates real-time image acquisition, storage, and display capabilities. It even includes a patented feedback processor to perform real-time recursive operations such as averaging and subtraction.

If you're looking for more processing power, our modular product lines offer such features as large frame memories, programmable video buses, real-time pipeline processing, tightly-coupled array processors, and several display options including the highest resolution display in the industry (2048 × 1536 × 9-bits).

All of our products are supported by ITEX™, a library of over 200 high-level image processing functions. In addition, several interactive packages featuring mouse and menu-driven operation are available.

For all of your image processing needs, turn to the company that leads the field in products, experience, and support. Technology and service so clearly superior, they named the industry after us.
Imaging Technology.

Single-Board Subsystems	Expandable Subsystems	
VMEbus, MicroVAX, PC AT®	PC AT, VMEbus	MicroVAX
<input type="checkbox"/> Real-time image acquisition and pseudocolor display <input type="checkbox"/> Input and output look-up tables <input type="checkbox"/> Up to 1.5 Mbytes image storage <input type="checkbox"/> Zoom, pan, and scroll <input type="checkbox"/> Real-time feedback processing <input type="checkbox"/> Interactive and driver-level software	<input type="checkbox"/> Up to 4 Mbytes image storage <input type="checkbox"/> Real-time convolutions, histogramming, and feature extraction <input type="checkbox"/> Programmable (C and FORTRAN) 20 MFLOPS floating-point accelerator <input type="checkbox"/> Interactive and driver-level software	<input type="checkbox"/> Continuous processing on images up to 4K × 4K <input type="checkbox"/> Tightly-coupled array processor <input type="checkbox"/> Multiple high-resolution display options up to 2048 × 1536 <input type="checkbox"/> Real-time disk interface <input type="checkbox"/> Interactive and driver-level software

Imaging Technology subsystems and software available for the PC, VMEbus, Q-bus™, Multibus. Please contact us for complete product specifications.

1-800-532-3500

IMAGING Technology Inc.

Imaging Technology Inc., 600 West Cummings Park, Woburn, MA 01801 □ (617) 938-8444

PC AT is a registered trademark of IBM Corporation; Q-bus and MicroVAX are trademarks of Digital Equipment Corporation; Multibus is a registered trademark of Intel Corporation; Sun Microsystems is a registered trademark of Sun Microsystems, Incorporated; the IMAGING logo is a registered trademark, and ITEX, PCVISIONplus, Series 100, Series 150, Series 151, and Series 200 are trademarks of Imaging Technology Incorporated.

Eastern Region 617-938-8444 □ Midwest Region 313-855-2680 □ Western Region 714-960-7675 □ Australia (3)-8734455 □ Canada (604)-273-8655 □ Eastern Bloc [49]-(61)-8227338 □ Finland (0)-674191
 □ France (1)-45347535 □ Germany (89)-809020 □ Hong Kong (5)-8976678 □ India (91)-244771 □ Israel (3)-495898 □ Italy (2)-4817930 □ Netherlands/Benelux (76)-710144 □ New Zealand (3)-798740
 □ Norway (2)-555977 □ Portugal (2)-666501 □ S. Korea (2)-6333547 □ Singapore 2780011 □ Spain (3)-2042099 □ Sweden (8)-830980 □ Switzerland (1)-7307655 □ Taiwan (2)-3923170
 □ United Kingdom (273)-608331

CIRCLE 442 ON READER CARD

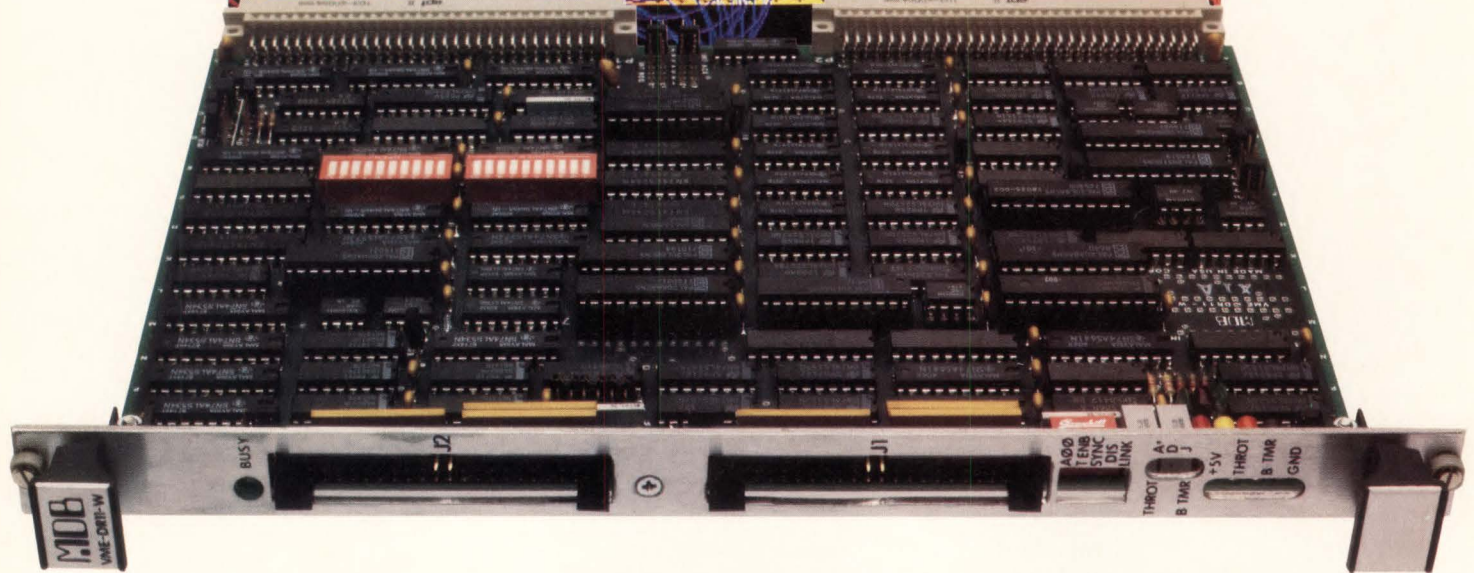
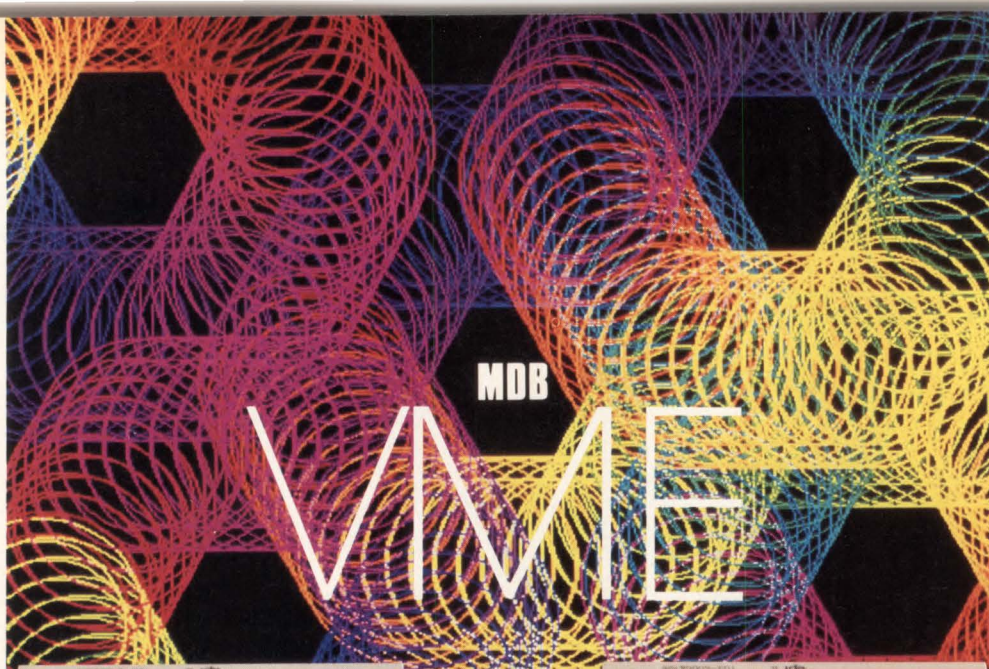

The leader in DR11-W connectivity just entered the VME world.

We've been solving connectivity opportunities in the DEC world since 1982 when we introduced the MDB DR11-W. And we've been the technology leader in parallel DMA I/O connectivity since, thanks to MDB's proprietary DMA Throttle which prevents peak I/O rate CPU overloading during DMA transfers.

Because of its parallel data path with data transfer speed up to 5 Mbytes, the new VME DR11-W operates high resolution graphics terminals. Or, link VME based systems to other VME systems, or to DEC™ and Data General Computers, or to stand alone workstations such as Sun Microsystems. It means connectivity is no longer limited to LANs such as Ethernet or serial interfaces.

See us at DEXPO/Spring—Booth # 1100

MDB
SYSTEMS INC.

— We put the *State of the Art* to work —

Its performance is equally impressive. Burst and Block Mode capabilities with programmable boundaries allow DMA transfers up to 128 Kbyte blocks anywhere over a 16 Mbyte address range. Plus, switch selectable Asynchronous/Synchronous modes allow greater throughput when connected to computers or other devices with similar capabilities.

Like all members of MDB's DR11-W family, its VME module is 100% DR11-W compatible, and also has a switch selectable DRV11-WA mode. This means VAX or MicroVAX users who are migrating to VME systems will have a much easier task of software driver conversion from DEC systems to VME.

Now that you've entered the VME world, it's good to know the leader in connectivity is already on-board.

Data General, DEC and Sun are trademarks of their respective companies. VAX and MicroVAX are trademarks of Digital Equipment Corporation.

Corporate Headquarters 1110 W. Taft, Box 5508, Orange, CA 92613-5508 • TEL: (800) 556-0222. In CA (800) 637-2028 • FAX: (714) 637-4060 • TWX: (910) 593-1339

FOR UNITED KINGDOM MDB Systems, U.K., Ltd. Intec 2, Wade Road, Basingstoke, Hants. RG24 0NE • TEL: 0256 464767 • FAX: 0256 59748 • TELEX: 858389 MDBSYS G

FOR WESTERN EUROPE MDB Systems, IRL., Ltd. Portumna Co., Galway, Republic of Ireland • TEL: (353) 509 41163/41413 • FAX: (353) 509 41447 • TELEX: 50918 MDB EI

CIRCLE 436 ON READER CARD

HC/WG Labs Builds a UNIX Workstation

If you're thinking about attaching a workstation to increase the distributed processing power of your VAX, the HC/WG Labs staff shows you how to turn an IBM PC/AT into a powerful UNIX workstation without losing the use of your DOS-based applications

by the HC/WG Laboratory Staff

If you're planning on attaching a UNIX workstation to your VAX, but would like to do it for minimal cost and possibly use existing equipment, there is a way. You can add a powerful 32-bit coprocessor board to your IBM PC/AT that gives you UNIX, X Windows, and Ethernet connectivity all rolled into one package.

At HC/WG Labs, we're always looking for ways of extending the processing power of our VAX 11/750. However, our intentions go far beyond just adding another piece of equipment. Indeed, our commitment is to show you, the *Hardcopy*

reader, ways to make better use of your Digital Equipment Corp. system and operating environment. To this end, we established the following goals for our workstation project:

- use existing equipment where possible,
- use UNIX as the operating environment, and
- use Ethernet to enhance connectivity.

Leveraging What's on Hand

After developing our basic plan, we carefully evaluated the hardware and capabilities at hand.

In addition to ensuring that our

VAX 11/750 and MicroVAX II were properly equipped with Ethernet support, we found (within our inventory of available systems) that we had our choice of IBM PCs—ranging from a 4.74-MHz XT to an 8-MHz AT—as well as a Compaq Computer Corp. Deskpro 286. Although you can use the latter system, and we did, we don't necessarily recommend it for this type of project.

Although it's possible to run UNIX or Santa Cruz Operations XENIX (see "Report 4: Operating Systems," page 32 this issue) on an Intel 80286 system, our goal was to create a system that offered operating characteristics similar to a Sun Microsystems 2 workstation. This included running UNIX System V, bit-mapped graphics for X Windows, Ethernet, and multiuser/multitasking capability, as well as VAX 11/780 performance of at least 1 million instructions per second (MIPS).

We found that we could meet all our needs by using Opus Systems' Model 110-PM (personal mainframe).

This board is based on a Nation-

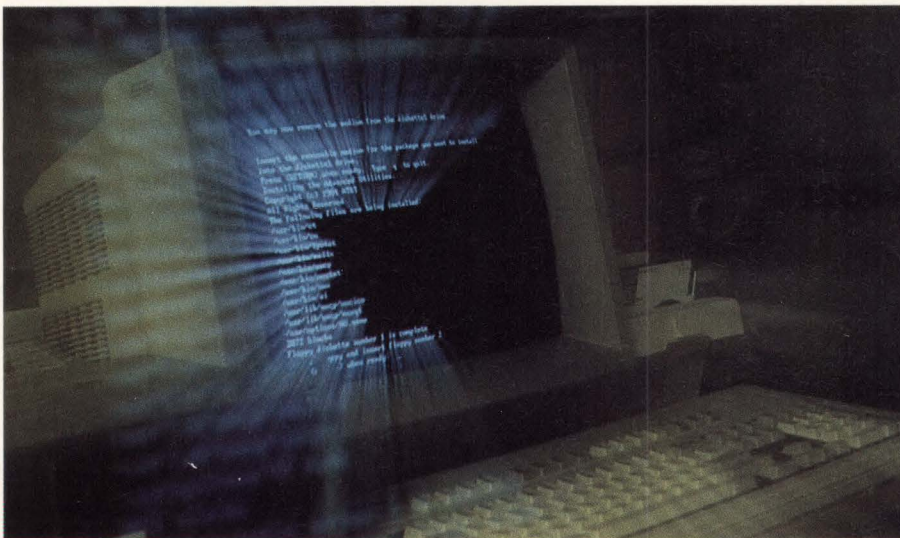

The HC/WG Labs UNIX workstation, built around an Opus Systems 100-PM, 32-bit processing board, with 2 Mbytes of RAM, and a Moniterm 19-in. Viking 1 monochrome display monitor, adds extended processing power to your VAX with powerful processing tools such as X Windows and multiuser/multitasking functionality, as well as Ethernet connectivity.

Coordinated by Carl Warren, Editor-in-Chief; responded to by Steve Bostwick, Senior Scientist; Chris Serrano, Senior Respondent, Software; Richard Steincross, Senior Respondent, Hardware; and John Schimpf, Technical Support, Opus Systems.



Figure 1—Although it's possible to run X Windows in color, as depicted, with the proper interface card, the HC/WG Labs workstation used a Moniterm Viking 1 monochrome display. Either way, X Windows provides a high-level graphics interface that provides the same windowing system used by Apollo, Data General, DEC, Hewlett-Packard, Siemens, and Sun Microsystems in their workstation systems.

al Semiconductor NS32032 micro-processor running at 10 MHz and is available with 2-4 Mbytes of memory. Prices start at \$1,995 for the 2-Mbyte version. Adding another \$1,000 puts on an additional 2 Mbytes of 120-nsec, dynamic memory at current prices. This isn't the only board made by Opus (see Table), but 1 MIPS is adequate for most functions and, as you will see in Chapter 3 of this series (June *Hardcopy*), stacks up performance-wise with most top-of-the-line workstations.

The processing board is only part of the Opus package. The board uses AT&T's UNIX System V, Release 3 with a complete workbench, C, and Bourne shells, and support for such languages as C, FORTRAN 77, COBOL, BASIC, and Ada.

Bit-Mapped Superiority

Among the features that attracted us to the Opus system was the ability to support X Windows (Figure 1). This feature, which is also found on workstations made by Apollo, Data General, DEC, Hewlett-Packard, Siemens, and Sun, provides a common user interface for the operation of applications but, due to its architecture, supplies the necessary underpinning for a platform for application developers.

A workstation using the Opus 110-PM, for example, and using X Windows can actively support as many as four sessions (active opera-

tions), displayable on the screen simultaneously. Moreover, the system can also be serving as a resource to four additional clients (terminals)—well within the operational scope specified by Opus.

The software functionality of X Windows is indeed impressive. But, in order for the system to have bit-mapped graphics capability, Opus offers a number of alternatives, in-

cluding the choice of a Moniterm 19-in., monochrome, high-performance bit-mapped monitor that displays 1280 x 960 pixels with a 66-Hz refresh rate to minimize flicker. We chose the Moniterm monitor, the same monitor employed by Sun, for its low price.

Performing the Integration

How you set up the AT for use as a UNIX workstation greatly depends on the system (Figure 2). We found that the best system was the least known. In fact, we created the actual workstation using a 286 AT-compatible backplane from Taiwan with 640 Kbytes of system memory. If you have extended or enhanced memory, you might as well remove it; the Opus PM doesn't take advantage of it. Since we have a Compaq 286 Deskpro, we did set the system up using that as the base, at first. But the Compaq is a difficult system to integrate with foreign products such as third-party coprocessor boards.

For example, when using the Moniterm board you will run into difficulties. The display controller

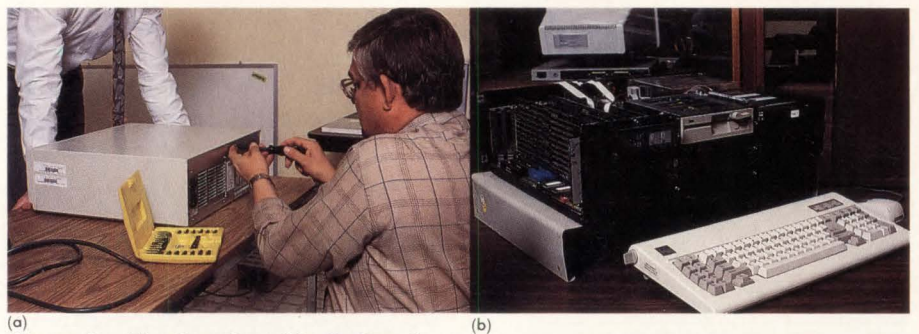

Figure 2—The Opus board is designed to fit into a variety of IBM PC-, XT-, or AT-compatible systems, such as the Compaq Deskpro 286 (a), or a basic clone made up of several manufacturers' boards (b). The latter system was created at the HC/WG Labs using a 286 motherboard and off-the-shelf standard AT case.

HARD FACTS:

Opus 110 PM-02 Processor Board

Price: \$1,995

- Uses National Semiconductor 32032 processor
- Memory: 2 Mbytes

Opus Systems
20863 Stevens Creek, Bldg. 400
Cupertino, CA 95014
408-446-2110

Circle No. 237

Moniterm Viking 1 System

Price: \$2,035

- Resolution of 1280 x 960
- Refresh rate of 66 Hz

Moniterm Corp.
5740 Green Circle Dr.
Minnetonka, MN 55343
612-935-4151

Circle No. 238

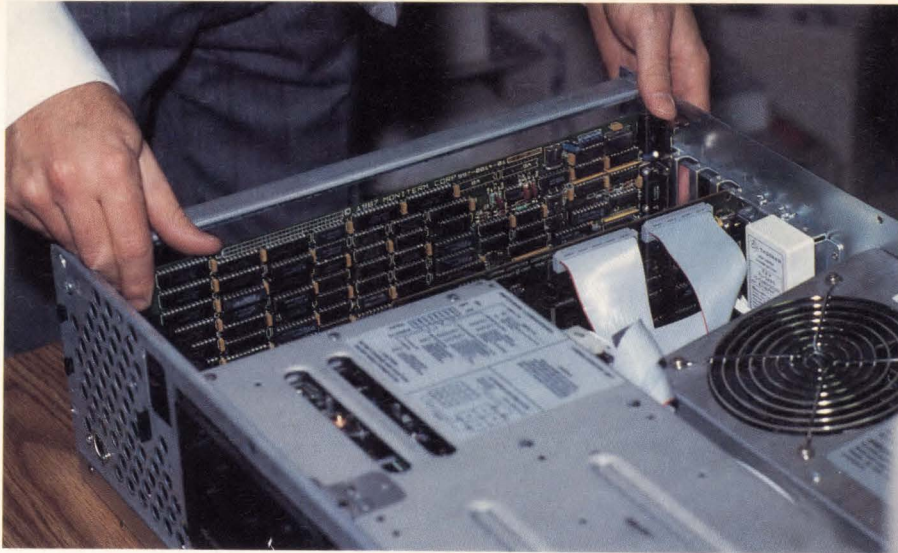

Figure 3—The Viking 1 control board uses only one slot on the AT backplane. The board, as designed, uses the existing monochrome display board in the AT as the basic driver to establish the horizontal and vertical sweep signals. If you're using a Compaq 286 Deskpro, the Compaq enhanced color display card will have to be taken out and the Viking board set to C00A0 to avoid conflicting with other BIOS services.

board, supplied by Moniterm, relies on the raster signal output from a standard monochrome/color adapter. The board supplied with a standard Deskpro provides only color or enhanced color graphics output. Additionally, standard address settings of the Moniterm board (B0000 to B8000 hex) are in conflict with display services found on the Compaq, thus the board must be re-addressed to C8000 hex.

The price for the Moniterm display monitor and board may not seem low at \$2,035, but the monitor and board do provide the necessary display performance needed to accommodate X Windows.

Even though the the Moniterm board requires only one AT slot (Figure 3), you still must have a standard monochrome adapter—thus two slots are used for one display function. You can elect to use the Microfield Graphics Inc. T8 Color Graphics controller, which can use the Moniterm monitor, or, more appropriately, a color monitor. The price is hefty, however, at \$3,495. In addition to using only one slot, the T8 gives you the ability to display 1280 x 1204 pixels with eight planes of color. We recommend that if you need this kind of display power, you also consider the 300-PM series of

CPU board with the Intergraph Clipper processor. It costs \$13,000 but provides 5 MIPS of performance—something you might consider for high performance and process-demanding CAD.

Once the platform is chosen and the display board properly set up, you can add the Opus board (Figure

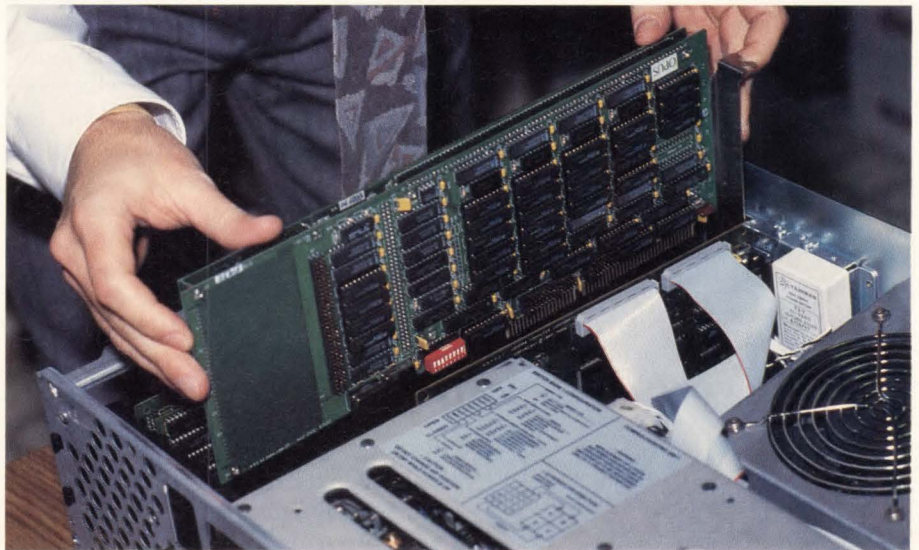

Figure 4—The Opus 110-PM tucks nicely into one AT slot and essentially acts as a separate processor, making only a few demands on bus services. The National Semiconductor processor has the task of running UNIX and X Windows, as well as any other UNIX task within its own processing boundaries. The AT processor takes a subservient role and manages the I/O functions, including disk accesses. However, DOS can be accessed via X Windows and data transferred to and from each environment.

4). Basically, this board only uses one slot but, even with the 110-PM, we recommend that a slot remain open alongside it. This provides sufficient ventilation for reasonably cool operation. Most AT cases have improper thermal design and tend to keep heat encased.

Putting UNIX to Work

Once we had the boards properly installed and were sure no memory conflicts existed, our next task was to create the UNIX working areas. This proved to be the meat of the integration task and really isn't for the novice.

Rather than attempt this part of the project alone, we asked John Schimpf, from Opus Technical Support, to lend us a hand.

With the Opus system you have two choices: create a partition on the disk, or set up DOS files for UNIX to operate from. Since our Compaq system was a working unit with existing data and applications on disk, we chose the latter. This does reduce the efficiency of the system and we found it to be difficult with the Compaq due to the BIOS incompatibilities of an IBM PC.

Our clone system, which we dub Betty in workgroup KLATCH (this

VMEbus users:

NEW

**NISSHO N8200
256 Kbyte
FAST SRAM**

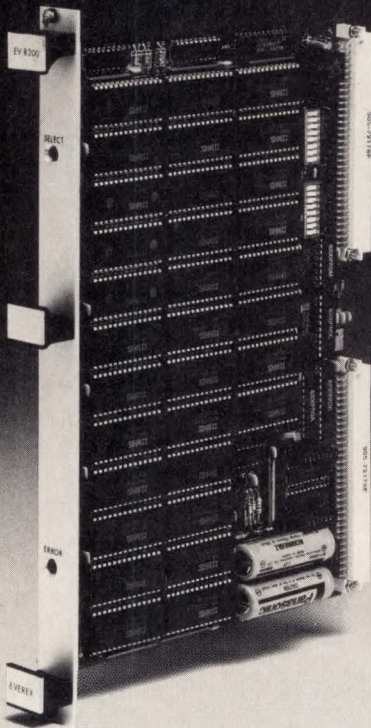

- High speed SRAM — 35ns
- Battery backup for memory retention
- VMEbus (Rev C) compatible
- Placement boundaries 64K byte or larger
- User selectable starting and ending address
- LED indicators for valid select and error

FOR MORE INFORMATION CALL
(800) 233-1837 In Calif. (714) 261-8811

NISSHO
ELECTRONICS

17310 Red Hill Avenue, Suite 200, Irvine, California 92714
FAX (714) 261-8819, TLX 181-308
CIRCLE 466 ON READER CARD

Table—Opus Personal Mainframe Processor Boards

Model	Price	Processor	Memory	Performance
110 PM-02	\$1,995	National 32032	2 Mbytes	1 MIPS @ 10 MHz
110 PM-04	\$2,995	National 32032	4 Mbytes	1 MIPS @ 10 MHz
220 PM-04	\$3,995	National 32032	4 Mbytes	2.25 MIPS @ 16 MHz
220 PM-08	\$6,155	National 32032	8 Mbytes	2.25 MIPS @ 16 MHz
220 PM-16	\$9,755	National 32032	16 Mbytes	2.25 MIPS @ 16 MHz
340 PM-04	\$6,140	Clipper	4 Mbytes	4 MIPS @ 25 MHz
340 PM-08	\$8,300	Clipper	8 Mbytes	4 MIPS @ 25 MHz
340 PM-16	\$11,900	Clipper	16 Mbytes	4 MIPS @ 25 MHz
350 PM-04	\$7,640	Clipper	4 Mbytes	5 MIPS @ 30 MHz
350 PM-08	\$9,800	Clipper	8 Mbytes	5 MIPS @ 30 MHz
350 PM-16	\$13,400	Clipper	16 Mbytes	5 MIPS @ 30 MHz

is all networking functions), was much easier. We had specifically set this system up to be a host to the Opus board and act primarily as a UNIX machine. Thus, we established a 17-Mbyte partition for UNIX, leaving 3 Mbytes for DOS. This also provided the necessary swap areas we wanted, as well as support for the Excelan software. Ideally, you should consider using the largest Winchester you can accommodate. We recommend that you consider a minimum of 40 Mbytes.

Installing UNIX does take some time. First, you have to determine whether you want to partition the disk or have UNIX run as logical disks within DOS files. When doing the latter, you have to decide how many disk blocks you need to allocate for Opus system software, back up DOS, and establish the necessary logical disk files for UNIX. You need a minimum of 5 Mbytes of *StorAGE* for a small Opus system.

The program, *opinit* install, is designed to manage the installation of the Opus UNIX system. This also causes the running of a configuration program called *opconfig*. This program has the responsibility of setting up how devices are handled and establishing the UNIX System V parameters.

The most efficient way of handling the Opus system is to install it within its own disk partition. Our

original system had a 20-Mbyte drive and we chose to use 17 Mbytes of it for Opus and the remaining 3 Mbytes for DOS. As we said earlier, 40 Mbytes is really the ideal minimum, especially if you're planning on two operating environments.

Ideally, if you're setting up a UNIX workstation and work group, you will want full utilities and languages. However, if you're running UNIX/Ultrix on your VAX, you might want to implement only a minimal configuration of Opus UNIX and use either RFS or NFS for file commonality.

Monitor Serves As Overseer

In operation, the Opus boards use an active monitor that takes up about 64 Kbytes of the AT memory and does block moves of data to and from the AT I/O space. There is no double copying, so the operation is fairly quick. The overhead is considerable if you need the memory space on your AT. The 200- and 300-PM series processor boards, however, are more efficient and appear as 16 bytes in the AT I/O space. This is used to transfer status and commands and specify the addresses for the data. A DMA acknowledge sets up the direct move of data to the new address area.

Regardless of the Opus board chosen, the interrupt logic is used to control the board in a master-slave relationship. In some cases, the AT

processor acts as the master and transfers control to the Opus processor board, which then assumes command of the bus by using interrupts. The Opus processor is primarily interested in controlling its own local bus and memory, making system bus calls only when I/O is necessary.

The interrupt structure of the AT bus is set up with the following status:

Priority Level	AT Function
0 (high)	Timer
1	Keyboard
2	Daisy-chain to upper octet
3	COM1
4	COM2
5	Unused
6	Disk
7	Printer
10	Opus default
11-15	Available

If you want to add extra ports to the system for additional users, you can open up eight serial ports (including COM1 and COM2) using I/O addresses 280 hex to 2C0 hex. Depending on what each terminal/user is doing, you may want to establish interrupt levels ranging from low to high priority—an interrupt setting of 3 is typical and should accommodate most system requests. Your network, which is discussed next month, will have the highest priority. ■

Next Month Chapter 2: Adding the Excelan Ethernet

Next month, in Connection Directions, Chapter 2, we will show you how to add an Excelan Ethernet network to your UNIX workstation and attach it to a 386-based system running XENIX with a VAX 11/750 and MicroVAX operating in the background as powerful system servers on the same network. ■

Move Data...Error Free and Secure At Speeds Up to 2 Megabits... Exceeds DMR-11 Capabilities for the Q-Bus

Talon's new MaxComm/QB™ Data Communications Co-processor for the MicroVAX and MicroPDP-11 is designed to move data at high speeds with minimum host computer loading.

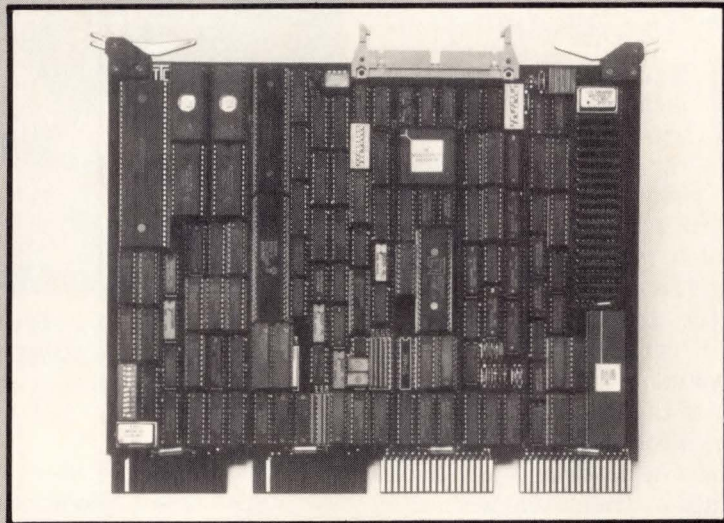

The MaxComm/QB co-processor's unique programmability features allow it to support industry standard protocols for specialized applications. Here are some standard features:

- **HDLC** protocol with extended framing and selective retransmission for efficient satellite communications.
- **DMR-11** emulation, operates with DMR-11 driver.
- **512 Kbytes** of RAM supports multi-hop satellite links.
- **DECnet** or **TCP/IP** operation over T1 circuits.
- **Block-mode DMA** minimizes Q-Bus usage.
- **Cryptography** in real-time using DES for secure transmissions.
- **MaxComm/UB** for DEC VAX and PDP-11 computers provides full product line integration and software portability.
- **FFTS** (Fast File Transfer System) communication software for optimizing point-to-point connections.

These are just a few reasons why our MaxComm co-processors should be your first choice for cost effective data communications. Contact Talon to see how MaxComm or FFTS can improve your communication system.

TTC TALON
TECHNOLOGY
CORPORATION

1819 FIRMAN DR., SUITE 137
RICHARDSON, TX 75081
(214) 680-9913 • TELEX-293291
FAX: 214-690-1001

MicroVAX, VAX, PDP, DECnet, Q-Bus, DMR-11, are Trademarks of Digital Equipment Corporation.
MaxComm/QB, MaxComm/UB, FFTS, are Trademarks of Talon Technology Corporation.

CIRCLE 467 ON READER CARD

The HC/WG Lab Reads the Traverse VMS Menu

by the HC/WG Lab Staff

Attempts to support non-technical users have met with varying success over the years. Clearly, experience demonstrates that both hard work and ingenuity are essential to producing an effective user interface—the interactive environment that exists between the end-user (consumer) and the computer system.

One of the first simplified man-machine interfaces was the familiar model of a desk where all activities performed by the system were analogous to those activities the user performs at his desk. Now, Visitech Graphic Resources Inc. offers the results of its work to the rest of the MIS community. HC/WG Labs tested Visitech's Traverse application interface program for the VAX to determine just how well the work pays off.

We found that Visitech's product is no mere menu system to trap users in a seemingly endless maze of choices. The interface provides a list of possible choices along with a list of past selections. In addition to all these choices, Traverse offers the option of allowing users to access selections outside the normal path from anywhere in the selection environment. Thus, users can jump directly to many points from their current position. You can customize the interface to suit your users' needs, and also expand the interface without affecting the existing environment (Figure 1).

These and other features make Traverse a workable interface for both sophisticated and occasional VAX users. We tested the program on a VAX 11/750.

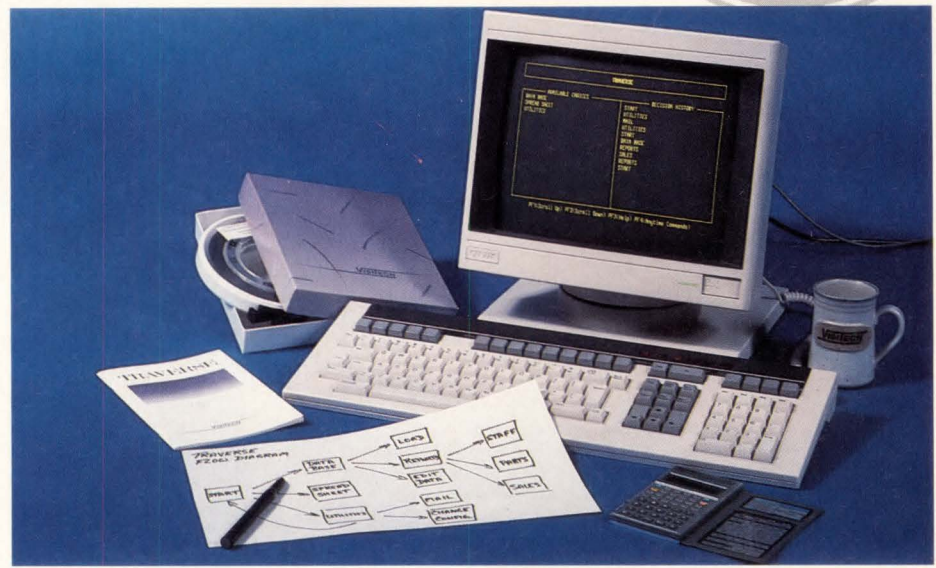

Figure 1—Based on the viewpoint that a good user interface should provide fast access to functions without presenting an overwhelming number of choices, Traverse avoids the tedious menu-maze approach and allows you to define the way some selections lead to others in a tree/node fashion.

Within Traverse, users can make two types of selections: those that offer a choice of more selections and those that perform some function. When you create the user selections, you define the paths to connect them and assign certain attributes to each selection. The attributes determine what actions Traverse will take when that selection is made. For example, a selection that initiates an application program can include qualifiers or parameters associated with the application.

When users enter the Traverse environment, a selection display window appears on the left that shows currently available choices

and a selection history window appears on the right that provides a history of past choices (Figure 2). The selection history window is a handy feature because it allows users to select from any of the previous choices displayed.

Pressing the PF4 key replaces the selection history window with a display of Anytime commands that are available from any point in Traverse. Pressing PF4 a second time restores the selection history to the screen's right window.

Traverse can display a maximum of 15 selections per window. When there are more than 15 selections, the PF1 and PF2 keys are used

HARD FACTS:

Traverse V. 1.2.0
 Price: \$2,920 (MicroVAX) to \$15,625 (graphics version for VAX 8800)

- Screen-drive interface to access any program
- Selection history window allows user to choose any previously selected option, providing greater ease of use when only one or two program selections are ever accessed by user

- Compatible with directional arrow keys on standard alphanumeric terminal or Intergraph graphics interface permits VAX-based workstation to make menu selections using a mouse

Visitech Graphic Resources Inc.
 3115 12th St., N.E.
 Calgary, Alberta
 Canada T2E 7J2
 403-250-1266
Circle No. 118

to scroll the currently selected window up or down, respectively. Up to 28 choices can be accessed from a given selection.

Users make selections from either window by using the arrow keys to position the cursor on the desired choice and then pressing the Return key. Traverse also has an Intergraph graphics interface that allows users with an Intergraph VAX-based workstation to make menu selections with a mouse.

Our favorite suggestions for Anytime commands are GRIPE and EXIT WITH RESTART. As the latter indicates, it allows a graceful way to get out of Traverse at any time and later return to the same point. In a normal menu environment, such an exit would entail backing out of a chain of selection menus and then reentering those menus from the beginning. Thus, the EXIT WITH RESTART command can save a lot of work.

The second of these Anytime commands, GRIPE, calls the VAX-mail utility and allows the user to send a message to the person designated at product installation time as the recipient of any gripe. This command gives users the comfort of knowing that a person is out there somewhere who will hear their complaints or pleas for help.

An alternative to human help is an on-line help facility that can be customized. Positioning the cursor on a menu selection and pressing either the PF3 key or the HELP key clears the screen and displays your description of the selection. A welcome addition to this facility would be qualifiers for additional information on the topic.

Installing the Software

HC/WG Labs tested V. 1.2.0 of Traverse. It was received stored in a VMS saveset that we transferred to a directory we created for testing purposes. We would prefer that the installation use the standard VMSINSTAL software installation procedure, which would create all the directories and define any logicals necessary to run the product.

The *Traverse Delivery and Installation Guide* mentions that you might need to extend the job logical

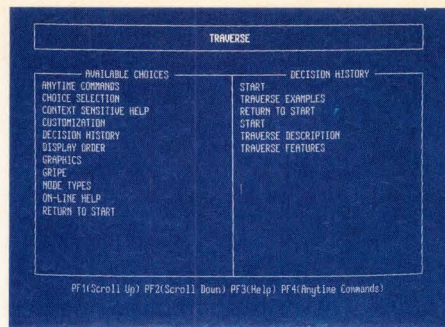

Figure 2—The availability of both a current selection list and a decision history gives users many choices at any given point; Traverse allows a user to select any of the choices on the screen by moving the cursor to that choice and pressing the Return key.

table size to accommodate the logical names—we found this to be true. Note that, although the guide says you can use the VAX AUTHORIZE utility to modify the job table size, it fails to name JTQUOTA as the actual quota you must increase.

Pieces of the Interface

The Traverse system includes five modules: Traverse, Layout, Edit, Modify, and Restart. The first module, Traverse, uses the system definition file to control system interaction. Most users won't need to employ any other module in the package after creating the Traverse environment.

The Layout module allows you to define or modify the system components (selections, paths, etc.) and test their relationships (Figure 3). The Edit module is really just part

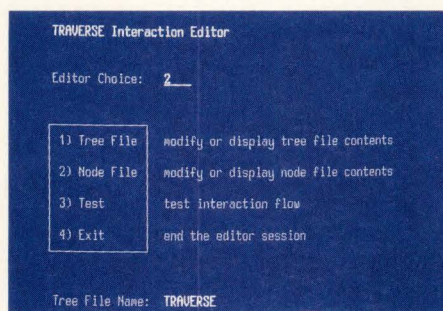

Figure 3—A simple menu gives access to a Layout module for modifying the way selections are interconnected in Traverse. The tree and node files define how each selection leads to others, and you can test the interrelationships to make sure they are complete before they go into actual use.

of the Layout module, but it's used by other Visitech products and can be accessed independently or from the Layout main menu.

The Modify module enables you to modify the various system components for a specific user or group of users.

The Restart module helps implement the EXIT WITH RESTART command. The module allows a user to specify a file previously created by exiting Traverse with the EXIT WITH RESTART command, thus skipping unnecessary steps in the menu-selection process.

Add a New Selection

On our first trial run with Traverse, we followed the instructions in Appendix B of the *Reference Manual on Modifying the Traverse Demonstration Package*. The modifications dealt with a section of Traverse functions called the Traverse Examples, which allow you to keep items such as appointment listings, a diary, and phone numbers. As instructed, we deleted all paths from the Traverse Examples section to the phone number function and created a new selection called Phone Book. Then we created a new path from Traverse Examples to Phone Book. Finally, we created new paths from Phone Book to the phone number functions. This modification worked just as explained in the documentation.

Next, we decided to add DECalc as an activity selection from the Traverse Examples selection path. We were able to create a selection for DECalc, but we couldn't get the application to run. A call to Visitech cleared up the problem; we had to create a DCL command file so that Traverse could call DECalc.

Traverse allows any user to customize his interface environment. This is a good idea in theory, but in practice many users will find it difficult to modify the Traverse environment without help from someone familiar with VMS and DCL command procedures.

Documentation Confusion

The documentation for Traverse is printed using easy-to-read type from a laser printer on quality

stock. It comes in an attractive gray binder. Our demonstration package included a *Product Overview* and a *Demonstration Guide*.

Despite the outer appearance of quality, the manuals are poorly organized. Two of the documentation's three sections include tables of contents, but there are no indexes of any kind. Since the information you need can be in different manuals, looking up a specific subject is sometimes difficult.

For example, the *Reference Manual's* section on setting up activity selections makes no mention of using command files to run applications. Appendix A does offer a sentence on the subject, however. Also, the current documentation doesn't explain many of the on-screen messages from the Layout and Modify utilities.

Such explanations would make it much easier to customize Traverse. Only by getting assistance from Visitech and examining the sample selections in the demonstration were we able to understand how the

product operates.

Fortunately, the *User Manual* provides adequate information for using Traverse once you set up the system.

Reports from Users

To see how actual Traverse users view the product, we talked to individuals at two different companies. Douglass Keen, manager of integrated exploration and production systems for Tenneco Oil (Houston, TX), says it's "easy for the user to get in it and zoom around." Krystal Kainer, who is responsible for implementing Traverse on Tenneco's VAX systems, says that after she had been trained for a day, she had no problem creating the Traverse environment for the applications on her system. However, she cautions that the documentation is hard to understand and it would be a good idea to get the day's worth of training available from Visitech.

Pricing

Traverse is priced by CPU and

ranges from \$2,920 for the alphanumeric MicroVAX version to \$15,625 for the graphics version on a VAX 8800. The primary license includes all applicable software modules and two copies of the documentation. You can purchase additional product manuals for \$40 each. The annual maintenance fees range from \$580 for a MicroVAX to \$3,125 for the VAX 8800.

Views and Opinions

From outer appearances, Traverse is a technically sound product. We at the HC/WG Labs feel there's room for improvement, however, especially in the documentation.

Technical users might find it difficult to imagine why it's necessary to have a product that makes VMS easier to use. But for those environments that have a high personnel turnover rate, a large number of employees unfamiliar with computers, or application programs that use confusing acronyms (are there any that don't?), Traverse can be a welcome teacher. ■

IN THE QUEUE

The following products have been received by *Hardcopy* for review or HOW evaluation.

Access Technology Inc.
South Natick, MA
Product: 20/20
Status: At review

CIE Systems
Irvine, CA
Product: CI-2500 Dot-Matrix Printer
Status: At review

Data Technology Corp.
Santa Clara, CA
Product: Crystall Print VIII
Status: At review

Houston Instruments
Austin, TX
Product: DMP-61 Plotter/Scanner System
Status: In the HC/WG Lab

Imagen Corp.
Santa Clara, CA
Product: RCDI-1000 Personal Publishing System
Status: At review

Jyacc Inc.
New York, NY
Product: Jam V. 3.1 Development Environment
Status: At review

Lightgate
Oakland, CA
Products: Felix; Post-mouse
Status: At review

Meridian Software Systems Inc.
Laguna Hills, CA
Product: Meridian AdaVantage Compiler
Status: At review

Microsoft Corp.
Redmond, WA
Products: Microsoft Works for IBM PC; Microsoft Pageview
Status: At review

Modgraph Inc.
Burlington, MA
Product: GX-2000 Graphics Terminal
Status: At review

The Santa Cruz Operation
Santa Cruz, CA
Product: SCO Xenix OS
Status: At review

Traveling Software
Bothell, WA
Products: LapLink Plus; Desklink Communication Software
Status: At review

VM Personal Computing
Danbury, CT
Products: Beyond.BAT; Relay Gold
Status: At review

White Crane Systems
Norcross, GA
Product: The Brooklyn Bridge Communications Program
Status: At review

CONNECTION DIRECTIONS HANDBOOK PROJECT

Excelan
San Jose, CA
Product: LAN Workplace; MicroVAX Ethernet Controller and Software; EXOS 1130 Fan-Out; Ethernet Controller for IBM PC
Status: In the HC/WG Lab

Easy E-Mail

**Around the
office or
around the
world.**

ProMail™

Electronic Mail Software

The Fantastic Voyage

Meet E-man, the wizard of ProMail electronic mail. E-man makes the voyage from your terminal through the EasyLink network. No more dealing with unruly addresses. No more hassles making your message conform. You simply specify a VMS mail name (That's right. That's all!) and E-man delivers mailgrams, telegrams, cablegrams, telex, FAX, and other E-mail around the world. From terminal to terminal. Yours to ours. Receive more information at EasyLink #62128960, telex: 489553. Or phone (801) 224-5306, Clyde Digital Systems, 371 East 800 South, Orem, UT 84058.

Clyde®

CIRCLE 412 ON READER CARD

An open invitation to VARs.

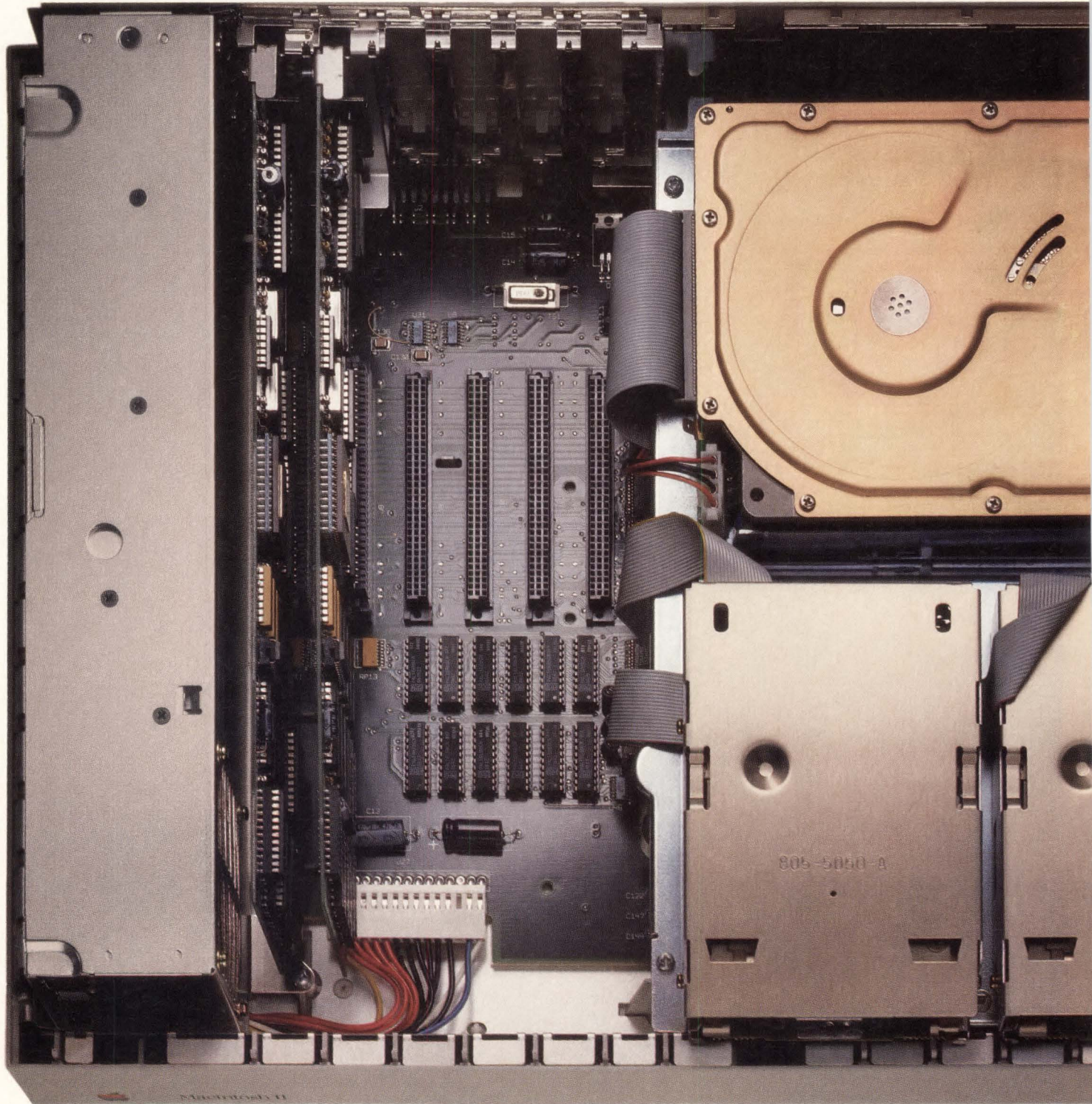

As a VAR, you undoubtedly find increased power very inviting.

Which is why Apple® keeps bringing you more powerful tools to help you build more sophisticated systems.

Our latest leaps in technology, the Macintosh™ SE and Macintosh II personal computers, are two prime examples.

They're designed to let you put together systems that offer more speed and graphics power. And are actually more affordable and easier to use.

Look at the SE, for instance. It comes with up to four megabytes of memory and an optional built-in 20-megabyte hard disk.

And you can add value easily, using its internal expansion slot, external SCSI port and two RS-232 serial ports.

The Macintosh II, on the other hand, offers a VAR even more. It's a full 32-bit machine, based on the new generation Motorola 68020 processor and 68881 math co-processor.

The latter of which can perform complex calculations up to 200 times as fast as conventional computers.

It comes with six internal expansion slots. Memory up to eight megabytes on the motherboard. And hard disk storage of 20, 40 or 80 megabytes.

But even better for your business as a value added reseller, the Macintosh II can be set up to run other operating

systems. Like MS-DOS and AT&T UNIX.®

And because its slots are NuBus technology, they not only move information much faster—they have the good manners to “configure” themselves.

So even intricately customized systems are easy to assemble.

With no DIP switches to set.

As for the options you can add, both the SE

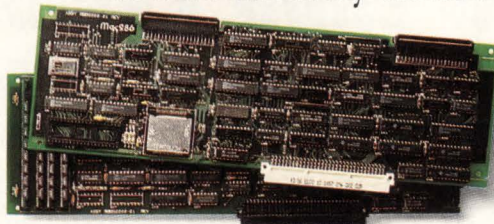

Build your own Macintosh II. Expansion cards let you add new power, such as the ability to run MS-DOS programs.

and II offer some formidable choices.

From co-processor and communications cards to cards that are custom-built for the systems you design.

With the Macintosh II, you can even add a video card for a color monitor that lets you work with 256 brilliant colors from a palette of over 16 million.

Of course, we're offering VARs a lot more than a choice of powerful computers.

We have special programs that make it easier to get the equipment you need for system development. As well as sales programs to help you promote and develop your market.

We can also keep your business healthy with promotional programs and after-sale support. And provide complete Apple product training.

For information about Apple's VAR programs, just call 800-538-9696, ext. 505.

We'll tell you more about how the Macintosh SE and Macintosh II make it easy to add new features. And new customers, too.

The power to be your best.™ 





HC/WG Labs Evaluates Alisa Systems' AlisaTalk, Part II: Making the Final Connection

by Alen Darr and Paul Morrin, *Price Waterhouse*

We don't understand why the best laid plans seem to fall apart. After being in data processing for more than 10 years, we should have realized that even something that seemed easy, could seemingly take forever to complete. Our goal, for the February '88 issue of *Hardcopy*, was to describe implementation of the AlisaTalk Macintosh-to-VAX software product. Unfortunately, obtaining all of the hardware components for our MicroVAX II in time to meet the deadline for the February issue was not possible, and, in fact, we also missed the March issue—still trying to get all of the pieces put together. The good news though, is that AlisaTalk was worth the wait.

Recap of Our Objectives

As you may recall from the February issue (see "HC/WG Labs Evaluates Alisa Systems' AlisaTalk, Part I," page 38, February 1988), our goal here at Price Waterhouse in implementing the AlisaTalk system was to integrate our current Macintosh AppleTalk networks (all three of them, with more than 35 Macintosh computers) to our MicroVAX II system. Our primary objectives were:

- Using the VAX as a print server for report spooling. We also wanted to be able to print to the PostScript printers on AppleTalk from the VAX.

- Using the VAX as a file server. The existing AppleTalk-based file servers function quite well in that capacity, but our real goal in using the VAX as a file server was to be able to utilize the VAX/VMS BACKUP facilities to provide for an "automatic" backup of files, since the backup function is not very efficient.

- Having a convenient way for Macintosh users to access the VAX without having two terminals on their desks and having to rewire all of their offices.

- Provide for a common mail system for both Mac and VAX users. We are quite pleased with the implementation of E-mail on the VAX

and In-Box on the Mac, but we were searching for a way to integrate the two services.

The Installation

After installing the hardware in both the MicroVAX and the Kinetics Inc. FastPath, we were able to install and test the AlisaTalk software. The process went as well as could be expected (for first-time installers); however, a defective FastPath almost caused us to pull our hair out! Initially, we thought something was wrong with our software installation. Finally, using the EPEEK utility to monitor the Ethernet, we were able to determine (with the help of the people at Alisa

HARD FACTS:

Kinetics' FastPath EtherTalk Gateway

Price: \$2,500-2,750

- Programmable bridge connects AppleTalk network to Ethernet network
- TCP/IP network protocol
- Compatible with both ThinWire and standard Ethernet configurations

Kinetics Inc.
2500 Camino Diablo
Walnut Creek, CA 94596
415-947-0998
Circle No. 240

AlisaTalk

Price: \$3,750-\$11,500

- Utilizes AppleTalk network as the basic communication highway
- Implements VAX file server utility on the Mac
- Provides terminal emulation for VAX/VMS
- VAX print spooler is available for use by Macintosh
- Supports DEC Print-Server 40

Alisa Systems Inc.
221 E. Walnut, Ste. 175
Pasadena, CA 91101
818-792-9474
Circle No. 241

Systems Inc. and Kinetics) that the FastPath was defective, and were able to get a replacement the same day (thank goodness Kinetics is only 70 miles away!). As it turned out, this minor setback forced us to use some of the utility programs that we would probably not have tested in detail (unfortunately there's nothing like hands-on experience).

Measuring Up AlisaTalk

Disk serving—we expected AlisaTalk to perform the tasks of being both a print and a file server, and it did the job quite well. From the standpoint of a Mac user, the VAX-based virtual disk created by Alisa-

Talk functioned exactly as either a local Mac disk or an AppleTalk file server would. We were concerned initially about two items:

- performance of the VAX-based virtual disk through the FastPath compared to our existing AppleTalk file servers, and
- the performance impact additional processes would have on our MicroVAX II.

First, the performance of the VAX-based virtual disk was comparable to that of a local file server. We thought it might be slower because of the overhead of the VAX processes, but since the real limitation in both networks was the speed of the AppleTalk network, the re-

sponse time was quite good.

We monitored the VAX during our file-serving process and were quite pleased that the AlisaTalk processes, used to perform the virtual disk management, required minimal VAX resources to perform the print- and file-serving processes.

Print serving—There are three flavors of print serving offered by Alisa:

- The basic print spooling package is provided with the standard system and allows Macintosh workstations on AppleTalk to transparently spool documents to a LaserWriter. The basic print spooling package also allows VAX users to

Notes from the Lab Notebook

Kinetics Inc.'s FastPath is a physical gateway between AppleTalk and Ethernet networks. Because AppleTalk and Ethernet use two different protocols, the FastPath hardware and software is needed to provide the common connection/translator between the two networks with a program that resides in the FastPath itself.

After booting your Mac from the FastPath Installation disk, select the FastPath manager icon from the desktop. Choose Find All Gateways from the Gateways Menu.

If a gateway is found that has not been configured, the message "Gateway 220 has been RESET and has not had configuration data sent to it" will be displayed. When the FastPath manager finds the gateway, a default configuration window will be displayed, at which time you will enter your Gateway Name, AppleTalk Zone Name for both the AppleTalk and Ethernet sides, the AppleTalk Network Number (ours was 128 on the AppleTalk side and 1 on the Ethernet side—remember these numbers for installing AppleTalk/VMS on the VAX), and a unique Ethernet address, one component of which is the FastPath's serial number

(ours is 00848) found on back of the FastPath.

The configuration data is then saved in a configuration file and downloaded directly to the FastPath by clicking on SEND LOAD, then SEND CONFIG, and finally GO. Our configuration file is illustrated in Figure 1. Your FastPath is now installed.

The process of installing the FastPath software, both on the physical FastPath and on the Macintosh, is very simple if directions are followed and if your FastPath is functioning correct-

ly. The documentation is clear and concise, with step-by-step instructions. Having never seen a FastPath before, this was greatly appreciated.

A Painless VAX Installation

The first step to installing AlisaTalk on your VAX is to perform the AppleTalk for VMS Installation provided with the AlisaTalk distribution kit. (The documentation provided by Alisa Systems Inc. is excellent, both for product installation and for general product usage). This will cre-

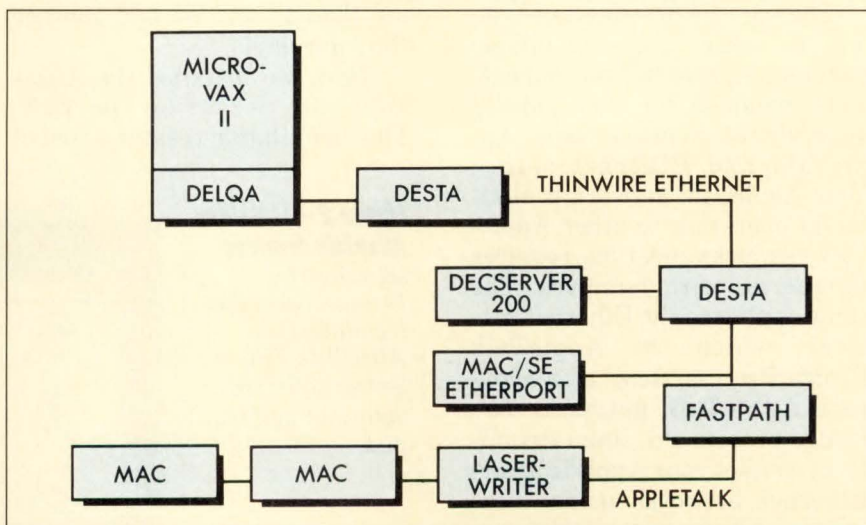

Figure 1—Due to protests from our users (imagine that!), we were forced to create our own mini-network. At the conclusion of testing, we are planning to move the FastPath and connect it to the three active networks.

print plain text or PostScript files to a LaserWriter located on the AppleTalk network.

- The Digital Equipment Corp. print system allows AppleTalk users to print to DECserver-40 and LN03-R laser printers located on the VAX.

- The AlisaTalk print system (which is a separate product and not included with the base system) allows full two-way printing capability between printers located on the VAX and printers located on the AppleTalk network.

Our distribution from Alisa only

included the basic print spooling package, so we were unable to install or verify the DEC print system or the AlisaTalk print system. In our mini-network we obtained (stole) a LaserWriter for testing, and the basic print spooling package worked quite well. For those VAX

ate and install four key elements of AppleTalk/VMS on your VAX:

- VMS AppleTalk Library (ATKLIB—a shareable image library for use in linking with user AppleTalk interface programs);
- AppleTalk bridge process (a VMS process—“ATK/VMS Bridge”);
- AppleTalk Bridge Control Program (ATKBCP); and,
- Virtual AppleTalk Network Driver (VNDRIVER).

The basis of AppleTalk and an important point to remember is that VMS processes created as a part of this installation are treated as actual nodes on the AppleTalk. AppleTalk will create a virtual network on the VAX, with a bridge process that will connect your virtual network on the VMS host to any external network. The installation will also create the required rooted directory (in our case, ATK\$ROOT, assigned to DUA0:[SYS0.]), the requisite startup command files, and the user APPLETALK (whose default directory is defined as ATK\$ROOT:[APPLETALK]).

During the installation, you will be asked to assign unique port names, zone names, and network numbers for each side of your virtual network (both AppleTalk and Ethernet sides). Your AppleTalk network is similar in operation to other AppleTalk networks and, thus, requires unique network numbers. The same applies to the Ethernet network, which the AppleTalk Bridge Process views as a separate AppleTalk network. The bridge process will link (virtually, of course) your AppleTalk and Ethernet networks using these names and numbers, which are the same as you used to configure your Kinetics FastPath, and which, for us, just happen to be

the defaults for the AppleTalk/VMS installation (simplicity is a virtue).

The network port names, network numbers, and zone names that you assign are stored in the port descriptor file (PORTDESC.TEXT) in the AppleTalk directory. We took default responses to all questions: AppleTalk port name is “VLAP PORT”, AppleTalk Ethernet port name is “AELAP PORT”, zone is “VAX ZONE”, virtual AppleTalk Network Number is 8000, and the AppleTalk Ethernet Network Number is 0001.

Following a successful installation of AppleTalk/VMS, the next installation we performed was EXAMPLES, which installed several useful (KERMIT, among other things) and interesting (try DFREQUESTOR) network applications, including EPEEK, which will examine packets being sent over your Ethernet network to AppleTalk. We used EPEEK to determine that the first Kinetics Gateway was defective. One call to Kinetics, though, and we had another the same day!

Next, we installed the AlisaTalk File Server on the VAX. This installation creates a rooted

directory MFS\$ROOT (we took the default of DUA0:[SYS0.APPLETALK.FILESERVER.-MFS0.]) where all Macintosh volume information is stored. The root MFS\$ROOT:[000000] contains directories of volumes, VOL.NAMES (a text file used by the server containing the file server name and the names of all volumes), and FILELIST.TEXT (which contains a list of files that the server treats as private).

During the file server installation, you are asked to provide the name of the server (default of VAX) and the names of the initial Macintosh volumes. Our initial volume was MACVOL, and our server was VAX. This information is stored in VOL.NAMES and will be used by the server to identify all volumes for use by Mac AppleTalk users. Following installation, we executed the installation-supplied command procedure that starts the server process on the VAX.

Next, you install the utilities—the file server utility) and the LaserWriter print utility, which are explained later in this article.

AlisaTalk Installation

Installing AlisaTalk on your

Figure 2—Installing AlisaTalk involves selecting the Installer icon, then installing the AlisaTalk File Server software onto your system disk.

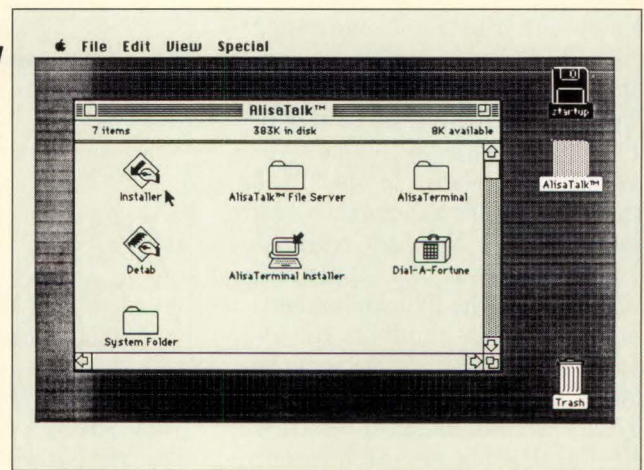

HELIX VMX™

The Best of Both Worlds

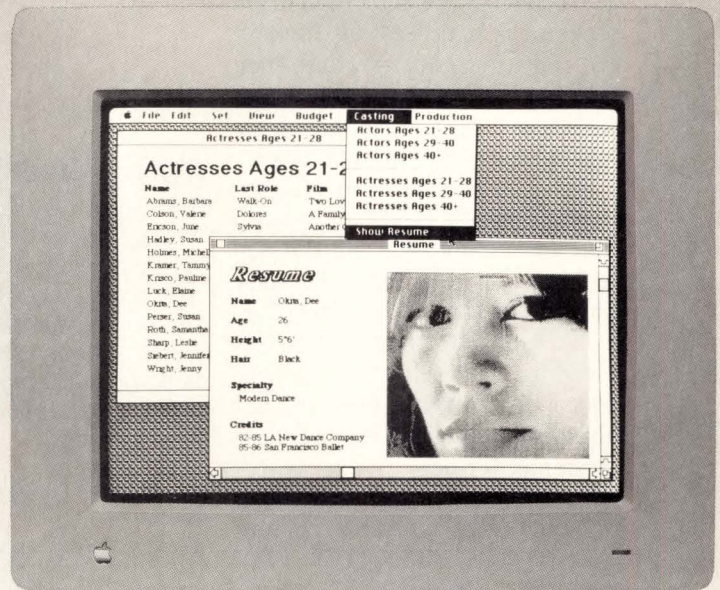
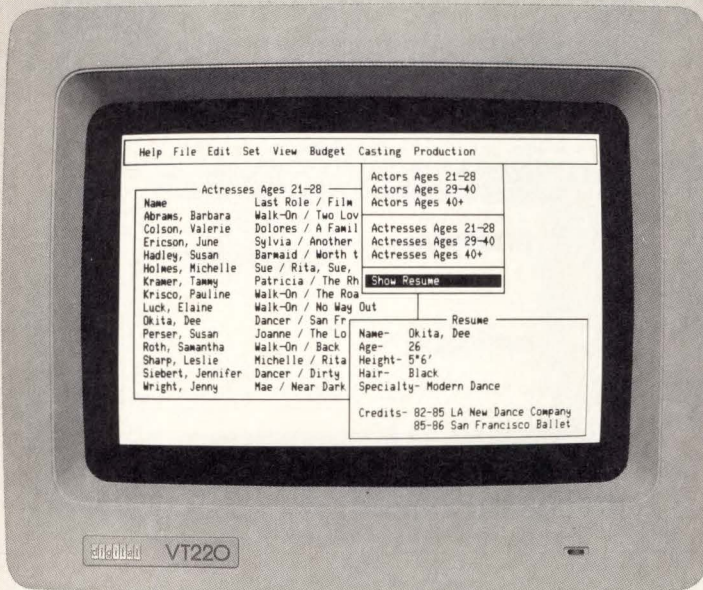

MACINTOSH II

VAX. The best system architecture for organizational computing.

Macintosh. The best interface for personal computing.

Helix VMX. The best of both worlds.

- **Helix VMX gives your VAX a Macintosh interface.** Graphics, flexibility, ease-of-use, independent problem-solving, and the excitement of personal computing.
- **Helix VMX gives your Macintosh users a VAX backbone.** Power, system services, networking, security, and responsible access to corporate information resources.
- **Helix VMX gives you a revolutionary, visual application development environment** that lets you rapidly develop VAX-based software. These applications can be used from either Macintoshes or VT terminals.

"...a breakthrough software technology that exemplifies Digital's concept of what PC integration should mean."

Richard Smith
Business Development Manager, MicroVAX Systems
Digital Equipment Corporation

Come See Us at DEXPO South 88, Booth #1808



ODESTA CORPORATION

4084 COMMERCIAL AVENUE, NORTHBROOK, ILLINOIS 60062 800-323-5423 (IL: 312-498-5615)
CIRCLE 441 ON READER CARD

Helix VMX is a registered trademark of Odesta Corporation. Digital, the Digital logo, VT-220, and MicroVAX are registered trademarks of Digital Equipment Corporation. The Apple logo and Macintosh II are registered trademarks of Apple Computer, Inc.

Macintosh is a process, which, like VAX installation, is well documented and easy to follow. Two steps are involved: installing the driver and desk accessory, and setting your user name in "Chooser". To install the driver and desk accessory, boot your Mac from the AlisaTalk Installer diskette, click on the Installer icon (Figure 2), select which drive you want it installed on, click on the program to be installed, then click "install". The file server resources are then installed in the system file of the selected disk.

After re-booting your Mac using your newly modified system disk, select Chooser from the Apple Menu, and enter your user name in the User Name box (Figure 3). A unique user name is required for each AlisaTalk user to ensure that private files are not shared among users. AlisaTalk is now ready for use!

To use AlisaTalk on your Mac, you must first mount a remote

Figure 3—A unique user name must be entered for the file server to use when accessing private files.

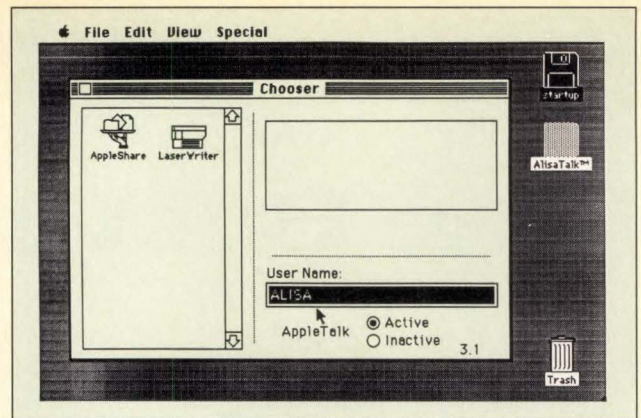
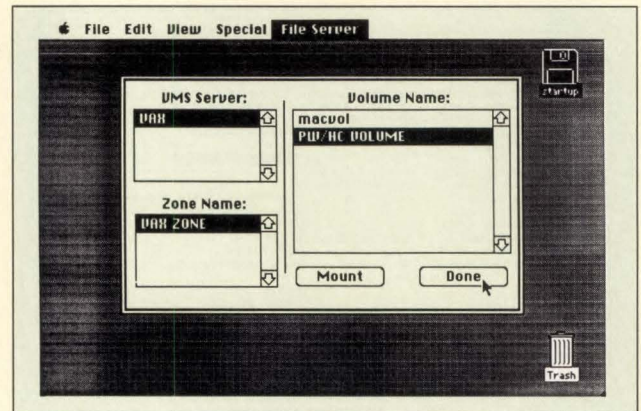

Figure 4—Remote volumes are mounted by selecting "VMS Volumes" from the Apple Desktop icon. The user selects the zone and server; then double clicks on the volume to be mounted. Clicking Done will cause the volume(s) to be mounted.



**EMULEX
INTRODUCES
THE FIRST
TERMINAL SERVER
THAT'S
LAT COMPATIBLE...**

volume containing your files (i.e., PW/HC_VOLUME). After installing the file server software on your Macintosh, a new entry is placed on the Apple Desktop icon: "VMS Volumes". Clicking on this will display the message "Looking for VMS Volumes ... " and also create a pull down "File Server" menu, which allows you to select VMS Volumes, or to show network, node, and bridge numbers regarding the AlisaTalk File Server. The desk accessory will then search the AppleTalk network for zones, servers, and volumes, and will list them in a dialog box (Figure 4). During AlisaTalk installation on the VAX, you have already assigned AppleTalk networks to a zone (VAX_ZONE). Each zone may have multiple servers, and each server, multiple volumes.

You may then select which volume you wish to access. Double-clicking the volume, then selecting Done, or single-clicking

users who had their base print priority turned up one notch, it was disappointing to find out that the print processes printed first-in first-out. At least the next time someone is printing a 40-page MacDraw document (you, of course, only find that out after all the pages have printed), you can queue up your print job and resume processing.

We are looking forward to installing the AlisaTalk print system since this module allows true queue management of print devices on both the AppleTalk network and those located on the VAX.

Room for Improvement(s)

The AlisaTalk system does not have a built-in facility to provide terminal emulation to the VAX; however, it does provide a method where you can add one of three terminal emulators (Mac240, VersaTerm, or VersaTerm/Pro). We installed the Mac240 terminal emulation product and it worked quite well. We were disappointed that some sort of standard terminal em-

ulation function wasn't built into the AlisaTalk product, and, therefore, are now required to buy a terminal emulation package for each of the Macintosh users requiring a VAX connection.

Price Waterhouse currently uses two incompatible E-mail services. Theoretically, since all Mac users would be connected to the VAX (through the utilization of the VAX virtual disk, at least), we had hoped that Alisa would supply a product to allow us to tie the two products together. Unfortunately, the AlisaTalk product does not support VAX E-mail (unless you're connected to the VAX with a virtual terminal session via a terminal emulator). We use electronic mail quite heavily on the Mac network and are still looking for a cost-effective solution to integrate the two systems.

Connect or Wait?

When we set out to make the Mac-to-VAX connection, we had some pretty definite goals and we think that AlisaTalk met most of

AND MORE...

More Power

The Performance 4000 is a powerful and expandable terminal server for DEC Ethernet networks. It incorporates all the features you like about your DECserver, including total compatibility with LAT protocol.

But there's more. Including more performance, more line capacity, and many more



Performance 4000 Ethernet Terminal Server

features. All for approximately half the per line cost of the DECserver 200! And since it's fully compatible with DEC's LAT protocol, the Performance 4000 is truly "plug and play" Which eliminates the need for special hardware or software. It's really as simple as that. The Performance 4000 has more.



those objectives. After reviewing the associated costs of implementing the network (see Table), the total cost is not low, and, in fact, may be quite steep to a casual Mac/VAX user. Price Waterhouse is a little different from most Mac/VAX users in that the Macintosh is our primary computer—not necessarily the VAX. In our situation, we were looking to expand the functionality of the our Macintosh network by utilizing an existing VAX system. Our primary interest was not file transfer (in the traditional sense, we primarily wanted a reliable and easy backup system). Additionally, spreading the cost over 35 to 40 users may make the cost of this system feasible.

Although we were very impressed with the Alisa file transfer capability, Mac users looking primarily for file transfer capabilities may be able to find a more efficient method to make the Mac-to-VAX connection. Most of us Mac and VAX users stood up and cheered at the DEC and Apple joint announce-

ment in January. At last DEC is recognizing the Apple Macintosh workstation and is planning to integrate it into the VAX environment. The question now is: do we wait for the DEC/Apple connection (remember how long it took for the MicroVAX II) or do we make the connection now? It's easy for us now, because our system is working. ■

Alen Darr is a management consulting services manager in the Sacramento office of Price Waterhouse. Paul Morrin is a senior consultant for the company.

**Table—AlisaTalk
Implementation Costs**

Hardware Required	Cost
Ethernet Controller (DELQA)	\$ 2,650
Ethernet Adapter (DESTA)	279
Cabling	100
FastPath	2,750
AlisaTalk	4,600
AlisaTalk Print Spooler	750
Total Cost:	\$11,129

the volume and selecting Mount will mount your volume (Figure 4). If the volume is password protected, you will be asked to supply the correct password before mounting. If the volume is being mounted for the first time, you will see "You don't have a desktop file on volume 'PW/HC Volume'." Mounting it may create one." After the volume(s) is created on the desktop (they will appear as icons), you can open, drag, or close any volume you please. To dismount, drag the Volume icon to the Macintosh's trash can.

A key program provided by the installation of the file server is CREVOL. This program is located in ATK\$ROOT:[APPLE-TALK.FILESERVER], which is used to create new volumes on the VAX. When you execute this program, you will supply the name of the Macintosh volume (the name you see when using the File Server) and the name of the VMS

AND MORE...

More Performance

With a throughput rate of approximately 60,000 characters per second, the Performance 4000 can handle all 32 lines at 19.2Kbps, or 16 lines at 38.4Kbps ... *simultaneously* ... with no penalty on performance.

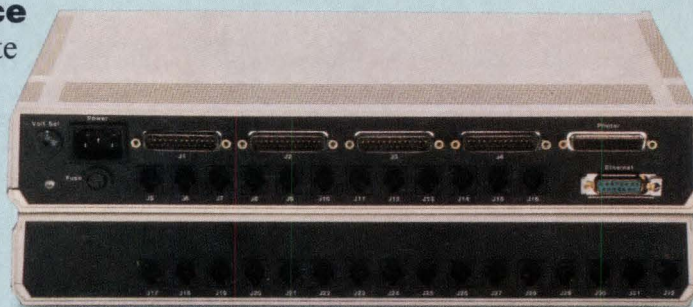

Performance 4000 Ethernet Terminal Server

More Capacity

The Performance 4000 puts a lot more lines in a lot less space—up to 32 serial ports and one parallel port in a package only 4½ inches high. Start with a 12- or 16-line base unit, and add a 16-line expansion unit when needed.

DEC, DECnet, and DECserver are trademarks of Digital Equipment Corporation. Emulex and Performance 4000 are trademarks of Emulex Corporation. © 1988 Emulex Corporation, Inc.

See us at DEXPO/Spring—Booth #1115

volume directory (a standard name is "PW_VOLUME") after which the volume directory is created in MFS\$ROOT:[000000]. The VOL.NAMES file is automatically updated to reflect the addition of a new volume, and a file [volume name].VOL (i.e., PW_VOLUME.VOL) that contains Macintosh file and volume information needed by the server created in the volume directory.

Following the addition of a volume, the server must be notified that a volume has been added. The process "VMS Volume" must be started on the VAX (or if started, stopped and then restarted) for the new volume to be placed on-line. That volume is then immediately available to any Macintosh user using Alisa-Talk. If a volume is to be deleted or password protected, a privileged VAX user must edit the file VOL.NAMES and either remove the volume to be deleted or ap-

pend a password to the volume that's to be password protected. If a volume is to be deleted, all files in that volume, along with the volume directory, will need to be deleted from the VAX. Following is our VOL.NAMES file. MACVOL is password protected—passwords are case sensitive.

```
VAX
MACVOL:Test
PW_VOLUME
```

Following is a directory of our MFS\$ROOT:[000000]. Note the volume names PW_VOLUME (created after installation) and MACVOL (created during installation).

Each volume directory contains all files in that volume accessible from the Macintosh, which, by the way, are actually stored as two separate files: a data fork file (file type .DF, used to store text and formatting information) and a resource fork file (file type .RF, used to store special data used by the files' "application"). When you access one of these volumes, you are, essentially, setting their default directory to that volume. Since you can have several volumes open at once, you have access to several different VAX directories at a time. This allows the Macintosh

Directory MFS\$ROOT:[000000]

FILELIST.TEXT;1	1	4-NOV-1987 12:14	[APPLETALK]
MACVOL.DIR;1	4	18-FEB-1988 13:58	[APPLETALK]
PW_VOLUME.DIR;1	1	11-MAR-1988 15:41	[APPLETALK]
VOL.NAMES;4	1	18-FEB-1988 16:44	[APPLETALK]

Total of 4 files, 7 blocks

AND MORE...

More For Everyone

The Performance 4000 was truly designed with the System Manager in mind. Remote control of DECnet devices, extensive status multiscreen displays, and enhanced security features all make network management simpler. And the superset of DECserver commands plus VMS-like command editing

I want more. Send me your Performance 4000 brochure.

Name: _____

Company: _____

Address: _____

City: _____ State: _____

Zip: _____ Phone: _____

Emulex Corporation, 3545 Harbor Blvd., Costa Mesa, CA 92626

make the Performance 4000 easier for everyone to use.

More To Come

If you want a lot more of everything in a terminal server, you really need the Performance 4000.

And we'd like to tell you more! So return this coupon, circle the reply card, or call Emulex toll free. We'll send you a detailed brochure.



Call toll-free (800) EMULEX-3, (714) 662-5600 in California

Regional Offices: Anaheim, CA (714) 385-1685 Atlanta, GA (404) 587-3610 Burlington, MA (617) 229-8880
 Chicago, IL (312) 490-0050 Dublin, CA (415) 829-1170 Teaneck, NJ (201) 836-3717 Washington, DC (703) 264-0670
 International Offices: Bracknell 344-484234 Munich 89-3608020 North Sydney 2-957-1669 Paris 134-65-9191 Tokyo 3-234-8951 Toronto (416) 673-1211

user to transfer documents, applications, and entire folders from one volume to another without the assistance of a VAX user/manager. While being a very handy feature of AlisaTalk, this also creates somewhat of a performance issue. In our office, up to 35 (those with Macintosh's at this time) AlisaTalk users could, potentially, access or transfer large applications, documents, or folders between volumes at the same time. While being a workhorse, and performing flawlessly with no performance degradation during our AlisaTalk two-user benchmarks, our MicroVAX II may choose not to fully cooperate should such an event occur!

File Server Utility

One of the utilities mentioned previously was the file server utility (FSU). This is a program installed on the VAX that provides information about your volumes, as well as providing the means of transporting files to and from your volumes. VMS cannot be used to update volume information or to move files to and from your volume, and a file copied to the volume directory via the VMS COPY command will not be recognized by the volume. Therefore, the FSU provides for the transfer and conversion of Macintosh format files from the AlisaTalk file server to and from standard RMS file formats for use in VMS.

FSU is invoked as a DCL command by typing FSU. The first time you enter FSU, you will need to set your zone (SET ZONE VAX ZONE), set your server (SET SERVER VAX), and set your volume (SET VOLUME MACVOL). Your responses are then used to create file FSU\$INIT in your SYS\$LOGIN, which, if the logical FSU\$INIT is defined (it is, at installation), will set your zone, server, and volume the next time you enter FSU.

Several commands are available in FSU. DIRECTORY will return information about files,

volumes, or servers. The following is a partial DIR/FULL that we did on MACVOL, showing file type, creator, dates, and data and resource fork information. Note the applications MacWrite and MacDraw and that LOGIN.COM is a standard VMS text file created in EDT and imported to the volume.

dates the file MACVOL.VOL. Should any user have MACVOL mounted (and if they are watching), LOGIN.COM would immediately disappear from the volume when this command is executed.

The most important FSU commands—other than HELP, which, by the way, sometimes

```
FSU>DIR/FULL
```

```
Directory of MACVOL on VAX in zone VAX  
ZONE:
```

```
F# 1: LOGIN.COM
```

```
Type: TEXT Creator: MACA
```

```
Created: Thu Feb 18 14:47:50 1988
```

```
Last Mod: Sun Mar 13 15:30:51 1988
```

```
Data fork: size = 1357 alloc = 1536 (3 blocks)
```

```
Resource fork: size = 0 alloc = 0 (0 blocks)
```

```
.
```

```
.
```

```
F# 29: MacWrite 4.6
```

```
Type: APPL Creator: MACA
```

```
Created: Tue Jul 7 14:42:52 1987
```

```
Last Mod: Sun Mar 13 15:39:10 1988
```

```
Data fork: size = 0 alloc = 0 (0 blocks)
```

```
Resource fork: size = 78994 alloc = 79360 (155 blocks)
```

```
F# 30: MacDraw 195
```

```
Type: APPL Creator: MDRW
```

```
Created: Mon Jun 15 21:39:10 1987
```

```
Last Mod: Sun Mar 13 14:03:10 1988
```

```
Data fork: size = 0 alloc = 0 (0 blocks)
```

```
Resource fork: size = 103482 alloc = 103936 (203 blocks)
```

```
DIRECTORY also allows wild cards, such as
```

```
FSU>DIR MAC*
```

Either DIRECTORY/SERVER or DIRECTORY/VOLUME is used to display information relevant to available servers or volumes. The SHOW command may also be used to display information about servers (SHOW SERVER), zones (SHOW ZONES), volumes (SHOW VOLUMES), or (ALL) of them.

You can also delete files in the volume. DELETE LOGIN.COM deletes both data and resource forks of LOGIN.COM and up-

placed us in standard VMS HELP (feature?)—are IMPORT and EXPORT. IMPORT is a command to transfer RMS text files to Macintosh files controlled by the server. EXPORT is the reverse, wherein Macintosh files are transferred back to RMS files. In general, non-text Mac files are unable to be used by RMS utilities once exported from the volume. There are exceptions, however. As noted in the documentation, Microsoft Excel can

import and export worksheets in Lotus WKS format files, which may then be used directly by applications on the VAX and on MS-DOS systems running Lotus 1-2-3.

Each file in a volume has two important attributes—a type and a creator—that the IMPORT command applies to each file. These attributes relate a file to its “creator” application. For example, the file creator of LOGIN.COM is MacWrite and the type (of file) is text, which is the default type and owner for text files imported with no qualifiers (i.e., FSU>IMPORT LOGIN.COM). If, however, we had wanted to import the file for use by Microsoft Word, we would have used:

```
FSU>IMPORT/CREATOR=
MSWD LOGIN.COM
```

The “creator” attribute then allows you to double click on a document and locate and start the proper application.

There are several “creators” available for importing text files: EDIT (MDS Editor), KAHL (Lightspeed C Editor), MACA (MacWrite), MDRW (MacDraw), QUED (QUED Editor), MSWD (Microsoft Word), PANT (MacPaint), and XCEL (Microsoft Excel).

EXPORT is used to transfer documents from the currently selected server volume back into RMS. This will convert text files stored on the server to standard RMS format files or binary files to a format usable by other applications (i.e., Lotus WKS format files). As noted before, non-text files are generally useless in the VMS environment once exported, in light of the incompatibilities between Macintosh and RMS format files. If you are sure a document contains text, however, you can export that document to RMS. Using the /LOG qualifier will verify whether a document is text or not before exporting. This document (“ALISA TALK”) was

created with Microsoft Word, and then the data fork of the document (where the text is stored) was exported to VMS with a width of 80, to the output file HARDCOPY.TEXT using the command:

```
FSU>EXPORT/DATA=
TEXT:80/OUTPUT=HARDCOPY.
TEXT “ALISATALK”
```

LaserWriter Print Utility

The LaserWriter print utility (LWPRINT) is another utility provided by AlisaTalk for use on the VAX. By using LWPRINT, any VAX user can print plain text and PostScript files to LaserWriter printers connected to your AppleTalk network. It is invoked by typing LWPRINT at DCL, followed by the name of the

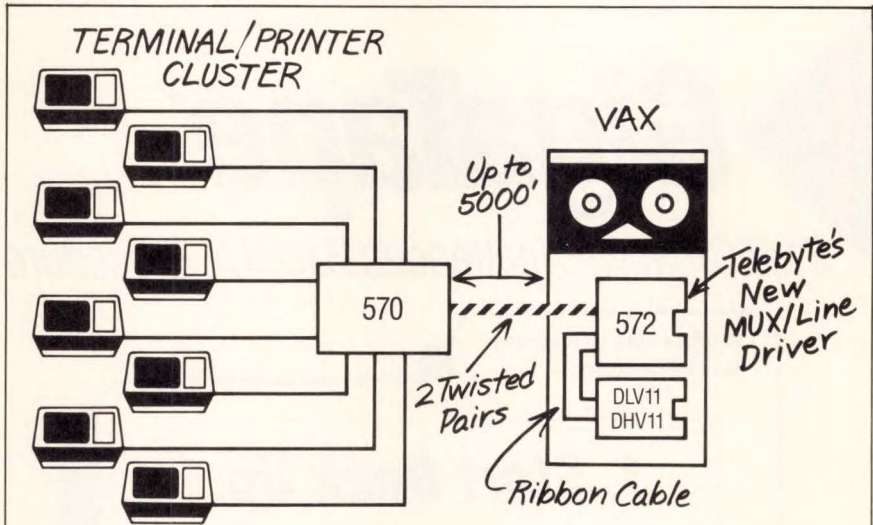

VAX/MICROVAX REMOTE TERMINAL CLUSTER WIRING IS A SNAP WITH TELEBYTE'S NEW QUICK MUX 572.

Everything about the new Quick Mux 572 multiplexing controller for the DEC multi-user environment is simple. Eliminated are the RS-232 connector panels on the backpanel of the CPU. Instead, there's one small bracket.

Instead of 8 separate hook-ups, cables, line drivers, etc., there's one 4-pin connector for a single, 2 twisted pair composite link cable over which the CPU communicates with 8 full duplex remote terminals, all operating simultaneously up to 19,200 baud. And the remotes can be located 5000 feet from the CPU.

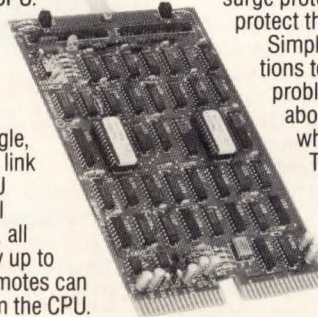

To make things even simpler, we've packaged the Quick Mux 572 on a dual DEC PC board to install “in a snap” inside the CPU. We've even built lightning and surge protection into each unit to protect the composite link.

Simple, elegant, low cost solutions to data communications problems—that's what we're all about. Call or write today to see what we've thought up for you.

Telebyte Technology, Inc.,
270 East Pulaski Road,
Greenlawn, NY 11740.
(516) 423-3232.
(516) 385-8080.
TWX: 510-226-0449.
FAX: (516) 385-8184.

**TALK TO
TELEBYTE
(800) 835-3298**

CIRCLE 401 ON
READER CARD

text file you want to print.

The specific printer to which you wish to print is determined by the logical LASERWRITER, which, on our system, was defined as "PRO-ONE PRINTER:LASERWRITER@*". Defined generically, this is [OBJECT]-:[TYPE]@[ZONE], where *object* is the name of the LaserWriter seen in Chooser on the Macin-

tosh, *type* being LASERWRITER, and *zone* being the name of the zone in which the LaserWriter is located. An "*" means our present zone or the zone in which the VAX from which we issued the LWPRINT command is located.

Several different format options are available with LWPRINT. For example, if we

want to print our document in a format similar in appearance to DP "green-bar" line printer paper, the command is LWPRINT/FORMAT=LPTGRAY <document name>.

Other formats available are LTR10, LTR12, LPT1UP (landscape mode, 1 up), LPT2UP (portrait mode, 2 up), and PostScript.

A Final Review

The Kinetics FastPath installation, the AppleTalk/VMS installation on the VAX, as well as the AlisaTalk installation on the Mac, in general went quite smoothly. The documentation for both product installation and general usage is well written, with many helpful figures and diagrams, and a format similar to VMS documentation, which we find very useful. The AlisaTalk software itself performed better than expected (we were pleased to discover we could put applications and folders in volumes). The operation is, for the most part, transparent to the Mac end-user. The only part that requires VAX user intervention is file-server volume maintenance on the VAX (adding, deleting, and password-protecting volumes).

The time required for the original product installation (both hardware and software) at our office, on a MicroVAX II with a TK50 tape drive, was three days. The reason for this, though, was a defective FastPath. At first, this appeared to be an AlisaTalk problem. One call to both AlisaTalk and Kinetics, though, confirmed it was a faulty device. As we stated before, once this was confirmed, we had another FastPath the same day. If we were to perform each step of the installation again, from connecting the FastPath to the point where we can access volumes from our Mac, it would take four hours, and that long only because VMSINSTAL using a TK50 on a MicroVAX II is not exactly greased lightning!

—A.D., P.M.

GigaTape™

2.33 Gigabyte Unattended Back Up Procedure

GigaTape Back Up Procedure
Keep for Reference

- 1. Start Back Up.**
- 2. Go home.**

Back ups will never be easier or more cost-effective.

Now you can back up 2.33 Gigabytes, the equivalent of 21 TK-50 cartridges, 7 TK-70 cartridges, 14 GCR 1/2" tapes, or 17 QIC120 1/4" cartridges on ONE 8mm cartridge.

The **GigaTape** from Summus Computer Systems, with its high capacity performance, can save you hundreds of hours and thousands of dollars in annual operator and media costs.

Featuring advanced 8mm technology, the **GigaTape** is fast — sustained data rates of 246 kilobytes per second. Accurate — error rates of less than one in 10¹³ bits read. Reliable — 20,000 hour MTBF. Compatible — TMSCP protocol, VMS software transparent.

Priced from \$5,495, there's a **GigaTape**, in standard 5 1/4" form factor, for every VAX model.

Ready for delivery with One-Year Warranty and 30 day return privilege. A full range of maintenance support options are available through our award winning National Support Group.

Look for us at

DEXPO/Spring—Booth #603

TK-50, TK-70, TMSCP VMS, VAX are trademarks of Digital Equipment Corp. Summus, GigaTape, & GigaBox are trademarks of Summus Computer Systems.



The **GigaTape**, in 5 1/4" form factor, integrates easily into high-capacity data storage systems such as our **GigaBox**, and uses standard 8mm data cartridges.

Let us show you how to get home faster with the **GigaTape**. Call our hotline today for a **FREE** cost analysis and product guide. Rep inquiries welcome.

1-800-255-9638

SUMMUS™
COMPUTER SYSTEMS

P.O. BOX 820549 • HOUSTON, TEXAS 77282-0549
TEL: (713) 589-9772 • TELEX: 6254352 - Answer Back: SCSSUM

CIRCLE 399 ON READER CARD

Technology Concepts has it today!

DECnet for your Mac

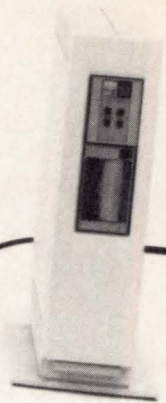

For a demonstration: (800) 777-2323 ext. 321

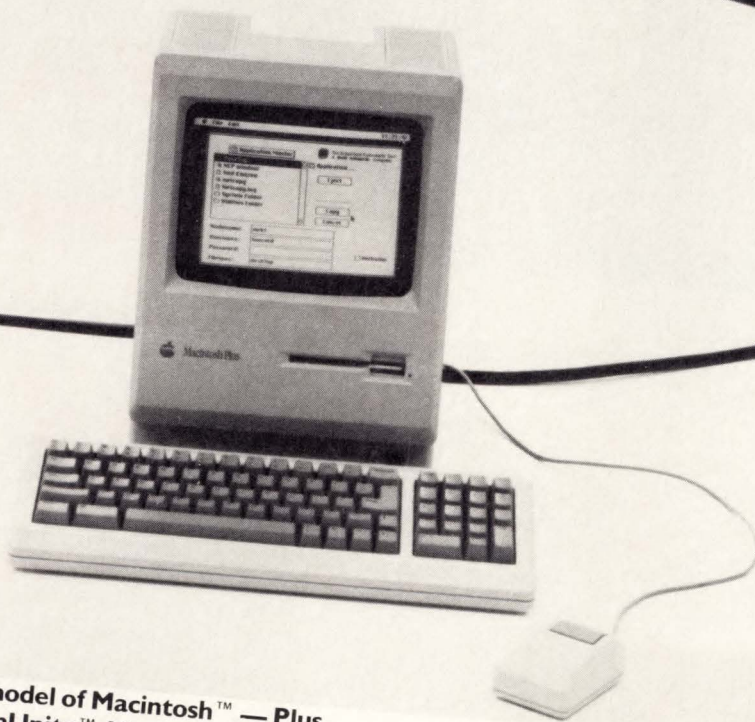

Whatever your model of Macintosh™ — Plus, SE, or II — CommUnity™-Mac gives you high-performance DECnet connectivity.

CommUnity-Mac combined with a FastNet intelligent (68000) SCSI Ethernet controller provides end-node DECnet functionality for your Macintosh Plus, SE, or II. Or for Macintosh II alone, CommUnity-Mac software can be combined with Apple's EtherTalk or 3Com's EtherLink/NB.

The CommUnity-Mac solution lets you talk to VMS, Ultrix, and RSX-11M computers, and features:

- compatibility with VAX/VMS Services
- VAX/VMS mail
- virtual terminal (VT220/240 emulation)

- file transfer/access
- task-to-task communications
- compatibility with MultiFinder
- no additional hardware or software required in your DEC system

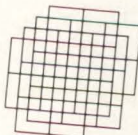

Technology Concepts Inc.
A Bell Atlantic Company

40 Tall Pine Drive, Sudbury, MA 01776
(617) 443-7311 • (800) 777-2323 ext. 321

CIRCLE 400 ON READER CARD

FastNet is a trademark of Dove Computer Corporation. DECnet, VT 220, VAX/VMS, Ultrix, and RSX-11M are trademarks of Digital Equipment Corporation. MultiFinder, Macintosh and EtherTalk are trademarks of Apple Computer, Inc. 3Com is a registered trademark of 3Com Corporation.

DILOG Subsystems



The PROBLEM SOLVERS

There's good news. And better news.

You know you can rely on DILOG to solve your controller/coupler problems...over 95,000 in the field. Good news.

Now, DILOG offers subsystems too. Better news. You and your customers can pick from over 350 subsystem combinations...any DILOG controller and peripheral you can think of. All from one source.

ADD-IN SUBSYSTEMS

You need a 5 $\frac{1}{4}$ " disk subsystem or $\frac{1}{4}$ " Q.I.C. tape back up with a reliable interface. DILOG Problem Solvers have it... complete in a BA123 or BA23 compatible housing with cables, ready to operate.

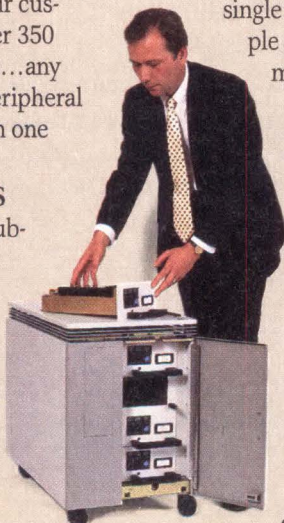

As your subsystem needs get larger, your problems don't. DILOG Problem Solvers offer state-of-the-art interfaces for today's or tomorrow's large capacity disks and high speed tape drives.

ADD-ON SUBSYSTEMS

You need hard disk capacities... single drive from 70 MB to multiple drives with 5 GigaBytes or more. And high speed tape back up. DILOG Problem Solvers have it...popular drives...interfaces... compatible housings... cables...everything.

INSTALLATION

DILOG Problem Solvers can help you install your subsystem, interface your computer system or run diagnostics tests...everything. Staff personnel world-wide make it easy.

SERVICE

Even after installation the DILOG Problem Solvers can handle service... subsystems or the complete system. Again, you can rely on DILOG's Problem Solvers. Sole source supply. Sole source service. Faster than 3rd party service too.

Subsystems, installation, service... all just a phone call away.



**1-800-DILOG32
(outside Calif.)**

Corporate Headquarters
1555 South Sinclair Street
Anaheim, CA 92806
(714) 937-5700, Telex 6836051
FAX: (714) 978-2420

CIRCLE 406 ON READER CARD

See us at DEXPO/Spring—Booth #1139

STORAGE™

MASS STORAGE INDUSTRY FORUM

FROM THE PUBLISHERS OF
HARDCOPY MAGAZINE AND HC/WG LABS

APRIL 15, 1988, VOL.1, NO.3

FINDING ERRORS BEFORE THEY OCCUR

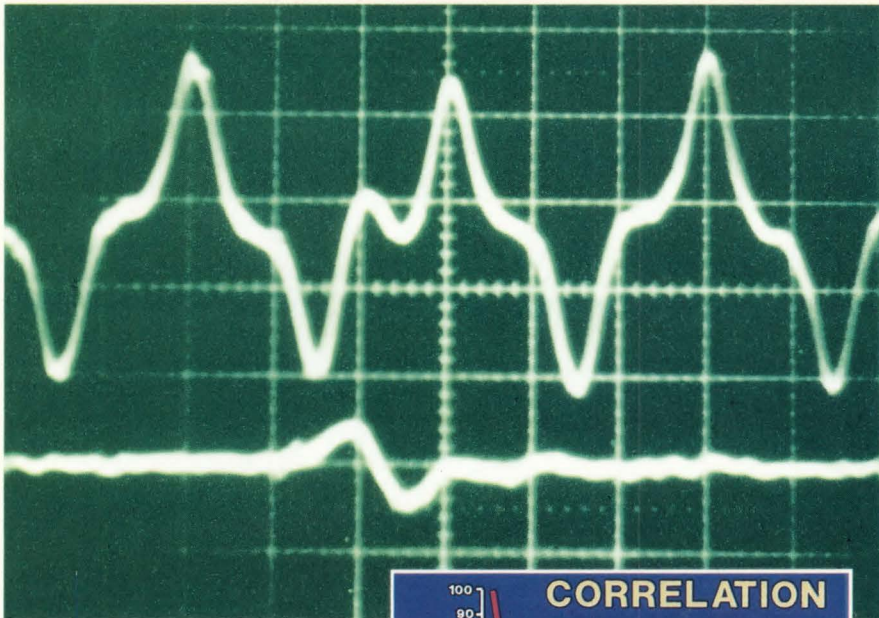

Winchester disk drives, regardless of physical size, are steadily increasing their storage capacity. But, the more bits you pack onto a metallic disk, the greater the probability for an error. Encountering that error after you have stored valuable data can be a problem; therefore, drive manufacturers are

working with test instrumentation companies, such as Luctor Corp. (Phoenix, AZ), which supplied these photographs to *Hardcopy*, to develop ways of actually mapping out an error before you encounter it. Using analog and digital technologies, the media of a Winchester drive is scanned and the number of analog-to-digital errors is determined. As depicted in the photo above, these errors are identified as signal distortions—such as an extra pulse—and the duration of the distortion can be an indication of the size of aberration. The error can then be mapped by location and bypassed by the drive electronics. You get error-free operation and, hopefully, no loss of data. But, error elimination isn't perfect, so you'll still want to back up your data.

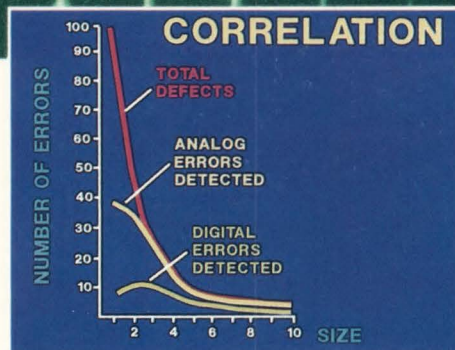

CONTENTS

QUICK-DISCONNECT SUBSYSTEMS: THE NEW- GENERATION DISK PACKS

Although disk pack technology is all but gone, users still want removability for security purposes, as well as to extend the storage capability of the system

by Tom Gardner,
Magnetic Storage Editor

page 8

I. DAL ALLAN AND KEN HALLAM'S I/O UPDATE

Optical standards...Why bother? After all, aren't they still trying to make that stuff work?

page 4

GEORGE LANGWORTHY'S INSIGHTS TO OPTICAL STORAGE

Some Interactive Thoughts

page 14

PHIL DEVIN'S ROTATIONS

Maybe There Really Is a
Subsystem Market

page 16

StorAGE™ is a trademark of
Seldin Publishing Inc.

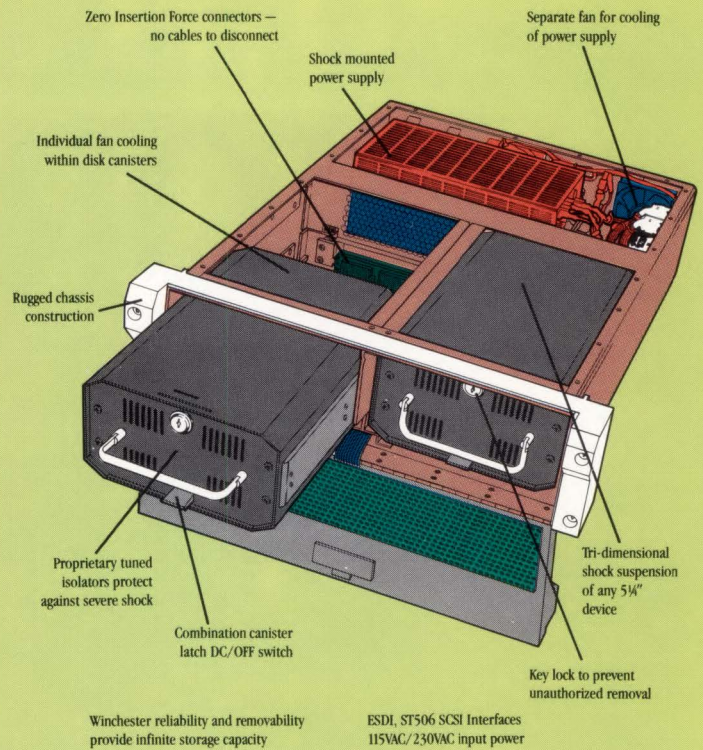
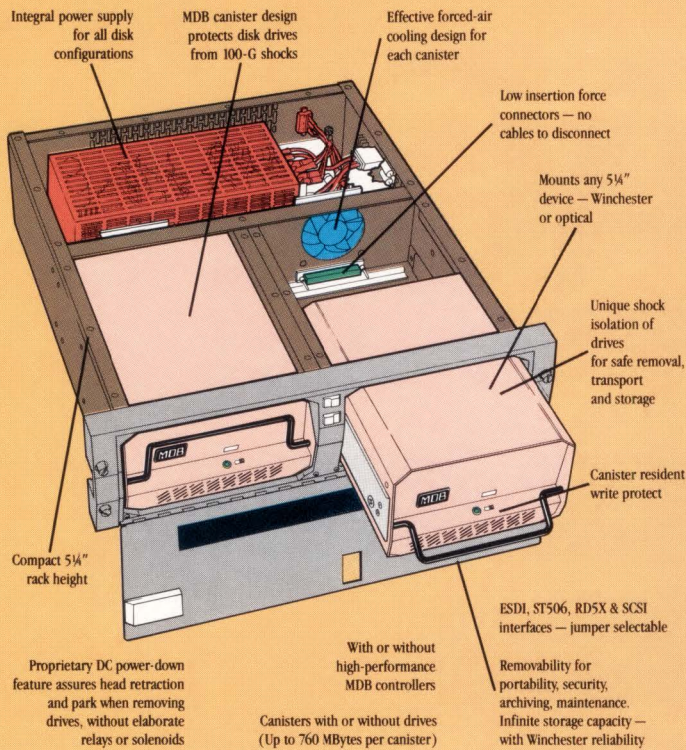

The best commercial removable-drive subsystem with shock isolation and superior design.

DATA SHUTTLE 2000™

There is no better shock-isolated, low-cost design for commercial, lab and industrial applications.

The DATA SHUTTLE 2000 is the latest in MDB's family of removable-disk subsystems. Drawing upon real experience in airborne and shipboard ruggedized, militarized installations, MDB is able to offer proprietary shock protection in this affordable and functional package.

You'll get the new freedom of removability: large-capacity data portability, the ultimate in data security, easy software updating, file duplication backup, and maximum system up-time during disk replacement. It has a failure-proof power-down scheme that is automatically implemented when removing the canister.

Plus you get something else: ease of mind, knowing that MDB's unique drive mounts will protect your drives during transport.

That's why MDB will warranty the disk drives for shock-related failures for one-year — even if the manufacturer doesn't! Available with or without controllers or drives so you can integrate your own disks.

The removable-drive subsystem for harsh environments not requiring the added cost of MIL-Spec.

DATA SHUTTLE 3000™

Rock solid dependability ideal for heavy industrial environments.

Designed for use in non-military environments, but where shock and vibration protection is a prime requirement, the DATA SHUTTLE 3000 offers many of the operational features of the Model 4000 for rock-solid rugged dependability.

For example, it utilizes the same shock and vibration protection canister with its built-in-fan as the MIL-Spec Model 4000, making it ideal for use in the heavy industrial machine factory environment where shock and/or vibration may pose problems. Zero Insertion Force connectors provide long life to an already reliable product.

The rugged chassis of the 3000 also includes a shock isolated commercial power supply, with commercial interface connectors and slides.

Put it all together and it's a cost-effective alternative to the full MIL-Spec DATA SHUTTLE 4000.

Available with or without controllers or drives so you can integrate your own disks.

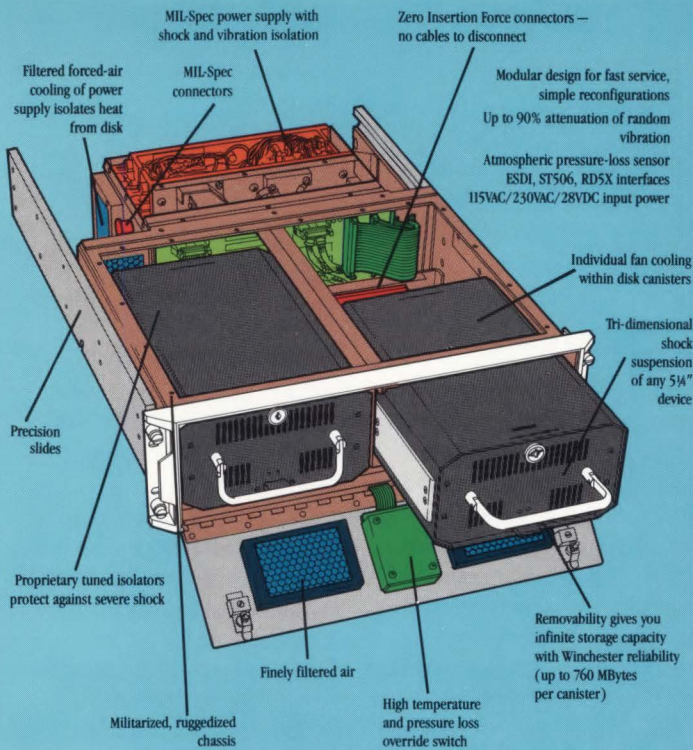

DATA SHUTTLE. The family of shock isolated removable drive subsystems designed to take it... anywhere.

The most ruggedized, militarized,
TEMPEST certifiable
removable-drive subsystem today.

DATA SHUTTLE 4000™

The peripheral subsystem that's good enough for MDB's Rugged Computer Systems — militarized and able to take the harshest operational shock and vibration.

The DATA SHUTTLE 4000 is the subsystem to specify for hostile environments — proved by actual MDB experience in airborne and shipboard installations. This is the peripheral subsystem (RCS-P) in our RUGGED COMPUTER SYSTEM series. It's designed for militarized computer systems — not just an adaptation of a commercial product.

It's put together with thoughtful engineering and proprietary concepts. Power is automatically disconnected from the drives when the canister is being removed. Zero Insertion Force connectors provide long life to an already reliable product. Individually cooled canisters protect drives against shock and vibration within the DATA SHUTTLE and during transport.

You can configure the DATA SHUTTLE 4000 to have one or two removable drives and one shock protected fixed drive, such as a floppy diskette drive or cartridge tape drive.

Available with or without controllers or drives.

*Data Shuttle™ Family
for use with all
computer systems*



See us at DEXPO/Spring—Booth #1100

— We put the *State of the Art* to work —

Corporate Headquarters

1110 W. Taft, Box 5508, Orange, CA 92613-5508

TEL: (800) 556-0222 In CA (800) 637-2028

FAX: (714) 637-4060 TWX: (910) 593-1339

FOR UNITED KINGDOM: MDB Systems, U.K., Ltd.

Intec 2, Wade Road

Basingstoke, Hants. RG24 0NE

TEL: 0256 464767 FAX: 0256 59748

TELEX: 858389 MDBSYS G

FOR WESTERN EUROPE: MDB Systems, IRL., Ltd.

Portumna Co., Galway, Republic of Ireland

TEL: (353) 509 41163/41413 FAX: (353) 509 41447

TELEX: 50918 MDB EI

MDB
SYSTEMS INC.

Data Shuttle 2000, 3000 and 4000 are trademarks of MDB Systems, Inc.

CIRCLE 410 ON READER CARD

I. DAL ALLAN AND KEN HALLAM'S I/O UPDATE



These are legitimate questions, for optical *StorAGE* is still an infant industry with many aspects of the technology not yet fully understood. Some have even wondered if the industry will ever recover all of the nonrecurring engineering costs expended so far on the development of this technology. Yet the promise of low-cost, high-density removable *StorAGE* is still enough to attract investment dollars.



Back to the question of standards. One of the main attractions of optical *StorAGE* media is its removability. Removable media should be recorded in a standard way so it can be read by differing brands of drives. Winchester drives, with their lack of removability, enjoyed an immediate and widespread popularity despite differing formats. Drives formatted on an IBM PC/XT cannot be read on an IBM PC/AT; drives formatted on a Xebec controller cannot be read by a Western Digital controller (no matter what the computer system); and the list goes on.

This lack of compatibility has never hampered the growth of the Winchester drive market because the drive is not likely to be moved to another system. Therefore, format compatibility has never been a significant marketing issue for Winchester drives.

Optical drives have format compatibility as a key marketing issue. You may have heard of the complaints voiced by the Federal government about the lack of compatibility between the various 12-in. optical *StorAGE* systems purchased by the Library of Congress, the Patent Office, and other agencies. Lack of recognized interchange standards has limited and will continue to limit the acceptance and growth of the optical *StorAGE* market.

Optical drive manufacturers have been motivated to resolve this problem with the newer 5.25-in. drives; however, a format design is needed before the drive design is finalized. Changing the format after the drive has been designed is difficult and costly at best, impossible at worst.

This explains the impetus behind the

broad-based support given to standardization efforts by both drive and controller manufacturers. The problem has been the classic "chicken and egg" situation—trying to develop a standardized format for a media and technology still in the very early stages of development. Both the format and the drive/controller design are very interdependent.

The primary efforts for standardization of optical media within the United States are divided into two groups, both under ANSI. Accredited Standards Committee (ASC) X3B11 has the charter to develop standards for optical media in diameters ranging from 3.5-14 in.

A separate ASC, Z39, also known as the National Information Standards Organization (NISO), has picked up the charter for only one type of optical media, the CD-ROM. The CD-ROM is 4.72 inches in diameter and based on the very successful consumer product known as the compact disc (CD). NISO was formed to develop standards for libraries and the publishing industry, while X3B11 is part of the computer architecture branch of ANSI, X3.

Differences

Aside from the obvious differences in diameter, other, more fundamental, differences exist between CD-ROM and the 5.25-in. optical disk cartridges.

The CD-ROM is based on the consumer product and shares several features with its more-well-known brother. These products spin at a varying rate, depending on what track the laser head is moved to. The purpose of this is to use the highest bit-packing density on all tracks, while leaving the read/write frequency constant—a technique known as constant linear velocity.

Another way to picture it is to imagine the space on a disk that each track occupies. As we go further toward the center, less space (a smaller diameter) exists on each track. If the rotation speed and the write frequency are left constant, the outer tracks will have a lower bit density than the inner tracks. In fact, this is exactly the situation

**OPTICAL
STAN-
DARDS...
WHY
BOTHER?
AFTER ALL,
AREN'T THEY
STILL
TRYING TO
MAKE THAT
STUFF
WORK?**

Freedom for VAXcluster and BI users means more than just freedom to choose a storage alternative to DEC's SA482. It also means more freedom in configurations, and the freedom to add more capacity per drive without giving up full Digital Storage Architecture functionality and compatibility.

Free yourself from DEC's RA-series drives.

Even DEC's largest RA subsystem locks you into drives with lower capacities and slower access than readily available industry standard

drives provide. You take what you can get from DEC in reliability and cost too.

60% more capacity.

Emulex's SMDI (SMD-Interconnect) subsystems offer the freedom to choose between the best new SMD and SMD-E drives as they become available from the best industry sources. Then freedom to choose from up to 36 configurations, using high performance drives with seek times of less than 15msec and capacities to over 1 gigabyte per drive—60% more than DEC's.

More for less.

SMDI can give your budget a break too, with prices two-thirds of DEC's. Or choose 50% more capacity for the same price.



Now that you've been guaranteed freedom of choice again, enjoy it. Call (800) EMULEX3 or (714) 662-5600 in California. Emulex Corporation, 3545 Harbor Blvd., Costa Mesa, CA 92626.



See us at DEXPO/Spring—Booth #1115

New freedom for VAXcluster and VAXBI users.



U.S. Regional Offices: Anaheim, CA (714) 385-1685; Schaumburg, IL (312) 490-0050; Roswell, GA (404) 587-3610; Burlington, MA (617) 229-8880. **International Offices:** Australia, Eastwood, N.S.W. (61) 02-858-4833; Canada, Mississauga, Ontario (416) 673-1211; France, Montrouge (33) 14735-7070; United Kingdom, Bracknell, Berkshire (44) 344-484234; West Germany, Munich (49) 89366031. DEC, MicroVAX II, World Box, Q-bus, VMS, UNIBUS and Massbus are trademarks of Digital Equipment Corporation.

CIRCLE 434 ON READER CARD

"CONTRASTED WITH THE CD-ROM, THE OPTICAL DRIVES ANNOUNCED IN THE 5.25-IN. FORM FACTOR ARE REAL SPEED DEMONS."

on today's Winchester drives. The fixed-write frequency is a compromise: On the inner tracks, the bit-packing density can't exceed the capability of the media; therefore, the recording density on the outer tracks is fairly "loose" and some space is wasted.

By changing the speed of rotation and leaving the write frequency the same, we can get a constant bit density on every track, while the total number of bits per track varies. The recording frequency can then be as high as the media will reliably sustain and no tracks will be recorded at less than the optimum density. The capacity will be increased by about 50% over the fixed revolution-per-minute (rpm), or constant angular velocity (CAV) method.

As you might guess, there's a snag in this technique, or it might be more widely used. The time required to change the rpm and synchronize a spindle motor (if the change is more than 1-2% of the base speed) is fairly significant. In the consumer CD players, this isn't a problem, since the data is usually being retrieved sequentially. This is not the case in the computer environment, where random access is the rule. Many milliseconds are needed for each speed change.

Another issue with CD-ROM is the data transfer speed. The speed of the consumer product was optimized for audio sound reproduction. At 150 Kbytes per second, the CD-ROM falls between a floppy and a standard ST506 Winchester in terms of transfer rate.

Couple this with the very slow seek time (up to one second for a maximum seek), due to the low-cost laser head used on the product, and you have a product not well adapted at all for use in a direct-access *StorAGE* application.

This situation is not likely to change, since the low-cost appeal of the CD-ROM is due to the commonality of its parts with the consumer product.

Contrasted with the CD-ROM, the optical drives announced in the 5.25-in. form factor are real speed demons. Most use the CAV, or constant-speed rpm method and have transfer rates close or equal to Winchester drives. They are still somewhat slow in their access times. Most optical drives that have been announced or are being shipped exceed 100 msec in their average seek times.

Because of a combination of the material

of the media and the wavelength and duty cycle of the laser, rotational speeds are 1800 rpm or fewer in today's optical drives. This gives an average latency of 32.6 msec after each seek for the fastest of the optical drives compared to the 16.3 msec of the typical Winchester.

Recording frequencies are expected to increase on the erasable optical drives. Sony has announced a drive with a 7.5-Mbit-per-second transfer rate and others are sure to follow.

The media standard for the 5.25-in. drives calls out a cartridge that protects the media and a hub mounted on the center hole for more accurate positioning within the drive. These features were viewed as necessary for computer-grade media.

Standards

When X3B11 began its work on optical media standards about four years ago, the main goal was to develop a standard for 12-in. media.

It soon became apparent that little progress could be made in X3B11 to agree on a standard for the 12-in. optical media due to the large installed base of products that no manufacturer wanted to obsolete. Attention soon shifted to the new 5.25-in. size, since no one had a customer base to protect and the drives were still in the early stages of design. The priority of the committee became the development of a standard for the 5.25-in. write once, read many (WORM) media.

The goal of most of the membership was to accommodate the erasable type of media within the WORM standard, so that a dual-purpose drive—one that would operate on both types of media—could be made. In September, the X3B11 membership voted approval of the standard for 5.25-in. WORM media. Now the document goes out for a period of public comment and a review by the legal experts.

Still left for X3B11 are standards for erasable 5.25-in. media, 14-in. WORM, 12-in. WORM, 8-in. WORM, and 3.5-in. erasable media. Of these, only the 5.25-in. and 3.5-in. erasable projects have generated any real excitement. Both are being worked on by a number of companies. The 5.25-in. erasable project is almost complete (it is virtually a copy of the WORM document) and faces little controversy. The 3.5-in. project, however, is causing much controversy. S&I

AMAZING PDP-11 MIRACLE REVERSES THE AGING PROCESS.

*Now your PDP-11/04, 24,
and 34 can perform
like kids again.*

You can increase system performance by up to 300%, thanks to the miracle of the QED 11/90 CPU upgrade. It will improve your memory, too. The QED 11/90 can address 4 Mbytes of memory and comes standard with a 16K cache, so its J-11 processor can run flat out. That'll mean a real performance boost if your PDP is configured as a multi-user system.

Your software is safe, too. Our CPU upgrade is 100% compatible with your existing applications and peripherals. It even supports floating point operations.

Surprisingly, the QED 11/90 can be installed in any PDP-11 in just a couple of minutes, because it fits all existing CPU's with no backplane changes.

All of this comes with a one year warranty and nationwide on-site service (overnight replacement available). Best of all, it's thousands less than the competition.

*And you thought your
PDP-11's were
getting senile.*

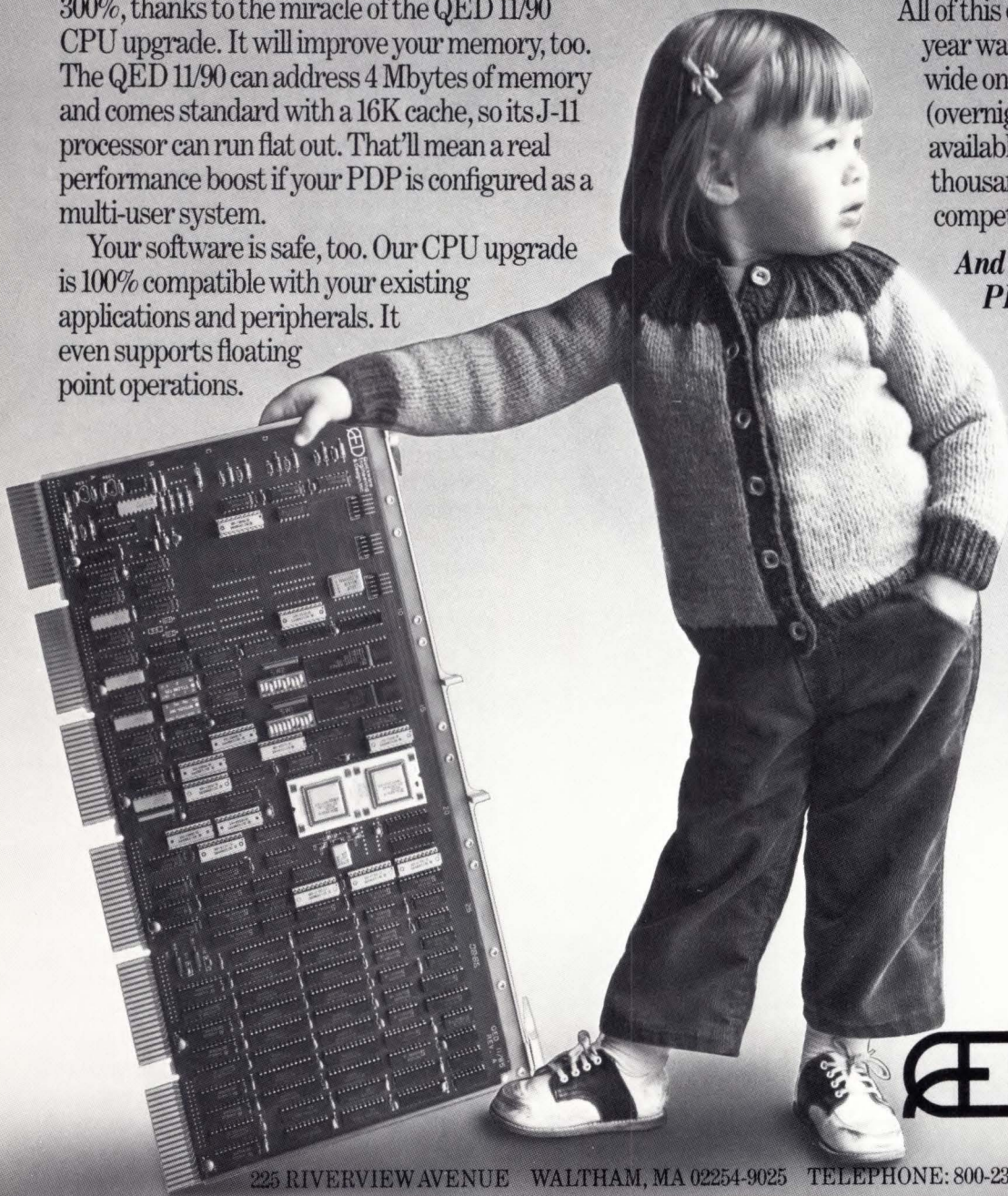

QUICKWARE
ENGINEERING
& DESIGN, INC.

225 RIVERVIEW AVENUE WALTHAM, MA 02254-9025 TELEPHONE: 800-237-1185 IN MA 617-647-3800

CIRCLE 435 ON READER CARD

Quickware and QED are trademarks of Quickware Engineering & Design, Inc. PDP, J-11, and Unibus are trademarks of Digital Equipment Corporation.

QUICK-DISCONNECT SUBSYSTEMS: THE NEW-GENERATION DISK PACKS

BY TOM GARDNER, Magnetic StorAGE Editor

ALTHOUGH DISK PACK TECHNOLOGY IS ALL BUT GONE, USERS STILL WANT REMOVABILITY FOR SECURITY PURPOSES, AS WELL AS TO EXTEND THE StorAGE CAPABILITY OF THE SYSTEM

Since the introduction of Winchester technology in the mid-'70s and its huge commercial success in small fixed disk drives of the '80s, the demise of the disk pack drive has been predicted. Disk drive market analyst James Porter, Disk Trend Inc. (Mountain View, CA), predicts in his 1987 "Disk/Trend" report that disk packs will decline from less than 5% of 1986's \$15 billion rigid magnetic disk drive market to virtually nothing by 1990.

Yet there is a continuing need for users to remove data from their systems. For example, the need to secure proprietary information and/or programs requires frequent removal from the system when not being accessed. This requirement can be particularly acute in a classified environment, where the alternative to removing files and locking them up is locking up an entire system. Other examples of the need for removability include system reconfiguration (as in reconfiguring a CAD/CAE system for different engineers) and distributions of large data files.

Cartridge disk drives provide one solution to this customer need, but their capacity, until recently, has been limited to less than 20 Mbytes (see "Small Cartridge Disk Drives Offer Performance and Extensibility," *StorAGE*, page 9, February 1988) and their reliability was suspect. For several years now, some innovative users have solved their need for removability by simply removing the entire fixed disk drive. Plus Development's HardCard is rumored to be a particular favorite for data distribution (a 40-Mbyte HardCard loaded with data sent via Federal Express represents a respectable transmission rate at a very low cost) while external disk drives reportedly have been used in security applications by disconnect-



Figure 1—Tandon Corp.'s Personal Data Pac 30 stores 30 Mbytes of data in a full-height, 5.25-in. form factor drive that can be removed and locked in your desk, carried to another department, or slipped into your briefcase for a meeting across the country.

ing and locking them up. An additional benefit of the removable Winchester is improved reliability compared to the traditional disk pack approach. This is due to the sealed environment, lower power, and lighter weight of these Winchester drives. The power and weight factors mean less electrical and mechanical stress, thus improving component life—ensuring a longer-lasting disk drive.

In the past 18 months, manufacturers have begun supplying small fixed disk drives designed to be removable. Disk drive manufacturers JVC Information Products Co. and Tandon Corp. have redesigned and repackaged small fixed disk drives into portable units. Tandon's Personal Data Pac (Figure 1) is one of the smallest and lightest offered.

Other companies have designed disk drive carriers and mating receivers that transform any conventional fixed disk drive into a removable drive module. Typically, they purchase the disk drive on an OEM basis, mount the drive to a carrier that mates with a corresponding receiver, and sell a complete subsystem for attachment to Digital Equipment Corp. systems and/or personal computers. Emulex Corp.'s Removable Winchester Subsystem (Figure 2) has two removable modules and the two large subsystems (Figure 3) by System Industries Inc. (SI) include the highboy with eight removable drives and the lowboy with four removable drives.

Fostering the Demand

The demand for removability has clearly been driven by classified security requirements, but it does appear that these products are leaving the secure world and moving out into the commercial world. It seems that customers are willing to pay a premium for the benefits of removability. Tandon's Casey Hughes, vice president of sales, describes this as a portable system environment, not merely an archive or security product.

While removability clearly has value, there are a number of potential problems that need to be addressed as fixed drives become removable. In spite of reliability levels in excess of 30,000 hours MTBF, fixed Winchester disk drives are unsuitable for removable applications due to limited shock protection and connector systems, which are not designed for multiple insertions and removals. A further problem is that operating systems and controllers are generally

designed with fixed Winchester disk drives in mind rather than removable versions. Thus, no hardware provisions—electronic latches or their software counterparts—are normally included. The consequences of these controller and O/S shortcomings can vary from unpredictable system behavior (i.e., crashes) to corrupted data files. This is a particular problem with Microsoft Corp. (Redmond, WA) MS-DOS and similar systems since the file allocation and buffer control algorithms and the Block Device Driver were built based on the presumption that the fixed disk drive is never removed.

Following is a discussion of currently available removable drive modules. No attempt is made to evaluate these products along more traditional lines such as access time, transfer rate, or other performance enhancements since such evaluations are well known throughout the industry.

DataPort Inc.
852 Via Alondra
Camarillo, CA 93010
805-388-2700
Circle No. 201

Model I, 3.5-in. Winchester Adapter
*PC Internal Mount (half-height 5.25-in.)
3.5-in. Drive Adapter
Carrying Case*

The DataPort Inc. Model I consists of a drive carrier suitable for most 3.5-in. disk drives (with industry-standard dimensions) and a mating receiver that has a half-height, 5.25-in. form factor. An integral lock is included in the receiver to prevent unauthorized removal of a drive. An optional carrying case is available to protect the drive when it is out of the receiver.

Given today's state of the art in 3.5-in. disk drives, DataPort is limited to capacities ranging from 10 to 40 Mbytes, with 100+ Mbytes expected by late this year. Shock resistance is essentially that of the drive. L. Durwood Kinsey, DataPort sales, states the carrier-to-receiver connector system is rated in excess of 1500 insertion/removal cycles.

Receivers are available with connector systems compatible with either ST506/412 or SCSI interfaces. The receiver then plugs into the cable from the user's controller of choice. No system or controller support is provided; resolution of any insertion/removal compatibility problems is up to the purchaser.

"GIVEN TODAY'S STATE OF THE ART IN 3.5-IN. DISK DRIVES, DATAPORT IS LIMITED TO CAPACITIES RANGING FROM 10 TO 40 MBYTES, WITH 100+ MBYTES EXPECTED BY LATE THIS YEAR."

With a suggested retail price of \$149, the Model I represents the lowest-cost approach for obtaining a removable disk drive; however, it is up to the user to be sure that no system or controller problems occur. Note this does not include the cost of the drive or controller, which might cost \$500 retail for a 40-Mbyte drive and PC-compatible controller. Kinsey states that, because of the low cost and high reliability, as much as 35% of his sales is going into backup applications, a market segment that typically uses tape drives.

Emulex Corp.
3545 Harbor Blvd.
Costa Mesa, CA 92626
714-662-5600
Circle No. 202

ER2 Removable Subsystem
ER2 RETMA 19-in. Chassis
UC04 Q-Bus-to-SCSI Host Adapter
UC14 Unibus-to-SCSI Host Adapter
MD21 SCSI-to-ESDI Controller
PDM170 170-Mbyte ESDI Drive
PDM380 380-Mbyte ESDI Drive
PDM Carrying Case

The Emulex ER2 removable Winchester subsystem (Figure 2) consists of a RETMA 19-in. rack-mounted receiver that can accept

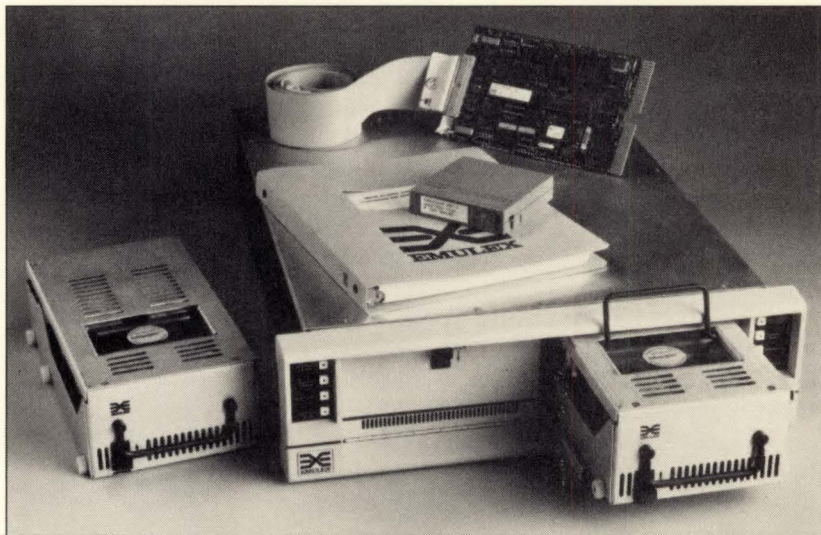

Figure 2—The Emulex Corp. ER2 removable Winchester subsystem includes a RETMA 19-in. rack-mountable receiver that can accept two Emulex PDM drives of 170, 180, or 380 Mbytes each (formatted). The ER2 subsystem is available with either SCSI or ESDI interface for connection to a Q-bus, Unibus, or IBM PC/AT-compatible bus.

two Emulex PDM drives of 170, 180, or 380 Mbytes (formatted) capacity each. The drive prices range from \$4,195 to \$7,490. The capacity of a single subsystem ranges from 170 to 760 Mbytes with the possibility of as much as 3 Gbytes when four subsystems are chained together.

Emulex purchases the drives on an OEM basis and mounts them in the drive carrier—carriers are not available separately. The drive carrier provides no additional shock protection beyond the 40-G non-operating specification typical of this drive class. A precision roller and guide system ensures the integrity of the low insertion-force connector system.

ER2 subsystems are available with either SCSI or ESDI interfaces. SCSI has subsystem daisy-chaining capability while ESDI offers higher performance. Subsystem prices range from \$6,770 (SCSI with one 170-Mbyte drive) to \$18,330 (ESDI with two 380-Mbyte drives). Host adapters and supporting software are available for connection to a Q-bus, Unibus, or IBM PC/AT-compatible bus. Note: an IBM PC/AT-compatible bus has to be rebooted after each module change.

JVC Information Products Co.
41 Slater Dr.
Elmwood Park, NJ 07407
201-794-3900
Circle No. 203

20-Mbyte Removable Drive System
Docking Port
Drive Unit
Carrying Case

JVC packages its 26.68-Mbyte (unformatted) 3.5-in. disk drive in a carrier that increases its shock resistance from 70 to 100 G's, non-operating. An optional carrying case enables the drive to withstand dropping from desktop height onto a hard floor. The drive mates with a receptacle having a half-height, 5.25-in. form factor.

A special connector system developed by JVC is rated for a minimum of 5000 cycles with significantly more cycles expected. The connector system is designed to protect the device connector when the drive is removed and guide it into alignment during insertion.

The drive interface is a JVC variant of the ST506 and is, today, only supported by an IBM PC/XT-bus-compatible controller

offered by JVC. A SCSI controller is planned to be available later this year.

John Harris, manager of business development for JVC, states that the company is "primarily marketing on an OEM basis." He is unwilling to state OEM prices, particularly given the recent yen-dollar fluctuations, but invites interested OEMs to contact JVC for quotes.

MDB Systems Inc.

1995 N. Batavia St.
Orange, CA 92613
714-998-6900

Circle No. 204

Data Shuttle 2000

Disk Chassis

Full-Height, 5.25-in. Drive Canister (two maximum)

MDB Systems Inc.'s Data Shuttle 2000 removable Winchester subsystem consists of a RETMA 19-in. rack-mounted receiver that can accept two 5.25-in. full-height drives with capacity up to 760 Mbytes per drive (formatted).

MDB purchases the drives on an OEM basis and markets them mounted in the drive carrier or the carriers are sold separately so you can select and install the drives of your choice. Carrier lists for \$461 (quantity 2-9). MDB supports the installation of a wide variety of disk drives, including CDC, Fujitsu, Micropolis, and Maxtor.

The drive carrier provides shock attenuation, reducing a 100-G shock to 20 G's, which is well within the capability of most drives of this class. A guide-rail system ensures the integrity of the low insertion-force connector system. However, MDB is unwilling to cite an insertion/removal cycle rate.

MDB's Data Shuttle 2000 subsystems are available with and without controllers. Without controller and carriers, it lists for \$3,660; optional cable kits support ESDI, ST506, RD5X, or SCSI drive interfaces.

Controllers, cables, and supporting software are available for connection to DEC Q-bus and MicroVAX computers.

Sigma Information Systems

3407 E. La Palma Ave.
Anaheim, CA 92806
714-632-0474

Circle No. 205

SA-H162 MicroVAX II Expansion Unit

System Enclosure Unit (freestanding)

Full-Height, 5.25-in. Drive Bracket (four maximum)

SA-H163 Dual Winchester Enclosure

Expansion Chassis (RETMA)

Full-Height, 5.25-in. Drive Bracket (two maximum)

Two of Sigma Information Systems' industrial products feature removable Winchester disk drives. The SA-H163 subsystem is a RETMA 19-in. rack-mounted receiver that can accept two 5.25-in. full-height drives, and the SA-H162 consists of a DEC BA23 MicroVAX II and up to four 5.25-in. full-height drives installed into a freestanding enclosure. The list prices are \$1,431 and \$3,750, respectively.

IT'S THE USER'S RESPONSIBILITY TO ENSURE PROPER OPERATION OF THE CONTROLLER

Sigma's drive carrier provides no additional shock protection beyond the 40-G non-operating specification typical of this drive class. A guide-rail system ensures the integrity of the low insertion-force connector system; in excess of 20,000 cycles can be expected.

No drive controller is provided with these products; the interface can be ST506, ESDI, or SCSI compatible so you have a wide choice of controller. It's the user's responsibility to ensure proper operation of the controller and system in a removable environment.

Controllers, cables, and supporting software are available for connection to DEC Q-bus and MicroVAX computers.

System Industries Inc.

560 Cottonwood Dr.
Milpitas, CA 95035
408-432-1212

Circle No. 206

SI was a pioneer in removable Winchesters with the introduction of a line of removable 8-in. Winchesters in 1984. This early experience with removable drives, claims the company, is reflected in the 5.25-in. product family announced late last year.

The SI Series 5000 Quick Disconnect System includes configurations ranging from table-top boxes through RETMA rack units and desk-high units to maximum-capacity cabinets (Figure 3).

SI currently offers two drives: the 385-Mbyte (unformatted) SI56 for \$7,500 and the

"IT HASN'T BEEN PROVEN THAT REMOVABLE DRIVES ARE A REASONABLE ALTERNATIVE TO THE CARTRIDGE AT LOW StorAGE CAPACITIES."

769-Mbyte (unformatted) SI57 for \$14,000. The drives are purchased by SI on an OEM basis and mounted in the drive carrier—carriers are not available separately.

The SI drive carrier provides no additional shock protection beyond the 40-G non-operating specification typical of this drive class. A precision guide and floating connector system ensures the integrity of the low insertion-force connector system; no appreciable wear has been observed after 100,000 cycles. Unlike most other drive carriers, the handle is an active two-step element in the insertion/removal cycle. The company claims this prevents inadvertent removal and the consequential problems.

SI views itself as service oriented and focused upon the DEC market. Consistent with this view, its removable products are offered as complete systems designed for use with DEC's MicroVAX II and 3xxx-series CPUs. SI's DSA-compatible C-Series removable drives can be connected to DEC's HSC50, HSC70, KDA50, KDB50, and UDA50 controllers. A minimum system with two 380-Mbyte drives, controller, and chassis lists for approximately \$23,000, while an

eight-drive system could cost more than \$160,000.

Tandon Corp.
20320 Prairie St.
Chatsworth, CA 91311
800-556-1234 ext. 171
Circle No. 207

Data Pac 30 Drive Module

Ad-Pac /A PC/AT External Drive Receiver

Ad-Pac /X PC/XT External Drive Receiver

Tandon's Data Pac is somewhat larger than the JVC removable drive and mates to a receiver having a full-height, 5.25-in. form factor. Presently, capacity is limited to 30 Mbytes (formatted) with a suggested retail price of \$399, but Tandon's Hughes expects to announce Data Pacs ranging in capacities from 20 to 60 Mbytes shortly, with still higher capacities to follow. He predicts prices will drop to \$10 per Mbyte.

The drive includes a special mechanism that retracts and supports the heads when the drive is not installed in the receiver; the resultant non-operating shock specification of 200 G's is extraordinary—it corresponds to an 18-inch drop onto a hard floor. The connector system's life is specified at 10,000 cycles, minimum.

Tandon developed this technology for its personal computer product line and the Data Pac is featured on several of its computers. The PC market is its primary focus with two external receivers currently available; the Ad-Pac /A and Ad-Pac /X for the IBM PC/AT and PC/XT compatibles, respectively. These Ad-Pacs, priced at \$599 retail, include controller, cable, etc., and device driver software that supports removable volumes and allows the system to be booted from these devices. An internal receiver—In-Pac—is in the planning stages.

Trimarchi Inc.
P.O. Box 560
State College, PA 16804
814-237-8031
Circle No. 208

E-Z Box

5RO Universal Chassis

5MV Motorized Chassis

DQ686 / 696 Q-Bus-to-ESDI Controller

WQESD Q-Bus-to-ESDI Controller

MQDX3 Q-Bus-to-ESDI Controller

DU686 Unibus-to-ESDI Controller

10-320-Mbyte, Full-Height, 5.25-in. Drives



Figure 3—The disk units used in System Industries Inc.'s (SI's) 5.25-in. Quick Disconnect Systems are interchangeable among all SI 5.25-in. quick-disconnect carrier slots. A flush-mounted handle is integrated into each drive's faceplate for easy transport, but a two-step powering-down procedure prevents accidental removal.

3.5-in. Drive Chassis

31-Mbyte 3.5-in. Drive (RD52 emulation)

42-Mbyte 3.5-in. Drive (RD32 emulation)

Trimarchi Inc.'s line of E-Z Boxes has two distinct product offerings relevant to the subject of removable *StorAGE*—the 3.5-in. E-Z Box and the E-Z Box 5RO and 5MV.

The 3.5-in. E-Z Box accepts any 3.5-in. Winchester disk drive, but has the form factor of a full-height, 5.25-in. disk drive. The E-Z Box can be purchased with connector systems suitable for use with ST506, ESDI, or SCSI interfaces; again, the responsibility for controller and system function rests with the user. Shock mounting is provided within the drive carrier, but the ultimate shock specification is a function of the installed drive. The connector system is rated at a conservative 5000 insertion/removals. The primary reason for citing a relatively low number of insertion/removal cycles, says Trimarchi President, Tom Trimarchi, is: "They are more in line with the actual specifications provided by the connector manufacturer." The approach used by Trimarchi to achieve a high number of insertion/removal cycles is to use a disposable connector system called E-Z Flex. "When electrical or mechanical degradation occurs," explains Trimarchi, "the failing connectors can be easily replaced." The carrier without Model 3-RO drive lists for \$995; for \$1,995, you can purchase the E-Z Box 3-RO with a 42-Mbyte drive that emulates the DEC RD32.

Similarly, the E-Z Box 5RO and 5MV removable Winchester subsystems each consist of a RETMA 19-in. rack-mounted receiver that can accept two 5.25-in. full-height drives with capacities up to 760 Mbytes per drive (formatted). The Model 5MV features motorized insertion/removal of the drive modules, while the 5RO is manual. Interestingly, the Model 5MV has a standard voice synthesis unit to aid the operator and issue warnings.

Trimarchi, like other subsystem manufacturers, purchases disk drives on an OEM basis and markets them mounted in the drive carrier or the carriers are sold separately.

Trimarchi's carrier can accept a wide variety of disk drives, including CDC, Fujitsu, Micropolis, and Maxtor.

E-Z Box subsystems are available with or without controllers. Without controller and

including two carriers, the Model 5RO lists for \$2,495 while the 5MV lists for \$3,995. In this configuration, it is the user's responsibility to ensure proper operation of the controller and system.

Controllers, cables, and supporting software are available for connection to both Q-bus and Unibus.

No Basis for Comparison

With products ranging from DataPort's \$149 carrier and receiver (no drive) to SI's \$160,000 eight-drive system, it is challenging to generalize; nonetheless:

- It hasn't been proven that removable drives are a reasonable alternative to the cartridge at low *StorAGE* capacities. Most

THE DEC MARKETPLACE IS WELL SERVED WITH A NUMBER OF ALTERNATIVE PRODUCTS, FROM SIMPLE SUBSYSTEMS TO SOPHISTICATED TURNKEY SYSTEMS.

removable products will accommodate several media per receiver—Iomega Corp. (Roy, UT) reports eight cartridges per drive. And a number of companies suggest, at the low end, at least two drive modules per receiver. From a cost perspective, at capacities less than 50 Mbytes, the break-even point is very close to one module per receiver, and any buyer needing simple removability would be well advised to consider cartridges.

- A number of suppliers prefer to provide a turnkey solution—combining, for example, drive carriers and drives, rather than pricing separately. This service comes at a price, of course. If the buyer is willing to assemble (and capable of assembling) his subsystem, there appears to be significant savings available in dealing with suppliers willing to unbundle the components.

- The DEC marketplace is very well served with a number of alternative products. These range from simple subsystems offering device selection and removability with the breakpoint at the device interface to very sophisticated, large, turnkey systems.

- Other system markets are not yet at the level of product offering of the DEC market. Removability is available with the breakpoint at the device interface. Particular attention should be placed upon the controller and system implications of such implementations.

GEORGE LANGWORTHY'S INSIGHTS TO OPTICAL STORAGE



SOME INTERACTIVE THOUGHTS

The notion of packing pictures, words, and even sound on some form of mass *StorAGE* media is indeed intriguing. And, for the past couple of years, you've been reading about how wonderful all this can be and how technology is making the electronic story-book possible.

One product called the compact disk interactive (CD-I) is a promised new consumer product that, if you believe all the hype and hoopla found in the press and at Microsoft Corp.'s annual CD-ROM conference, is expected to make information readily available at very little cost.

A Simple Base Technology

In its simplest form, CD-I is based on a well-known and tried-and-true technology—compact disk (CD). This technology uses plastic disks with embedded information that is read back by reflecting a laser light on the pits and lands—the flat surfaces between pits—in the media surface. CDs are designed to hold digital audio. CD-I ROMs, on the other hand, hold audio, video, digital data, graphics, and control codes for use by the operating system.

The idea of CD-I was, not surprisingly, created by the same people who created the CD concept: NV Philips Gloeilampen-Fabriek (Eindhoven, the Netherlands) and Sony Corp. (Tokyo). During 1984–1986, with the help of Matsushita (Tokyo) and Microware Systems Corp. (Des Moines, IA), CD-I specifications were created, now known as the green book.

The green book defines more than just the idea of combining data types; the controlling hardware and software are defined as well. The CD-I player/environment consists of:

- a Motorola 68000 class of microprocessor on a 16-bit bus,
- an 8-bit character set that conforms to the international ASCII character set ISO/DIS8859/1 standards,
- the use of pulse coded modulation—audiophiles will know this for use with keyboards and synthesizers,
- a real-time operating system developed by Microware, and

- about 1 Mbyte of RAM—this element may be tough to come by if RAM prices keep spiralling upward, and will affect the price tag of CD-I dramatically.

Consumer View

Unlike other optical *StorAGE* devices, which are primarily for commercial/industrial use, CD-I is being marketed as a consumer product with industrial aspects. This has colored much of the thinking in the specification; for example, the developers are going to great lengths to ensure that the output conforms to 384 pixels by 280 lines of resolution—the best possible on standard domestic (525-line) and European (625-line) television. The reasoning being that television will be the primary output device used with CD-I. However, emerging digital televisions with twice the resolution may eventually influence CD-I specifications.

More than 100 companies, ranging from Hitachi to Sony, have signed up as CD-I developers, and the implication is that they will also be responsible for providing the information databases. By perusing the list of supporting companies, however, you'll come to believe that maybe there will be more hardware than information available.

Most likely, the information base is tougher to create than the hardware and software technology used to access it.

Tackling the information-creation job isn't for the faint of heart, nor is it cheap. Besides the expertise and equipment needed to "prep" the data for embossing on the plastic wafers, new age information vendors must have other skills as well. Specifically, CD-I information preparation demands the skills normally associated with film, animation, and audio production.

Moreover, the choice of information is critical. A few years ago with personal computers, the question was: "What can I do with it?" The stock answer circa 1976–1980 was to keep recipes and to do your check-book. Proponents of CD-I, and optical *StorAGE* in general, offer similar answers: "teach, interactive databases [whatever they are]." I don't discount the potential power and use of CD-I; I'm just not sure what the real application will be. S!



The reasons to purchase our new optical storage system are endless.

Introducing Archeion. The Optical Disk Subsystem for VAX Computers.

If it seems like there's no end to the difficulties of storing vast amounts of data, take heart.

Because now, there's EMC's Archeion.

Archeion is the answer VAX users have been hoping for. A high-performance, practical, compact system for archiving.

It puts an end to the costliness, inefficiency and aggravation associated with on-site and off-site tape storage facilities.

Archeion provides up to 56 gigabytes of on-line storage. One platter alone stores an amazing 2 gigabytes of information. And because data is actually burned into the disk, accidental crasure and head crashes are a thing of the past. Of course, because Archeion employs optical technology, it offers

an exceptional capacity for storing data. But what's more, Archeion has incredible data *retrieval* ability. All information is available to you instantly. Seeks are performed electronically, enabling Archeion to give you the speed of a disk while allowing you the convenience of using your standard tape commands.

It's not hard to see the benefits of Archeion for your archiving needs. Miles of data in inches of space. Information accessed in milliseconds. Dramatic savings in time and personnel.

What's more, it's quick and easy to convert tapes to optical storage. Archeion is fully compatible with all VAX systems. Plus, Archeion understands all of your

tape commands and the language you're already using, so there's no need to change your application software or

go through a slew of new manuals to re-educate your users. In addition, any suspected problem can quickly be isolated by Archeion, which means that if your entire data base is on-line and a disk drive goes down, your system won't. That means convenient, hassle-free service-ability.

The end result of all of this is simple: you can't find a better way of storing and retrieving tremendous amounts of data than with Archeion Optical Disk Subsystem. For more information, call 1-800-222-EMC2 (In Mass, 617-435-1000). EMC Corporation, 171 South Street, Hopkinton, Massachusetts 01748-9103.



The 90 reels of magnetic tape shown above could be instantly accessed using just 6% of Archeion's total on-line storage capacity.



EMC²
The System Enhancement Company

CIRCLE 408 ON READER CARD

VAX is a registered trademark of Digital Equipment Corporation.
Archeion is a registered trademark of EMC Corporation.

PHIL DEVIN'S ROTATIONS

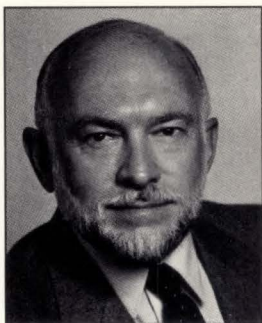

**MAYBE
THERE
REALLY IS A
SUBSYSTEM
MARKET**

When the gods created computer companies, one of the lost stone tablets was inscribed "Thou shalt not allow little guys to attach *StorAGE*." This commandment has been liberally interpreted to mean that small *StorAGE* subsystem vendors can collectively have 10% of the aftermarket before they feel the wrath of big daddy.

Now clear evidence exists that Digital Equipment Corp.'s plug-compatible followers are gaining momentum in the quest for their rightful share of peripheral revenues.

Times Seem to Be A-changin'

Recent Dataquest interviews of *StorAGE* subsystem producers indicate a strong, continued growth of the revenues derived in 1987 from beating out DEC on the *StorAGE* battlefield.

DEC has dropped litigation against EMC and System Industries (SI). These companies have forged ahead with strong, new programs to supply new *StorAGE* products. The 12 major suppliers to the DEC third-party *StorAGE* subsystem market increased sales revenue by 15.5% between 1986 and 1987.

Earlier forecasts showed only a 2.7% increase. Thanks to some innovative product management at SI, and strong acceptance of the high-performance products from Emulex, I was proved wrong.

A Look at the Winners

Most industry publications have continued to attribute higher hardware revenues to SI than SI publishes. With 25% of its sales derived from service revenues, we estimate that SI equipment sales to the DEC *StorAGE* market were \$84 million, 40% of the industry total. A service base is an indication of customer confidence.

Struggling under the shadow of continued legal pressures, Emulex sold 20% of the subsystems. The recently announced reorganizations at Emulex may focus greater attention on the profitable subsystem market and inspire this high-performance powerhouse of an engineering staff to shake the industry.

Scientific Micro Systems Inc. (SMS) has grown into a Medusa as a result of multiple acquisitions. In spite of the distractions of

the Macintosh aftermarket and the disk controller chip business, SMS continues to increase its profitable DEC subsystem revenues, holding onto its 7% market share.

The bulk of the remaining major producers are privately held, or are divisions of larger corporations, making it difficult for them to expose their sales.

What Makes a Winner?

When winner-watching, SI must be the prime target. The high-end VAX market supplies strong revenue, allowing the new management team to fuel the development labs with ideas and resources. The SI quick disconnect, 5.25-in. rigid disk drives have focused worldwide attention on this approach to removable rigid *StorAGE*. It's possible that DEC will purchase similar products from a third party in order to grab a part of this new business.

SI has recently acquired a solid-state memory subsystem house, Imperial Technology. Semiconductor memory is not destined to cross the magnetic *StorAGE* dollars-per-Mbyte curve until well into the '90s, but the wise planners of the late '80s are starting to offer solid-state SMD-interface devices today.

The Emulex success story is not as obvious as that of SI. A strong dedication to quality and high performance at a low cost has kept this evolving organization on a profitable track. Offering a broad line of peripheral types and device mixes, Emulex can solve any Q-bus problem.

A Golden Opportunity

DEC's peripheral sales are approaching \$3 billion at a rate of almost 25% per year. About 50,000 major VAX installations are in use throughout the world, all crying for more disk and tape *StorAGE*. If DEC actually allows 10% of the aftermarket to escape its grasp, the third-party revenues can continue to grow at the 1987 rate.

I anticipate the entry into this market by several major *StorAGE* manufacturers as a result of 1987's encouraging sales and profit results. The sales and service capabilities of IBM or Control Data could seriously impact this cozy little fraternity of suppliers while offering sophisticated new solutions to the user.



Creating another system tool

Toolbox this month provides a DCL command procedure that gives information on the various processes on a VAX/VMS system. PROCESS.COM shows the user's VMS username, process name, process ID, and terminal as just the SHOW USERS command. PROCESS.COM also displays other information useful in managing a VMS system, such as the name of the image the user is running.

PROCESS.COM provides two levels of functionality. When executed without a parameter, the procedure shows the information for each process on the system. When a valid process ID is passed as a parameter to PROCESS.COM, the procedure limits its reporting to that process.

PROCESS.COM is handy to have around and takes only a minute to type. Once entered, it can be easily tailored to suit your specific needs.

PROCESS.COM begins by identifying itself and its author. PID is the symbol that will be used to keep the process ID. PID is first set equal to a null (""). Then, the next line indicates if a parameter is passed (P1 .NES. ""); PID is then set to the value of that parameter.

Next, the headings for the process information are printed to the terminal with five WRITE SYS\$OUTPUT commands. The dashes after the WRITE SYS\$OUTPUTs continue the command to the subsequent line. The first WRITE SYS\$OUTPUT identifies the information as "System Process Information." The next WRITE SYS\$OUTPUT sends a blank line to the terminal.

The next two WRITE SYS\$OUTPUT outputs two lines of titles to identify the columns of information to be displayed. The fifth

WRITE SYS\$OUTPUT underlines the column descriptors to separate them from the system information.

The label GET_INFO: is established to create a loop for retrieving information on each process. When a null is passed to it, the F\$PID lexical function returns the next available process ID from the system's process list. After the last process ID from the system process list is returned, F\$PID returns a null.

If the user has GROUP privilege, F\$PID returns the process IDs for that group. If the user has WORLD privilege, F\$PID returns the process IDs for all processes on the system.

If the user lacks WORLD or GROUP privileges, F\$PID returns only the user's own process ID.

So, the next line of PROCESS.COM says that if no specific process ID has been passed (P1 .EQS. ""), set the symbol PID equal to the next available process ID. PROCESS.COM then checks to see if PID is null (PID .EQS. "") because that would indicate the last process ID has been retrieved and that it's time to EXIT.

If PID isn't null, there is an ID to process and execution falls to the next line, which sets the symbol USERNAME equal to the VMS username using the F\$GETJPI (get job/process information) lexical function. If the username is null (IF USERNAME .EQS. ""), then PROCESS.COM transfers control back to GET_INFO (THEN GOTO GET_INFO) because the lack of a username indicates a process of no interest.

If the username isn't a null value, execution falls to the next line where F\$GETJPI uses the current process ID (PID) to get the process name

("PRCNAM") and place it into the symbol PROCESSNAME. After the process name, the F\$GETJPI function puts the device designation for the terminal associated with the process ("TERMINAL") into the symbol USERTERM. Then, F\$GETJPI puts the name of the image ("IMAGENAME") that the process is running into the symbol IMAGENAME.

In the next line, F\$PARSE takes the filespec provided by F\$GETJPI (IMAGENAME) and trims it to eliminate the node, device, directory, type, and version number. Thus, the symbol IMAGENAME contains only the file "NAME."

On the next line, F\$GETJPI is invoked again. This time it's to put the process state ("STATE") into the symbol STATE. F\$GETJPI then determines the priority at which the process is running and places that value into the symbol PRIO. Next, F\$GETJPI returns the count of direct I/O operations for the process to the symbol DIRIO. Likewise, in the next line, F\$GETJPI returns the count of buffered I/O for the process to BUFIO.

Finally, F\$GETJPI returns the number of page faults that the process has incurred to the symbol PAGEFLTS. F\$FAO is a lexical function that converts integer values into the ASCII representations of their decimal, hexadecimal, or octal equivalents and substitutes the results into an output string. F\$FAO will also insert variable string data into an output string without conversion.

F\$FAO uses a control string as its first argument to determine how the formatting will take effect. The !15AS instructs F\$FAO to format the first 15 characters from the symbol

```

$ type boxcod.txt
$:
$ PROCESS.COM
$:
$: Written by Dave Cole.
$:
$ Command procedure to print information
$ about processes on the system.
$:
$ PID = " "
$ IF P1 .NES. " " THEN PID = P1
$ WRITE SYSS$OUTPUT -
" System Process Information"
$ WRITE SYSS$OUTPUT " "
$ WRITE SYSS$OUTPUT -
"      User                I/O   Page"
$ WRITE SYSS$OUTPUT -
" Process name Username Term Imagename PID State Prio Count Flts"
$ WRITE SYSS$OUTPUT -
"-----"
-
$:
$   Print the display heading
$:
$ GET_INFO:
$ IF P1 .EQS. " " THEN PID = F$PID( NULL )
$:
$   If no parameter is passed then get the first process id
$:
$ IF PID .EQS. " " THEN EXIT
$:
$   If there are no more process ids then exit
$:
$ USERNAME = F$GETJPI( "PID", "USERNAME" )
$ IF USERNAME .EQS. " " THEN GOTO GET_INFO
$:
$   Don't print info for NULL and SWAPPER jobs
$:
$ PROCESSNAME = F$GETJPI( "PID", "PRCNAM" )
$ USERTERM = F$GETJPI( "PID", "TERMINAL" )
$ IMAGENAME = F$GETJPI( "PID", "IMAGENAME" )
$ IMAGENAME = F$PARSE( IMAGENAME,,,"NAME" )
$ STATE = F$GETJPI( "PID", "STATE" )
$ PRIO = F$GETJPI( "PID", "PRI" )
$ DIRIO = F$GETJPI( "PID", "DIRIO" )
$ BUFIO = F$GETJPI( "PID", "BUFIO" )
$ PAGEFLTS = F$GETJPI( "PID", "PAGEFLTS" )
$:
$   Assign the info for the display to their respective symbols
$:
$ DETAIL_LINE = F$FAO( ":!15AS!12AS!6AS!11AS!9AS!6AS!5SSL!2(8SL)", -
PROCESSNAME, " " + USERNAME, " " + USERTERM, " " + IMAGENAME, " " + PID, -
" " + STATE, PRIO, BUFIO + DIRIO, PAGEFLTS )
$ WRITE SYSS$OUTPUT DETAIL_LINE
$:
$   Build and print the detail line
$:
$ IF P1 .NES. " " THEN EXIT
$:
$   If a process id was passed we're done
$:
$ GOTO GET_INFO
$:
$   Loop back to get the next process id

```

(PROCESSNAME) as is. !12AS indicates that the result of the second symbol (USERNAME) is twelve characters and its value should not be translated either.

Likewise, with USERTERM, IMAGENAME, PID, and STATE, the number following the exclamation point indicates the number of bytes in the output, and AS indicates to F\$FAO not to make a conversion of the value.

The argument "!5SL" in the control string indicates that F\$FAO should convert the longword value in the symbol PRIO to a decimal notation that is 5 bytes long. BUFIO and DIRIO are added together to produce a single I/O count, and !2(8SL) indicates to F\$FAO to convert the sum and the value of PAGEFLTS from longwords into two 8-byte decimal fields.

F\$FAO formats the symbol arguments as indicated by the control string and places the result into the symbol DETAIL_LINE. The WRITE SYSS\$OUTPUT on the subsequent line then sends that formatted output to the terminal.

Next, the parameter P1 is checked again and, if not a null, then PROCESS.COM can exit—assuming that the information on the desired process has been displayed and nothing more is required.

If P1 is null, no one specific process is of interest and execution falls to the next line, which transfers control back to GET_INFO for more processing. In the VMS documentation under lexical functions, many other pieces of process information are listed that are available using F\$GETJPI. All VMS users have their own ideas about what information is important to see. Try substituting different items for the ones in PROCESS.COM, but don't forget to change the control string used by F\$FAO. We hope you'll enjoy crafting your own process monitoring utility. ■

Reader Interest Level

High	Circle No. 264
Medium	Circle No. 266
Low	Circle No. 268

ARCHIVER

**moves
seldom-used files
off magnetic disk . . .
and on to tape
or optical disk!**

Archiver is the software solution for your VAX/VMS system's "over-crowded" magnetic disks.

With Archiver, files you select can be moved off your system's disks and on to magnetic tape, optical disk, or a combination of both. Archiver's "virtual disk" performance and on-line directory let you quickly recall files as you need them.

Use Archiver's new Optical Option for greater storage capacity, longer data life, or when you need archived files back on your system's magnetic disks in only seconds. Or choose Archiver's tape storage features as a cost-effective alternative to purchasing additional disk drives. Either way, Archiver is fast, powerful, yet easy-to-use.

The new Archiver totally automates all aspects of optical disk management. Optical Archiver can be purchased with hardware from Strategic Information, or may be purchased separately for use with your existing optical drive hardware.

Discover how Archiver can be the cost-effective, software solution to your data management and storage needs.

Call 1-800-227-1209 today for complete information.

STRATEGIC INFORMATION



80 Blanchard Road
Burlington, MA 01803
Call 1-800-227-1209
In Massachusetts,
call (617) 273-5500

Ziff Davis
Technical Information Company

STRATEGIC
INFORMATION

5 1/4" MOBILITY, SECURE STORAGE AND WINCHESTER RELIABILITY...

With up to 760 MB per canister, each DEX Power Shuttle System comes complete with one or two 5 1/4 inch Winchester Disk Drive in 2 removable canisters and a disk controller.

Along with a one year warranty including shock related failure, the DEX Power Shuttle Family is designed to get you in and out of a wide range of environments from shock isolated commercial use to the harshest industrial requirements.

DEX

1061 SOUTH MELROSE AVE
PLACENTIA, CA 92670

DEX POWER SHUTTLE-172

1 OR 2 86 MB DISK DRIVES

DEX POWER SHUTTLE-346

1 OR 2 173 MB DISK DRIVES

DEX POWER SHUTTLE-760

1 OR 2 380 MB DISK DRIVES

714 • 632 • 1841

...IN A LOW COST PACKAGE

DEX Power Shuttle Family for use with all computer systems

- Integral power supply for all disk configurations
- Canister design protects disk drives from 100-G shocks
- Compact 5 1/4" rack height
- Proprietary DC power-down feature assures head retraction and park when removing drives, without elaborate relays or solenoids
- Canisters with or without drives (Up to 760 MBytes per canister)
- With or without high-performance MDB controllers
- Effective forced-air cooling design for each canister
- Low insertion force connectors — no cables to disconnect
- Mounts any 5 1/4" device — Winchester or optical
- Unique shock isolation of drives for safe removal, transport and storage
- Canister resident write protect
- Removability for portability, security, archiving, maintenance. Infinite storage capacity — with Winchester reliability
- ESDI, ST506, RD5X & SCSI interfaces — jumper selectable



Configuring for better management

How you set up your system under TSX-Plus determines how well it can be managed and its efficiency. One method first described by Greg Adams of G.A.B.A. (Studio City, CA) at the Fall 1987 Digital Equipment Computer Users Society (DECUS) Symposium, as well as my experience of learning from mistakes, meets the following objectives:

- Apply some organization to the files in the system.
- Simplify the system management job.
- Reduce the risk of accidental system damage by eliminating the need for most users to have write access to the system disk.
- Improve user support by providing each user some private disk space.

Setting Up the Organization

To meet the goals, you must analyze the physical system (i.e., terminals, *StorAGE* connectors) and establish a working guideline to configure the system. One of your first tasks is to organize system files as logical disks, essentially defining the physical disk as multiple units—volumes. While the logical disk approach isn't a substitute for a hierarchy of subdirectories available with more robust operating systems such as UNIX, by being innovative you can use logical disks in much the same manner. The most important benefit logical disks offer is ease of use and management. Moreover, you end up with smaller multiple directories that tend to speed file operations.

Once you have converted to logical disks, the next task is to simplify system control and manage users' access. The main tools you use for this are the startup command files in

TSX-Plus. The three types of startup command files are the detach command files declared by the DETACH macro in TSGEN, the physical-line startup command files declared in the line definitions in TSGEN, and each user's login command file defined by the TSAUTH program when the user's account is created.

Detaching from the Job

For the startup detach file, I recommend that no matter how many detach jobs you have, configure only one (preferably named "DETACH.TSX") into TSGEN. This file can be used to issue system-wide startup commands needed each time TSX-Plus is started. If you need addi-

```
! DETACH.TSX
!
! This command file is started as a detached job when
! TSX-PLUS is started up. It is used to perform various
! system-wide initialization commands.

SET ERROR NONE           ! Continue on errors
SET LOG FILE=SY:STRUP.XXX ! Record what happens
SET PROCESS /NAME="Startup" ! Identify job

! Set up a CL line as a serial printer
SET CLO LINE=3           ! Define CLO as Line 3

! The next two commands are useful for printers
! that can do bit map graphics

SET CLO BINOUT           ! Send all 8 bits
SET CLO BITS=8           ! Send 8 data bits

SET CLO CR               ! Send CR to printer
SET CLO CTRL             ! Send control chars
SET CLO FORM             ! Printer does form feed
SET CLO FORMO            ! Form feed on block 0
SET CLO LC               ! Send lowercase
SET CLO LENGTH=66       ! Lines per page
SET CLO LFOUT            ! Send line feed chars.
SET CLO SKIP=6           ! Skip across perforations
SET CLO SPEED=4800      ! Set line speed
SET CLO NOTAB            ! Simulate tab stops
SET CLO WIDTH=0         ! Unlimited width

! Install Non-Standard Programs
INSTALL SY:KERMIT.SAV /SINGLECHAR/NOWAIT/MEMLOCK
INSTALL SY:XMODEM.SAV /SINGLECHAR/NOWAIT/MEMLOCK

! Begin Directory Caching on Selected Disks
MOUNT DU1:
MOUNT DU2:

! Set TSX Control values
SET IO ABORT             ! Try to abort I/O

! Define system password and enable it on modem line
SET SYSPASSWORD IMM*BACK
SET TERMINAL 4 SYSPASSWORD

! Detach the print window detach Job
DETACH SY:WINPRT.TSX

SET LOG CLOSE            ! Turn off logging
SET ERROR ERROR         ! Normal error processing

Listing 1. DETACH.TSX

! VT100.SUP
! Physical line startup file for VT100 terminals

SET TT VT100            ! Set terminal type
@COMMON.SUP             ! Common line start

Listing 2. VT100.SUP
```

tional detach jobs started, include DETACH commands in this file. An example DETACH.TSX is shown in Listing 1. Note that a number of the commands (for example, the device SET commands) are not strictly needed each time the system starts up, since they're remembered across startups. Executing them every time ensures that the devices come up in the same, known, state each time.

Next, you need a physical-line startup file (defined in TSGEN) for each class of line or terminal you have. Typically, this means a single physical startup file, but be aware that this method is at odds with the way TSGEN is delivered.

If you follow the example of TSGEN, you end up with a separate startup command file for each physical line, with the filename of

LINEn.TSX. The result is a large number of command files with not very descriptive names. Besides using a different startup file for each class of terminal, I like to use a different file type, such as .SUP (for Start UP). This makes it easier to find the startup files. For example, Listings 2 and 3 are startup command files for VT100 and ADM3A ASCII terminals. Note that, after setting the terminal type, they both call a standard startup file (COMMON.SUP shown in Listing 4) to perform common startup processing.

User Startup

The user's startup filename should be the user's name (or an identifiable abbreviation) as entered into TSAUTH, possibly with the .USR suffix to avoid confusion. Similarly, a

file type, such as .LOG, allows the login command files to be easily found. As with the line startup command files, the user login files should be organized on a class basis. Examples of classes of users are word processing users, program developers, and electronic mail users. Each class of user usually needs access to different combinations of system resources. While there is a separate login file for each user, the only commands that should be in the file are calls to generic user-class command files. The generic-class login files should issue the ACCESS commands and other restriction commands that are appropriate to that class of user.

You should also provide a place for users to keep personal files. These include specialized command files, text files, calendars, and other files that make it convenient to use the system. You want each user to be able to keep track of his own files and not be affected by other users. The best way to do this is to allot each user a personal logical disk. This does not normally need to be very big and should have the same name as the user's login command file (with the .DSK type).

One of the more important personal files users need is an easily modified login command file. This command file is naturally located on the user's logical disk.

Listings 5 and 6 are examples of command files. The generic login file (Listing 5) mounts the user's private logical disk by passing the user's name as one of the parameters.

All these command files make your job easier by minimizing modifications to TSGEN and eliminating the need for users to change SY:. Another advantage to command files is that commands can be collected as the system changes and stored as easily modified files. These files, in turn, can be used by variations in the controller command file structure depending on the desired operation. ▀

```

! ADM3A.SUP
! Physical line startup file for ADM3a terminals

SET TT ADM3A          ! Set terminal type
@COMMON.SUP          ! Common line start

Listing 3. ADM3A.SUP

! COMMON.SUP
! Common physical line startup commands

TYPE SY:GREETN.TXT   ! Display System Greeting
R/LOCK LOGIN         ! Run the Login processor

Listing 4. COMMON.SUP

! JOHND.LOG
! Login command file for John Doe.

@SY:PRGRMR.LOG JOHND DU3 ! Call the generic
!- ``programmer'' login file

Listing 5. JOHND.LOG

! PRGRMR.LOG
! Generic login command file for programmers
! Executed as @PRGRMR.LOG name devc
!
!      Where:
!           name - the user's name
!           devc - the device where the user's
!                 private LD is located
!
TYPE SY:SYNOTE.TXT   ! Display post login text
! Allow access to various devices

ACCESS/READ SY:      ! read access to SY:
ACCESS ^2:^1.DSK    ! user's private LD device
ACCESS CL0:          ! CL that is serial printer
ACCESS DU1:SOURCE.DSK ! source files LD:
ACCESS DU2:LIST.DSK ! listing files LD:
ACCESS DU2:BINARY.DSK ! object (binary) files LD:
ACCESS DU1:EXE.DSK  ! executables files LD:
ACCESS DU3:SCRATCH.DSK ! scratch files LD:

ASSIGN CL0 LP       ! Make LP: a device name

! Mount various logical disks

MOUNT LD1 DU1:SOURCE.DSK SRC ! source
MOUNT LD6 DU2:LIST.DSK LO   ! listings
MOUNT LD5 DU2:BINARY.DSK BO ! object
MOUNT LD4 DU1:EXE.DSK EXE   ! executables
MOUNT LD7 DU3:SCRATCH.DSK SCR ! scratch

MOUNT LDD ^2:^1.DSK DK      ! user's personal disk

SET ENDSTARTUP          ! Disallow startup commands

@LDD:LOGIN.COM          ! Execute user maintained
!- startup command

Listing 6. PRGRMR.LOG

```

Reader Interest Level

High	Circle No. 252
Medium	Circle No. 254
Low	Circle No. 256



Windows on the world

The hottest thing in user interfaces today is windows. You can categorize windows as a text-dominated graphics approach to display that makes it easy to generate a desktop metaphor. The desktop metaphor has become so widespread as to be a cliché, and windowing is just a way of implementing some of the features of that metaphor dynamically.

Windowing provides independent rectangles on the screen that let the user isolate portions of an image or file. As the rectangles are independent, the user can display both that window and other isolated information. Thus, in word processing applications, a set of notes can be displayed next to part of the text being created; in design applications, a previously created file can be displayed side by side with a new one. But the most enticing feature of windowing is that each one becomes a movable icon.

Although Apple popularized the desktop metaphor, the best known of the windowing products runs on PCs and comes from Microsoft Corp.—Windows/2.0 and /386. Microsoft has aimed these products at OEMs and systems integrators wanting to develop systems that take advantage of today's windowing capabilities. Thus, the product comes as a developer's tool kit. This software provides application windows (with standard menus, scroll bars, title bars, and other window components) that you can turn into icons as well as overlaid pop-up windows that provide prompts.

Microsoft's complete Windows/2.0 operating environment retails for

CONTENT BASE ADDRESS	
CONTENT WRAPAROUND MASK	
CONTENT MEMORY WIDTH	
CONTENT END-OF-SCREEN "FLYBACK"	
BORDER BASE ADDRESS	
BORDER WRAPAROUND MASK	
BORDER MEMORY WIDTH	
BORDER END-OF-SCREEN "FLYBACK"	
L/R BORDER WIDTH	
DISPLAY ACCESS SKEW	
X1: LEFT VIRTUAL ACCESS	L PIXEL OFFSET
X2: RIGHT VIRTUAL ACCESS	R PIXEL OFFSET
Y1: TOP SCAN LINE	
Y2: TOP CONTENT SCAN LINE	
Y3: BOTTOM CONTENT SCAN LINE	
Y4: BOTTOM SCAN LINE	
A WINDOW DESCRIPTOR	

Figure 1—Hardware window descriptor registers make it easy to change the location or contents of any of the independent windows.

\$99 and Windows/386 costs \$195. Windows/386, jointly developed with Compaq Computer, takes advantage of an expanded memory utility to provide a virtual memory so that applications running under windows operate faster.

Despite the fact that Microsoft has named its product Windows, there are other ways to get windowing.

As an example, Professional Graphic Services has introduced a new tool kit aimed at simplifying the user interface for a graphics application program. The CG-VDI Programmer's Toolkit provides a library of subroutines that implement windowing capability. These subroutines provide classes of objects and a set of tools for creating, displaying, inquiring, and manipulating those objects. The package, with documentation and source code that demonstrates

each function, costs \$350.

The drawback to any windows program is that it tends to run slower than standard text display (especially in high-resolution systems) and uses a lot of memory. Running multiple applications uses even more.

Getting Hardware Help

Some chip manufacturers are doing their part to make windowing run faster as well as making it easier to implement. A number of firms offer high-performance tiling engines that will support a wide range of visual analysis and display tasks. But, for simple windowing, some display chips also take that task into account.

The hardware that helps most is a graphics controller featuring a set of descriptor registers (Figure 1) that track the front-to-back ordering of windows on the screen. Without this hardware, software implementations rely on a data structure called a tiling list—each window rectangle is referred to as a tile. The advantage of hardware registers is that changing either the location or the contents of a window means modifying the descriptor for that window—a much faster operation than rebuilding a tiling list. Scrolling the contents of a window changes the base address; moving a window horizontally changes the content base address and the x registers that define the horizontal location.

The presence of descriptor registers means that each window location requires a simple definition: the chips divide each scan line into sections called virtual accesses (Figure 2). The width of a virtual access depends on the number of pixels read in

from memory. The location of a virtual access determines the location of the window.

Because the chip uses registers for each window, there has to be a finite number of windows, whereas a software implementation would have no such limit—the more windows you need, the more data structures you build. But, with software implementations, the more windows used, the longer it takes for screen updates. The flexibility of an undetermined number of windows means that the data structure has to be completely modified every time you move or change the presentation.

If you think about scrolling through a window, the problem becomes clearer. The only reason you might need to scroll is that the image you want to present in a window is bigger than the memory space allowed for that window. To scroll, the software must create a memory space that is both wider and taller than the window. The software will typically use BitBlit operations to shift the image in memory, moving the desired contents into the memory that overlaps both the visible window and the larger memory space.

Hardware scrolling allows the program to adjust the flyback value in the descriptor register to scroll the image. The scrolling rate is then a multiple of the screen refresh rate.

Making the Windows Do Real Work

No matter how you implement

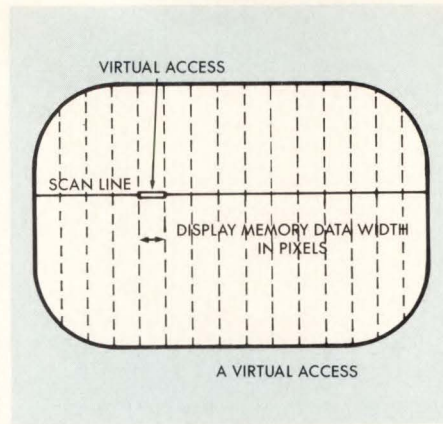

Figure 2—Dividing the screen into sections (virtual accesses) provides a reference for easily re-locating the window anywhere on the screen.

windows, it seems clear that windowing is a trend—and a positive one. And although windowing on a PC is probably the most pervasive example of this interface, it certainly isn't the most important application. Some of the Digital Equipment Corp. connections to Apple and Apollo Computer Inc. are making windows important (and relevant) in the minicomputer arena. One area where the technology of windowing is proving to be particularly vital is in the CAM environment. A number of ways exist for a workstation to connect to larger computers. Two of the easiest are:

- direct connection to the host computer with the workstation emulating a terminal used by the system, such as a DEC VT100 (for VAX sys-

tems), an IBM 5080 graphics terminal (for IBM mainframes running CADAM or CATIA software), or a Tektronix graphics terminal; and

- connecting to a network with a terminal emulator.

When you want to use the local graphics processing power of a workstation, such as an Apollo, either alternative is possible. Apollo's Domain/Access provides transparent file access to VAX/VMS systems via TCP/IP protocols, and the workstation also offers emulation of a number of terminals. But, whether you choose to network or emulate a terminal, the application running on the host runs at the same time as the local processing, and that brings us back to windows.

With windowing capability, the system breaks the screen into multiple virtual monitors. Each window can then represent a different function and, in this case, the function might be on the host computer, rather than local (Figure 3). The power of a workstation can add to the capabilities of a host. For instance, a screen running multiple programs can integrate a CAD drawing on a host into an interleaf document.

The specific application or computer type doesn't matter much in today's networked, multi-vendor computing systems. But, windowing gives us a technique for presenting large amounts of information in a usable manner.

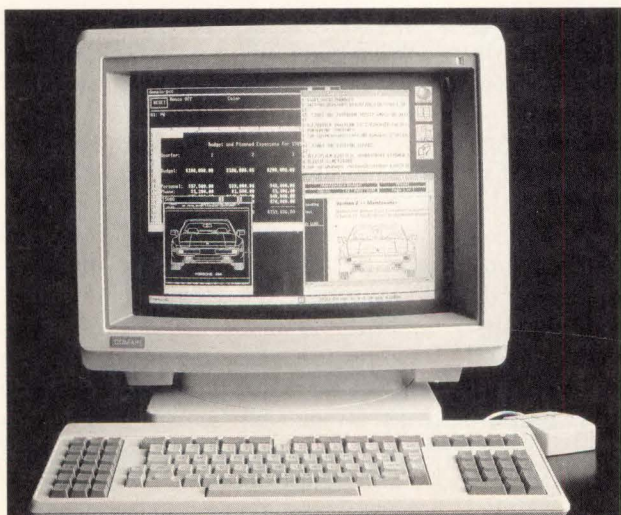

Figure 3—Windows offer virtual screens for the simultaneous execution of multiple programs; it is possible to have some running on the host computer, while others run on a workstation.

Additional information about the products or services described in this column can be obtained by contacting the companies directly or by circling the appropriate reader service number.

Apollo Computer Inc.
330 Billerica Rd.
Chelmsford, MA 01824
617-256-6600
Circle No. 101

206-882-8080
Circle No. 102

Microsoft Corp.
16011 N.E. 36th Way
Redmond, WA 98052

Professional Graphic Services
7427 S.W. 34th Ave.
Portland, OR 97219
503-244-4717
Circle No. 103

Reader Interest Level

High	Circle No. 258
Medium	Circle No. 260
Low	Circle No. 262

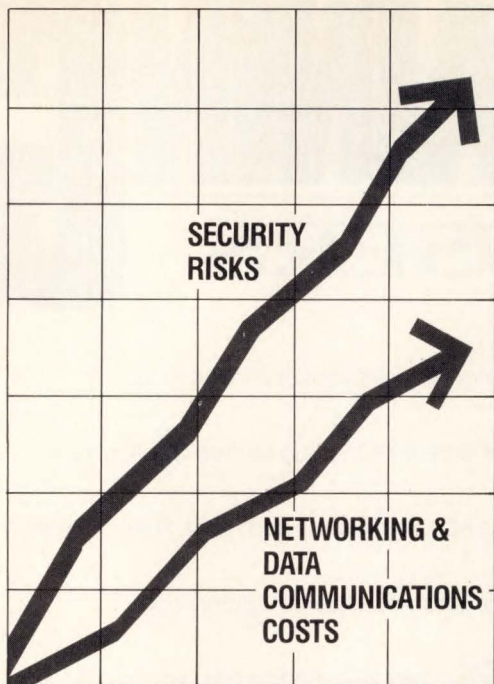

Unfortunately, about the only things rising faster than networking and data communications costs are the security risks they bring.

As your company spends millions expanding your computer network, the probability for computer abuse increases dramatically.

Think of it. More information. More readily available. From an increasing number of locations. Any one of those factors means increased security risks. Together, they mean a responsibility to protect your valuable computer information that you, as a manager, cannot ignore.

Most companies are investing heavily in 1980's technology. Yet they are protecting their financial and corporate data with 1950's technology. Every year thousands of unauthorized entrances into computer systems cost companies millions of dollars and loss of information. And these abuses come from both within and outside the company.

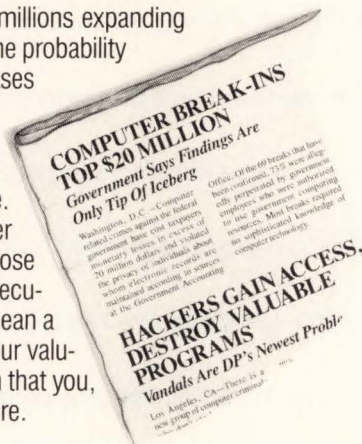

But now there is a new security system that is being adopted by major corporations around the world. It's called ACE—Access Control Encryption, and it's available only from Security Dynamics. ACE eliminates the problems of old fashioned password and dial-up security systems.

Our unique, patented technology includes a SecurID™ card, which generates a new passcode for every user every 60 seconds. ACE is inexpensive to buy, easy to use, and it's available for most major computer systems and networks on the market. That's why leading manufacturers, financial institutions, telecommunications firms and government contractors are today protecting their computer systems with ACE.



If you're responsible for managing access to your computer systems and networks, you owe it to your company to make your network secure. For information on the leading access control system, give Chris Nelson a call today. **(617) 547-7820**



SECURITY DYNAMICS INC.

2067 MASSACHUSETTS AVENUE, CAMBRIDGE, MA 02140

SPRING TRAINING

FOR DEC USERS

Managing Your DEC Systems. It's No Game. You demand peak productivity from your

DEC equipment. You need special training to get it. That training starts with DEXPO Spring 88. See applications and enhancements for your MicroVAX* or VAX* system. For DEC PCs, PDP-11s* — and more. Find integration products that link all your systems. Connect to PCs, Macs, mainframes, supercomputers and workstations. Compare 10,000 DEC-computing innovations. Over 200 vendors help you find the best solutions for your DEC system needs. And it takes only  one solution to improve productivity.

Cover All the Bases ... Attend DECUS* and DEXPO. DECUS Spring Symposia attendees are admitted to

DEXPO Spring FREE. Attend both. It's the best way to evaluate new technologies. Learn new techniques.

Take advantage of show savings. And sharpen your competitive edge. For serious DEC users, it's more

than spring training. It's a grand slam! **Free Show Preview & V.I.P. Tickets.**



Call **800-628-8185**. We'll send you a FREE Preview of over 100 DEC computing products. We'll also send money-saving V.I.P. tickets. (DECUS is not affiliated with DEXPO and requires separate registration.)

*FREE Show Admission for
DECUS Attendees!*

REGISTER TOLL-FREE AT 800-628-8185

Organized by Expoconsul International, Inc., 3 Independence Way, Princeton, NJ 08540

*Registered trademark of Digital Equipment Corporation. DECUS is not sponsored by or affiliated with DEXPO. Macintosh is a trademark of Apple Computer Inc.

DEXPO[®]

Spring 88

THE 15TH NATIONAL DEC*-COMPATIBLE EXPOSITION
Cincinnati Gardens
Cincinnati, Ohio
May 17-19, 1988

Put Away Your Bifocals and Search and Scroll No More

Moniterm Corp. recently announced both 19- and 24-in. monochrome high-resolution monitors for Sun Microsystem workstations. Your work can be made considerably easier by use of these monitors—especially for advanced desktop publishing, CAD/CAM engineering, or spreadsheet applications.

When you're using Lotus 1-2-3, for example, the entire spreadsheet can be viewed without panning or scrolling—saving both time and frustration. For desktop publishing, the 24-in. monitor permits you to view two full-tabloid pages simultaneously, which can be a great help when initially planning page layout or viewing the impact of editorial modifications since you can see the "big picture."

The Monitor Market

One "big" drawback, however, of the 24-in. monitor is its large footprint; it's too big, some feel, for convenient desktop use. But size doesn't appear to be impacting the market growth.

Indeed, almost 80% of the 100,000 workstations shipped during 1987 included a 19-in. monitor, which makes the 19-in. monitor the de facto standard for graphics workstations, according to Mike Tyler of market research firm Dataquest Inc. (Cupertino, CA). Says Tyler, "Of the 1987 shipments, approximately 60% were color monitors and 40% monochrome."

For the traditional graphics workstation, the 19-in. color monitor is now the standard; however, for PC-level (Macintosh) worksta-

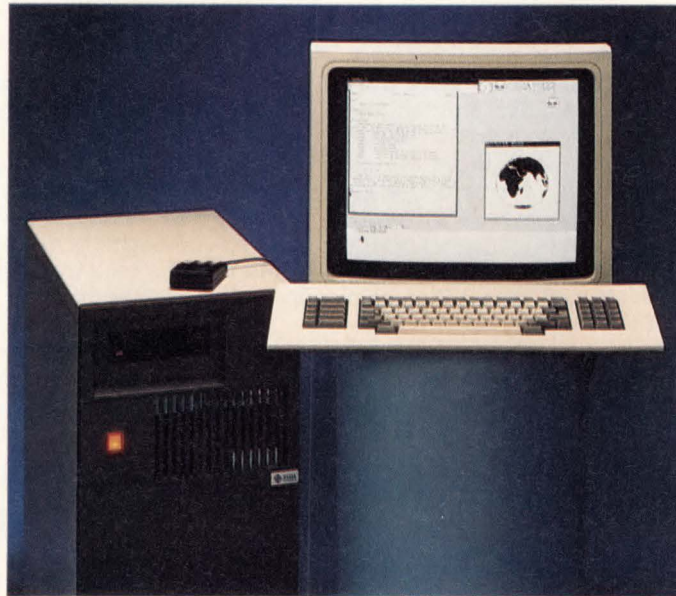

The 19-in. VY1962 monochrome monitor is plug-and-play compatible with Sun Microsystem workstations. A color version of this monitor is now under development by Moniterm.

tions, a 19-in. monochrome monitor is considered an upgrade from a 12- or 13-in. monitor. But the trend is definitely toward the 19-in. size. According to Tyler, 1987 sales of 19-in. monitors for the Mac and the PC have reached 75,000-80,000; they were fewer than 20,000 in 1986.

Moniterm has been a major supplier of monitors to Sun for incorporation into its workstations. But, for the first time, these monitors can be purchased directly from the manufacturer (Moniterm). The VY1962 (19-in.) and VL2462 (24-in.) both provide 1152- x 900-pixel displays and plug-to-plug compatibility with the Sun-3/50, 3/60, and 3/100 workstations.

Importance of Phosphor

Both the 19- and the 24-in.

nating. The particle size of the phosphor deposited onto the screen provides extremely fine pixels for high-resolution images (not grainy). P104 is defined at the coordinates .280 x .312 on the chromaticity chart, allowing a fast, crisp, high-resolution white pixel.

Resolution/Bandwidth

Generally speaking, monitors that run at 15.75 KHz are considered low-resolution (standard) monitors. Those in the 25-50-KHz range are considered medium-resolution; frequencies above 50 KHz—the entire Moniterm product line—are considered to be high-resolution.

High bandwidth means high speed. The speed of the video amplifier of the Moniterm 19- and 24-in. Sun-compatible monitors exceeds 150 MHz, or 100 pixels per second. This enables the 1152- x 900-pixel display to be "refreshed" at 66 Hz to minimize screen "flicker."

On large-screen monitors, where the viewing angle is wider, the refresh rate is a critical specification as your peripheral vision is most sensitive to the flicker that is generated at lower refresh rates.

HARD FACTS:

Model VY1962 19-in. and Model VL2462 24-in. monochrome monitors for Sun workstations

Price: \$1,525 (19-in.) and \$2,495 (24-in.)

• Plug-to-plug compatibility with Sun-3/50,

3/60, and 3/100 workstations

- Non-interlaced, paper-white P104 phosphor display
- High resolution/high bandwidth

Moniterm Corp.
5740 Green Circle Dr.
Minnetonka, MN 55343
612-935-4151
Circle No. 239

No Choice of Beta or VHS When Using Helical-Scan Recording

You can store up to 2.5 Gbytes of data from your VAX, MicroVAX, or IBM PC system on one economical VHS T-120 videocassette. Yes, 2.5 Gbytes—or 25,000 Mbytes! That's a lot of data; equal to more than 50 ANSI/IBM tapes recorded at 1600 bits per inch.

The Gigastore tape drive from Digi-Data Corp. is a new *StorAGE* device that utilizes helical-scan recording techniques and is intended for high-volume applications such as digital image processing, archival *StorAGE*, and total system/disk backup. Regardless of the application, your media costs per megabyte will be less than \$0.004 using the Gigastore.

Market Forecast?

Although pundits of helical-scan tape are predicting rapid growth for the emerging tape format, some remain wary. Robert Abrahams, vice

president of consulting firm Freeman Assoc. (Santa Barbara, CA), for one, thinks it's a niche market. "There does not seem to be a need currently for multi-gigabyte tape *StorAGE*," says Abrahams.

Abrahams' conservative beliefs may not be the opinion of the majority, however. Already, system manufacturers are eyeing the dense *StorAGE* tapes as ideal replacements for quarter- and half-inch tape subsystems.

Easy As a Picture

Just as when you take a home movie with your videotape camera, the Gigastore tape drive employs a cylinder that rotates at 1800 rpm. This cylinder serves as the mount for diametrically opposed video heads that read and write the tape on a horizontal plane with the tape skewed at an angle across the surface to provide the proper striping

bands.

An internal microprocessor controls the industry-standard Pertec interface and a 256-Kbyte rotating data buffer, allowing a peak transfer rate of 464 Kbytes per second—which allows emulation of a nine-track, .5-in. streaming tape drive.

The integral microprocessor controls all tape positioning and ensures highly reliable formatted *StorAGE* by combining true read-after-

write with a powerful error correction technique. An average transfer rate of 120 Kbytes per second and a high-speed search mode enable easy access to any point on the tape, with an average search time of three minutes and a worst-case search time of six minutes (assuming 32-Kbyte blocks). Any fixed block size—from 1 byte to 65,536 bytes is supported without penalty in total formatted data *StorAGE*. ■

HARD FACTS:

Gigastore Tape Drive

Price: \$4,780 (drive only);
\$6,675 (Unibus subsystem);
\$6,275 (Q-bus subsystem)

- 2.5 Gbytes of data on one T-120 VHS videocassette,
- Emulates nine-track, .5-in. streaming tape drive

- Industry-standard Pertec interface
 - True read-after-write and error correction
- Digi-Data Corp.
8580 Dorsey Run Rd.
Jessup, MD 20794
301-498-0200
Circle No. 209

The Digi-Data Corp. Gigastore tape drive is available in a 19-in. tabletop or rack-mountable chassis and emulates a nine-track, .5-in. streaming tape drive.

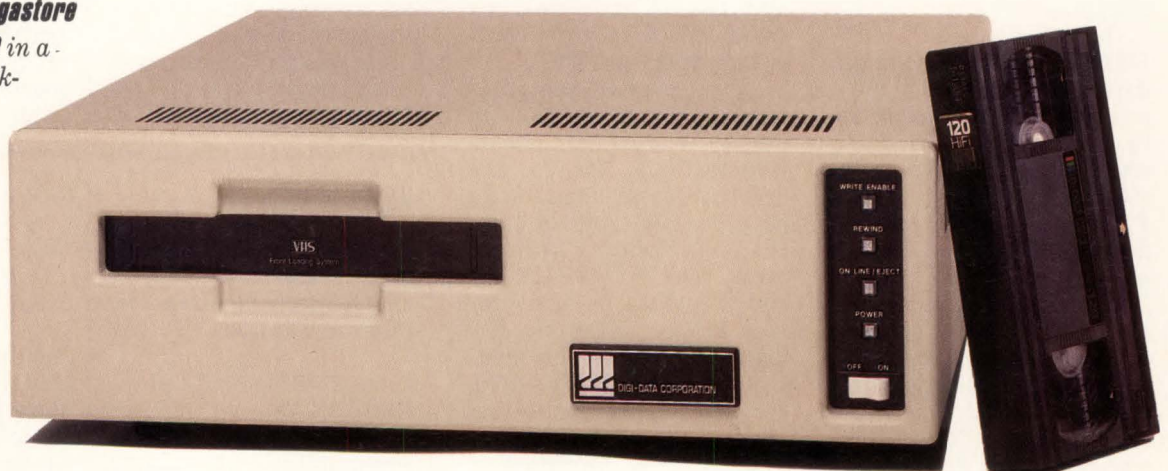

Introducing a new solution for managing business contacts . . .

or, HOW TO KEEP THREE DEPARTMENT HEADS OUT OF YOUR HAIR

Your **Sales Manager's** looking for a computer solution to track sales leads and accelerate the sell cycle. Your **Director of Field Service** wants to get his contacts organized. And your **VP of Marketing** is clamoring for a way to increase volume — FAST.

CIS is a complete, state-of-the-art system for managing sales, marketing and service contacts.

The CIS system is:

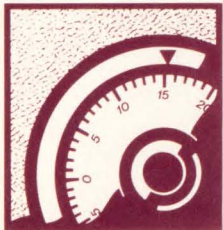

SECURE Categorize contacts into any number of separate lists by territory, salesperson, product interest or source (eg: print ad response, trade show).

CIS shows users only the lists they can access. And you can restrict any user to any combination of READ, MODIFY, CREATE, DELETE or NO access to any list.

FLEXIBLE You can make an unlimited amount of notes on each contact so there's no need to memorize special codes or numbers. A keystroke inserts date/time stamp to simplify reports to management.



"We use OWEN+DAVIS software to store thousands of listings for our Digital Annual Directory of vendors."

— Susan Francis, *Hardcopy Magazine*

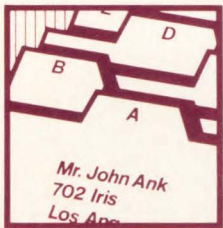

FAST, EASY Gain instant access to contacts by company, contact name, zip code and keywords you make up for searching. A keyword can be the product they want, literature you've sent, date to call back—

anything. And you can have over 100 keywords per contact!

"I couldn't live without it. CIS makes all my customer notes easy to find whenever I need them."

— Scot Lamb, *Info West*



EFFICIENT Automatically personalize letters to any contact in the system. Select contacts for mailing by company, contact, follow-up date, zip code, product interest or any of the keywords you've created.

"I sent out 650 letters in one day, without my secretary!"

— Paul Thurman, *Computer Upgrade Corp.*

INFORMATIVE

Reports for management can be generated automatically, showing a moment by moment account of the day, week, month or any time period. CIS can report companies chronologically, alphabetically, by zip code, product interest, call back date, and more.



The CIS system is available from OWEN+DAVIS SYSTEMS, exclusively for Digital's VAX/VMS environment.

Call today and discover how this system can pay for itself in a matter of weeks.

714-540-8878

OWEN+DAVIS SYSTEMS

3100 Airway Ave., Suite 116, Costa Mesa, CA 92626

CIS and COMPUTER INTEGRATED SALES is a trademark of OWEN+DAVIS SYSTEMS, VAX/VMS are trademarks of Digital Equipment Corp.

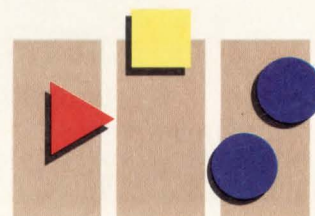

COMPUTER INTEGRATED SALES

ORGANIZING THE BUSINESS OF SALES

CIRCLE 372 ON READER CARD

GRAPHICS PLUS GP-220

**NOW WITH
DISPLAY LIST ZOOM**



The most versatile text and graphics terminal available today.

- ▶ Accurate Tektronix 4014, 4010 emulation.
- ▶ Full DEC VT220, VT100, VT52 emulation.
- ▶ Fully programmable VT220 style keyboard.
- ▶ 1024 x 780 high resolution display.
- ▶ Four level gray scale.
- ▶ Extended graphics capability such as pan, zoom, area erase, area move, seed fill, 4 to 16 frame animation and conic section draw.
- ▶ Two 200K byte display memories.
- ▶ 75 pages of off-screen, scrolling memory.
- ▶ 80 or 132 columns.
- ▶ 24 or 50 or 66 lines.
- ▶ Four complete set-up configurations.
- ▶ Printer support with built-in print buffer.
- ▶ Transparent mode with History Buffer.
- ▶ Optional Mouse and digitizing tablet.



Northwest Digital Systems

P.O. Box 15288
Seattle, WA 98115
(206) 524-0014

PRODUCT NEWS

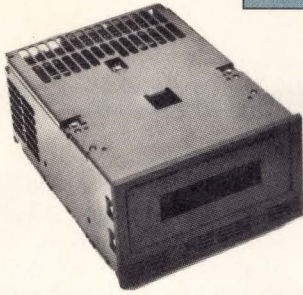

Because of its compact size, the SI59 can store large volumes of data in much less physical space than is now required for traditional tape libraries.

Two Gbytes of Data on a Single 8-Millimeter Cartridge

System Industries Inc.'s newly announced SI59 Cartridge Tape Subsystem for DEC Q-bus-based computers stores more than 2 Gbytes of formatted data on a single 8-millimeter cartridge. By combining removable, rewritable magnetic media with a compact, integral drive and controller, the *Storage* demands of today's sophisticated application systems can be met. The SI59 records data using helical-scan techniques. Because of its compact size and high areal recording density, it can store large amounts of data in much less space than required in previous tape systems.

The unprecedented per-tape capacity of the SI59 supports all functions associated with traditional tape applications in the 5.25-in. form factor. As well as meeting both the archiving and the backup/restore requirements of most DEC systems, by pre-loading a cartridge, time-of-day-initiated system backup can be performed without operator intervention. Each data cartridge stores the equivalent of 14 full-sized, 6250-bpi tapes or 51, 1600-bpi tapes.

*Systems Industries Inc.
560 Cottonwood Dr.
Milpitas, CA 95035
408-432-1212*

Circle No. 348

The 12- x 12-in. digitizer surface has a built-in AutoCAD template and resolution to 1000 lines per inch. Sensitivity to the stylus (or puck) is within 0.5 in. from the surface.

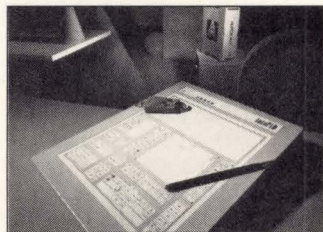

Resolution to 1000 Lines Per Inch

The AVCOM Corp. AutoPad Digitizing Tablet is compatible with all Autodesk Products—AutoCAD, AutoShade, AutoSketch, AEC, and Engineer Works—and is compatible with engineering workstations from Sun, Compaq, IBM (and compatibles), and Apple.

The AutoPad emulates all major input devices, including Microsoft Mouse, Kurta, CalComp, and Summagraphics, and is ready for use as shipped, with all cables in-

cluded, no switches to set, no separate power supply, and no complicated set-up procedures. Metal stylus and stylus holder as well as four-button puck are included. Ergonomic design allows for operator comfort; high-impact plastic construction provides durability and ease of maintenance.

*AVCOM Corp.
119 University Ave.
Palo Alto, CA 94301
415-326-8686*

Circle No. 281

Unprecedented A/D Range and Accuracy

For digitizing the rapid, time-varying signals encountered in professional audio encoding applications, the new AM40516 from Analogic Corp. is a superior choice. For those applications with multiplexed DC signals or an external sample-and-hold amplifier, the AM30516 is the model you need.

Providing low peak distortion and wide dynamic range, Analogic meets the most stringent requirements of

frequency-division-multiplexed telecommunications, high-resolution imaging, medical data acquisition, seismic instrumentation, and other demanding applications. Analogic guarantees no missing code when used within the standard environmental operating conditions.

Analogic Corp.

8 Centennial Dr.

Centennial Industrial Park

Peabody, MA 01961

617-246-0300 Circle No. 352

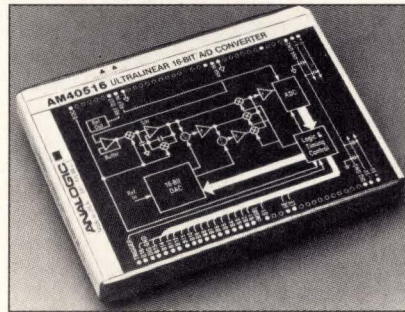

Unique architecture uses a three-pass recycling technique to minimize parts count and furnish unprecedented stability, linearity, and accuracy.

Ruggedized MicroVAX-II System Approved by DoD

The Department of Defense (DoD) has notified Ruggedized Digital Systems that its ruggedized MicroVAX II has received the military designation AN/UYK and is identified as standard military hardware. The AN/UYK-79 is based on a MicroVAX II CPU with 9 Mbytes of MOS memory (expandable to 16 Mbytes). The chassis measures 12.25 x 19 x 22 in., with mounting space for four 5.25-in. peripherals or four fully removable Winchester disk drives.

This system can be integrated with a variety of options such as interfaces for the U.S. Mil-Std-1397 NTDS bus or -1553B avionics bus; Ethernet controllers; Mil-Std-188C serial lines; as well as most MicroVAX II-compatible options.

The AN/UYK-79 is to be used in a wide range of tactical military C3I applications requiring high levels of com-

puting power such as image processing, signal intelligence, synthetic aperture radar, sonar, and artificial intelligence. It can withstand typical military tactical environments and meets the testing requirements of Mil-Std-810D as well as Mil-E-16400, the Navy's shipboard environmental specification.

*Rugged Digital Systems Inc.
665 Clyde Ave.*

Mountain View, CA 94043

415-966-1770 Circle No. 350

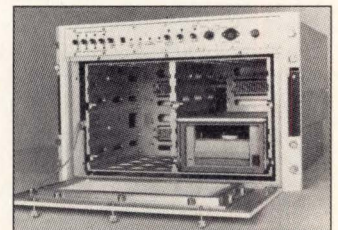

The AN/UYK-79 is a fully provisioned computer system with a completely implemented Integrated Logistics Support system.

PRODUCT NEWS



The PPC 640 features an 8086, 8-MHz, 16-bit CPU; 640K memory; full-sized keyboard; modem; and MS-DOS V.3.3 and telecommunications software.

What Constitutes "Portability?"

What is your definition of portable—compact?, easy to carry?, lightweight?, alternate power sources?

The recently announced Amstrad Inc. PPC 640 Personal Portable PC is a compact 4 x 17.75 x 9 in. and weighs only 12 pounds. The carrying case includes a pocket for the manual and storage space for 3.5-in. diskettes. And, for the first time, a portable PC is available that you can run on standard AC, a car's cigarette lighter, or regular "C" flashlight batteries—or it can be plugged into the nine-pin D connector of any PC-compatible monitor.

The PPC 640 is fully load-

ed with a regular, full-sized AT-style keyboard, 80 x 25 LCD display, single or dual 3.5-in. disk drives, 640K RAM memory, MS-DOS V. 3.5, an integral Hayes-compatible modem, power supply, expansion ports, and optional add-on features. The design and features of the PPC 640 are intended for anyone who needs full computing power with them as they travel—sales reps, consultants, exporters, dealers, bankers, CEOs.

*Amstrad Inc.
1915 Westridge Dr.
Irving, TX 75038
214-518-0668*

Circle No. 370

Attention: Marketing Managers— This May Be for You!

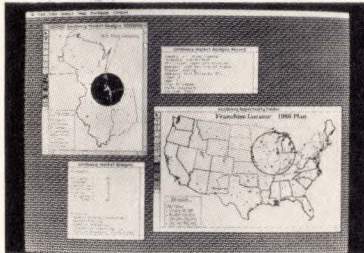

Did you ever need geographic analysis of database records? With Odesta Corp.'s new software product, GeoQuery, you can automatically create maps that classify and pinpoint the location of real-world data. Data to be analyzed, such as customer, membership, or personnel records; retail, service, or distribution center information; or any type of marketing information, can come from microcomputer, minicomputer, or mainframe databases.

GeoQuery is to be used with database, statistical,

GeoQuery includes U.S. maps with state boundaries, major cities, and all zip code locations. Regional and state maps, with county and major metropolitan area boundaries, are also available.

and spreadsheet software such as Odesta's Double Helix II or Data Desk, and Microsoft's Excel. Using Apple's Multifinder O/S, GeoQuery can run on the same Macintosh as Odesta's Helix VMX network and use information from VAX computers. An integral interface to Apple's HyperCard provides you with a business-oriented, geographic context for HyperCard information.

*Odesta Corp.
4084 Commercial Ave.
Northbrook, IL 60062
312-498-5615* **Circle No. 368**

VAX/VMS Users Can Run Standard PC Applications Software

Virtual Microsystems Inc.'s V-Server, a DECnet-based, DOS application server, enables VAX users to run standard, off-the-shelf PC applications directly from their terminals or VAXstations. A standalone hardware and software system containing an array of independent, 286-based, board-level PCs that support up to eight users, each processor (or cell) runs at 12 MHz with zero wait states and 1 Mbyte of RAM (upgradeable to 4 Mbytes).

Two features of the V-Server much in demand by today's users are:

- Dedicated processing power for each user: 1) no performance degradation when other users log on, and 2) should one cell malfunction, the remaining cells continue to operate without the entire system going down.

- DECnet-compatible applications and services, allowing DECnet users to access resources on remote VAXes as well as V-Server capabilities.

*Virtual Microsystems Inc.
1825 S. Grant St., Ste. 700
San Mateo, CA 94402
415-573-9596*

Circle No. 364

V-Server users transparently access

VAX disk drives to centrally store PC-formatted files, using native DOS commands and applications.

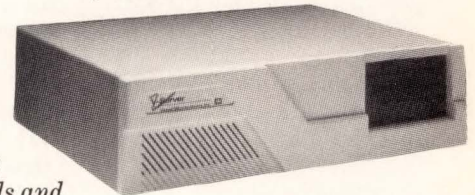

Unhappy Over Graphics Productivity on the PC/AT?

Architectural, mechanical, textile, and engineering designers now want the economical 20-MHz, 32-bit processor of the 386-based IBM PC/AT for their work. However, lack of a graphics controller card fast enough to keep up with the 20-MHz PC/AT has limited the capabilities of this system.

A new graphics controller card, the 7000CB from Kontron Datasystems, with one or two QDPM chips, offers a solution to this problem. The lightning-fast processor runs at 16 or 20 MHz and has four bit-planes internal to the chip. As each bit plane has its own 16-bit bus internal to the

QDPM, all planes are drawn in parallel; therefore, you don't lose speed when additional bit planes are addressed. The 7000CB can draw more than 100,000 vectors per second (10 pixels in length).

Displayable resolution is 1280 x 1024 or 1024 x 780 pixels. Both resolutions can display either 16 or 256 colors out of a standard 4096-color palette. Optionally, a 16.7-million-color palette is available.

*Kontron Datasystems
630 Clyde Ave.
Mountain View, CA 94039
800-227-8834*

Circle No. 366

With the 7000CB, you can achieve life-like colors on screen as

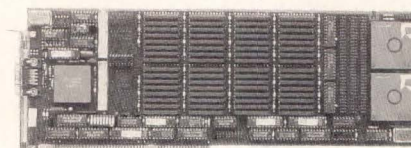

fast as you can conceive of them—or color and pattern variations used in textile and fashion design.

DEC-Compatible Systems

Second-Generation Minisupercomputers

FX/40, FX/80; deliver up to 15 times the performance of a VAX 8700 in computationally intense applications such as finite element analysis, computational fluid dynamics, computational chemistry, electronics simulation, scientific visualization, and image processing; FX/80 features up to eight high-performance vector processors providing a peak rating of 188.8 MFLOPS; in standard 1000 x 1000 Linpack benchmark, it performs at 65 MFLOPS.

FX/40 incorporates as many as four vector processors to reach a peak rating of 94.4 MFLOPS; in standard 1000 x 1000 Linpack benchmark, it performs at 30 MFLOPS; both systems include an Ethernet controller, VME I/O chassis, console video terminal, dot-matrix printer, operating-system software, FX/FORTRAN, and the Alliant Scientific Libraries; FX/80 \$299,000; FX/40 \$149,000; available now.

Alliant Computer Systems Corp., One Monarch Dr., Littleton, MA 01460, 617-486-4950. **Circle No. 270**

Computing Platform

Pegasus Superframe; a computing platform featuring a 320-Mbyte-per-second system bus, 250 VAX MIPS, 100 MFLOPS (100 x 100 Linpack), and 10-Mbyte cache; supports up to 10 CPUs, four I/O processors, 2 Gbytes of high-speed memory, and up to four operating systems running concurrently; offers fast IEEE-standard single, double, and extended precision floating-point computation and fully pipelined processor to ensure very high sustained execution rates; system with one 6460 CPU, 32 Mbytes of memory, 823 Mbytes of disk *StorAGE*, magnetic tape system, and operating system software \$695,000; fully configured 10-

CPU system with 250-MIPS performance \$4 million; standalone Pegasus CPU \$450,000; available fourth quarter 1988.

Elxsi Corp., 2334 Lundy Pl., San Jose, CA 95131, 408-942-0900 or 800-445-8148. **Circle No. 272**

32-Bit Supermicrocomputer

Cubix³/386; high-speed, 32-bit 80386 supermicrocomputer with superior price/performance; has 32 user ports and more users can be added through CubixNet networking; to offload CPU overhead, I/O peripheral devices are managed by an 8085 processor, an 82258 four-channel ADMA controller, and 4 Kbytes of dual-ported memory; contains 16 slots for RAM memory configuration; memory features high-speed 80 nsec RAMs with byte parity mounted on individual 1-Mbyte modules; RAM can be extended to 16 Mbytes in 4-Mbyte increments; all memory is on-board, providing data transfer up to 32 Mbytes per second; supports full demand-paged virtual memory with 2 Gbytes of user virtual address space in 4-Kbyte pages.

Cubix³/386 includes a high-speed Winchester drive, a large-capacity SCSI tape drive, and a dual-speed floppy drive; up to three 10-Mbyte-per-second or 15-Mbyte-per-second Winchester drives are supported; features a built-in power-fail protection device; comes with a 60-Mbyte tape, a 170-Mbyte Winchester drive, 4 Mbytes RAM, a floppy disk drive, Cubix-Power, and a UNIX runtime license.

Cubix Corp., 2800 Lockheed Way, Carson City, NV 89706, 702-883-7611.

Circle No. 274

Trace Supercomputers

Trace 7/100, Trace 14/200; incorporate Trace Scheduling compacting compiler technology; 7/100 includes 16 Mbytes of memory, 420 Mbytes of disk capacity, a cartridge tape drive, video console, and the Trace/UNIX operating system.

VMEbus users:

NEW

NISSHO N8201 16 Mbyte DRAM

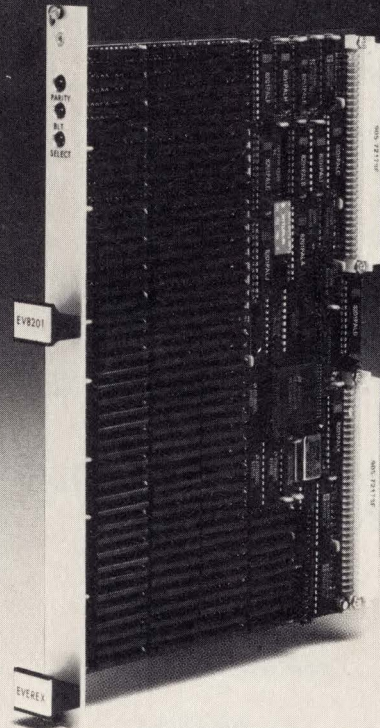

- Capacity 2, 4, 8, 16 Mbyte
- Single VME module
- VMEbus (Rev C) compatible
- Memory addressable 8, 16, 32 bits
- Error detection — byte parity
- Front panel error indicating LEDs

FOR MORE INFORMATION CALL
(800) 233-1837 In Calif. (714) 261-8811

NISSHO

ELECTRONICS

17310 Red Hill Avenue, Suite 200, Irvine, California 92714

FAX (714) 261-8819. TLX 181-308

CIRCLE 398 ON READER CARD



WHEN VAX PERFORMANCE COUNTS

There's...

I-MON

THE IMAGE MONITOR FOR VAX/VMS SYSTEMS

"It isn't hard to find a good analysis tool, but it is hard to find a good one that's also easy to use. Both qualities are demonstrated, however, by ... I-MON"

-- Digital Review, Jan. 11, 1988

Also from the developers of I-MON...

E-MON

THE ETHERNET MONITOR

D-MON

THE DISK MONITOR

S-MON

THE VAX SYSTEM MONITOR

Don't Settle for a Fraction of Your Resources!

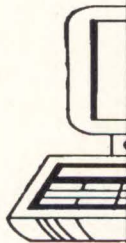

Call or write for more info today

medcom INFORMATION SYSTEMS, INC.
6312 E. Santa Ana Canyon Rd., Suite 361
Anaheim Hills, CA 92807
(714)974-1564

CIRCLE 414 ON READER CARD

100 HARDCOPY/April 1988

PRODUCT NEWS

Trace 14/200 includes 32 Mbytes of memory, 1.1 Gbytes of disk capacity, a cartridge tape drive, video console, and the Trace/UNIX operating system; Trace 7/100 \$197,500; Trace 14/200 \$399,500; available now.

Multiflow Computer Inc.,
175 N. Main St., Branford, CT
06405, 203-488-6090.

Circle No. 276

Performance Enhancements

20-MFLOP Array Processor

MicroMSP-4; a 20-MFLOP array processor that interfaces to LSI-11 and MicroVAX computers; features a single-quad board that plugs directly into the Q22 bus; comprises four basic sections: the Vector Processor, the Control Processor, the Host Interface, and the shared Multiport Memory; allows arithmetic, control, and host I/O functions to operate in parallel.

MicroMSP-4 features data memory expandable to 4 Mbytes and a built-in 68020 microprocessor; is user-programmable in FORTRAN-77, C, or Microcode; POR.

Computer Design & Applications Inc., 411 Waverly Oaks Rd., Waltham, MA 02154, 617-647-1900.

Circle No. 278

Enhanced RAM System

Wide Word 2000; memory system captures up to 640 Mbytes in 3.2 seconds; rack-mountable 15.75- x 19- x 24-in. units can be combined for a total capacity of up to 80 Gbytes; single system provides a memory transfer rate of 200 Mbytes per second and permits easy interface with as many as eight I/O peripheral devices; 1-Mbit RAM technology quadruples previous Wide Word memory capacity with fewer components, while consuming less power; innovative multi-ported bus system provides easy interfaces for many popular I/O devices including VAX/MicroVAX and Gould computers, Star and Numerix array processors, VME periph-

erals, and various high-speed A/D devices.

Wide Word 2000's error checking and correction circuitry automatically corrects soft errors; dedicated bus and tester card executes memory diagnostics and interface confidence tests fast and accurately; available now.

Dataram Corp., P.O. Box 7528, Princeton, NJ 08543-7528, 609-799-0071 or 800-822-0071. Circle No. 280

Storage Devices

Hard Disk Subsystems for MicroVAX II and MicroPDP-11

MVS-70, MVS-160, MVE-155, MVE-320; MVS-70 (71 Mbytes) and MVS-160 (159 Mbytes) are two hard-disk subsystems that are functionally equivalent to the RD53 and RD54 drives; MVS-160 features an average access time of 22 msec, a data transfer rate of 625 Kbytes per second, and an MTBF of 40,000 power-on-hours.

MVE-155 (155 Mbytes) and MVE-320 (319 Mbytes) are two high-performance, high-capacity ESDI hard disk subsystems for the MicroVAX II; MVE-155 has an average access time of 16.5 msec and a MTBF of 30,000 power-on-hours; MVE-320 features an average access time of 20 msec and an MTBF of 20,000 power-on-hours; MVS-70 \$1,900; MVS-160 \$3,450; MVE-155 \$3,665; MVE-320 \$6,800.

CMS Enhancements Inc., 1372 Valencia Ave., Tustin, CA 92680, 714-259-9555.

Circle No. 251

Low-Cost, DEC-Compatible Hard Disk Subsystem

EQR series; a family of low-cost, DEC-compatible mass storage systems that feature a high-performance hard disk subsystem with either a tape backup or a floppy drive in a single box; interfaces with DEC's LSI-11, MicroPDP-11, and MicroVAX II; basic model comes with one hard disk drive with 180 or 380 Mbytes of memory; an additional hard disk, tape

**HOW TO
SERIES**

FILL THIS CABINET WITH A MICROVAX II

AND 2.88 GIGABYTES

WITH ROOM TO SPARE



	DISK DRIVES W/CONTROLLERS	RAM	PORTS
POWER II			
STANDARD SYSTEM	173 MEGABYTES	5 MEGABYTES	8
EXPANDED SYSTEM	692 MEGABYTES	17 MEGABYTES	64
POWER IV			
STANDARD SYSTEM	380 MEGABYTES	9 MEGABYTES	16
EXPANDED SYSTEM	1.52 GIGABYTES	17 MEGABYTES	64
POWER VI			
STANDARD SYSTEM	720 MEGABYTES	17 MEGABYTES	32
EXPANDED SYSTEM	2.88 GIGABYTES	17 MEGABYTES	64

DATALEASE HAS THE SPACE

Imagine your MicroVAX II System in a file cabinet size configuration with more capacity and capability than offered by DEC and at a much, much lower price.

Each DATALEASE power system comes complete with a MicroVAX II central processing unit, BA23 enclosure, 95 megabyte Tape Cartridge and a 24"H × 17"W × 27"D cabinet.

MicroVAX, PDP and DEC are trademarks of Digital Equipment Corp.



THE CASH CONSERVATION COMPANY

714 • 632 • 6986
FAX 714 • 632 • 9248

DATALEASE SYSTEMS & FINANCIAL • 1061 SOUTH MELROSE AVE • PLACENTIA, CA 92670

**DISK DRIVES • TAPE DRIVES • SUBSYSTEMS • CONTROLLERS • MODEMS
VIDEO TERMINALS • ADD-IN MEMORY • PRINTERS • LASER PRINTERS**

CIRCLE 419 ON READER CARD

Before anyone promises you the moon, take a good look at Saturn.

You'll see PDP and VAX software, plus excellent service to back it up.

**SATURN-CALC, SATURN-GRAPH
SATURN-BASE, SATURN-WP**



We're so sure you'll want to see our software for yourself, we offer a program called Try-N-Buy.

Try thirty days of Saturn software and technical support. Try thirty days of working with us to solve your problem.

Buy, confident you have the best software for your DEC computer.

Let us show you how Saturn software and Saturn people can make the difference. Call 612-944-2452.

SATURN

6875 Washington Avenue South • Minneapolis, MN 55435
Phone: 612-944-2452 Telex: 290322 FAX: 612-944-2503

CIRCLE 405 ON READER CARD

Far-Reaching Solutions With Down-to-Earth Support

PRODUCT NEWS

backup, or floppy disk drive may be added.

EQR can be rack-mounted in a MicroVAX cabinet system or placed on a table; no separate software drivers are required; MSCP/DU compatible; optional .25-in. cartridge tape drive adheres to QIC-02 standard and TMSCP; optional floppy disk drive emulates the RX formats; features simultaneous transfers, command queueing, seek ordering, and non-interleaved disk format; \$4,800+; available 48 hours ARO.

*CMS Enhancements Inc.,
1372 Valencia Ave., Tustin,
CA 92680, 714-259-9555.*

Circle No. 253

High-Capacity 5.25-in. Disk Drives

SI57; disk drives that feature 765 Mbytes of unformatted capacity and a seek time of 18 msec; individual formatted capacity of up to 601 Mbytes when integrated with SI's advanced QDA4E Caching Controller in MicroVAX environments; also available in DSA-compatible C-Series configurations that connect directly to DEC controllers and can be ordered as a fixed unit in a multi-drive storage array or as a module in SI's Quick Disconnect System for high-security environments; POR

*System Industries Inc.,
560 Cottonwood Dr., Milpitas,
CA 95035, 408-432-1212.*

Circle No. 354

Compact Storage Subsystem for DEC Computers

CPF; a high-performance mass storage subsystem featuring a high-capacity ESDI hard disk drive in an enclosure that accommodates up to four additional peripherals; compatible with the DEC LSI-11, MicroPDP, and MicroVAX II; comes with a 180- or 380-Mbyte hard disk drive; user can add tape backup subsystems, floppy disk drives, or additional hard disk drives in the enclosure for up to 1.2 Gbytes of mass storage; includes 252W power supply and can accommodate a maximum of five storage periph-

**HOW TO
SERIES**

CHAMPAGNE AND CAVIAR ON A FAST FOOD BUDGET

A RENTAL
OR LEASE
PROGRAM
DESIGNED FOR
DEC USERS



DATALEASE HAS THE MENU

APPETIZERS

- Freedom to Upgrade
- Try Before You Buy
- 100% Financing
- Preserve Credit Lines
- Protect Against Obsolescence
- Lease Back Arrangements
- 90 day to 60 month Terms
- Credit Toward Purchase
- Extended Warranties

714 • 632 • 6986
FAX 714 • 632 • 9248

ENTREES

- DEC RA81CA and EA
- Disk Drives & Subsystems
- Tape Drives & Subsystems
- Esprit & Lanpar Terminals
- Xerox, Printronix & Data Products Printers
- Clearpoint & National Semiconductor Memory
- Emulex, Dilog & Spectralogic Controllers

VAX, PDP and DEC are trademarks of Digital Equipment Corp.



THE CASH CONSERVATION COMPANY

DATALEASE SYSTEMS & FINANCIAL • 1061 SOUTH MELROSE AVE • PLACENTIA, CA 92670

**DISK DRIVES • TAPE DRIVES • SUBSYSTEMS • CONTROLLERS • MODEMS
VIDEO TERMINALS • ADD-IN MEMORY • PRINTERS • LASER PRINTERS**

PowerStation™

A Complete VT220 / VT241 Work Station Upgrade for the IBM PC/XT/AT and PS/2

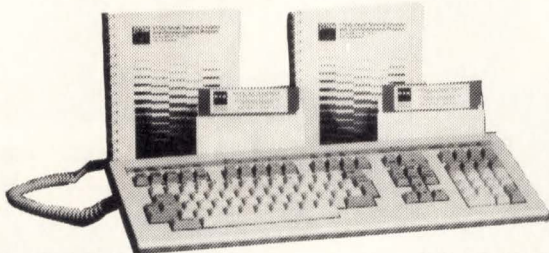

"Now true 800 pixel wide VT241 display and support for VMS Services for MS-DOS."

- | | | | |
|---|--------------|--|-------------|
| PowerStation™ 240
VT240 style keyboard and ZSTEM VT240 Emulation Software. Optional WPS labelled keys (GOLD KEY MODEL) add \$30. | \$435 | EGAmate™
Daughterboard option for 132 columns and true 800 pixel wide ReGIS display on standard EGA adapters. | \$39 |
| ZSTEM pc™ - VT240 Emulator Emulation Software only.
VT240/241 Emulation Software with all the features of ZSTEM VT220 plus ZSTEM 4014, sixel and ReGIS graphics. | \$295 | PS220/2
Keyboard adapter cable for PS200 on PS/2 systems. | \$19 |
| PowerStation™ 220
VT220 style keyboard and ZSTEM VT220 Emulation Software. Optional WPS labelled keys (GOLD KEY MODEL) add \$30. | \$289 | ZSTEMpc™-4014 Emulator
Use with ZSTEM VT100, VT220, or stand-alone. Interactive zoom and pan. Save/recall images from disk. Keypad, mouse, digitizer, printer, plotter, and TIFF support. 4100 color and line style color mapping. 640 x 400 and 640 x 480 on some adapter/monitors. | \$99 |
| ZSTEMpc™-VT220 Emulator Emulation Software only.
All the features of ZSTEM VT100 plus 8-bit mode, downloadable fonts, user defined keys, full national/multi-national modes. Extended macros-/script language. True 132 columns on Hercules, VGAs, Super EGAs, and standard EGAs using the EGAmate option. 128 columns on CGAs. 43 line support on EGAs. Enhanced keyboard support. Ungermann Bass Net/One and VMS Services for MS-DOS support. | \$150 | ZSTEMpc™-VT100 Emulator
High performance COLOR VT100. True double high/wide, smooth scrolling. ISO and attribute mapped color. XMODEM and KERMIT, softkey/MACROS, DOS access. | \$99 |

KEA Systems Ltd.

#412 - 2150 West Broadway, Vancouver, B.C. Canada V6K 4L9
Telephone (604) 732-7411 Telex 04-352848 VCR Fax (604) 732-0715
Order Toll Free (800) 663-8702
30 day money back guarantee AMEX/MC/VISA

CIRCLE 395 ON READER CARD

PRODUCT NEWS

erals, two of which are half-height floppy disk drives; basic model comes with a power supply and one drive.

CPF features an average access time of 16.5 msec; hard disk device is MSCP/DU compatible; .25-in. cartridge tape drive is compatible with TMSCP; floppy disk emulates RX33 or RX50 formats; features simultaneous transfers, command queueing, seek ordering, an on-board formatter, MTBF of 30,000 power-on-hours, and firmware-resident diagnostic software; \$5,600+.

CMS Enhancements Inc.,
1372 Valencia Ave., Tustin,
CA 92680, 714-259-9555.

Circle No. 255

Portable Hard Disk Unit for VAX

DM370H; 75-Mbyte microportable hard disk unit for the VAXmate, MicroVAX, and IBM PC/AT/XT-compatible marketplace; rugged and easily transported between

DEC® DISK CARTRIDGES
Overnight!

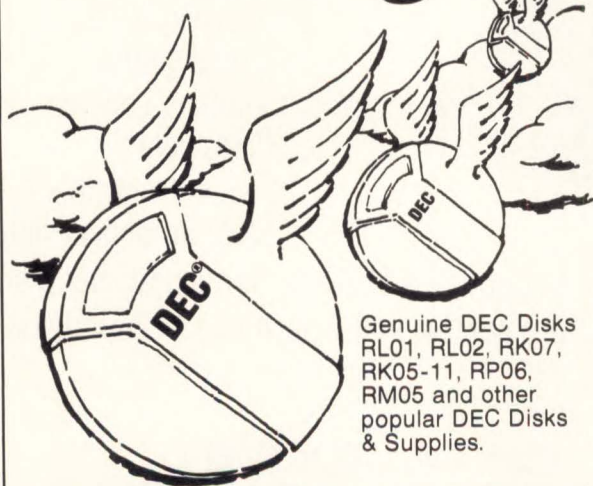

Genuine DEC Disks
RL01, RL02, RK07,
RK05-11, RP06,
RM05 and other
popular DEC Disks
& Supplies.

RADGO SALES CO.

3988 McMann Rd., Cincinnati, Ohio 45245

TOLL FREE Ordering 1-800-543-1986

except in Ohio phone 1-513-752-6880

Ask for free catalog

® DEC is a registered trademark of Digital Equipment Corporation.

CIRCLE 413 ON READER CARD

If your job depends
on your computer...
why haven't we
heard from you yet?

NEW!
1-800-356-5794
Ext. 3167

Best Power Technology's UPS systems deliver clean, computer grade power more reliably, more efficiently, and more quietly than any other. With less heat, too. Best technology represents a true breakthrough in UPS design, and never relies on the raw incoming AC line as a backup.

Find out more about the elegant simplicity of a Best UPS. Find out why we're more reliable, and why we cost less to own, less to operate. Find out why Best is #1 in the world.* Call for our NEW FREE CATALOG today!

Call 1-800-356-5794 ext. 3167 TODAY!

In Wisconsin call (608) 565-7200, ext. 3167

BEST®

Best Power Technology, Inc.
P.O. Box 280, Necedah, Wisconsin 54646

"Advanced Technology . . . for less."

*The world's largest manufacturer of single phase UPS, based on KVA shipped.

CIRCLE 421 ON READER CARD

systems; small enough to hold in the palm of your hand; requires no external subsystem to operate; special cabling system allows the unit to function with the existing system power and control; additional cables and controllers are available.

DM370H has an access time to data of 28 milliseconds, uses the SCSI interface, and requires no special packaging or handling when being transported since heads are automatically parked when the unit is disconnected; plugs into the back of your PC and a simple disconnect allows the user to remove the disk unit for portability or data StorAGE protection; special key lock deters unauthorized tampering; \$2,995.

DMI Inc., 1 Hughes, Irvine, CA 92718, 714-583-1800.
Circle No. 257

Portable Hard Disk Unit for Rainbow

DM120; a 20-Mbyte micro-portable hard disk unit for the DEC Rainbow that provides rugged construction for portability and data protection; can be used to upgrade the capabilities of a Rainbow Model A, B, or 100+, or to provide first-time hard disk capability; will operate with the standard DEC disk controller and no modifications are required.

No additional external subsystem is required for the DM120 since it operates from the host's internal hard disk controller and power supply; one hard disk unit can be shared among many Rainbows or many hard disk units can be used on one Rainbow by means of a simple connect/disconnect procedure; key lock ensures against unauthorized tampering; DM 120 \$995; \$100 per cable set.

DMI, 1 Hughes, Irvine, CA 92718, 714-583-1800.

Circle No. 259

Versatile Multiprocessor Data Storage Systems

Cluster Series; fully integrated data storage systems that incorporate very large disk storage capacity and

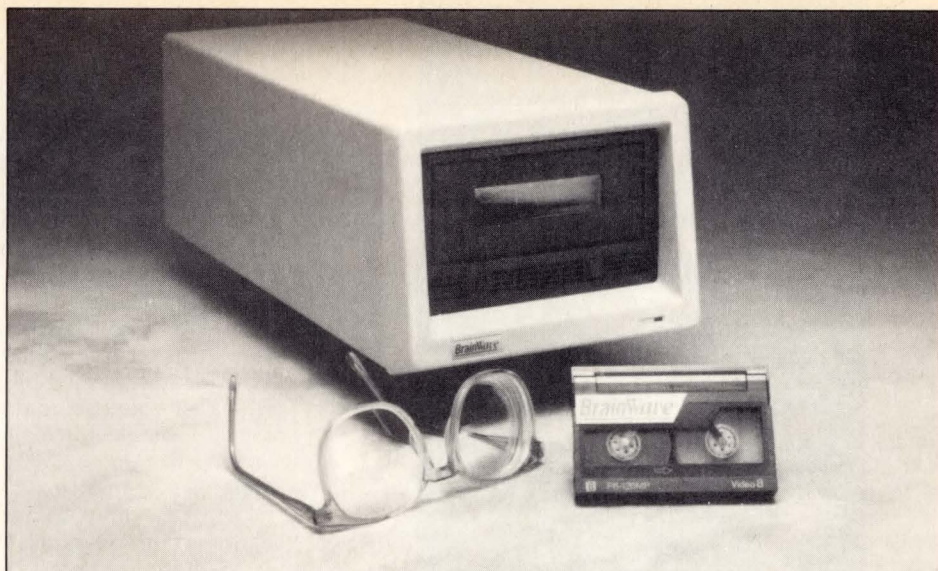

Protect your valuable data investment with powerful tape mass storage capabilities available immediately from BrainWave Systems.

Remarkable 8mm helical scan technology provides you with the compact and effective solution to your mass storage dilemma in both PC and DEC environments.

IBM PC compatible Data Historian™ Series 100 uses its own menu-driven software for

2 Gigabytes of Storage 2 Great Solutions

easy to use backup/restore functions.

DEC compatible Data Historian Series 200 is designed to function within your existing data management environment using standard backup/restore utilities.

Act now by calling BrainWave Systems to learn more.

Phone 303/466-6190.

BrainWave 3400 Industrial Lane, Suite 3
Broomfield, Colorado 80020

DEC is a Trade Mark of Digital Equipment Corp. IBM PC is a Trade Mark of IBM Corp.

CIRCLE 396 ON READER CARD

Network DEC to UNIX?

What You Didn't Know--Will Help You!

TCP/IP Networking Software...

Did you know that most UNIX computers already support industry-standard TCP/IP networking protocols? And that Process Software Corporation gives you TCP/IP networking solutions for more DEC operating systems than anybody?

For VMS, RSX, RT-11, IAS, And TSX-Plus...

Network to UNIX using just our TCP/IP software and your standard DEC Ethernet hardware on the UNIBUS, Q-bus, VAXBI, or the new MicroVAX 2000. And run concurrently with DECnet, LAT, or LAVC.

Designed To Benefit You...

Say goodbye to special hardware, messy installation, and unneeded layers of software. Our TCP/IP products are modular, efficient, and designed for the operating system they run on. You benefit from ease of use, simple installation and virtually no maintenance.

For Every Application...

And we support the full range of popular TCP/IP applications, including FTP (File Transfer), TELNET (Virtual Terminal), TCP, IP, and UDP programming interfaces, and others.

You won't find a better lower-cost way to connect DEC to UNIX anywhere!

Interested? Call Process Software Corporation today.

PROCESS SOFTWARE 413-549-6994

35 Montague Road • PO Box 746 • Amherst, Massachusetts 01004

DEC, IAS, RSX, RT-11, UNIBUS, VAX, and VMS are Digital Equipment Corporation trademarks. Unix is an AT&T trademark. Ethernet is a Xerox Corporation trademark. TSX-Plus is a S&H Computers trademark.

CIRCLE 397 ON READER CARD

VMEbus users:

NEW

**NISSHO N2306
ESDI Disk
Controller**

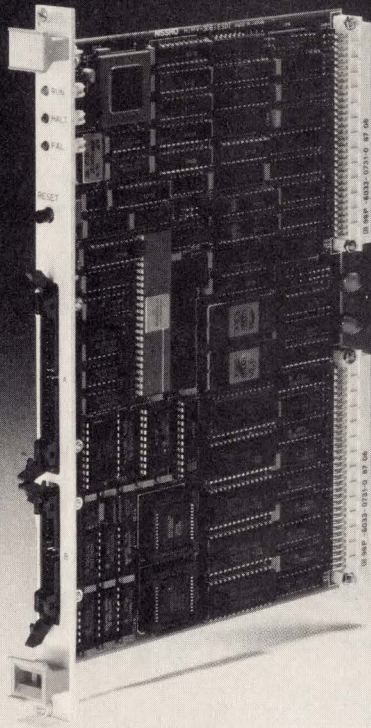

- ESDI Rev F drive interface
- High speed data transfer — 17 Mbits/sec
- Dual access Command Packet Memory
- 64 Kbyte data buffer — dual ported
- Command chaining without limitation
- LED display for RUN, HALT, FAIL
- Format soft/fixed sector
- ECC 32 bit

FOR MORE INFORMATION CALL
(800) 233-1837 In Calif. (714) 261-8811

NISSHO
ELECTRONICS

17310 Red Hill Avenue, Suite 200, Irvine, California 92714

FAX (714) 261-8819, TLX 181-308

CIRCLE 428 ON READER CARD

PRODUCT NEWS

multiprocessor connectivity; feature cache processing, performance monitoring, removable Winchester chassis, patch panel switching, drive status, long-line connections, overlapped seeks, simultaneous data transfers, and command queueing.

Clustor's on-board processors handle many of the I/O functions performed by host CPUs in conventional systems; accommodate extended cabling to remote CPUs and simplified connections; configurations may be redundant for fault tolerance; POR.

*System Industries Inc.,
560 Cottonwood Dr., Milpitas,
CA 95035, 408-432-1212.*

Circle No. 360

Tape Backup System

GigaTape; a high-capacity tape backup subsystem that features a sustained data rate of 246 Kbytes per second; error-correcting code ensures an error rate of less than one in 10^{13} bits read.

GigaTape features a 20,000-hour MTBF; proprietary controller firmware provides TMSCP protocol and VMS software compatibility; available in Q-bus or Unibus; \$5,495+.

*Summus Computer Systems,
P.O. Box 820549, Houston,
TX 77282-0549,
800-255-9638 or 713-589-9772.*

Circle No. 362

**Controllers and
Host Adapters**

SCSI Host Adapter

SQ716 Host Adapter; provides a SCSI interface for connecting up to seven disk drives to MicroVAX II, LSI-11, or other DEC Q-bus computers; capable of interfacing asynchronous SCSI drives with data transfer rates up to 1.5 Mbytes per second and synchronous SCSI drives with rates up to 3 Mbytes per second; supports the SCSI differential cable option; has non-volatile RAM memory.

SQ716 Host Adapter has a 64-Kbyte data buffer; features an automatic self-test function that disallows any communication between the

CPU and the disk drive if the self-test fails when the adapter is powered up; transparent to the DU software driver contained in the RT-11, RSX-11M+, RSTS, MicroVMS, and Ultrix operating systems; compatible with disk drives by Control Data and IBM; \$1,795.

*DIALOG, 1555 S. Sinclair
St., Anaheim, CA 92806,
714-937-5700. Circle No. 347*

**Data Input and
Display Devices**

Mouse Addition to VT200

ANSI-Locator; allows the addition of a mouse or trackball to DEC's VT220 series and other ANSI-compatible terminals; ANSI-Locator is connected between the host and the terminal and the mouse is connected to the ANSI-Locator; mouse should be compatible with Logitech C7; trackball should be compatible with Microsoft; in simplest operating mode, issues a series of "arrow-key" movements and the cursor moves accordingly; this mode requires no software modifications or special host/application support; second mode requires application modifications to recognize a logical cursor position; cursor may be moved as much as desired; host will not be interrupted until one of the "select" buttons is pressed; application can then update the logical cursor position with the actual cursor position.

ANSI-Locator can be confined to boundaries defined by the application; thus, different categories of users could be allowed access to different areas of the screen; includes keyboard emulation mode in which a keyboard can be displayed at the bottom of the screen and the user can choose the characters to be sent by using the mouse; is RS-232 compatible, housed in a small plastic case, and comes with power supply and cables; Logitech C7 mouse is optional; ANSI-Locator \$349; introductory price \$299; available now.

Applied Business Sys-

tems, 12141 Candy Lane, Saratoga, CA 95070, 408-446-9469. **Circle No. 349**

Data Output Devices

Digital Thermal Videoprinter

TX-2000; digital videoprinter operates at about one-tenth the cost of existing analog-type videoprinters and costs several thousand dollars less to purchase; produces superior hardcopies in only 10 seconds per full-screen image; incorporates Axiom's exclusive complete digital image *StorAGE* and recovery technique; provides accurate screen *Hardcopy* from any high-resolution raster-scan graphics display from the standard composite or separate video signal; high-resolution images for CAE, scientific, medical, and other systems can be quickly copied without needing any software or hardware interface.

TX-2000 features both digital *StorAGE* and dot-clock recovery; fixed-array thermal technology produces extremely high-resolution printout (200 dots per inch); hardcopies can be obtained from any raster-scan display up to 1536 x 1024 pixels.

Axiom Edwards-CPE Inc., 1014 Griswold Ave., San Fernando, CA 91340, 818-365-9521. **Circle No. 351**

Data Communications And Interconnects

Data Communications Exchange System

Data Communications Exchange System, Model 24; allows peripheral sharing, computer-to-computer communication, and buffering of print data; has a powerful 16-bit CPU plus multiple, high-performance I/O processors that allow super-high-speed transfer of data; customized by combinations of serial and parallel ports installed in four-port I/O modules to a maximum of 24 total ports; ports are user-set as computer or peripheral ports; data

input and output are simultaneous on all ports; 512-Kbyte buffer is expandable to 4.5 Mbytes.

Full duplex communication on the Model 24 eliminates isolated islands of information by providing computer-to-computer communications concurrent with all operations; fully compatible with virtually all computers, printers, plotters, modems,

and other peripherals; is \$895-\$1,895.

Bay Technical Associates, 200 N. Second St., Bay St. Louis, MS 39520, 601-467-8231. **Circle No. 353**

Dual-Cable Support for Broadband LAN Products

CR/5NT, RFM/5NT; CR/5NT is a channel remodulator that resides at the cable head

end, inspects each incoming packet for collisions, and regenerates the packet for the outbound cable, filtering out channel noise in the process.

The microprocessor-controlled RFM/5NT modems, working in conjunction with the CR/5NT in a closed-loop feedback process, adaptively self-adjust transmit signal levels to compensate for RF fluctuations in the cable re-

New Rackmount BA123* Compatible System Enclosure

SE105 System Enclosure

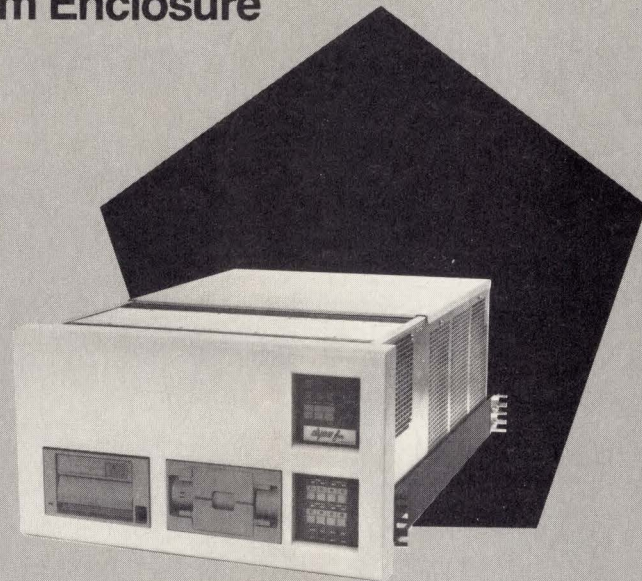

- ◊ First rackmountable enclosure that meets or exceeds all DEC* BA123 specifications (Available in pedestal and table top configurations).
- ◊ Mounting for five 5 1/4" peripherals...750 watts of power...12 slot backplane
- ◊ Supports either MicroVAX II or Micro 11 processors and memory.

Three powerful reasons to use Dyna Five system enclosures when configuring MicroVAX II* and Micro 11 (LS111)* systems...call or write for the complete list.

Dyna Five System and Peripheral Enclosures

Model #	Enclosure Styling	Backplane Slots	Peripherals Supported	Power Watts
SE100 P/R/T	BA23	8 Slots	5 1/4" & 8"	360
SE101 R/T	BA11	8 Slots	5 1/4"	252
SE102 P/R/T	BA123	12 Slots	5 1/4" & 8"	750
SE105 P/R/T	BA123	12 Slots	5 1/4"	750
PE103 P/R/T	Tray	None	8" Fujitsu	396

P-Pedestal R-Rackmount T-Table Top

Also available from Dyna Five...

◊ Communications ◊ Power Supplies ◊ Backplanes ◊ Q-Bus Expanders

Nationwide Field Service by National Support Group (NSG)

If DEC doesn't have it, call Dyna Five.



See us at DEXPO/Spring—Booth #348

CORPORATION
Dyna Five Corporation 3421 W. Segerstrom Avenue • Santa Ana, CA 92704
(714) 751-0133 • Telex 559508

*Trademarks of Digital Equipment Corporation

CIRCLE 427 ON READER CARD

PRODUCT NEWS

sulting from environmental changes or electrical drifts in other network components; automatic control mechanism maximizes network uptime and minimizes routine maintenance; provide read-outs of the receive and transmit signal levels.

CR/5NT and RFM/5NT are compatible with entire Bridge family of broadband server products; CR/5NT \$5000; RFM/5NT \$795; available 60 days ARO.

Bridge Communications Inc., 2081 Stierlin Rd., Mountain View, CA 94043,

415-969-4400. Circle No. 355

Network Shell Technology

VXM Network Shell; a network shell that provides transparent access to resources about a network; independent of architecture, operating system, and network configuration; can be used to develop distributed applications, link heterogeneous software and hardware, join heterogeneous databases, or do virtually anything that requires cooperative, intelligent process-

ing; applications are written in the proprietary VXM language, specifically designed for developing applications across distributed, heterogeneous hosts.

VXM Network Shell can provide extensive application layer services to non-OSI networks such as those using TCP/IP and Netbios; gives developers and users an off-the-shelf OSI-type capability for these existing networks, as well as greatly extends the capabilities of the newer OSI network applications; \$395+; available now.

Command Technologies Inc., 347 Congress St., Boston, MA 02210, 617-451-5221.

Circle No. 261

Modular Multiport Board

Modular Multiport; serial port board uses eight RJ-11 telephone-style connectors instead of 25-pin connectors; compatible with the IBM PC/XT/AT and compatibles as well as 386-based computers; new connection method uses modular jacks identical to those used in home telephone equipment to provide quick, inexpensive connections from the host computer to terminals, printers, modems, and other peripheral devices; designed for multiuser systems running UNIX, XENIX, Pick, and others; can handle data rates of up to 56,000 bps.

Arnet Corp., 618 Grassmere Park Dr. #6, Nashville, TN 37211, 800-366-8844.

Circle No. 263

VME Controllers

LC 202, EXOS 302; LC 202 Ethernet link board achieves link speeds of up to 9 Mbits per second; optimized for the link environment; provides significant performance enhancements when running host-resident protocols, such as 4.2 BSD and other UNIX derivatives.

EXOS 302 intelligent Ethernet front-end processing board uses the Intel 80286 microprocessor providing users with up to 70% higher performance over existing technologies; fully compatible with the EXOS 202 product allowing customers to run the same TCP/IP software on both board families; can function as an intelligent controller or in link mode; LC 202 \$1,495; EXOS 302 \$2,495; is available second quarter 1988.

Excelan Inc., 2180 Fortune Dr., San Jose, CA 95131, 408-434-2226. Circle No. 265

New Communication Option

New communication option for MicroVAX 2000 systems simplifies connection to IBM host systems and sup-

Andromeda's Winning Pair

SMDC

- Controls 2 SMD Drives
- 25 Mbit/sec Data Rate

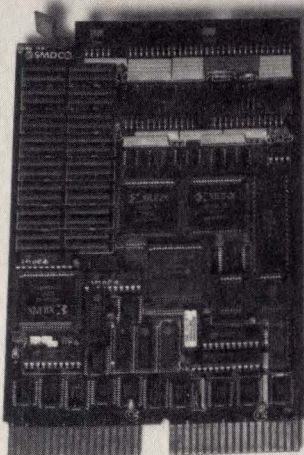

- 1 MB Cache
- Adaptive Readahead
- User Service Port



ESDC

- Controls 7 EDSI Drives
- Controls 3 RX50/33 Drives
- 25 Mbit/sec Data Rate

- Field Upgradable Microcode
- 16 MB Cache Expansion Board
- Dual Porting

If sheer, flat-out performance is what you are looking for, have we got a deal for you! Under typical system conditions Andromeda's cache controllers experience hit rates of over 80 percent. This means that, using either the ESDC or the SMDC, seek time and rotational latency are reduced to ZERO over 80 percent of the time. Thus typical disk accesses are up to *FOUR TIMES* faster.

Caching technology isn't the only area where Andromeda is setting new standards. The on board access port provides extensive disk diagnostics, a real time cache performance monitor and allows customer to upgrade controller microcode via modem. Thus, more advanced cache algorithms as they are developed by Andromeda's engineers are only a phone call away.

See us at DEXPO/Spring—Booth #539

 **ANDROMEDA[®]
SYSTEMS**

9000 Eton Avenue, Canoga Park, California 91304 U.S.A. (818) 709-7600 • TWX-910-494-1248

1 9 8 8
digital review
**TARGET
AWARDS**
N O M I N E E

CIRCLE 426 ON READER CARD

ports the X.25 international communications protocol; extends MicroVAX 2000 users' ability to utilize WAN.

New communication option is a single-line synchronous communication interface that supports VMS/SNA software system V. 1.2 and VAX Packet Switching Interface V. 4.1 running under VMS V. 4.6; \$1,500.

Digital Equipment Corp., Maynard, MA 01754-2571.

Circle No. 267

Printer Sharing System

430 Metro Switch System; allows users to connect 4-20 computers to one or two printers; users can build and expand upon a sharing system for existing computers without having to invest in multiple printers or a LAN; default settings are compatible with most commonly used printers including the HP LaserJet.

430 Metro Switch System's 256- or 512-Kbyte buffer stores documents from the computer, freeing the user to move to other tasks while the document prints; users use their standard word processing print commands.

Datacom Technologies Inc., 11001 31st Pl. W., Everett, WA 98204, 206-355-0590.

Circle No. 269

TCP/IP for UNIX

NP722; protocol processor embedded with TCP/IP software for UNIX System V. 3 VME-bus-compatible systems provides a full set of hardware and software tools for TCP/IP processing; fully supports TLI Streams, FTP, Telnet, Remote File Sharing, UC Berkeley R-utilities; provides a socket interface library that allows programmers to port and develop network applications under Berkeley 4.2.

NP722 processes DMA data and command transfers between the host's main memory and the network; hardware consists of an 80186 microprocessor, an 82586 LAN coprocessor, and 512 Kbytes of resident RAM; is

mounted on a single-slot, double-height VME bus card; \$2,390; available now.

Micom Systems Inc., 155 Swanson Rd., Boxborough, MA 01719, 617-263-9929.

Circle No. 271

Full-Featured, Dual-Mode LAN Transceiver

Model 2010DM; LAN transceiver is fully compatible with 10-Mbit-per-second

Ethernet V. 1.0/2.0 and IEEE 802.3 specifications; switch-selectable 10-MHz "heartbeat" is generated by the sending transceiver after each data frame as a signal-quality error test and to control collision conditions; a "watchdog" timer prevents any one terminal from generating continuous transmissions and monopolizing the network.

Three versions of Model 2010DM are available: 2010DMS, which includes a side-mounted connector and stinger, 2010DMN, with "N"-type connectors, and the 2010DMT, with a BNC connector and a T connector for attaching to Thinnet; \$198.

TCL Inc., 47621 Westinghouse Dr., Fremont, CA 94539, 415-657-3800.

Circle No. 357

Image Processing.

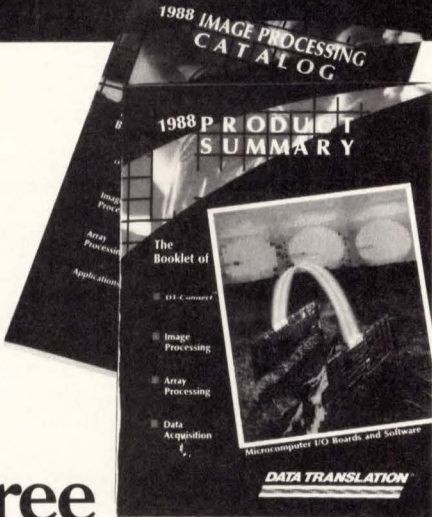

Free Handbook Set.

Data Translation invites you to receive the premier edition of our 1988 Image Processing Handbook Set.

The Book
Our first ever Image Processing Catalog—featuring full product information and 28 documentary stories on image processing and array processing applications.

The Booklet
Our 1988 Product Summary—a summary on pricing, frame grabber and processor boards, and application software.

R.S.V.P. to receive an edition (while they last) by calling:
(617) 481-3700

DATA TRANSLATION®

100 Locke Drive, Marlboro, MA 01752-1192 USA

CIRCLE 447 ON READER CARD

April 1988/HARDCOPY 109

PROBLEM: High Inrush Current
SOLUTION: Multiple Time Delay™



PC 300

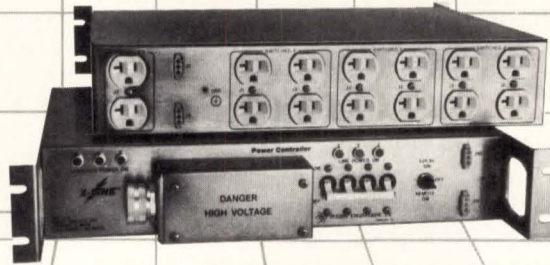

3 phase Power Distribution & Control System

MTD™: Sequence power up your computer system with a controlled delay between each phase.

REMOTE: On/off & emergency shutdown, power-up additional equipment downline.

LINE PROTECTION: EMI/RFI, Spike & Surge.

PULIZZI ENGINEERING INC.

3260 S. Susan Street Santa Ana, CA 92704-6865 (714) 540-4229
 FAX #714-641-9062

CIRCLE 423 ON READER CARD

See us in Boston at ELECTRO 88—Booth #608

PRODUCT NEWS

Graphics

**RGB Plot Utility
 For VAX/MicroVAX**

RGB Plotting Software Utility; for VAX and MicroVAX computers using VMS; enables the direct plotting of RGB (red, green, and blue) data on Versatec plotters; supports all Versatec electrostatic- and thermal-transfer color plotters; written in ANSI FORTRAN-77.

RGB Plotting Software Utility supports user customization in the following ways: to be used with additional color systems (HLS, HSV, CMYK: CIE, L*u*v*, L*a*b*), to operate on RGB data stored in one file or in three separate files, to support additional plotters for producing gray scale, to change the pixel plot resolution, to change the pixel size, to change the number of pixels on x and y axis, and to change the color palette; \$500; available now.

Versatec, 2710 Walsh Ave., Santa Clara, CA 95051, 800-538-6477 or 800-341-6060 in CA. Circle No. 273

**Text and Graphics
 Utilities for VAX**

NRUNOFF; this series of text and graphics utilities are integrated into the CASE 2000 DesignAid environment; accept either DesignAid CASE or ASCII format files with special formatting tags for graphics areas; stores and then strips graphics from the source file and creates a DSR-formatted output file with spaces for figures; can edit the DSR source file on-line and preview the results; figure spaces can be increased or decreased.

Once DSR text file is completed, NRUNOFF merges the DesignAid graphics back into the output file; final output is a CASE file containing DSR-formatted text and DesignAid graphics, all integrated on the specified pages; includes a print utility and directory command that accepts all standard VAX/VMS

Give Yourself A
VACATION!

**VAX/VMS
 SITE MANAGEMENT**

Regain control of your single VAX, VAX cluster or network. Let our fully integrated, distributed management system streamline, automate and simplify your operations.

- ACT - Usage Accounting and Chargeback**
- SCHEDULE - Automated Job Initiator**
- PROJECT - Control and Accounting**
- ARCHIVE-2000 - File Manager**
- MEDIA - Tape/Disk Librarian**
- VAULT - Saveset Manager**

Prices from \$900, available for MicroVAX through VAX 8800.

ISE INTERNATIONAL
 STRUCTURAL
 ENGINEERS, INC.

P.O. Box 241740
 Los Angeles, CA 90024-1740, USA
 Telephone (213)837-8339
 TWX 910-340-6449 (ISE LA)
 TLX 322616 (ISE LA UW)

CIRCLE 424 ON READER CARD

MicroVAX, VAX/VMS trademarks of Digital Equipment Corp.



qualifiers; VAXstations \$1000; VAX mainframes \$10,000; available now.

Nastec Corp., 24681 Northwestern Hwy., Southfield, MI 48075, 313-353-3300 or 800-872-8296.

Circle No. 359

Interactive Drawing Package For VAX

Draw; generates logic diagrams, training aids, engineering designs, floor plans, word charts, maps, and other line art; has three interface modes: command mode for fast operation, graphical menu mode for novice or occasional users, and tablet mode for maximum precision and for digitizing line art; input can come from a keyboard, joydisk, mouse, or graphics tablet; output can be directed to a wide range of *Hardcopy* devices including HP pen plotters, DEC laser printers, Tektronix ink-jet plotters, and all PostScript devices.

Draw's primitives include polyline, polygon, arc, circle, ellipse, markers, rectangle, text, and library symbol; system library contains more than 300 symbols; users can build their own private libraries of symbols; available transformations include zoom, pan, mirror, copy, move, scale, rotate, extrude, group, and ungroup; runs on VAX/VMS systems with VT240/340 and Tektronix display-list graphics terminals or equipment; \$3,500+; available now.

Precision Visuals Inc., 6260 Lookout Rd., Boulder, CO 80301, 303-530-9000.

Circle No. 275

Systems Software

Terminal Emulation Software

TGRAF-07, TGRAF-15; Tektronix terminal emulation software packages support IBM 8514A; TGRAF-07 is a single-screen emulation product—both text and graphics appear on the 8514A monitor; TGRAF-15 supports dual screens—the graphics

display is on the 8514A screen and alphanumeric is displayed on a VCA monitor; TGRAF-07 \$995; TGRAF-15 \$1,995.

Grafpoint, 1485 Saratoga Ave., San Jose, CA 95129, 408-446-1919. Circle No. 277

FORTLAN Converter

VM77; enhanced conversion tool identifies and converts non-standard DEC extensions in FORTRAN programs, producing highly portable FORTRAN code conforming to the ANSI-77 FORTRAN standard; now runs on VMS-based computers; new DEC extensions include ASSOCIATE VARIABLE, FIND and REWRITE, LOGICAL inside IF, CLOSE options, DEFINE FILE, and BYTE data types. \$3,500.

Computer Translations, 2235 W. Potter, Phoenix, AZ 85027, 602-582-9515.

Circle No. 282

Software Device Driver

Software device driver supports the Berkeley TCP/IP utilities over Ethernet networks; compatible with computer systems using UNIX System V/VME Release 3.1 and AT&T WE 321SB VME bus Single Board Computer.

Using the software device driver, AT&T-based VME bus systems can exchange files with, log onto, and generally gain access to a wider variety of computer systems; runs with the CMC ENP-10 or ENP-10 Plus VME bus Ethernet boards.

AT&T, Dept. 51AL230230, 555 Union Blvd., Allentown, PA 18103, 800-372-2447 or 800-553-2448 in Canada.

Circle No. 361

Timing Device for VAX

Time Source, Time Server; Time Source is a precision timing device with host-resident software that synchronizes the calendar clocks of networked VAX/VMS computers; can be used as a time reference in standalone applications where coordination or monitoring of activities is critical; generates a

IT'S LIKE A Money Machine

FOR PDP OR VAX USERS

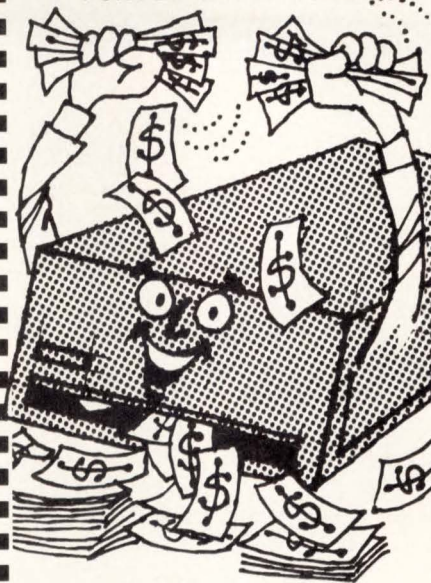

THE UNISTORE™ ULTRA HIGH CAPACITY tape & backup subsystem

Guarantees

**Labor Savings!
Time Savings!
Space Savings!
Money Savings!**
Can you beat that?

Unistore is the revolutionary new 8mm, 2,332,000,000 bytes tape backup system that ensures low cost, high performance information data storage. The bigger, more complex your present off-line data storage problem is, the better we look.

**Let us prove it!
CALL OR WRITE TODAY**



advantage
SYSTEMS CORPORATION
1807 Glenview Road
Glenview IL 60025, Suite 100
(312) 965-7800

CIRCLE 425 ON READER CARD

"Ahh, my little flicker-free."



Ahh, yes indeed. The DEC-compatible ADDS 3220, with its unique 70 Hz refresh display, is so remarkably flicker-free your operators won't get tired working with it.

You'll love our supporting cast of easy-to-read double high and double high/wide characters, viewed in a choice of 80 or 132 column format. All presented on a 14" flat green, amber or white screen.

An outstanding performer.

Our DEC-style keyboard enhances the performance of your software. With value-added features like 22 fully programmable function keys and 256 bytes of non-volatile memory that help you distinguish your product from the competition.

© 1987 W. C. Fields Productions, Inc., L.A., Calif.

The ADDS 3220 is fully compatible with the DEC VT220, VT100, VT52 and ANSI X3.64. It won Digital Review's 1987 "Best Alphanumeric Terminal of the Year" award.

See for yourself. Screen test our little flicker-free, the ADDS 3220. For more information, call 1-800-231-5445. In New York, 516-231-5400. Ask for Displays Marketing.

ADDS

Applied Digital Data Systems Inc.
A Subsidiary of NCR Corporation

100 Marcus Blvd., Hauppauge, NY 11788.

CIRCLE 422 ON READER CARD



PRODUCT NEWS

signal that is within 10 msec of the the international time standard, Coordinated Universal Time; runs unattended and sets itself when turned on; can't be set or adjusted by hand.

Time Server is software that lets a VAX computer equipped with a Time Source unit operate as a network time server, synchronizing DECnet nodes to a standard time signal; Time Source \$695-\$1,495, available now; Time Server \$250-1,000, available 60 days ARO.

Precision Standard Time Inc., 105 Fourier Ave., Fremont, CA 94539, 415-656-4447. Circle No. 363

4GL Rapid Development System And Interactive Debugger

Informix-4GL Rapid Development System, Informix-4GL Interactive Debugger; Rapid Development System is a 4GL that dramatically reduces application development time; Informix-4GL code is compiled into pseudo-code (p-code), read into memory, and executed by a p-code runner, with no need for an external compiler or linker; programmers can quickly develop fully customized applications in a variety of computing environments, with features such as scrolling, windows, and color.

Informix-4GL Interactive Debugger provides fast, interactive debugging capability and a source-level debugger; gives user the ability to see code execute line by line, learn unfamiliar programs quickly, set break points, interrupt program at predetermined point, display contents of a variable program array, and trace a function; POR.

Informix Software Inc., 4100 Bohannon Dr., Menlo Park, CA 94025, 415-322-4100.

Circle No. 365

Interface Analyzer

Model 500 EIA RS-232 Interface Analyzer; a diagnostic tool designed for use at the standard EIA RS-232 or CCITT V. 24 data interface of modems, multiplexers, terminals, and computers; inserted

in series between the Data Terminal Equipment (DTE) and the Data Communications Equipment (DCE) to provide access to, and monitoring of, all data, timing, and control signals; miniature rocker switches allow the user to program a "make" or "break" for each signal at the DCE/DTE interface; mini-patchcords are provided for cross-patching or loopback patching of signals.

Model 500 EIA RS-232 includes a reference chart with

a complete table of EIA/CCITT-standard interface signal descriptions; requires no AC or DC power supply; power is derived from the signals under test; pocket-sized and constructed in a sturdy aluminum case; \$98.

Electro Standards Laboratory Inc., P.O. Box 9144, Providence, RI 02940, 401-943-1164. Circle No. 367

Production Compiler

Production Compiler; allows application developers

to create and distribute unlimited copies of Level5/PC expert system applications that are free of the copy restrictions that apply to the Level5 development system itself; takes PRL syntax and produces a standard .EXE file; \$3000.

Information Builders Inc., 1250 Broadway, New York, NY 10001, 212-736-4433.

Circle No. 283

Backup Utility for VAX

After Hours Software;



2.5 Gigabytes Unattended Backup

Digi-Data's GIGASTORE™ provides 2.5 Gigabytes of data storage on a single T-120 VHS video cartridge. That permits backup of your largest disk drive on off-hours without an operator.

Utilizing true read-after-write coupled with very powerful error correction, GIGASTORE gives you an unsurpassed error rate of 1 in 10²³ bits. In addition, you get a high speed search capability not available in most 9-track drives.

GIGASTORE can be provided with an interface for DEC computers, such as VAX and Micro Vax, for operation under VMS. It is also available with an IBM PC interface, operating under MS/DOS.

Call Digi-Data, an organization with a 25 year history of manufacturing quality tape drives, at (301) 498-0200.

™GIGASTORE is a trademark of Digi-Data Corporation.



DIGI-DATA CORPORATION

8580 Dorsey Run Road
Jessup, MD 20794-9990
(301) 498-0200
Telex 87-580

© ... First In Value

In Europe contact: Digi-Data Ltd. • Unit 4 • Kings Grove • Maidenhead, Berkshire
England SL6 4DP • Telephone No. 0628 29555/6 • Telex 847720

CIRCLE 429 ON READER CARD

Frustrated?

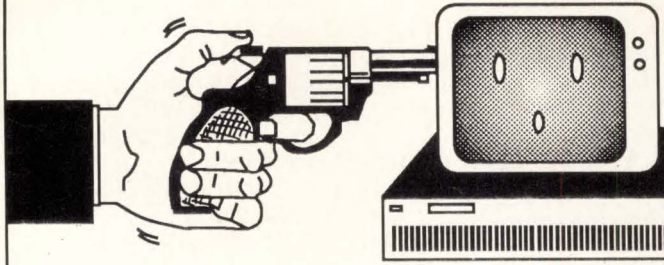

EDCON SYSTEMS has the solution:

- Integrated Business Systems
- Database Management Solutions
- Disaster Recovery Plans
- Custom system development in 4th generation languages
- Training in both off-the-shelf and custom software

EDCON SYSTEMS

45 Ember Lane, Carlisle, MA 01741 (617) 369-2674
CIRCLE 430 ON READER CARD

DON'T BUY A VAX SPREADSHEET

Without trying GRAPHIC OUTLOOK from
Stone Mountain Computing.

If you are looking for LOTUS-like capability on the VAX, try GRAPHIC OUTLOOK. It's powerful. It's useable. And it's affordable.

GRAPHIC OUTLOOK provides

- A LOTUS command mode that makes it as easy to operate as 1-2-3.
- Automatic transfer of worksheets to and from 1-2-3 (versions 1A and 2) and Symphony.
- High-quality business graphics on most popular graphics terminals, plotters, and laser printers.
- 2-user, 6-user licenses, a lease plan and right-to-copy discounts for clustered VAXes.
- Probably more capability than you've ever seen in a spreadsheet program.

Call about our demonstration package. GRAPHIC OUTLOOK. Tomorrow's VAX spreadsheet program that's available now.



Stone Mountain Computing See us at
P.O. Box 1369 DEXPO/Spring
Goleta, CA 93116 Booth #1215
(805) 964-9101

VAX is a registered trademark of Digital Equipment Corporation.
LOTUS and 1-2-3 are registered trademarks of Lotus Development Corporation.

CIRCLE 518 ON READER CARD

PRODUCT NEWS

backup utility manages scheduling, reports, system-management activities, job tracking, and selective restoring; GIGA-Backup handles 2000-Mbyte tape and optical devices; Librarian helps users maintain a complete tracking record of all physical media and files used for backup purposes; tracks free volumes, media sent off-site for StorAGE or cleaning, and bad or missing volumes.

After Hours Software features automatic modem-control utility, personal card file, and calendar; File Defragmentor helps you clean up file structures and speed up disk access; MicroVAX \$795; VAX \$1,895; available now.

SYCO System Communications Inc., P.O. Box 838, 165 Mechanic St., Leominster, MA 01453, 617-534-6499.

CIRCLE NO. 284

Sybase Products For VAX and IBM PC

DataToolset, DB-Library; DataToolset is the component of Sybase that provides visual tools for building and running applications; applications can transparently access data from Sybase DataServers residing on the same or different machines in a network; DataServer handles all data management functions and is specifically designed to handle on-line applications.

DB-Library, one product in the DataToolset, provides a programming language interface for applications to access the Sybase DataServer; allows Sybase applications to be integrated under MS Windows with DOS 3.3; DataToolset and DataServer combined \$1,000-\$150,000; DB-Library \$1,000-\$8,000.

Sybase Inc., 2910 Seventh St., Berkeley, CA 94710, 415-548-4500. CIRCLE NO. 285

DBL Utilities for Application Software Development

DBL Synergy; a set of DBL utilities that aid in application software development; window tool features portability among operating systems, field definitions

that simplify menu selections, multiple window displays, ability to save and restore windows, a prototyping utility, simple implementation procedures, and borders and titles; POR.

Digital Information Systems Corp., 11070 White Rock Rd., Rancho Cordova, CA 95670, 916-635-7300.

CIRCLE NO. 287

Serial Breakout Box Offers Parallel Interface Test

Model 225; a high-quality RS-232C serial breakout box that includes parallel interface testing capabilities; features 52 LED's that give four-state signal indication; includes 26 in-line switches and 52 sockets that allow breaking and re-directing of all 25 lines plus one unassigned line; a battery simulates high or low signals; \$229; available now.

M-Test Equipment, P.O. Box 146008, San Francisco, CA 94114-6008, 415-861-2382.

CIRCLE NO. 286

Transparent Terminal Emulation

TouchTerminal; general-purpose, transparent terminal service software allows Apple Macintosh or MS-DOS users to establish terminal sessions to a VAX/VMS host across a Touch OSI network using unmodified existing terminal emulation programs; enhances an existing terminal emulator's capabilities by allowing the user to establish multiple terminal sessions via the Touch OSI network; transparency allows users to preserve their installed base of terminal emulation software and minimize user retraining.

TouchTerminal allows network hardware to act as the terminal emulator's physical medium for connection to the host computer; available in June as an option to any Touch OSI product; will be free with Touch OSI products ordered through September 30, 1988.

Touch Communications Inc., 10 Victor Square, Scotts Valley, CA 95066,

408-438-4800. CIRCLE NO. 288

DISK/TEST 88

JUNE 16-17, 1988

SAN JOSE HYATT HOUSE

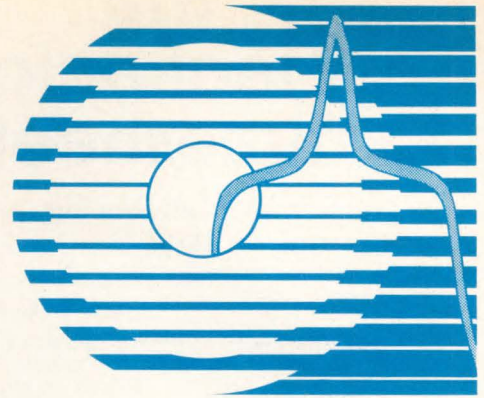

Testing a highly complex and sophisticated piece of equipment like a disk drive is no simple task. It does not help that intelligent interfaces such as SCSI and IPI isolate the buyer from intimate contact with the internals of the disk drive and make testing even more difficult.

- How does the builder and the user test intelligent drives?
- Can embedded SCSI drives incorporate their own testability?
- Are window margins useful or are they of exaggerated importance?
- What progress is being made on testing thin film heads and media?
- Does Run Length Limited Coding exacerbate the issue of identifying and handling defects?

Specific test issues to be covered during the seminar include:

- Phase Margin
- Window Margin
- Defect Analysis
- Test Data Correlation
- Qualifying the Interface
- Run Length Limited Codes and ECC
- Correctable vs Non-correctable Errors
- Data Access with Intelligent Interfaces

DISK/TEST 88 is aimed at those involved with engineering, manufacturing, and marketing of disk drives as well as those responsible to evaluate, suppliers, repair centers, controller companies, system integrators and test equipment suppliers will find **DISK/TEST 88** a valuable forum for the interchange of ideas and technology.

There is more than talk at **DISK/TEST 88**. The Exhibitors Reception allows attendees the opportunity to compare competitive and complementary products side-by-side in a convivial atmosphere. Attendees can question both users and suppliers of test equipment on their respective merits.

In addition to exhibitors, speakers include representatives from system integrators and major disk manufacturers:

Adaptec
Applied Computer Techniques
Applied Magnetics Corp
AVA Instrumentation
D-Designs
Datapoint
Data Systems Technology
Flexstar

Hewlett Packard
IBM
I/O XEL
JCS Technology
KODE
Luctor
Magnetic Peripherals
Maxtor

Micropolis
Memory Technology
Peer Protocols
Pioneer Research
Prime Computer
Seagate
Wilson Laboratories
Zeissner Consulting

Only **DISK/TEST 88** can supply the information you need to evaluate the components, the drive and the interface. Register now:

Please register me for **DISK/TEST 88**

Further Information: 408-554-7889

Name: _____ Company: _____

Street: _____

City: _____ State/Zip: _____ Phone: _____

Signature: _____

Registration: \$495 Check Enclosed: _____ Purchase Order No: _____

Please add my name to the mailing list for future information

Mail to: **DISK/TEST 88**
14426 Black Walnut Ct, Saratoga, CA 95070

The Electronic Timesheet™

VAX Software for:

- Time and Billing
- Project Management
- Office Automation

A VAX-based software solution to the process of filling in timesheets and producing related reports: • project costing • labor • expense • client billing and other project management related reports.



“

fbn Management Science Corporation claims that ET offers several advantages over a manual system. These advantages include:

1. Productivity gains through reduction of unnecessary paperwork by facilitating automatic and systematic collection of data.
2. Reduction of errors.
3. Project cost control.
4. Improvement in cash flow by providing up-to-date client billing and project costing reports on demand.

As you become familiar with ET, you'll realize that ET does fulfill each of these advantages. This package is pleasant and fun to use and I recommend it enthusiastically.

”

DEC Professional,
February 1988



“

ET is the only general-purpose VMS product we've seen in this category. Running on all VAXes, it lets managers monitor employees at a glance, while employees enter their own charges . . . ET is easy to learn and use . . .

”

digital review,
January 25, 1988

The Electronic Timesheet is installed in organizations ranging from 20 to several hundred employees, and has been used to manage and control projects ranging from risk analysis to a multi-million dollar shuttle spacelab experiment.

Evaluate ET on your VAX:

An evaluation kit including The Electronic Timesheet Software, Users Manual, and a video cassette containing an on-line demonstration is available for \$95.00. To Order Your Evaluation Kit, Call Igal Hauer at (416) 534-6878

Prices Start at
\$1295.00
(limited time offer)

CIRCLE 519 ON READER CARD

PRODUCT NEWS

Applications Software

Flat-File Database for VAX

FastFile; flat-file database for VAX/VMS; similar to PC list managers and allows a non-technical user to create computerized files such as mailing lists, simple inventories, and personal data; contains an internal data dictionary and English-language report writer that provide formatted input screens and custom report-writing capabilities to the end user; each screen can have up to 50 data fields, which can be alphanumeric, numeric, dates, or numeric with decimals.

FastFile user creates reports by typing "print" plus the name of each field he wants printed; produces a complete, formatted report that can include multiple lines, imbedded-text literals, and mailing label formats; includes the ability to sort the database, select specific records, calculate new values, and take totals and subtotals; data may be imported from and exported to PC applications, such as popular databases and spreadsheets, that support ASCII or DIF files.

Datamate Co., 4135 S. 100th East Ave., Ste. 128, Tulsa, OK 74146. Circle No. 289

Accounting Package

TSX-Plus System Resources Utilization Accounting Package (TSRUAP) V. 3.0; consists of a system statistics logging program, a report-generating program, utility programs and command files, and user documentation; data on individual sessions, user disk allocation, user memory utilization, and miscellaneous resources utilization are recorded by the statistics logging program; Records project and programmer numbers, TSX-Plus line number, logon date and time, and connect time in minutes of each individual session; disk allocation in kiloblock-minutes and memory utilization in kilobyte-min-

utes are recorded as cumulative quantities; miscellaneous resources are definable by the system manager including execution of proprietary software, user-requested backups, and user disk-space reallocations; total CPU time is picked up from the data logged by TSX-Plus in its access control file.

TSRUAP V. 3.0 report-writing program produces a system manager's summary report and individual project-programmer summary reports; utility programs aid in selecting project and programmer numbers, logging miscellaneous charges from both the user's line and the system operator's line, and in establishing the schedule of charges; additional utility programs read and display the contents of the data files on the terminal; new features include a sampling algorithm that improves the quality of the data recorded and two alternative methods of selecting project and programmer numbers; single CPU license is \$600+.

Nab Software Services Inc., P.O. Box 20009, Albuquerque, NM 87154, 505-298-2346. Circle No. 290

IBM/DEC Connectivity

Streamline and Softerm PC

Streamline, Softerm PC; Streamline is a PC-to-VAX interface that helps PC users extract and download data from the VAX in formats for Lotus, dBase, DIF, and others; on the VAX, it provides standard menu-driven interface for Oracle, Ingres, and Datatrieve; available with VT220 terminal emulation that runs memory-resident on the PC.

Softerm PC emulates 45 popular asynchronous terminals and supports seven file transfer protocols, including Kermit and Xmodem; features a full-screen text editor, background operation, seamless remote virtual disk, scripting, and keyboard remapping; POR.

Keystep Corp., 7580 W. 16th Ave., Third Floor, Lakewood, CO 80215, 303-238-7710.

Circle No. 292

MINI MART

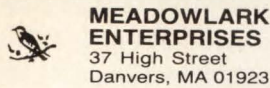

We need to buy your excess DEC equipment now!

VAX & PDP-11

Turn your unwanted computer equipment into cash!

- ✓ Large inventory
- ✓ Immediate availability
- ✓ Super Prices

617-777-4666 dba

800-DEC-DLER
FAX# 617-777-8433

CIRCLE 511 ON READER CARD

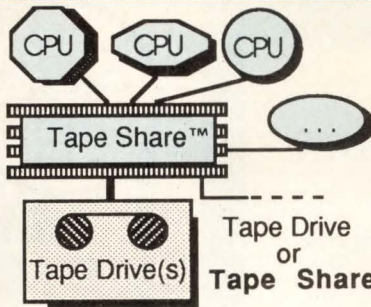

Easily connect several CPUs to 1 tape drive. Or several tape drives. Please call for our brochure. (415) 969 - 5109



67 EAST EVELYN AVE.
MT. VIEW, CA 94041
ASSOCIATES Inc.

CIRCLE 512 ON READER CARD

miniMAX™
Data Storage Subsystem
Minimal size with Maximum capacity using 5.25" devices

2.3 Gigabytes

- Compatible with Q-bus, Unibus, PC-bus
- VMS, UNIX, PS-DOS, RSTS Systems supported
- Rewritable / Removable Magnetic Media

415-969-5109



67 EAST EVELYN AVE.
MT. VIEW, CA 94041
ASSOCIATES Inc.

CIRCLE 513 ON READER CARD

VAX® RENTALS

**MICROVAX II
VAX 700 SERIES
VAX 8000 SERIES
Systems & Peripherals**

- Fast Turnaround
- Dependable Products
- Upgrade/Add-On Flexibility
- Purchase Option Available

3 Months • 6 Months • 12 Months

BROOKVALE ASSOCIATES

dba Digital Dealers Association

EAST COAST WEST COAST
(516) 273-7777 (206) 392-9878

CIRCLE 514 ON READER CARD

DEC SPRING FEVER FAVORITES

4A-KA85-AA	\$101,600
4A-KA86-AA	\$105,500
4A-KA88-AA	\$127,900
4A-KA865-AA	\$133,300
861-UP/AA	\$59,000
KA820-AA	\$15,000
L0224	\$750
MS86-AA	\$2,400
VAX 11/785 Modules	CALL

BUY-SELL-TRADE-EXCHANGE
QEI Immediate Delivery dba
INCORPORATED (617) 275-6800
Louisiana Branch 800-331-6140
In Louisiana (504) 641-6140
FAX 617-275-6873

CIRCLE 515 ON READER CARD

VAX MEMORY

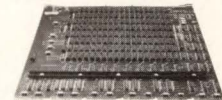

FOR 11/750, 11/730, 11/725,
OR VAX 11/780, 11/785

CI-V53

1MB Plug compatible with VAX
11/750, 11/730, 11/725

CI-VAX4

4MB Plug compatible with VAX
11/780, 11/785

800-468-0736

FAX No. (809) 876-6140



Chrislin Industries Caribe, Inc.

P.O. Box 1657, Canovanas, PR 00629

VAX is a trademark of Digital Equipment Corp.

CIRCLE 516 ON READER CARD

SOLEAD
UTION
SUCCESS

GRAPHICS ON YOUR VT220!

GRAPH220™
generates business and presentation graphics on your VT220 and compatibles without additional hardware!

- Pie charts
- Line graphs
- Bar charts*
- Histograms*
- Clustered bar charts*
- Stacked bar charts*
- Also outputs to file or printer
- Horizontally and Vertically

Micro-VAX® and VAX-11® \$795.

VAX® 8000 Series \$1495.

CALL (408) 734-9511

WILLIAM A. PEDERSEN AND ASSOCIATES
1037 N. FAIR OAKS AVE. • SUNNYVALE, CA 94089

VAX® is a registered trademark of Digital Equipment Corporation.

CIRCLE 517 ON READER CARD

Look for the logo



It's your insurance that you are doing business with a reputable dealer in the used DEC marketplace. The Digital Dealers Association (dda) was formed in 1982 as a trade association to promote ethical dealings in the secondary hardware market.

For more information
(313) 475-8333 DIGITAL DEALERS ASSOCIATION
107 S. Main St.
Suite 202
Chelsea, MI 48118

This publication is available in microform from **University Microfilms International.**

Call toll-free 800-521-3044.

Or mail inquiry to:
University Microfilms International,
300 North Zeeb Road,
Ann Arbor, MI 48106.

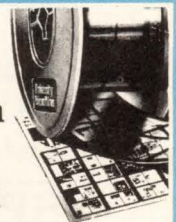

NEW/USED EQUIPMENT

MRI COMPUTERS

Performance Enhancement Products

USI/HSR

PEP-70

PDPII-SEP

NEW AND USED
DEC* EQUIPMENT

Buy • Sell • Lease

1520 N.W. 65th Avenue, Suite 2
Ft. Lauderdale, FL 33313

1 (800) 992-6340

In FL (305) 587-7464

CIRCLE 378 ON READER CARD



**COMPUTERS & PERIPHERALS
IN STOCK PROMPT DELIVERY**

NEW & USED

BUY digital™ SELL
SYSTEMS • MODULES
PERIPHERALS
VAX • Q-BUS
UNIBUS

COMPETITIVE PRICING — CALL TODAY

617-547-4005 • 800-892-9230

FAX (617) 354-1417 TELEX 374-8460

LET US QUOTE YOU
ON ALL OF YOUR DEC NEEDS DIGITAL DEALERS ASSOCIATION

**ELI HEFFRON
& Sons inc.**

**139 HAMPSHIRE ST., CAMBRIDGE,
MASSACHUSETTS 02139 U.S.A.**

CIRCLE 379 ON READER CARD

digital

digital

PUBLIC NOTICE!!

BOSTON BOARDS & SYSTEMS, INC.



Boston Boards
&
Systems

55 Rear Main Street, Kingston, MA 02364

617-747-6222

Our Guarantee Is Our Reputation!!



Boston Boards
&
Systems

SPECIAL

VAX 11/780 XA-AE FCC

\$18,900

MICROVAX II

Systems & Peripherals

**8000
SERIES**

Systems
&
Peripherals

**\$1 MILLION + *DEC inventory
15% to 60% OFF DIGITAL LIST!!
CABLES TO CPU's!! CALL TODAY!!**

**WE ALSO BUY NEW & USED
EXCESS *DEC INVENTORY**

FAX #617-747-6255
Telex #920038BBS

EMC²

cipher
data products, inc.

GD
CONTROL
DATA

EX
EMULEX
TM

KENNEDY

FUJITSU

T.M.
National
Semiconductor

CIRCLE 380 ON READER CARD

digital

FAX #617-747-6255
Telex #920038BBS

Digital is a registered trademark of Digital Equipment Corporation

digital

MRI COMPUTERS

Presents:

A FOUR STAR PERFORMANCE!



USI/HSR

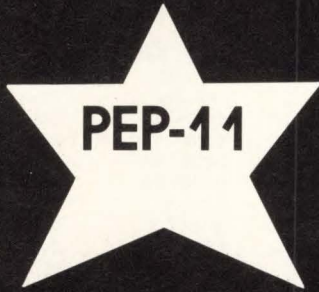

PEP-11

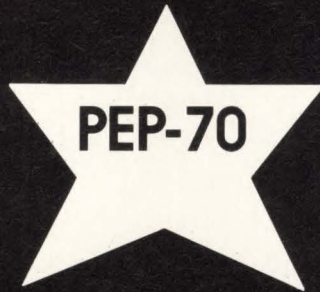

PEP-70



CACHE-70

NOW APPEARING AT SELECTIVE SITES NEAR YOU

Including users such as: AT&T, Bell Labs, E.I. Dupont, Ford Aerospace, General Dynamics, NASA and many, many others...

PERFORMANCE ENHANCEMENT PRODUCTS FOR DEC VAX AND PDP11 SYSTEMS

USI/HSR

(UNIBUS Segment Isolator / High Speed Repeater)

The USI/HSR was specifically designed to allow maximum UNIBUS utilization and freedom in system configurations. The unit is totally transparent to system operation and requires no hardware or software changes.

As a UNIBUS Segment Isolator, the Unit electronically breaks the bus into smaller segments, thus enhancing the reliability of UNIBUS transfers. The unit will virtually eliminate TRAP 4, UNIBUS TIME-OUTS and VECTOR 0 Interrupts. And as a High Speed Repeater, this 25 nanosecond device allows your UNIBUS to run as fast as your CPU and memory can push it. Installation is "Plug and Play". Unplug an M920 or M9202 and plug in a USI/HSR.

Now you can...

- Add a second UDA50 to your existing UNIBUS.
- Add up to 60 units of DC load.
- Eliminate the need for additional UNIBUS Adapters (DW7XX-XX).
- Plan a migration to new CPU technology with the UNIBUS devices you now own.

PEP-11

(The PDP-11 Performance Enhancement Package)

This performance package consists of an amazing new 5ns UFUM (ULTRA FAST UNIBUS MEMORY) and a USI/HSR (UNIBUS SEGMENT ISOLATOR/HIGH SPEED REPEATER). Your PDP-11/24, 11/34 and 11/44 systems now have growth potential beyond all expectations.

If you are using older DEC UNIBUS Systems such as PDP 11/40, 11/45, 11/50, 11/55, or 11/60 you can easily double or perhaps triple your system throughput.

The memory comes in either 1/4 or 1 mb static ram arrays on a single board. It directly replaces the memory now in the system.

The upgrade is simply "plug and play", while the associated costs are only a fraction of replacing your current system with a new one. There is no need to retrain your people, renovate your computer room or rebuild your files.

DEC, PDP-11, VAX, RSTS and UNIBUS are registered trademarks of Digital Equipment Corp.
USI/HSR is a registered trademark of Setasi Research and Development.
UFUM & PEP-70 is a registered trademark of Digital Data Systems, Inc.

PEP-70

(The PDP 11/70 Performance Enhancement Package)

This package consists of a new static ram, 2 or 4 mb memory board with a 15 nanosecond access time and a complete read or write cycle time between 100 and 200 nanoseconds.

The PEP-70 increases CPU and Bus throughput, thus allowing a previously CPU bound system to have the same User Response as a lightly loaded system. The additional UNIBUS bandwidth allows you to increase I/O capacity, I/O transfer rates, and User loads. System performance has increased by factors of 25%-45% at various RSTS user sites.

The PEP-70, when installed, is fully compatible with present hardware and operating system software. Installation is a simple process with minimum system down time.

The new memory board directly replaces the DEC MK11-B, C or MJ11 style memory. It is physically plugged into slot 19 in the 11/70 CPU backplane. This eliminates the need for the entire MK11 memory cabinet, thus reducing CPU footprint by 50%.

CACHE-70

(PDP 11/70 Hyper-Cache)

This two board set directly replaces the DEC Cache Control and DATA PATH modules (M8142 and M8145 respectively). It allows you to fully utilize the efficiency and speed of the PEP-70.

The Cache-70 reduces the time required for memory bus overhead handling required by previous PDP 11/70 memories.

This adds a new dimension of speed over the PEP-70 by a factor of 15-25%.

dda DIGITAL DEALERS ASSOCIATION

Write or call for information

MRI COMPUTERS

1520 N.W. 65th Avenue, Suite 2
Ft. Lauderdale, FL 33313

800-992-6340

FL. 305/587-7464

CIRCLE 388 ON READER CARD

NEW/USED EQUIPMENT

California Boards—A Reliable Source For Buying And Selling DEC Equipment.

California Boards is one of the largest distributors of new and refurbished secondary and after-market equipment—our customers rely on our huge inventory of options, upgrades, terminals, modems, modules, spare kits and other hardware.

California Boards is one of the nation's largest buyers of used systems and peripherals—our customers rely on us to buy the hardware they've outgrown.

California Boards has one of the nation's largest and most comprehensive test facilities—our customers rely on the fact that our entire inventory of unused and used/refurbished hardware is tested and certified operational on our own test beds.

California Boards customers rely on our educated staff for *all* their computer needs including depot printer repair, leasing, financing and maintenance.

California Boards is prompt—our customers rely on our quick response. Whatever the need.

For more information, call or write: California Boards
4030 Spencer Street
Torrance, CA 90503
(213) 542-3000
Fax (213) 542-4294
Telex 6502240619

DEC*

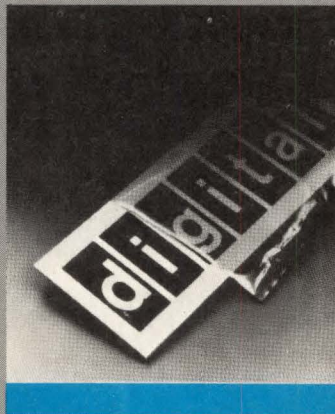

SYSTEMS AND PERIPHERALS

- PURCHASE
- SALES
- INSTALLATION
- DE-INSTALLATION
- MAINTENANCE
- PRINTER DEPOT REPAIR

WE DO IT ALL

California Boards

dda DIGITAL DEALERS ASSOCIATION

CIRCLE 382 ON READER CARD

Plain & Simple.

For the best of service, when you buy or sell DEC* equipment, call New York Computer Exchange.

You will receive prompt, up-front, direct answers combined with a willingness to serve your interests. We believe that extra care and service leads to long term, headache-free business relationships.

TOLL FREE: (800) 645-9109

CURRENT DEC* SPECIALS

1173-BE	DHU11-AP	KDJ11-AB	RA81-AA
1184-BA	DLV11-J	LA12X-AL	RD54-AA
11750-FA	DMF32-LP	LA120-BA	RK07-PA
11780	DRV11	LA120-RA	RL02-AK
BC26V-50	DW780-AA	LP06-YA	RLV12
C1780-AA	DZ11-A	MK11-CE	RM05-AA
CS11-F	DZ11-DP	MS86-BA	RQDX3-AA
DD11-CK	DZ11-E	MS630-BB	SC750
DD11-DK	DZQ11-AP	MS630-CA	TK50-AA
DELUA-AA	H7112-A	MS750-CA	TK70-AA
DEUNA-AA	H9602-HA	MS780-FD	UDA50-A
DH630 Q2-Q5	H9642-AS	MS780-JA	VT100-AA

Only a partial list of our fully warranted equipment for sale. If you don't see what you need, please call.

CASH PAID FOR YOUR EXCESS NEW AND USED HARDWARE.

New York Computer Exchange, Inc.

Corporate Offices
130 Gazza Boulevard
Farmingdale, NY 11735
FAX: (516) 752-9202
(516) 752-8666



New England Sales Office
40 Beach St., Suite 105
Manchester, MA 01944
FAX: (617) 526-8293
(617) 526-8259

dda
DIGITAL DEALERS
ASSOCIATION

Telex: 146012

*DEC is a registered trademark of Digital Equipment Corp.

CDIA
Member Computer Dealers
& Lessors Association

DEC ★ BEST DEALS

VAX • UNIBUS • Q-BUS
BUYING • LEASING • SELLING

CALL 305-771-7600

FREE

To DEC Users

Subscription to "DEC-BEST DEALS" our quarterly catalog packed with hundreds of great values on DEC equipment from small options to full systems, Q-BUS through VAX.

Call today for your copy--or mark your business card "BEST DEALS" and mail today.

dda
DIGITAL DEALERS ASSOCIATION

CIRCLE 383 ON READER CARD

CDIA Member Computer Dealers & Lessors Association

dataware
incorporated

1500 Northwest 62nd Street
Suite 512
Fort Lauderdale, FL 33309
Telephone 305/771-7600

Dealers in computer equipment since 1974.

NEW/USED EQUIPMENT

**DEC* DEPOT REPAIR • DEC* SERVICE TRAINING
DEC* SPARE PARTS**

New - 1-YEAR WARRANTY ON ALL EQUIPMENT SALES & REPAIRS - New

**L
O
W

C
O
S
T**

**Q
U
A
L
I
T
Y

P
R
O
D
U
C
T
S**

**F
A
S
T

S
E
R
V
I
C
E**

- 11 YEARS IN THE DEC* BUSINESS
- PDP 8 TO VAX, AND PERIPHERALS COVERAGE
- 5 DAY STANDARD TURNAROUND ON REPAIRS
- OPTIONAL 24 HR. EMERGENCY REPAIR
- ADVANCE SWAP/EXCHANGE PROGRAM
- LEASING OR RENTALS
- FLAT RATE REPAIR PRICES/VOLUME DISCOUNTS
- UPGRADES AND ECOs AT NO ADDITIONAL COST
- TRAINING, AT YOUR FACILITY OR ESS's
- AN INVENTORY IN EXCESS OF 100,000 ITEMS
- SAME DAY SHIPMENTS ON PURCHASES
- OPTIONAL 24/7 COVERAGE
- PERSONALIZED SERVICE/COMPETITIVE PRICES

New - CDC† DEPOT REPAIR & SPARES - New



**ELECTRONIC
SERVICE
SPECIALISTS**

A Bell Atlantic* Company

N92 W14612 Anthony Ave.
Menomonee Falls, WI 53051

CIRCLE 384 ON READER CARD

**is
Your Answer for DEC* Repairs & Spares**

CALL US FOR QUOTES
REPAIRS/BUYING/SELLING/
RENTING/TRAINING/LEASING

PHONE: 414-255-4634

FAX: 414-255-5418

**TELEX: 260183
ESS LTD MEFS**

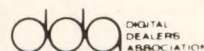

*Registered Trademark of Digital Equipment Corporation
†Registered Trademark of Control Data Corporation

NEW/USED EQUIPMENT

• MICRO-TERM • FUJITSU • TRIMM • DILOG • CAMINTONN • SPECTRALOGIC • XYLOGICS • DILOG •

• EMULEX • KENNEDY • FUJITSU • C.ITOH • VISUAL • CDC • TRIMM • EMULEX • KENNEDY • C.ITOH • FUJITSU • AMPLEX •

BUY FROM SOMEONE WHO IS DIRECT

DAX

**Kennedy Blowout
Kennedy Overstock**

We will not be beat price wise on Kennedy 9610

Sub System Specials

I don't think anybody can beat me, **price wise, support wise**, on a Fujitsu or Kennedy sub system for any DEC or Sun computer.

**KENNEDY 9610 (800, 1600, 3200, 6250)
FUJITSU M2344 (690 MB)
CONTROLLERS & CABLES**
\$22,850

KENNEDY 9600A, CONTROLLER & CABLES
\$5,150

Please Call me and make me beat my own prices.

DAX

3868 Carson Street, Suite 310
Torrance, CA 90503

CALL:
(213) 540-2639

CIRCLE 386 ON READER CARD

VAX SYSTEMS AND OPTIONS

8000 Series, 11/785, 11/780, 11/750, 11/730
MICROVAX II and PDP 11 Systems

SELECTED ITEMS, NEW & USED

VAX 8530 System	CALL	DZ11-DP	\$400
VAX 11/750 FCC VMS	\$6,500	LP11-AA	\$2,500
VAX 11/780	CALL	MS750-CA	\$375
DEUNA w/cab, kit	\$2,200	MICROVAX 11Q2, Q3	CALL
DELNI-AA	\$1,095	RD54 Equiv (Maxtor)	\$2,500
DFM04-AC	CALL	UDA50-A	\$1,900
DMF32-LP	\$600	RAB0-AA Used	\$3,300
DMZ32-AY	\$4,500	FP750	\$2,700
TU81E-BA	\$22,000	RAB1-AA	\$12,000
RD53-AA	\$1,100		

WANT TO BUY:
ALL VAX Systems & Options

NATIONAL DATA SYSTEMS, INC.

CIRCLE 387 ON READER CARD
299 Market St. Saddle Brook, NJ 07662

201-843-5300 • FAX: 201-843-0216

 DIGITAL DEALERS ASSOCIATION

INVENTORY CLEARANCE



DISK DRIVES

- DEC RA81
- Fujitsu 172MB 5 1/4"
- Fujitsu 168.6MB 8"
- Fujitsu 337MB 8"
- Fujitsu 474MB 10 1/2"
- Fujitsu 690MB 8"
- Fujitsu 823MB 8"

DISK DRIVES

- Toshiba 166MB 8"
- Toshiba 340MB 8"
- Toshiba 510MB 8"
- Toshiba 720MB 8"
- Toshiba 86MB 5 1/4"
- Toshiba 173MB 5 1/4"
- Toshiba 380MB 5 1/4"

PRINTERS

- DEC LA12
- DEC LA100
- DEC LA120
- Data Prods 300 lpm
- Data Prods 600 lpm
- Data South 80 cps pp1
- Data South 157 cps pp2
- Xerox 4045 Laser Printer 10 PPM

REMOVABLE WINCHESTER DRIVE SUBSYSTEMS

- Power Shuttle 172 (2) 86MB Drives
- Power Shuttle 346 (2) 172MB Drives
- Power Shuttle 760 (2) 380MB Drives

SYSTEMS

- MicroVax II, 5MB, (1-4) 173MB Drives
- MicroVax II, 17MB, (1-4) 380MB Drives
- MicroVax II, 17MB, (1-4) 720MB Drives
- Vax 750 XA-AE

TERMINALS

- C.Itoh 220+ Amber
- DEC VR201 Monitors Only
- DEC VT101
- DEC VT132
- Esprit Opus 220 Amber or Green
- Esprit Opus 2A Amber
- Falco F500 Green, Amber and Black/White
- Falco Fame II
- Lanpar Vision II-GFX

MEMORY

- Clearpoint
- DEC MicroVax II
- National Semiconductor

COMMUNICATIONS

- Prentice P-2424 Modems

CONTROLLERS

- Emulex SC11
- Emulex SC21
- Emulex SC41
- Emulex SC7000
- Emulex SC01
- Emulex SC02
- Emulex SC03
- Emulex SC04
- Emulex QD32
- Emulex TC12

We also carry hundreds of Cables and Modules

All systems, subsystems and peripherals available for short term rental or lease.

714-632-6986

 DIGITAL DEALERS ASSOCIATION

DATALEASE

Registered Trademarks of Digital Equipment Corporation

CIRCLE 385 ON READER CARD

NEW/USED EQUIPMENT

Imagine Buying New Equipment at Used Prices!

NEW

RA81-AA-AD
\$11,000

NEW

MS630-CA
\$2,195

NEW

KDJ11-AB
\$1,650

NEW

RA60-AA
\$12,500

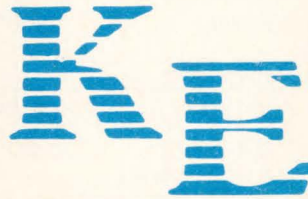

NEW

VT320
\$435

NEW

HSC5X-BA, CA
\$9,650

KIMBERLY ELECTRONICS

800-843-4009

In NJ 201-387-0872

140 Route 17 North
Suite 210

Paramus, NJ 07652

NEW

LA75-CA
\$650



NEW

DELNI-AA
\$1,150

NEW

DSRVA-AA
\$2,495

NEW

LN03-AA
\$2,295

NEW

DESTA-AA
\$235

NEW

H4000
\$250

NEW

DELUA-M
\$3,195

Warranty

Customer Service

Compatibility

Immediate Delivery

Call us for our latest prices on Digital, Fujitsu, Emulex, National Semi, Cipher and ask for our new catalog.

Call Kimberly where what you imagine can become a reality!

DEC and VAX are Trademarks of Digital Equipment Corp.

CIRCLE 381 ON READER CARD

NEW/USED EQUIPMENT

We Have It Now!

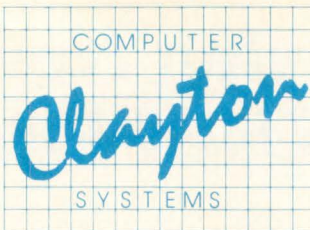

(916) 925-5727

FAX: 916-925-7340

DIGITAL SYSTEMS

LSI - PDP11 - VAX - BI

VAX 8550

VAX 8350

VAX 8200

VAX 11/785

VAX 11/780

VAX 11/750

Micro VAX II

CPU's - Options - Parts

SPECIALS

Disk & Tape Drives

RA81-AA 456MB . . .9500°°

RA60-AA 205 MB 11,500°°

Communications

*DEQNA-M2200°°

*DHUII-M2850°°

Networking

*DELNI-AA1345°°

*DSRVB-AA3350°°

*NEW EQUIPMENT

FUJITSU PRODUCTS

M2246E 171MB 5¼" . . .795°°

*M2333K 337MB 8" . . .3495°°

*M2344K 690MB 8" . . .6995°°

M2351A 474MB5295°°

*M2351A 474MB7595°°

*M2361A 690MB 10½" 8450°°

*M2372 824MB 8"7550°°

*NEW EQUIPMENT

Controllers, Expansion Boxes
& Subsystems Also Available

Clayton Computer Systems

271 Opportunity Street, Suite I
Sacramento, California 95838

All Equipment Subject To Prior Sale

BUY • SELL • LEASE

CIRCLE 389 ON READER CARD

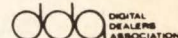

Kimberly Disk and Tape EXTRAVAGANZA

NEW

Digital

RA82-AA,AD \$16,995

RA81-AA, AD \$10,955

RA60-AA \$12,500

NEW

Cipher

F880 \$2,795

M890 \$3,395

M891 \$3,695

M990 \$6,195

NEW

Fujitsu

M2333K \$3,900

M2344K \$7,195

M2351A W/TERMINATOR \$7,495

M2361A W/TERMINATOR \$8,195

ALL EQUIPMENT IS NEW AND IN STOCK WITH WARRANTY



CIRCLE 390 ON READER CARD

140 Route 17N, Suite 210, Paramus, NJ 07652
Kimberly Electronics 1-800-843-4009 • In NJ 201-387-0872 • Fax 201-261-2206

NEW/USED EQUIPMENT

DEC MICROVAX II with 16 MB memory

500+ MB Disk Storage
1600 BPI Tape Drive
1-8 Users

6 month rental ... \$4,765 per month
12 month rental ... \$3,216 per month
24 month rental ... \$2,360 per month

IN STOCK
READY TO SHIP

dda DIGITAL DEALERS ASSOCIATION



1061 S. Melrose Placentia, CA 92670
(714) 632-6986

CIRCLE 392 ON READER CARD

Call Now

We are U.S. Leasing Corporation, the nation's oldest and largest independent lessor of business equipment, and we do more than lease.

- We sell new and off-lease DEC equipment.
- Call us with your equipment needs—complete configurations or simple add-ons.
- We offer excellent service and competitive prices.

VAX • MICROVAX • PDP11
DEC W/P • TERMINALS • PERIPHERALS

VAX 8530 In Stock

Buy • Sell • Lease • Trade

• COMPLETE SYSTEM INTEGRATION •

Call 415/627-9682

415/627-9692

Fax: 415/627-4313

733 Front Street
San Francisco, CA
94122

US
LEASING

dda DIGITAL DEALERS ASSOCIATION

CIRCLE 393 ON READER CARD

MICROVAX II'S (IN-STOCK)
KA630-CPU, 1MB, FP
MS630-BA 2MB Add'l Memory
RD53-71MB Disk Drive
RQDX3-Disk Controller
TK50-95MB Cartridge Tape Drive
TQK50-Tape Controller
DZQ11-4 Line Mux
BA23-Enclosure
1-2 User VMS License
System Price \$15,300

VAX 11/780 TO INCLUDE:
KA780-CPU
(2) MS780-FD-2MB Memory
DW780-Unibus Adapter
H9602-Expansion Cabinet
BA11-KU-Expansion Chassis
DD11-DK-9 Slot Backplane
VMS License
System Price \$13,900

Printers/Terminals	MISC. EQUIPMENT	Drives/Packs	
VT240 (New)	\$1,300	RL02-A	\$395
VT220	\$395	RL02K-DC	\$95
VT100	\$295	CDC9766	\$2,800
LA100	\$795	FUJI EAGLE	\$5,900
LA120	\$850	RA81-AA	\$11,500
HSC5X-BA	COMMUNICATIONS & CLUSTER EQUIPMENT		\$1,150
HSC5X-CA	\$8,900	DELNI (New)	\$1,750
DECSA-EA	\$8,900	DEONA	\$1,695
	\$6,000	DEUNA	

dda DIGITAL DEALERS ASSOCIATION

Minnecomputers, Inc.
9201 E. Bloomington Frwy. • Mpls., MN 55420
(612) 884-6601 FAX (612) 884-6652

CIRCLE 391 ON READER CARD

SOFTWARE

EDITECH, The one-stop source for all your DEC software needs, offering:

WORDPERFECT AND DATABILITY FOR YOUR VAX

NOW SHIPPING

- WordPerfect Version 4.2
- All-In-One Integration
- WordPerfect's New Office Program

CORPORATE DISCOUNTS
SPECIAL GOVT, EDUCATIONAL AND CLUSTER PRICES
SOFTWARE LEASING

ORDER YOUR DEMO TODAY

EDITECH

310 Madison Ave, Suite 2008
New York, NY 10017

(212) 661-7178

(212) 949-9143

Authorized WORDPERFECT & DATABILITY DEALER

CIRCLE 394 ON READER CARD

NEW/USED EQUIPMENT

DEC VT240/340 ALTERNATIVE!!

LANPAR



**TEKTRONIX or
ReGIS GRAPHICS
The Choice is Yours**

- 800 x 360 Resolution
- Multipage
- Separate Text Handling
- Logic for High Speed
- VT220 Compatible

Call For Low, Low Price

714 632-6986

CIRCLE 506 ON READER CARD

DEC EQUIPMENT

★ Immediate Delivery

★ Fully Guaranteed ★ Lowest Prices

ESS COMPUTER INC.

127 W. MAIN
WEST FARGO, ND 58078



701-282-8380

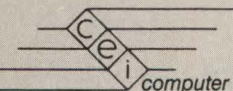

computer enhancements, inc.



BUY - SELL - TRADE

DEC and DEC Compatibles

SYSTEMS • PERIPHERALS • TERMINALS
MODULES • MEDIA

5008 West Linebaugh Ave. Suite 56
Tampa, Florida 33624

(813) 968-5533
FAX (813) 264-0280

DIGITAL SOLUTIONS BUY • SELL LEASE • TRADE



11X84-BA	\$15,900
RA81-AA USED	\$10,200
CIBCI-AA	\$ 7,395
BA11-KU	\$ 525
11/70-NK	\$ 2,350
CI750-BC	\$ 6,995
VT220-D, F (New)	\$ 425
CDC9766	\$ 1,895
CDC9762	\$ 795
SI9400	\$ 250
SC70	\$ 400

COMMUNICATIONS

DELNI-AA (NEW)	\$1,195	KDA50-QA (NEW)	\$5,750
DEMPR-AA (NEW)	\$2,895	RA60-AA (NEW)	\$13,750
DSRVA-AA (NEW)	\$3,295	RA60-P (NEW)	\$825
DSRVA-AA (USED)	\$2,195	RA81-EA (NEW)	\$39,950
DSRVB-AA (NEW)	\$3,365	RA81-AA (NEW)	\$12,900
DH11-AD	\$175	RA81-AA (USED)	\$10,200
DHQ11-M (NEW)	\$1,350	RD53-AA	\$900
DHU11-M (NEW)	\$2,995	RH780-AA	\$500
DHV11-M (NEW)	\$1,285	RK11-D	\$225
DMC11-AL	\$150	RP06-AA	\$100
DMF32-LP	\$595	RQC25-AA, Q BUS CONTL	\$450
DZ11-A, B	\$345	RQDX3 (NEW)	\$1,795
DZ11-DP	\$495	RXV11 (M8029)	\$100
DZ11-M	\$225	UDA 50-A Kit	\$500
		UDA 50-A (NEW)	\$3,500
		UDA 50 (USED)	\$1,550

DISK & TAPE

MEMORY, TERMINALS, PRINTERS & MORE

916-638-5606

3083 Gold Canal Dr., Suite 500 Rancho Cordova, CA 95670

YOUR NATIONWIDE SOURCE FOR DEC * FAX 916-638-3172

* REGISTERED TRADEMARK OF DIGITAL EQUIPMENT CORP.



CIRCLE 507 ON READER CARD

SINCE 1979



"THE FIRST NAME IN SECOND SOURCE"

**BUYS - SELLS - LEASES
NEW & USED DEC® EQUIPMENT**

VAX COMPUTER SYSTEMS, PERIPHERALS
DISK & TAPE DRIVES, MEMORY
MICRO VAX II

**IMMEDIATE DELIVERY
ON 90% OF ALL
DEC ITEMS!**



**SAVE UP TO
50% OFF
MFG'S LIST PRICE**

MULTITRONICS INC.
340 Manley Street
W. Bridgewater, MA 02179
TELEX 517030

**Call Today For a Quote
WITHIN MA (617)584-2800
OUTSIDE MA (800) BUY-A-VAX**

FAX MACHINE #617-584-8172

Registered trademarks of Digital Equipment Corporation

NEW/USED EQUIPMENT

BUY • SELL • LEASE

SA482 NEW 1 Year Warranty \$70,500

DISK & TAPE		CPUS & OPTIONS	
RA81-CA	\$10,750	VAX 785	\$62,000
RA81-AA	\$ 9,800	VAX 780	\$15,200
RM80-AA	\$ 1,500	VAX 750	\$ 5,000
TU81-AA	\$15,000	MVII	\$11,300
CDC9766	\$ 2,500	11/70	\$ 3,400
2351	\$ 5,500	HSC50	\$28,500
F880	\$ 1,200	CI780	\$ 8,800
		CI750	\$ 7,800

For Special System & Subsystem Pricing

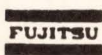

Call Those Who Offer More Than Just Price And Availability



VAX • PDP • LSI



2363 Teller Rd. #114
Newbury Park, CA 91320
(805) 498-4577
FAX # (805) 498-6827

3868 Carson Street #317
Torrance, CA 90503
(213) 540-0292
FAX # (213) 540-9380

CIRCLE 510 ON READER CARD

DEC PDP-11
SYSTEMS & PERIPHERALS

BUY & SELL

THE **One-Stop EXCHANGE!**

- CPUS • TERMINALS
- DISC DRIVES • PRINTERS
- INTERFACES, ETC.

dcb DIGITAL COMPUTER EXCHANGE INC
27773 Industrial Blvd., Hayward, CA 94545
FAX (415) 887-5590 TLX 709536
Call (415) 887-3100

NEW for PRO 300

- NEW AFFORDABLE MEMORY BOARDS for PRO 350 / 380
- DISK DRIVES - BIG & FAST for P/OS V2 and V3
- RAM-DISK SOFTWARE for Micro/R SX, 11M(+) & P/OS

Call (415) 420-9579

Proto Systems
1238 Josephine St
Berkeley, CA 94703
RSX, P/OS & PRO are trademarks of Digital Equipment Corporation

We Still Support
**PRO 350/380,
DECMATES &
RAINBOWS**

Systems & Upgrades
Printers, (Too)

LA50 LA100 LA210
LQP02 LQP03 LN03

item, inc.

5510 Cherokee Ave. #320
Alexandria, VA 22312
800-367-4836 or 703-941-1860
Fax 703-354-2329

SOFTWARE

ASA PMS

A COMPLETE SYSTEM FOR MANAGING PROJECTS

ASA — P.O.Box 3397,
Church Street Station,
New York, NY 10008.
Tel: (212) 321 - 2408

Serving the profession of project management since 1969.

VAX TIMESHARING

- 5 Dollars Per Connect Hour
- Local Network Dial-In Option
- Tape/Media Storage Vaults
- Consulting and Software Development

Accountant II Financial Applications: O/E & Inventory, A/R, A/P, G/L, Payroll



701 Seventh Avenue, Suite 9W
New York, NY 10036

212-221-2517

30-DAY WARRANTY OVERNIGHT DELIVERY

LA-34 (DECWRITER IV) SPARES

LOGIC BOARD	(54-13374)
SERVO MOTOR	(70-15737)
PWR SUPPLY	(H7834)
PRINT HEAD	(70-15734)
STEPPER MOTOR	(12-15558)
KEYBOARD ASSY	(70-15514)

LA-35/36(DECWRITER II) SPARES

LOGIC BOARD	(M7722)
SERVO MOTOR	(70-09691)
PWR BOARD	(54-10805)
PRINT HEAD	(70-09883)
STEPPER MOTOR	(12-11563)
KEYBOARD ASSY	(LK02)

LA-120 (DECWRITER III) SPARES

LOGIC & PWR	(M7081)
SERVO MOTOR	(70-15388)
PWR SUPPLY	(H7110/H7150)
PRINT HEAD	(70-15085)
STEPPER MOTOR	(70-15389)
KEYBOARD ASSY	(70-15763)

LA-180 (DECWRITER I) SPARES

LOGIC BOARD	(54-11023)
SERVO MOTOR	(70-10092)
PWR BOARD	(54-11021)
STEPPER MOTOR	(12-11563)

LQP01 PRINTER SPARES

TRANSDUCER	(29-22466)
LOGIC 1	(29-22487)
LOGIC 2	(29-22488)
SERVO PCB	(29-22489)
CARRAGE PCB	(29-22490)
PNT-WHEEL PCB	(29-22491)
PWR SUPPLY	(30-13094)

VT05 TERMINAL SPARES

TUBE	(30-10326)
LOGIC	(M7000)
CHAR GEN	(M7001)
TIMING	(M7002)
INTERFACE	(M7003)
HIGH SP I/F	(M7004)
KEYBOARD	(30-10166)
PWR SUPPLY	(H733)

VT50 (DECSCOPE I) SPARES

ROM UART	(54-10893)
DATA PATHS	(54-10906)
PWR SUPPLY	(54-10886)
KEYBOARD	(54-10906)

VT52 (DECSCOPE II) SPARES

ROM UART	(54-11743)
DATA PATHS	(54-11745)
PWR SUPPLY	(54-10886)
KEYBOARD	(54-11170)

VT78 TERMINAL SPARES

MONITOR BD	(54-11444)
CMOS-8 LOGIC	(54-12660)
MEMORY	(54-12691)
DIST.PANEL	(54-12861)
PWR SUPPLY	(H7832)

VT100 TERMINAL SPARES

BASIC VIDEO	(54-13009)
MONITOR BD	(70-17362)
PWR SUPPLY	(H7831)
KEYBOARD	(70-15765)

No payments due for 10-DAYS to give you time to install and test our spares. Telephone orders accepted. (We also DROP-SHIP directly to your customers under your name if needed.) Same day shipping on most items. No extra charge to expedite orders. Many more spares and options are listed in our new 1986 40-page catalog.

CALL TODAY!

1-(800)443-6400

(In Texas Call: (214)278-4031)

FEDERATED CONSULTANTS
2306 COUNTRY VALLEY
GARLAND TX 75041

CIRCLE 508 ON READER CARD

LP25/26/27 PRINTERS

REMANUFACTURED PRINTERS DIRECT
FROM THE ORIGINAL MANUFACTURER



Dataproducts

Resale Department

Call Today
(818) 888-4488
Ext. 650



CIRCLE 509 ON READER CARD

NEW/USED EQUIPMENT

Look for the logo



It's your insurance that you are doing business with a reputable dealer in the used DEC marketplace. The Digital Dealers Association (dda) was formed in 1982 as a trade association to promote ethical dealings in the secondary hardware market.

For more information

(313) 475-8333

DIGITAL DEALERS ASSOCIATION

107 S. Main St.
Suite 202
Chelsea, MI 48118

CIRCLE 468 ON READER CARD

ADVERTISING SALES

NATIONAL SALES MANAGER Cal James Franklin, 1061 S. Melrose Ave., Ste. D, Placentia, CA 92670-7180, 714-632-6924

REGIONAL SALES MANAGERS

Southwest—Karen Silverstein, 1061 S. Melrose Ave., Ste. D, Placentia, CA 92670-7180, 714-632-6924

Northwest—Candace Ahern, 1250 Oakmead Pkwy. #210, Sunnyvale, CA 94088-3599, 408-720-1758

Northeast—Ken Melchin, 6 Faneuil Hall Marketplace, Boston, MA 02109, 617-723-2477

Mid-Atlantic—James Shannon, 6 Faneuil Hall Marketplace, Boston, MA 02109, 617-723-2477

Midwest—Lynn Bhullar, 1061 S. Melrose Ave., Ste. D, Placentia, CA 92670-7180, 714-632-6924

ADVERTISING SUPPORT MANAGER Christine Withrow

CLASSIFIED SALES MANAGER Holly Debany

LIST RENTAL COORDINATOR Jeff Flasco

TELEMARKETING SALES REPRESENTATIVE Kirk Phillips

SALES SECRETARY Yolanda Mathey

ADVERTISING SALES OFFICE 714-666-8314

ADVERTISERS INDEX

Reader Inquiry Number	Page Number	Reader Inquiry Number	Page Number
444 Access Technology Corp.	36,37	442 Imaging Technology	41
617-655-9191		617-938-8444	
425 Advanced Systems Corp.	111	438 Interactive Technology	27
426 Andromeda Systems	108	800-362-6203	
818-709-7600		In OR 503-644-0111	
437 AOK Software	14	424 ISE Inc.	110
312-884-6800		213-837-8339	
— Apple Computer Corp.	52,53	395 KEA Systems	104
800-538-9696 ext. 505		800-663-8702	
422 Applied Digital Data Systems	112	381 Kimberly Electronics	123
516-231-5400		390 Kimberly Electronics	124
421 Best Power Technology	104	800-843-4009	
608-565-7200		In NJ 201-387-0872	
380 Boston Boards & Systems Inc.	118	436 MDB Systems	42
617-747-6222		714-998-6900	
396 Brainwave Systems Corp.	105	511 Meadowlark Enterprises	117
303-466-6190		617-777-4666	
514 Brookvale Associates	117	414 Medcon	100
West Coast 800-252-6200		714-947-1452	
East Coast 800-645-1167		439 Miltope	29
382 California Boards	120	516-420-0500	
213-542-3000		391 Minnecomputer Inc.	125
516 Chrislin Industries		612-884-6601	
Caribe Inc.	117	378 MRI Corp.	118
800-468-0736		388 MRI Corp.	119
389 Clayton Computer Systems Inc.	124	305-587-7464	
916-925-5727		416 MTI Systems Corp.	11
375 Clearpoint	Cover IV	800-645-6530	
800-CLEARPT		387 National Data Systems	122
— Clyde Digital	50a,50b	201-843-5300	
412 Clyde Digital	51	— New York Computer Exchange	120
377 CMD Technology Inc.	Cover III	516-752-9202	
714-549-4422		466 Nissho Electronics Corp.	46
440 CMS Enhancements Inc.	25	398 Nissho Electronics Corp.	99
714-259-9555		428 Nissho Electronics Corp.	106
376 Codonics Inc	3	800-233-1837 ext. 420	
216-243-1198		In CA 714-261-8811 ext. 420	
374 Cognos	5	402 Northwest Digital Systems	96
800-4-COGNOS		509-447-5631	
418 Cyborg Systems Inc.	7	441 Odesta Corp.	57
312-454-1865		312-498-5615	
419 Datalease	101	372 Owen + Davis Systems	95
420 Datalease	103	714-540-8878	
385 Datalease	122	403 Perceptics	Cover II
392 Datalease	125	615-966-9200	
506 Datalease	126	432 Polytron	6
714-632-6986		503-645-1150	
407 Datamedia Corp.	23	397 Process Software	105
800-DMC-INFO		413-549-6994	
509 Dataproducts Corp.	127	423 Pullizzi Engineering Inc.	110
818-888-4488 ext. 650		714-540-4229	
447 Datatranslations	109	515 QEI Inc.	117
433 Datavision	19	617-275-6800	
414-673-7041		413 Radgo	104
383 Dataware Inc.	120	800-543-1986	
305-771-7600		513-752-6880	
386 DAX	122	411 Restor	13
213-540-2639		606-342-5800	
373 Demac Software Ltd.	31	405 Saturn Systems	102
800-267-3862 (continental U.S. only)		612-944-2452	
613-748-0209 (Canada)		417 Security Dynamics	91
714-553-8683 (California)		617-547-7820	
409 Dex	86	443 Sigma Information Systems	35
714-632-1841		714-630-6553	
429 Digi-Data Corp.	113	518 Stone Mountain Computing	114
301-498-0200		805-964-9101	
510 Digital Consultants	127	404 Strategic Information	85
805-498-4577		800-227-1209	
468 Digital Dealers Association	128	In MA 617-273-5500	
313-475-8333		399 Summus Computer Systems	64
507 Digital Solutions	126	713-589-9772	
916-638-5606		467 Talon Technology Corp.	47
406 DIALOG	66	214-680-9913	
714-937-5700		400 Technology Concepts	65
427 Dyna Five Corp.	107	800-777-2323	
714-751-0133		401 Telebyte Technology	63
512 Eakins Associates	117	516-423-3232	
513 Eakins Associates	117	393 U.S. Leasing	125
415-969-5109		415-627-9682	
430 Edcon Systems	114	517 William A. Pederson & Assoc.	117
617-369-2674		408-734-9511	
394 Editech	125	423 Z-Line	110
212-661-7178		714-540-4229	
384 Electronic Service Specialist Ltd.	121		
414-255-4634			
379 Eli Heffron & Sons Inc.	118		
617-547-4005			
445 Emulex Corp.	58,59		
446 Emulex Corp.	60,61		
800-EMULEX-3			
— ENDL Consulting	115		
408-867-6630			
— Expoconsul International	92		
800-433-0880			
519 FBN Management	116		
416-534-6878			
508 Federated Consultants	127		
214-278-4031			
415 GraphOn	8		
800-GRAPHON			

STORAGE ADVERTISERS

408 EMC Corp.	SA15
800-222-EMC2	
434 Emulex Corp.	SA5
800-EMULEX-3	
In CA 714-662-5600	
410 MDB Systems	SA2,3
714-998-6900	
435 Quickware Engineering	SA7
800-237-1185	
In MA 617-782-8330	

IN THE SPOTLIGHT

The optical storage market for write-once is expected to grow to more than four times its present size in the next four years (see graph). If you're interested in this fast-growing market, plan to attend **Optical Storage 88**, which is being held May 16-18 at the Hyatt Regency in Denver. This three-day conference, priced at \$995, will focus on actions required to make optical storage a major growth industry and not just a promising technology.

Two "must attend" events, **DEXPO Spring 88** and the **DECUS U.S.**

Chapter Spring '88 Symposium, will be held in Cincinnati in May. DEXPO will take place at the Cincinnati Gardens, May 17-19, and DECUS will be held May 16-20 at the Cincinnati Convention Center and the Clarion Hotel. A day of Pre-Symposium Seminars will be held on May 15. Pre-registration fees (deadline is April 29) for the DECUS symposium range from \$200 for one day to \$400 for all five days. Walk-in fees are considerably higher. The pre-registration rate for the Pre-Symposium Seminars is \$225 and the walk-in rate is \$335.

PROJECTED WORLDWIDE SHIPMENTS
WRITE-ONCE OPTICAL DRIVES

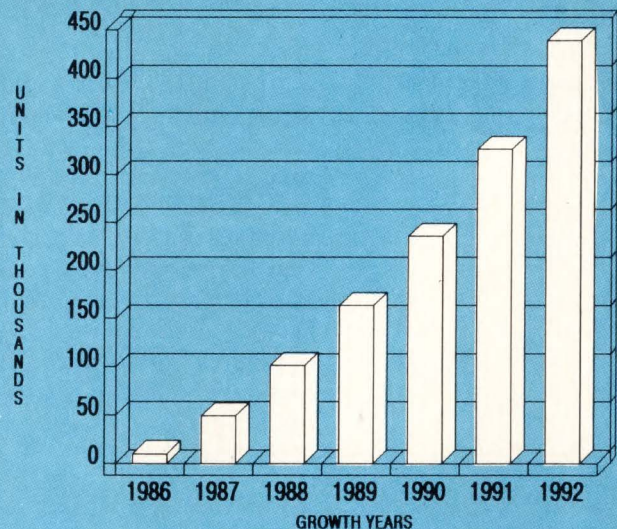

MAY

2-4—Evaluating and Implementing Local Area Networks; Boston; contact the Institute for Advanced Technology, Registrar (ETCIAT), 1450 Energy Park Dr., St. Paul, MN 55108-5299, 800-638-6590; also May 16-18 in New York.

2-5—AutoCAD Expo '88; Chicago; contact Autodesk Inc., 2320 Marinship Way, Sausalito, CA 94965, 415-332-2344.

3,4—1988 National Conference on Managing DEC-IBM Integration; Chicago; contact Gregg Martin, DeBoever & Associates Inc., 179 Great Rd., Ste. 220, Acton, MA 01720, 617-264-0155.

3-6—CASExpo-Spring; Dallas; contact CASExpo-Spring Coordinator; 3825-I S. George Mason Dr., Falls Church, VA 22041, 703-845-1657.

4-6—AI '88; Long Beach, CA; contact Dr. Murray Teitell, General Program Chairman—AI '88, c/o Intelligent Choice, 1050 Duncan Ave., Ste. D, Manhattan Beach, CA 91109, 213-379-9680.

9-11—Voice/Data Integration and ISDN; Washington, DC; contact the Institute for Advanced Technology, Registrar (ETCIAT), 1450 Energy Park Dr., St. Paul, MN 55108-5299, 800-638-6590.

9-12—Comdex/Spring '88; Atlanta; contact Comdex/Spring '88, Registration Department, 300 First Ave., Needham, MA 02194.

11-13—Neural Networks and Parallel Distributed Processing; San Francisco; contact The Institute for Professional Education, P.O. Box 756, Arlington, VA 22216, 703-527-8702.

11-13—Project Management: A Practical Workshop; Atlanta; contact The Institute for Professional Education, P.O. Box 756, Arlington, VA 22216, 703-527-8702.

15—DECUS Training Seminars; Cincinnati; contact the Digital Equipment Computer Users Society, 219 Boston Post Rd., BPO 2, Marlboro, MA 01752-1850, 617-480-3290.

15-20—Third International Conference on Supercom-

puting and Second World Supercomputer Exhibition; Boston; contact the International Supercomputing Institute Inc., Ste. B-309, 3000 34th St. S., St. Petersburg, FL 33711, 813-866-2694.

16-18—Aligning MIS With Business Goals; San Francisco; contact The Institute for Professional Education, P.O. Box 756, Arlington, VA 22216, 703-527-8702.

16-18—Data Communications and Information Systems Security; San Francisco; contact the Institute for Advanced Technology, Registrar (ETCIAT), 1450 Energy Park Dr., St. Paul, MN 55108-5299, 800-638-6590.

16-18—Optical Storage 88; Denver; contact Optical Storage 88, c/o Cartridge & Associates Inc., 3097 Moorpark Ave., Ste. 202, San Jose, CA 95128, 408-554-6644.

16-20—Analysis of Messy Data; San Francisco; contact The Institute for Professional Education, P.O. Box 756, Arlington, VA 22216, 703-527-8702.

16-20—1988 Spring DECUS U.S. Symposium; Cincinnati; contact the Digital

Equipment Computer Users Society, 219 Boston Post Rd., BPO 2, Marlboro, MA 01752-1850, 617-480-3319.

17-19—DEXPO Spring 88; Cincinnati; contact Susan Werlinich, Press Officer, Expoconsul International Inc., 3 Independence Way, Princeton, NJ 08540, 800-628-8185.

23-25—Relational Database Management Systems: A Comparative Analysis; San Francisco; contact the Institute for Advanced Technology, Registrar (ETCIAT), 1450 Energy Park Dr., St. Paul, MN 55108-5299, 800-638-6590.

23-27—Ninth Annual Conference on Applications of Computer-Aided Software Engineering Tools; Ann Arbor, MI; contact Rebecca Sizemore, general chairperson, Meta Systems, 315 E. Eisenhower, Ste. 200, Ann Arbor, MI 48108, 313-663-6027.

26—The California Computer & Graphics Show; Palo Alto, CA; contact Norm De Nardi Enterprises, 289 S. San Antonio Rd. #204, Los Altos, CA 94022, 415-941-8440.

Bus Stop

BOY, THOSE TINY DRIVES KEEP ON COMING

It seems that all it takes is for somebody like IBM to start using something and a whole bunch of that something starts appearing. That's the case with 3.5-in. Winchester. Quantum Corp. (Milpitas, CA) now has 10 models of the small drive to choose from, ranging in formatted capacity from 42-168 Mbytes with interfaces that include SCSI, ESDI, and the so-called AT bus interface that we call extended bus interface (EBI). The drives all sport a 19-msec average access time and use Quantum's DisCache buffer management system that can, the company claims, lop off another 7 msec on access. This intriguing drive is the 168-Mbyte model; currently only Conner Peripheral (San Jose, CA) is able to deliver a 100-Mbyte unit—primarily to Compaq Computer Corp.—and everyone else, including Maxtor Corp, has announced higher capacities that can't be delivered yet. The bottom line for the disk drive industry hasn't really changed: "They are announcing products in quantity and delivering spec sheets in box cars."

BREAD, MILK, COFFEE, PANTY HOSE . . . AND, OH YES, SOME OSI PLEASE

It may sound funny to order high tech at a grocery store, but if you live in Santa Clara, CA, you can do just that at Fry's. While loading up on Twinkies, you can also grab a package of Touch Communications Inc.'s (Scotts Valley, CA) Open Systems Interconnection (OSI) protocols that enable mixed vendor interoperability. The company supplies its brand of OSI for PCs, Macs, and the ever-present VAX. Andy Laut, Touch's product manager, says that the package is the first to implement all seven layers of the International Standards Organization model. What makes the product nifty in our jaundiced *Hardcopy* eyes is that for \$545 you can pick up a shrink-wrapped version of the Touch OSI Macintosh Developer's Kit. This kit lets you develop applications that will fit nicely into an OSI network—and guess what? It does work; we saw it and liked it.

SHORT THOUGHTS AND CONSIDERATIONS

At *Hardcopy* we happen to be fans of Xerox Corp.'s Ventura Publisher. It's a well-thought-out product and has more potential than any other desktop publishing program around. Apparently everyone is catching on to the viability of the product as well. Data General (DG)—you might remember they used to be in the mini business—has latched onto the powerful publishing system to go with its CEO Desktop Composer package, which is a complete PC-based desktop composition system for the corporate environment. Xerox says that the version DG has licensed is a special version—and special has lots of connotations. It seems that, in the past, all of DG's CPUs were special and this is what cost them the minicomputer business.

EVERYONE IS GOING MAC

The latest whoop-de-do in the industry is to have your machine talk to an Apple Computer Corp. (Cupertino, CA) Macintosh or at least have the attributes of one. The latter seems to be the goal of Microsystems Engineering Corp.—MEC—(Hoffman Estates, IL) with its MASS-11 Draw 5.0—a product that the company promises [that's the key word] will add Macintosh-type illustrating capabilities to the IBM PC. The company expects to ship the product this month with a price tag of \$495. MEC has now made a name for itself by providing high-level office automation software for the DEC market, and Apple is saying that the way to handle business problems is to connect a Mac to a VAX, but of course you might already have an IBM PC, so . . . well, what the heck, you get the point. It just goes to prove there's always something out there that will improve the way you work.

CMD PERFORMANCE

Intelligent SCSI Host Adapters

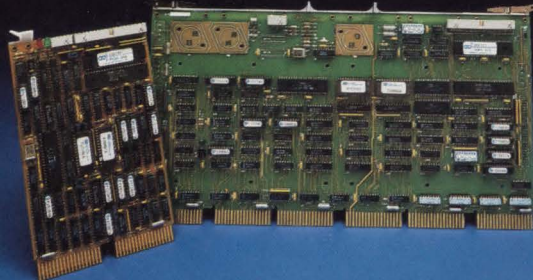

CQD200 CDU700

High-Speed ESDI Controller

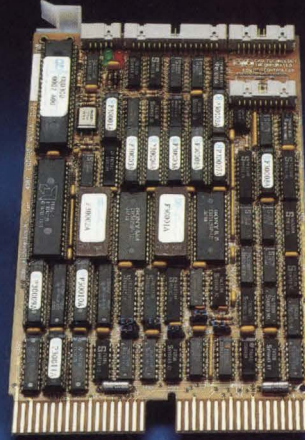

CQD300

"Q-Card™", On-Board Q-Bus Disk Subsystem

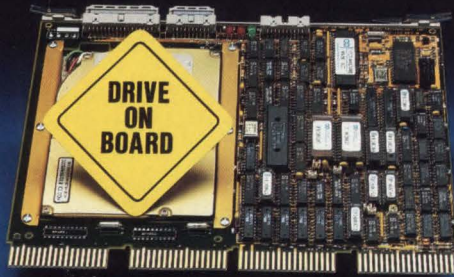

CQD100

"U-Card™", On-Board Unibus Disk Subsystem

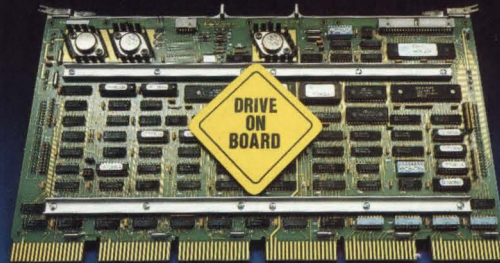

CDU600

MSCP Compatible Controllers and Subsystems For MicroVAX, MicroPDP-11, LSI-11, PDP-11.

CQD100 (Q-Bus), CDU600 (Unibus) —

A cost effective disk subsystem that consists of on-board 3½ inch drive(s) and an MSCP compatible controller. Formatted Capacity: 20MB-140MB/drive.

CQD200 (Q-Bus), CDU700 (Unibus) —

An intelligent SCSI host adapter that offers the best solution to bridging DEC MSCP protocol and SCSI optical, magnetic disk and tape products.

CQD300 (Q-Bus) —

A high performance dual wide MSCP disk controller that interfaces up to two ESDI drives with 15MHz transfer rate.

CQD50 (Q-Bus) —

A low cost dual wide MSCP disk controller that interfaces up to two ST506 drives.

All the above controllers feature a user-friendly on-board utility for formatting and configuration.



For more information or to order call:

1-800-4-CMD-TEC

(1-800-426-3832)

3851 South Main Street • Santa Ana, California 92707 • (714) 549-4422 • FAX: (714) 549-4468

DEC, MSCP, MicroVAX, MicroPDP-11, LSI-11, PDP-11, Q-Bus, Unibus are trademarks of Digital Equipment Corporation. Q-Card, U-Card are trademarks of CMD Technology, Inc.

CLEARPOINT

Only one vendor delivers all your workstation memory needs

◆ Superior Performance ◆ Lifetime Warranty ◆ 24-hour-a-day Support

Memory is critical—don't settle for less. Clearpoint's workstation memory consistently outperforms system vendor offerings with:

- ◆ innovative design
- ◆ superior reliability
- ◆ highest density
- ◆ round-the-clock support
- ◆ unconditional lifetime warranty

Backed by state-of-the-art engineering, manufacturing and QA testing, Clearpoint memory makes the most of workstation performance.



DEC

MicroVAX 2000- Compatible

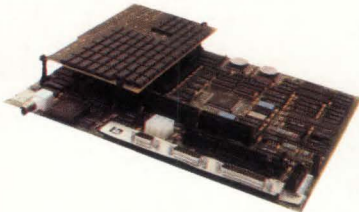

The MV2000/16 MB* nearly triples the density offered by DEC. Achieve identical performance and memory processor to the full configuration MicroVAX II—at half the cost!

MicroVAX II- Compatible

The MV2RAM/16 MB* places the full system memory capacity on one board. Designed to run cooler and draw less power for maximum board life and reliability, the MV2RAM supports jumperless addressing and parity error checking.

*AVAILABLE IN OTHER SIZES

Clearpoint is a registered trademark of Clearpoint Research Corporation. DEC, MicroVAX 2000, MicroVAX II are trademarks of Digital Equipment Corporation. Sun is a trademark of Sun Microsystems Inc. DN3000, DN4000 and Apollo are trademarks of Apollo Computer. IBM, RT PC are trademarks of International Business Machine Corporation.

SUN

Sun 3/2XX and 4/2XX-Compatible

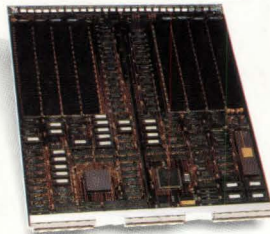

The SNX2RAM/32 MB* delivers the Sun 3/2XX system maximum on a single board. It also offers the enhanced functionality of a micro-processor-managed "on-board hotline" for local and remote diagnostics.

Sun 3/1XX-Compatible

The SNXRAM* fits up to 28 MB in just one slot, freeing four slots for peripherals. Using the latest one megabit DRAMs, you get the highest density plus increased reliability.

Sun 3/60-Compatible

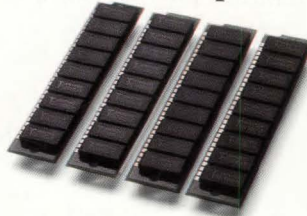

The SNX60, comes in 4 MB SIMM sets that upgrade your Sun 3/60 to an expansive 24 MB. Each SIMM is one MB of reliable Clearpoint memory with a 1 megabit DRAM to support parity checking.

VME

For VMEbus local memory or RAM disks

Offering maximum flexibility, the VMERAM supports 24 and 32 bit addressing and 8, 16 and 32 bit data transfers. Compatible with VMEbus Rev.C specs, the VMERAM is available in 16, 8, 4 or 2 MBs.

APOLLO

DN 4000-Compatible

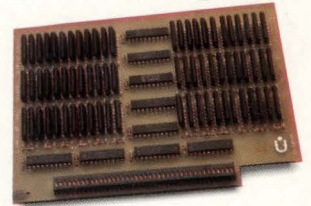

Bring your DN 4000 up to its 32 MB capacity with the DNX4RAM*. Available in 8 MB boards, Clearpoint's cost-effective memory provides Apollo-equivalent performance with lifetime product support.

DN 3000-Compatible

The economical 1 or 2 MB DNXRAM memory offers Clearpoint's quality engineering and manufacturing with performance identical to Apollo.

IBM

RT PC-Compatible

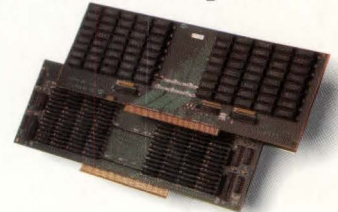

Supporting the upgraded RT models 6150 and 6151, the low-cost RTRAM is available in 4 or 8 MB boards.

Call or write for

- Clearpoint's Product and Services Catalog
- the new Designer's Guide to Add-in Memory
- Specific product info



Clearpoint Research Corp.

99 South Street

Hopkinton, MA 01748-2204

1-800-CLEARPT (617) 435-2000

Telex: 298281 CLEARPOINT UR

Clearpoint CANADA 416-620-7242

Clearpoint EUROPE b.v. 31-23-273744

Clearpoint ASIA 03-221-9726



CLEARPOINT

CIRCLE 375 ON READER CARD