

\$4.90

VOL. 1, NO. 1 • SUMMER 1985

S-100 journal

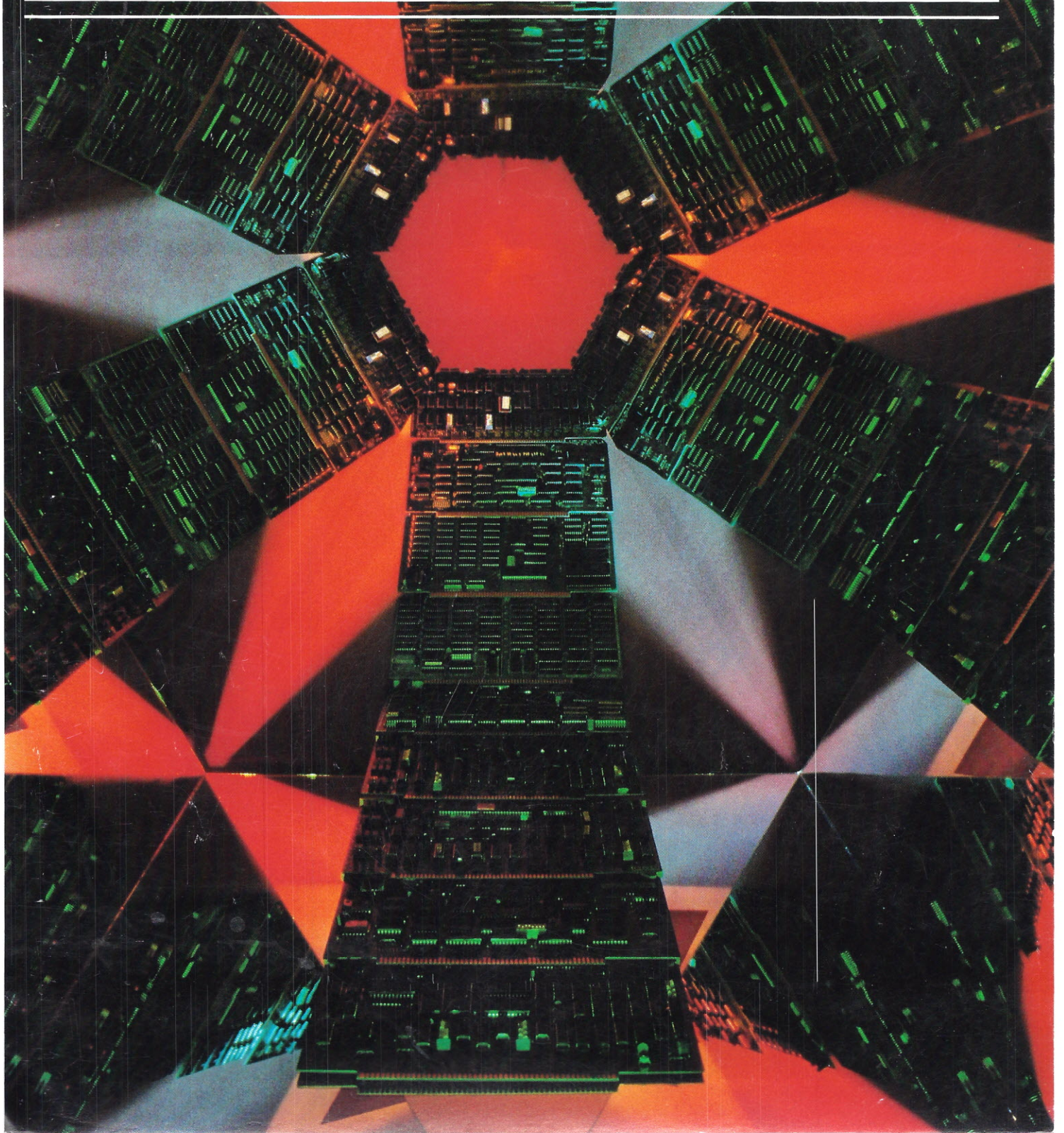



S-100 journal

VOL. 1 NO. 1

SUMMER 1985

Editor

Jay Vilhena

Associate Editor

Robert Petersen

Business Manager

Linda Pereira

Advertising

Jay Vilhena

Technical Consultant

Steve Renshaw

Art Director

Joslyn L. Johanna

S-100 Journal is published quarterly by Octoplus Corporation, 2426 Wade Avenue, Raleigh, NC 27607.

Copyright © 1985 by Octoplus Corporation. All rights reserved.

Subscriptions: U.S., Canada, and Mexico, send \$14.00 for 1 year, \$25.00 for 2 years, to S-100 Journal, P.O. Box 12881, Raleigh, NC 27605. Other countries add \$3.00 per year. Foreign payments must be in U.S. currency.

Advertising: Contact S-100 Journal Advertising, P.O. Box 12881, Raleigh, NC 27605.

POSTMASTER: Send address changes to S-100 Journal, P.O. Box 12881, Raleigh, NC 27605.

Application to Mail at Second-Class Postage Rates is pending at Raleigh, NC and additional mailing offices.

outline

10 ASSEMBLING A 68000-BASED MICROCOMPUTER

14 COMDEX/Spring'85

18 AN EDITOR IN BASIC

21 BUILD A SERIAL SWITCH

38 THE C. ITOH A10-30

40 EDIT-68K

2 EDITORIAL

4 NEW PRODUCTS

6 EDITOR INTERFACE

8 READER I/O

8 BUG REPORT

8 EVENT REGISTER

8 BITS

46 S-100 DIRECTORY

OUR COVER

S-100 boards offer
a kaleidoscope
of high-performance

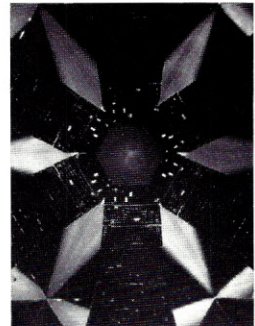

Ten Years After

"After a decade of golden years, S-100 machines lost ground in the press. The warlords of information united to declare the "end" of an era. But the amazing episode was that some users actually believed them and replaced their forever-upgradable S-100 machines by that technology-stopping wart that everyone seems so obsessed in asexually reproducing.

The S-100 industry was stunned for a few months, and those manufacturers that did not succumb to the blue wave, avidly sought refuge in multiuser niches. But you may look now. The blue dragon has been tamed. Software and hardware druids in active cells of the S-100 world once again proved that our machines can and will run anything."

Enough tales! Reality shows that S-100 systems will continue to be the most versatile and upgradable microsystems in existence. We were getting pretty tired of the lack of media support for our systems so the publication of S-100 Journal came as a logical conclusion. We hope that the magazine now in your hands will be a constant help in upgrading and using your S-100 system to its full potential.

S-100 Journal is dedicated to users, user-integrators, and professional integrators, in that order. The technical level of our articles will range from very basic to sophisticated. The goal is to provide stimulating information for advanced S-100'ers while not losing the beginners.

We want S-100 Journal to be an open magazine. Open in the sense that readers will always be encouraged to express their opinions and participate with articles. But also open in the sense that we will use the magazine to attract new users to the S-100 community. This is a basic necessity, if we want S-100 systems to continue evolving.

We will also be a complete magazine. We will cover peripherals, languages, operating systems, other software, shows, and many other topics. If it can be of interest to S-100'ers, and it is not a competing system or general MS-DOS/PC-DOS software, we will cover it.

S-100 Journal will support both new and older machines. Whether you are perfectly happy with your vintage Altair or can't wait for the latest multi-user 12-MHz powerbox, you can count on support from us. We will provide information on setting up new systems, upgrading older ones, or simply on using older or new systems for general or special applications. We are biased towards S-100 products that abide by the IEEE 696 Standard, but we will support just about anything built with S-100 boards.

Well, turn the pages and see for yourself what S-100 Journal is all about. Then, let us know what you think. We want to continually improve the magazine, and your suggestions are always welcome.

Jay Vilhena

S-100 JOURNAL ADVERTISEMENT POLICY

S-100 Journal is fully dedicated to the support of the S-100 bus. This editorial policy will extend to the advertisements that will be accepted for publication.

We welcome advertisers of S-100 systems, S-100 boards and other components, and most products or services adequate for the typical S-100 environment or which we judge to be of interest to the S-100 community in general. This includes terminals, printers, modems, software, accessories, supplies, and other products or services. It *does not* include nonS-100 systems and accessories, software, or services specific to nonS-100 systems.

MS-DOS/PC-DOS software will be accepted *only* if it is specially configured

or produced for an S-100 system. General purpose MS-DOS/PC-DOS software will *not* be accepted.

We reserve the right not to publish any advertisement and to decide whether or not a product or service meets our S-100 criteria. Our decision will be final.

Whenever the application of a product is not obvious, we ask that advertisers, if possible, please state explicitly on the ad what S-100 systems their products are intended for.

In the particular case of mail-order houses and other general vendors to whom it may be difficult to produce S-100 specific advertisements, up to 50% of nonS-100 material may be included per ad.

**YOU CAN'T BUY HIGHER QUALITY,
MORE RELIABLE S-100
STATIC MEMORY BOARDS
AT ANY PRICE!**

256K BYTES
S-RAM 256™

\$749 *
Qty. One

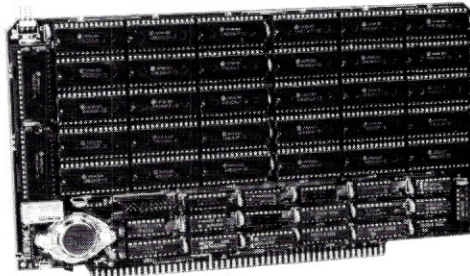

128K BYTES
S-RAM 128™

\$449 *
Qty. One

STANDARD FEATURES:

- Operates in excess of 12 MHz
- Certified system ready (industrial grade dynamic burn in)
- Supports 8 and 16 bit data transfers
- IEEE 696/S-100 compatible
- 24 bit addressing
- Address strappable to any 128K block within the 16 meg address range
- Extremely low power consumption
- Single +5 volt operation
- One year warranty

OPTIONS

- Battery back-up capability
- Military MIL-STD-883B type burn in
- Faster ram chips available

***SAVE AN ADDITIONAL \$100!** Buy one 256K board at \$749 and receive a \$100 certificate towards the purchase of your next 256K board. Buy one 128K board at \$449 and receive a \$50 certificate towards the purchase of either board.

NO HIDDEN CHARGES! Performics Inc., prices include dynamic burn in, insurance and UPS ground delivery within the continental U.S.

TERMS: Certified check, COD, Visa/Mastercard Volume discounts available.

Performics continues to deliver high performance products and excellent service at realistic prices.

S-RAM 128 and S-RAM 256 are trademarks of PERFORMICS INC.



ORDER NOW!
(603) 881-8334

11 Morning Dove Rd. • Kingston, New Hampshire 03848

IEEE 696 SINGLE BOARD 68000 COMPUTER

A 68000 Single Board Computer (less RAM), called the X-tended 68000, is available from PSCE, Inc. This board features an 8 MHz 68000 CUP, 8-16K of EPROM, two RS-232 ports, Centronics port, and floppy controller that handles 8-, 5¼-, or 3½-inch drives.

The CPU can access up to 16 Megabytes of 8- and/or 16-bit memory.

PSCE also offers CP/M-68K with optimized BIOS for this board. A program is included that allows the user to interactively reconfigure the BIOS. This includes interactively setting any-size buffers for the parallel and serial ports.

The board lists for \$850, without the Operating System. Quantity discounts are available. Contact PSCE, Inc., PO Box 8, Port Jefferson, NY 11777. Telephone (516) 473-7500.

COMPUPRO 816 WITH CADD GRAPHICS

Genesys Systems, Inc. and Illuminated Technologies, Inc. have announced a multipurpose, multiuser CADD (Computer-Aided Drafting and Design) system configured on Viasyn's CompuPro 816 series. The graphics capabilities are provided by the GB3MP S-100 single board from Illuminated Technologies. This graphics board offers eight colors and 1024x1024 resolution.

The system features up to three independent AutoCad-2 drafting workstations, in addition to several other stations, in the multiuser environment provided by Viasyn's Concurrent DOS 8-16. All features of Concurrent DOS 8-16, including the

ability to read a variety of disk formats, are present.

Plotters, mice, and digitizer tablets can be plugged into the system.

Genesys can supply a driver to run Digital Research's GSX graphics package in addition to AutoCad. Software is also available that permits printing of typeset text, together with AutoCad graphics, on the Hewlett-Packard LaserJet.

Systems with 40-Megabyte hard disk, one AutoCad station, and two other users, start at \$25000. Contact Genesys Systems, Inc., PO Box 277, 105 N. Main, Ellingwood, KS 67526. Telephone (316) 564-3636.

NEW MULTIUSER MICROS FROM IMS INTERNATIONAL

Two new series of multiuser microcomputers, the 1600 and the 800, have been introduced by IMS International. Both series are based on a proprietary architecture of the S-100 Bus, called S-100+ bus by IMS.

The 1600 series, available in various configurations, features an 80186 master CPU running at 8 MHz. The 800 series, also available in various configurations, uses a Z80B master CPU running at 6 MHz. Both series offer multiprocessing capabilities. Both can be configured with 80186 and Z80B slaves running simultaneously. The processor boards carry their own RAM, up to 1 Megabyte with the 80186 and 128K with the Z80B.

These systems run under a customized version of TurboDOS. The 80186 slaves will also run MS-DOS programs.

Standard configurations include a floppy drive and a Winchester hard disk. Complete systems, featuring the 80186 master and 85-Megabyte Winchester, start at \$8620. The starting price for a

complete Z80B system with 24-Megabyte Winchester is \$4395.

For more information contact IMS International, 2800 Lockeed Way, Carson City, Nevada 89701. Telephone (702) 883-7611.

NEW MULTIUSER SYSTEM RUNS MIRAGE OS

The MultiUser-16, a multiuser multitasking system, is now available from Inner Access. The system features the Motorola 68000 processor running at 8 MHz, or optionally at 10 MHz. It comes with 512K of RAM, 40-Megabyte hard disk, and 2.76-Megabyte floppy drive.

Multiuser-16 runs the Mirage Operating System and supports eight users. Several major languages are available for running under Mirage.

The system provides four empty S-100 slots for expansion, and it adheres to the IEEE-696 standard. The OEM/VAR price is \$8995.

Contact Inner Access Corporation, PO Box 888, Belmont, CA 94002. Telephone (415) 591-8295.

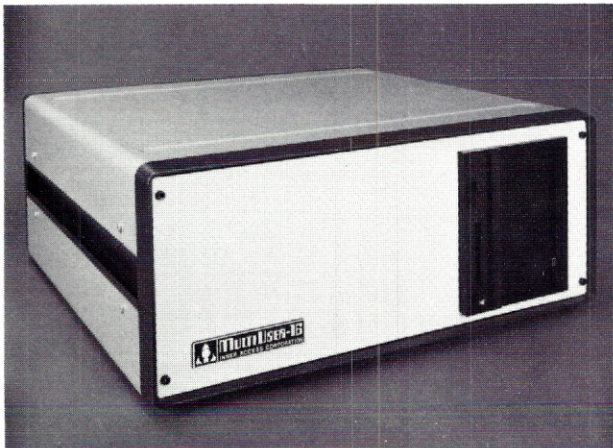

S-100 BOARD BOOTS PC-DOS DIRECTLY

Tarbell Electronics has announced that the Duplex 816 S-100 Board will now boot the stock PC-DOS bought at "your local computer store." Tarbell provides an installation program to customize PC-DOS to a terminal for proper cursor addressing.

Tarbell suggests that it should also be possible to configure the Duplex 816 with Viasyn's PC Video Board and thus run PC-DOS programs with bit-mapped graphics.

In addition, the Duplex 816 also boots CP/M-80 2.2, CP/M-86 1.1, Concurrent CP/M 3.1, and Multiuser Concurrent CP/M 3.1.

The Duplex 816 is a dual-processor board featuring an 80186 and a Z80H, both running at 8 MHz. It lists for \$1100.00. Owners of this board can exchange the old boot PROM for the new one, for \$10, or simply buy the new one for \$40.

For more information, contact Tarbell Electronics, 1082 E. Artesia Blvd., Long Beach, CA 90805. Telephone (213) 422-7081.

The New Products section is compiled from manufacturers' press releases. In most instances, we have not seen, much less tested, the products described. For additional information, the manufacturers or their vendors should be contacted.

Only press releases on S-100 products and peripherals will be considered for publication. High-quality photographs are welcomed. Press releases should be dated and should include prices. Send to New Products, S-100 Journal, 2426 Wade Ave., Raleigh, NC 27607.

editor interface

This is the column where we publish and respond to readers' letters, particularly those that concern the contents or the orientation of the magazine.

Whenever you feel like expressing an opinion (an action that we exalt), sit at the terminal and let your thoughts flow. Transfer the message to paper and send to Editor Interface, S-100 Journal, P.O. Box 12881, Raleigh, NC 27605.

This being the first issue, there are no letters to publish yet. However, quite a few of you have already expressed comments, questions, uncertainties, wherever you could find a blank area on the subscription card that you sent back. Personally, I liked the messages that simply said "Hooray!" across the card.

All the requests that we've had for editorial

content seem, so far, to agree closely with material that we have planned for the magazine.

A few subscribers questioned how long S-100 Journal would continue supporting S-100 systems exclusively. The answer is very clear: For as long as there are S-100 systems to support and the magazine continues to be published.

I would like to thank all that sent us encouraging words and whose enthusiastic replies kept us excited about bringing S-100 Journal to publication. Thanks are also due to all the charter subscribers who have been placing their trust on us even before seeing a single copy of the magazine. We will make S-100 Journal live up to and beyond your expectations.

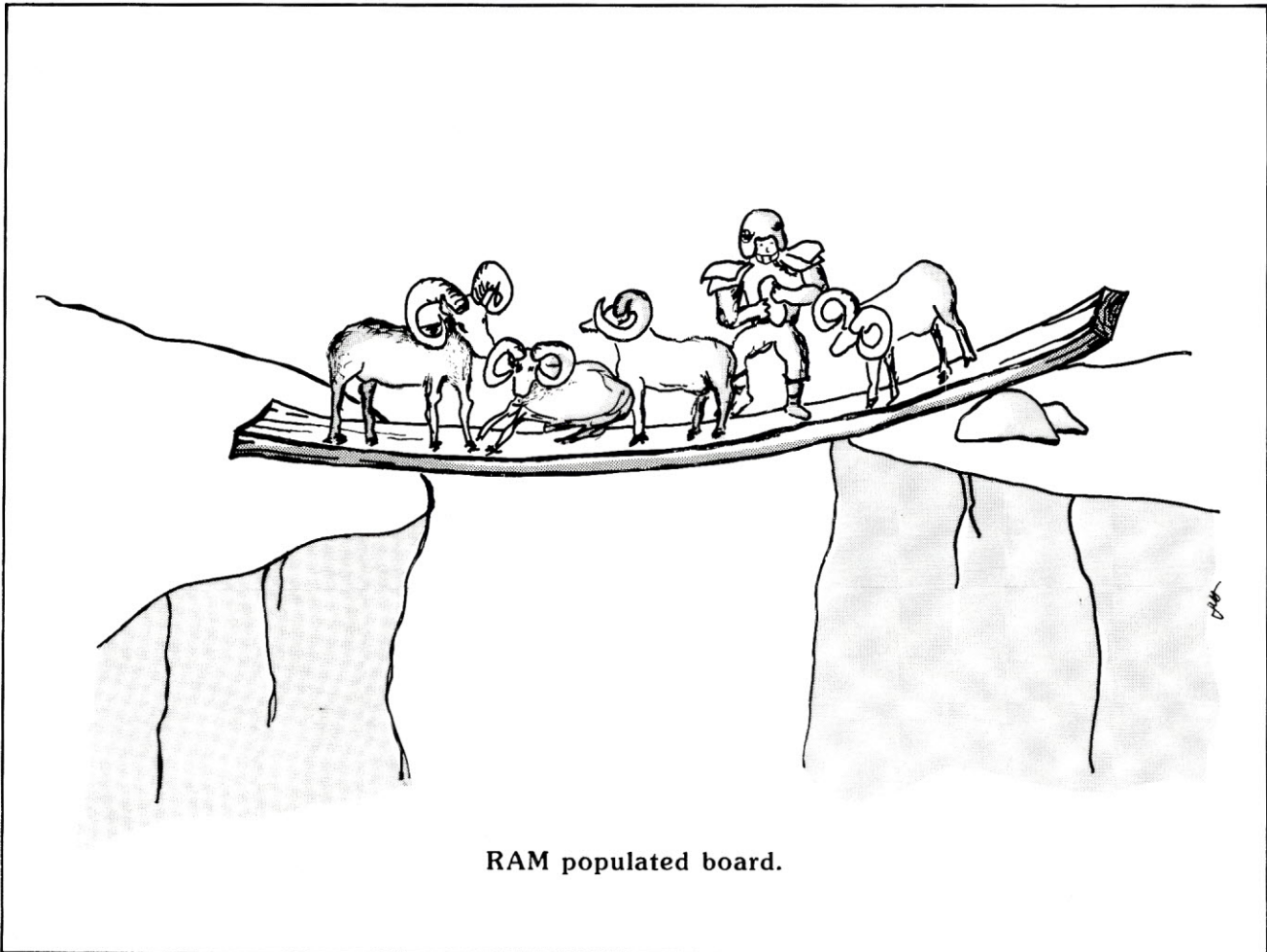

S-100 JOURNAL ANNOUNCES

THE S-100 SOFTWARE GUIDE

Every November, S-100 Journal will mail to all subscribers, at no charge, **THE S-100 SOFTWARE GUIDE**. **THE GUIDE** is published as a service to the S-100 community. We hope that **THE GUIDE** will help promote development of software for S-100 systems by offering software publishers a vehicle to advertise at nominal cost.

Plan now to include your software product in the 1985 **GUIDE**. The cost is only \$50 for 1/2 page. Deadline is October 15.

All software must conform to S-100 Journal's Advertisement Policy (see the first pages of the magazine).

Yes! I want to reserve space in **THE GUIDE**.
Please send size requirements and **GUIDE**lines.

NAME _____

ADDRESS _____

MAIL TO: **THE GUIDE**, c/o S-100 Journal
PO Box 12881, Raleigh, NC 27605

The departments on this page are intended for reader use and will be implemented as soon as enough letters start arriving. Please print your letters and send to: (department name), S-100 Journal, PO Box 12881, Raleigh, NC 27605.

reader i/o

This department will be an interactive medium for readers. There are two ways to participate. A reader may send in questions or send in answers. Selected questions will be published in each issue. Then, in the following issue, we will publish a sample of the answers received. The questions published may vary from just a short technical inquiry to long

ongoing debates on some theme.

READER I/O will be subdivided into three parts. The **HARDCORE FORUM** is for discussing advanced topics. The **SOFTCORE FORUM** is for topics and questions of a less technical nature. Finally, the **PHILOSOPHICAL FORUM** is for letting out steam, discussing ethics, and so on.

bug report

We envision this department as an efficient way for communication between users and manufacturers. Users should use the column to report bugs and undocumented features (or documented but non-

existent features) on hardware and software. Manufacturers and software publishers should send in notices about bugs, updates, and similar information useful to those using their products.

event register

Announcements of events that may be of interest to the S-100 community will be published at no charge. All announcements must include the date of the

event, topic, and whom to contact for more information.

bits

Non-commercial small advertisements will be published at no charge. Readers may take advantage of this service to sell or buy used hardware, trade

personal programs, etc. Messages should be kept short.

REVOLUTIONIZE

**YOUR S-100 SYSTEM TO 68000 POWER
WITH OUR MULTIUSER HARDWARE/SOFTWARE
PACKAGE THAT SUPPORTS 8 OR MORE USERS**

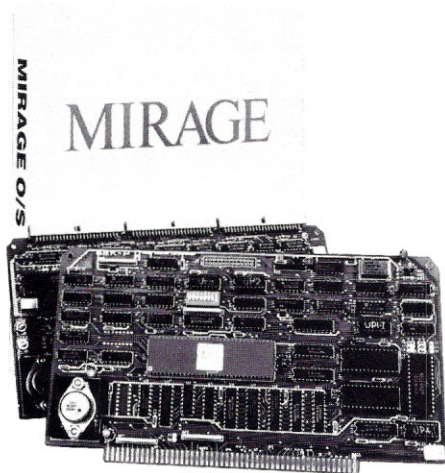

**For as little as
\$1295***

- Time Sharing
- Multi-tasking
- Multi-Directory Filing System
- Password Protected Login
- RAM Disk
- Device Independence
- Printer Spooling
- Basic, Fortran, Pascal, APL, and FORTH compilers available

*includes our 68000 Processor and Multi-User operating system.

**CALL OR WRITE FOR DETAILS AND
FOR OUR FREE S-100 CATALOG**



Inner Access Corporation

Box 888 · Belmont, CA 94002 · 415/591-8295

ADVERTISING

If you would like
to advertise in S-100 Journal
please request our ADVERTISER'S KIT

ASSEMBLING A 68000-BASED S-100 MICROCOMPUTER

Jay Vilhena

The system that I describe here is based on the CPU 68K from Viasyn (formerly CompuPro). The complete project features a Motorola 68000 CPU running at 10 MHz, 128K of static memory, three serial ports, one parallel port, one Centronics parallel port, sixteen empty slots for future expansion, and two double-sided, double-density 8-inch drives with an on-line storage of 2.4 Megabytes. The system will run under CP/M-68K and the Forth and C languages are included.

Even if you are not building this system, you might benefit from reading this article. It will tell you the basics about the internal components of an S-100 system.

This is meant to be a high-performance basic system that you can add features to and upgrade indefinitely. I assembled it, about one year ago, for a little over \$3,000. Prices have come down during the past months so you might be able to do better.

All the parts described here work together with no glitches. After one year of almost daily use, I have not had a single failure or other problem. Obviously, I have not tried everything that the system can do, but what I tried always worked.

To build this system, you will need four S-100 boards, an enclosure, a motherboard, power supply, a pair of disk drives, cables and connectors, and of course software. There are many brands of hardware components that could be used to assemble a system like this, but I tried to do it with a minimum

of work (and headaches). There is nothing to solder, and no special tools are required (a voltmeter might be handy but is not absolutely necessary). Most of the components are from Viasyn. I chose to use their CPU board because of its fast speed (10 MHz), and because I wanted to run this system under CP/M-68K which they had already configured for the hardware. Their products are very reliable and also carry an excellent warranty: one or two years.

Finally, you might ask, why bother assembling a system? Why not just buy it already assembled and running? There are several reasons. The first one is cost. CompuPro System Centers will sell you a beefed up version (currently going by the name of CompuPro 816/E1) of the system described here, but it will carry a beefed up price. And therein lies the problem. An individual, or a small firm, may not afford the fancy version, but might like to have the basic system and expand it as needs increase. Another alternative is to have the System Center assemble your basic system. This is certainly viable, but again be prepared to spend more cash. Assembling takes time, making cables takes time, testing takes time, and we all know what time translates into.

The main reason to assemble your own system, however, is to become well acquainted with your computer hardware. You learn where the boards are, what each board does, how all the parts connect, etc. This gives you an advantage in

Build the system that runs CP/M-68K,
UNIX, and the new S1 Operating System

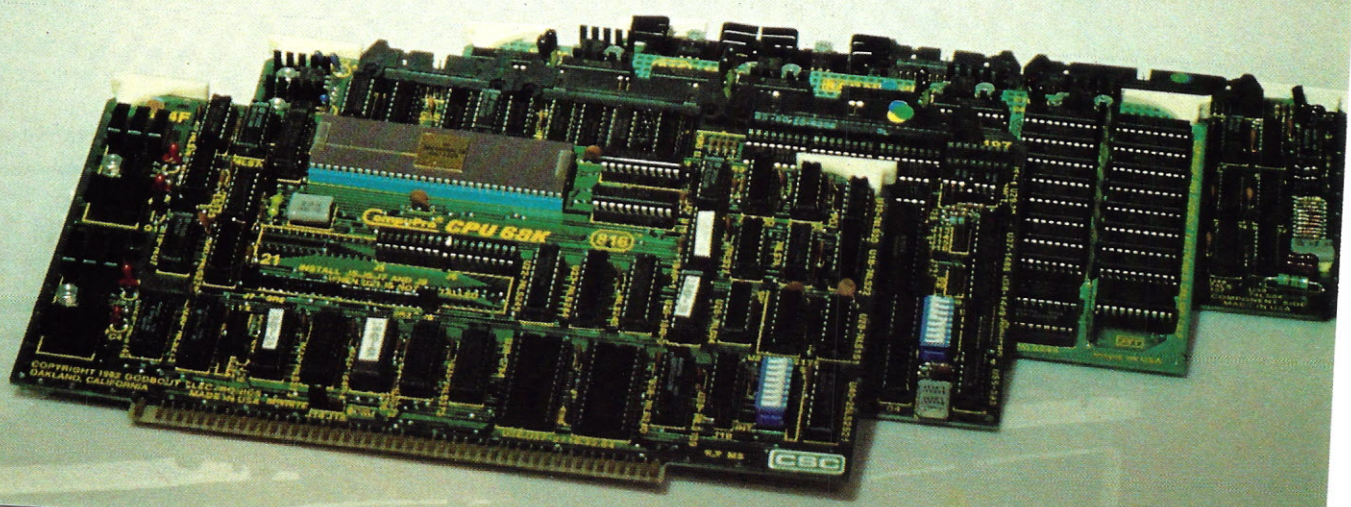
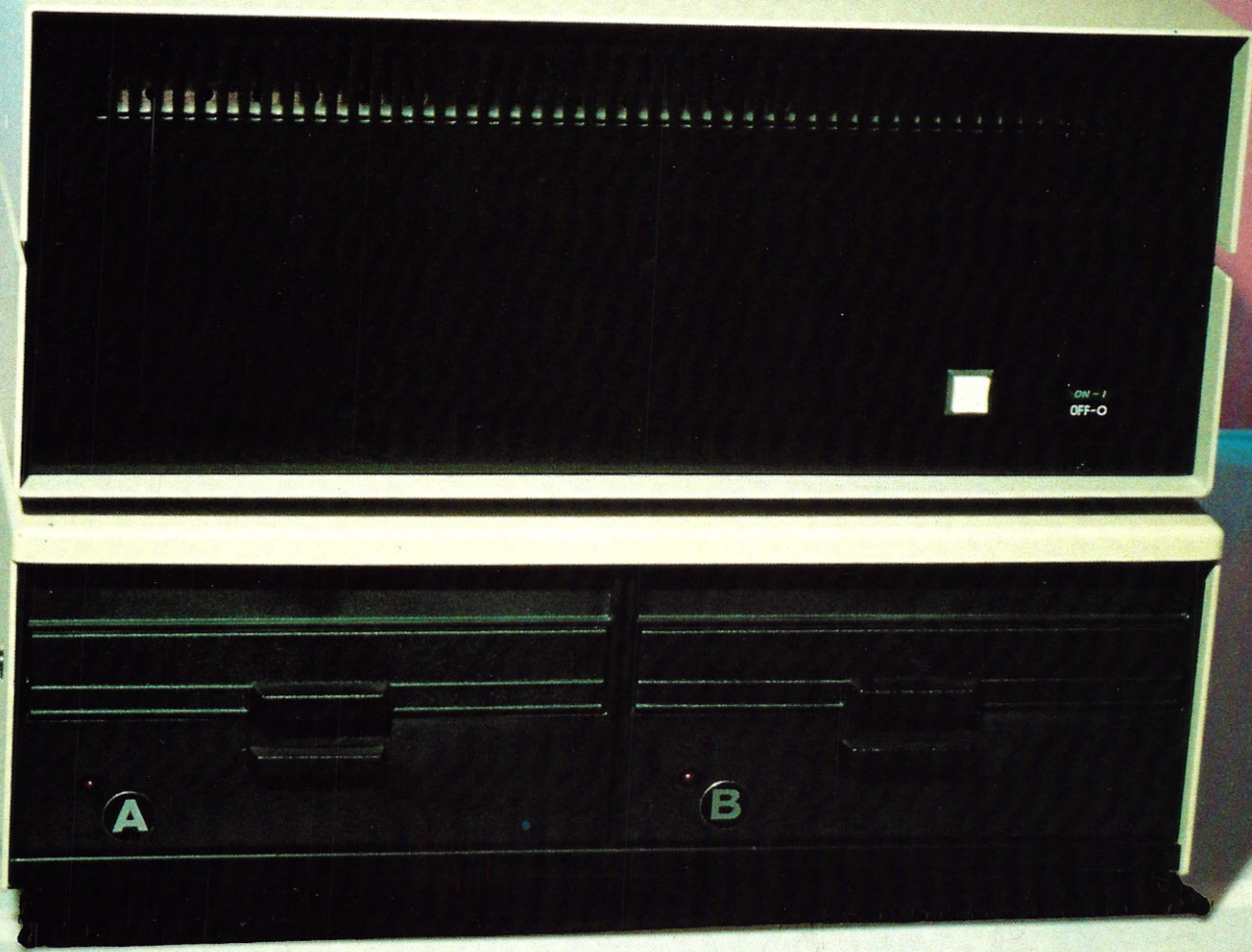

knowing what expansion boards to buy when you decide to upgrade. In addition, you gain ample confidence to open your machine and diagnose minor malfunctions that may pop up in the future. This might save you plenty in the cost of service calls and downtime.

Then, of course, there's the thrill of

S-100 Journal will feature a regular column on integrating S-100 systems. These may be simple one-board systems or complex advanced systems. They may include components from a single or from several manufacturers.

We will assemble a system, try out different component options, and use the system for at least a couple of months before publication, to make certain that it runs without snags. Often, to assure bug-free operation, we will prefer to use components that are at least one year old over just-released components. In this column, we are more interested in providing information on building solid workhorses than on assembling the latest novelty.

Both general-purpose machines and specialized systems will be featured.

We welcome tips on what systems to build and what components to use. In addition, we will accept complete articles for publication. Or, we may accept an article draft for us to polish up and provide illustrations and photos.

Should you like to write an article on assembling a system, here are basic guidelines: The article may be directed to readers of any level of expertise. Hence, you might write an article for people who have never looked inside an S-100 system, or you might write to the OEM-level audience. The system that you describe must actually have been assembled and be running without bugs. Whenever possible, recommend where to obtain the parts. In this column, as in other sections of the magazine, we encourage authors to mention places, complete with addresses, that they have obtained good service from.

To receive more information about writing S-100 Journal articles, send for our Author's Guidelines.

building it yourself.

THE COMPONENTS

In the paragraphs that follow, I will describe exactly what components you will need, how to buy them, and alternatives that you may want to consider.

CPU Board

This board is the head of your system. The CPU (Central Processing Unit) board controls all the operations that take place in your machine. It decides when to send data to or request data from the other boards. This CPU board is, in S-100 lingo, called the bus master. All the other boards, including any secondary CPUs that you may add later, are called slave boards. The speed of your system is controlled by the bus master.

In this system, the CPU board that we will use is the CPU 68K from Viasyn. The heart and brains of this board (the CPU) is the Motorola 68000 processor chip, one of the most powerful microprocessors available. The board runs at 10 MHz. By comparison, the speed of most new personal computers is typically 4 or 6 MHz.

I strongly suggest that you buy this board new from one of the CompuPro System Centers. Buy the board with the CSC program (longer warranty) even though it costs a little more. Remember that this is the main board in your system.

Memory Board

The CPU needs memory to store the operating system, other programs, and data being processed. We will use a separate board, a memory board, that carries the RAM (Random Access Memory) chips for the system. Current S-100 memory boards usually come populated with either 128K or 256K bytes of RAM. I prefer two 128K boards over one 256K because, if the board malfunctions, a smaller chunk of memory will be lost.

Since this is a basic system, we'll start with just one 128K board. This is enough for most applications. Later, you may easily add as many memory boards as you wish, up to a total of 16 Megabytes (by comparison, an IBM PC is expandable to only 0.64 Megabytes).

The memory board on my system is the CompuPro RAM 21. Viasyn is now selling the RAM 23, so you'll probably want to get that instead. However, if you find the RAM 21 being sold at a bargain price, and it is guaranteed to run, buy it. In addition, you might consider using a memory board of a different brand. This is the only board, of the four used in this system, that you can get from a different manufacturer and successfully integrate without having to know quite a bit more. A word of caution: Don't buy any different memory boards for this system unless they are guaranteed to run with the Viasyn boards, and you can return them if they don't.

Disk Controller Board

This board is necessary to write and read information to and from the floppy disks. As the name indicates, it controls the operation of the floppy disk drives.

In this system, the CompuPro Disk 1 (or Disk 1A) is the disk controller board used. You cannot use any other controller board because you need the BOOT EPROM which is part of this board. The BOOT EPROM contains the software necessary to boot (start up) the Operating System. Either the Disk 1 or the Disk 1A can be used. A standard Disk 1 can only control 8" drives while the Disk 1A can control 8" and 5¼" drives simultaneously. The Disk 1A is newer and might be the only one of the two that you can find. I was not interested in using 5¼" floppies (they hold too little information), so I bought a Disk 1 for much less than a Disk 1A would cost. (You know how it is, once the new stuff comes (with bugs and all) the old stuff sells for a bargain and does exactly the same thing.)

If you look for a Disk 1, either new or used, there is a word of caution: Make sure that the EPROM (that's the funny colored chip on the board)

has a sticker with the numbers 68/85/86 on it. If the 68 is not there, you cannot use the board on your 68000 system.

Interface Board

Your computer cannot do real work unless it can communicate with your terminal, printer, and other peripherals. To interface to these devices, you need, obviously enough, an interface board. As we will discuss below, your terminal and printer will connect directly to this board which, in turn, connects to the CPU board and the rest of the machine.

The interface board used here is the CompuPro Interfacer 4. This board gives you three serial ports, one parallel port, and one Centronics Parallel port.

Important: You must use the Interfacer 4. Other interface boards will not work with the stock CP/M-68K that you get from Viasyn. To use other interface boards, you would need to buy additional S-100 boards or modify the BIOS (Basic Input Output System) part of CP/M-68K.

Motherboard, Power Supply, Enclosure

All the S-100 boards in a system are plugged into a larger board, called the motherboard. The boards communicate with each other through 100 parallel traces running the whole length of the motherboard. (For newcomers: that's where the 100 in S-100 comes from.) Obviously, you'll need a motherboard.

You will also need a power supply. The power supply is essentially a fancy transformer that takes the 120 Volts (or whatever it is in your area) from the power lines and converts it to the low DC voltages that the boards run on.

Finally, you'll need a box to put all the above hardware in. The box should have a fan to keep the machine cool.

You can buy the motherboard, power supply, and enclosure separately, but usually the simplest and most economical way is to buy them already assembled together. This

combination is often called the mainframe. For our system, we will use a mainframe from Integrand, model 800D/20. Integrand makes many types of mainframes and sells them with a variety of options. You want yours to have connectors **and** terminators already installed on the motherboard. This is something that you must specifically ask for, when ordering the mainframe. The connectors are the receptacles where the boards plug in. There should be 20 of them. The terminators come at each end of the motherboard. They are necessary to prevent signal "echo" in the motherboard. When you receive the mainframe, look for the terminators (see Fig. 1). If they are absent, call the place that you ordered from and make arrangements to send back the mainframe (or just the motherboard). Do not assemble the system until you have the terminators installed.

Many other mainframes can be used. If you like to have all your parts from the same manufacturer, Viasyn sells one that is said to be of superior quality. It does cost twice the price of Integrand's and offers little, if any, advantage.

In choosing a mainframe, pay attention to how the fan and vents are placed in relation to the boards. The cooling system of the Integrand 800D/20 is impressively efficient. Several other mainframes force the air to turn 90 degrees inside the box, a design that I doubt is as effective.

Disk Drives

We will use two double-sided, double-density 8-inch disk drives as our file storage system. The most

convenient way is to buy them already mounted inside a cabinet, with their own cooling fan and power supply. This is normally called a floppy subsystem, and it is often sold together with the disk controller board.

In this project, I used a floppy subsystem from Viasyn; it comes ready to work with the Disk 1. The two included 8-inch drives are made by Qume and are noisy but very robust. Usually, you have several compatible alternatives in floppy subsystems, and you may want to call around and see what's available. Be sure to get one that is made to work with the Disk 1 (or Disk 1A).

(For the more adventurous: You can, of course, save money by assembling your own floppy subsystem. If you want to try this route, there are meager instructions in the Disk 1 manual on interfacing to different disk drives. But I cannot guarantee the results.)

Cables

You can either build or buy the internal cables for this system. I list here what you'll need in both cases.

For making the cables yourself: You need to obtain ten feet of 50-conductor ribbon cable, three 50-pin female insulation displacement connectors (IDC), and one 40-pin female IDC. (These connectors are not the edgcard type; they plug into male IDCs mounted on the boards.) You will also need one IDC female Centronics connector and three IDC female DB-25 connectors. The Centronics and DB-25s will be the ports in the back of your computer, so they

(continued on page 31)

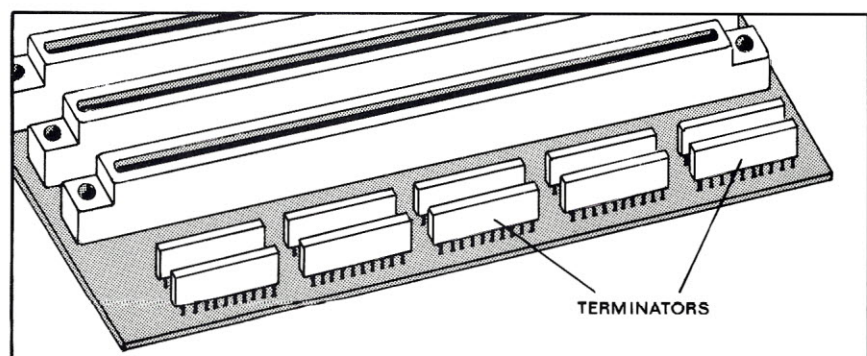

Figure 1. Terminators must be present on the motherboard.

COMDEX/Spring '85



Glad in its traditional fanfare, the COMDEX/Spring '85 took place in Atlanta on May 6-9. Absent were nearly all S-100 manufacturers and the excitement of variety. Apart from a few Macintosh overtones, they might have renamed the show IBMDEX and hardly anyone would have noticed the difference. More MS-DOS word processors, more PC-DOS accounting software, more 1-2-3's, more blue clones with enhanced gizmos . . . SIGH!

For those who cared to notice, IMS International presented its new high-performance multi-user S-100 systems (see the New Products section for details), ACE Inc. and Teletek both displayed their line of S-100 products, and Multi Solutions Inc. was busy promoting its SI Operating System which, the company claims, will outperform every OS in existence. Haughtiness apart, SI does in fact seem like a very nice and powerful Operating System and is now available for some 68000-based S-100 systems.

The spotlight of COMDEX/Spring was, no doubt, on peripherals. New laser printers attracted wide attention. However, despite all the excitement surrounding the new laser printers, none had any significant improvements over those which entered the market during the last year. But, the new



The TeleVideo 955 is code compatible with the TeleVideo 950.

prices are certainly good news. One should now be able to purchase a laser printer in the \$3,000 range with features similar to last year's \$6,000 printers. Among the laser printers displayed, were units from Ricoh, Quadram, and Corona. The Quadram printer, called Quadlaser, was unveiled at the show and can be loaded with up to 2 Megabytes of RAM. Sumitronics displayed a printer made by CASIO (to be sold in the US under the Sumitronics name) which is not a laser printer but instead uses liquid crystal technology to control the light striking the photoconductor; on paper, text and graphics will look the same as laser printer output. All of these printers have a resolution of 300 dots per inch or less. This is, of course, much better than impact dot-matrix technology, but it is still far below true typesetting quality. Digital typesetters typically print over 1,000 dots per inch and some as much as 5,000.

Nevertheless, laser printers are quiet, print 8 to 12 pages per minute, are easy to load, and several fonts can be accessed simultaneously.

The world of printers has expanded to amazing proportions. New printers were everywhere at COMDEX. Most new impact dot-matrix printers offer very high-quality output, and many feature outstanding color graphics and text. And they're fast too, although in fast mode they leave much to be desired in terms of print quality.

A few printers caught our attention: The JDL-750 by JDL, Inc. features a top speed of 216 CPS, about the best print quality that we've seen, six resident fonts, and color. The C. Itoh Prowriter 24LQ also offers color, a top speed of 200 CPS, and a 24-pin printhead . . . A unique printer at the show was the Brother Twinriter 5. The Twinriter has two printheads, a daisy-wheel head and a dot-matrix head. This printer is capable of mixing text

from both heads on the same line. One convenient application is to mix daisy-wheel quality text with dot-matrix graphics on the same page . . . IBM demonstrated the Color Jetprinter, a new \$745 ink-jet printer. The Jetprinter produces very high quality output with vivid colors but is extremely slow.

Terminals are always of interest to S-100 users, since most of us work closely with one. Several manufacturers displayed their 1985 models. Among the terminals exhibited, were new models from Visual, Lear Siegler, and Televideo. Visual has produced the 200 series of terminals designed to compete with DEC's VT200 series. They all feature 14-inch screens and slim designs. The top models offer Tektronix compatible graphics and are available in either color or monochrome. Televideo's new terminal, the model 955, is snazzy looking and lists for under \$700. The 955 is 925/950 compatible so, for everyone out there still



Access, a remote terminal with local computing power.

Addresses:

ACE, Inc.
430 N Halstead Street
Pasadena, CA 91107
(818) 351-5451

Brother International Corp.
8 Corporate Place
Piscataway, NJ 08854
(201) 981-0300

C. Itoh Digital Products
19750 S. Vermont Ave. #220
Torrance, CA 90502
(800) 423-0300

Corona Data Systems, Inc.
275 East Hillcrest Drive
Thousand Oaks, CA 91360
(800) 621-6746

IBM Corporation
P.O. Box 1900
Boulder, CO 80302
(303) 447-1900

IMS International
2800 Lockheed Way
Carson City, NV 89701
(702) 883-7611

JDL, Inc.
2801 Townsgate Rd., #104
Westlake Village, CA 91361
(805) 495-3451

Lear Siegler, Inc.
901 East Ball Road
Anaheim, CA 92805
(714) 778-3500

Melard Technologies, Inc.
5 Westchester Plaza
Elmsford, NY 10523
(914) 592-3044

Multi Solutions Inc.
123 Franklin Corner Rd. #207
Lawrenceville, NJ 08648
(609) 896-4100

Quadram Corp.
4355 International Blvd.
Norcross, GA 30093
(404) 923-6666

Ricoh Corp.
3001 Orchard Parkway
San Jose, CA 95134
(408) 942-8100

Sharp Electronics Corp.
10 Sharp Plaza
Paramus, NJ 07652
(800) 526-0264

Sumitronics Inc.
17862 East 17th St. #106
Tustin, CA 92680
(714) 730-6061

Teletek
4600 Pell Drive
Sacramento, CA 95838
(916) 920-4600

TeleVideo Systems, Inc.
550 East Brokaw Road
P.O. Box 6602
San Jose, CA 95150-6602
(800) 521-4897

Visual Technology Inc.
540 Main Street
Tewksbury, MA 01876
(617) 851-5000

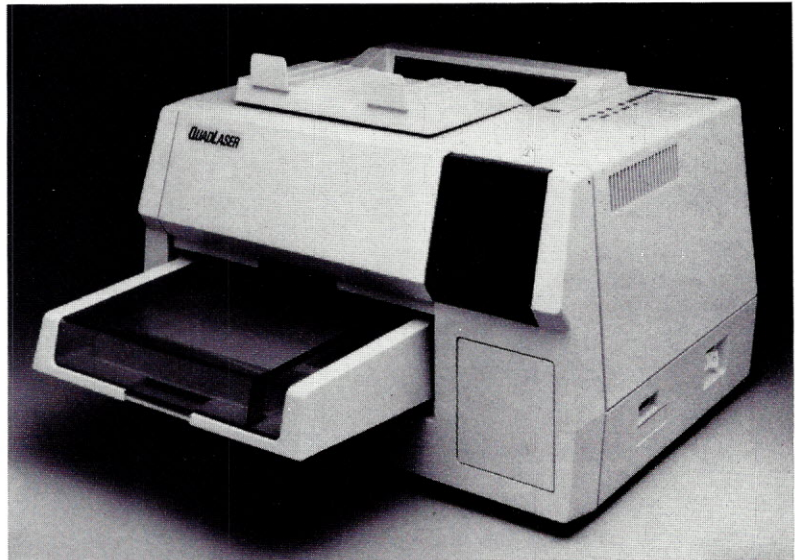

The new QuadLaser from Quadram.

hammering on that old 950, this is the item needed to modernize the office and get a 14-inch screen in the process. In addition, the 955 has 64 programmable function keys, 132-column mode, extra pages of memory, and is available with either green or amber display.

For people on the move, Melard Technologies introduced the clever ACCESS, a tiny remote terminal with full microprocessor power and up to 120K bytes of memory. With ACCESS, one can communicate with an S-100 system from anyplace where there is a telephone. Two unique rubber cups are furnished for connecting to the telephone. Another feature is a serial port for direct transfer of data. Weighing only 24 ounces, ACCESS has built-in telecommunications software, calculator, word processor, personal scheduler, and address book. The 8-line by 40-character liquid-crystal display is actually a scrollable window on a full 25x80 screen. However, what makes ACCESS different is its small size. It actually fits in a pocket.

And here's a real beauty for creative OEM's. Sharp Corporation demonstrated a product called the Color Scanner that "reads" a color image. Just place a color photograph, painting, or printed page under the lid and off the image goes to a monitor screen, to a disk, or to the memory chips. But, you will need to write the software to interface the Color Scanner to your next S-100 project. The unit on display was connected to a high-resolution monitor, and the video image was practically indistinguishable from the original print. ■

AN EDITOR IN BASIC

Viron E. Payne

The program described here is a simple word processor without many of the features of expensive word processing programs. However, it has two features that many programs lack. First, it has a built-in EDIT function, using the EDIT function of BASIC itself. Second, it can right justify by increasing the spacing between letters in increments of 1/120" if your printer supports this.

The program is copyrighted, but permission is hereby granted to use the program for any purpose, personal or commercial, modified or unmodified. Permission is not granted to sell the program or any program containing the EDIT or right justifying functions.

This program has served me well for at least seven years. From time to time, new features have been added and old ones polished up, mainly as a result of changes in the hardware. If you have hardware identical to mine, you can simply type in the program as written and use it. If not, with a few simple changes you should be able to make it run on your equipment without much trouble except for the EDIT and PAGE functions.

I am using an Altair 8800A with a

NEC Spinwriter Model 5503, an ADM-3 terminal, and a National Multiplex digital cassette recorder plugged into the extension port of the ADM-3. The program is also capable of reading audio cassettes because I still have some old audio tapes from the days prior to my purchasing the digital recorder.

The program is written in a modular format. However, it uses GOTOS rather than GOSUBs for a reason explained below. In line 60, the CLEAR 25000 is temporary due to a sudden loss of a 16K RAM board. The DIM statement is set for the full RAM complement. The program was written to utilize the features of MITS BASIC residing in ROM in the top 16K, which uses approximately the bottom 1K for scratch pad. With the full memory installed, the CLEAR 25000 is replaced by POKE 213,0: POKE 214,26. This has the effect of a CLEAR 42496, but MITS BASIC can only take CLEAR values up to 32767. When the POKES are included, it is necessary that the value 25000 in line 640 be changed to 42496 for the FREE function to give the correct value for unused string space.

Although few readers will have it in

ROM, MITS BASIC is very similar to several Microsoft BASICs. Thus, the changes needed to use other BASICs should, in most cases, be minimal. MITS BASIC is an excellent BASIC, but it has no hooks to install a DOS. Therefore, I am using digital cassettes, so that I can keep this BASIC.

In line 60, the W=80:WIDTH W is used to set the number of characters before an automatic CR is issued by the computer. The CR character causes errors in loading, so the width is always set to 80 before loading a tape. Also in line 60, N, AD, LA, and I are initialized. It is critical that this be done before the EDIT function is used, since it uses the VARPTR function. If a new numeric variable is encountered in a program, it is added to the numeric variable list, causing the string variable table to be pushed upward in memory. Consequently any address obtained by VARPTR will be incorrect if a new numeric variable is introduced before that particular address is used. Thus, the need to initialize these variables.

At the end of line 60 is a GOTO 100, which is the first line of what I have here called the "control block." This block, ending with line 240, is

where all program control takes place. NULL 0 at the beginning of this line resets the NULLs to zero when any function is completed. Although this is not required for some of the functions, it does no harm and ensures that NULL will always be zero when required, as in loading data from the digital cassette recorder.

For those who are not familiar with the NULL command, it sets the number of binary zeros to be sent following any CR and is sometimes required by serial printers to allow time for the carriage to return before receiving the next character. The NULL command is also needed when saving data (or programs) on digital tape, since the computer takes time to move the data from the input buffer to its permanent location in RAM. If the first character of the next line arrives too soon, it will be lost. Higher baud rates require more nulls because the nulls take less time. For this BASIC and a 2MHz clock, a null value that is two less than the line length will give sufficient delay. All NULL commands may be omitted if you are using a disk system.

THE FUNCTIONS

The control block expects complete words in reply to the request for FUNCTION. No menu is provided. The new user may wish to keep handy a typed list of the available commands until he becomes familiar with the system. All of these commands are in lower case, the normal mode of operation. Commands in upper case do not work, but do no harm. The lines in the control block all end with a GOTO, and the various functions all end with GOTO 100. Were these lines to end with GOSUB and the functions to end with RETURN, a GOTO 100 would be required at the end of each command line (after the GOSUB) to prevent the program from falling through to line 240. This would generate, after completion of each function, the error message contained on that line.

Any function can be deleted by deleting the line that calls it and deleting the lines which contain the function itself. New functions can be

added by inserting new lines in the control block with a GOTO address of any value higher than the last line of the existing program and then, placing the function at that address.

The DISPLAY function (caps are used here, but lower case is to be used during operation) simply displays the stored data on the terminal, twenty lines at a time. Hitting RETURN (ENTER on some terminals) causes the next twenty lines to be displayed. Scrolling is used instead of SCREEN CLEAR. This allows one to see the last line or two of the previous page in conjunction with the new page. Those who do not have the MOD (modulo) command in BASIC may substitute "IF I/20=INT(I/20)" for

the MOD command on line 560. Change the 20 to change the lines on each page.

The LEN command, short for length, returns the length of any line. This function is handy when planning changes to text. "Which line?" is asked and must be answered with the number of that line in the text. If this is not known, it should first be determined using the FIND command. If you have already given LEN, just use any line number and then use FIND.

The FREE command is a real time-saver if you want to determine how much string space you have left. If a PRINT FRE("") command were used, it would initiate garbage collection which can take a very long time if

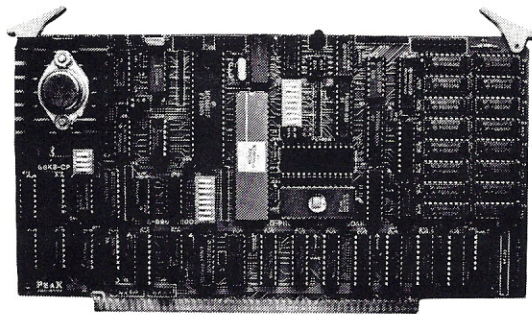

68K8-CP

The World's First 68000 Coprocessor

Peak Electronics' 68K8-CP is a high performance processor card designed to function as one of several CPU elements within a multiprocessor S-100 system. This card features the MC68008™ (8-bit object code compatible version of the industry renowned 68000), up to 512K bytes of RAM and 128K bytes of EPROM, two serial ports and a parallel printer port.

The true power of the 68K8-CP card is shown with its ability to be plugged into any existing S-100 system running CP/M®-2.2 and to be running CP/M-68K within minutes without any change in existing hardware or software. This card does not replace your current processor. All of the original system's devices (RAM, disks, and other peripherals) are immediately available to the user of CP/M-68K, files can be accessed by whichever operating system is currently active.

Features:

- Does not replace your current CPU card
- IEEE-696-1983, S-100 Compatible
- MC68008 8 or 10 MHz CPU
- 128K bytes of RAM expandable to 512K
- 8K bytes of EPROM expandable to 128K
- No wait state access to on board RAM and EPROM
- Two high speed serial ports (up to 38.4K BAUD)
- 8-bit parallel printer port
- Supports CP/M-68K and Concurrent-68K
- Onboard 16-bit counter-timer
- Includes printer buffer and RAM disk firmware

\$995⁰⁰, includes CP/M-68K



P.O. Box 700112
San Jose, CA 95170-0112
(408) 253-5108

you have some 40K of string space already used. Using the VARPTR command speeds up the operation greatly. The number of lines, string space used, string space remaining, and remaining memory space (symbolized by #) are all displayed.

The PAGE command causes the text to be printed out in page format, with page numbers at the top. Text is right justified by adding 1/120" increments between letters. Therefore, it can only stretch a line, not shorten it. The text input routine contains provisions to aid in keeping line length within any given number of characters. A number of questions are asked to format the text. You are asked for the left margin setting, the number of copies, the first page number, the paper type, the line spacing (single or double), and the width. For paper type, the answer should be sheet, roll, or fold. The default is fold. If sheet is specified, the computer stops printing after each page and waits for you to insert a new sheet. Printing is resumed by lifting switch A8 on the Altair front panel. That is the purpose of the WAIT 255,1 command on lines 440 and 510. If there is no front panel on your computer, substitute an IN-PUT or INKEY\$ statement. If paper

type is specified as roll, the computer will draw a cut line of hyphens across the paper after each page. Actually, any reply to paper type other than sheet or roll will be accepted as fold (for fanfold).

The width must be set to a value equal to or greater than the longest line in the text, if right justification is to be done. Normally the width is set to the same value used when typing in the data. However, by using a very small width setting, the justification is effectively bypassed. If only a few lines are longer than the width setting, the others will be justified while the long lines will extend past the nominal right margin.

The NEC Spinwriter Model 5503 has little intelligence, and it depends on the computer for control. In this respect, it is the same as some Qume printers. In fact, MITS BASIC has built-in routines for different printers. The Qume routine is used with this model Spinwriter. The spacing increment is 12/120" and is in ROM where it cannot be changed. However, the print head does not move when a space is transmitted. Instead, the total distance to move is accumulated in a RAM register, and when the first printable character is encountered

the print head moves the total distance in one move. By adjusting the register, the spacing between letters is regulated.

The program first checks (line 370) the length of the line to be printed. If the line is longer than the width setting, or is shorter than 80% of the width setting, the line is printed as is, without justification. If the line consists only of two number signs (##), a form feed is initiated. This is the only embedded command presently supported although others could easily be implemented. If neither of these exceptions exists, the line is right justified (lines 380 through 410). The number of 1/120" increments needed is calculated and these are then added to the move distance register by the POKE 205,PEEK(205)+S statement in line 410. The 205 is the address of the low order byte of the two-byte move register. Since it is impossible to POKE a negative number, this routine cannot compress a line. To do so would require PEEKing both bytes and POKEing both bytes. I have not felt enough need for this to go to the trouble. The justification process slows down the printer and causes uneven speed.

With another computer, software, or printer, adjustments must be made. If your software has a routine for the Qume and is in RAM, simply POKE the move increment. If it is in ROM you cannot do this. Instead, locate the move register and change the 205 to the proper address. If the printer supports control characters to change spacing between letters, use those.

The LINE function simply prints out a specified line. It is convenient for checking a line after EDITing it or for verifying a line number before using a more critical command.

The DELETE function deletes a single line, which must have a known line number. Should you ever call DELETE and then realize that you do not know the line number, hit Control C, or BREAK, to exit the program. Then, while in command mode, type GOTO 100. Line 100 is always a safe reentry point. I keep it this way in all of my programs to avoid losing data. The DELETE function uses the SWAP command, which moves values in the string table. This is

(continued on page 25)

SCIENCE • MEDICINE ENGINEERING

A large number of S-100 systems are used in data acquisition, process control, laboratory interfacing, and other specialized professional applications. S-100 Journal welcomes articles describing these implementations and including technical details for the benefit of other professionals wanting to set up or upgrade similar systems.

BUILD A SERIAL SWITCH

Eric Miller

Switch from a dot-matrix printer to a daisy-wheel printer. Switch from a computer to a modem. These are operations that you can perform with the serial switch, an RS-232 device that you can build in one evening. With this switch,

any serial port becomes two ports.

The serial switch is basically a box with three serial ports on the back. One for input and two for output. A set of five slide switches on the front lets you choose which of the two output ports to use.

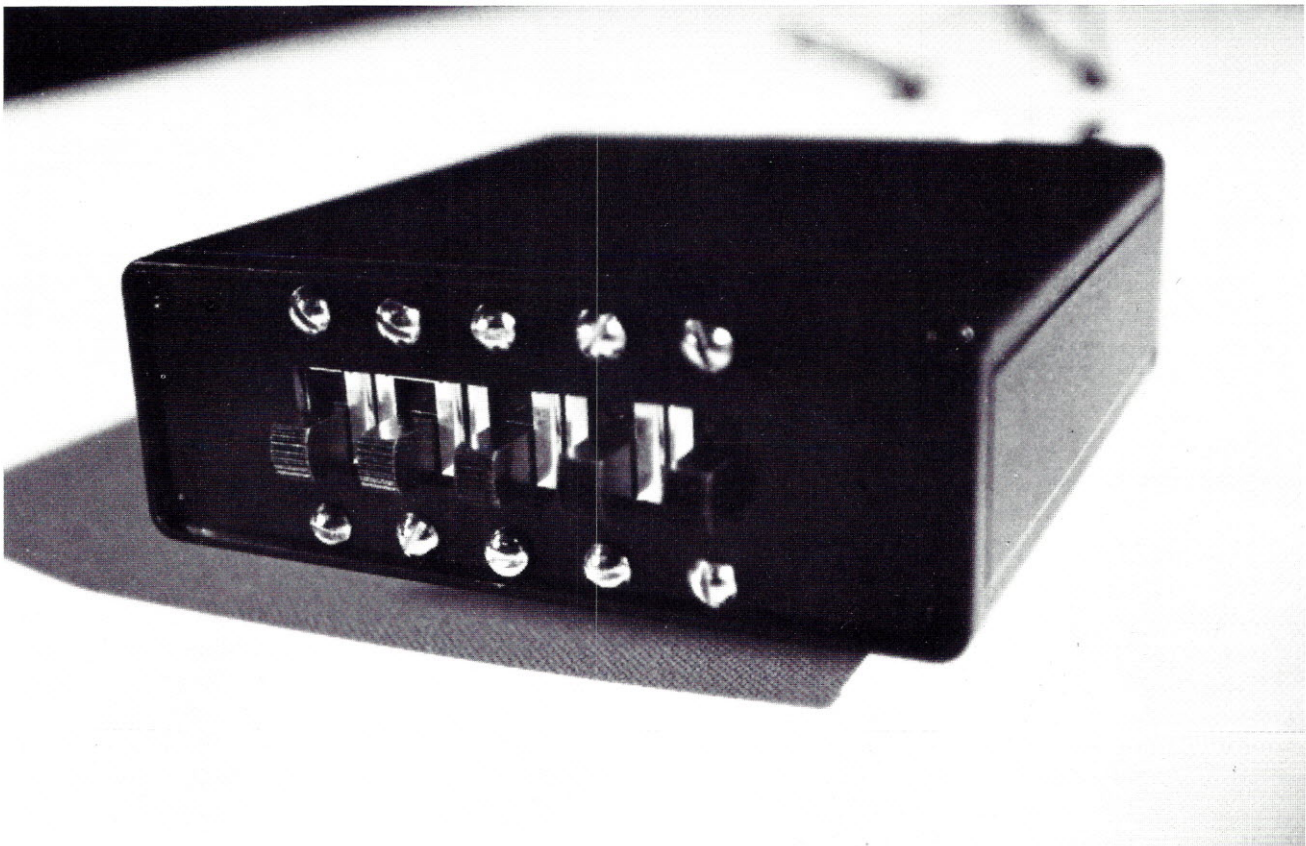

Five slide switches, instead of the usual rotary switch, are used because they are very inexpensive and easy to obtain.

The Parts That You Need

To build the serial switch, you need the “Aluminum Utility Case” from Radio Shack, Cat. No. 270-286,

and three packages of slide switches, also from Radio Shack, Cat. No. 275-403. You also need three female DB-25 connectors (the kind that connects to ribbon cable), mounting screws, and about 2 ft of 25-wire cable. The cost for all these parts is about \$25. Alternatively, you can use DB-25 connectors that crimp on or solder to individual wires. These are less expensive and will result in a “cleaner” job, but there will be additional soldering, or crimping, to do.



Building The Switch

At the center of one end panel of the case, cut a $2\frac{1}{2} \times \frac{1}{2}$ -inch hole. On the other panel, cut three holes to mount the three connectors. Use a male connector (from a serial cable) as a template to draw the holes. Also, make certain that the holes are spaced far enough apart, leaving enough room for the hoods on the male connectors to fit when all three cables are plugged into the switch.

The plastic end panels are rigid, but with care can be cut with a utility knife. It makes the job easier to

drill first at the corners of the cutout areas, and then cutting with the utility knife. The cuts should be made from the inside to prevent scratching the panels' smooth surface.

With a pair of nose pliers, bend back, just a little, the tip of the flanges on the slide switches until they fit flush against the inside of the front panel. Avoid warping the area where screws go through.

Using the slide switches and the connectors as templates, mark the holes for the mounting screws on both panels. Drill the holes and mount the switches and connectors.

Cut the ribbon cable in three equal lengths and install on the connectors. Solder the other side to the terminals of the slide switches. The input port connects to the middle row of terminals. One output port connects to the row of terminals above, the other to the row below. Since you have 10 connections on the switch side versus twenty-five from each port, care is necessary to connect the correct wires. Usually the pins that are used in RS-232 connections are 1-8, 20, and maybe 22, but check what it is for your hardware.

Evidently, each vertical set of 3 switch terminals must be soldered to wires coming from DB-25 pins with the same number.

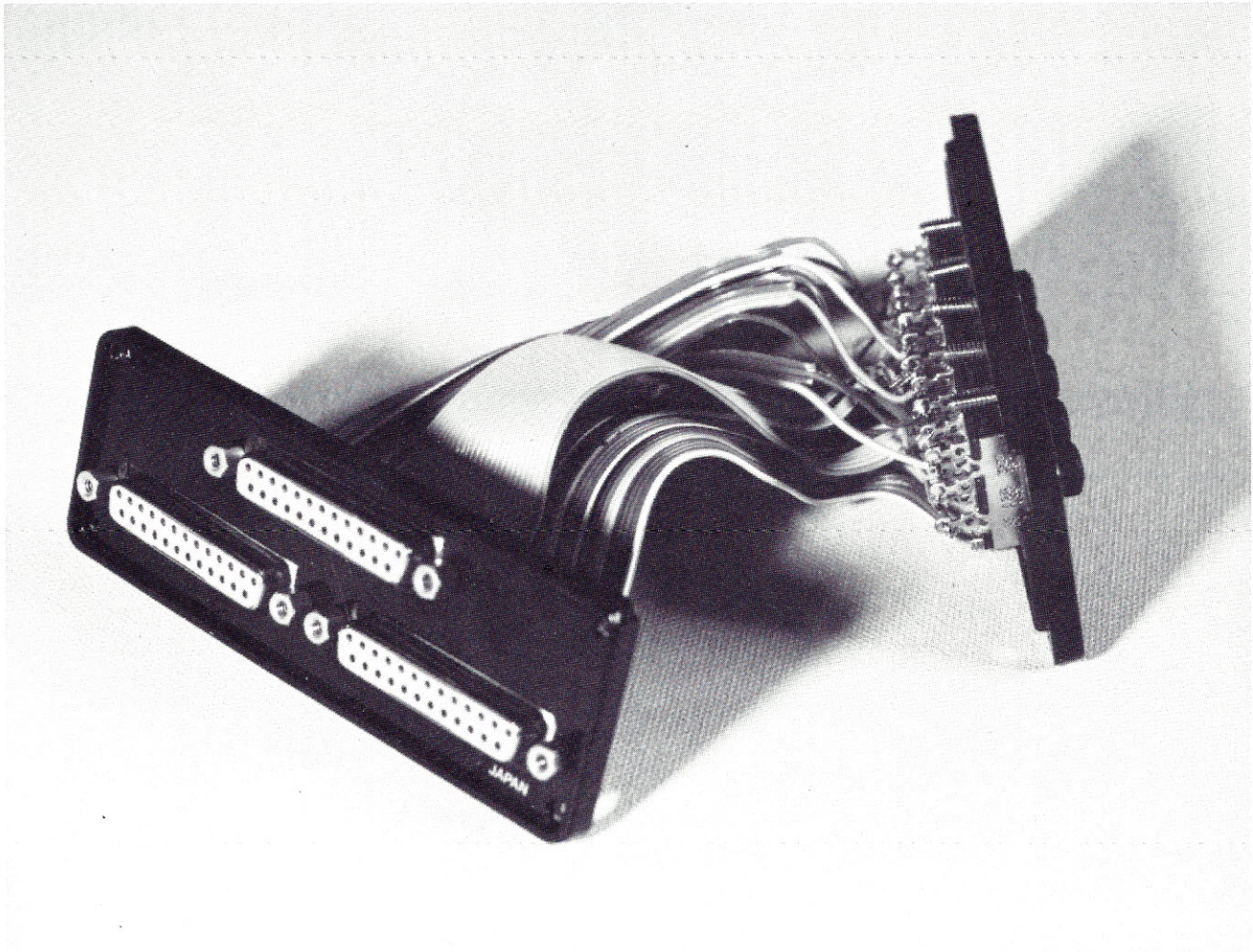
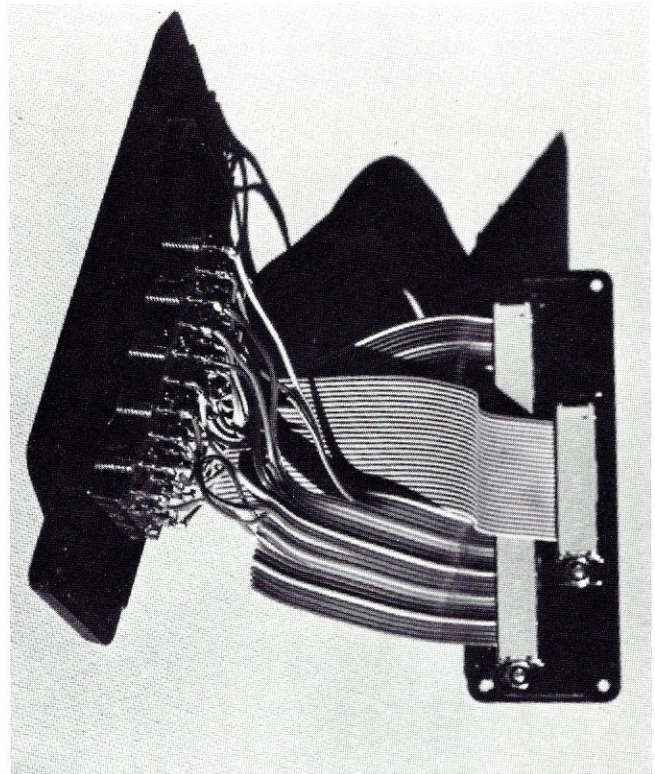

Now, simply slip one end panel through the case, and screw on both panels. The serial switch is ready to use. Flip all switches up to use one output port,

and flip all switches down to use the other output port.

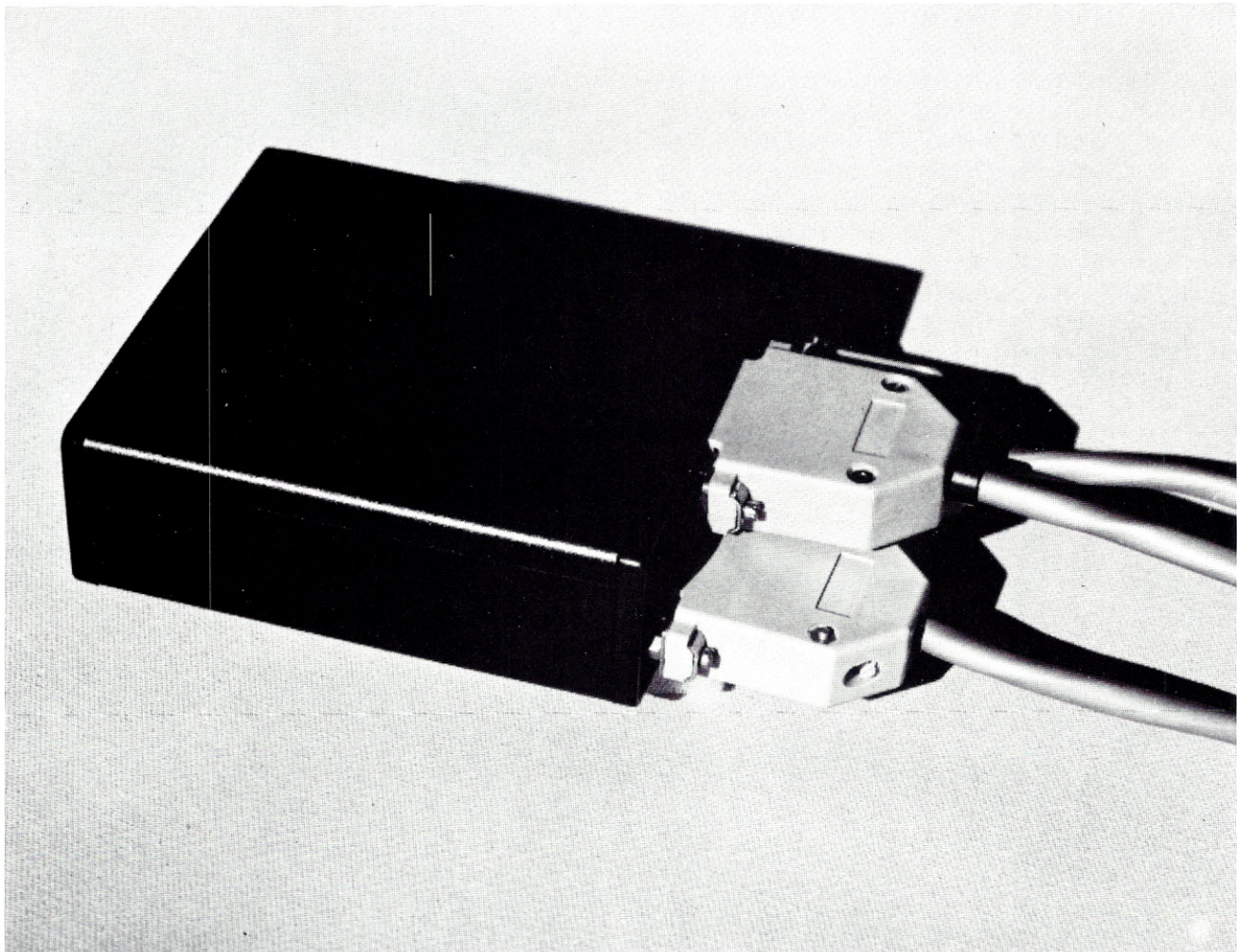

DEALERS TO CARRY S-100 JOURNAL

S-100 Journal is currently available by subscription only. However, if there is enough demand, we will make it available at computer stores.

Dealers interested in carrying our magazine should contact Linda at (919) 839-0115.

(continued from page 20)

much faster than moving actual strings, and does not fill up string space with a lot of garbage. If you do not have the SWAP command, it can be simulated through the use of VARPTR, PEEKs, and POKEs. Another way of handling the lack of SWAP is to set up a separate list of line numbers to be used as an index in printing, and then to exchange numbers in that list. This is also the way to greatly speed up sorting of strings when the SWAP command is not available.

The LOAD function loads data from an audio tape. You will be prompted to press the PLAY button only and then to lift A8. You may substitute INPUT or INKEY\$ statements if you have no front panel. A delay is introduced to permit the tape to feed past the leader and past any garbage generated at the junction of the leader and the tape itself. Next the command CONSOLE 6,3 is given to switch the terminal port from 16, where it normally is, to 6, where the audio I/O port is located. The 3 sets the port parameters. For other hardware or software, the CONSOLE command will have to be changed or replaced. The input operation is ended when a line containing only the word "END" in capital letters is received. When the end is sensed, the CONSOLE 16,0 command returns control to the ADM-3. If for some reason the end is missed, or is missing, playing an audio tape with the CONSOLE 16,0 command on it will return control to the terminal.

The SAVE command saves your text on the digital recorder. It does so by simply sending it to the terminal to which the digital recorder is connected. You are prompted to press PLAY and RECORD on the recorder and then hit RETURN. NULL is set to two less than the width, and a delay loop lets the leader on the tape pass by. The text is PRINTed on the terminal and passed on to the recorder. The word "end" (in lower case this time) is used to mark the end of text. Again, a WAIT command is used and must be changed if you have no front panel. This WAIT function is important to prevent the

FUNCTION prompt from being printed on the tape.

INSERT lets you insert a single line anywhere in the text if you know the line number where you want it inserted. After all the subsequent lines are moved down, you are prompted to type in the new line. Again, the SWAP command is used in moving the lines. To insert a number of lines, use APPEND and move.

MOVE is used to move a block of lines from one place in the text to another. Before using this command, note the number of the first line to be moved, the number of lines to be moved, and the new location of the first line. This function only moves the block of lines toward the top of

the file, but you can effectively move a block back down the file by moving other text upward. Again, SWAP is used.

The EDIT function is the core of the program. You must know the line number of the line you wish to EDIT. The function works by using VARPTR to locate the line in string space and to determine the length of the line. It then uses PEEK and POKE to move that line into the input buffer. You are then prompted (as a prompt in a LINEINPUT statement) to "Hit C/A" or CONTROL A. In this BASIC, anytime you are typing something and realize that you have made an error, merely hit CONTROL A to go directly into the built-in EDIT

S-100 USERS

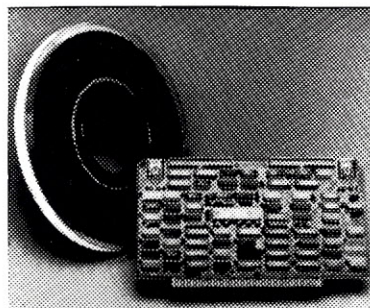

INTERFACE 9-TRACK TAPE DRIVES

With the DTI - DMA Tape-Unit Interface

- Transfers data via DMA up to 200K bytes per second
- Allows full control over all tape-drive functions

SPEED NUMBER-CRUNCHING SOFTWARE 5-10 X's AND MORE

With the FMP - Fast Math Processor

- Kit or assembled
- 32-bit floating point operations for arith., trig., exponential, etc. functions
- Or 64-bit floating point operations for arithmetic functions

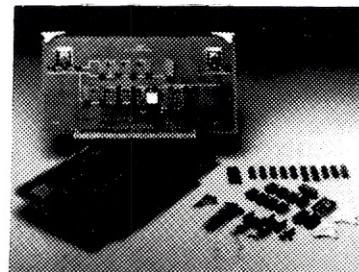

Both the DTI and FMP meet the IEEE S-100 standard. Software is available.

For further information contact:



SPC TECHNOLOGIES, INC.

1425 N. Quincy Street, Arlington, VA 22207
(703) 841-2980

```

10 '                               EDIT
20 '                               Written by Viron E. Payne, Sr.
30 ' Copyright 1981. All rights reserved. Copyright assigned to:
40 ' VIRON E. PAYNE & CO., Inc., 200 Juniper Ave., Merritt Island FL 32952
50 '
60 CLEAR 25000: DIM I$(673): W=80: WIDTH W: N=0: AD=0: LA=0: I=0: GOTO 100

70 N=N+1: LINEINPUT I$(N): IF I$(N) <> "end" GOTO 70
80 N=N-1

90 '                               *** CONTROL BLOCK ***
100 NULL 0: INPUT "FUNCTION"; A$: IF A$="display" GOTO 560
110 IF A$="len" THEN INPUT "Which line"; I: GOTO 620
120 IF A$="free" GOTO 630
130 IF A$="page" THEN INPUT "Left margin"; M: GOTO 340
140 IF A$="line" THEN INPUT "Which line"; I: PRINT I$(I): GOTO 100
150 IF A$="delete" THEN INPUT "DELETE which line"; D: GOTO 250
160 IF A$="load" THEN PRINT "Press play ONLY then lift A8": GOTO 470
170 IF A$="save" THEN INPUT "PRESS PLAY & RECORD THEN HIT RETURN"; A$: GOTO 260
180 IF A$="insert" THEN INPUT "Insert at which line"; I: GOTO 540
190 IF A$="move" THEN INPUT "How many lines"; M: GOTO 580
200 IF A$="edit" THEN INPUT "What"; A: LA=VARPTR(I$(A)): GOTO 280
210 IF A$="find" THEN INPUT "String"; S$: L=LEN(S$): GOTO 310
220 IF A$="append" THEN INPUT "width"; W: WIDTH W: GOTO 70
230 IF A$="decap" GOTO 650
240 PRINT "Illegal input. Try again.": GOTO 100

250 FOR I=D TO N-1: SWAP I$(I), I$(I+1): NEXT I: I$(N)="" : N=N-1: GOTO 100

260 NULL W-2: FOR I=1 TO 3000: NEXT I
270 FOR I=1 TO N: PRINT I$(I): NEXT I: PRINT "end": WAIT 255, 1: GOTO 100

280 AD=PEEK(LA+1)+256*PEEK(LA+2)
290 FOR I=1 TO PEEK(LA): POKE 537+I, PEEK(AD+I-1): NEXT I: POKE 537+I, 0
300 LINEINPUT "Hit C/A"; I$(A): GOTO 100

310 FOR I=1 TO N: IF LEFT$(I$(I), L) <> S$ GOTO 330
320 PRINT I; I$(I)
330 NEXT I: GOTO 100

```

Table 1A. Listing for the Basic Editor.

```

340 INPUT"How many copies";NC:INPUT"First page number";FP:P=FP
350 INPUT"Paper type";P$:INPUT"single or double space";S$
360 INPUT"width";WP:FOR CI=1 TO NC:GOSUB 510:FOR K=1 TO N:LPRINT TAB(M);
365 IF I$(K)="##" THEN LPRINT CHR$(12);:GOSUB 510:GOTO 440
370 L=LEN(I$(K)):IF L<.8*WP OR L=>WP THEN LPRINT I$(K):GOTO 420
380 D=12*(WP-L):S=INT(D/(L-1)):IF S=0 THEN S=1
390 IF S*(L-1)<D THEN S=S+1
400 FOR J=1 TO L:IF D<S THEN S=D
410 LPRINT MID$(I$(K),J,1);:POKE 205,PEEK(205)+S:D=D-S:NEXT:LPRINT
420 LI=LI+1:IF LI=61 THEN LPRINT CHR$(12);:GOSUB 510:GOTO 440
430 IF S$="double" THEN LPRINT:LI=LI+1:IF LI=61 THEN LPRINT CHR$(12);:GOSUB 510
440 NEXT:LPRINT CHR$(12);:IF P$="sheet" THEN WAIT 255,1:LPRINT:GOTO 460
450 IF P$="roll" THEN LPRINT STRING$(71,45)
460 P=FP:NEXT CI:GOTO 100

470 WAIT 255,1:FOR I=1 TO 6500:NEXT I:CONSOLE 6,3
480 N=N+1:LINEINPUT I$(N):IF I$(N)<>"END" GOTO 480
490 N=N-1:CONSOLE 16,0
500 PRINT"Loaded. N=";N:PRINT STRING$(50,7);:GOTO 100

510 IF P$="sheet" THEN WAIT 255,1:GOTO 530
520 IF P$="roll" THEN LPRINT STRING$(71,45)
530 LPRINT:LPRINT TAB(35);P:LPRINT:LPRINT:LI=5:P=P+1:RETURN

540 FOR K=N TO I STEP -1:SWAP I$(K+1),I$(K):NEXT
550 PRINT"Insert new line.":LINEINPUT I$(I):N=N+1:GOTO 100

560 FOR I=1 TO N:PRINT I$(I):IF I MOD 20=0 THEN INPUT A$
570 NEXT:GOTO 100

580 INPUT"First line to be moved";L1
590 INPUT"New location of first line to be moved";L2
600 FOR I=0 TO M-1:FOR J=L1+I TO L2+I+1 STEP-1:SWAP I$(J),I$(J-1):NEXT J,I
610 GOTO 100

620 PRINT LEN(I$(I)):GOTO 100

630 TT=0:FOR I=1 TO N:TT=TT+PEEK(VARPTR(I$(I))):NEXT
640 PRINT"N=";N;"Used $=";TT;"FREE $=";42496!-TT;"FREE #=";FRE(8):GOTO 100

650 FOR I=1 TO N:L=LEN(I$(I)):IF L=0 GOTO 720
660 FOR J=1 TO L:A=ASC(MID$(I$(I),J,1))
670 IF A<65 OR A>90 GOTO 710
680 IF J<3 GOTO 700
690 IF MID$(I$(I),J-1,1)=" " AND MID$(I$(I),J-2,1)=" " GOTO 710
700 MID$(I$(I),J,1)=CHR$(A+32)
710 NEXT J
720 NEXT I:GOTO 100

730 '..

```

Table 1B. Listing for the Basic Editor.

mode. After the corrections have been made, hitting either RETURN or E will cause the line to be entered into the program or string space as the case may be. The trick here is to make it appear to the program that you have just typed the line which you wish to correct. Although I have not done this on any other system, I believe it can be done on any computer that allows use of CONTROL A (or any similar action) to enter the EDIT mode on a line being typed in. However, you must know where the first byte of the input buffer is located. With this BASIC it is located at 538 decimal.

If you do not know where the input buffer is located, enter command mode and type in a long string (at

least 100) of any single character, and hit RETURN. After the SYNTAX ERROR message has been displayed, type in the following:

```
FOR I=n1 to n2:PRINT I,
CHR$(PEEK(I)):NEXT
```

where n1 and n2 are educated guesses at addresses between which the input buffer should be found. Note that part of your string of symbols will have been replaced by the above direct command. You may have to make some calculations to determine the address of the first byte. If you miss it, it will become obvious when you first use the EDIT function and you can then adjust the value. If you POKE outside the buffer, a program crash may result.

The 537 in line 290 is one less than the first buffer byte. After the entire string has been POKEd into the buffer, a binary zero is POKEd into the byte following the last character. This marks the end of the string for the EDIT routine.

All of the normal EDIT commands, except the Q for quit, work just as they normally do. If you use Q, you will end up with a null string. The LINEINPUT command must be used, instead of INPUT, at the end of the routine in case the string contains a comma or a colon. This EDIT function is well worth the trouble of finding the location of the input buffer.

There is one more precaution to observe when using EDIT. The first entry after the "Hit C/A" prompt absolutely must be CONTROL A or whatever substitutes for it in your software. If you make a mistake and enter any other character, such as L for list, that character will replace the first byte in the buffer, and a binary zero will be placed after it. Then, when you enter EDIT you will find you only have a one-letter string. If you then hit RETURN, or E, that one-letter string will replace your line. There are two ways to recover from this. One, simply hit H for hack and retype the whole line. Or, before hitting CONTROL A, hit CONTROL C (or BREAK) and then type GOTO 100. I can assure you that when you do a lot of editing and become sleepy, you will encounter this problem. Hence, remember these instructions.

FIND is used to obtain the line number of any line. You will be prompted to input a string, which should include enough of the first part of the line to distinguish it from other lines. Usually two words will suffice. The line number (subscript number) and the line are displayed. If two or more lines match the search string, they will all be displayed.

APPEND is used for loading text from a digital tape and from the keyboard. The tape input goes through the terminal. To minimize time wasted in finding the right line following the GOTO 70 in line 70, this routine is placed at the beginning of the program. Text can be entered from the keyboard, more text appended from tape, and vice versa. Also, you can load data from two or more tapes by repeated use of AP-

PRAM PERMANENT RAM

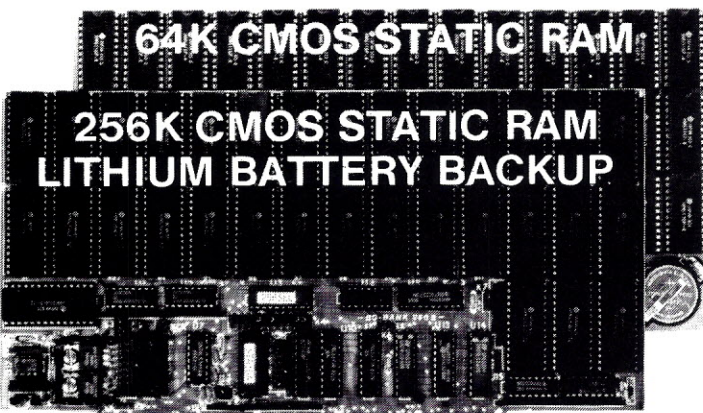

GUARANTEED IN YOUR SYSTEM
 CROMIX-D • MPM • CCS • OASIS • AMOS

✓ PLUS: 8/16 BIT TRANSFERS • 24-BIT EX ADDRESSING
 8-12 MHZ • 2K DESELECTS • RAM-EPROM MIX
 IEEE 696/S-100 • LOW POWER • FULLY STATIC

LITHIUM BATTERY BACKUP avoids power failure crashes intelligently. Unique POWER-FAIL -SENSE circuit allows processor to save register information and disable board before POWER FAILURE CRASHES memory.

BG BANK 256S \$1,299	Battery Backup..... \$79
BG BANK 64S 399	Battery Backup 39

BG COMPUTER APPLICATIONS, 206 Brookside, Bryan, Texas 77801. International orders add 30%.
(409) 775-5009

PEND. You will always be asked for the width. To be on the safe side, always use a width of 80 when appending data from a tape, but answer the question with the actual width desired when typing in text. This will result in your getting a CR if you exceed the specified value. Note that in the EDIT mode, with the same width setting, you can put two characters on the line following the automatic CR, since two spaces are taken up by the "!" at the front of a line being edited.

The final function is DECAP. I have a few old audio tapes with text in all caps. This DECAP function changes all caps to lower case unless they are the first letter of a new sentence. I then use EDIT to make any final corrections, such as restoring capital letters to proper names. If you do not need this routine, just leave it out.

Someone is certain to ask why line 730 is there. That was a quick solution to a problem. For a time I was having a hardware problem which sometimes resulted in getting something other than a binary zero in the

two bytes following the end of the program. This resulted in the program going awry, because it did not know where the end was. Line 730 is simply something I could find easily by using either PEEKs or the front panel controls. I could then use either the front panel or POKEs to get these two bytes back to binary zeros and then reenter the program at line 100 without any lost data. A front panel is often a real data saver, if you know how to use it; you can make changes in a program without losing the stored data. ■

I will try to answer any questions you may have if you will write to me at 200 Juniper Ave., Merritt Island, FL 32953 and enclose a SASE for the reply. I can also provide copies of this program on digital tape or audio tape (Altair standard) for \$10 if you do not want to type it in. I can also transfer it into one of my TRS-80s and record it on a diskette in either TRSDOS or in LDOS for \$15. In LDOS it can be on either a single- or a double-sided disk. If you request help, include a listing of the program as you have it in your computer and any pertinent data concerning your computer and software. Good luck!!

DID YOU BUILD OR INTEGRATE YOUR OWN S-100 SYSTEM?

Share your baby with us!

Send S-100 Journal a printed letter (up to 3 pages) explaining what boards you used, what OS and software you've got running, how you overcame any problems that you encountered, etc. No need to make your letter sound like a magazine article, we'll take care of that.

Be sure to include your name and address and, if you wish, a photo of your system.

SUBSCRIBE



PLEASE ENTER MY SUBSCRIPTION TO S-100 JOURNAL.
ENCLOSED IS \$14.00 FOR 1 YEAR. \$25.00 FOR TWO YEARS.
(Same price for Canada and Mexico. Other countries please add \$3.00
per year. All payments must be in U.S. currency.)

NAME _____

ADDRESS _____

PLEASE MAIL TO: S-100 JOURNAL, PO Box 12881, Raleigh, NC 27605

CS85

(continued from page 13)

must be the type for mounting on the frame. Order the frame-mounting hardware for the DB-25s too.

(Also see Fig. 5 and the part below on making the cables.)

For buying already-made cables: Order these from a CompuPro System Center or any other place that knows what the CompuPro cables are. You need three cables: the 3-serial-port internal cable for the Interfacer 4, the Centronics internal cable for the Interfacer 4 (omit this one if you are planning on using a serial printer), and the cable that connects the disk-drive subsystem to the Disk 1 controller board.

CP/M-68K

Finally, we need an Operating System for our machine. Of those available (more on others below), CP/M-68K is the least expensive to obtain. CP/M-68K has now been available for a couple of years. It is one of the best operating systems that Digital Research has so far produced; it even comes with its own C language.

Unfortunately, like many other top-quality products on the market, CP/M-68K has not gained wide popularity. This implies that the availability of software is less than desirable. But the software that does exist is generally of high quality and includes several powerful languages.

The C language that comes with CP/M-68K is not a full implementation of UNIX C, lacking, for example, floating-point arithmetic. However, to dismiss it a priori would be an unfair mistake. The language comes with a good set of library functions, including the basic I/O functions, and a lot of advanced software can be written with it. Besides, it is compatible with UNIX C. If you start with CP/M-68K and later decide to purchase UNIX, all your programs will run with little or no modification.

Buy the CP/M-68K from Viasyn, already configured for this system. They also include Forth in the package at no extra cost. Mine came with

two versions of Forth. One that boots and runs by itself and another that runs under CP/M-68K. Both versions have many many words (functions).

Where to get the parts

Where you buy your parts depends a lot on how much help you think that you might need assembling your system. Since this article describes what you need to know, you should, theoretically, need no other help. This makes mail order the most attractive alternative (lower prices and no sales tax). Still, be sure to select a mail-order house that offers some level of technical support over the phone. Also, as previously mentioned, at least some of the parts you will need to buy from CompuPro System Centers. One place that I recommend, based on prior experience, is S-100 Div./696 Corp. (You can tell what those folks are into!) They have very good prices and service, are a CompuPro System Center, and offer reliable technical support.

(All addresses of recommended places follow at the end of this article.)

Technical support is, unfortunately, a problem with Viasyn. They absolutely refuse to offer direct customer support and insist that you address all your questions to the CompuPro System Centers. This sounds OK, until you try it. Many System Centers must, in order to stay in business, sell boards and other hardware from many manufacturers. There is no possible way that they can keep up with all internal details of individual boards. Not long ago, I called a nationally known System Center to ask a question about a board. The technician, very cooperative, read me a manual that was two years outdated. Also, when I first decided to integrate this system, no one seemed to know the minimum number of boards required to run CP/M-68K . . . A mortal sin that you can commit is to buy your Viasyn parts from different System Centers. You usually get no help from a place unless you buy

all the parts there. And you can't really blame the System Centers; they have no way of knowing what shape your other parts are in. But the parts **are** Viasyn, so why should you not be able to get help from Viasyn?

I have been telling you this so that you know what to expect, if you build the system described here, and to help you decide where to buy the parts. However, don't get discouraged. The main reason S-100 Journal exists is to support S-100 users and integrators. If you have questions, write, and we'll try to come up with the answers.

Onward: The Integrand mainframe, you can buy directly from Integrand. However, if you buy from a mail-order retailer, you'll get a better price. They will not have it in stock, so order at least a month before you plan to assemble your system.

If you are making your own cables, a place that I recommend for the ribbon cable and connectors is Electro Mavin. Good service and quality products at bargain prices!

Some of these components you might be able to buy used. If you can obtain a warranty, even a small one, used products are worth considering. One item that should be available is the CompuPro 8-inch floppy subsystem, because many people have been "upgrading" to hard disk. (Have the used drives cleaned, overhauled, and tested before you place any master disks in.)

CONFIGURING THE BOARDS

Little work is required to configure the boards. There are two types of wee devices that you need to worry about: jumpers and DIP switches. The jumpers are marked on the board with names that start with J, like J1 or J12. The switches start with S, like S1 or S2. A name like S2 actually refers to a group of switches. To indicate individual switches in the group, a hyphen is used, as in S2-3 or S1-5.

The switches, you just flip ON or OFF with the tip of a pen. A jumper is

more boards to your system, the DC voltage will drop so you may have to adjust accordingly.

CAUTION: *Don't touch anything inside the cabinet, and don't plug or unplug things, while the computer is running. Before measuring voltages, practice the use of the voltmeter probes with the computer OFF.*

For users in other countries: If your line voltage is 220, you can order the Integrand mainframe with a 220 V power supply.

MAKING THE CABLES

Cut the ribbon cable into two 3-foot sections and one 4-foot section. Split away fourteen of the wires in one of the 3-foot sections, thus ending up with a 36-conductor cable. Also, partially split the second 3-foot section as indicated in Fig. 5. Then, attach the connectors to the cables as shown in the figure.

The little triangle on the connectors indicates pin 1. The Centronics and DB-25 connectors will have the pin numbers marked on. Where the 36-conductor cable connects to a 40-pin IDC, two pins are left unconnected on each side. The three split-ends start at pin 1 on each of the DB-25s. Everywhere else, pin 1 connects to conductor 1 (usually colored red in gray ribbon cables).

Unless you have a special tool, you will need a small slab of wood to press the cable onto the connectors. Once you've fixed the cable in place between the two parts of the connector, use the wood to press the parts together against a flat surface. Don't hit it! Well, at least don't hit it hard.

PLUGGING IN

This part is easy (and fun). Plug the boards into the motherboard. The boards can be plugged anywhere on the motherboard, but leaving at least one empty slot between boards will help cooling. The component sides face to your right when you face the front of the machine; the card cage should not allow any other position. If the boards are too tight or too loose in the cage, adjust the cage accordingly. Moderate force is required to

push the boards into the connectors. Use the handles on the corner of the boards to push in, or eject the boards.

Plug the cables into the Disk 1, Interfacer 4, and floppy subsystem (see Fig. 5). Mount the Centronics and DB-25 connectors in the back of the computer (cutouts are provided in the back, but you still may have to use a little imagination in order to mount the Centronics port).

Organize the cables neatly inside, making sure that they will not be squeezed between the cover and the rest of the frame.

Congratulations! Your system is assembled.

FIRING HER UP

Plug your terminal into the back of the machine (the correct port is the DB-25 marked A in Fig. 5). The terminal must be set for 9600 baud, 8 bit word, 2 stop bits, and no parity. Hold your breath a minute. Recheck all connections. You did take the shipping cardboard piece out of the drives, right? Relax a bit . . . FIRE! The fan should be on, the reset switch on the mainframe should be lit, and the light on the left (A) disk drive should be blinking. All OK? Take the "CP/M-68K System Master Disk 2 of 3" and insert it into the blinking drive. Close the drive. You should hear a few strange noises, while the system boots, then a message will appear on the screen. You are now on your own to explore, but remember to backup the CP/M-68K first; follow the instructions in the "Tech. Manual" that comes with it.

If things did not work out as above, you have some rechecking to do. Start by verifying that all three power switches are on (mainframe, floppy subsystem, and terminal). Next, follow the troubleshooting procedure in the back of CompuPro's "CP/M-68K Teck Manual and Installation Procedures." If necessary, recheck all the switches and jumpers on the boards. Reread this article and read the manuals. Then, call the dealer(s) for tech support. If all else fails, write to me, and I'll try to answer questions in future issues.

To use a printer as the LST: device for CP/M-68K, connect a parallel

printer to the Centronics port or a serial printer to the serial port corresponding to the DB-25 marked B in Fig. 5. (Note the previously described procedure for configuring the Interfacer 4 to a printer.)

MORE INFORMATION

This system has many features that I have not mentioned. Obviously, the most complete source of information is the set of manuals that you receive with the parts. Unfortunately, most of the manuals are poorly written and assume that you already know a lot of electronic lingo. The exception is the CP/M-68K manual which, rather unlike previous Digital Research manuals, is very good.

To learn more about S-100 systems

TERMINALS

ADDS REGENT 200s — These exceptionally smart terminals have separate numeric, cursor control, & function key areas, and support the following software-selectable attributes: Normal, half-intensity, underlined, graphic, blinking, & reverse video, protected and unprotected fields. These attributes may be used together, and can cover all or any part of a screen.

Online/block/page transmission modes. Switch selectable: RS-232/Current loop; 75-19,200 baud; auto scroll on/off; upper only or upper & lower case; normal/reverse video; half/full duplex; even/odd/no parity. \$225 each.

MICRODATA PRISM 4700s — Industrial grade RS-232 dumb terminal. Displays upper case only, generates upper/lower case. Numeric keypad, heavy metal housing, detached keyboard w/5' cord, internal fan for hostile environments. Switch selectable: 110-9600 baud; half/full duplex; normal/reverse video; even/odd/no parity. Power cord \$5 extra. Excellent for control projects. \$175 each.

These terminals have each been cleaned, completely refurbished, and tested prior to shipping. CRTs are all in excellent shape. I also have some of each type with new amber CRTs for \$50 extra. Buyer pays freight. I guarantee satisfaction, or money (incl. freight) refunded within 30 days of purchase.

Dave Simpson, 151 Warwick, Park Forest, Ill. 60466-1627 or phone 312-747-3107 12-9 pm CDT. Quantity prices available.

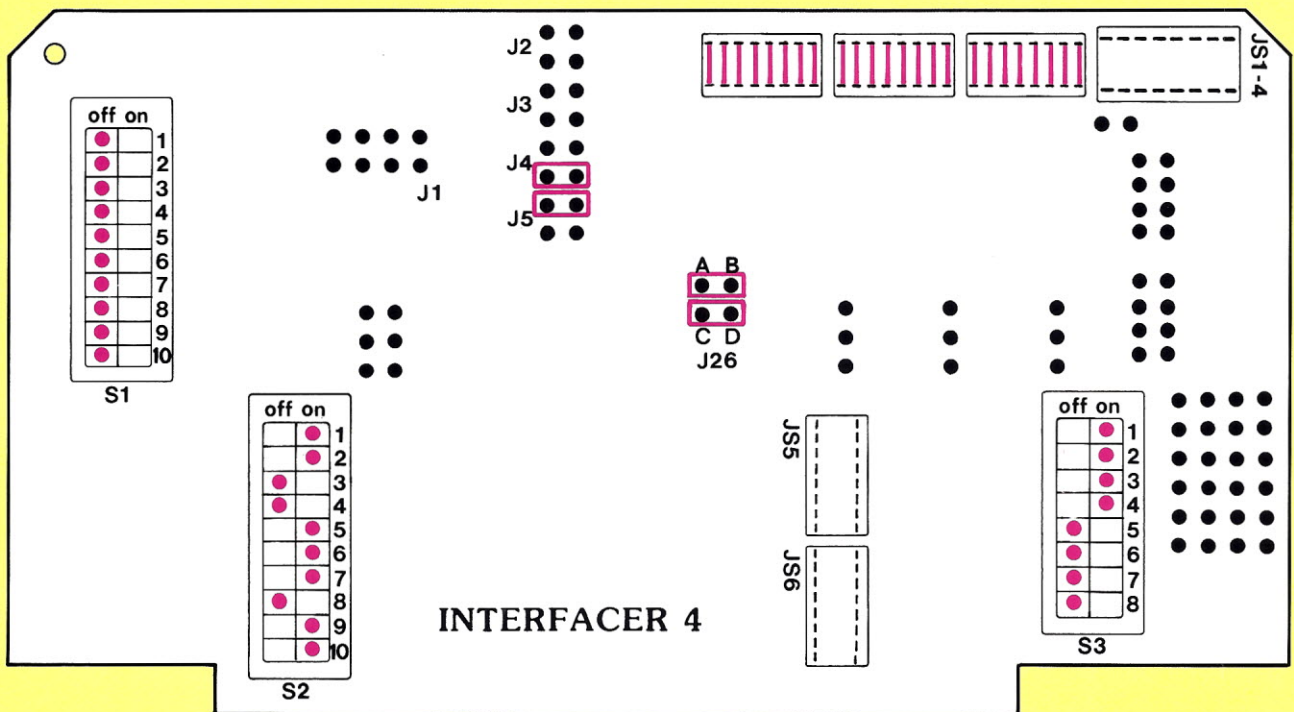
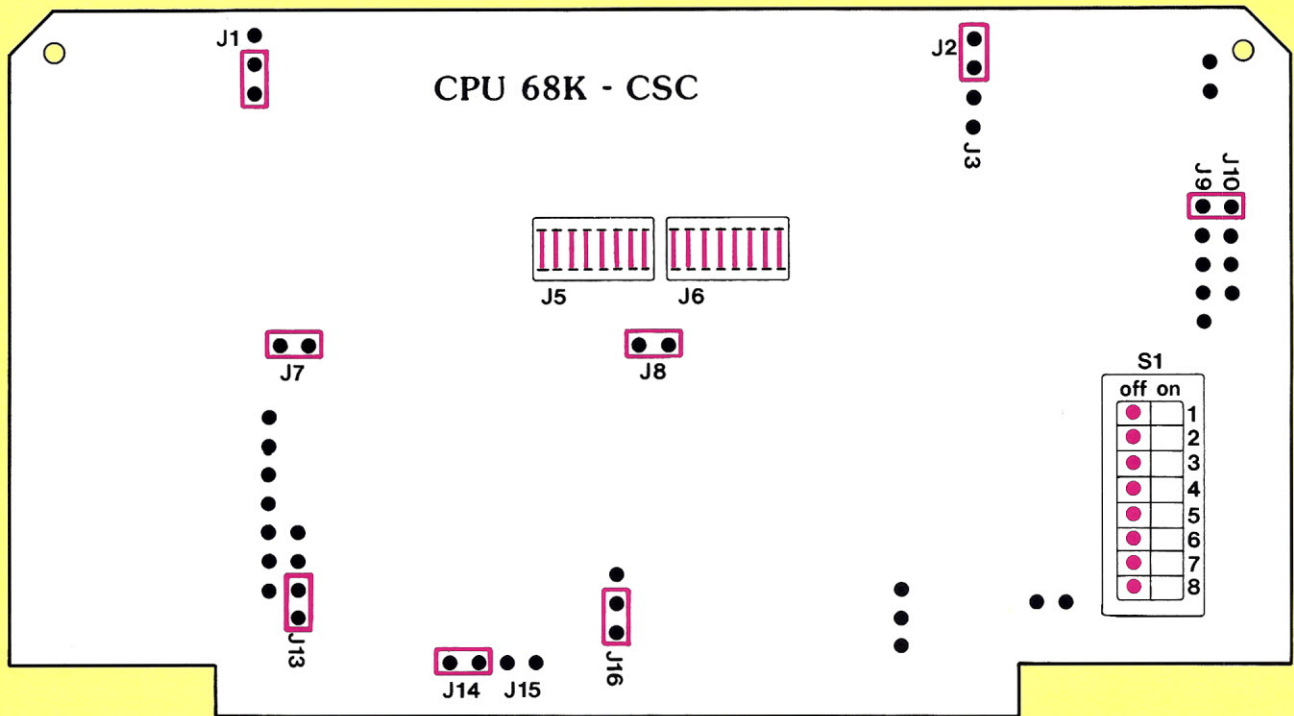

Figure 2. How to configure the CPU 68K and the Interfacer 4. Red rectangles and lines indicate where shunts should be installed. Red dots indicate positions of microswitches.

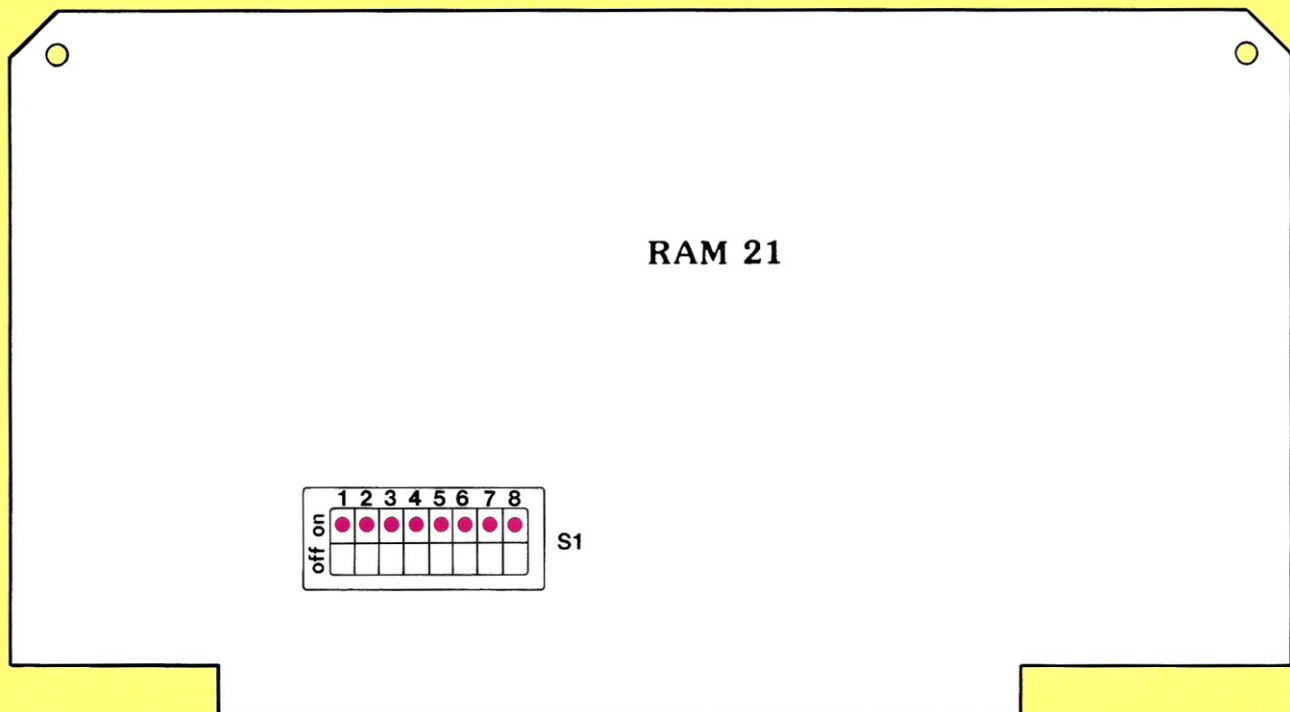
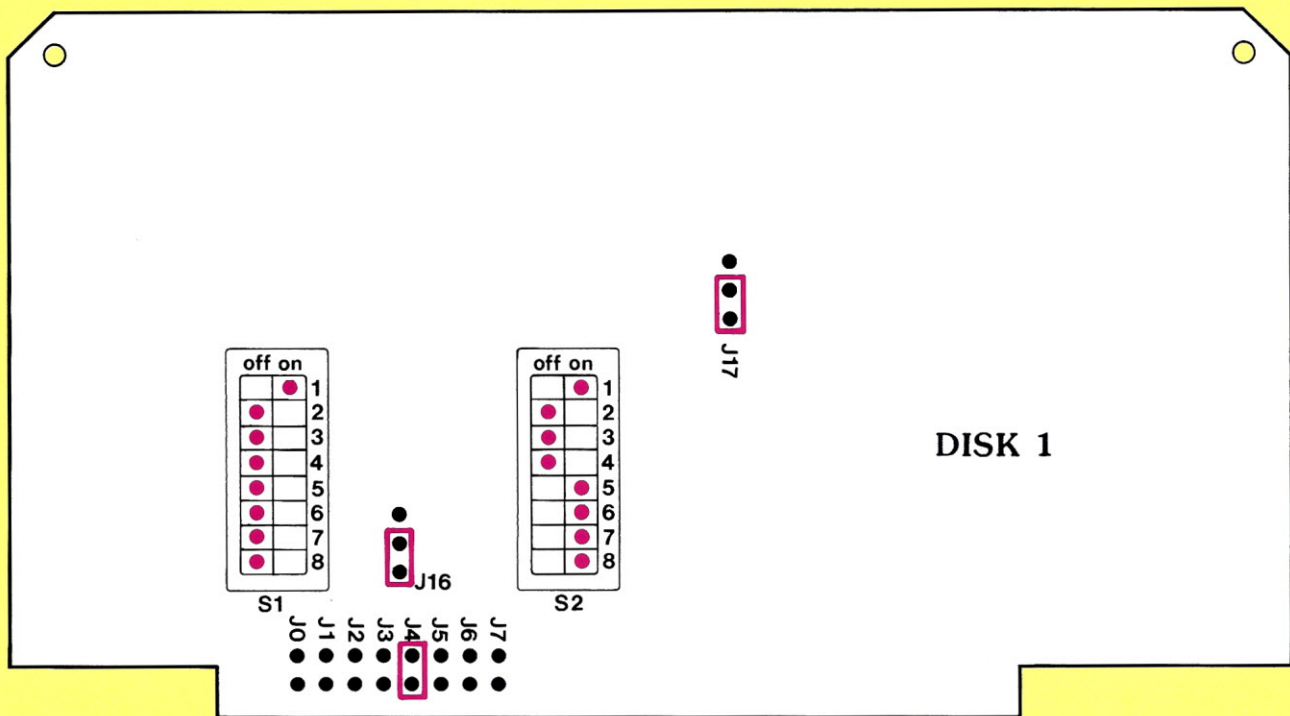

Figure 3. How to configure the RAM 21 and the Disk 1. Red rectangles indicate where shunts should be installed. Red dots indicate positions of microswitches.

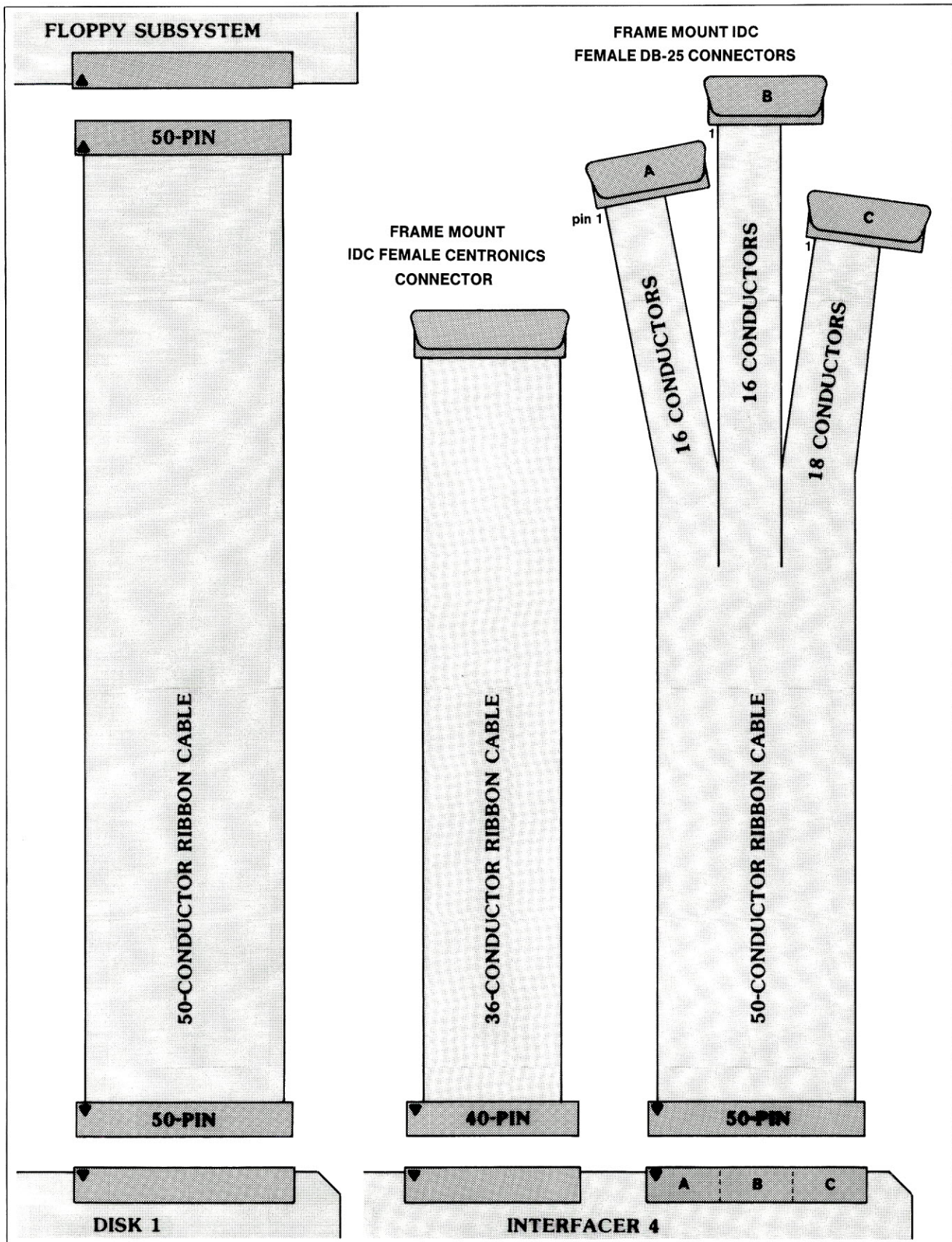

Figure 5. Internal cables and connectors.

in general, old issues of BYTE and of Microsystems will help. Two books that you should get are "The S-100 BUS Handbook" by Dave Bursky and "interfacing to S-100/IEEE 696 microcomputers" by Sol Libes and Mark Garetz. The "Handbook" is now fairly outdated but still useful; B. Dalton bookstores usually carry it. The "interfacing" book can be ordered from Micro/Systems Journal (*address at the end*). Old issues of Microsystems can also be ordered from Micro/Systems Journal.

WHERE TO GO FROM HERE

As an alternative to CP/M-68K, at least two other powerful operating systems are available for this system, UNIX and SI. For UNIX, contact Dynacomp. For SI, contact Multi Solutions. These operating systems may require more hardware (like extra memory) than the basic CP/M-68K machine.

What I have described in this article is only the beginning of a very advanced system. From now on, as in all S-100 systems, you can expand endlessly. Your next best purchases are probably more memory and the CompuPro System Support 1. Then, add a hard disk, if you need a large storage system. Add RAM disk for super fast disk access operations. Go multiuser with several different options. And so on. ■

Addresses:

Electro Mavin
12600 Yukon Ave.
Hawthorne, CA 90250
(213) 978-0909

S-100 Div./696 Corp.
14455 North 79th St.
Scottsdale, AZ 85260
(800) 528-3138

Dynacomp Computer Systems
210 W. Broadway
Vancouver, BC V5Y 3W2
(604) 872-7737

Multi Solutions, Inc.
123 Franklin Corner Rd., #207
Lawrenceville, NJ 08648
(609) 896-4100

Micro/Systems Journal
Box 1192
Mountainside, NJ 07092

Integrand
8620 Roosevelt Ave.
Visalia, CA 93291
(209) 651-1203

WANTED: S-100 BUS WIZARD

. . . to write a regular (four times per year) column for S-100 Journal.

We are looking for an individual with sound technical knowledge of the S-100 Bus and the IEEE 696 Standard. To qualify, you must write well and have access to various S-100 systems.

Your column will answer technical questions sent directly to you by readers.

Please call Jay Vilhena at (919) 839-0115 if you are interested.

THE C. ITOH A10-30

Joseph Alukal

an affordable daisy-wheel printer may appear as the solution to your modest letter-quality requirements. Perhaps you already own a fast dot-matrix. A not-necessarily-so-fast, but low-cost, daisy-wheel would be a nice second printer. So you visit a few dealers and become disappointed. You had not realized that low-cost daisy-wheel printers were THAT slow. Look again! The C. Itoh A10-30 runs at 29 CPS (characters per second), almost twice the speed of comparably priced daisy-wheel printers. The list price is \$669, but mail-order prices are much lower. Furthermore, the A10-30, which is actually a TEC (Tokyo Electric Co., Ltd.) printer distributed by C. Itoh, is built tough and with attention to quality.

Hardware Features

The A10 carries a one-year warranty, and it is available with either a serial or a parallel interface. It uses the same widely-available ribbon cartridge as the Diablo printers. The daisy wheel itself is a proprietary TEC quick-mount type. After six months

of use, I find this TEC daisy wheel to be superior to the Diablo wheels. The "petals" on the daisy are held together by a fabric that prevents them from breaking off and increases accuracy in character spacing. C. Itoh has over twenty wheels available for the A10. They include several domestic styles, foreign character sets, and even an APL wheel.

A tractor is available as an option. It mounts easily and functions perfectly. The width of the tractor is adjustable up to 13 inches wide, not quite wide enough for 14-inch paper but fine for most everything else. An auto sheet feeder is also available. I have not tried the feeder, but some reports indicate that it is not so great, and the price is certainly horrendous. If you do so much letter writing that you need an auto sheet feeder, I suggest that you find a different printer (e.g., the C. Itoh F10 series).

The control and monitor panel on the A10 includes a switch to set the default character pitch. Three positions are available: Pica, Elite, and Proportional Spacing. The pitch can also be software controlled (see below). A red LED alerts for out-of-paper, ribbon end, cover open, or motor trouble, and the printer will

not work until you correct the problem. The hideous days of trying to defeat out-of-paper sensors with string or tape seem to be finally gone, since many manufacturers now provide a means of disengaging this feature. In the A10, this is done via a DIP switch. In addition, the set of DIP switches is conveniently located at the top-rear of the printer and easily accessible.

Faults: Like most daisy-wheel printers, the A10 is noisy and vibrates a lot. You will want to give it its own sturdy stand. The switches on the control panel are inconveniently small. The manual is very condensed and has many typos, but it provides the information needed to use the printer.

The interface buffer supplied with the printer is only 200 Bytes, but it can easily be expanded by plugging a 2K or 8K chip on the logic board (the manual tells how). Your dealer will probably do this for about \$10, if you are not into printer gutting.

Software Features

The A10 features a nice set of control commands, most using ESCape se-

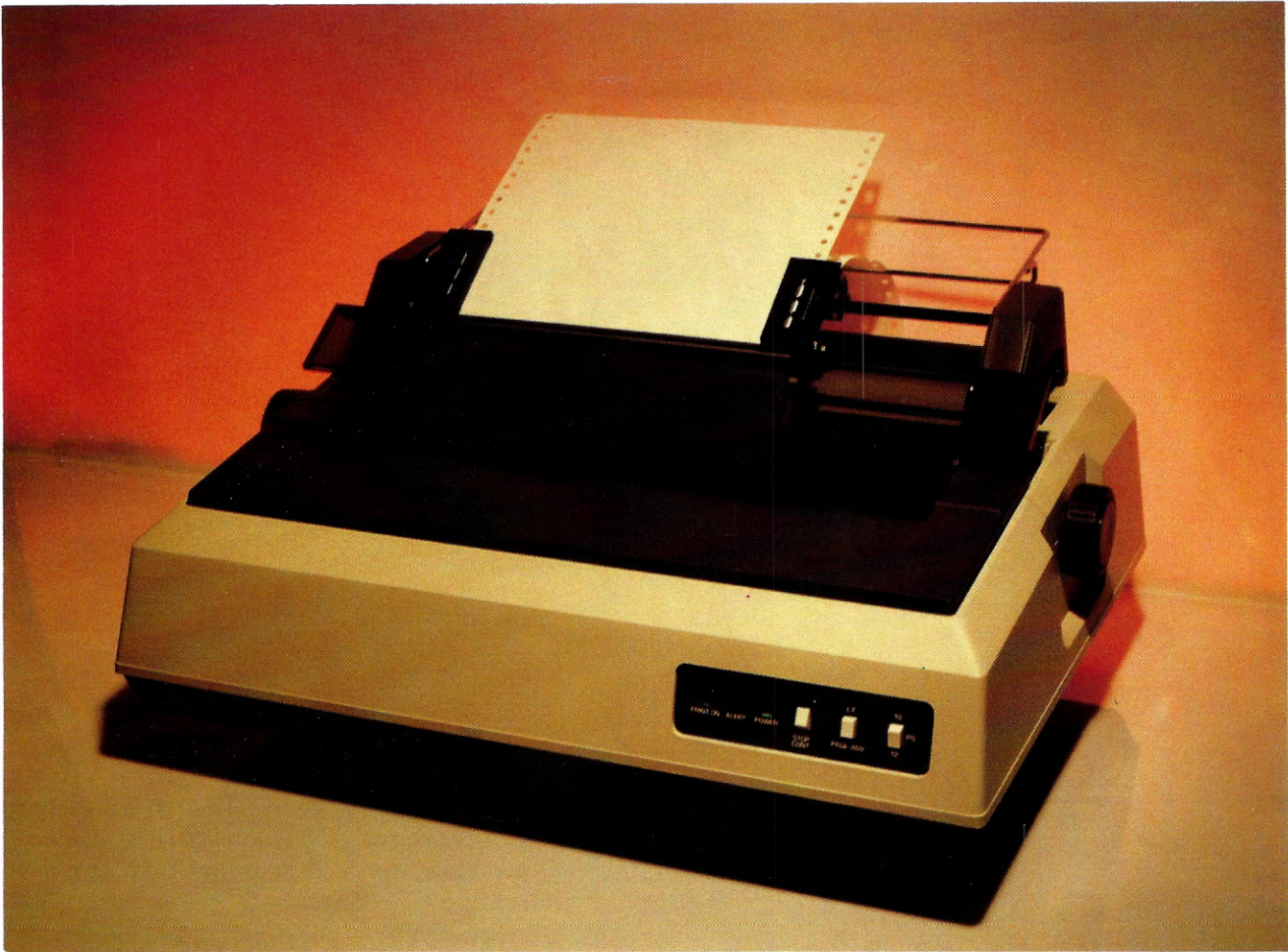

The C. Itoh A10-30 with optional tractor.

quences. These are fairly standard in modern printers but a few are worth mentioning.

BS — True back-spacing! This may seem trivial, but it is listed here because I am amazed at the number of printers currently on the market that ignore this ASCII code and instead rely on external software to move the printhead around.

Line Feed Spacing Pitch. You can control the spacing between lines from 1/48 inch to about 3.3 inches in 1/48 increments.

Reverse Line Feed. This is nice to do super- and subscripts. How far up or down the super- and subscripts will appear can be controlled by the above LF Spacing Pitch.

Horizontal Spacing Pitch. Probably the most desirable feature, it allows

the spacing between characters to be software controlled in increments of 1/120 inch. Moreover, it is possible to change the width for each individual character in order to achieve proportional spacing and/or typeset-quality right justification. Of course you will need to write (or purchase) a program that tells the printer what spacing to leave for each character. Note that the printer comes with a standard built-in proportional mode to be used with TEC's proportional spacing wheels. This "default" mode works very well for regular text but is somewhat crude in all-uppercase lines such as titles.

Margin Setting and Tabs. The set of tab commands is very complete and allows both relative and absolute tabbing, either vertical or horizontal.

Downloadable Character Sets. What this really means is that a program can teach the printer where the characters are located in a nonstandard daisy wheel (assuming that you actually have one that fits in the printhead). The information can include how much pressure to place on each character (hammer impact) and the proportional spacing for each character.

Graphics mode. Finally, the silly possibility of doing graphics on your daisy-wheel printer is supported. This mode works by placing the characters right next to each other, both vertically and horizontally, and thus allowing a program to draw lines, bars, and whatever else your imagination (and a lot of programming time) can conceive. ■

EDIT-68K

Jay Vilhena

Metacomco is a British software house that specializes in languages and utilities for 68000-based systems. The company's top product is Cambridge LISP 68000, a high-performance LISP interpreter/compiler that runs under CP/M-68K. LISP is a language used widely in artificial intelligence and expert systems. In its Cambridge LISP package, Metacomco includes, at no extra charge, a full-screen editor called EDIT-68K.

I had just started my article on assembling a CP/M-68K system (elsewhere in this issue) when I learned that EDIT-68K was available by itself for \$95. This seemed like the perfect piece of software to add to a 68000 starter system. Metacomco provided S-100 Journal with an evaluation copy of the editor, and I've used it for about a month. It is excellent for writing and editing programs. In addition, I used it to write this article and part of the "assembling a system" article with very satisfactory results.

For more information on Metacomco's products, contact Tenchstar Inc., 201 Hoffman Avenue, Monterey, CA 93940. Tel. (408) 375-5012.

EDIT-68K is primarily intended as a full-screen editor to write and edit programs. It is not a word processor, hence it does not support printer drivers, embedded control characters, or justification. Nevertheless, if you can dispense with those, it can also serve as a nice text editor for purposes other than program editing.

The prime attribute of EDIT-68K is its full-screen orientation. The editor is optimized to run on a smart terminal, and therefore takes advantage of capabilities already built into the terminal such as scrolling and inserting lines. This makes it much faster than other full-screen editors (and many word processors) that must rewrite the screen everytime trivial changes are made.

When you call up the editor, via the "EDIT *filename*" command, it provides an empty screen ready to accept data. If the file being edited already contains data, the screen fills up with the first 23 lines of text.

Margins and tab distances can be set up, or the default values of 1 and 80 for the margins, and 3 for the tabs, are used.

As new text is entered, a return/linefeed is automatically inserted as close to the right margin as it is possible without breaking words. When the cursor is at the bottom of the screen, the whole display scrolls up a line and a blank line appears. To prevent from having to always look at the bottom of the screen, one simply needs to maintain several leading blank lines below the cursor. Then, when returns are inserted, new lines

appear in the middle of the screen.

The right margin can be set as far as 255 characters. If it is set to a value greater than the width of the terminal, and data is entered past the right side of the screen, all text scrolls left in 10-character increments to make room. It scrolls back to the right when the cursor returns to the left margin. With these scrolling capabilities, the terminal screen is in effect a window on a text surface of 255 characters by an infinite (actually finite due to memory limits) number of lines.

To move within the text surface (the file), cursor control commands are issued. The cursor can be moved left, right, up, down, to the top or bottom of the file, to the beginning of the next word, to the end of the previous word, to an absolute line number, etc. Text can be inserted or deleted anywhere the cursor goes.

EDIT-68K responds to two types of commands. Immediate commands and extended commands (see inset). Immediate commands are control codes that lead to immediate action. The editor is always ready to receive

immediate commands. Examples are the cursor movements and character deletions. In addition, by entering a special mode, the cursor jumps to the 24th line and waits for an extended command. Most extended commands are unique, and others are repeats of the immediate commands. The extended commands can be grouped. They can also be preceded by digits indicating the number of times the execution is to take place, a feature that is particularly welcome when using the "find" or the "string exchange" commands.

The 24th line is reserved for the extended commands, and it is also used to display error or status messages.

A very useful feature of the editor is the ability to process blocks of text. Once a block is defined, a copy of it can be moved to a different location simply by positioning the cursor and issuing an "IB" extended command. The block can also be sent to a disk file or to the printer. To send to the printer, simply enter LST: as the *filename*. Unfortunately, if you write a block to an existing file, the data already in the file is erased and only

S-100 Journal welcomes software packages and books for review. Of the items received, we will pick for review those that we find more interesting based on originality, usefulness, and performance. Also "interesting" are products that, although not original, have not been previously available for a particular operating system.

Books and software that we receive, but do not review, will be listed in the magazine with a short description of what they do or say. No books or software will be returned. They will be kept for reference and for continued use. We may decide not to review a product, then use and test it for several months and come to the conclusion that, after all, it deserves a review.

In addition, we may solicit from publishers, copies of software for evaluation. All materials that we solicit will be returned after evaluation, if the publisher so requests.

Only software for S-100 systems or for any of the operating systems running on S-100 computers will be listed and considered for review. MS-DOS/PC-DOS software will be con-

sidered only if it is a package specially developed for an S-100 system. Please do not send us general purpose MS-DOS/PC-DOS software. We will neither list it, nor review it, nor return it.

Under no circumstances will any copies of books or software that we receive, solicited or unsolicited, be sold, given away, or distributed in any manner to anyone outside S-100 Journal. We do, however, reserve the right to assign temporary possession of a copy to outside parties for review purposes only. In these instances, the outside party will be required to return the copy to S-100 Journal and to sign a statement indicating that no additional copies have been made.

All our reviews can be expected to be favorable to the product. This is because we will not waste time reviewing a software package unless we have reason to believe that it is worthwhile. Nevertheless, we will try to point out shortcomings as well as qualities.

Qualified free-lance software and book reviewers are invited to contact us.



YOUR COMPLETE COMPUTER STORE

FOR ALL YOUR S-100 EXPANSION BOARDS

BOARDS FOR Z-100 ZENITH DATA SYSTEMS COMPUTERS:

Hudson Memory Expansion Boards — 256K	\$595
Hudson 8087 Math Co-Processor Board	\$595
Hudson 256K Memory Expansion and 8087 Math Co-Processor Boards	\$1195
D.E.L. Gemini Board (IBM-PC Emulation)	\$549

FOR ALL YOUR PRINTER NEEDS CONTACT US

C. Itoh • Okidata • Toshiba • Other Popular Printers

CONTACT US FOR TERMINALS AND MONITORS

Amdek • Princeton Graphics • Qume • Wyse • Zenith

AUTHORIZED SERVICE CENTER

for Zenith Data Systems and Morrow Computers.

Authorized Service Center for Okidata and C. Itoh printers.

One week turnaround on most products (plus shipping time). Call first,
if you have any questions.

DIGITZ • 3015 HILLSBOROUGH ST. • RALEIGH • NC 27607
(919) 828-5227 Service Center (919) 828-1098

the block will be there. There seems to be no way to append a block to a disk file, a desirable feature that could easily have been implemented.

Text can also be called from a disk file and inserted below the cursor, a very convenient and versatile way to join files.

The "SA" command allows a copy of the most current version of the file being edited to be saved to a file or printed. If a *filename* or LST: is given, the editor uses that to send the text to. If only the letters "SA" are supplied, the current version is saved in the *filename* being edited. EDIT-68K keeps a backup copy of the previous version of the file.

While editing, the text is kept in a memory buffer. The default size of this buffer is about 60K bytes, but this value can be reset by the user according to the memory available.

Although EDIT-68K can be used with almost any terminal, it is most elegant with a smart terminal that features a set of editing keys. For editing and cursor movement, the editor sends control sequences that the terminal responds to. But, in addition, EDIT-68K can be set up to accept codes from the terminal's built-in keys. This is a step beyond simple function key programming (although you could use that too). Say, for example, that your terminal has a down-arrow key that generates the sequence ESC [B. You need to tell the editor, during installation on your system, that ESC [B stands for CTRL J, the editor's code for cursor down. From then on, it will always respond to the down-arrow key by moving the cursor down. The translation (or mapping) is nearly invisible to the user, and there is usually no noticeable decrease in speed — the response is immediate with or without mapping. I say "nearly" and "usually" because I found an instance where this mapping adversely affects the editor's performance. When using the repeat action of the arrow keys beyond

the limits of the terminal's screen, the editor must move the display while trying to translate all those arrow-key codes coming in. The result is the insertion of extraneous characters on the screen. To avoid this, simply press and release the key in fast sequence instead of holding it down. Or use the 12-line scrolling feature to move the cursor by large steps up or down.

I installed EDIT-68K for a Televideo 970. The editor already comes with a good list of terminals in its installation files. The 970 was not there so I wrote the file from scratch. It is printed here (see inset) as an example and as reference. The lower part of the file, where all commands start with *map*, tells the editor what to do with the codes from the 970's editing keys. Note that ESC ESC has been mapped into ESC (same as CTRL []). This is because the editor uses ESC as the key command that switches it into extended command mode. But ESC is also the code that the 970 and all other ANSI terminals use to introduce a command sequence. So, when sending a sequence from a command key, the editor would pick up the ESC and go into extended command mode. However, with the above mapping, it enters extended command mode only when it receives ESC ESC, i.e. press the ESC key twice. This works very well.

Another nice feature of the editor, is the possibility of including, in the installation file, two sequences of commands that are automatically sent to the terminal at the beginning and at the end of an editing session. These are the *init* and *uninit* commands seen at the top of the table with the codes for the 970. These commands can be as long as one wants. They could be used, for example, to set function keys for EDIT-68K to use and then to reset them back to the previous values, when the editor is finished. I used this feature to set the 970 to a 24-line page and to line-editing mode. EDIT-68K will not function with this terminal unless the terminal is set this way.

WANTED: MULTIMAGICIAN

. . . to write a regular column for S-100 Journal.

We are looking for an expert in S-100 multiuser systems and networks built with S-100 systems. To qualify, you must write well and work regularly with a variety of S-100 multiuser systems and networks.

Your column will try to provide answers to questions sent directly to you by readers.

Please call Jay Vilhena at (919) 839-0115 if you are interested.

There are a few basic things that EDIT-68K cannot do. One cannot type over (replace) characters. The new characters always must be inserted and the old ones deleted, in two separate operations. It seems that it might have been relatively easy to include an extended command to go into character replace mode if one wished, but such command is nonexistent. Also, a column delete would be very helpful. Presently, there is no way of deleting a whole column, of numbers for example, with a single command. I already mentioned the inability to append a block to a file. In addition, blocks can only contain whole lines, but that's not really a problem.

Overall, I was very satisfied with EDIT-68K. It is

simple to use and straightforward. Powerful, yet free of cumbersome or awkward features. And it is refreshing to see that somebody is developing software for alternative operating systems like CP/M-68K. ■

EXTENDED COMMANDS OF EDIT-68K	IMMEDIATE COMMANDS OF EDIT-68K
<p>Setup and formatting</p> <p>EX <i>Extends the right margin.</i> SL n <i>Sets the left margin.</i> SR n <i>Sets the right margin.</i> ST n <i>Sets the tab distance.</i> J <i>Joins the current line with the next.</i></p> <p>Cursor movement</p> <p>B <i>Moves cursor to bottom of file.</i> T <i>Moves cursor to top of file.</i> M n <i>Moves cursor to line n.</i></p> <p>Searches</p> <p>F/strgname/ <i>Finds a string.</i> BF/strgname/ <i>Backwards find a string.</i> E/strg1/strg2/ <i>Exchanges "strg1" into "strg2."</i> EQ/strg1/strg2/ <i>Same as above but queries first.</i> LC <i>Recognizes upper and lower case.</i> UC <i>Treats upper and lower case as the same.</i></p> <p>Block operations</p> <p>BS <i>Defines start of a block at cursor position.</i> BE <i>Defines end of a block at cursor position.</i> SB <i>Displays area of file containing block.</i> DB <i>Deletes the block.</i> IB <i>Inserts a copy of block below cursor line.</i> WB/filename/ <i>Writes the block to a file.</i> IF/filename/ <i>Inserts a file below the cursor line.</i></p> <p>Other extended commands</p> <p>RP <i>Repeats a command until an error is found.</i> U <i>Undoes any changes made on current line.</i> SH <i>Displays status of current edit session.</i> Q <i>Quits editing. Changes are not saved.</i> SA/filename/ <i>Saves current version of text to a file.</i> X <i>Exits the editor. Saves new version of file.</i></p> <p><i>(Extended versions of most immediate commands also exist.)</i></p>	<p>Changes in text</p> <p>CTRL A <i>Inserts a line below the cursor.</i> CTRL B <i>Deletes the current line.</i> CTRL F <i>Changes the character case.</i> CTRL N <i>Deletes the character at cursor.</i> CTRL O <i>Deletes from cursor to end of word or spaces.</i> CTRL Y <i>Deletes from cursor to end of line.</i> CTRL M <i>Inserts new line or breaks current line.</i></p> <p>Cursor movement and scrolling</p> <p>CTRL H <i>Moves cursor left.</i> CTRL X <i>Cursor right.</i> CTRL J <i>Cursor down.</i> CTRL K <i>Cursor up.</i> CTRL E <i>Moves cursor to top or bottom of screen.</i> CTRL R <i>Moves cursor to end of previous word.</i> CTRL T <i>Cursor to start of next word.</i> CTRL] <i>Moves cursor to start or end of line.</i> CTRL I <i>Moves cursor to next tab stop.</i> CTRL D <i>Scrolls text down 12 lines.</i> CTRL U <i>Scrolls text up 12 lines.</i></p> <p>Other immediate commands</p> <p>CTRL G <i>Repeats the last extended command.</i> CTRL V <i>Rewrites the screen.</i> ESC <i>Enter extended command mode.</i></p>

**INFO.VDU file to use EDIT-68K
on a TeleVideo 970 terminal**

<pre> Vdu Tvi970; Output; init send H1B,['1','0','z' send H1B,['1','Q']; uninit send H1B,['1','1','z'; length return 24; width return 80; highlighton send H1B,['1','m'; highlightoff send H1B,['0','m'; insertchar send H1B,['@']; deletechar send H1B,['P']; insert send H1B,['L']; deleteline send H1B,['M']; deol send H1B,['K']; clearscreen send H1B,['2','J'; cursorup send H1B,['A']; cursordown send H1B,['B']; cursorleft send H1B,['D']; cursorrigh send H1B,['C']; setcursor send H1B,[' ypos H81 send ',' xpos H81 send 'H'; scrollup goto 0,23 send H1B,'D'; scrolldown goto 0,0 send H1B,'M'; End; Input; map H1B,['A' to CTRL K; map H1B,['B' to CTRL J; map H1B,['C' to CTRL X; map H1B,['D' to CTRL H; map H1B,H1B to CTRL [; map H1B,['M' to CTRL B; map H1B,['L' to CTRL A; map H1B,['P' to CTRL N; map H1B,['8','0','G' to CTRL]; map H1B,['H' to CTRL E; map H1B,'D' to CTRL U; map H1B,'M' to CTRL D; map H1B,['K' to CTRL Y; map H1B,[' ','A' to CTRL R; map H1B,[' ','@' to CTRL T; map H1B,['2','J' to CTRL O; End; </pre>	<p><i>Initializes terminal to run EDIT-68K (this is required).</i></p> <p><i>Undoes the initialization.</i></p> <p><i>Tells the program the codes that need to be sent to the terminal in order to perform specific actions.</i></p> <p><i>Tells the program to interpret as immediate commands, the input from the following ter- minal keys:</i></p> <ul style="list-style-type: none"> <i>Up arrow</i> <i>Down arrow</i> <i>Right arrow</i> <i>Left arrow</i> <i>ESC pressed twice</i> <i>LINE DELETE</i> <i>LINE INSERT</i> <i>CHAR DELETE</i> <i>HOME shifted (reprogrammed)</i> <i>HOME</i> <i>Down arrow, shifted</i> <i>Up arrow, shifted</i> <i>LINE ERASE</i> <i>Left arrow, shifted</i> <i>Right arrow, shifted</i> <i>CLEAR SPACE</i>
---	---

The S-100 Directory will appear in the back pages of every issue of S-100 Journal. All services and products being offered through the directory must be related to S-100 systems. Only short messages are allowed.

To list your business in the directory, send \$80 for one year or \$140 for two years, along with your entry, to S-100 Directory, c/o S-100 Journal, P.O. Box 12881, Raleigh, NC 27605.

Users Groups and Bulletin Boards, not identified with any non-S-100 system, are also welcome for listing in the directory. A separate heading will be provided. There is no charge for listing nonprofit Groups or Boards.

ARIZONA

S-100 (602) 991-7870
14455 N. 79th. St., Scottsdale, AZ 85260

S-100 stocks most popular brands of S-100 boards, peripheral devices and software. We offer excellent pricing on all items especially drive subsystems.

CALIFORNIA

COCHLIN COMPUTER SYSTEMS INC. (415) 495-5999
330 Townsend St. #107, Santa Cruz, CA 95060
303 Potrero St. #29-104, Santa Cruz, CA 95060

Authorized CompuPro System Center. We provide on-site service and maintenance, custom software design, multi-user system integration, user training and more.

DATABANK (805) 962-8489
228A West Carrillo, Santa Barbara, CA 93101

SMD 8" Disk Subsystems — 84 — 168 — 300 MBytes with S-100 Controller. Mag Tape — 9 Track Tape. Boards from CompuPro, Macrotech, Dual Systems — all S-100.

MENTZER COMPUTER SYSTEMS (415) 340-9363
1441 Rollins Rd., Burlingame, CA 94010

CompuPro Full Service System Center. Custom S-100 systems, CAD Systems.

PRO*ACCESS (415) 969-4969
P.O. Box 747, Mountain View, CA 94042

If you don't find the File*works File Processor program the most powerful file backup and manipulation program you have ever used, return it within 30 days for your money back. For CP/M 2.2 or later, including CompuPro 8/16 series. \$149. Please specify format.

FLORIDA

JURIS SCRIVENER, INC. (305) 920-7772
2019 B Hollywood Blvd., Hollywood, FL 33020

System Integrator and Vendor. S-100 Granturbo Computers running TURBODOS 8 and 16 bit, will also run CP/M and MS-DOS. Systems for 4 users and up. FMS 80 Data Base Management Software for S-100 computers. Primage printers.

ILLINOIS

SMALL BUSINESS SYSTEMS, INC. (312) 579-3311
1016 E. 31st St., LaGrange Park, IL 60525

CompuPro multi-user systems, networking, peripherals, software. Fast, reliable, and versatile systems for any business computer needs.

MARYLAND

MICRO COMPUTER COMPANY, INC. (301) 942-5442
101 Wheaton Plaza North, Wheaton, MD 20902

We offer a wide selection in Syntech Data International and CompuPro S100 Bus products.

MICHIGAN

WALDORF ASSOCIATES, LTD. (313) 996-0646
4477 Jackson Road, Ann Arbor, MI 48103

CompuPro Full Service Center specializing in UNIX on S-100 Buss and special configurations for both R&D shops and Universities.

MONTANA

HARRIS-LARSEN & ASSOC. (406) 721-7070
211 North Higgins, Missoula, MT 59801

CompuPro Full Service System Center. System Integrators. S100 Consultants.

PENNSYLVANIA

FOREFRONT TECHNOLOGY CORPORATION (215) 386-1500
3508 Market Street, 2nd Floor, Philadelphia, PA 19104

CompuPro (Viasyn) System Center Plus! Software emphasized to take full advantage of hardware capabilities.

FRASER BUSINESS EQUIPMENT (215) 378-0101
523 Franklin Street, Reading, PA 19603

AUSTRALIA

BJ ELECTRONIC SYSTEMS (079) 513064
11 Wood St., Mackay 4740, Australia TELEX AA 46044

Fully integrated Fleet Management System with fuel, maintenance, driver, workshop, spare parts control and debtors, creditors, stock control. Payroll system.

CANADA

M.A.E. MICROSYSTEMS, INC. (514) 341-1210
8255 Mountain Sights, #175, Montreal, Canada H4P 2B5

S-100 Integrator for Custom Applications. Turbodos Applications 8/16 Bits. Sweda Cash Register interfacing and more.

GERMANY

CO-SY COMPUTER UND SYSTEME (2173) 52071
Krischerstr. 70, 4019 Monheim, West-Germany

We are looking for cooperation with Software manufacturers-authors to adapt and translate Software into German. We specialize in UNIX and C language, MS-DOS and C, and C-Basic.

IN FUTURE ISSUES OF **S-100 journal**

RAM Board Roundup
TurboDOS
S1 Operating System

High-Performance Terminals
Single Board Computers
and other goodies.

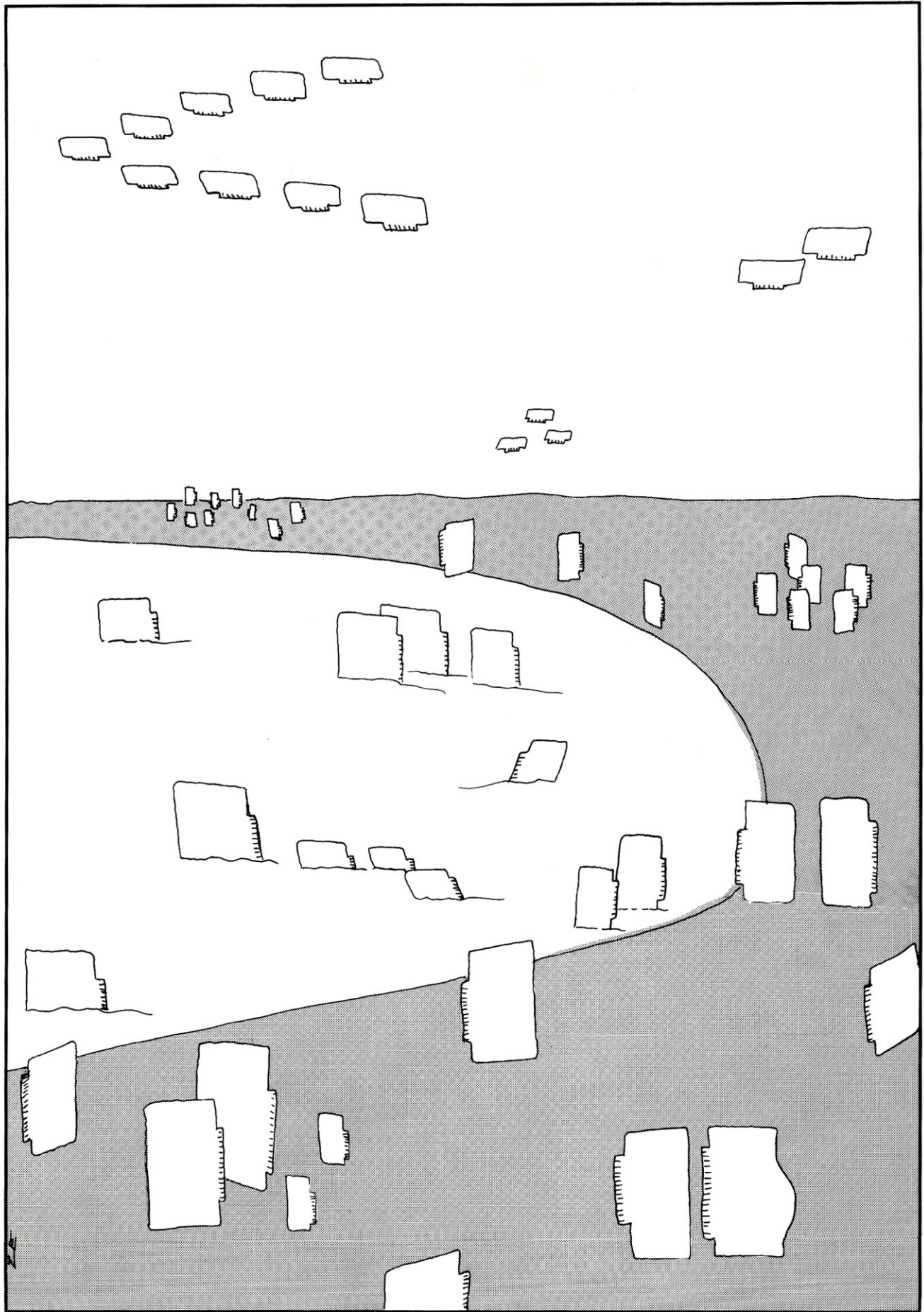

WRITING AN ARTICLE?
REQUEST OUR
"AUTHOR'S GUIDELINES"

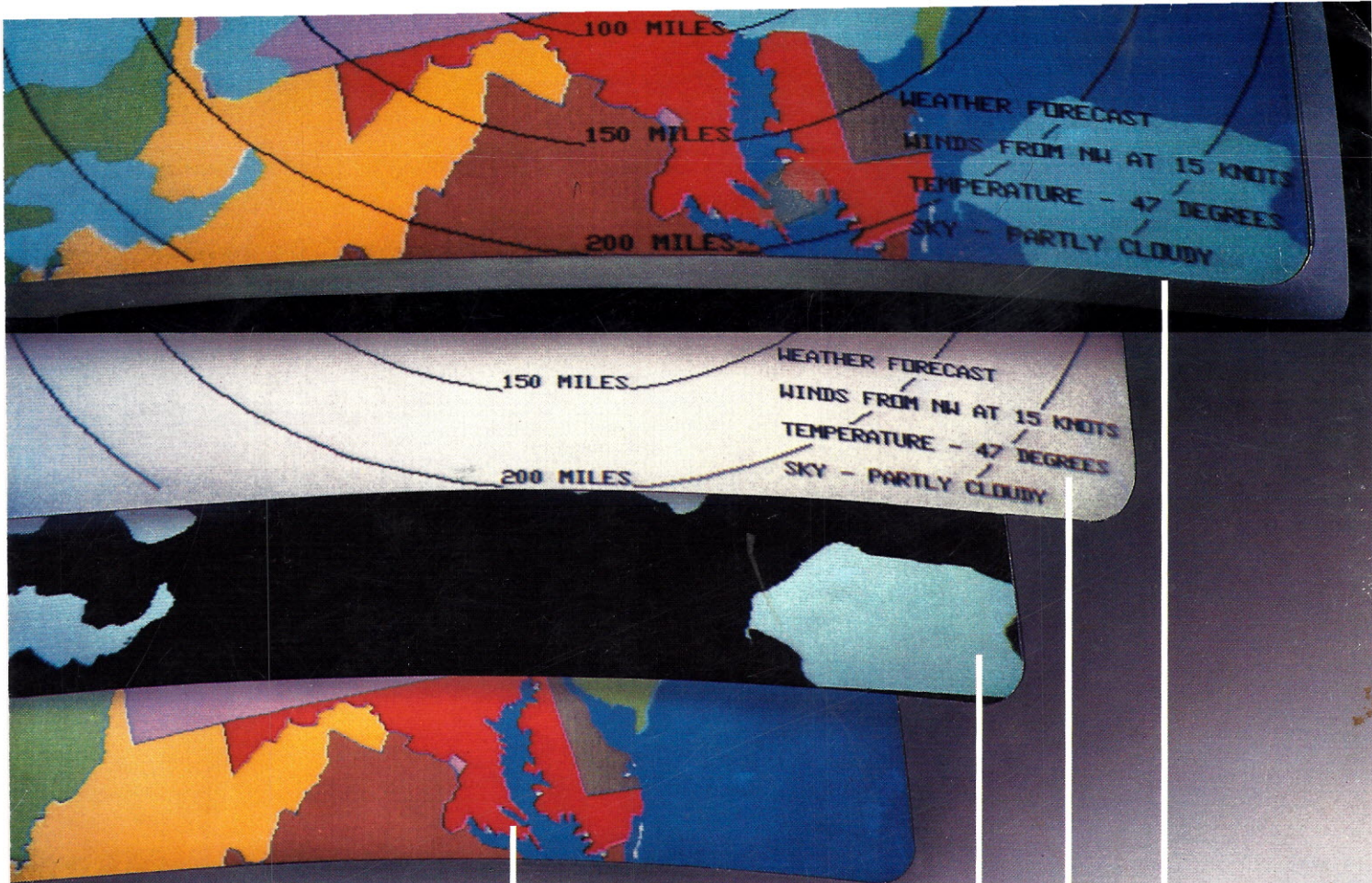

Add Multi-Transparency Color Graphics to Your S-100 or Multibus[®] System

The system builder's best choice for color graphics is a CS5000 color system from SCION. Its basic component is MicroAngelo[®], the single board graphics display computer that has revolutionized monochrome display capability with low cost 512x480 pixel graphics resolution and 40 line by 85 character text capacity.

When MicroAngelo boards are combined, they create high resolution color graphics that have a unique advantage. The displayed image is a combination of transparencies. So you can add, modify or delete images by transparency rather than as an entire image.

SCION's Series CS5000 builds an image with up to 8 bit planes, each generated by a MicroAngelo board. You select the assignment of those bit planes to transparencies. Each transparency can display $2^n - 1$ colors where n is the number of bit planes it uses... 2 bit planes would make a three color transparency, 8 bit planes would make a 255 color transparency. Once each transparency has been defined, your host can work with it independently, generating and modifying its graphics and text without interacting with the others. The independent transparencies are combined by the Color Mixer board which also assigns one of 16.8 million possible colors to each color of each transparency.

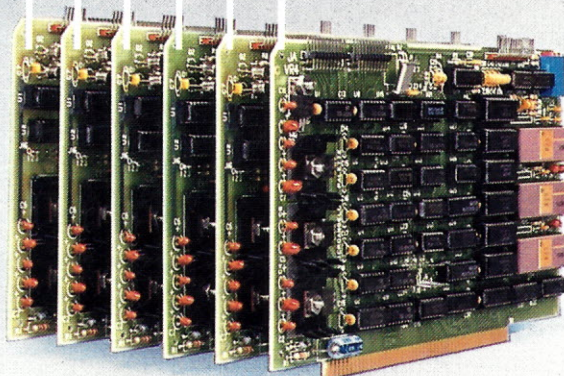

Your computer talks to the SCION Color System in SCREENWARE[™], SCION's high level display firmware language. SCREENWARE commands are used by the computer in each MicroAngelo bit plane to generate graphics and text primitives. User interface is made simple with prompted system set-up using SCION's ColorPak.

MicroAngelo based color graphics systems are easy to use. Just plug the boards into your Multibus or S-100 host. Or use the freestanding work station configuration with its RS-232 interface. In each case, you get high resolution color graphics for such a low price you can't afford to design your own.

**Think SCION for your graphics display needs.
Think MicroAngelo. Call us at (703) 476-6100.**

System shown is a Model CS5050S.
*A trademark of Intel Corp.

SCION

if the image is important.

12310 Pinecrest Rd./Reston, VA 22091
(703) 476-6100 TWX: 710-833-0684