

THE ELECTRONIC ENGINEER



Wiring....some like it flat p. 75

LSI: no longer mission impossible p. 53

Part 3 of telemetry course p. 65

OUR MAGNETIC PERSONALITY GIVES US SOME OF THE BEST CONTACTS IN THE RELAY BUSINESS

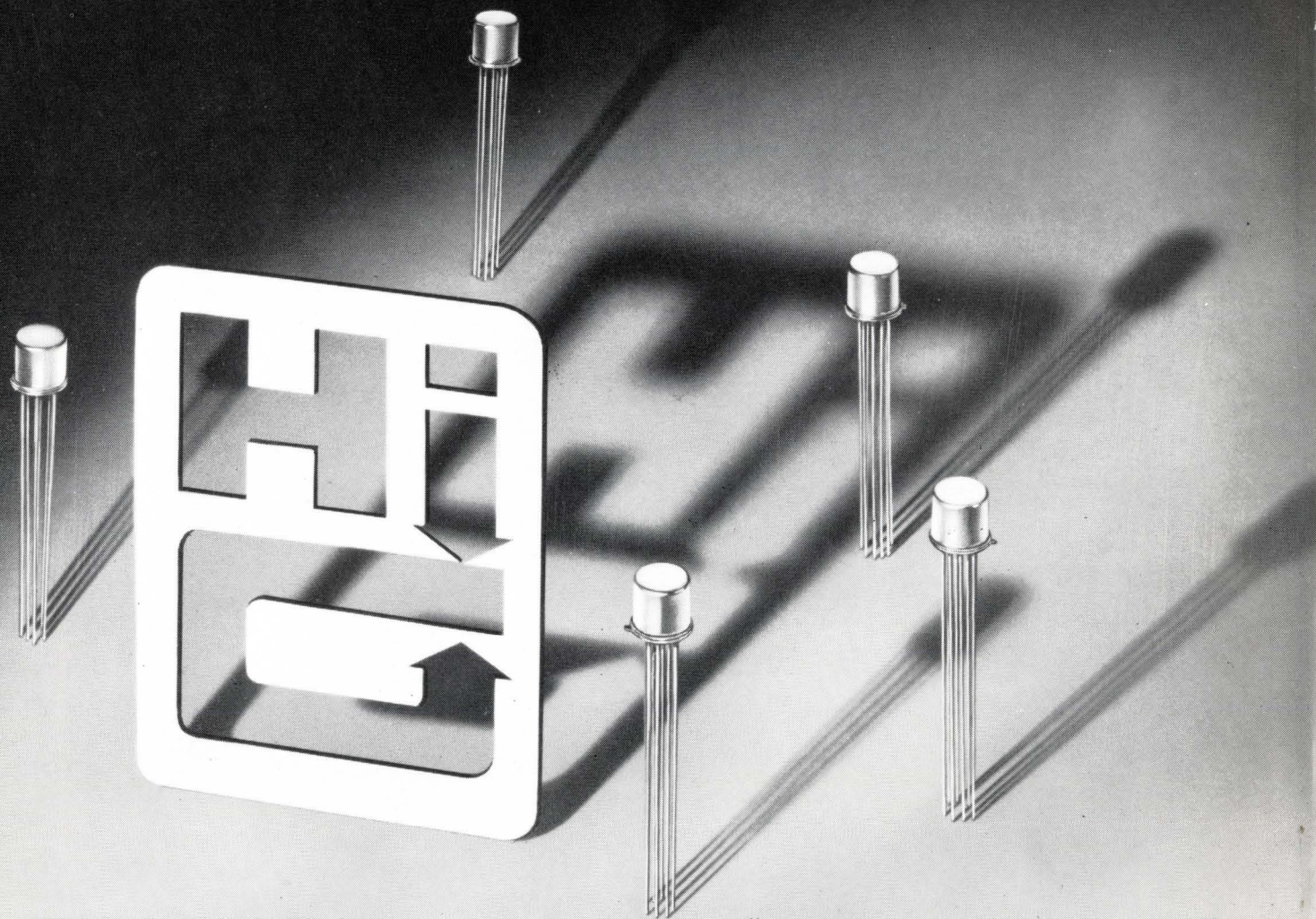

RELAY TYPE	SERIES MA & MS
Size	TO-5
Contact Arrangement	DPDT
Max. Rated Contact Current	1 amp at 32 Vdc
Construction	All Welded
Weight	
Series MA	2.9 Gms Max.
Series MS	4.5 Gms Max.

A uniquely designed and unusually efficient magnetic assembly gives our new TO-5 size relays exceptionally good contact resistance. But this isn't the only reason for great reliability in our MA-MS series.

For example, every MA-MS relay we make is miss-tested. Relays that pass our test are accepted only on the basis of *uniformity* within the acceptable maximum limits.

Relays are assembled and then subjected to a multi step cleaning process all in laminar flow chambers. All units are then out-gassed in an open state at .001 microns of mercury and over 200°C temperature. From start to finish all assembly including welding is done under a strictly controlled atmosphere.

Hi-G's concern for design and manufacturing processes gives you an ultra reliable relay that will withstand tough environmental stresses and meet all applicable portions of MIL-R-5757.

For more details write or call Hi-G for Bulletin #90. It could be one of the best contacts you've ever made.

Something New Has Been Added!

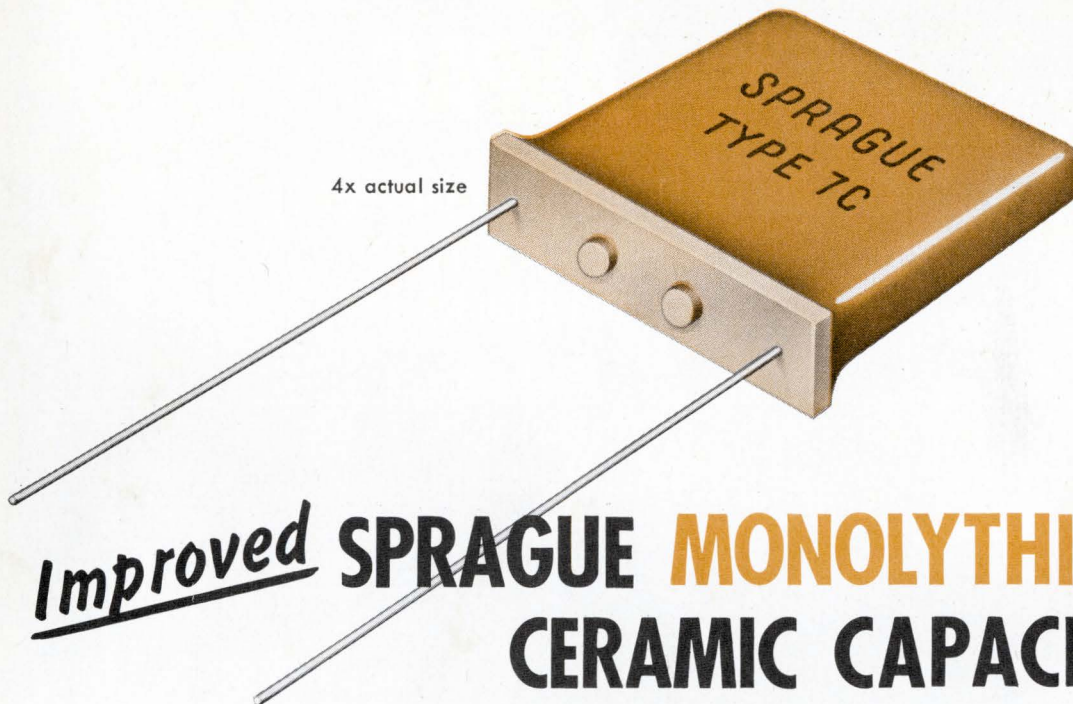

Improved SPRAGUE MONOLYTHIC[®] CERAMIC CAPACITORS

now have a phenolic terminal base

Type 7C Radial-lead Capacitors are made with alternate layers of sprayed ceramic dielectric material and screened metallic electrodes, fired into a solid homogeneous block and coated with a tough phenolic resin. Their new bossed terminal base construction provides these advantages: (1) No resin run-down on leads. (2) Uniform lead spacing is automatically maintained. (3) No dirt and moisture entrapment; degreasing fluid flows freely between capacitor and board.

Body Code	EIA Characteristic	Operating Temperature Range	Maximum Cap. Change over Temp. Range	WVDC	Capacitance Range	Capacitance Tolerance
082	NPO	-55 C to +125 C	±60ppm/°C	50 100 200	51 pF to .024 μF	±20% ±10% ±5% ±2%
075	N750	+25 C to +85 C	-750 ± 120 ppm/°C	50 100 200	.001 μF to .082 μF	±20% ±10% ±5% ±2%
		-55 C to +125 C	Meets MIL-C-20 Char. UJ			
067	X7R	-55 C to +125 C	±15%	50 100	.0018 μF to 1.5 μF	±20% ±10%
023	Z5U	+10 C to +85 C	+22%, -56%	50	.01 μF to 3.3 μF	+80, -20% ±20%

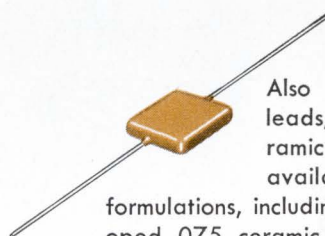

Also made with axial leads, Monolythic[®] Ceramic Capacitors are available in four body formulations, including a newly-developed 075 ceramic material, as described in the adjacent chart.



For complete technical data write for engineering bulletins on Monolythic Ceramic Capacitors to: Technical Literature Service, Sprague Electric Co., 233 Marshall St., North Adams, Mass. 01247.

SPRAGUE COMPONENTS

CAPACITORS
TRANSISTORS
RESISTORS
INTEGRATED CIRCUITS
THIN-FILM MICROCIRCUITS

PULSE TRANSFORMERS
INTERFERENCE FILTERS
PULSE-FORMING NETWORKS
TOROIDAL INDUCTORS
ELECTRIC WAVE FILTERS

CERAMIC-BASE PRINTED NETWORKS
PACKAGED COMPONENT ASSEMBLIES
BOBBIN and TAPE WOUND MAGNETIC CORES
SILICON RECTIFIER GATE CONTROLS
FUNCTIONAL DIGITAL CIRCUITS



'Sprague' and '®' are registered trademarks of the Sprague Electric Co.

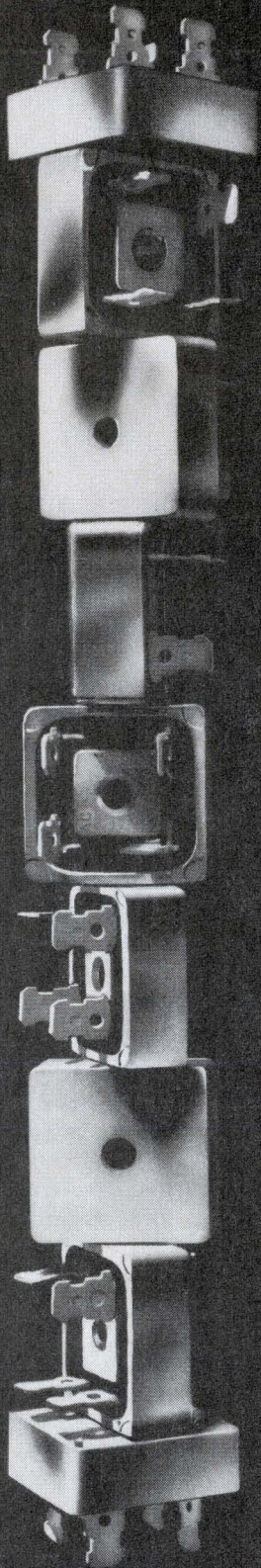

ALPAC[®]

only
the high current
bridge rectifier
that stacks up —

**Performance
Packaging
Reliability
Price**

This power bridge rectifier is designed to out perform anything on the market. Years of reliable performance, in on-the-line operation, has proven the ALPAC concept. ALPAC is a Semtech design.

ALPAC utilizes a functional aluminum case to guarantee maximum thermal conductivity and light weight — replacing out-moded stud rectifiers and all the miscellaneous hardware associated with it.

ALPAC is easy to use. The devices are fitted with three way, universal terminals (insulated from the case) to minimize production costs.

Internally, ALPAC utilizes the Semtech high performance rectifiers — welded together for mechanical strength.

Average Output Current . . . 25 amps
Peak Inverse Voltage . . . 50 to 600 Volts
Thermal Resistance (Max.) . . . 1.5°C/watt

If you want quality "designed in" you'll buy ALPAC . . . another good idea from Semtech.

For immediate delivery see your representative:

San Francisco—941 E. Charleston, Suite 10, Palo Alto, California 94303 / (415) 328-8025

Chicago—140 N. La Grange Road, La Grange, Illinois 60525 / (312) 352-3227 / TWX: 910-683-1896

Dallas—402 Irving Bank Tower, Irving, Texas 75060 (214) 253-7644

New York—116-55 Queens Blvd., Forest Hills, New York 11375 / (212) 263-3115 / TWX: 710-582-2959

European Sales—Bourns A. G. Alpenstrasse 1, Zug, Switzerland / (042) 4 82 72/73

SEMTECH
CORPORATION

652 Mitchell Road, Newbury Park, California 91320
(805) 498-2111, (213) 628-5392 / TWX: 910-336-1264

® ALPAC is a registered trade-mark of the Semtech Corporation.



The Electronic Engineer

February 1969 Vol. 28 No. 2

Editorial	7
Up to Date	8
Forefront	17
EE Shorts	19
Speak up	22
Calendar	28
Careers	31
Welcome	38
EEs Get Ahead	42
Microwaves	45
Microworld	53
Fanout	62
Design Features	65
Drawer	75
IC Ideas	85
Abstracts	89
New Products	93
Lab Instruments	96
Microworld New Products	100
Elroy	102
Literature	116
Ad Index	122

Stacked gate tetrode operates at 200 to 300 V 8

It is essentially an insulated gate field transistor with "high voltage" capabilities.

New Product Management 31

Part II: A case history on the new product procedure at a midwestern instrument plant. Factors which cause new product projects to be dropped are discussed and positive steps you can take to get more products for your engineering dollars are suggested.

Diode rf sources: combine them for high power 45

Single-diode rf sources often have insufficient power outputs. For higher power levels, you can combine a number of diodes so that their outputs add together. Here's how to do it.

LSI: No longer a mission impossible 53

Large-scale integrated arrays, both catalog and custom, are really here. But it takes critical judgments to acquire and apply LSI products economically.

Telemetry Course 65

Part III: Time-division multiplexing

Now you can see it, now you don't. By sampling the data, time-division multiplexing accommodates it all in a single channel, simply and efficiently—without losing information.

Wiring . . . some like it flat 75

Many engineers are going flat—with their wiring, that is. They have found that reduced size and weight are only two of many advantages of flat flexible cable and flexible printed circuitry.

IC Ideas 85

- Stable squarewave generator
- Synchronous pulses from asynchronous logic level changes
- Gated oscillator has remote frequency control
- Very high duty cycle one-shot

COVER:
Flat flexible cable and circuitry come in a wide variety of shapes, sizes, and forms. Almost as diverse are their applications—it's quite possible that the computer or telephone or test instrument you use contains them. Or the car you drive to work, the capsule that took our astronauts to the moon, or the system that guides our missiles. For more on these cables, see the article beginning on page 75. (The units on our cover were supplied by Flexible Circuits Inc., Warrington, Pa.)



The Electronic Engineer

Vol. 28 No. 2

February 1969

Alberto Socolovsky, *Editor*

John E. Hickey, Jr., *Managing Editor*

Smedley B. Ruth, *Associate Editor*

Sheldon Edelman, *Associate Editor*

Mark B. Leeds, *Features Editor*

Stephen A. Thompson, *Western Editor*

David H. Surgan, *Eastern Editor*

Joan Segal *Assistant Editor*

Dr. O. M. Salati, *Consultant*

Anne Axe, *Editorial Assistant*

Dorothy Vondran, *Editorial Assistant*

Lynda Rothstein, *Editorial Assistant*

Mae Moyer, *Editorial Reader Service*

Andrew Mittelbrunn, *Chilton Art Director*

Phaue Featherson, *Art Assistant*

George Baker, *Washington News Bureau*
Neil Regeimbal,

K. Robert Brink, *Publisher*

Chilton   

Executive and Editorial Offices:

One Decker Square, Bala-Cynwyd, Pa. 19004
Tel. (215) SH 8-2000

Address Mail to: 56th & Chestnut Sts.
Philadelphia, Pa. 19139

Western Office: Stephen A. Thompson
1543 W. Olympic Blvd., Los Angeles, Calif. 90015
Tel. (213) DU 7-1271

New York Office: Mark B. Leeds & David H. Surgan
100 E. 42nd St., New York, N.Y. 10017
Tel. (212) OX 7-3400

Chilton Company Officers & Directors: Chairman of the Board: G. C. Buzby; President: R. E. McKenna; Financial Vice-President: Stanley Appleby; Vice-Presidents: J. H. Kofron, L. F. King, H. W. Barclay; Treasurer: James Miades; Secretary: J. A. Montgomery, Jr. Other directors: C. W. Hevner, T. J. Casper, W. A. Barbour, R. S. Davidson, S. H. Collmann, R. Rimbach, R. H. Groves and K. Robert Brink, Asst. Secretary: I. C. Holioway. Regional Vice-Presidents: New York, Irving E. Hand; Chicago, John Bernhardt; Cleveland, William P. Saunders; Los Angeles, James A. Crites; Dallas, Harold E. Mott.

Monthly publication of Chilton Company, Chestnut & 56th Sts., Phila., Pa. 19139. (Area Code 215) SHerwood 8-2000. Controlled circulation postage paid at Philadelphia, Pa. \$1 a copy. Subscription rates U. S. and U. S. Possessions: 1 yr. \$12.00; 2 yrs. \$20.00. Canada 1 year \$14.00; 2 yrs. \$25.00. All other countries 1 yr. \$20.00; 2 yrs. \$35.00. © Chilton Company 1969. Title Reg. U.S. Patent Office. Reproduction or reprinting prohibited except by written authorization.



CUT THIS OUT

Instructions: Place this paper cut-out gasket between the flanges of any of your equipment needing RFI/EMI shielding.

Fact: This paper gasket may be as effective an RFI/EMI shield as the one you're presently using.

Fact: This paper gasket may possess the same compressibility as the one you're presently using.

Fact: This paper gasket will not leave the scars between flanges that may be already corroding your present equipment.

Fact: This paper gasket does not contain the bristling stainless steel wires that may have already broken off the gasket you're now using and fallen into your equipment.

Alternative: Although a paper gasket has some good features, it's not the solution to your RFI/EMI shielding problems. Chomerics shielding material is "Cho-Seal®" is made from a silicone elastomer and a patented silver-plated copper powder. What you really want is a conformable, resilient, heat-stable and highly conductive material. If you think you'll get this from that glorified steel wool or wire screen you're now using, CUT IT OUT!

Write for more information about Chomerics' conductive elastomeric composites for electronics:

 **chomerics, inc.**
Subsidiary of Deering Milliken, Inc.
85 Mystic St., Arlington, Mass. 02174
Tel: (617) 648-8650

Teledyne TO-5 Relays quality & experience

(right...today and tomorrow)

TELEDYNE

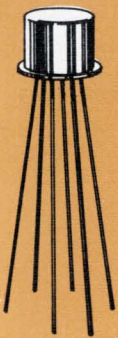

TO-5 Relay

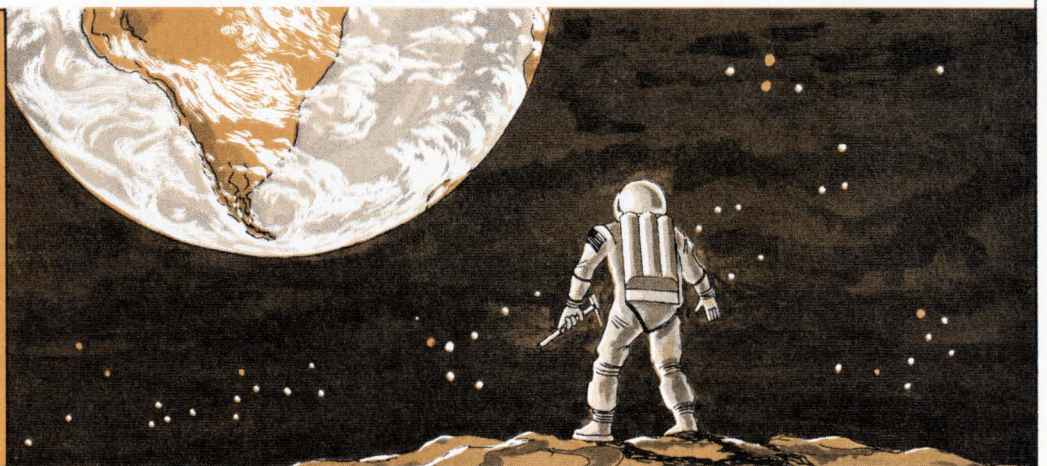

Teledyne's reputation for quality demands adherence to the right specifications, the right delivery schedule, the right experience and facilities and the right Q.C. system to eliminate human error.

Right you are, that Teledyne, the originator and world's most experienced producer of quality TO-5 Relays, can meet the needs and standards of tomorrow's designs. The price is right.

Send for further information and complete catalog.



TELEDYNE RELAYS
A TELEDYNE COMPANY

3155 West El Segundo Boulevard Hawthorne, California
90250 Telephone: (213) 679-2205

Three new A version linear ICs. Tightest specs you can get.

Raytheon is coaxing record performances from three veteran circuits with new advanced A versions. Compare these key maximum specifications, rated over the full military -55 to 125°C temperature range.

RM709A High Gain Op Amp. Offset voltage 2.0 mV , drift $6.0\mu\text{V}/^{\circ}\text{C}$. Low temp (-55°C to 25°C) offset current drift is $1.0\text{ nA}/^{\circ}\text{C}$, high temp drift only $0.3\text{ nA}/^{\circ}\text{C}$. (Best competitive specs: V_{os} 3.0 mV , drift $10.0\mu\text{V}/^{\circ}\text{C}$, $2.8\text{ nA}/^{\circ}\text{C}$.)

RM710A Differential Voltage Comparator. V_{os} is 1.5 mV , drift $5.0\mu\text{V}/^{\circ}\text{C}$. Low and high temperature offset current drift only 50 and $10\text{ nA}/^{\circ}\text{C}$, respectively. (Competition: V_{os} 3.0 mV , drift $10.0\mu\text{V}/^{\circ}\text{C}$ and $75\text{ nA}/^{\circ}\text{C}$.)

RM711A Dual Differential Voltage Comparator. Offset voltage is 1.5 mV . Low temp offset current drift $25\text{ nA}/^{\circ}\text{C}$, high temp drift $10\text{ nA}/^{\circ}\text{C}$. (Best elsewhere: V_{os} 4.5 mV , current drift N/A.)

And price? Surprisingly low. Only 10% over costs of standard mil-temp versions. Available now from Raytheon distributors across the nation. Send for data sheets and distributor list from the company that gets the ideas and delivers the goods. Raytheon Semiconductor, Mountain View, California, (415) 968-9211.

RAYTHEON

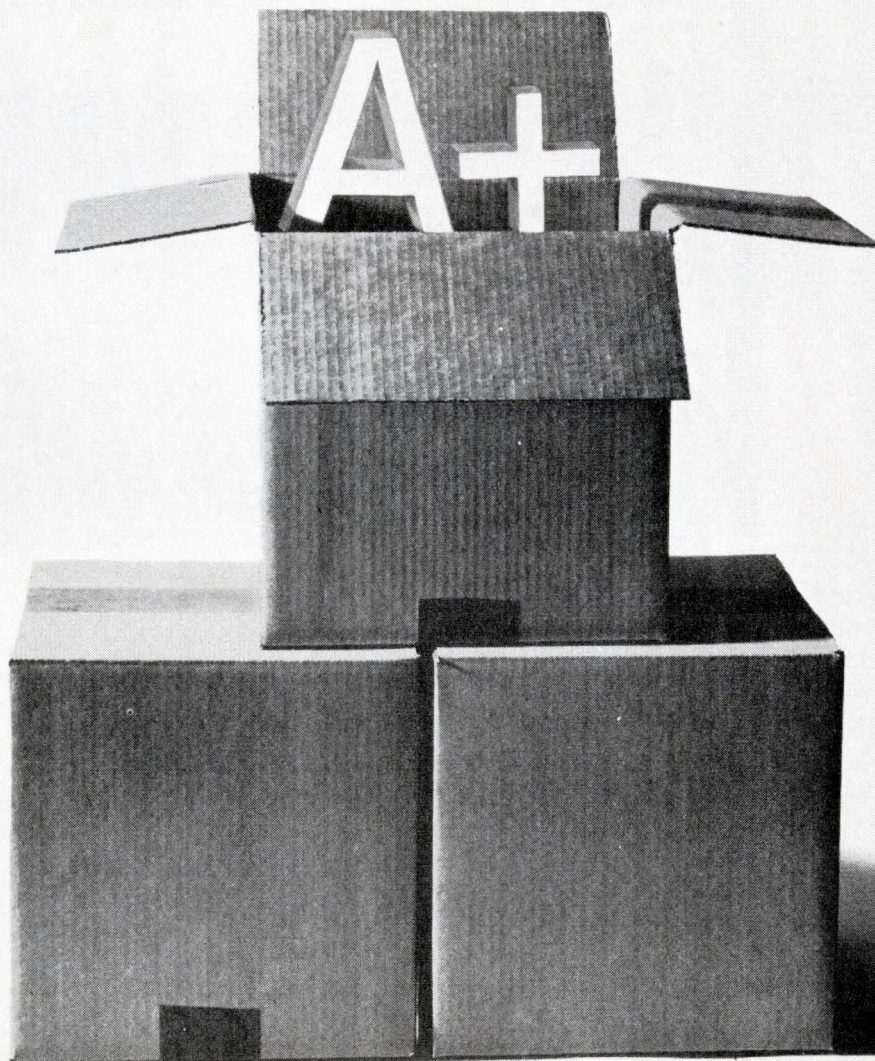

Yes, doctor there is an EE in the house

The response to the article by Roger Kenneth Field, "Is there an EE in the house?" [*The Electronic Engineer*, November 1968, p. 50] has been nothing less than startling, and it spans the range from altruism to self-interest, from hope to cynicism. Many readers have offered to help doctors for nothing, while many more remembering what they pay to doctors when they have a problem, have offered their help at fat consulting fees. On the other hand, while many look for a rewarding technical association with doctors, some simply do not believe that a physician would ever accept help from the engineering profession. In the words of one reader who has had extensive experience in medical electronics, "*If you ask me to imagine an M.D. inviting a B.S. E.E. to observe, make recommendations, and improvements, you are asking too much. That is completely beyond my imagination. It would be easier for me to imagine a medical lobby having a bill passed requiring a prescription to buy aspirin.*"

Unfortunately, this reader is not alone in his bitter experience. Perhaps one of the first instances where electronics offered to come to the aid of medicine was back in 1936, when Dr. Ernest O. Lawrence was working with the cyclotron he and his graduate students had developed at The University of California at Berkeley. Dr. Lawrence (after whom the Lawrence Radiation Lab is named) had recently visited Memorial Hospital in New York where the director, Dr. James Ewing, showed him his stock of 2 or 3 grams of radium, about all he had to treat cancer patients. Lawrence reflected that the neutrons his cyclotron was emitting, and the isotopes it produced could do the same job for cancer that X-rays and radium were doing. With his brother John, who had just graduated as an M.D. from Harvard, he wanted to develop medical applications for the cyclotron but they had little success in convincing the University Medical School to use it. The doctors there flatly refused.

Around that time, cancer struck at the Lawrence's ancestral home in South Dakota, where their mother was given three more months to live. The Lawrence brothers decided to take it upon themselves to treat their mother with the cyclotron, and did so for six months right at the Radiation Lab of Berkeley. The story had a happy ending for their mother, who lived 20 more years after being cured, but not for the medical profession, which did not recognize the value of man-made radiations and artificial isotopes until 1938. At that time, Prof. Maxwell Ellis of The University of London visited Berkeley and was so impressed that he introduced a medical cyclotron in England.*

The electro-medical interface has failed many times since, but the failures are no reason to give up. Mankind needs medicine, and medicine needs electronics. That's the reason why we published the November article on Dr. Levy and his computer. There is a communications problem between electronic engineers and doctors, and we can help to solve it. No matter how few and far between the cases of cooperation, each individual case we can bring about will be a step in the right direction.

Alberto Socolovsky
Editor

*You can read this and other moving accounts of the early days of nuclear physics in the recent double biography "Lawrence and Oppenheimer," by Nuel Pharr Davis (Simon and Schuster, New York, 1968).

Stacked gate tetrode operates at 200 to 300 V

A new device called the Stacked Gate MOS Tetrode, or Insulated Gate Tetrode (IGT), has been developed at the Hughes Research Laboratories. As disclosed by Dr. Hans Dill, head of the field effect devices section, it is essentially an Insulated Gate Field Effect Transistor (IGFET) with main gate G_1 , offset from the drain and with a second stacked gate G_2 , over a 1-to-2 micron thick insulator to induce the offset channel. (See Fig. 1.)

This device is not in the same class as planar gate tetrodes, which are mainly for low power switching and amplifier applications. The IGT can be used as a power amplifier, or in MOS switching circuits as a high voltage output driver.

The prime advantages of the IGT are its high drain breakdown potential V_{DB} , very low Miller feedback capacitance, and ability to optimize device performance by varying the potential to G_2 . The added potential supplied to G_2 is not generally a problem, since no power is expended. The IGT design depends mainly on the trade-off between V_{DB} and the limited frequency response caused by the time constant of the offset channel.

The drain voltage range of present MOSFETs is about 30 V for n-channel and 60 V for p-channel devices. In the IGT, bias applied to G_2 forms a conduction channel

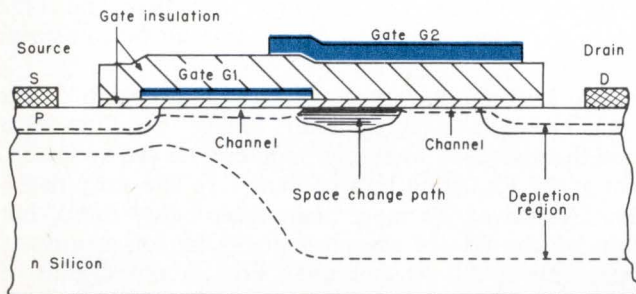

connecting the G_1 channel to the drain. The surface field is reduced by adjusting the conductivity of this bridging channel. This allows V_{DB} to approach the bulk breakdown of the drain junction. IGTs with V_{DB} 's up to 300 V for p-channel and 200 V for n-channel devices and are available in limited quantities.

The $V-I$ diagrams in Fig. 2 show the operation of a p-channel tetrode in more detail. If G_2 is grounded (Fig. 2a), no drain current flows until the drain depletion region punches through to the channel under G_1 . From this point the drain current is limited by the space charge region until the channel under the gate G_1 acts as a current source.

If a negative bias is applied to G_2 , the offset inversion channel causes the constant current region to dominate the $V-I$ diagram, as in a normal MOS device (Fig. 2b). Then V_{DB} increases because the field is reduced on the drain side.

For very high G_2 potentials the offset inversion channel causes the drain breakdown region to shift toward the G_1 side (Fig. 2c). This manifests itself as G_1 modulation of V_{DB} and a reduction of V_{DB} approaching the operating conditions of the full gate device. The magnitude of optimum V_{DB} depends on device geometry.

Fig. 1. Stacked Gate Tetrode. Fabrication is complex because of the stacked gate, but good stability, yield, and electrical performance have been achieved with a molybdenum control gate and a pyrolytic $\text{SiO}_2\text{-Si}_3\text{N}_4$ sandwich film of 1-2 microns. An aluminum film is used for the second gate and for contact to the source, drain, and first gate.

Fig. 2. IGT characteristics as a function of voltage applied to the stacked gate, G_2 .
Scale for scope is: Vertical, $I_D = 1 \text{ mA/div}$
Horizontal, $V_D = 20 \text{ V/div}$
Gate $G_1 = 1 \text{ V/step}$

$V_{G2} = 0$

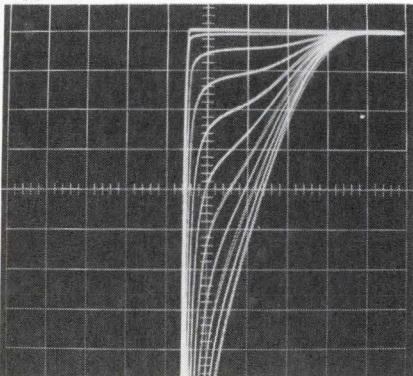

$V_{G2} = -200\text{V}$

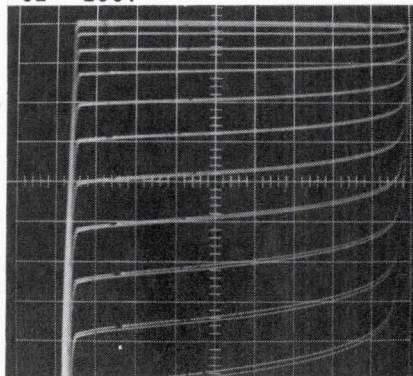

$V_{G2} = -400\text{V}$

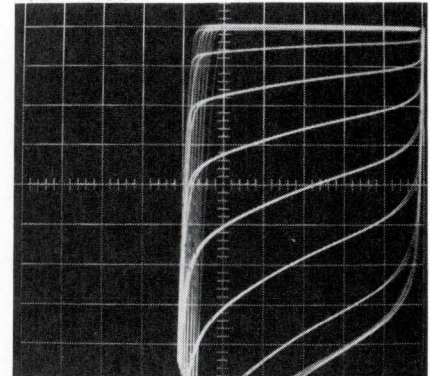

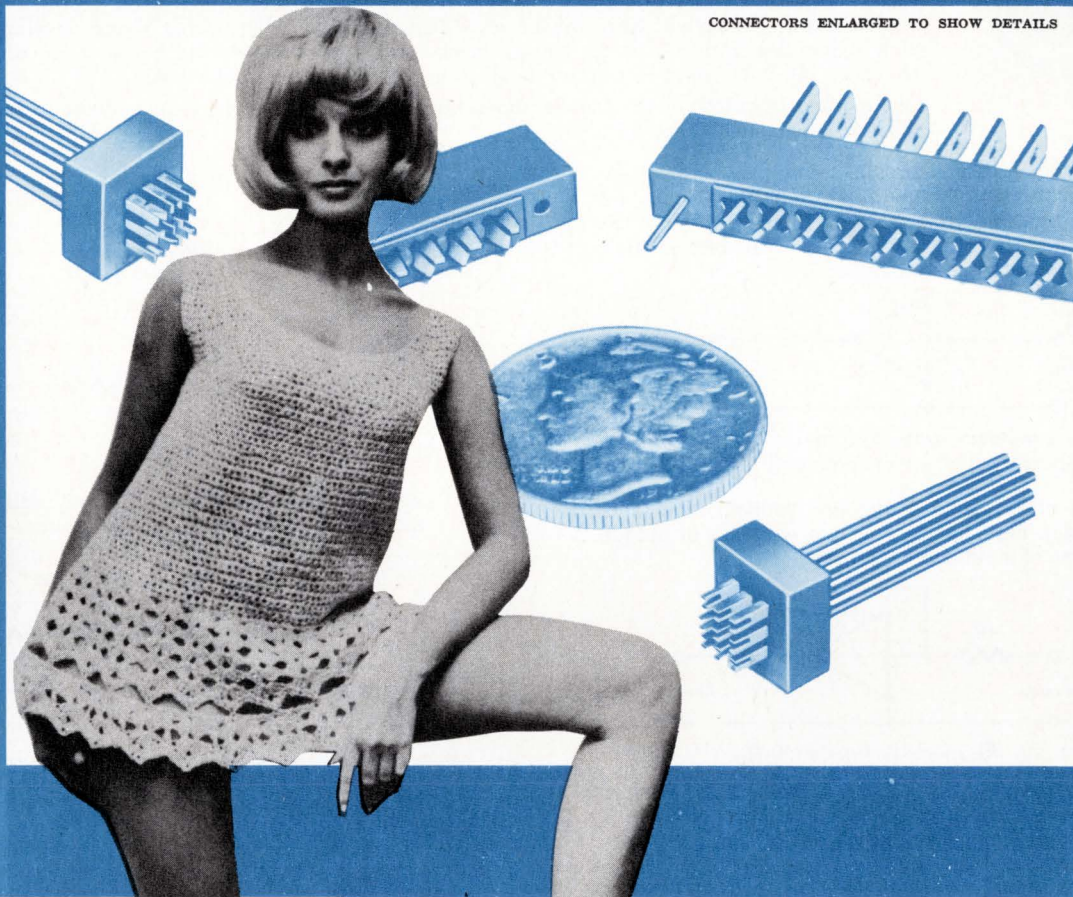

CONNECTORS ENLARGED TO SHOW DETAILS

• TRADE-MARK

We're not afraid to say it out loud: 'Design.'

BECAUSE ELCO MINIATURE CONNECTORS

SET THE 'MINI' TREND IN OUR INDUSTRY.

The smaller our connectors become, the larger your interconnection parameters can grow. It all started, and still continues, with the Elco Varicon* Connector; followed closely by smaller, lighter, even more exotic versions such as the Elco Bicon* Connector; Miniature Rack-and-Panel Connectors; Receptacles for DIPs (Dual In-Line Packages); Miniature Card Edge Connectors; and much, much more. Today, our line encompasses countless miniature designs, for virtually every spacing need and every terminating technique—with emphasis on back panel automatic wire wrap.

Our Miniature Connector literature demonstrates how big our "little" thinking can work in your favor. Write, wire, call or TWX us for it.

Elco Corporation, Willow Grove, Pa. 19090;
215-659-7000; TWX 510-665-5573.

P.S.—FREE SAMPLE? Let us know after you read our literature.
We'll be delighted to send you one.



When is a Power Supply Not a Power Supply?



The product of the regulated power supply industry has, strictly speaking, never been properly labeled. Few of the devices marketed as *power supplies* actually *supply* any power. What they do is *control* the power supplied by somebody else, probably the utility people. Now, *control* is an area in which KEPCO is rather expert. We've probably built more sophisticated power *controllers* than anyone else. The important thing is that we've developed a nice logical *description* — of the control mechanism — that we can teach you in no time at all. After all, what good is a controller if you don't know how to drive it?

Our method is based on the familiar operational amplifier technology. . . . Want to take a short driving course? Read on:

- 1 A power supply's circuit, references, regulators, power transformers and all, can very simply be described in terms of *signal flow* — rather than *power flow*. In fact, it closely resembles a high gain, three-terminal amplifier.

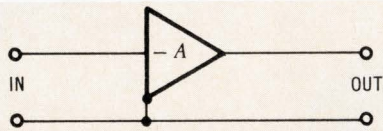

The amplifier symbol contains the *entire* power supply, pass elements and all.

- 2 If you provide this "amplifier" with an input and feedback impedance, a simple equation of output in terms of input can be written.

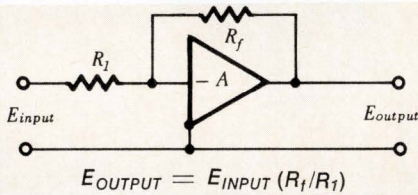

- 3 If you make E_{INPUT} a fixed, stable voltage (like a shunt-regulated 6.2V zener) then our device is a controllable "power supply" whose output is variable by adjustment of R_f or R_1 (usually R_1)

- 4 If you make E_{INPUT} YOUR SIGNAL, the power supply's output is its inverted image, multiplied by the "gain" R_f/R_1 .

- 5 If you combine 3 and 4, you've got a summer:

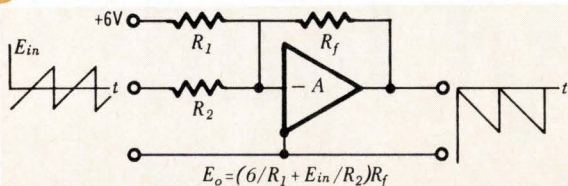

- 6 Substitute a capacitor for R_f and presto: An integrator:

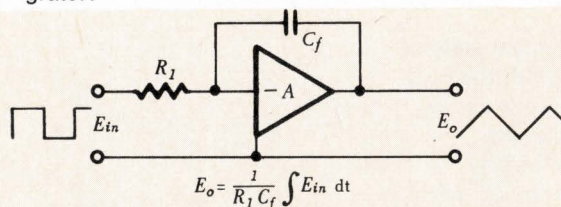

- 7 Bring feedback from your load and the power supply is a servo amp:

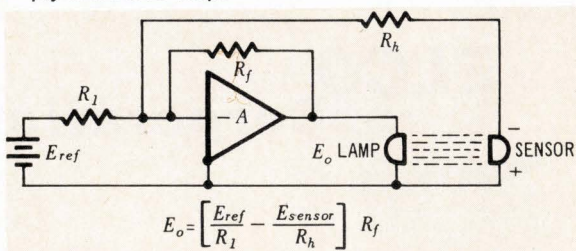

- 8 Bring feedback from a current sensor and it will regulate current.

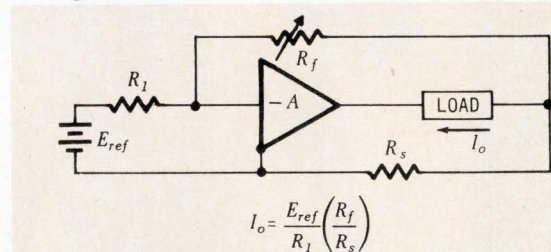

- 9 Vary the feedback resistor digitally and you have a computer controllable voltage source.

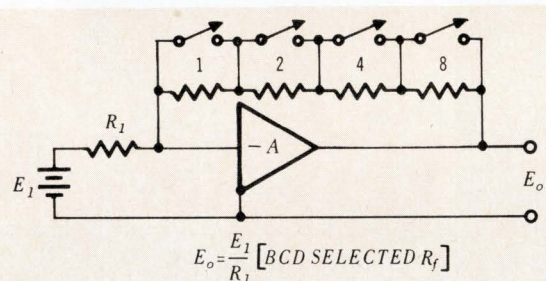

- 10 Describe the "errors" in terms of equivalent input offsets—rather than in terms of output "regulation" (an ambiguous term) and you have . . .

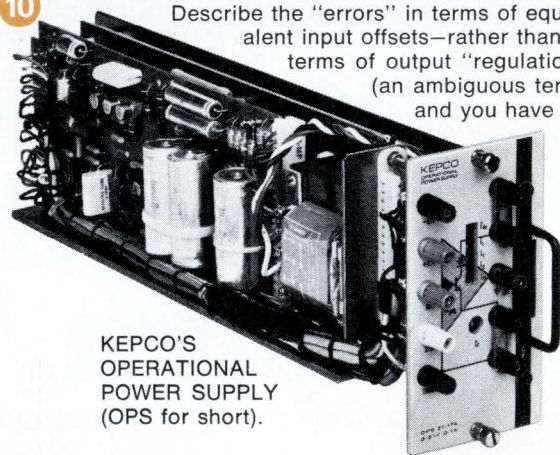

KEPCO'S OPERATIONAL POWER SUPPLY (OPS for short).

We've got models from 7 volts to 2000 volts. Why not *control* your power instead of simply *regulating* it? For many applications an operational power supply will replace whole complexes of static power supplies and dynamic amplifiers. All models feature built-in references (+ and - 6.2 volts) and adjustable offset nulling (to precisely zero the system).

If you'll write to us we'll send you the full course for your advanced degree in Operational Power Supply Technology.

Write Dept. BO-19



KEPCO, INC. • 131-38 SANFORD AVENUE • FLUSHING, N.Y. 11352
(212) 461-7000 • TWX # 710-582-2631
Telex: 12-6055 • Cable: KEPCOPOWER NEWYORK

More on lasers and holography

Last month (January, p. 10) we described a system for storing holograms discovered by Bell Telephone Labs. This month we have learned of two more possible laser-holography applications. One is the use of holography to measure small changes in a three-dimensional object for volume or space. General Electric's Electronic Laboratory, Syracuse, N.Y., uses a technique called "holographic interferometer" which compares the image of an object, as constructed from a hologram, with the object itself after it has undergone change due to stress or vibration. The measurements have been classified into three general categories: real-time, double-exposure, and time-average.

With the *real-time* approach, the object and a hologram of the object are illuminated simultaneously by a laser. This results in a holographic image and object that are precisely superimposed. When the object is subjected to change, its wave fronts differ from those in the hologram and interference fringes appear. These fringes are the differences between the position of the image in the hologram and the position of the object. The change applied to the object can be altered continuously to study the object's behavior under various conditions. With this technique, changes with time such as airflow patterns, gas flow from a jet nozzle, and vibrations of sonar transducers can be analyzed.

In the *double-exposure* method, an object can be compared with itself after some type of expansion or contraction has occurred. In this approach, a hologram is made of an undisturbed object. The object is then distorted in some manner and another exposure is made on the same plate while it is still in position. After the plate is developed, interference fringes will appear as in the real-time method.

In the *time-average* method, an object can be analyzed as it undergoes harmonic motion. With this motion the hologram consists of many holograms of the object in its different positions, and all the images add together coherently to produce the interference pattern. All points on the object that move will produce light and dark fringes corresponding to the maximum positive and negative movement. This pattern of fringes represents contours of constant amplitude or vibration.

A read-only memory

The second laser-holography application was announced by RCA Laboratories in Princeton, N.J. It is a holographic read-only memory, delivered to the U.S. Army Electronic Command at Ft. Monmouth, N.J. A small model was made to demonstrate the feasibility of such memory units which has a "block" consisting of four holograms, called "pages." Each page contains 26

bits of information. In a practical model, thousands of pages, each containing thousands of bits, would be used. The pages are all in the same plane within the block.

Each page of the model is illuminated by one of four corresponding light emitting (GaAs) diodes. When one of the four diodes is turned on, the real images of the 26 information bits in the corresponding holographic page are projected onto a 26-bit photo detecting array. This array converts the light image to signals corresponding to the parallel output of a binary number from a computer memory.

Since the only connection between the accessing, storage, and detecting portions of this memory system is "optical," it is easy to change the stored program information. You simply remove one block of holograms and replace it with another.

Lasing diodes promise memory capacities of millions of bits at access times below 100 ns. methods.

Holographic interferometry can be used to measure physical displacement resulting from changes in temperature. This photo was made by taking a hologram of the object at one temperature and then re-exposing the same hologram after the temperature had changed. The object is a gyro gimbal.

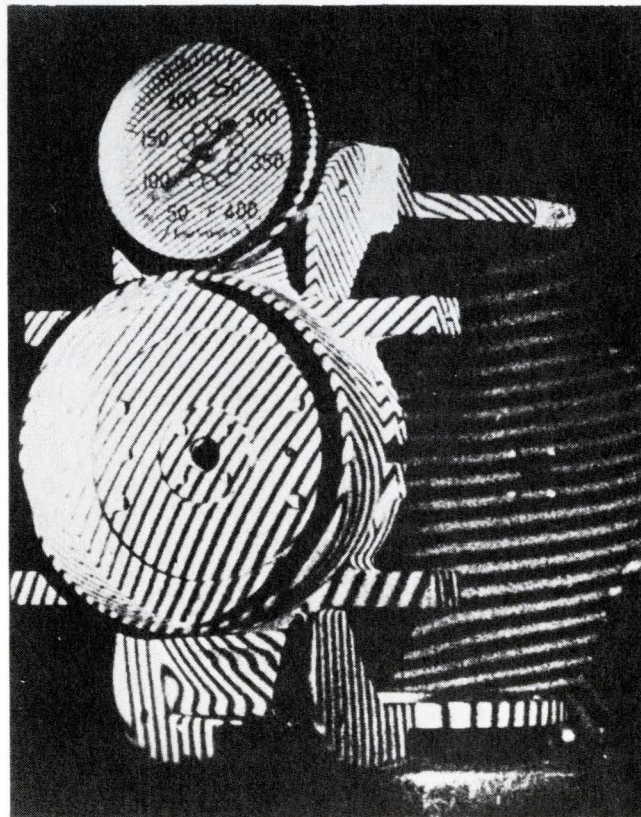

Fairchild told everyone what MSI could do.

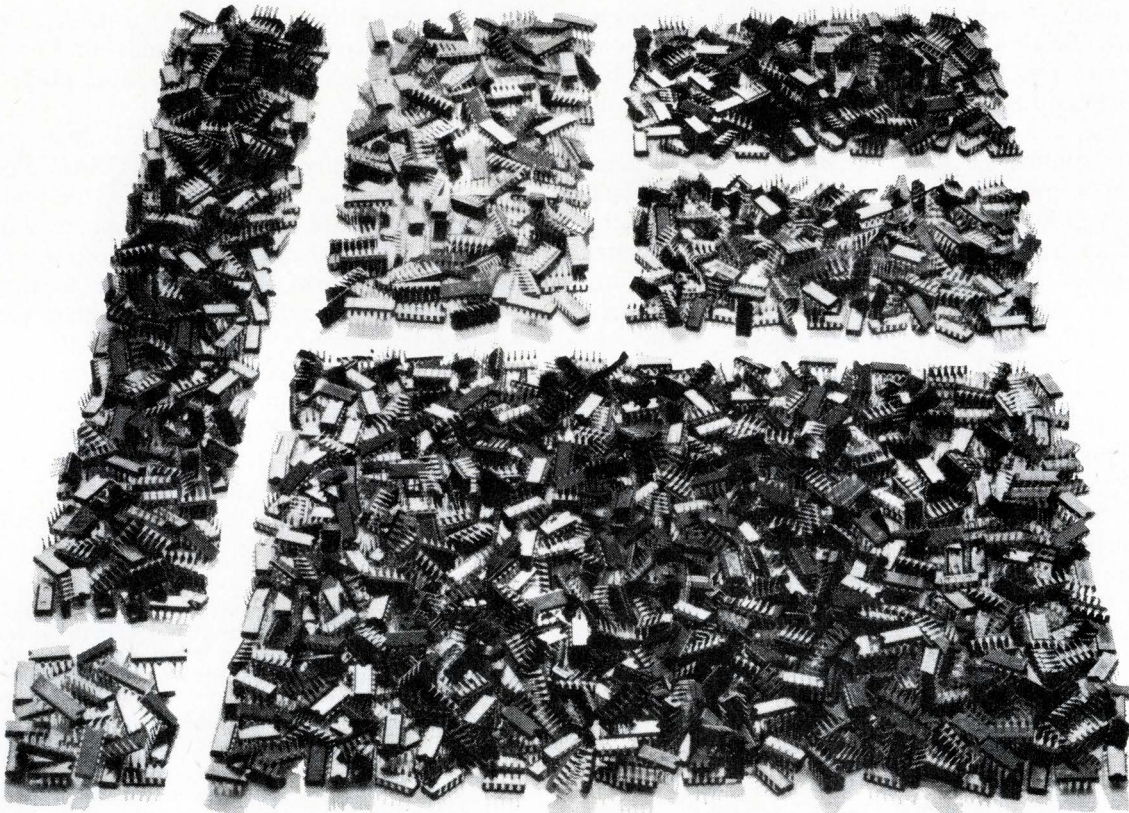

Ever since we introduced medium scale integration in 1967, we've been talking about the systems approach to computer design. Basic, compatible fundamental building blocks that do more jobs than a hundred Integrated Circuits.

Versatile circuits that function like shift

registers, counters, decoders, latching circuits, storage elements, comparators, function generators, etc. We said we had enough MSI device types to build more than half of any digital system you could design. An imaginative company in Boston took us up on it.

We're glad someone was listening.

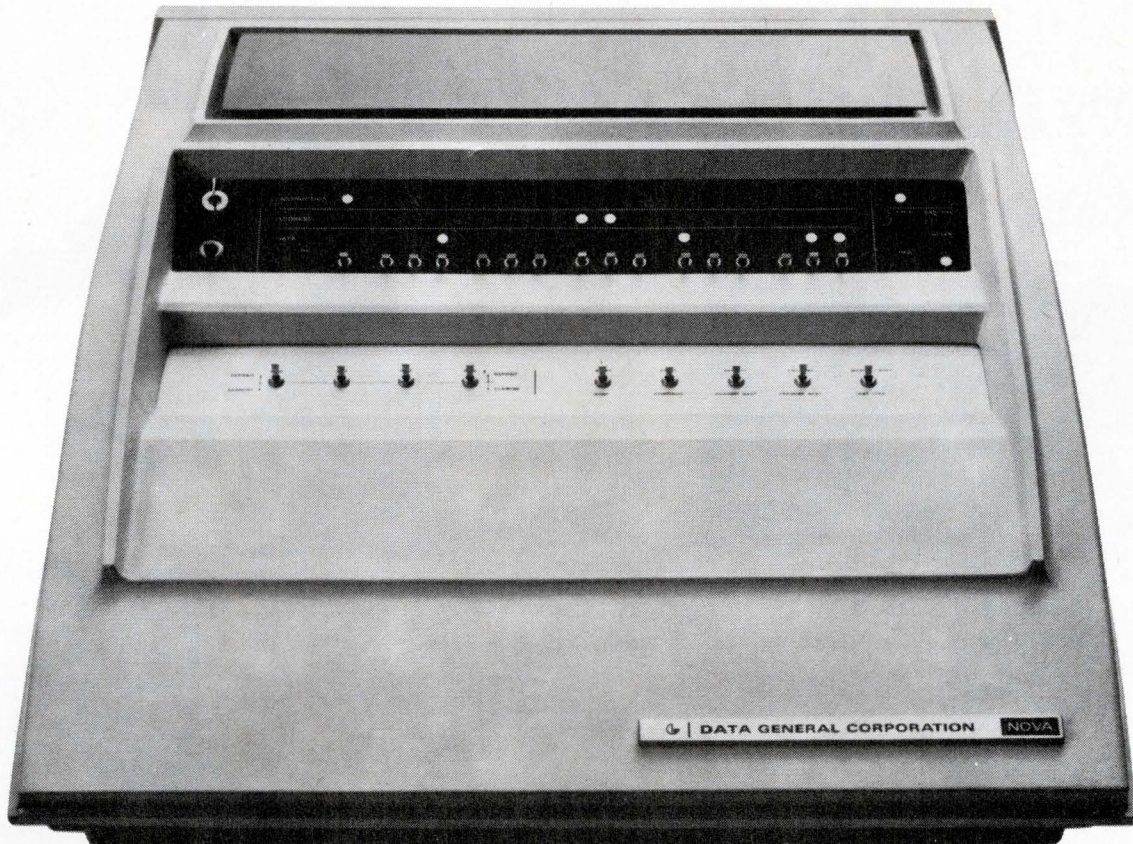

Data General Corporation built a revolutionary computer with Fairchild MSI circuits. The building block approach allowed them to design and build the whole system in six months. And put it in either a desk top console (shown above) or a 5¼-inch high standard 19-inch rack mount package. The central processor fits on two 15-inch by 15-inch plug-in circuit boards.

Another board houses a 4,096-word core memory. A fourth board provides enough space for eight I/O devices. And there's still enough room left for boards that expand the memory capability up to 16K. Any circuit board can be changed in seconds, so the computer has zero down

time. The NOVA is the world's first computer built around medium scale integration. The first general-purpose computer with multi-accumulator/index register organization. The first with a read-only memory you can program like core. The first low-cost computer that allows you to expand memory or build interfaces within the basic configuration. And the first to prove the price/performance economy of MSI circuitry: The NOVA 16-bit, 4K word memory computer with Teletype interface costs less than \$8,000.

If you'd like more information on MSI, use the reader service number on the opposite page. For specs on the NOVA, use the reader service number below.

FAIRCHILD
SEMICONDUCTOR

FAIRCHILD SEMICONDUCTOR / A Division of Fairchild Camera and Instrument Corporation ■ 313 Fairchild Drive, Mountain View, California 94040, (415) 962-5011 ■ TWX: 910-379-6435

In microwave diodes, nobody likes surprises. When you buy from Varian you know what you're getting: We build every lot of diodes to your specification and 100% inspect it to make sure that spec is met. There is no product sorting. You never get a diode that's been downgraded from a tougher specification. Our exclusive material selection, production and QA procedures insure the high yields necessary to guarantee you on-time delivery at the highest acceptance rate — bar none — in the industry. We make tuning diodes, multiplier, switching and step-recovery diodes, paramp and oscillator diodes, either Impatt or Gunn-effect type. We build them to a standard tolerance of $\pm 10\%$ or at special tolerances to $\pm 3\%$.

And we package them in any of over 30 different case configurations or deliver them in chip form. So get the diode you really need, every time, from more than 30 Electron Tube and Device Group Sales Offices



varian
solid state micro-
wave project

throughout the world, or from our Solid State Microwave Project, Beverly, Massachusetts.

**You get
what you
specify.
Every time.**

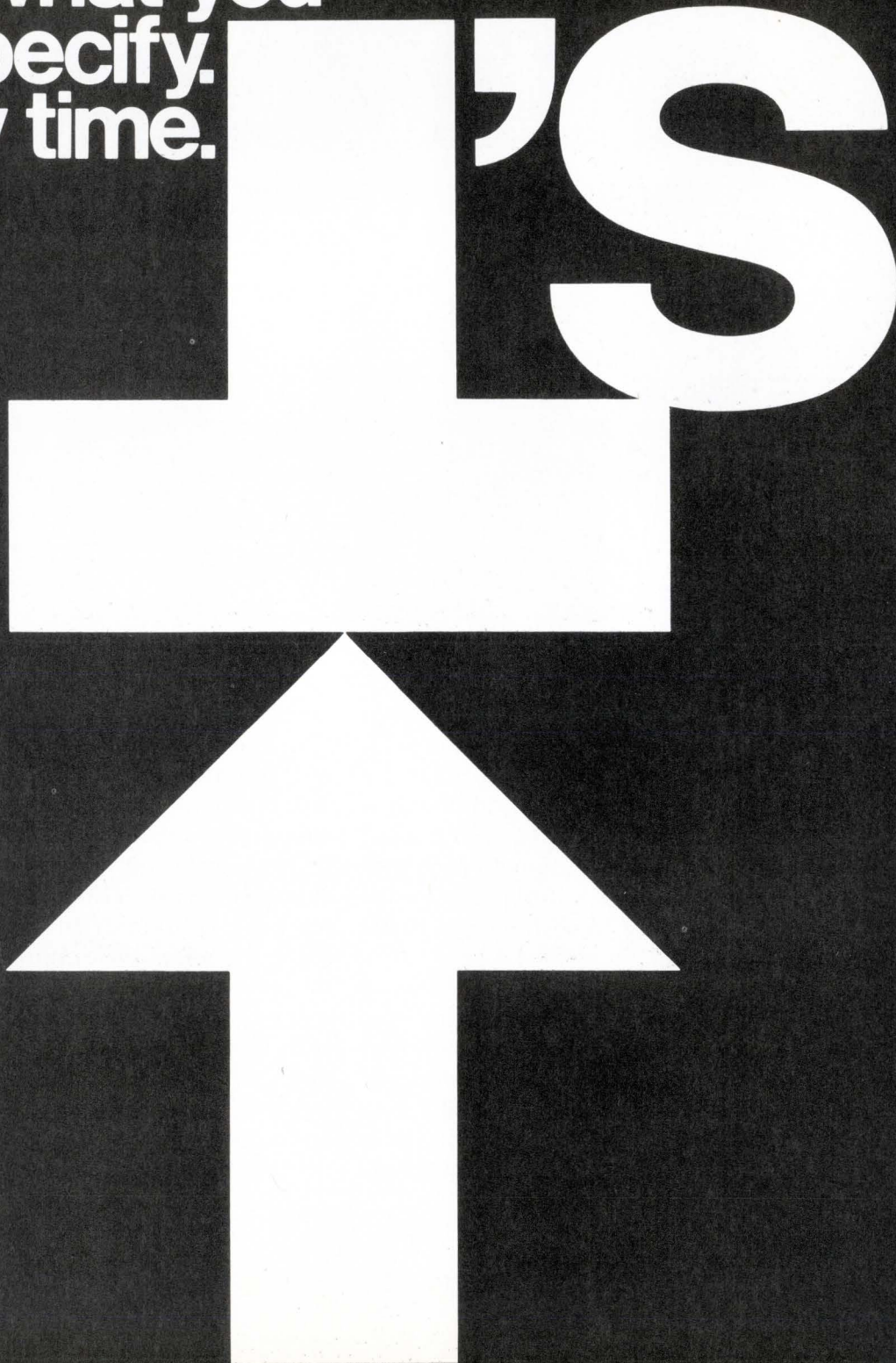

\$44,000,000

WILL BUY 1,000,000 TRIPLETT 310 VOM'S BUT YOU ONLY NEED ONE...AT \$44⁰⁰ THAT'S A BARGAIN

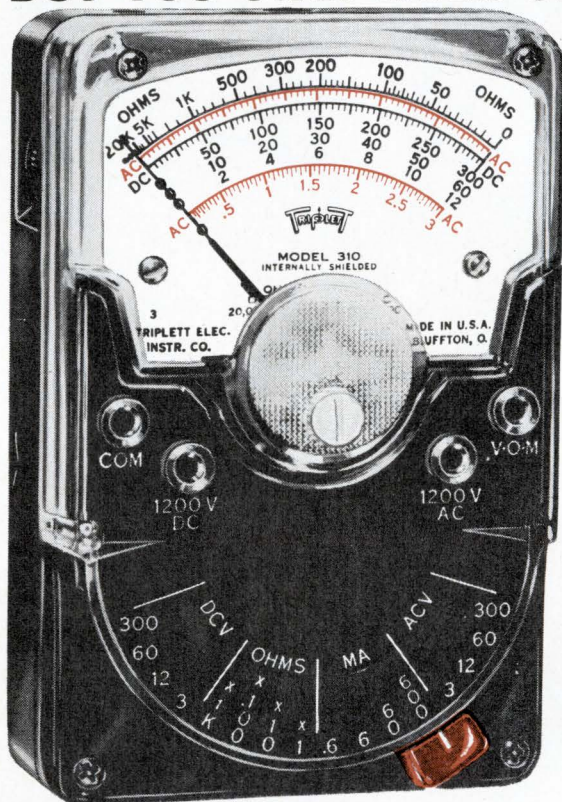

MODEL 310
World's Largest Selling
Volt-Ohm-Milliammeter
(SHOWN ACTUAL SIZE)

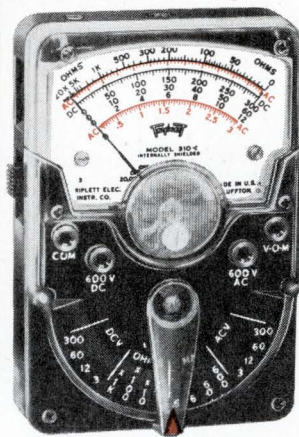

MODEL 310-C
Volt-Ohm-Milliammeter

- 1** HAND SIZE V-O-M WITH PROVISION FOR ATTACHING AC CLAMP-ON AMMETER.
- 2** 20,000 OHMS PER VOLT DC SENSITIVITY; 5,000 AC.
- 3** ONE SELECTOR SWITCH MINIMIZES CHANCE OF INCORRECT SETTINGS AND BURNOUTS.

310-C PLUS FEATURES

- 1** Hand size V-O-M with provision for attaching AC Clamp-on Ammeter.
- 2** 15,000 OHMS per volt AC sensitivity; (20,000 DC same as 310).
- 3** Single fully enclosed Lever Range Switch, plus DC Polarity Reversing.

MODELS 100 AND 100-C

Comprehensive test sets. Model 100 includes: Model 310 V-O-M, Model 10 Clamp-on Ammeter Adapter; Model 101 Line Separator; Model 379 Leather Case; Model 311 leads. (\$83.20 Value Separate Unit Purchase Price.)

MODEL 100 — U.S.A. User Net. \$78.00

MODEL 100-C — Same as above, but with Model 310-C, Net. \$88.00



SELF-SHIELDED Bar-Ring instrument; permits checking in strong magnetic fields. FITTING INTERCHANGEABLE test prod tip into top of tester makes it the common probe, thereby freeing one hand. UNBREAKABLE plastic meter window. BANANA-TYPE JACKS—positive connection and long life.

Model 310—\$44.00 Model 310-C—\$56.00 Model 369 Leather Case—\$4.20
All Prices are Suggested U.S.A. User Net, Subject to Change

THE WORLD'S MOST COMPLETE LINE OF V-O-M's • AVAILABLE FROM YOUR TRIPLETT DISTRIBUTOR'S STOCK



TRIPLETT ELECTRICAL INSTRUMENT COMPANY, BLUFFTON, OHIO 45817

Aesop was wrong

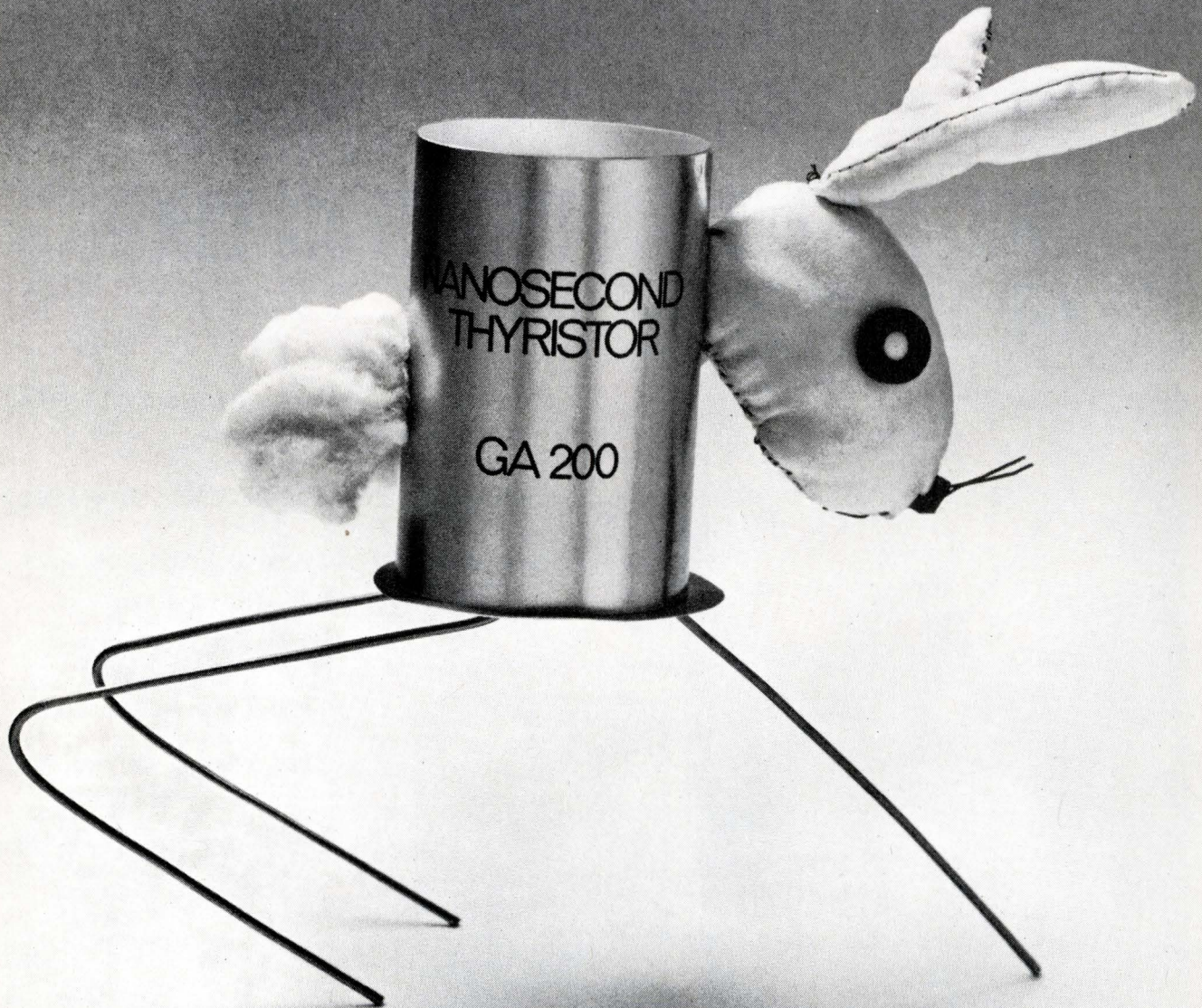

Slow and steady does not win the race.

With SSPI's new GA200 series nanosecond thyristors, it's speed that counts. And what speed! They're capable of switching 1 amp in 10 nanoseconds or 30 amps in 20 nanoseconds. The fastest, high-current switching elements on the market. And the only ones! With this speed, they're ideal for use in high speed pulse modulator circuits, in high current, precise digital switching, or in laser driving.

But there's more to the GA200 series than speed. It can meet any voltage requirement and maintain a 20 nanosecond switching speed. How? By series stringing . . . without

sacrificing a nanosecond.

The new GA200 nanosecond thyristors are available in space-saving TO-18 packages. Quite a story, eh Aesop?

For further information about the nanosecond thyristor or series stringing techniques (The New Design Ideas 210) call or write Ralph Lowry at:

SOLID STATE PRODUCTS **SSPI** DIVISION OF UNITRODE CORPORATION
1 Pingree Street, Salem, Massachusetts 01970
Telephone: (617) 745-2900



The EE Forefront is a graphical representation of the practical state of the art. You will find here the most advanced components and instruments in their class, classified by the parameter in which they excel.

A word of caution

Keep in mind the tradeoffs, since any parameter can

be improved at the expense of others. If there is no figure-of-merit available, we either include other significant parameters of the same products, or we provide additional bar graphs for the same products.

Do not use these charts to specify. Get complete specifications first, directly from the manufacturers.

INSTRUMENTS

Differential voltmeters (dc)

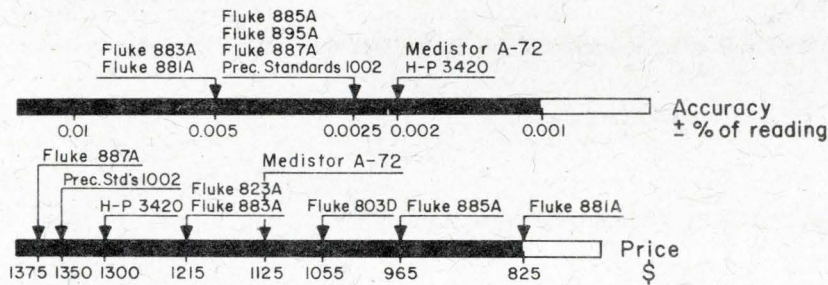

Differential voltmeters (ac)

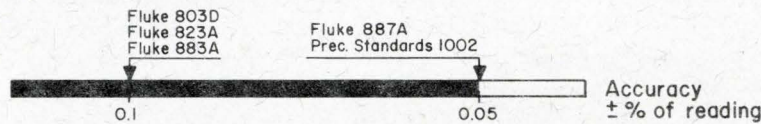

Pulse generators

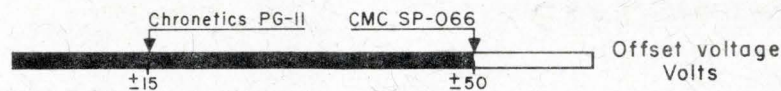
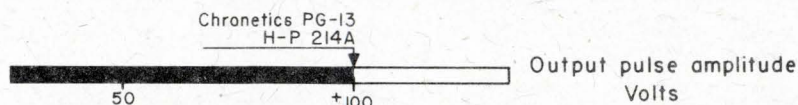
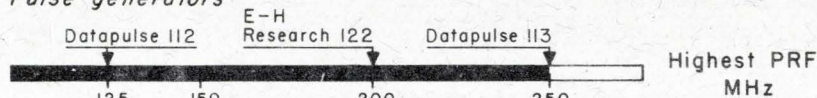

Counters

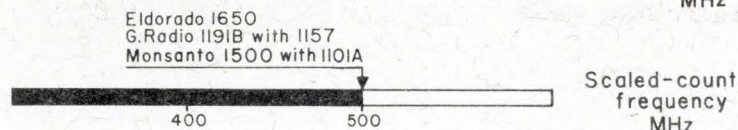
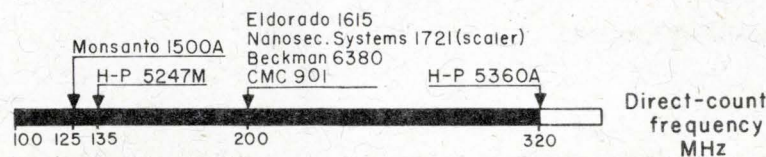

INTEGRATED CIRCUITS

Operational amplifiers

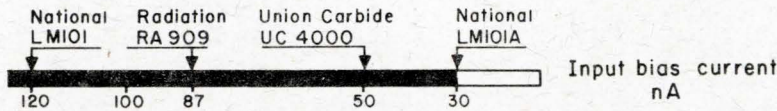

Power amplifiers

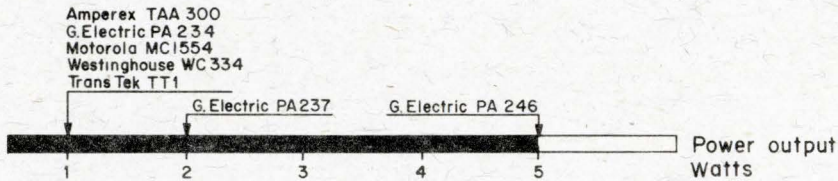

SEMICONDUCTORS

Thyristors

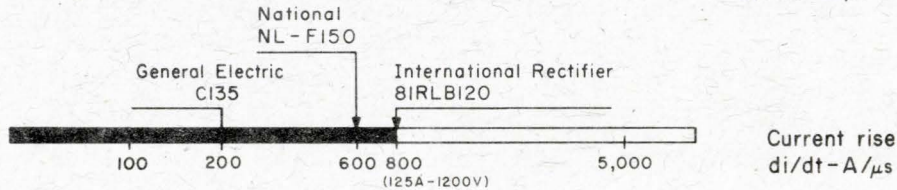
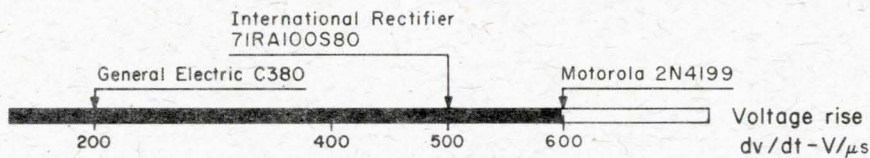
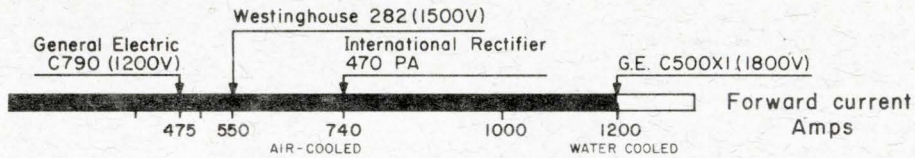

Microwave semiconductors (power)

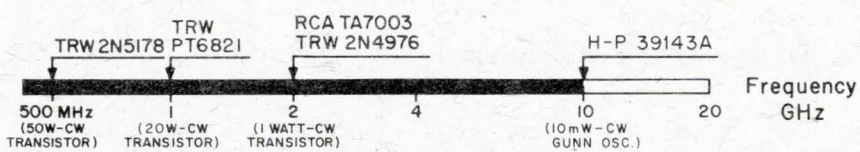

Junction FETs

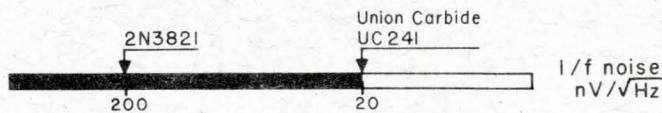
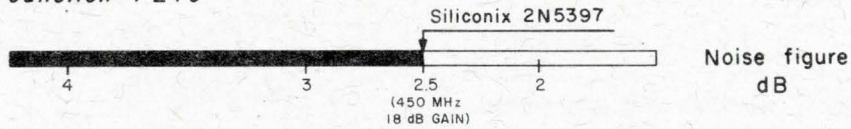

vhf MOS FETs

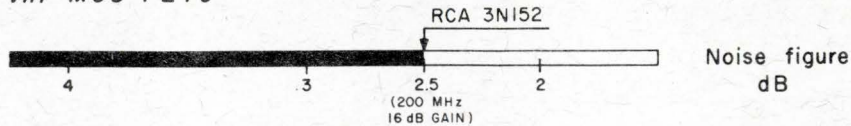

Our man in the Pentagon. HP co-founder David R. Packard had fairly clear sailing with the Senate examining panels and is now the new Deputy Secretary of Defense. The import to electronics is still unclear and Pentagon spending is budgeted at \$79 billion versus \$78.4 billion for '68.

Tickets please. Penn Central's high-speed Metroliner, with its GE electric propulsion system, and loads of communications electronics, successfully completed its New York-to-Washington run.

Sky's the limit. Prices of copper, aluminum, and nickel were raised to new highs. Component price increases can't be far behind. Price rise is one of the reasons Amphenol sold its cable division to Essex Wire.

Round two. IBM has reviewed Control Data's anti-trust complaint against it and calls the "allegations unfounded, mutually inconsistent and baseless." Meanwhile, the U.S. Government has joined CDC and filed an anti-trust suit.

Computer heating. Using heat channeled from its Honeywell 200 computer, Computer Management Consultants, Inc., expects to save up to \$4000 in heating its 6500-square-foot plant. Heat from the computer is used along with that from the lights and the 70 employees.

Stop-action holography. A ruby laser holography system from Union Carbide's Korad Div. is capable of high-resolution holograms of such high-speed events as shock waves, projectiles, and minute vibrations in metal surfaces. The system uses a Pockels cell Q-switch rather than a dye switch.

CCTV on trial. First courtroom use of closed-circuit TV is in the Sirhan Sirhan trial. Legal experts caution against considering this a precedent, however.

Perfect setting. The National Society of Professional Engineers held its annual management seminar at the Stardust Hotel in Las Vegas on Jan. 15. The subject: "Motivation and Discipline."

First generation. *Plan Calcul*, the French Government-sponsored development program, has introduced its first computer. The machine, dubbed IRIS 50, is a 16k-bit, 0.95- μ s, \$500,000 unit.

Straight talk about static power conversion from a no-nonsense company

When you buy a static power conversion unit, it has to be good. It has to be reliable. It has to do the job you want it to do without being overdesigned. *This calls for specifications that are meaningful and a unit that you can be sure will meet them.*

Unitron has been solving this kind of problem for a good many years now. Many of our solutions have had so many practical applications they've become shelf items — inverters with sine wave outputs and 60-400 and 400-60 Hz frequency converters, for example.

Whatever your requirements in static power, you should talk it over with Unitron. You'll get straight talk, practical solutions, and on-time deliveries. We take all these things very seriously around here.

**STATIC INVERTERS
FREQUENCY CONVERTERS
CUSTOM POWER SUPPLIES
for Shipboard, Airborne,
Ground Support, Communications
and Industrial Control
Applications**

Write for complete information

UNITRON

DIVISION OF ELECTRIC MACHINERY MFG. COMPANY

1624 N. FIRST ST.
GARLAND, TEXAS 75040 (214) 276-8591

Circle 16 on Inquiry Card

microtopics

product news from Philco-Ford Microelectronics

Radiation-tolerant IC's now in production

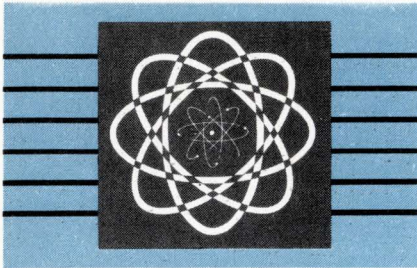

We have developed techniques for producing dielectrically isolated bipolar integrated circuits which can tolerate high levels of transient radiation. Our oxide isolation process has proven reliability. We are now supplying in production quantities.

Prototype quantities of gates, buffers and flip-flops are readily available. Write or call for a consultation on your specific application.

Circle 17 on Inquiry Card

New packages for LSI

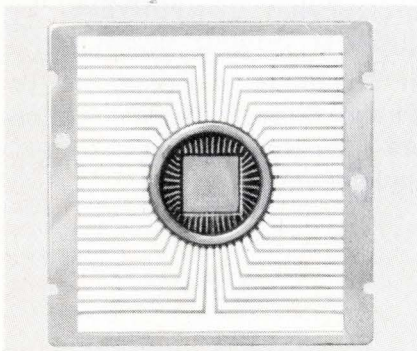

Radial flat packs with 34 and 44 leads are now ready for use with LSI circuits. Leads have .050" spacing. Precision lapped sealing surface to maximize sealing yields. Supplied with brazed sealing ring and isolated metal base. Prototype quantities can be delivered promptly. For data on production quantities, write or call us.

Circle 18 on Inquiry Card

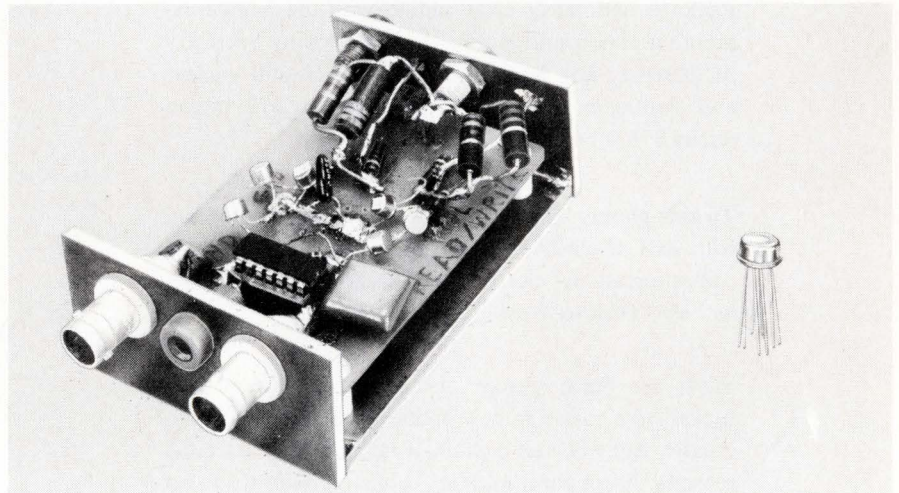

Discrete circuit write amplifier at left was shrunk to hybrid version at right, in TO-5 case.

Microminaturize your discrete circuits the economical, fast, hybrid way

A write amplifier for magnetic tape, when made of discrete components, used to fill a 2" x 3" x 1" chassis. We converted it to a hybrid microcircuit that fits in a TO-5 case. Four weeks after receiving full circuit data, we had a prototype ready for evaluation. In ten weeks we were producing at a rate of 500 per month.

Performance? The hybrid version is electrically equal, and environmentally superior, to the discrete circuit.

Cost? In volume production, the hybrid circuit cost about the same

as the discrete, but its price included REL and qualification... the discrete did not.

Hybrid circuits by Philco-Ford are the way to get complex circuits into small packages... to provide voltage, current and power output beyond the present abilities of monolithic devices... and to do the job quickly, with minimum tooling cost. We've made hundreds of different hybrid circuits. Call a Philco-Ford Hybrid Hunter now, for a consultation on your circuit.

Circle 19 on Inquiry Card

When you go T²L ... go Cerdip

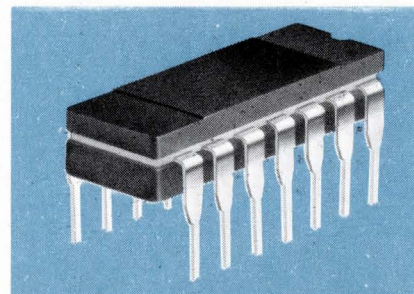

It pays to buy state-of-the-art logic in state-of-the-art packaging. We make a full line of T²L gates, expanders and flip-flops, pin interchangeable with SUHL* II. And we supply them in cerdip packages of proved reliability. Both MIL and industrial temperature ratings are available.

For your new logic designs, why settle for less than the convenient, economical handling and assembly of dual in-line packaging, with proven hermeticity?

Oh, yes, we also supply T²L in ceramic flat packs.

*Trademark of Sylvania Electric Products, Inc.

Circle 20 on Inquiry Card

New avalanche oscillator X-band source is available from stock

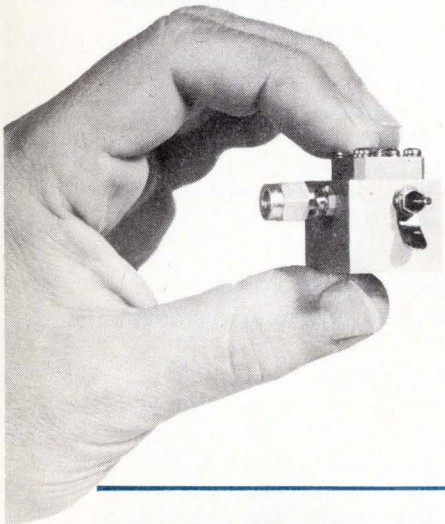

The Philco-Ford P8510 source is now in full production at our Spring City, Pa., plant. And it has more than instant availability to recommend it. It's highly efficient at low DC input levels. You get 60 milliwatts of X-band power from only 1.5 watts DC. At higher DC input, you can

get up to 200 milliwatts out. The secret of its performance is high efficiency Philco avalanche oscillator diodes. Check the specs. Then write to us for data and prices on our complete line of avalanche oscillators from 6 to 16 GHz.

Circle 21 on Inquiry Card

Specifications of the Philco-Ford P8510.

- Frequency range (any 5% bandwidth): 6 GHz to 11 GHz
- Mechanical tuning: 5% full power to 20% with reduced power
- Power output: 60 mw min (CW)
- Power input: 80 to 100 VDC, 15 to 25 ma. from constant current source
- Efficiency: 3-5%
- Weight: 1.5 oz.
- Volume: 0.8 cu. in.
- Connector: 3 mm miniature coaxial
- Operating temperature: -40°C to $+85^{\circ}\text{C}$
- AM noise: typically 110 db per KHz below carrier from 1 KHz to 100 KHz
- FM noise: typically 500 Hz rms per 100 Hz from 1 KHz to 100 KHz

MOS 1024-bit read-only memory costs less than 5c per bit

Systems designers: get acquainted with the Philco-Ford pM1024 MOS read-only memory... then let your imagination run wild. The off-the-shelf pM1024 is programmed with a sine look-up table, and is available for

immediate delivery. By use of a custom mask, the pM1024 can be programmed as a look-up table for cosine, tangent, log, exponential or any other commonly used function. Or a synched eight signal waveform

generator with a period 128 times basic clock frequency. Stack them up, and you can get character generation, provide microprogramming of sub-routines, or solve recurrent equations having variables of known interaction. The fast cycle time of the pM1024... short as 1 microsecond... makes many new applications practical.

Pattern organization can be 128 eight-bit words, or 256 four-bit words. Built-in chip select lets you parallel chips to build up memory capacity. Address decoding, memory, and output buffers are all contained on the chip. Output buffers can drive DTL and T²L directly.

Through the use of computerized software, your custom bit pattern is transferred to the pM1024 with complete accuracy, and with fast turnaround.

Cycle times of 1 and 2 microseconds are available. We supply in full temperature rating, -55 to $+125^{\circ}\text{C}$; or limited temperature rating, 0 to 70°C .

Circle 22 on Inquiry Card

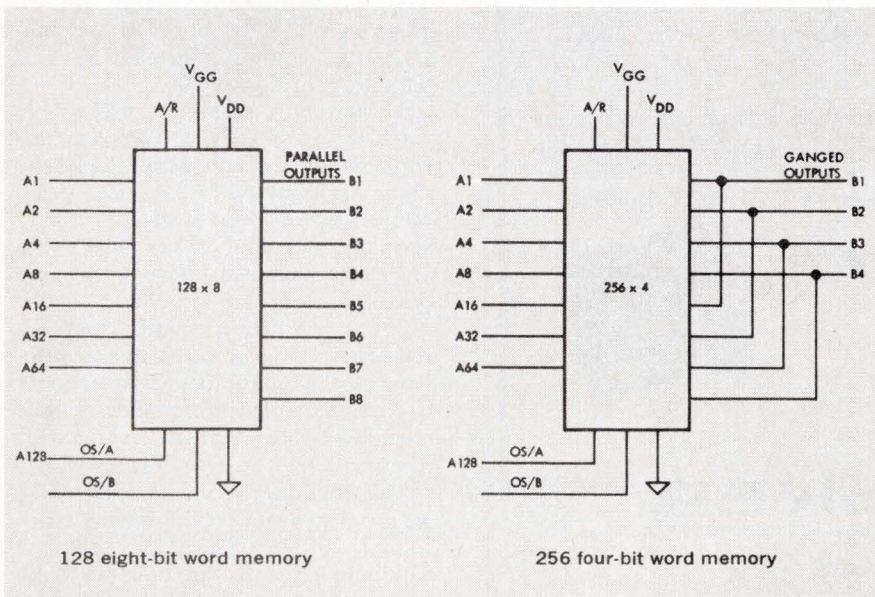

NEW IDEAS

FROM **TITCHENER**

No. 8 of a series

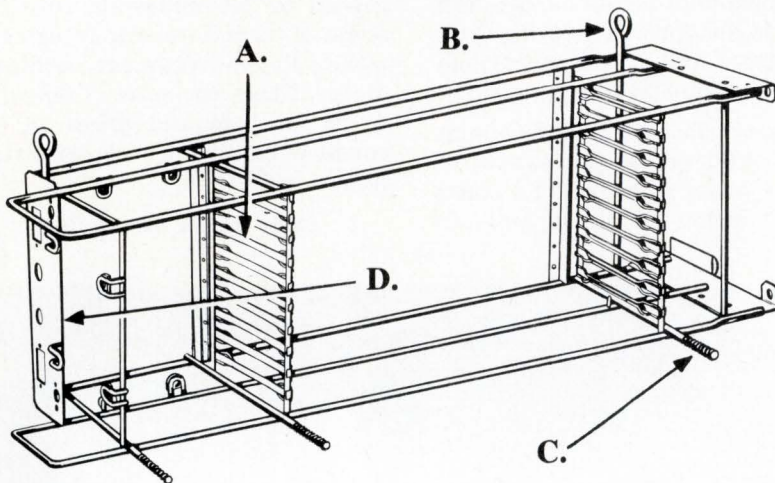

THESE DESIGN TIPS HELP KEEP COSTS DOWN WHEN YOU'RE DESIGNING CB RACKS AND CHASSIS.

A. This combination of guide wires and a flat spring holds circuit boards gently, yet firmly . . . grips from all directions — eliminating stress on connectors.

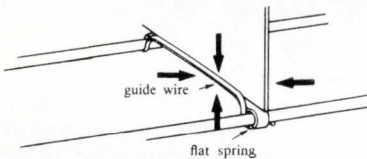

B. Simple eyes formed at wire ends provide inexpensive mounting holes. If fastener is too small for the smallest eye that can be turned in the wire itself, weld a washer to the eye.

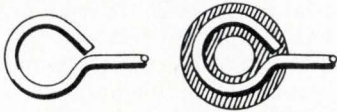

C. Rolled threads at the ends of chassis or CB racks act as mounting bolts. Use cut threads if necessary, though roll threading provides a stronger part at lower cost.

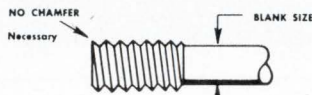

D. Inexpensive standard weldments — threaded nuts, threaded studs, washers and many other shapes can be welded to CB racks and chassis for mounting components in either fixed or adjustable configurations.

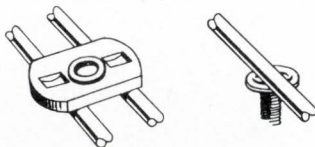

Want more helpful design tips? Send today for "How Titchener Wire Construction Improves Electronic Product Design."



E. H. TITCHENER
AND COMPANY
Working Wonders with Wire
2 Titchener Place, Binghamton, New York

EE SPEAK UP

Take it from a technical writer

Sir:

In regard to the letter "Who will be concerned about technicians?" by S. G. Johnson and Robert Lowe's response to same (*The Electronic Engineer*, August 1968, p. 22 and October 1968 p. 34). Any literate BSEE or good electronic technician can find rewarding employment as a technical writer. This work keeps one up with the state of the art, and has professional status. Demand has always exceeded supply in this rapidly growing field.

C. F. Eggert, Manager
Commercial Avionics
Publications Engineering Dept.
Collins Radio Company
Cedar Rapids, Iowa

Don't buy test equipment without good instruction manuals

Sir:

Your publication covers a wide variety of test instrumentation in just about every issue of your publication. As a manufacturer of IC test equipment we appreciate your coverage of this subject. We feel certain that other manufacturers like us feel the same way.

There is one area of the test equipment field, however, which neither you nor anyone else in the publishing business has explored for your readers. This is the area of the instruction manuals which accompany the test equipment. Computer manufacturers and computer buyers make certain that the software problems are explored and solved prior to the purchase of a computer installation—and with good justification!

Hardware is seemingly useless unless accompanied by a complete and meaningful set of instructions and other information leading to the effective use of that hardware. It is a sorry situation when many people who buy test equipment have very little prior knowledge of what type of software or instruction manual they are receiving with their purchase. Consequently, the customer (your reader) has realized many times that he gets much less value than he expected to receive.

This condition is always most prevalent when a new and growing marketplace is identified. Many companies jump into hardware building to fill

(continued on page 24)

New product number **67.**

3530 64-BIT STATIC RANDOM ACCESS MEMORY

The 3530 is an MOS non-destructive read-out (NDRO) random access memory organized as 64, 1-bit words. Addressing of any selected bit is through a 6-line decoder included on the chip, and access time is under $2\mu\text{sec}$. Several 3530's may be stacked for longer words.

The need for external gates is reduced by a built-in wired-OR capability. And system power needs are less (under 3mW/bit) because the chip is built with p-channel enhancement mode MOS.

The 3530 was designed to be used in military or commercial airborne, space, or ground-based systems. It is easily integrated into any data storage system, from computer peripherals and calculators to scratch pad and process control memories.

The 3530 comes in a 16-pin DIP. Write for complete specs and application notes. Or order it from stock from your Fairchild distributor.

To order the 3530, ask for:

Part No.	Temperature Range	Price		
		(1-24)	(25-99)	(100-999)
A6J353014X	-55°C to $+85^{\circ}\text{C}$	\$36.00	\$32.00	\$24.00

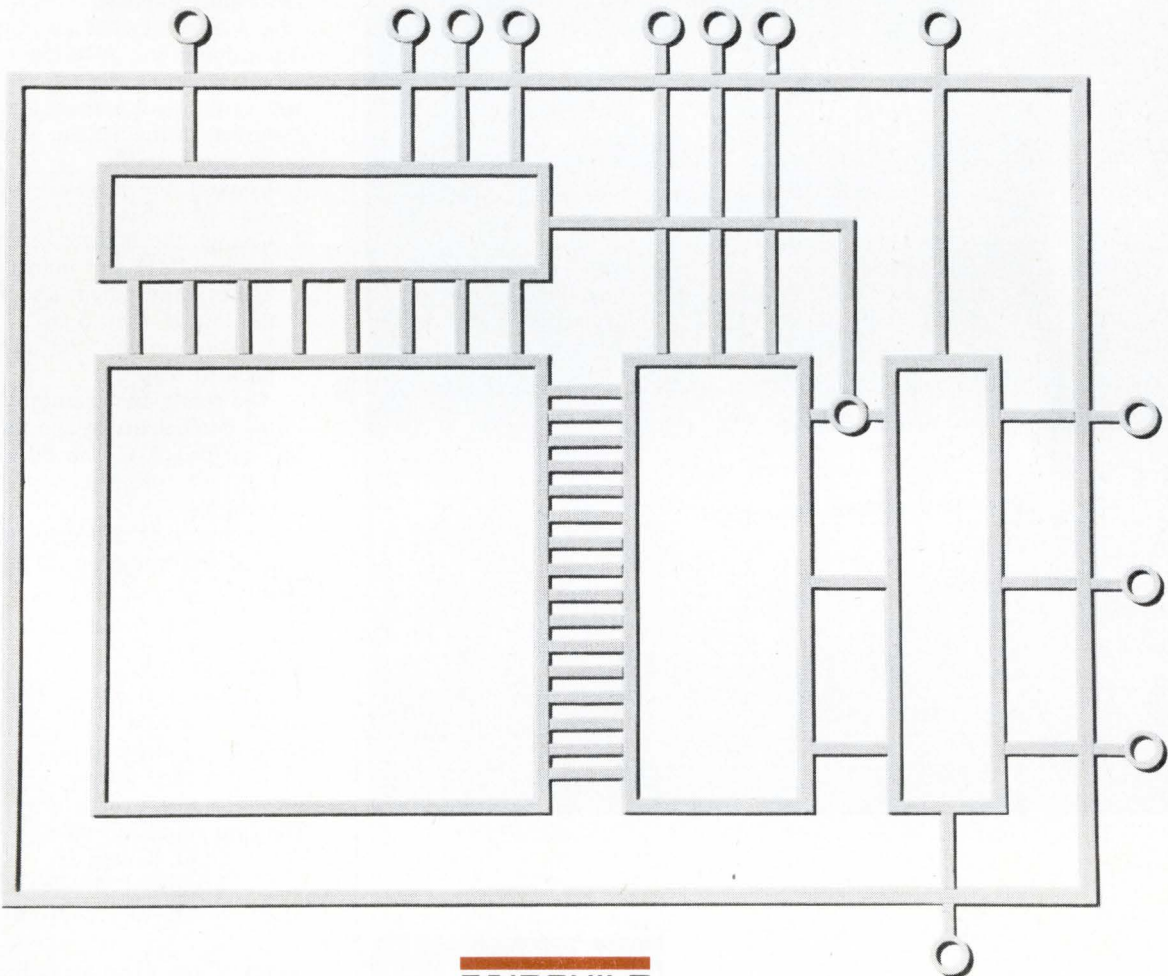

FAIRCHILD
SEMICONDUCTOR

FAIRCHILD SEMICONDUCTOR A Division of Fairchild Camera and Instrument Corporation 313 Fairchild Drive, Mountain View, California 94040, (415) 962-5011 TWX: 910-379-6435

THE WIDEST SELECTION* OF VOLTAGE-TUNED SOLID STATE OSCILLATORS

- ... in P-band
 - WJ-2811
0.25 to 0.5 GHz
100 mW power output
 - WJ-2801
0.5 to 1.0 GHz
100 mW power output
- ... in L-band
 - WJ-2803
1.0 to 2.0 GHz
100 mW power output
- ... in S-band
 - WJ-2805
2.0 to 4.0 GHz
40 mW power output

*Many variations of basic models available in each band.
PLUS: Delivery in 30 days ARO for most models.

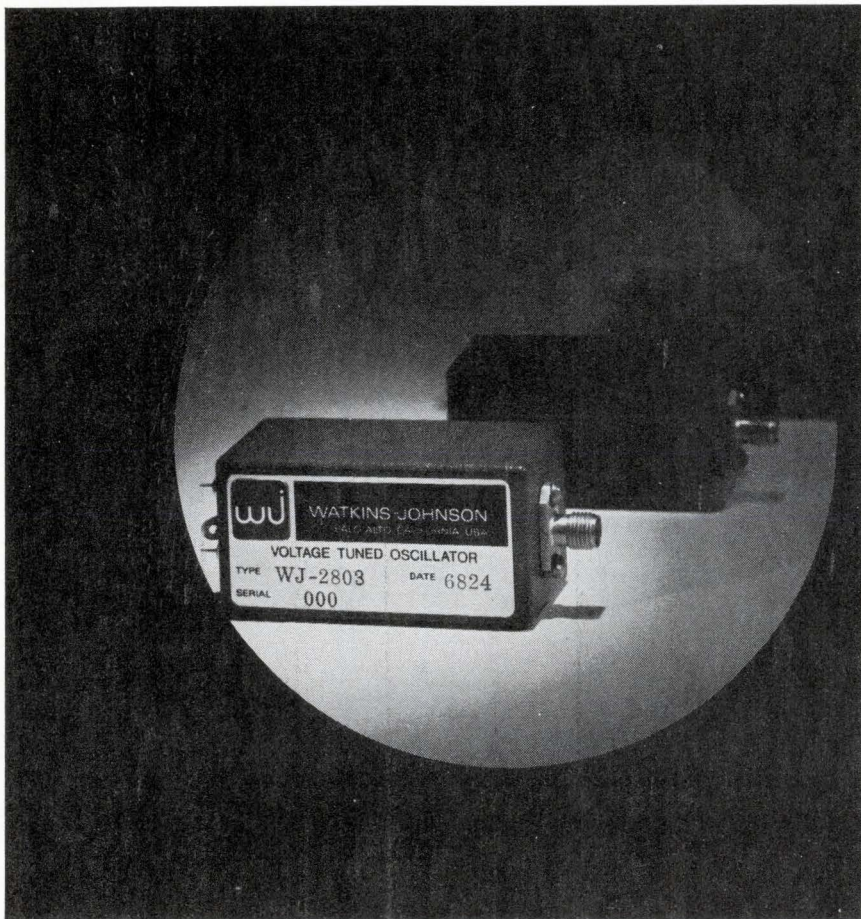

3333 HILLVIEW AVE., STANFORD INDUSTRIAL PARK, PALO ALTO, CALIF. 94304 • (415) 326-8830

EE SPEAK UP

(continued from page 22)

the gap when they see it in the market. However, seldom do they consider realistically the quality of the software to go with this equipment. Upon consideration, the cost and the effort necessary usually delay this part of a program—sometimes to an eternity.

May I suggest that with each article you run and with each new product released that some indication of the size and quality of instruction manuals be delineated. This effort on your part would prove valuable to the electronics industry per se, and to your readers and advertisers in particular.

M. R. Barr
Marketing Manager
Redcor Corporation
Canoga Park, California

Better a practical method than elegant algorithm

Sir:

Regarding your article, "The Mathematician and the Transformer" [*The Electronic Engineer*, Sept. 1968, Pg. 19], I have devised an algorithm for determining the winding connections which, if not as elegant, is a lot faster and easier to use than the algorithm described in the article. The following procedure is used:

1. Convert the desired voltage from base 10 to base 3.
2. Change the highest order "2" to a flagged 1 ($\bar{1}$) and increase the next higher order digit (the number to the left of the 2) by 1.
3. If there are any "2's" remaining go back to Step 2.
4. The result, for example 1011, gives the coefficients of the terms.

The flagged 1 is shown as 1 where $1 = -1$, $1 + 1 = 0$

Example:

Assume that 23 volts are desired from the transformer, hence

$$\text{Step 1: } 23_{10} = 212_3$$

$$\text{Step 2: } 1 \bar{1} 1 2$$

$$\text{Step 3: } 1 \bar{1} 2 \bar{1}$$

$$\text{Step 4: } 1 0 1 \bar{1}$$

$$= 1 \times 3^3 + 0 \times 3^2 - 1 \times 3^1 - 1 \times 3^0 = 23V$$

Since 1 = positive polarity voltage

0 = zero voltage

-1 = negative polarity voltage

The sum equals 23 volts.

C. O. Gragg II

Lockheed Missiles & Space Co.
Sunnyvale, California

Letters to the editor are published at the discretion of the magazine. Please say so if you do not want to be quoted. Signed letters have preference over anonymous ones.

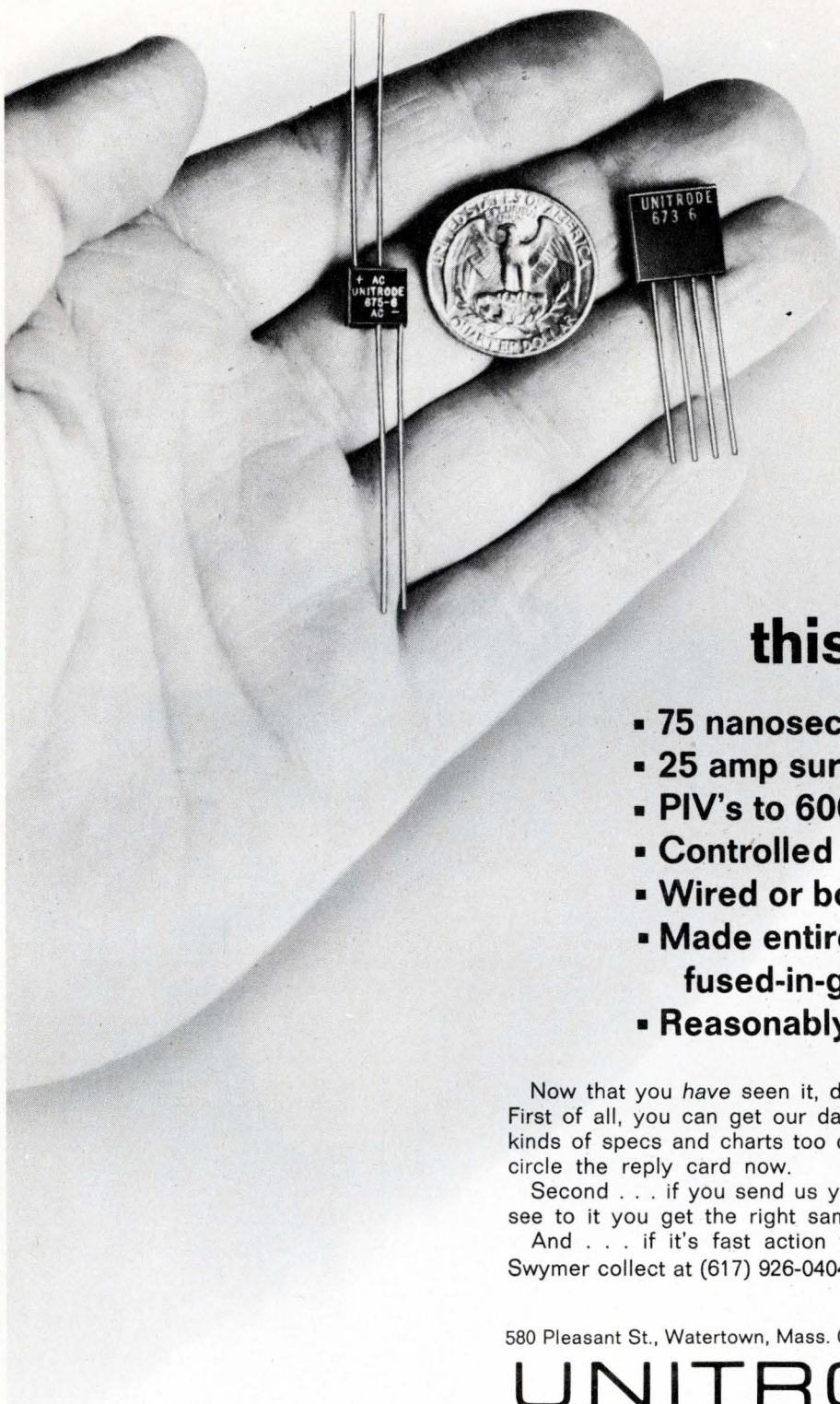

**Two bits
says
you've
never seen
a 1.5 amp
bridge
this small with**

- 75 nanosecond recovery
- 25 amp surge rating
- PIV's to 600V
- Controlled avalanche
- Wired or board mounted
- Made entirely with individually fused-in-glass diodes
- Reasonably priced

Now that you *have* seen it, don't you want to know more? First of all, you can get our data sheet, just packed with all kinds of specs and charts too detailed to put in this ad. Just circle the reply card now.

Second . . . if you send us your circuit requirements, we'll see to it you get the right sample for the job.

And . . . if it's fast action you want, why not call Fred Swymer collect at (617) 926-0404.

580 Pleasant St., Watertown, Mass. 02172, (617) 926-0404

UNITRODE



STANDARD RECOVERY

PIV to 600V
Rating 1.5A
Surge 25A

FAST RECOVERY (500 nsec)

PIV to 600V
Rating 1.0A
Surge 20A

ULTRA-FAST RECOVERY (75 nsec)

PIV to 200V
Rating 1.0A
Surge 20A

HERE'S WHAT IT LOOKS LIKE INSIDE

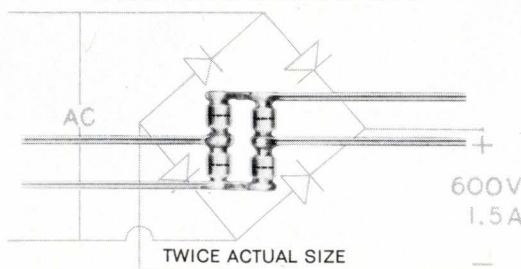

AND HERE'S WHAT IT LOOKS LIKE

INSIDE THE INSIDE



With the silicon die metallurgically bonded between terminal pins of the same thermal coefficient, the hard glass sleeve is fused to the entire outer silicon surface. Result — a voidless, monolithic structure.

See us at the IEEE Show

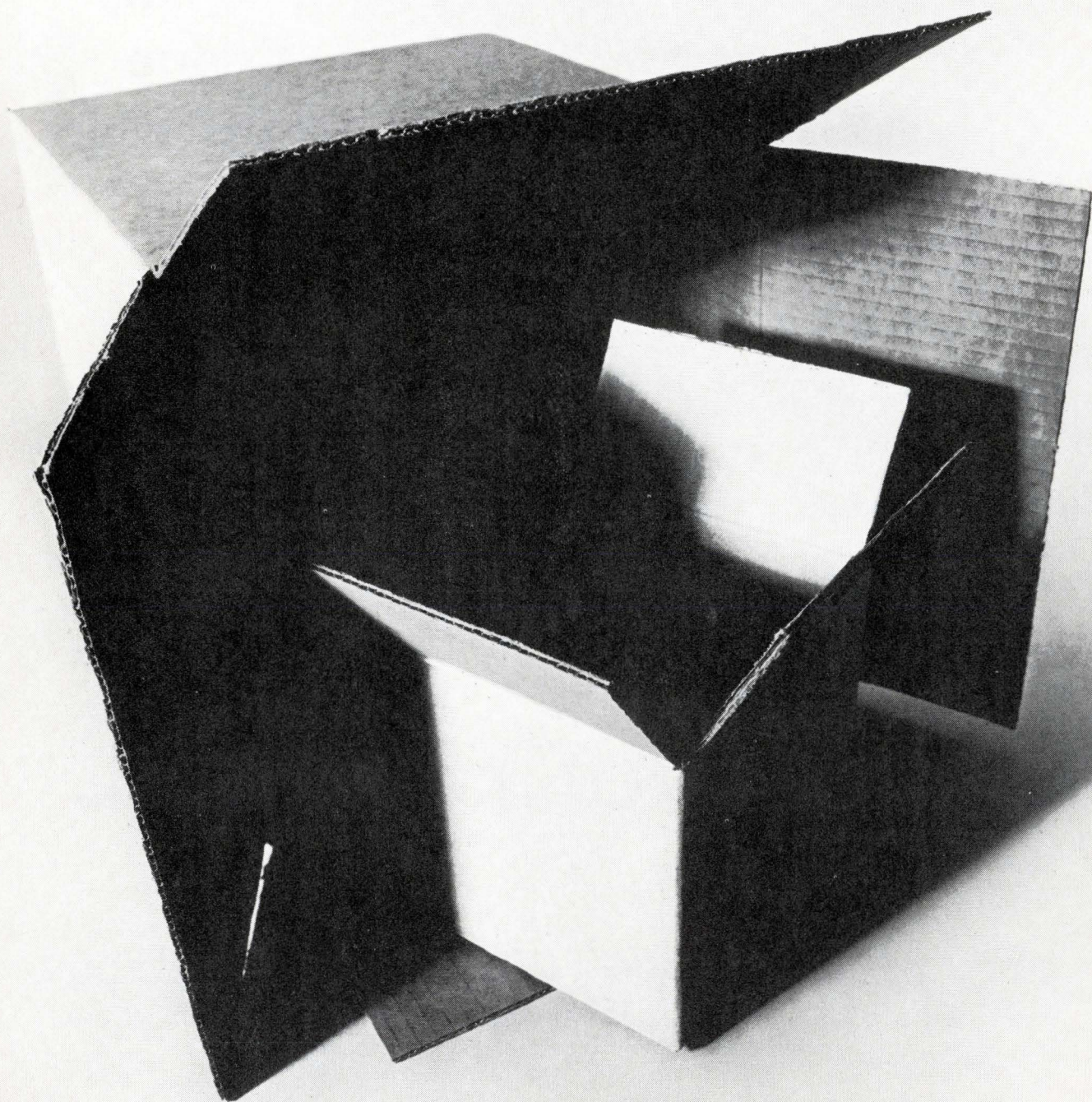

We made TTL half as big. And half as big is twice as good.

We had an idea you weren't getting all you could from T²L. If it were smaller we knew it would be better. And we figured we could make it smaller.

So we added a few circuit improvements, reduced our active chip area over 50%, and turned the problem over to our production line.

The result is Ray III. With no increase in power and far less parasitic capacitance, it's the fastest T²L available. Flip flops toggle up to 100 MHz. Gate propagation delay is only 5½ nsec maximum. Improved transfer characteristics and input clamp diodes guarantee more noise immunity than before. And it's in production now.

All because we had an idea how to squeeze the fat out of a T²L chip... and delivered!



Circle 27 on Inquiry Card

Samples available from distributors:

RG 3220/3222 Quad 2-Input NAND Gate. RF 3200/3202 AND-Input JK Flip Flop. RF 3210/3212 OR-Input JK Flip Flop.



Please send me the brand new 1969 Acopian catalog that lists

**82,000
DIFFERENT
POWER
SUPPLIES**

available for shipment in 3 days.

Name _____

Title _____

Company _____

Address _____

City _____

State _____

ZIP _____

ACOPIAN CORP.
EASTON, PENNSYLVANIA
TEL: (215) 258-5441



Circle 28 on Inquiry Card

EE CALENDAR

FEBRUARY

16	17	18	19	20	21	22
23	24	25	26	27	28	

Feb. 19-21: Int'l Solid State Circuits Conf., Univ. of Penna. & Sheraton Hotel, Philadelphia, Pa. Lewis Winner, 152 W. 42nd St., New York, N. Y. 10036.

Feb. 21: 10th Annual West Coast Reliability Symp., Century Plaza Hotel, Beverly Hills, Calif. Addtl. Info.—Robert H. Anderson, TRW Systems, Redondo Beach, Calif. 90278.

MARCH

							1
2	3	4	5	6	7	8	
9	10	11	12	13	14	15	
16	17	18	19	20	21	22	
23	24	25	26	27	28	29	
30	31						

March 5-7: Particle Accelerator Conf., Shoreham Hotel, Washington, D. C. Addtl. Info.—E. H. Eisenhower, Ctr. for Radiation Res., NBS, Washington, D.C. 20234.

March 6-7: Ultra-Microminiaturization: Precision Photography for Integrated Electronic Circuitry, Travelers Hotel, La Guardia Airport, New York, N. Y. Addtl. Info.—Society of Photographic Scientists & Engineers, 1330 Massachusetts Ave., N.W., Washington, D. C. 20005.

March 12: Plastics Powders-III, Sheraton Motor Hotel, Akron, Ohio. Addtl. Info.—Robert G. Hills, c/o NRM Corp., 47 W. Exchange St., Akron, Ohio 44308.

March 24-27: IEEE Int'l Conv. & Exhbt., Coliseum & N. Y. Hilton Hotel, New York, N. Y. Addtl. Info.—J. M. Kinn, IEEE, 345 E. 47th St., New York, N. Y. 10017.

APRIL

1	2	3	4	5			
6	7	8	9	10	11	12	
13	14	15	16	17	18	19	
20	21	22	23	24	25	26	
27	28	29	30				

April 8-10: Cleveland Electronics Conf., Cleveland Eng'g Center, Cleveland, Ohio. Addtl. Info.—Mike Lapine, Conf. Director, 1610 Euclid Ave., Cleveland, Ohio 44115.

April 15-18: Int'l Computer Aided Design Conf., Univ. of Southampton, Southampton, England. Addtl. Info.—IEE, Savoy Pl., London, W.C. 2, England.

April 22-23: 17th Annual Nat'l Relay Conf., Oklahoma State Univ., Stillwater, Okla. Addtl. Info.—Dr. Monroe W. Kriegel, Director, Eng'g and Industrial Extension, Oklahoma State Univ., Stillwater, Okla. 74074.

April 23-25: Southwestern IEEE Conf. & Exhibition, San Antonio Conv. Ctr. & Palacio Del Rio Hotel, San Antonio, Tex. Addtl. Info.—S.W. Seale, S.W. Res. Inst., Box 2296, San Antonio, Tex. 78206.

April 30-May 2: Electronic Components Conf., Shoreham Hotel, Washington, D. C. Addtl. Info.—Electronics Ind. Assoc., 2001 "I" St., N.W., Washington, D. C. 20006.

'69 Conference Highlights

WESCON—Western Electric Show and Conv., August 19-21; San Francisco, Calif.

IEEE—Institute of Electrical and Electronics Engineers Int'l Convention & Exhibition, March 24-27; New York, New York.

Call for Papers

Oct. 6-8, 1969: Int'l Electronics Conf. Submit title, 100-word abstract (including author's name, company affil., and telephone number) and 500-word summary by **March 15, 1969** to Dr. Rudi deBuda, Technical Program Chrmn., Int'l Electronics Conf., 1819 Yonge St., Toronto 7, Canada.

Call For Technical Program

Aug. 19-22, 1969: Western Electronic Show and Convention (WESCON). Submit "letters of intent" describing suggested sessions by **March 1, 1969** to Mr. Dalton W. Martin, WESCON Technical Program Committee, 3600 Wilshire Blvd., Los Angeles, Calif. 90005. The program will emphasize sessions in areas of applied technology.

Circle 29 on Inquiry Card →

We've submini-priced subminiature switches

and the deal's OFF...

Or on. Or off-again-on-again-off-again. Or on-again-on-again-on-again. Now, you can order both subminiature push button switches and subminiature toggle switches at the miniest prices on the market. How mini? Submini! Now how many?

Submini-Price List of Pushbutton and Toggle Switches

TOGGLE-SWITCH MODELS	1-24	29-99	100-499	500-999
7101	\$ 1.65	\$ 1.10	\$.96	\$.82
7103, 5, 7, 9	1.95	1.30	1.16	.97
7201	2.15	1.43	1.28	1.07
7203, 5, 7, 9	2.55	1.70	1.52	1.27
7211	2.85	1.90	1.70	1.41
7213	3.15	2.10	1.87	1.55
7215	3.45	2.30	2.06	1.71
7301	3.85	2.57	2.30	1.92
7303, 5, 7, 9	4.80	3.20	2.87	2.38
7401	4.85	3.28	2.90	2.43
7403, 5, 7, 9	6.05	4.10	3.61	3.00
7411, 13, 15	6.90	4.30	4.11	3.41

PUSHBUTTON SWITCH MODELS	1-24	25-99	100-499	500-999
P8121	\$ 2.55	\$ 1.70	\$ 1.52	\$ 1.27
P8221	3.45	2.30	2.06	1.71
P8321	4.80	3.20	2.87	2.38
P8421	6.05	4.10	3.61	3.00

Call or write for quantity prices:

CK COMPONENTS, INC.
103 Morse Street,

Watertown, Mass. 02172 tel.: (617) 926-0800

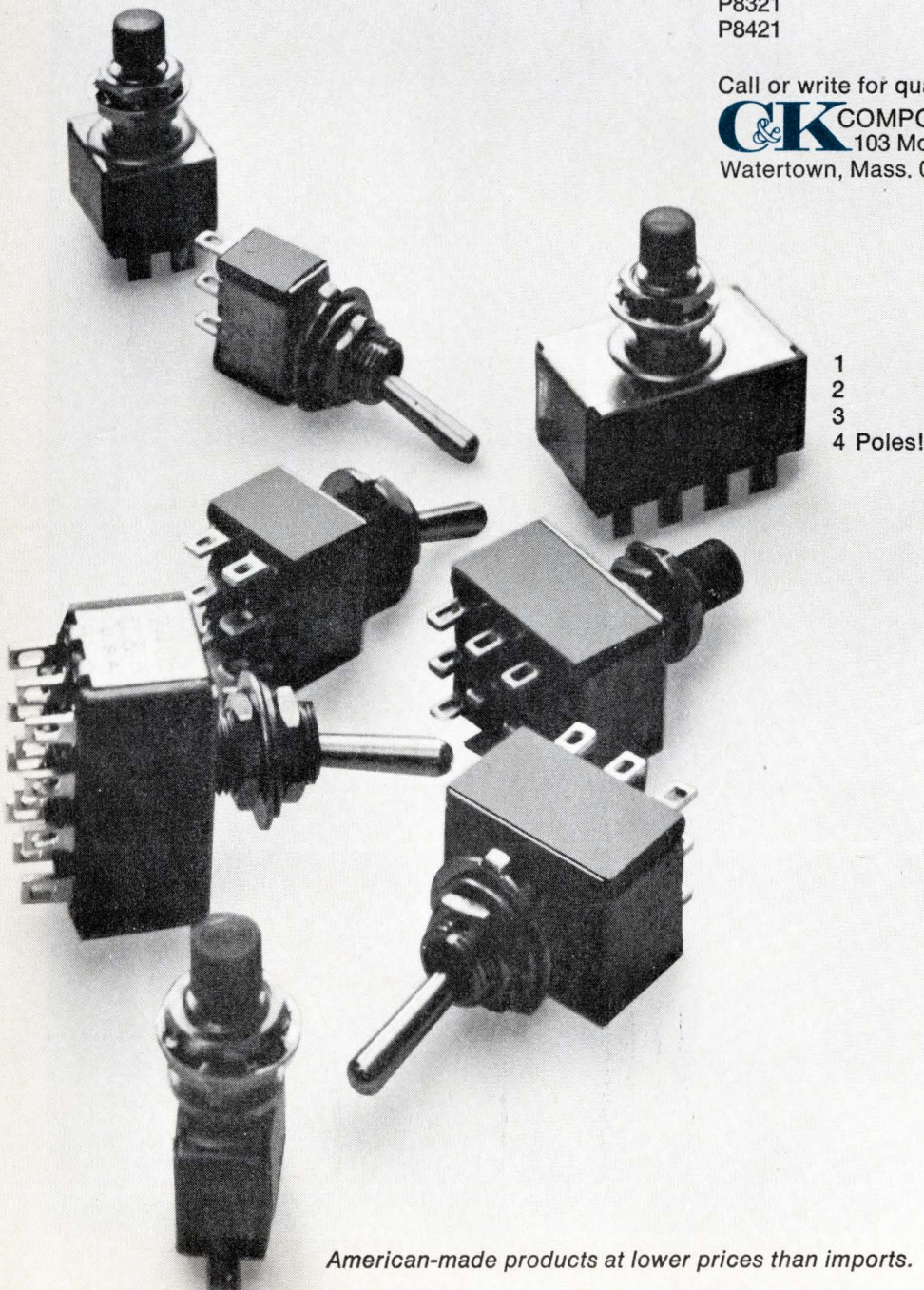

1
2
3
4 Poles!

American-made products at lower prices than imports.

The many facets of a rewarding career.

Like a diamond, a career can be judged by its facets. In a diamond, it's the facets that add to the depth and luster. In a career, there are many contributing factors that make it more rewarding.

At Memorex, we can offer you a stimulating, creative environment with unsurpassed opportunity. For example, we will provide you with excellent business associates... the finest technical talent in the world. Growth... from 6 people to over 1800 in just seven years and growing faster. Outstanding reputation... quality products, backed by service. Location... the beautiful San Francisco Peninsula. And many more reasons to make your career have the proper depth.

Of course, the most important facet in making your career a success is you. What interests and motivates you? If you want more information about Memorex, write us today and while you're at it tell us something about you.

Some of current openings include:

Electronic Maintenance Manager BSEE preferred, with previous maintenance supervisory experience required. Will assume total department responsibility including budgeting, manpower, etc. Mechanical aptitude required, plus the ability to communicate effectively.

Specification Engineer Engineering degree preferred, with 2-5 years' experience in configuration control, systems development, or industrial engineering. Will devise and control product specification systems, including purchased components' specifications. Also, will participate, with Quality Control, in purchased products review and vendor approval.

Control Systems Engineer Requires a BSEE plus 5 years design and project management experience. Knowledge of the process industries control technology

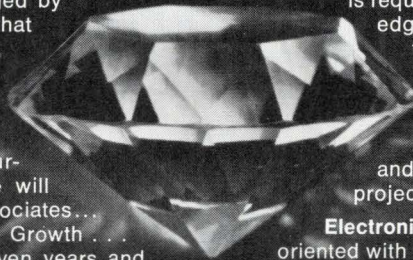

is required. Also, prefer individual with knowledge of electrical power distribution practices. You will be responsible for the design, construction and debugging of control systems on manufacturing equipment and processes. Also, responsible for the instrument and electrical part of Engineering Division projects.

Electronic Engineer (Senior) Should be digital oriented with a knowledge and understanding of production equipment. BSEE required with mechanical engineering experience desired.

Recording Specialist Engineer Requires degree in Physics or Electrical Engineering and at least 2 years' magnetic recording experience. Duties include developing new and improved test methods, and defining equipment requirements and generate operation procedures for new tests. Also, will perform analysis of a highly technical nature, involving test instrumentation performance and validity of test results.

Project Engineer Challenging and rewarding opportunity for an individual with a degree in Engineering. Requires 3-5 years' experience in systems and circuit design with emphasis on analog circuits. Previous supervisory experience desired. You will work in the circuit design of process and test equipment in magnetic tape manufacturing. Previous magnetic experience is not necessary.

Project Manager BS in Physics or Electronics, MS preferred. Must have proven managerial skills and the ability to communicate effectively. Should have an interest in the magnetic recording or television areas.

Please send your resume to: Professional Employment Office, 1180 Shulman Avenue, Santa Clara, California 95052. An Equal Opportunity Employer.

MEMOREX
CORPORATION

New product management

Part II: A case history

A study of a midwestern instrument division indicates that a better new product system will lead to more product successes and reduce the effort spent on products that never reach the marketplace.

By Eugene W. Parry, Microwave Calibration Manager
Hewlett-Packard, Palo Alto, Calif.

In the discussion of new product management in Part I, two assumptions were made:

- Companies that do not use a detailed new product program waste their resources developing products that never reach the marketplace.
- Most factors which cause a specific new product project to be dropped are of such a nature that they could be determined early enough to save considerable effort.

To confirm these assumptions, I made a detailed study of the instrument division of a medium-sized midwestern manufacturing company, where I analyzed the expense and progress reports of all the projects worked on over the 10-year period from 1956 through 1965. The projects were separated into four categories:

- 1) investigation
- 2) projects resulting in new products reaching the market
- 3) projects discontinued
- 4) miscellaneous—engineering time spent on other areas

The results of this part of the study are presented in Table I as percentages of total development expenditures. Table II was derived from the same data and shows relationships of discontinued project expenditures, new product expenditures, and total engineering expenditures.

The information in these tables brings out several points. The company consumed 24.7% of its new product expenditures on projects that were dropped.

To recapitulate

In Part I of this article, which appeared in the January 1969 issue of **The Electronic Engineer**, we discussed the basics of new product management. To recapitulate, much of the effort spent in new product development is applied to projects that do not result in a product that reaches the market. A large proportion of the expenditures misdirected toward unsuccessful products is in the development phase of the new product continuum. There are seven stages in the cycle of a new product project:

- 1) exploration
- 2) screening
- 3) business analysis
- 4) development
- 5) testing
- 6) commercialization
- 7) review

You can more wisely use your company's resources by devoting more effort to the early stages of the new product cycle. You must ask the proper questions, and fit the answers you get into a standard system. A carefully established new product system will guide managers towards successful decisions.

In Part II of this article, we now discuss a study of an actual instrument company that confirms these points, and that suggests what you can do to set up an improved new product procedure. A system used in another instrument company is then described to illustrate how proper control of new product resources leads to efficient operation.

This percentage compares favorably to the 70% industry average (refer to "New product management, Part I," EE, Jan. 1969, p. 38).

But before you consider this company an example of efficient operation, note the following two factors. First, many of the most costly projects which failed were not novel from a technical standpoint. Very little basic research was carried on by the departments studied. Projects that would be considered applied research were generally put into the investigation category. As a result, the projects listed in the new product categories were probably not technically unique compared to the projects worked on by companies reporting only a 30% yield.

Secondly, no attempt was made to determine the degree of success of a product which later became available to the market. Items are carried in the catalog and sold, even if their return on investment is marginal.

Thus, the 24.7% figure is not insignificant in relation to the total effort expended. In effect, it means that one out of four persons working on new products were putting their efforts and the company's investment on projects destined to fail.

You can also note from these tables a sharp reduction of discontinued product effort in the final two years covered in this study. There are several reasons for this reduction. The first is the improvement of product management from experience. The second is a general trend in the group studied from product line expansion and diversification to a policy of existing product improvement and refinement.

The third factor is an important one, and is an application of Parkinson's Law. In the last few years studied, the labor market tightened, while sales rose. Because of this combination of events, fewer personnel were available to work on projects with lesser priority. This same condition existed in 1956, the first year of the study, when relatively little money was spent on discontinued projects. These facts suggest that when engineering personnel are not available, marginal projects are less likely to consume effort.

You can further substantiate this idea by investigating the discontinued projects in the study. In most cases, these were lower priority projects. Generally less attention was given to analyses of projects where interest was low, despite the fact that they continued for several years and cost thousands of dollars. Loosening of the labor market and leveling sales could cause more effort to return to lower priority projects.

Why are new product projects stopped?

The second portion of my study was directed towards establishing the factors which caused new product projects to be discontinued. I used two questionnaires for this purpose. The first was for establishing the opinions of the managers involved in new product decisions. On this questionnaire, technical inability was rated very low as a reason for project failure.

The opinions obtained from the first questionnaire were used to structure the reasons for terminating a project on the second questionnaire. Nine reasons were listed:



Before joining Hewlett-Packard in 1967, Gene Parry was a design engineer and then a project supervisor at a midwestern instruments plant. "Through my experience with projects there," he says, "it became apparent that early analysis of new products was quite weak"—and thus the company spent much money and effort on projects destined to fail. "Although there was a new product procedure," he adds, "there was no formal requirement to use it." Noting that this problem appeared to be typical of many companies led Gene to make the study presented in this article. Analyzing the company's problems, Gene remarks that "it was run pretty much by Marketing." In contrast to that firm, at Hewlett-Packard the Engineering Dept. initiates new product projects, Marketing then approves. He notes that there is an improvement in efficiency when there is a more equal say between Marketing and Engineering.

- unit cost too high
- project volume too low to justify
- change in competitive market
- decline of priority or interest
- design incompatible with customer needs
- product too late for market
- needed earlier market information
- needed earlier economic analysis
- other reasons not listed

Sixteen projects were chosen which represented all of the discontinued new product projects with expenditures exceeding 1% of the total. Out of the total of 38 projects, these 16 accounted for 90.2% of the discontinued project expenditures.

I then gave the second form to the managers, asking them to check the appropriate reasons for stopping each project. The results from this form were compiled to determine the most significant reasons. There were four major factors: unit cost too high, decline of priority or interest, projected volume too low to justify added investment, and the need for earlier economic analysis. Two other factors were also significant, but to a lesser degree: product too late for market, and needed earlier market information. Two of the listed reasons—change in competitive market and design incompatible with customer needs—were checked only once, both on the same project, by the same manager.

You can derive several points from these results. First, there was not much agreement among the replies

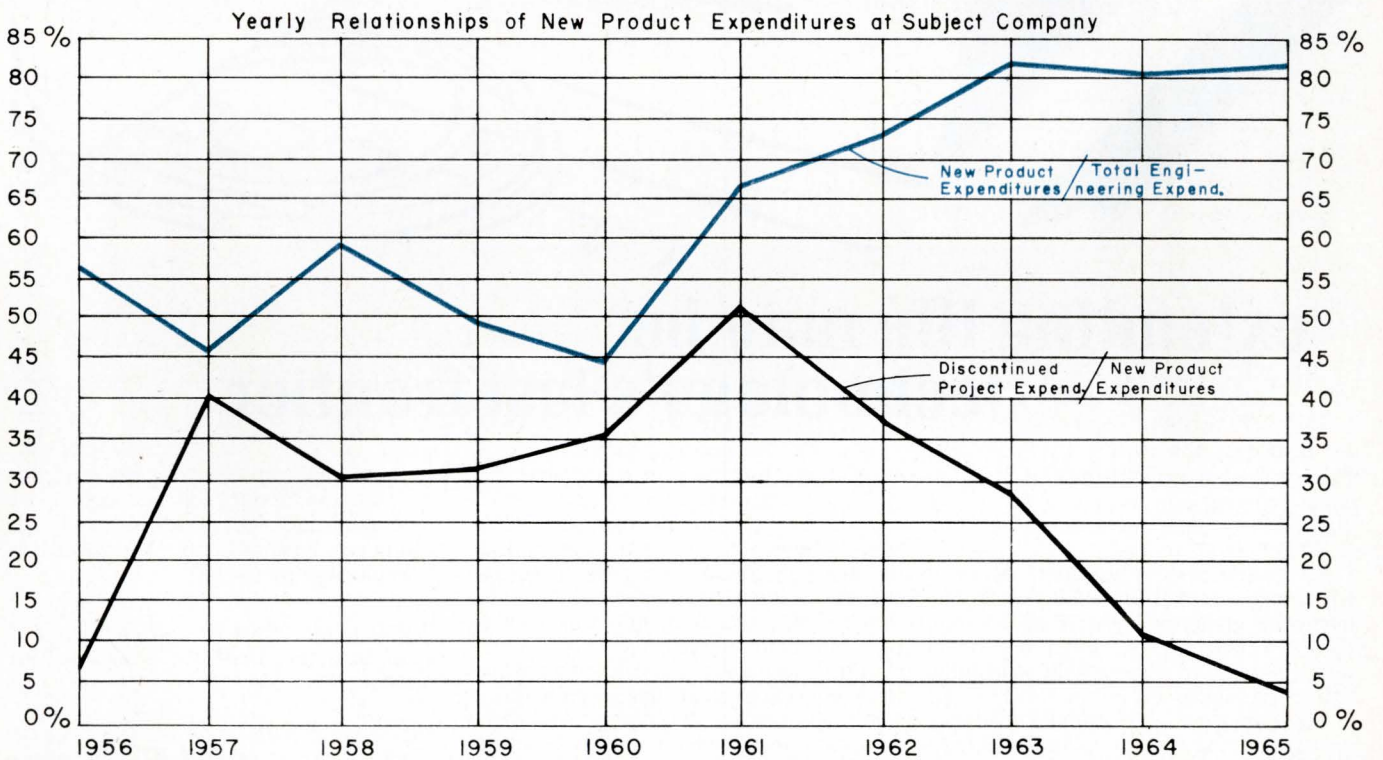
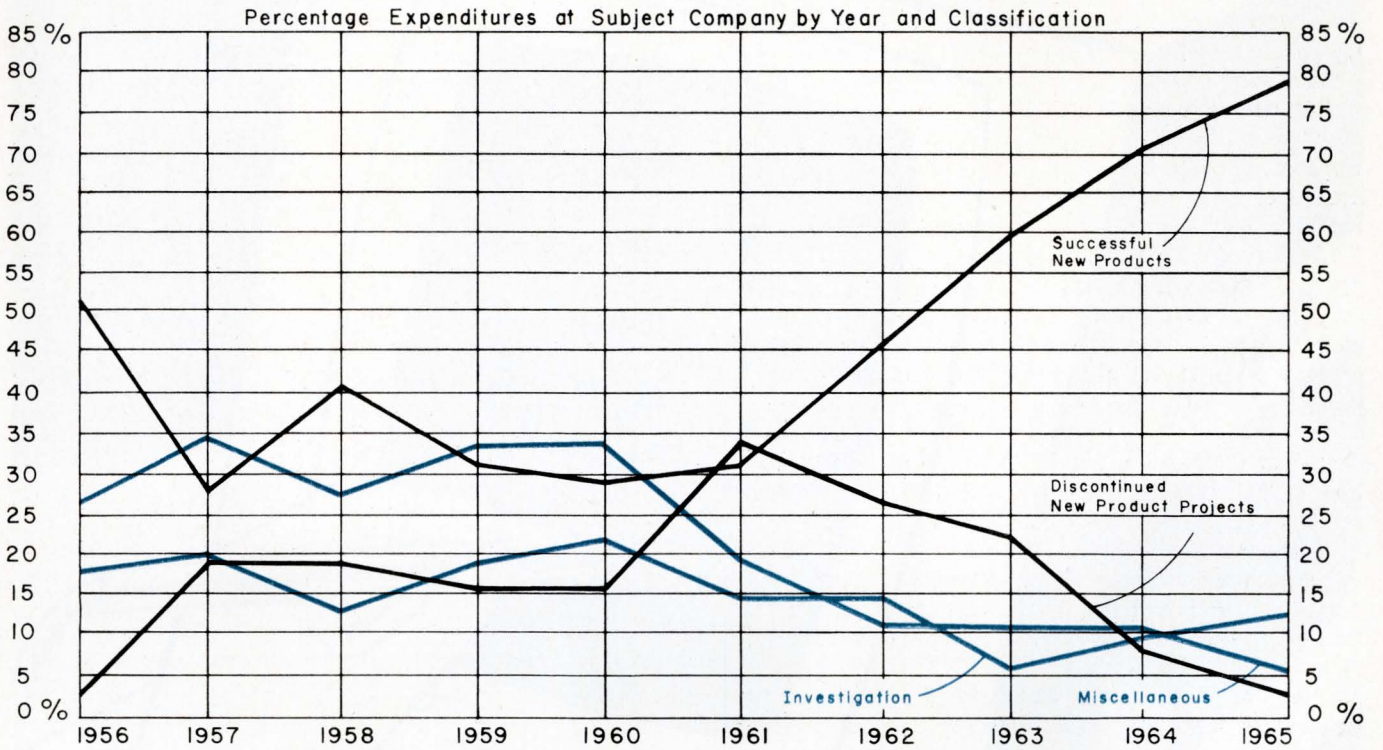

Tables I and II

from the various managers on each given project. In other words, although projects had been stopped after tens of thousands of dollars had been spent, the individuals involved did not agree on the reason.

Second, in almost all cases the factors could have

been estimated during any portion of the program. The factors were generally internally controllable, or at least observable. The factor of projected volume, which is an external factor, was estimated only internally. The problem was not one of answers changing as a project

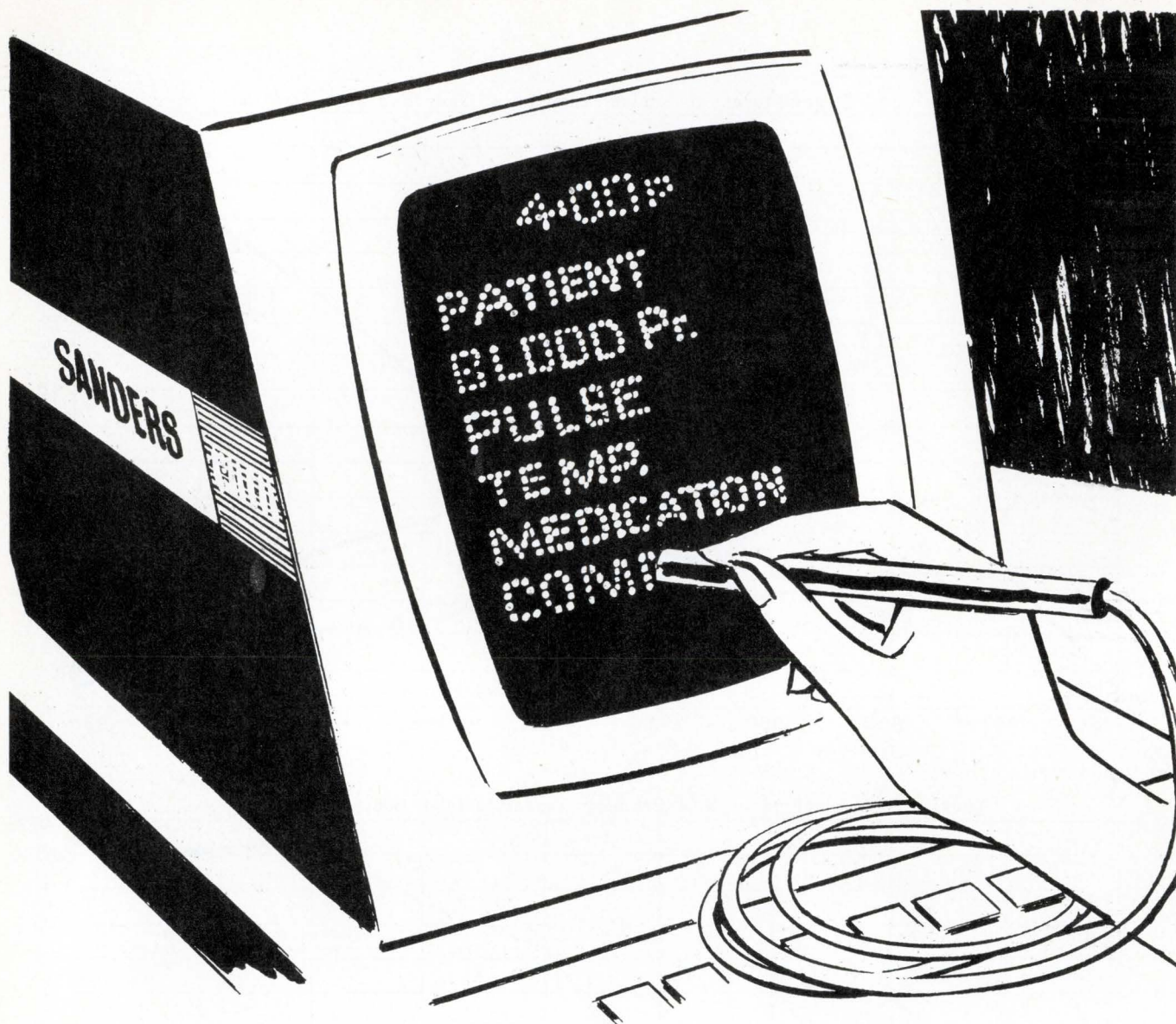

extending life may be technology's last frontier

The early feats of biomedical electronics, while bringing new hope to us all, have warned the system engineer that this battle is not like his others.

He usually designs a system so that it will survive as well as work. But in biomedical engineering he confronts a failing system faulty in its design and must resign himself to a piecemeal remedying of imperfections.

And that's where the ultimate challenge may rise: learn enough about heredity to keep its risks within acceptable limits.

We believe that the best contributions of system engineering are yet to be made,

that what has been accomplished has been practice for what lies ahead.

Sanders intends to be a leader in bringing the disciplines of system engineering to bear on all its real opportunities—urban renewal, communication, safer streets, full employment, arms control, and international security.

That's why we stress continuing education, offering graduate degree programs in our facilities and fellowships at nearby universities. We have found no substitute for formal training in the engineering of advanced systems.

Tell us how you would take advantage

of these opportunities. You will find this an encouraging atmosphere: engineering innovation is a way of life, systems are everyone's business, and the individual is the contributor.

WRITE to Mr. James L. Hackbush, Sanders Associates, Inc., Dept. 467EE, 95 Canal St., Nashua, N.H. 03060.

SYSTEM ENGINEERS • ECM ENGINEERS • ASW ENGINEERS • DIGITAL ENGINEERS • ANTENNA ENGINEERS • MICROWAVE ENGINEERS

CREATING NEW DIRECTIONS IN ELECTRONICS

SA  **SANDERS ASSOCIATES, INC.**

* T. H. SANDERS ASSOCIATES, INC.
An Equal Opportunity and Affirmative Action Employer M/F

NASHUA, N.H. MANCHESTER, N.H. BEDFORD, MASS. CAMBRIDGE, MASS. PORTLAND, ME. PLAINVIEW, L.I., N.Y. RESTON, VA.

Product management (continued)

progressed, but that the questions were not asked. The lack of agreement among the managers on reasons for project failure substantiates this observation.

Third, the factors causing failure generally were economic. The company had no formal requirement for economic analysis before the tooling analysis, and the tooling analysis was not officially required until most of the engineering was complete. It was possible, therefore, to spend \$30,000 in engineering, and then stop a project because the economics involved would not justify a \$3000 expenditure in capital tooling. The complexity of the tooling analysis tended to discourage its use during the earlier stages of engineering.

The factor of change in priority or interest is more difficult to define; however, in 10 of the 11 cases where priority was listed as a factor, at least one of the economic reasons was also listed. A correlation between low priority and insufficient economic justification appears to exist. It is unlikely that a project with proven high profit potential would decline in interest to the point of being dropped.

Drawing from the data collected from the subject company, I recommend the following:

- 1) Have all individuals involved clearly set down divisional goals relating to new products.
- 2) Define a formalized procedure for new product engineering to insure that the proper information is available at the proper time. Have some method of exempting a certain percentage of applied research projects from this procedure. The formalized procedure should include the following provisions:
 - a) An initial proposal which would include unit cost goals and projected sales volume, as well as tentative product specifications and engineering time tables.
 - b) Some method of periodical review of the proposal and specifications, including revised cost figures.
 - c) Specific responsibility assigned to insure that the steps in the procedure are followed.
 - d) Responsibility defined for final decisions relating to new products.

Does a new product system spell success?

The question to answer, then, is: Does a more formal procedure work towards success without affecting the morale of the technical staff? Unlike the subject company, which like most other firms lacks or only pays lip service to a formal procedure, Hewlett-Packard Co. uses such a new product system with great success. David Packard, while Chairman of the Board of Hewlett-Packard, presented an address before the 13th International Management Congress in New York City on September 19, 1963, where he indicated that such a procedure does work. A segment of that speech, titled

"Making Maximum Utilization of Corporate Resources," follows:

"Studies have indicated that of all the new product projects initiated by industry, only a very small percentage is ultimately successful. Thus, while more successful new products would probably result from an increase in total new product development effort, there appears to be considerable room for improvement in the results which can be achieved with the present level of effort.

"Yet many successful companies achieve excellent success from their research and development expenditure. Crawford Greenewalt, reporting as board chairman of the du Pont Company, stated that for every dollar they spend in the laboratories on research and development, they have sooner or later spent three dollars for new plants and processes to produce the products they have developed. And the growth and profitability of du Pont is a magnificent tribute to the efficiency and success of their new product program.

"The growth, and I believe the profitability of our company, is the direct result of our new product effort, and so a word about our program may be of interest.

"Our sales in 1962 were \$109 million, over half of which came from new products developed since 1957. On a corporate-wide basis, for every dollar spent on new product development, five dollars in profits before taxes have been generated, and in addition, the dollar spent on research and development has been recovered.

"Without question, the most important step in a new product program is the initial selection of the project to be undertaken. No company has unlimited resources in either money or manpower, and it is mandatory that the resources available be applied to the projects most likely to be successful. Toward this end certain guiding policies have been adopted, and a specific procedure has been followed.

"Since the character of a company tomorrow is determined by the product it is developing today, and since we intend to remain exclusively in the field of electronic instrumentation, all new product projects are limited to this field. We often encounter new ideas in our laboratories which could be the basis of other products, but since our manufacturing and marketing capabilities are directed toward instrumentation, we limit our new product development to this field. One would think such a policy would be obvious, but many concerns fail to coordinate their new product programs with rational overall corporate objectives, and end up with good products, but no manufacturing or marketing capability to exploit the products.

"We have found from experience that the new products with the largest measure of innovation are most successful. In other words, when a competitor is well established in a market—even a very attractive market—it is difficult to achieve a satisfactory market position unless the new product is in itself an important contribution to the art of measurement.

"These guidelines stem from overall corporate policy and provide broad objectives which each new product

Component Engineers and Physicists

For:
Application • Design
Reliability • Evaluation
Failure Analysis
Phenomena Studies

The Components and Materials Laboratory of Hughes Aircraft Company in Southern California has immediate needs for Engineers and Physicists to fill challenging, permanent positions in the following fields:

Microelectronics Engineers. To evaluate integrated and hybrid devices, analyze failure modes, investigate effects of environments and materials on device characteristics and determine application criteria.

Component Engineers. Will coordinate component-equipment requirements, provide technical consultation, select vendors, determine evaluation programs and initiate procurement documentation.

Component Application Engineers. Will provide technical consultation and liaison to design activities, assist in selection and application

of component parts and participate in design reviews.

Magnetic Designers. To design static magnetic components, develop new magnetic devices, initiate evaluation tests, investigate and apply new design concepts.

Reliability Engineers. To coordinate reliability programs, conduct component failure analyses, define and direct experiments, establish mathematical models and investigate component performance.

Physicists. Will investigate component performance, analyze failure mechanisms, conduct phenomena studies and experiments.

Component Development Engineers. To develop components using advanced techniques, investigate new design concepts, study component phenomena, direct experiments and design evaluations.

Supervisors. In addition to requirements for both junior and senior engineers for these positions, several supervisory openings are available.

Requirements. BS, MS or PhD degree in Physics or in Electrical/Mechanical Engineering. (Openings are also available for non-degreed engineering personnel.) Assignments are available in the following and associated technical fields:

Microelectronics • Electron Tubes • Potentiometers • Connectors • Microwave • Capacitors • Crystals • Relays • Instruments • Mechanical • Filters • Motors • Semiconductors • Resistors • Switches • Reactors • Resolvers • Transformers.

U. S. Citizenship Is Required

For immediate consideration, please airmail your resume to:

Mr. Robert A. Martin
Head of Employment
Dept. 56
11940 W. Jefferson Blvd.
Culver City, Calif. 90230



An equal opportunity
employer — M & F



An EE gets ahead

The story of David Packard is well known to most electronic engineers. How he and William Hewlett started out in a garage in 1939 with \$539. How their technical skill and their approach to management enabled them to build Hewlett-Packard into a \$300-million-a-year business.

The reasons for Packard's success at H-P are no doubt the very reasons why President Nixon and Secretary Laird chose him for the job of Deputy Secretary of Defense—the No. 2 spot in the Defense Department.

In assessing his own capabilities for the post, Mr. Packard remarks, "It's a little embarrassing for me to talk about what I can do . . . I am going to have the job of administering the Pentagon which is a very large organization, but I don't see that the management principles involved in an organization that size are necessarily any different from the management principles applied to any other organization." These management principles, including the ones dealing with new products that he outlines below, are generally considered a prime factor for H-P being one of the largest electronic instrument manufacturers in the world.

Product management (concluded)

project must meet. The proposed product must be in the field of electronic instrumentation, and it must, if possible, bring some new contribution to the field—not be just a copy of something someone else has already done. But, in addition to these general objectives, we need to provide specific guidance for the project.

"Each new product project is carefully investigated by marketing and manufacturing people before it is approved. Often exploratory research in the laboratory is necessary to evaluate the technical feasibility of the idea; but before substantial resources are committed, a well-defined procedure is followed.

"First, the marketing and the technical people, working together, prepare a tentative specification for the proposed product. Usually, the proposed product is discussed with potential customers for their reaction. The marketing people then prepare a five-year forecast of sales volume. From this, an estimate of five years' profit is made. The research and development people prepare a time schedule for the development and estimate the cost—including production engineering and tooling. The ratio between estimated five-year profit

and estimated development cost then becomes a figure of merit for that project. With a figure of merit thus calculated for each proposed project, we have a fair method of comparing projects and selecting the most attractive for development.

"The detailed specifications of the proposed project and the figure of merit calculations provide a very specific objective for the project. These provide guidance toward what the product will be, what it will cost, what will be the volume, and what will be the resulting profit. These specific objectives are kept before the development team throughout the course of development."

In the final analysis

The results of the study described, and the comments of David Packard, indicate that a carefully established new product system, as opposed to a system based on intuition, will save much effort, time, money, and valuable engineering talent. More effort can then be applied towards successful projects, or to legitimate basic research endeavors.

INFORMATION RETRIEVAL
Project management, Careers

Check out your opportunities

In minutes, Conductron Ground Support Equipment can check out the electronic systems of most commercial or military jet aircraft.

In minutes, you can check out our excellent career opportunities in electronics.

Engineers and technicians can begin a new career — and a lasting one — in these areas: **Logic and circuit design • Electrical and electronic systems • Math modeling • Scientific programming • Aerodynamics • Reliability and maintainability engineering • Communications • Optics • Mechanical and manufacturing engineering • Microcircuitry • Value engineering • Environmental testing.**

Send us your resume today. Write: Mr. D. H. Besgrove, Professional Employment, Conductron Corporation, P.O. Box 426, St. Charles, (near St. Louis), Mo. 63301

CONDUCTRON CORPORATION



An equal opportunity employer

Welcome! In this new column we say "hello" to new companies or new divisions in the electronics industry, and let you know a little about their products. For more information, circle the appropriate numbers on the reader service card.

IC tester tryout. "The problem is to get people to believe that you exist and can deliver a product," says Ronald J. Portugal, president of newly-formed E & L Instruments, Inc., Derby, Conn. This electronic instrument manufacturer does have a product to sell—two, in fact, with others in the planning stage.

The first is a diode-transistor-logic (DTL) integrated circuit tester that sells for about \$850. This portable, automatic unit performs dynamic functional tests on the popular 930 Series modules, and can also test those TTL and other ICs that have pinouts corresponding to the 930 types.

The Model 714 will check such faults as improper logical operations, shorts, and open and parasitic diode connection between pins. It will also test flip-flop toggle frequency, gate operating frequency, fan-in and fan-out.

Another product for the IC user is the company's Dynamic Breadboard. It contains in one 4¼ x 11 x 15 in. cabinet all the components needed to assemble and test blocks of logic. Its built-in power supply and pulse generator let the engineer test his design with respect to frequency and pulse width variation, as well as power supply sensitivity. It also features built-in indicator lamps and built-in volt and amp meters.

Interconnections between elements and components on the breadboard are made without the use of patch cords. All you need are a roll of #22 hook-up wire and wire strippers. The breadboard sells for about \$650 with 30-day delivery.

E&L's president feels that the future of the instrumentation industry lies on the periphery of electronics, and is extremely interested in the medical area. The firm has already built a signal analyzer for a doctor at Yale, as well as some low-priced medical devices. Says Portugal, "If you can only learn to work with doctors and develop rapport with them, you can make money and do something useful."

Packaging specialist John Pfeifer, the young vice president, hopes E&L will be able to solve the M.D.-vs-

For Capacitors with **GREATER RELIABILITY** . . .

Choose

EL-Menco

The Capacitors You Find Wherever There's Electronics!

EL-MENCO DUR-MICA CAPACITORS

Only 1 Failure Per 43,000,000 Unit-Hours!

- It has been computed that "debugged" DM30, 10,000 MMF units, when subjected to 257,000 hours of life at 85°C with 100% of the rated DC voltage applied, will yield only 1 FAILURE PER 43,000,000 UNIT-HOURS!
- DM15, DM16, DM19, DM20 . . . perfect for miniaturization and for new designs using printed wiring circuits. Also available in DM30, DM42 and DM43.
- New "hairpin" parallel leads insure easy application.
- Exceed all electrical requirements of military specification MIL-C-5A.

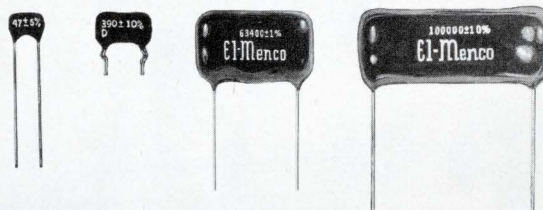

EL-MENCO TRIMMERS & PADDERS

Design Versatility!

- Available in 350 VDC and 500 VDC as well as other test voltages.
- All bases are of low-loss steatite.
- Special lugs are obtainable for printed circuitry.
- Miniature units are available.
- Solder Lugs can be bent in any position without affecting the capacity setting due to the rigid construction.
- Various types of mounting brackets are available for all trimmers.
- Units can be constructed for special applications.

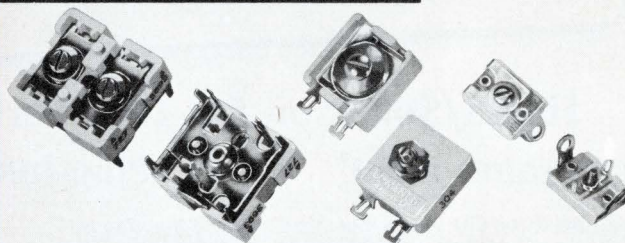

EL-MENCO *MYLAR-PAPER DIPPED CAPACITORS

Only 1 Failure in 7,168,000 Unit-Hours!

- Life tests at 100°C with rated voltage applied have yielding only 1 FAILURE PER 716,800 UNIT-HOURS for 1 MFD. Since the number of unit-hours of these capacitors is inversely proportional to the capacitance, 0.1 MFD Mylar-Paper Dipped capacitors will yield only 1 FAILURE PER 7,168,000 UNIT-HOURS!
 - Working volts DC: 200, 400, 600, 1000 and 1600.
 - Durez phenolic resin impregnated.
 - Tolerances: $\pm 10\%$ and $\pm 20\%$ (closer tolerances available).
 - Dielectric strength: 2 or 2½ times rated voltage, depending upon working voltage.
 - Exceed all electrical requirements of E.I.A. specification RS-164 and military specifications MIL-C-91A and MIL-C-25A.
- *Registered Trademark of DuPont Co.

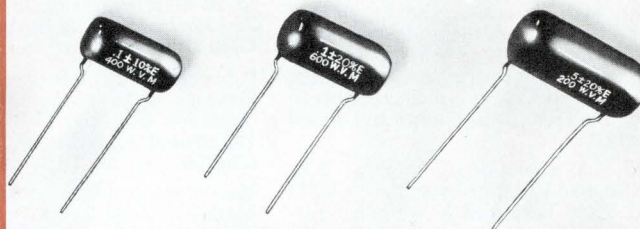

EL-MENCO MOLDED MICA CAPACITORS

Superior Performance!

- Unmatched for excellent stability, dielectric strength, high insulation resistance, extremely high "Q" and correspondingly low power factor.
- Units can be subjected to a short "debugging" life test at elevated voltage and temperature for removal of early life failures and for improved reliability.

Write for Free Samples and Booklets on Any of The Above Capacitors

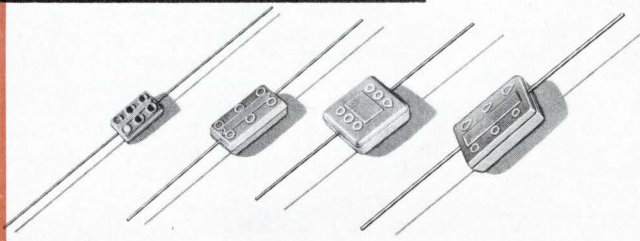

THE ELECTRO MOTIVE MFG. CO., INC.

WILLIMANTIC, CONNECTICUT 06226

Dipped Mica • Molded Mica • Silvered Mica Films • Mica Trimmers & Padders
Mylar-Paper Dipped • Paper Dipped • Mylar Dipped • Tubular Paper

West Coast Manufacturers contact: COLLINS & HYDE CO., 900 N. San Antonio Rd., Los Altos, California 94022
5380 Whittier Blvd., Los Angeles, California 90022

ALSO SOLD NATIONALLY THROUGH ELECTRONIC PARTS DISTRIBUTORS

a double gun 15 MHz Scope for \$774*

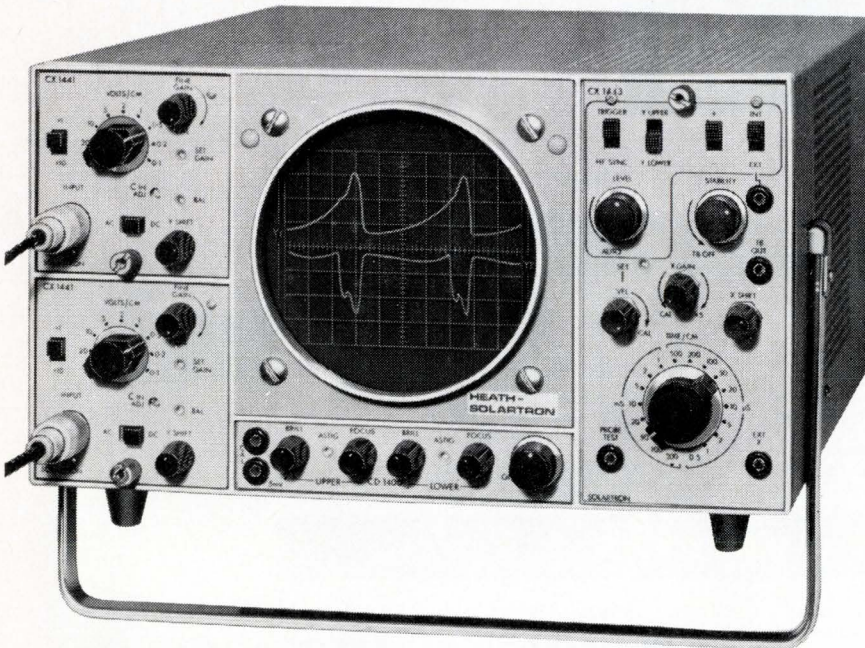

Heath/Solartron CD-1400 Series

Main Frame \$450*

Plug-Ins \$91* up

The Heath/Solartron CD-1400 is more than a portable, general-purpose, true dual-beam oscilloscope: it is a fully modular system of vertical amplifiers and time bases to fill your measuring requirements with unmatched flexibility. The 5" CRT, coated with P31 phosphor, operates at 4 kV to give you high resolution and bright displays. Viewing area of the graticule is 8 by 10 cm. Separate gun assemblies, positioned vertically to minimize geometric distortion, have separate focus and brilliance controls. Available in factory assembled and tested form only.

The CD-1400 shown above with two CX-1441 Wide-Band Amplifiers and a CX-1443 General Time Base and X Amplifier features:

- DC to 15 MHz bandwidth
- 24 ns rise time
- 9 sensitivity ranges from 100 mV/cm to 50 V/cm (10mV/cm, DC to 750 kHz with switched x10 gain)
- 18 calibrated sweep ranges from 0.5 us/cm to 200 ms/cm in a 5, 2, 1 sequence (a continuous uncalibrated coverage up to 500 ms/cm gives a 5 s sweep)

- $\pm 5\%$ accuracy
- x1 to x5 expansion
- Int, Ext, +, -, Normal, Auto, HF Sync Trigger Modes . . . all for just \$774

A sensitivity of 100 uV/cm is available up to 20 kHz, increasing to 1 mV/cm up to 75 kHz by plugging in the CX-1442 High Gain Differential Amplifier.

High frequency low level signals in the presence of large in-phase signals can be displayed with the CX-1449 Wide Band Differential Amplifier featuring 10 mV/cm sensitivity on the DC-10 MHz bandwidth.

Variable sweep delay to 100 ms is provided on the CX-1444 Sweep Delay Time Base.

DC external trigger, DC coupled X input and Single Shot are available on the CX-1448 Wide Range Time Base which has 20 ranges from 0.5 us/cm to 1 s/cm extendable to a 25 s sweep.

The modular design of the CD-1400 system protects it against obsolescence and gives greater measurement capability customized to your needs at an unassuming price: the main frame costs only \$450, plug-ins start at \$91.

EE WELCOME

B.S.E.E. communication problem and be able to provide "just what the doctor wants." He offers, "Electronic equipment must be designed to speak the doctor's language. No matter how simple a thing is, if a guy needs it, find out what it is and design it to meet the need as cheaply as possible."

Circle 352 on Inquiry Card

Similar name, different company.

Shallco, Inc., a new company that makes audio and rf attenuators and delay lines, has created some confusion in electronic circles. The firm's president, John S. Shallcross, formed the company after leaving Shallcross Manufacturing Co. (now a subsidiary of Cutler-Hammer) which his father had founded. To further complicate matters, Shallco (based in Smithfield, N.C.) is only five miles away from Shallcross.

Upon leaving his former firm, John Shallcross purchased that company's drawings, designs, and tooling for its attenuators and delay lines. At Shallco they are prepared to supply all former Shallcross types in addition to a newly designed group of audio attenuators.

Shallcross will continue to manufacture its well-known line of wire-wound resistors and rotary switches.

Circle 353 on Inquiry Card

MIC facility makes debut. Sage Laboratories, Natick, Mass., has installed a new microwave integrated circuit facility. It can vacuum-deposit on a variety of substrates and photoetch thin film components, stripline and microstrip circuits on copper-clad dielectrics such as Teflon fiberglass, Polyolefins, PPO, and so forth.

Although Sage has been making microwave ICs on a contract basis, it has not produced any catalog items. By March 1969, however, it will have a catalog line of microwave IC devices. These will include a group of terminations, a group of attenuators, and two different types of couplers. Also in the works are a line of power dividers and a line of mixers.

Circle 354 on Inquiry Card

Thick film firm. HEI Incorporated, a firm specializing in thick film circuits, has been formed. Photo-sensing arrays are its first standard proprietary product. The company also does custom electronic R&D and electronic assembly.

The Chaska, Minn., firm is also working on complete light sensing functions—amplifiers combined with sensing circuits—and is making custom circuits for the hearing aid industry.

Circle 355 on Inquiry Card

<p>For more information send for the NEW HEATH Scientific Instrumentation Catalog</p>		<p>HEATH COMPANY, Dept. 520-25 Benton Harbor, Michigan 49022</p>
	<p><input type="checkbox"/> Please Send Free New Scientific Instrumentation Catalog</p> <p>Name _____</p> <p>Company _____</p> <p>City _____ State _____ Zip _____</p> <p>Prices & specifications subject to change without notice. *Mail order prices; F.O.B. factory.</p>	
		TE-196

Philbrick/Nexus DC log amplifier— a slip stick in 2.65 cubic inches

Quicker than you can operate your favorite slide rule, Model 4350 Log Amplifier will calculate the logarithm of a positive voltage or current, or solve the positive antilog of an input voltage. Model 4351 performs the same functions on negative voltage or current.

The combination of two Philbrick/Nexus log amplifiers multiplies and divides. Add scaling resistors and you can compute arbitrarily selected powers and roots. Units are fully temperature compensated for use over wide temperature ranges.

Units are fully encapsulated and measure 1.4" x 2.7" x .7". They feature fast response and a wide 6-decade dynamic range. Priced well below competition at only \$95. Contact your Philbrick/Nexus sales representative for complete details and specifications. Or write, Philbrick/Nexus Research, 67 Allied Drive at Route 128, Dedham, Mass.

World leader in operational amplifiers



PHILBRICK/NEXUS RESEARCH

A TELEDYNE COMPANY

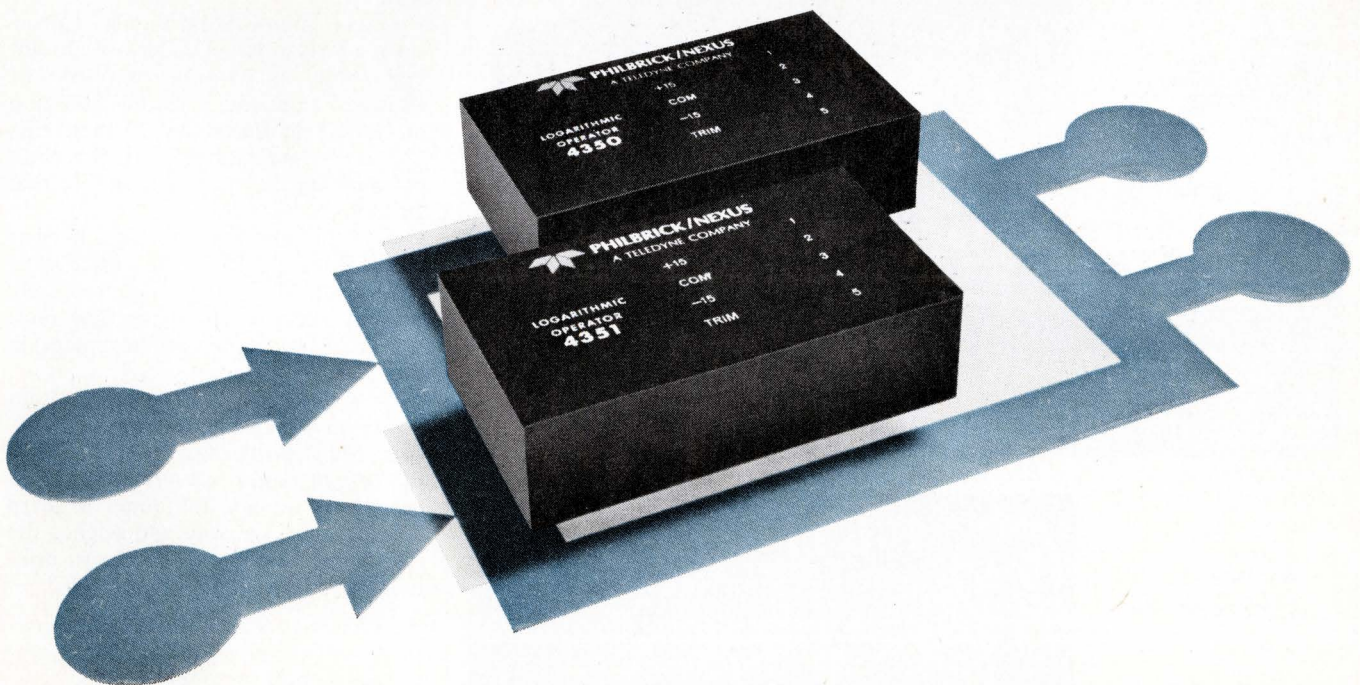



ELDORADO

THE LEADER IN NANOSECOND
AND FREQUENCY COUNTERS



200 Series
Crystal Time Base
Display Storage
Panel Mount
100 kHz: 4 digit \$325
15 MHz: 5 digit \$395
1 μ s Time Interval: \$395

1600 Series
Counter/Timers
with Display Storage
25 MHz: 5 digit \$ 550
25 MHz: 7 digit \$ 650
200 MHz: 6 digit \$1,050
200 MHz: 8 digit \$1,250
500 MHz: 8 digit \$1,650

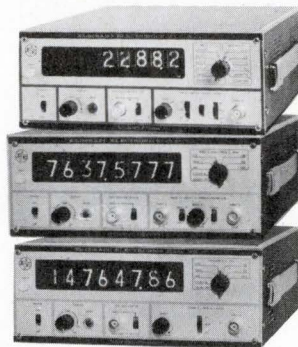

1400 Series
Universal Counter/Timers
15 MHz \$ 950
Preset \$1,050
150 MHz \$1,450
500 MHz \$1,825

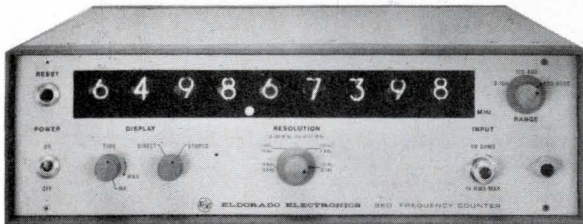

900 Series
Microwave Frequency Counters
Fast Sample, Optional Offsets
Remote Programming
6.5 GHz: 7 digit \$4,250

600 Series
Digital Delay Generator
Remote Programming
500 kHz Rep Rate
10ns Steps \$3,500
1ns Steps \$4,500

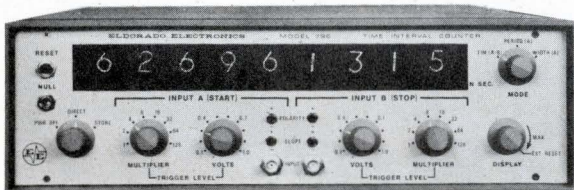
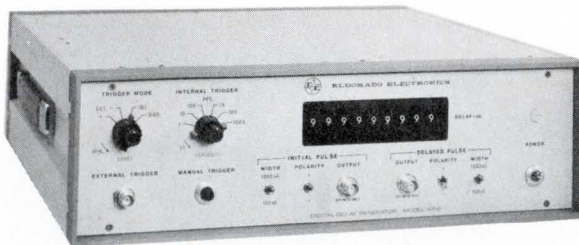

700 Series
Time Interval Counter
Full Input Conditioning
TIM, Period, Width,
Rise Time
1ns \$6,500
10ns \$1,750

Send for
Free Catalog



ELDORADO

601 Chalomar Road
Concord, California U.S.A.
(415) 686-4200

EEs GET AHEAD

"Beam-leading is a sensible new technology."



Dr. Barry G. Cohen

"I'm here for one purpose only—to produce a saleable line of reliable microwave semiconductor devices," says Dr. Barry Cohen, recently-appointed director of Solitron's Microwave Semiconductor division. This New York-based (Long Island City) firm will soon be introducing an improved line of microwave devices, including Schottky diodes, mixers/detectors, and noise sources.

The company also plans to produce these diodes in beam-leaded form. "Beam-leading is a sensible new technology," notes the new director. "In the future the bulk of microwave systems will use beam-leaded diodes." Included in Solitron's plans is a line of beam-leaded passive components compatible to its active devices.

Apart from this, the firm also intends to develop such products as microwave oscillators and Impatt diodes.

Before joining Solitron, Dr. Cohen spent a year in Israel under a Fulbright Fellowship as visiting professor of electrical engineering at the Technion in Haifa. He notes that "Israeli EEs are very Americanized in their technical thinking, but not in their business attitudes."

At Bell Labs for 10 years, he was one of a team of three that discovered the Impatt effect in p-n junctions. He refers to Impatt devices as "the most important microwave development in 30 years."

Dr. Cohen received his B.E.E. from Brown in 1951 and his Ph.D. in E.E. from Johns Hopkins in 1960, and feels the best managers are practicing engineers by training. "It's better to learn business the hard way and science the easier way," he says. "You learn business by doing—not by watching."

Take the heat off miniaturization.

New Du Pont technical bulletins tell how Freon* Dielectric Coolants eliminate heat problems in the most compact electronic assemblies.

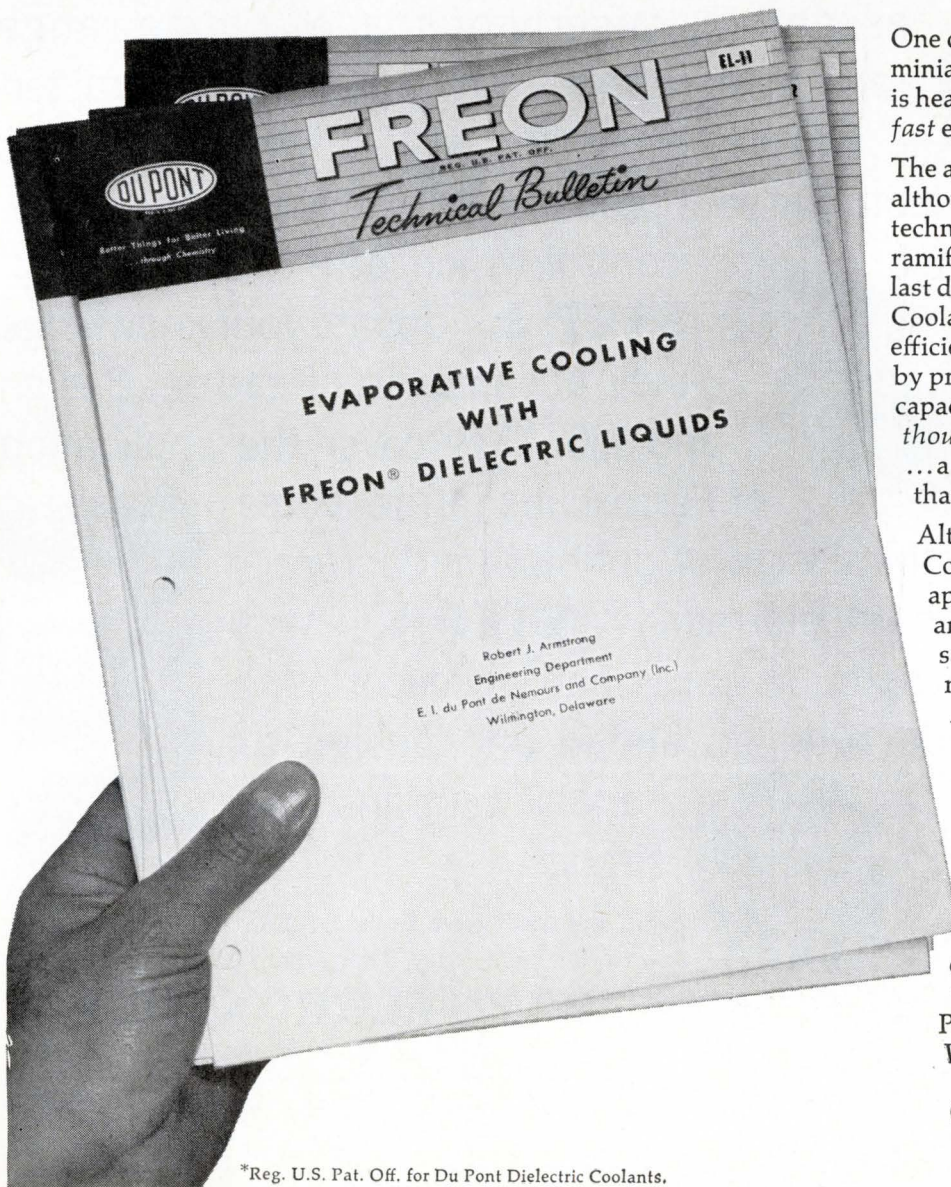

One of the big problems in miniaturization, as you're well aware, is heat: How to get rid of *enough* of it *fast* enough.

The answer is now quite simple, although it takes several Du Pont technical bulletins to explain all the ramifications. These bulletins tell to the last detail how FREON Dielectric Coolants offer the fastest, most efficient method of transferring heat... by providing the greatest cooling capacity per unit of volume. Up to a *thousand times* more effective than air... a *hundred times* more effective than oil.

Although each FREON Dielectric Coolant is formulated for specific applications, they are all chemically and thermally stable. They are all safe, being nonflammable, nonexplosive and low in toxicity. And all have high dielectric strength and resistivity and low dielectric loss.

Find out now how FREON Dielectric Coolants can help you design components and circuitry that are smaller, smaller and smaller. For your complete set of technical bulletins, write on your letterhead to Du Pont, FREON Products Division, Room 7258, Wilmington, Del. 19898.



*Reg. U.S. Pat. Off. for Du Pont Dielectric Coolants.

How to save money and avoid headaches in transformer and inductor design.

STEP 1. Mental attitude is important. Don't think you have to use laminated metal cores just because Steinmetz did. He didn't know about ferrite cores. **STEP 2.** Reflect on the advantages of ferrite cores: self-shielding for complete packaging freedom... easy to wind and assemble, miserly of space... wide range of standard sizes, shapes and magnetic characteristics... two-way economy of manufacturing your product—lower direct costs and indirect savings in tight tolerance control, which often “unburdens” associated circuitry. **STEP 3.** Update your knowledge of ferrite cores and their advantages. Read our Design Manuals 220 and 330. They cover the application of Ferroxcube ferrite cores to the design of optimum inductors and transformers. **STEP 4.** With Ferroxcube cores and accessories, a pad and a slide rule, go ahead and design all manner of pulse, HF and power transformers, filters and tuned circuits.

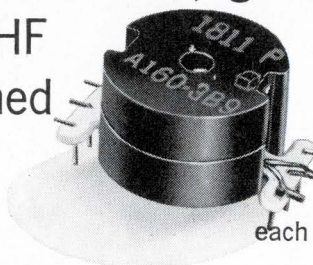
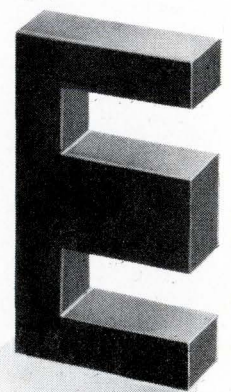
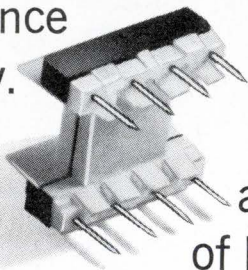
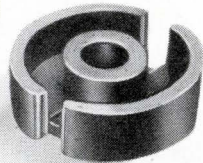
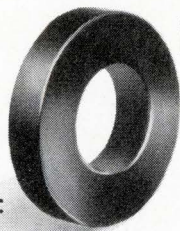

If you don't have Bulletins 220 and 330 (Step 3), write for them today. They'll help you breeze through each of the other stages. **FERROXCUBE** 

Atlanta—Cartwright & Bean, (404) 237-2273; Baltimore—Eastern Components, (301) 322-1412; *Burbank, Cal.—(213) 849-6631; Columbus, Ohio—Mulligan & Mathias, (614) 486-2976; *Dallas—Gillett Industries, (214) 363-0107; Fayetteville, N.Y.—R. P. Kennedy Co., (315) 637-9531; Huntsville, Ala.—Cartwright & Bean, (205) 852-7670; Hyde Park, N.Y.—R. P. Kennedy Co., (914) 229-2269; Littleton, Col.—Wm. J. Purdy Agents, (303) 794-4283; Minneapolis—(612) 920-1830; *New York—Kahgan Sales, (516) 538-2300; *Northlake, Ill.—(312) 261-7880; No. Miami Beach—Cartwright & Bean, (305) 945-2962; Orlando—Cartwright & Bean, (305) 425-8284; Ormond Beach, Fla.—Cartwright & Bean, (904) 677-3480; *Philadelphia—Eastern Components, (215) 327-6262; Phoenix—(602) 264-3129; Rochester, N.Y.—R. P. Kennedy Co., (716) 271-6322; *San Francisco—Wm. J. Purdy Agents, (415) 347-7701; Saugerties, N.Y.—(914) 246-2811; Union, N.J.—(201) 964-1844; *Waltham, Mass.—(617) 899-3110; Winston Salem—(919) 725-6306; *Woodstock, N.Y.—Elna Ferrite Labs, (914) 679-2497; *Toronto, Ont.—Philips Electron Devices, Ltd. (416) 425-5161. *Denotes stocking distributor.

Diode rf sources: combine them for high power

Single-diode rf sources often have insufficient power outputs. For higher power levels, you can combine a number of diodes so that their outputs add together. Here's how to do it.

Dr. A. I. Zverev, Consulting Engr., Radar Systems
Westinghouse Electric Corp., Baltimore, Md.

You can relieve the power limitations of single-diode microwave rf sources by combining the power outputs of many similar diodes. To be effective, such *arrays* must meet certain basic conditions:

- The individual signals must be in the same phase, to properly add together.
- The total combination of diodes must operate at a useful impedance level.
- Each diode must run at its maximum power capability.
- There must be adequate heat-sinking to dissipate diode-generated heat.

Figure 1a shows a well known method of power combination. Each diode circuit is complete in itself, and feeds one input of a hybrid junction. The output of the hybrid is, of course, the sum total of all the inputs (less the loss of the hybrid).

A great advantage of such a circuit is that if you lose the power output of one circuit, the others are still at work, and the hybrid junction isolates the malfunctioning circuit. But the overwhelming disadvantage of this method is that it gives you circuits that are too large to be practicable, when you combine more than just a few diodes.

Another approach is to stack a number of diode chips in a single package. But for large power outputs, you have the problem of uniformly distributing the power among the constituent diodes. Figure 1b shows how the components are mounted in a rod-like structure within the package. You can see that you have another problem in removing relatively large amounts of heat from a small physical volume.

Semiconductor rf power sources promise size, weight, and cost reductions for microwave equipment, as well as higher reliability. Diode structures in particular, such as step-recovery and varactor devices, already are widely used.

With such semiconductors, however, you often cannot get enough power from a single device. So you combine diodes in an attempt to raise the power output level of your equipment. And here is where your troubles begin. For you just cannot simply "wire together" a number of rf sources and hope that you'll get what you're after. If you do, the chances are good that you will waste your time and money, as well as the device's capabilities.

Among the factors you must consider in the design of an array are phasing, impedance levels, and heat dissipation. In this article, Dr. Zverev appraises several diode array configurations in the light of these factors. With such information, you can make an intelligent decision as to which array best suits your application.

Yet a third way to combine diodes is to array them with spacings of one-half wavelength (or multiples thereof) between them. Figure 1c shows such a configuration. Besides leading to physically large structures, this method has a frequency-sensitivity problem. If you shift frequency, the connecting lines are no longer a half-wavelength long.

Finally, you can form an array of diodes on an equiphase surface of a TEM (transverse electric mode) transmission line.¹ Figure 2 shows how you arrange the diodes in a series-parallel connection. Such an ar-

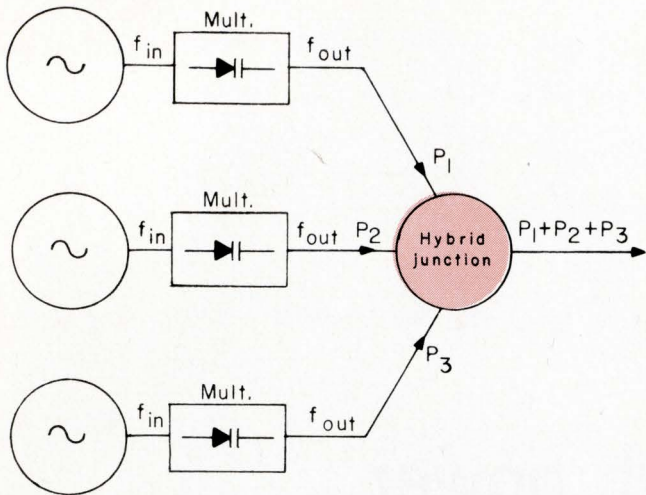

Fig. 1a. A hybrid junction is a common way to combine the power outputs of many sources. It gives you a single output from many inputs, and if one fails, the others still operate. A disadvantage of this method is that for many sources, the circuits become impractically large.

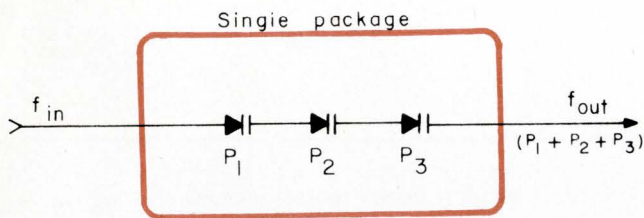

Fig. 1b. Stacking diode chips in series within a single package is another way to combine sources. The diode junctions must be larger than normal, in direct proportion to the number of stacked diodes. Power-handling capacity increases as the square of the number of stacked chips, but the total capacitance does not change.

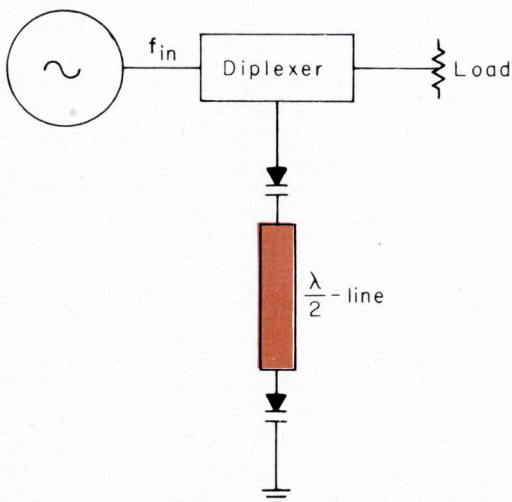

Fig. 1c. Half-wavelength transmission lines are yet another way to combine power sources. The lines space the diodes so that their power outputs are properly phased to add together. Besides leading to large structures, this method has a frequency-sensitivity problem: as the frequency changes, the lines depart from a half-wavelength.

angement lets you set desirable impedance levels for the individual diodes as well as for the TEM line. Since all the diodes are at the same electrical position with respect to any terminal-plane of the transmission line, there are no interdiode phasing problems. And they are distributed through a volume large enough to minimize the heat removal problem, but small enough so that you are able to use large numbers of diodes. Also, these structures are not particularly sensitive to frequency.

Stackpack varactors

Let's go back, for a moment, to the problem of stacking diodes. There is a way to do this that is practicable, but the diodes must be designed for the application. Suppose you connect two or three beryllia-packaged diodes in series, brazing them into a single unit. The rod-like structure puts the diodes in series electrically, but in parallel thermally. Diodes used in this way should have junction areas larger than normal. The increase in junction area corresponds exactly to the number of diodes to be series-connected. A three-diode stack, for example, has three-fold larger junctions and a total junction area nine times larger than a single conventional varactor.

These combination devices—called *stackpack varactors*—give you two benefits. First, the total power distributes itself over a comfortably large junction area. Second, the total capacitance does not change. Power handling capacity increases as the square of the number of chips used. And because you can maintain high impedance levels (through series-stacking), you do not need elaborate matching schemes. Breakdown voltage of individual junctions need not be increased to accommodate higher power, regardless of junction size.

You can also stack conventionally-sized chips to increase total varactor impedance. This is especially useful at lower frequencies, where circuit loss is the main factor in overall multiplier efficiency. For example, a three-diode stack of conventional chips can have an input impedance of 45- Ω , and handle three times the power of a single 15- Ω chip. This gives you modest power increases, but with substantially higher circuit efficiencies.

Stackpack diodes are suitable for high-power applications. For example, you can get 150 W at 750 MHz, at least 50 W at L-band, and 1.2 W min. at Ku-band.

Equi-phase stackpacks

You can devise several versions of the equi-phase surface approach mentioned earlier. A *spherical* version, using a conical transmission line, is essentially unlimited in the number of diodes it can hold. A *radial transmission line* can combine power from a large, but limited, number of diodes. Figure 3 shows a *coaxial line* version.¹ (Note that electrical access to all of these versions is by coaxial line.) It has three columns of diodes and is useable as a high-power doubler.

Each column consists of six diodes in series, and the columns are in parallel. This cylindrical array itself is in series with the center conductor of a 50- Ω coaxial-line assembly. Valves let the structure fill with a flowing dielectric cooling fluid. Thin copper disks between adjacent diodes in the same column deliver heat to the cooling fluid. The diode columns are widely spaced so that the coolant flows freely among them. The cavity's

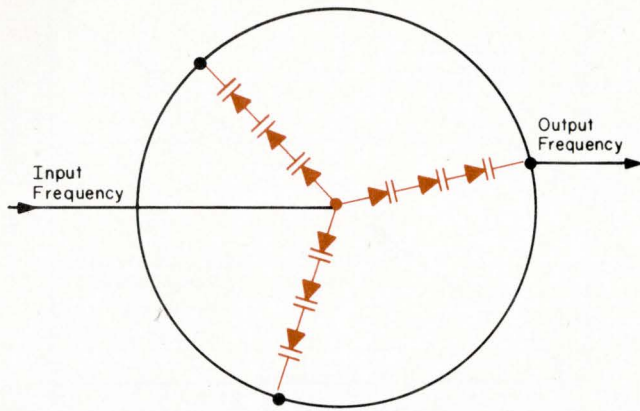

Fig. 2. An array of diodes on an equi-phase surface of a TEM transmission line. The series-parallel diode connection lets you set reasonable impedance levels. Heat removal is simple, and the structure isn't frequency-sensitive.

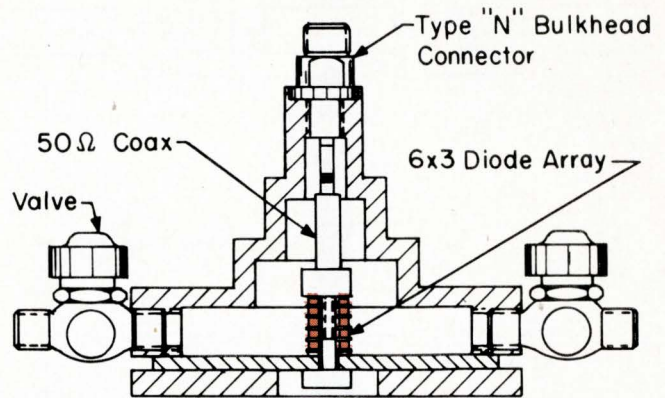

Fig. 3. This coaxial power-combiner has three columns of six diodes each. The columns are spaced 120° apart around the center conductor of the coaxial assembly. The diode array is 0.5 in. dia. x 0.5 in. long, and sits in a cavity 3 in. in diameter. It has 53% efficiency as a doubler from 0.5 to 1 GHz, with 40 W input power.

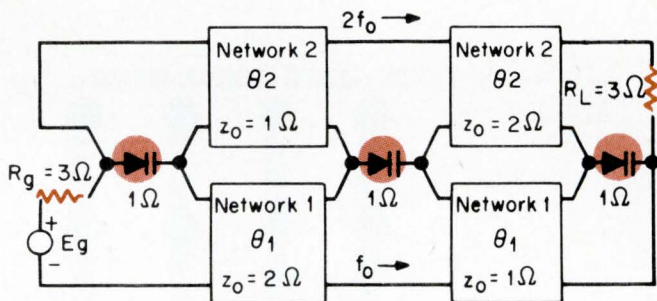

Fig. 4. This array can use any number of identical varactors. The three diodes shown here are operating in a parallel transmission mode. The input and output frequencies flow through separate networks, but in the same direction (from left to right). At the (doubled) output frequency, the three varactors appear as three sources in series.

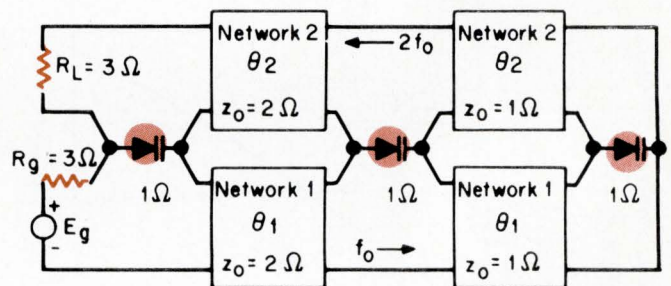

Fig. 5. Another version of the configuration of Fig. 4. These diodes operate in an antiparallel mode. Again, the input and output frequencies flow through separate networks, but this time in opposite directions. So the source and the load are at the same end of the array.

large size helps in cooling. It provides not only a reservoir for the coolant, but also a larger radiating surface.

At 1000 MHz, the array is 0.06 wavelengths long in the dielectric. This is short enough so that you can use lumped, rather than distributed, electrical parameters. Putting the cavity inductance and the diode impedances in series, you may consider that a uniform current flows through the cavity inductance and diode array. Further, the voltage across the array divides equally and in phase over each row of diodes (assuming identical diodes). Such a voltage division would not be possible if the array were much longer. It is for this reason that the power-combining technique of Fig. 3 is limited in frequency and number of diodes.

Doubler efficiency

You can bias each column of diodes separately: bring out a dc connection for each column through feed-through capacitors at the base of the structure. If you do this, you will find that you can disable any column (evidenced by lack of bias current and change in output) by setting the bias for that column at a markedly different value than that used for the other two columns. But you can optimize the bias point simply

by connecting together the dc leads of the three columns and biasing them simultaneously.

Coaxial power combiners such as these have given 53% maximum efficiency, running as doublers from 500 to 1000 MHz with 40 W input power. This includes the effects of tuners and diplexer, and is the same efficiency as that of a single diode in the same setup. Note that this power combiner acts like a single diode with twice the impedance and a much greater power capacity. Its function—whether doubler, tripler, or up-converter—depends on its external circuitry.

Varactor arrays

D. Parker and A. Grayzel described a type of array that uses an arbitrary number of identical varactors.² Figure 4 shows one configuration. All of the power developed across the diodes adds in phase at the load. Such a circuit is useful for combining multiple-chip diodes with single-chip varactors.

At the input frequency, a single (resonated) varactor appears as a resistance. Thus, n resonated varactors in series appear to the source as n resistances in series. If you separate the n varactors by lossless phase-shift networks of appropriate characteristic impedances, then the diodes are still matched at the input frequency, and

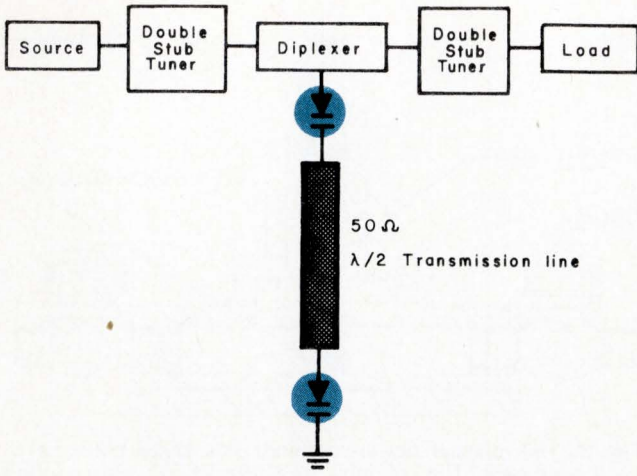

Fig. 6. This circuit is typical of frequency doublers with output of 1 GHz or so. The power outputs of the two diodes are added through the medium of the half-wavelength line.

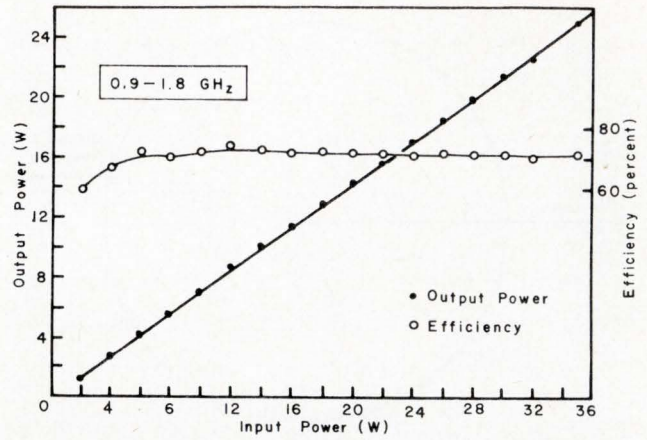

Fig. 7. Here are the measured results of the circuit of Fig. 6. Doubling from 0.9 to 1.8 GHz, and with resistive self-biasing, the efficiency is more than 70%. The circuit was tuned only once, at 20 W input power. Diodes with higher cutoff frequencies will give you even higher efficiencies, but with a smaller dynamic range.

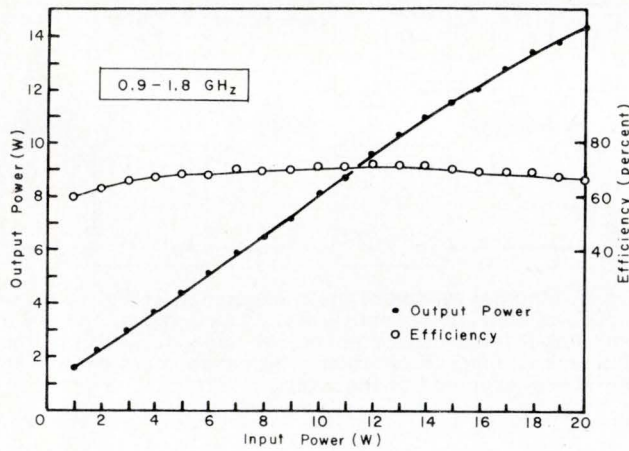

Fig. 8. A single step-recovery diode doubler showed these results. Compare them with those of Fig. 7. This circuit was tuned at 10 W input. Note that, as expected, it can handle only about half the power of the circuit of Figs. 4 and 5, but the efficiency is lower. The higher efficiency of the two-diode circuit is due to the higher (total) diode impedance.

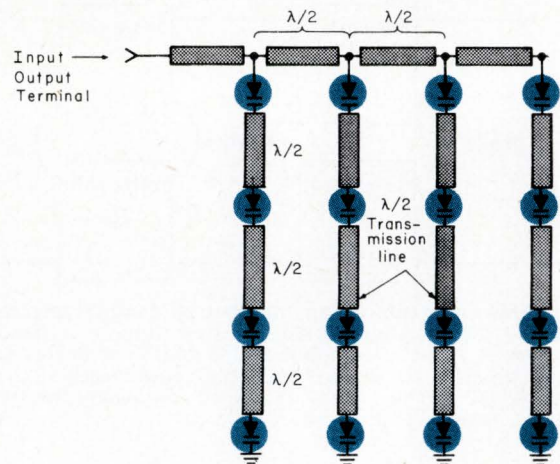

Fig. 9. A 16-varactor array that doubles from 0.9 to 1.8 GHz. It uses half-wave transmission lines to separate the diodes. The point is that if you have a properly tuned single-diode circuit, you should be able to replace the single diode with an array of n diodes, each separated from the other by a half-wavelength transmission line.

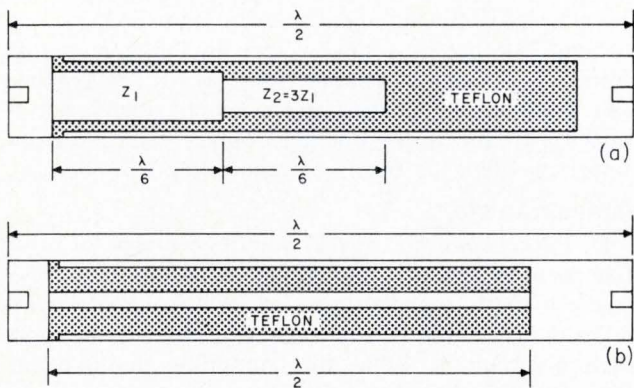

Fig. 10. Two types of series stubs. The open-circuited half-wave stub (a) is resonant at the input frequency and also at twice that frequency. It is useful only in doublers. The shorted half-wave stub (b) passes the fundamental and all higher harmonics. Its use, therefore, is not limited to doublers. Both types of stub help to prevent spurious parametric oscillations in varactor arrays.

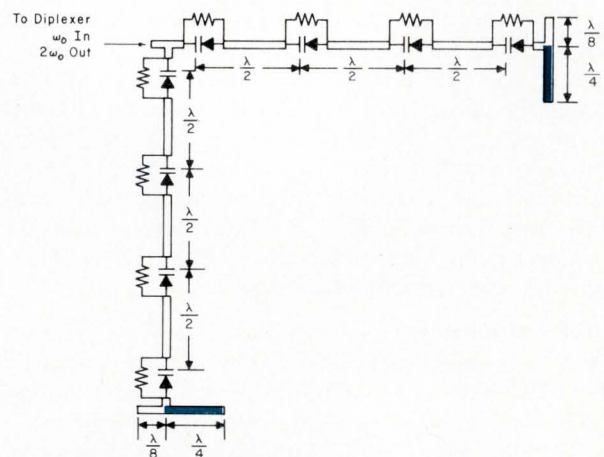

Fig. 11. This series-parallel array of eight varactors uses resistive self-biasing. The figure shows how, in such a doubler, you can use capacitive quarter-wave stubs to terminate the ends of a series array. These stubs are yet another way to reduce low-frequency idler currents.

each handles the same input power.

At the output frequency, the n varactors appear as n power sources in series or, equivalently, as n negative resistances in series. And, the output power is n times the power of a single varactor or a multiple-chip diode.

There are three general modes of operation. One is a *parallel-transmission* mode; another is an *antiparallel transmission* mode; and the third is a *diplexer* mode. The circuit of Fig. 4 shows three diodes in series. They are operating in the parallel-transmission mode. The input and output frequencies flow through separate networks, but in the same direction (from left to right). To maintain equal power distribution among the diodes at the input frequency, the network impedances must increase to the left (toward the source). In the output-frequency circuit, the characteristic impedances of the phase-shift networks increase in the opposite direction (toward the load). To assure that all of the power combines in phase at the output, $\theta_2 = k\theta_1$ for a k^{th} order multiplier.

Figure 5 again shows a circuit with three diodes in series. But here they are operating in the antiparallel transmission mode. In this mode, the input and output frequencies flow through separate networks, and in opposite directions. The load and source are at the same end of the array, and the characteristic impedances of the networks increase to the left, for both frequencies. The phase condition for which all of the output power appears at the load is, again, $\theta_2 = k\theta_1$.

In the antiparallel mode, both frequencies can flow on the same line. A diplexer separates the source from the load at one end of the array. Multipliers using this configuration operate in the diplexer mode.

An alternative design

You can use two varactors in a special configuration of these transmission-line phase-shift networks.² Both frequencies will appear at the same terminals of the array. The phase shift between diodes at the second harmonic (ϕ_2) must be twice the negative of the phase shift at the fundamental (ϕ_1); i.e., $\phi_2 = -2\phi_1$. Further, if you use a single TEM transmission line for both frequencies, ϕ_1 must be a multiple of 90° .

If $\phi_1 = 90^\circ$, you can resonate each varactor at its terminals, being sure to choose a transmission line characteristic impedance that maintains a match along the array. At the second harmonic the diodes are separated by 180° , so they can be resonated at the output of the array. This is because the characteristic impedance of the transmission lines connecting the varactors in the array is immaterial.

On the other hand, suppose you choose $\phi_1 = 180^\circ$. Now you can resonate both the fundamental and the second harmonic at the terminals of the array. And you can use transmission lines of any characteristic impedance.

The circuit of Fig. 6 is typical for a frequency doubler with an output frequency of 1 GHz. Figure 7 shows the output power and efficiency of such a circuit. This circuit was tuned only once for maximum efficiency at 20 W input power. Note that the two diodes handle nearly twice as much power as the single diode of Fig. 8, but at a higher efficiency. No spurious oscillations showed up on a spectrum analyzer with a 60 dB dynamic range.

Large arrays

In general, in 2-diode arrays, you adjust the double-stub tuners to give about twice the impedance of a single diode (since the diodes are in series). Once you tune the circuit for a single diode, you should be able to replace the single diode by an array of n diodes. Figure 9 shows a 16-diode array for a 900-MHz to 1.8-GHz doubler.

You can build the arrays in separate boxes, placing the center conductors between parallel ground planes. Such designs have shown 78% efficiency, a significant gain over the 50% efficiency of a single varactor. The four diodes in series handle about 45 W.

You can use the same array in a frequency tripler with a 2.7-GHz output. (Make provision at the diplexer for tuning the idler frequency at the second harmonic.) This tripler will have a 60% max. efficiency, which is better than the 52% (typ.) for a single diode.

Spurious oscillations

You may see spurious oscillations when you tune the frequency multipliers in arrays of several diodes. Or, if the multiplier is already tuned, you may see spurious oscillations when you vary the input frequency. These spurs are attributable to parametric oscillations in which the sum of the oscillation and idler frequencies equals the multiplier input frequency (which acts as the pump). Such oscillations occur whenever the varactor impedances at these frequencies resonate with the input and output filters of the diplexer.

It is possible to analyze the impedance needed to resonate a single abrupt-junction varactor. Such an analysis shows that if the impedance of the diplexer has a capacitive reactance for all frequencies below the input frequency, then the varactor cannot be easily resonated, and parametric oscillations do not occur.

Series stubs

Transmission lines may change the impedance of a diode in an array, however, to a value which can resonate with a capacitively-coupled diplexer. To prevent spurious parametric oscillations, you can build a *series stub* into each half-wave line. Figure 10 shows two types of stubs. The open-circuited stub of Fig. 10a has its length and impedance chosen so that it looks like a short-circuit at both f_0 and $2f_0$ (f_0 is the doubler's input frequency). Below f_0 , the stub looks like a large capacitive reactance, so low frequency currents cannot flow on the line. You can use these capacitive stubs only in frequency doublers.

Figure 10b shows a half-wave series stub that passes the fundamental and all higher harmonics. It is therefore useful in higher order multipliers. If the characteristic impedance of the stub is 50Ω or higher, currents of wavelengths similar to that of the stub cannot flow easily. This means that any signal or idler current, to be suitable for a spurious parametric oscillation, must be at a low frequency. So, if the impedance of the diplexer has a capacitive reactance at this low frequency, the array cannot be resonated and parametric oscillations do not occur.

Connecting resistors across the gaps in the series stubs further reduces the probability of parametric oscillations, and also improves the operating efficiency. Place the resistors in shunt with the series stubs in the lines or

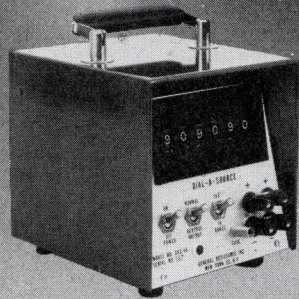

AN UNIMPEACHABLE SOURCE

(0.1 μV to 10 VDC and 25 mA with 0.0025% Accuracy)

DIAL-A-SOURCE

Twiddle your thumb and get any reference voltage you like from $\pm 0.1 \mu\text{V}$ to ± 10 volts with $0.1 \mu\text{V}$ or $1 \mu\text{V}$ resolution, $\pm 0.0025\%$ accuracy; and draw up to 25 mA without affecting output voltage in the least.

Compact decade thumbwheel programming (6 or 7 decades), and in-line readout, remote sensing, floating output, ± 1 PPM typical 24 hour stability, $1 \text{ PPM}/^\circ\text{C}$ t.c., low noise and ripple. Regulation? How about 0.0005% line and load?

And you can get the compensated zener output at a pair of added terminals as a $\pm 0.0015\%$ voltage reference, with 4-terminal "zero impedance" front panel output. Rack adapters available.

DIAL-A-SOURCE: Secondary DC voltage standard; D to A Converter reference; stability test source; remote reference; calibration source; etc, etc, etc; 6" wd x 6-7/16" h x 7" d. \$875 or \$985 or \$1,045.* Fantastic.

Write or phone for literature, a demonstration or both.

General Resistance, Division of Chronetics. 500 Nuber Avenue, Mt. Vernon, N.Y. (212) 292-1500. In Europe: 39 Rue Rothschild, Geneva, Switzerland (022) 31 81 80.



GENERAL RESISTANCE
DIVISION OF CHRONETICS

*f.o.b. Mt. Vernon, N.Y., domestic

Diode arrays (concluded)

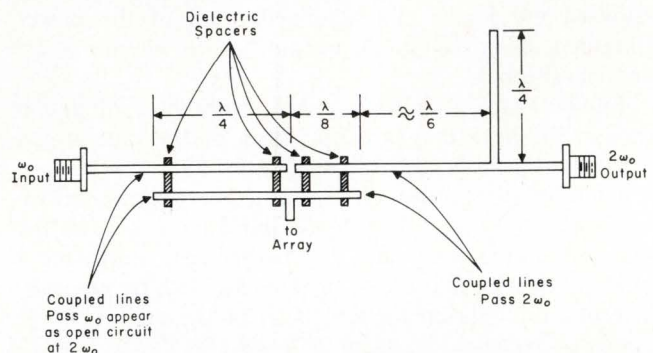

This is the schematic diagram of a diplexer suitable for a frequency doubler. It can handle arrays of any size.

the stubs at the ends of the array. When the reactance of the stub is large relative to the resistance of the resistor, the resistance appears in series with the diodes, and increases the effective R_s . When a stub has zero reactance, it short-circuits the resistor, thus taking it out of the circuit.

Besides using series stubs in the connecting transmission lines, you can terminate the end of a series array of varactors with capacitive quarter-wave stubs at both frequencies (Fig. 11). This further reduces the possibility of low-frequency idlers.

References cited

1. W. J. Getsinger, "A Multi-diode Power Combiner," *NEREM Record*, 1967.
2. A. I. Grayzel and D. Parker, "Varactor Arrays," *NEREM Record*, 1967.

Bibliography

- Evans, G., Westinghouse Electric Corp., private communications with the author.
- Taylor, R. S., "A 1200 Watt VHF Varactor Tripler," *NEREM Record*, 1966.
- Zverev, A. I., "Designing varactor multipliers," *The Electronic Engineer*, Vol. 26, No. 3, March 1967, pp. 56-61.
- Zverev, A. I., "Varactors and frequency multipliers," *The Electronic Engineer*, Vol. 25, No. 9, Sept. 1966, pp. 54-61.

INFORMATION RETRIEVAL:

Microwave semiconductors, Circuit design,
Microwaves and microwave products



*The
Standard of
Excellence*

S/D D/S converters by CLIFTON

Excellent means — “first class, of great worth, eminently good.” Definite qualities of our ADverter S/D, D/S converters. But we should add one other feature: *not expensive!* (Model SD12A1, \$795 qty. 1-9.)

In fact, their low cost, combined with such other features as: reliable, all solid state circuitry, easily interchangeable

encapsulated sub-modules, no calibration or adjustments, multi-channel capability, wide variety of options, make them superior in many ways to brush encoders.

Although designed especially for the process control and machine tool fields, this system can easily be modified for military applications.

So take advantage of our

application engineering know-how which is yours for the asking. Call our DITRAN division in Burlington, Mass. (617) 272-6210, or your local Clifton sales office. When you consider Litton, Clifton, Ditrان quality, you couldn't do better!

CLIFTON 
DIVISION OF LITTON INDUSTRIES

Pearls by J. E. Caldwell Co., Philadelphia—\$5,600

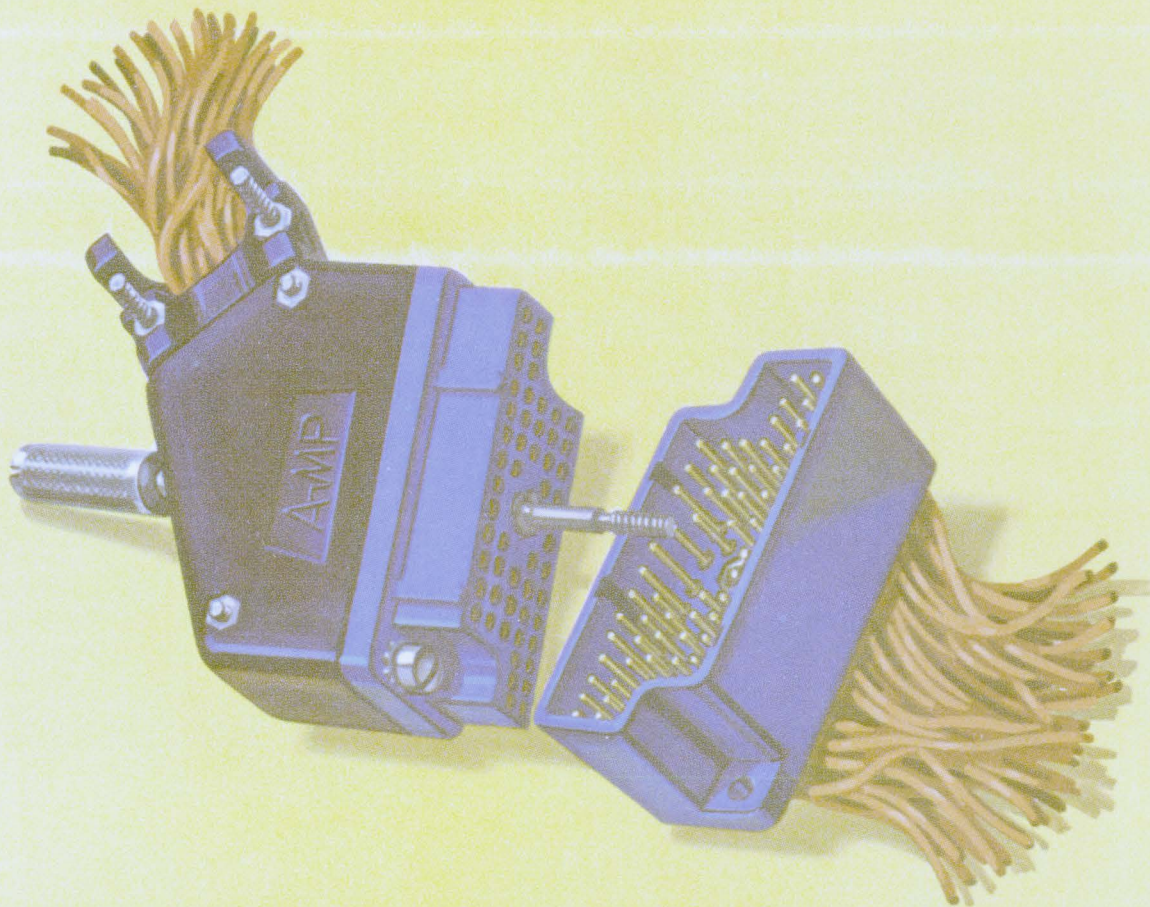

THE SPACE SAVER

This is one of our growing family of AMP's High Density Rectangular Connectors. Its contacts are on a .100" grid with 54 circuits in 1.800" x .700". It has center jackscrew, non conductive backshell and cable clamp. Size 20 pins (.040 diameter) and contacts are used throughout. Major features:

- Wire range is 20-24 and 24-30 AWG.

- Mix pins and sockets in either half of housing.

- Contact furnished in selective gold, full gold or tin plating.

- Five amp rating. Eight ounce maximum engagement. Half ounce separation force. Ten pound retention in housings.

- Cable clamp handles up to half-inch cable.

- One side-feed stripper-crimper automatic tool applies both pins and sockets and provides assembly Economy with speeds up to 4000 terminations per hour.

- Designed for communications, avionics, ground support, office and test equipment.

Write for complete details to AMP Incorporated, Harrisburg, Pa. 17105

AMP
INCORPORATED

LSI: No longer a mission impossible

Large-scale integrated arrays, both catalog and custom, are really here. But it takes critical judgments to acquire and apply LSI products economically.

By Mark B. Leeds, Features Editor

"You can always tell who the pioneers in an industry are," remarked an official of Systems Engineering Laboratories recently. "They're the ones with the arrows in their backs." Such was the case for some overzealous pioneers of large-scale integration (LSI).

After being overpromoted and prematurely dangled before the electronic community as the ultimate design

tool, LSI is now alive and well. The arrays are here after about a year's respite — during which medium-scale integration was raised as a bridge to LSI.

The user is now faced with many decisions. Buy or make? Metal-oxide-semiconductor (MOS) or bipolar? MSI or LSI? Standard or custom? Monolithic or hybrid? He must also decide where and when it's needed, what the economics are, how long it will take, what it will do
(Continued on following page)

Automation trend. Progressive IC makers are turning to the computer for LSI. Fairchild uses the equipment for design, analysis, test, and mask generation. Aside from higher accuracy, CAD reduces design costs and delivery time for LSI. Interconnection of elements is now performed by operator on computer-graphics equipment.

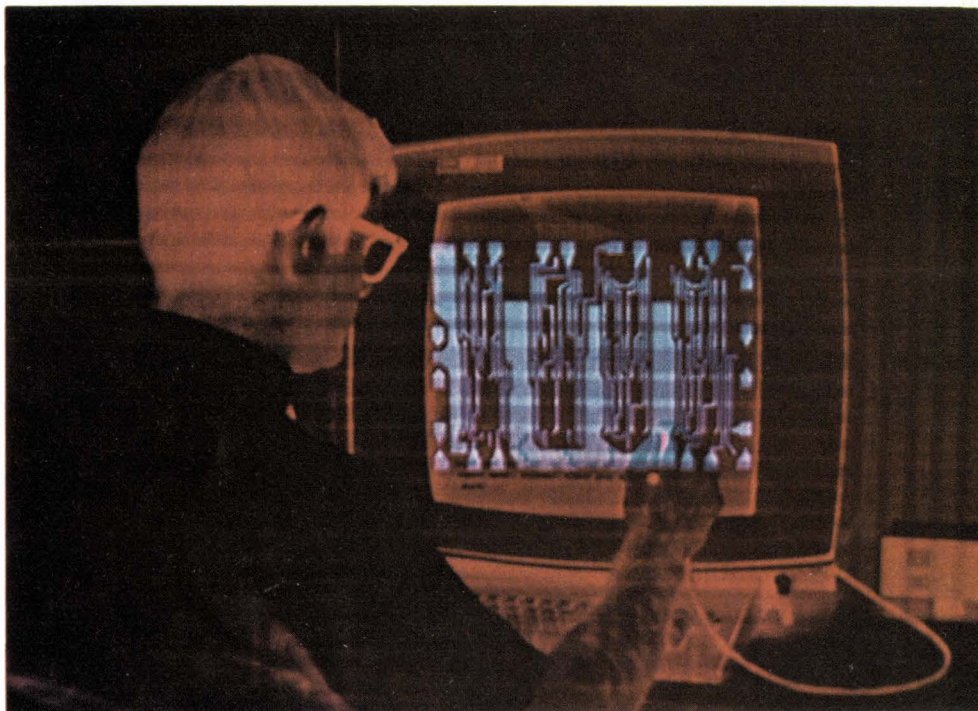

for him, and what he should do with it. And, as never before, the customer's relationship with the vendor is exceptionally critical.

What is LSI?

Although the catalogs of LSI products are small—compared with those of standard ICs and custom arrays—the lists are growing. But basically, LSI today is a custom art, characterized by a number of standard approaches. Since the overwhelming majority of engineers do not have practical experience with LSI, let's begin with what it is.

LSI is the culminating evolution of the IC (see **The Electronic Engineer**, Sept. 1968, p. 64). Its context however, is in the subsystem now (and will be in the system tomorrow), instead of in the circuit.

Although a 100-gate complexity threshold was originally (and arbitrarily) posed as the definitive characteristic of LSI, other criteria have been offered. One definition is based on a plurality of metallization layers, another stresses the use of computer design aids, and still others go by the number of distinct functions in a system context. But, among users, the 100-gate requisite has caught on. Thus, if the equivalent gate count does not reach the century mark, in the eyes of the beholder it's not LSI!

Pinning down the actual or equivalent gate complexity is often a tricky task. Some products are billed by gate count, others by number of bits.

As Dr. Clare G. Thornton, director of R&D at the Microelectronics Div. of Philco-Ford, points out, "LSI complexity can vary between 30 and 3000 gates depending on its makeup, when the functional sense is the criteria." For example, memories, which are very repetitive, have been built with complexities of 2000 or more bits, and these are the equivalent of a few hundred gates. In dual shift registers, where the layout is less homogeneous, a bit is often the equal of a gate. And there are 8-bit full adders with gate equivalents of 100 or more.

User's choice

Major semiconductor firms with LSI capabilities offer many choices to the user. These cover custom, standard, and semi-custom; monolithic and hybrid; MOS and bipolar; TTL (transistor-transistor logic), DTL (diode-transistor logic), and ECL (emitter coupled logic); low-volume and high-volume; and so forth. User aids range from design kits to computer systems, from engineering assistance to "leasable" engineering teams; even exclusive production lines are offered.

Who needs it?

Semiconductor technology moves so rapidly that it pushes users to LSI. In simple terms, the life-cycle of a customer's equipment is shrinking—and the need for innovation becomes more acute. In the heyday of vacuum tubes and mechanical devices, equipment life-cycles ran a good 15 years. Discrete semiconductors reduced that period to less than 10 years, and first-generation ICs cut it to about five years. Complex arrays are lowering the tenure to two or three years. And if some users think the pace has been too heady, they can take some comfort in the fact that (thus far) no replacement for LSI is in sight.

Ben Anixter, Fairchild's product manager, says "economy, not functions per chip, is the prime factor for evaluating LSI." He advises would-be users to think in terms of the number of printed-circuit boards and interconnections saved.

The prime considerations for the military market remain size, weight, and power. "For computer makers, though," adds Anixter, "the motives are cost-per-function for small equipment and speed and design for larger systems."

Richard Przybylski, senior engineer at American Micro Systems Inc., reveals that larger systems houses make up the bulk of customers "not only because they can afford it better than smaller outfits, but because they show a higher degree of competitive ambition."

Who sells it?

In terms of overall LSI capabilities and achievement, Fairchild Semiconductor and Texas Instruments lead their semiconductor rivals significantly. Considering the metal-oxide-semiconductor technology alone, General Instrument has the inside track.

Motorola, a traditional slow-starter, is fast-closing the LSI gap in both bipolar and MOS, and is banking on its Computer-Aided Graphics facilities (see **The Electronic Engineer**, Oct. 1968, p. 17) to forge ahead. Also among the activists are National Semiconductor, Signetics, American Micro Systems Inc., Sylvania, and Philco-Ford. Among the leading systems houses that can make LSI are Autonetics, Bell Labs, IBM, and RCA.

Virtually every semiconductor house has an LSI project or two on the boards; so do many systems houses. The majority of the latter construct their arrays for themselves, but a few sell them too. For example, Autonetics makes shift-registers, memories, differential analyzers, multiplexers, and complex modems for communication over telephone lines.

Despite the fact that makers are prone to brag about complexity achieved in monolithics, many make hybrid circuits—which combine several chips on a single substrate—as an interim step before 1000-gate monolithics are built. As Dr. Thornton predicted a year ago, 6-, 8-, and 10-chip hybrids are cropping up all over, with 100- to 300-gate complexities.

The catalog products

The trend is also toward steady improvement of catalog monolithic products. Densities of 40 to 60 gates are now common, 1970 will see standard 90- to 120-gate ICs, and 200-gate components will be off-the-shelf items within four to five years.

Wally Raisanen, manager of MOS and memory products at Motorola, maintains memories are the easiest arrays to implement, because their regularity enhances yields, lowers costs, simplifies testing, and speeds up assembly and delivery.

For general LSI products, an Autonetics spokesman says custom monolithic arrays take 12 to 16 weeks till delivery, standard cell arrays require six to eight weeks, and hybrid arrays of MSI chips require one to two weeks for assembly.

RCA's Defense Electronic Products' microelectronics team has developed universal MOS LSI arrays and claims it needs only five weeks to deliver custom arrays. A takeoff on the master cell concept, the arrays only re-

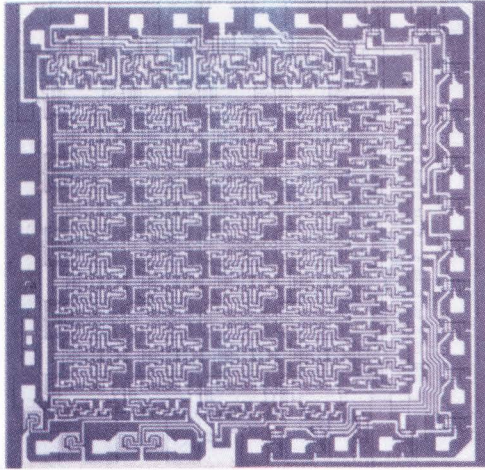

Fairchild's 285-gate TTL

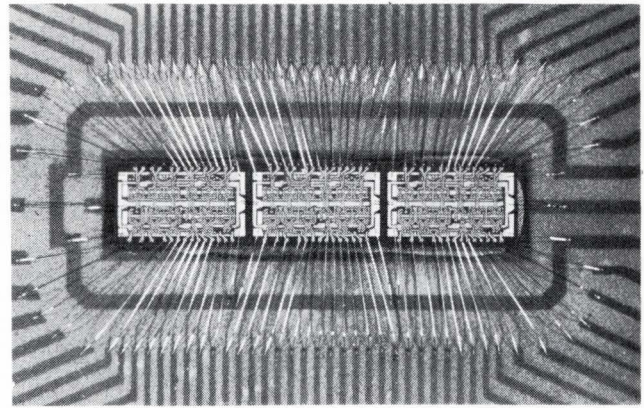

216-gate ECL by RCA

Superiority complex. Depicted here are three most complex monolithic large-scale-integration arrays that have more than 200 gates. In addition to the ones shown here, the table lists some representative LSI products.

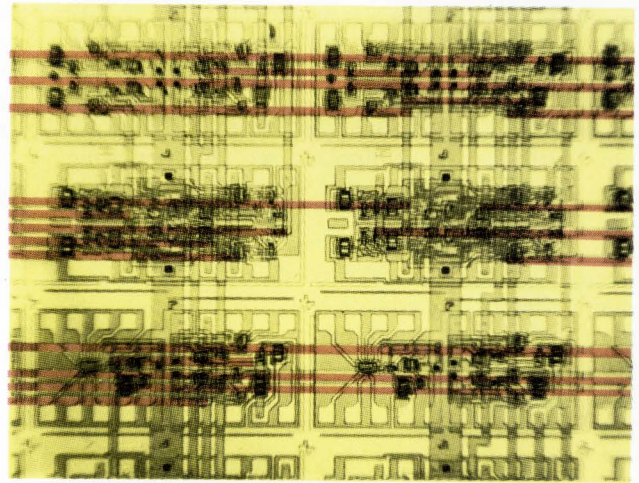

TI's 264-gate TTL

Company	Products	Type-logic	Gates (actual or equivalent)
American Micro-Systems, Inc.	Dual 100-bit shift registers	MOS	100
	Expandable gate array	MOS	100
	12-bit serial/parallel converter	MOS	>100
Fairchild	64-bit random access memory	TTL (bipolar)	285
	Dual 8-bit shift register	TTL (bipolar)	105
	CTR numeric character generator	MOS	>100
	1024- and 2048-bit read-only-memories	MOS	>150
General Electric	Arithmetic unit	MOS	>100
General Instrument	1024- and 2048-bit ROMs	MOS	150
Motorola	Expandable cell array	MOS	68-224
	16-bit parallel-IN parallel-OUT shift register	MOS	168
	Unit cell array	TTL (bipolar)	100
Philco-Ford	1024- and 2048-bit ROMs	MOS	100
RCA	Processing array	ECL (bipolar)	219
	Gate universal array	MOS	100
	Register universal array	MOS	100
Sylvania	Adaptive 4-bit register	TTL	100
	1024-bit ROM	TTL	100
Texas Instruments	Unit cell array	TTL	264
	2048- and 4096-bit ROMs	MOS	200
	8-bit full adder	TTL	192

quire interconnection tailored to a specific set of functions. They plan a similar program for bipolar LSI.

MOS vs bipolar: drawing the lines

The two dominant forms of monolithic LSI technology are bipolar and metal-oxide-semiconductor transistor elements. They account for near-equal shares of the arrays built thus far.

There really is little head-on competition between the two, so don't be misled by firms pushing one side to the exclusion of the other. Both have their place. They have even been combined on the same chip.

In ICs, MOS technology has lagged behind bipolar technology for a number of reasons. Bipolar is more universal because makers waited until bipolar ICs were established before turning their energies to MOS; also, MOS stability problems had to be licked. Although most experts concede MOS is still more of a custom art than a catalog business, the crossover is expected to occur in 1½-2 years—because of the increased volume and the more severe competitiveness among suppliers. Many agree MOS will eventually account for 12-20% of the total IC business. (In the 1970's, LSI business will exceed a billion dollars annually.)

Comparing the two technologies, MOS elements are about one-fourth the size of bipolars (see **The Electronic Engineer**, Dec. 1968, p. 46), and their processing time is usually one-fifth to one-half of that for bipolars. In contrast to bipolars, they require no isolation, and one basic element serves as transistor, resistor, and capacitor in many circuits. Impedance levels of MOS elements are higher, and speeds much slower. (Bipolar LSI is largely TTL, because this type of logic is faster than DTL.)

A later form, complementary MOS, requires isolation and extra processing steps. For this reason, a majority of firms do not believe it will become a full working partner of conventional (single-channel) MOS. However, complementary MOS—pioneered by RCA—is becoming a fairly widespread sub-technology.

Berry Cash, TI marketing manager for MOS ICs, submits that the smart user and responsible maker find little difficulty in choosing between MOS and bipolar LSI, but that there are few instances where the choice

is gray. "MOS is preferable where the need is for less power, or for higher input impedance, or where the speed limit is 5 MHz or slower," he says.

Speaking for one of the few suppliers with a competence in both MOS and bipolar, Raisanen of Motorola maintains the choice between the two technologies is cut and dry. "MOS products are only applicable for speeds of 100 ns per logical decision or slower," he insists. "And until MOS elements can be made with fractional-volt thresholds, they will lag the speed-power product of bipolars." But the smaller area requirements of MOS give it a cost advantage, Raisanen argues.

Jack Carsten, TI manager of TTL marketing, maintains MOS is too costly for random logic. "It's O.K. for off-the-shelf memories and shift registers, where the cost is about two and one-half cents per gate. But MOS logic costs 40 cents per gate, and has poor gate-to-pin ratios that swell the user's manufacturing costs."

Charles H. Phipps, manager of the Technology Custom Center at TI (and a team member of the first IC task force) feels the gray area occurs in control—i.e., random-logic. He offers this guide: "If the volume involved exceeds 1000 pieces, MOS is more economic; if it doesn't, standard bipolar cells with custom interconnections are the better bet."

Where to use LSI

Now that LSI is a reality, users must ask "Where is it needed?" Equally important, they should be able to determine where *not* to use the arrays. The industry consensus predicts LSI arrays will become commonplace for general repetitive functions and in these areas:

- small memories (conventional, associative, and control)
- registers, especially shift types
- direct differential analyzers
- digital-to-analog converters
- analog-to-digital converters
- standard computer logic
- aerospace computers
- multiplexers
- encoders
- decoders

A good word for hybrid LSI

Paul Sullivan, Raytheon IC marketing manager, believes LSI is still away, that it doesn't yet merit a full-scale effort. "We propose MSI chips on a hybrid substrate to effect LSI now," he says. MSI is known, its yields are much better than with LSI chips, and beam-leading can impart higher reliability. "In this way," he adds, "you only have to worry about interconnection of the substrate."

"LSI really shows packaging expertise, not array innovation," says Joseph Nola of Sylvania. "It

wouldn't at all surprise me to learn that hybrid LSI is superior to the monolithic LSI made so far."

RCA's Rosenberg explains the preference for hybrids this way: "The ultimate user isn't concerned with device reliability. He focuses on the system and subsystem level. Since LSI covers 10% or so of a system, what good is its 1000-year reliability if the other 90% lasts 100 days? So, since the whole thing can't be monolithic, you use both MSI and LSI chips to maintain high, compatible reliability."

- counters
- adders

In the broadest sense, LSI is suitable for innovation in equipment. Anixter of Fairchild puts it this way: "Generally, LSI is more appropriate for new designs rather than for retrofits."

"LSI should not be construed as a means of building an existing computer cheaper," maintains Dr. Thornton of Philco-Ford. "In the economical sense," he says, "LSI requires a restructuring of the computer. For example, the memory and control functions may be included in peripheral gear, instead of confined to the central unit." Thornton and other experts call this aspect the "decentralization of equipment."

Dr. Thornton insists that the major LSI markets are for repetitive systems, such as calculators and terminal gear. But he predicts calculator volume will be limited until costs come down, and adds: "LSI should be considered for new, expanded-capability calculators, not for the same calculators that exist today." For these, costs are just too high and the improvements can't justify the investment.

Michael J. Flynn of the Argonne National Laboratory concludes LSI offers less connections per logic decision, minimum space per decision, and a broader tradeoff of power-speed for varying applications than other technologies. He also says that, in combinatorial processes, LSI impact will be minimal until logic and machine designers are retrained.

Not just for computers

LSI appears destined to play a key role in non-data-processing systems too. Despite the fact that its main impact has been on computers and not on communications equipment, a RAND Corp. official proclaims that "only the most obtuse engineer does not now appreciate what LSI portends for the communications revolution." He cautions that present communications systems must be redesigned to harness LSI's advantages. Engineers should consider where and when LSI can be economically applied to:

- sequence generators
- repeater amplifiers
- multiplexers
- control circuitry
- converters
- filters
- frequency synthesizers
- phased-array antennas
- microwave transmitter circuitry

Stanley Rosenberg, director of microelectronics at RCA's Defense Electronics Products division, predicts the array content of general systems will grow to 25% (up from the few percent figure of today). "I think this will compel semiconductor houses to sell more and more unpackaged chips to systems houses," he adds. And the general feeling among these customers is that the best chips do come from the semiconductor industry, particularly when the volume is large.

To the would-be LSI customer, General Instrument offers a set of guidelines: pick out those functional blocks in the system that exist in quantities of 100 or



Pointing the way. Don Schare, manager of digital applications at General Instrument (right) shows Features Editor Mark B. Leeds LSI packages for MOS arrays. Units include 24-pin dual-in-line and 40-pin plug-in standards, and developmental 40-pin ceramic plug-in. Since the implementation of LSI requires close cooperation between users and manufacturers, Mark gathered information at both types of companies for this report.

higher, that have few input-output terminals, that contain repetitive or similar elements, and that require 100 or more devices. If these criteria aren't met, the array probably won't be economical.

Another key user decision involves the selection of a vendor. The criteria go beyond the conventional—cost, performance, delivery, service—because the supplier-user relationship is more intimate and longer than in the case of regular semiconductors.

For example, when the Air Force Avionics Lab decided upon LSI for an airborne computer, it selected as its prime supplier a firm with "an excellent IC track record." An official of the Lab offers, "It was a sound, responsible outfit whose technological thrusts weren't flashy. We knew from experience that it could and would deliver."

And a number of other users that have bought custom LSI arrays from semiconductor firms indicate that after initial alarm over the estimated cost, and after getting the products into the systems and figuring the savings that accrue, "it was more than worth it." Many volunteer the opinion that LSI gives the equipment maker a manufacturing and performance edge in his own markets—and that's what it's all about.

The vendor-user interface

The bulk of semiconductor manufacturers who sell LSI consider the vendor-customer interface critical, and warn the user to be prepared. In turn, more and more customers are "arming" themselves for the confrontation. Says Lester Hazlett, manager of Motorola's CAD facility, "Most of our clients come in with a functional block diagram and a parts list of gates, flip-flops, and other standard elements that reflect a good working knowledge of the technology." This simplifies array imple-

Universal array . . .

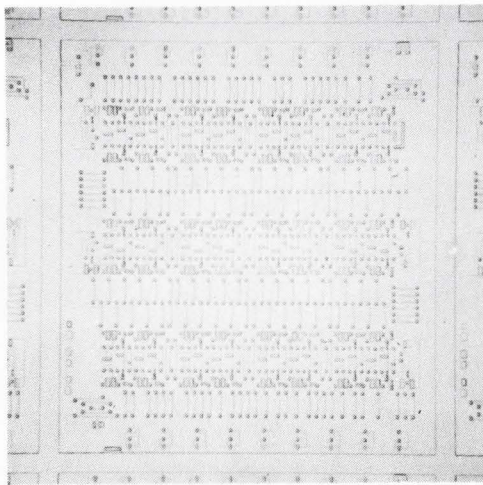

Master wafer

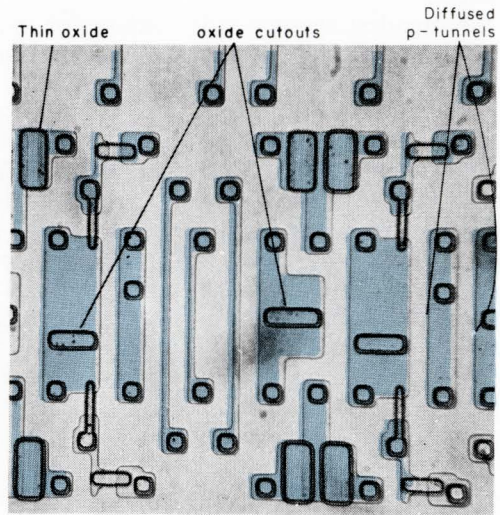

MOS elements of wafer

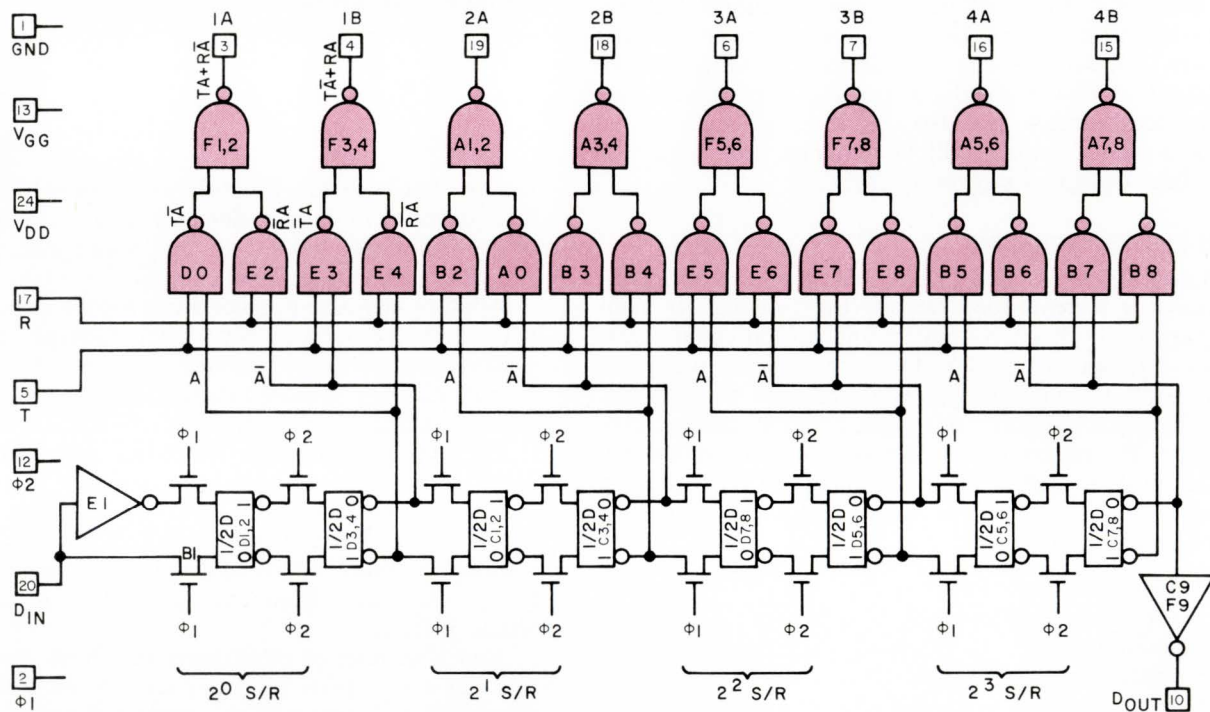

4-bit shift register with temporary storage

mentation and speeds up the turn-around time.

Joseph Nola, manager of IC product planning at Sylvania, also counsels users: "Be prepared to follow the vendor's suggestions and modify the design. Expect to spend weeks, maybe months, just to work out a mutually-acceptable test program. And be sure you can afford the entire effort, in both dollars and people."

Some customers produce their own masks for the proprietary portions—hopefully to save money. Startup costs for a custom bipolar array range from \$10,000 to

\$50,000, say the experts. Much more is spent for design verification, test program and equipment generation, and proof testing than on device design and layout, mask design, and mask checkout.

Texas Instruments' Jack Kilby, inventor of the IC, reports the sharper makers are gearing up engineering services that go far beyond the traditional applications assistance. The trend, linked intimately to the LSI technology, is for the users' and makers' engineering teams to unite and mutually develop the black boxes.

... yields remote storage subsystem

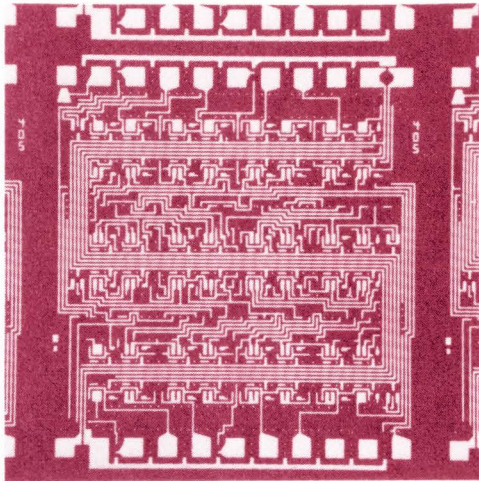

Photomask

Array evolution. Universal array, a p-channel MOS complex IC, meets a wide variety of digital applications by tailoring the metallization. **Master wafer** contains a number of array chips, each containing over 200 components in an 82 x 90 mil² area. Logic components are distributed along both sides of power busses and clock lines. Between the rows of flexible **logic elements** is a two-level interconnection area composed of p-tunnels and potential metallization paths. The silicon diffused tunnels, located beneath the SiO₂ layer, connect the elements with the metal leads atop the oxide surface. Thus elements are connected in runways with minimum cross-overs. Some of the MOS elements are inverters, some load devices, others transmission devices. Similarly, some elements have fixed interconnections (e.g., to produce an inverting stage), and other interconnections are uncommitted for design flexibility. To build a function with the array, we start from the block diagram and generate a **photomask**. (The block diagram corresponds to a 4-bit serial-input/parallel and serial-output shift register, with temporary storage of complementary parallel output data.) Metal is then etched to form the appropriate **interconnects**. (Note that the metal busses run over the oxide cutouts.) The end result is a **completed storage array**. The same universal chip could be used to implement a BCD up/down counter and other logic functions. It is part of a complete universal-array family developed by the microelectronics department at RCA's Defense Electronic Products division.

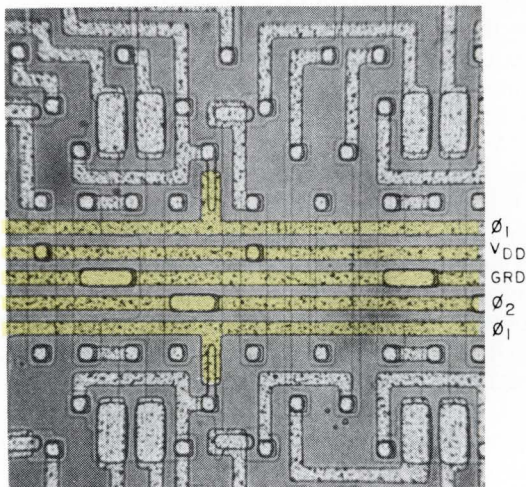

Metallization

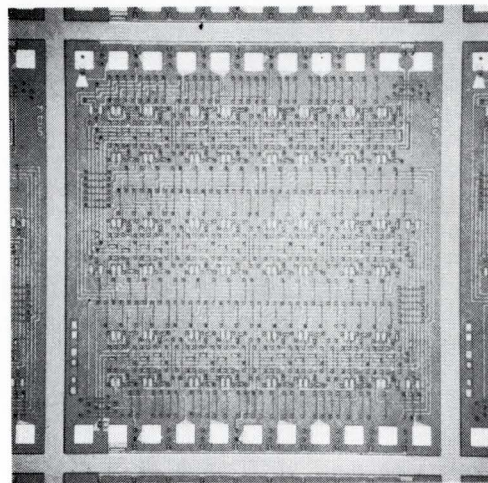

Completed circuit

The user's dilemma: make or buy?

Customers, especially systems houses, are still wrestling with the "buy or make" decision in regard to ICs. LSI has brought this dilemma into sharper focus, because the stakes are higher.

In nearly all cases some kind of in-house IC facility is advisable. But if it is overdone, it proves to be costly. And if underdone, even costlier. The advantages of an in-house capability for a systems firm are many. It

- sharpens the choice between purchasing (standard or custom) vs manufacturing the array.
- provides a cost reference.
- assures some degree of second-sourcing.
- keeps the designs competitive.
- enables the user to "keep tabs" on the maker.
- lessens user dependency on makers.
- safeguards proprietary designs.
- provides a margin of "value-added" to the ultimate final product.

But there are pitfalls to watch out for too:

- The art is so dynamic, it's hard to keep up.
- Costs are high, can run into the millions annually.
- The in-house facility and personnel may be swamped by demands from "sister groups."
- Some of the effort is wasted on duplication.
- It can get out of hand and can obscure the primary business of the company.

Block building and busting

To aid users in the development of arrays, several suppliers have established building block programs. In essence, these are sophisticated design kits. The user selects standard functional blocks (from gates and flip-flops, up to entire subsystems) and pastes them down in proper order. Guides are provided for interconnecting blocks, area consumption, input-output levels, and so forth. Each "kit" has its own set of rules, tailored to both processing restrictions and the maker's "bag" of product capability.

The building-block catalog concept, pioneered by Philco-Ford and now used by some half-dozen makers, has become a popular tool for custom array generation.

Fairchild, with its various Micromatrix® approaches, has the broadest block program of all—and the biggest line of compatible products to boot. Both Autonetics and RCA also have design rule manuals for array implementation. Motorola will soon announce building block catalogs for both bipolar and MOS arrays.

TI, one of the few major firms not to use the building block concept, feels that computer aids serve the purpose better. Berry Cash says that the user's logic and timing diagrams, fed to a computer by the maker, will result in "better designs, obtained more quickly and with less strain to the user."

GI is another firm that doesn't push the building block kit idea. It also promotes the combinational logic approach, and tells users to just come in with a truth table or logic diagram to implement an array. An official says, "With our read-only-memory we have only to tailor a mask for the oxide to determine which elements will represent logical '1s' and which will be '0s'."

In defense of the kit block approach, Dr. Thornton of Philco-Ford claims it makes better use of silicon real estate, is faster, protects proprietary designs, gives the user a degree of control, and familiarizes the user's engineers with IC techniques.

But critics of the block concept maintain its simplicity belies the sophistication of the LSI technology. They discredit it for its abundance of design rules, claim it wastes real estate, and insist it gives the user a false sense of security. Says one, "If you want to learn how to drive a car for the first time, you don't bank on your previous experience with bicycles and tricycles, and you don't learn it from a correspondence school. You get in next to a licensed driver. LSI also demands a strong, personal tie between the user's engineers and the vendor's team."

A survey of systems houses discloses widespread concern over the ultimate intentions of the semiconductor industry. The latter's potential for encroachment—via LSI—lies in the back of the minds of many, including instrumentation firms. An official of a ranking instrumentation company offers: "We stopped buying from one of the semiconductor giants as soon as they got in on our act. We weren't going to help subsidize our own demise."

The confident systems houses, however, feel their experience with systems provide an edge — greater familiarity with designs, partitioning, and applications —over the semiconductor manufacturers. But, without sound management, this is no guarantee of success.

Some vendors have built arrays for special customers where the functions weren't known. These are called "black box arrays," and are combinations of gates, flip-flops, and other standard elements. In some cases the user puts down the interconnects; in others the vendor does. But without knowing the logic and the application, the chip remains an enigma. Wickes of TI says this competence of working in the dark preserves the user's secrecy.

Systemsmanship

After various Department of Defense directives encouraging the use of ICs and the LSI technology, systems houses were forced to consider microelectronics as more than a class of products. For example, RCA's DEP microelectronics operation has been producing a few thousand monolithics a month—with average complexities of 75-100 gates—fairly sizable for a systems house. It also provides customers with a kit-like building block program. But don't be misled by the apparent RCA success. It's merely an example, not a prescription. And not every user can afford to follow suit.

For example, their IC operation has more than 60 employees, of which one-third are skilled, experienced engineers, and a few million dollars worth of capital equipment. All this, ably run as it is, produces a few thousand circuits a month of moderate-to-high complexity, in a closed and thus far limited market. RCA's Rosenberg suggests "LSI is so custom on the systems level, an O.E.M. house can and should get into it." He explains, "The average R&D contract is \$100,000 or so, making the \$30,000 LSI development price tag of a vendor unaffordable. And, of course, you have to be concerned about the lack of multiple sources."

On the other hand, Alvin B. Phillips of Autonetics advises users planning on IC manufacture, "Don't go directly to the LSI big chip route from first-generation ICs. It's too tricky and very risky. MSI should be the bridge you learn from and smoothly cross." Autonetics, however, has probably made the boldest IC move among systems houses—it's gearing up to compete head-on with the semiconductor industry.

The high cost of LSling

At this point, the user considering in-house LSI manufacture should realize it's a multi-million dollar effort. In contrast, the acquisition of vendor arrays—although typically higher priced in comparison to standard ICs—costs much less.

The costs for obtaining an array vary according to volume, engineering required, and turn-around-time needed. The respectable vendors suggest users come

in as fully armed as possible — with logic diagrams, truth tables, some knowledge of IC processing and restraints, and preferably a familiarity with computer aids. The buyer and maker then mutually determine which portions of the system may be implemented with standard blocks, and which will require custom units.

Generally, for the high-volume user—say 25,000 or more pieces per year—engineering costs will range between \$15,000 and \$50,000 for an all-custom job. Since this might be considered too stiff for the low-volume prospect, most makers have established alternatives that will tally out at \$5,000-\$10,000. These usually take one of two forms: *standard cells*—where customized interconnections tailor the array to the application—and *computer-aided fabrication*—where the array is designed from a “library” of standard cells.

Costs are usually lower for highly-structured arrays, because the vendor's effort is less. For example, TI's Bill Wickes, manager of advanced integration programs, points out that custom bipolar shift registers and read-only memories of up to 1000 bits can be delivered in less than one month, cost about 50¢/bit, and rarely include fixed fee costs for wafers. In contrast, the non-structured arrays carry a fixed fee of \$10,000 or more plus \$1000 per wafer (five or more wafers is the usual minimum) and require three months for delivery.

Contrary to the majority that insists LSI is and will remain a custom business, highly successful Signetics declares standard products will dominate. A marketing official maintains “custom is just too costly for most needs, and some people that have had arrays built for them have paid through the nose for yielding to the fad.” After a long study devoted to system partitionings, Signetics will soon unveil a line of catalog LSI that is an outgrowth of that evaluation.

An official of Friden Inc., San Leandro, Calif., agrees and suggests the costs of design and tooling of LSI arrays, coupled with relatively short product lives, will impel most designers to opt for standard arrays.

Accounting for savings

Anixter of Fairchild says there will be instances where the initial appraisal shows LSI costs to be equal to or even slightly higher than those of ICs. “But when they account for reduced manufacturing costs, the advantages of LSI are made clear.” For example, the average estimated lead insertion cost is 10 cents per lead. If a single LSI array with 50 outside leads replaces an 850-lead hodge-podge of simple ICs, discretes, and individual components, the saving for just one subsystem unit is \$80. If the maker is turning out a few thousand of the equipments per year, LSI will save him hundreds of thousands of dollars in labor.

TI's Cash says, “As a general rule, the gate-to-pin ratio must be a minimum of two-to-one if a projected array is to be economic.”

For another perspective, take the case of IBM. One of its experts, from the Watson Research Center in Yorktown Heights, N. Y., suggests LSI will bring more function per dollar, and not lower cost per se. He stresses that logic hardware costs typically run from 10 to 30% of the total manufacturing cost of computers, terminal and peripheral equipment, and small data-processing systems. And he feels that only 5 to 15% savings are realized by LSI when other new costs—hardware, software, and so forth—are included.

Testy testing

Testing the arrays is another area where costs aren't always obvious. Again, the vendor-user interface is critical.

“The wise user,” says Richard Rogoff, bipolar IC product manager of Philco-Ford, “will help generate the functional test program for the array. Makers are more adept at the construction test program, and less familiar with the end use. Shifting the functional test load to him may delay completion, or expose or leave the array vulnerable to some critical functional failure.”

Cash of TI cautions against incomplete test programs. “Don't only test for construction and function; put in incorrect data to make sure the array doesn't provide false outputs,” he advises.

The computer influence

Computers play many roles in the LSI act. Foremost of these are analysis, logic simulation, test sequence generation, mask set generation, and interconnection. Roger B. Helmick, manager of product marketing for memories and arrays at Motorola, avers, “The computer interface supplements the purchase order interface.”

Among semiconductor houses, the most advanced computer-aided design facilities are those of Motorola, and Fairchild, followed by TI and RCA. Many experts expect computer aids to provide the balance of power in the future. Despite the ingenuity of designers, the increasing complexity of arrays shifts the optimum design role to automated methods, particularly in the face of ever-shortening design cycles.

LSI must be packaged, too

Kenneth Hook, vice president of operations for Barnes Development Corp., predicts some package standardization is in the wings. “Since large customers, particularly military agencies and computer firms, insist on multiple sources, package standardization is being pushed,” he says.

Raisanen of Motorola adds, “Where during the 1960's the aim was to minimize the number of gates, the focus of the 70's will shift to minimizing the number of input-output pins per package.”

How important will LSI be?

Experts estimate some 200-odd firms are now manufacturing ICs (both monolithic and hybrid). Aside from the two dozen or so prime semiconductor houses, scores are at least experimenting with LSI (typically hybrid LSI), and many are building their own. An official of Image Enterprises, Los Angeles, predicts 500 to 1000 companies will be making ICs by the next decade, and a high percentage of these will be fabricating arrays. Vital equipment such as high-resolution step-and-repeat cameras will see market growth, and the official believes smaller makers will lease equipments through nationwide service bureaus (in a fashion similar to time-sharing of computers).

INFORMATION RETRIEVAL:
Systems, Semiconductors, Integrated
circuits, Computers, Digital design
Computers and peripherals

Package deal. To ease handling and testing of LSI arrays, Barnes Development Corp. will soon market catalog package carriers. These will be 40- and 50-pin dual-in-line and flat-pack type units, offshoots of packages Barnes developed for two major semiconductor vendors. A company official predicts the advent of standard array packages, not only because of economy, but also because of the pressures exerted by government agencies and large computer firms—who insist on multiple sources for high-volume circuits.

Stifling smell of success. Don't look forward to quick delivery of plastic-packaged dual in-line TTL ICs from Motorola during the winter months. The company, whose IC sales have been progressing at record rates, finds its plastic lines too overtaxed to meet the demand for the low-costing plastic version of transistor-transistor-logic circuits. The market introduction of plastic TTL would mean long delays for plastic DIL-packaged RTL, DTL, and other big sellers.

The company is racing to increase its plastic packaging production capabilities, so that TTL—currently the dominant digital IC logic form—will be brought in out of the cold by spring. In the meantime, metal-can, flatpack, and ceramic DIL-packaged TTL—all priced slightly higher than the plastic version—will be available.

Defense LSI escalation. The microelectronics department of RCA's Defense Electronic Products division will soon accept custom business from outsiders. The group, which has thus far confined itself to internal RCA array needs, will solicit business from DOD agencies and other O.E.M. concerns. A specialist in hybrid and MOS technologies, the department will add bipolar and complementary-MOS to its LSI mix.

Manager Stanley Rosenberg reports his operation can turn out custom arrays in 5-7 weeks for less than \$5,000—which competes with the price-delivery capabilities of semiconductor houses (see LSI feature in this issue, page, pp 53-61).

Rosenberg disclosed a setup for multiple sourcing has been achieved, enhancing the move. RCA's prime IC operation in Somerville, N. J., and two non-RCA companies provide the backup—considered vital to LSI prospects. The group, which both buys and makes its monolithics, will start accepting orders in a few months.

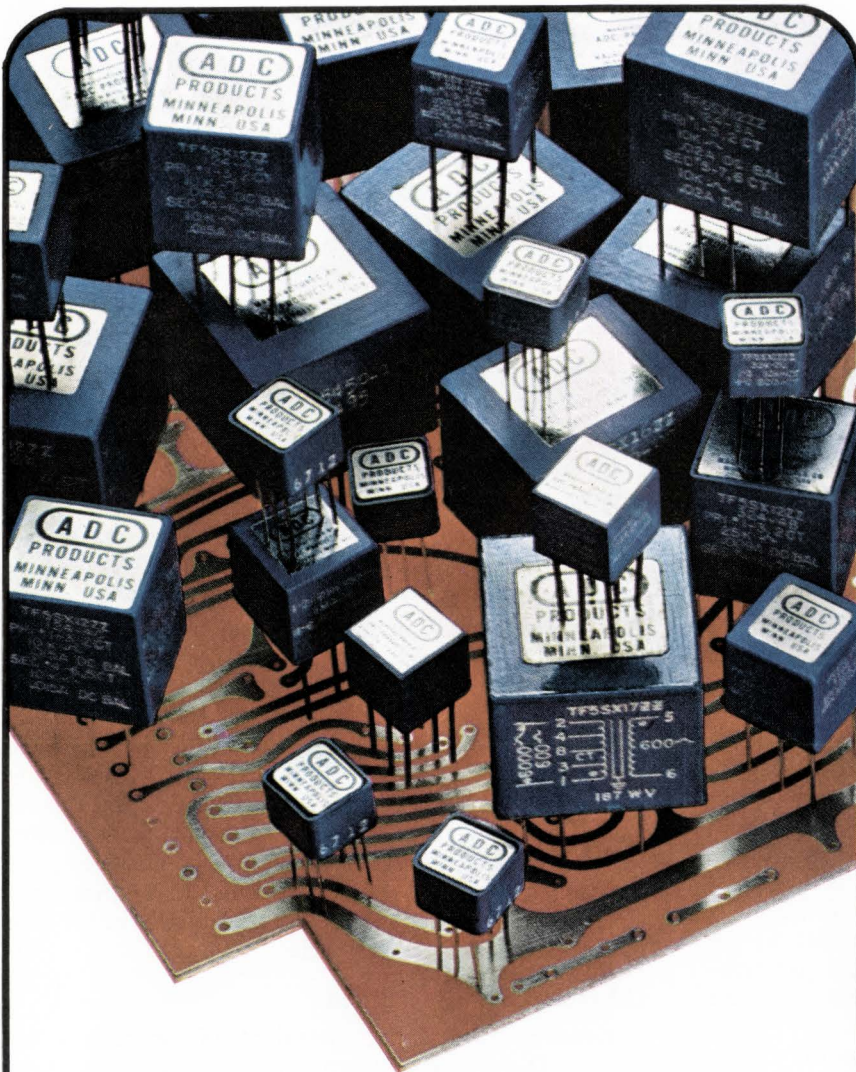

HOW MANY CHOICES?

"BLUE CHIP" TRANSFORMERS offer 71 different off-the-shelf versions that enable you to custom select transformers for printed circuit applications. The combination of choices in size, frequency, power and impedances available allows you the utmost in design flexibility. ■ Parameter choices available: Impedance: 4 ohms to 100,000 ohms, Frequency: 60 Hz to 100,000 Hz, Power: 30 MW to 7.5 W, Volume: .060 cubic inches to 1.16 inches (6 sizes), Weight: .09 oz. to 2.5 oz. ■ All Blue Chip transformers meet Mil-T-27B, Grade 5, Class S requirements.

ADC

ADC PRODUCTS

A DIVISION OF MAGNETIC CONTROLS CO.
6405 CAMBRIDGE STREET ■ MINNEAPOLIS, MINN. 55426

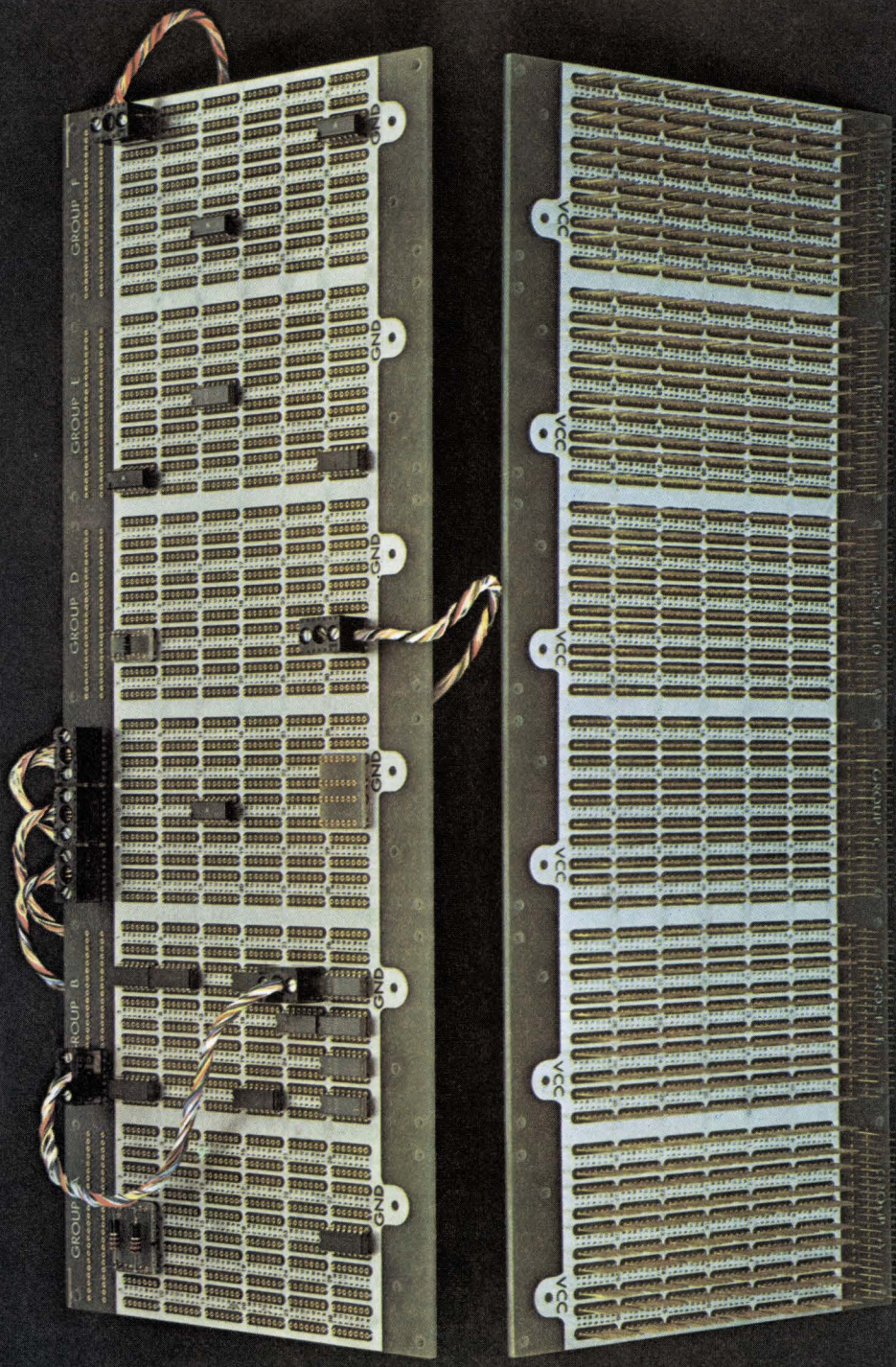

Take the 2-dimensional approach:

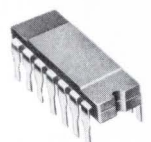

Let Augat in-depth design save up to 60% in total IC Packaging costs

That's what our customers tell us about our unique two dimensional approach in IC packaging panels. They simplify design and production operations — no need for functional logic cards. Our high density chassis, with three-level wire-wrap socket pins, is ready for interconnecting any desired logic or function at design, prototyping or production stage. Modular construction of panels permits user to specify any multiple of 30 up to 180 patterns. Available as standard catalog items or built to exact specifications.

Save time making circuit design changes. Simply disconnect one level of wiring on back of panel; plug in new logic and interconnect on other levels of wire-wrap pins — no waiting for design and fabrication

of logic cards. Boards can be automatically, semi-automatically or manually wrapped.

Save space. Boards may be mounted vertically or horizontally. Interconnecting is point to point with components. Also logistics problems minimized. No cards, connectors or back panels.

Eliminate many hidden costs such as designing and producing individual logic cards and maintaining spares.

Let Augat show you how to reduce your IC packaging cost — and give you greater flexibility in prototyping, production and field service.

Tel: 617/222-2202 or write: Augat Inc., 39 Perry Ave., Attleboro, Mass. 02703. **AUGAT** INC.

BOOTH 758 WESCON

Circle 43 on Inquiry Card

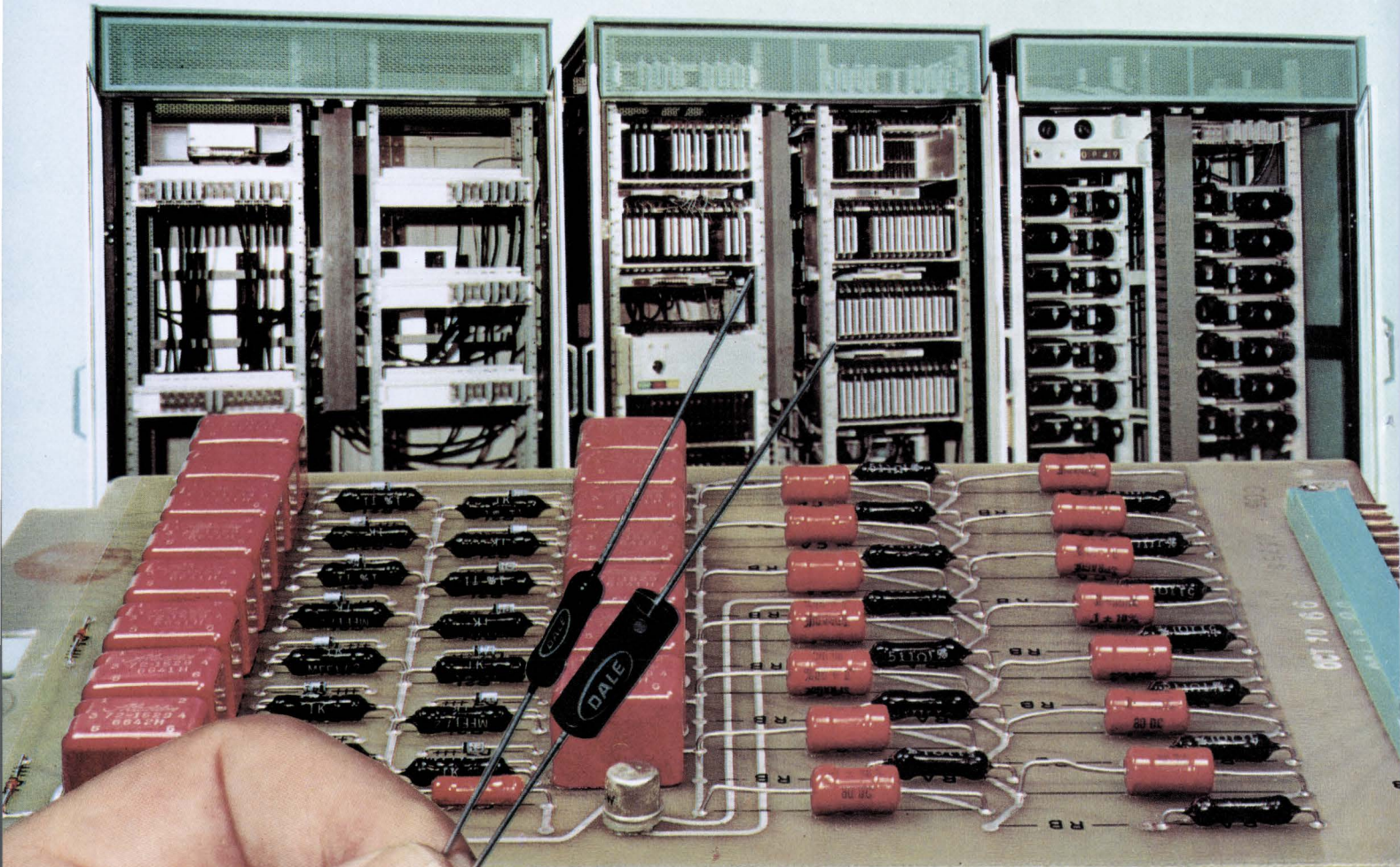

DALE

Metal Film Resistors

...chosen for long life in the
Westinghouse PRODAC System

GENERAL SPECIFICATIONS TYPE MF* MIL-R-10509F

DALE TYPE	MIL. TYPE	125° C RATING (Char. C & E)	70° C RATING (Char. D)	RESISTANCE RANGE (Ohms)
MF50	RN-50	1/20 w	1/10 w	30.1 to 80.6K
MF-1/10	RN-55	1/10 w	1/8 w	30.1 to 301K
MF-1/8	RN-60	1/8 w	1/4 w	10 to 1MΩ
MF-1/4	RN-65	1/4 w	1/2 w	10 to 1 MΩ
MFS-1/2	RN-70	1/2 w	3/4 w	10 to 1.5 MΩ
MF-1	RN-75	1 w	—	25 to 2.6 MΩ
MF-2	RN-80	—	2 w†	100 to 10 MΩ

*Also available in conformal coated (MFF) styles. †Char. B.
Tolerance: ±1%, ±5%, ±25%, ±10% standard.
Characteristics D, C, or E apply depending on T.C. required.

Computers for industrial process control demand long resistor life. To insure this, Dale Metal Film resistors are used extensively in the versatile Westinghouse PRODAC System. Value analysis dictated the choice—with the long life characteristics of metal film winning over the lower price of carbon and carbon composition types. Dale verifies this reliability with long-term load life tests (see below). Delivery is reliable, too. Expanded production facilities can put quantities up to 50,000 in your plant in 2 weeks (1% tolerance units). We'll prove it—call 402-564-3131 today.

NEW METAL FILM LOAD LIFE DATA

Dale MF resistors have undergone 16,320,000 hours of load life testing without a failure (100% rated power, 70°C; failure defined as $\Delta R > 1\%$). Based on these tests, the MF resistor has a proven failure rate of .004% per 1,000 hours (60% confidence at 50% power, 70°C ambient). Write Dale for complete test data.

FOR COMPLETE INFORMATION CIRCLE NO. 181

DALE

for optimum value in industrial resistors

DALE ELECTRONICS, INC., 1304 28th Ave., Columbus, Nebr. 68601 In Canada: Dale Electronics Canada, Ltd.

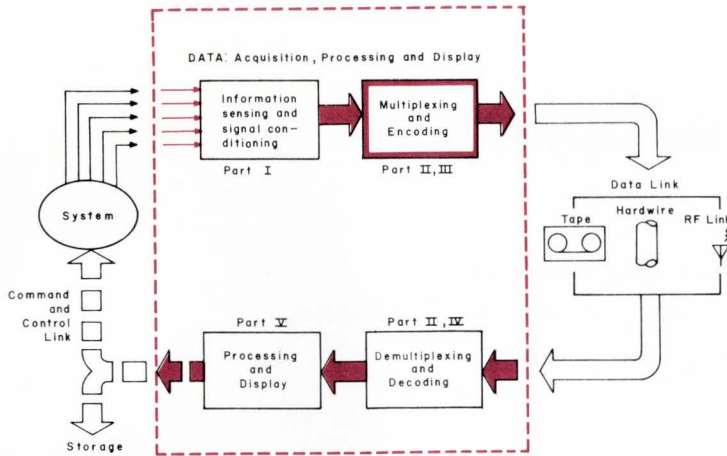

Data: acquisition, processing, and display

Last month's article on frequency-division multiplexing (FDM) detailed one method of sending several data channels down a single transmission medium —by putting the information from each channel into a different frequency band.

Time-division multiplexing (TDM) is another technique for achieving the same end. Information channels are

sampled, one at a time; then each sample is encoded into pulses that represent the analog value of the data at the instant it was sampled. The transmission medium carries a serial train of pulses that represents all of the inputs.

Intuitively, it would seem that the continuous data FDM provides would be more accurate than those samples, but that is not necessarily the case. As long as the sampling rate is five times

(theoretically, only twice) the highest data frequency being sampled, no information is lost.

First developed for telemetry, TDM has been refined to such an extent that it has found applications in control loops; in digital voice communications; and in instruments such as DVMS, counters, and frequency meters. You can probably think of a few other places to use it.

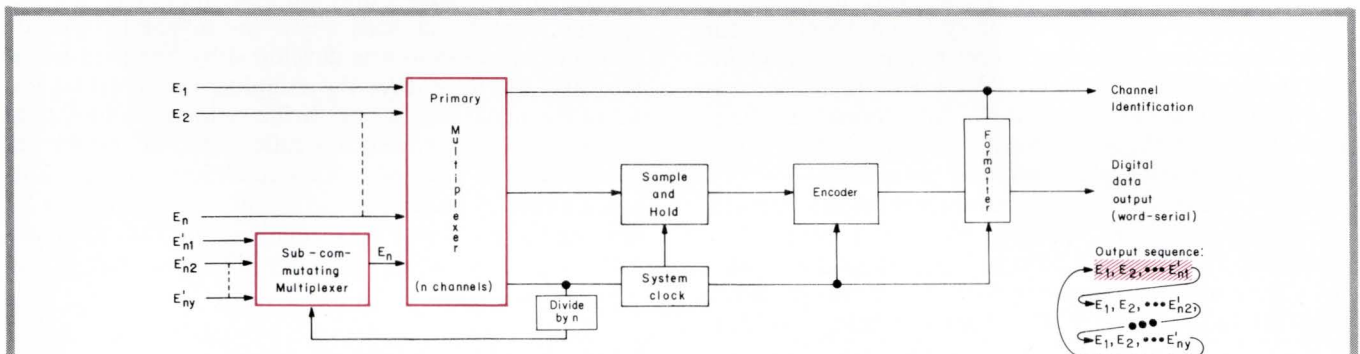

Sampler. In time-division multiplexing, a single set of electronic equipment digitizes several data sources (by sampling each source at a different time). At the start of the sampling sequence, the first clock pulse turns on the multiplexer switch that connects the first data source to the digitizing electronics. The analog voltage at this instant in time is **sampled**, then **held** until the encoder converts this value to a digital word. As it is clocked, the multiplexer sequences through all n data sources, one at a time.

If some of the sources change at a much slower rate than others, there is no need to sample them as frequently. A slower, subcommutating multiplexer switches to one of these sources only for every n th clock pulse; it takes y passes through the primary multiplexer to sam-

ple all inputs. Each data block generated by a single pass through the primary multiplexer is called a **prime frame**; while the data block generated after scanning all sources is a **sub-frame**. (In the output sequence, each row represents a prime frame, the total sequence shown is a sub-frame.)

If some data sources require a higher sampling rate, they may be connected to more than one of the primary multiplexer inputs. Those channels will then be **super-commutated** during each prime frame.

Often, one or more channels are reserved to present a specific digital code word for frame identification and channel synchronization. For example, channel 1 could be used to identify each prime frame, while channel E'_{ny} could supply sub-frame identification.

Time-division multiplexing

Now you see it, now you don't. By sampling the data, time-division multiplexing accommodates it all in a single channel, simply and efficiently—without losing information.

By **Harry C. Morgan**, Project Leader
Autonetics, division of North American Rockwell, Anaheim, Calif.

From the earliest telephone relay switching "trees," to the electronic multiplexers of today, time division multiplexing (TDM) has developed into a fine art. And the techniques and tools of TDM that were developed and refined for aerospace telemetry systems have now become practical for a much wider range of applications. Also, the advent of powerful, low cost, general purpose computers makes it feasible to automate testing systems or process control systems.

What is time-division multiplexing?

Basically, TDM is an analog-digital data system which samples a number of analog voltages, queues them into a serial chain of pulses, and then converts (encodes) each analog sample to a digital number for subsequent transmission, recording, or processing directly by a digital computer. Accessories of the system are a clock that synchronizes and starts system operations, and a "channel analyzer" that determines which data input has been digitized. In addition, we use a data formatter whenever the bits in the words must be rearranged for some methods of recording or computer processing.

Often, one or more analog input channels are reserved to present a specific recognizable digital code. The computer interprets this code as input channel zero and then uses internal computer logic (such as an index register) to determine which channel is being received. If the data system is part of a specific integral system, such as a missile, the data system clock is either keyed to or replaced by the computer clock system itself.

There are several types of TDM

The most common form is called *fixed time multiplexing*, where each analog channel is sequentially sampled. An important but less common form is called *demand multiplexing*, where input data channels are monitored and the sampling rate is increased or decreased to match the rate of change of the information. In some systems (such as rocket-engine testing), this is done by using fixed programs which change the sampling rates at specific times; in others sampling is under computer control.

How fast can we sample?

Information theory helps us to find the limiting frequencies at the input channel for specific sampling rates and sampling intervals.^{1,2} The following formula for the minimum sampling frequency is adequate for the design of the usual multiplex data system.

$$f_p = 2 \frac{f_h}{m}; \text{ where}$$

- f_p = sampling frequency
- m = largest integer not exceeding f_h/w
- $w = (f_h - f_l)$ = modulation-frequency (signal) bandwidth
- f_h = highest frequency limit of modulation-frequency (signal) band
- f_l = lowest frequency limit of modulation-frequency (signal) band

The formula shows that the minimum sampling frequency must be at least twice the signal bandwidth. This theoretical ratio was developed by Shannon in the late '40s, but in practice the sampling rate must be five times the signal bandwidth. If the ratio is too low, false lower frequency waveforms called *aliasing errors* are generated (see page 67). This condition can be eliminated either by increasing the sampling frequency or by limiting the maximum frequencies in the data channels with passive or active frequency filters as part of the signal conditioning.

Basic electronic multiplexer circuits

The first practical electronic multiplexers used semiconductor diodes as the switching elements. They provided accuracies of better than 0.05% and stepping rates greater than 1 MHz.

Transistor multiplexers became practical in the late fifties when their collector-to-emitter saturation voltages dropped under 0.1 V. Their acceptance received a boost when switching transistors became available as a matched pair on a single semiconductor chip with saturation drops of less than 1/2 mV.

In 1960, junction-field effect transistors (JFETs) became available. It was soon found that the depletion-mode JFET (a gate voltage is required to pinch-off the conduction channel) made an excellent analog

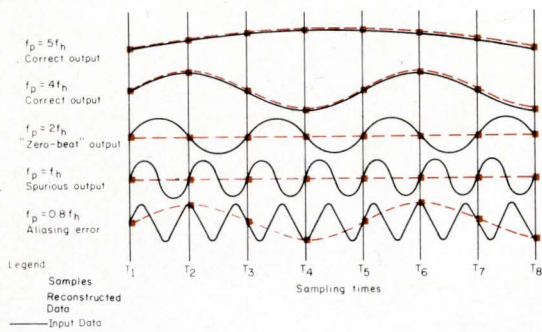

switch. When the gate voltage is zero, the JFET is simply a semiconductor resistor, and the only drop across it is that due to the multiplexed voltage.

In the early '60's, the MOSFET (metal-oxide-semiconductor field effect transistor) was introduced. Now MOSFET multiplexer transistors are available with a channel resistance of 20 Ω or less at a gate voltage of 10 V. Although channel resistances of JFETs are usually greater than those of MOSFETs due to chip layout problems, even these devices have recently become available with channel resistances below 30 Ω . The insulated gate of the MOSFET allows a simpler gate drive circuit, but just as with JFETs, we must insure that the MOSFET remains ON or OFF during the maximum analog data voltage swing.

All of the multiplexer circuits shown on page 68 can handle both positive and negative data voltages. Since the data is conditioned, peak-to-peak voltage swings are seldom greater than 20 V. Both JFET and MOSFET multiplexers are more suitable than the transistor and diode types for low level data (<1 V) because their voltage drop is lower than that across a semiconductor junction. They are not always better for the user, however, since switching transients feed through the MOSFET gate capacitance to the multiplexer output. This becomes important for low data voltages and channel sample times less than 10 μ s.

The MOSFET multiplexer has recently become very important where system size and weight are critical. As many as 16 multiplexer switches integrated with some switching logic are now available on a single chip.

Where input ground isolation is important, we use optical multiplexer coupling or transformer coupling. For medium-speed multiplexing applications, transformer coupling with data channel amplification by magnetic amplifiers has proven very practical. However, semiconductors are used for general multiplexing, with accuracies of 0.1% or better.

Some large, high-speed analog-digital data systems use the old "relay tree" concept to save parts or economize on power. In such trees, groups of low-speed multiplexers feed their outputs into a high-speed multiplexer.

Sample-and-hold circuits

Since the encoder takes a finite time to convert the

How sampling rates affect the data output. The curves illustrate Shannon's theory that for a sampling system to yield accurate data, the sampling rate f_p must be greater than twice the data frequency f_h .

For curves (a) and (b), the sampling rate is much higher than the data frequency, so the output is correct. For curves (c) and (d), the sampling rate is an integral multiple (<2) of data frequency; sampler output is dc. (Their output is zero; were the two curves shifted left or right in time, the outputs would be other dc levels.) In curve (e), sampled too slowly, the output frequency is only $1/5$ the actual data frequency.

data from analog to digital form, rapidly changing data can cause errors. If the data change during the sampling interval is greater than the value of the least significant bit in the binary word, a spurious output results. The solution is a circuit that *samples* the analog signal fast, then *holds* this value as a dc level for the full conversion time. This is the basis of the sample-and-hold circuit.

These circuits are also usually required when the multiplexed sample interval is <5 μ s and the accuracy must be >1%. To get such accuracy, the *time constant* of the switched circuit and the *charge-storage time* of the switching element must be large enough so that the time for the multiplexer output to reach its final value is a major fraction of the multiplexing time.

The basic sample-and-hold circuit is a normally-open switch that closes for a very short time interval so that the analog voltage value can be stored in a memory element. This value is then held constant, independently of the input signal, while it is encoded. The memory element (often a capacitor) is buffered from the output to minimize decay error.

Where the change in data voltage is more than the least bit during the multiplexer period, the data channel is sampled at the beginning of the multiplexer's normal sample interval. When the multiplexer risetime is too slow and does not allow enough encoding time, the sample-and-hold circuit takes its analog sample at the end of the multiplexed interval, with the voltage closest to its final value. The encoder then digitizes that voltage while the next data channel is switching to the multiplexer output and is rising to its final accurate value.

The digitizing process

The critical step in any analog-digital data system is the encoding of analog data. Most encoders (often termed analog-to-digital converters) use the binary system—their output is the digital equivalent of the analog voltage expressed as a binary number, either as time serial or time parallel pulses or voltage levels. A majority of the existing analog-digital encoders are closed-loop analog-digital servo systems.

The A-D encoders can be divided into six general classifications:

- space encoders
- chronometric encoders

Multiplexer circuits

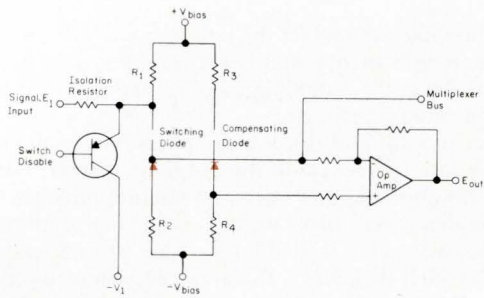

Balanced diodes

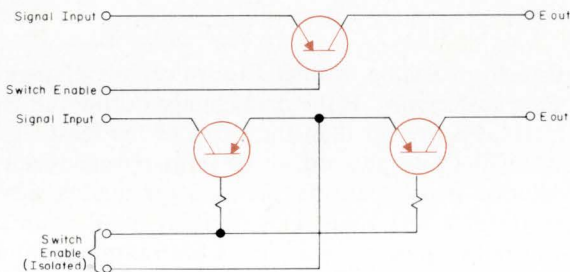

Bipolar transistors

Semi switches. Semiconductor devices are often used as switching elements in multiplexers. Diodes and bipolar transistors are preferred for fast stepping rates (>1 MHz); FETs are chosen for low-level (<1 V) inputs where junction voltage drops cannot be tolerated. The saturation

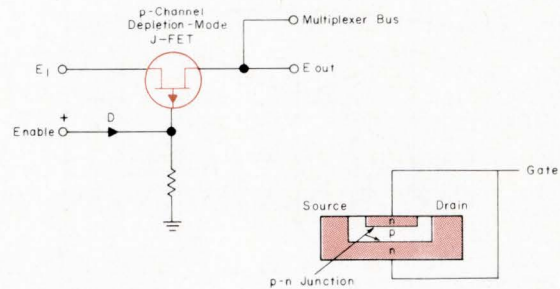

Junction FET

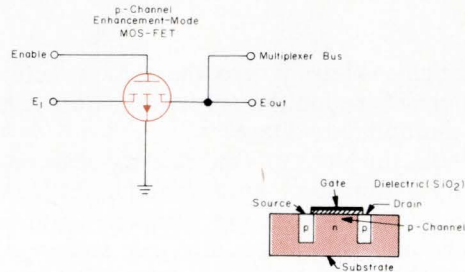

MOS FET

voltage drops cancel in the matched bipolar transistor pair, which also simplifies the isolation of their bases from the output. Compared with the JFET, the MOS FET requires more gate voltage to conduct (-3 to -8 V), but its insulated gate allows a simpler gate drive circuit.

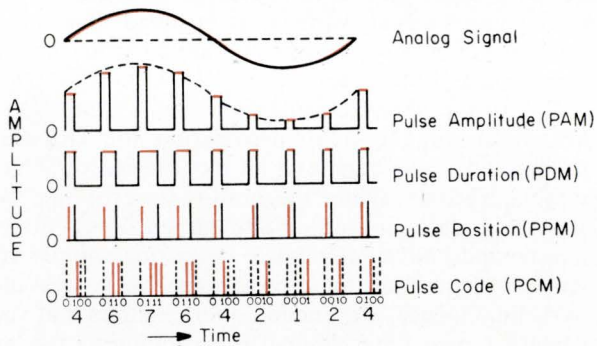

Pulse modulation systems. Periodic sampling of the input sinewave yields the pulses shown below it. This is called **pulse-amplitude modulation (PAM)**, because the pulses directly modulate a carrier.

Since amplitudes are degraded by noise, it is better to convert the information to constant-amplitude pulses. **Pulse-duration modulation (PDM)** carries the information in the pulse width, which varies with the amplitude of the signal at the sampling time. If this waveform is differentiated, then rectified, **pulse-position modulation (PPM)** results. The distance between two pulses represents the sampled amplitude of the sine wave, with the first pulse as the zero time reference. Average system power for PPM is much lower than that required for PDM, but at the expense of greater bandwidth.

Both PPM and PDM use constant-amplitude pulses, but are still analog representations of an analog signal. To improve system performance we use **pulse-code modulation (PCM)**, where the sampled value is converted to a binary code. PCM data can be used by a digital computer without further processing.

PCM coding. Return-to-zero (RZ), non-return-to-zero (NRZ), and split-phase are the three common methods of coding in PCM systems. The RZ format is standard, easy for both coding and decoding. The NRZ format requires, on the average, half the bandwidth (or, conversely, it allows twice the data rate) of the RZ format. When accuracy is the prime criterion, use the Manchester split-phase format. It makes data easier to synchronize, because there is one transition from HIGH to LOW (or from LOW to HIGH) levels for each bit.

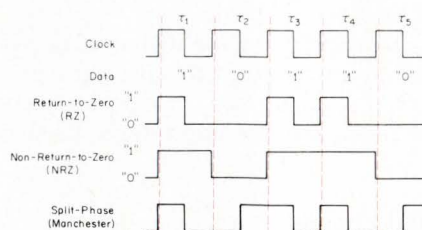

Sample-and-hold

Two popular sample-and-hold circuits. The MOS FET switch samples the inputs and charges a memory capacitor. The voltage across this capacitor is applied to the high-impedance, non-inverting input of the IC operational amplifier, which acts as an active buffer between input voltage and encoder. The diode bridge—a very fast switch—conducts current when both transistors are off. Since the input signal modulates this current, the operation is in the "sample" mode. When both transistors are ON the diodes are back-biased and the capacitor "holds" the signal.

The longer the multiplexed (sample) interval, the closer the capacitor will charge to the value of input voltage. As a function of the sampler time constant RC , the accuracy varies as follows:

Multiplexing time	Accuracy
1.0 RC	-26.8%
4.6 RC	-1.0%
6.92 RC	-0.1%
7.6 RC	-0.05%
9.2 RC	-0.01%
10.0 RC	-0.005%

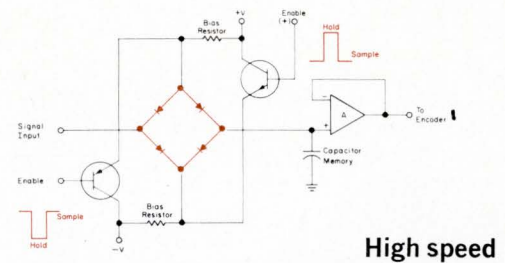
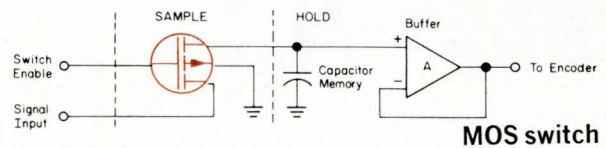

- successive-approximation encoders
- successive-comparison encoders
- time parallel encoders
- combination or special technique encoders

Space encoders

In the space encoder, a combination of physical elements (such as discs or optical masks) does the encoding. **Shaft encoder** and **cathode ray tube encoders** are typical examples of this classification.

The **shaft-encoder**, one of the earliest types, does not digitize an angle but is an important element in many data acquisition systems. It is actually a transducer that converts the angular position of an input shaft directly into a digital word. The earliest designs were based on brushes contacting the surface of a disc that was coded with alternating conducting and non-conducting segments. For greater reliability, magnetic and then capacitive code pickups were developed, finally ending in today's optically-coupled shaft-encoders described in Part I of this course (*The Electronic Engineer*, Dec. 1968, p. 53).

Brush encoders are still used where low resolution and low speeds are required, because the minimum size of contacts and brushes limit the maximum number of code elements that can be put on a disk. This upper limit is about 12 bits (the code disk is subdivided into 2^{12} increments).

Optical encoders are more suitable for high resolution or high speed. The speed limit generally depends on the readout electronics, while the present state of the art in resolution is 20 binary bits (2^{20} increments). Encoders of all types are now being used in military applications (radar systems, telescope and gun mounts), in industrial applications (machine tools and xy tables), and even in commercial devices.

The first all-electronic encoder was the **cathode ray tube spatial encoder** (shown on page 70). Designed by R. W. Sears of Bell Labs during the late 1940's, it remained the fastest digitizing method known until very

recently. But the best accuracy this encoder can have is 1% or 7 binary bits.

Unfortunately, the Sears design produced ambiguous readings—caused by the electron beam strobing at not quite right angles to the code pattern, or by the electron beam being half on, half off a code area. To correct this problem, Dr. Frank Gray, also of Bell Labs, worked out a variation of the regular binary code where only one digit could change from a zero to a one or a one to a zero at a time. This is the present-day Gray, cyclic, or reflected binary code. (Some shaft encoders use this code.) If such a code is used, special computer logic or programs are needed to decode the numbers into straight binary numbers.

Chronometric encoders

The common element in all chronometric encoders is an electronic counter which times or counts electrical events. Both the event and counter are scaled so that at the end of the encoding process the electronic counter contains a digital number equivalent to the data input voltage. This design could be simply implemented by a counter that would totalize the number of pulses from a transducer (which directly generated pulses proportional to some physical parameter).

Since transducers generate a voltage, not pulses, this voltage must be digitized. The single integration chronometric encoder was one of the early techniques used for analog-to-digital conversion; but double integration is a more modern and accurate method.

The advantage of double integration is that it averages out input random noise. These circuits are in use in data systems and digital voltmeters, where accuracies of 0.10% of full-scale reading are now common.

Successive-approximation encoders

The successive-approximation encoding technique is widely used today and is the fastest conventional time serial logic known. More encoders of this type are used

Encoders

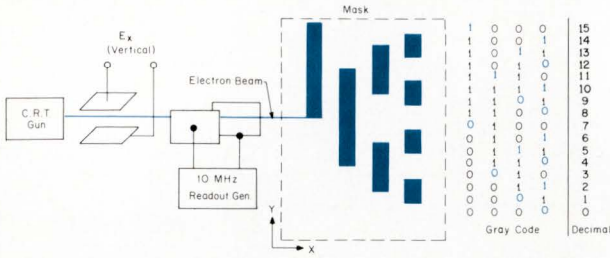

Cathode-ray-tube spatial encoder. Vertical plates of CRT deflect the beam according to magnitude of analog video signal. This beam falls on a binary-coded (Gray code) readout mask at the end of CRT. A high-frequency readout generator strobes the beam from right to left, giving a time-serial binary-coded output. Gray code is less sensitive to errors than straight-binary code, because only one digit changes at a time.

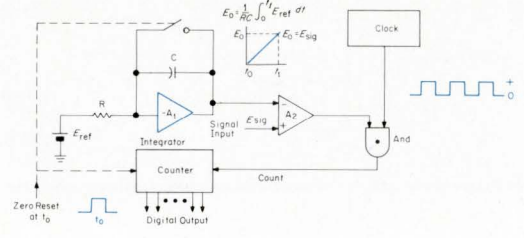

Single-integration chronometric encoder. Linear ramp generated by integrator A1 converts analog input to digital. At t_0 , the counter is reset to zero and the integrator capacitor discharged. As long as E_0 is smaller than the signal voltage to be digitized, the output of A2 is positive, gating clock pulses through to the counter. When E_0 exceeds E_{sig} , the output of difference amplifier A2 goes negative and closes the AND gate. The counter stops, and its output is directly proportional to the signal voltage. Scaling factor depends on clock rate, slope of ramp, and on leakage of capacitor C.

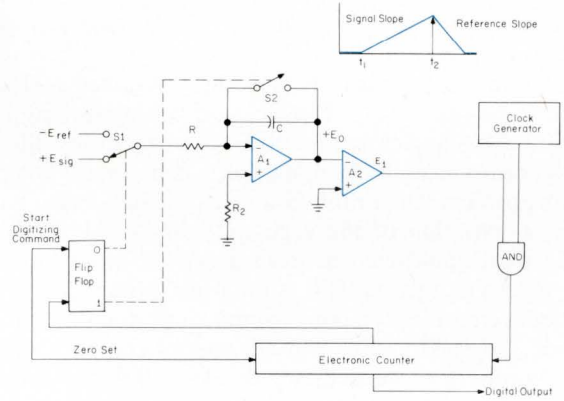

Double-integration chronometric encoder—Dual-slope integration. On receipt of a "start" digitizing command, counter and mode-control flip-flop are set to zero. At t_1 , one output of the flip-flop momentarily shorts the integrator capacitor C to discharge it. The other side switches and holds S1 closed for a time t_2 , while A1 integrates the unknown voltage E_{sig} . Both A1 and A2 doubly invert E_{sig} , applying it as a positive voltage to enable the AND gate, thus gating positive clock pulses to the electronic counter. When this counter overflows one clock pulse beyond t_2 , it sets the flip-flop and resets itself to zero. The "one" (or true) output of the flip-flop switches the integrator from E_{sig} to the negative reference voltage E_{ref} . The integrator then goes back to zero voltage at a fixed, known negative ramp. The instant the integrator output reaches zero, the output of difference amplifier A2 goes negative, and disables the AND gate. The counter stops accumulating clock pulses, and now contains the digital equivalent of input voltage E_{sig} .

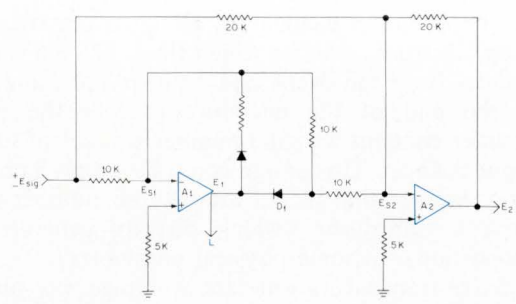

Rectifier encoder used when the data source generates both positive and negative excursions, yet the logic requires a positive signal. When input voltage E_{sig} is positive, E_1 is negative, diode D1 conducts and the input to the second amplifier is negative and of the same magnitude as E_{sig} . For the values of feedback resistors shown, output E_2 is equal in sign and magnitude to the positive input signal. When the input signal is negative, D1 disconnects E_1 from the second amplifier. Amplifier A2 acts now alone and inverts the negative input voltage with unity gain. Again the output voltage is equal in magnitude to the input signal and still positive. The output of the first amplifier at E_1 may be used to indicate the polarity of the input voltage.

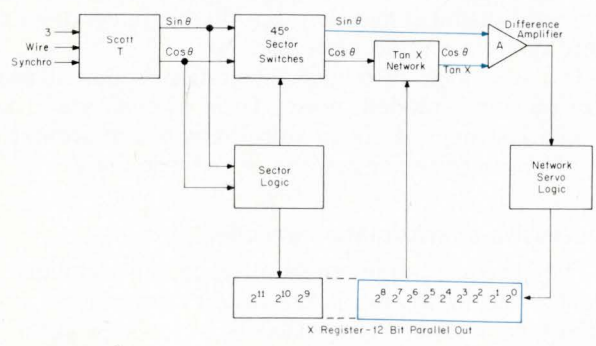

Synchro-to-digital encoder. The 3-wire ac information is first changed into 2-wire information by a transformer whose outputs are the sine and cosine of the synchro shaft position θ . Logic compares the magnitude and signs of these two values and determines which 45-degree sector (out of the 8 sectors in a 360-degree rotation) the shaft is in. The sector number is stored as a three-bit word in the output register. To digitize the angle, the larger of the sine or cosine feeds a difference amplifier, while the lesser of the two is first multiplied by $(\tan X)$, then fed to the amplifier. The flip-flops in the register also control the $(\tan X)$ network (a nonlinear resistance ladder). When the register count X is equal to the servo angle θ , the output of the difference amplifier becomes zero (because $\sin \theta = \cos \theta \tan X$) and the servo logic stops cycling. The angle register contains no more than 9 bits, limited by the accuracy of standard synchros.

Voltage-summing successive approximation encoder follows the equation $E_{sig} - E_{bits} = 0 \pm 1/2 \text{ LSB}$. At time t_1 , the most significant bit weight is turned on and all of the other bits are reset to zero voltage. Each bit voltage weight try is called a "conditional set." Just before each next bit voltage is turned on, the last bit voltage weight to go on is turned off again if the bit sum is greater than the input analog voltage. This is called a "conditional reset." This continues to the end of the conversion time. In operation, all of the flip-flops which control the ladder switches are zero-set via OR gates, except the most significant bit, which is one-set. The "conditional reset" time t_i AND the output of difference amplifier A (error amplifier), reset the most significant flip-flop (provided the output of A is high, because $E_{bits} > E_{sig}$). The timing logic sequences through the flip-flops until each bit weight voltage has been tried and either left on or reset. The stage of the flip-flops now contains the binary number equivalent of the E_{sig} analog voltage.

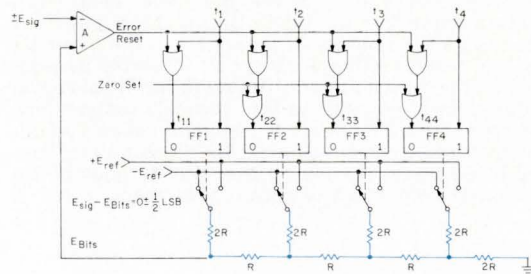

Current summation successive-approximation encoder. When the bridge is balanced, $E_{sig}/E_{ref} = R_{range}/R_{bits}$. The servo loop, consisting of the error amplifier and flip-flops, varies the parallel sum of bit weight resistors until the bridge balances. At null, current supplied from E_{sig} via the resistor R_{range} equals the current supplied from the reference, and $i_{sig} - i_{bits} = 0 \pm 1/2 \text{ LSB}$ (least significant bit). This circuit accepts positive inputs only; the addition of a constant positive current i_r (from a zener reference diode) at the input permits handling negative values as well. In this case $i_r + i_{sig} - i_{bits} = 0 \pm 1/2 \text{ LSB}$.

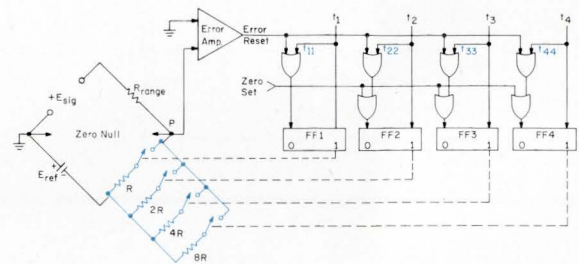

DAC ladder combines both current summation and voltage summation. Binary decrements of currents are summed at the inverting input P1 of operational amplifier A. Its output voltage $+E_{bits}$ drives P1 to virtual ground through feedback resistor R_{fb} . When each logic-enabling voltages L_1 through L_4 are $\cong 1 \text{ V}$ above ground, they back-bias their diode D2, cutting off the current to the summing point P1. If L_1 through L_4 is $\cong 1 \text{ V}$ below ground, diode D1 is cut off and D2 supplies current to the summing point P1. If negative voltage $-V$ is sufficiently large, the binary-increment resistance ladder acts as a passive constant current source, eliminating the error contributions of the D2 diode drops. To convert this circuit to bipolar outputs ($\pm E_{bits}$) add either a constant, positive, half-scale pull-up current, or a single, positive, diode-switched constant current.

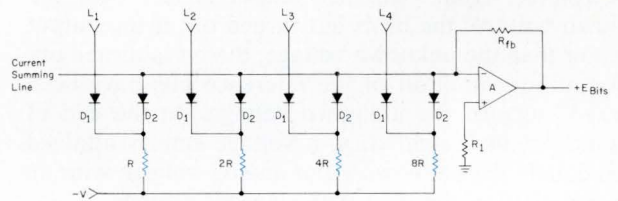

Time-parallel encoder has a reference voltage for each and every binary number value, and detection circuitry for each reference voltage (to determine if the analog voltage E_{sig} is within $1/2$ a binary increment of each voltage). This encoder is fast, but requires a lot of hardware. Since the decisions are essentially in parallel, the binary number decision requires only one amplifier delay time, but at the expense of fifteen difference amplifiers for four significant binary digits. The output of all amplifiers is coded into four-line output codes.

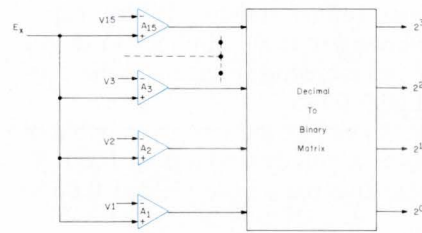

Tracking chronometric encoder combines a current-summation D/A converter with logic similar to that in a chronometric encoder. Note that two difference amplifiers are required. If null point P is positive, amplifier A1 enables a countup AND gate. This advances the counter and the bit weight sum to greater values in one least-bit increments. If P1 goes negative, amplifier A2 enables the count-down AND gate and the counter goes down towards lower numbers. If the error is zero, the counter stays inactive or—if the null is too sensitive—"hunts" between two or three adjacent numbers. This encoder tracks the input up and down, is always ready to read out. If the code is not Gray, use logic "hold" circuitry to eliminate ambiguous readings.

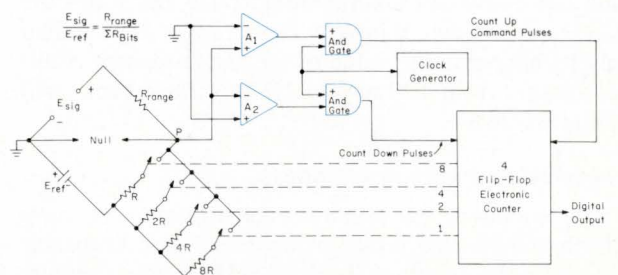

Seven-channel tape code, devised by IBM, uses seven parallel magnetic recording tracks at a linear bit density of 200 bits/in. The table shows bit positions, transverse to tape length, and the associated assigned characters. Fifth and sixth bit positions, when not zero or associated with bits in the first four positions, represent letters and special characters. The seventh channel is reserved for the error-detecting "parity bit". Seven magnetic heads read or write transverse to the tape. During recording, the formatter counts the number of binary 1's in the lower six channels, and inserts either a "1" or a "0" in the seventh track to make the total number of 1's **odd**. During playback, an error-detecting circuit checks for "vertical" redundancy, and turns on an error signal when it reads an **even** number of 1's. Most formatters check also for "longitudinal" redundancy in all tracks, to insure that the number of 1's in each track of every block of data is also even.

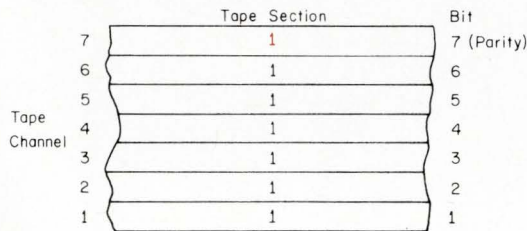

	Bit 6	5	4	3	2	1	
✓ Tape Mark	0	0	1	1			
‡ Group Mark	0	0	0	0			- 8
Segment Mark	0	0	0	1			1 / J A
△ Mode Change	0	0	1	0			2 S K B
‡ Record Mark	0	0	1	1			3 T L C
= Word Separation	0	1	0	0			4 U M D
	0	1	0	1			5 V N E
	0	1	1	0			6 W O F
	0	1	1	1			7 X P G
	1	0	0	0			8 Y Q H
	1	0	0	1			9 Z R I
	1	0	1	0			0 ‡ ! ?
	1	0	1	1			# , \$.
	1	1	0	0			a % * □
	1	1	0	1			=
	1	1	1	0			
	1	1	1	1			✓ △ ‡

in multiplexed analog-digital data systems than in any other kind.

Starting with the most significant bit, the weight of each binary bit is fed to a voltage summer and the output of this summer is compared against the unknown input voltage. If the summer output is less than the unknown voltage, the bit is left turned on; if the output is greater than the unknown voltage, the bit is turned off. This continues until all of the reference bits have been "stacked" against the unknown voltage. At the end of the series of bit weight tries, a voltage sum is attained which equals the unknown input analog voltage with an accuracy of $\pm 1/2$ the least significant bit weight.

Most successive-approximation encoders are closed-loop analog-digital servos consisting of three main elements: a D-A converter (either resistive ladder, capacitance DAC, or inductance DAC); an amplifier to detect the difference between input analog voltage and the converter output; and a digital servo.

Resistance and inductance DAC ladders are capable of at least 0.01% absolute accuracy and up to 0.001% relative accuracy. Capacitive DACs have yielded 0.05% accuracies.

The logic of the current summation successive-approximation encoder is identical to that of the voltage summation successive-approximation encoder, but it has the advantage that different input voltage ranges are handled simply by changing the value of the range resistor. Full-scale voltages from 100 mV to 1000 V have been used in actual hardware.

Successive-comparison encoders

These encoders are usually asynchronous and have not been widely used because they need logic to disable them over the readout interval. They also require

decision amplifiers for each bit weight. The advent of inexpensive IC amplifiers, however, has made new circuits and hardware practical for many applications.

Time parallel encoders

The basic principle of time parallel encoders is quite simple. There is a reference voltage for each and every binary value, and detection circuitry for each reference voltage to determine if the unknown analog voltage E_x is within $1/2$ a binary increment of each voltage. Since the decisions are essentially in parallel, only one amplifier delay time is required for the binary number decision.

The main advantage of these encoders is speed. For example, a 4-bit, 10-ns parallel encoder (100 MHz rate) was designed and built at Autonetics in 1968. Their main drawback, on the other hand, is the large amount of hardware they require for more than three binary bits, although ICs are easing this problem somewhat.

For four significant binary digits, time-parallel encoders require 15 difference amplifiers, each one with its own reference voltage at its inverting input. The output of all amplifiers must be coded into four-line output codes. Since the encoder is asynchronous, it is better to use Gray code (to eliminate "crack" readings). The encoder also requires feedback logic, for only the highest activated difference amplifier must energize the matrix.

Data compression saves power

Data compression, as applied to encoding, consists in modifying the usual linear relationship between *input analog voltage* and *output binary number*. It is used, for example, on a space mission where transmitter power must be conserved and only significant data transmitted.

Or, it can be used to achieve more resolution with the lower signal levels than with the higher levels from a transducer. With time-parallel encoders, this might be done by using reference voltages on the lower difference amplifiers that increase in 0.1-V increments up to the amplifiers used for the least significant bits, then in increasingly large increments up to the last amplifier.

One special kind of analog-to-digital conversion used in both aerospace and industrial systems is *synchro-to-digital*, which converts shaft positions to relative amplitudes (on three wires) of a carrier frequency. To add digital control to a system, we must furnish synchro position information as a digital number.

Tape coding and formatting

Telegraph systems were among the first to use special codes which permitted automatic operation of teleprinters or paper tape perforators. Early digital computers (and today's time-shared computers) took advantage of such teletypewriter equipment and of the paper tape codes.

At present, the major medium for data recording is magnetic tape; cards are also used but are not as efficient for mass storage. While magnetic tape has been used for about 20 years for analog data recording, digital data recording began about 15 years ago. It has become the standard method of off-line computer data storage. The design of read/write pickup heads limits the maximum width of magnetic track to 0.02 in. and magnetic tape transports can handle no more than 10 parallel recording tracks on 1/2-in.-wide tape. Binary bit recording densities on a single track have reached 2000 bits per lineal inch, but due to tape skew and other problems, present computer tape handlers only go up to 800 bits/in.

Data is usually recorded on magnetic tape as a "non-return-to-zero" (NRZ) signal (discussed earlier). The NRZ method by IBM is called NRZI since it has the added feature of recording only "ones." (Binary zeros do not change the magnetic flux on the tape.)

Two other data coding systems in general use today in magnetic tape systems are: the 9-channel Extended BCD Interchange Code (EBCDIC) used in both the RCA Spectra 70 and the IBM System-360 computers, and the 9-channel American Standard Code for Information Interchange (ASCII).

The logic of a typical formatter consists essentially of a number of flip-flop binary memory elements to temporarily hold all data and identification information, simple counting logic to add parity bits, and gating logic to permit "clocking" out the data in the proper time parallel and serial order required by the particular code format. Line driver amplifiers or amplifiers to drive the recording heads are needed to match the formatter to the recording or other output device.

Where do the errors come from?

The maximum error of a data system is the sum of errors of each subsystem, with an appropriate weighing factor that accounts for the significance of each error to the system total. The unit that establishes the maximum system accuracy is the encoder, because it performs the main digitizing function.

Multiplexer errors are basically analog in nature (provided all sampling rates and intervals have been

properly established). Even though we can compensate for most of the errors by calibrating the equipment with known data inputs, environmental and aging factors still produce system errors.

Before we discuss any errors, let us clarify the relationship between *accuracy* and *resolution* in encoders.* Like most analog instruments, *chronometric encoders* can have greater resolution than accuracy because they continuously count increments. *Successive-approximation encoders* should have equal resolution and accuracy. If their resolution were greater than their accuracy, they would miss numbers (mostly near half, quarter, and three-quarter scale). *Shaft encoders*, on the other hand, can have a much higher accuracy than resolution.

The first kind of error is the *digitizing error*, which amounts to $\pm 1/2$ the least bit value. The second kind can be called *static error*, due mostly to the inaccuracies of the DAC ladder or to integrator resistance and capacitance. Another such analog error source is the non-infinite gain of the error amplifier. Finally, the resistance variations of the switching semiconductors, and the power supply accuracy, also contribute to analog errors.

The third kind is the *dynamic error*. Capacitance or inductance, present in resistance ladders, can produce either a "ringing" oscillation of a bit or multiplexed waveform, or an RC time constant rise-time error. Also, semiconductor current carrier storage time can add to errors.

The fourth kind is the *environmental error*, due to temperature, vibration, electrical noise, and so forth. The operating power dissipation of the hardware is also a temperature problem.

The last kind is the *aging error*, produced by components that change value or operating characteristics with time, which in turn can change the operating accuracy of the encoder or multiplexer. Part failures must also be considered as an error of this class.

Except for the digitizing error, all of the errors just discussed usually add geometrically (*rms error*). A *worst case* error sum is sometimes used for critical applications to help decrease the system failure rate. A more sophisticated technique is to determine the shape of the distribution error curve for each component and so alter its error contribution to the total system error.

***Accuracy** is the difference between a reading and the true value, whereas **resolution** is the minimum value that can be read.

Bibliography

- Goode & Machel, *Systems Engineering*, McGraw Hill Book Co.
Klein, Morgan and Aronson Inst. Pub. Co., "Digital Technique for Computation and Control".
Klein, Morgan and Rush, "High Speed Data Conversions and Handling," U.S. Patent 3,293,608 (General Data System Patent).
Morgan, H. C., "Clamping Circuit," U.S. Patent 3,164,775.
Barbour, C. W., "Cancoder No. 8, A/D Converter," *Instruments and Control Systems*, Vol. 35, Aug. 1962.
Naydan, Bob, "Modern D/A and A/D Conversion," Conference on Surface Launched Weapon Control Systems, June 1965.
Computer Industry Annual 1967-68, Computer Design Publishing Corp.
Richards, R. K., *Digital Computer Components and Circuits*, D. Van Nostrand Co., Inc.
International Telephone & Telegraph Corp., *Reference Data for Radio Engineers*, Fifth Ed., Chapter 21, Howard W. Sams & Co., Indianapolis, 1968.

INFORMATION RETRIEVAL:
Transducers, Instruments and
measurements, Data acquisition
and processing, Computers and peripherals



Camera Shy?

Don't be. Here's a truly compact CCTV camera (2 7/8" head) that delivers over 1,200-line horizontal resolution.

The Fairchild TCS-950B

It's ideal for those who have shied away from high resolution cameras because of their large sizes and price tags. Fairchild's new TCS-950B gives the sharpness and clarity of over 1,200-line horizontal resolution and 700-line vertical resolution. With the smallest head on the market and exceptionally compact design, the TCS-950B is perfect for data transmission, microscopic component inspection, flight simulation, photo interpretation, medical observation and a multitude of other applications.

If your CCTV needs are varied and sometimes unusual, you should also consider the versatility available with the TCS-950B:

- Switchable scan rates (either or both scan directions).
- Interlaced or sequential frame scan.
- Video polarity reversal.
- Scan polarity reversal.
- Militarized construction.

Reliability of the TCS-950B is ensured by Fairchild's solid-state Micrologic® circuitry. For its size and high resolution performance, it's one of the lowest priced cameras on the market.

New: The TC-177. You'll get remarkably stable, crisp, high-contrast video signals from this self-contained camera. Features Micrologic® circuitry, 800-line resolution (standard); 2:1 interlace, EIA sync remote control, high resolution (over 900-line), video polarity reversal and other options available.

For specifications and performance data, contact:

FAIRCHILD

SPACE AND DEFENSE SYSTEMS

A DIVISION OF FAIRCHILD CAMERA AND INSTRUMENT CORPORATION
30 PARK PLACE, PARAMUS, NEW JERSEY 07652
TEL. 201-262-7000 / TWX 710-990-6610



Wiring . . . some like it flat

Many engineers are going flat—with their wiring, that is. They have found that reduced size and weight are only two of many advantages of flat flexible cable and flexible printed circuitry.

By Smedley B. Ruth,
Associate Editor

Flat flexible cable (and flexible printed circuitry) has long excited the imagination of design engineers but, unfortunately, its use was more often than not confined to the engineer's imagination. But this is changing. The long-awaited emergence of flat flexible cable appears to be at hand as an increasing number of engineers take advantage of its many desirable characteristics.

Flexible and still tough, it is replacing the more familiar bundles of round wires in certain applications, particularly where there is a space or weight problem. However, its inherent size and weight savings are only two of its many advantages. Unfortunately, the others have not been so well publicized.

What prevented its acceptance?

But before we discuss these advantages, let's consider the factor that has prevented the wide acceptance of flat cable to date. Foremost reason is that the industry lacked satisfactory methods for terminating the cables.

Even though various methods were proposed over the years, most were unsuitable, and many felt that connector manufacturers were dragging their feet — that they were putting their efforts into what they thought were more lucrative areas. Some still feel this is true, but indications are that it is not—new connectors and techniques for terminating flat cable announced in the last year or two promise to correct the problem.

New connectors and terminations abound

An infrared bonding technique developed jointly by Bell Telephone Laboratories and Western Electric enables 50 or more connections to be made simultane-

ously. Infrared soldering has been used before, but to our knowledge not with flexible cable. Now Spectra Instruments Inc. has a similar soldering system (Model 717B) that can be used for this purpose. We're told that it can solder a flat cable to a connector even through Kapton®. The company also has an IR cable stripper that strips Teflon from the ends or some other area on the cable.

AMP Incorporated's "Insulating Piercing Crimped" termination for general purpose, non-environmental applications ("the majority of users don't need an hermetic seal anyway") has been well received. In this method, ears on the contact pierce the insulation on both sides of the conductor. These ears are then folded over to grip and force the insulated conductor up into a wire barrel containing insulation piercing tips which make contact with the conductor.

This technique shouldn't be used with soft insulations like polyvinyl chloride, however. Also, conductor center-to-center spacings can't be less than 0.100 in., although AMP claims that this will soon go to 50-mil centers.¹

Digital Sensors Inc. has the Flex-Weld® technique,² in which the termination is made by resistance welding through the insulation. The completed termination is then coated with an epoxy.

Another long-time welding advocate for flat cable (Termineweld™), Elco Corp., uses special welding equipment to melt the insulation away from the conductor

¹While most users are still not calling for 50-mil-center units, it's felt that the demand for these connectors is not far off. Most users currently want 75, 100, 125, and 150-mil centers. Connectors for flat cable that could accommodate 50-mil-center cable were not available for some time, but now several companies make them.

²Schmid, L. H., "Terminating flat cable by welding," *The Electronic Engineer*, July 1967, p. 70.

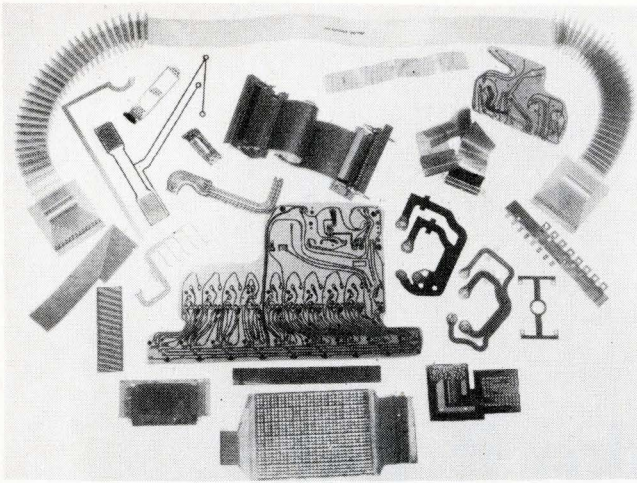

Flat flexible cable and flexible printed circuitry takes various shapes and forms as shown. These can be accordion pleated, rolled, contoured, flat or multilayered. (Flexible Circuits, Inc.)

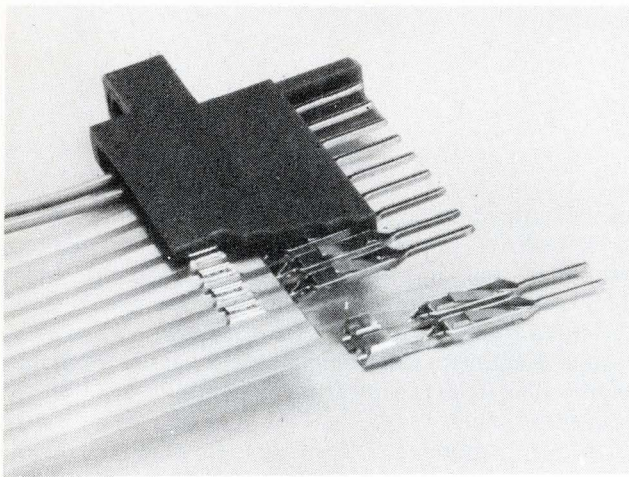

Crimp terminations are proving useful for non-environmental applications. Ears on the contact first pierce the insulation on both sides of the conductor. They are then folded over, forcing the conductor up into a barrel containing tips which pierce the insulation and make contact with the conductor. (AMP, Incorporated)

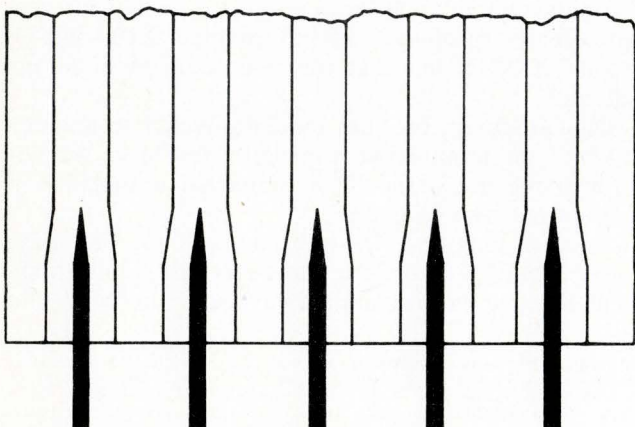

Knife-edge contacts in this system penetrate lengthwise into the conductor. (Cinch Manufacturing Co.)

and then weld the conductor to the connector terminal. The company now plans to offer complete flat cable harness assemblies.

Melting the insulation and welding the contact directly to the conductor is also the method used in Amphenol's "Ribbon Weld" process. Result is a gas-tight solid metal connection.

In a system developed by Cinch Manufacturing Co., knife-edge contacts penetrate lengthwise into the conductors. This method requires very little cable preparation and can be done in the field. Cable with center-to-center spacings as close as 50 mils can be handled.

Microdot and ITT Cannon are other manufacturers that recently announced connectors for 50-mil-center flat cable.

Some systems use a contactless approach. For example, in Rogers' Positerm system, the cable ends are creased and bonded around a rigid plastic mandrel. Then a plug is molded onto the cable. Finally a chemical process is used to remove the insulating film from contact surface portions of the conductors, which are then gold plated.

The Sim/Plug harness system, just announced by Electro Connective Systems, Inc., also uses the conductors themselves as contacts, whether the connector is a termination point, a branched conductor, or a part of a bussed system. Regardless of the number of interconnections, the cable is one piece and continuous throughout. Connectors can now be made for flat cable with from six to thirty-six 0.80-in. conductors on 0.100-in. centers.

Still another connecting method comes from 3M Co. This self-stripping device, called a "U" contact, makes gas tight connections to solid or stranded wire, from #30 AWG to #22 AWG. The connections are made by forcing the "U-type" element points through the cable's insulation, driving the legs down over the conductor. A base member supports the conductor and cable. It has narrow clearance wells to channel the legs of the "U" contact as they pass through the cable. Constant-pressure is applied to the conductor by the spring-reserve action of the contact.

In this system, wire gauges can be mixed in a given cable web. Wire spacings to 0.050 in. are available, as are balanced impedance systems from 50 to 300Ω. Although the "U" contact reduces the cross sectional area of the conductor, the tensile strength is not usually decreased by more than 18%.

It should be mentioned that NASA, an early advocate of flat cable, has developed connectors that use the flat conductors themselves as the contacts. NASA has also developed many tools for handling and terminating flat cables.

Thus, it appears that with satisfactory termination methods available, the major roadblock to widespread flat cable acceptance has been removed.

Another complaint against flexible cable is that a particular wire is in a fixed position and it's difficult to reroute it or break it out of the cable. So, what is an advantage for some users becomes a problem for others. In some cases the cable can be slit with a special tool and the wire properly routed. In others the cable can be folded or twisted to change the position of the wires. The use of a junction box has been suggested as another possible solution.

When discussing flexible cable or flexible printed

What is flat conductor cable?

The term flat conductor cable is often a misnomer as the conductor itself isn't always flat.

There are two widely used types of flat (or flexible) cable—etched and laminated. (A third type, commonly called "ribbon" cable, is another breed and will receive only cursory mention in this report.)

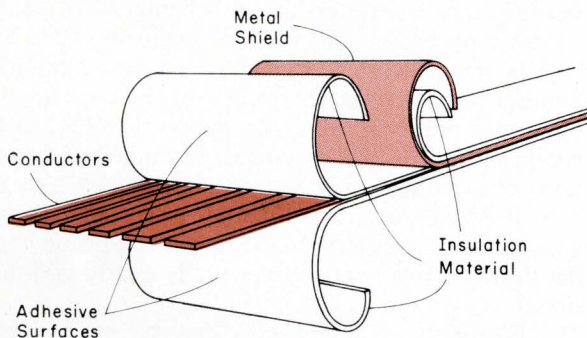

Single shield flat conductor cable construction. Various shielding configurations can be used, but they do affect the cable's flexibility.

The etched variety consists of flat, etched conductors bonded between thin (0.003 to 0.010 in.) layers of tough dielectric material. The insulating material may or may not require an adhesive, which often serves as an additional insulation. The conductors are etched in parallel rows or in an irregular pattern to conform to circuit requirements. When they are etched in such a pattern they are called flexible printed circuitry—usually a custom unit. The flexible circuitry can be etched in almost any complex configuration. (As an example, see the illustrations on page 76.)

The laminated type consists of either flat or round wires laminated between thin layers of dielectric material. The conductors are uniformly placed and parallel to each other, but the center-to-center spacing between them can be varied.

The two above descriptions are typical cases, but there are always exceptions. For example, the cables can be made with a shield on one or both sides, with the outer conductors in continuous contact with the shielding material (usually a 0.0005-in. thick solid or perforated foil, but sometimes corrugated foil or even a conductive coating deposited on one or both sides). If a shield is used, however, it will affect the cable's flexibility.

The cable may also be stripped bare and plated in spots so that terminations can be made to it. Or, it may have connecting pads, holes and other refinements.

The third type mentioned earlier is called ribbon cable. It has multiple round or flat discrete wires in an insulating material parallel to each other and in the same plane. Coaxials, twisted pairs, shielded triads, vertically stacked pairs, leads shielded with braids, served foil, or overall cable shields can be combined in the same cable.

Several companies have demonstrated their ability to make still another type—multilayer flexible cables. Up to 16 layer circuits have been made, but once you get past, say five or six layers, the circuit is no longer very flexible, even though it can be bent around curved surfaces.

Advantages of multilayer flex circuits are very high interconnection density and short conductor routing. Also, because they are more rigid than single layer types, you can mount components on them.

Let's compare the two most common types of flat cable.

Etched

- 1) Usually a batch process* and requires artwork.
- 2) Can make a very complex system—lines don't have to be parallel.
- 3) More expensive for long lengths.
- 4) Can only laminate standard materials—polyesters, polyimides, and epoxies—as these aren't affected by conductor etchants.
- 5) Use only flat conductors.
- 6) Loses a little of its ductility during processing. Possible to get pinholes due to dust and dirt, but this is generally not a serious problem.
- 7) Takes two steps to laminate on both sides.
- 8) Tolerance on line widths can be held closer.

Laminated

- 1) Continuous process and can be readily tooled.
- 2) Lines must be parallel although they are sometimes spread at the ends.
- 3) Much cheaper in long lengths.
- 4) Can laminate anything that can be adhered together.
- 5) Can use flat wires, or stranded or solid round wires.
- 6) Loses none of its ductility during processing.
- 7) Can laminate on both sides in one step.
- 8) Tolerances on line widths not as close.

*Although etched flat cable is normally a batch process, several companies (Electro Connective Systems, Rodgers, and Schjeldahl) publicize theirs as a continuous and economical process. Others claim the capability, but say cost is prohibitive.

circuitry, a question that always arises is "How are repairs made?" Understandably, this is an area of concern for the prospective user. However, the manufacturers feel that the many advantages of flexible cables (flexibility, tensile strength, tough insulation, and so forth) make them extremely reliable and almost eliminate the need for repairs.

When repairs are needed, sometimes a section of the harness can be replaced, or a short conventional piece of wire used as a jumper past the failed area. The ability to repair depends upon many factors—the nature of the failure, the location of the failure, the type of insulation, the connector or termination being used, and so forth.

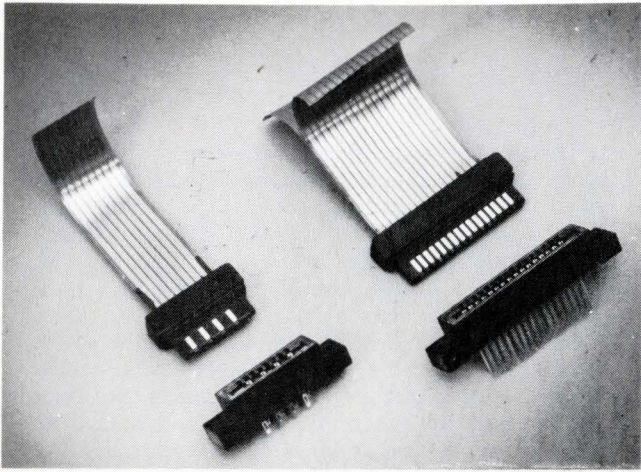

This one-piece harness system uses the flat conductors themselves as contacts. Various contact tails are available. (Electro Connective Systems, Inc.)

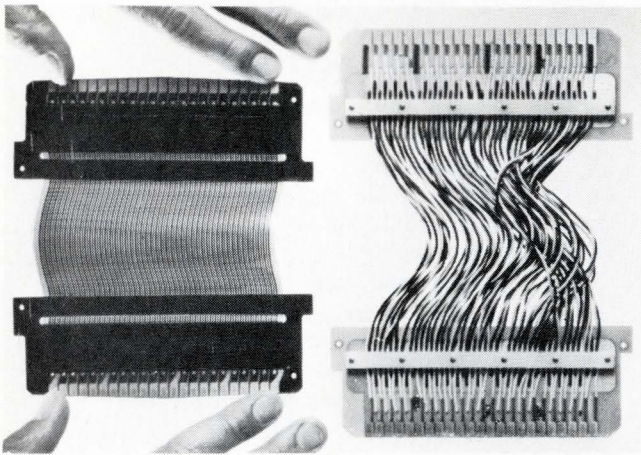

Flat cable advantages are obvious in this photo of intra-frame jumpers for a computer. In addition to being cheaper than the conventional wire jumper, the mass-terminated flat cable version is neater in appearance and more reliable. (Rogers Corp.)

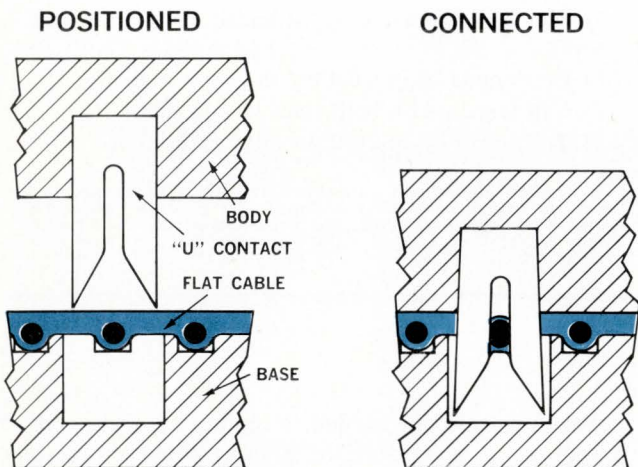

Another insulation piercing method of making terminations is this "U" contact system. Points of the "U" are forced through the cable's insulation, driving the legs down over the conductor. The base member supports the conductor and cable. Narrow clearance wells channel the "U" contact legs as they pass through the cable. (3M Co.)

Why use flat flexible cables?

While some of the advantages of flat flexible cable are obvious, others not so evident are often overlooked. Let's look at the advantages, both obvious and not so obvious.

- *Weight reduction.* Significant weight reductions are possible with flat cable systems. Not only is the harness itself lighter, but the supports and receptacles needed in such a system are also lighter. For example, NASA reports³ that when a 180° segment of the Saturn S-IVB stage aft skirt was changed from round-wire bundles to flat cables, the weight of the harness assemblies was reduced 70%, the supports 89%, and the receptacles 50%. Other sources estimate weight reductions of a harness to be anywhere from 40% to 80%.

- *Volume reduction.* Estimates here also vary, but a reasonable figure is 50%. If height is a prime concern flat flexible cable really shines—it is nearly two-dimensional.

- *Flexibility.* These cables can be easily bent or folded to conform to unusual shapes or patterns, giving the user more design latitude. They can be used in narrow spaces; can follow the contours of equipment, chassis, or cabinets; and can turn corners. They can be heat treated and formed into accordion pleats or wound on spring loaded retractors—ideal for equipment drawers, door harnesses, and the like.

- *Reduced costs.* This comes from lower assembly times required per connection. The cable can be handled as an entity (mass terminated) instead of each connection being handled individually. In quantity, connections made with flat cable cost about 1¢/connection compared with discrete wires at a minimum of 3¢ to 4¢/connection. In certain applications the cost for discrete wires could skyrocket to \$1.00/connection.

With flat cable you can also save on inspection time as all wires are visible and cuts and other defects can be quickly found—none are hidden in the center of a harness, and the insulations used with flat cable are almost all clear or translucent. Installation errors are almost non-existent.

- *Greater current carrying capacity.* Flat cable can carry higher currents with less heat rise than round conductor cable of similar size and weight. It dissipates heat better because its inherently larger ratio of surface area to volume gives it a larger heat dissipating surface. And since flat cable has a thinner insulation, it has less resistance to heat flow. (There are those who feel this advantage receives more emphasis than it deserves, however. They claim that very few applications are environmentally suited to this advantage, cable foldovers cause hot spots, multiple layers require that middle conductors be derated, and it's almost impossible to route continuously in open air or against a heat sink.)

- *Uniform electrical characteristics.* Because they are mechanically uniform, flat cables have uniform capacitance and impedance. The original harness will be identical with all others. Each conductor has a specific location with reference to all others and it never changes as it might in a round wire harness. (The insulating material is evenly distributed between conduc-

³"Flat Conductor Cable Technology—A Report." NASA SP-5043.

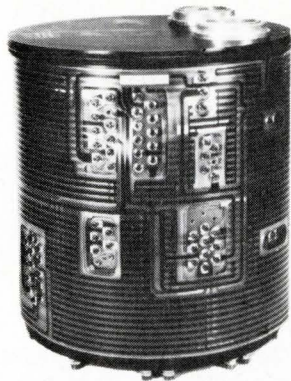

Being almost two-dimensional, flexible printed circuitry conforms to cylindrical surface of this missile subsystem, saving space and weight and making visual inspection easy. Note that several layers are used and terminations are via pads on the circuitry. (Sanders Associates, Inc.)

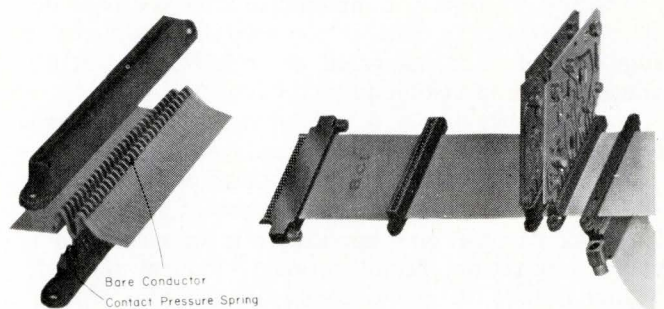

Various connection configurations are possible with flat cable by removing the insulation and then plating the conductor area. Some of the possibilities are illustrated here. The circuitry in selected conductors can be ended by punching holes through the conductors. These holes are sealed or left open depending on applications. The interrupted conductors can be used again further along. (aci, Inc.)

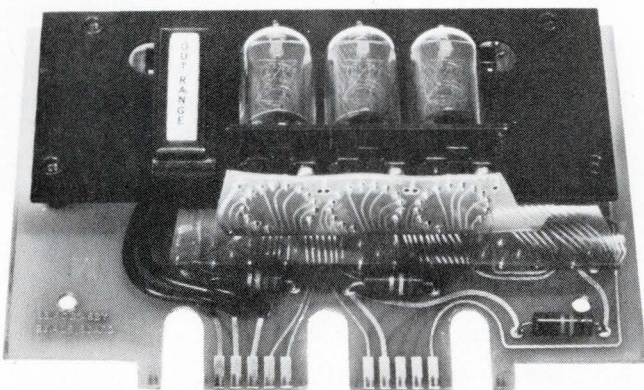

Flexible printed circuitry makes a neat package. Used here on a readout board for a digital instrument, it also results in a lower overall cost because assembly is easier; the flexible circuitry harness is dropped in place over all the pins at one time and then soldered. (Weston Instruments)

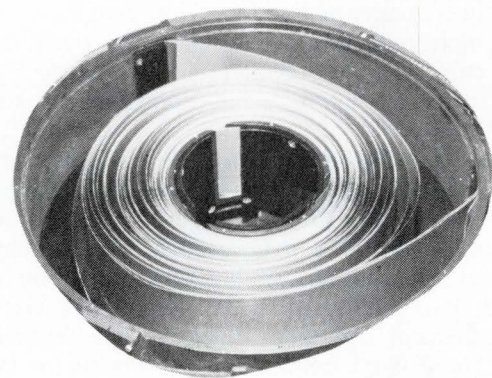

Either flat flexible cable or ribbon cable can be used to advantage in limited rotation applications. This optical tracking unit uses a flat conductor ribbon cable. (W. L. Gore Associates, Inc.)

tors.) Thus, the effect of adjacent conductors on sensitive leads can be measured and controlled—the sensitive leads can be isolated. Some shielding problems can therefore be eliminated and once the problem is solved for one harness, it is solved for all.

When shielding is necessary, flat and perforated foils have been effective. Edge to edge capacitance of the conductors under the shields is usually so small that shielding between them is unnecessary. The use of quasi-twisted conductors has also proven effective in minimizing the effects of strong EMI. In this technique the conductors are printed and etched on both sides of a flexible copper-plastic-copper laminate in a zigzag pattern that resembles twisted wires.

When crosstalk is a problem, it's relatively easy to solve by proper arrangement of ground and signal conductors and by the proper selection of cable shape and size. As you can see, flat flexible cable has excellent features for use as transmission lines.

- *Rugged.* With flat flexible cable, many conductors are bound together, giving them collective strengths. Tensile loadings, compression, and cut-through are distributed over the whole group and the insulation

material (which is often superior to that used in conventional cables) carries the load. Thus, minimum conductor sizes can be used, and these are determined by electrical rather than mechanical properties. With flexible cable you might be able to use AWG #30 wire in place of AWG #22, for example, and still more than meet your electrical requirements.

- *Conductors serve as contacts.* The conductors in flat cable are often used as connector contacts. They can be stripped and soldered to connector terminals. The bare conductors are usually plated and then potted for structural strength. They can also be designed with contact pads that can be slipped over terminals. Or, metal pins can be swaged onto the conductors and connected later (usually done with flexible circuitry but not with flat cable). Standard eyelets and solder lugs are sometimes preassembled to flexible circuits prior to installation.

Welding directly through the insulation is another way to connect the conductors. And since they are in a fixed position, they can't be accidentally crossed when they are being connected. It is easy to count off the conductors; so they don't require color coding.

You should know . . .

The first decision you must make after you have decided to "go flat" is whether you need flat flexible cable (and should it be laminated or etched?) or whether you should have flexible printed circuitry.

If you don't know the differences between these types, refer to the boxed information on page 77.

But, let me reiterate: if your application is for a long (over three feet) straight run, you should probably use laminated cable. If your application is for a short complex configuration, flexible printed circuitry (etched) is your answer. A hybrid combination is also a possibility.

Your next decision is which insulation material you will need. The choice is dictated once again by application, and especially by temperature requirements. As you can see by the accompanying table on insulation materials, you have a wide selection depending upon physical characteristics, electrical properties, and environmental durability. Tradeoffs may be necessary to find the best quality material for your use.

Insulation materials most commonly used for flat flexible cable include polyesters such as Mylar,[™] polyimides such as Kapton,[™] and fluorocarbons such as Teflon.[™]

Mylar's high dimensional stability makes it useful for complex fine line circuitry. It can be used where hand soldering or welding through the insulation is practical.

Kapton or H film can be used in extreme environments and has properties similar to Mylar at room temperature. It maintains its excellent physical, electrical, and mechanical properties over a wide temperature range. There is no known organic solvent for it, it is infusible, and it does not melt or flow. Adhesives are needed to bond Kapton type H film to itself or copper. However, Kapton type F (the same base film coated on either one or both sides with Teflon FEP) may be heat bonded to itself or to treated copper without using additional adhesives.

Teflon is a high temperature material that resists acids, alkalis, and organic solvents. With proper care it can be dip soldered.

Once you have selected your insulation material you can pick the conductor material and size. The most

common material used is drawn, rolled, or annealed soft copper; but for special applications materials such as brass, nickel, nicrome, Kovar[®], and aluminum may also be used. You can have the conductor surfaces plated or oxidized if you wish.

Conductor sizes are determined by the current requirements and voltage drop. See Table 1 and the nomograph (page 82) for further details.

Your next step is to select the termination method—weld, solder, insulation piercing or contactless approach.

The systems approach

You can purchase the flexible cable and circuitry and make your own termination, but it is also sold as a complete system. In fact, the systems approach (cable, connectors, and terminations) is the only one offered by at least one manufacturer—aci Incorporated. Other makers of flex cable will, of course, build you a complete system if you wish. They may even design a connector for your needs.

This approach has merit as it lets the vendor control all the design parameters, and thus meet the characteristics of the system into which the harness will be placed. The harness when delivered has been checked out as a unit and the only thing that remains to be done is to place it in the equipment. It takes the burden of making terminations from the user and places it on the manufacturer.

One disadvantage is that you must know exactly where in the equipment your wires must go. You can't order "x" feet of flexible cable when taking the systems approach.

What the makers suggest

The old lament of the connector manufacturer is now being heard from the flat cable people—"the designer waits until the very end before considering how the equipment will be connected." In fact, they claim that the majority users want a retrofitting job instead of calling them in from the start. And, they want a completed harness "immediately if not sooner."

Another common complaint is that the users don't understand their (the manufacturers') problems. This

®Trademark of Westinghouse Electric.

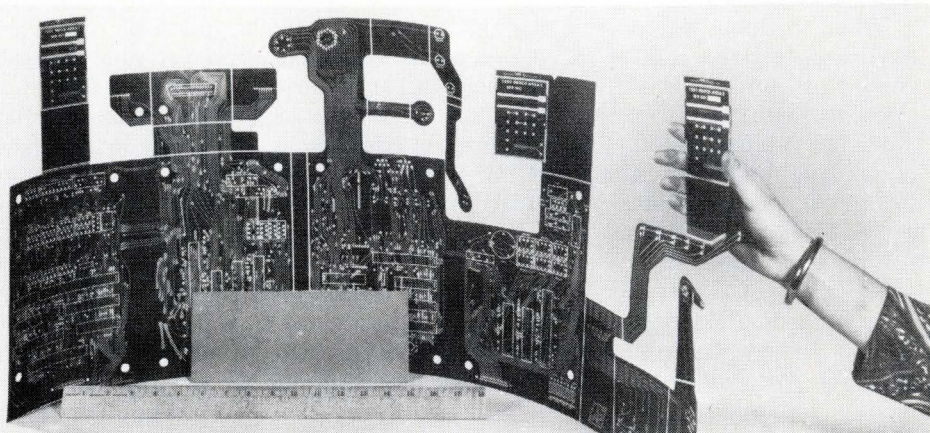
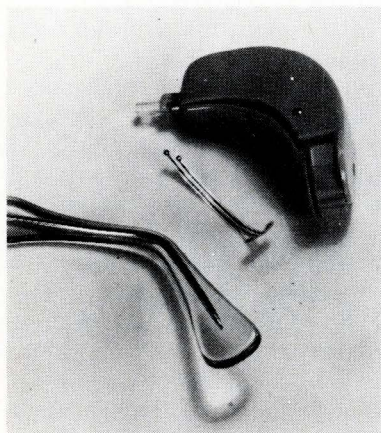

Flexible printed circuitry runs the gamut from complex to very simple, as is illustrated in these two applications. The complex circuit at the left resulted in a space reduction of 70%, weight reduction of 75%, elimination of over 500

solder joints, and increased ease of assembly and inspection. The circuit at the right, although uncomplicated, provided a large size, weight, and cost reduction for a miniature hearing aid. (Sanders Associates, Inc.)

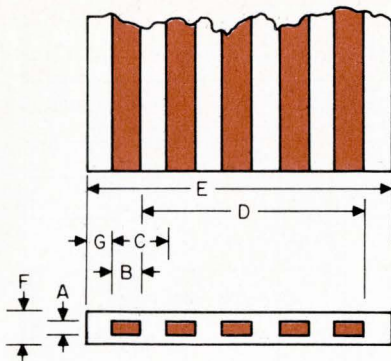

For letter dimensions see the table below.

Table 1. Typical standard for flat flexible cable

Equiv. AWG No.	No. of Conductors	Conductor			Spacing		Cable		
		Thickness A ±0.0005	Width B ±0.002	Width C ±0.008	Width D ±0.008	Width E ±0.010	Thickness F ±0.003	Margin G ±0.008	
32	17	0.0020	0.025	0.050	0.800	1.000	0.010	0.087	
32	37	0.0020	0.025	0.050	1.800	2.000	0.010	0.087	
32	57	0.0020	0.025	0.050	2.800	3.000	0.010	0.087	
30	17	0.0030	0.026	0.050	0.800	1.000	0.010	0.087	
30	37	0.0030	0.026	0.050	1.800	2.000	0.010	0.087	
30	57	0.0030	0.026	0.050	2.800	3.000	0.010	0.087	
32	12	0.0020	0.025	0.075	0.825	1.000	0.010	0.075	
32	25	0.0020	0.025	0.075	1.800	2.000	0.010	0.075	
32	38	0.0020	0.025	0.075	2.725	3.000	0.010	0.075	
30	12	0.0030	0.026	0.075	0.825	1.000	0.010	0.075	
30	25	0.0030	0.026	0.075	1.800	2.000	0.010	0.075	
30	38	0.0030	0.026	0.075	2.775	3.000	0.010	0.075	
28	12	0.0030	0.042	0.075	0.825	1.000	0.010	0.075	
28	25	0.0030	0.042	0.075	1.800	2.000	0.010	0.075	
28	38	0.0030	0.042	0.075	2.775	3.000	0.010	0.075	
26	9	0.0030	0.062	0.100	0.800	1.000	0.010	0.069	
26	19	0.0030	0.062	0.100	1.800	2.000	0.010	0.069	
26	29	0.0030	0.062	0.100	2.800	3.000	0.010	0.069	
24	9	0.0050	0.062	0.100	0.800	1.000	0.012	0.069	
24	19	0.0050	0.062	0.100	1.800	2.000	0.012	0.069	
24	29	0.0050	0.062	0.100	2.800	3.000	0.012	0.069	
22	6	0.0050	0.100	0.150	0.750	1.000	0.012	0.100	
22	12	0.0050	0.100	0.150	1.650	2.000	0.012	0.100	
22	19	0.0050	0.100	0.150	2.700	3.000	0.012	0.100	

Table 2. Insulating materials

Characteristic	TFE Teflon ^a	TFE-Teflon glass cloth	FEP Teflon ^a	FEP-Teflon glass cloth	Kapton polyimide ^a	KEL-F ^b	PVF Tedlar ^a	Polypropylene	Mylar ^a polyester	Polyvinyl-chloride	Polyethylene
Specific gravity	2.15	2.2	2.15	2.2	1.42	2.10	1.38	0.905	1.395	1.25	0.93
Tensile strength psi @ 25°C	3000	20,000 ^d	3000	20,000 ^d	25,000	4500	13,000	5700	20,000	3000	2000
Appearance	Trans-lucent	Tan	Clear bluish	Tan	Amber	White and opaque	Clear	Clear	Clear	Trans-lucent	Clear
Modulus of elasticity psi	58,000	4.0 ^d	50,000	4.0 ^d	510,000	190,000	280,000	170,000	550,000		50,000
Flammable	No	No	No	No	Self-ext	No	Yes	Slow burning	Yes	Self-ext	Yes
Service temp. min (°C)	-60	-60	-60	-60	-60	-70	-70	-55	-60	-40	-20
max (°C)	280	250	250	200	400	150	105	125	150	85	80
Thermal expansion in./in./°F x 10 ⁻⁶	(-30°C to 30°C) 55	Low ^d	(-30°C to 30°C) 50	Low ^d	(-14°C to 38°C) 11	(-195°C to 90°C) 48	(-30°C to 30°C) 28	(-30°C to 30°C) 61	(21°C to 50°C) 15	(^e)	(-30°C to 30°C) 100
Bondability with adhesives	Good ^c	Good ^c	Good ^c	Good ^c	Good	Good ^c	Good ^c	Poor	Good	Good	Poor
Bondability to itself	Good	Poor	Good	Good	Poor	Good	Good	Good	Poor	Good	Good
Resistance to chemicals	Ex.	Ex.	Ex.	Ex.	Ex.	Ex.	Good	Good	Ex.	Good	Good
Water absorption (%)	< 0.01/24 h	0.10/0.68 ^d	0.01/24 h	0.18/0.30 ^d	3/24 h	0	0.5/2 h	0.01	0.8/24 h	0.10	0.01/24 h
Vol. resistivity Ω-cm	> 10 ¹⁸	10 ¹⁶	> 2 x 10 ¹⁸	10 ¹⁶	10 ¹⁸	3.1 x 10 ¹⁶	3 x 10 ¹³	10 ¹⁶	10 ¹⁸	10 ¹⁰	10 ¹⁶
Dielectric constant 10 ² - 10 ⁸ Hz	2.2	2.5/5 ^d	2.1	2.5/5 ^d	3.5	2.5	7.0	2.0	2.8-3.7	3.6-4.0	2.2
Dissipation factor 10 ² - 10 ⁸ Hz	0.0002	0.0007/0.001	0.0002	0.0001/0.001	0.003/0.014	0.015	0.009/0.041	0.0002/0.0003	0.002/0.016	0.14	0.0006
Dielectric strength V/mil	600	650/1600 ^d	2800	650/1600	7000	1100	4000	600	7000	800 ^c	585

(^a) Trademark, E. I. DuPont de Nemours & Co., Inc. (^b) Trademark, 3 M Co. (^c) Must be treated. (^d) Depends on % glass cloth. (^e) Depends on formulation (plasticizer).
 (^f) Major portion of this data was obtained from NASA report SP-5043, "Flat Conductor Cable Technology, A Report."

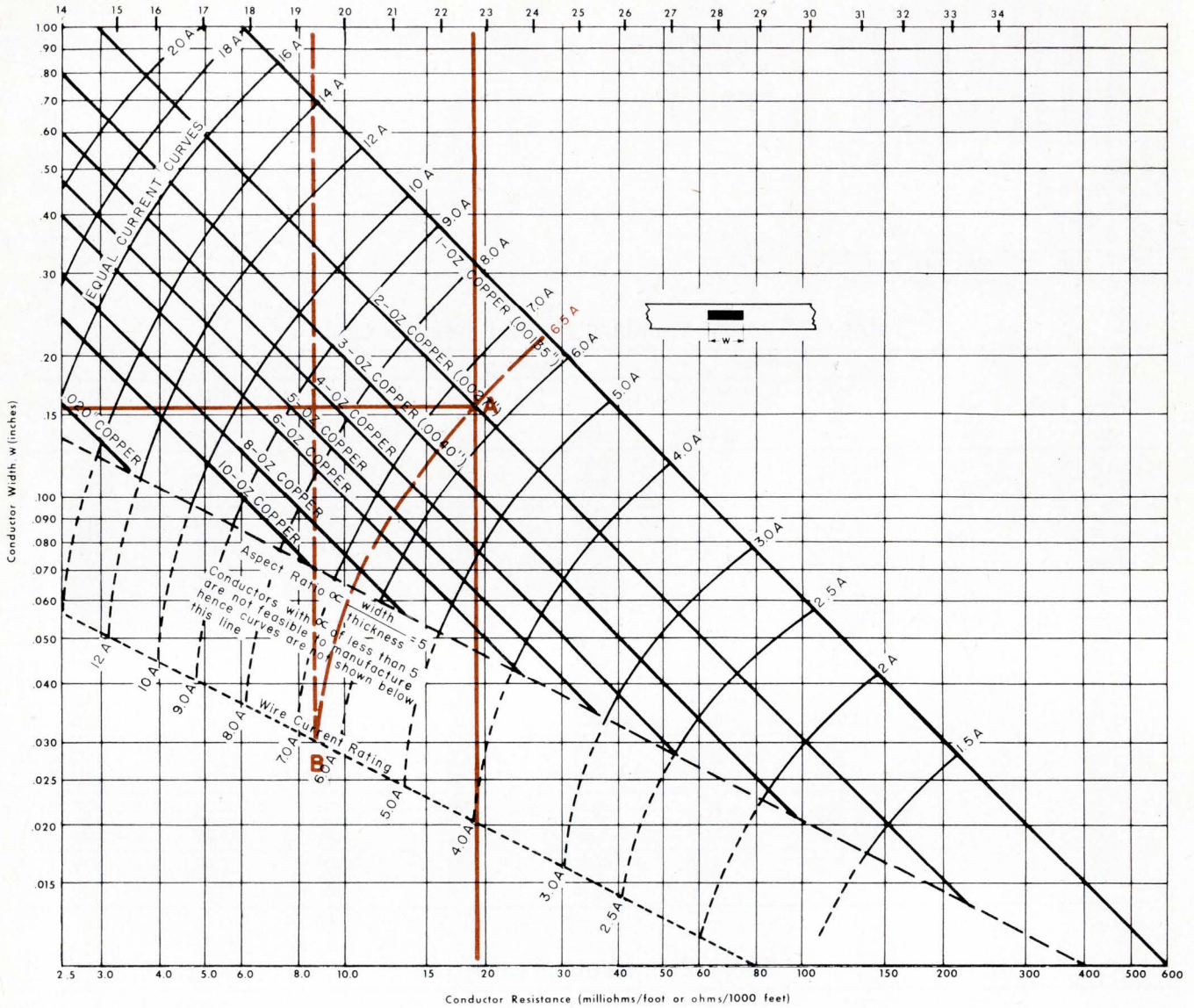

*Based on single flat conductors with 0.010" insulation assuming 10°C allowable temperature rise at 20°C ambient temperature.

Conductor nomograph. Used to find the electrical characteristics of flat conductors and to compare these with AWG round wire sizes.

For example, to find the resistance of a 2-oz flat conductor 0.160 in. wide, project horizontally from the Conductor Width scale to the 2-oz. Copper line as shown. From the intersection at point A project down to Conductor Resistance scale and read 19mΩ/ft. To find the AWG wire size with equivalent resistance, project up from point A to find that #23 wire is the nearest equivalent.

The Constant Current curve which passes through A shows that the flat conductor will safely carry 6.5 A. To find the AWG wire size with equivalent current capabilities, extend the 6.5 A Constant Current curve until it intersects with the Wire Current Rating line at Point B and read AWG #19 is the nearest round wire size that will safely carry the 6.5 A current.

The nomograph can also be used to find the flat conductor dimensions you need to replace existing round wires. (Sanders Assoc.)

is probably a valid complaint since many of their customers are first-time users of flat cable, accustomed to conventional round wire harnesses. With the round wire types they can make last minute routing changes, often without too much thought or effort. However, with flat cable, particularly the etched type, they must give it more thought. Remember, with the etched type, artwork is involved.

This may seem a disadvantage that might discourage some, but the makers claim that once an engineer gains experience with flat cable, he generally becomes an advocate.

Some manufacturers recommend that a user send at least one engineer to the vendors' plant to see the manufacturing process and samples of other non-proprietary applications. Getting the production people in on design talks will avoid later problems.

Reputable vendors don't try to get you to use flat cable for all applications. On the contrary, they feel that one failing is to attempt (many try) to replace round wires with flexible cable where it shouldn't be done—for example, where there aren't too many wires and where there is the possibility of many wiring revisions.

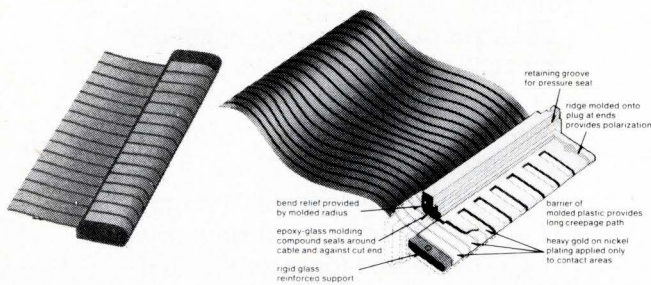

Environmentally sealed termination. Cable is cut to size and cable ends are creased and bonded around a rigid plastic mandrel. A reinforced thermosetting plug is then molded onto the cable. Insulation is removed from contact surface portions of the conductors by a chemical process and the contacts are gold plated. (Rogers)

You should learn how to handle (solder, strip, weld, and so forth) the finished cable or circuitry. For example, although the insulation might be good to 400°C and shouldn't be affected by a soldering iron, the adhesive used with it might be good to only 200°C and delaminating could occur.

This raises another point. Temperature requirements usually dictate which insulation film will be selected, but users often overbuy, e.g., choosing Kapton when Mylar would do. Thus, it is probably best to let the vendor select the adhesive. Some adhesives used are epoxies, fluorocarbons, silicones, polyimides, polyamide-imides, polyesters, phenolics, and so forth. It is also best—and cheaper in the long run—to let him do as many of the operations as possible, such as stripping and welding.

Specifications written

Both military and industry specs have been written for flexible cable. The most recent and probably the most important are two military specs that NASA and the military services prepared. They had important inputs from The Institute of Printed Circuits (Chicago) and principal industry groups. IPC and these groups reviewed and commented on the specs.

They are:

Military Specifications

Mil-C-5543 (non-shielded flat multiconductor cable).

Mil-C-55544 (non-shielded and shielded flat cable connectors).

Others are:

The Institute of Printed Circuits Specifications

IPC-FC-218 (flexible flat cable connectors).

IPC-FC-250 (flexible flat conductor cable).

IPC-FC-240 (flexible printed wiring).

AIA Specification

NAS-729 (flexible flat conductor cable).

NASA

MSFC-Spec 220B (flat conductor cable).

Associate Editor Smedley Ruth discusses flexible cable with one of the many industry people who supplied inputs for the article. Smed was impressed with the enthusiasm of those working with flexible cable and circuitry. He was also surprised at the amount of good design literature available from the manufacturers.



Acknowledgements

I would like to thank the following individuals for contributing to the report: George Stollsteimer, Millard Hendrickson, and Jim Hannum, Flexible Circuits Inc.; Bill Sinclair, aci Inc.; R. W. Wilbank and Dave McCarter, W. L. Gore & Associates, Inc.; Robert Geisler, Electronic Components Lab, Fort Monmouth; Ross Morrone, Spectra Instruments, Inc.; and Robert Van Ness, Picatinny Arsenal.

For further information on the manufacturers and their products, circle the following numbers on the Inquiry Card.

aci, Inc.	Circle number 298
AMP Incorporated	Circle number 299
Amphenol Corp.	Circle number 300
Cerro Wire & Cable Co.	Circle number 301
Cinch Mfg. Co.	Circle number 302
Digital Sensors Inc.	Circle number 303
E. I. DuPont de Nemours & Co.	Circle number 304
Elco Corp.	Circle number 305
Electro Connective Systems, Inc.	Circle number 306
Flexible Circuits, Inc.	Circle number 307
General Circuits, Inc.	Circle number 308
W. L. Gore & Associates, Inc.	Circle number 309
Hughes Aircraft Co.	Circle number 310
Methode Electronics, Inc.	Circle number 311
Microdot, Inc.	Circle number 312
Rogers Corp.	Circle number 314
Sanders Associates, Inc.	Circle number 315
G. T. Schjeldahl Co.	Circle number 316
Spectra Instruments, Inc.	Circle number 317
3 M Co.	Circle number 318
Westinghouse Electric Corp.	Circle number 319
ITT Cannon	Circle number 320

INFORMATION RETRIEVAL

Wire and cables, Packaging, Materials, Connectors.

Dual Darlington diff amp array

RCA-CA3050 and CA3051 now offer the circuit designer another significant opportunity to work with the inherent device match of monolithic construction PLUS the flexibility of RCA building-block arrays. On a single chip, in a dual-in-line package, each type offers:

- independently accessible inputs and outputs
- diode temperature compensation of constant-current-transistor bias
- high input impedance—460 K Ω typ
- low input offset current—70 nA max
- low offset voltage—5 mV max
- low input bias current—500 nA max

Get the feel of real design freedom with CA3050 or CA3051 for matched dual amplifiers, dual sense amplifiers, dual Schmitt triggers, doubly balanced detectors and modulators, and a multitude of applications that call for matched device performance from DC to 20 MHz.

For more information, contact your local RCA Representative or your RCA Distributor. For technical data, write RCA Electronic Components, Commercial Engineering, Section ICJ-2, Harrison, New Jersey 07029.

Ask About These Linear Transistor Arrays from RCA

CA3018	Darlington pair, plus 2 independent transistors	\$.98 (1,000 units)
CA3018A	Tight-spec version of CA3018	\$1.35 (1,000 units)
CA3026	High gain dual diff ampl array for DC to 120 MHz	\$1.25 (1,000 units)
CA3036	Dual Darlington array	\$.89 (1,000 units)
CA3045	Darlington pair plus 3 transistors in dual-in-line ceramic package	\$1.50 (1,000 units)
CA3046	Dual-in-line plastic package version of CA3045	\$.98 (1,000 units)

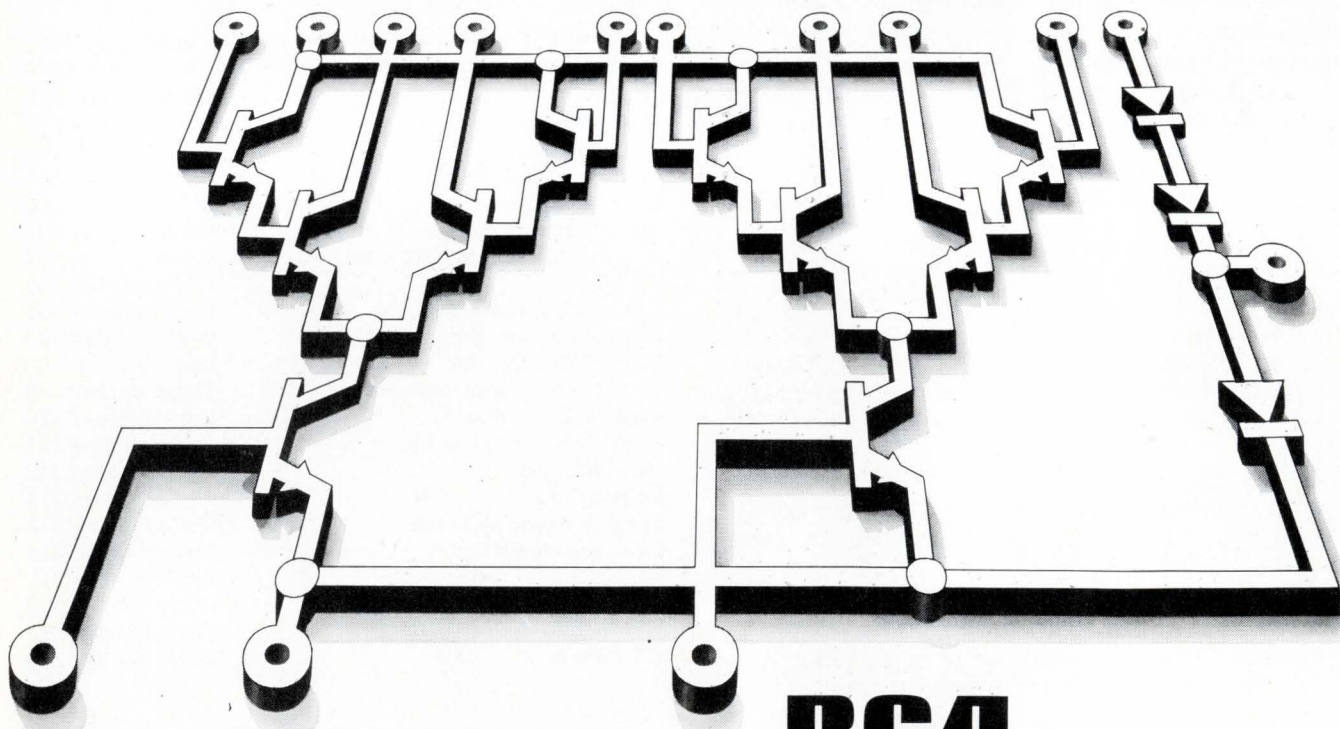

RCA-CA3050 in 14-lead dual-in-line ceramic pkg \$2.25 (1000 units)
 RCA-CA3051 in 14-lead dual-in-line plastic pkg \$1.65 (1000 units)

RCA
 Integrated
 Circuits

Very high duty cycle one-shot	906
Stable squarewave generator	907
Gated oscillator has remote frequency control	908
Synchronous pulses from asynchronous logic level changes	909

Vote for the one you like best.

Write the number of the Idea you like best in the box on the Inquiry Card, and send to us.

Send us practical, reproducible ideas that are original with you and have been implemented with linear or digital ICs.

idea for all 12 issues. The winner gets his choice of either a Hewlett-Packard 1206A or a Tektronix 310A oscilloscope.

- If we publish your idea you win a check for \$25.00.
- If our readers vote yours the best of the issue in which it appears, you have your choice of a Simpson 270 or a triplett 600 multimeter.
- After 12 issues our readers will vote on the best

Submit your IC Ideas to:
Alberto Socolovsky
Editor
THE ELECTRONIC ENGINEER
Chestnut & 56th Sts.
Philadelphia, Pa. 19139

Here's how you voted

The winning Idea for the September 1968 issue is, "Make a crystal-controlled clock with DTL gates."

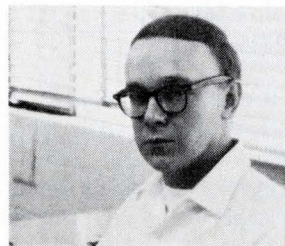

Richard Juengel, the author, is a Design Engineer at the Barrett Electronics Corporation, Western Division, Palo Alto, Calif. Mr. Juengel chose the Triplet 600 TVO multimeter as his prize.

906 Very high duty cycle one-shot

Robert C. Baskin and
Daniel A. Esakov

Connecticut Technical Corp.
Hartford, Conn.

A quad 2-input DTL NAND gate and a Miller integrator make up a stable one-shot circuit. With such a circuit, you can get long pulse durations with duty cycles to 92% (the pulse duration decreases only about 2% max.).

The input RC network differentiates negative-going trigger pulses or level changes, setting the wired two-gate flip-flop. In this set state, transistor Q_1 is off, and C_1 charges through the IC's internal resistor. R_1 increases the charge time—it provides another current drain path.

When C_1 has charged to the

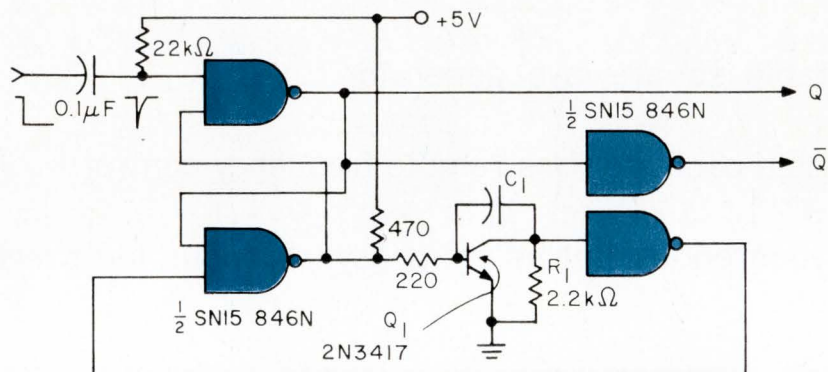

switching potential of the following NAND gate, the flip-flop resets, and stays reset until another trig-

ger occurs. The output pulse duration, in milliseconds is about $4.1C_1$ (C_1 is in μF).

907 Stable squarewave generator

Arnold J. Steinman

Lawrence Radiation Lab., Livermore, Calif.

Here is an inexpensive squarewave source that should prove useful around the lab. A unijunction oscillator, an IC flip-flop, and an emitter-follower output driver make up the circuit.

Capacitor C charges through R_1 and R_2 until it reaches the firing voltage of Q_1 , a unijunction transistor. When C discharges through Q_1 , the JK flip-flop—a Texas Instruments SN7470N—receives a pulse and changes state. (Because Q_1 's η is 0.5-0.7, you can approximate the oscillator's frequency as $1/(R_1 + R_2)C$.) The flip-flop changes state each time the capacitor discharges, giving a squarewave output. The output emitter-follower, Q_2 , gives the circuit a low output impedance—it can drive a 50- Ω

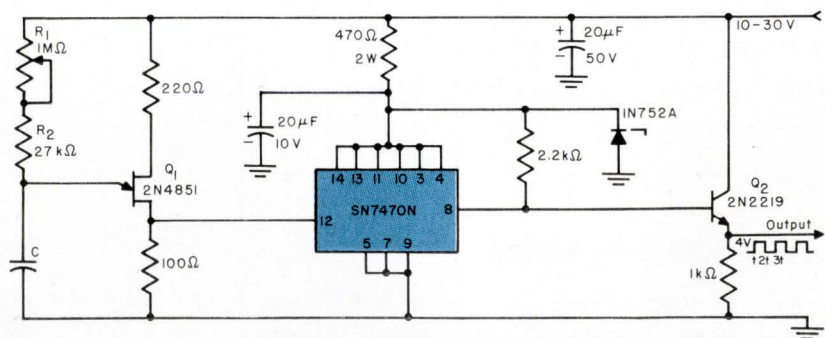

cable.

The upper frequency limit for this circuit is about 50 kHz, which you can increase by adding a buffer amplifier between Q_1 and the flip-flop. The lower limit is set simply by the size of C that you can tolerate. A 10- to 30-V supply gives you a 4-V output; risetime is 25 ns,

while capacitive loading will set the falltime.

Frequency is stable to better than 100 Hz at 50 kHz, with a temperature coefficient of about 0.08%/°C. (Precision components for R_1 , R_2 , and C improve this figure.) The voltage coefficient of frequency is about 0.05%/V.

908 Gated oscillator has remote frequency control

William F. Harrick
CBS Laboratories, Stamford, Conn.

The output of this gated oscillator always starts in the same phase with respect to the gating signal. Adjustable in frequency from a remote location, the oscillator has excellent frequency stability, and is compatible with standard 5-V ICs.

Inductor L_1 is the heart of the oscillator. Electrically variable, the inductance is set by the value of the dc current that flows through its winding A. This current, and thus the frequency, is controlled by the 500- Ω frequency set pot, which gives the circuit its remote control capability.

A logic 1 at the gating input turns on Q_1 , which supplies a constant-current through L_1 's winding B. When the gating input returns

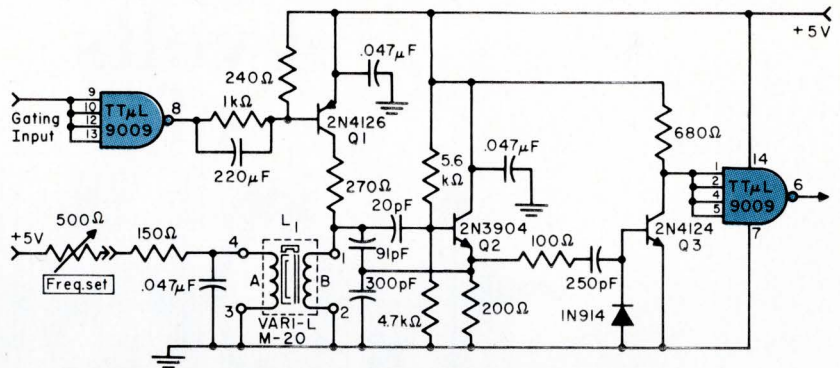

to ground, Q_1 turns off, disconnecting the current source. At this time, L_1 starts to resonate with the capacitors across it. Regenerative feedback from amplifier Q_2 sustains the oscillations.

Q_3 squares-up the signal, and

feeds it to a half of the dual 4-input buffer IC. This is a Fairchild TT μ L 9009 NAND power gate that lets you load the oscillator. With the components shown in the schematic, the oscillator has a frequency range of 8.5 to 12 MHz.

909 Synchronous pulses from asynchronous logic level changes

John R. Thompson
Emerson Electric Co., St. Louis, Mo.

In control and timing circuits, sequential operations must often follow an input command. When this command is an asynchronous logic level change, you can convert it to a single synchronous pulse with a dual JK flip-flop.

With the input initially at 0, FF-1 and FF-2 are both in the 1 state. When the input goes positive to its 1 level, FF-1's K input becomes HIGH, causing FF-1 to reset on the trailing edge of the next clock pulse. The 0 output of FF-1 is then HIGH, enabling the K input of FF-2 and causing this flip-flop to reset on the trailing edge of the second clock pulse. FF-1 also returns to 1 on the second clock pulse, and feedback from FF-2 to FF-1's dc SET input locks it in this

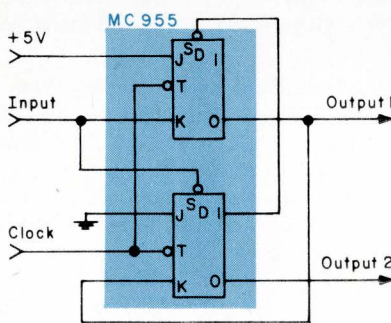

state.

When the input returns to 0 level, FF-2 returns to its 1 state through its DIRECT SET input. The circuit is now ready for the next cycle. If you need several sequential pulses, you can gate output 1 with other clock phases to give as many sequential pulses as there are

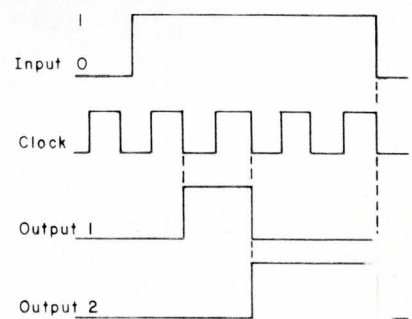

clock phases.

Compared to asynchronous circuits that use one-shot multivibrators, multi-phased clock systems such as this cost less and are more reliable. Also, you don't need the discrete components (resistors and capacitors) that are often found in circuits that detect level changes.

Now
from
AMELCO

4 volts
of

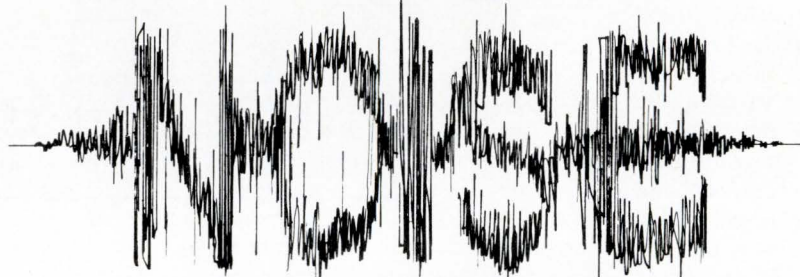

IMMUNITY

~~\$2.00~~ \$1.85 per quad gate

Now you can have High Noise Immunity Logic (HNIL) with no penalty in cost! In fact, considering all the fringe benefits like throwing out the low voltage supply, direct lamp and relay drive, elimination of interfacing circuitry, etc., you're bound to save money. If you're already using HNIL, just lower the prices. If you're new to HNIL, compare the following functions and prices:

301 Dual 5 Buffer	2.05	312 Dual JK	4.80
302 Quad 2 'Or'able Buffer	2.25	370 Quad D Flip Flop	4.80
321 Quad 2 Gate	1.85	303 Quad Input Interface	2.25
325 Dual 2, Dual 3 Gate	1.85	371 Decade Counter	} available March
342 Dual One-Shot	4.80	380 BCD Decoder	
323 Quad 2 'Or'able Gate	1.85	+ 8 more	

The prices are further enhanced by a complete logic family with 16 pin packaging. For example, instead of a Quad two we offer a Quad two with expanders on two of the gates, or a Dual 3 Dual 2, etc. We also have a complete applications report covering not only the logic, but the entire noise problem. We're not so naive that we believe noise immunity ends with volts, so we've given it complete coverage in terms of power. So if you want to learn about noise and forget about it at the same time, design with 300 Series HNIL and ask for our new 300 Series Application Note.

Quality in Quantity



AMELCO SEMICONDUCTOR

1300 Terra Bella Ave., Mountain View, California (405) 968-9241
Westwood, Massachusetts (617) 326-6600 • Orlando, Florida (305) 423-5833
Ridgefield, New Jersey (201) 943-4700 • Des Plaines, Illinois (312) 439-3250
Anaheim, California (714) 635-3171

Feature article abstracts

Published information is vital to your job.

To save time in finding this information,
we have abstracted the important technical features
from eight electronic engineering publications.

Should any of these articles interest you, contact the magazine—
names and addresses are listed below.

Reprints of articles with an asterisk are available free.

Save this section for future reference.

Circuit Design

Applying the operational amplifier (part 5 of a series on active filters), George S. Maschytz and Ralph W. Wyndrum, Jr., Bell Telephone Labs., "Electronics," Vol. 41, No. 25, Dec. 9, 1968, pp. 98-106. With hybrid integrated active filters emerging in the spotlight, the use of the versatile, economic monolithic op amp for those functions becomes desirable. The author addresses himself to the question of designing with the amplifier. He shows characterization, procedures, pole-zero theory, methodology, and how to check for gain stability.

Impedance matching can be easy, C. N. Char-est, Philco-Ford, "EDN," Vol. 14, No. 1, Jan. 1, 1969, pp. 48-51. How to compute L, T, and π matching networks quickly, and without recourse to charts or nomographs, is detailed.

Practical guide to A/D conversion, part 3, Hermann Schmid, General Electric Co., "Electronic Design," Vol. 17, No. 1, Jan. 4, 1969, pp. 97-112. In this final installment of the A/D design guide, the author presents unique or special conversion techniques for oddball applications. He treats all-serial, all-parallel, and serial parallel, ultra-high-speed converters, propagation, logarithmic and CRT converters. Another section is devoted to offset correction methods and "time-sharing."

Stop noise problems before they start, Thomas E. Skopal, Burroughs Corp., "Electronic Design," Vol. 17, No. 1, Jan. 4, 1969, pp. 90-94. Noise—through transients or unwanted couplings—can plague any design. And, the best time to design noise out is before layout and design are frozen. This article carefully dissects the more common noise sources and gives dozens of hints on how to avoid them.

Communications

FET converter is self-oscillating, Daniel R. von Recklinghausen, H. H. Scott Inc., "Electronics," Vol. 41, No. 26, Dec. 23, 1968, pp. 54-56. Field-effect transistors continue their excursion into communications applications, particularly in consumer entertainment equipment. Now a new FET converter circuit may push out bipolar and tube versions, via a superior AGC technique that is not accompanied by detrimental clipping. The article covers the circuit theory, design and performance of the FET converter, using actual component values.

Antenna breakdown in the Martian atmosphere, C. H. Brockmeyer, Martin Marietta Corp., "EDN," Vol. 13, No. 13, Nov. 11, 1968, pp. 83-85. Available data indicates that the atmospheric pressure at the surface of Mars is about the same as that of the Earth's atmosphere at 130,000 ft. At such altitudes, our probe and space vehicle antennas suffer corona breakdown. And we think that the Martian atmosphere holds argon, which can cause even lower ionization potentials than those at the equivalent of 130,000 ft. altitude. Such rf breakdown phenomena reduce the effectiveness of radio transmission, upon which rests the mission's success. The author describes test in simulated Martian atmospheres that point the way to solutions of the breakdown problem.

Components

The negative capacitor: a challenging new component, William J. Travis, Sprague Electric, "EEE," Vol. 16, No. 10, Oct. 1968, pp. 86-87. The author claims to have developed a "negative capacitor" (probably an active circuit that exhibits a negative time constant) but does not disclose the circuit, claiming that it is proprietary. The possibilities of such a capacitor are startling (it could, for one, cancel stray capacitances that limit the frequency range of practical components), and the author discusses a few. One is left, however, with the feeling that this article is a hoax. The author states that the negative sign of his capacitor operates in "negative time," so that it would make possible the investigation of past events, and the prediction of future ones within its time constant.

*Wiring . . . some like it flat, Smedley B. Ruth, Associate Editor, "The Electronic Engineer," Vol. 28, No. 2, Feb. 1969, pp. 75-83. In this penetrating report, the author examines the advantages and the limitations of flexible printed circuits, the conductors and insulator materials used, the systems approach the user must follow, plus many details about the inseparable companion of the flexible printed circuit: the flat-conductor flexible cable.

Circulators for vhf and up (part 2 of a series devoted to ferrites), Vernon E. Dunn, Melabs, "Electronics," Vol. 41, No. 24, November 25, 1968, pp. 84-87. Circulators, heretofore confined to applications in the microwave realm, may also be used to lower frequencies. Dunn shows why, where, and how to employ them, providing a compact design guide that includes pitfalls and how to avoid them. And he uses actual applications to frame the presentation.

Magazine publishers and their addresses

EDN

Cahners Publishing Company
3375 S. Bannock Street
Englewood, Colo. 80110

EEE

Mactier Publishing Co.
820 Second Avenue
New York, N. Y. 10017

Electronic Design

Hayden Publishing Co.
850 Third Avenue
New York, N. Y. 10022

Electronic Products

United Technical Publications
645 Stewart Avenue
Garden City, N. Y. 11530

Electronics

McGraw-Hill, Inc.
330 W. 42nd Street
New York, N. Y. 10036

Electro-Technology

Industrial Research Inc.
Industrial Research Bldg.
Beverly Shores, Ind. 46301

IEEE Spectrum

Institute of Electrical & Electronics Engineers
345 East 47th Street
New York, N. Y. 10017

The Electronic Engineer

Chilton Company
56th & Chestnut Streets
Philadelphia, Pa. 19139

Integrated Circuits

Rival preleaving schemes head for a market showdown (part 2 of a two-installment series), Lawrence Curran, L. A. Bureau Manager, "Electronics," Vol. 41, No. 25, Dec. 9, 1968, pp. 88-96. Current catalog items, the relation of flip-chip and beam-lead technology to ICs, and product trends are covered. Curran dwells at length on the relative advantages of flip-chip and beam-lead techniques, and provides case histories to document the claims and guide the would-be user's design thinking.

Thermal management of integrated circuits, "Electro Technology," Vol. 83, No. 1, Jan. 1969, p. 21. Thermal problems associated with ICs are becoming more acute as the complexity of the circuits increase. These problems are discussed in this four-page series.

Part I. Heat transfer and integrated circuits, R. Gary Daniels, Motorola, Inc., "Electro Technology," Vol. 83, No. 1, Jan. 1969, pp. 22-30. The author reviews the factors that affect IC heating and heat dissipation. He then develops thermal and electrical analogs for semiconductors, and discusses various packages and how they affect heat flow. Finally, he covers methods of making IC thermal measurements.

Part II. Circuit design for minimum thermal effects, James W. Hively, Motorola Inc., "Electro Technology," Vol. 83, No. 1, Jan. 1969, pp. 31-34. To minimize thermal effects the designer must have knowledge of how parameters vary with temperature. The author discusses which parameters must be considered in practical applications, and shows how they depend on the general circuit configuration.

Part III. Device failure causes by high temperature, James R. Black, Motorola Inc., "Electro Technology," Vol. 83, No. 1, Jan. 1969, pp. 35-38. Several device failure modes involving bonds, metallization, and packaging are directly related to temperature. Most of these apply to all semiconductor devices, but the problems are greater in ICs because of their complexity, close spacing, size, and because multiple layers of metallization are often used. The author describes some of these failures to show the interrelationship between device design and selection and device application to reliability.

Part IV. ICs selection and thermal effects, Bob Burlingame, Motorola Inc., "Electro Technology," Vol. 83, No. 1, Jan. 1969, pp. 39-40. Selection of ICs for minimum temperature effects shouldn't be based only on the parameters which affect the system. Factors that affect the devices themselves should also be considered. The author shows how.

In search of a lasting bond, Lawrence Curran, L. A. Bureau Manager, "Electronics," Vol. 41, No. 24, November 25, 1968, pp. 72-80. Reliability-conscious users of integrated circuits now have alternatives to wire-bonded devices: flip-chips and beam-leads. The pros and cons of these lead-package concepts are presented and weighed against one another. The author includes the reasoning behind the choices, and a lineup of vendors behind each method.

***LSI: No longer a mission impossible,** Mark B. Leads, Features Editor, "The Electronic Engineer," Vol. 28, No. 2, Feb. 1969, pp. 53-61. If a user needs LSI today, chances are it must be custom made for him, with the attendant cost. This cost must be weighed against making the same system with standard, available integrated circuits, or medium-scale integrated (LSI) circuits. To find out what the cost is, the user must go to the traditional source of suppliers. This article, therefore, lists these suppliers and their capabilities. Each supplier has a number of choices. He can make the circuits with MOS, with bipolar, with a combination of the two, or with neither if he uses hybrid techniques. And, finally, after his system is delivered, the user must test it. The report ends with a list of equipment available to test LSI.

MOS arrays come on strong, William F. Jordan, Computer Control Division, Honeywell, Inc., "Electronics," Vol. 41, No. 26, Dec. 23, 1968, pp. 54-56. The semiconductor thrust into memory applications is being led by metal-oxide-semiconductor integrated arrays. The MOS ICs offer high packaging density and low power consumption; although slower than bipolar memories, they're fast enough for many applications. Author Jordan pinpoints the advantageous application areas, discusses MOS characteristics, and touches on cost and installation criteria.

Schottky diodes speed up digital IC's, Robert H. Cushman, Eastern Editor, "EDN," Vol. 14, No. 1, Jan. 1, 1969, pp. 37-40. Schottky diodes have negligible storage time, thus they are exceptionally fast devices. Because they can be made with the same aluminum used for IC interconnections, the diodes can be an integral part of an IC. Their first use is in TTL and DTL logic as antisaturation clamps, where they significantly reduce delay times.

Materials

Ferrites' attraction is magnetic and growing, R. Gundlach, Military Electronics Editor, "Electronics," Vol. 41, No. 21, Oct. 14, 1968, pp. 104-118. An overview of the properties, components, and application of ferromagnetics, with particular emphasis on the jobs they perform in radar and communications. It also discusses the impact ferrites will have on microwave ICs. This step-by-step account is a near-must for newcomers, and will be a valuable guide for hybrid sub-system designers working at rf and higher frequencies.

Microwaves and Microwave Products

***Diode rf sources: combine them for high power,** Dr. Anatol Zverev, Westinghouse, "The Electronic Engineer," Vol. 28, No. 2, Feb. 1969, pp. 45-50. Step-recovery diodes, varactor diodes, Schottky barrier diodes and so forth, are practical semiconductors that generate rf power at microwave frequencies. But the amount of power that you can get from a single diode is still not enough for many applications. To overcome this limitation, microwave engineers can combine a number of diodes as an array, so that their power outputs add together. In such arrays, each diode must operate at its maximum capability, and their power outputs must be in phase to add together. The author appraises for our readers the number of ways to construct diode arrays. With such information, a reader can intelligently select the array that is better suited to his particular needs.

High frequency connectors, "Electro Technology," Staff report, Vol. 83, No. 1, Jan. 1969, pp. 59-64. Connectors for microwave applications are a common source of trouble and ultimately limit system capabilities, according to this report. The report discusses historical factors in developing rf connectors for microwave applications and summarizes the present state of the art.

Packaging

A survey of vapor phase cooling systems, R. E. Simons and J. H. Seely, IBM, "EDN," Vol. 14, No. 1, Jan. 1, 1969, pp. 53-56. Where convection heat-removal systems are inadequate for your equipment, you should consider some form of vaporization cooling. In such systems, boiling causes part of the coolant to be in a vapor state. The coolant may or may not be expendable, but the emphasis here is on non-expendable coolant systems.

Power Supplies

Reducing transformer inrush transients, Richard J. Daniels, International Business Machines Corp., "Electro Technology," Vol. 83, No. 1, Jan. 1969, pp. 48-52. Critical circuits must be protected against transformer inrush transients. However, protective devices can also be a problem. The author shows how to determine the effectiveness of control methods. He verifies the effectiveness of each method with a computer analysis.

Semiconductors

SC reliability: manufacturers hold the key, A. J. De Berardis, Unitrade Corp., "EDN," Vol. 14, No. 1, Jan. 1, 1969, pp. 42-45. The author tells users what to look for on a semiconductor chip and in its processing specs and quality control procedures, to assure themselves a reliable device. There is a table of failure mechanisms and their causes.

Systems

***Telemetry Course, Part III: Time-division multiplexing,** Harry C. Morgan, Autonetics, "The Electronic Engineer," Vol. 28, No. 2, Feb. 1969, pp. 65-73. This third part of the course treats the conversion of information from analog (proportional to the magnitude we are measuring) to digital (encoded for transmission). The most popular component used to convert data from analog to digital is the "analog-to-digital converter". In addition to describing this component, the article describes the format into which pulses are strung to encode the analog information.

Sectionalize your digital controller, Prof. Y. T. Li, MIT, "Electronic Design," Vol. 17, No. 1, Jan. 4, 1969, pp. 82-88. Noise and crosstalk can be troublesome in the design of adaptive control systems. But, sectionalizing the primary controller and using a processing approach to control loop design can help. This article, with some simplified examples, shows how.

Test and Measurement

Measurements of average and rms values, Dr. Howard Handler, Burr-Brown Research Corp., "Electro Technology," Vol. 83, No. 1, Jan. 1969, pp. 42-45. Average and rms values of electrical signals must often be measured in data analysis. The noise rejection properties of a system should be included in any characterization of a measurement because unwanted noise is often a part of the received signal. Digital methods have been used to measure signal parameters, but they are often too costly. Analog-hybrid measurement techniques are sometimes more desirable. This article discusses the use of practical measurement methods that use analog-hybrid computer-like setups.

The insulation resistance of connectors is not infinite, George Genise, Burndy Corp., "Electronic Products," Vol. 11, No. 6, Nov. 1968, pp. 104-108. The material used in the body of a connector must have adequate mechanical and electrical properties. The author discusses such materials, placing emphasis on their insulating properties. He defines insulation resistance, tells how to measure it, and how the standard measurement procedures differ from each other.

Miscellaneous

***New product management, Part II: A case history,** Eugene W. Parry, Hewlett-Packard, "The Electronic Engineer," Vol. 28, No. 2, Feb. 1969, pp. 31-37. A study of a midwestern instrument plant reveals the percentage of new product dollars wasted on new product projects that were later dropped, and establishes those factors which caused the projects to be discontinued. It then suggests some positive steps you can take to get more new products for your engineering dollars.

What are designers worth?, P. S. Bayer, News Editor, "EDN," Vol. 14, No. 1, Jan. 1, 1969, pp. 75-78. EDN has sampled its own readers to come up with this salary and education survey of the electronics industry in 1968.

Powder metallurgy in electronics, "Electronic Products," Vol. 11, No. 6, Nov. 1968, pp. 110-116. Powder metallurgy is a precision manufacturing process for metal structural parts and shapes. The process has a number of major advantages over other metalworking techniques (such as excellent reproducibility, high production rates, and reduced labor skill requirements). But to use powder metallurgy successfully, the electronic designer must understand the parameters of the process.

Conducting a successful interview, Robert D. Compton, Midwest Editor, "EDN," Vol. 13, No. 13, Nov. 11, 1968, pp. 113-115. Suppose you, as an engineer representing your company, have to interview a job applicant. You have a dual responsibility: your company is waiting for your opinion before it makes a final judgment and, at the same time, the applicant is going to size you up as typical of the type of people he will be working with and/or for. You want to be honest with him and your employer. Such an interview can go smoothly, and needn't be a source of jitters. This article tells you how to prepare for it, and how to conduct it.

**Rectifiers, diodes, SCRs and Zeners
from Power House distributors.**

For those commercial and industrial applications where both performance and price are critical parameters, International Rectifier offers the industry's most complete line of high reliability power rectification components in low cost, rugged plastic packages.

For instance, our proprietary 21PT half-wave rectifier unit: only about 1/4-inch square, it replaces stud-mounted DO-4 rectifier packages up to 15 amps, at a fraction of their size and cost.

And we have rectifier bridges from 1 through 10 amperes. We offer diodes, SCRs, zeners. Even plastic Klip-Sels, our handy surge arrestors for use with our other power components. Everything you need, at the price and performance you want, and available now from your Power House distributor's shelves.

INTERNATIONAL RECTIFIER

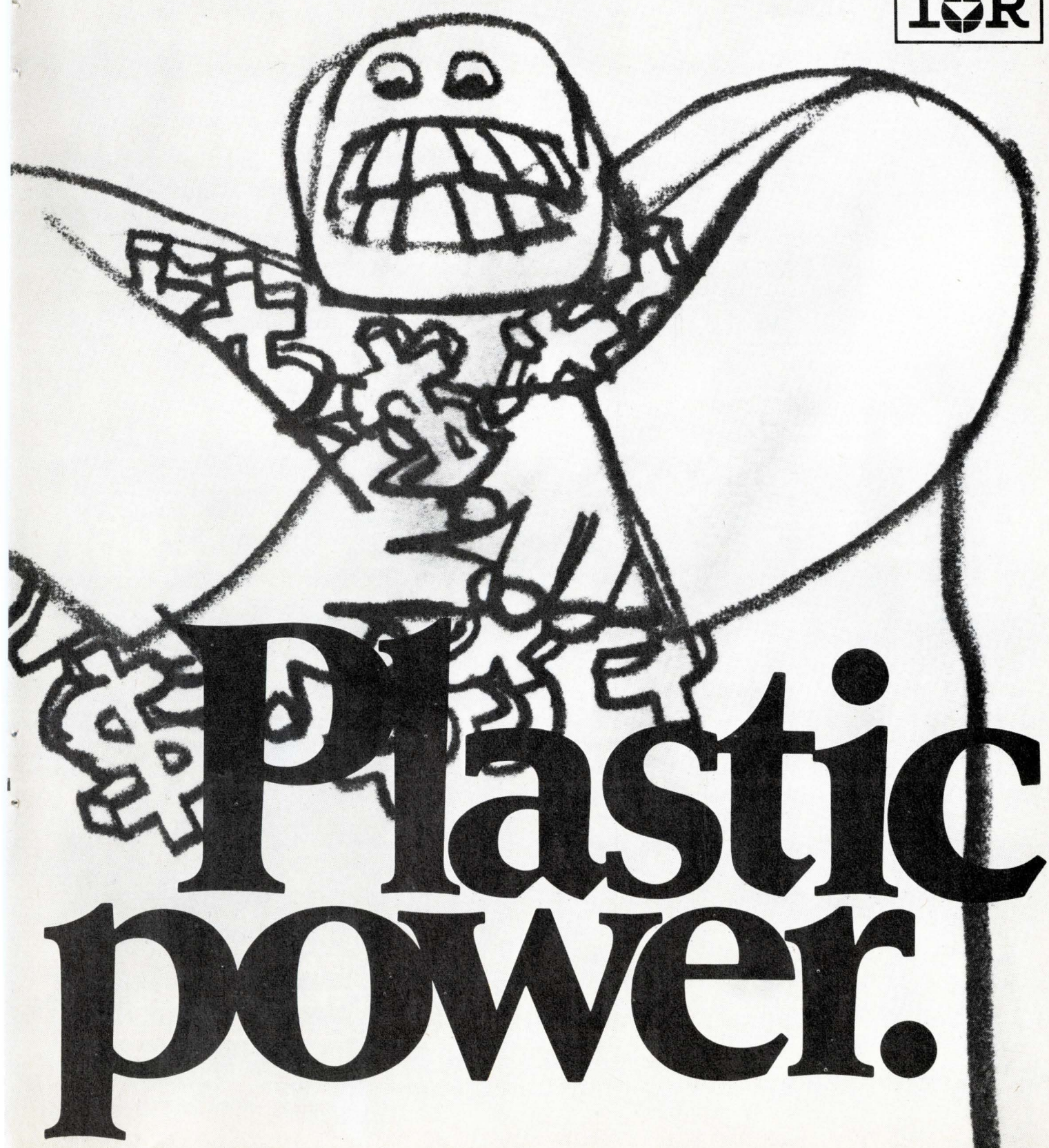

**Plastic
power.**

NOW you can meter better for less...much less

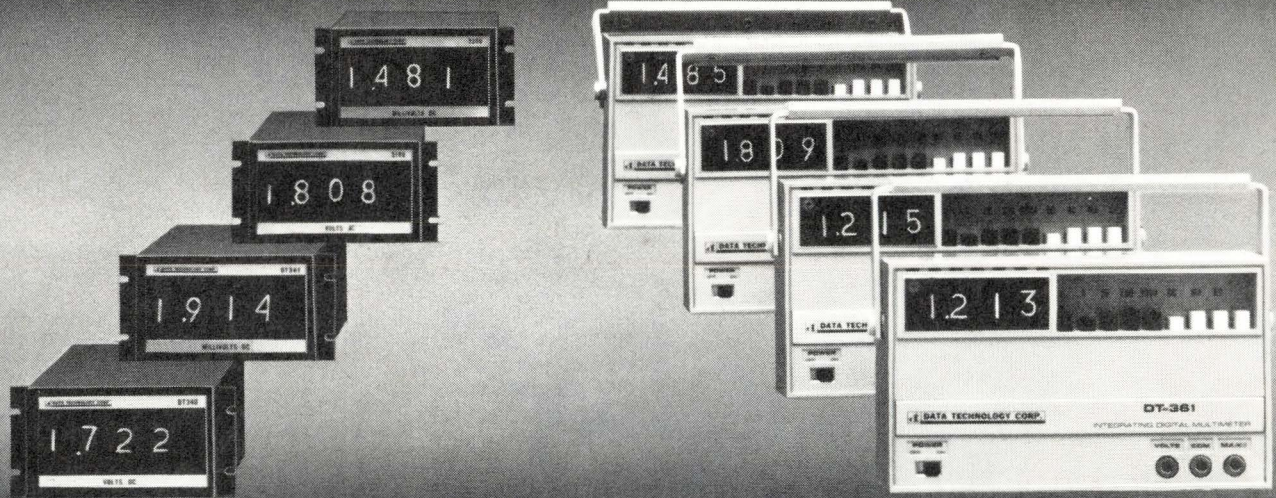

DT-340 Digital
Panel Meter

\$129

100 units

DT-361 Integrating
Digital Multimeter

\$295

5-9 units

- Versatile—measures volts, ohms, or current
- High Accuracy—0.1% of reading
- Lightweight—less than 25 ounces

- Versatile—bench, rack mounted, or portable
- Measures ACV, DCV, DCMA, ACMA and Kohms
- Compact—8½" x 5¾" x 3"; weighs only 42 ounces

FOR FURTHER INFORMATION CALL COLLECT:
(415) 321-0551, Ext. 216



**DATA
TECHNOLOGY
CORPORATION**

1050 East Meadow Circle
Palo Alto, Calif. 94303

Spectrum analyzer has absolute calibration

This 1- to 1250-MHz instrument has calibrated vertical and horizontal scales. You can use it as a "frequency domain oscilloscope."

Hewlett-Packard refers to their new instrument as a "frequency domain oscilloscope," because they feel that its applications are immense. And maybe they have a point.

A multi-conversion swept superhet receiver, the Model 8554L/8552A advances the state of the art of spectrum analyzers. For instance, the local oscillator is not a bulky BWO, but an IC. Another example is a 13-pole filter on the input, also a microcircuit. Such features give HP's instrument its improved performance, as well as its small size: roughly 9 in. high, 17 in. wide, and 18 in. deep.

Use it like a scope

But the features which give versatility to the analyzer are its absolutely calibrated frequency and amplitude scales. You can dial up a center frequency, and the display center will be within ± 10 MHz of that setting. And the frequency error between any two points on the display will be less than $\pm 10\%$ of the indicated separation.

This is HP's 1250-MHz spectrum analyzer. Model 8554L/8552A has frequency and amplitude calibrations that give it versatility in the frequency domain similar to that of a scope in the time domain.

Absolute amplitude calibration means that you have a dial similar to the vertical sensitivity control of a scope. That is, you can set a reference level in either dBm (log mode) or volts/div (linear mode); and you read the rms values of the spectral display right off the graticule. Such a feature is a boon for circuit or equipment testing: you can make measurements in the frequency domain with the same ease and confidence as with a scope in the time domain.

Pertinent specs

The useable range of the analyzer is from well below 1 MHz to 1250 MHz, with scan widths settable from 2 kHz/div to 100 MHz/div (For scan widths of 200 kHz/div or less, the first L.O. automatically phase-locks to an internal reference.) The i-f bandwidth (resolution) is settable between 300 Hz and 300 kHz.

The overall noise figure is 24 dB, which means better than -120 dBm sensitivity at the narrowest band-

widths. An input filter assures you that signals beyond the instrument's 1250-MHz limit cannot appear on the display. (In other words, they cannot mix with oscillator harmonics to produce spurious spectral lines. Such lines are very difficult to identify, and can play havoc with conventional analyzer displays.)

Time scans run from 0.1 ms/div to 10 s/div, and can be synchronized in many of the same ways as in an oscilloscope.

The vertical sensitivity control plus the graticule give you calibrations from -120 to $+10$ dBm, at 10 dB/div. The graticule itself has a 70-dB display range. Also marked linearly, the same control shows settings from $0.1 \mu\text{V}/\text{div}$ to $100 \text{ mV}/\text{div}$.

A vernier control establishes absolute calibration. There is a cw calibration reference output on the front panel. This port gives you a 30-MHz, -30 -dBm signal for calibration. Needless to say, all amplitude accuracy

(Continued on page 94)

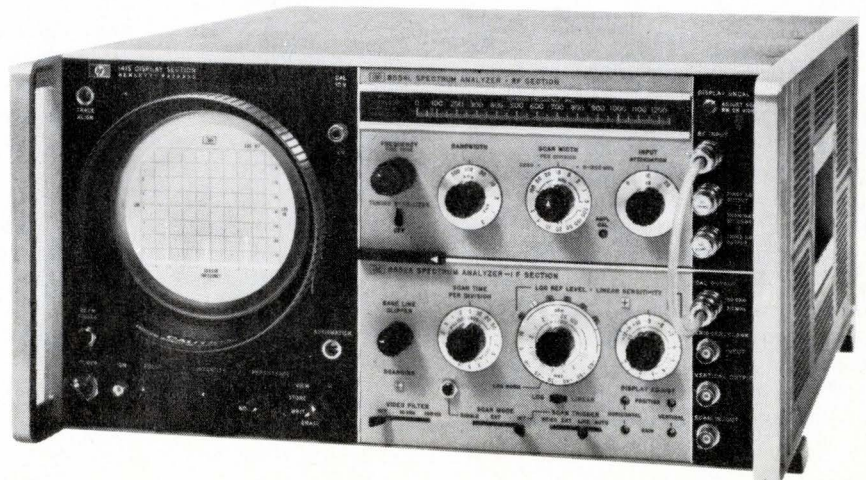

The Complete Line of Fuseholders For All Applications

Panel mounted, in-the-line, lamp indication, signal-activating, visual indicating . . . with solder terminals, quick connect terminals. Also holders to meet Military Specifications under MIL-F-19207B.

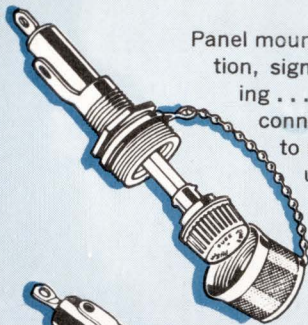

HMR RF shielded holder for 1/4 x 1 1/4 in. fuses.

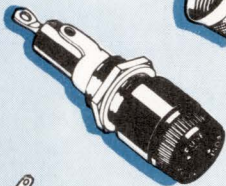

HPC Panel mounted holder for 13/32 x 1 1/2 in. fuses. Rated 30 amperes for any voltage up to 600.

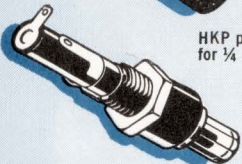

HKP panel mounted holder for 1/4 x 1 1/4 in. fuses.

HKA lamp-indicating, signal activating holder.

Write for BUSS Form SFB

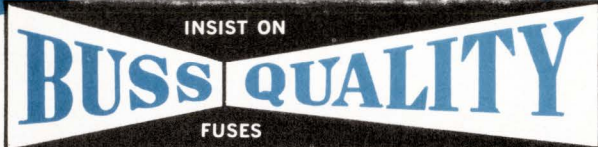

BUSSMANN MFG. DIVISION, McGraw-Edison Co. St. Louis, Mo. 63107

The Complete Line of Signal-Indicating Alarm-Activating Fuses

For use on computers, microwave units, communication equipment, all electronic circuitry.



BUSS GLD-1/4 x 1 1/4 in. Visual-Indicating, Alarm-Activating.



BUSS Grasshopper Fuse, Visual-Indicating, Alarm-Activating.

BUSS GBA-1/4 x 1 1/4 in. Visual-Indicating.



BUSS MIC-13/32 x 1 1/2 in. Visual-Indicating, Alarm-Activating.



BUSS ACH Aircraft Limiter, Visual-Indicating.

BUSS MIN-13/32 x 1 1/2 in. Visual-Indicating.



FNA FUSETRON Fuse 13/32 x 1 1/2 in. slow-blowing, Visual-Indicating, Alarm-Activating. (Also useful for small motors, solenoids, transformers in machine tool industry.)

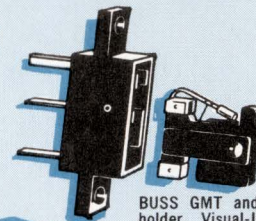

BUSS GMT and HLT holder, Visual-Indicating, Alarm-Activating.

Write for BUSS Form SFB



BUSSMANN MFG. DIVISION, McGraw-Edison Co. St. Louis, Mo. 63107

BUSS: The Complete Line of Fuses and . . .

(Continued from page 93)

specifications are within a small fraction of a decibel of the indicated settings of the panel controls.

Two other conveniences are a panel light that warns you of an i-f or video bandwidth too narrow for your combination of scan width and scan time, and a post-detection video filter that averages a time-varying display. You can select either a 100-Hz or a 10-KHz bandwidth.

Why they did it

The analyzer is the culmination of a two-year development effort. HP decided to undertake it, discloses Rod Carlson, Manager of the Signal Analyzer Laboratory, "because we got tired of explaining to users how to calibrate a spectrum analyzer." He adds, "No one had really provided a full and absolute calibration of both horizontal and vertical scales for the major part of the frequency spectrum, 1-1000 MHz." And as a user of its own instrumentation products, HP was convinced that the engineering community would appreciate this feature.

Also behind the successful evolution of the unit is the company's own mi-

crocircuits capability. Carlson says, "Our designers came up with the idea of using a local oscillator to drive the mixer hard into saturation; if we hadn't developed the L.O. as an IC, we would have been forced to use a big, costly BWO. And we also built such complex circuits as the 13-pole filter and the YIG oscillator. You couldn't get these ICs commercially.

HP is championing the spectrum analyzer as worthy of the mainline instrument status enjoyed by such general-purpose systems as the oscilloscope. Engineering experts at rival houses Singer-Metrics and Polarad also feel there is a place for units like the 8554L. They indicate users working in communications, navigation, and troposcatter systems eagerly await general-purpose analyzers.

Although they sharply disagree with HP's claim of being the first maker to provide absolute calibration, the experts concede the characteristics of the new analyzer are "admirable," and "fill a gap in the application spectrum."

Tektronix, for example, has an absolutely calibrated analyzer plug-in.

But their model 3L5 covers only 50 Hz to 1 MHz, and has few of the features of the "everyman" Hewlett-Packard machine. However, it is seldom that any development occurs in a vacuum. More often than not, where there is smoke, there is fire. So don't be surprised if this HP rival soon evolves a competitor.

How to get one

First deliveries of the 1250-MHz analyzer will be made in March. If you buy the complete unit—Model 8554L 1250-MHz rf section, Model 8552A i-f section, and the Model 140S display section—the price is \$5925. Should you wish a variable persistence display section (Model 141S), add \$800. A complete system with a large screen display (8 x 10 in. graticule: Model 143S) will cost you \$6675.

If you already own the Model 8553L/8552A 110-MHz analyzer, you can purchase the 1250-MHz 8554L plug-in alone, for \$3300. Inquiries Manager, Hewlett-Packard Company, 1501 Page Mill Rd., Palo Alto, Calif. 94304. (415) 326-7000.

Circle 201 on Inquiry Card

EE NEW LAB INSTRUMENTS

COUNTER/TIMER

Dc to 150 MHz.

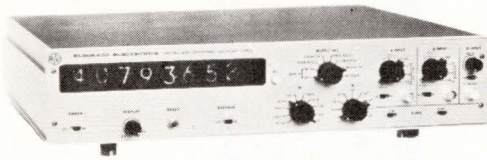

This timer has a 100 ns resolution time interval, period and multiple period, ratio and totalizing measurements. The eight digit data-display indicators with legend and decimal point, full input conditioning in addition to zero crossover triggering provide versatility. Oscillator stabilities are available from a part in 10^6 per month to 1 part in 10^9 per day. The unit has options available for data handling outputs and remote programming of all functions. The Model 1415 is packaged in a standard relay rack size, 3.5 in. high and sells for \$1450 with 45 day delivery. Eldorado Electronics, 601 Chalomar Rd., Concord, Calif. 94520. (415) 686-4200.

Circle 202 on Inquiry Card

STEPPING OSCILLATOR

Selects up to 13 pre-set frequencies.



Oscillator provides the operator with virtually simultaneous frequency display in 4 decades. Frequency stepping is accomplished by time indexing the oscillator to successive frequency steps selected for a given time period, so that a very low-distortion output is obtained for each selected frequency burst. All step-frequency output levels have a constant amplitude or can, by option, be varied. It operates in three frequency bands from 50 Hz to 5MHz and has 13 center-frequency steps in a 1:5 ratio. Each center-frequency step is adjustable over a decade. It also has cw, constant amplitude, adj. sync., recycle, and step multiplier time. The price is \$1,800, delivery 30 days. Micom, Inc., 855 Commercial St., Palo Alto, Calif. 94303.

Circle 203 on Inquiry Card

.. Fuseholders of Unquestioned High Quality

THE COMPLETE LINE OF *Small Dimension* FUSES

For The Protection of All Types of Electronic and Electrical Circuits and Devices . . .

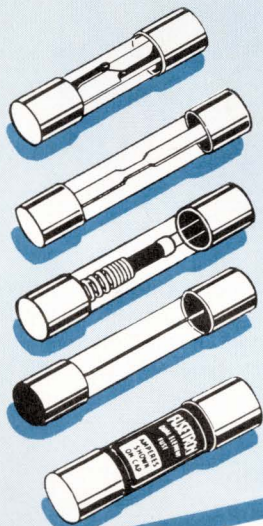

. . . includes dual-element "slow-blowing", single-element "quick-acting" and signal or visual indicating types . . . in sizes from 1/500 amp. up.

For special fuses, clips, blocks or holders, our staff of fuse engineers is at your service to help in selecting or designing the fuse or fuse mounting best suited to your requirements.

Write for BUSS Form SFB

INSIST ON
BUSS QUALITY
FUSES

BUSSMANN MFG. DIVISION, McGraw-Edison Co. St. Louis, Mo. 63107

Circle 49 on Inquiry Card

SUB-MINIATURE FUSES

Ideal for space tight applications, light weight, vibration and shock resistant. For use as part of miniaturized integrated circuit, large multi-circuit electronic systems, computers, printed circuit boards, all electronic circuitry.

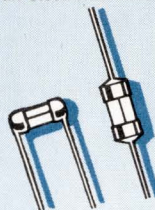

TRON Sub-miniature Pigtail

Fuses — Body size only .145 × .300 inches. Glass tube construction permits visual inspection of element. Hermetically sealed. Twenty-three ampere sizes from 1/100 thru 15.



BUSS Sub-miniature GMW Fuse and HWA Fuseholder

Fuse size only .270 × .250 inches. Fuse has window for visual inspection of element. Fuse may be used with or without holder. 1/200 to 5 amp. Fuses and holders meet Military Specifications.

Write for BUSS Form SFB

INSIST ON
BUSS QUALITY
FUSES

BUSSMANN MFG. DIVISION, McGraw-Edison Co. St. Louis, Mo. 63107

Circle 49 on Inquiry Card

ANOTHER DATA CONVERSION SOLUTION BY ANALOGIC

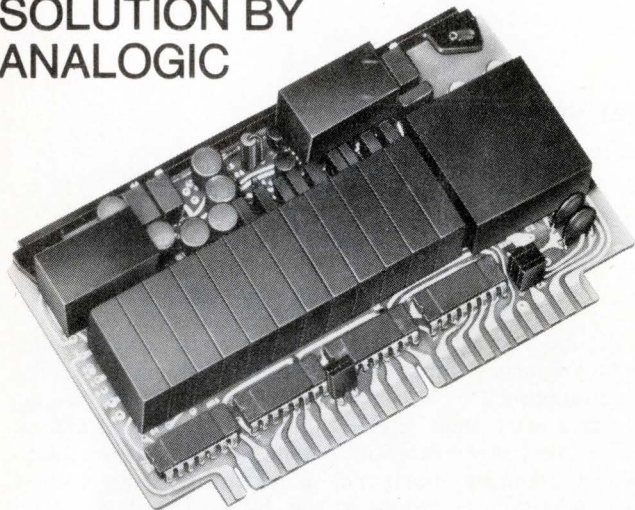

A 13 BIT FOUR-QUADRANT MULTIPLYING D/A CONVERTER ON ONE CARD...\$335*

Analogic's AN1013 digital to analog converter is self-contained (including amplifier and optional register) on a single 2 $\frac{1}{16}$ " x 4 $\frac{5}{8}$ " card, and in addition to conventional D/A conversion, is capable of multiplying any arbitrary AC or DC analog reference by a 13 bit digital code. Polarity of the reference may also be digitally controlled, thus providing true four-quadrant operation.

Specifically designed for long-term adjustment free operation over the -10°C to +70°C temperature range, the converter is available in configurations up to 13 binary bits including sign or three BCD digits plus sign. Typical applications include vector generation, digital to synchro conversion, function generation, digital scaling or attenuation, etc. An unusual combination of important features includes:

- Guaranteed conversion accuracy of 0.005% F. S. (20V P-P) \pm 0.007% of reading \pm 0.0005% F. S./°C.
- Reference accuracy (with optional internal D. C. reference) 0.005% \pm 0.0009%/°C.
- Updating rate in excess of 10 MHz.
- 20V P-P sine wave reference feed through @ 10 KHz (with all bits off) only 1.0 MV RMS.
- Switching transients for any combination of transfer changes completed within 1 μ s.
- \pm 10 VDC @ 5 ma. output with 5V/ μ s slew rate; optional high speed amplifier provides 20 ma. output @ 30V/ μ s slew rate settling in approximately 2 μ s.
- Wide variety of reference and reference switch options to meet virtually any requirement.
- Storage register option provides *Reset* as well as *Strobe* input, and output of storage register is available for simultaneous external use.
- Operates from \pm 15 VDC and + 5 VDC.

Write for complete specifications on the AN1013, and on Analogic's complete line of data conversion modules including analog/digital and synchro/digital/synchro converters, multiplexers, power supplies, and complete equipments.

ANALOGIC

Analogic Company, 296 Newton Street
Waltham, Mass. 02154, Tel: (617) 891-4708

*Substantial OEM
discounts available

© 1968, Analogic Co.

EE NEW LAB INSTRUMENTS

PLUG-INS

Expand the 560-Series Oscilloscope capability.

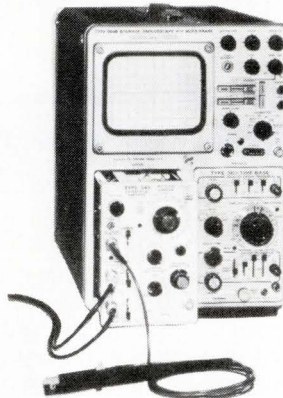

The Type 3A9 is an all solid-state unit with protected FET input stage. Basic deflection factor is 10 μ V/div., dc coupled, with a bandwidth of dc to 1 MHz. DC drift is 10 μ V/h, dc coupled, with constant line voltage and temperature. Displayed noise is 12 μ V or less tangentially measured at full bandwidth. Common mode rejection ratio is 100,000:1, from 10 μ V/div. to 10 mV/div. with a dynamic range \pm 1 V. An internal offset feature is usable over the full dynamic range of the instrument. When used with a Tektronix 125-turn ac current probe, the plug-in gives direct readings from 1 mA/div. to 1 A/div. The 3A9 is priced at \$490, current probe P 6019 is \$75. Tektronix, Inc., P. O. Box 500, Beaverton, Oregon 97005.

Circle 204 on Inquiry Card

RF SIGNAL GENERATORS

Have direct digital calibration.



The Series 900 Generators have direct digital calibration which eliminates the conventional, hard-to-read dial and substitutes a 4- or 5-digit numerical readout that indicates precisely the output frequency generated. The generators have digital interfaces entirely compatible with digital systems in automatic test systems.

Model 920, freq. range 50 kHz to 80 MHz

Model 940, freq. range 2 MHz to 230 MHz

Model 930, freq. range 50 kHz to 80 MHz

Model 910, freq. range 100 kHz to 32 MHz

Many standard features such as internal and external AM, frequency shift capability, FM and AM programming, BCD printout. Logi Metrics, Div. of Staut/Fin Corp., 100 Forest Dr., Greenvale, N. Y. 11548.

Circle 205 on Inquiry Card

RECORDER CONTROLLER

Provides fail-safe control.

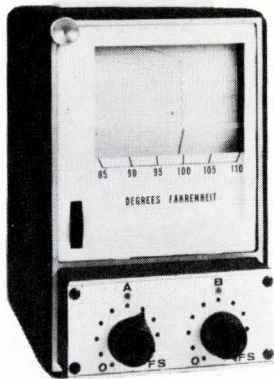

The Model F204 provides accurate control and is available as an optional feature on all Rustrak ac-operated recorders. Standard features include a sliding access window; a chart advance thumb wheel, full 31-day chart reroll or tearoff capability; and quick, easy chart review and rewind. Controller action is not interrupted or affected during chart reloading or reviewing. The basic circuitry consists of a high gain operational amplifier which compares the dc across the galvanometer to a stable, adjustable reference over the full range of the instrument by front panel controls. Rustrak Instrument Div., Gulton Industries, Inc., Municipal Airport, Manchester, N. H. 03103.

Circle 206 on Inquiry Card

CAPACITANCE & DF LIMIT BRIDGES

Makes 100-ms decisions.

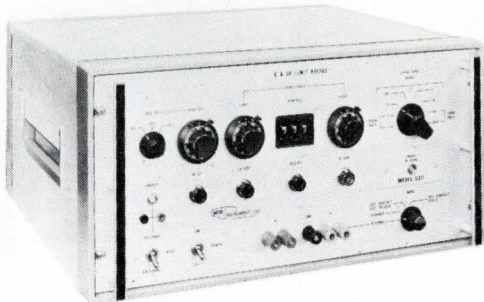

The Series 5310 high speed C + DF Limit Bridges features true series capacitance measurements from 2.5 pF to 1500 μ F. The three bridges cover the test range in 120 Hz and 1 kHz test frequencies. They have front panel indication of decisions, both local and remote. Remote indicators may also be arranged on bins or trays for fast sorting into specific categories. In addition, an output signal is provided for control of remote handling equipment. Decision limits may be quickly set by front-panel mounted precision 10 turn potentiometers for HI CAP, LO CAP, ACCEPT, or HI DF. Capacitance accuracy is $\pm 0.2\%$ using 4 terminal connections. DF accuracy over the 0 to 30% range is 1%. Price from \$3000. Micro Instrument Co., 12901 Crenshaw Blvd., Hawthorne, Calif. 90250.

Circle 207 on Inquiry Card

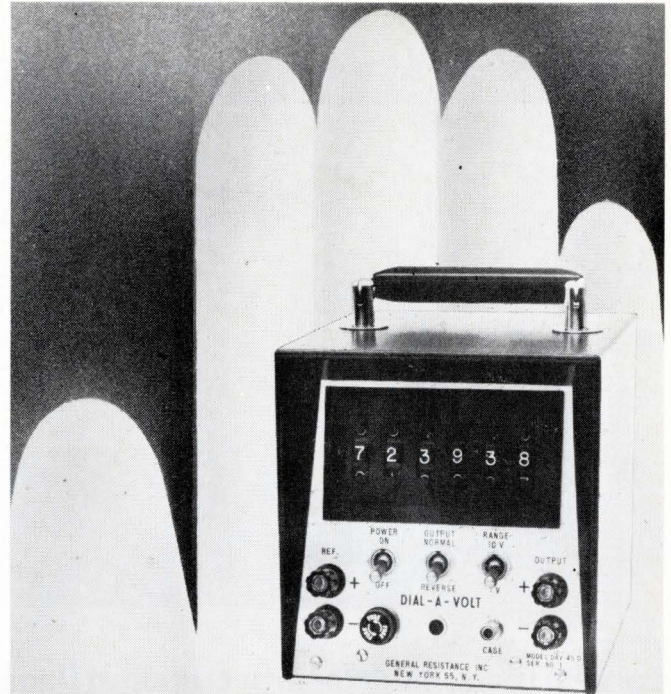

OUR REFERENCES ARE IMPECCABLE.

We have impeccable references from ± 0.1 nanovolt to ± 10 volts. DIAL-A-VOLT, GR's high accuracy ($\pm 0.0015\% + 5 \mu$ V) dialable voltage reference. With it and its NAV-453 Attenuator you have any reference voltage in its range at your fingertips, instantly, as easily as dialing your favorite phone number. Six-decade resolution, an in-line readout to eliminate setting error and simple recalibration of the temperature compensated zener's unique circuits.

Accuracy is traceable to NBS (we furnish a certificate). Stability is ± 5 PPM over 8 hours and ± 15 PPM per year. Noise and ripple combined are less than 0.0015% of output setting. The output floats, is short circuit protected and can be guarded to 500 volts.

In the same 6" x 6 $\frac{1}{8}$ " x 7" case (adapters for rack mounting are available) you get absolutely free an independently usable 6-decade 0.003% isohmic (so called Kelvin-Varley) voltage divider (it divides down the zener supply output).

DIAL-A-VOLT prices start as low as \$399 f.o.b. Mt. Vernon, N. Y., domestic. Write or phone for complete literature, a demonstration or both. DIAL-A-VOLT — its references are impeccable.

General Resistance, Division of Chronetics. 500 Nuber Avenue, Mt. Vernon, N. Y. (212) 292-1500. In Europe: 39 Rue Rothschild, Geneva, Switzerland (022) 31 81 80.



MB Environmental Dynamics

Analysis Instruments • Signal Conditioning • Electrohydraulics • Pressure Measurement • Vibration Systems

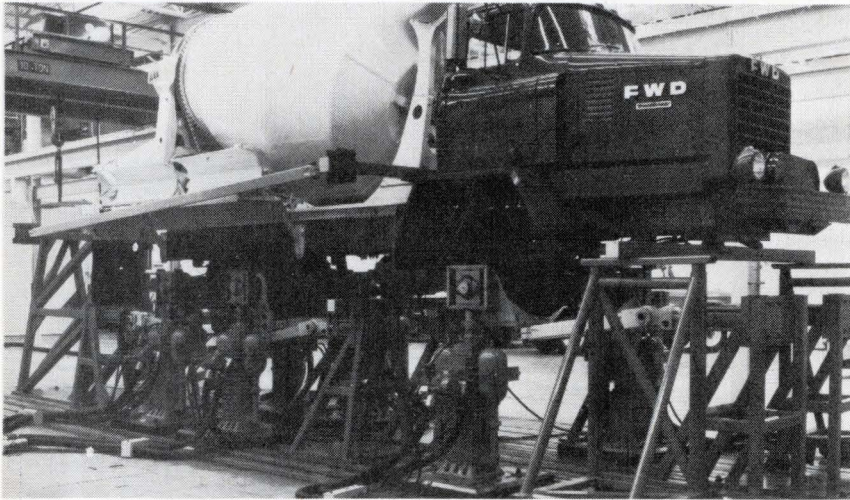

MB equipped test facility owned and operated by Dana Corporation. According to Dana officials, patent protection for the facility has been applied for.

Largest road simulator in operation at Dana Corporation

Located at Dana's Detroit Sales and Research Center in Dearborn, this MB electrohydraulic Teststructure[®] system is capable of handling vehicles up to the 80,000 pound G. V. W. class. Shown above is a cement mixer under test. Six actuators, fully controlled by in-field generated tape or predetermined console inputs, can exert an accumulative force of approximately 170,000 pounds. Displacement is 10 inches D. A.; peak velocity is 250 inches per second from the 3,000 psi power system. The system required installation of a half-million pound seismic mass foundation. ([®]Teststructure is a trademark of MB Electronics)

5-Volt pressure cells strike ideal cost/accuracy ratio

The Series 500 pressure cells have achieved outstanding acceptance in laboratory and permanent field applications. At a cost of approximately \$200, the units are sufficiently inexpensive for very broad use. Yet their ½% error band provides more than the level of accuracy required for most applications and their 5-volt output simplifies instrumentation. The 500 (psig) and 510 (psia) Pressure Cells are but two of the extensive line of transducers produced by MB using its unique bonded strain gage, integral diaphragm construction.



Reader Service No. 103

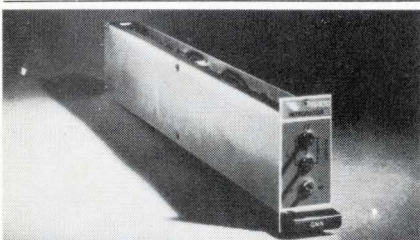

Simultaneous single and double frequency integrated outputs are offered by the N409 Integrator. This wide band instrument works with any signal conditioning or data acquisition system, including units of the unique low-noise Zero Drive System, of which it is a flexible, self-contained module. Features include selectable gain, isolated input and output terminations.

Reader Service No. 105

Reader Service No. 101

Use of small vibration test systems considered unlimited

The range of known materials and products being tested and evaluated on MB PM Systems is so vast that no limit is foreseen on their expanding use. Wire, automotive transmissions, human arteries, plastics — these are but a few of the known test subjects. Any R&D lab can establish its own vibration test facility for under \$1,500 with a PM shaker and amplifier.



Reader Service No. 102

Spectrum analysis described

A new, basic-to-advanced technology description and application review will be found in an MB brochure which describes the T-1000 Spectrum Analyzer. Credited as the world's most accurate analyzer, the T-1000 offers broad applications in determining Fourier Series; PSD Analysis; Fourier Spectrum; and Random, Transient and Complex Signal Analysis, all of which are covered in Bulletin No. 214.

Reader Service No. 104

MB ELECTRONICS
A **texttron** COMPANY

P.O. BOX 1825, NEW HAVEN, CONNECTICUT 06508
Tel. (203) 389-1511 Twx 710 465-3283 Telex 0963-437

NEW LAB INSTRUMENTS

SWEEP OSCILLATOR

Covers from 0.02 Hz to 200 kHz.

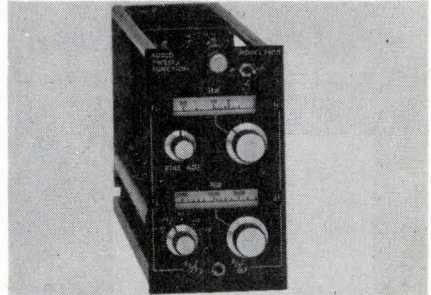

Model 3400 was designed for use in Telonic's 2003 Sweep/Signal Generator System. It is equipped with controls for two modes of frequency range selection, either by setting a center point and a bandwidth, or by setting high and low end points. The oscillator's sweep width is continuously adjustable from 0.1% of full scale to full scale, or 3 decades, on any band. Its output is 7 Vrms across 50Ω. Sine, triangle, or square wave output can be selected by a switch. Sweep rate may be at line frequency or continuously adjustable from 0.001 to 50 sweeps/s. Telonic Instruments, 60 N. First Ave., Beech Grove, Ind. 46107.

Circle 208 on Inquiry Card

SWEEP GENERATOR

With post marker injection.

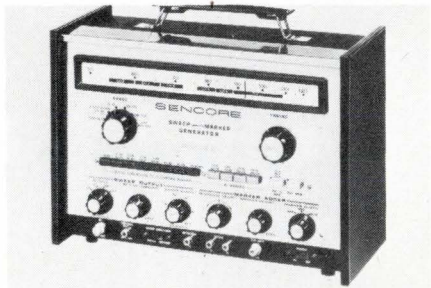

A vhf sweep, a uhf sweep, a crystal-controlled marker generator, and a marker adder are combined in the SM152. It is a complete alignment instrument with linear sweep from 10 MHz to 920 MHz for all TV and fm work. Its sweep frequency generator is calibrated in megahertz and TV channel numbers; the sweep width is calibrated from 0.3 MHz to 15 MHz. Crystal-controlled markers are provided for both i-f and rf. Simply by pushing a button a marker appears on the sweep response curve. The unit is housed in a rugged vinyl-clad steel case; its price is \$349.50. Sencore, Inc., 426 S. Westgate Dr., Addison, Ill. 60101.

Circle 209 on Inquiry Card

COUNTER/TIMER

Has normalized readings.



Operating modes of the Model 104A are: direct totalization from 1 to 10^5 ; preset totalization, with all five decades presettable from 0 to 9; "rate", in which gate times are selectable from $1 \mu\text{s}$ to 100 s for normalized readings; ratio for either conventional ratio measurements or scaling ratio measurements by N; period or multiple period, indicating time for N events to occur from $2 \mu\text{s}$ to 100 s; and preset time intervals, counts the interval clock during preset interval from $1 \mu\text{s}$ to 100 s. The basic counting rate is from 5 Hz to 8 MHz. Price is \$850. Monsanto Electronics Technical Center, 620 Passaic Ave., West Caldwell, N. J. 07006.

Circle 210 on Inquiry Card

PORTABLE OSCILLOSCOPE

Weighs less than 7 pounds.

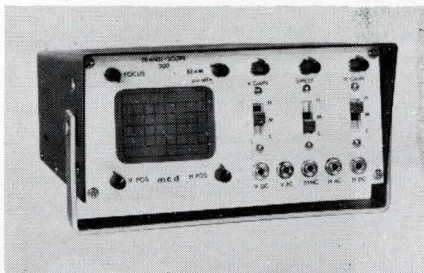

The Model 300 is fully solid-state with identical dc-vertical and horizontal amplifiers having a sensitivity of better than 10 mV pk-pk. Display is a 3 in. CRT with a $\frac{1}{4}$ in. divided graticule. Vertical and horizontal amplifier response is 0 to 100 kHz (-3 dB) dc and 10 Hz to 100 kHz (-3 dB) ac. Attenuation for the horizontal and vertical planes is in 3 steps of about 20 dB, plus 25 dB in gain control. Scope sweep is automatically synchronized and repetitive and is continuously adjustable from 10 Hz to 20 kHz in three steps. Price is \$169.50. Measurement Control Devices, Inc., 2445 Emerald St., Philadelphia, Pa. 19125. (215) Ga 6-8602.

Circle 211 on Inquiry Card

san fernando

electric manufacturing company

Electronic components
of proven reliability

INTRODUCES AN OUTSTANDING RFI FILTER

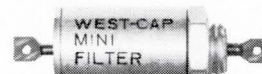

Actual Size

TYPE CF MINIATURE RFI LOW PASS
FILTER SERIES DEVELOPED BY WEST-CAP®

▶ PACKS MORE INSERTION LOSS IN A
SMALLER UNIT THAN EVER BEFORE

Plus all these features:

MINIATURE SIZE • LOW WEIGHT • LOW D.C. RESISTANCE • HIGH ATTENUATION • HERMETICALLY SEALED • BROADER RANGE OF VALUES • GOLD OR SILVER PLATED, STEEL CASE • HIGHER CURRENT RATINGS (TO 15 AMPS.)

Dimensions (inches)

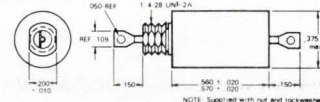

Ordering information

CF	4	A	PO6	-1	G	Voltage
TYPE	CIRCUIT	VOLTAGE	CURRENT	MOUNTING STYLE	TERMINAL STYLE	

A	50 VDC
B	100 VDC
C	200 VDC (115 VAC)

Circuit

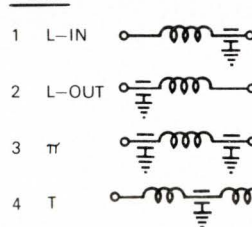

Mounting Style

1	.312	NO FLATS
2	.312	2 FLATS
3	.190	NO FLATS
4	.190	2 FLATS

Current in Amperes

PO6	.06 Amps.
P15	.15 Amps.
P25	.25 Amps.
P50	.50 Amps.
1PO	1.0 Amps.
2PO	2.0 Amps.
3PO	3.0 Amps.
5PO	5.0 Amps.
10P	10.0 Amps.
15P	15.0 Amps.

Terminal Style

G	90° LUG
L	LEADS

Call your representative of West-Cap high-reliability products or contact West-Cap Division—where service and quality count.



WEST-CAP DIVISION

1501 First Street, San Fernando, California
Telephones: (213) 365-9411 TWX (213) 764-5963

STANWYCK WINDING
NEWBURGH, NEW YORK

WEST-CAP ARIZONA
TUCSON, ARIZONA

GENERAL SCIENTIFIC
SAN FERNANDO, CALIFORNIA

EE NEW MICROWORLD PRODUCTS

ENCAPSULATED SUBMINIATURE COILS

For hybrid ICs.

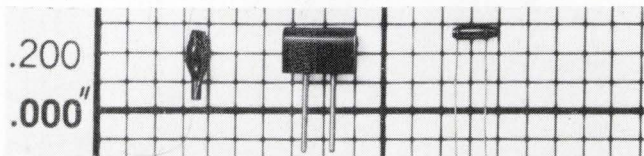

No bigger than a match head, Series 1054 coils are only 0.075 in. dia. x 0.17 in. long. There are 55 individual fixed rf inductors in the series. They range in value from 0.1 to 3300 μ H, with Q's from 21 to 50. Self-resonant frequencies range from 1 to 450 MHz.

Series 1050 variable coils have a "flocked" tuning element for inductance tuning. This series consists of ten coils in overlapping inductance ranges spanning 0.06 to 2000 μ H. Dimensions are 0.08 in. dia. x 0.188 in. long, max.

Series 1051 variable inductors are for PC board mounting, and cover a range of 0.10 to 10,000 μ H. The diallyl phthalate molded package is 0.1 x 0.16 x 0.26 in., and has solid, machined mounting pins.

In quantities of 1-9 pcs., the Series 1054 is priced from \$2.04; the Series 1050, from \$2.72. The Series 1051 is priced from \$7.90 for the higher inductance values. Prices are considerably lower in volume quantities, and the units are available for immediate delivery from stock. Cambridge Thermionic Corp., 445 Concord Ave., Cambridge, Mass. 02138. (617) 491-5400.

Circle 212 on Inquiry Card

VOLTAGE COMPARATOR

Guaranteed offset voltage.

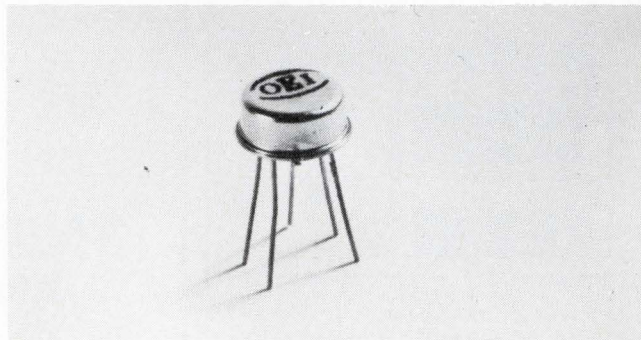

This precision voltage comparator gives you a maximum comparison error of ± 1 mV, including gain and offset errors. It is a single-chip monolithic device packaged in a 5-lead, low profile, TO-5 can. Model 5501 has 80 dB min. voltage gain, with ± 10 V min. output capability at 25 mA. The common-mode input voltage range is ± 7 V min., with a 70 dB min. common-mode rejection ratio. Input and output impedances are 100 k Ω min. and 300 Ω max., respectively. Response time is 1 μ s max. You can run the device between power supply voltages from ± 10 to ± 20 V and at temperatures from 0 to 70°C.

The 5501 comparator costs \$27 ea., 1-9; \$21, 100-299; and is stocked for immediate delivery. Optical Electronics, Inc., P. O. Box 11140, Tucson, Ariz. 85706.

Circle 213 on Inquiry Card

CTS series 750 cermet resistor networks with snap-in formed leads . . .

for either automatic insertion or hand mounting.

- Available in 3 sizes and an infinite number of circuit combinations.
- Extremely good environmental specifications.
- 5 lbs. pull strength on leads.
- Available with or without active devices.

Delivery: 2 weeks for prototypes; 4-6 weeks for production quantities.

Order from: CTS of Berne, Inc., Berne, Indiana 46711. (219) 389-3111.

CTS CORPORATION

Founded 1896

Series 750	4-pin 3 resistors	6-pin 5 resistors	8-pin 7 resistors
1,000 piece price	29.6c ea.	40.6c ea.	50.9c ea.
10,000 piece price	15.5c ea. (5.2c/ resistor)	21.0c ea. (4.2c/ resistor)	26.1c ea. (3.7c/ resistor)

These prices are based on $\pm 5\%$ tolerance, ± 300 ppm/ $^{\circ}$ C standard TC, and 50 ohms thru 100K ohms resistance range with all resistance values being within a 10:1 ratio per side.

CERMET

RESISTOR

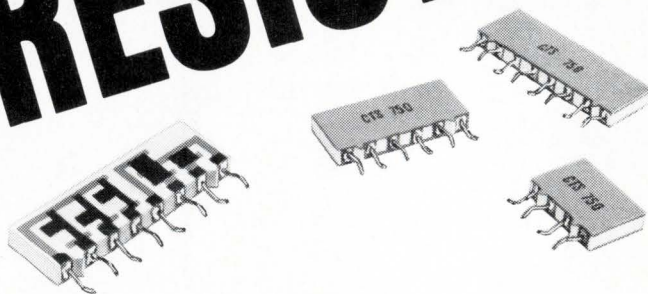

CHIP CAPACITORS

Multilayer monolithic construction.

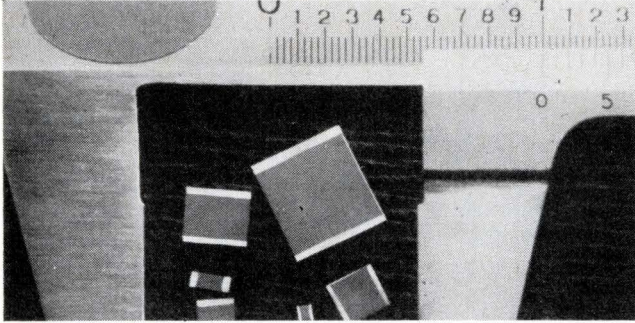

Featuring high volumetric efficiency and meeting the requirements of applicable MIL-specs, these rectangular chips have a bonded silver end termination. You can have special sizes and other termination metals, upon request. Insulation resistance is greater than 100,000 MΩ or 1000MΩ —μF at rated voltage. Dielectric strength of the various elements is tested at twice rated voltage for 5 s at 25°C, with current limited to 50 mA.

Dissipation factor ranges from less than 0.1% at 1 MHz for Class 1 bodies, to less than 2.5% at 1 kHz for Class 2 bodies. The capacitors are life tested at 2000 hrs., at twice rated dc voltage, at 125°C (per MIL-C-11015D). Capacitance ranges and temperature coefficients vary with each capacitor type. Maida Development Co., 214 Academy St., Hampton, Va. 23369.

Circle 214 on Inquiry Card

STANDARD PHOTO-ARRAYS

For paper tape readers.

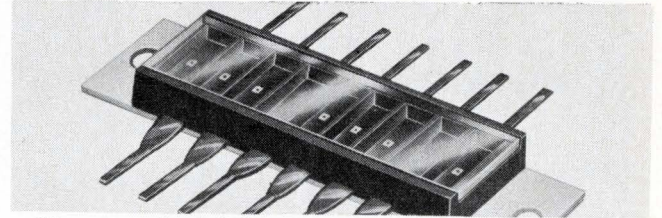

These standard light arrays use thick-film technology. You can have from five to twelve sensors in a single package; shielding between adjacent sensors eliminates crosstalk. The chips have their collectors connected in common; individual emitter leads are brought out. The package and lead frame are similar to that of a standard 14-lead DIP plastic IC.

The photo chips are mounted on 0.1 in. centers. But for custom applications, you can have them as close as 0.05 in. on centers. The chips are aligned to within ±0.002 in. on both the x- and y-axes. (Tolerances such as these are superior to those of discrete devices mounted on a PC board.)

The LA-800 series has been designed specifically for paper tape readers. But you can also use these arrays in computer card readers, curve readers, mark sensing equipment, character recognition sensors, level and positioning guides, and so forth. HEI Incorporated, Jonathan Industrial Center, Chaska, Minn. 55318.

Circle 215 on Inquiry Card

NETWORKS

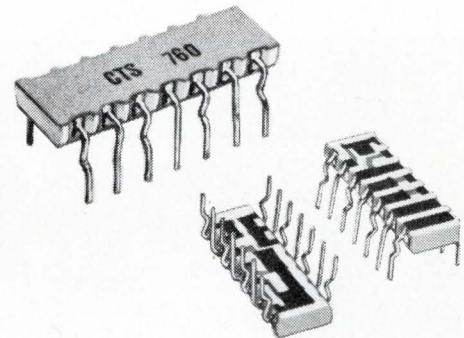

CTS Series 760 cermet resistor network or thick film hybrid circuit is mechanically compatible with standard 14 lead dual-in-line package . . . simplifying automatic insertion

and reducing assembly costs accordingly. The networks can also be easily hand mounted.

Series 760 provides:

- Up to 13 resistors per module with an infinite number of circuit combinations.
- Extremely good environmental specifications.
- 5 lbs. pull strength on leads.

Delivery: 2 weeks for prototypes; 4-6 weeks for production quantities.

Order from: CTS of Berne, Inc., Berne, Indiana 46711. (219) 389-3111.

Series 760	9 resistors	11 resistors	13 resistors
1,000 piece price	82c ea.	86c ea.	90c ea.
10,000 piece price	41c ea. (4.5c/resistor)	43c ea. (4c/resistor)	45c ea. (3.5c/resistor)

Prices shown are based on ±5% tolerance, ±300ppm/°C standard TC, and 50 ohms through 100K ohms resistance range with all resistance values within a 5:1 ratio per side.

CTS CORPORATION



Circle 53 on Inquiry Card

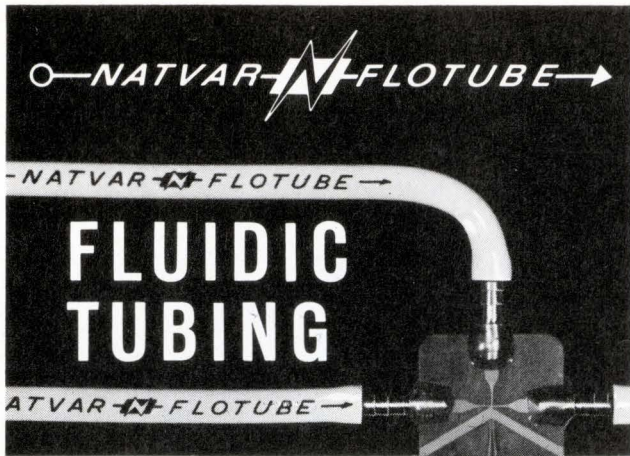

- Tight, leakproof connections
- Won't kink on sharp turns
- Smooth, uniform bore.
- Resists chemicals

Natvar Flotube is a PVC tubing, specially formulated for use in fluidics. The smooth, uniform bore assures uniform impedance and low pressure-drop in fluidic circuits. Holds tight, leakproof connections and won't kink even on small radii. Available in all sizes for the most commonly used devices in clear and colors, with four transparent colors for circuit tracing. Send for technical data and FREE samples.



Circle 54 on Inquiry Card

ELROY



"Elroy, we have flat cables in the stock room!!"

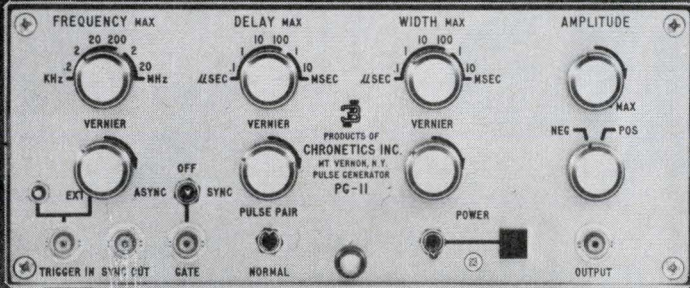

PG-11. \$375. Hallelujah.

The high performance, sensibly priced PULSE GENERATOR you've been looking for is here! Meet the Model PG-11: 10 Hz to 20 MHz.

±15 volts at maximum or any other rep rate. Rise time typically 4 ns at full amplitude. Single or double pulses, manual one-shot, pulse bursts. Synchronous or asynchronous gating. Triggering, DC to 20 MHz. Continuously variable rep rate, width, delay, amplitude.

Clean pulses: total distortion at full amplitude from all sources is less than 5%. All

solid state. Optional rack adapter for mounting one PG-11, or mounting two PG-11's side by side in 3-1/2" of rack height. Bench model dimensions are 4" h x 8-1/2" wd x 9-1/2" d; weight 7 pounds, net. Full year guarantee. Available from stock.

Write or phone your nearest Representative (eem) for literature, a prompt demonstration or both.

PG-11. \$375. Hallelujah.

Chronetics, Inc. 500 Nuber Avenue, Mt. Vernon, N.Y. (914) 699-4400. In Europe: 39 Rue Rothschild, Geneva, Switzerland (022) 31 81 80.



LOW MELT SOLDER

Melts at 212°F.

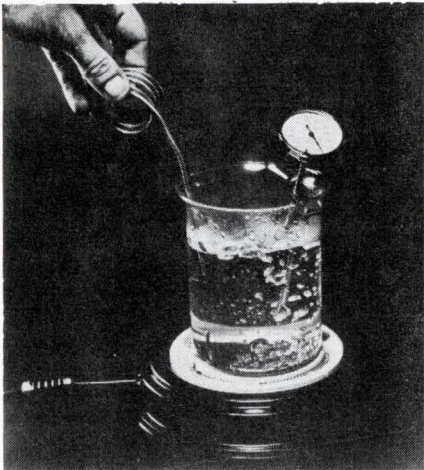

"Cerrosolder" is a bismuth-based alloy that softens at 209°F and is fully liquid above 212°F. Lead wires, pins and the like must be pretinned before using it to assure proper intermolecular bond. This solder solves production problems where normal soldering temperatures, or even special alloy solders cause damage, e.g., assembly ICs where too much heat can cause damage to or even obliteration of some of the discrete components. Electrical conductivity is 2.9% that of copper and resistivity is 349 circular mΩ/ft. Cerro Corp., 300 Park Ave., New York, N. Y. 10022. (212) 688-8822.

Circle 217 on Inquiry Card**PASSIVATED DIODE CHIPS**

For power hybrids.

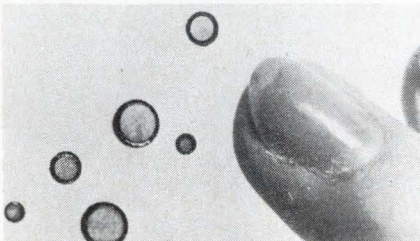

These hermetically sealed power rectifier devices may be used in micro-miniature power supplies and other power circuitry. They meet the requirements of rigorous high reliability Mil Specs. Tests have proven the hermetic seal to be reliable. The glass passivated diode chips have switching speeds to 75 ns, voltages to 1200, current from 1 through 35 A. They are impervious to thermal shock. A choice of contact metal is available. Solitron Devices, Inc., 256 Oak Tree Rd., Tappan, N. Y. 10983 (808) 431-1850.

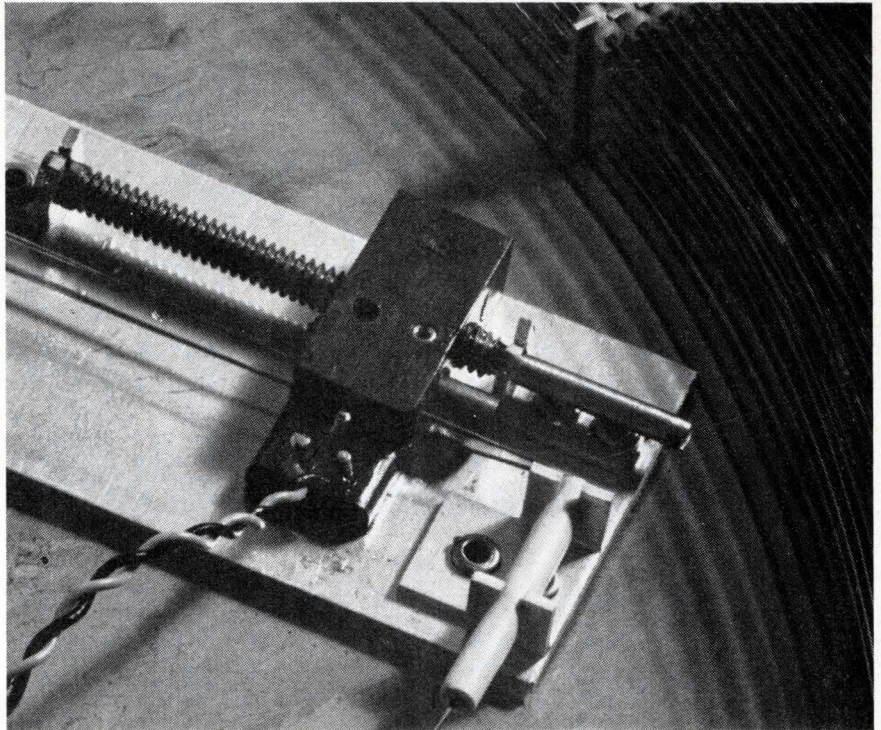
Circle 218 on Inquiry Card**Serial memory
for sale bit by bit.****4 for a penny.**

Why pay from 5 cents to as much as 20 cents per bit for some other memory device when you can get a versatile, reliable magnetostrictive delay line memory for as little as a quarter-cent a bit. Whether you're looking for a memory module for alphanumeric CRT displays, computer terminal buffers, communications buffering, radar and sonar signal processing systems, desk calculator memories or any other temporary or peripheral storage need, we can supply a serial memory that will do the job better and cheaper in bit price and total unit price. Try us. Digital Devices delay lines store up to 30,000 bits of information at 2 MHz. Their reliability and temperature stability have been proven in systems assembled and sold by leading electronics manufacturers. And they're adaptable to almost any use you can think of. Let us know what you have in mind: total storage, access time, internal bit rate, environment, physical configuration, interface requirements and other pertinent data. We'll send you an immediate answer. Write Digital Devices Division, Tyco Laboratories, Inc., 200 Michael Drive, Syosset, L.I., New York 11791. Or call (516) 921-2400.

TYCO

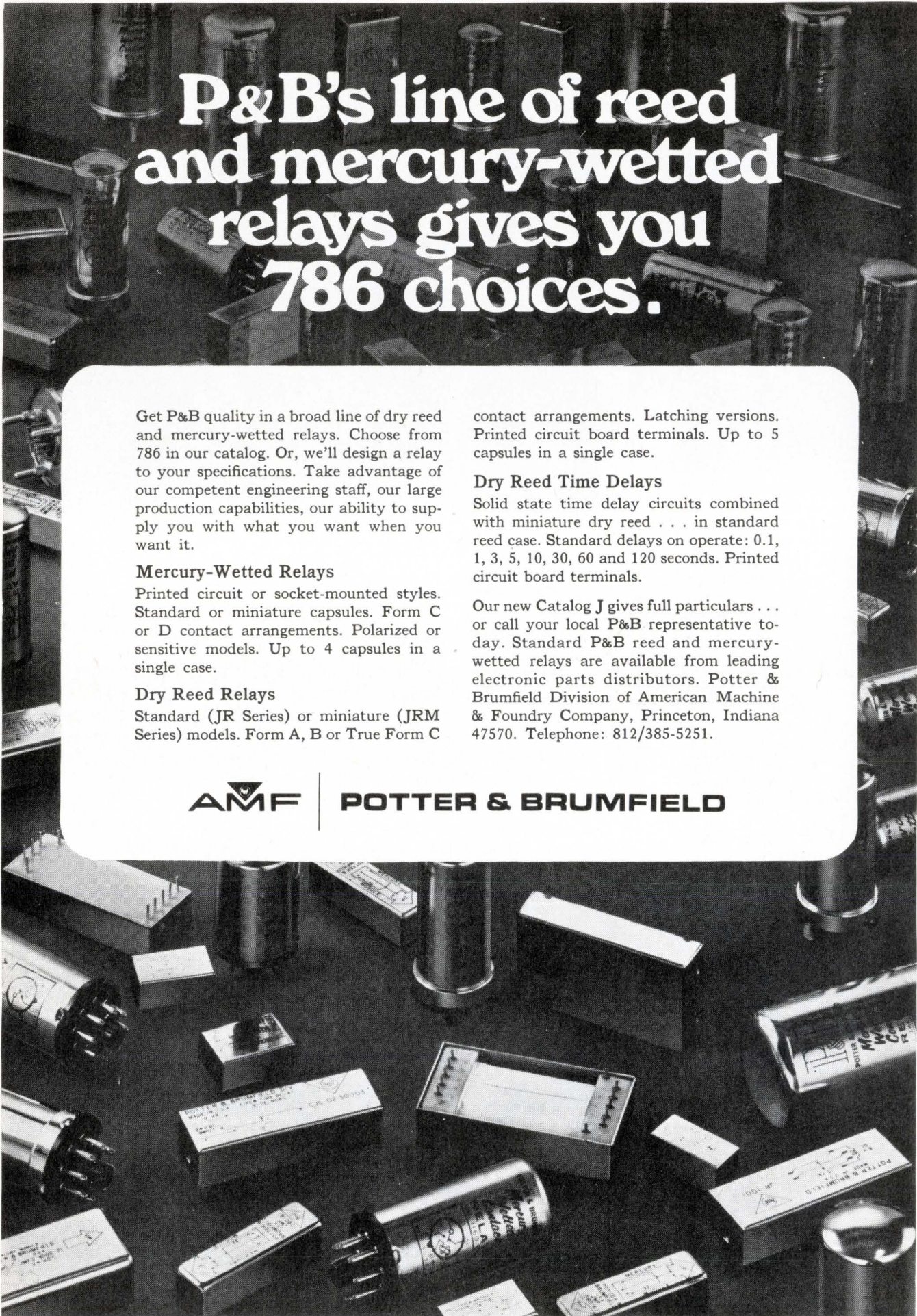

P&B's line of reed and mercury-wetted relays gives you 786 choices.

Get P&B quality in a broad line of dry reed and mercury-wetted relays. Choose from 786 in our catalog. Or, we'll design a relay to your specifications. Take advantage of our competent engineering staff, our large production capabilities, our ability to supply you with what you want when you want it.

Mercury-Wetted Relays

Printed circuit or socket-mounted styles. Standard or miniature capsules. Form C or D contact arrangements. Polarized or sensitive models. Up to 4 capsules in a single case.

Dry Reed Relays

Standard (JR Series) or miniature (JRM Series) models. Form A, B or True Form C

contact arrangements. Latching versions. Printed circuit board terminals. Up to 5 capsules in a single case.

Dry Reed Time Delays

Solid state time delay circuits combined with miniature dry reed . . . in standard reed case. Standard delays on operate: 0.1, 1, 3, 5, 10, 30, 60 and 120 seconds. Printed circuit board terminals.

Our new Catalog J gives full particulars . . . or call your local P&B representative today. Standard P&B reed and mercury-wetted relays are available from leading electronic parts distributors. Potter & Brumfield Division of American Machine & Foundry Company, Princeton, Indiana 47570. Telephone: 812/385-5251.



AMF

POTTER & BRUMFIELD

EE NEW PRODUCTS

PORTABLE VACUUM SYSTEM

Pumps below 6×10^{-5} Torr in 90 s.

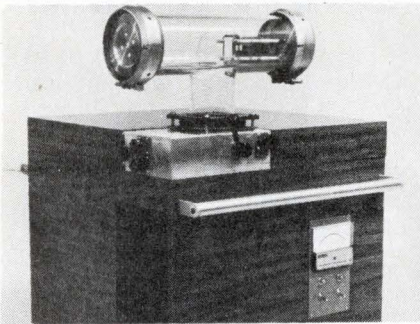

The DRV-2 is a portable, compact, high vacuum system for use in sample preparation and storage, electron and ion beam experiments, vacuum coating, and other applications in the 10^{-5} Torr to 10^{-6} Torr range. Ultimate pressure of the system is 4×10^{-7} Torr. A cartridge-style zeolite trap allows the system to be pumped from atmospheric pressure to less than 6×10^{-5} Torr in 90 seconds. Micro-Tol Engineering Corp., Box 154, State College, Pa. 16801.

Circle 219 on Inquiry Card

PRECISION ATTENUATORS

Very low SWR.

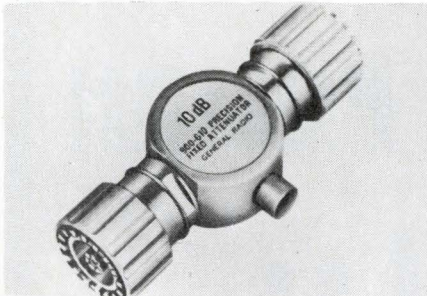

The Type 900-G6 precision fixed attenuator provides 6 dB attenuation; the Type 900-G10, 10 dB attenuation. Each has uniform attenuation over a wide freq. range, permitting improved accuracy in measuring insertion loss, impedance, power, or phase, especially in sweep-freq. measurements. Use of GR900® precision coax. connectors provides a high degree of repeatability in SWR, contact resistance, and insertion loss, contributing to the attenuators' value for substitution measurements. Price is \$175. General Radio Co., 300 Baker Ave., West Concord, Mass. 01781. (617) 369-4400.

Circle 220 on Inquiry Card

IC CONNECTOR

For flat ribbon cable assemblies.

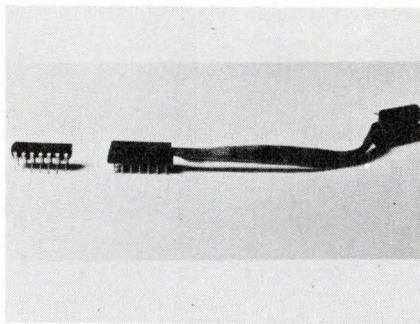

Flat ribbon cable assemblies have low-profile, 14-pin dual-in-line IC connectors at one or both ends. The connector matches IC elements in height, with a profile down to 0.187 in. It incorporates strain relief for the crimp or solder type connector connections. The 14 conductors (26, 28 or 30 AWG) can emerge from the ends, sides, or top of the connector. Ten-color coding is available. Spectra-Strip Corp., Box 415, Garden Grove, Calif. 92642. (714) 892-3361.

Circle 221 on Inquiry Card

DUAL WORK STATION

Cuts cost by one-third.

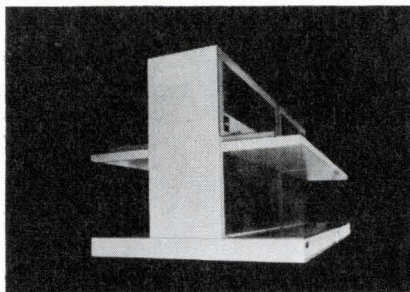

Two identical clean room work stations (Type WS) are built back to back in this unit. By sharing a common wall, filters, and blower speed controls, the cost per square foot of work area is decreased by a third while the area itself is doubled. Contamination in both work areas is reduced to 50 particles/ft.³, 0.5 μ and larger. A HEPA-type filter removes more than 99.97% of particles 0.3 μ and larger. Filtered, ultraclean air moves horizontally across both work areas at about 100 ft./min., sweeping away contamination. Westinghouse Architectural Systems Dept., 4300 36th St., Grand Rapids, Mich. 49508.

Circle 222 on Inquiry Card

**LOOKING
BEYOND
THE
"SPECS"
WITH P&B**

**NEW SOLID STATE
TIME DELAY RELAYS
AS LOW AS \$12.50**



This new solid state time delay relay (CU Series) could be the biggest \$12.50 relay value you've ever seen. Timing tolerance is $\pm 5\%$. Internal dpdt relay is rated at 10 amperes. Fixed timing ranges: 1, 5, 10, 30, 60 and 120 seconds. Designed for delay on operate applications. Both AC and DC models are available.

DC relays are internally protected against reversal of input polarity and will not be damaged by a transient input up to twice rated voltage for a duration of eight milliseconds.

Mounting versatility: Standard .187" quick-connect terminals are pierced for solder connections. A slotted case for direct-to-chassis mounting is available. A nylon socket is also available for plug-in convenience.

Resistor-adjustable models are available for any timing period up to 120 seconds at a slightly higher price.

PLUS P&B Capabilities and Facilities that insure

- **Controlled Quality**
- **Reliability**
- **Long Life**
- **On Time Deliveries**

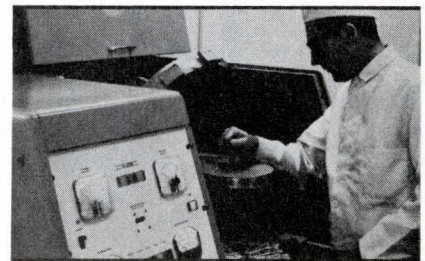

P&B's facilities include the most sophisticated quality control tests. Here the hermetic seals of aerospace relays are being leak-tested by radioactive krypton 85, at a sensitivity of 1×10^{-8} cc/sec. at a differential of one atmosphere.

AMF
POTTER & BRUMFIELD
Division of American Machine & Foundry Co.
Princeton, Indiana 47570

Circle 58 on Inquiry Card

**NOT JUST ANOTHER
FACTORY**

in another
FACTORY TOWN

but a site where you can
LIVE while you **WORK...**
in the **DAYTONA BEACH
INDUSTRIAL AREA**



A new 200 acre Central Industrial Park is ready for your plant in the Daytona Beach Industrial Area. Located at the heart of Florida's Interstate Highway System, this area fills every practical plant location requirement. It offers full community support, with outstanding educational and recreational facilities.

To receive a survey for Industry That Is Young At Heart



write to: **ROBERT H. MILES**
Committee of 100
**DAYTONA BEACH
INDUSTRIAL AREA**
P.O. Box 1309, Dept. IA-9
Daytona Beach, Fla. 32015
Tel. 904-255-1711

Circle 59 on Inquiry Card
(Please Use Home Address on the Card)

EE NEW PRODUCTS

TRIMMER

For PC wiring boards.

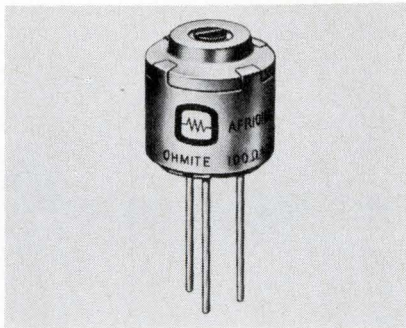

Rated at 1/4 W, Type AFR trimmers are single-turn controls built to withstand severe environmental conditions. They have a hot-molded resistor track bridged by a single moving contact brush. Fifteen models cover the range of 100Ω to 5.0 megohms, ±20%. Leads mount on 0.1 in. matrix PC wiring boards. Enclosure is non-magnetic, corrosion resistant, and watertight. Metal screwdriver adjustment shaft rotates 295° ± 5°. Size: 1/2 in. dia. x 17/32 in. high. Price for 1 thru 9 pieces is \$3.00. Ohmite Mfg. Co. 3601 Howard St., Skokie, Ill. 60076.

Circle 223 on Inquiry Card

Specify **RSC**
FOUNDED 1933

**RF and POWER
SWITCHES**

A complete line of rotary, high voltage and high current ceramic-type switches for RF and low frequency applications.

Write for catalog, containing information on the mechanical and electrical properties of our standard line of switches.

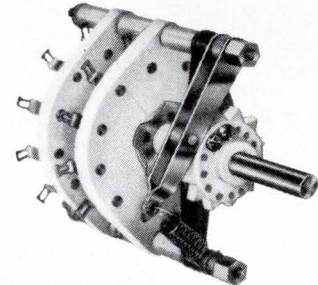

RADIO SWITCH CORPORATION

MARLBORO, NEW JERSEY

Telephone: HOpkins 2-6100 (Area Code 201)

Circle 60 on Inquiry Card

RUBBERIZED ABRASIVES

DEBURR SM-O-O-TH POLISH



COMPLETE KIT \$750

CONTENTS: 8 tapered edge wheels 3/4" dia. x 3/2" long; 16 cylinder points 1/4" dia. x 3/8" long; 16 bullet points 3/2" dia. x 1" long; 8 bullet points 3/8" dia. x 3/4" long; 8 straight wheels 1/2" x 1/4" x 1/8" hole; 16 straight wheels 3/8" x 1/4" x 1/8" hole; 8 straight wheels 1" x 3/16" x 1/8" hole; 2 wheel mandrels 1/4" shank; 2 point mandrels 1/8" shank. For use at speeds up to 25,000 RPM.

\$7.50 BUYS IT ALL — 80 piece introductory Kit 777 equally assorted in 4 grit textures: coarse, medium, fine and extra fine. **TRY IT** — Cratex Rubberized Abrasives improve the surface while preserving critical workpiece dimensions by its unique cushioning action. **FINISH THE JOB** — to your most exacting specifications — often in a single operation. **SEND FOR KIT 777** — or your **FREE SAMPLE** and catalog illustrating the full Cratex product line and its applications.

**CRATEX[®] RUBBERIZED
ABRASIVES**

1600 Rollins Road • Burlingame, California
Sold through leading industrial distributors

HV CONNECTORS

Corona-free.

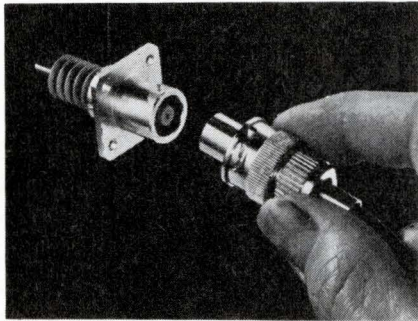

Applications for these high voltage, corona-free connectors include lasers, power supplies, and display systems. New "J" series connectors have an unmated flashover rating of 12 kVdc. Maximum operating levels are 20 kV mated and 10 kV unmated at -55° to 125°C . They are for use with standard coaxial cables (RG-59, -58, -54, etc.) as well as a corona suppressing type. Price is \$8 to \$10 each. Rowe Industries, Inc., Toledo, Ohio.

Circle 224 on Inquiry Card

CERMET ADJUSTMENT POT

Priced for commercial use.

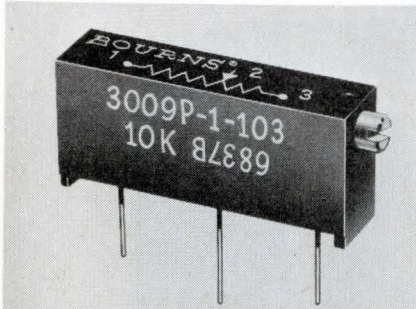

The 20-turn Model 3009 measures 0.75 x 0.19 x 0.35 in. Date code traceability and $\pm 0.05\%$ settability are 2 features. Standard specs:

- Standard res. range: 10 Ω to 1 megohm
- Power rating: 0.75 W at 25°C
- Temp. coef. ± 150 ppm/ $^{\circ}\text{C}$ max.
- Vibration: 20G
- Shock: 50G

They are available in 2 terminal configurations with 0.021 in. dia. pins. Standard pin mounting is Model 3009P. Model 3009Y is with the RJ11 configuration. Price, 500-piece quantity, \$1.45 each; delivery, stock to 4 weeks. Bourns Inc., Trimpot Products Div., 1200 Columbia Ave., Riverside, Calif. 92507.

Circle 225 on Inquiry Card

CRYSTAL OSCILLATOR

It's voltage controlled.

The VCCO Series crystal oscillator offers voltage controlled frequency deviation with good linearity and stability. Frequency swing of $\pm 0.2\%$ with a linearity of 1% can be obtained at specified frequencies in the 3 to 50 MHz range. Typical units operate on 24 Vdc input with a modulating voltage of ± 5 Vdc and a modulation rate

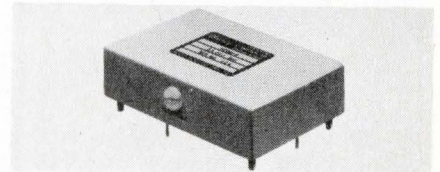

up to 5 kHz. Hermetically sealed module is for printed circuit board mounting. Bliley Electric Co., 2545 W. Grandview Blvd., Erie, Pa. 16512.

Circle 226 on Inquiry Card

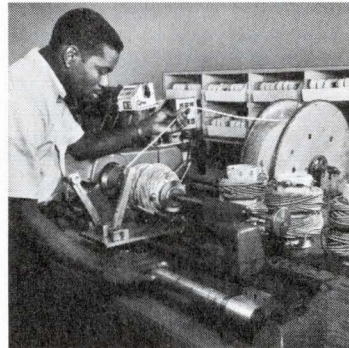

**Heavy Duty Filter Chokes
In Stock
Custom Filter Chokes
In 10 Days**

Series 7830 heavy duty line filter chokes provide up to 250 uH, carry up to 75 amps; widely used for RFI filters and reducing transient surge peaks; available from L.A. shelf stock; see Catalog 69.



Special RF chokes and coils designed to meet your requirements are shipped within 10 days to 2 weeks; production quantities start within 3 to 4 weeks after sample approval.

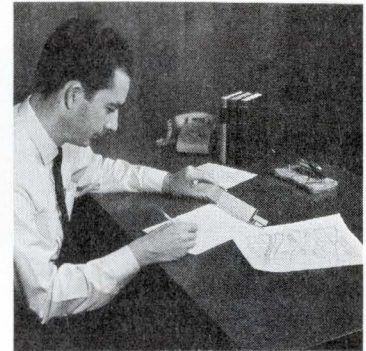

Intensive specialization in coil design and manufacture assures excellent operating results with a high degree of reliability. Engineering assistance helps achieve optimum performance.



Write for your copy of Catalog 69 containing specifications and prices for the complete line of J. W. Miller Co. RF chokes, RF and IF coils, transformers, filters, coil forms and components.

Call a Miller coil design specialist for your special coil requirements — (213) 233-4294.



J.W. MILLER COMPANY

5917 SOUTH MAIN STREET ■ LOS ANGELES, CALIFORNIA 90003

See your local distributor for the full line of standard coils and chokes

*Unlocking
the Future*

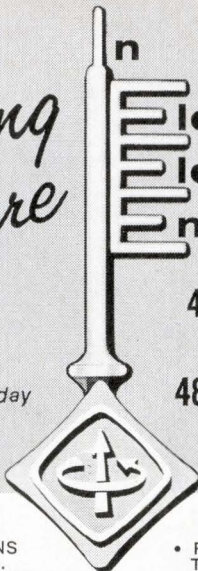

**Electrical
Electronics
Engineering**

**4 FLOORS OF EXHIBITS
NEW YORK COLISEUM
48 TECHNICAL SESSIONS
NEW YORK HILTON**

Monday through Thursday

- 48 TECHNICAL SESSIONS at the New York Hilton. Hours: 10:00-12:30; 2:00-4:30.
- FOUR FLOORS OF EXHIBITS at the N. Y. Coliseum including over 600 firms. Hours: 10 a.m.-8 p.m. 4 Days.
- GALA ANNUAL BANQUET—Wednesday 7:15 p.m. N. Y. Hilton Grand Ballroom — \$18.00.
- FREE SHUTTLE BUSES between the Hilton and the Coliseum — every few minutes.
- REGISTRATION — Good all days — Technical Sessions and exhibits. In and out privileges. — IEEE Members \$3.00. Non-members \$6.00. Ladies \$1.00. High School Students \$3.00 if accompanied by an adult — One student per adult: Thursday only — limit of 3 students per adult.
- REG-IDENT CARD speeds request for exhibitors' literature. Ask for one when registering.
- ESCALATORS/EXPRESS ELEVATORS to the Fourth Floor.

IEEE '69  **INTERNATIONAL
CONVENTION & EXHIBITION
MARCH 24-27, 1969**

Circle 63 on Inquiry Card

EE NEW PRODUCTS

ROUND WIRE FLAT CABLES

Conductors are on 0.050-in. centers.

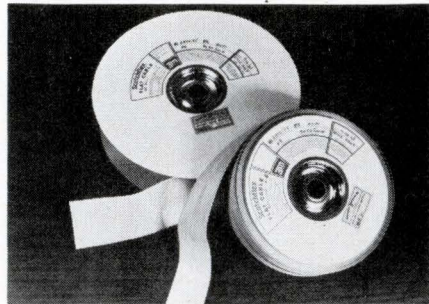

Both "Scotchflex" Nos. 3380 and 3386 have #30 AWG conductors and a controlled impedance ground plane. The 3380 has 50 conductors and costs 0.0219¢/conductor ft. (in 1000-ft. quantities). The 3386 has 28 conductors and costs 0.0383¢/conductor ft. (in 1000-ft. quantities). Larger quantity prices are available for both cables. Both have PVC insulation rated to 80°C. The expanded copper ground plane is cable-wide and laminated the length of the cable during manufacturing. Dept. E18-85, 3M Co., 3M Ctr., St. Paul, Minn. 55101.

Circle 227 on Inquiry Card

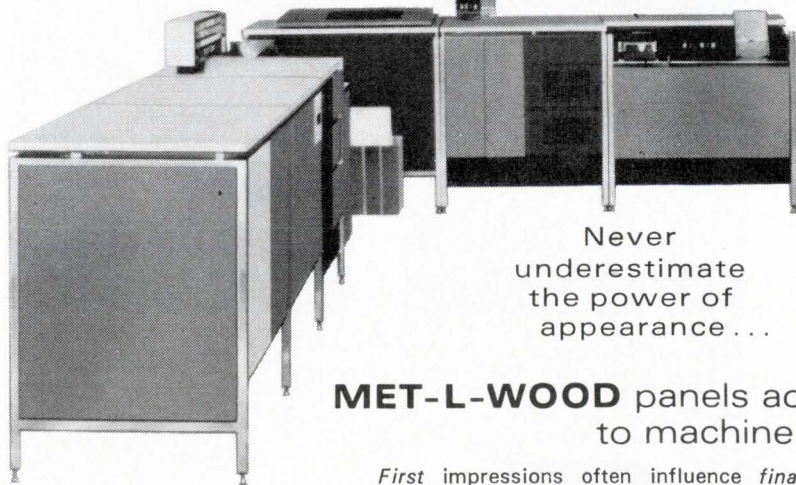

Never underestimate the power of appearance...

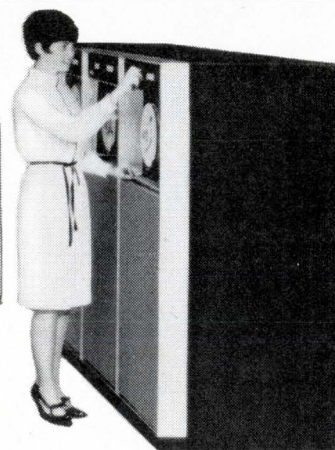

MET-L-WOOD panels add beauty and backbone to machine housings

First impressions often influence final decisions. To compete in today's marketplace, even sophisticated machinery cries out for housing design that says . . . beauty . . . purpose . . . versatility. And nothing says it better than unique MET-L-WOOD. MET-L-WOOD is a laminate, consisting of a core of plywood or other lightweight material with metal or other durable facings structurally bonded to both surfaces. The result is a panel of great durability and versatility that lends itself to dramatic design, withstands abuse and continues to look like new for years. MET-L-WOOD panels are easy to work with, requiring no special tools, or may

be prefabricated for easy assembly. Learn for yourself how MET-L-WOOD fits into your housing plans. Write for brochure to: MET-L-WOOD CORPORATION, 6744 West 65th Street, Chicago 60638.

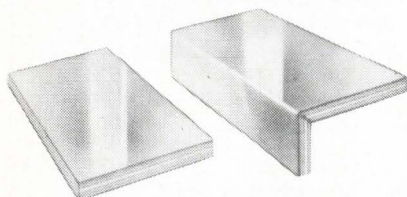

MET-L-WOOD
Corporation

STRUCTURAL LAMINATES SINCE 1925

ULTRASONIC CLEANER

Measures 10 $\frac{5}{8}$ x 8 $\frac{1}{2}$ x 6 $\frac{3}{4}$ in.



Tank (stainless steel) capacity for this self-contained portable cleaner is 1 $\frac{5}{8}$ qt. The Model SP-100 has a 100 W average output, resulting in high intensity uniform action and efficient cleaning. It is a simplified unit—the only control is an Off-On switch. It also has an automatic tune feature. The transducer using lead zirconate titanate provides optimum efficiency at frequencies of about 34 kHz and is guaranteed not to crack, depolarize, or become detached from the tank. Blackstone Ultrasonics, Inc., Sheffield, Pa. 16347.

Circle 228 on Inquiry Card

PLASTIC TRIACS

Six and ten ampere devices.

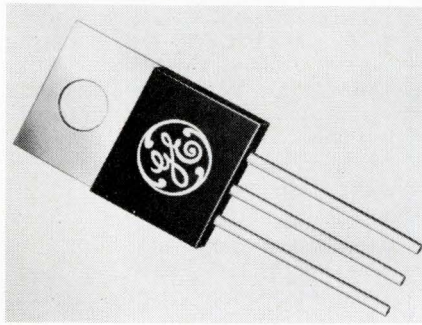

Medium current plastic power pac triacs are the 6A (rms) SC141 and the 10 A (rms) SC146. These devices feature: a molded gray silicone package; round leads for easy handling and mounting; a solid copper heat sink for low thermal impedance (2°C/W); simple mounting by fastener; and a glass passivated triac pellet insuring device hermeticity. The new package is dimensionally compatible with the hermetic TO-66 package and other plastic packages. The 6A, 200 V SC141 is priced at \$.80 in 10K quantities. The SC146 10A, 200 V triac is priced at \$1.04 in quantities of 10K. Contact A&SP Distribution Services, General Electric Co., 1 River Rd., Schenectady, N. Y. 12305.

Circle 229 on Inquiry Card

"SMALLER-THAN-YOU-THOUGHT"

COMPACT HEAT EXCHANGERS

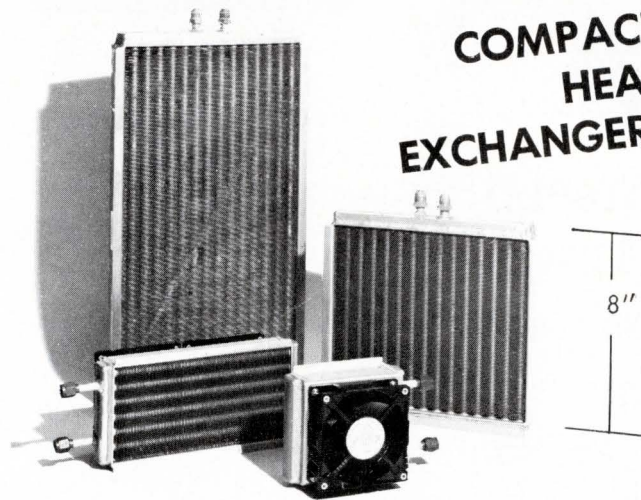

So compact that up to 60% reduction in coil size lets you design efficient heat transfer into much less space than you may have thought possible. INNER-FIN® construction provides significantly greater inside surface area to permit more rapid heat transfer.

Standard, low-cost copper units and INNER-FIN aluminum units, with or without fans, plus gas and liquid heaters and liquid-to-liquid heat exchangers are available from stock—exclusively from Astrodyne and its representatives.

NEW 16-PAGE CATALOG ON REQUEST



astrodyne, inc.

SUBSIDIARY OF ROANWELL CORP.
207 CAMBRIDGE ST., BURLINGTON, MASS. (617) 272-3850

Circle 65 on Inquiry Card

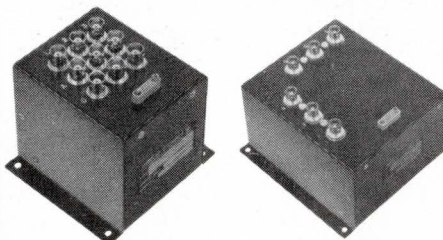
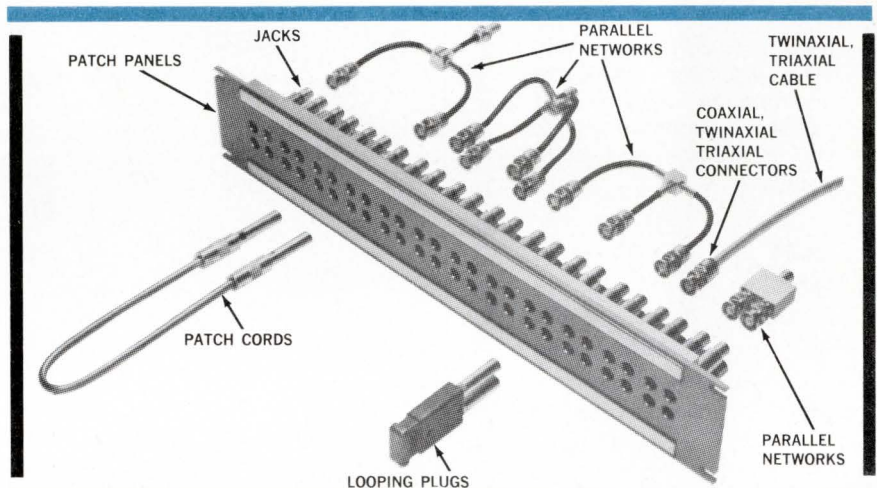

SWITCHES/MATRICES

PATCHING & SWITCHING

STANDARDS OR "SPECIALS"

complete catalogs available



TROMPETER ELECTRONICS, INC.

8936 Comanche Ave.

Chatsworth, Calif. 91311

(213) 882-1020



COLDWELD CRYSTALS

set the stage
for economical
high-precision
Frequency
Standards

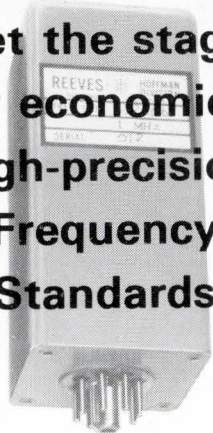

Reeves-Hoffman coldweld crystals assure superior aging; proportional oven-control provides high precision; our standardized design gives you price benefits.

The result: Model S12206 1MHz and 2 to 10 MHz high-precision frequency standards for time-base applications at prices that make it uneconomical for you to design and build your own.

Stability 1×10^{-9} rms/sec
Aging $.5 \times 10^{-9}$ /day
Range -55° to $+65^{\circ}$ C
Input 23-30 v dc, .65A max
during warm-up
Output 1 v rms, 1K-ohm load
Size $2 \times 2 \times 4$ in., seated

Government tests show aging of cold-weld crystals-superior to crystals in any other holder, including glass.

Write for additional specifications and prices.

REEVES-HOFFMAN

DIVISION, DYNAMICS CORPORATION OF AMERICA
400 WEST NORTH ST., CARLISLE, PENNSYLVANIA 17013 • 717/243-5929

Circle 67 on Inquiry Card

EE NEW PRODUCTS

THICK FILM RESISTORS

No derating from -55° to $+125^{\circ}$ C.

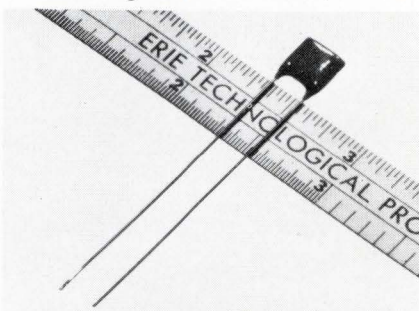

New radial lead metal glaze resistors take only 0.03 in.² of board space and reduce assembly time in most applications. "Blue Chip" resistors are available from 1 Ω to 1 M Ω with a $\pm 1\%$ tol. They are rated at $\frac{1}{8}$, $\frac{1}{4}$ and $\frac{1}{2}$ W. TCR is ± 300 ppm/ $^{\circ}$ C max. "Jet Seal," a hard, glossy polymeric encapsulant, protects the resistor mechanically and electrically from rough handling and the most severe environments. Customer Engineering, Advanced Products Div., Erie Technological Products, Inc., 645 W. 12th St., Erie, Pa. 16512. (814) 456-8592, Ext. 383.

Circle 230 on Inquiry Card

CHIP CAPACITORS

Capacitance ranges, 0.01 to 0.10 μ F.

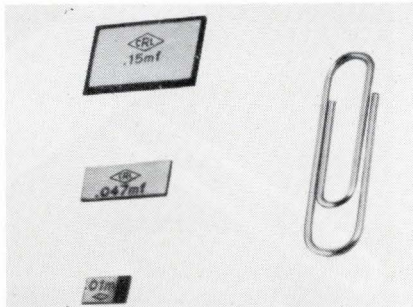

A line of chip Ultra-Kap capacitors feature optimum capacitance in sizes as small as 0.135 in. square. Rated at 25 Vdc max. in both standard and polarized types. They are semiconducting ceramic devices made from reduced barium titanate. A range of sizes can be made, varying from squares to rectangles. They are available as insulated or uninsulated units. Chips are supplied with metalization for attachment to substrates for hybrid circuitry construction. Contact G. Tuscany, Centralab Electronics Div. of Globe-Union Inc., 5757 N. Green Bay Ave., Milwaukee, Wisc. 53201. (414) WI 5-3201.

Circle 231 on Inquiry Card

DELIVERY FROM STOCK

\$ **69.00**

BUYS THIS
**dual output
POWER
SUPPLY**



Model
OS 15-.3D

for OP AMPS and IC'S

An exceptional value, the new Deltron Model OS 15-.3D is a dual output tracking Power Supply for use with operational amplifiers and integrated circuits. Its features include . . .

- Built to top quality standards.
- All Silicon.
- Regulation—0.05% typical.
- Ripple and noise—500 microvolts typical.
- No overshoot or turn on, turn off or power interruption.
- Output ratings:
Positive —8-15 VDC, 0-300 MA
Negative—0-15 VDC, 0-300 MA
- Plug or wire-in.
- Mounting—horizontal, vertical or card cage.
- Size— $4\frac{1}{2}$ " H, $7\frac{1}{2}$ " L, $1\frac{7}{8}$ " D.

Write for full details.

See our complete catalog
in eem . . . Section 4000

D 101

Deltron

WISSAHICKON AVE., NORTH WALES, PA. 19454
PHONE: (215) 699-9261 TWX: (510) 661-8061

Circle 68 on Inquiry Card

EE NEW PRODUCTS

DIP SOCKETS

Have replaceable contacts.

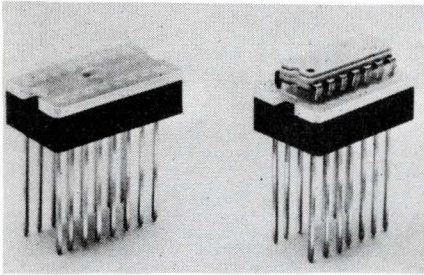

These sockets are for all standard DIP ICs with 14 or 16 pins. A compact, low profile insulator permits high packaging density. The Series 8359 sockets are for side-by-side mounting on 1/2 in. centers; in-line mounting on 0.800 in. centers (14 pin) or 0.900 in. centers (16 pin). Double-leaf contacts give positive wiping action against DIP leads. Contact tails are 0.025 in.² and come in lengths for solder or wire-wrap terminations. Price for the 14-pin socket is 47¢ and for the 16-pin it's 52¢. Availability is 6-8 weeks. Elco Corp., Willow Grove, Pa. 19090. (215) 659-7000.

Circle 232 on Inquiry Card

IC TEST CLIP

Eases testing of ICs.

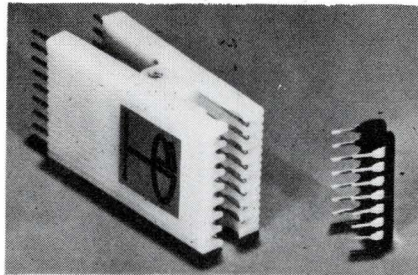

New IC test clip accommodates 14- and 16-pin DIL packages. It provides full accessibility to IC leads, solves oscilloscope probe attachment problems, and acts as an excellent extractor. A "contact comb" prevents the adjacent IC leads from shorting, and also functions as an attachment guide. Capacitance effects on hf transitions are negligible. This clip is molded of acetal homopolymer with gold-over-silver plated phosphor bronze contacts. Price is \$5; availability is from stock. AP, Incorporated, 6273 Melshore Dr., Mentor, Ohio 44060. (216) 257-2658.

Circle 233 on Inquiry Card

Hydrive Amplifiers

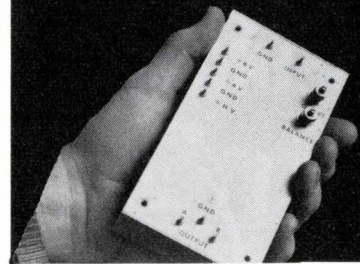

Size: 1" x 3" x 5/8". Has 4 threaded inserts for mounting on your chassis.

Linear amplifiers:

1 volt in, 60 volts out
1 volt in, 100 volts out
1 volt in, 150 volts out
1 volt in, 200 volts out
Bandwidths to 2.5 MHz
Differential output

Switching amplifiers:

0/2 volts in, 0/30 volts out
0/2 volts in, 0/60 volts out
T_r & T_f to 50 ns

Price: \$88 each, postpaid.

Infotech, Inc.

7 Cherry Avenue,
Waterbury, Conn. 06720
Phone 203-754-4159

Circle 69 on Inquiry Card

true .01% DVM accuracy from DIGITEC®

NEW
at
\$795

model 251 / 251-4

- Auto-Zero and Calibration
- Long Term Stability
- 100uv Resolution
- Systems Compatibility
- 4 Full Digits + 40% Over range

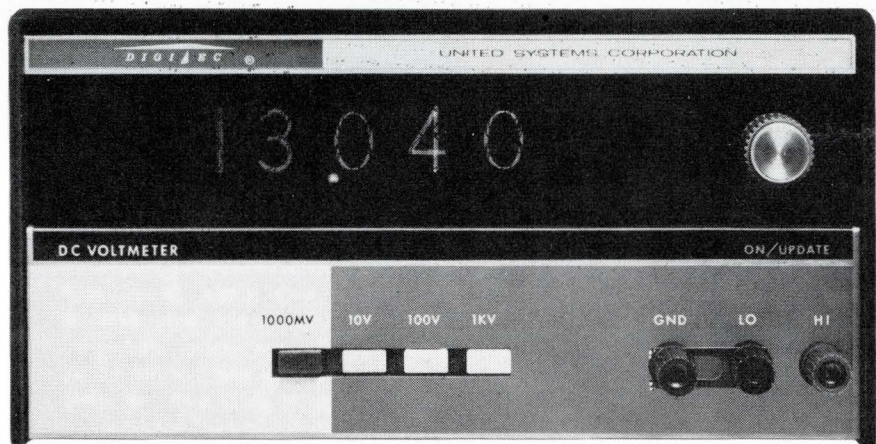

attention:

Owners of model 251 DVMs, step up to .01% with a model 251-4 plug-in at \$350.

For Complete Specifications request new catalog D69
Stocking Representatives Throughout the World

DIGITEC

by UNITED SYSTEMS CORPORATION

918 Woodley Road • Dayton, Ohio 45403 • (513) 254-6251

New High Voltage High Power Rectifiers



VC Series from Varo.

Our new VC Series rectifiers may be tiny (3" long, 3/4" high, 3/4" wide), but they're plenty tough enough to stand up under high voltage, high power conditions.

They have voltage ratings of from 2 KV to 8 KV, current ratings of 1 to 2 amps, and they're available with an optional 300 nanoseconds recovery time.

Varo VC Series rectifiers are made to handle the biggest jobs. Like X-ray power supplies, radio and radar transmitters, and things like the new microwave oven power supplies.

And they'll handle most of the new high voltage, high power system demands that'll be coming along in the future, too.

The new VC Series from Varo.

It's the kind of thing we know you've come to expect from us.

\$4.18 EACH

VC-80 (8,000 Volts — 1 Amp).
1,000 quantity.



SEMICONDUCTOR DIVISION
1000 N. SHILOH ROAD, GARLAND, TEXAS
75040 (214) 272-4551

Circle 71 on Inquiry Card

EE NEW PRODUCTS

OPERATIONAL AMPLIFIER

General purpose, it sells for \$13.50.

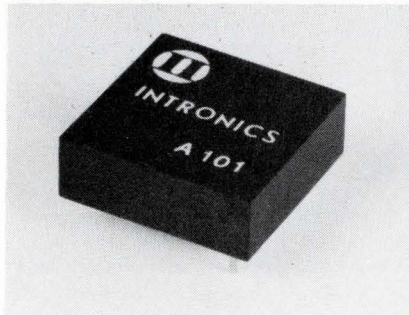

The A101 is in a very thin encapsulated package. The unit is 0.385 in. thick and 1.12 x 1.12 in. It is a differential amplifier capable of a full 10 V common mode voltage, 5 mA output current and a bandwidth of 125 kHz. Some of its important operating parameters are input offset drift 20 $\mu\text{V}/^\circ\text{C}$, input current 2 nA/ $^\circ\text{C}$, common mode input impedance 50 megohms and a common mode rejection ratio of 90 dB. The unit is fully short circuit protected; it is frequency compensated for a 6 dB/dec roll-off with a slew rate of 1.2 V/ μs . Contact Carl Kramer, Intronic, Inc., 57 Chapel St., Newton, Mass. 02158. (617) 332-7350.

Circle 234 on Inquiry Card

ADJUSTABLE INDUCTORS

Miniature units come in 5 sizes.

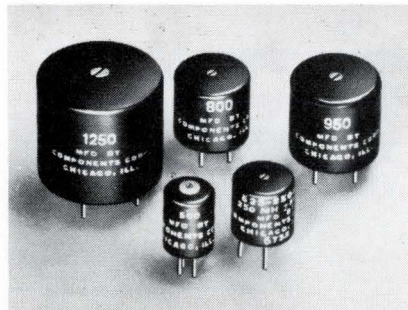

Adjustable with screw driver, each adjustment is constant regardless of the number of times coil is readjusted. Positive stop at top and bottom of adjustment range. High Q with low temp. co-efficient allows these inductors to be used in oscillators, tuned circuits, servo systems, equalizers and filters. Standard units, nominal inductance can be varied by $\pm 5\%$. Magnetic shielding permits high density packaging. Designed for PC board mounting. Price, \$1.95 to \$10.10; delivery, 3 weeks. Contact Werner Nauman, Components Corp., 2857 N. Halsted St., Chicago, Ill. 60657.

Circle 235 on Inquiry Card

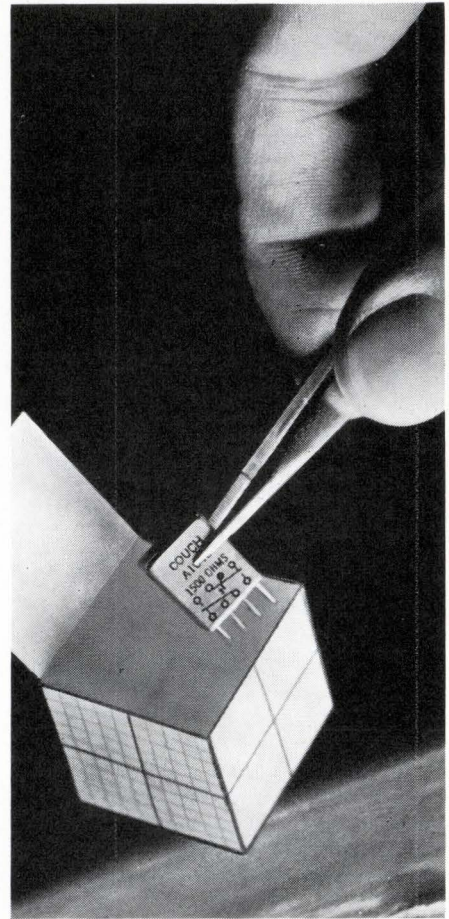

Couch 2X 1/7-size relays meet MIL-R-5757D/19 in 1/25th of a cubic inch

The new, third generation Couch 2X relays solve switching problems where space and weight are critical. Thoroughly field-proven in electronic and space applications. Relays are delivered *fully tested*. Additional screening tests available at your option.

	2X (DPDT)	1X (SPDT)
Size	0.2" x 0.4" x 0.5"	same
Weight	0.1 oz. max.	same
Contacts	0.5 amp @ 30 VDC	same
Coil		
Operating Power	100 mw 150 mw	70 mw 100 mw
Resistance	60 to 4000 ohms	125 to 4000 ohms
Temperature	-65°C to 125°C	same
Vibration	20 G to 2000 Hz	same
Shock	75 G, 11 Ms	same

Broad choice of terminals, coil resistances, mounting styles. Write for detailed data sheets.

RUGGED ROTARY RELAYS  Dynamically and Statically Balanced

Couch
1894

COUCH ORDNANCE INC.

3 Arlington St., North Quincy, Mass. 02171
Area Code 617 CYPRESS 8-4147
A subsidiary of S. H. COUCH COMPANY, INC.

Circle 72 on Inquiry Card

VISHAY LOWERS THE COST OF HIGHER RESISTANCE VALUES

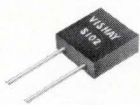

NOW TO 50K

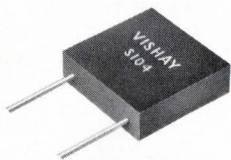

NOW TO 100K

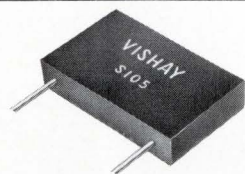

NOW TO 150K

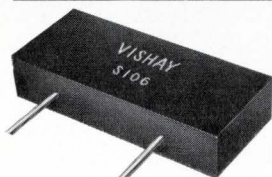

NOW TO 200K

Now Vishay extends resistance values of its standard styles by 66% . . . lets you use a precision resistor that's smaller and costs less than the larger size you needed before!

You get these savings without a single compromise of Vishay's unique spec package . . . the "no-trade-off" performance specs that only Vishay can offer.

- Tolerance (Abs.): to 0.005% ■ TC (any value): $0 \pm 1 \text{ppm}/^\circ\text{C}$. (0° to $+60^\circ\text{C}$.) ■ Stability: Shelf 25ppm/yr. (50/3 yrs.), Load $< 0.02\%$ max. (0.15w. @ 125°C ., 2000 hrs.) ■ Speed: 1ns., no ringing (non-inductive) ■ Noise: Non-measurable

This complete Data Catalog tells how Vishay does it, where you can use them and gives complete spec data on Vishay Precision Resistors. Send for your free copy today.

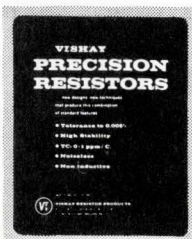

VISHAY RESISTOR PRODUCTS
a division of Vishay Intertechnology, Inc.



63 LINCOLN HIGHWAY
MALVERN, PA. 19355

Circle 73 on Inquiry Card

EE NEW PRODUCTS

TIME DELAY RELAY

Reset and recycle times, 60 ms max.

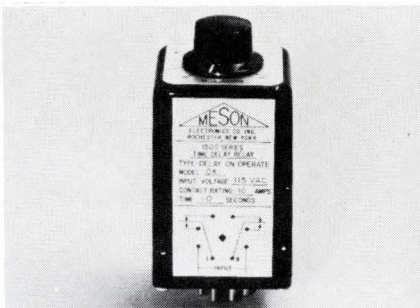

The 1500 series relay comes in fixed, knob-adjustable types. It is available in 115 or 24 Vac; 115, 24, or 12 Vdc. Output is DPDT 10 A, 115 V. Contacts are silver cadmium oxide-gold diffused. Accuracy is 5% and repeatability is 1% for second and following operations. It operates at temperatures from -40° to $+55^\circ\text{C}$. Storage temp. is -55° to 85°C . The units have a minimum life of 10 million mechanical operations. Prices range from \$23.70 to \$11.37. Harvey B. Dorren, Pres., Meson Electronics Co., Inc., 380 Cottage St., Rochester, N.Y. 14611. (716) 235-7070.

Circle 236 on Inquiry Card

GLASS THERMISTOR PROBES

For liquid immersion application.

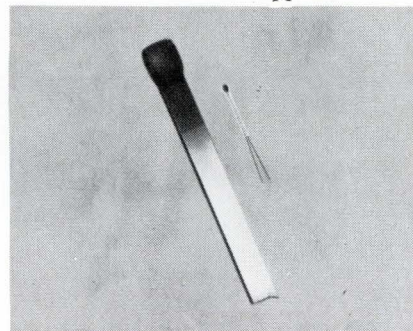

Microminiature units feature small size and extremely fast response time. They consist of a tiny (0.011) diameter bead thermistor hermetically sealed into the tip of a thin wall glass tube. It is impervious to electrically conductive and/or corrosive mediums. Well suited for applications involving the measurement and control of temp., liquid level or gas flow and where space limitations are stringent. Units available with resistance values (a 25°C) from 1000Ω to 5 megohms, covering a span of -50° to 300°C . Fenwal Electronics Inc., 63 Fountain St., Framingham, Mass. 01701. (617) 875-1351

Circle 237 on Inquiry Card

ESC DELAY LINES SOLVE

high density packaging problems

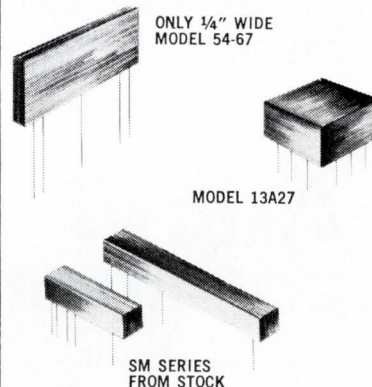

An example of ESC's sophisticated design capability is our Model 54-67 (size: $3''\text{L} \times \frac{1}{4}''\text{W} \times \frac{1}{2}''\text{H}$). Used in an airborne application, this rugged flat pack unit has a time delay of 29 usec. with a tap at 11 usec. The rise time is 1.8 usec. maximum with an impedance of 400 ohms and an attenuation of 2 db maximum.

Our Model 13A27 (size: $.490''\text{L} \times .490''\text{W} \times .370''\text{H}$) is transfer molded and illustrates a low cost, high production run unit. Designed for printed circuit board use in a computer application, the 13A27 has become one of a series of "custom standards" to a valued ESC customer. It has a time delay of 7 nsec. with taps at 4, 2 and 1 nsec.

The SM series of subminiature nanosecond delay lines provides a high figure of merit in a small volume without compromising reliability. Standard items range from 10 to 1,200 nsec. at impedance levels of 100, 200 and 500 ohms. Available off-the-shelf in two standard sizes: $1'' \times 0.32'' \times 0.32''$ and $2'' \times 0.32'' \times 0.32''$, both with $\frac{1}{2}''$ leads.

All ESC delay lines conform to MIL-D-23859A.

Write for complete catalog.

ESC ELECTRONICS CORPORATION

a subsidiary of Simmonds Precision

534 Bergen Blvd., Palisades Park,
New Jersey 07650 • (201) 947-0400

World's Leading Designer and Producer
of Delay Lines

Circle 74 on Inquiry Card

NEW O.E.M.

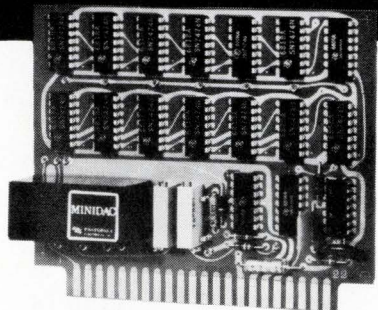

3 3/4" x 4 1/2" x 1/2"

A-to-D Converter

Pastoriza offers the first utility converter for systems applications . . . priced for quantity sales.

Having first introduced the modular A-to-D and D-to-A converter, Pastoriza Electronics now offers an unprecedented innovation: A printed circuit card A-to-D converter featuring . . .

High Performance

- 12 bits conversion in 8 microseconds.
- 10 bits conversion in 4 microseconds.
- 8 bits conversion in 2 microseconds.

Low Cost

Priced competitively with any ADC available today, and designed for volume production.

Open Book Concept

No black magic in the design — circuitry is accessible and repairable.

User Confidence

Design and component information is supplied to insure ease and confidence in customer application.

This complete single-card A-to-D converter includes reference supply and comparison amplifier, using dual in-line integrated circuit logic with a MINIDAC D-to-A module. It accepts 0 to +10 volts input range, and provides up to 12 bits resolution.

Write for eye-opening facts on this newest modular A-to-D utility converter.

PASTORIZA
ELECTRONICS, INC.

385 Elliot St., Newton, Mass. 02164 • 617-332-2131

Circle 75 on Inquiry Card

EE NEW PRODUCTS

REED SWITCH

Fits new PC spacing standard.

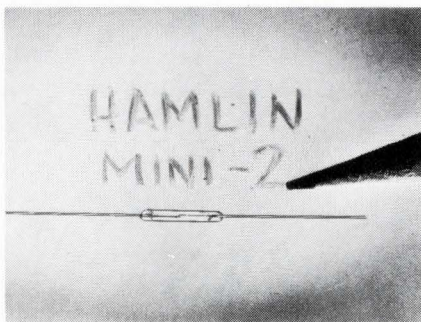

The Mini-2, a new form "A" reed switch, is for low profile reed relays. It has a 0.500 in. glass length and a 0.070 in. max. dia., giving a completed relay height of 0.187 in. to fit a dual-in-line spacing. Sensitivity range is 7.5 to 32.5 ampere turns. This permits a nominal relay operate power of 100 mW and actuate time of 200 μ s. It handles up to 3 W at 110 mA, 28 Vdc, with a breakdown voltage of 200 Vdc. Life expectancy is 5×10^6 operations. Hamlin, Inc., Lake & Grove Sts., Lake Mill, Wis. 53551.

Circle 238 on Inquiry Card

SOLID STATE RELAY

Single pole, double throw.

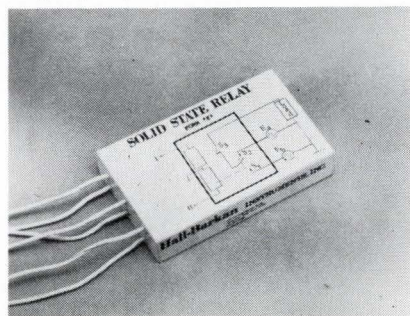

Requiring no external power, the relay draws only 2 mA from 60 Hz load sources and will handle loads up to 4 A. Solid state assures reliability, long life and environmental capability. The H-B Form "K" relay is protected from RFI and false actuation due to line transients. Sensitivity of inputs is 500 μ A average at 12-60 Vdc. Isolated inputs permit arbitrary command signal reference. Fully encapsulated, relay is 1/2 x 2 1/2 x 1 1/4 in. Optional "throws" are available on special orders. Price is \$40 each in sample quantities; delivery is 3-4 weeks. Hall-Barkman Instruments, Inc., 173 Marbledale Rd., Tuckahoe, N. Y. 10707.

Circle 239 on Inquiry Card

PRECISION OSCILLATOR

Provides 1V sine wave output.



Model 6222 precision oscillator provides sine wave output of precision frequencies as low as 1000 Hz.

Freq. range: 1 to 40 kHz.

Stab. vs temp: $\pm 0.005\%$ ($+15^\circ$ to $+35^\circ\text{C}$) to $\pm 0.05\%$ (-55° to $+85^\circ\text{C}$).

Output: Sine wave 1 V rms to 10 k Ω load.

Size: 2 x 2 x 1/2 in. for mounting. Price in prototype quantities ranges from \$150 to \$225. Varo Time and Frequency Products, Box 1500, Santa Barbara, Calif. 93102.

Circle 240 on Inquiry Card

FLUIDIC TEST KIT

Learn fluidic applications.



A basic experimenter's kit comes in two styles: the SF-1 kit, which has a Sensiflex Model SF-1, heavy duty 15 A precision switch; and the SF-3 kit, which features the miniature SF-3 model with interchangeable 3, 5, 10, and 15 A switches. Included in each kit are 1/16 and 1/8 in. jets and receivers; tubing; adapters; and flex-tested polyurethane bellows, sizes 1.25, 1.50, and 2.00 in. dia. Bellows can be easily interchanged so that experimenters can try combinations of different jets and bellows, varying threshold sensitivity and reaction speed. Gagne Associates, Inc., 50 Wall St., Binghamton, N. Y. 13901. (607) 723-9556.

Circle 241 on Inquiry Card

HEAT SHRINKABLE TUBING

Shrinks up to 50%.

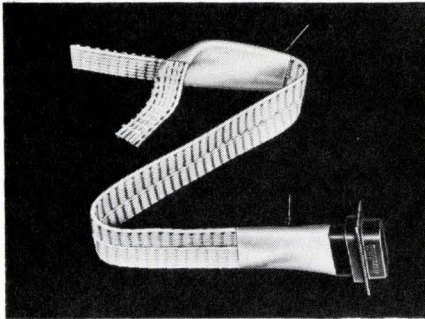

Type TLT heat-shrinkable tubing has a very thin wall and is low in cost. It can be used along with flat ribbon cable, or any type of cable where conductors need protection. It is also useful in insulating conductors at the point of attachment to connectors. The tubing shrinks up to 50% upon application of 200°F heat. It is standard in white, black, and clear in diameter ranges of ¼ to 3 in. Standard packing is 100-foot spools. The Zipertubing Co., 13000 S. Broadway, Los Angeles, Calif. 90061.

Circle 242 on Inquiry Card

VHF CRYSTAL OSCILLATOR

Has output in 25-125 MHz range.

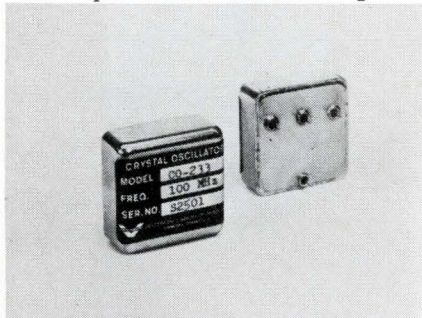

The CO-233 provides a stable fixed frequency output at a level exceeding 0.5 Vrms into 50 Ω. This 1½ x 1½ x ⅝ in. module is for PC mounting. It operates from any specified voltage in the 15-30 Vdc range with a current drain less than 15 mA. Stability is better than ±0.0003% over 20°C to 30°C and ±0.0025% over 0°C to 70°C. Two broader temp. range options are available. While the oscillator is factory set to within 0.001% of the specified freq., a freq. adjustment for setting within 0.0001% is optionally available. Contact Mr. A. Camhi, Vectron Laboratories, Inc., 146 Selleck St., Stamford, Conn. 06902. (203) 324-9225.

Circle 243 on Inquiry Card

TEST CHAMBER

For miniature components.

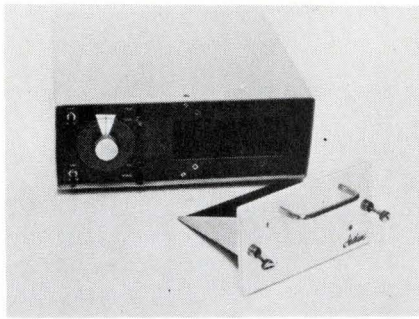

The Model SD2 miniature temperature test chamber has a temperature range of -65° to +150°C with control accuracy of ±1°C. It has a fail-safe thermostat and warning light. Heating rate is 18°C and cooling rate is 60°C/minute. Fiberglass insulation and small specimen area (2 x 5 x 5 in.) promote economy of operation. It is built for portability (12 lb) and easy stacking. Miss Daisy W. Kay, Mgr., Marketing Services, Statham Instruments, Inc., 2230 Statham Blvd., Oxnard, Calif. 93030. (805) 487-6321.

Circle 244 on Inquiry Card

IMAGE DISSECTOR TUBE

It minimizes aperture loss effect.

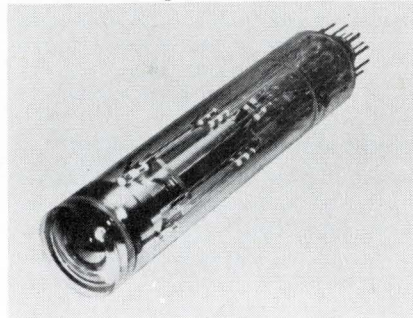

The BX 750 is electrostatically-focused, magnetically-scanned, and has multiple aperture and multipliers for accurate counting of single photoelectron events. Its image dissecting element is composed of 9 cone-shaped channel multipliers arranged in a 3 x 3 matrix configuration behind the corresponding aperture plate. The small ends of the cone multipliers, which have a diameter less than 0.005 in., provide fine image resolution while the large ends of the multipliers provide high current output and facilitate coupling to separate anodes. Bendix Research Labs, 20800 10½ Mile Rd., Southfield, Mich. 48075. (313) 353-3500.

Circle 245 on Inquiry Card

New!

14-bit D-to-A Converter < 2 μsec conversion time



4.85" x 4.85" x 1"

MODEL DAC-14T: a high speed, high resolution, 14-bit, integrated circuit Digital-to-Analog Converter with a 0.006% accuracy. It features a unique controlled transition output which insures that the output signal changes with negligible pre-shoot and overshoot monotonically from one value to another.

Applications include precision scope displays such as information displays or signal recognition and analysis. Also applicable for integrated circuit testing requiring low transient errors proportional to signal magnitude. High speed of settling time is compatible with high speed testing where computer control and evaluation is employed.

Essentially a miniaturized programmable power supply, DAC-14T may be placed in close proximity to the device being excited — a necessity if high precision and high resolution are to be maintained.

All elements, including reference supply, switches, network, storage registers, output amplifier, gain and offset adjustment, are packaged within a single printed circuit card plug-in.

Write or call for prices and complete specifications.

PASTORIZA
ELECTRONICS, INC.

385 Elliot St., Newton, Mass. 02164 • 617-332-2131

Circle 76 on Inquiry Card

Preferred semiconductors

This "Preferred Semiconductors and Components" catalog is a "must" for any EE who has to select discrete semiconductor devices. The catalog contains several hundred pages of data on TI's most popular discrete semiconductor devices—based on broad

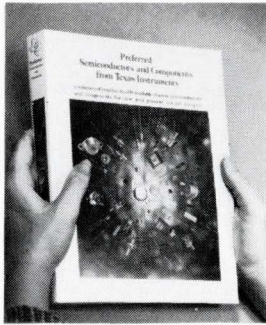

usage in present or new designs and volume availability. There are detailed specs on 285 preferred products plus a listing of 1800 standard TI discrete devices with cross-reference data to products of other makers. Application ideas are also provided for many of the devices. Texas Instruments Incorporated, Box 5012, Dallas, Tex. 75222.

Circle 321 on Inquiry Card

Microwave power meter

A 4-page data sheet discusses the capabilities of a microwave thermistor power meter. The device's key features include automatic zero setting and high accuracy measurement over a broadened power and temperature range. Application information and specs are included in the note. Inquiries Mgr., Hewlett Packard Co., 1501 Page Mill Rd., Palo Alto, Calif. 94304.

Circle 322 on Inquiry Card

Capacitors catalog

Two booklets, No. 3521B (12 pages) and No. 3537A (10 pages), contain technical data on two types of capacitors. Type 164D, a solid electrolyte capacitor, is recommended for use in commercial digital computers and various types of industrial electronic equipment. Type 151D, a non-polarized hermetically sealed device, can be used as a phase-splitting capacitor for small low-voltage motors in servo systems. Sprague Electric Co., Marshall St., North Adams, Mass. 01247.

Circle 323 on Inquiry Card

Microwave ICs

The 1969 edition of a component catalog introduces a new line of microwave integrated circuits. These include circulators, phase shifters, mixers, and complete operating transmitters, as well as hybrid arrays. Microwave components listed in the 24-page catalog include isolators, circulators, duplexers, phase shifters, equalizers, and avalanche transit time oscillators. Sperry Rand, Microwave Electronics Div., Clearwater, Fla. 33518.

Circle 324 on Inquiry Card

IC logic assemblies

Application Note 6-68 provides some useful technical data for the industrial control equipment designer. This 16-page treatise emphasizes the advantages of the company's IC logic assemblies in performing relay functions in industrial control applications where increasing size and complexity impose strains on reliability. It discusses Boolean Algebra (switching algebra), truth tables, and the implementation of various logic functions (AND, OR, and NOT). Cambridge Thermionic Corp., 445 Concord Ave., Cambridge, Mass. 02138.

Circle 325 on Inquiry Card

Audio amplifier applications

An 8-page booklet gives operation and application data on an IC audio driver amplifier for use with entertainment products and industrial communications equipment. The application

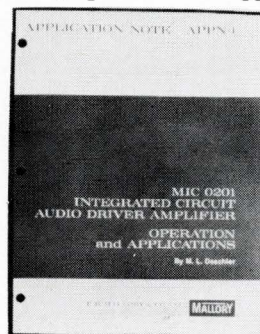

note (Form No. 15-4) features circuit diagrams and equations. It describes several class A audio amplifier circuits in which the device could be used. P. R. Mallory & Co., Inc., 3029 E. Washington St., Indianapolis, Ind. 46206.

Circle 326 on Inquiry Card

I-F strip

Note AN-15 discusses a monolithic i-f strip for a-m/agc applications. The LM172 strip offers an efficient approach in which selectivity precedes the broadband microcircuit, with agc, gain, detection, and dc bias stabilization direct-coupled on the chip. Typical applications described in the 6-page note include a superheterodyne receiver i-f strip, and a complete trf (tuned radio frequency) receiver. National Semiconductor, 2975 San Ysidro Way, Santa Clara, Calif. 95051.

Circle 327 on Inquiry Card

MOS/LSI integrated circuits

A well-organized 38-page brochure covers a family of MOS/LSI integrated circuits and other recent MOS IC products. Sections on MOS standard off-the-shelf products and custom MOS arrays are included. A brief intro-

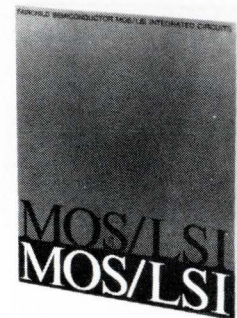

duction to the guide outlines the development of MOS technology, explaining its advantages and its capabilities. Fairchild Semiconductor, 313 Fairchild Drive, Mountain View, Calif. 94040.

Circle 328 on Inquiry Card

Photocell-lamp modules

Photomods[®] are photocell-lamp modules that combine hermetically sealed photo-conductive elements with high quality lamps in encapsulated packages. The modules are used for variable resistor or switching applications where complete mechanical and electrical isolation is desirable. A 12-page bulletin features application and circuit design information. It also gives specs for eight different types of modules. Clairex Electronics Inc., 1239 Broadway, New York, N. Y. 10001.

Circle 329 on Inquiry Card

Voltage variable capacitors

Have you found the non-linear capacitance vs voltage or frequency vs voltage relationship of voltage variable capacitors inconvenient at times?

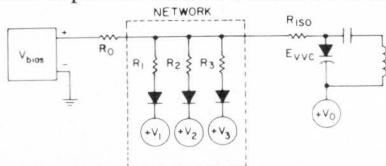

Advanced shaping network. Here is a refined shaping network that uses three shaping diodes. With this network the non-linearity can be reduced greatly.

A 4-page application note will help you solve this problem. It explains how you can get linear variable capacitance or linear variable frequency by using voltage variable capacitors. Easton Corp., 25 Locust St., Haverhill, Mass. 01830.

Circle 330 on Inquiry Card

Magnetic control boards

Various applications for magnetic visual control systems are discussed in a 27-page catalog. Of particular interest to engineering managers is a magnetic flow chart for EDP, PERT, and similar programs. Also shown are control boards for computer scheduling, production, ordering and shipping, and management. Methods Research Corp., 105 Willow Ave., Staten Island, N. Y. 10305.

Circle 331 on Inquiry Card

IC packaging

Dual inline packaging, a new concept in high density packaging of dual-in-line integrated circuit modules, is discussed in a 20-page catalog. Engineering and manufacturing costs of this system are compared to those of conventional printed circuit packaging systems. Scanbe Manufacturing Corp., 1161 Monterey Pass Rd., Monterey Park, Calif. 91754.

Circle 332 on Inquiry Card

CLASSIFIED ADVERTISING

GROWTH POSITIONS \$12,000-\$25,000

MANAGEMENT — ENGINEERING — SALES
RESEARCH — MANUFACTURING
Nationwide Coverage

Fees company paid. Include present salary, minimum salary requirement and location flexibility with resume. Longberry Employment Service, Inc., 910 Niles Bank Bldg., Niles, Ohio 44446. (216) 652-5871.

Converters compendium

Listed in this 20-page catalog are analog-to-digital converters, digital-to-analog converters, and shaft encoders. Two series of solid state converters and three types of electromechanical converters are detailed. The catalog contains application notes, operation information, specs, dimensions, and illustrations. Vernitron Corp., Digital Products Div., 59 Central Ave., Farmingdale, N.Y. 11735.

Circle 333 on Inquiry Card

Drum memory systems

A militarized drum memory system for tactical and strategic applications is the subject of an 8-page brochure. The memory was specifically designed to meet the need for a reliable, low volume, rugged information system. Options, mechanical characteristics, application information, and design features are given in the booklet. RCA, Electromagnetic and Aviation Systems Div., 8500 Balboa Blvd., Van Nuys, Calif. 91409.

Circle 334 on Inquiry Card

Applications of controls

Titled "New Ideas in Controls," a 10-page booklet offers solutions to application engineering problems which involve controls and control systems. Case histories are included.



A companion folder for design engineers, "Controls that Make Modern Living Possible," deals with the company's major product lines and their applications. Time delay relays, push-button switches, indicator lights, industrial solenoids, synchronous motors, and ac and dc motors are a few of the products listed. Controls Company of America, 2001 N. Janice Ave., Melrose Park, Ill. 60160.

Circle 335 on Inquiry Card

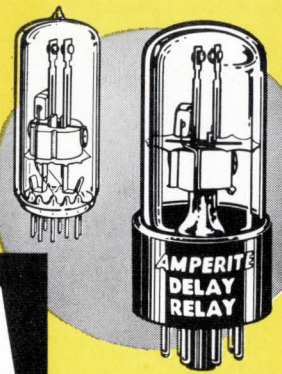

AMPERITE

GLASS ENCLOSED Thermostatic DELAY RELAYS

Offer true hermetic sealing.
Assure maximum stability
and life.

Delays: 2 to 180 seconds

Actuated by a heater, they operate on A.C., D.C., or Pulsating Current . . . Being hermetically sealed, they are not affected by altitude, moisture, or climate changes . . . SPST only — normally open or normally closed . . . Compensated for ambient temperature changes from -55° to $+80^{\circ}\text{C}$. . . Heaters consume approximately 2 W. and may be operated continuously. The units are rugged, explosion-proof, long-lived, and inexpensive!

TYPES: Standard Radio Octal and 9-Pin Miniature . . . List Price, \$4.

Amperite Delay Relays are approved for all voltages up to and including 115V under the component regulations of Underwriters' Laboratories, Inc.



PROBLEM? Send for Bulletin No. TR-81.

AMPERITE

BALLAST REGULATORS

Hermetically sealed, they are not affected by changes in altitude, ambient temperature (-50° to $+70^{\circ}\text{C}$), or humidity . . . Rugged, light, compact, most inexpensive.

List Price, \$3.00

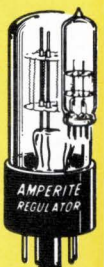

Write for 4-page Technical
Bulletin No. AB-51

AMPERITE

600 PALISADE AVE., UNION CITY, N.J. 07087

Telephone: 201 UNION 4-9503

In Canada: Atlas Radio Corp., Ltd.,
50 Wingold Ave., Toronto 10

Circle 77 on Inquiry Card

Rectifier and diode data

Covered in short-form catalog C-146 is a line of silicon diodes, rectifiers, zeners, and high voltage assemblies. Applications and reliability data, as well as operating characteristics for each of the devices, are given. Charts, graphs, and schematics help make this a useful reference. Unitrode Corp., 580 Pleasant St., Watertown, Mass. 02172.

Circle 336 on Inquiry Card

Bolts, nuts, and screws

Non-stainless steel fasteners, including steel, aluminum, brass, bronze, and nylon products, are the subject of a 48-page catalog and price list (No. 68NS). Fasteners made to both commercial (USASI, SAE, etc.) and government (MS, NAS, and AN) specs are included. Listed are machine screws, set screws, cap screws, bolts, nuts, washers, rivets, pins, and other items. Allmetal Screw Products Co., Inc., 821 Stewart Ave., Garden City, N.Y. 11530.

Circle 337 on Inquiry Card

Support system

An 8-page booklet describes the Philcollogic Support System, a service to assist logic system designers. This system is said to provide built-in guarantees against errors in assembly, to

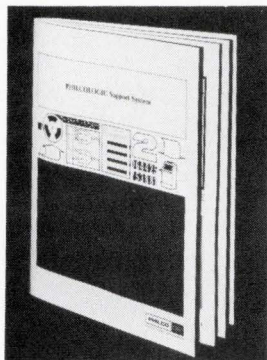

relieve engineers of clerical work, to achieve certain economies, and to take over some of the engineering documentation functions. Western Development Laboratories Div., Philcollogic, Philco-Ford Corp., 3939 Fabian Way, Palo Alto, Calif. 94303.

Circle 338 on Inquiry Card

Display systems

Five new instruments are shown in this data sheet. Highlighted is a computer control display unit that controls the number of copies being made by a copier/duplicator and features a numerical display. A frequency comparator that has a high noise immunity system is also discussed. Included, too, are a hexadecimal display unit and other special purpose display systems. Burroughs Corp., Electronic Components Div., Plainfield, N. J. 07061.

Circle 339 on Inquiry Card

Metal housings

Illustrated and described in a 72-page guide are two different lines of Imlok components and structures. These corner connectors and extrusions interlock to form the framework of precision cases, cabinets, boxes, and consoles. The housings are recommended for R&D, pilot models, and short run work. Bud Radio, Inc., Willoughby, Ohio 44094.

Circle 340 on Inquiry Card

When Only Excellent is Adequate TURN to Grayhill

for MINIATURE PUSH BUTTON SWITCHES

- WIPING, SNAP ACTION and BUTT CONTACTS.
- SPST, SPDT, DPST, DPDT.
- PUSH-PULL — LIGHTED.
- 25,000 to 1,000,000 OPERATIONS.

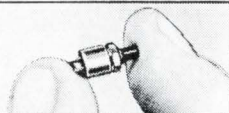

... the Difference Between Excellent and Adequate

Select Materials

- Contacts — Fine Silver
- Springs — Tinned Music Wire
- Housing — Molded Phenolic per MIL-M-14
- Shorting Bar & Terminals — Fine Silver or Silver Plated Copper Alloy

Typical Specifications:

- ¼ Amp. to 10 Amps., 115 VAC Resistive
- Contact Resistance 10 Milliohms
- Insulation Resistance — 25,000 to 900,000 Megohms

All fully described in Engineering Catalog G-304-A Write



543 Hillgrove Avenue
LaGrange, Illinois 60525
Area Code 312, Phone 354-1040

"PIONEERS IN MINIATURIZATION"

Circle 78 on Inquiry Card

CONNECT UP WITH SPRINGTER SOCKETS



- CONTACT AT ENTRANCE OF SOCKET
- EASY INSERTION & WITHDRAWAL
- ALLOWANCE FOR MISALIGNMENT
- GOLD-PLATED
- DESIGNED FOR PIN DIAMETERS OF .020", .030", .040", and .050"
- STANDARDS & SPECIALS

Pylon

Also: POGO CONTACTS, PROBES, & CONNECTORS

Pylon Company, Inc., Attleboro, Mass. 02703
57 Newcomb Street — Tel. (617) 222-3726

Circle 79 on Inquiry Card

Data-handling devices

Price List 1068 and 13 data sheets are available on modular data-handling devices. Various A/D and D/A converters are described. Other products include digital to analog subsystem components, a digital op amp, two sample-and-hold amplifiers, an 8-channel electronic switch, and several power supplies. Pastoriza Electronics, Inc., 385 Elliot St., Newton, Mass. 02164.

Circle 341 on Inquiry Card

Fans and blowers

A 23-page quick reference catalog describes various air moving devices for commercial, industrial, and military applications. Highlighted are lines of propeller, tubeaxial, and vaneaxial fans; squirrel cage blowers; radial wheel and centraxial blowers; high pressure/vacuum low speed blowers; spiral blowers; and coolant fans. A selector guide is included. Rotron, Inc., Hasbrouck Lane, Woodstock, N.Y. 12498.

Circle 342 on Inquiry Card

Electrolytic capacitors

A 68-page replacement guide will help you quickly find single, dual, triple, and quadruple section replacement electrolytics. The units are listed in three ways: by CDE catalog number, by capacity, and by voltage. There

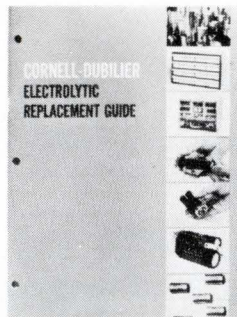

are also handy cross-reference sections that include OEM numbers of 42 color set manufacturers and those of major black and white set makers. Given, too, is a listing by voltage of the company's tubular capacitors. Cornell-Dubilier Electronics, 50 Paris St., Newark, N.J. 07101.

Circle 343 on Inquiry Card

IC logic modules

A 7-page application note describes the basic operation and applications of RS (Reset-Set) flip-flops. These modules are used mainly for storage and general purpose logic. Basic definitions, performance specs for three models, schematic diagrams, figures, and truth tables are given. Wyle Labs, Systems Div., 128 Maryland St., El Segundo, Calif. 90245.

Circle 344 on Inquiry Card

Numerical control system

A 16-page reference manual describes the System 350 numerical control. This is an advanced paper-tape-programmed system for a variety of applications requiring point-to-point positioning or straight-line motion parallel to or at 45° to the primary axes. Topics include the use of direct digital drives, maintenance, programming, input/output requirements, and applications. Icon Corp., 156 Sixth St., Cambridge, Mass. 02142.

Circle 345 on Inquiry Card

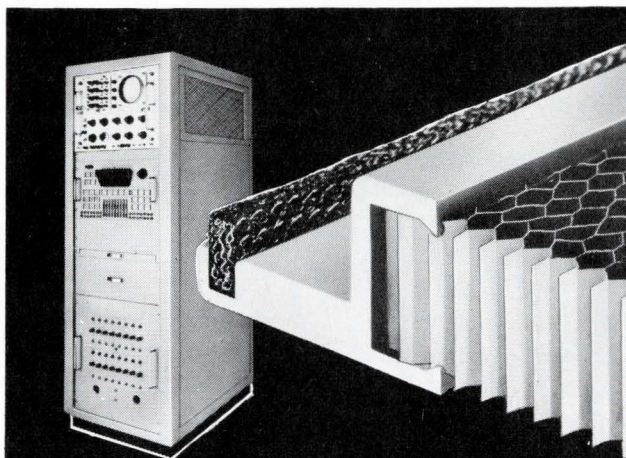

EMI/RFI SHIELDING PANELS COOL AND ATTENUATE

TECKCELL ■ Provides over 100 dB of Total Shielding Effectiveness ■ Available fully gasketed, ready to mount ■ Cell sizes from 3/2" to 1/4" ■ Overall size from 2" x 2" to over 6' Square ■ Aluminum, Steel and Brass panels plated to meet your specifications ■ Dozens of standard mounting frame designs ■ Write for data # 600.



Honeycomb panels offer lowest restriction to air flow.

TECKNIT TECHNICAL WIRE PRODUCTS, INC.

East Division • 129 Dermody St., Cranford, N. J. 07016 (201) 272-5500
West Division • 427 Olive St., Santa Barbara, Calif. 93101 (805) 963-1867

Circle 80 on Inquiry Card

STANPAT GIVES SHARP, CRISP REPRODUCTION EVERY TIME!

STANPATS are made specifically for use on drawings. Inferior imitations create endless problems. STANPAT will preprint your own repetitive items for instant drafting. Every sheet is guaranteed to meet your exact requirements. Adhesion is instant . . . reproduction is always perfect.

Unbelievable? Send today for free samples—judge for yourself. Be sure to enclose a sample of your own repetitive details and we'll send you a quote. Use quick-reply coupon below.

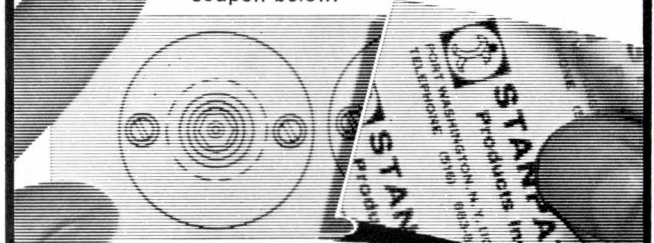

Tel: 516 883-8400

faithfully serving the architect and engineer for over 25 years



STANPAT PRODUCTS INC.

Dept. C-2, 366 Main St., Port Washington, N.Y. 11050

Send free samples and literature. Quote on my attached art.

Name _____ Title _____

Company _____

Address _____

City, State, Zip Code _____

Circle 81 on Inquiry Card

DC to DC CONVERTER TRANSFORMERS

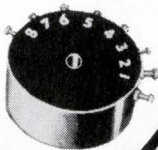

M 8100 SERIES

E_{IN} 13.6 and 28VDC
 E_{OUT} 28,70 and 500VDC
 P_{OUT} 5 and 50VA

FROM STOCK!

SEND FOR APPLICATION BULLETIN F162
COVERING COMPLETE LINE

MICROTRAN
VALLEY STREAM, NEW YORK 11582

Circle 82 on Inquiry Card

EE LITERATURE

Switchboard instrumentation

There's data on switchboard instruments, accessories, transducers, reverse power relays, and alarm relays in this 1968-69 catalog. Featured is a line of ac and dc taut-band switchboard instruments with 1% accuracy.

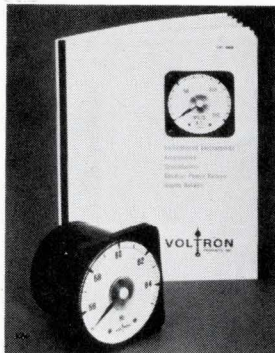

The 28-page catalog (SB68) includes features, schematics, specs, dimensions, application drawings, and wiring diagrams. Voltron Products, Inc., Switchboard Instrument Dept., 403 S. Raymond Ave., Pasadena, Calif. 91105.

Circle 346 on Inquiry Card

Coaxial cable nomogram

A calculator, in the form of a nomogram, will help designers and specifiers of low-loss coaxial cables determine cable dimensions and capacitance. With this calculator they can also find characteristic impedance, velocity of propagation, and dielectric constant without having to use algebraic equations. Publication No. WC-3734N is available from General Electric Co., Wire and Cable Dept., Bridgeport, Conn.

Circle 347 on Inquiry Card

Magnetic materials

A colorful 8-page brochure describes the company's wide range of products. These include tape and bobbin wound cores, powder cores, silectron cores, laminations, chemical blanks, and permanent magnets. Others are special magnetic materials, precision rolled foils, electromagnetic field devices, and electronic components and instruments. The Arnold Engineering Co., Marengo, Ill. 60152.

Circle 348 on Inquiry Card

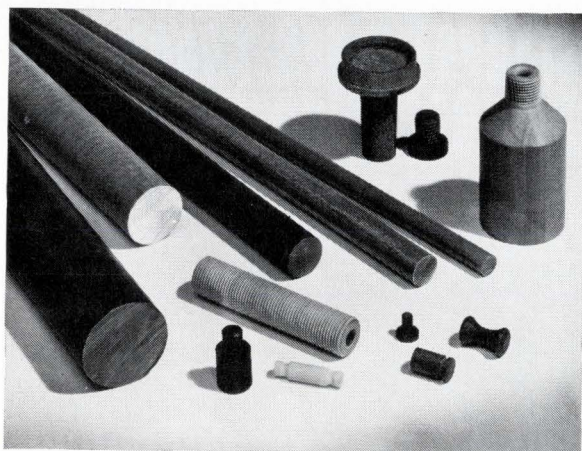

How do you like your laminated plastic rods?

We mill them. Drill them. Turn and bore them. Saw, sand, screw machine them. Grind, polish or varnish them. We do it all — with the nation's largest fabrication facility devoted exclusively to plastics. And we stock a large inventory of round and other shaped rods from 3/32" to 4" in diameter for immediate shipment. Convoluted-wound laminated plastic rods resist heat, impact and chemicals, and are excellent insulators. For complete information write to: Synthane Corporation 18 River Road, Oaks, Pa. 19456.

SYNTHANE
CORPORATION

Laminated Plastic Sheets. Rods. Tubes and Fabricated Parts

Circle 83 on Inquiry Card

NEW from GRC®

Tiny Injection Molded THERMOSET Precision Parts

GRC's unique special methods for automatically injection molding tiny parts in thermoplastics (like those shown) can now be applied to THERMOSETS. Small part users can have the same advantages of greater uniformity, precision, design flexibility and economy.

Maximum Size: .03 oz.; 1¼" long.



Actual Size

Write Today For New Thermoset Data and Samples ...
GRIES REPRODUCER CO.

Division of Coats & Clark Inc.

world's foremost producer of small die castings & plastic moldings

165 Second St., New Rochelle, N. Y. 10802 • (914) 633-8600

Plants in: New Rochelle, N. Y.; Warren, R. I.; Toccoa, Ga.

In Canada: Gries Div., Dynacast Ltd. Lachine, Quebec

Circle 84 on Inquiry Card

Data acquisition system

Two analog/digital data acquisition and recording systems are the subject of this 8-page brochure. These systems will provide you with a fast and inexpensive means to convert data acquired in either analog or digital form



into a format compatible with computer input requirements. A typical system is made up of input multiplexing circuitry, conversion equipment, and an output recording device. Datatron, Inc., 1636 E. Edinger Ave., Santa Ana, Calif. 92705.

Circle 349 on Inquiry Card

Wire and cable

Technical data on military electronic wire is given in this 46-page catalog. Popular commercial types of wire and cable are also listed. Tables of wire characteristics, a military specification index, and a numerical index make this a handy ordering guide. Standard Wire and Cable Co., 3440 Overland Ave., Los Angeles, Calif. 90034.

Circle 350 on Inquiry Card

Interconnection systems

"Creative Capabilities in Interconnection Systems" is the subject and title of a 14-page brochure. Literature describes how the company solves complex interconnection problems. Design, engineering, production, and management capabilities are outlined. Also covered is product experience in cable assemblies, harnesses, and connectors. Marketing Dept., Amphenol Space and Missile Systems, 9201 Independence Ave., Chatsworth, Calif. 91311.

Circle 351 on Inquiry Card

VISUAL MAGNETIC CONTROL

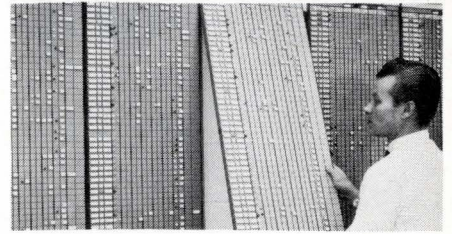

MAGNETS MOVE FASTEST—AND EASIEST—OF ALL!
SIMPLEST VISUAL CONTROL FOR

Sales • Production • Personnel
Maintenance • Machine Loading • Scheduling
Charts • Visual Presentations • Graphs
Data Processing • PERT

COLORFUL MAGNETIC ELEMENTS

ORGANIZE FOR ACTION
SHOW FACTS INSTANTLY
ELIMINATE MISTAKES
GET THE JOB DONE

Priced From

\$38⁰⁰

Including Magnetic Elements

28 Page
Illustrated
Catalog EI-2

FREE
On Request

METHODS RESEARCH CORP.

54 Willow Ave., Staten Island, N.Y. 10305

Circle 85 on Inquiry Card

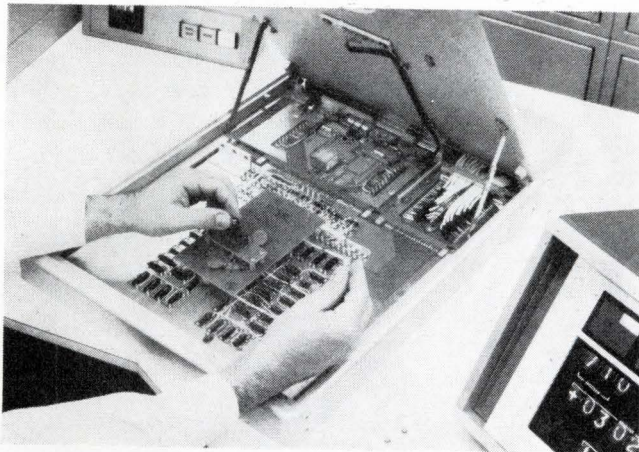

Chemtron* REED RELAYS widely used in computer-controlled automatic test systems

Chemtron 225 Reed Relays are used in the above-pictured linear IC test station of the Model 553 Dynamic Test System by Texas Instruments.

Because they're

- **SMALLEST:** 0.2 x 0.2 x 0.8 inches
- **FASTEST:** 0.5 ms including bounce
- **SHIELDED:** Electrostatic & magnetic standard on 225
- **RUGGED:** Vacuum-encapsulated epoxy uses patented technique
- **PC MOUNT:** No leads to bend or form

Chemtron 225 Reed Relay with 4.5V coil for IC DRIVERS is standard stock item. Write for complete information and new catalog.



*T.M.

SELF-ORGANIZING SYSTEMS, INC.

P. O. BOX 9918 • DALLAS, TEX., 75214 • (214) 276-9487
PLANT: 3121 BENTON STREET, GARLAND, TEXAS

Circle 86 on Inquiry Card

Varflex invites you to . . .

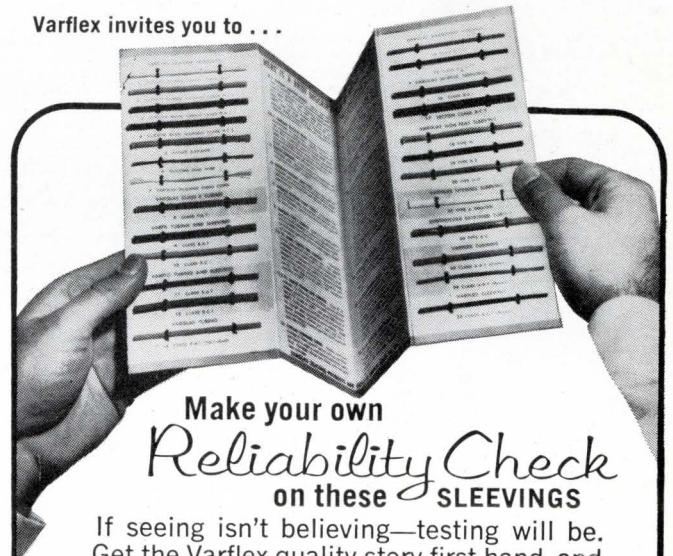

Make your own Reliability Check on these SLEEVINGS

If seeing isn't believing—testing will be. Get the Varflex quality story first hand, and you can count on exactly the same quality every time you order.

Send today for your free folder containing test-length samples of **Silicone, Varglas, Varfil, and Varflo** flexible insulating sleeveing and tubing.

Let us know how we can serve you.

Send For Free Folder of
Actual Test Samples

Varflex
CORPORATION

506 W. Court

Rome, New York

Circle 87 on Inquiry Card



Advertisers—February 1969

This index is published as a convenience.
No liability is assumed for errors or omissions.

DISTRICT SALES MANAGERS

EDWARD G. SHAUD
PHILADELPHIA 19139—56th &
Chestnut Sts.
(Area Code 215) SHERWOOD 8-2000

JOSEPH DRUCKER
NEW YORK 10017—100 East 42nd St.
(Area Code 212) OXFORD 7-3400

JOHN UPHUES
THOMAS A. MORIE
CHICAGO 60606—120 S. Riverside
Plaza
(Area Code 312) 782-1400

GIL L. ALFANO
NEEDHAM HEIGHTS, MASS. 02194—
570 Hillside Ave.
(Area Code 617) 444-0010

TERRENCE D. BUCKLEY
LOS ANGELES 90015—1543 W.
Olympic Blvd.
(Area Code 213) DUNKIRK 7-1271

RALPH PETERSEN
SAN FRANCISCO—839 Mitten Rd.
BURLINGAME 94010
(Area Code 415) 697-8703

LEONARD PREYSS
CLEVELAND 44114—601 Rockwell Ave.
(Area Code 216) SUPERIOR 1-2860

FRANK A. SMITH
HOLLYWOOD, FLA. 33020—
2419 Hollywood Blvd.
(Area Code 305) 927-7829

JOSEPH CORSILLO
ATLANTA 30309—1776 Peachtree St.
N.W.
(Area Code 404) 875-1255

HAROLD E. MOTT
DALLAS 75206—Meadows Bldg.
Expressway at Milton
(Area Code 214) EMERSON 3-6426

JOHN F. WALLACE
HOUSTON 77027—West Loop Bldg.
Rm. #209, 4848 Guiton
(Area Code 713) 621-3428

European Sales Offices

MAX F. HOLSINGER
LONDON, S.W. (1)—67/68 Jermy St.
St. James
Tel: TRafalgar 6318/9

4 DUSSELDORF—RATH, Germany
United International Industrial Press
Eitelstrasse 32
Tel: Dusseldorf 632031

STEPHEN BROWN-JOUSSARD
PARIS 8e, France
70 Rue de Ponthieu
Tel: ELYsees 65-77

Far East Sales Office

CLARENCE T. SAKAGUCHI
TOKYO, MARUNOUCHI, Japan
C.P.O. Box #1572, Room 814
Tel: 211-3506-3509
Togin Bldg.

BUSINESS STAFF

K. ROBERT BRINK
Publisher
STEPHEN A. FARKAS
Marketing Services Manager
BERNARD GITELMAN
Directories Manager
DENNIS J. PERKINS
Promotion Manager
PAT PIEHL
Advertising Production
WILLIAM M. COFFEY
Circulation Director
JAMES F. NAGY
Circulation Manager
JOSEPH P. BABCOCK
Reader Service Manager

ACOPIAN CORP. Mort Barish Associates, Inc.	28	LEACH CORP. Chiat/Day, Inc.	Insert Fol. p. 18
ADC PRODUCTS John Gompper & Associates	62	MB ELECTRONICS, A TEXTRON CO. Codella Savage Peck Inc.	98
AMELCO SEMI-CONDUCTOR Steven Jacobs Design Associates	88	MEMOREX CORP. Diener & Darskind (West)	30
AMERICAN MACHINE & FOUNDRY CO., POTTER & BRUMFIELD DIV. Grant, Wright & Baker, Inc.	104, 105	METHODS RESEARCH CORPORATION Vincent J. Mielcarek Agency	121
AMP INC. Garceau, Hallahan & McCullough, Inc.	52	MET-L-WOOD CORP. Drew & Carr, Inc.	108
AMPERITE CO. H. J. Gold Co.	117	MICROTRAN CO. Packer Advertising Corp.	120
ANALOGIC CO. Hargood Associates, Inc.	96	J. W. MILLER CO. Schaeper Industrial Advertising	107
ASTRODYNE, INC. Robert J. Allen, Mktg. & Public Relations	109	NATVAR CORP. Sanger-Funnell Inc.	102
AUGAT, INC. Horton, Church & Goff, Inc.	63	PASTORIZA ELECTRONICS, INC. L. K. Frank Co., Inc.	114, 115
BUSSMANN MFG. DIV. Henderson Advertising Co.	94, 95	PHILBRICK/NEXUS RESEARCH Culver Advertising, Inc.	41
CHOMERICS Van Christo Associates, Inc.	4	PHILCO-FORD CORPORATION The Aitkin-Kynett Co., Inc.	20, 21
CHRONETICS, INC. GENERAL RESISTANCE DIV. i. s. Ianza & associates	50, 97	POTTER & BRUMFIELD DIV., AMERICAN MACHINE & FOUNDRY CO. Grant, Wright & Baker, Inc.	104, 105
3-I PRODUCTS DIV. Van Christo Associates, Inc.	102	POWER DESIGNS INC. Taube/Violante, Inc.	Inside Back Cover
C&K COMPONENTS INC. Van Christo Associates, Inc.	29	PYLON CO., INC. American Line-A-Graph Corp.	118
CLIFTON DIV OF LITTON INDUSTRIES Ivey Advertising Inc.	51	RCA ELECTRONIC COMPONENTS & DEVICES Al Paul Lefton Co.	84, Back Cover
CONDUCTRON CORPORATION J. Walter Thompson Co.	38	RADIO SWITCH CORP. Carpenter, Matthews & Stewart, Inc.	106
COUCH ORDNANCE, INC. Culver Advertising, Inc.	112	RAYTHEON SEMICONDUCTOR Botsford, Constantine & McCarty, Inc.	6, 26, 27
CRATEX MANUFACTURING CO. Wank, Williams & Neylan, Inc.	106	REEVES-HOFFMAN DIV. Adams Associates, Inc.	110
CTS CORP. Reincke, Meyer & Finn, Inc.	100, 101	SAN FERNANDO ELEC. MFG. CO. West-Ad Communications	99
DALE ELECTRONICS, INC. Swanson, Sinkey, Ellis, Inc.	64	SANDERS ASSOCIATES, INC. Harold Cabot & Co., Inc.	34
DATA TECHNOLOGY, INSTRUMENTATION DIV. Cookley/Heagerty Inc.	92	SELF-ORGANIZING SYSTEMS Warren Associates	121
DAYTONA BEACH INDUSTRIAL AREA Keyes, Madden & Jones	106	SEMTECH CORP. burress/advertising	2
DELTRON, INC. Benn Associates, Inc.	110	SOLID STATE PRODUCTS, DIV. OF UNITRODE CORP. Van Christo Associates, Inc.	16
DUPONT, FREON PRODUCTS DIV. Batten, Barton, Durstine & Osborn, Inc.	43	SPRAGUE ELECTRIC CO., CAPACITOR DIV. The Harry P. Bridge Co.	1
ELCO CORPORATION Fien and Schwerin, Inc.	9	STANPAT PRODUCTS INC. Morton Advertising, Inc.	119
ELDORADO ELECTRONICS Techno, Metrics, Inc.	42	SYNTHANE CORP. Arndt, Preston, Chapin, Lamb & Keen, Inc.	120
ELECTRO MOTIVE MFG. CO., INC., THE Reynolds & Foster, Inc.	39	TECKNIT Douglas Brush Advertising Agency	119
ESC ELECTRONICS CORP. Comar Advertising Agency, Inc.	113	TELEDYNE RELAYS S. Michelson Advertising	5
FAIRCHILD SEMICONDUCTOR Chiat/Day, Inc.	12, 13, 23	E. H. TITCHENER CO. Conklin, Labs & Bebee, Inc.	22
FAIRCHILD SPACE AND DEFENSE SYSTEMS Keyes, Martin & Co.	74	THE TRIPLETT ELEC. INST. CO. Burton Browne Advertising	15
FERROXCUBE CORP. W. H. Schneider, Inc.	44	TROMPETER ELECTRONICS, INC. Jansson Advertising, Inc.	109
GRAYHILL, INC. Merchandising Advertisers, Inc.	118	TYCO LABS., INC., DIGITAL DEVICE DIV. Kenyon & Eckhardt Inc.	103
GRIES REPRODUCER CO. Harold Marshall Advertising Co., Inc.	120	UNITED SYSTEMS, INC. Advertising and Merchandising Inc.	111
HEATH COMPANY Advance Advertising Service	40	UNITRODE CORPORATION Silton Brothers, Inc.	25
HI-G, INC. Marketing Assistance Inc.	Inside Front Cover	UNITRON Warren Associates	19
HUGHES, AIRCRAFT CO. Foote, Cone & Belding	36	VARFLEX CORP. Barlow/Johnson Inc.	121
IEEE Alpaugh Advertising	108	VARIAN ASSOCIATES Botsford, Constantine & McCarty, Inc.	14
INFOTECH, INC. S&S Creative Services	111	VARO INC. Tracy-Locke Company, Inc.	112
INTERNATIONAL RECTIFIER Botsford, Constantine & McCarty, Inc.	91	VISHAY RESISTOR PRODUCTS Alpern Communications	113
KEPCO, INC. Weiss Advertising	10	WATKINS-JOHNSON COMPANY William C. Estler—Public Relations	24

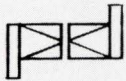

PRECISION IN MINIATURE

REMOTE CONTROLLED HIGH VOLTAGE POWER SOURCE

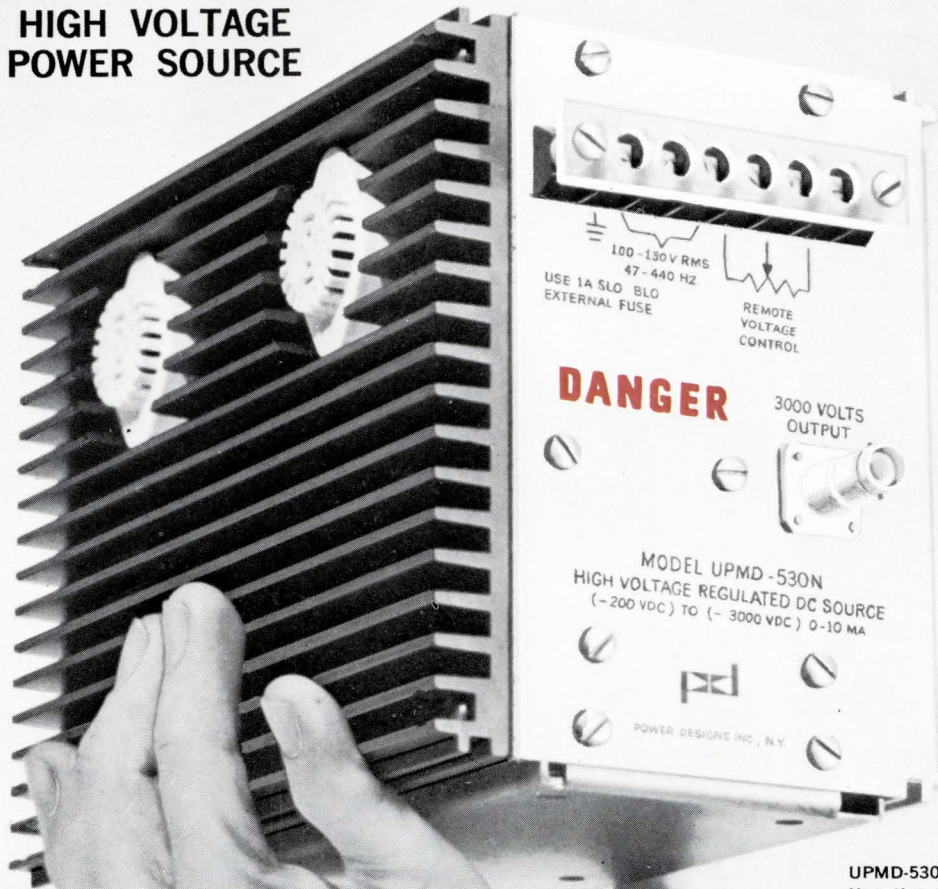

UPMD-530N \$385.00
Negative output polarity

UPMD-530P \$420.00
Positive output polarity

Output: Remotely resistance programmed over a 200 to 3000 VDC range at 10ma. No high voltage potentials at programming terminals (15V max)

Stability: 0.01%

Ripple & Noise: 10mv p-p

Regulation: 0.0025% +5mv

T.C.: 50 ppm/°C

Size: 6h x 4½w x 7½d

Ideally suited for photomultiplier and small CRT display applications.

fob westbury, n.y.

WRITE FOR DETAILED SPECIFICATIONS

POWER DESIGNS, INC.

3381 MIRANDA AVE. · PALO ALTO, CALIFORNIA
415-321-6111 TWX: 910-373-1251

1700 SHAMES DRIVE · WESTBURY, N.Y.
516-333-6200 TWX: 510-222-6561

Circle 2 on Inquiry Card

Four power levels for SSB

New...
four tubes for SSB. And four power levels—500 W,
1 kW, 5 kW, and 10 kW. These rugged Cermolox[®]
tubes, developed from proved, in-use designs, feature
new lows in feedthrough capacitance and screen and
cathode inductance plus superb IM characteristics.
Their rugged construction makes them suitable for
mobile service in shipboard and airborne equipment
as well as in fixed stations.

Available at surprisingly low cost, the four are: 8791,
8792, 8793, and 8794. In addition to their efficient use
in SSB service, the tubes are attractive for FM,
VHF-TV, and VHF/UHF communications.
See your RCA Representative for details, including
prices and delivery. For technical data on specific
types, write: Commercial Engineering, Section B-50T,
RCA Electronic Components, Harrison, N. J. 07029.

RCA

8794, 10 kW PEP

8791, 500 W PEP



8792, 1 kW PEP

8793, 5 kW PEP