

THE ELECTRONIC ENGINEER



- Will optical memories ever forget? p. 20**
- Integrating DVMs fight noise p. 40**
- Taking the mystery out of DVM specs p. 46**
- Manufacturing steps for hybrids p. 60**
- Mixed up in microwave mixers? p. 68**



MORE BIPOLAR POWER

from **KEPCO**

We've expanded our line of the unique "BOP" *Bipolar Operational Power* supplies. Now there are eight models available either metered (with a functional patch panel) or unmetred (blank panel) for systems users.

±72 VOLT
MODELS

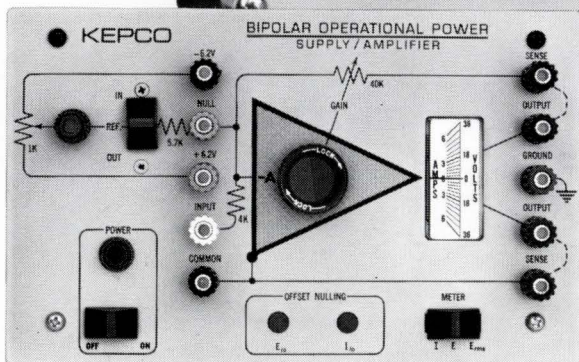
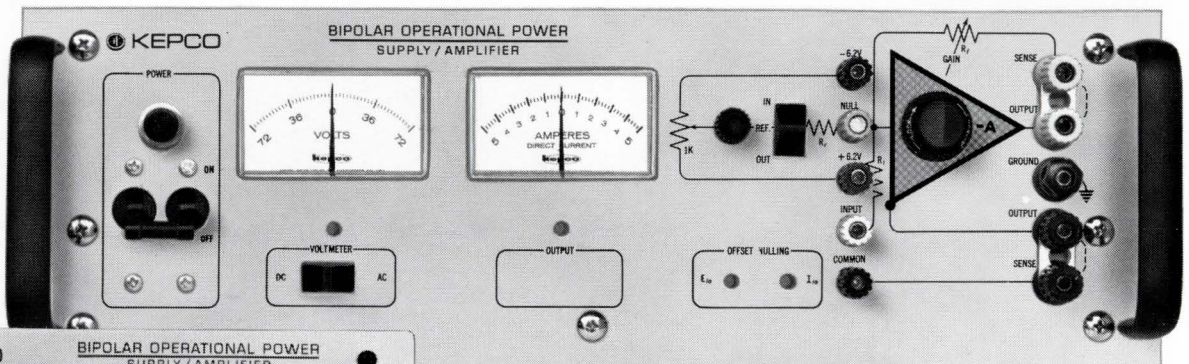

±36 VOLT MODELS

MODEL	VOLTS	AMPS	PRICE
BOP 36-1.5M	+36 to -36	+1.5 to -1.5	\$525.00
BOP 36-1.5	+36 to -36	+1.5 to -1.5	465.00
BOP 36-5M	+36 to -36	+5 to -5	750.00
BOP 36-5	+36 to -36	+5 to -5	690.00
BOP 72-1.5M	+72 to -72	+1.5 to -1.5	1,125.00
BOP 72-1.5	+72 to -72	+1.5 to -1.5	1,065.00
BOP 72-5M	+72 to -72	+5 to -5	1,475.00
BOP 72-5	+72 to -72	+5 to -5	1,415.00

The Kepeco BOP supplies employ a complementary-symmetry output stage so that the output can be continuously and linearly varied *through* zero without switching. Frequency response: Full power from d-c to 20 kHz (-3 dB).

The bi-directional power output is suited to many interesting tasks. It can be set to full voltage in either direction, and loaded fully indefinitely—or it can be modulated by any waveform, to any amount with or without a d-c component. Use the patch panel to control the feedback (any amount to 100%) or substitute your own input and feedback elements for algebraic manipulation.

Use the BOP as an a-c supply, servo driver, shake table amplifier, hi-fi, x, y deflector or integrator.

WHAT CAN YOU DO WITH OUR BOP?

Encircle number below or write Dept. BT-19

for a full data sheet, and turn your imagination loose!



KEPCO, INC. • 131-38 SANFORD AVENUE • FLUSHING, N.Y. 11352

(212) 461-7000 • TWX # 710-582-2631

Telex: 12-6055 • Cable: KEPCOPOWER NEWYORK

Circle 1 on Inquiry Card

...want a tantalum capacitor with proven performance?

Buy TYPE 150D TANTALEX[®] SOLID-ELECTROLYTE CAPACITORS

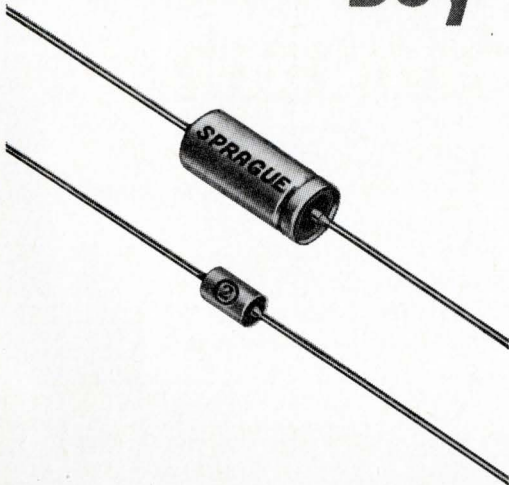

Circle 4 on Inquiry Card

Hermetically-sealed in metal cases. Four case sizes, ranging from 1/4" to 3/4" length. Value-packed performance characteristics — low impedances at high frequencies, low dissipation factor, minimal capacitance drift with temperature, practically no change in capacitance with life. Low leakage current limits. Investigate new higher capacitance ratings.

45C-9144R1

Buy resistors with built-in dependability...

Vitreous-enamel BLUE JACKET[®] POWER WIREWOUND RESISTORS

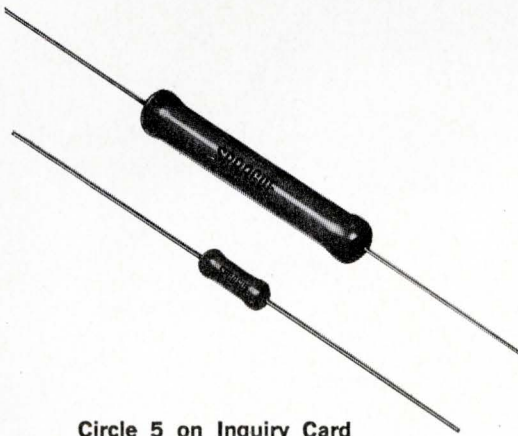

Circle 5 on Inquiry Card

All-welded end-cap construction eliminates moisture along the leads, also anchors leads securely to resistor body. Expansion coefficients of vitreous enamel coating, ceramic core, and end caps are closely matched. Standard wattage ratings include 1, 2, 2.5, 3, 5, 7, 10, and 11 watts. Also available with radial tab terminals in ratings from 8 to 230 watts.

For complete technical data on Type 150D Tantalex Capacitors, write for Engineering Bulletin 3520F. For information on Blue Jacket Resistors, request Bulletin 7410D. Write to: Technical Literature Service, Sprague Electric Co., 233 Marshall Street, North Adams, Massachusetts 01247.

45R-9145



'Sprague' and '®' are registered trademarks of the Sprague Electric Co.

THE BROAD-LINE PRODUCER OF ELECTRONIC PARTS

Lots of people have told us they could use an active filter with low power requirements and a low enough price.

How does 0.3 mW at \$10* sound?

Ask for carload prices or send \$12 for an evaluation sample.

You'll find there's a lot to evaluate. Like that power spec—ideal for all kinds of battery-powered gear. Plus a price/performance combination that we think will eliminate a lot of in-house filter making, even for commercial applications. Mail the coupon and a check or P.O. for \$12.00 today (please attach your company letterhead). We'll respond by air with a sample FS-60 and our brand new Filter Design Handbook. 'Till then, here are the basic specifications: Delivers band-pass, high-pass and low-pass outputs simultaneously Any desired form of the second order transfer function Complex zeros anywhere in the S-plane Multi-loop negative feedback for added stability F. and Q of basic unit can be tuned by adding external resistors Frequency range from DC to 10 kHz Q range from 0.1 to 500 Voltage gain is adjustable to 40dB Supply voltages from $\pm 2V$ to $\pm 15V$ with 0.3 mW power consumption Dimensions: (14-pin DIP) 0.804" x 0.366" x 0.474" IC hybrid construction.



PRICES:	1 - 49	\$28	5,000 - 9,999	\$14
	50 - 199	\$23	10,000 - 19,999	\$12
	200 - 999	\$19	*20,000 - 49,999	\$10
	1,000 - 4,999	\$16		

Gentlemen at KTI:
 Please send me an FS-60 evaluation sample. Our check P.O. is attached, in the amount \$12.00. Send me more information on:
 FS-60 All active filters Hybrid subsystems
 Please add my name to your permanent mailing list

Name _____
 Company _____
 Address _____
 City _____
 State _____ ZIP _____

My applications are: _____



KINETIC TECHNOLOGY, INCORPORATED
 3393 De La Cruz Boulevard
 Santa Clara, California 95051
 (408) 246-8100 TWX: 910-338-0279
 The name to remember for Hybrid Integrated Systems and Active Filters . . .

THE ELECTRONIC ENGINEER

Oct. 1969 Vol. 28 No. 10

Editorial	7
Up to date	9
Forefront	17
Calendar	24
Speak Up	26
Welcome	30
Careers	34
Courses	39
Product Seminars	56
Microworld	60
Books	66
Microwaves	68
IC Ideas	75
Abstracts	85
Microworld New Products	94
Lab Instruments	98
New Products	104
Literature	117
Ad Index	123
Product Index	124

X-rays disappear with solid state packages 9

Most of the radiation generated in color TV sets comes from the high voltage tubes. Solid state devices eliminate this hazard.

Will optical memories ever forget? Now they can! 20

A new magnetic hologram can be written, read, and erased repeatedly, opening the door to dynamic optical memories.
By Roy Schwartz

Can management give engineers what they really want? 34

It's a two-way street—management should provide a better atmosphere for engineers, and engineers should be more professional.
By Joan Segal

Integrating DVM's fight noise, but . . . 40

. . . their noise rejection varies with frequency, and depends on the period of integration.
By Delbert L. Johnson

Taking the mystery out of DVM specs 46

There are no industry standards on specification for digital voltmeters, yet these specs are the only thing you can go by to compare DVMs.
By Ken Jessen

Hybrids . . . Thick and thin 60

Whether you plan to build or buy, you should be familiar with the steps involved in making hybrid circuits. There may also be a point at which you will want to stop buying and start making your own. These charts should help you decide.
By Smedley B. Ruth

Mixed up in mixers? Try an HCD 68

Hot-carrier diodes (HCDs) approach ideal Schottky-barrier junction operations. Such junctions virtually eliminate stored charges and extend the devices' high-frequency performance.
By Aki Tanka and Suleyman Sir

IC Ideas 75

- A pulse-width measure, sample-and-hold circuit By D. L. Sporre
- Inexpensive pulse source has "high-priced" features By T. M. Farr, Jr.
- A staircase waveform generator By J. W. Foltz
- Modified latch changes low-frequency inputs to logic level signals
By E. B. Beach

COVER

Although still experimental, holographic memories promise to expand substantially the capacity of computer memories, thanks to their high bit density and low cost. Up to now, however, holographic memories have been static. Our cover shows a new holographic memory by RCA, described on pages 20-23, that is dynamic—it can be both written in and read out.

op amp art

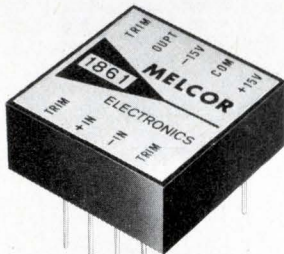

MODEL 1861
FET INPUT
1-24...\$10.00

An FET Input Amplifier at a Bipolar Price

An FET input stage combined with an IC yields a combination with the best features of both devices. The low bias current of an FET amplifier combined with the low, low price of an IC. All shaping networks are internal. No extras required except the zeroing potentiometer, if desired.

Output ± 10 volts ± 5 MA minimum • Input impedance 10,000 megohms • DC Gain 15,000 minimum • Unity Gain Bandwidth 1.0 MHz • Slew Rate 1.5V/ μ sec • Power Bandwidth 20 KHz • Voltage Drift 75 μ V/ $^{\circ}$ C max • Bias Current 0.25 na maximum • Dimensions $1\frac{1}{8}$ " x $1\frac{1}{8}$ " x 0.5"

Write for our new catalog C-1009 for additional information about this unit and many other Melcor Operational Amplifiers.

MELCOR ELECTRONICS CORPORATION
AMPLIFIERS FOR INDUSTRY

1750 New Highway,
Farmingdale, New York 11735
516/694-5570
TWX 510-224-6429



The Electronic Engineer

Vol. 28 No. 10 October 1969

K. Robert Brink, *Publisher*

Alberto Socolovsky, *Editor*

John E. Hickey, Jr., *Managing Editor*

Smedley B. Ruth, *Associate Editor*

Sheldon Edelman, *Associate Editor*

Stephen A. Thompson, *Western Editor*

Robert Patton, *Eastern Editor*

Joan Segal, *Assistant Editor*

Arthur J. Boyle, *Technical Editor*

Roy Schwartz, *Contributing Editor*

Dr. O. M. Salati, *Consultant*

Anne Axe, *Editorial Assistant*

Alice C. Bach, *Editorial Assistant*

Lynda Rothstein, *Editorial Assistant*

Mae Moyer, *Editorial Reader Service*

Andrew Mittelbrunn, *Chilton Art Director*

Phaue Featherson, *Artist*

George Baker, *Washington News Bureau*
Neil Regeimbal,

Chilton   

Executive and Editorial Offices:

One Decker Square, Bala Cynwyd, Pa. 19004
Tel. (215) SH 8 2000

Address Mail to: 56th & Chestnut Sts.
Philadelphia, Pa. 19139

Western Office: Stephen A. Thompson
1543 W. Olympic Blvd., Los Angeles, Calif. 90015
Tel. (213) DU 7 1271

New York Office: Robert Patton
100 E. 42nd St., New York, N.Y. 10017
Tel. (212) OX 7 3400

Chilton Officers & Directors: Chairman of the Board: G. C. Buzby; President: R. E. McKenna; Financial Vice-President: S. Appleby; Senior Vice-Presidents: J. Kofron, L. King; Vice-President: H. Barclay; Publishing Vice-Presidents: C. W. Hevner, W. A. Barbour, R. H. Groves, K. Robert Brink; Treasurer: James Miades; Secretary: J. A. Montgomery, Jr.; Other Directors: T. J. Casper, S. H. Collmann, R. Rimbach, Jr.; Asst. Secretary: I. C. Holloway.

Monthly publication of Chilton Company, Chestnut & 56th Sts., Phila., Pa. 19139. (Area Code 215) SHerwood 8-2000. Controlled circulation postage paid at Philadelphia, Pa. \$1 a copy. Subscription rates U. S. and U. S. Possessions: 1 yr. \$12.00; 2 yrs. \$20.00. Canada 1 year \$14.00; 2 yrs. \$25.00. All other countries 1 yr. \$20.00; 2 yrs. \$35.00. © Chilton Company 1969. Title Reg. U. S. Patent Office. Reproduction or reprinting prohibited except by written authorization.

The Chilton Electronics and Instrumentation Group •
The Electronic Engineer • Instruments and Control
Systems • Instrument & Apparatus News • Medical
Electronics News • Electronic Component News

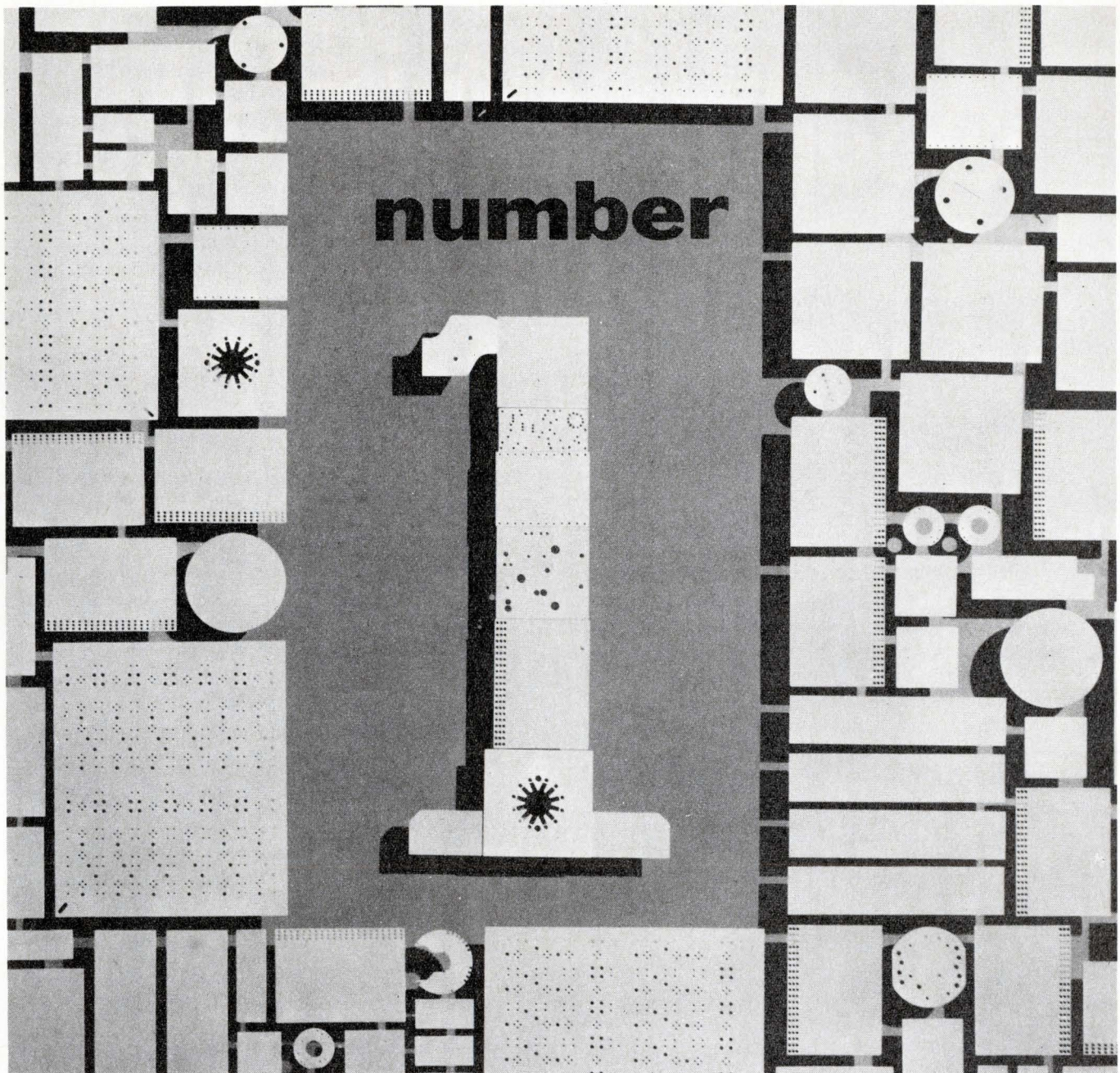

Coors Porcelain Company is the Number 1 producer of high-alumina ceramics and a major producer of alumina-ceramic substrates for thick- and thin-film circuits. This produces a number of benefits for you. Namely:

LOW COST—Whether your substrate order is large or small, you'll always find fair, competitive prices at Coors.

QUICK DELIVERY—Large-quantity substrate orders normally require only 6 to 8 weeks to complete. Small orders and prototype quantities usually take 2 weeks or less. Stocked blanks are shipped within 48 hours.

HIGHEST QUALITY—Coors has long been known as *the quality* manufacturer of technical ceramics. This means you can be sure Coors substrates will have uniform surfaces, precise dimensions,

maximum strength, maximum flatness, minimum camber, minimum waviness.

Coors can produce substrates to your specifications from either glazed or unglazed 96% alumina ceramic or unglazed 99.5% alumina ceramic. Both of these ceramics are dense, impervious, resistant to high temperatures, easily metallized, and have excellent electrical-insulation characteristics and good heat-transfer properties.

For details on Coors ceramic substrates, send for Bulletin 1400. Coors Porcelain Company, 600 Ninth Street, Golden, Colorado 80401.

9/2



Varian's the name. Coupled cavity TWT's the game.

When your system needs a broadband power amplifier, remember that

Varian's in the coupled-cavity Pulse and CW TWT business. And the name of that game is power.

Varian's line covers frequencies from 1.75 GHz to 17.20 GHz. There are CW models from 750 W to 12.5 kW, and pulse tubes from 10 kW peak to 100 kW peak. Gains range from 30 to over 50 dB, bandwidths of 15% or more. Both electromagnetic and permanent-magnet-focused types are included with grid, mod-anode or cathode pulsed beam control. Add to this an engineering capability to adapt from existing tubes or to develop quickly the precise TWT for your job.

Don't accept less than you need. Talk to the man who has the products, the backup and the pride that only the name Varian guarantees. He's at our more than 30 Electron Tube and Device Group Sales Offices throughout the world. Or contact our TWT Division, 611 Hansen Way, Palo Alto, California 94303.

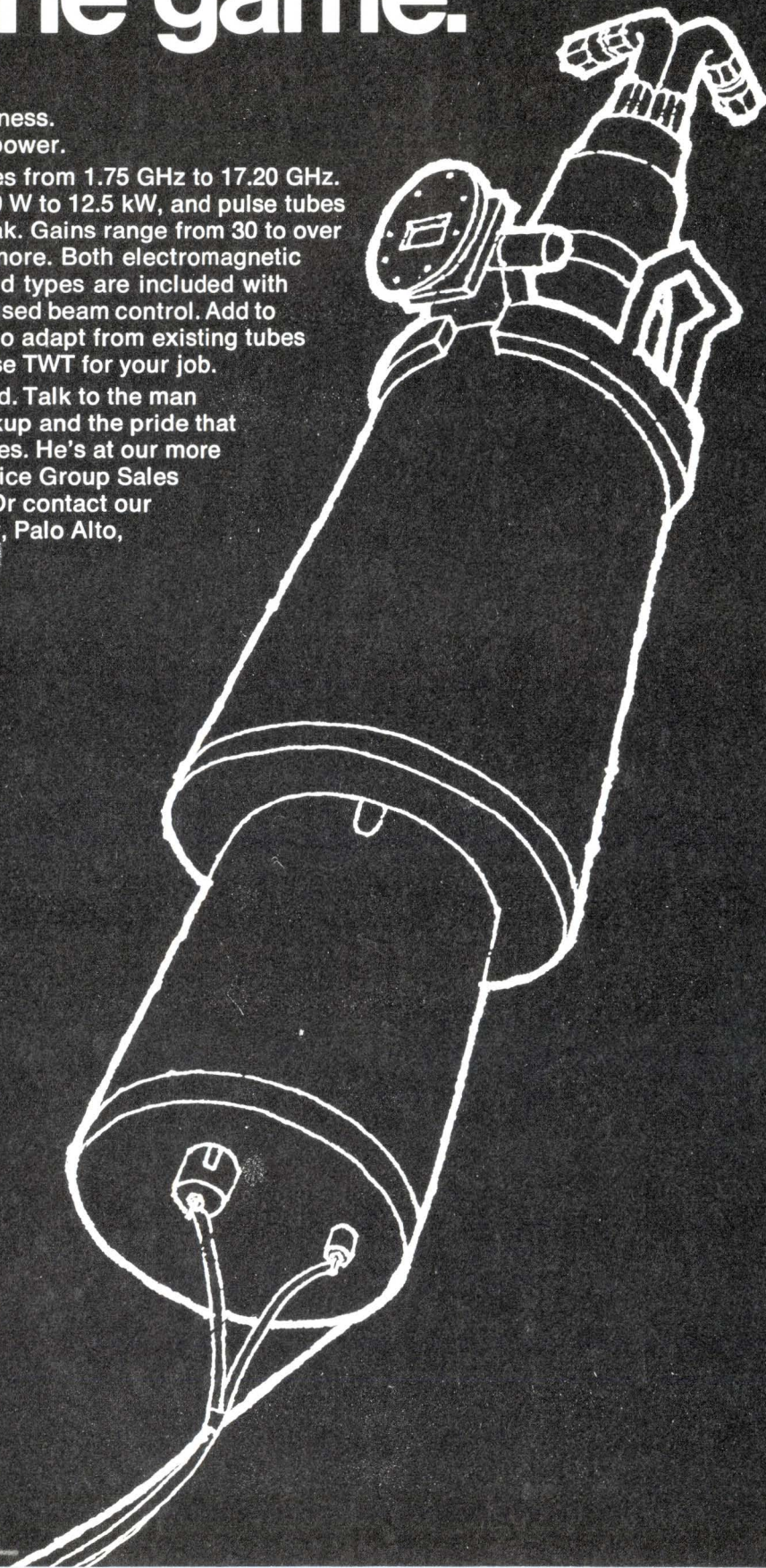

Go Midwest, young man

If the explosive birth rate of semiconductor electronic companies in the West Coast, and of new manufacturers of memories and of integrated circuit testers in the East, is still a cause for amazement, isn't it even more amazing that this boom keeps shuttling between East and West, but has largely bypassed the Midwest?

Before we answer this question, let us explore the reason for the East-West boom. We can trace it to the seeds of semiconductor technology, planted by Bell Labs in Murray Hill, N.J., and by Dr. Shockley (the Nobel prize laureate, one of the three inventors of the transistor) who in 1955 founded Shockley Transistor in Palo Alto, with the backing of Beckman Instruments. If, instead of Beckman, it had been Raytheon who successfully lured Dr. Shockley, the boom would have perhaps bypassed the West, and concentrated around Boston's "electronic belt"—Route 128.

Will the twin booms, East and West, ever meet? We see now the hopeful signs of fertility developing in the Midwest. First of all, there is the need. The major market for integrated circuits is rapidly shifting from applications in defense and aerospace industries, to commercial applications in computers, instrumentation and communications, three specialties that were practically born in the Midwest. And there are now the opportunities that attract talented engineers to the area.

Last month, for example, Honeywell opened a new Solid State Electronics Center in suburban Minneapolis, chartered to advise the corporation on all facets of this technology. Also, many manufacturers of consumer products are adding integrated circuits to their bread-and-butter lines, and hiring the engineers who can both design and evaluate them. It won't take long before an enterprising engineer sees the need to manufacture ICs locally, probably some special circuits, and to fill the need with its own enterprise.

That's the only missing ingredient for an electronic boom in the Midwest. The market is there, and there is as much capital available there as anywhere else in the nation. Also, the fine engineering schools in the area, such as Purdue and the University of Illinois, have offered for the past decade an excellent curricula on solid state physics for engineers. At the present time, however, many of their graduates must move elsewhere to apply their knowledge.

The Midwest, then, seems to be ripe for a boom. It only waits for you to kindle it.

Alberto Socolovsky
Editor

Quality starts in the washroom— not in the clean room

"Do you really want to know how good the workmanship is in the components you buy?", the relay specialist for a large aerospace company asked recently. "Then look into the vendor's washroom before he shows you his clean room."

The relay specialist didn't mean the executive washroom, but the one the workers use. His point is that, if the manufacturer cares about them, they will care about his product. And the best place to check that care is in the facilities he provides for his production workers—the cafeteria, lockers, recreation room and, the easiest one to check, the washroom. If you don't see quality starting there, it won't be added in the clean room.

For high speed harnessing
with continuous lacing...



HERE IS THE WORK SPEEDING - MONEY SAVING -

GUDEBROD SYSTEM "C"

GUDEBROD FLAT TAPE BOBBINS—This special packaging of Gudebrod Flat Braided Lacing Tape is highly popular in the harness shop. Whether used in all hand tying or with the Cable-Lacer (for which it was designed) the bobbin makes conveniently available, high quality Gudebrod Tape in most of its many types—all engineered to lie flat, tie tight.

GUDEBROD CABLE-LACER®—This unique harnessing hand tool has proved a production speeder and harness improver. Makes up to 30 knots per minute. While making firmer harnesses with tighter, more uniform knots, it eliminates wear and tear on operator's hands because special brake takes strain of knot setting. Holds bobbin of Gudebrod Tape in handle.

LONGER WIRE HOLDING PINS—They make wire threading much easier, quicker (no repeated wire redressing between pins). In harness tying they preserve the layout while using the Gudebrod Cable-Lacer. Special case hardened pins, nail better, stay straight, no nailheads.

GUDEBROD SWIVEL-TILT HARNESS BOARD MOUNT—Two dimensional balanced mobility puts every section of the cabling within easy, natural reach of the operator. Work done in this unstrained manner goes faster, is better, all day through.

There it is, the Gudebrod System "C" solving the cable making problems in a speedy, economical, profit improving way. Ask about System "C" (If you use intermittent tying, ask about Gudebrod System "S").

Gudebrod's
Special, Longer
Case Hardened Pins

©T.M.—UNION SPECIAL
MACHINE CO.

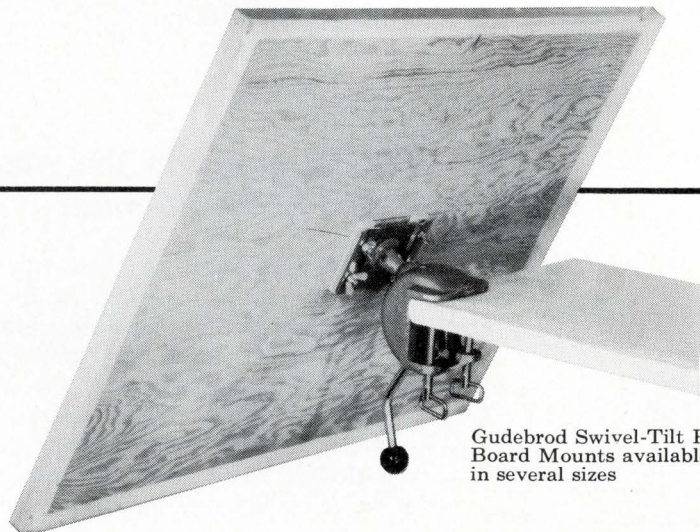

Gudebrod Swivel-Tilt Harness
Board Mounts available
in several sizes

GUDEBROD
Electronics Division

GUDEBROD BROS. SILK CO., INC. Founded 1870, 12 South 12th Street, Philadelphia, Pa. 19107

Seven at one blow—a new cathode-ray display tube

Future CRT readout systems may display up to 3000 symbols, writing each character in well under a microsecond and maintaining a brightness level comparable with any system available today. This is the opinion of Sylvania engineers, who have developed multibeam, single-gun display tubes at the firm's Electronic Tube Division in Seneca Falls, N.Y.

The first of these, a 12-inch, seven-beam CRT, is now available in sample quantities at \$780 each. Although the tube itself is more expensive than conventional single-beam tubes, it promises savings on over all sys-

tems costs by reducing external circuit complexity. Writing with seven individual electron beams, the new tube is potentially brighter and faster than a single-beam CRT, making it ideally suited to applications that require high writing speed under high ambient light conditions.

The only multibeam version presently available is the seven-beam SC-5299, but at least one 12-beam CRT has already been constructed, and Sylvania engineers feel confident that this approach can be applied to single gun tubes with up to 24 individual beams.

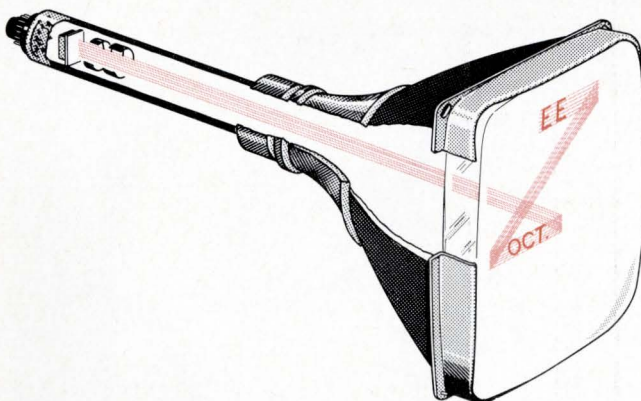

Seven beams sweep simultaneously to write on the screen of this display tube. Unblanking pulses applied to the control grids turn the beams on and off to form 5/32-inch-high characters. In a given system the beams will either sweep out each line of characters sequentially or, in a random-access mode, step from one character position to the next.

One big advantage of the multibeam tube is speed. Conventional single-beam displays achieve speed only at the expense of brightness and, furthermore, few systems can form a character in less than 10 to 12 microseconds. The multibeam tube makes it possible to construct a system that writes a character in under a microsecond without an unacceptable reduction in display brightness.

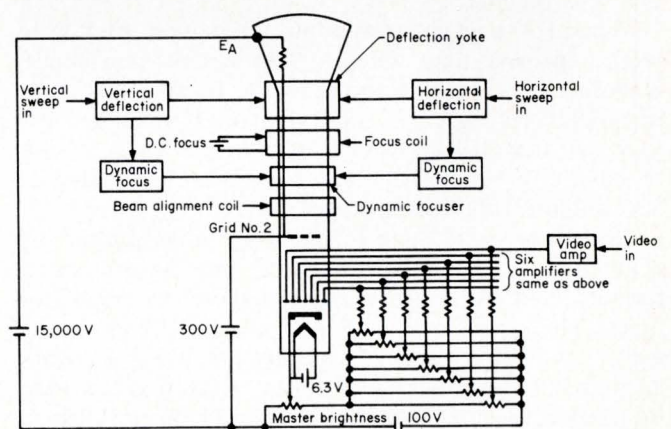

Simplified drive circuits are possible with the new tube. Bias control voltage is applied to an indirectly heated cathode and a 6.3 volt source supplies heater current. Amplified video signals, applied to each of the seven control grids, turn the electron beam on and off. As shown by this typical drive circuit, focus and deflection requirements are minimal. Since the tube writes by blanking and unblanking at appropriate points as the beams sweep out each line of characters, the horizontal yoke current is a sawtooth rather than a step function. This eliminates the need for extremely fast writing and the attendant high-frequency deflection yoke response associated with single-beam operation. Only the Z-axis modulation remains significant.

X-rays disappear with solid state packages

Most of the radiation generated in color TV sets comes from the high voltage tubes. Solid state devices eliminate this hazard.

The television industry has been under attack to eliminate X-ray radiation from color TV sets. The radiation hazard has been attacked in the press and was even mentioned in one of President Nixon's speeches shortly after he took office.

X-rays are very easily generated within vacuum tube rectifiers and voltage regulator tubes. While this radiation hazard has been greatly reduced through shielding and better design in the high voltage portion of the set, it will never be truly eliminated until the high voltage system is converted to solid state.

Until now, very little solid state, contrary to the advertising, has been used in most TV sets. The reason is primarily an economical consideration. TV engineers often refer to today's TV sets as "tribrid" because most sets sold use tubes, a few transistors and one to three integrated circuits in them.

Several companies have had high voltage triplers and quadruplers available for almost two years for use in color TV. These have not been generally accepted until recently. TV manufacturers are slow to accept new items for reasons, such as the designs are locked up as much as a year prior to manufacturing a new set, price because of the very competitive nature of consumer electronics, and manufacturers will not accept something that's new until they are absolutely certain that it is reliable.

When HV packages came into the market, they were more expensive than standard tube circuits and hence, manufacturers were reluctant to use them. Right now, manufacturers of these solid state high voltage packages feel they will be widely used in the 1972 models of color TV sets. The market has been estimated at \$35 million for these packages.

These new solid state high voltage units permit the elimination of some windings on the flyback transformers, and the focus rectifier and voltage regulator tubes. The most common high voltage package is the tripler. The tripler input is usually about 8.3 kV with an output of approximately 25 kV at around 2.5 mA. Regulation is better than 6% from no load to full load and many supply a focus voltage in the 8 kV region at 0.5 mA. They are completely potted in molded cases to prevent corona, arcing and shock hazards.

Varo in Garland, Texas, is one of the first to make a high voltage package for TV sets. They announced their package over a year and half ago. Several other companies have also offered high voltage packages for color TVs—General Instruments, Atlantic Semiconductor Div. of Aerological Research Corp. and the latest entry is Scientific Components, Inc.

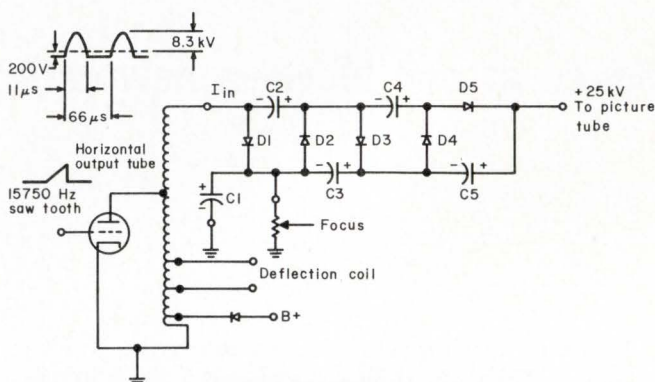

While this high voltage tripler circuit design is General Instrument's, others will be similar.

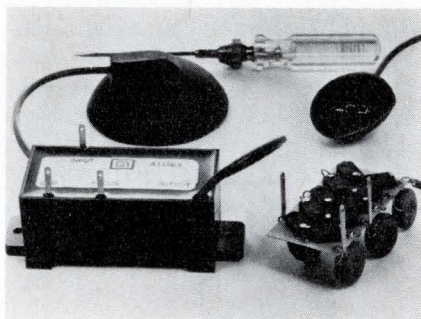

On the left is the HV tripler packaged by General Instrument. Below is a high voltage tripler which is made by Scientific Components, Inc., a new entry in the field.

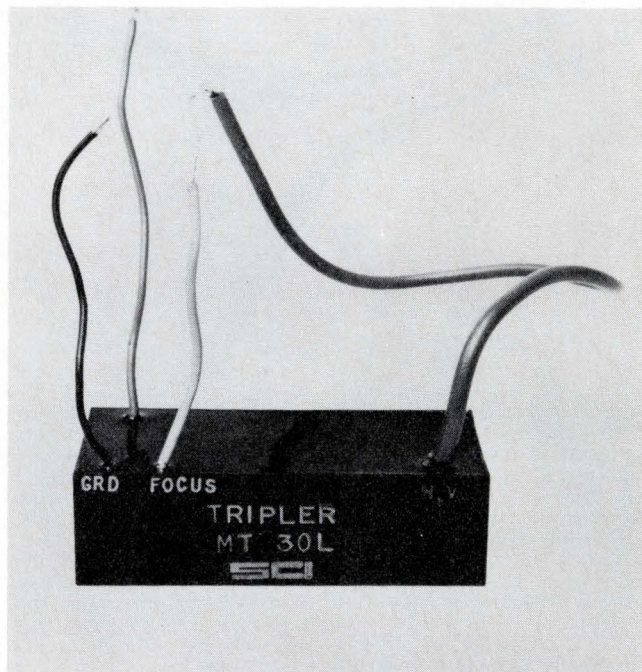

Ferroxcube is $\pm 1\%$ intolerant about pot cores

Ferroxcube is extremely intolerant of wide tolerances in pot core inductance.

As one example out of dozens, our 3B9 material 1408 size pot cores with 100 A_L maintain $\pm 1\%$ tolerances. No one else in the industry holds to better than $\pm 3\%$. Maybe they could. But then maybe they couldn't match our competitive prices.

Ferroxcube's ability to beat down pot core tolerances means that you get better stability (be-

cause you have a smaller tuning range). And it isn't just A_L values. We keep our specs strict in every parameter.

We also deliver faster. No one else has eight Stocking Centers nationwide . . . loaded for immediate local shelf-to-you deliveries.

And no one else gives you such a wide choice of bobbins and hardware accessories. Not to mention

an unbeatable variety of pot cores in sizes from 9 mm to 42 mm and in five materials.

If you were harder on your pot core supplier, maybe you could be easier on yourself . . . in design, in costs. Write to Ferroxcube for Bulletin 220-C. When you study the pot cores there, you won't tolerate any other kind.

Ferroxcube 
Saugerties, New York
A NORTH AMERICAN PHILIPS COMPANY.

**BEAT
POT CORE
TOLERANCES**

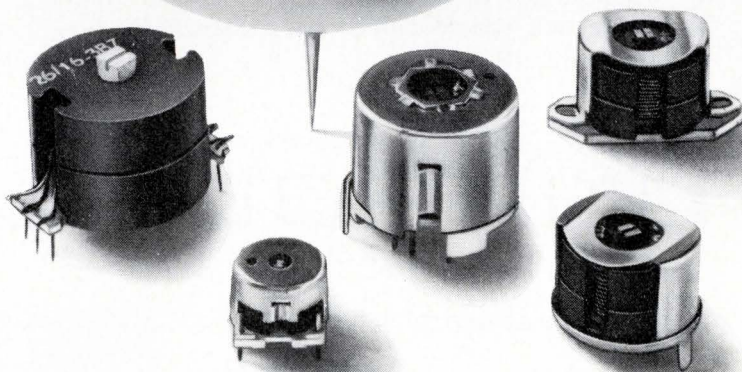

Atlanta—Cartwright & Bean, (404) 237-2273; Baltimore—Eastern Components, (301) 322-1412; *Burbank, Calif.—(213) 849-6631; Cedar Rapids—Thomas & Modricin, (319) 377-6261; Columbus, Ohio—Mulligan & Mathias, (614) 486-2976; *Dallas—Gillett Industries, (214) 363-0107; Fayetteville, N.Y.—R. P. Kennedy Co., (315) 637-9531; Hazelwood, Mo.—Thomas & Modricin, (314) 838-6448; Huntsville, Ala.—Cartwright & Bean, (205) 852-7670; Hyde Park, N.Y.—R. P. Kennedy Co., (914) 229-2269; Indianapolis—Thomas & Sukup, (317) 251-4574; Kansas City—Thomas & Modricin, (913) 432-2131; Littleton, Col.—Wm. J. Purdy Agents, (303) 794-4283; Marion, Ia.—Thomas & Modricin, (319) 377-6261; Minneapolis—(612) 920-1830; *New York—Kahgan Sales, (516) 538-2300; *Northlake, Ill.—(312) 261-7800; No. Miami Beach—Cartwright & Bean, (305) 945-2962; Orlando—Cartwright & Bean, (305) 425-8284; Ormond Beach, Fla.—Cartwright & Bean, (904) 677-3480; *Philadelphia—Eastern Components, (215) 927-6262; Phoenix—(602) 264-3129; Rochester, N.Y.—R. P. Kennedy Co., (716) 271-6322; *San Francisco—Wm. J. Purdy Agents, (415) 347-7701; Saugerties, N.Y.—(914) 246-2811; Shawnee Mission, Kans.—Thomas & Modricin, (913) 432-2131; St. Louis—Thomas & Modricin, (314) 338-6448; Union, N.J.—(201) 964-1844; *Waltham, Mass.—(617) 899-3110; *Woodstock, N.Y.—Elna Ferrite Labs, (914) 679-2497; *Toronto, Ont.—Phillips Electron Devices, Ltd., (416) 425-5161. *Denotes stocking distributor.

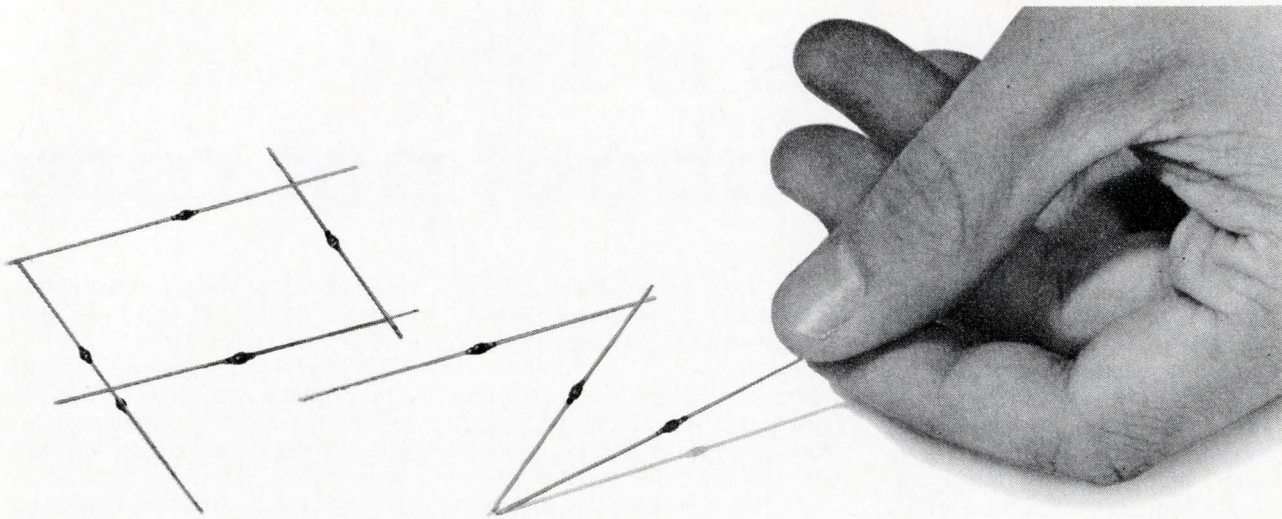

Introducing the PZ Zener

The new fused-in-glass
1 watt zener . . .

Typical Unitrode fused-in-glass
stability and high-performance at
the price of an ordinary device

Order your free samples today

- Fills the bill from 400 mw thru 1 watt
- Voltages from 6.8 to 200 V
- 8 millisecond surges to 30 watts
- Low reverse current — to 500 nA
- A quarter the size of a conventional 1 watt
- Weighs less than 1/4 gram
- No plastics, epoxies, silicones, oxides, gases, or solders are used

580 Pleasant St., Watertown, Mass. 02172 • (617) 926-0404

UNITRODE

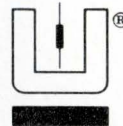

TOUGH AS ALL GET-OUT FROM THE INSIDE OUT

With the silicon die metallurgically bonded between terminal pins of the same thermal coefficient, the hard glass sleeve is fused to the entire outer silicon surface. Result — a voidless, monolithic structure.

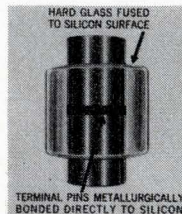

4 EASY WAYS TO GET FREE SAMPLES AND SPECS

1. Call Bud Anderson COLLECT, at (617) 926-0404.
2. Call your nearest Compar office.
3. Call your nearest Daniel & Co. office.
4. Check off the magazine Reply Card number.

Double divider aids precision measurements

With a new instrument from Julie Research Labs, you can now measure voltage, ratio, or resistance with eight-place precision. The key to the vastly improved performance of the new instrument is a double divider technique that eliminates sources of error inherent in previous potentiometric systems.

Basic to any measurement is a comparison of one thing to another—a standard to the parameter under test. If you use two separate instruments—or even separate parts of the same instrument—to make such a comparison, you will introduce errors that are more than one part in ten million. Hence, instruments previously have been essentially limited to one part per million accuracy.

To improve this level of accuracy you must use one instrument to compare the unknown to the standard. The same parts of the instrument must be used for both measurements. The double divider technique makes this possible. A single Kelvin-Varley divider is used in conjunction with a switching arrangement so that two independent sets of dials use the same resistance decades.

In operation, you simply use one set of dials (call them the "A" dials) to measure the unknown.

Now, to refer this measurement to some standard, you switch to a second set of dials (the "B" dials) and measure the standard. You have now set eight dials in the A set and eight dials in the B set. The ratio of these two eight place numbers is the ratio of the unknown to the standard with a precision of eight places and an accuracy of better than seven places.

By using the double divider, you eliminate the errors that would creep in if you were to use two separate instruments. Furthermore, the change from one set of dials to another can be made in a fraction of a second so that both measurements are made at essentially the same time.

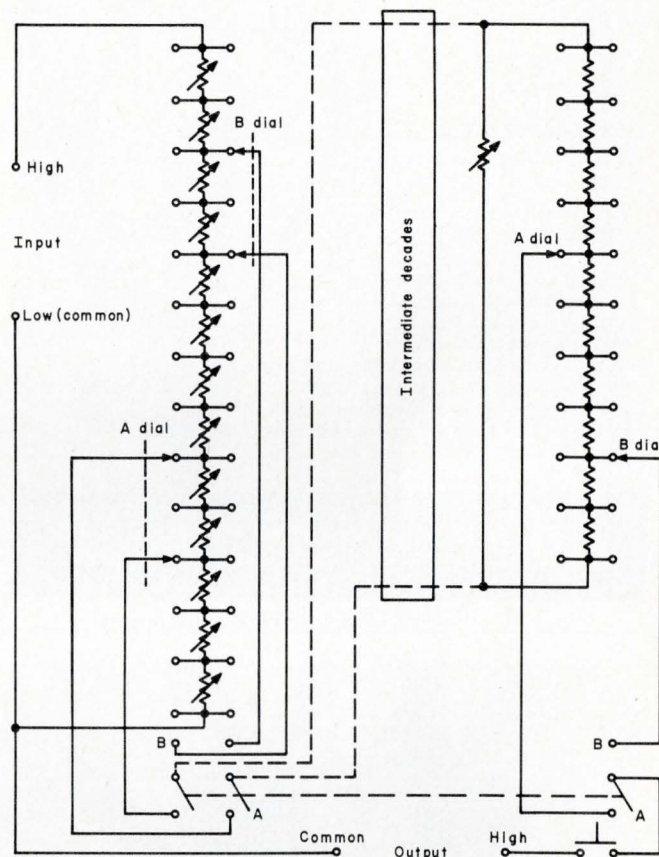

Heart of the double divider is a Kelvin-Varley divider in which a dpdt switch connects each decade to the preceding decade. Unlike the conventional divider, each decade is equipped with two sets of poles and the ganged selector switches are provided to switch between them. The instrument under development by JRL will have eight such decades. Each resistor in the first two decades will be individually adjustable and one trimming resistor will be provided for each of the last five decades.

Relay information available

Section X1—"Relays, Electromechanical: of NAVAIR 01-1A-514 Technical Manual: Design of Electric Systems for Naval Aircraft and Missiles" is now available as a separate document from the Superintendent of Documents, General Printing Office, Washington, D.C., 20402 under catalog number D217.14:EL2/CH at \$2.75.

This designer oriented manual for users of relays

is the outgrowth of the SAE A-2R relay committee activities where users, manufacturers and the military participated. Section X1 contains an extensive alphabetical index of subject matter and includes innumerable examples of recommended and non-preferred circuits along with suitable explanation. There are, in addition, tables of military part numbers with contact ratings for various load voltages and number of phases.

NATVAR  FLOTUBE

FLUIDIC CABLE

- Easy to install
- Self-contained harness
- Permits fast assembly
- Variety of colors for coding

Now you can get Natvar Flotube fluidic tubing in cable design of 7, 14, 21 and special configurations. Perfect for fast assembly and color coding of fluidic circuits. You get tight, leakproof connections that won't kink even on small radii. Available in all sizes for commonly used devices. Select combination of sizes needed and color combinations from 10 colors and clear. Send for technical data and Free samples.

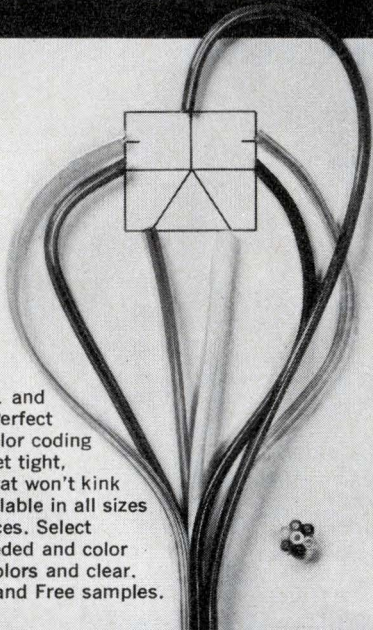

 **NATVAR CORPORATION**
P. O. BOX 67 • RAHWAY, N. J. 07065

Circle 15 on Inquiry Card



Our family plan makes motor variations unlimited.

Indiana General's Family Plan concept provides an unlimited variety of motor characteristics from five sizes of PM and WF motors. We simply vary such factors as stack lengths and windings. And for just a fraction more than standard units cost, in any quantity.

IGC has also put an end to blind specifying, by providing all characteristics for your specified motor through actual tests. So you save considerable system development time, and get just what you order.

We'll send you specifying forms, and complete data on our standard 2¼, 3¼, 4, 4½ and 5" motors. Write Mr. R. D. Wright, Manager of Sales, Indiana General Corporation, Electro-Mechanical Division, Oglesby, Ill. 61348.

INDIANA GENERAL  We make it easy for the design engineer.

UP TO DATE

Electromechanical printer works with dots

A high-speed electronic calculator incorporates a new type of printout device. Built with ICs, the P-251 desktop unit has what is called a "mosaic" printer which gives rapid and quiet operation, along with a permanent printed record.

The mosaic printer consists of 7 electronically controlled needles which move only a few millimeters at a combined rate of 720 strokes/s. These 7 needles are moved by electromagnets which are in turn driven from integrated circuitry. Energizing a magnet causes the corresponding needle to move through the narrow tubing, striking ordinary typewriter ribbon and forming a dot on a paper roll, typical of those used in adding machines and calculators.

Activating all 7 magnets simultaneously produces a column-of-dots printout and, as the machine moves left to right to its next incremental position, another column is produced. The machine, and hence the printer, can be programmed to a variety of character configurations including Roman numerals, hieroglyphs, *(continued on page 19)*

Small needles or pins located in the "fingers" and actuated electromagnetically, strike a typewriter ribbon, thus imprinting onto a paper tape. Any kind of character can be printed by proper programming of the calculator.

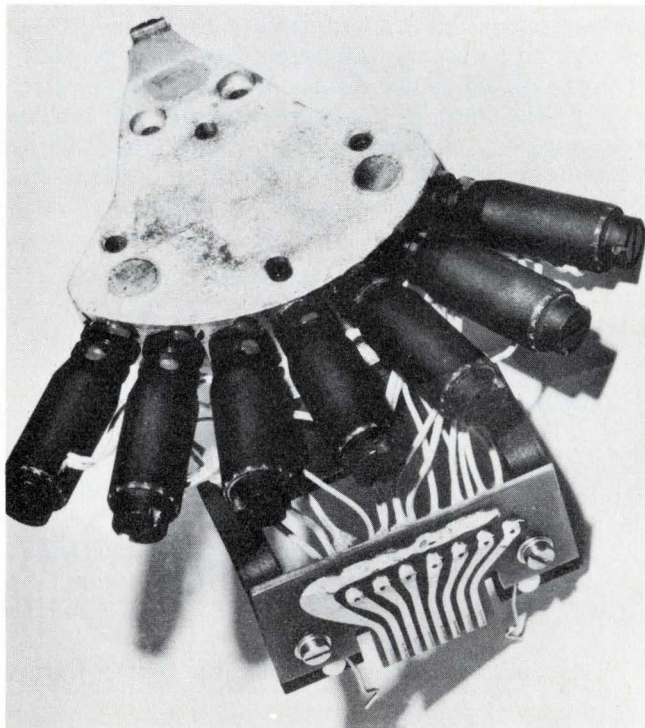

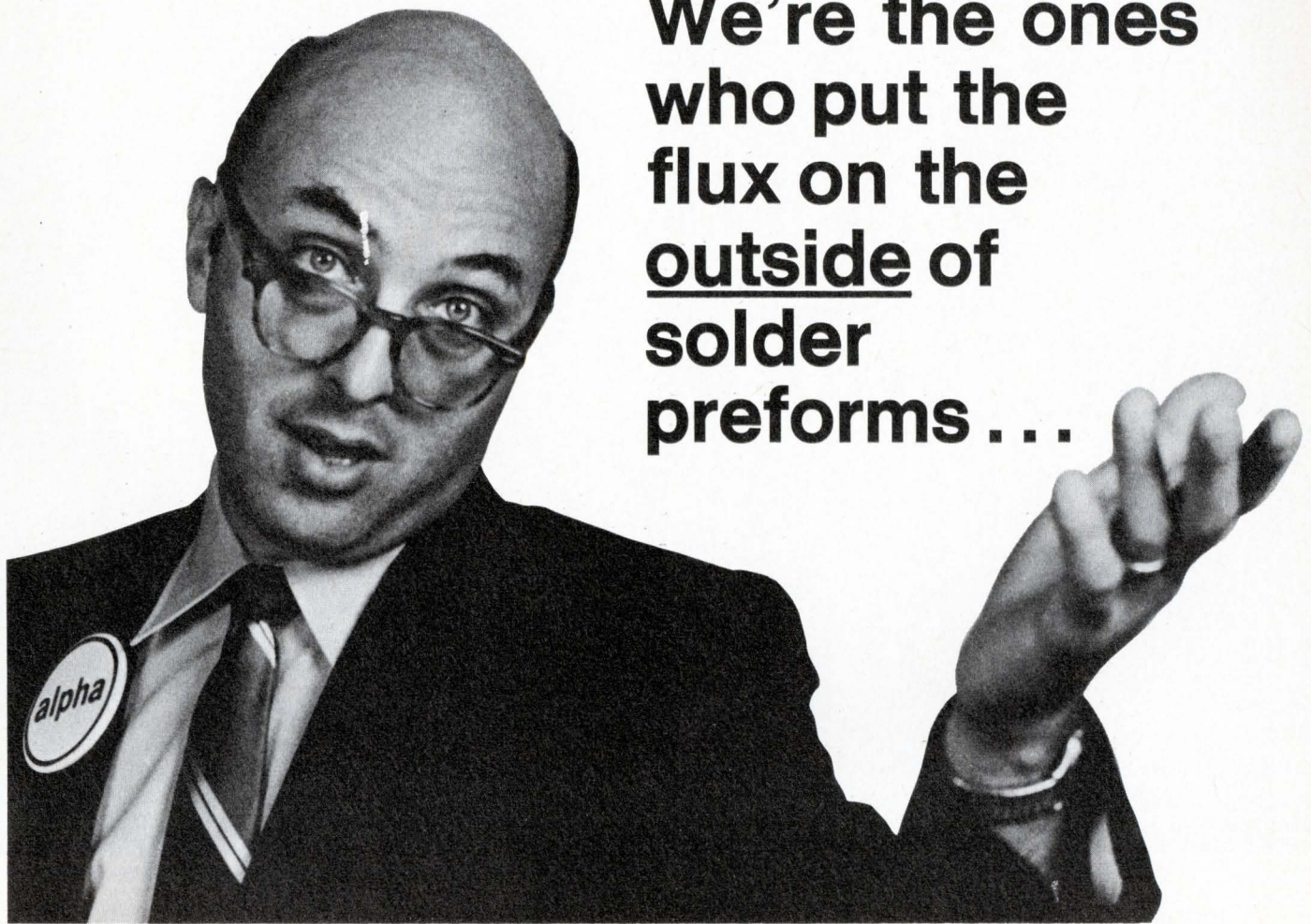

**We're the ones
who put the
flux on the
outside of
solder
preforms . . .**

. . . because that's where it belongs

The advantages are obvious. Flux on the outer surface of the preform liquefies first and flows onto the base metal before the solder melts. With flux-filled preforms, the solder must melt before the flux can escape and there's a good chance liquid solder will come in contact with the metal surface before it has been properly cleaned.

Flux-coated preforms also provide other advantages over solid solder or flux filled solid preforms: a quicker, more even spread rate, 100% flux coverage and consistently reproducible dimensional control upon melting. You can choose from a wide variety of standard and special shapes, coated with the finest grade of water-white rosin flux in all degrees of activation.

Flux-coated preforms join a long list of Alpha product innovations for better soldering, including oxide-free, Vaculoy® processed bar solders and anodes, a foam flux that meets MIL-F-14256, Type A specification, a complete line of neutral pH, electronic grade cleaners and a host of others.

Back these with our full range of quality industrial solders, fluxes and soldering chemicals, the largest research staff and the most proficient technical service and assistance in the industry, and you have a supplier you can really rely on. Call or write for full information today.

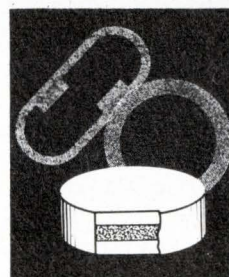

Alpha flux-coated solder preforms in standard configurations as well as multi-layers and spheres. Flux-filled and solid solder preforms are also available.

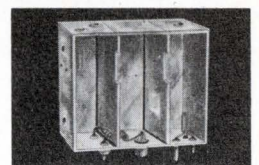

Alpha Solder Creams cut costs in mass production operations. (III: attaching feed throughs and dividers in tuner box.)

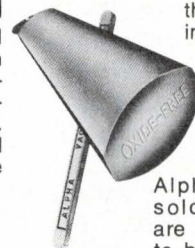

Alpha bar solders and solder and tin anodes are Vaculoy® processed to be oxide-free.

ALPHA METALS, INC.



56 WATER STREET, JERSEY CITY, N. J. 07304 • 201 • 434-6778
Alpha Metals, Inc., Los Angeles, Calif.
Alpha Alloy Corp. (Div.) Chicago, Ill.
Alpha Metals, Inc. (U.K.), Ltd., London, England

10659-E

ДРУГАЯ ЛОЖЬ КАПИТАЛИСТОВ- ИМПЕРИАЛИСТОВ ОБНАЖЕНА

В современном издательстве "SSPI", — доклада знаменитого фабриканта транзисторов, который советские агенты в Америке перехватили, появилась другая капиталистическая ложь. Она новая из серии сказанных Буржуазными Империалистами и Вождями Соединённых Штатов.

Мы построили первый самолет, но Американцы украли эту честь от нас. Мы были первыми в формуляции "Coca-Cola", но империалисты взяли Славу за это. Теперь, — окончательное оскорбление — "SSPI" заявляет, что они построили мира первый энергию-переключательный транзистор. (Мы построили его в 1946 году. Планы сейчас заключены в подвале в Кремле.)

Доклад "SSPI" называемый "LITPAK-PST" — большая ложь с начала до конца. На пример: Так как этот доклад только крикливая пропаганда, Центральный Комитет объявил этот документ

Unitrode's SSPI Division has developed a new line of **POWER SWITCHING TRANSISTORS** . . . the world's first transistor family specifically designed for power switching applications, with every parameter important to power switching guaranteed. Transistors in our TO-5, TO-59, TO-66, and TO-111 packages all have noteworthy parameters for power switching. They're capable of handling from 40 to 400 volts and 0.2 to 20 amps. Available with: saturation voltages of less than 1 volt at 10 amps, minimum current gains of 100 at 1 amp, and turn-on times of less than 100 nanoseconds at 5 amps. For complete specifications and prices, contact Alex Polner (617) 745-2900, and ask for our LITPAK-PST.



**SOLID STATE
PRODUCTS**

DIVISION OF UNITRODE CORPORATION
ONE PINGREE STREET, SALEM, MASSACHUSETTS 01970
PHONE 617-745-2900, TWX 710-347-0226

неприличной и извращённой литературой. Люди имеющие копию "LITPAK-PST", или читающие его, будут считаться предателями советского народа.

FOREFRONT

The EE Forefront is a graphical representation of the practical state of the art. You will find here the most advanced components and instruments in their class, classified by the parameter in which they excel.

A word of caution

Keep in mind the tradeoffs, since any parameter can

be improved at the expense of others. If there is no figure-of-merit available, we either include other significant parameters of the same products, or we provide additional bar graphs for the same products.

Do not use these charts to specify. Get complete specifications first, directly from the manufacturers.

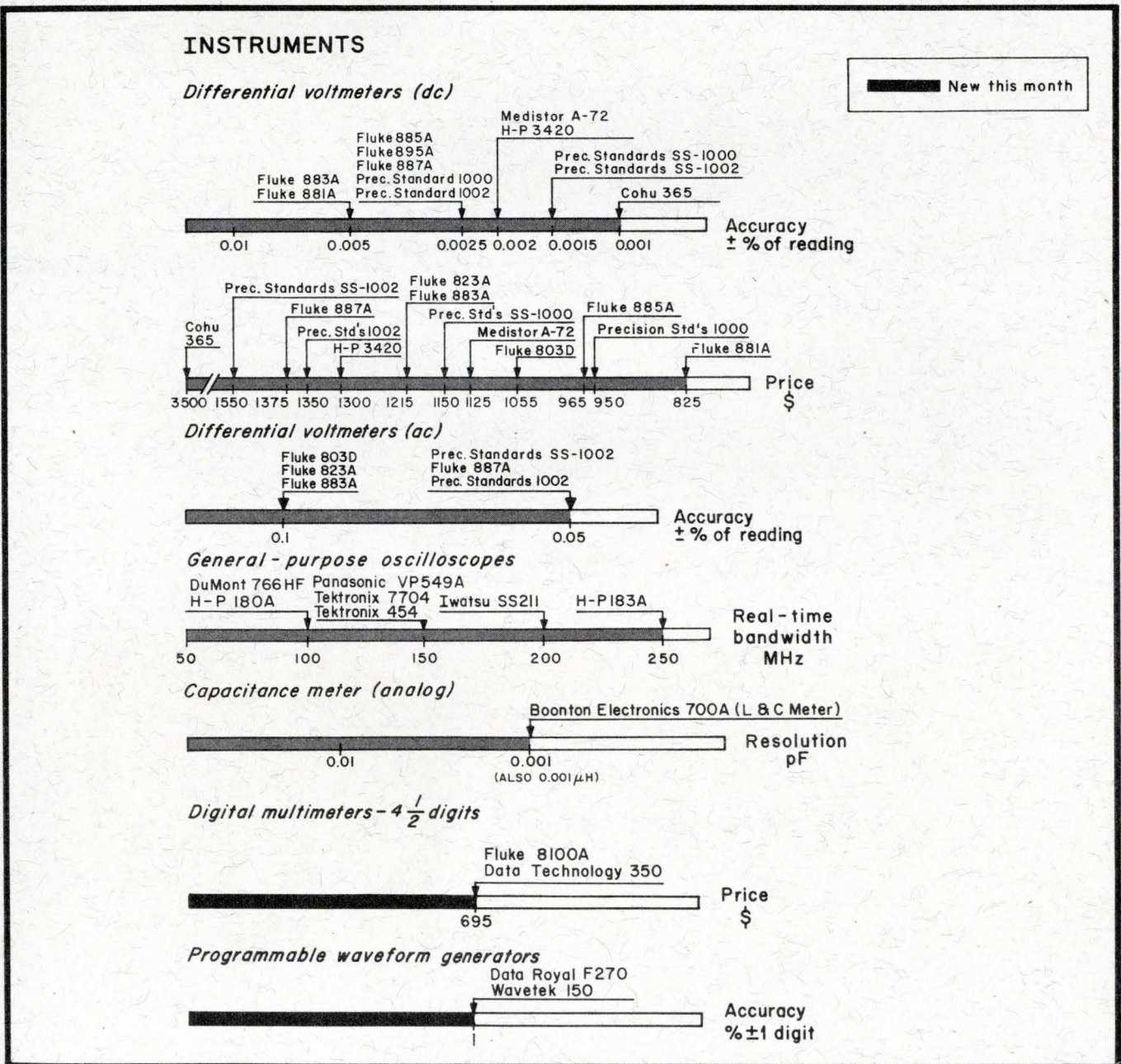

INTEGRATED CIRCUITS

Digital ICs (DTL)

Fairchild 930
ITT 930
Motorola MC930
Philco-Ford PL9930
RCA CD2300
Raytheon 200 & 930
Signetics SP600A
Siliconix 930 & 1830
S-W 930
T.I. 15930

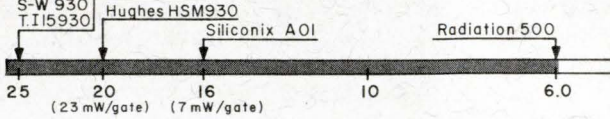

Typical prop delay - ns

Fairchild 930
ITT 930
Motorola MC930
Philco-Ford PL9930
RCA CD2300
Raytheon 200 & 930
Siliconix 930 & 1830
S-W 930
T.I. 15930

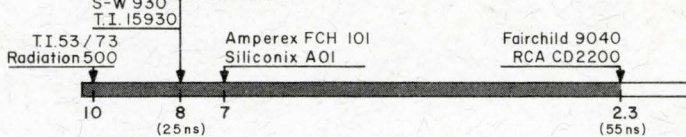

Power dissipation mW/gate

Digital ICs (TTL)

Amperex FHH
Mot. MTTL II
Philco-Ford 9620
Sprague 54H/74H

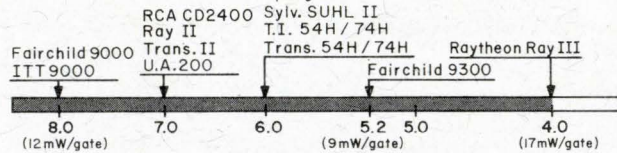

Typical prop delay - ns

Amperex FJH 101
Hughes HSM 5400
ITT 5400/7400
Motorola MC 5400
National DM7000-8000
NPC 7400
Philco-Ford 7400
Raytheon Ray I
Signetics 35400-N7400
Sprague 54/74
T.I. 54/74

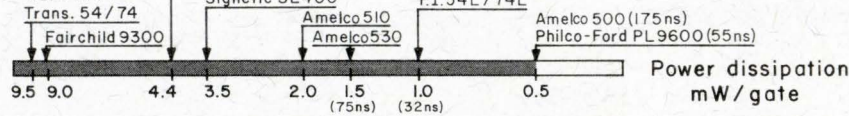

Power dissipation mW/gate

Digital ICs (ECL and special types)

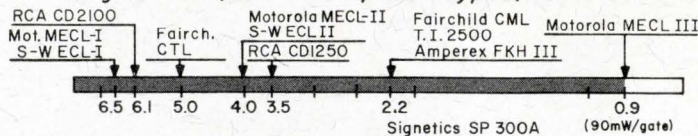

Typical prop delay - ns

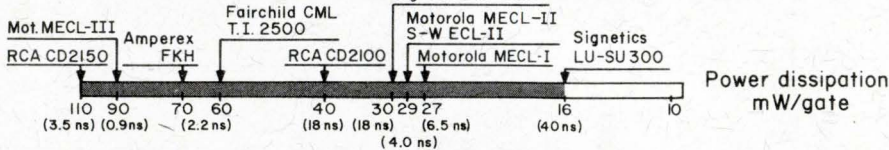

Power dissipation mW/gate

Operational amplifiers

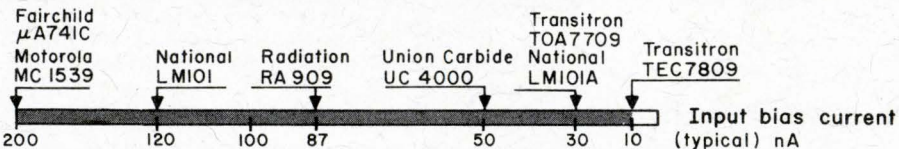

(continued from page 14)

or Chinese idiograms without changing the printing head. Characters (digits, symbols, etc.) are made up of patterns or mosaics of dots, printed at the rate of 90/s.

The North America Phillips Corporation, New York, is presently using this printer in one desk calculator selling for \$1,195. They expect, however, to find many uses in other printer applications, including computer peripheral devices.

This calculator supplies a permanent record on a paper tape with a new "mosaic" printer which prints in a dot matrix configuration.



Fallout on systems analysis

Many of the modern tools for systems analysis and project management have been developed specifically for the largest program America has ever managed: the space program. The application of these tools, however, is not restricted to space—they can be useful for solving problems in both industry and government. In a new publication, NASA discusses its know-how and methods as applied to such management problems as long-range planning, cost-effectiveness and control, and market development.

Statistical decision theory, decision analysis, linear and nonlinear programming, and special computer programs are but a few of the many techniques either developed or improved for NASA. For more information on these and other management tools, read NASA SP-5048, "Applications of Systems Analysis Models." At 50 cents a copy, it's not much of an investment—and it could prove one of your most valuable references.

A word of caution. Do not expect these tools to "solve" problems for you. When properly used, they become powerful methods for helping you to make decisions or crack complicated problems. But they do not replace your judgment, nor are they worth the effort when your problems are simple.

ANNOUNCING...

A Course in INTEGRATED CIRCUITS

And an important opportunity for all design, equipment and systems engineers to stay ahead of the evolution in integrated circuits.

There is now available a practical and authoritative course in Integrated Circuits. This 10 part course appeared originally in *The Electronic Engineer* and is now being reprinted by popular demand. The course is designed for engineers who are buying or using, or who plan to use the whole range of integrated circuits—Silicon monolithic, thin-film, MOS, and hybrids. The course describes the function and use of integrated circuits in clear and complete form.

You achieve new skills—This course gives you the required background to properly communicate with device designers. The course will also sharpen your capability to make the right decisions about the selection and use of ICs. In addition, the course traces the history of integrated circuits so you can evaluate new developments and anticipate those now on the drawing board. The course also includes a study of manufacturing details to keep you abreast of the complexities in this area.

The complete 10 part course costs \$2.00. To get yours, just fill out the coupon below and send it today. Send your order to *The Electronic Engineer*, Chestnut and 56th Streets, Philadelphia, Pennsylvania 19139.

E-10

Yes, I accept your offer. Send me ___ complete course(s) in Integrated Circuits at a cost of \$2.00 each. My check, cash or money order is enclosed. Send as soon as possible to:

Name _____

Address _____ Company _____

City _____ State _____ Zip _____

Send me special quantity prices

Will optical memories ever forget? Now they can!

A new magnetic hologram can be written, read, and erased repeatedly, opening the door to dynamic optical memories.

“Why didn’t somebody think of that before?” The question arises when you see the erasable magnetic hologram developed at RCA. The seemingly simple device offers the possibility of a 10^{12} -bit dynamic optical memory in a one-inch square (although RCA only claims storage of 10^8 bits in one square inch).

The experimental setup looks like any other read-write-erase memory, except for the hologram. Rubin Mezrich, the developer of the new hologram has taken advantage of the magnetic properties of manganese bismuth crystal film by using it for the recording material. Manganese bismuth (MnBi) is deposited in a single-crystal layer, two millionths of an inch thick on a base of mica. A strong magnetic field, applied to this film, causes the magnetic moments of the atoms to line up with all the north poles in one direction perpendicular to the plane of the film, the south poles in the other direction. It is then ready to be used for a hologram.

The laser beam that writes the hologram is now split. One beam is transmitted through the dot pattern that holds one page of bit information, and then proceeds to the film. At the film, this beam interferes with

the other half of the beam which has come directly from the laser. This interaction causes an interference pattern on the face of the MnBi film,

and the hologram is recorded by Curie-point writing.

In Curie-point writing on the thin film, the interference pattern of laser

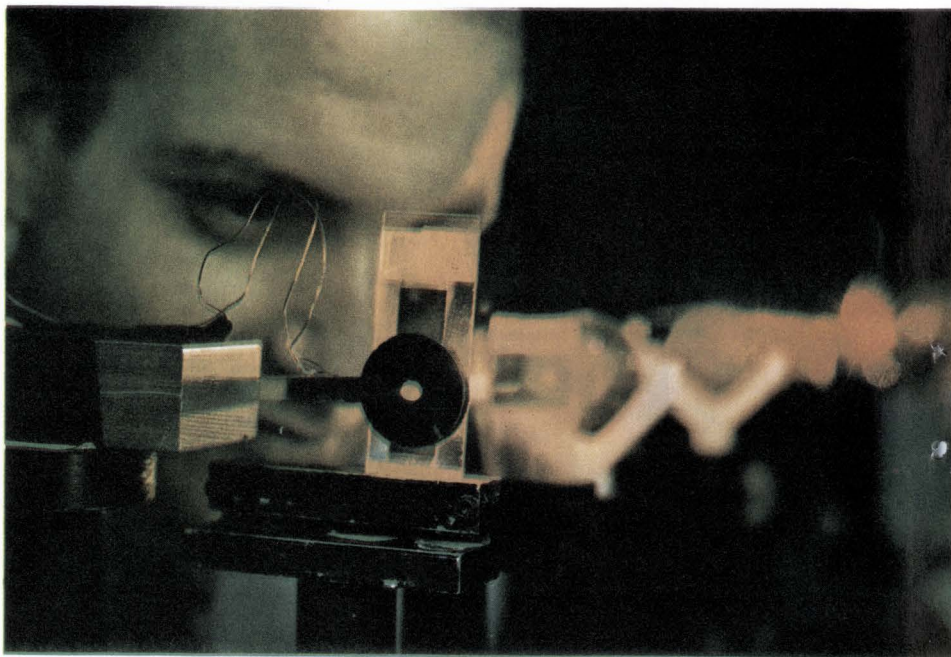
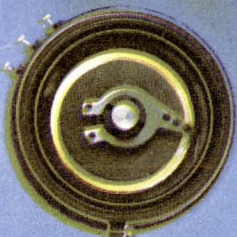
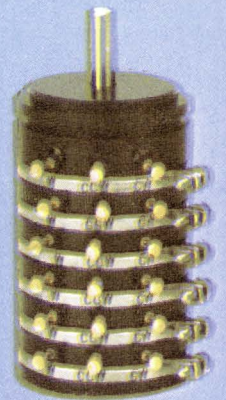
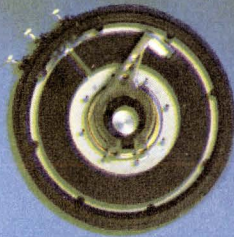

Photo shows the developer of the new hologram visually reading out a magnetic hologram. The manganese bismuth film that holds the hologram is on the mica slide in the center of the picture. The dark circular object with the wires attached is the erasure coil. The laser light comes from a continuous-wave He-Ne laser that is used to read the hologram.

Design Now... ...Specify Later



WIREWOUND



CERMET



CONDUCTIVE PLASTIC



BIFILM



Would you believe a WIREWOUND CERMET CONDUCTIVE PLASTIC BIFILM?

It's true! Bourns new *Bee-Line* permits project design without first considering potentiometer element to be used!

STANDARD SIZES

Available in $\frac{7}{8}$ ", $1\frac{1}{16}$ ", 2" diameters! Each potentiometer can be ganged up to 10 cups in increments of only 0.2"!

VERSATILE ELEMENTS

Your choice of wirewound, cermet, conductive plastic or BIFilm™* — Linear or Nonlinear — available interchangeably, singly or in combination!

Complete details on the new, versatile *Bee-Line* are available from the factory, your local Bourns Sales Office or representative.

*BIFilm is Bourns new, low TC Conductive Plastic



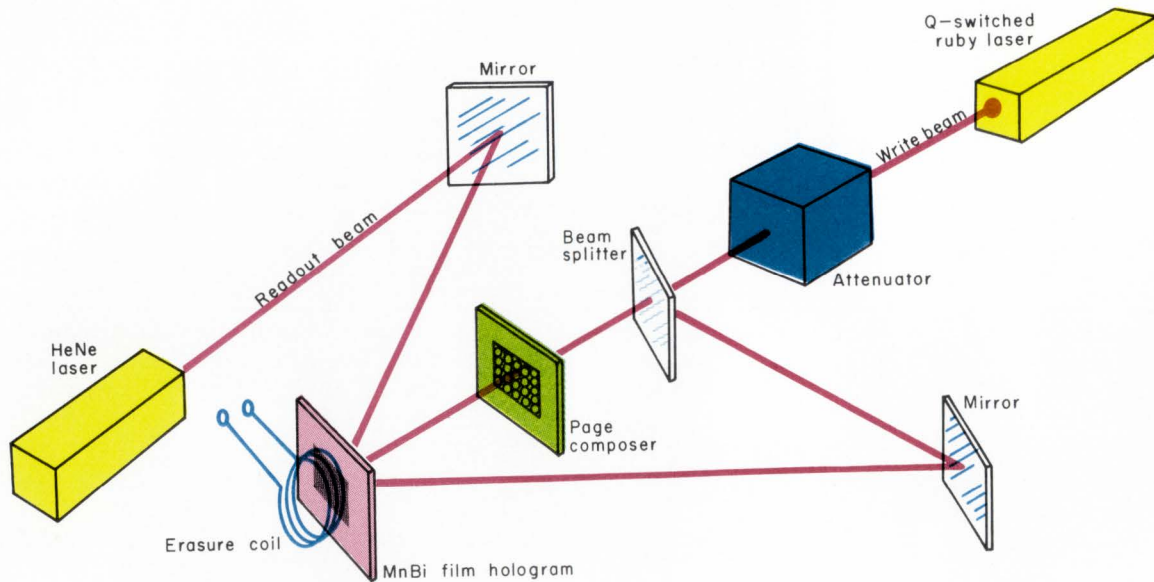

Apparatus for writing and reading the magnetic hologram. The pulsed ruby laser forms the hologram, while

the He-Ne continuous wave laser reads it. Pulsing the coil erases the hologram.

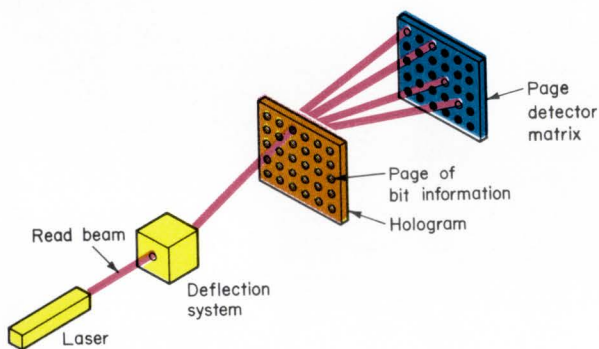

How the laser reads a hologram that contains 10,000 pages of bit information. (Each page contains 10,000 dots, where each dot is a bit of information.) The deflection system chooses the particular page to be read. The bit information on that page is then observed visually or by a light sensitive detection matrix.

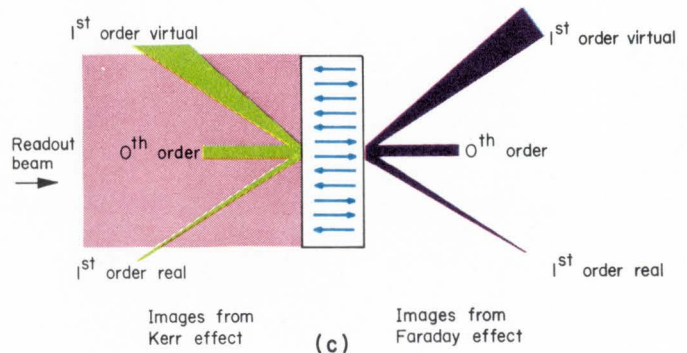
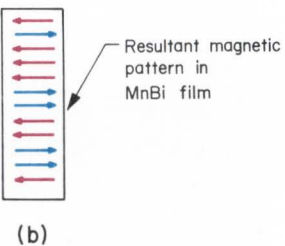
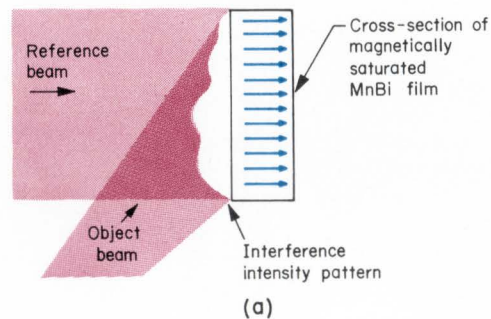

Magnetic hologram formed by a method called Curie-point writing. Initially, the reference beam and object beam interfere at the face of the MnBi film. The film has all its magnetic poles lined up in one direction (a). Upon removal of the writing beams, the magnetic poles that were heated above the Curie temperature (by the light interference intensity pattern) reverse polarity. The result is a magnetic pattern that exactly corresponds to the light interference pattern (b). This magnetic hologram can be read by using the Faraday magneto-optic effect or the Kerr effect. The Faraday effect forms the image from the transmitted light, while the Kerr effect uses the reflected light. In both cases, a real and virtual image of the object is formed (c). Notice that the virtual image from the Faraday effect appears to the left of the MnBi film in (c), even though the light is coming out on the right. This is because the rays from a virtual image are diverging. The directions are reversed for the Kerr effect.

Some Background

Holograms are formed by the interference of a reference beam of light with a beam of light that is reflected or transmitted by an object. Since the light must be coherent, a laser is an ideal source. This interference pattern is recorded in one of several media. Then, by transmitting the reference beam through the recorded image, the object is reconstructed as both real and virtual images which maintain the complete 3-dimensional characteristics of the original object.

Holograms can be divided into two general categories—absorption holograms and phase holograms. Absorption holograms—the type commonly used—are the kind that form when the recording medium is photographic film. These holograms are characterized by light and dark areas which amplitude modulate (by absorbing light in the dark areas) the reconstruction beam of light to form the image. The phase hologram, on the other hand, shifts the phase of adjacent rays of light, causing amplitude interference, which in turn forms the reconstructed image.

Because absorption holograms have light and dark areas, their transmission efficiency is much lower than that of phase holograms. As a matter of fact, phase holograms in many cases look clear to the naked eye and are capable of theoretical transmission efficiencies up to 100%.

One of the most useful applications of holography is in computer optical memories. Their ability to reproduce an entire image—even if a section of the hologram is wiped out—is significant because built in redundancy is a must today in most systems. The image which we talk about here can be thought of as a page of white dots

on a grid, where the presence or absence of a dot in a particular position represents a bit of information. Optical memories are capable of storing 10^4 bits (dots) on each page, and each page is stored in 1 mm^2 on the hologram. In a 10-cm^2 square hologram, 10^4 pages are stored, for a total of 10^8 bits.

Until now, optical memories have been confined to the static read-only type. This means that once made and inserted into the memory, the hologram can be read whenever necessary—but its information cannot be changed. Any change in the bit information requires removal of the old hologram. A new hologram is then made, and inserted into the memory.

Dynamic, read-write memories are still in the laboratory stage. These memories are capable of being written upon in the memory, stored, read at will, and then erased when new information must be entered. Ideally, they can be reused repeatedly for an indefinite length of time. Several materials have been used for these erasable holograms. Photochromic crystals, thermoplastic films, and ferroelectric crystals (such as lithium niobate) are the most common. Presently, Bell Laboratories is experimenting with barium titanate (another ferroelectric crystal). Unfortunately, each material has had its own problems—lithium niobate requires a long exposure in order to form the hologram, and the thermoplastics do not erase completely after continued use. The photochromics tend to fade spontaneously and are bleached by the readout beam. In contrast, the magnetic (MnBi) hologram that RCA developed seems to have eliminated most of these problems.

light heats the MnBi. The bright areas where the beams have interfered constructively raise the film above its Curie temperature (360°C for MnBi) and reverse the magnetic polarity. The north poles in the heated areas assume the same direction as the south poles in the unheated portions. On the other hand, the polarity does not change in those areas where the laser beams interfere destructively. The MnBi film now contains a magnetic pattern that corresponds to the laser interference pattern—a magnetic hologram. The time used for writing is about 10 ns.

The magnetic hologram can be read in two ways, either by transmitting a laser beam through it (using the Faraday magneto-optic effect), or by reflecting the beam from it (using the Kerr effect). The Kerr effect is preferred, because it renders a transmission efficiency of 0.1%; while the Faraday effect attains only a 0.01% efficiency. No polarizers or analyzers are needed to reconstruct the image. Note that these efficiencies are quite low, especially considering that

this hologram is of the phase type—rather than an absorption hologram.

The hologram is erased by simply switching a nearby wire coil which creates a strong magnetic field normal to the hologram surface. This field realigns the magnetic moments in the crystal so that all the north poles once again are in the same direction. The erasing time is about $20 \mu\text{s}$.

There is no apparent thermal decay or other type of fatigue in the material after continued use. It appears as if the write-erase cycle can be repeated indefinitely. In the original setup, a Q-switched ruby laser with a $200 \mu\text{J}$, 10-ns pulse was used to write; a continuous wave, helium neon laser was used to read, and a coil producing a 4000-Oe field erased the hologram.

INFORMATION RETRIEVAL
Magnetic devices, Computers and
peripherals, Data acquisition and processing

Pogo Probe

- SPRING-LOADED PROBE WIRE
- ADJUSTABLE PROBE WIRE EXTENSION
- FLEXIBLE GUIDE TUBE AS SMALL AS .006" DIAMETER
- LOW AND UNIFORM RESISTANCE
- REPLACEABLE PROBE WIRE & SPRING ASSEMBLY
- FLEXIBILITY FOR DENSE PACKING
- ACCEPTS STANDARD MALE PLUG
- WRITE FOR BULLETIN 85

Also:
POGO CONTACTS,
& CONNECTORS

TUNGSTEN
TIP

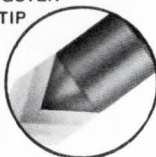

Pylon

Pylon Company, Inc., Attleboro, Mass. 02703
57 Newcomb Street — Tel. (617) 222-3726

Circle 18 on Inquiry Card

Varflex invites you to . . .

**Make your own
Reliability Check
on these SLEEVINGS**

If seeing isn't believing—testing will be. Get the Varflex quality story first hand, and you can count on exactly the same quality every time you order. Send today for your free folder containing test-length samples of **Silicone, Varglas, Varfil, and Varflo** flexible insulating sleeving and tubing.

Let us know how we can serve you.

Varflex
CORPORATION

Send For Free Folder of Actual Test Samples

506 W. Court Rome, New York

Circle 19 on Inquiry Card

CALENDAR

NEREM-69 Technical Program

	Commonwealth Room Hotel	Fairfax Room Hotel	Independence Hotel	Ballroom Hotel	Constitution Ballroom Hotel	Weber Room Auditorium
Wednesday 10:00 A.M.	Opto-Electronics	Bioelectronics	Computer-Aided Design	Computer-Instrument Systems		
Wednesday 2:30 P.M.	Nonlinear Optics	Radiation Hardening	Automatic Artwork Generation	Solid-State Microwave Power Generation	Device Modeling for Computer-Aided Design	
Wednesday 8:00 P.M.	The New Enterprise Its Life Cycles					
Thursday 10:00 A.M.	Analog Circuit Development	Transportation	Satellite Communications	Digital Signal Processing	Circuit Design for Integration	
Thursday 2:30 P.M.	Recent FET Developments	Perspectives in Energy Utilization	The Role of Electronic Systems in the APOLLO Lunar Landing Program	Small Computers	Hybrid Microelectronics	
Friday 10:00 A.M.	Antennas and Propagation	Earth Sciences	Air Traffic Control	Monolithic Memories	Contemporary Filters	
Friday 2:30 P.M.	Array Systems	Electronics in Oceanology	Electronic Navigation Systems	Computerized Testing Techniques	Microwave Measurements	

CALENDAR

OCTOBER

12 13 14 15 16 17 18
 19 20 21 22 23 24 25
 26 27 28 29 30 31

Oct. 27-29: 1969 IEEE Southeastern EMC Symp., Regency Hyatt House, Atlanta, Ga. Addtl. Info.—D. W. Mathias, Omnionics Vercor Inc., 1111 Mt. View Dr., NE, Marietta, Ga. 30060.

Oct. 27-30: 1969 Joint Conf. on Mathematical and Computer Aids to Design, Disneyland Hotel, Anaheim, Calif. Addtl. Info.—1969 JCMCAD, c/o SIAM, 33 S. 17th St., 6th Fl., Phila., Pa. 19103.

NOVEMBER

1
 2 3 4 5 6 7 8
 9 10 11 12 13 14 15
 16 17 18 19 20 21 22
 23 24 25 26 27 28 29
 30

Nov. 5-7: IEEE Northeast Electronics Research & Eng'g Meeting, War Mem. Aud. & Sheraton Boston Hotel, Boston, Mass. Addtl. Info.—NEREM, 31 Channing St., Newton, Mass. 02158.

Nov. 18-20: Fall Joint Computer Conf., Las Vegas Conv. Ctr., Las Vegas, Nevada. Addtl. Info.—AFIPS Hdqs., 210 Summit Ave., Montvale, N.J. 07645.

Nov. 18-21: Conf. on Magnetism & Magnetic Materials, Benjamin Franklin Hotel, Phila., Pa. Addtl. Info.—J. D. Blades, Franklin Inst. Res. Labs., Phila., Pa. 19103.

DECEMBER

1 2 3 4 5 6
 7 8 9 10 11 12 13
 14 15 16 17 18 19 20
 21 22 23 24 25 26 27
 28 29 30 31

Dec. 8-9: Symp. on Consumer Electronics, Conrad Hilton Hotel, Chicago, Ill. Addtl. Info.—C. Hepner, Zenith Radio Corp., 6101 W. Dickens Ave., Chicago, Ill. 60639.

Dec. 8-10: Int'l Symp. on Circuit Theory, Mark Hopkins Hotel, San Fran., Calif. Addtl. Info.—R. A. Rohrer, Fairchild Semicond., 4001 Junipero Serra Blvd., Palo Alto, Calif. 94304.

Dec. 8-10: National Electronics Conf. & Exhibition, Conrad Hilton Hotel, Chicago. Addtl. Info.—Oakbrook Exec. Plaza #2, 1211 W. 22nd St., Oak Brook, Ill. 60521.

'69-'70 Conference Highlights

NEREM — Northeast Electronics Research and Eng'g Meeting, Nov. 5-7; Boston, Mass.

IEEE—Institute of Electrical and Electronics Engineers Int'l Convention & Exhibition, March 23-26; New York, New York.

Call for Papers

May 13-15, 1970: 1970 Electronic Components Conference, Wash., D. C. Submit four copies of an extended abstract with a minimum of 250 words plus a list of the papers, salient concepts and features by Nov. 15, 1969, to D. P. Burks, Tech. Prog. Chairman, Electronic Comp. Conf., Sprague Electric Co., Marshall St., N. Adams, Mass. 01247.

METERS ARE OUR BUSINESS!

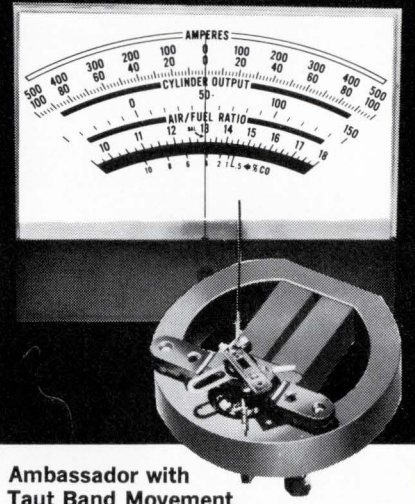

Ambassador with Taut Band Movement

Ideal Precision has a meter to satisfy every meter need — fit any specification — or cost requirement.

- Imperial Series
- Ambassador Series
- Capitol Series
- Edgewise Series
- Statesman Series
- Diplomat Series
- Moving Magnet Indicator Series
- 250° Long Scale Series
- Plus a full line of Military & Avionic Meters

And if you have special applications or unique design specifications, our Custom Service manufactures to fit individual specifications.

For detailed specifications and ranges write for your free catalog to

IPM IDEAL PRECISION METER CO., INC.

214 Franklin St., Brooklyn, New York 11222
 Telephone: 212-383-6904



Varian means choice in solid-state microwave.

Circle 20 on Inquiry Card

Circle 21 on Inquiry Card

SPEAK UP

Medical Instrumentation

Sir:

I appreciate getting some more detailed information on the problems of medical instrumentation (The Electronic Engineer, July 1969, p. 35) after all the non-technical newspaper stories.

D. E. Wilson
Lockheed MSC
Patrick A.F.B., Florida

Contract reliability for medical electronics

Sir:

Regarding the article "Would you put that probe on your sick grandmother?" (The Electronic Engineer, July 1969, p.35). The AMA and ADA (American Medical and Dental Assns., respectively) would be well advised to contract with a reliability-maintainability group, for the approval of all electronics and mechanical equipment they may use. Most medical men, to my knowledge, have a profound ignorance of electronics and mechanics. Inspection of hospital electronics should be mandatory on an annual basis, and repairs should be subject to inspection. I would also recommend that standards be established and be made mandatory.

Dean A. Later
Senior Rel. & Maint. Engineer
Conductron-Missouri
Downey, Calif.

Hybrid op amps

Sir:

I noticed in the June 1969 issue of **The Electronic Engineer**, the interesting article "IC Op Amp selection charts" (pp 61-71). In the interest of accuracy I would like to point out the absence of Optical Electronics, Inc., from your listing.

Richard C. Gerdes
President
Optical Electronics Inc.
Tucson, Ariz.

Mr. Gerdes is right; Optical Electronics makes both monolithic and hybrid op amps. Following are their part numbers and prices per 10 units. (Do not compare them with the chart prices, which were for 100 units.)

9300 and 9302 (monolithic)	\$18.00
9308 (monolithic)	\$27.00
9314 (monolithic)	each \$12.60
9406 (hybrid)	\$28.00
9412 (hybrid)	\$43.00

If you wish more information on these op amps, circle No. 420 on the Inquiry Card.

← Circle 22 on Inquiry Card

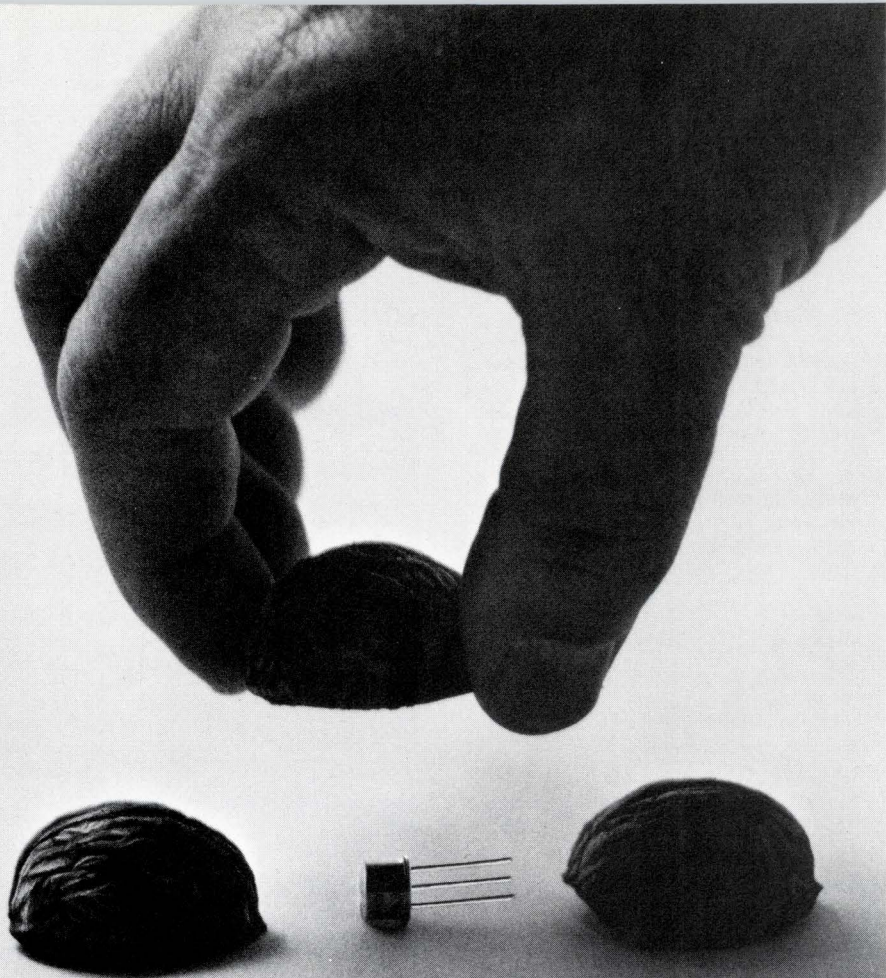

got a
FET
selection problem?

let
AMELCO
help you

**LOW COST EPOXY
FETS — 2N5163**
1000 pieces only 25¢ each

**LOW NOISE
AMPLIFIERS — 2N5391**
 $e_n=17.5$ nV

**HIGH VOLTAGE
AMPLIFIER — 2N4881**
 $BV_{DGO}=300V$ min

SWITCHING FET — 2N4977
 $R_{on}=15$ ohms max

**HIGH FREQUENCY
AMPLIFIER — 2N5078**
 $G_{ps}=12$ db min at 400 MHz

**DUAL N-CHANNEL —
SU2098B**
 $V_{GS1}-V_{GS2}=5$ mV max

**DUAL P-CHANNEL
MOS FETS — 2N4067**
 $I_{G(F)}=0.5$ pA

For FET selection charts and
application notes contact
Amelco.

"World's Largest Producers of FETS"

Quality in Quantity

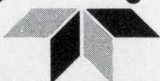

AMELCO SEMICONDUCTOR

1300 Terra Bella Ave., Mountain View, California (415) 968-9241
Westwood, Massachusetts (617) 326-6600
Orlando, Florida (305) 423-5833
Ridgefield, New Jersey (201) 943-4700
Des Plaines, Illinois (312) 439-3250
Anaheim, California (714) 635-3171
Wiesbaden, Germany 372820

Clare announces a new treat in General Purpose Relays

It's called the GP1.

If you haven't heard the name before, it's because we haven't made it before.

You see, we didn't want to make just another general purpose relay. We wanted to make the best. Now we have it.

The new GP1 gives you everything standard 4 PDT, 3 amp relays do. Plus a lot more. Contacts rated at 1/10 horsepower, 240 volts AC. Opposite polarity capability. Largest selection of contact types.

And you can buy it at a price competitive enough to make you the company hero.

With every order of Clare General Purpose Relays, you get something no other company can offer. The Clare guarantee of outstanding service. The new GP1. Only from Clare.

The first of a complete line of Clare General Purpose Relays—all fully interchangeable with existing types.

For full information, circle Reader Service number, call your Clare Sales Engineer or local Clare Distributor. Or write C. P. Clare & Co., Chicago, Illinois 60645... and worldwide.

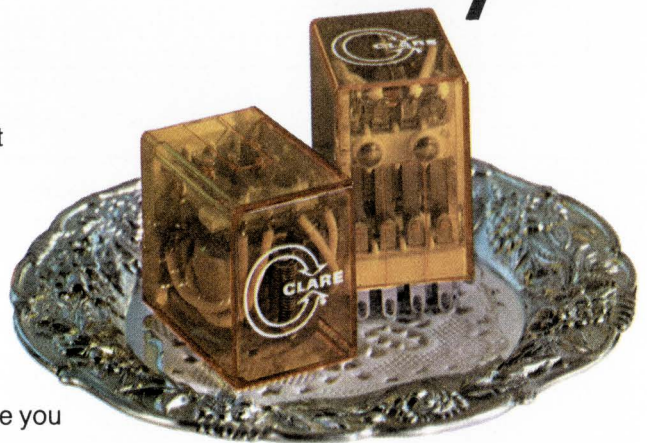

- Competitively Priced
- Interchangeable with Existing Types
- 4 PDT
- 3 amps—1/10 HP Contact Rating
- Opposite Polarity Capability
- Designed for U/L Recognition
- Six Contact Types
- All Standard AC & DC Coil Voltages

LOOK FOR



CLARE ON GENERAL PURPOSE RELAYS

a GENERAL INSTRUMENT company

For your High Quality Inductor Coil needs

See

STANWYCK

'COIL SPECIALISTS FOR 34 YEARS'

Extensive product life testing in our modern, fully equipped environmental test laboratory, plus rigid quality control standards, result in high quality products.

One of the industry's largest and most complete lines . . .

MOLDED INDUCTORS

STANWYCK SERIES	INDUCTANCE MICROHENRIES	NO. OF VALUES AVAILABLE	NOMINAL SIZE DIA. - LENGTH	NEW MS NUMBER	LT TYPE	OLD MS NUMBER	STYLE
1A1000M	0.15 to 1000	47	.095 x .240				AXIAL
20000M	0.15 to 1000	56	.156 x .375	MS-18130 MS-90536	LT4K074 to 099 LT10K001 to 021	MS-16225	AXIAL
30000M	0.10 to 10	37	.170 x .440				AXIAL
40000M	11. to 1000	48	.190 x .440	MS-90539	LT10K022 to 036		AXIAL
50000M	1000. to 10000	24	.240 x .740	MS-90541	LT10K050 to 060		AXIAL
60000M	1.1 to 12 1100. to 100000	13 15	.300 x .740 .300 x .740				AXIAL AXIAL
70000M	0.15 to 27	25	.170 x .440	MS-75008	LT4K027 to 051	MS-16224	AXIAL
80000M	1.2 to 120	25	.280 x .900	MS-91189	LT4K002 to 026	MS-16221	AXIAL
90000M	0.47 to 39 1100. to 3600	20 13	.215 x .560 .215 x .560	MS-90542 MS-90540	LT4K315 to 338 LT10K037 to 049	MS-16222	AXIAL AXIAL
A	47. to 150	7	.250 x .560	MS-75052	LT7K211 to 217	MS-16223	AXIAL
B	180. to 390	5	.310 x .560	MS-75053	LT7K218 to 222	MS-16223	AXIAL
C	470. to 1000	5	.375 x .625	MS-75054	LT7K223 to 227	MS-16223	AXIAL
D	1500. to 10000	5	.468 x .667	MS-75055	LT7K228 to 232	MS-16223	AXIAL
SWS	0.10 to 100	37	.170 x .440				AXIAL
SWM	1.0 to 1000	37	.240 x .590				AXIAL
SWL	1.0 to 10000	49	.280 x .900				AXIAL
DINK - Shielded	0.10 to 180000	76	.174 x .425				AXIAL
DKM - Shielded	0.10 to 1000	49	.125 x .335				AXIAL
SIV - Adjustable Vertical	0.10 to 4700	29	.400 x .500				PRINTED CIRCUIT
SIH - Adjustable Horizontal	0.10 to 4700	29	.400 x .500				PRINTED CIRCUIT
SSD - Shielded	0.10 to 100000	73	.157 x .395	MS-90537	LT4K242 to 314		AXIAL

Other Stanwyck Products

Stanwyck RF and IF Transformers, Hash Chokes, Toroids, Relay Bobbin Coils CUSTOM DESIGN

In addition to the comprehensive inductor line, Stanwyck offers the electronic engineer a variety of special custom design electronic components.

Call your representative of Stanwyck high reliability components, or contact Stanwyck Winding Division, where service and quality count.

SEND FOR FREE CATALOG



STANWYCK WINDING DIVISION
SAN FERNANDO ELECTRIC MANUFACTURING CO., INC.
137 WALSH AVE., NEWBURGH, NEW YORK 12550
Phone (914) 561-3360 New York City (212) 732-6282

SPEAK UP

The ground-circuit interrupter

Sir:

One of our customers has called my attention to the article on electrical safety "Would you put that probe on your sick grandmother?" [*The Electronic Engineer*, July 1969, Page 35].

The article is of particular interest for we have been studying electrical safety to consumer products for 20 years. Because of a near tragedy in the family, a new invention was born and on February 2, 1965, U.S. Patent No. 3,168,682 was granted for a ground-fault interrupter incorporating the use of an isolation transformer. Other patents are pending.

Reader's Digest first mentioned the patent and, since then, other publications and radio have carried the story. In 1968 this device was awarded the Gold Medal of Merit at the International Products Exposition in competition with some 6000 patents from all parts of the world. This device prevents electrical shock and offers other benefits above and beyond accepted electrical standards for the protection of life and property. It will detect electrical leakage below 1 μ A of current and deactivate the main power supply in time to prevent injury or damage. This particular model will soon be available for hospital use. Other models will also be available for consumer protection in the home, office and outdoors.

To our way of thinking, this is the first time in history that electrical safety per-se is now possible. It has immense possibilities in safeguarding the consumer against faulty products used in every day living.

We are considering the granting of several royalty free licenses to qualified manufacturers along with certain conditions for the privilege.

C. R. Moore, Pres.

Permavolt Transformers, Inc.
Box 2582
South Bend, Indiana

EDITOR'S NOTE: Mr. Moore refers here to the article "A little box that stops electric shock" (*Reader's Digest*, April 1968), which mentions the Moore patent as well as two other patents for a GFI (ground-circuit interrupter). There are a few GFI's already available in the market (a few of them UL approved) mostly for lighting of swimming pools.

Readers interested in Mr. Moore's offer to license should write to him directly at the above address.

Letters to the editor are published at the discretion of the magazine. Please say so if you do not want to be quoted. Signed letters have preference over anonymous ones.

New. A true micro-system connector. Look at what you can do with it.

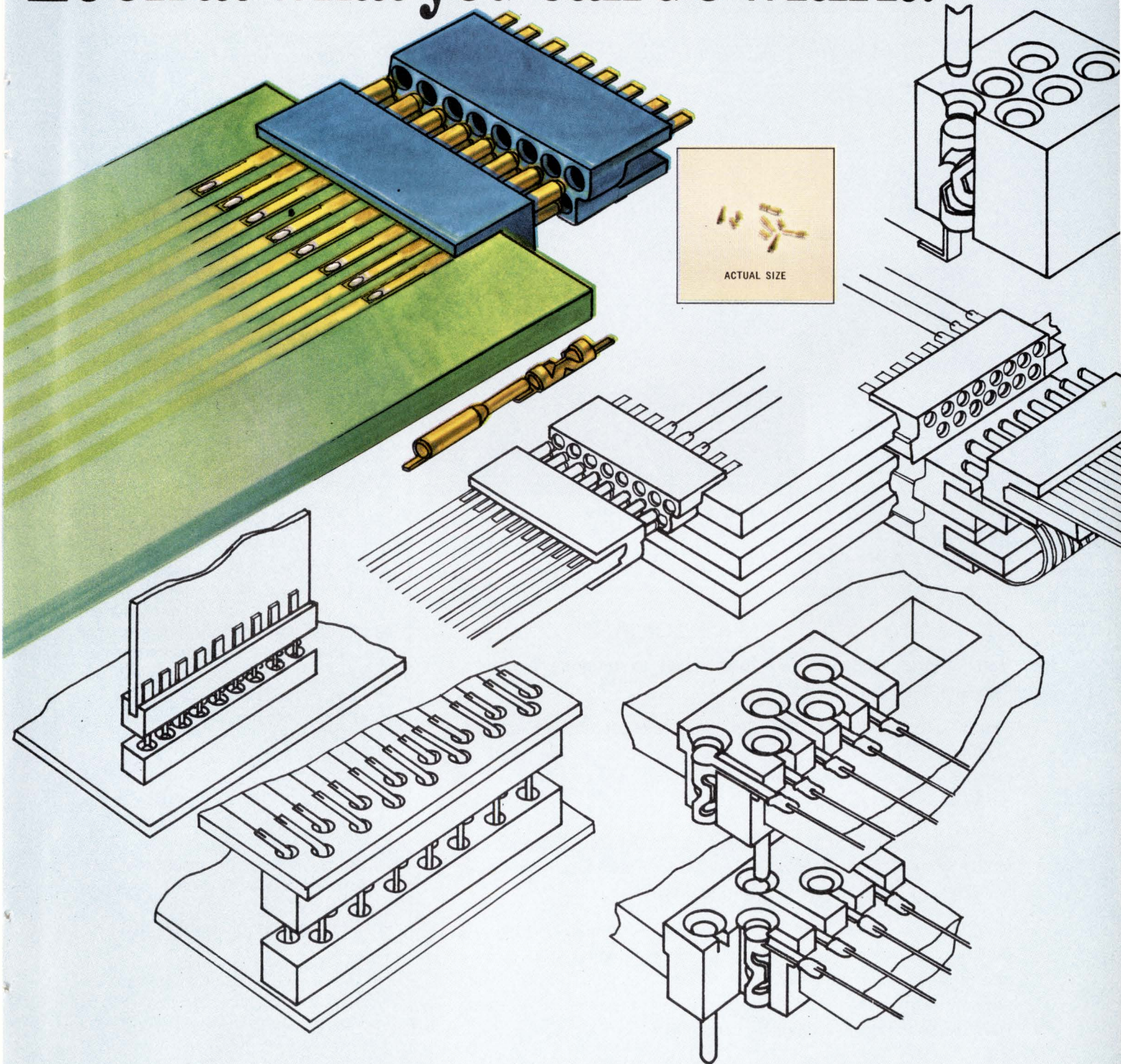

This is our new .025"/.050" Connector.

It fits all micro-system packaging situations. In all environments. Reliably. The redundant points of contact provided by the spiral springs of the receptacle assure it.

With stacked or staggered centers, the receptacles don't lose any critical contact spacing. Circuit centers of .050" and .025" are standard. The receptacles and pins come housed. The circuit contact tines are pre-solder coated so all you have to do is reflow and plug in. Easy? The low insertion

force and the wide misalignment allowance make it even easier.

So, what could be better for sophisticated electronic requirements? A reliable connector that's dense, convenient and versatile.

For further information write to Industrial Division, AMP Incorporated, Harrisburg, Pa. 17105.

AMP
INCORPORATED

NOW

Hamilton precision metals has added facilities...and is in the Photoformed® Parts business...



BIG!

Hamilton has added a new plant—just to produce precision, Photoformed® parts!

This new facility is equipped with the most modern photo-etching machinery on the market. The new equipment will produce precision parts in large quantities to the highest standard of dimensional accuracy.

Now, you can get from the Precision Metals Division, finished parts to the same degree of precision as world wide metal users have come to expect in Hamilton's strip and foil.

Hamilton offers the Total Capabilities of a completely integrated facility controlling every step from melt to finished strip or foil—and now to finished parts. This means that you get the same adherence to metallurgical standards and dimensional accuracy that has become the hallmark of Hamilton.

For the complete story on the capabilities of Precision Metals Division and what it can do for you, write for your copy of the new Photoforming brochure. It's yours for the asking—write today!



PRECISION METALS DIVISION
HAMILTON
WATCH COMPANY • LANCASTER, PA. 17604
• PHONE (717) 394-7161

Circle 26 on Inquiry Card

WELCOME

Here we welcome new companies or divisions in the electronics industry. For more details, circle the appropriate numbers on the reader service card.

The closing of the cermet resistor gap. The design and manufacture of cermet ultra-high-value resistors, particularly thick-film devices, is the forte of Cermetrics, Inc., located on Manhattan's lower East side (16th St.). Included in the round-up of products are ampere hour meters for determining plating thickness, and systems for adding chemicals to plating baths.

In the discrete electronic components sphere Cermetrics offers high-value resistors with values up to 1000 MΩ. The devices combine a good temperature coefficient of resistivity (50 ppm/°C) with stability and reliability. The resistors are suggested for high impedance devices where exacting applications are necessary. All items are available off-the-shelf.

Cermetrics hopes to attract those in the electro-chemical field and people involved in plating (especially the plating of precious metals where thickness and performance must be controlled). The fledgling company feels too that instrument manufacturers, those involved in the biological transducing field, and other precision measurement industries will be interested in its wares.

The president of Cermetrics, Stanley Schneider, comes from the thick film field. He ventured forth and formed his own company because he felt "there was an unfulfilled market for precision devices." With Cermetrics, hopefully that gap has been filled.

Circle 321 on Inquiry Card

A division of business enterprises. Electronic Products and Controls is a new division of Monsanto. It was formed as an R&D outburst with the intention of establishing new business under the direction of the mother company. The business groups that comprise EP&C are: Electronic Instruments, Electronic Special Products, Electronic Materials, Electronic Research, Microwave Products and Industrial Elec-
(continued on page 32)

Circle 27 on Inquiry Card →



Not everyone needs a multimeter that can measure the resistance of a piece of solder.

But you may be looking for a digital multimeter that will measure relay contact resistance. Or check cable continuity. Or handle other applications that require 100 μ ohm resolution without error caused by lead resistance. If that's the case, you may be looking for our 5500/135 DMM.

And it's more than an ohmmeter. You can turn it loose on dc volts, mV, dc/dc ratios, or square, triangular, sawtooth and sine waves. It will give you the true rms of an ac waveform, so accurately and distortion-free that we call it Computing RMS™ and have a patent pending on this revolutionary new technique.

But it is possible that the 5500 is more or less multimeter than you need. If that's the case, don't buy one. Buy one of our 32 others instead. We make them for labs and production lines, for use on the bench and in systems, militarized models, 4- and 5-digit, from \$1150 to over \$8000. (Actually, with our unique plug in modules, you can create some 300 different configurations. For every imaginable application. To fit every budget).

Which one suits you best? Ask for the decision maker. Our free brochure.

Dana Laboratories, Inc., 2401 Campus Drive, Irvine, California 92664.

DANA®

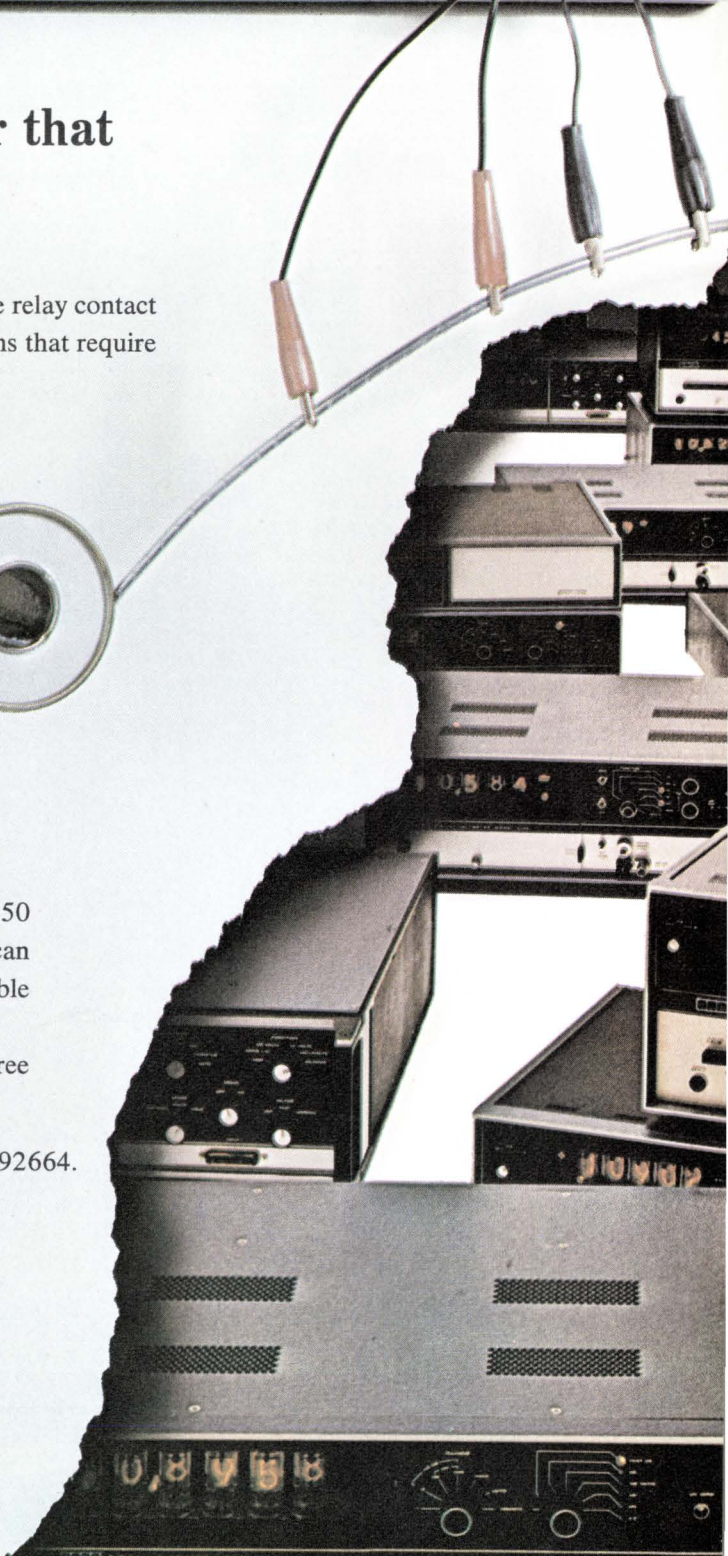

(continued from page 30)

tronics Research. Fisher Controls Co., Inc. has recently merged with Monsanto and is preparing to take its place in the above division.

Electronic Products & Controls' sections are involved in most phases of electronic technology. Among those on the list are electronic test instruments, including a 150 MHz programmable universal counter/timer for remote programming of time base selection; light emitting semiconductors including semiconductor lasers, and 7-segment solid-state numerics fabricated from red light-emitting gallium arsenide phosphide. The numeric device, which was shown publicly for the first time at Wescon, is operable with commercially available decoder/drivers thereby giving the equipment designer flexibility. The 7-segment light emitting numeric is being put to the test in digital test instruments such as a digital voltmeter made by the electronic instrument group. The device can be used as an instrument by itself or as a key component of a larger digital system. With this application (adopting the 7-bar numeric indicating version of the diodes), Monsanto is the first instrument manufacturer to take advantage of solid-state technology for readout as well as in circuit design. Included too in the roundup of products available from EP&C are semiconductor materials (silicon and gallium arsenide), Gunn diodes, and Gunn-effect microwave oscillators with a minimum cw output power of 100 milliwatts. Most of the products are available from stock or shortly thereafter.

Potential customers for the various sections include semiconductor manufacturers, computer people, the military (a contract for \$2½ million has recently been signed by Kelly AFB for 2000 portable solid-state oscilloscopes. Delivery is scheduled for early 1970), and those in the OEM market.

The new division's competition is strong. Such prominent or established firms as HP, Honeywell and Foxboro will be in the line of fire.

Circle 322 on Inquiry Card

The Electronic Engineer • Oct. 1969

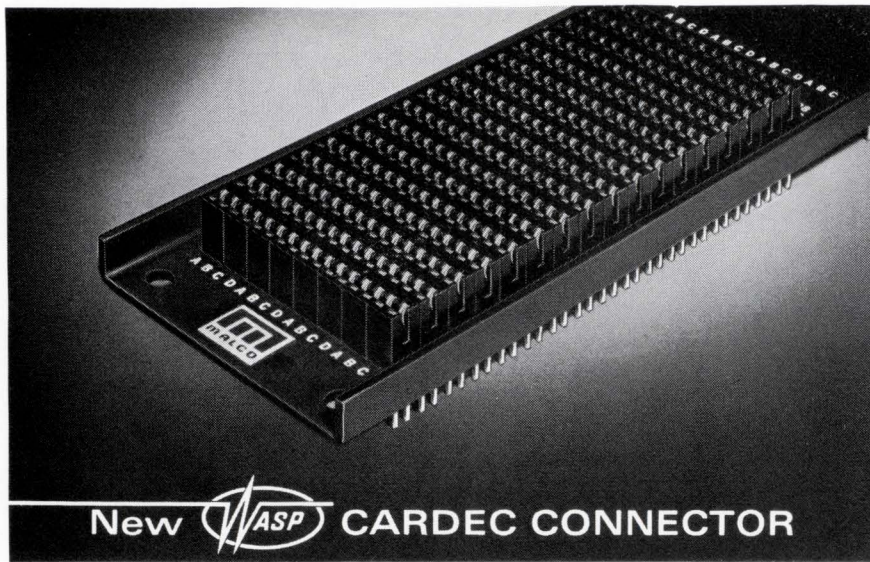

New ASP CARDEC CONNECTOR

Why Settle For Standard Connector Systems When You Can Custom Build At Less Cost?

The new Malco CARDEC (Aluminum Plate-Type Card Edge Connector) gives you a custom-made connector designed to fit your system with ideal performance characteristics—all this at a total cost no greater (and probably less) than you are presently paying for "off the shelf" connector systems.

Malco's CARDEC gives you a bonus in:

QUALITY: Malco's new CARDEC is the only aluminum plate-type connector that meets all requirements of MIL-C-21097 B. Insulators are polysulfone—a new plastic that withstands temperatures from -62° to $+125^{\circ}$ C.

LOW RESISTANCE: CARDEC's high reliability contacts have a maximum resistance of 5 milliohms at 5 amps under all conditions—average readings are well under this.

DURABILITY: CARDEC's new leaf-spring contacts are designed to withstand up to 1000 insertions and withdrawals and still perform like new.

VERSATILITY: The new CARDEC system features modular construction which results in design flexibility and economy. You can select from a broad range of peripheral hardware (feed-through terminals, cable connectors, bus bars, jumper clips, "piggyback" patching receptacles), and they are all compatible components in the aluminum grid-plate structure.

ECONOMY: All of these features are available in the CARDEC "total package" connector at a cost that is lower than the old single component connector systems.

CONVENIENCE: Now you can have a connector system built specifically for your application, shipped complete, ready for wire-wrapping.

Let us prove this to you. Phone or write today. Request Bulletin Nos. 664 and 645 for general information.

Cardec is a Malco T.M.



PRECISION ELECTRONIC TERMINALS AND CONNECTORS

MALCO MANUFACTURING COMPANY INC

5150 W. ROOSEVELT RD. • CHICAGO, ILLINOIS 60650 • PHONE (312) 287-6700

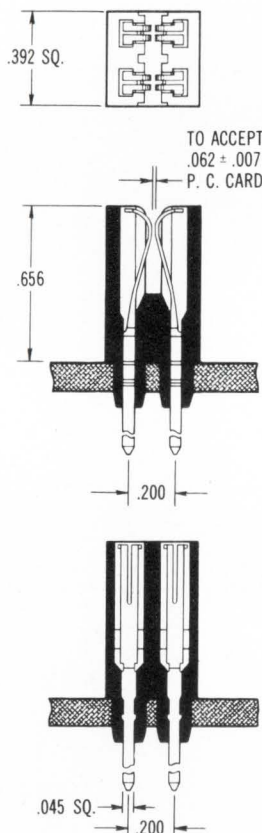

It's time for a change in your digital displays! Increase versatility, decrease costs — with RCA's new NUMITRON Digital Display Devices

Compare these RCA product advantages:

- Sharper, cleaner displays
- Controllable high brightness
- Up-front planar numerals for wider viewing angle
- Unlimited filter-color selection
- Low voltage operation—designed for 4½ V
- Fully compatible with RCA's new Integrated Circuit Decoder/Drivers
- Rugged construction
- Long life—high reliability
- Designed for low-cost 9-pin miniature sockets

Interested? For more information on the new RCA NUMITRON Digital Display Devices, contact your local RCA Representative or write to RCA Electronic Components, Commercial Engineering, Section J-50 DE, Harrison, N.J. 07029. Also ask for

data on the new RCA Integrated Circuit Decoder/Drivers, especially designed for use with RCA's Digital Display Devices. Type Numbers of NUMITRON Digital Display Devices:
RCA-DR-2000—Numerals 0 through 9
RCA-DR-2010—Numerals 0 through 9, with decimal
RCA-DR-2020—Plus-Minus and Numeral 1
RCA-DR-2030—Plus-Minus

Unretouched photograph of operating NUMITRON devices mounted on plastic tubing.

RCA
Digital Display Devices



Can management give engineers what they really want?

It's a two-way street—management should provide a better atmosphere for engineers, and engineers should be more professional.

By Dr. Arthur D. Kellner, Director-Personnel
ITT Defense Communications Div., Nutley, N. J.

It has been said that people are naturally creative—that if they are *not* creative, assuming they are motivated, it is because conditions in the psychological environment inhibit creativity.

What are these conditions? Among the blocks to creativity, particularly in the case of engineers, are the business disciplines imposed by management to achieve program objectives. Meeting of scheduled deadlines, for example, applies time pressure on the creative process—which experience has shown does not respond well to pressure. Another constraint is working to meet technical specifications, which can be very complicated and sometimes arbitrary.

Such design challenges often limit the engineer to the point where they preclude free-wheeling creativity of any sort. Rather, the approach becomes one of cut-

and-dry or theoretical analysis. Engineers can become frustrated on such assignments and hence become less productive.

Yet, sound business requirements dictate an approach to managing engineers which is based on controls and restraints. There are few exceptions: most of these are company-funded laboratories—"Think Tanks"—where creativity enjoys free rein in an atmosphere of permissiveness. But such pursuits are for the "scientists," it seems. It is the nature, and the fate, of engineers to be project-oriented—to work on tangible programs, which have a beginning and an end, and usually result in a real-life system or piece of hardware. Technical developments are a business proposition and as such require a business approach.

Business vs creativity

These requirements are unfortunate if we assume, as do some behavioral scientists, that engineers are

Continued on page 37



How management looks at engineers

It may be true in some cases that management looks at its average, working-level engineer as just another "body" in the bullpen. But this is the age of "enlightened management," and in many other cases management considers each of its engineers as vital to the total effort and responsible for the ultimate success of the organization. This article gives one view of how today's managers look at engineers. While the author exhorts management to give its engineers a more creative, responsible atmosphere, he also urges engineers to apply a more "professional" attitude to their work.

well motivated, that they *want* to be productive. It is only the artificially negative situation that will cause them *not* to be creative. This places a very subtle, complex challenge on management to provide a work environment which has the needed business controls but does not stifle creativity. It is probably safe to say that the ideal situation exists in only few cases; it occurs mainly in growing organizations, where the work is spread thin, where the challenges just slightly exceed the capabilities of each engineer and spur him to rise to the situation.

Characteristically, the engineer struggles to adapt himself to the many demands and restraints placed upon him, including management controls. He looks for support from the organization in achieving his personal goals. He wants reassurance because he does not feel he has complete control over his destiny—he is *not* the master of his fate. For the most part, management has the initiative, and the options.

In a healthy organization, however, there is a good balance of initiative. In fact, in an engineering company a large part of the initiative (at least technical) should come from lower-level personnel. Management cannot legislate ideas or creativity; it can only provide an environment in which this can be expressed.

This concept sounds ideal on paper. But it's difficult to apply due to two factors in our organizations:

- the leaders move to the top,
- the flow of information is downward. These two factors lead to frustration and misunderstanding. What is needed is a blend of technical competence with hierarchical authority.

The key is "involvement"

What gives a company a healthy climate for creativity? A major element is involvement—that is, the individual engineers can personally identify with the goals of the organization.

Unfortunately, this is not always the case. How many times have you heard a fellow engineer complain about the restraints and controls his company places on him, in such terms as: "What are *they* doing that for? Look what effect it is having on *me*." It is a mythical "*they*" whom the engineers refer to, a vague abstraction which is the management of the organization. In using this term, engineers express fears about their status and how it might be threatened by what *they*, the decision-makers of the company might do to affect them.

What the engineers lack is an identification or involvement with the organization, a recognition that they, too, are *part* of this company. They fail to understand that it is the sum total of what each employee does which affects his future and that of every other employee.

As a manager, how can you get your engineers personally, *involved*, committed to organization goals? It is easy, if you let them participate in company problem-solving (if not decision-making). This does not mean involvement in specific technical problems—that is a normal part of the engineer's work. Rather, it refers to broader management problems, problems related to *how* to get the work done and particularly problems dealing with interpersonal relationships in the operation.

Here, we should make a distinction between deci-

sion-making and problem-solving. Unless we were to make basic changes in the whole philosophy of management and organization, **decision-making** must be a function of higher management, which is where the responsibility and authority traditionally are placed. **Problem-solving**, on the other hand, should be partly the domain of engineers.

Engineers and problem-solving

The three basic steps in the overall management process that pertain to problem-solving are:

1) Finding as many as possible decision alternatives relevant to the problem.

2) Defining each alternative, which means determining as many consequences as possible of each alternative.

3) Making a choice of one or more alternatives.

Engineers can participate fruitfully in steps (1) and (2); step (3), the final decision, must be made by management. An organization with a healthy climate will be characterized by a great deal of participation in problem-solving by working-level employees.

Here are some specific examples of where engineering managers can engender this kind of participation.

- Engineers can take part in proposal efforts, where they develop personal commitment to such aspects of programs as schedules, specifications, material requirements, and costs. In this case the design engineer contributes to the estimate and is measured on his performance against that estimate.

- Engineers can participate in ad-hoc groups or task forces to solve specific problems of technical and management nature.

- Engineers can interact with higher management in meetings where two-way communications takes place. Information passes downward while management encourages reactions in the form of questions and suggestions. Such meetings can provide a background for constructive problem-solving.

A challenge to engineers

At the core of this approach to management is the need for greater professionalism on the part of engineers. Professionalism means that a person identifies with a field of knowledge, accepts a code of ethical values covering quality of performance and personal behavior, and recognizes that the work done represents a contribution to the organization and society, as well as a means toward tangible personal reward. It also implies that he finds a degree of personal gratification from the intrinsic value of his work.

The logic is simple: If management is going to become more scientific and enlightened, then technical staff members must become more professional—so that the forces can merge in the best possible way.

It is not easy to manage creative engineers effectively. But for a company that can do this, the payoff in technical accomplishments will be great. Can management give engineers what they really want? The answer must be yes, if it is to realize the full creative potential of its technical resources.

INFORMATION RETRIEVAL:
Careers, Management



Extending man's senses:

Command joint forces from 20,000 feet.

Bounce a newscast around the world.

Navigate precisely from Cape Horn to the Cape of Good Hope.

Turn night into day with an airborne floodlight.

Set up a TACAN transceiver, anywhere, in minutes.

Airborne command and control stations. Communications satellite networks. The global Omega navigation system. Nighttime military and civilian operations. Portable TACAN.

All demand fail-safe technology – the finest electronics

and systems available.

That's our business.

LTV Electrosystems has the scientific and engineering talent, fast-reaction capacity and the production facilities (15 nationwide) to build the sophisticated, new-generation systems our customers need to extend their senses and capabilities into every environment.

Why don't you join us?

See the opposite page for a listing of current professional opportunities at LTV Electrosystems.

LTV ELECTROSYSTEMS, INC.

PO BOX 6030, DALLAS, TEXAS 75222

*A quality company of Ling-Temco-Vought, Inc. **LTV***

COURSES

Computation for Engineers and Physical Scientists: Oct. 20-22, Minneapolis; Nov. 17-19, N.Y.C. CEIR, Inc., 5272 River Rd., Washington, D.C. 20016.

Automatic Impedance Measurement: Oct. 21-23, West Concord, Mass., no charge. Techniques, instrumentation, and systems for the automated measurement of Z, R, L, and C. General Radio Co., West Concord, Mass. 01781.

Data Communications Systems: Oct. 22-24, N.Y.C.; Nov. 5-7, Washington, D.C. CEIR, Inc., 5272 River Rd., Washington, D.C. 20016.

Time-Sharing Systems: Oct. 27-29, N.Y.C.; Dec. 1-3, Minneapolis. CEIR, Inc., 5272 River Rd., Washington, D.C. 20016.

Technical Writing and Editing: Oct. 27-31, Univ. of Alabama, Huntsville. Principles of good writing that can be applied to scientists, engineers, writers, and editors. Office of Special, Non-Credit Courses and Conferences, Univ. of Alabama, in Huntsville, Box 1247, Huntsville, Ala. 35807.

Designing with Plastics: Oct. 27-31, New York, (Hotel Manhattan). Course will cover criteria by which a product is produced in plastic from a technical, structural, economic and manufacturing standpoint. Fran Zimmer, International Plastics Industry Consultants, Inc., Hotel Manhattan, New York, N.Y. 10036.

Integrated Logistics Support: Oct. 28, Washington, D.C.; Oct. 27, Chicago, \$80. The objectives are to present sufficient data to enable participants to deal intelligently with customers and their in-house ILS experts. MDSI Management Development Div., Merrand Data Systems, Inc., 229 Park Ave. S., New York, N.Y. 10003.

Data Management: Oct. 29, Dallas; Oct. 30, Los Angeles, \$80. Will provide an over-view of data management and a solid fund of knowledge suitable for managing government proposals or contracts requiring data management. MDSI Management Development Div., Merrand Data Systems, Inc., 229 Park Ave. S., New York, N.Y. 10003.

Elements of Metallurgy: Oct. 29-Nov. 6, Chicago. Dr. William M. Mueller, Dir. of Education, ASM, Metals Park, Ohio 44073.

LSI Technology: Oct. 31, Phoenix, \$175. Seminar Registrar, ICE Corp., 4900 E. Indian School Rd., Phoenix, Ariz. 85018.

Microfilm and its Applications: Oct. 31, New York (Park Sheraton Hotel), \$75. Describes the different forms of microfilming and demonstrates their advantages and disadvantages in various applications. Industrial Education Institute, 221 Columbus Ave., Boston, Mass. 02116.

Computer Operations Management: Nov. 5-7, N.Y.; Dec. 3-5, Washington, D.C. CEIR, Inc., 5272 River Rd., Washington, D.C. 20016.

Automatic Pattern Recognition: Nov. 10-14, San Francisco (Hotel Canterbury), \$350. Presentation of concepts and techniques used for machine recognition of images and other data. Will emphasize practical as well as theoretical concepts. Cybex Associates, Inc., 50 Shelley Lane, Great Neck, N.Y. 11023.

Compression, Transfer and Injection Molding of Thermosets: Nov. 10-14, New York (Hotel Manhattan). Will provide instruction in molding techniques using preforms, radio frequency preheating and a discussion of preheating techniques. Fran Zimmer, International Plastics Industry Consultants, Inc., Hotel Manhattan, New York, N.Y. 10036.

Processing and Analyzing Data from Measurements of Environmental Phenomena: Nov. 11-14, Los Angeles \$200. Designed for laboratory engineers concerned with processing and analyzing data from environmental phenomena, the program will deal with spectrum analysis. Robert H. Morse, MB Electronics, Box 1825, New Haven, Conn. 06508.

Liquid crystal workshop: Nov. 13-14, Sewickley, Pa., \$155. Will present a background of basic theory to give participants an understanding of the properties of liquid crystals. Penn State Continuing Education, New Kensington Campus, 3550 Seventh Street Rd., New Kensington, Pa. 15068.

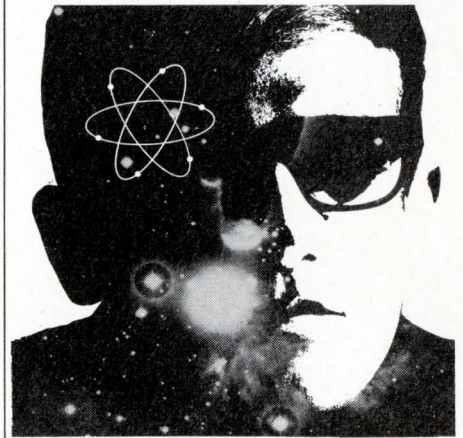

A new bulletin of professional opportunities at LTV Electrosystems.

Greenville Division

(Systems for strategic and tactical surveillance, reconnaissance, detection; tracking; command and control; airborne lighting systems; artificial intelligence; tactical warfare.)

Digital Systems Analysts
Digital Circuits Designers
Electro-Optics Systems Analysts
RF Systems Analysts
RF Circuits Designers
Scientific Programmers
Business Programmers

Facilities — Greenville, Texas; Greenville, South Carolina; Roswell, New Mexico

Garland Division

(Long-range digital communications; fluid mechanical systems for aircraft, missiles, spacecraft; high-precision antennas; guidance and navigation systems; space systems.)

RF Circuits Designers
RF Systems Analysts
Digital Circuits Designers
Digital Systems Analysts
Antenna Design Engineers
Scientific Programmers

Facilities — Garland and Arlington, Texas

Continental Electronics

(This subsidiary company builds super-power RF transmitters for radio communications, broadcasting, re-entry physics radars, radio astronomy, nuclear accelerators.)

Transmitter Design Engineers
RF Circuit Designers
RF Systems Engineers

Facilities — Dallas, Texas; Waltham, Massachusetts

Memcor Division

(Portable and stationary TACAN systems, tactical radio systems, nuclear controls, resistance products.)

Project Engineers (TACAN Systems)
Electronic Design Engineers
Instrumentation Engineers
Mechanical Engineers
Digital Systems Engineers

Facilities — Huntington, Indiana; Salt Lake City, Utah

Please call or write: Bill Hickey, Supervisor of Professional Placement, LTV Electrosystems, Inc., P. O. Box 6118, Dallas, Texas 75222, Telephone (214) 276-7111. An equal opportunity employer.

LTV Electrosystems:
extending man's senses.

Circle 32 on Inquiry Card

(Please Use Home Address on the Card)

← Circle 31 on Inquiry Card (Please Use Home Address on the Card)

Integrating DVM's fight noise, but...

... their noise rejection varies with frequency, and depends on the period of integration

By **Delbert L. Johnson**, Chief Engineer
Lear Siegler, Inc., Cimron Division, San Diego, Calif.

Among the sets of conflicting requirements facing the designer of digital voltmeters, none is more perplexing than the conflict between response time and normal (series) mode rejection. Experienced users demand faster response to step function inputs, but they also require good rejection of normal mode noise for many signal sources. There are two ways of rejecting noise, shown in Fig. 1: by filtering it out, or by cancelling it over an integration.

Active filters—faster response

Many DVMs use passive RC filters, both monotonic and frequency selective to reject noise. They are simple and reliable, but rather slow by today's standards. Normal mode rejection (NMR) can be improved by increasing capacitance; however, this results in a predictable degradation of step response.

Most new instruments use active filters, because these respond faster than equivalent passive filters. The availability of new inexpensive linear amplifiers, whether integrated or modular, has made active filters economically feasible.

The reason for the improvement in speed is not obvious, because all practical DVM filters, whether active or passive, use only RC elements. However, the feedback configurations possible in an active filter allow us to simulate inductance. While the poles and zeros of a passive RC filter are restricted to the negative real axis of the complex frequency plane, those of an active filter can be located anywhere in the complex plane. Stated

another way, the designer can adjust the damping of an active RC feedback network over very wide limits.

Integration averages out noise

Several integration schemes have been used to take advantage of the fact that principal noise components

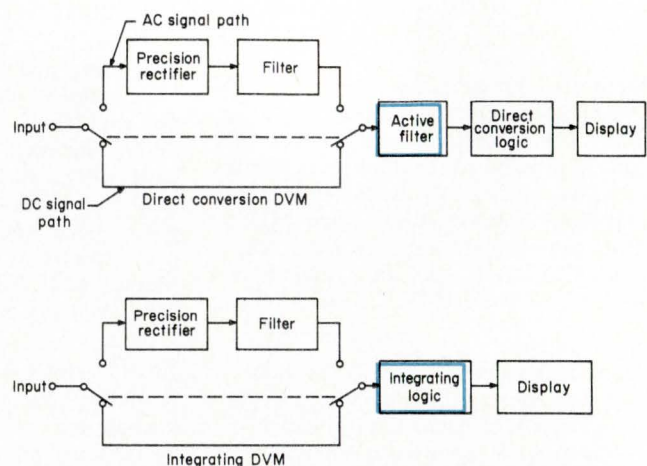
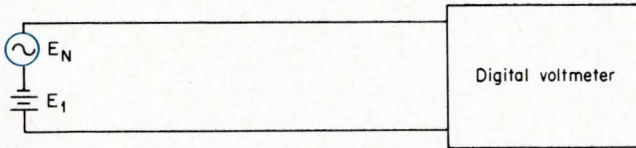

Fig. 1. Two ways of rejecting noise, as implemented in dc/ac DVMs. In a non-integrating DVM, an active filter rejects noise. In the integrating DVM, all NMR is provided by the integration technique. Both types need some filtering, following the precision rectifier, to handle ac inputs.

How integration averages noise out



The input signal (E) to the DVM consists of the dc voltage to be measured (E_1), and a normal-mode (series) noise, which we assume sinusoidal of peak value E_N .

$$E = E_1 + E_N \sin \omega t$$

The average input, E , is obtained by integrating the total input over the time interval from $t = 0$ to $t = T$,

$$E = \int_0^T \frac{(E_1 + E_N \sin \omega t) dt}{T} = \frac{1}{T} \left[E_1 t - \frac{E_N}{\omega} (\cos \omega t) \right]_0^T$$

$$E = \frac{1}{T} \left[E_1 T + \frac{E_N}{\omega} (1 - \cos \omega T) \right]$$

The second term within the bracket represents the noise voltage appearing in the DVM display.

$$E_{\text{noise}} = \frac{E_N}{\omega T} (1 - \cos \omega T)$$

If the instrument did not integrate, the worst-case display degradation would be E_N , the peak amplitude of the sinusoidal noise. The ratio describing *normal mode rejection* (NMR) is defined as

$$\text{NMR} = \frac{E_N}{\frac{E_N}{\omega T} (1 - \cos \omega T)} = \frac{\omega T}{1 - \cos \omega T}$$

The numerator of this equation (E_N) is somewhat arbitrary; however, the peak value is universally used by manufacturers, possibly because it yields the largest number for the NMR ratio.

Since ($\omega = 2\pi f$) and ($1 - \cos 2\alpha = 2 \sin^2 \alpha$),

$$\text{NMR} = \frac{\pi f T}{\sin^2 \pi f T}$$

Expressed in dB,

$$\text{NMR} = 20 \log \frac{\pi f T}{\sin^2 \pi f T} \text{ (dB)}$$

For a fixed integration time T , the numerator of this equation increases linearly with f , while the denominator cycles between 0 and unity. The ratio, therefore, shows infinite peaks for all integral values of the product fT .

This equation can be rewritten as follows, to help describe its properties,

$$\text{NMR}_{\text{dB}} = 20 \log \pi f T - 20 \log \sin^2 \pi f T$$

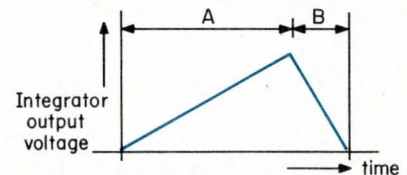
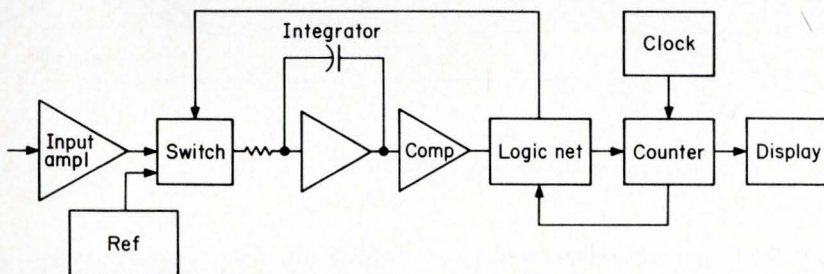

Block diagram of dual-slope integrating DVM. The digitizing time is divided into two periods. The length of period A is fixed, and corresponds to the time required for an internal clock to fill an internal counter. Since the input is integrated during this period, the voltage level at the integrator output at the end of period A depends on the level of the dc input. The counter is cleared at the end of this period.

During period B , the input signal is disconnected from the integrator input and replaced by an internal reference signal of the opposite polarity. Therefore, the integrator

output returns toward zero at a known rate.

The internal reference is chosen so that if the unknown input had corresponded to the full scale value, the integrator output would reach zero when the counter again became filled. Period B would be at its maximum value, B_{max} , and should equal period A . For dc values less than full scale, the time it takes to return to zero is proportionately less than B_{max} . Because the counter stops counting when the integrator output reaches zero, it contains a time count, B , proportional to B_{max} , that is identical to the signal's proportion of the full scale value.

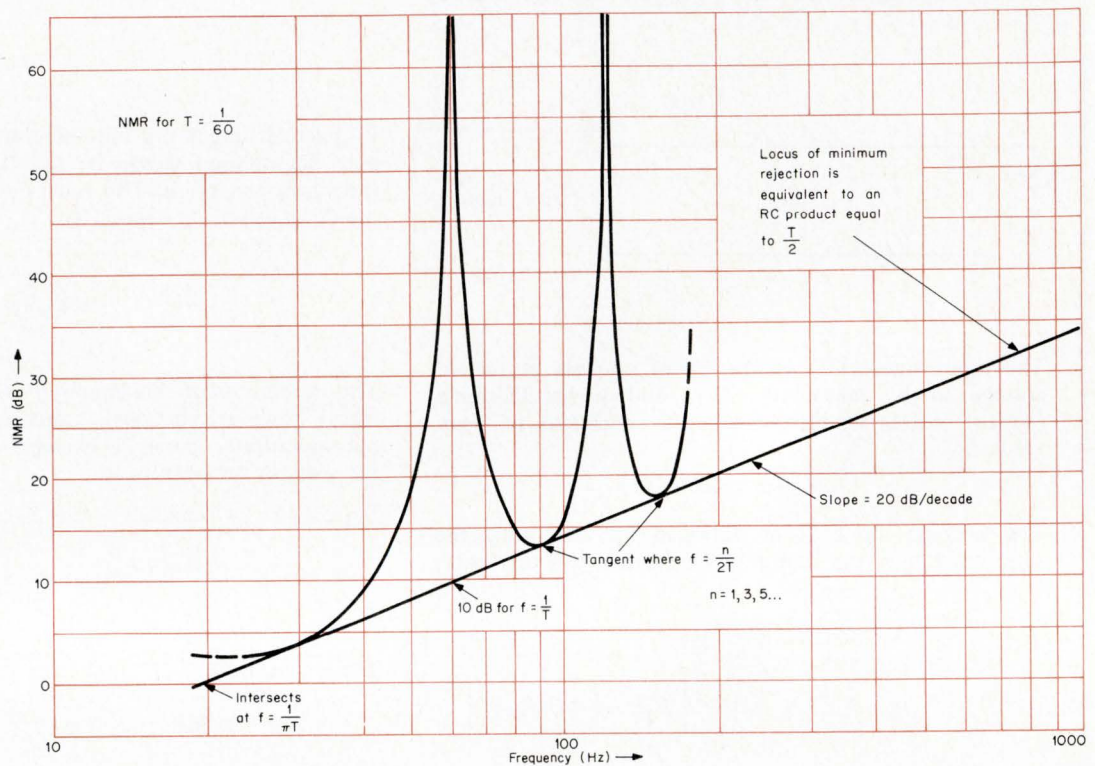

Fig. 2. The two components of NMR, as described by the equation $NMR_{dB} = 20 \log \pi f T - 20 \log \sin^2 \pi f T$. Since the integration time is $T = 1/60$ s, the infinite peaks appear at frequencies multiple of $f = 1/T = 60$ Hz.

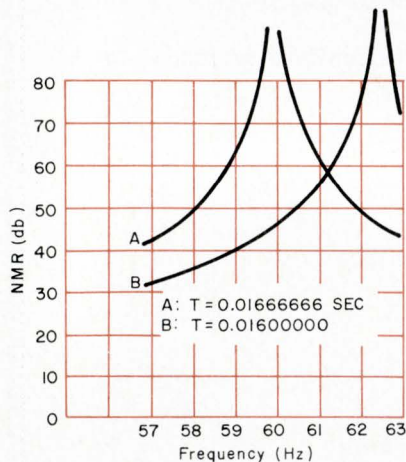

Fig. 3. The NMR peak shifts in frequency with the change in integration time T . (It also narrows as T becomes longer.) For example, if the integration time decreases slightly to 16.5 ms (not shown), the rejection drops to 70 dB at 60 Hz, 44 dB at 58 Hz and 56 dB at 62 Hz. If the integration time is further reduced to 16 ms, as shown by curve B, the peak shifted to approximately 62.5 Hz and rejection is 46 dB at 60 Hz, 35 dB at 58 Hz and 74 dB at 62 Hz.

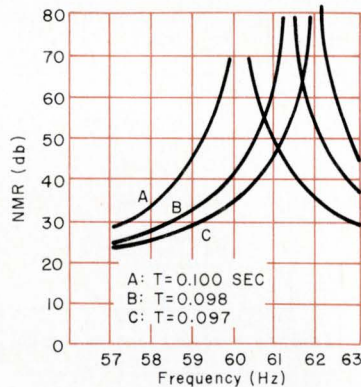

Fig. 4. For longer integration times, very small percentage errors in integrating time accentuate the loss in NMR at a given frequency because the peaks become narrower. For example, if the integration time drifts by only 2%, from 100 to 98 ms, the rejection falls to 28 dB at 58 Hz, 32 dB at 118 Hz and 43 dB at 402 Hz. The 400 Hz peak shifts to approximately 398 Hz, where rejection is calculated to be 117 dB. For an integration time of 100 ms, the 10 dB point is at 10 Hz, and the minimum curve contributes 25 dB at 60 Hz, 31 dB at 120 Hz, and 42 dB at 400 Hz. Because the slope of the minimum rejection locus is rather low, its shift with changes in T is not as apparent as the shift of the rejection peaks.

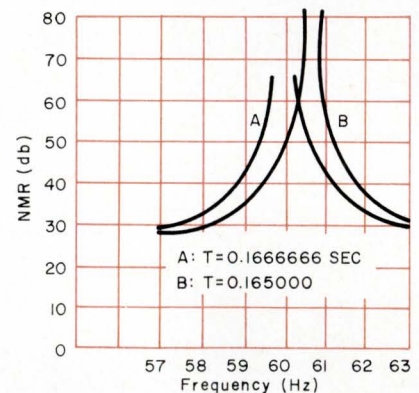

Fig. 5. Example of an instrument that integrates for $1/6$ s (approximately 167 ms). In this case, the locus of minimum rejection contributes 30 dB at 60 Hz, 36 dB at 120 Hz and 46 dB at 400 Hz. The rejection peaks are very closely spaced and very narrow, and so small changes in frequency of the noise signal yield severe changes in the peak rejection. Performance of the peaks is virtually coincident with the minimum rejection locus, and so it is quite stable with changing integration time. For example, if the integration time is exactly $1/6$ of a second, rejection at 58 Hz is only 32 dB, just slightly above the minimum locus. If the integration time drops to 165 ms, the attenuation at 58 Hz drops only 2 dB to 30.

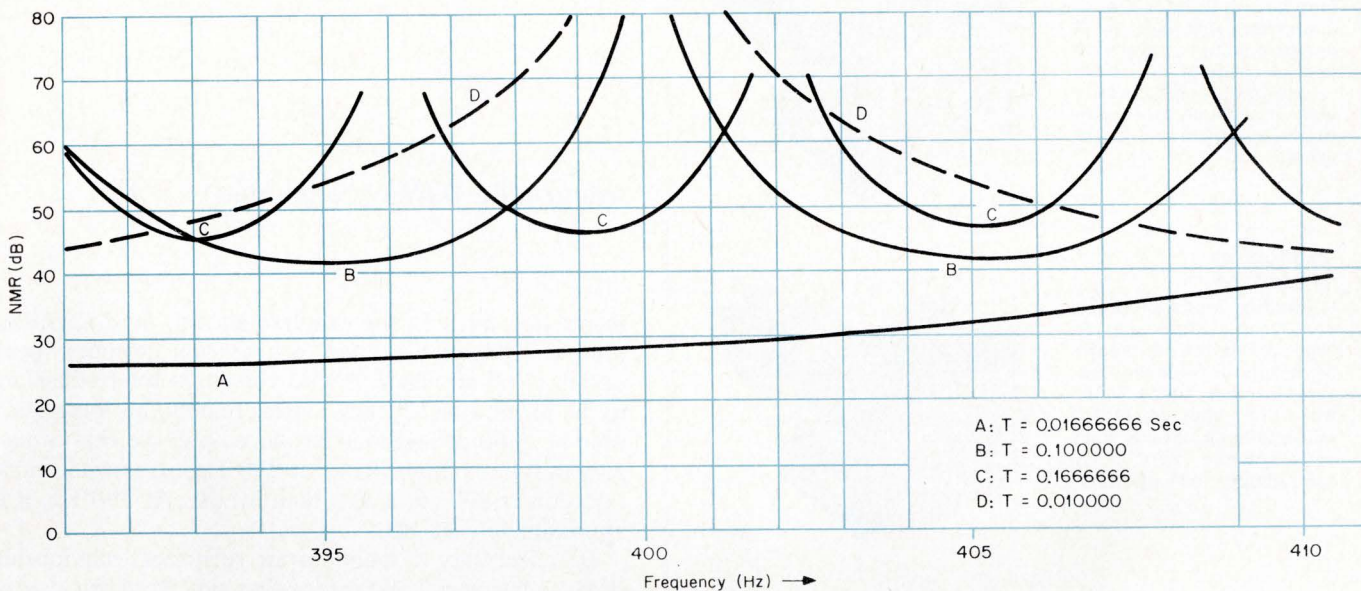

Fig. 6. NMR near 400 Hz as a function of integrating time.

Instrument Type	Normal mode rejection at:				Worst case measuring time (including amplifier settling)
	61 Hz	64 Hz	395 Hz	399 Hz	
Direct conversion— no integration					
No filter	0	0	0	0	75 ms
Medium filter	40 dB	40 dB	80 dB	80 dB	300 ms
Full filter	90 dB	90 dB	>100 dB	>100 dB	700 ms
1/10 sec integrator	46 dB	27 dB	42 dB	62 dB	380 ms
1/60 sec integrator	61 dB	38 dB	27 dB	28 dB	65 ms
1/100 sec integrator	7 dB	8 dB	54 dB	82 dB	50 ms

Comparison of NMR and reading time for integrating and non-integrating DVMs. The measuring times all include delays for amplifier setting, because these delays are significant.

For example, an integrator having an integration time of 100 ms, could produce a full-scale reading in 200 ms, but 380 ms are required to account for all settling delays.

average zero over a predictable time interval. The most popular integrator today is the dual slope type, explained in the sidebar that accompanies this article. One reason for its current popularity is that it is a very simple and relatively inexpensive instrument to implement, particularly with today's integrated circuits.

As shown by the mathematical derivation in this article, the equation for normal mode rejection is

$$NMR_{dB} = 20 \log \pi f T - 20 \log \sin^2 \pi f T$$

The first term in the right hand side describes a straight line (when drawn on semi-log paper, as in Fig. 2). The rejection resulting from this term increases at 20 dB/decade beginning at the frequency where the product $fT = 1/\pi$. An easily calculated point to fix the location

of this line is for the frequency where $f = 1/T$. The log of π is approximately 1/2, and so where $f = 1/T$ the rejection due to this term (9.94 dB) is approximately 10 dB. This is also the first frequency where the second term goes to infinity.

This straight line due to the first term of the equation is equivalent to the rejection produced by a single RC filter section with a time constant half the integration time. The infinite peaks due to the second term of the equation add linearly to this equivalent capacitor line on the semi-log plot.

The peaks indicate that an instrument using this technique has unlimited normal mode rejection at all frequencies whose periods are integral multiples of the

You say you want a

low-profile snap-in-mounting push button switch or matching indicator that is interchangeable with most 4-lamp displays... available in a full range of cap colors... with a choice of bezels with or without barriers in black, gray, dark gray or white.

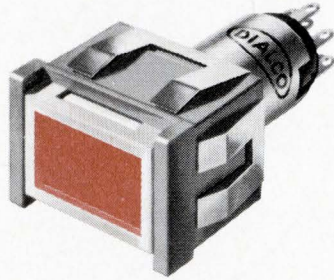

and a

legend presentation that's positive (like this one) or negative (like the one below) or just plain (like the one above)... one that's white when "off" and red, green, yellow (amber), blue or light yellow when "on"... or colored both "on" and "off."

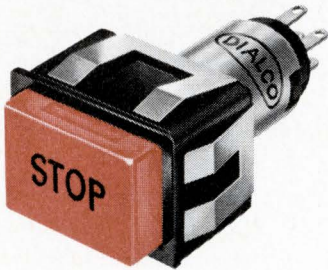

and a

highly reliable switch proven in thousands of installations... available in momentary or alternate action... N.O., N.C. or two circuit (one N.O., one N.C.)... that accommodates a T-1 3/4 bulb with midget flanged base, incandescent, in a range of voltages from 6-28V.

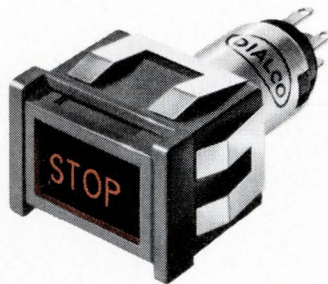

*etc.
etc.
etc.*

Now, for the first time Dialight gives you custom panel designing with a standard line of push-button switches and matching indicators

Dialight offers a broader range of switch and indicator possibilities than you'll find anywhere in a standard single-lamp line. Sizes: 3/4" x 1", 5/8" square and round. Send today for our new full-color catalog L-209.

DIALIGHT

Dialight Corporation, 60 Stewart Ave., Brooklyn, N.Y. 11237

DT-125

Integrating DVMs (concluded)

integration time. In the example shown, the integration time is 1/60 of a second, so the first rejection peak occurs at 60 Hz. NMR is also very high for frequencies in the vicinity of 120 Hz. Unfortunately, an integration time of 1/60 of a second produces a curve that is tangent to the minimum locus at 390 Hz, so normal mode rejection at 400 Hz is less than 30 dB. At 390 Hz, it is approximately 26 dB.

It is necessary to maintain the reciprocal relationship of noise frequency and integration time to a fair degree of precision, to maintain significant rejection at the power line frequency. Figure 3 shows how the rejection peaks shift significantly with small changes in integration time.

A longer integration time decreases the spacing of the rejection peaks and produce a more uniform response over the total range of interest. For example, an integration time of 100 ms (as in Fig. 4) will produce peaks at 60 Hz, 120 Hz, and also 400 Hz, because the peaks occur with a spacing of 10 Hz. However, the closer spacing implies that the peaks are far narrower than for a shorter integration time.

One clear advantage of a longer integration time is that the locus of minimum rejection intersects the 0 dB axis at a lower frequency and therefore contributes higher rejection over the whole frequency spectrum.

The three examples of Figs. 3, 4 and 5 demonstrate that short integration times yield the most stable performance near rejection peaks, but the lowest noise rejection between peaks. Longer integration time yields very unstable performance near rejection peaks, but a much higher base of minimum rejection. The amount of rejection represented by the locus of minimum rejection is very important for higher line frequencies such as 400 Hz (as shown in Fig. 6) but it is also very important for frequencies removed from 60 Hz by only a few percent.

Integration is a rather economical technique to implement, and so this conversion technique is used for many inexpensive and rather slow DVMs. Active filters are used in more expensive digital voltmeters, where large values of stable NMR are combined with excellent step response. In addition, filtering can be switched out when not needed.

INFORMATION RETRIEVAL

Instruments and measurements,
Circuit design, Digital design

For Capacitors with **GREATER RELIABILITY . . .**

Choose



E-Menco

The Capacitors You Find Wherever There's Electronics!

EL-MENCO DUR-MICA CAPACITORS

Only 1 Failure Per 43,000,000 Unit-Hours!

- It has been computed that "debugged" DM30, 10,000 MMF units, when subjected to 257,000 hours of life at 85°C with 100% of the rated DC voltage applied, will yield only 1 FAILURE PER 43,000,000 UNIT-HOURS!
- DM15, DM16, DM19, DM20 . . . perfect for miniaturization and for new designs using printed wiring circuits. Also available in DM30, DM42 and DM43.
- New "hairpin" parallel leads insure easy application.
- Exceed all electrical requirements of military specification MIL-C-5A.

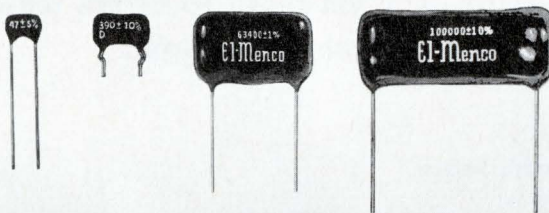

EL-MENCO TRIMMERS & PADDERS

Design Versatility!

- Available in 350 VDC and 500 VDC as well as other test voltages.
- All bases are of low-loss steatite.
- Special lugs are obtainable for printed circuitry.
- Miniature units are available.
- Solder Lugs can be bent in any position without affecting the capacity setting due to the rigid construction.
- Various types of mounting brackets are available for all trimmers.
- Units can be constructed for special applications.

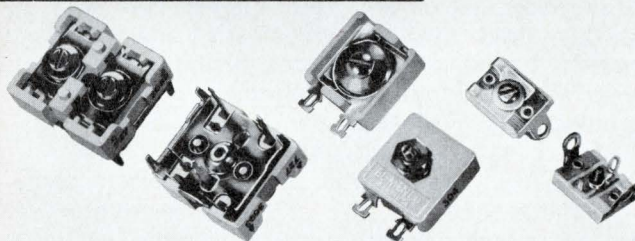

EL-MENCO *MYLAR-PAPER DIPPED CAPACITORS

Only 1 Failure in 7,168,000 Unit-Hours!

- Life tests at 100°C with rated voltage applied have yielding only 1 FAILURE PER 716,800 UNIT-HOURS for 1 MFD. Since the number of unit-hours of these capacitors is inversely proportional to the capacitance, 0.1 MFD Mylar-Paper Dipped capacitors will yield only 1 FAILURE PER 7,168,000 UNIT-HOURS!
- Working volts DC: 200, 400, 600, 1000 and 1600.
- Durez phenolic resin impregnated.
- Tolerances: $\pm 10\%$ and $\pm 20\%$ (closer tolerances available).
- Dielectric strength: 2 or 2½ times rated voltage, depending upon working voltage.
- Exceed all electrical requirements of E.I.A. specification RS-164 and military specifications MIL-C-91A and MIL-C-25A.

*Registered Trademark of DuPont Co.

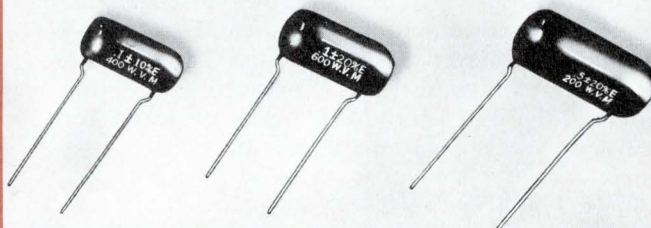

EL-MENCO MOLDED MICA CAPACITORS

Superior Performance!

- Unmatched for excellent stability, dielectric strength, high insulation resistance, extremely high "Q" and correspondingly low power factor.
- Units can be subjected to a short "debugging" life test at elevated voltage and temperature for removal of early life failures and for improved reliability.

Write for Free Samples and Booklets on Any of The Above Capacitors

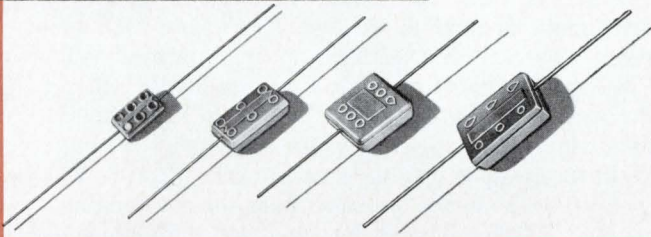

THE ELECTRO MOTIVE MFG. CO., INC.

WILLIMANTIC, CONNECTICUT 06226

Dipped Mica • Molded Mica • Silvered Mica Films • Mica Trimmers & Padders
Mylar-Paper Dipped • Paper Dipped • Mylar Dipped • Tubular Paper

West Coast Manufacturers contact: COLLINS & HYDE CO., 900 N. San Antonio Rd., Los Altos, California 94022
5380 Whittier Blvd., Los Angeles, California 90022

ALSO SOLD NATIONALLY THROUGH ELECTRONIC PARTS DISTRIBUTORS

Taking the mystery out of DVM specs

There are no industry standards on specifications for digital voltmeters, yet these specs are the only thing you can go by to compare DVMs.

By **Kenneth Jessen,**

Product Engineer
Hewlett-Packard Co., Loveland Div., Loveland, Colo.

There are over 200 models of digital voltmeters (DVM's) being sold on the World market, each with its own data sheet. Intelligently comparing and selecting DVM's is becoming quite difficult because the only standards which exist are those informally adopted by the manufacturers. Fortunately for the user, most specifications are easy to understand. Some do require clarification, however, and this article is devoted to them. A digital voltmeter, like any other instrument, is designed to solve a measurement problem. Only after clearly defining your problem, should you look at DVM specs.

You may have heard a lot about the digitizing techniques used in DVM's; for example single or dual slope integration, successive approximation, etc. Don't worry about them. Whatever advantages and limitations a technique has will ultimately be reflected in the performance of the DVM. A DVM should be evaluated for *what* it does, rather than *how* it does it.

How many digits do I have?

The number of digits a DVM has is often confused by the overrange digit. A four digit display of "1999" may have only three *full* digits, i.e., the three "9's" the instrument is able to display. The extra "1," or overrange digit, allows the user to read beyond full scale without loss of resolution or sensitivity. If a signal changes from 9.99 V to 10.01 V, a 3-digit DVM without overranging could measure the "9.99" V, but would have to up-range to measure the "10.0" V, losing the 0.01 V in the process. With an overranging 3-digit DVM, 10.01 V could be measured without any loss nor need to up-range.

Resolution and sensitivity

In the example above, the ability to measure 0.01 V by itself is a measure of sensitivity. The ability to measure 0.01 V as part of another signal (as in 10.01 V) is a matter of resolution. Digital voltmeters, by their nature, have high resolution. A 6-digit DVM

with a 1 V range may be able to resolve changes as small as 1 μV in the last digit. DVM manufacturers have come to call the least significant digit on the lowest range "sensitivity" and others call it "resolution." There is no right or wrong to this situation as long as the user understands what they mean.

As an example of resolution and sensitivity, take a 4-digit DVM with 20% overranging and a 1-V range. This DVM would be able to read 1.2000 V on its lowest range and would therefore have a resolution of one part in 12,000. Since the least significant digit is equal to 100 μV , this would be given as the sensitivity (or resolution per some manufacturers).

The only drawback to this specification is that it is based on what the user *sees* and may not reflect what the DVM can do. For example, all DVM's have at least a ± 1 digit error because of uncertainties in the digital logic. This means that it is unlikely that the 4-digit DVM described above would actually respond with a one digit change to exactly a 100 μV change in the input. It might take only 90 μV or even up to 150 μV . The point is that a sensitivity specification equal to the last digit on the lowest range may be *close to* the actual sensitivity but is not likely to *equal* it. "Short-term-stability," which will be covered later, is a better measure of the usable sensitivity.

Accuracy

Accuracy is the exactness to which voltage can be determined in relation to the Legal Volt maintained by the National Bureau of Standards. A manufacturer must maintain calibration standards which are traceable to the Legal Volt before he can attach an accuracy specification to an instrument. An equal burden is put on the user. Purchasing a DVM without the equipment or ability to keep the instrument within its rated accuracy would be foolish. The point is that purchasing a high accuracy DVM may mean purchasing new calibration equipment.

To be meaningful, accuracy *must* be stated along with the conditions under which it will hold. These include time, temperature, line variations, and humidity. Accuracy should hold over some temperature range

unless the DVM is to be operated in a tightly controlled environment. A temperature coefficient is usually given to allow the user to calculate the expected accuracy outside the specified range.

The period of time over which accuracy holds is an important indication of the instrument's stability and also gives the user an idea of how often the DVM will have to be recalibrated. Any instrument should hold its accuracy over normal power line fluctuations in voltage and frequency. Relative humidity can be very important when combined with temperature. If any of these conditions are omitted from the data sheet, the potential purchaser has a right to question the manufacturer.

Accuracy is usually stated in two parts: a percent of reading and a percent of full scale. The full scale error can also be expressed as $\pm X$ digits. A typical 4-digit DVM might have the following accuracy specifications:

$\pm(0.02\%$ of reading $+0.01\%$ of range) which is the same as

$\pm(0.02\%$ of reading $+ 1$ digit)

Figure 1 plots this accuracy as the percent of full scale vs error up to 120% of full scale to indicate 20% overranging. Notice that the best accuracy is at or near full scale.

Accuracy is always related to resolution. The resolution of a 4-digit DVM is one in 10,000 or $\pm 0.01\%$. For absolute voltage measurements, it would not make sense to buy a 4-digit DVM with an accuracy of ($\pm 0.1\%$ of reading $+0.1\%$ of range). The error would be 20 counts at full scale making the least significant digit useless. For relative measurements where the user is only interested in the difference between two voltages, the least significant digit would have meaning.

Ideally, a DVM would have an accuracy specification equal to its resolution so that the maximum error would be one digit. This is not practical, because a DVM always has a percentage of reading error combined with a percentage of range error. Figure 2 lists typical accuracies and shows what spreads in readout can realistically be expected.

Short term stability

Unlike accuracy, short term stability is not relative to the Legal Volt, though it is also specified under restricted conditions. The difference between a typical accuracy specification and short term stability specification is shown in Fig. 3.

Short term stability tells how good a DVM is for relative measurements and indicates its effective sensitivity. This specification is used when two voltages are compared over a short period of time (while temperature remains constant) or when looking at the drift of a single voltage.

Calibration

The current trend in DVMs is to make the instrument self-calibrating, and eliminate adjustment at the front panel. In using a front panel adjustment, the instrument is manually connected to its internal standard and adjusted to read correctly. The internal reference is not part of the measuring circuit. There should be two accuracy specifications: one to cover the internal refer-

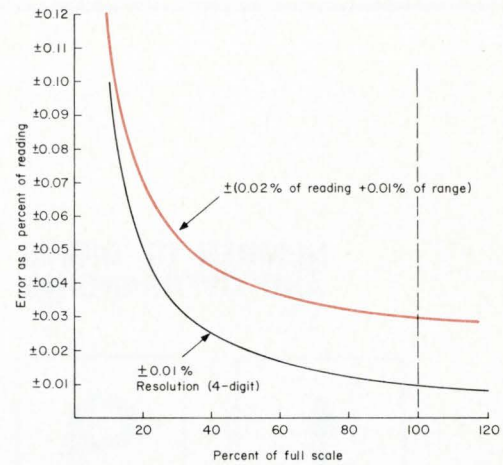

Fig. 1. Accuracy of a 4-digit DVM with 20% overranging, plotted in terms of error of reading vs percent of full scale. The accuracy is always greater at or near full scale. The theoretical limit for accuracy is the resolution, ± 1 digit.

Accuracy	Display limits for a 1 V Input
3-digit	
$\pm(0.1\%$ of reading $+ 0.1\%$ of range)	1.002
90 days; 20°C to 30°C	0.998
4-digit	
$\pm(0.02\%$ of reading $+ 0.01\%$ of range)	1.0003
90 days; 20°C to 30°C	0.9997
5-digit	
$\pm(0.004\%$ of reading $+ 0.002\%$ of range)	1.00006
90 days; 20°C to 30°C	0.99994
6-digit	
$\pm(0.004\%$ of reading $+ 0.0002\%$ of range)	1.000042
90 days; 20°C to 30°C	0.999958

Fig. 2. Typical dc accuracy specifications for various DVM's according to the number of digits. Note that a 6-digit DVM does not have substantially greater accuracy than a 5-digit DVM. All meters have an overrange digit.

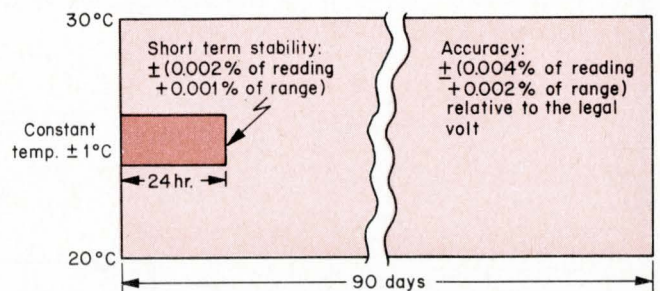
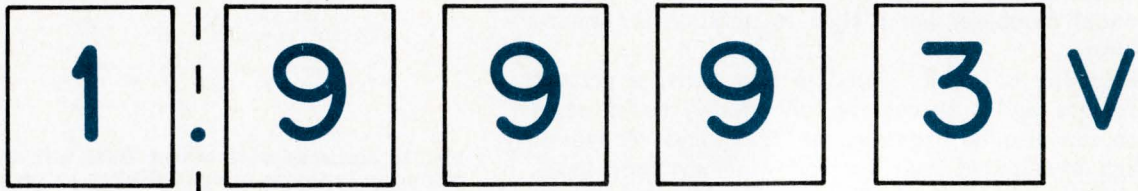

Fig. 3. Illustration of the difference between an accuracy specification and a short-term-stability specification as a function of time and temperature for a 5-digit DVM. Note that accuracy is relative to the Legal Volt and short-term-stability is not.

DEFINITIONS OF DVM SPECS

NUMBER OF DIGITS AND OVERRANGING:

Consider a DVM displaying the following reading:



This is the
OVERRANGE DIGIT.

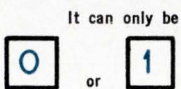

These four digits are FULL DIGITS. They cycle through the

integers from to Since there are four of them, this is a FOUR DIGIT DVM.

The percentage of overranging is:

$$\frac{\text{highest reading with overrange}}{\text{highest reading without overrange}} - 100\%$$

Rounding off, this DVM has an overrange capability of:

$$\frac{2.0000}{1.0000} - 100\% = 100\%$$

This DVM, then, is characterized as having FOUR DIGITS plus 100% OVERRANGE.

RESOLUTION:
$$\frac{\text{the smallest observable change}}{\text{full scale reading}} = \frac{0.0001}{2.0000}, \text{ or } 0.005\%$$

SENSITIVITY: The minimum signal strength to which the instrument will respond, usually the smallest unit on the lowest scale. If this DVM is on its lowest scale, its sensitivity is 100 μV .

ACCURACY: A comparison of the indicated value with the true value of the input signal. In the illustration below, it is
$$\frac{\Delta V}{V_{\text{true}}}$$

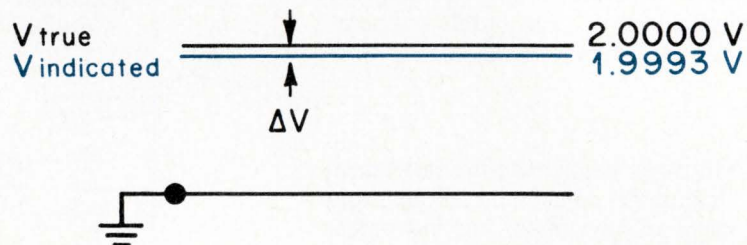

If V_{true} is 2.0000 V, the accuracy of this reading is $\frac{-0.0007}{2.0000}$, or 0.035%.

Usually this spec is broken down into a percent of reading error and a percent of full scale, or digits, error.

STABILITY:

A measure of the reproducibility of the same reading for the same input, usually defined over an elapsed time and within a temperature envelope. Suppose a constant input of 2.0000 V was applied and a long term record of this DVM's output showed the following:

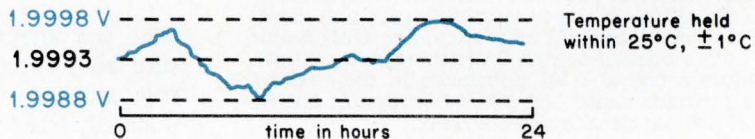

The reading varied a total of 10 parts in 20,000, or 0.05%. It was stable to within $\pm 0.025\%$ of 1.9993 V for the time and temperature conditions. Note that the accuracy was really $+0.0000$, -0.06% during this time.

RESPONSE TIME:

The time required, after applying a step input, for the instrument to indicate a specified percentage of the new signal. It reflects the cumulative settling times in the unit. Suppose this DVM is on the 10-V scale, and the following is a chart of its response to a step input:

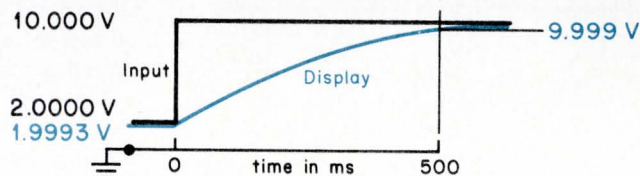

The response time under these conditions is 500 ms.

COMMON-MODE NOISE REJECTION:

The ability of the grounding system of the instrument to cancel the common-mode signal appearing between the input terminals and ground. It is expressed in dB.

NORMAL-MODE NOISE REJECTION:

The ability to reject noise which is superimposed on the signal to be measured. It is expressed in dB.

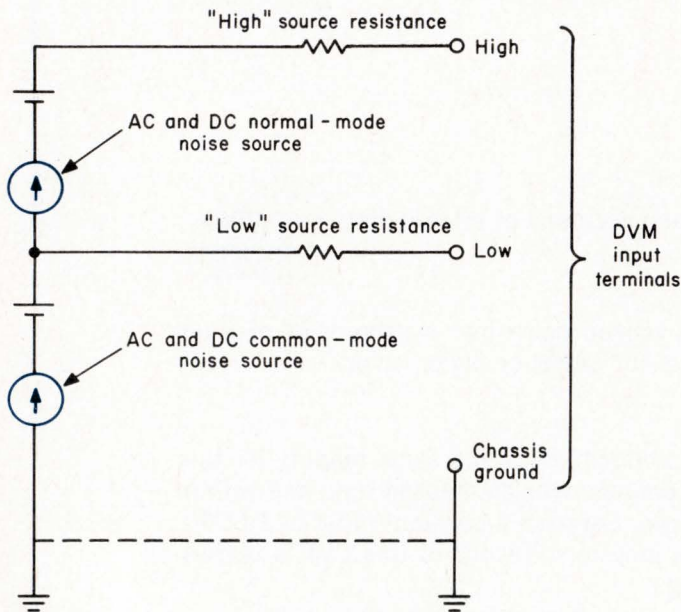

Fig. 4. Equivalent circuit of common-mode and normal-mode noise sources. The difference between the "high" and "low" source resistances represents an unbalance. For every factor of 10 change in the unbalance, the CMR changes by 20 dB. Most manufacturers use a 1 k Ω unbalance in their specs, which typically provides about 160 dB of rejection at 0.6 Hz and drops by 20 dB per decade of bandwidth.

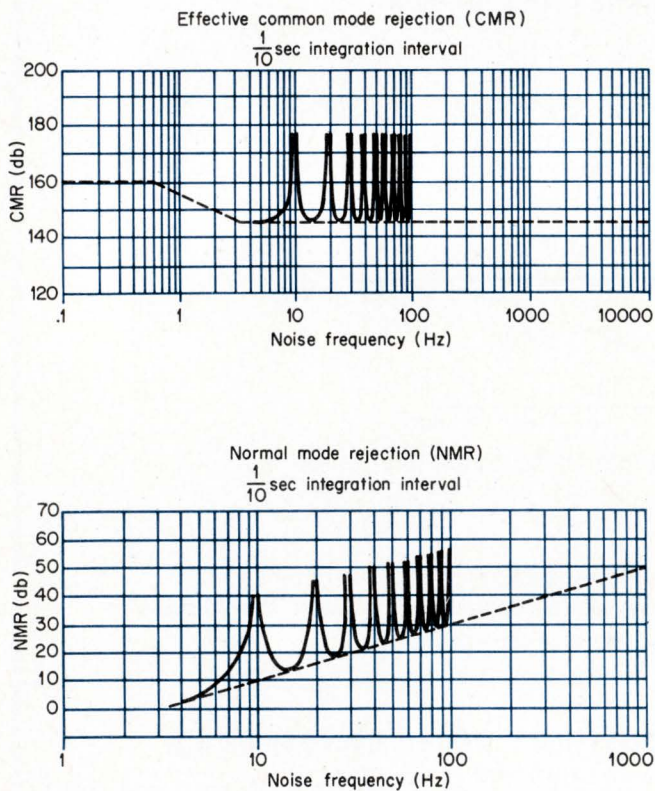

Fig. 5. Examples of "effective" common-mode rejection and normal-mode rejection for a 5-digit integrating DVM. The "cusps" are formed as a result of the integrating technique, which provides essentially infinite rejection at multiples of integration frequency.

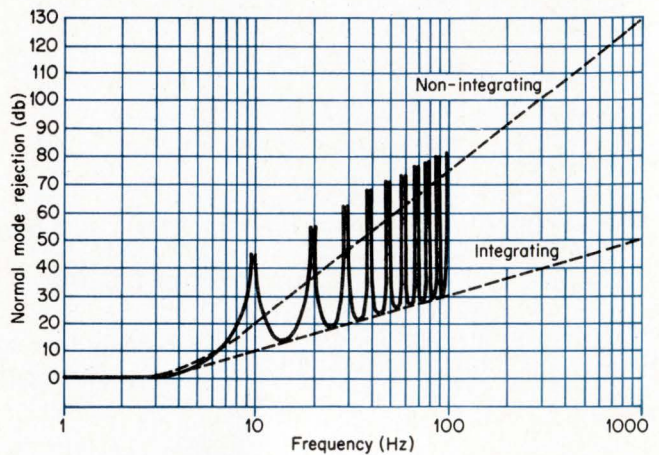

Fig. 6. Noise rejection produced by two commercially available DVM's; one which integrates, and one which does not integrate and uses a filter.

ence and another to cover the measuring circuit. Be sure both specifications are combined to indicate the true accuracy. Watch for data sheets which make a manually calibrated DVM appear to have higher accuracy than a self-calibrating DVM by putting the accuracy of the internal reference in a prominent position.

Speed

Speed is confusing, mainly due to the number of terms involved. DVM users need to know three things about speed: (1) the time required for the DVM to respond within its rated accuracy, after application of the input signal; (2) the effect of any input filtering, and (3) the reading rate when the DVM is used in a system.

From the instrument's standpoint, these are three different times: (1) the time for the input amplifiers to respond to a change in the input; (2) the time required to reject incoming noise, and (3) the time required to change the input signal into digital form.

Fixed or adjustable internal triggers are designed to relieve users of supplying external triggers when making bench measurements. Triggering rates vary from 1 reading every 5 seconds to 30 readings/second, and are independent of any other response time in the instrument. The maximum rate at which a DVM may be triggered in a system can far exceed what the internal trigger can supply.

A DVM may be able to take 100 readings/second but if the response time (settling time) of its input amplifiers is only 100 ms, then the DVM may take only 10 *correct* readings/second. Since the internal trigger might be adjustable up to 20 readings/second, it is up to the user to determine the trigger setting for correct readings.

Input amplifiers usually have an exponential response curve. Amplifier settling time should be specified for a full scale change in the input signal, because the time required to respond to a full scale change may be much longer than for small changes. Quite

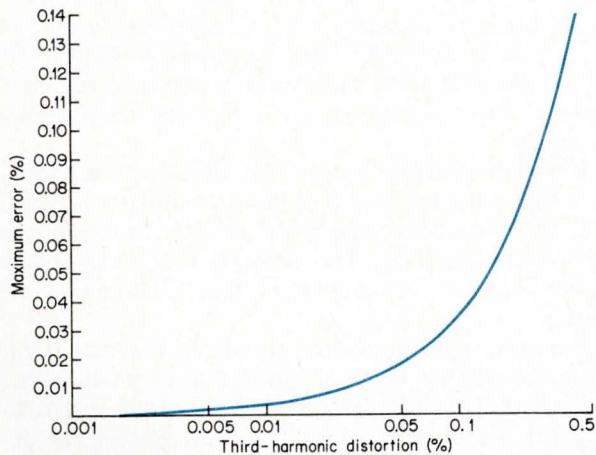

Fig. 7. Maximum possible error in an average-responding DVM when the distortion is third harmonic. A very small amount of distortion can destroy the accuracy. In contrast, a true-rms responding DVM is not affected by distortion.

often the lower ranges require more time to respond. The user should check that the internal trigger will be sufficient to cover the response times, and the maximum reading rate is fast enough to take advantage of the response time.

Noise rejection also affects speed. Whenever filtering is used, it should be clear from the data sheet what effect each filter position has on the response time. (The integration period is an important time in integrating DVMS.)

Other speed factors include autorange time, time to recover from an overload, and time to program a range change or function change. The effect of all of these on the basic measuring speed should be clearly stated on the data sheet.

Noise rejection

Noise rejection specifications appear to be complex, but involve simple fundamentals. The main point is that you do not want noise to destroy the accuracy of your measurement. The source and type of noise are important in determining what type of noise rejection is needed. Figure 4 illustrates the difference between the types of noise in equivalent circuit form.

Normal-mode noise (also called superimposed noise) enters with the signal, and must be eliminated by the DVM's measuring technique. Filtering is the simplest way to eliminate normal-mode noise by shunting it to ground, but it does slow the measurement. Integration "calculates" the noise out of the measurement by changing the input voltage to a frequency. The total counts accumulated during the integration period is proportional to the average of the input voltage. If the period of the noise equals a multiple of the integration period, the noise is effectively integrated out of the measurement.

Common-mode noise appears between the DVM's input terminals and ground. It is caused by differences between the instrument ground and the ground at the measured circuit.

To reduce the effects of common-mode noise, a passive technique called guarding is commonly used. Guarding shunts the noise to ground by using a shield, or box within a box. The ultimate solution is a battery operated DVM, which disconnects the instrument from ground.

Common-mode noise may enter a DVM as normal-mode noise by flowing through the source resistance of the circuit being measured, thus appearing across the input terminals. Because of this, a new term called "effective" common-mode rejection has evolved.

This specification is a combination of the "pure" common-mode rejection achieved by guarding and the normal-mode rejection of the instrument. It is the overall effect of common-mode noise on the voltage reading.

Figure 5 shows normal-mode and effective common-mode noise rejection for an integrating DVM. Generally, common-mode voltage is specified with a 1 k Ω resistor in either the high or low input lead, thus giving a basis for comparison.

Figure 6 illustrates the difference between noise rejection using filtering and integrating techniques. Integration eliminates noise as part of the measurement and the basic speed of the instrument is maintained. Essentially infinite rejection is produced at multiples of the integration period, producing the "cusps" shown in the figure. Since the most common source of noise is the power line, the integration period is chosen to be a multiple of the period of the line frequency, such as (1/6) s or (1/60) s, thus integrating out those frequencies.

Filtering is far less expensive and, in a way, more flexible. Although filtering cannot produce infinite rejection at line related frequencies, it can offer better broadband rejection. Several filter positions will allow the user a wide range of measurement speeds and noise rejection. In general, filtering is slower than integration for the same amount of noise rejection.*

Ac voltage measurements

The trend in digital voltmeters is to offer greater capability in the classical measurements and to offer new capability to measure new parameters. Measuring new parameters requires the evaluation of new specifications.

AC converters designed for DVMS may be classified according to their response to the input signal. Average responding converters are the most common, and fairly inexpensive, but are limited to measuring pure sine waves. Quasi-rms converters are able to measure sine waves with a limited amount of distortion. True-rms converters are new to the DVM market and offer virtually complete immunity to distortion, but are relatively expensive.

The nature of a digital voltmeter implies high accuracy. A 4-digit DVM, for example, should have an accuracy of at least $\pm 0.05\%$ to make the last digit meaningful. An average responding ac converter can be very sensitive to distortion. Even-order harmonics are usually not an important source of error in an

*A bibliography of articles on noise rejection appears at the end of this article.

NEW MICROCIRCUIT PROBER

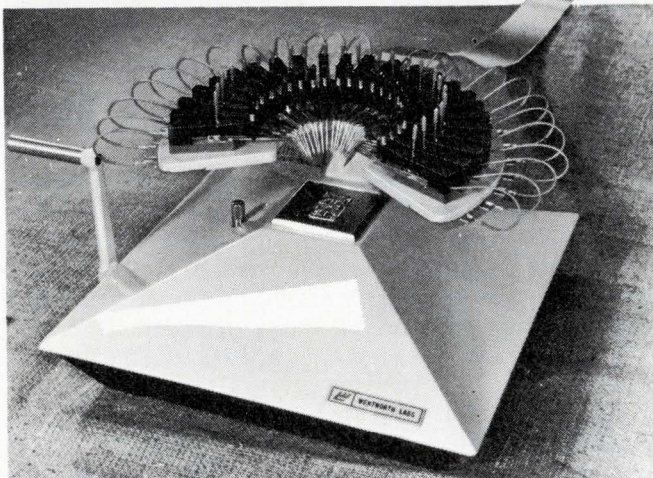

The MP-0200 is a manually operated Multi-Point Microcircuit Prober designed for rapidly checking resistors and other devices used in thick and thin film hybrids. The Prober features 24 Wentworth Labs' pre-wired probes; a pre-wired Kelvin contact probe ring assembly; automatic vacuum system for substrate hold-down; an interchangeable chuck and a shielded double flat cable interface system with connectors. Rate 700-900 substrates per hour.

WENTWORTH LABORATORIES INC.
ROUTE 7, BROOKFIELD, CONN. 06804 — (203) 775-1750

Circle 35 on Inquiry Card

NEW ALTERNATE ACTION PUSH BUTTON SWITCHES

(Push-On, Push-Off)

...the Reliable Ones by Grayhill

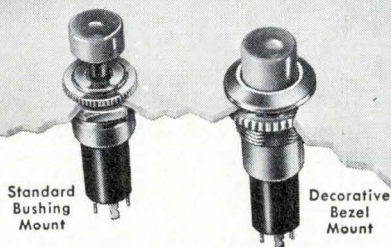

250,000 operations —
WITHOUT A MISS.

- SPDT, SPST
- 1/4 Amp., 115 VAC resistive
- Totally enclosed
- Space saving - .937" behind panel
- Momentary action counterpart available

For your Grayhill Engineering Catalog
offering complete technical data — contact



543 Hillgrove Avenue
LaGrange, Illinois 60525
Area Code 312, Phone 354-1040

...the Difference Between Excellent and Adequate

average responding DVM. Odd harmonics, on the other hand, result in considerably more error, the polarity depending on the phase relationship.¹ For example, a basic $\pm 0.05\%$ accuracy will be degraded to $\pm 0.1\%$ by as little as 0.1% of third harmonic distortion. Figure 7 illustrates the maximum possible error in an average responding DVM when the distortion is third harmonic.

It is not possible to see the difference between a pure sine wave and one that has 1% distortion, yet the 1% distortion can cause a 0.333% error in an average responding DVM. The point is that DVMs require higher accuracy ac converters than did analog voltmeters.

The quasi-rms converter simulates the action of a thermocouple by using a curve-fitting network combined with a rectifier. Since this type of converter does not find the thermal energy of the input signal, it is limited in the amount of distortion it can tolerate, but it is fast.

The true rms converter offers the ultimate in performance and is designed specifically for DVM accuracy. A thermocouple measures the heating value of the input signal, thus measuring the true rms value, independent of distortion. The true-rms converter, although slow, covers a bandwidth up to 1 MHz, compared to the 100 kHz limit on average and quasi-rms-responding converters. Once again, there is no one "right" converter; the choice depends strictly on the application.

Ohms measurements

Each of the three types of converters has an advantage. The 2-wire converter is the most common and the most economical but is sensitive to lead resistance. If low resistance values are being measured at a remote location, lead resistance will cause an error in the measurement.

The 3-wire ohms converter may have four terminals on the front panel and may even be called a 4-wire converter. It is also sensitive to lead resistance, especially on the low side of the input, but it may be possible to null out the lead resistance with an internal adjustment.

The "true" 4-wire ohms converter has a fully isolated current source and is insensitive to lead resistance. It makes low ohms ranges useful for remote measurements. The value of the unknown resistor is sensed at the point of measurement by a separate pair of leads which do not carry any current. Although this scheme offers the ultimate in performance, it is the most expensive due to its separate power supply and grounding system.

Articles on noise rejection

McCullough, William, "How to reduce common-mode effects", *EEE*, Feb. 1967.

Wasserman, Philip D. "Voltmeter noise rejection", *Measurements and Data*, pp. 110-115, May-June, 1968.

McCullough, William, "Understanding digital voltmeter specs", *Electro-Technology*, pp. 57-61, Aug. 1968.

Franklin, Gary, "DVM specs", *Electronic Products*, pp. 76-88, Nov. 1968.

¹ Fred L. Hanson, "Effects of Distortion on Calibration", *Hewlett-Packard Journal*, Vol. 19, No. 10, pp 6-7, June 1968.

INFORMATION RETRIEVAL

Instruments and measurements



STATIC SHIFT REGISTERS — Very mod, very new, very reliable. AMI/MOS shift registers are available *now*, in quantity, at very low prices to make your system very special in performance, price and predictability. Our Dual 100 plugs into existing systems pin-for-pin. Both dynamic and static shift registers are available, to get you from DC to 10 MHz. For details, write, call, or better yet, hop a jet and visit our new production facility — America's largest.

NOW IN PRODUCTION NEW SHIFT FAMILY



AMERICAN MICRO-SYSTEMS, INC.

3800 Homestead Road, Santa Clara, California 95051
Telephone 408-246-0330, TWX 910-338-0018
CUSTOM & STANDARD MOS ARRAYS/MEMORIES/REGISTERS/LOGIC





Several hundred thousand unfair advantages.

There you are, busting your back trying to beat another company to market with a new, improved electronic Thing.

Everything looks good — up to the point where sub-assembly X has to be connected to board B. And you've never seen a connection like that before.

What do you do now? Take an R&D break? Give a connector-maker a panic call, and half your budget, to develop a special?

Sweat not. We're sitting over here with several hundred thousand different connectors. Most of them were specials, once. Many of them are patented. And all of them are ready. Now.

Card edge connectors. Two-piece PC connectors. Board-to-board connectors. Miniatures. Sub-miniatures. Dual-in-Line receptacles. Back panel metal plates. Rack and panel connectors. Mil spec cylindrical connectors. Tube and transistor sockets. Even new Mojo™ modular card edge connectors which you sort of invent as you go along. All available with the respected Varicon™ metal-to-metal connection that fully meets Mil-E-5400.

Because they're ready, you get a jump on your competitor while he re-invents one. Because they're standard, you put your Thing together for less money than he can. It may be unfair. But it's fun. And profitable.

But what if we *don't* have a standard for you? Still no problem. Because, with hundreds of thousands of different connectors already behind us, your special will just be a not-quite-standard. So we'll be able to save a lot of time and R&D, too.

We have several pounds of catalog, containing more information about connectors than you probably care to have. So don't just send back a reader information card. Call, write, wire, or TWX us, and tell us either your specific problem or your general field of interest. We'll send you the pertinent few ounces.

Elco Corporation, Willow Grove, Pa. 19090. (215) 659-7000 TWX 510-665-5573.



ELCO Connectors

HICKOK

DMS 3200 DIGITAL MEASURING SYSTEM (Fully solid state with IC's)



This all-solid-state precision measurement system offers unlimited expansion capability through plug-in additions, resulting in a specialized instrument for each type of measurement. New plug-ins now broaden the measurement capability of this field-proven unit. Over 10,000 are in use at present.

Scaling controls make possible resolution of up to seven digits on the three-digit display by utilizing the overrange capability of many of the plug-ins, thus providing high resolution and accuracy with minimum investment. Companion devices such as the PR 4900 Digital Printer and 1050 Digital Set-Point Controller further extend the utility of the DMS 3200 System.



DC VOLTMETER PLUG-IN DP 100 \$175
00.1 mv to 999. volts
± 0.1% rdg ± 1 digit

DC MICROVOLTMETER PLUG-IN DP 110 \$475
0.001 mv to 999.9 volts
± 0.05% rdg ± 1 digit
4-digit resolution

AC VOLTMETER PLUG-IN DP 130 \$395
0.01 mv to 999. volts
± 0.1% rdg ± 1 digit
22 Hz to 1.0 MHz

EVENT COUNTER/SLAVE PLUG-IN DP 140 \$100
Up to 1,000,000 counts/sec
Cascade with second DMS to
obtain 6-digit display

1 MHz COUNTER PLUG-IN DP 150A \$255
00.1 Hz to 999. kHz
± 0.0005% rdg ± 1 digit
7-digit resolution

80 MHz COUNTER PLUG-IN DP 160 \$395
00.1 Hz to 80.0 MHz
± 0.00005% rdg ± 1 digit
7-digit resolution

OHMMETER PLUG-IN DP 170 \$295
.001 ohm to 999. megohms
± 0.1% rdg ± 1 digit
Microamp test current

CAPACITY METER PLUG-IN DP 200 \$295
.001 picrofarad to 9,999 mfd
± 0.1% rdg ± 1 digit
Low DC test voltage

TIME INTERVAL METER PLUG-IN DP 210 \$295
0.01 ms to 999. seconds
± 0.0005% rdg ± 1 digit
Period or time interval

DC CURRENT METER ADAPTER D 310 \$100
.0001 microamp to 9.99 amps
± 0.15% rdg ± 1 digit

EEs GET AHEAD

"... Engineers are builders of useful things ..."



*Dr. Malcolm R. Currie
Vice President, R & D*

Dr. Malcolm R. Currie has recently been appointed to the new position of vice president-research and development for Beckman Instruments, Inc.

One of his key tasks is directing the combination of various disciplines into the new hybrid technologies involving electronics, biochemistry, biomedical and process instrumentation. "It's often difficult to join individual disciplines because of their diverse origins and languages," he observes. "But it's essential in the measurement field, and when it's done successfully, the technical and economic gains can be enormous.

"The variety is enormous, too. Measurement is essential to scientific progress. The development of useful new instruments involves you in medicine, industry, research, education—just about any field you can name."

Dr. Currie views engineers as builders of things that are useful, socially and economically. "Engineers have to get involved in many activities to be really productive. Management, for example : you can't separate management from engineering in a company like ours. Good engineers need personal involvements and broad perspective on the world around them to be fully effective in their disciplines and their organizations."

Dr. Currie joined Beckman after 14 years with the Hughes Aircraft Co., where he was a vice-president and manager of the Research and Development Division.

He holds an AB degree in physics, and MS and PhD degrees in electrical engineering, all from UC Berkeley. He has taught electrical engineering at Berkeley and UCLA and has won many awards, including being selected as the Nation's Outstanding Young EE by Eta Kappa Nu in 1958.

HICKOK ELECTRICAL INSTRUMENT COMPANY, 10514 Dupont Ave., Cleveland, Ohio 44108

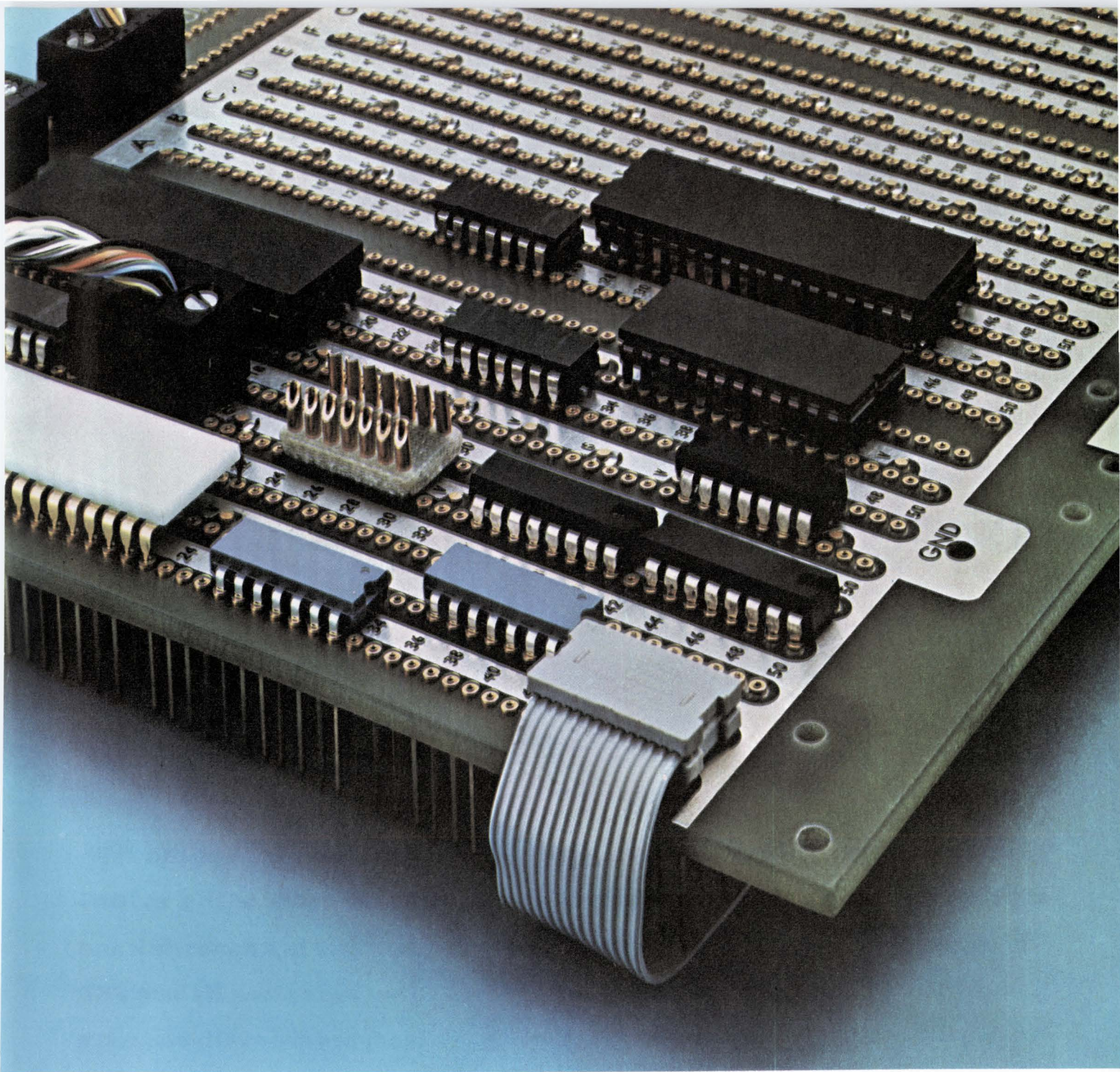

Plug in anything

Let Augat's new universal board provide complete flexibility in IC packaging and prototyping.

You can plug in any dual-in-line IC including popular 14, 16, 24 or 36 packages. The rows of contacts also accommodate our adaptor plugs for interposing discrete components and plugs for I-O connections and interfacing. Board also accepts Augat's new 14-pin, flat cable plug with unique patented design permitting fast assembly without stripping the wire. Plugs directly into IC socket pattern.

Universal board is available in modules of 9 rows with 50 contacts to a row up to 6 modules. Additional pins

are tied in to power and ground planes are strategically located . . . easily accessible. No interference with IC patterns. Like all Augat panels, board is available automatically wrapped to your specifications.

Why be restricted in your packaging and prototyping? Let Augat open the door to greater flexibility.

Call us, (617) 222-2202, or write for our complete IC folder. Augat Inc.
30 Perry Ave. Attleboro, Mass. 02703.

AUGAT^{INC.}

Now switch analog at digital speeds...

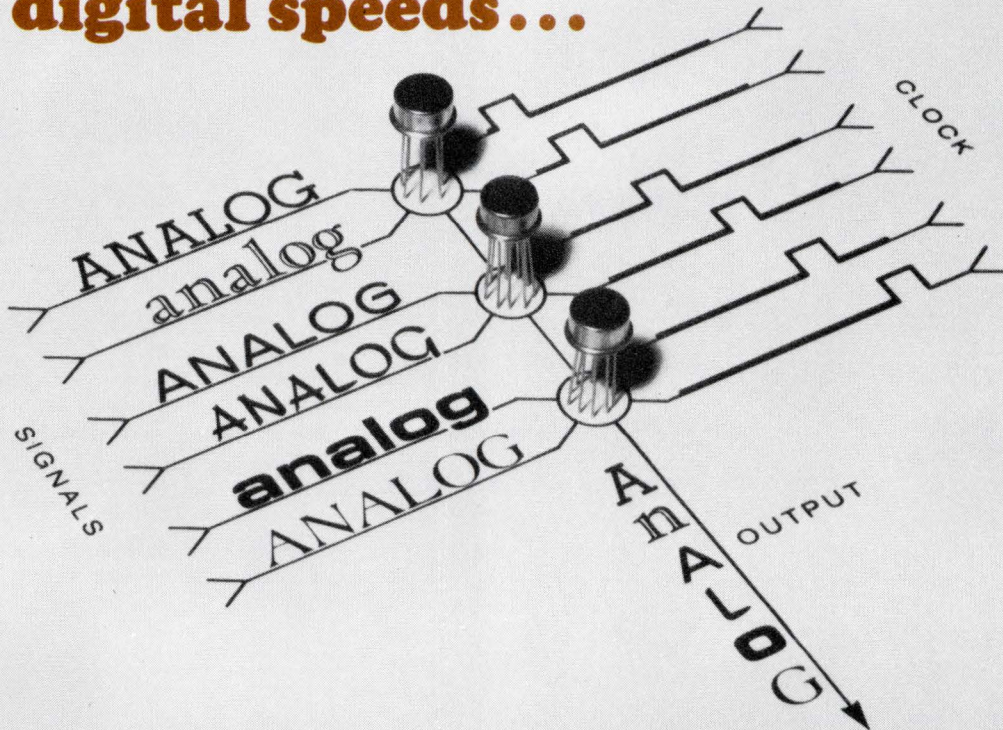

...and leave the driving to us

“Logic really turns us on”, say our Hybrid FET Analog Gates with built-in driving circuitry. And turn on they do, in as little as 20 nanoseconds with a 10^8 ON/OFF ratio.



If you need a gate that operates in a nanowink and has an ON/OFF ratio like a knife switch,

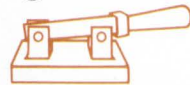

we have stock Hybrid FET Analog Gates that fit this description to a



Five types are available, with R_{ON} as low as 6 ohms and speeds to 20 nanoseconds. [Shown above is our CAG13 Dual FET Analog Gate.]

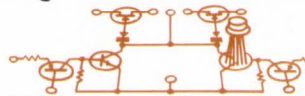

All types include drive circuits for direct operation from DTL or TTL. They're fully described in our 24-page

“Condensed Compendium Containing Comprehensively Characterized Hybrid ICs”. It's yours for the asking.



CRYSTALONICS

A TELEDYNE COMPANY

147 Sherman St. • Cambridge, Mass. • 02140

CALL YOUR LOCAL CRYSTALONICS OFFICE FOR DETAILS

(201) 835-0332	(305) 647-4000	(415) 349-6316	(609) 784-5000
(206) 323-5100	(305) 531-0200	(416) 751-5980	(612) 488-6634
(213) 466-6201	(312) 547-6200	(505) 268-0928	(617) 491-1670
(213) 469-5871	(313) 474-0661	(513) 299-4144	(617) 891-4582
(214) 348-4283	(315) 446-5920	(514) 331-4884	(816) 471-2850
(301) 668-4646	(317) 546-4967	(516) 593-2628	(914) 452-5730
(303) 798-8439	(319) 363-6425	(602) 277-9739	(919) 226-8053

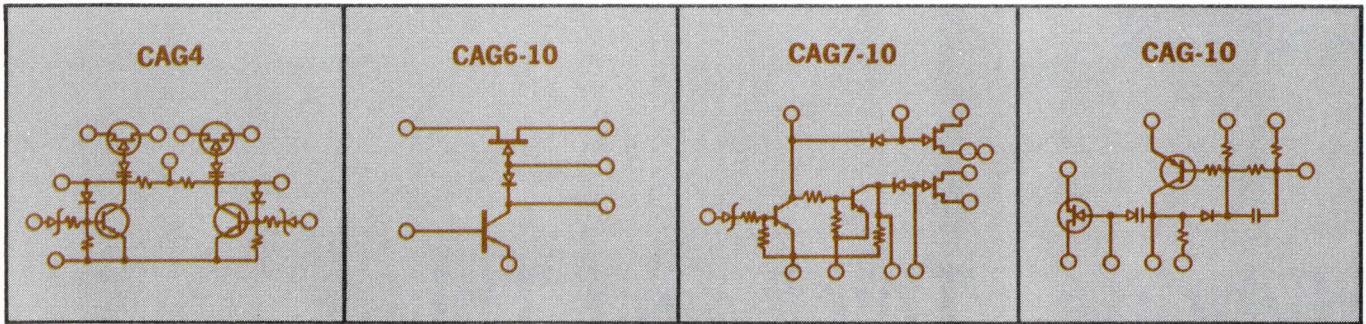

FET ANALOG GATES (OPERATE DIRECTLY FROM DTL OR TTL)

TYPE	FUNCTION	MAX. RON (OHMS)	MAX. VSIG (VOLTS)	MAXIMUM SWITCHING TIME (μSEC)	SUPPLY VOLTS	PACKAGE	100-999 PRICE
CAG4	DUAL SPST	50	- 9 to +10	0.5	±15	T0-5	\$40.00
CAG6 ¹	SPST	6	- 5 to +10	0.7	±15	T0-5	22.00
CAG6-10 ¹	SPST	10	- 5 to +10	0.7	±15	T0-5	20.00
CAG7	SPDT or DPST	6	- 5 to +10	1.5	±15	T0-8	50.00
CAG7-10	SPDT or DPST	10	- 5 to +10	1.5	±15	T0-8	39.70
CAG10	SPST	30	- 5 to + 5	0.05	±15	T0-5	28.00
CAG10B	SPST	50	-10 to + 5	0.05	±15	T0-5	28.00
CAG13	DUAL SPST	50	- 9 to +10	0.5	±15	T0-5	33.50

¹Require 0 to +15V Drive Signal

D/A SPDT LADDER SWITCHES FOR R/2R LADDERS (OPERATE DIRECTLY FROM DTL OR TTL — SWITCH BETWEEN REFERENCE & GROUND)

TYPE	REFERENCE VOLTAGE	TYPICAL RON (OHMS)	ACCURACY ² IN BITS	SWITCHING TIME (μSEC)	PACKAGE	100-999 PRICE
CDA1-1	-15	5	12	1.0	T0-5	\$ 29.50
CDA1-2	-15	5	12	1.0	T0-5	43.00
CDA1-3	-10	5	12	1.0	T0-5	20.00
CDA1-3S12 ³	-10	5 ± 1	14	1.0	T0-5	240.00
CDA1-3S14 ⁴	-10	5 ± 1/2	15	1.0	T0-5	280.00
CMDA1	-10	10	11	1.0	D.I.P.	13.00
CMDA1A	-10	5	12	1.0	D.I.P.	14.35
CMDA1S14 ⁴	-10	5 ± 1	15	1.0	D.I.P.	190.00
CDA2-1 ⁵	0 to +20	25 ± 5	—	3.0	T0-5	40.00
CDA2-2 ⁵	0 to +20	30 ± 10	—	3.0	T0-5	35.00
CDA2-3 ⁵	±10	25 ± 5	—	3.0	T0-5	35.00
CDA2-4 ⁵	±10	30 ± 10	—	3.0	T0-5	28.00
CDA4A	+10	5	12	0.6	T0-5	25.50
CDA5	±4	10	11	3.0	1/4" x 1/4" FLAT PACK	24.00
CDA6	±10	5	12	0.7	T0-5	35.00
CDA10 ⁶	-20	5	12	2.0	T0-8	48.00
CDA11 ⁷	-10	5	12	1.0	T0-8	120.00
CDA11S12 ⁸	-10	5 ± 2	13	1.0	T0-8	360.00
CDAL1	8-BIT 10K/20K LADDER WITH 10-BIT ACCURACY				T0-5	60.00
CDAS1	COMPLETE 8-BIT CONVERTER WITH 10-BIT ACCURACY				T0-8	\$300.00

²Based on 10K/20K ladder

³12-unit set, most significant bits color-coded

⁴14-unit set, most significant bits color-coded

⁸3-unit set, most significant bits color-coded

⁵Dual SPST for current-summing conversion

⁶2 circuits per package

⁷4 circuits per package

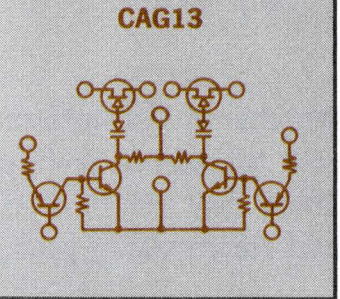

CDA1-1 & -2

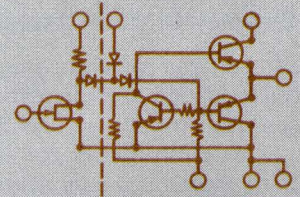

CDA1-3 CMDA1 CDA11

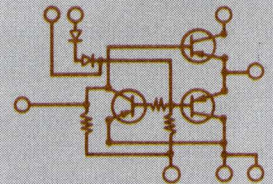

CDA2 - 1 through 4

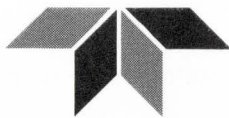
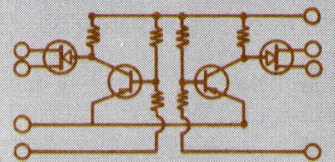

CRYSTALONICS

A TELEDYNE COMPANY

147 Sherman St. • Cambridge, Mass. • 02140

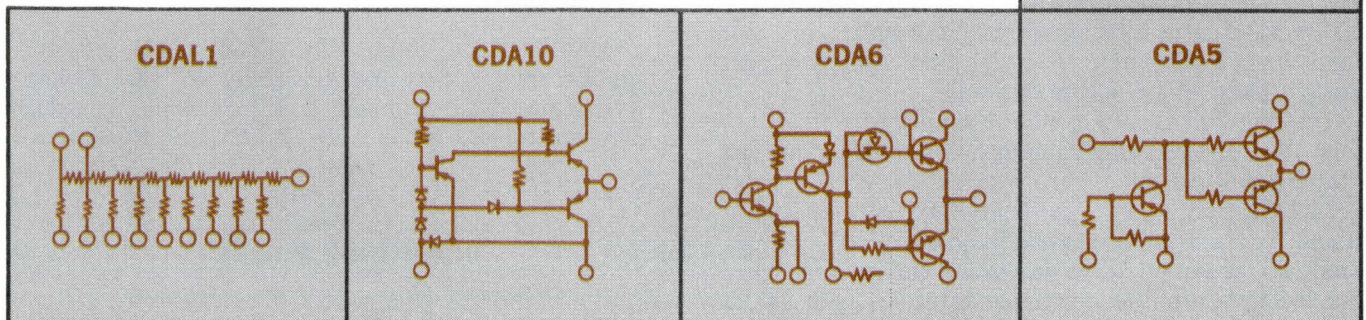

Hybrids... Thick and Thin

Whether you plan to build or buy, you should be familiar with the steps involved in making hybrid circuits.

There may also be a point at which you will want to stop buying and start making your own. These charts should help you decide.

By Smedley B. Ruth, Associate Editor

The number of companies setting up hybrid circuit facilities, both for their own use and for sale to others, is growing by leaps and bounds. Still others have chosen to compromise for various reasons. They don't wish to purchase completed circuits, but neither do they want to install a complete hybrid facility.

A look at the charts on pages 62-65 will show the steps involved in fabricating both thick and thin film circuits. From these you can see that there are many possibilities for compromise. For example, it's possible to enter the thick film process at step 8 by purchasing the substrate complete with resistors and conductors already screened in place. You may then purchase capacitor and semiconductor chips for in-house mounting, testing and packaging.

Or, perhaps you feel that a particular resistor composition you have developed should be screened and fired in-house. Fine, then enter the process sequence at step 5.

Whether you plan to build, buy or compromise, the accompanying charts should give you some feel for the alternatives available. With them you can also get an idea of the equipment you would need for each step. Thus, for the thick film process you might need: drafting equipment (steps 1 and 2); camera system (steps 3 and 4); ultrasonic or other cleaners, inks, screen printer, and conveyor furnace (step 5); abrasive or laser trimmer (step 6); glass composition (step 7); thermocompression or ultrasonic bonder and chip handler (step 8); welder (step 9); and test equipment (steps 10 and others where desired).

The thin film process could be similarly evaluated—deposition or sputtering equipment (step 4), photoresist (step 5) and so forth.

The most important ingredient of a successful hybrid circuit venture is, of course, knowledgeable people. They would know the intricacies of the various steps. For example, how to determine resistor length, width

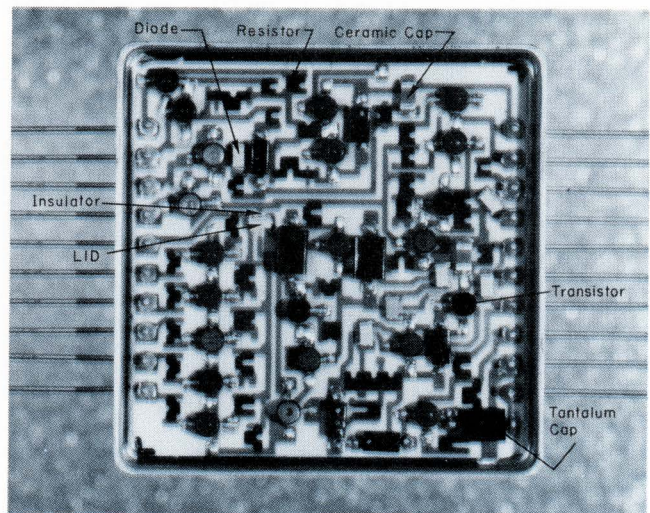

Callouts on this amplifier/pulse generator photo show component parts of a thick film circuit. (Lansdale Microelectronics Inc.)

and form factor or how the firing profile affects resistor compositions.

Methods of making hybrid circuits may vary somewhat from those described here, but these are representative. Various manufacturers may change the sequence or they may use different inks, but their overall methods are probably similar.

Acknowledgements

Many thanks to those who helped supply information for this report, and especially to Joel Cohen, Crystalonics; Matt Romano and Jack Dale, Lansdale Microelectronics; Richard S. Ringer, Electro-Science Laboratories, Inc.; and John Kukulka, Tele-Dynamics Division of American Bosch Arma.

INFORMATION RETRIEVAL

Integrated circuits, Materials, Packaging

Typical Characteristics of Common Substrate Materials

Material	Thermal coeff. of expansion (10 ⁻⁶ /°C)	Thermal Cond. cal cm/cm ² /S/°C at 25°C	Softening temp. (°C)	Density (g/cm ³)	Die. cons. at 1 MHz (at 25°C)	Log. Vol. resis. (Ω-cm) at 25°C	Die. strength at 60 Hz (V/mil)
Alumina (96% Al ₂ O ₃)	6.4	0.084	1550	3.7	9.2	>10 ¹⁴	210
Barium Titanate (BaTiO ₃)	8.1	0.003	1550	5.5	6500	12.0	—
Beryllia (99.5% BeO)	6.4	0.59	1500	2.8	6.5	>10 ¹⁴	220
Glass (7059)	4.5	0.002	870	2.7	5.8	>13.5	—
Steatite	6.9	0.014	1000	2.7	6.3	>10 ¹⁴	230

Typical Properties of Thick Film Conductors

Material	Resist. (Ω/sq)	Firing temp. (°C)	Solderability	Si Chip attachment	Bonding	Adhesion
Pt-Au	0.05-0.10	760-1000	Any lead/tin solder or gold alloys	With gold alloy pre-forms & heat	TC or soldering	Exc. on Alumina & Steatite. Good on Beryllia
Pd-Au	0.05-0.10	760-1000	Any lead/tin solder or gold alloys	With gold alloy pre-forms & heat	TC, par. gap weld	Exc. on Alumina & Steatite. Good on Beryllia
Au	0.003-0.01	750-950	Tin/lead solder (60/40) AuSi, AuSn	Directly with heat & scrubbing	Ultrasonic, TC	Good on Alumina & Steatite. Fair on Beryllia.
Pd-Ag	0.01-0.05	750-950	Tin lead or tin silver or tin-lead-silver	With pre-soldered land areas	TC, par. gap weld solder	VG on Alumina & Steatite. Good on Beryllia.
Ag	0.005-0.01	500-800	Readily soldered	—	TC ultrasonic	Exc.

Common Dielectrics

Materials	Application	Process	Die. cons.	Breakdown volt	Char. cap. pF/sq. mil	Temp. coef. ppm/°C
Barium Titanate BaTiO ₃	thick	screen print	25	>100	0.32	±300
Silicon Monoxide (SiO)	thin	vac. evap.	6	50	0.01	+110
Silicon Dioxide (SiO ₂)	thin	vac. evap.	3.8	50	0.3	±200
Aluminum Oxide (Al ₂ O ₃)	thin	vapor plating	9.8	25	0.3	+125
Tantalum Pentoxide (Ta ₂ O ₅)	thin	reactive sputtering	25	25	2.5	+300
Glass-Ceramic	crossover	screen print	8	<500	—	—

Thin film process

Step 1—Circuit design. Circuit is first breadboarded to check its operation.

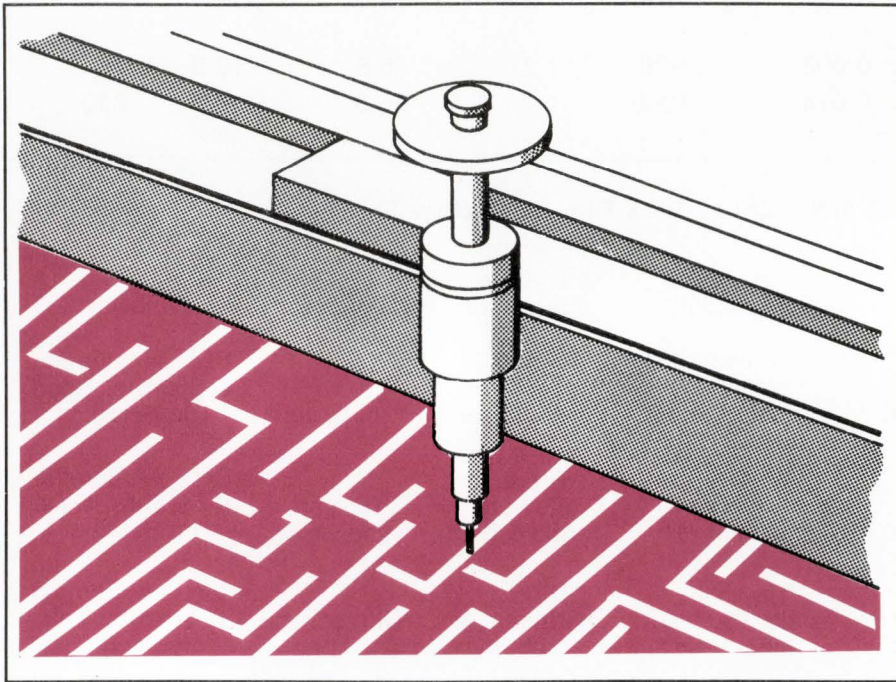

Step 2—Circuit layout. Circuit schematic is laid out as separate oversize drawings of each circuit layer. Conductor, resistor and capacitor (if deposited capacitors are to be used) patterns and discrete component placement are included. A highly accurate coordinatograph (± 0.00005 in. on final image) is then used to make the necessary artwork.

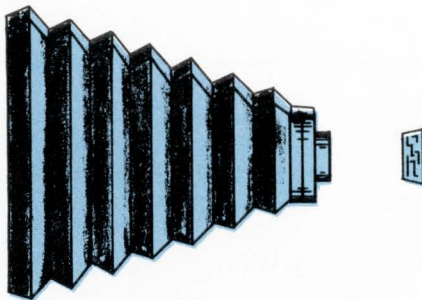

Step 3—Photographic reduction. The oversized circuit layouts are reduced to a fraction of their size by microphotography. Further processing yields high resolution photo-masks.

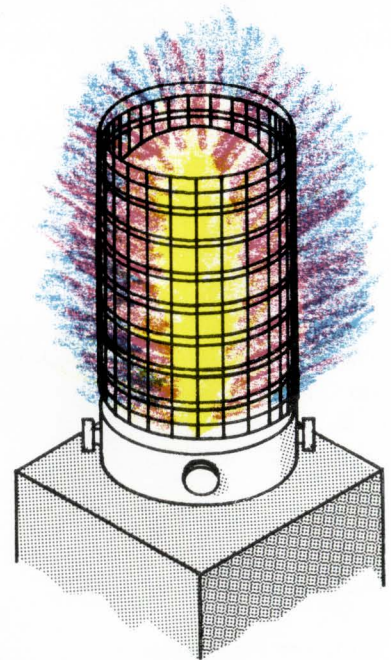

Step 4—Deposition. Various films that make up the resistive and conductive patterns are deposited on the carefully cleaned substrate, either by cathodic sputtering or by vapor deposition. First to be deposited is a coating of nickel chromium (or similar material). Next, the conductive material is deposited or plated on the substrate.

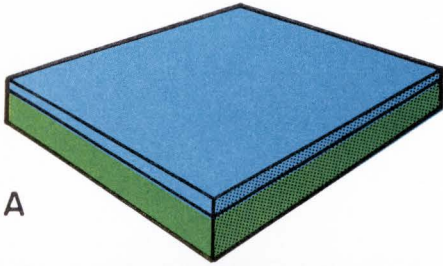

A

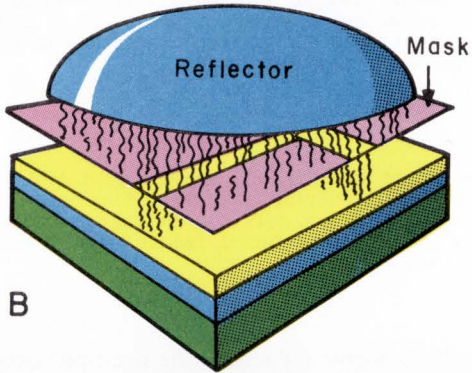

B

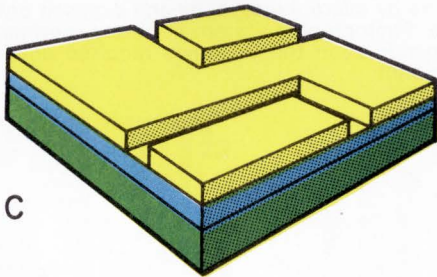

C

Step 5—Photoetch. (a) A layer of photoresist is now applied. (b) The photoresist (either wet or dry) is then exposed to ultra-violet light through the photomask containing the conductor pattern. (c) The unprotected areas are then chemically etched to form the conductor pattern. This process is repeated using the other mask to establish the resistor pattern. (Capacitors are made with conductors and oxides). Two different acids are used to etch—one type attacks the conductor and not the resistor, the other attacks the resistor and not the conductor. Photoetch sequence may be different for various manufacturers.

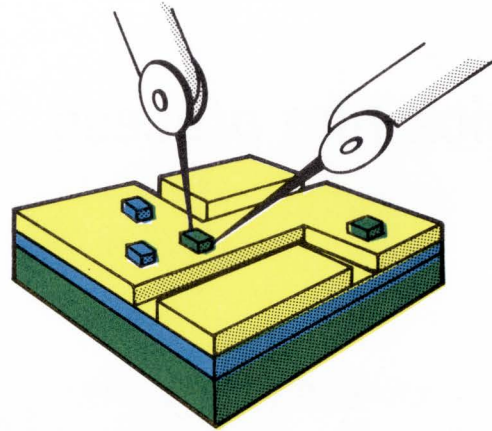

Step 6—Resistor trim. Resistors are next tested and, if necessary, electrically, mechanically or laser trimmed to value.

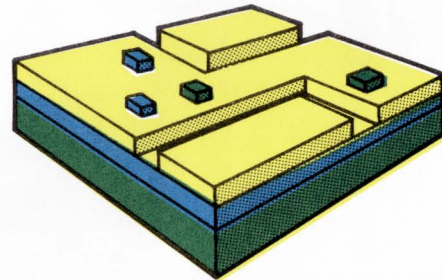

Step 7—Device mounting. Discrete components are now mounted on the substrate. The connections can be made by various means such as thermal compression or ultrasonic wire bonding. Unit is now visually inspected and electrically tested. Device and substrate (see step 8) mounting steps may be reversed in order.

Step 8—Substrate mounting. The substrate is now mounted in the package and the unit is again tested.

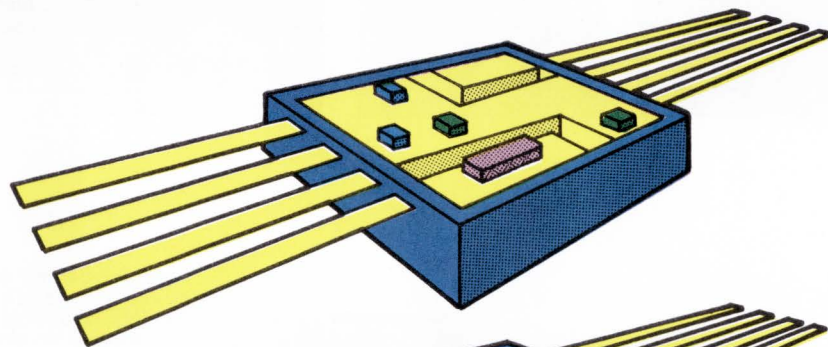

Step 9—Package sealing. Package is now sealed and further tests conducted (centrifuge, leak, and so forth) if desired.

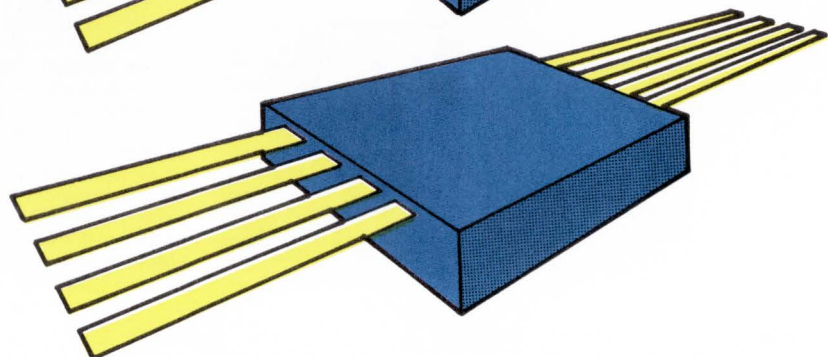

Thick film process

Step 1—Circuit design. Circuit is breadboarded to check its operation. A layout showing circuit paths, resistor patterns and discrete component locations on the hybrid substrate is then made.

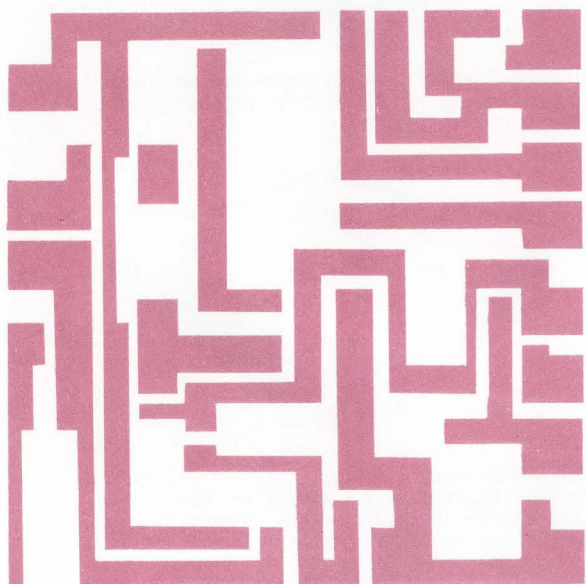

Step 2—Circuit layout. This circuit layout is transferred to a photolithographic drafting film on a light table (or the more accurate coordinatograph). Separate films are cut for conductor, resistor, glass overlay and crossover patterns.

Step 3—Photographic reduction. The oversized circuit layout, generally 10 to 20 times actual size, is reduced to its final size by microphotography and exposed onto a glass slide. Photographic system accuracy (normally 0.1 mil) depends upon the tolerance required on the completed circuit.

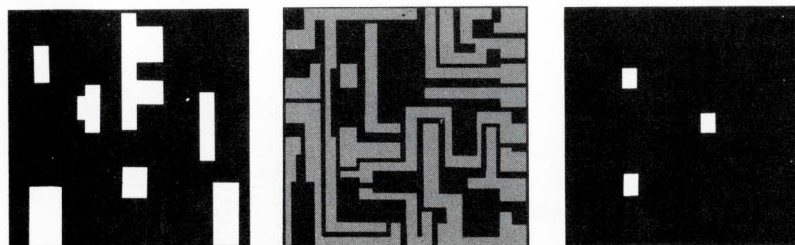
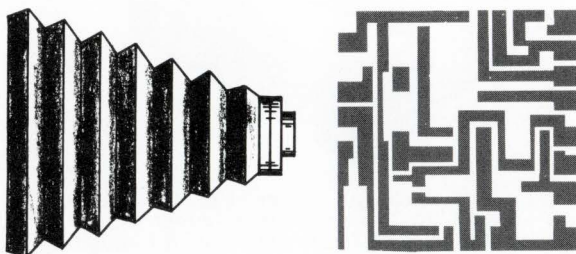

Step 4—Screen makeup. The slides are exposed onto a photosensitized, fine (150-350 wires/in.) mesh stainless steel screen. This screen which is placed in a cast aluminum frame, is used to screen print the resistor, conductor and dielectric patterns onto a substrate.

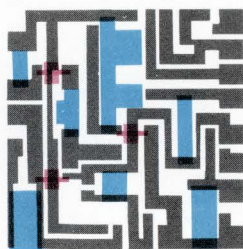

Step 5—Screen and fire. After the substrate is thoroughly cleaned, a slurry of carefully selected conductive ink is printed on it (by passing a squeegee over the screen, forcing ink through the exposed portion of the screen). The conductor pattern is printed first. The substrate is then fired at required temperatures (typically 750°C to 1000°C) in zoned conveyor belt furnaces or kilns. There are usually four to eight separately controlled zones with highest temperature firing first so that later firings will have minimal effects on previously fired patterns. The resistor pattern is similarly obtained, as are the dielectric and crossover patterns if needed. The firing operation also serves to stabilize the resistors.

Step 6—Trim resistors.

Resistors are trimmed, usually by an air abrasive method or by a laser. The process is such that the resistors are usually purposely screened to be lower in value than that ultimately desired. Thus, when resistance material is carefully removed, the desired value can be obtained to a closer tolerance (2 to 5% is common, but >1% is possible).

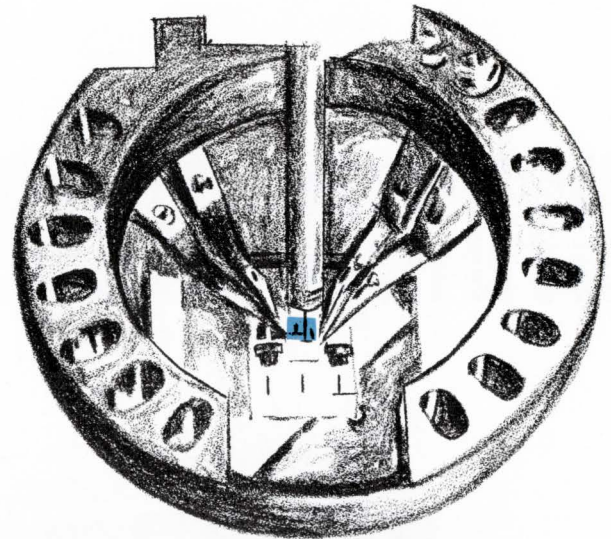
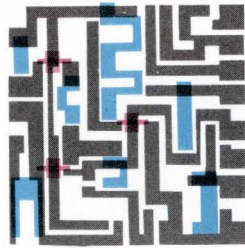

Step 7—Surface protection.

A layer of glass can be selectively screened and fired in place to protect less stable resistors. Glass can also be used for crossovers.

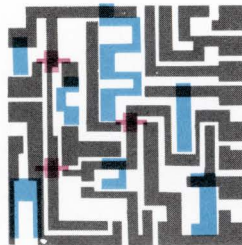

Step 8—Mount devices.

Semiconductor and other components such as chip capacitors can now be mounted on the substrate. Device and substrate (see step 9) mounting steps may be reversed in order. When small substrates must be mounted in miniature packages, the substrate is usually mounted first and then the components are mounted.

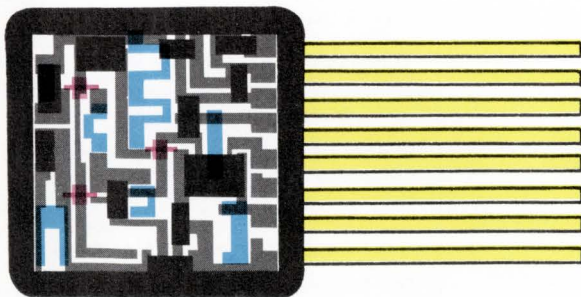
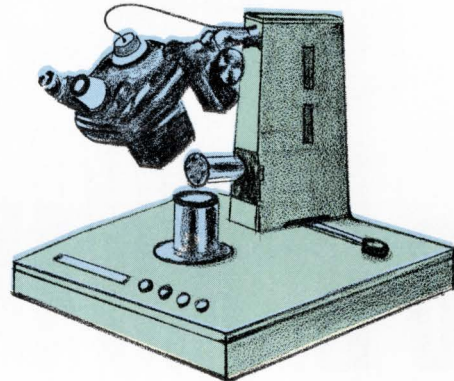
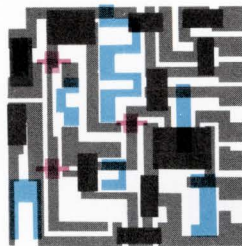

Step 9—Package. The substrate is placed in the package and the leads are attached. (Refer to article "Design guide to hybrid package size," September issue of *The Electronic Engineer*). The package lid may then be put on or the package encapsulated.

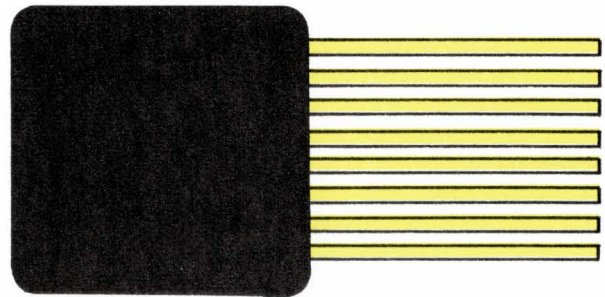

Step 10—Test. A final test is performed to insure that all operations have been successful. Testing (or monitoring) is also normally performed at each manufacturing stage. Purpose is to assure a one-to-one transfer ratio from the original discrete breadboard, and to check for defects.

HYBRID CIRCUITS

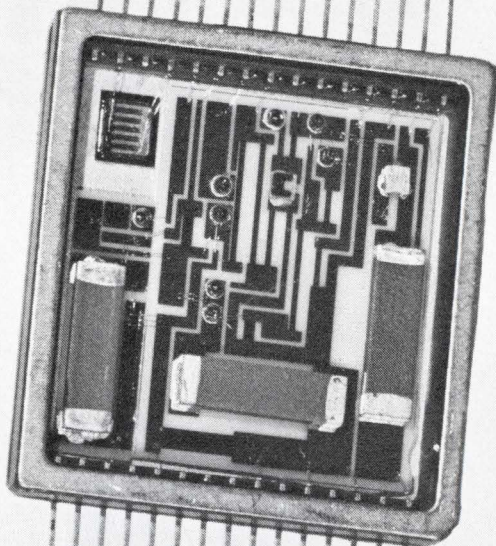

we make them!

DESIGNED AND BUILT TO YOUR SPECIFICATIONS
WRITE OR CALL FOR FURTHER INFORMATION



WEMS, INC. 4650 WEST ROSECRANS AVENUE

HAWTHORNE, CALIF. 90250 ■ TELEPHONE (213) 679-9181

An equal opportunity employer.

Circle 43 on Inquiry Card

READ THESE BOOKS

For more information about these books (sorry, no free copies), circle the corresponding number on the reader inquiry card.

Introduction to Large-Scale Integration

By Adi J. Khambata. Published 1969 by John Wiley & Sons Inc., 605 Third Ave., New York, N. Y. 10016. Price \$9.95. 196 pages.

This introductory text is probably the industry's first book that is devoted entirely to the field of large-scale integration. The book, written in a readable style, is oriented to the user's point of view. It is specifically intended for management, marketing, field service, and technical people who are new to this field.

For the convenience of the reader who may not desire to read it in sequence, the book is divided into four sections, each containing chapters on related topics. The first section discusses device and technology aspects of LSI; the second section covers the systems aspects; the third section covers aspects of application, and the fourth section covers other topics related to LSI.

Circle 323 on Inquiry Card

NFPA Handbook of the National Electrical Code

By Frank Stefka. Published 1969 by McGraw-Hill Book Co., 330 W. 42nd St., New York, N.Y. 10036. Price \$12.75. 694 pages.

Circle 324 on Inquiry Card

Electronic Devices and Circuits, Vol. II

By G. J. Pridham. Published 1969 by Pergamon Press Ltd., Headington Hill Hall, Oxford 4 & 5 Fitzroy Sq., London W. 1, England. Price \$5.50. 345 pages.

Circle 325 on Inquiry Card

Matrix-Computer Methods in Engineering

By L. A. Pipes and S. A. Hovanessian. Published 1969 by John Wiley & Sons Inc., 605 Third Ave., New York, N.Y. 10016. Price \$12.95. 333 pages.

Circle 326 on Inquiry Card

Semiconductor Silicon

Edited by Rolf R. Haberecht and Edward L. Kern. Published 1969 by The Electrochemical Society Inc., 30 E. 42nd St., New York, N.Y. 10017. Price \$10.00. 766 pages.

Circle 327 on Inquiry Card

Transistor and Thyristor Diode Manual

Published by RCA Electronic Components Div., Harrison, N.J. 07029. Price \$2.50. 656 pages.

Circle 328 on Inquiry Card

Formal Languages and their Relation to Automata

By John E. Hopcroft and Jerry D. Ullman. Published by Addison-Wesley Publishing Co., Reading, Mass. 01867. Price \$11.95. 24 pages.

Circle 329 on Inquiry Card

The Supervisor in On-the-Job Training

By Martin M. Broadwell. Published 1969 by Addison-Wesley Publishing Co., Inc., Reading, Mass. 01867. Price \$4.95. 132 pages.

Circle 330 on Inquiry Card

Understand and Using Unijunction Transistors

By Stu Hoberman. Published by Howard W. Sams & Co., Inc., Indianapolis, Indiana 46268. Price \$2.50. 95 pages.

Circle 331 on Inquiry Card



*The
Standard of
Excellence*

S/D D/S converters by CLIFTON

Excellent means — “first class, of great worth, eminently good.” Definite qualities of our ADverter S/D, D/S converters. But we should add one other feature: *not expensive!* (Model SD12A1, \$795 qty. 1-9.)

In fact, their low cost, combined with such other features as: reliable, all solid state circuitry, easily interchangeable

encapsulated sub-modules, no calibration or adjustments, multi-channel capability, wide variety of options, make them superior in many ways to brush encoders.

Although designed especially for the process control and machine tool fields, this system can easily be modified for military applications.

So take advantage of our

application engineering know-how which is yours for the asking. Call our DITRAN division in Burlington, Mass. (617) 272-6210, or your local Clifton sales office. When you consider Litton, Clifton, Ditrans quality, you couldn't do better!

CLIFTON 
DIVISION OF LITTON INDUSTRIES

Pearls by J. E. Caldwell Co., Philadelphia—\$5,600

Mixed up in mixers? Try an HCD

Hot-carrier diodes (HCDs) approach ideal Schottky-barrier junction operation. Such junctions virtually eliminate stored charge and extend the device's high-frequency performance.

By **Aki Tanaka**, Sr. Prod. Engr.,
and **Suleyman Sir**, Applic. Engr.,
Fairchild Semiconductor, Mountain View, Calif.

Hot-carrier diodes (HCDs) have a number of applications in many areas. Typical of such applications are: clamping, sampling, and gating circuits; logarithmic converters; limiters; discriminators; switches; detectors; and mixers. The largest customer today is the TV receiver manufacturer who uses the non-linear impedance of the HCD junction in mixers and detectors; and so this article concerns itself with HCD mixers. But before delving into the whys and wherefores, you should become familiar with the equivalent circuit model of the hot-carrier diode.

Figure 1 represents the HCD. You can use this figure, together with the diode equations

$$I = I_s (\epsilon^{qV/nkT} - 1) = I_s (\epsilon^{V/0.026} - 1), \quad (1)$$

to describe general HCD operation at low and moderate currents. In the diode equations,

I_s = saturation current (about 50 nA for the Fairchild FH1100)

V = applied voltage

q = electronic charge, 1.6×10^{-19} coulombs

T = temperature, °K

k = Boltzmann's constant, 1.38×10^{-23} joules/°K

n = diode index, about 1.08 for the FH1100.

The diode index depends on the temperature, and on the currents generated in the trap sites at the metal-semiconductor interface. To round out the representation, and to show the HCD's superiority to the point-contact diode, Fig. 2 shows the current-voltage characteristics of both devices.

Junction parameters

Both the junction resistance, R_j , and the junction

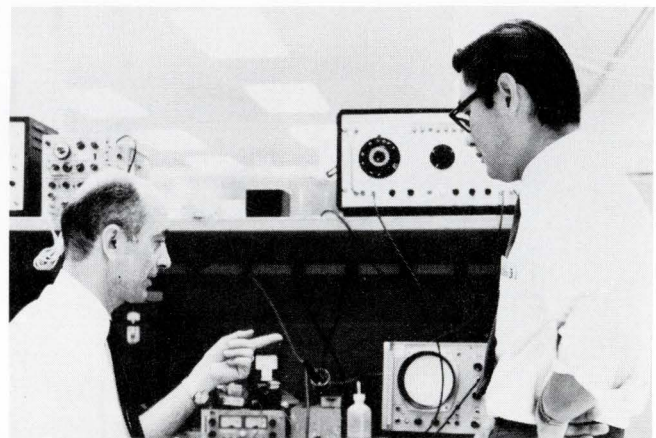

A team in action. Suleyman Sir, sitting at his test set-up in the applications lab, makes a point about a swept measurement to Aki Tanaka, of Diode Marketing.

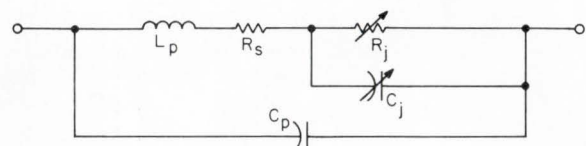

Fig. 1. Equivalent circuit model of a hot-carrier diode. The spreading resistance, R_s , and the junction resistance and capacitance, R_j and C_j , contribute to conversion loss, and thus are significant in determining noise figure. Improvements in processing technology continually reduce the magnitudes of the package parasitics, L_p and C_p .

capacitance, C_j , are functions of the current through the diode. From the diode equation,

$$R_j = \frac{V}{I} = \frac{26}{I_s} \epsilon^{-V/0.026} = \frac{0.026}{I_d}, \quad (2)$$

A **hot-carrier diode (HCD)** is a metal-to-semiconductor device with a single, non-linear (rectifying) junction. The theory of operation is based on work done by Schottky many years back. It is a majority-carrier conducting device—preferably of n-type semiconductor material with high-mobility electrons—with a virtual absence of minority carriers. This lack of minority carriers is a consequence of the Schottky barrier in the metal-semiconductor interface. Most devices of this sort are suitable for high-frequency and microwave applications, because they have very little stored charge.

The **p-n junction diode** cannot operate as high in frequency as can the HCD. For high-frequency applications, such as mixers and detectors, its long charge-storage time limits the usefulness of the p-n junction device. Further, in most applications it needs additional bias voltage because it has a higher ON-voltage than does the HCD. Mechanically, however, HCDs and p-n junction diodes are roughly equivalent to each other.

The **point-contact diode** is also inferior to the HCD, both electrically and mechanically. The HCD has the advantages of lower noise, higher conversion efficiency, larger square-law range, more uniform electrical performance, a higher breakdown voltage, a lower reverse current, and a better metal-silicon interface. And because the HCD is usually a planar epitaxial device, it can withstand larger energy pulses and higher power than can the point contact diode, and so is more reliable. Furthermore, the HCD surface is permanent, whereas the point-contact interface may change when subjected to mechanical disturbance. Although in theory both types operate as Schottky-barrier diodes, the HCD approaches the ideal more closely than does the point-contact diode. And this is the key to the HCD's superior microwave performance.

Compare HCD construction to that of the point-contact and p-n junction diodes, as represented in the sketches below. In particular, note how the metal-silicon junction of the HCD replaces the diffused junction of the p-n diode.

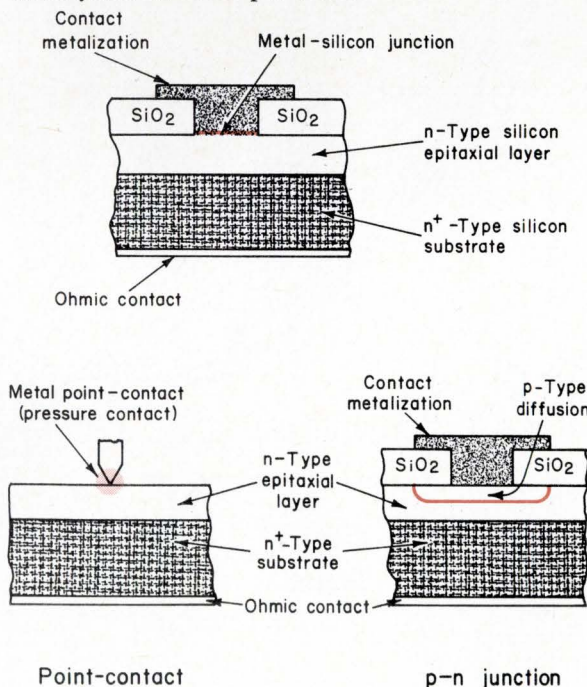

Diode operation. Both the point-contact diode and the HCD operate on the Schottky-barrier principle, while the p-n diode has a diffused junction. You can see the difference in their operation by means of the following energy-level diagrams.

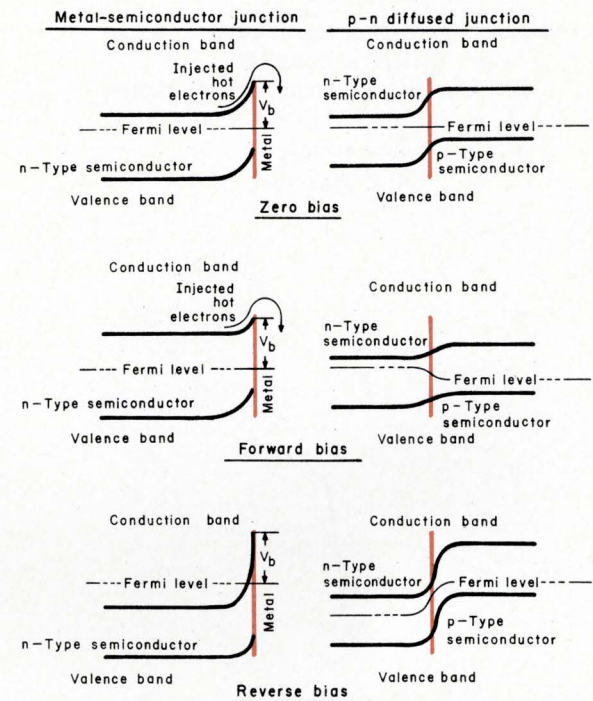

Forward biasing the HCD raises the energy of the electrons in the conduction band of the semiconductor material. They gain enough energy to overcome the barrier and inject themselves into the metal. See how, as forward bias increases, the barrier voltage decreases—the Schottky effect—and electrons flow freely into the metal. But reverse bias increases the barrier potential, so the electrons no longer have enough energy to inject themselves into the metal.

Note that the barrier potential as seen from the semiconductor side of the junction either increases or decreases with external bias. But the barrier potential as seen from the metal side of the junction is virtually unaffected by external bias—a phenomenon unique to metal-semiconductor junctions. And because the HCD's barrier potential is constant, independent of bias, electron flow from metal to semiconductor does not change. Thus, most of the current is due to electron flow from semiconductor to metal, while the minority-carrier current from metal to semiconductor is extremely small.

The p-n junction diode is another story. When you forward bias the junction, electrons diffuse across it into the p region. The carrier recombination rate limits the diffusion current. Now, when you apply reverse bias, electrons (minority carriers) flow back into the n region from the p region. These electrons—a stored charge—must be removed from the p region before the junction can operate normally again. This is the reason, mentioned earlier, that the HCD operates at a much higher frequency than the p-n junction diode: the HCD has very little stored charge under normal operating conditions.

where I_d is the instantaneous junction current in amperes, and R_j is in ohms.

The junction capacitance, C_j , is the depletion capacitance of the step junction.

$$C_j = \frac{C_j(0)}{\left[1 - \frac{V}{V_b}\right]^{1/2}} = \frac{\epsilon}{W} A, \quad (3)$$

where $C_j(0)$ = zero-bias capacitance
 ϵ = dielectric constant
 W = width of space-charge region
 A = junction area
 V = applied voltage
 V_b = built-in potential, about 0.45 eV.

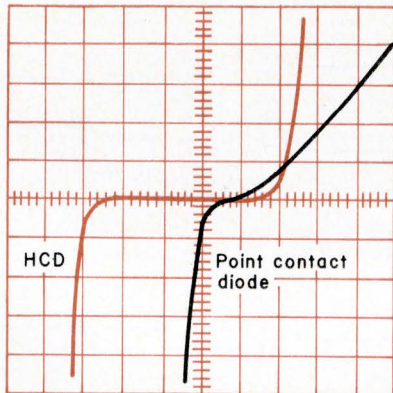

Fig. 2. A comparison of the forward and reverse dc curves of HCD and point-contact diodes clearly shows the superiority of the HCD. The forward characteristics in the first quadrant are scaled at 0.2 V/cm horizontal, 5 mA/cm vertical. The reverse characteristics in the third quadrant are scaled to 10 V/cm horizontal, 5 mA/cm vertical.

Mixing in brief

You can define a mixer as a device that converts a high frequency to a low frequency by means of a local oscillator (LO) and a non-linear element. The incoming rf and LO signals couple into the non-linear element, and the LO signal forces the non-linear element to become a time-varying, active network. Under such conditions, the non-linear diode element generates harmonics. These contain the sum and difference of the incoming signal and the local oscillator signal, as well as other harmonics. The difference between the incoming rf and the LO signals is filtered out as the i-f signal out of the mixer.

Point-contact diodes were the only devices used as mixers in uhf TV tuners until 1966, when hot-carrier diodes became available. The HCDs gained widespread acceptance because of these advantages over point-contact diodes:

- Almost perfect current-voltage characteristics
- Higher reverse-breakdown voltages allow high LO drive levels
- Higher burn-out energy
- A high-frequency performance not limited by minority-carrier lifetimes
- Lower noise figure
- Greater reliability
- Mechanical stability
- Uniformity in production.

Mastering the mixer

Two key parameters in the design of a mixer are noise figure and conversion loss, because they have a pronounced effect on the sensitivity of a receiver system. The overall noise figure of a receiver, as defined by Friss, is

$$NF_r = L(t_x + NF_{i-f} - 1) \quad (4)$$

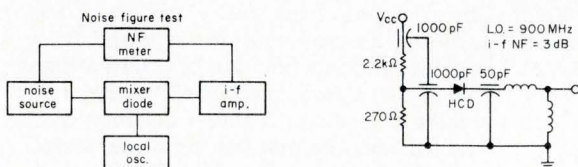
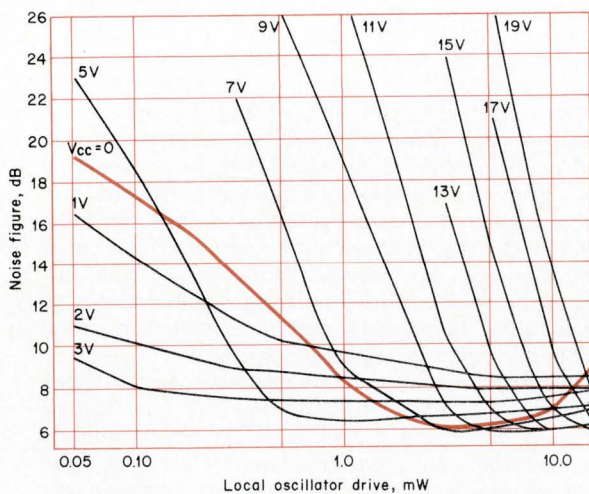

Fig. 3. Noise figure vs local oscillator drive level.

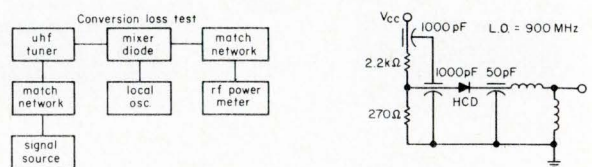
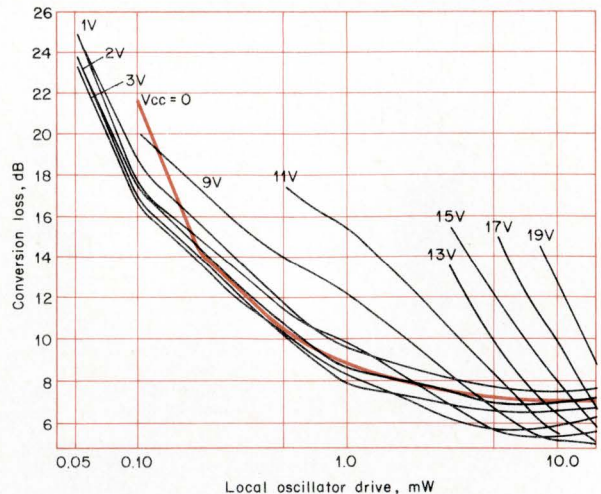

Fig. 4. Conversion loss vs local oscillator drive level.

where

NF_r = overall receiver-system noise figure

L = conversion loss

NF_{i-f} = i-f noise figure

$$t_x = \text{noise temperature of diode} = \bar{t} \left(1 - \frac{2}{L} \right) + \frac{2}{L} \quad (5)$$

where \bar{t} is the noise temperature that results from averaging the instantaneous values of diode noise as the LO power varies through one cycle. Any noise in the LO signal adds to \bar{t} .

Equation (4) applies to both broadband and narrowband systems. (To reduce LO radiation, by the way, uhf TV tuners are narrowband components.) Note that the values of t_x for broadband and narrowband systems are not the same.

To minimize the NF of any system, you must minimize the quantity $(\bar{t}_x + NF_{i-f} - 1)$. Remember that t_x depends on the LO drive level (and LO noise), as well as the noise generated in the diode itself. You can decrease LO noise with filters; but diode noise—caused by the spreading resistance R_s and the barrier resistance R_j —is not affected by filters. Therefore, to minimize system noise, you must simultaneously consider LO drive level, R_s , R_j , conversion loss, and i-f amplifier noise figure.

At some LO drive level a small forward or reverse bias may help the noise figure, because R_j is bias-dependent. If you do use bias in a uhf TV tuner, you should pay special attention to the LO level. Because this level is not constant across the uhf band, the bias may have an inverse effect at the low or high end of the band. Remember also that in the higher forward-current regions the diode deviates from its exponential behavior, and the diode equation becomes

$$I = I_s e^{q(V - IR_s)/nkT} \quad (6)$$

Loss reduction

The overall conversion loss L of a mixer is the sum of three separate losses,

$$L = L_1 + L_2 + L_3 \quad (7)$$

where L_1 = conversion loss due to rf and i-f mismatches

L_2 = conversion loss due to R_j , R_s , and C_j

L_3 = conversion loss due to R_j , R_s , and C_j tion.

You can reduce L_1 with matching circuits and filters to decrease the vswr at the rf and i-f ports.

The conversion loss in the junction, L_3 , depends on the diode's forward and reverse characteristics. You can calculate L_3 if you know the current-voltage characteristics, operating bias condition, LO drive level, and the mixed frequency.

The loss L_2 is a signal loss due to R_s , R_j , and C_j :

$$L_2 = 10 \log \left(1 + \frac{R_s}{R_j} + \omega^2 C_j^2 R_s R_j \right) \quad (8)$$

The R_s/R_j term comes from the power loss in the spreading resistance R_s ; the $\omega^2 C_j^2 R_s R_j$ term, from the power dissipated in R_s because of the shunt path through C_j . You can vary R_j , because its value depends on the LO drive level or the bias used in combination with the LO. When $R_s/R_j = \omega^2 C_j^2 R_s R_j$, maximum power transfers to the diode junction, $R_j = 1/\omega C_j$,

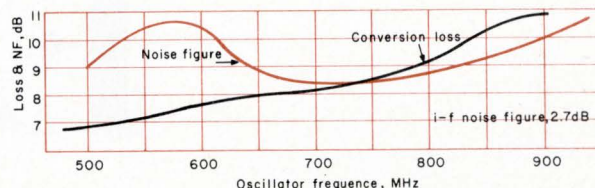

Fig. 5. Conversion loss and noise figure for an experimental uhf TV tuner working into an i-f amplifier system with a 2.7-dB noise figure. The LO is a Fairchild SE3005.

and the signal loss is

$$L_2 = 10 \log (1 + 2\omega C_j R_s) \quad (9)$$

Both R_s and C_j depend on the carrier density N , and

the carrier mobility b :

$$R_s = \frac{1}{(4 ANqb)} \quad (10)$$

$$C_j = \frac{\pi A^2 \sqrt{\epsilon q N}}{2 \sqrt{\phi - V}} \quad (11)$$

where ϵ is the dielectric constant, A is the radius of the contact, and ϕ is the barrier height. Combining the two equations shows you that the product $R_s C_j$ is proportional to A . Thus, for a fixed value of A , you may set either R_s or C_j (but not both) to its optimum value for conversion loss reduction. If the operating frequency is high, set C_j . If the operating frequency is low, set R_s .

Like noise figure, conversion loss depends on LO level, spreading and barrier resistances, junction capacitance, and rf/i-f matching conditions. If the LO drive level is low, with zero bias, then conversion loss is strongly dependent on R_j , which in turn is a function of LO drive level. As the LO level increases, both R_j and conversion loss decrease. At some point, $R_j = R_s$ and conversion loss is at a minimum. If you further increase the LO level, R_s becomes significant (because it dissipates more power) and conversion loss increases.

What the future holds

As the processing technology improves, the HCD will become even more effective and useful than it is today. The parameters most likely to improve are V_F , I_R , parasitic L and C , and the square-law current-voltage characteristics. Because of large-scale production (made feasible by batch wafer processing) and competitive pricing, it is now economical for you to design HCDs into a system.

Bibliography

Milton Crane and Hans Sorensen, "Using Hot Carrier Diodes as Detectors or Mixers," *Hewlett-Packard Journal*, Vol. 17, No. 4, December 1965.

R. E. Bayliss, Eduardo Cabrera, and S. E. Howe, "Why a Schottky-Barrier? Why a Point-Contact?" *Microwaves*, Vol. 7, No. 3, March 1968.

"The Hot Carrier Diode: Theory, Design, and Application," *Application Note 907*, Hewlett-Packard Associates.

INFORMATION RETRIEVAL:
 Semiconductors, Microwave semiconductors,
 Microwaves and microwave products, Circuit design

Equal

Gates

DM8000N (SN7400N)	Quad 2-Input NAND gate
DM8001N (SN7401N)	Quad 2-Input NAND gate (Open Collector)
DM8002N (SN7402N)	Quad 2-Input NOR gate
DM8003N (SN7403N)	Quad 2-Input NAND gate (Open Collector)
DM8004N (SN7404N)	Hex inverter
DM8010N (SN7410N)	Triple 3-Input NAND gate
DM8020N (SN7420N)	Dual 4-Input NAND gate
DM8030N (SN7430N)	Eight-Input NAND gate
DM8040N (SN7440N)	Dual 4-Input buffer
DM8050N (SN7450N)	Expandable Dual 2-Wide, 2-Input AND-OR-INVERT gate
DM8051N (SN7451N)	Dual 2-Wide, 2-Input AND-OR-INVERT gate
DM8053N (SN7453N)	Expandable 4-Wide, 2-Input AND-OR-INVERT gate
DM8054N (SN7454N)	Four-Wide, 2-Input AND-OR-INVERT gate
DM8060N (SN7460N)	Dual 4-Input expander
DM8086N (SN7486N)	Quad Exclusive-OR-gate

Flip Flops

DM8540N (SN7472N)	MASTER-SLAVE J-K flip flop
DM8501N (SN7473N)	Dual J-K MASTER-SLAVE flip flop
DM8500N (SN7476N)	Dual J-K MASTER-SLAVE flip flop
DM8510N (SN7474N)	Dual D flip flop

Counters

DM8530N (SN7490N)	Decade counter
DM8532N (SN7492N)	Divide-by-twelve counter
DM8533N (SN7493N)	Four-bit binary counter
DM8560N (SN74192N)	Up-down decade counter
DM8563N (SN74193N)	Up-down binary counter

Decoders

DM8840N (SN7441AN)	BCD to decimal nixie driver
DM8842N (SN7442N)	BCD to decimal decoder

Miscellaneous

DM8550N (SN7475N)	Quad latch
-------------------	------------

Spec-for-spec. Pin-for-pin. Second source on all popular 74N.

Opportunity

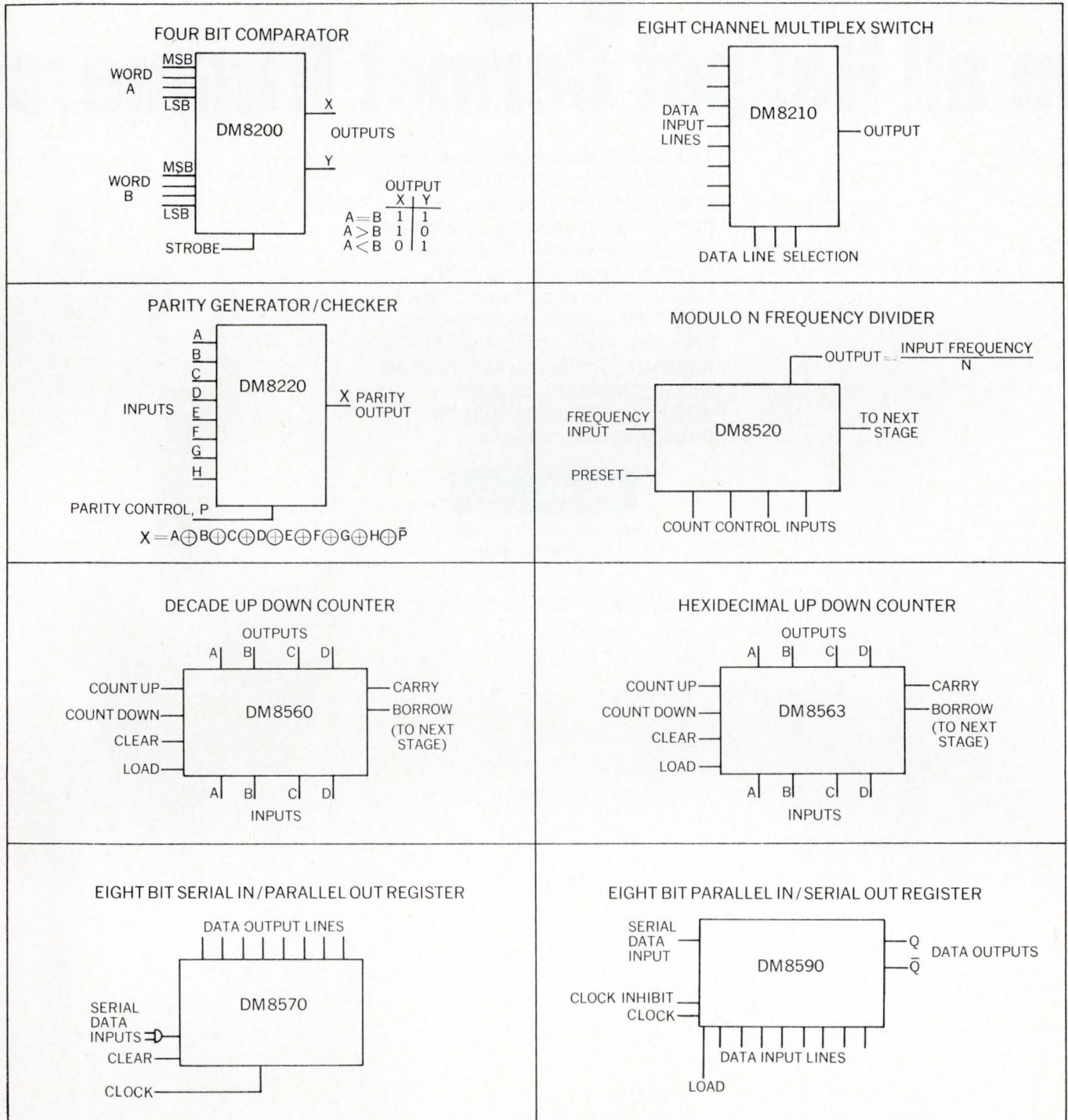

These exclusive National TTL MSI circuits offer designers increased opportunities for circuit savings in design time, board space and costs. Write or call for your free TTL Spec Guide, TTL Cross Reference Guide, and TTL Performance Tables. National Semiconductor, 2975 San Ysidro Way, Santa Clara, California 95051 (408) 245-4320 TWX: 910-339-9240 Cables: NATSEMICON

National/TTL

$\pm 50 \text{ ppm}/^{\circ}\text{C}$ in all Helipot Cermet Trimmers

This significant advance in Helipot's cermet technology is now available at only a dime/unit more . . . 100 ohms thru 2 megohms. In addition, you get essentially infinite resolution, environmental stability, reliability, no catastrophic failures — all superior to wirewound trimmers. We'll also deliver off-the-shelf, locally stocked trimmers with a standard tempco of $\pm 100 \text{ ppm}/^{\circ}\text{C}$ in the 100 ohm thru 2 megohm range.

Beckman

INSTRUMENTS, INC.

HELIPOT DIVISION

FULLERTON, CALIFORNIA • 92634

INTERNATIONAL SUBSIDIARIES: AMSTERDAM; CAPE TOWN; GENEVA; GLENROTHES, SCOTLAND; LONDON; MEXICO CITY; MUNICH; PARIS; STOCKHOLM; TOKYO; VIENNA

IC IDEAS

A pulse-width measure, sample-and-hold circuit	960
Inexpensive pulse source has "high-priced" features	961
A staircase waveform generator	962
Modified latch changes low-frequency inputs to logic level signals	963

Vote for the one you like best.

Write the number of the Idea you like best in the box on the Inquiry Card, and send to us.

Send us practical, reproducible ideas that are original with you and have been implemented with linear or digital ICs.

- If we publish your idea you win a check for \$25.00.
- If our readers vote yours the best of the issue in which it appears, you have your choice of a Simpson 270 or a Triplet 600 multimeter.
- After 12 issues our readers will vote on the best

idea for all 12 issues. The winner gets his choice of either a Hewlett-Packard 1206A or a Tektronix 310A oscilloscope.

Submit your IC Ideas to:
Alberto Socolovsky
Editor
THE ELECTRONIC ENGINEER
Chestnut & 56th Sts.
Philadelphia, Pa. 19139

Here's how you voted

The winning Idea for the May 1969 issue is, "Zero-beat detector."

Our winning author is Tim K. Aaltonen, who puts his test equipment design background to good use as president of ARZ Associates, a consulting firm located in New Rochelle, N. Y. Mr. Aaltonen chose a Triplet 600 TVO meter.

960 A pulse-width measure, sample-and-hold circuit

David L. Sporre
 Electronix Products, Westport, Conn.

This circuit measures the total width of a single pulse in a train of identical pulses. An electronic counter displays the measurement.

The only components external to the IC packages are a switch to start the count, and a resistor and Zener diode to protect the input gate from overvoltages. Both ICs are Motorola devices: an MC724P positive-logic, quad 2-input NOR gate; and an MC790P dual J-K flip-flop.

Flip-flops 1 and 2 stay CLEARED as long as S_1 is in its RESET position. To measure a pulse, put S_1 in its LOW, or COUNT, position. This lets a positive-going, leading edge on the input signal toggle FF-1, because this flip-flop was previously CLEARED and its S and R inputs are LOW.

When FF-1 toggles, its \bar{Q} output goes LOW. (The second flip-flop, FF-2, does not toggle and stays in its original CLEARED state.) With FF-1's \bar{Q} output LOW, the circuit's ENABLE output is also LOW and the counter starts its count.

The negative-going edge at the end of the input pulse toggles FF-2, but not FF-1 which was locked-up after the first transition of its Q output to a HIGH. With FF-2's Q output HIGH, the circuit's ENABLE output is also HIGH, and the counter stops its count.

After FF-2 toggles, it too locks up: the circuit counts the width of one pulse, and then stops. To

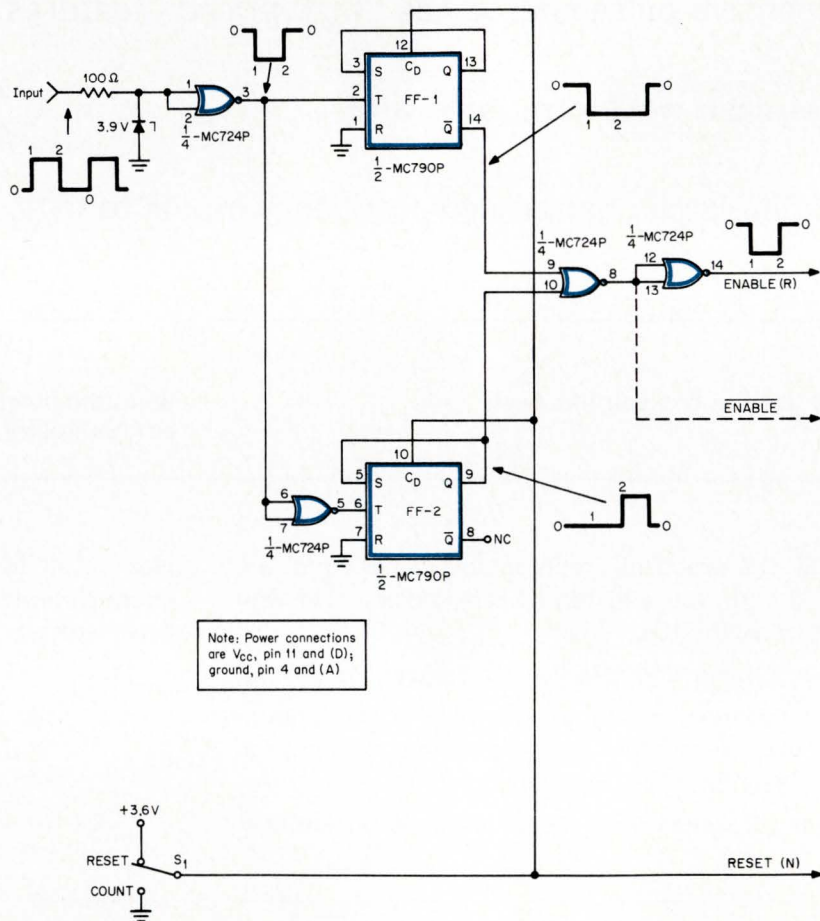

count another pulse, you must RE-SET the circuit with S_1 .

With this circuit, you can measure positive pulses as narrow as one microsecond. It is designed for use with a Monsanto Model 100A, which counts when its ENABLE input is LOW. The parenthetical

letters N and R , on the RESET and ENABLE lines, are pin designations on the Monsanto counter.

Other counters start to count up on receipt of a HIGH, and terminate on a LOW. For these, you can use the circuit's ENABLE output, shown as a dashed line on the diagram.

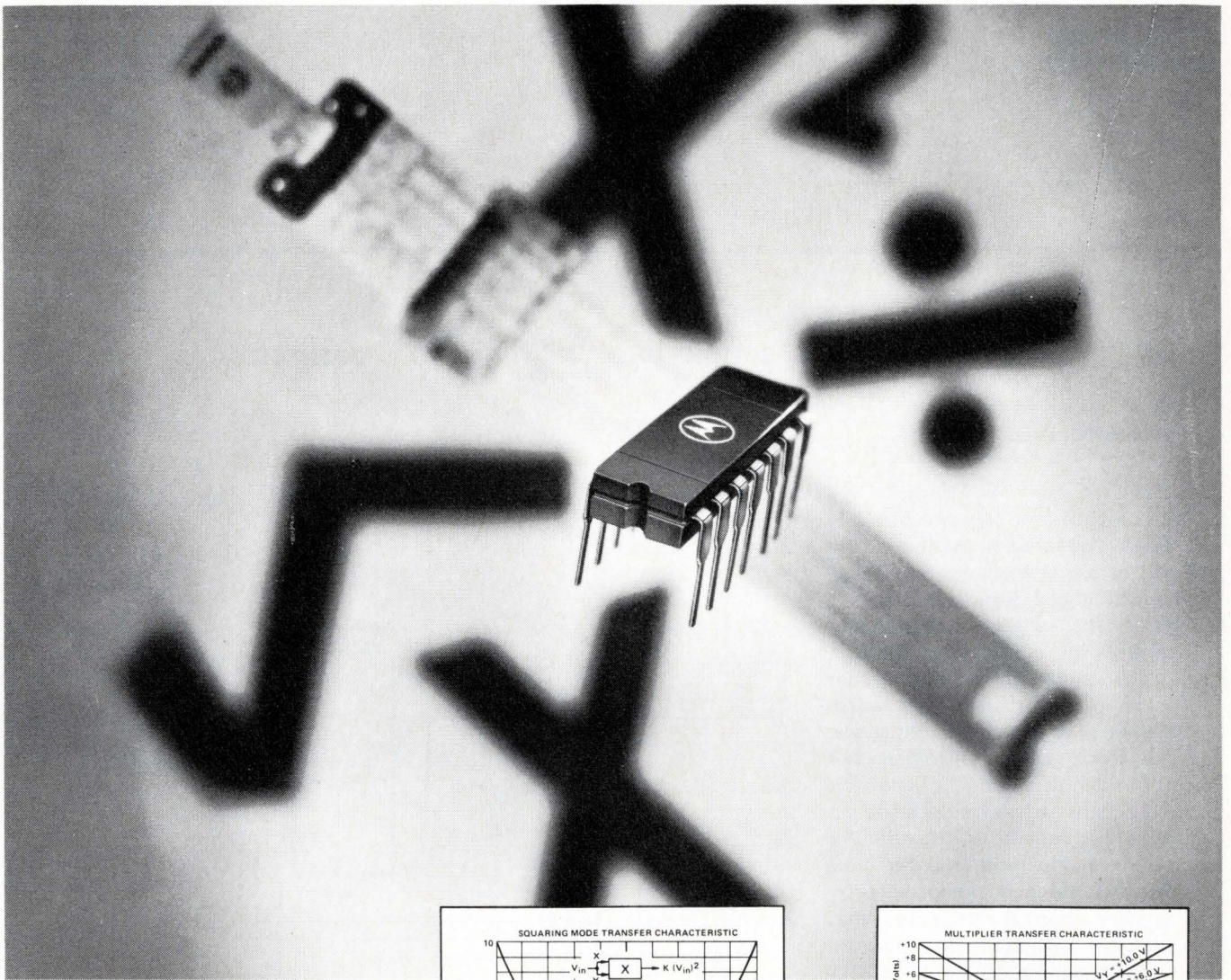

MC1595 is the industry's first true Linear, 4-Quadrant Multiplier IC.

Here is the first element in what promises to be a large family of monolithic, linear multipliers. The MC1595 is designed for uses where the output voltage is a linear product of two input voltages; and, as such, its list of applications is almost limitless, particularly in the control and instrumentation fields.

For example, some of the applications are:

- To Multiply
- To Divide
- To Find Square Root
- To Determine Mean-Square

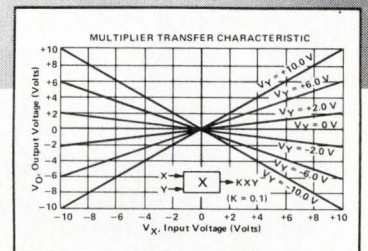
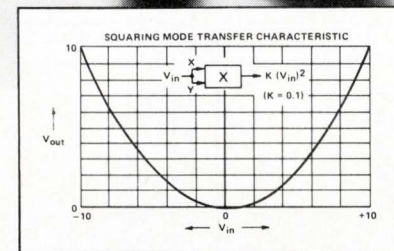
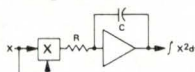
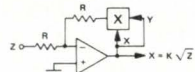
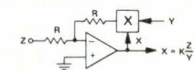
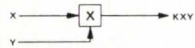

- Frequency Doubling

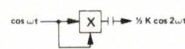

The MC1595 can also be used as a Balanced Modulator/Demodulator, and for Electronic Gain Control among many others. It even has the capability for determining true rms; plus direct power calculations.

Here are some of the features that contribute to the wide versatility of the MC1595:

- Excellent Linearity — 1% max error "X" input; 2% error max "Y" input.

- Wide Bandwidth—Phase Error $\leq 3^\circ$ from DC to 750 kHz.
- Adjustable Scale Factor.
- Large Input Voltage Range ± 10 V.

The MC1595 Multiplier is currently available from distributor stock in the 14-pin dual in-line ceramic package. So is its 0 to 70° temperature-range counterpart, the MC1495. For complete information, including a just-published Application Note, circle the reader service number, or write: P. O. Box 20912, Phoenix, Arizona 85036.

—where the priceless ingredient is care!



MOTOROLA
Integrated Circuits

961 Inexpensive pulse source has "high-priced" features

Thomas M. Farr, Jr.
T.M.F. Electronics, N. Palm Beach, Fla.

Although it uses only two Fairchild $TT\mu L$ 9601 one-shots, this circuit will be useful whenever you design or test digital logic. One IC is a PERIOD/DELAY generator, the other controls the output pulse width.

The PERIOD/DELAY one-shot runs as an oscillator when you switch the circuit to its INT. TRIGGER mode. For EXT. TRIGGER operation, this one-shot runs as a DELAY generator.

There is a PRE-TRIGGER output pulse that is about 30-ns wide. For INT. TRIGGER operation, this pulse precedes the main output pulse by a 30-ns interval, while for EXT. TRIGGER operation its duration equals the pulse delay.

When you operate the circuit in its SINGLE-PULSE mode, C_1 eliminates multiple triggers caused by contact bounce. Choose C_1 so that it dissipates its charge on the first contact closure.

The GATE INPUT gives you output bursts in the INT. TRIGGER mode, while in the EXT. TRIGGER mode it simply gates the triggers through to the PERIOD/DELAY one-shot.

Trailing (negative-going) edges from the PERIOD/DELAY one-shot trigger the PULSE WIDTH one-shot, and timing considerations are the same in both sections. That is, both PERIOD/DELAY and WIDTH are about $0.36RC$, where C is either C_P or C_W as shown on the schema-

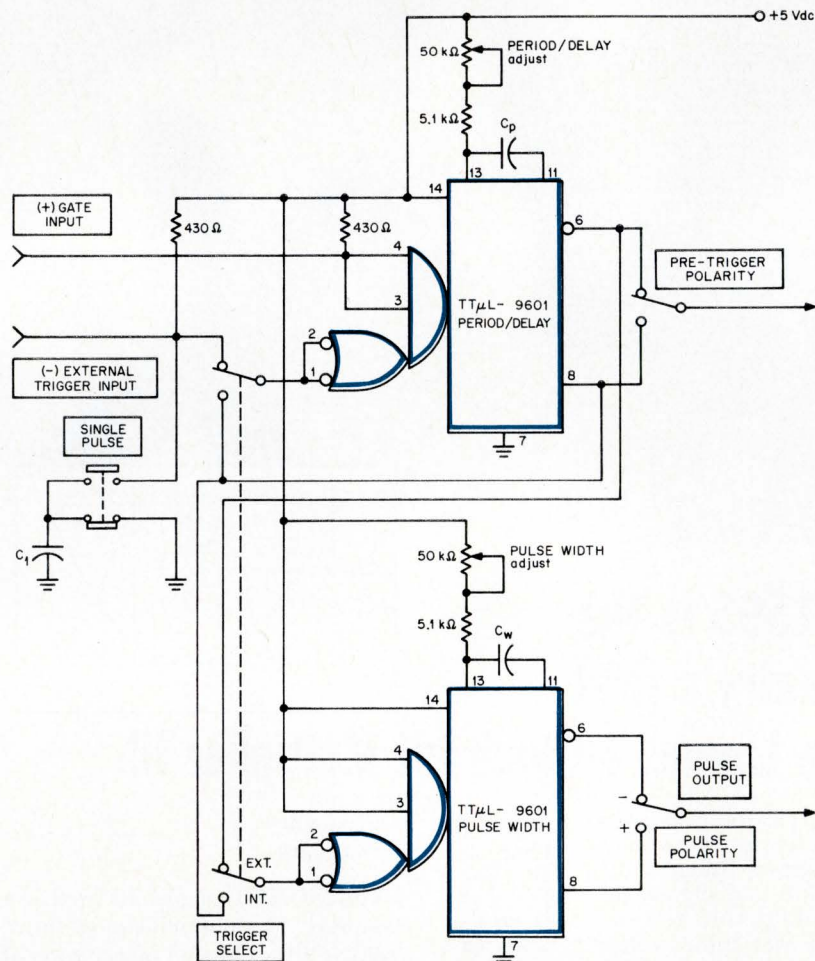

tic. You can go down to 70 ns for both PERIOD/DELAY and WIDTH, while their maximum values are set by the quality of the timing capacitors, leakages, and so forth.

Because the 9601s are retrigger-

able, there are no duty-cycle limitations. Output levels are compatible with DTL/TTL logic. For other logic types, you must add suitable interface elements to the circuit's inputs and outputs, as needed.

The
Choice
is **TTL.**

TI introduces an MSI parity generator/checker which has no equal.

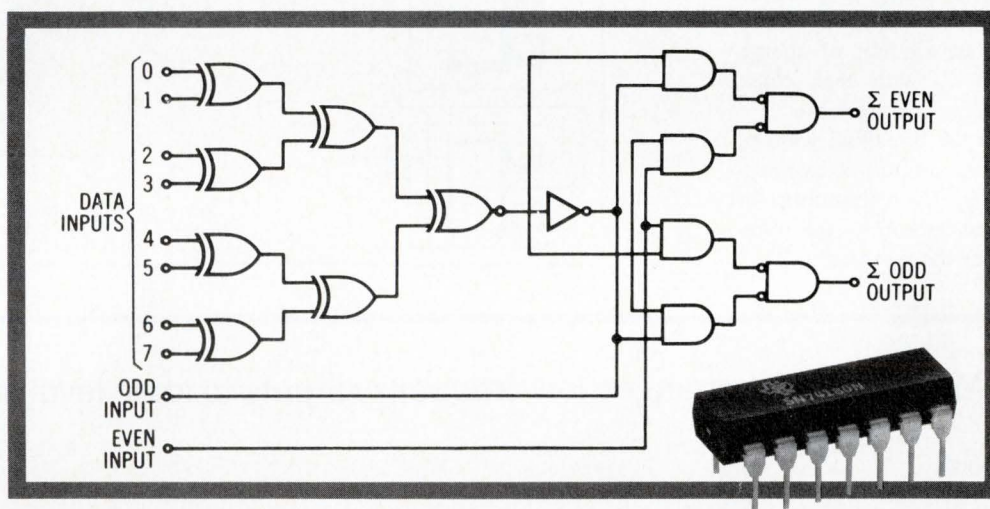

(Peerless speed and economy.)

TI's new SN54180/SN74180 MSI circuits generate ODD/EVEN parity for 8-bit words in only 32 nanoseconds. For longer word lengths, each additional 8-bits requires a mere 10 ns. Thus, parity for a 16-bit word is accomplished in a quick 42 ns.

Power dissipation: typically 170 milliwatts.

As for packages, you have an unparalleled choice of flat packs, ceramic or plastic dual-in-lines.

And you won't find the equivalent function anywhere else for

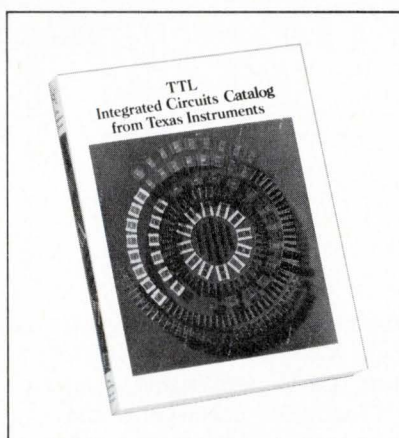

\$7.69 (plastic package, 100-999 quantities). Prompt delivery. Full compatibility with TI's other TTL and DTL circuits.

You'll want more facts, so we've put together a level-headed 424-page catalog containing the data sheets on every Series 54/74 TTL circuit from TI. Circle 113 on the Reader Service card or write Texas Instruments Incorporated, P. O. Box 5012, M.S. 308, Dallas, Texas 75222. Or check with your nearby authorized TI Distributor.



TEXAS INSTRUMENTS
INCORPORATED

962 A staircase waveform generator

Jim W. Foltz

Motorola Semiconductor Prod., Phoenix, Ariz.

A staircase generator is useful for time-amplitude coding applications, and you can build such a device with the circuit shown here.

Two Motorola MC856, dual J-K flip-flops form a four-stage counter. The outputs of this counter feed a four-input NAND gate, which gives a negative pulse equal in width to the clock period, and occurring every 16th clock pulse.

The MC862 inverter thus supplies a positive charging pulse to C_1 . But the clock input, applied to C_2 , removes an amount of charge (C_2V_0) from C_1 with each clock pulse, generating the staircase.

You adjust the threshold voltage, V_2 , and the step amplitude by varying the ratio C_1/C_2 . The number of counter stages determines the number of steps in the waveform.

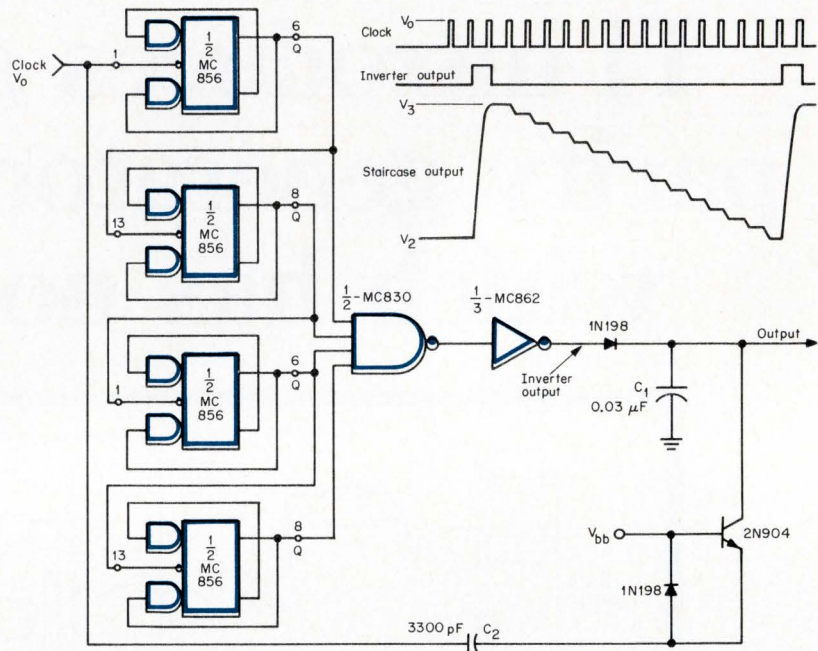

963 Modified latch changes low-frequency inputs to logic level signals

Edward B. Beach

National Radio Inst., Wash., D. C.

In the development of an electronic shutter to make still photographs from a TV receiver screen, a need arose for a 60-Hz pulse to trigger the shutter's KTL timing circuit. This pulse had to come from the TV's deflection circuits, which implied a high-impedance, noisy, signal source. Because the RTL J-K flip-flops in the shutter needed a jitter- and noise-free, fast-fall pulse, we could not use a conventional Schmitt trigger or cascaded gates.

The solution to the problem was to use a Fairchild μ L914 connected as shown here (DTL or TTL should work equally well). The two gates are a modified R-S flip-flop in which R_2 lets the signal from C_2 SET and CLEAR the flip-flop. The value of R_2 depends upon the input signal level and the sensitivity of

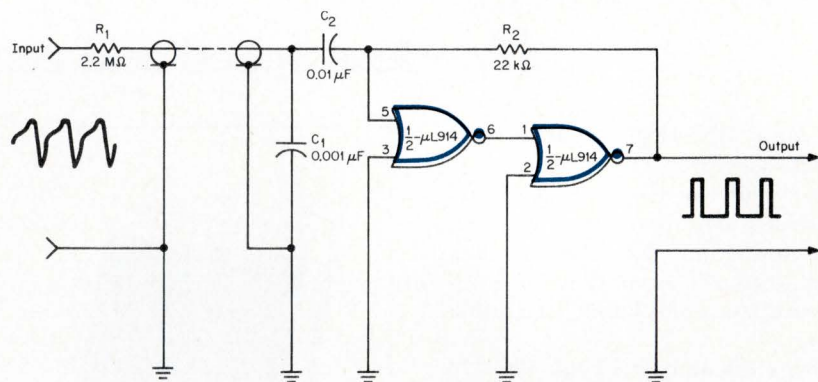

the input gate. In the original circuit, $R_2 = 22 \text{ k}\Omega$ was satisfactory with a 5-V pk-pk signal across C_1 .

The cable capacitance and C_1 , together with R_1 , form a low-pass filter that eliminates horizontal pulses and other noise. Resistor R_1 reduces the circuit loading at the

point of connection (a vertical-oscillator grid), as well.

If the input signal is a changing dc level, you will be able either to eliminate C_2 or to shunt it with a resistor. The rise- and falltimes of the output pulse depend upon the type of gate used.

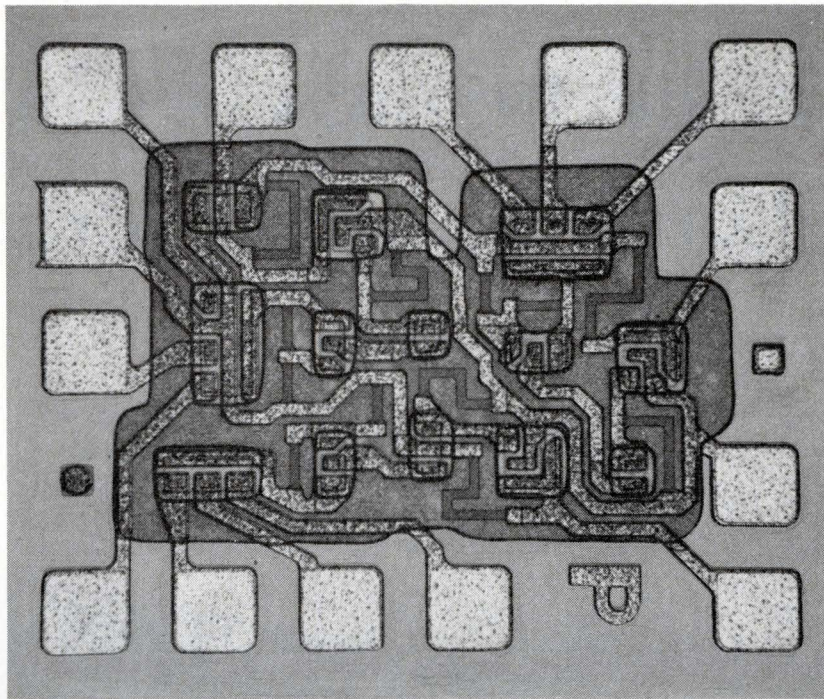

Next generation radiation-hardened IC's are here today.

Here's a better idea from Philco-Ford in radiation-hardened integrated circuits. It's a proven technique for mass production manufacturing which eliminates precision lapping and etching steps.

The payoff in performance: just by changing from conventional circuits to their Philco-Ford dielectrically isolated equivalents, you can get an order of magnitude increase in radiation tolerance; the circuit performance will no longer limit the overall system capability when exposed to a weapons environment.

The payoff in price: we expect that these circuits will turn out to be your most economical solution to radiation hardening.

All are pin interchangeable with conventional circuit counterparts. Now available in prototype quantities for your evaluation are these circuits:

- DTL dual 4-input gate with expander
- DTL dual 4-input buffer with expander
- DTL dual 4-input power gate with expander
- DTL RS/JK master-slave clocked flip-flop
- DTL triple 3-input gate
- Dual level shifter
- 709-type operational amplifier

For a copy of a recent technical paper, "Design Considerations for Radiation-Hardened Digital Circuits," write Joe Standeven, Bipolar Products Marketing, **Microelectronics Division, Philco-Ford Corporation**, Blue Bell, Pa. 19422.

the better idea people in bipolar IC's

PHILCO



**Now we're in the memory business.
And here's a bipolar scratch pad**

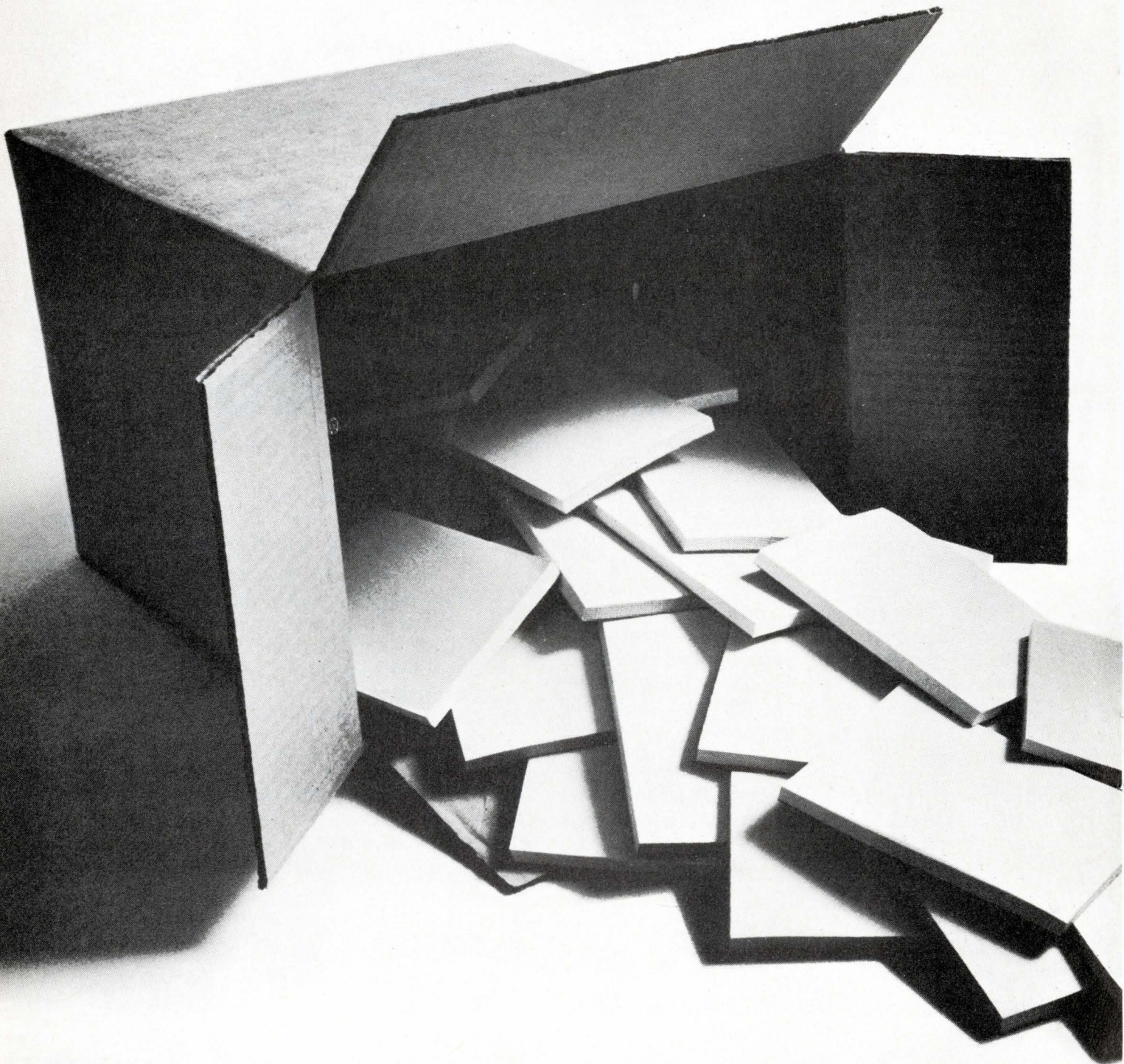

to help you remember.

Anyone with half an eye can see the bright future of the semiconductor memory business. And for months Raytheon's been deploying to nab a lion's slice of that action. We herded up all the processing niceties of our high-rel military components. All the 10th-mil-tolerance magic of our Ray III TTL. All our way-out beam-lead technologies. And now we're in the business.

Leading off with our spanking new 64 bit bipolar RAM. We guarantee a 45 nanosecond read time, but it usually coughs up a word in under 35 ns. And the entire chip, including on-chip address decoding, write and sense circuitry, perks along on only 350 mW. Cost per 100-999 is \$51.50 (-55° to $+125^{\circ}\text{C}$ version) and \$38.00 (0° to $+70^{\circ}\text{C}$). Available now, off distributors shelves, in a 16-lead DIP. Flatpacks coming up.

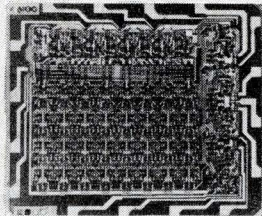

What else? Before the end of the year, look for beam-lead 256-bit and 512-bit multi-chip arrays in 24 pin DIP packages.

And by next June, a monolithic beam-lead 256-bit bipolar scratch pad in a 16-pin DIP. With super-quick access times, thanks to far tighter tolerances and new cell designs. Plus Schottky barrier diodes, washed emitters and like that.

Then in 1970 we'll be unveiling a line of IC read-only memories. And after that it's just a little time until we're mainly in the mainframe memory business.

All of which proves you better keep us in mind when you're in the memory market. The company that gets the ideas and delivers the goods. Raytheon Semiconductor, Mountain View, California. (415) 968-9211.



Circle 49 on Inquiry Card

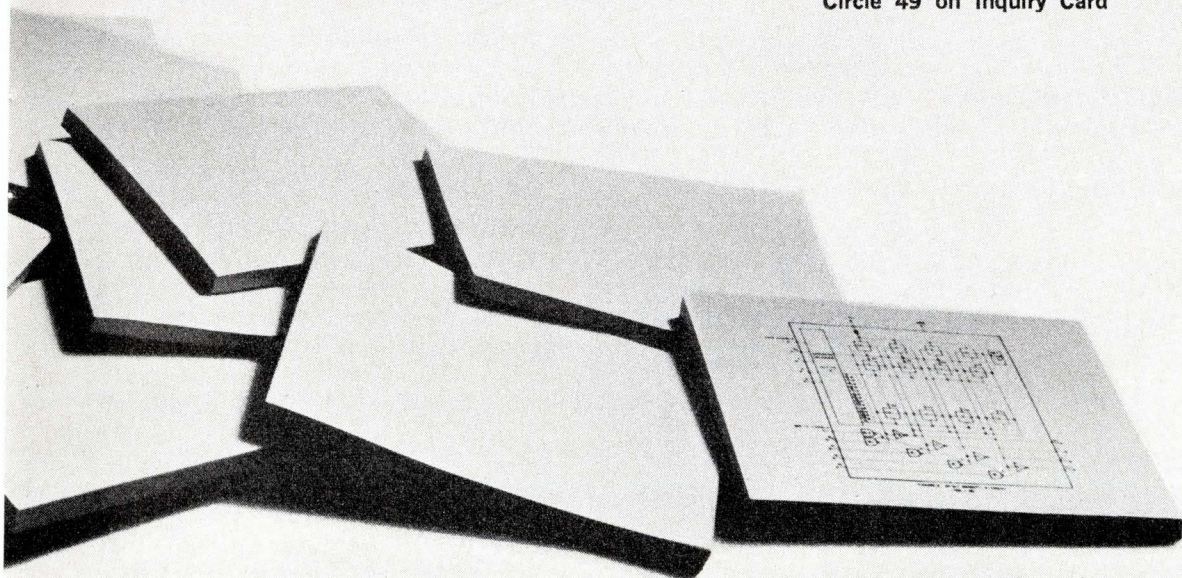

\$44,000,000

WILL BUY 1,000,000 TRIPLETT 310 VOM'S BUT YOU ONLY NEED ONE...AT \$44⁰⁰ THAT'S A BARGAIN



MODEL 310
World's Largest Selling
Volt-Ohm-Milliammeter
(SHOWN ACTUAL SIZE)

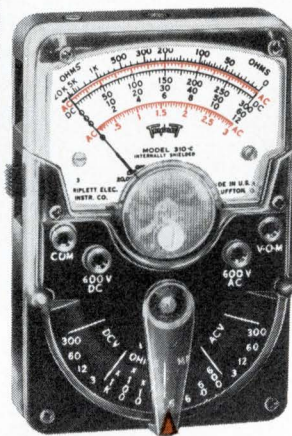

MODEL 310-C
Volt-Ohm-Milliammeter

- 1** HAND SIZE V-O-M WITH PROVISION FOR ATTACHING AC CLAMP-ON AMMETER.
- 2** 20,000 OHMS PER VOLT DC SENSITIVITY; 5,000 AC.
- 3** ONE SELECTOR SWITCH MINIMIZES CHANCE OF INCORRECT SETTINGS AND BURNOUTS.

310-C PLUS FEATURES

- 1** Hand size V-O-M with provision for attaching AC Clamp-on Ammeter.
- 2** 15,000 OHMS per volt AC sensitivity; (20,000 DC same as 310).
- 3** Single fully enclosed Lever Range Switch, plus DC Polarity Reversing.

MODELS 100 AND 100-C

Comprehensive test sets. Model 100 includes: Model 310 V-O-M, Model 10 Clamp-on Ammeter Adapter; Model 101 Line Separator; Model 379 Leather Case; Model 311 leads. (\$83.20 Value Separate Unit Purchase Price.)

MODEL 100 — U.S.A. User Net. \$78.00
MODEL 100-C — Same as above, but with Model 310-C, Net. \$88.00



SELF-SHIELDED Bar-Ring instrument; permits checking in strong magnetic fields. FITTING INTERCHANGEABLE test prod tip into top of tester makes it the common probe, thereby freeing one hand. UNBREAKABLE plastic meter window. BANANA-TYPE JACKS—positive connection and long life.

Model 310—\$44.00 Model 310-C—\$56.00 Model 369 Leather Case—\$4.20
All Prices are Suggested U.S.A. User Net, Subject to Change

THE WORLD'S MOST COMPLETE LINE OF V-O-M's • AVAILABLE FROM YOUR TRIPLETT DISTRIBUTOR'S STOCK



TRIPLETT ELECTRICAL INSTRUMENT COMPANY, BLUFFTON, OHIO 45817

Feature article abstracts

Published information is vital to your job.

To save time in finding this information, we have abstracted the important technical features from eight electronic engineering publications.

Should any of these articles interest you, contact the magazine—names and addresses are listed below.

Reprints of articles with an asterisk are available free.

Save this section for future reference.

Circuits

Popular SCR and triac circuits, Gene Cavanaugh, James Garrett and Max Schreiner, Texas Instruments, "EEE," Vol. 17, No. 8, August 1969, pp. 84-88. As the title suggests, this article reviews some popular applications—four for SCRs and two for triacs—to circuits such as speed controls (half and full wave), dimmers, and temperature controls.

Designing with power SCRs, David Cooper, International Rectifier, "EEE," Vol. 17, No. 8, August 1969, pp. 77-83. This article describes three applications of power SCRs. One is a very important application, explained in detail—a modified McMurray-Bedford force commutation inverter that can vary the output frequency. The other two are mentioned more briefly, a dc-to-dc converter (from 1500 V to 37.5/75 V) and a frequency multiplier (for induction heating).

Circuit Design

Design Attenuator Pads the Easy Way, Bill E. Johnson, Pacific Northwest Telephone Co., "Electronic Design," Vol. 17, No. 16, Aug. 2, 1969, pp. 90-94. A BASIC program is provided that takes the input and output impedances the pad works into, and the desired voltage or current loss, and provides impedances and losses for six types of attenuation networks.

Delay lines stretch squeezed information, Ed. M. Drogin and Abe E. Ruvin, AIL, "EDN," Vol. 14, No. 16, Aug. 15, 1969, pp. 95-99. The authors show how to convert short bursts of wideband data to long bursts of narrowband data. The burst-bandwidth product stays constant; the burst-time increases and the bandwidth decreases by the same factor. The method uses delay lines to recirculate the data, and the same hardware can recompress the information after processing. An example is given of a system designed to convert 200- μ s bursts of i-f information with a bandwidth of 2.5 MHz, into a video output of 2000- μ s duration and a 125-kHz cutoff frequency.

Determine Inverter Risettime Quickly, James J. Kubinec, Computer Microtechnology, Inc., "Electronic Design," Vol. 17, No. 16, Aug. 2, 1969, pp. 74-81. A design nomograph with instructions and examples is provided so that difficult analytical predictions of inverter performance or direct breadboard measurements can be avoided at the design stage.

Communications

An introduction to synthetic-aperture radar, William M. Brown, and Leonard J. Porcello, University of Michigan, "IEEE Spectrum," Vol. 6, No. 9, September 1969, pp. 52-62. To acquire good resolution from side looking radar, the beam should be made more narrow or the frequency increased. For many reasons neither of these are desirable. The method described here makes use of optical techniques to process and decipher the data, based on frequency shift of the signal return.

Components

Resistors—thick and thin, Thomas B. Stephenson, Los Angeles Regional Editor, "EDN," Vol. 14, No. 16, Aug. 15, 1969, pp. 85-92. The author, in a brief introduction, states that the controversy over thick-film vs thin-film resistors and resistor networks is a waste of time, because the choice between the two types of films must be based on a finite number of known factors. Such factors, themselves, resolve the choice of thick- or thin-films. A comparison chart gives major electrical and mechanical parameters for both thick- and thin-film resistors. The bulk of the article consists of comments, from several film houses, pro and con thick-film vs thin-film resistive devices.

Magnetic bubbles—a technology in the making, Harry R. Karp, Bell Labs, "Electronics," Vol. 42, No. 18, Sept. 1, 1969, pp. 83-87. Bell Labs is doing work in the area of very thin magnetic materials where magnetic spots can be moved around in the material. The magnetic "bubbles" could be used in low cost, high density shift registers, which of course are a memory. More work is still required to perfect such devices.

Cat's eyes for the military, Alfred Rosenblatt, "Electronics," Vol. 42, No. 18, Sept. 1, 1969, pp. 64-73. Low-light-level TV has not solved the military's night vision problem. The prime problem is lack of good tubes. Silicon vidicon units may lead to better night time vision. Silicon units are now getting into production.

Magazine publishers and their addresses

EDN

Cahners Publishing Company
3375 S. Bannock Street
Englewood, Colo. 80110

EEE

Mactier Publishing Co.
820 Second Avenue
New York, N. Y. 10017

Electronic Design

Hayden Publishing Co.
850 Third Avenue
New York, N. Y. 10022

Electronic Products

United Technical Publications
645 Stewart Avenue
Garden City, N. Y. 11530

Electronics

McGraw-Hill, Inc.
330 W. 42nd Street
New York, N. Y. 10036

Electro-Technology

Industrial Research Inc.
Industrial Research Bldg.
Beverly Shores, Ind. 46301

IEEE Spectrum

Institute of Electrical & Electronics Engineers
345 East 47th Street
New York, N. Y. 10017

The Electronic Engineer

Chilton Company
56th & Chestnut Streets
Philadelphia, Pa. 19139

*Reprints available free. Request them on your company letterhead.

Integrated Circuits

The art of building LSIs, Herschel T. Hochman, Honeywell Inc., "IEEE Spectrum," Vol. 6, No. 9, September 1969, pp. 29-36. Once the proper application of the interrelated factors of design, fabrication, and testing are recognized, large scale IC yields should be possible. The author discusses LSI production problems and ideas for increasing IC yields.

A logical approach to testing ICs, Joseph Brauer, Electronic Products, Vol. 12 No. 3, August, 1969, pp. 140-149. The approach to IC testing described in this article was developed at the Rome Air Development Center in Rome, N. Y. In addition, the article goes into the question of costs and delves into the problem of 100% testing vs sampling.

Semiconductors

***Mixed up in mixers? Try an HCD**, Aki Tanaka and Suleyman Sir, Fairchild Semiconductor, "The Electronic Engineer," Vol. 28, No. 10, Oct. 1969, pp. 68-71. Hot-carrier diodes have been around for some time, usually applied as mixers or detectors for uhf TV tuners. In such an application, they change the incoming uhf signals (470 to 890 MHz) to a lower frequency for TV receivers. But the hot-carrier diode can aspire to many other applications outside the TV field. This article outlines the construction, operation, and applications of hot-carrier diodes.

Triac methods of control, L. J. Reed, Motorola Semiconductor, "EEE," Vol. 17, No. 8, August 1969, pp. 66, 67. A short article that describes how triacs are constructed, how they conduct in either direction, and the four possible triggering modes resulting from the combination of polarities of terminal voltage and gate current. The article touches also upon phase control and zero-point switching (which reduces noise).

Transient suppression with a power zener diode, William Walters, Electronic Products, Vol. 12 No. 3, August, 1969, pp. 82-87. Essentially a product application story on the Motorola MPZ-5 line of power zener diodes, this article describes a way to use power zeners for transient suppression.

Designing with triacs, L. J. Reed, Motorola Semiconductor, "EEE," Vol. 17, No. 8, August 1969, pp. 68-76. Starting with the classical light dimmer, the author adds a not-so classical dimmer (with soft turn-on) plus eleven more applications of triacs. The article is actually a description of these applications, rather than a design guide, but the applications are useful.

Special report on zener diodes, Robert C. Drew, Electronic Products, Vol. 12 No. 3, August, 1969, pp. 74-81. This report discusses zeners as chips, discretes, and integrated circuit elements from the standpoint of the user. Manufacturing techniques are also discussed as are the advantages and disadvantages of various configurations such as chips, LIDs, and beam-leads. The article includes helpful specifying information on such topics as plastic vs glass encapsulation, temperature compensation, power ratings, areas of application and costs.

Test and Measurement

***A critical look at DVM specs**, Ken Jessen, Hewlett-Packard Co., "The Electronic Engineer," Vol. 28, No. 10, Oct. 1969, pp. 46-52. The price of laboratory-type digital voltmeters (DVMs) goes up, in general, with the number of digits the DVM displays. But the user pays for more than just digits. He pays for accuracy, stability, sensitivity, resolution, noise rejection, and many other factors. Unfortunately, however, there are no industry-wide specifications. In this article, a representative of one of the leading manufacturers of DVMs defines the technical meanings of the specifications used by various manufacturers.

Sorting IC's economically, Robert A. Hughes and W. Blaine Belecki, Digital Equip. Corp., "Electronics," Vol. 42, No. 18, Sept. 1, 1969, pp. 74-77. It's no secret that ICs must be tested as economically as possible. This is a requirement of any testing. This article describes a tester and program which will test 2500 ICs per hour, executing static, dynamic and burst tests. The tester is actually a computer that can be activated to test a specific device by simply typing in the type device's type number.

LSI Testing is a Large-scale Headache! Elizabeth deAtley, West Coast Editor, "Electronic Design," Vol. 17, No. 16, Aug. 2, 1969, pp. 24-34. This article covers the serious problem of testing LSIs. Complete testing is impossible, so reasonable testing is done to find most faults. Facets such as dynamic testing, race conditions, strobed outputs, propagation delays, and single shot testing are covered.

Memory testing is a task that comes in layers, Leonard Kedson and Alan M. Stoughton, Computer Test Corp., **Computer for core tests**, William R. Blatchley, Computer Test Corp., **Exercising memory systems with worst-case bit patterns**, Charles R. Elles, Computer Test Corp., and Elwood A. Dance, Scientific Measurement Systems, Inc., **Boosting plated-wire yield: which knob to adjust?** Gary Chernow, Computer Test Corp., "Electronics," Vol. 42, No. 18, Sept. 1, 1969, pp. 88-96. This is actually four articles in one with each portion written by different authors. Complex, multi-layer memories must be tested in segments and then tested for their inter-action and operation with each other section and/or layer. These tests are more complex than they initially appear. The authors explain some of the problems and give indications of testing methods.

Miscellaneous

Forum on Interconnection—Part 3: Wire and cable, Staff Report, Electronic Products, Vol. 12 No. 3, August, 1969, pp. 20-29. Fifteen members of industry representing both users and producers of wire and cable, join in a round-table give-and-take to wrestle with the problems of vendors and customers. Insulation materials, the growing use of aluminum, flat cable, fine computer wire, and coaxial cable are among the topics under discussion. The participants also give their views on the future of the industry.

Diary of a leadership trainee, Richard Turmail, Management & Careers Editor, "Electronic Design," Vol. 17, No. 15, July 19, 1969, pp. 96-103. In this first of a two-part series, the author gives a frank diary account of his experiences and emotions while attending a workshop for the development of the business personality, or sensitivity training. The article provides an insight into the mechanics of this popular process. Value judgments are promised in part two.

***Can management give engineers what they really want?** Arthur D. Kellner, International Telephone & Telegraph, "The Electronic Engineer," Vol. 28, No. 10, Oct. 1969, pp. 34-37. Are engineers happy only as long as they stay in engineering? Or do all of them prefer to work their way into management? What does management think of this? The points that the author makes are equally applicable to engineers of all specialties. But they are of particular importance to electronic engineers in view of the high mobility of electronic companies, and the rather high number of new companies that start in the electronics field.

The CRT in phototypesetting systems, R. J. Klensch, E. D. Simshauser, RCA Corp., "IEEE Spectrum," Vol. 6, No. 9, September 1969, pp. 75-80. Typesetting via a cathode ray tube can be fast and flexible for photo-offset printing. And this is possible if certain guidelines are followed. These guidelines and criteria are discussed here by the authors.

Vibrating varifocal mirrors for 3-D imaging, Eric G. Rawson, Bell Labs, Inc., "IEEE Spectrum," Vol. 6, No. 9, September 1969, pp. 37-43. There has been a need for a good three-dimensional man-machine interface. Unfortunately a practical one is not available. Here, the author describes a technique that will satisfy requirements for many applications.

Read this one first! Raymond E. Herzog, Daytona Beach, Fla., "EDN," Vol. 14, No. 16, Aug. 15, 1969, pp. 113-116. The author describes several ways to make your job resume stranger sounding and of more interest to its reviewers, so that you have a better chance of reaching the position you're after.

Enthusiasm-knowledge-experience; keys to a successful talk, Fred W. Kear, Sparton Southwest Inc., "EDN," Vol. 14, No. 15, Aug. 1, 1969, pp. 77-79. Those of you who must give a technical paper will find moral support in this article. The author states that there are few natural-born writers, and even fewer natural-born speakers. The naturalness and ease of presentation of a speaker is directly proportional to his preparation effort. You should of course know your topic, but you should also project your enthusiasm for it, and show the audience that you have a common bond of experience with them. The author also briefly discusses notes, visual aids, meeting-room preparation, and so forth.

It Makes Sense to Use LEDs in Sensing, Norman D. Kline, IBM Systems Development Division, "Electronic Design," Vol. 17, No. 16, Aug. 2, 1969, pp. 84-87. The problems of signal-to-noise ratio in position-measuring or hole-sensing applications using incandescent lamp and light-emitting diodes is discussed. The latter improve the S/N ratio by a factor of 7 and reduce power too.

Managerial Sensitivity Training Works, Richard L. Turmail, Management & Careers Editor, "Electronic Design," Vol. 17, No. 16, Aug. 2, 1969, pp. 98-102. Second and last part of the editor's experiences in a "Leadership Workshop." A survey of the participants one month after reveals that they are now more enthusiastic about the program than at graduation. Like most things, it is only as good as the follow-up, which is in the hands of the individual.

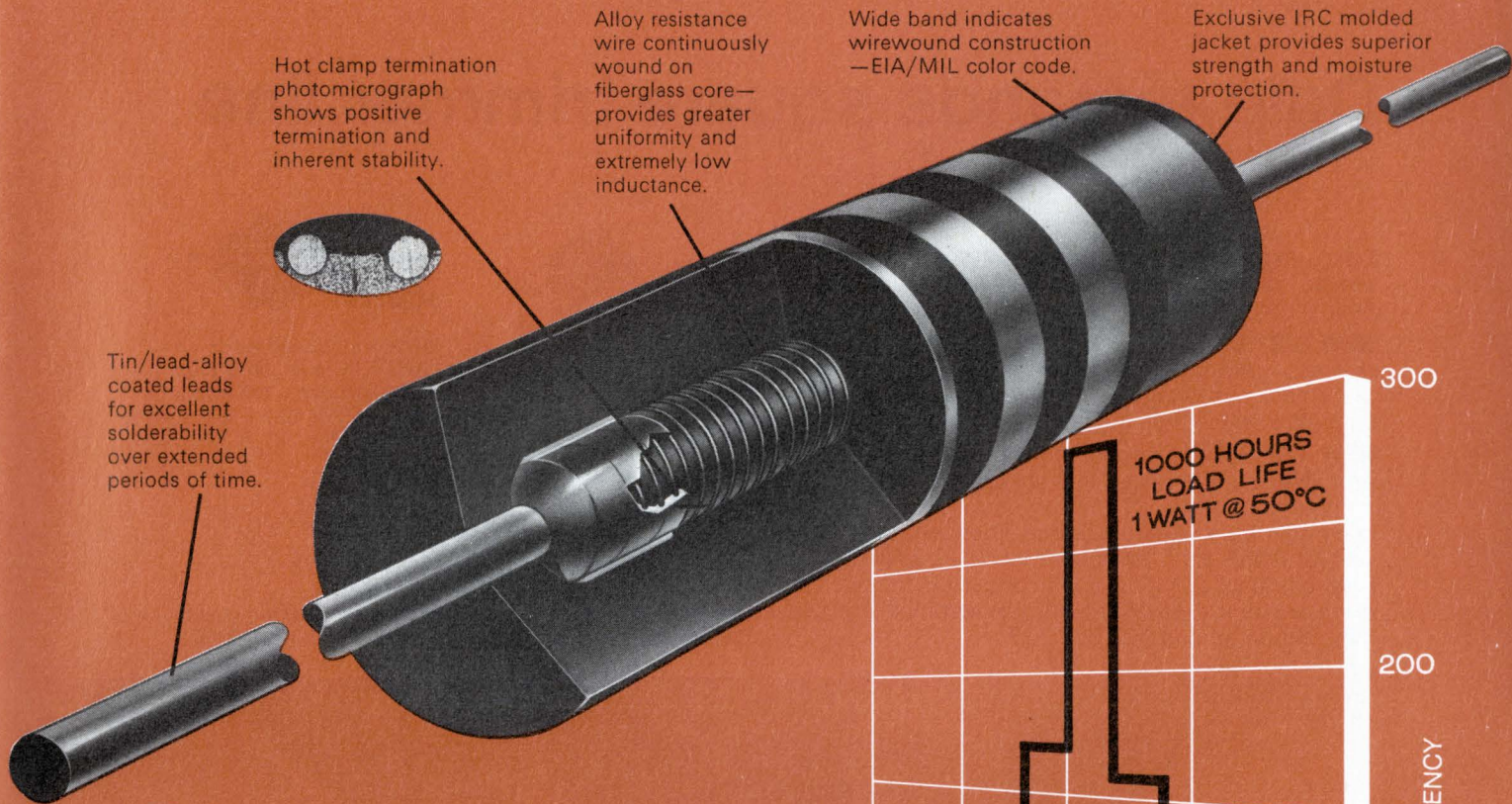

Hot clamp termination photomicrograph shows positive termination and inherent stability.

Alloy resistance wire continuously wound on fiberglass core—provides greater uniformity and extremely low inductance.

Wide band indicates wirewound construction—EIA/MIL color code.

Exclusive IRC molded jacket provides superior strength and moisture protection.

Tin/lead-alloy coated leads for excellent solderability over extended periods of time.

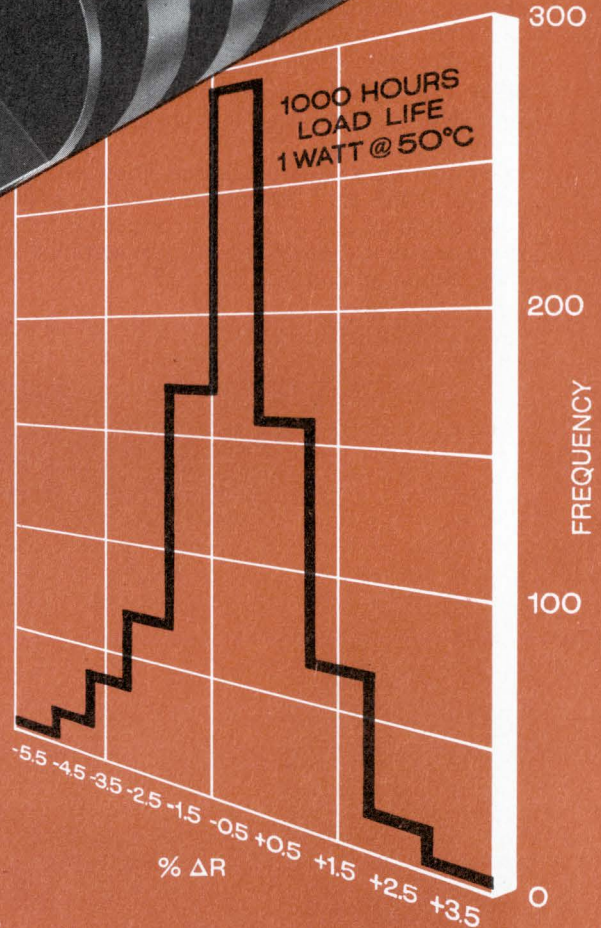

Saver

BW-20 saves space,
saves cost.
Has excellent stability.

The BW-20 bridges the cost-performance gap between composition resistors and premium wirewounds. Its one-watt rating in $\frac{1}{2}$ -watt size means you can replace one-watt units and save space; or use it in $\frac{1}{2}$ -watt space with the advantages of two-time safety factor and wirewound stability. As shown in the histogram, average load-life change is less than 1%.

The money-saving BW-20 has lower ranges than metal films or deposited carbons. It is ideal for semi-precision resistor needs in instrumentation, computer peripherals, networks, and other low-power needs.

BW-20's come in six forms of packaging to cut assembly costs, fit $\frac{1}{2}$ -watt inserting machines, and can be ordered with many cut-and-formed lead configurations. Write for data, prices, and samples to: IRC, Philadelphia Division of TRW, Inc., 401 N. Broad St., Philadelphia, Pa. 19108.

CAPSULE SPECIFICATIONS

	
	Size: .390" x .140" diameter.
RESISTANCE:	0.24 ohm to 750 ohms
POWER:	1-watt @ 50°C. Derated to zero @ 160°C.
TOLERANCE—STANDARD:	±5%, ±10%
—SPECIAL:	±2%
TEMPERATURE:	300ppm/°C. to 0.62 Ω
COEFFICIENT:	150ppm/°C. over 0.62 Ω
INDUCTANCE:	0.22 μh (0.24 ohm) to 2.4 μh (750 ohms)
EIA STANDARD:	RS-344



DIVISION OF TRW INC.

Circle 51 on Inquiry Card

Dale expands square trimmer line

New 3/8" & 1/2" models do more for you

Dale's expanded line of square wirewound trimmers has seven new models to meet your needs at prices near rectilinear levels.

NEW 3/8" LINE. Better for packaging because they're thinner—only .145". Stronger PC mounting. Heavier (22 AWG) pin design reduces mechanical problems caused when lighter pins fail under mounting stress.

NEW 1/2" LINE. Complete internal redesign for better performance and prices that are equal to or lower than competition.

Both new Dale square trimmer lines are rated at one watt at 70°C. Both are made to MIL-R-27208 specs. Dale has a lot going for you in square trimmers—and more are on the way. For complete technical and price information, phone 402-564-3131.

3/8" MODELS

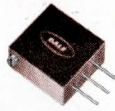

5850—Insulated leads
5880—PC pins, top adjust
5887—PC pins, side adjust
5891—PC pins, base mount
Size: .375" x .375" x .145"

Resistance Range: 10 ohms to 50K ohms
Resistance Tolerance: ±5% standard
Resolution: 1.01% to .09% (3/8") .54% to .10% (1/2")
Power Rating: 1 watt at 70° C
Operating Temperature Range: -65° C to +175° C
Temperature Coefficient: ±50 PPM/° C Max.
Moisture Resistance: 10 Meg. minimum insulation resistance
Mechanical Adjustment: 25 turns (3/8") 25 turns (1/2")

1/2" MODELS

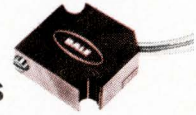

5050—Insulated leads
5091—PC pins, base mount
5080—PC pins, top adjust
Size: .50" x .50" x .19" (5050)
 .50" x .50" x .22" (5091, 5080)



thinner

stronger

lower cost

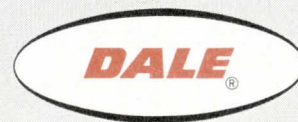

DALE ELECTRONICS, INC., 1304 28th Avenue, Columbus, Nebraska 68601 In Canada, Dale Electronics Canada, Ltd.

Keyboard Features Non-Contacting Key Switch

A new keyboard that needs no anti-bounce circuitry, is non-contacting, and that operates on any popular code has been announced.

Heart of this all solid state keyboard is a new Neverwear™ coded key switch. This capacitive switch provides a reliable means of generating any multiple level communication code such as ASCII. Output is compatible with TTL or DTL ICs, and lends itself to interfaces such as digital paper tape punches, digital magnetic recorders, digital printers, CRT displays or direct computer input. Thus, these keyboards may be used as direct replacements for existing electro-mechanical keyboards or for new design applications.

Only the key springs or snap action rubber boot can fatigue or wear, and both are replaceable. The non-contacting switch is guaranteed forever. With it, there aren't any electrical arcing, mechanical flexure or other failure modes.

Depressing the key brings the key plunger close to the data channel plates, ac coupling the plunger to each data channel detector. Any noise output that is not in phase with the drive oscillator is rejected by a strobe which is generated after the data channels are ac coupled. Depressing multiple

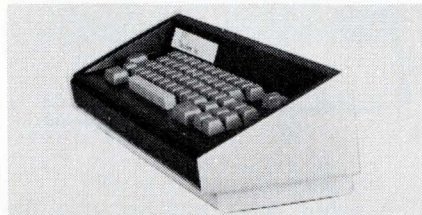

Solid state keyboard (above) uses a new noncontacting key (right). Depressing more than one key at a time would normally generate erroneous codes, but the circuitry (below right) prevents this.

keys simultaneously would normally generate erroneous codes, but this is prevented by detecting the depression of two or more keys and inhibiting the strobe.

In addition to an improvement in reliability, the coded capacitance keys were selected so that lower cost could be achieved. Thus, quantity prices are typically less than \$100 depending on the number of keys and other variables.

The standard keyboard has 3/4 in. key spacing, 2 to 3 oz. depression touch force and a 3/16 in. key strobe.

John Craft, V.P. of Marketing, Data-Term, Inc., 1611 Manning Blvd., Levittown, Pa. 19057. (215) 949-1910.

Circle 280 on Inquiry Card

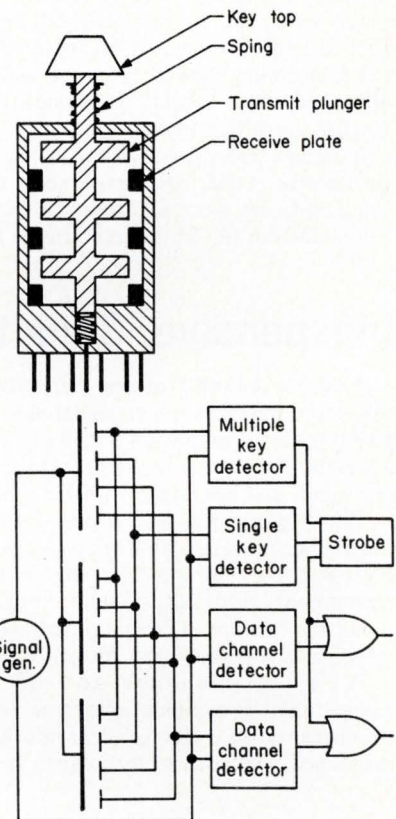

Amplifier/Pulse Generator

A prime advantage of this miniature hybrid circuit is its micropower capability. The Amplifier/Pulse Generator compresses 78 components into a 1.5 in.² package and still operates at only 1 mW. Circuit components include 3 FETs, 19 pnp and npn transistors, 8 tantalum and 2 ceramic capacitors, and 46 resistors.

Designed to interface with low impedance transducers, the LMI 9000 series unit is a highly sensitive, stable, gain programmable, Amplifier/Pulse Generator. The unit classifies various levels of excitation and generates a pulse output for six programmable

threshold levels of the input signal.

A typical application would be the monitoring of various levels of equipment vibration. Basic amplifier design

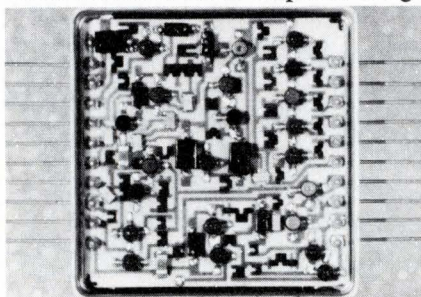

can be adapted to any vibration monitoring application with a great variety of signatures.

The premium units (LMI 9000 and 9001) have a temp. and voltage range from -50°C to 100°C at any B+ level from 5.5 to 35 Vdc. The standard (LMI 9002 and 9003) units operate over a limited temp. range from -30°C to 70°C at b+ levels of 7 to 10 V. All units come in a 1.5 in.² plastic package. Lansdale Microelectronics, Inc., Advance Lane & Rte. 309, Colmar, Pa. 18915. (215) 822-0155.

Circle 281 on Inquiry Card

A fully-portable digital voltmeter

Weighing in at only 8 lbs, this instrument can operate up to eight hours on its built-in, 24-V, rechargeable battery-pack. But you can also power the Model 6453 from the ac power line. This means that you have an instrument for general lab use—one which you may isolate from the ac line by using the battery pack—as well as a self-powered, field unit for outside work.

Because the 6453 will probably see much field use, it was designed to be rugged and easy to use. To these ends, the instrument makes extensive use of advanced MSI IC circuit techniques, and has full, push-button operation.

You can select function (AC volts, DC or LOW-DC volts, and resistance), FILTER, digitizing RATE, and REMOTE operation all from the front-panel. In the RE-

MOTE mode, you can externally initiate up to four conversions/s. You can select function and FILTER remotely, and have



a manual ranging control as well.

A hybrid input amplifier gives the 6453 a high input-impedance, a low TC,

and a bias current of less than 3 pA. The film-type attenuator does away with most of the usual calibration adjustments, and the instrument's internal reference voltage is temperature-controlled. The MSI display logic—which drives a low-voltage, single-plane read-out—contributes to the DVM's low power-consumption.

A 4-digit instrument with a 20% over-range fifth digit, the basic Model 6453 has five dc ranges from 100 mV to 1000 V, 0.01% accuracy, and automatic polarity and autoranging; it costs \$1125. As a full multimeter (with ac and ohms options), the 6453 costs less than \$1600. Cimron Division, Lear Siegler, Inc., 1152 Morena Blvd., San Diego, Calif. 92110. (714) 276-3200.

Circle 245 on Inquiry Card

Inexpensive, 3-digit DMM uses LSI circuitry

A handy handful of test capability, this multimeter uses LSI techniques to give it a size of only 9 x 5 x 2.88 in., and a weight of only 2.5 lbs. You hold it in one hand, and operate it with the other.

The Digitest 500 has a push-button matrix keyboard with function-select buttons along the right-hand edge of the instrument, and range-select buttons along the bottom. Three standard Nixie®-type tubes show the measurement.

You can measure any of 17 range/function combinations of ac volts or current, dc volts or current, and resistance. The DMM reads voltages from



100 μ V to 1000 V (300 Vac); currents from 100 nA to 100 μ A (you will soon be able to purchase shunts to extend cur-

rent readings to 1 A); and resistance to 1 M Ω . Accuracy varies from 0.2 to 1.5% with the function selected, but is constant through all ranges of that function.

The Digitest 500 operates from 110 Vac, but has a power connection point that lets you run it from any 11- to 18-Vdc supply as well. This basic version sells for \$250. An up-coming NiCad battery pack—which becomes an integral part of the basic instrument case—will sell for about \$45. Honeywell Test Instruments Division, Box 5227, Denver, Colo. 80217. (303) 771-4700.

Circle 246 on Inquiry Card

Oscilloscope has 200-MHz bandwidth and high input-impedance

This instrument is the third in a series of high-performance, realtime oscilloscopes from Iwatsu Electric Co., Tokyo. The first two, introduced at the 1969 IEEE Show, are the SS-112 and the SS-211; these are, respectively, 100-MHz and 200-MHz scopes. The new instrument—Model SS-212—combines a 200-MHz bandwidth with a high input-impedance.

The oscilloscope's vertical channel has a 1-M Ω input impedance. It also features both active and passive probes; the passive attenuator-type probes come with the scope as standard accessories, but there are optional FET source-follower probes that give you both high sensitivity and wide bandwidth. A dual-trace



scope, the SS-212 has vertical channel sensitivities down to 5 mV/cm.

The horizontal deflection system has sweep speeds to 10 ns/cm (to 1 ns/cm with X10 magnification), with stable triggering to 200 MHz. You can select the trigger signals from either of the vertical channels, or from an external source. A delayed sweep is among the many features of the horizontal display channel.

The CRT display is 6 x 10 cm, in a rather small front panel—only 8 1/2-in. wide x 12-in. high. The SS-212 costs \$3120 and is marketed by E-H Research Labs., Inc., 515 11th St., Box 1289, Oakland, Calif. 94604. (415) 834-3030.

Circle 247 on Inquiry Card

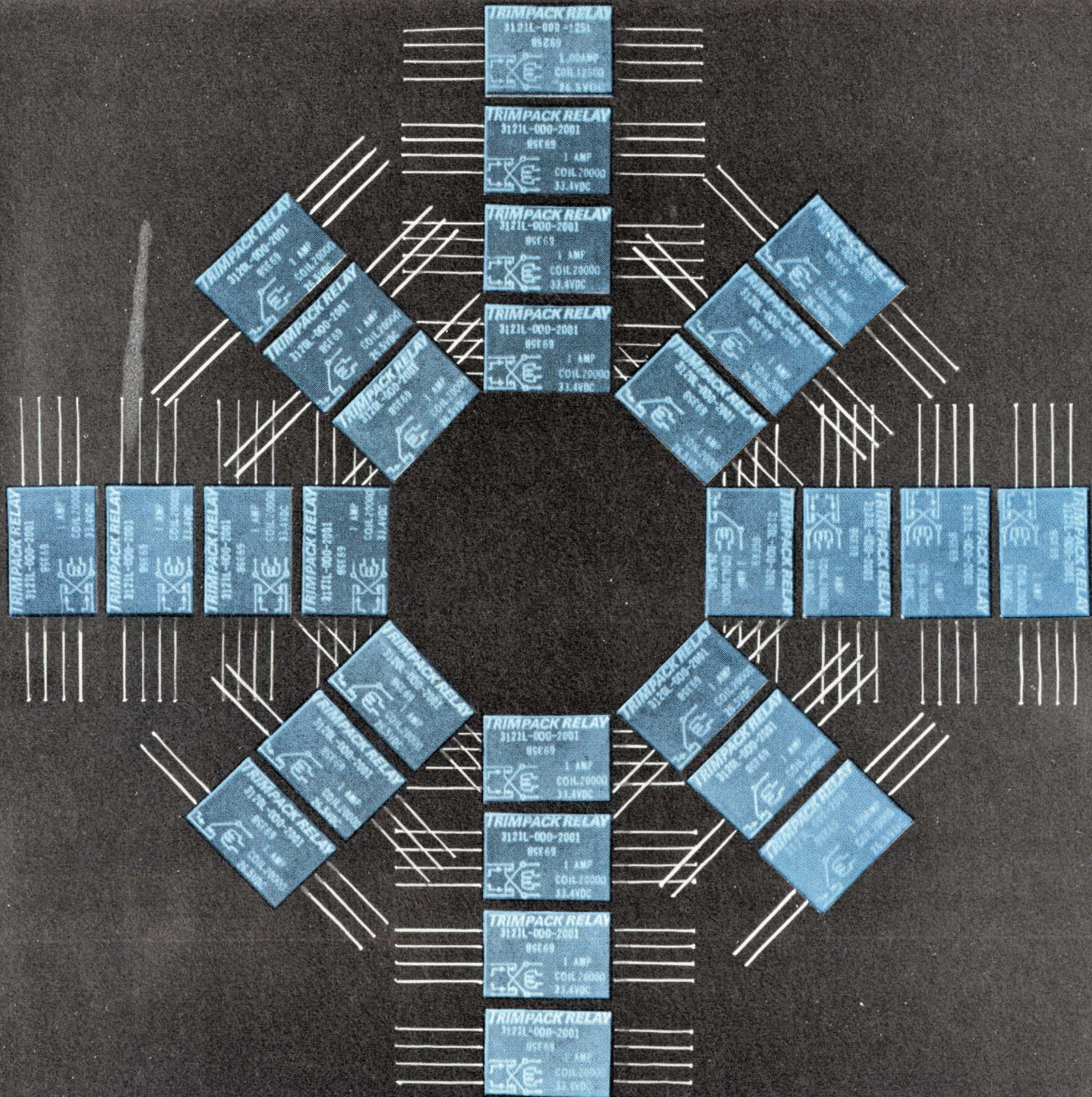

*BOURNS TRIMPACK RELAY TRIUMPH!

The new Model 3120 SPDT and 3121 DPDT TRIMPACK relays are just 0.80" long, 0.57" wide and—note this—only 0.25" high. Designed especially for PC board application, their .100 pin spacing and unique low profile accommodates the usual $\frac{3}{8}$ " spacing between PC boards to permit closer board stacking.

Another exclusive feature is that both new units are rated at 1.0 amp at 26.5 volts DC. The miniature size and outstanding power rating combine to make another Bourns first: THE MODEL 3120 AND 3121 TRIMPACK RELAYS HAVE THE LOWEST PROFILE IN THE INDUSTRY TODAY WITH A 1.0 AMP CAPABILITY.

The Model 3120 sensitivity is rated at 100 milliwatts; the 3121 is 160 milliwatts. Both have an operating

temperature range of -65 to $+125^{\circ}\text{C}$ and they meet all applicable requirements of MIL-R-5757.

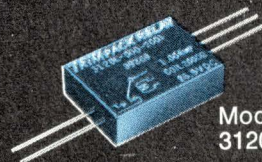

Model
3120

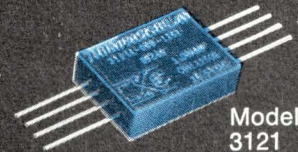

Model
3121

Complete data on the new low-profile Model 3120 and 3121 TRIMPACK relays are available upon request to the factory or your local Bourns sales representative.



NEW PRODUCTS

DIGITAL ISOLATOR

Eliminates interference.

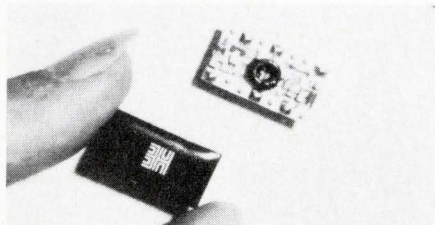

Digital-Isolator can eliminate interference to data transmission in noisy environments. The thick film hybrid circuit is packaged to interface computer and digital systems without requiring common ground connections. It is directly driven from DTL, TTL, or HTL logic signals. Hybrid Electronics, Inc., Bedford, Mass. (617) 275-7110.

Circle 270 on Inquiry Card

FET-INPUT OP AMP

Typical voltage drift is $50\mu\text{V}/^\circ\text{C}$.

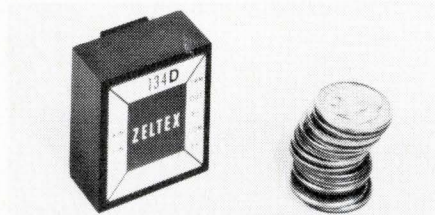

Differential op amp, Model 134D, can be used in differential, inverting and non-inverting circuits. Typical input bias current is 50 pA. Initial offset voltage can be adjusted to zero with an ext. pot. Output is $\pm 10\text{ V}$ at 4 mA, dc gain 50,000, GBW product 1.3 MHz, freq. at full output 100 kHz, and slew rate 6 V/ μs . Zeltex, Inc., 1000 Chalamar Rd., Concord, Calif. 94520. (415) 686-6660.

Circle 271 on Inquiry Card

LOW PROFILE CONNECTIONS

Only 0.200 in. high.

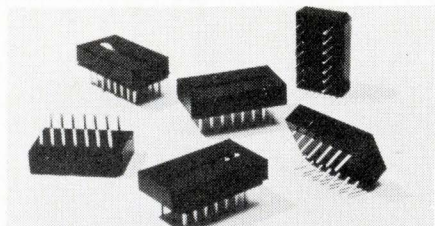

The connectors (14 or 16 pins) can terminate round conductors of up to 30 awg into PC boards, motherboards, backplanes and other IC circuit elements. Individual conductor terminations can be soldered and potted for extra strength, in contrast to ordinary pressure-type terminations. Spectra-Strip Corp., Box 415, Garden Grove, Calif. 92642. (714) 892-3361.

Circle 272 on Inquiry Card

TIME DELAY RELAY

Range is from 0.1 s to 500 s.

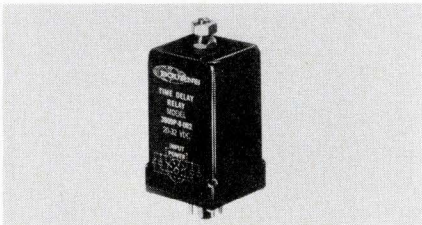

Model 3909 industrial time delay relay is a 10.0 A dpdt model with an operating temperature range of 0 to $+60^\circ\text{C}$. Voltage range is 20 to 32 Vdc and 105 to 125 Vac. Repeatability is $\pm 1.0\%$ and resolution is $\pm 1.0\%$. Bourns, Inc., 1200 Columbia Ave., Riverside, Calif. 92507. (714) 684-1700.

Circle 273 on Inquiry Card

WIDEBAND PREAMP

Features low noise figure, high gain.

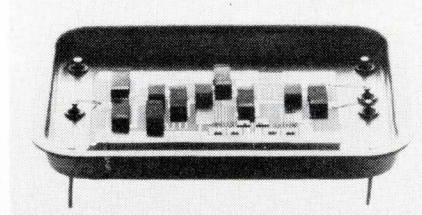

This hybrid i-f preamplifier covers a freq. range of 100 to 500 MHz. Minimum gain is 25 dB. The NF is $< 2.5\text{ dB}$ at 100 MHz and $< 4.0\text{ dB}$ at 500 MHz. The MHA-300 operates with a $+12\text{ dc}$ input and a current drain of 55 mA. Power output is $+5\text{ dBm}$ (at 1 dB compression) and output vswr 2:1. Fairchild Semiconductor, 313 Fairchild Dr., Mountain View, Calif. 94040. (415) 962-3562.

Circle 274 on Inquiry Card

PHOTOMULTIPLIER

Spectral response of 165 to 850 nm.

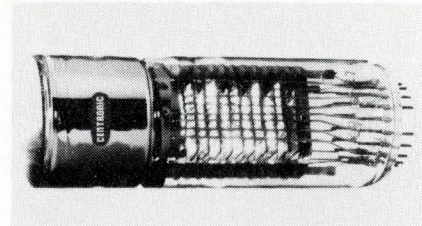

Centronic 2 in. photomultiplier Q4283R covers UV through IR with cathode sens. not less than 180 $\mu\text{A}/\text{Lumen}$, quantum eff. to 27% and low dark current, typically 1-2 nA. A newly developed tri-alkali cathode is mainly responsible for the high performance. The Bailey Co., 5919 Massachusetts Ave., Washington, D. C. 20016. (301) 656-2625.

Circle 275 on Inquiry Card

LOW CURRENT SCR

Plastic encapsulated.

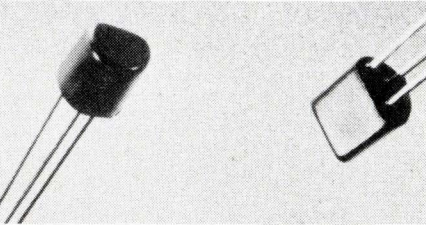

The C103 is interchangeable with over 100 existing types of TO-18 metal can and plastic devices. The C103 has a sens. of 200 μA (max.), voltage selections from 30 to 200 V, 8 A surge capability, and a low forward blocking current of 1 μA . A&SP Dist. Services, General Electric Co., 1 River Rd., Schenectady, N.Y. 13205.

Circle 276 on Inquiry Card

TRIMMER POT

Center-tap unit is only $\frac{3}{8}$ in. sq.

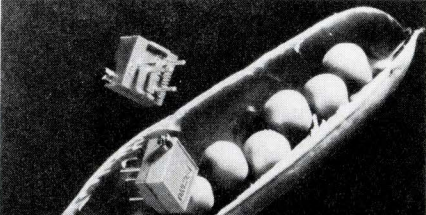

Multiturn wirewound Model 75SCT features resistance values from 100 to 20 k Ω and "stand-offs" for easy board washing. The unit meets MIL-R-27208 for continuity, noise, shock and vibration. Its 25-turn screw adjustment has clutch stop. A high temp. plastic case minimizes insulation and humidity problems. Techno-Components, 7803 Lemona Ave., Van Nuys, Calif. 91405.

Circle 277 on Inquiry Card

POWER TRANSISTORS

Less than 10 ns turn-on time.

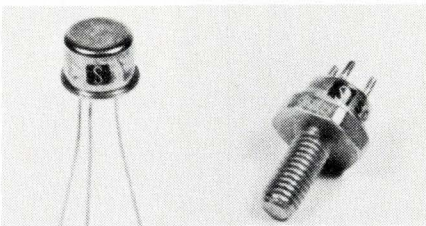

Typical characteristics of SDT6110-SDT6113 series, 10 A devices are: $V_{\text{CEO}} = 40\text{ V}$, $h_{\text{FE}} @ 5.0\text{ A} = 20$ to 60; $V_{\text{CE}} (\text{SAT}) = 1.5\text{ V max.}$; $t_{\text{R}} @ 5.0\text{ A} = 10\text{ ns max.}$; and $I_{\text{C}} \text{ max.} = 10.0\text{ A}$. They have a total switching time $< 80\text{ ns}$ and rise time $< 10\text{ ns}$. Solitron Devices, Inc., 1177 Blue Heron Blvd., Riviera Beach, Fla. 33404. (305) 848-4311.

Circle 278 on Inquiry Card

Why Picker X-Ray tests circuit boards with the Teradyne J259

Most people know Teradyne's J259 as an IC test system. Which is not surprising, since it won its campaign ribbons on IC production lines and in IC incoming-inspection departments.

Note, however, that the J259's official name is "Computer-Operated *Circuit* Test System." Nothing in that name says the circuits have to be integrated. An important point, which was not lost on engineers at Picker X-Ray.

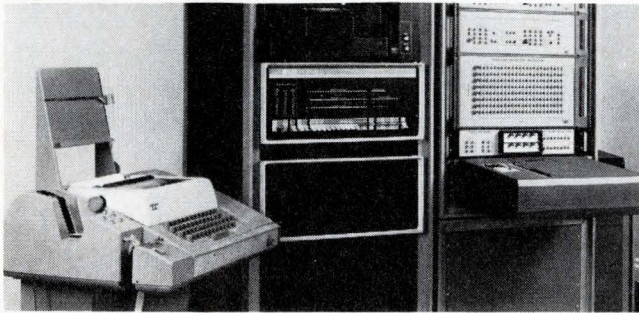

Picker uses its J259 to test circuit boards going into x-ray generators. The J259 whips through the 70 or 80 tests required on a board in a split second, automatically typing out the results of any test that is failed. Test data on a rejected board then accompanies the board to trouble-shooting, where a technician refers to his copy of the test program and keys the failed test to the bad component or connection.

Picker tests more than 50 different boards with the J259. What does Picker like most about the system?

Its efficiency. Only with an automatic system is it economically and humanly practical to test all the boards all the time.

Its strong software. The "datalog rejects only" mode used so profitably by Picker is only one of dozens of fea-

tures included in Teradyne's library of software packages for classification, datalogging, and evaluation.

Its device-protective and self-protective circuits and software. Picker wanted absolute protection of both boards and test instrumentation.

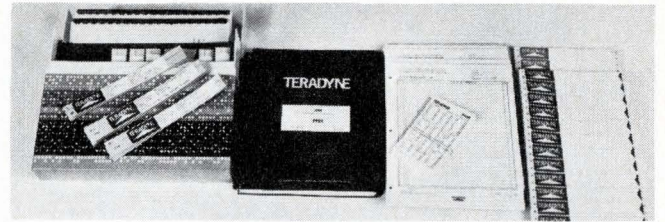

Its reliability. Picker will not take chances with its boards. An undetected bad board can destroy an \$1800 x-ray tube. The J259, like all Teradyne test equipment, is designed and built to make accurate measurements in industrial environments for many, many years.

Its provisions for the addition of special-purpose accessories. Picker uses the J259's unique Network Selector, for example, to interconnect a constant-current source consisting of a simple network of current-limiting diodes.

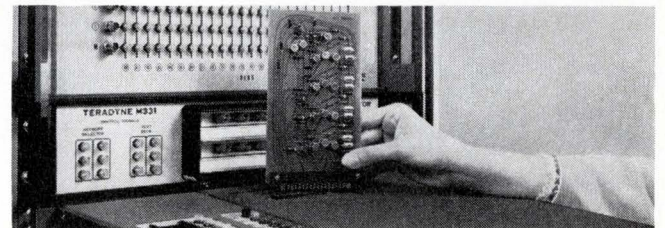

Teradyne's J259 makes sense to Picker X-Ray. If you're in the business of testing circuits — integrated or otherwise — it makes sense to find out more about the J259. Just use reader service card or write to Teradyne, 183 Essex St. Boston, Mass. 02111.

Teradyne makes sense.

Circle 29 on Inquiry Card

The Complete Line of Signal-Indicating Alarm-Activating Fuses

For use on computers, microwave units, communication equipment, all electronic circuitry.



BUSS GLD- $\frac{1}{4}$ x $1\frac{1}{4}$ in. Visual-Indicating, Alarm-Activating.



BUSS Grasshopper Fuse, Visual-Indicating, Alarm-Activating.

BUSS GBA- $\frac{1}{4}$ x $1\frac{1}{4}$ in. Visual-Indicating.



BUSS MIC- $\frac{13}{32}$ x $1\frac{1}{2}$ in. Visual-Indicating, Alarm-Activating.



BUSS ACH Aircraft Limiter, Visual-Indicating.

BUSS MIN- $\frac{13}{32}$ x $1\frac{1}{2}$ in. Visual-Indicating.



FNA FUSETRON Fuse $\frac{13}{32}$ x $1\frac{1}{2}$ in. slow-blowing, Visual-Indicating, Alarm-Activating. (Also useful for small motors, solenoids, transformers in machine tool industry.)

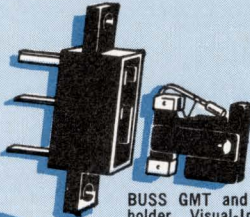

BUSS GMT and HLT holder, Visual-Indicating, Alarm-Activating.

Write for BUSS Form SFB

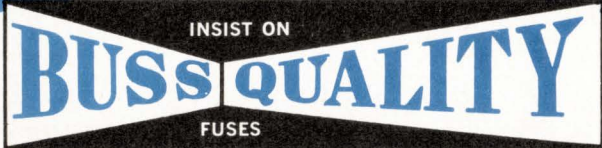

BUSSMANN MFG. DIVISION, McGraw-Edison Co. St. Louis, Mo. 63107

The Complete Line of Fuses For The Protection of Semi-Conductor Rectifiers

TRON Rectifier Fuses

Provide extremely fast opening on overload and fault currents, with a high degree of restriction of let-thru current. Many types and sizes available. Ampere ratings from $\frac{1}{2}$ to 1000 in voltage ratings up to 1500.

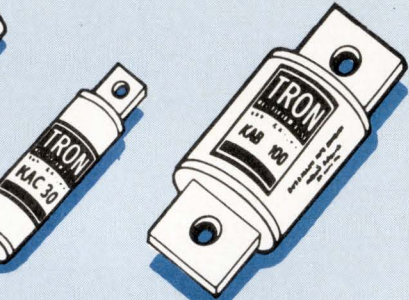
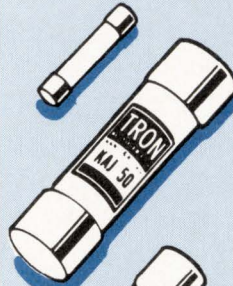

Write for BUSS Form SFB



BUSSMANN MFG. DIVISION, McGraw-Edison Co. St. Louis, Mo. 63107

BUSS: The Complete Line of Fuses and . . .

NEW MICROWORLD PRODUCTS

MOS COUNTERS

Use them with 7-bar indicators.

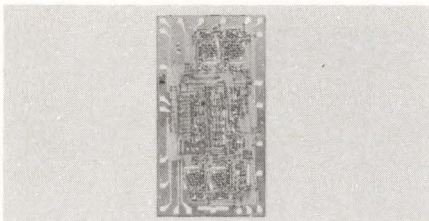

These units have output ratings of 40 V. The HCTR0117 uses negative-true logic and has a count rate of 250 kHz. \$13.80 ea., 100-999 pcs. The HCTR0107, with positive-true logic and a count rate of 1 MHz, is \$15.60. Hughes MOS Devices, 500 Superior Ave., Newport Beach, Calif. 92663.

Circle 261 on Inquiry Card

IC FOR TV RECEIVERS

Replaces about 25 components.

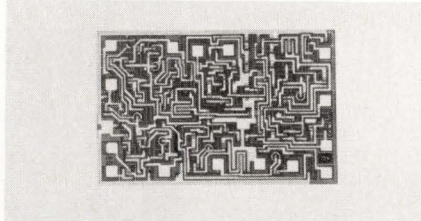

The TAA700 is a central signal processor and distribution circuit for video detector outputs. It is compatible with npn stages in the tuner and i-f amplifier, and with tubes or transistors in the deflection and video output stages. Amperex, Microcircuits Div., Slatersville, R. I. 02876.

Circle 262 on Inquiry Card

READ-ONLY MEMORY KITS

Control digital data displays.

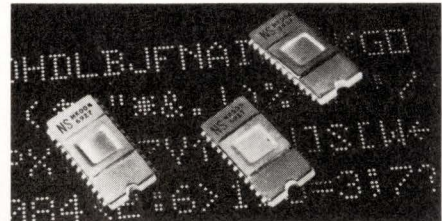

These kits convert standard communications code words (ASC11) into raster-scan or vertical-scan control signals. Kit SK0001, (raster scan) costs \$120, 1-24 pcs. Kit SK0002, (vertical scan) is \$150. National Semiconductor Corp., 2975 San Ysidro Way, Santa Clara, Calif. 95051. (408) 245-4320.

Circle 263 on Inquiry Card

OP AMP POWER BOOSTER

Gives load capabilities to 300 mAdc.

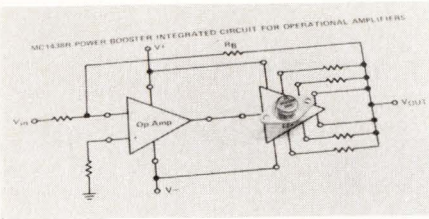

Type MC1438, a unity voltage-gain device, has these typical specs: 4-M Ω input imp., 10- Ω output imp., 1.5-MHz power bandwidth, and a current gain of 3000. It comes in a 9-pin TO-66 can. \$6.50 ea., 100-999 pcs. Technical Information Ctr., Motorola Semiconductor, Box 20924, Phoenix, Ariz. 85036. (602) 273-6900.

Circle 264 on Inquiry Card

MOS DYNAMIC SHIFT REGISTER

Input/output DTL/TTL compatible.

The SRD-25 (UC7330) is a dual 25-bit, fully bipolar-compatible device. It features low-voltage operation ($V_{dd} = -10$ V, $V_{gg} = -16$ V), and low power dissipation (0.4 mW/bit at 1 MHz). Union Carbide Corp., Semiconductor Dept., Box 23017, 8888 Balboa Ave., San Diego, Calif. 92123.

Circle 265 on Inquiry Card

FILM PRODUCTION SYSTEM

Two independent reactor stations.

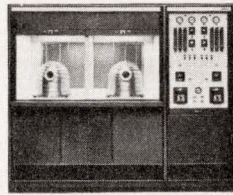

The 1200 Series Silox[®] vapor phase oxidation system produces pure and doped films for MOS, MSI and LSI ICs. Up to 42 two-in. wafers per run. Cycle time for a 5000 Å deposition is about 10 min. Applied Materials Technology, 2999 San Ysidro Way, Santa Clara, Calif. 95051. (408) 738-0600.

Circle 266 on Inquiry Card

PLUG-IN LSI PACKAGE

Hermetic unit has 51 leads.

HA-1772 has a high-alumina ceramic body and gold plated die-attach area. The seal ring (either alumina ceramic or kovar) is hard glassed to the base. Style HA-1772-1 has a hard glass seal frame for frit closure with a glassed ceramic cap. Mitronics, Inc., 132 Floral Ave., Murray Hill, N.J. 07974. (201) 464-3300.

Circle 267 on Inquiry Card

DIGITAL IC TESTER

Tests 8000 16-lead devices/h.

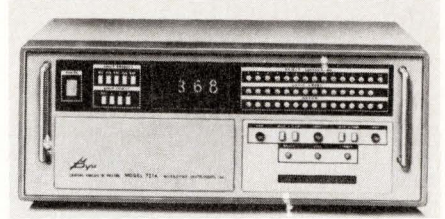

Model 721A makes up to 1024 sequential dc and functional measurements in 100 ms. Automatic (with a mechanical test handler) or manual operation. A plug-in, crosspoint matrix card programs the tester for automatic operation. Microdyne Instruments, 203 Middlesex Tpk., Burlington, Mass. 01803.

Circle 268 on Inquiry Card

TV CHROMA DEMODULATOR

Directly replaces μ A737A.

The μ A746E has a voltage drift of 0.3 mV/ $^{\circ}$ C. Its 9-pin EpiPak housing plugs into a standard 9-pin miniature tube socket. Chief use of the device is in NTSC color TV receivers and display monitors. \$3.75 ea., 1-24 pcs. Fairchild Semiconductor, 313 Fairchild Dr., Mountain View, Calif. 94040. (415) 962-3563.

Circle 269 on Inquiry Card

.. Fuseholders of Unquestioned High Quality

SUB-MINIATURE FUSES

Ideal for space tight applications, light weight, vibration and shock resistant. For use as part of miniaturized integrated circuit, large multi-circuit electronic systems, computers, printed circuit boards, all electronic circuitry.

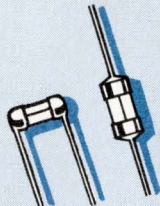

TRON Sub-miniature Pigtail

Fuses — Body size only .145 X .300 inches. Glass tube construction permits visual inspection of element. Hermetically sealed. Twenty-three ampere sizes from 1/100 thru 15.



BUSS Sub-miniature GMW Fuse and HWA Fuseholder

Fuse size only .270 X .250 inches. Fuse has window for visual inspection of element. Fuse may be used with or without holder. 1/200 to 5 amp. Fuses and holders meet Military Specifications.

Write for BUSS Form SFB

INSIST ON
BUSS QUALITY
FUSES

BUSSMANN MFG. DIVISION, McGraw-Edison Co. St. Louis, Mo. 63107

Circle 54 on Inquiry Card

THE COMPLETE LINE OF *Small Dimension* FUSES

For The Protection of All Types of Electronic and Electrical Circuits and Devices . . .

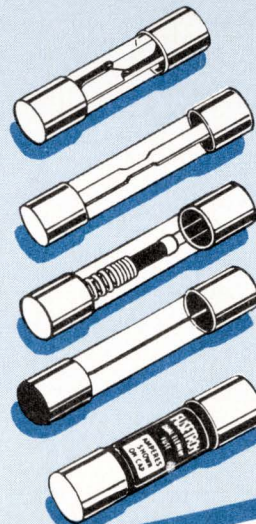

. . . includes dual-element "slow-blowing", single-element "quick-acting" and signal or visual indicating types . . . in sizes from 1/500 amp. up.

For special fuses, clips, blocks or holders, our staff of fuse engineers is at your service to help in selecting or designing the fuse or fuse mounting best suited to your requirements.

Write for BUSS Form SFB

INSIST ON
BUSS QUALITY
FUSES

BUSSMANN MFG. DIVISION, McGraw-Edison Co. St. Louis, Mo. 63107

Circle 54 on Inquiry Card

NEW MICROWORLD PRODUCTS

TTL MSI DATA SELECTORS

Two week availability.

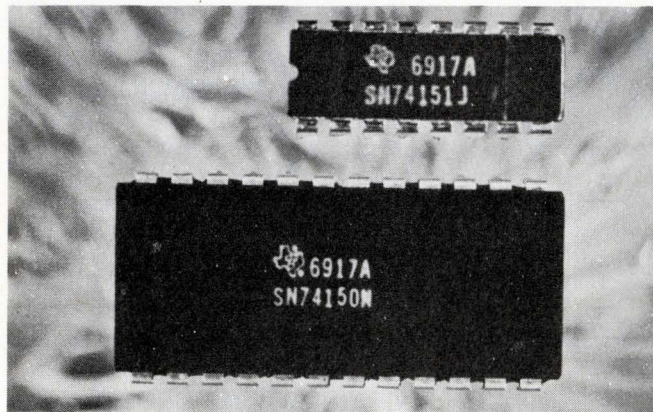

The SN54150/SN74150 are 16-bit data selectors in 24-pin plastic packages. A 4-line binary address selects the input data and routes it to the output where it is inverted. A strobe input lets you cascade the units. The 151 (an 8-bit version) comes in either 16-pin plastic or ceramic dual in-line packages. It has a strobe input and both true and inverted outputs. The 152 (in TI's 14-pin $\frac{1}{4} \times \frac{1}{8}$ in. flat pack) is the same as the 151 except the strobe and true outputs are deleted. Prices range from \$4.83 to \$12.10 depending on model and quantity. Texas Instruments Incorporated, Inquiry Answering Service, Box 5012, MS 308, Dallas, Tex. 75222. (214) 238-3741.

Circle 289 on Inquiry Card

FREQUENCY DIVIDER ARRAYS

Binary and decade programmable.

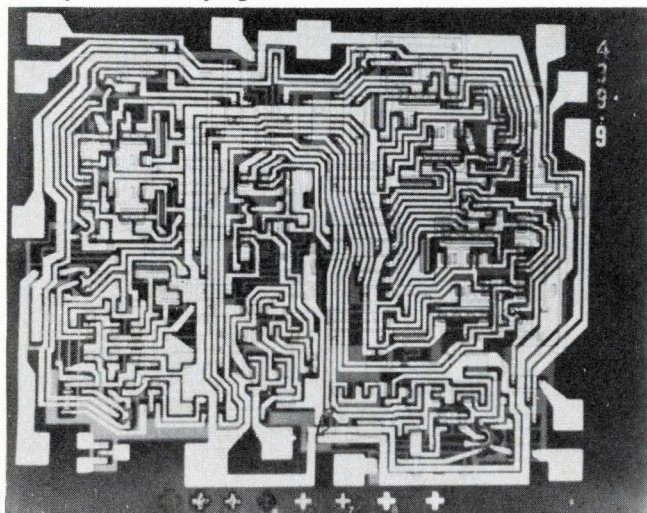

These TTL MSI arrays produce an output frequency equal to $1/N$ times the input frequency. The SM143 binary divider is programmed with a 4-bit binary number and can perform frequency division by any whole number up to 16. The SM153 decade divider is programmed with a BCD number and divides by any number up to 10. Available in 14-lead, hermetic flat-pack or plug-in packages, they operate from 0 to 75°C. Both devices are compatible with all other Sylvania arrays and SUHL I and II TTL integrated circuits. \$8.80 ea., 100 to 999 pcs. Sylvania Electric Products Inc., Semiconductor Div., 100 Sylvan Rd., Woburn, Mass. 01801. (617) 933-3500.

Circle 290 on Inquiry Card

DIELECTRIC DEFECT DETECTOR

Promises higher yields, lower costs for MSI/LSI ICs.

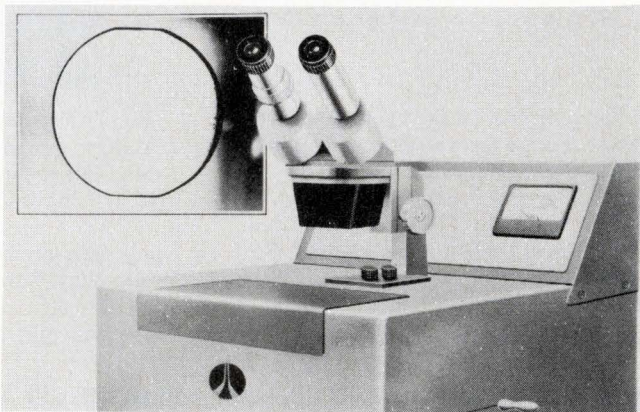

This unit can verify the integrity of organic and inorganic insulating coatings on conductive substrates to a degree not formerly possible. The instrument locates invisible pinholes as small as one-tenth of a micron in diameter in oxide, nitride, alumina, and similar layers on semiconductor wafers. You can also use it to determine the completeness of insulation coatings on wires and on various components. Potentially, the instrument can check the coverage of a number of conformal coatings on metals. Navan, Subsidiary of North American Rockwell, 1320 E. Imperial Highway, El Segundo, Calif. 90245. (213) 647-4888.

Circle 291 on Inquiry Card

FLUIDIC IC TEST HANDLER

Manual or automatic feed.

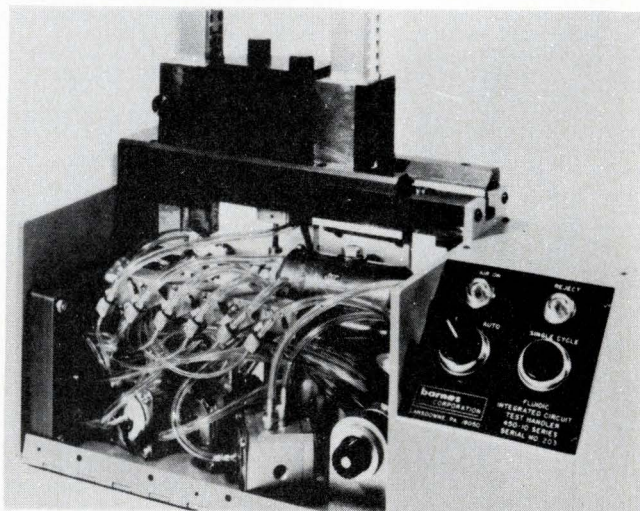

The 450-10 Series fluidic handler is designed to be slaved to an electronic IC tester to provide a fully automated test system. A 30-gate, fluid logic circuit replaces the cams and relays normally associated with the logic portion of an integrated circuit handler. Thus there is no electrical noise or spurious signals to interfere with the IC tester's performance. The handler can be adjusted to accept virtually all dual in-line, flat pack, or TO-style IC packages. It can process as many as 4800 devices per hour, depending on the time requirements of the tester. Barnes Corp., 24 N. Lansdowne Ave., Lansdowne, Pa. 19050. (215) 622-1525.

Circle 292 on Inquiry Card



Fairchild Acquires Union Carbide Modular Products Line.

All standard and special modular op amps formerly offered by Union Carbide are now manufactured and marketed by Fairchild Controls, Mountain View, California.

Fairchild Controls' purchase of these Union Carbide products is part of a continuing planned program of expansion through both internal new product development and acquisition of quality products which complement the Fairchild line.

Fairchild will also continue to produce all special modular op amps that until now have been provided by Union Carbide.

For availability or applications information regarding these products contact Fairchild Controls, Modular Products, 423 National Avenue, Mountain View, California 94040. (415) 962-3833.

Standard Union Carbide operational amplifiers now made and sold by Fairchild Controls include:

Class	Type	Model
Chopper Stabilized	General Purpose	H2000
		H2030
Instrumentation Amplifier	FET Input	H3100
Wide Temperature Range High Performance Types	General Purpose	H6000
	FET Input Wideband	H7000 H9000
Commercial Temperature Range Types	General Purpose	H6010
		H6020
		H9010
		H9020
		H9030
		FET Input
Output Current Booster	General Purpose	H6050
Comparator	General Purpose	H8010

FAIRCHILD
CONTROLS

A DIVISION OF FAIRCHILD CAMERA AND INSTRUMENT CORPORATION

Modular Products / 423 National Avenue / Mountain View, CA 94040 / (415) 962-3833

Circle 55 on Inquiry Card

NEW LAB INSTRUMENTS

UNIVERSAL DATA TEST SET

Handles synchronous or asynchronous data.

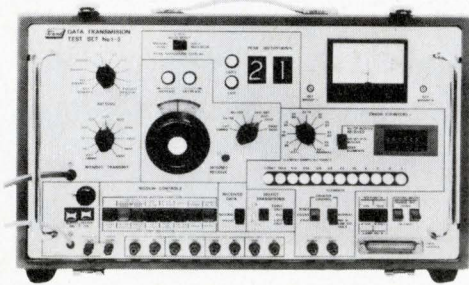

Trend Model 1-3 generates and receives digital data under control of either a built-in or external clock. The unit operates at data rates from 24 to 9600 bits/s. A pseudo-random 511-bit pattern is among the various bit patterns supplied. The receiver and measuring circuits give three readings: peak telegraph distortion, bias distortion, and error count. There is a control to vary the error threshold-level from the normal 50% distortion down to 0% distortion, in 5% steps. The modem interface connector is a standard 25-pin E.I.A. RS-232B. Price is \$4390. Transmission Measurements Inc., 1051 Clinton St., Buffalo, N.Y. 14206. (716) 852-4500.

Circle 248 on Inquiry Card

SERVO CALIBRATOR

Up to 168 vcOs, 24 discriminators, from 5 kHz to 2 MHz.

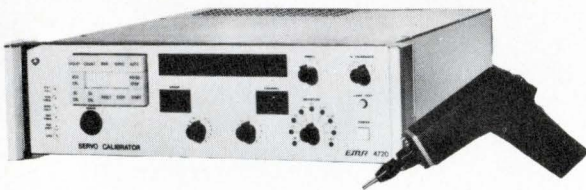

The EMR 4720 provides solid-state switch closures as a 9-point calibration check for signal conditioners. Internal or external voltages calibrate up to 12 different center frequencies. Accuracy of the reference-frequency outputs to the discriminators is ± 1 in 10^5 parts from 10 to 50°C. The display shows the selected vco output frequency (Hz), or the error between the internal reference and the selected vcOs (Hz) or discriminators (mV). Options include a printer readout capability and a servo loop to reduce vco or discriminator zero- or gain-error to less than $\pm 0.05\%$ of full bandwidth. EMR-Telemetry, Box 3041, Sarasota, Fla. 33578. (813) 958-0811.

Circle 249 on Inquiry Card

NUMERIC DISPLAY

Has full-scale accuracy of $\pm 0.1\%$.

The Numatron™ display receives analog sensor information, conditions and amplifies it, and converts it to digital form. The instrument then linearizes and scales this data and displays it directly in engineering units. The unit has four voltage ranges in addition to the linearized sensor range and an adjustable sampling rate. You can change the sensor or sensor range with a set of printed circuit cards. The instrument has BCD or analog outputs for a printer or recorder. Its half-rack size lets you mount the displays side-by-side in a standard 19-in. relay rack. Leeds & Northrup Co., North Wales, Pa. 19454. (215) 643-2000.

Circle 250 on Inquiry Card

PANEL MOUNTED DIGITAL COMPARATOR

Compatible with DTL/TTL BCD inputs.



Model 4310 compares both the sign and data of an input signal. A polarity switch selects the sign of the limit point. The unit will compare either continuously or on command. Outputs include a 2-A relay contact closure, a logic level change, and lamps for above- and below-limit indication. Four versions of the comparator offer a range of ± 1999 or ± 9999 ($3\frac{1}{2}$ or 4 digits), and adjustable, fixed, or remotely-programmed limits. You may mount the logic separately from the 1 1/2-in. deep control module. \$165 for adjustable limit models; \$95 for fixed limits. Delivery 4 to 6 weeks. API Instruments Co., Chesterland, Ohio 44026. (216) 729-1611.

Circle 251 on Inquiry Card

PRESET COUNTER

Frequencies or rates up to 10 MHz.

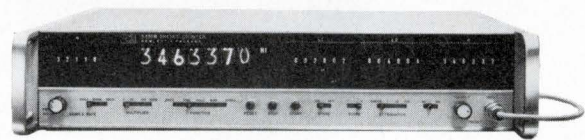

Model 5330B can normalize counted data, issue control signals when preset limits (either count or count-rate) are reached, and count and control both the number of items in a group and the number of groups. You can also use the unit as a precision pulse and digital delay generator. All functions are remotely programmable. The 5330B normally gives you five-digit readouts and limit settings, but six- and seven-digit models are also available. The 5330A is a lower-cost, less versatile model. Tentative prices are : 5330A, \$1200; 5330B, \$1550. Inquiries Mgr., Hewlett-Packard Co., 1501 Page Mill Rd., Palo Alto, Calif. 94304. (415) 326-7000.

Circle 279 on Inquiry Card



If these standard hybrids won't do it... we have more where they came from

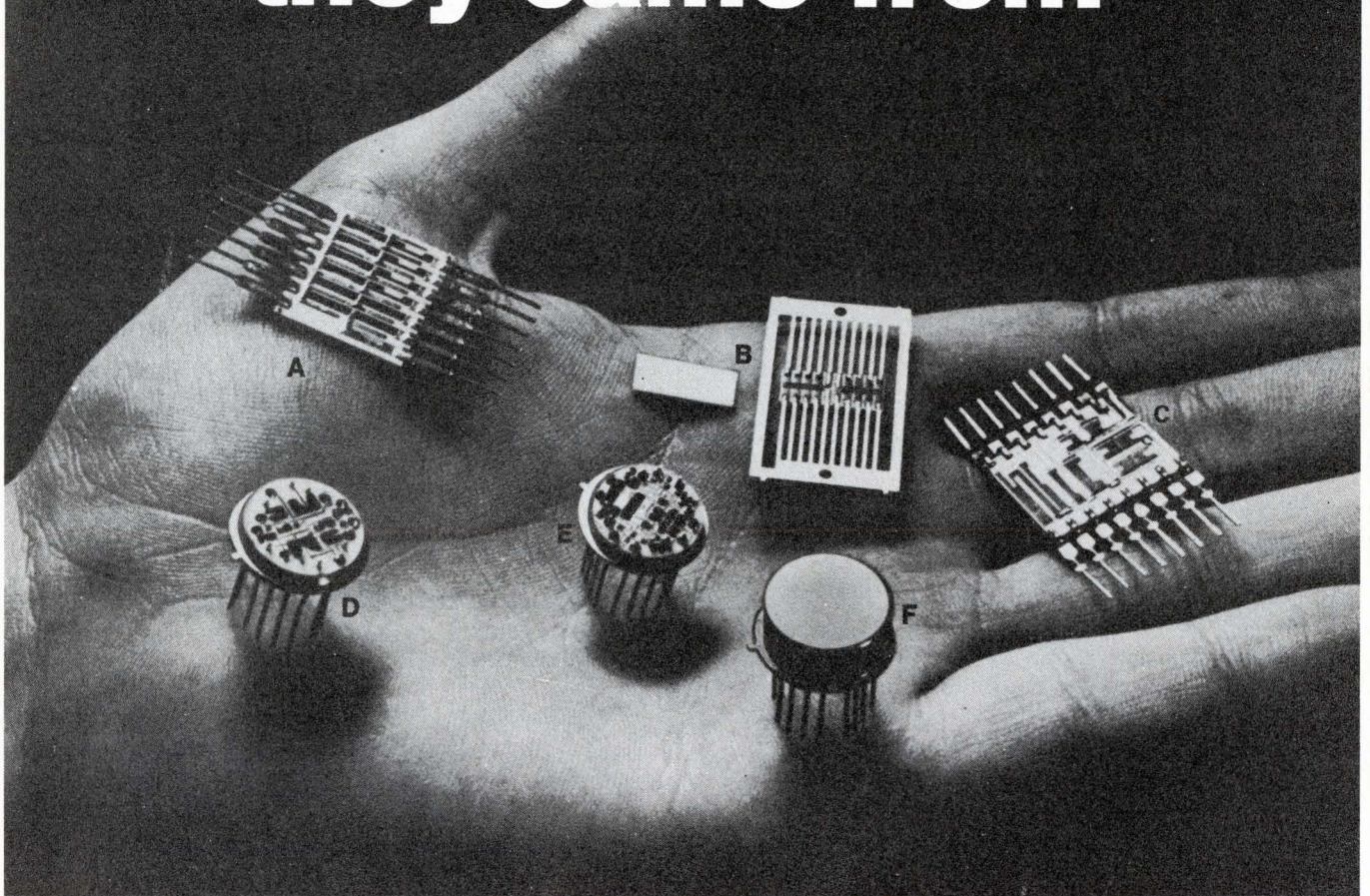

Standard hybrids featured in MEPCO "circuit of the month" program: **A** D/A binary voltage summing ladder; **B** ceramic sandwich resistor flatpack; **C** D/A binary current summing ladder; **D** DTL to MOS level shifter; **E** precision high speed ladder switch; **F** relay, lamp, core driver.

MEPCO microcircuit design engineers have perfected a good number of standard hybrid microcircuits lately. No doubt you've heard about our "standard circuit of the month" program. They're all designed to meet the most stringent high-reliability design requirements, while offering the time and cost advantages of mass production.

If we haven't yet perfected a standard circuit to meet your needs, it could very well

be that we're working on it now. Or perhaps we can find the fit among the hundreds of custom hybrids we've developed this year.

Before you look any further, ask us to show you a completely packaged hybrid integrated circuit that can outperform its counterpart. Write or call us collect for complete information, or talk to your MEPCO representative.



MEPCO, INC., COLUMBIA ROAD, MORRISTOWN, N. J. 07960 • (201) 539-2000 • TWX: 710-986-7437

MUCON[®] TUBULAR CERAMIC CAPACITORS

CK12 thru CK16

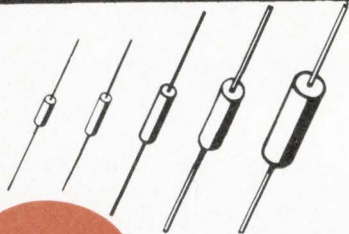

Approved MIL STYLES

10PF-.01MF

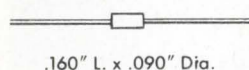

.160" L. x .090" Dia.

MIL Style
CK12

10PF-.047MF

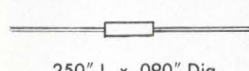

.250" L. x .090" Dia.

MIL Style
CK13

.012MF-.27MF

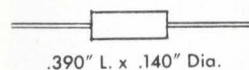

.390" L. x .140" Dia.

MIL Style
CK14

.1MF-1.0MF

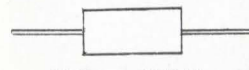

.500" L. x .250" Dia.

MIL Style
CK15

.47MF-3.3MF

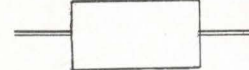

.690" L. x .350" Dia.

MIL Style
CK16

Republic Electronics makes a broad line of Mucon Subminiature Ceramic Capacitors to meet any requirement. Write for **NEW CATALOG**

REPUBLIC ELECTRONICS CORP.

176 E. 7th St. PATERSON, N. J. 07524
201-279-0300 TWX 710-988-5908

Circle 57 on Inquiry Card

NEW LAB INSTRUMENTS

DECADE COUNTER

Up to 2400 counts/min.

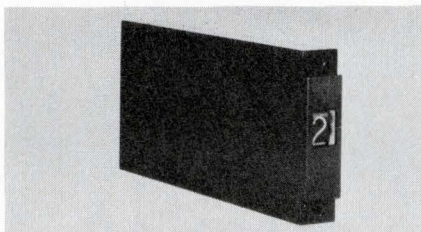

The Mod Counter is a bi-directional unit that counts on the trailing edge of the input pulse. You can use the instrument for serial or parallel input data. Price is less than \$50/decade. Tasker Industries, Subs. of Whittaker Corp., Counter Products, 18842 Teller Rd., Newport Beach, Calif. 92664. (714) 833-2100.

Circle 282 on Inquiry Card

RMS AC/DC LOG CONVERTER

Has bandwidth of 0.5 Hz to 100 kHz.



Model 1020 has dynamic ranges of 120 dB dc and 80 dB ac, and a 100-dB offset control. Accuracy of the unit is 0.5 dB. All circuits are isolated from the chassis to reduce ground current effects. Price is \$950. Pacific Measurements Inc., 940 Industrial Ave., Palo Alto, Calif. 94303. (415) 365-0212.

Circle 283 on Inquiry Card

VOLTAGE BREAKDOWN TESTER

Current limited output.



Model 791 has four voltage ranges: 0-50, 0-100, 0-1000, and 0-5000 V. You can use the instrument to test high- and low-voltage transistors, thyristors, diodes, and rectifiers for breakdown levels. SVI Electronics, 48 Broadway, Box 525, Albany, N.Y. 12201. (518) 465-5115.

Circle 284 on Inquiry Card

Phillips Vibra Sone

Cavmatic
Self-Contained
Ultrasonic
Cleaning
Systems make
sub-miniature
parts

COME CLEAN



Solid State
Generators

Nothing cleans critical parts and components like ultrasonic energy... and for production or laboratory applications, there's no system like Phillips Cavmatic Series—fully automatic, dependable, efficient.

- Bench-top sizes, fully automatic, self-compensating for operational variations.
- Integral generator and tanks in standard sizes to meet FCC regulations for conducted and radiated interference.
- Silicon high voltage transistors used throughout—generator has at least 50% reserve power over rated output.
- Operate at 40 kHz—generator output full wave modulated for peak power.
- Polished stainless steel tanks are corrosion resistant—transducer elements permanently bonded.

For details, ask for Bulletin 110.

**NATIONAL ULTRASONIC
DIVISION**

Phillips Manufacturing
Company

7334 North Clark Street
Chicago, Illinois 60626 • Phone 312-338-6200

WASHERS • DEGREASING SOLVENTS • DRYERS
ULTRASONICS • DEGREASERS

10748

Circle 81 on Inquiry Card

NEW LAB INSTRUMENTS

GENERAL-PURPOSE RADIATION SURVEY METER

Operates on two D-cell batteries.



Model 493 detects alpha, beta, gamma, and X-rays, depending on which Geiger-Mueller probe you use. One standard and three optional probes give you a choice of both radiation type and sensitivity. When the meter is calibrated with Cs-137, its accuracy is $\pm 20\%$ of full scale on all three of its ranges (0-0.5, 0-5, and 0-50 mR/h). You may also have calibration with Co-60 or Ra-226. Batteries supply power for about 150 h of operation at a rate of 4 h/day. The temperature range of the unit is -20 to 120°F . Victoreen Instrument Div., Victoreen Leece Neville, Inc., 10101 Woodland Ave., Cleveland, Ohio 44104. (216) 795-8200.

Circle 285 on Inquiry Card

METAL-FILM THICKNESS MONITOR

Measures thicknesses between 20 nm and $2\mu\text{m}$.

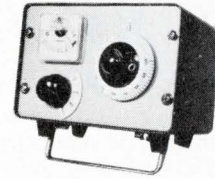

The Filmitor equipment uses a conductivity method to monitor thickness during vacuum deposition. The equipment is in two sections: a monitor head mounted in the deposition area, and a remote indicator unit. The monitor head includes a disposable probe. Metal builds up not only on the component being treated, but also on the probe: the increase in conductivity is thus a measure of the film thickness. There are two versions: one AC-operated at about \$260, and the other battery operated at about \$180. Electrotech Equipments Ltd., Prince of Wales Industrial Estate, Commercial Rd., Abercarn, Newport, Monmouthshire, NP1 5 RF, Britain.

Circle 288 on Inquiry Card

HAND-HELD IR DEVICE

Measures without contact.



Therm-a-ray® measures IR energy from moving or stationary objects. You sight the object and squeeze the trigger for the reading. The unit can measure from subzero to 3000°C at distances from 5 in. to infinity. Juron Measurement Corp., Box 438, Church St. Sta., New York, N.Y. 10008. (212) 267-2043.

Circle 286 on Inquiry Card

FREQUENCY STANDARD

Gives 1-MHz and 100-kHz outputs.

This unit has a synchronizing accuracy better than $1\mu\text{s}$. Outputs are directly traceable to the National Bureau of Standards. Model 112, \$495; Model 112-01, with phase comparator and recorder options, \$770. Beukers Laboratories, Inc., 1324 Motor Pkwy., Hauppauge, N.Y. 11787. (516) 234-2200.

Circle 287 on Inquiry Card

**For
high-temperature
acceleration
measurements,
get "the
hot ones"
from Gulton.**

Gulton
Industries, Inc.

SERVONIC DIVISION

1644 Whittier Avenue, Costa Mesa, California 92627 / (714) 642-2400

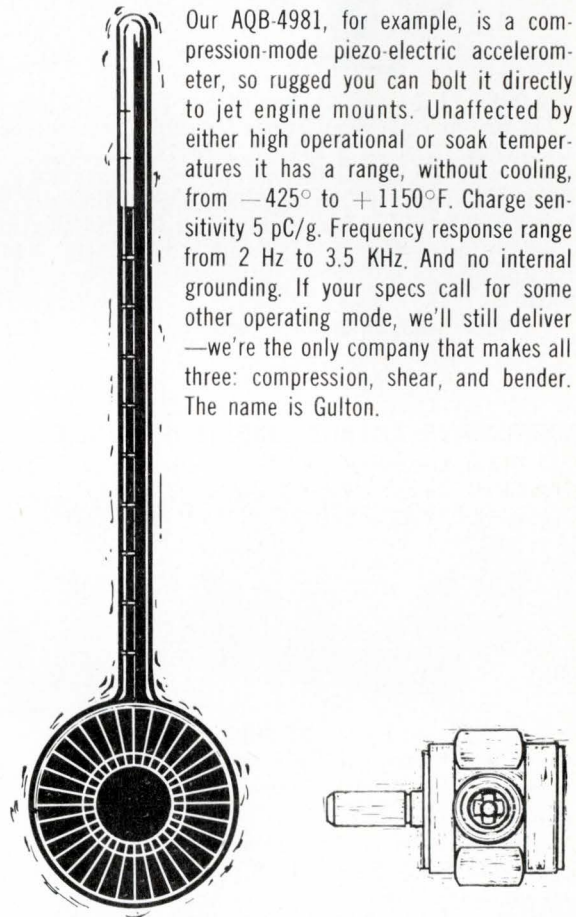

Our AQB-4981, for example, is a compression-mode piezo-electric accelerometer, so rugged you can bolt it directly to jet engine mounts. Unaffected by either high operational or soak temperatures it has a range, without cooling, from -425° to $+1150^\circ\text{F}$. Charge sensitivity 5 pC/g. Frequency response range from 2 Hz to 3.5 KHz. And no internal grounding. If your specs call for some other operating mode, we'll still deliver—we're the only company that makes all three: compression, shear, and bender. The name is Gulton.

NEW LAB INSTRUMENTS

ITFS TEST SET

Checks 2.5-GHz transmitters.



Model TTC-1A makes all necessary FCC periodic checks including transmitter frequency, power output, and modulation. Used with a scope, it replaces separate equipments now needed to perform these tests. Price \$4,100. Micro-Link Systems, 19 Warburg Ave., Copiague, N.Y. 11726. (516) 598-2240.

Circle 252 on Inquiry Card

SOUND LEVEL METER

Has range of 50 to 130 dB.



Model SLM-3 is individually calibrated and comes with a matched microphone. Its accuracy meets International Standard IEC-123. You can get an amplifier unit to extend the lower limit to 30 dB. Trans Atlantic Electronics Inc., 55 Bloomingdale Rd., Hicksville, N.Y. 11801. (516) 822-2110.

Circle 255 on Inquiry Card

TV DEMODULATOR

Unit is fully transistorized.



Type AMF demodulates monochrome and color TV signals (NTSC, SECAM and PAL), and TV sound signals, in the vhf and uhf bands. The instrument monitors and checks both picture and sound transmitters. Rohde & Schwarz Sales Co. (U.S.A.) Inc., 111 Lexington Ave., Passaic, N.J. 07055. (201) 773-8010.

Circle 258 on Inquiry Card

DECADE CAPACITOR

Has accuracy of $\pm 0.25\%$.

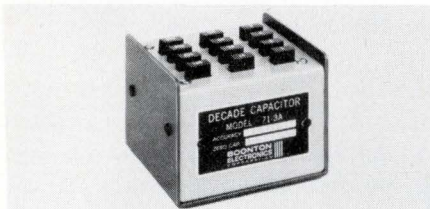

Model 71-3A has a range of one to 1221 pF, in 1-pF steps. It has a useful frequency range of 5 kHz to 1 MHz, and a temperature coefficient of better than 100 ppm/°C. Price \$350. Delivery within two weeks. Boonton Electronics Corp., Rte. 287 at Smith Rd., Parsippany, N.J. 07054. (201) 887-5110.

Circle 253 on Inquiry Card

DIGITAL THERMOMETER

Custom scales; -350 to $+1350^{\circ}\text{F}$.

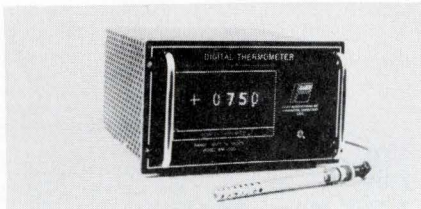

Series 1500 is a platinum probe thermometer that uses a resistance change vs temperature principle. Its accuracy is 0.01% \pm span non-linearity \pm one count. A differential-reading model is also available. Bauer Mfg., Inc., Farmington Industrial Park, Farmington, Conn. 06032. (203) 677-9707.

Circle 256 on Inquiry Card

TEMPERATURE CONTROLLER

Heats and cools IC packages.



Model TP-2000 quickly varies a single IC's operating temperature. Depending on the package, the unit changes a component's temperature from ambient to -55 or $+125^{\circ}\text{C}$ in 15 to 60 seconds. EG&G Inc. Electronic Products Div., 160 Brookline Ave., Boston, Mass. 02215. (617) 267-9700.

Circle 259 on Inquiry Card

MICROWAVE ACTIVITY MONITOR

All solid-state except for CRT.

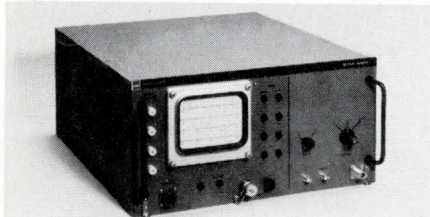

The WJ-1140 has a CRT display that shows signal activity in the 1- to 12-GHz microwave spectrum; it is designed for quick-look analysis. You can install the unit for airborne, shipboard, or van applications. Watkins-Johnson Co., 3333 Hillview Ave., Stanford Industrial Park, Palo Alto, Calif. 94304. (415) 326-8830.

Circle 254 on Inquiry Card

SLIDE WIRE ATTENUATORS

Linear to 54 dB.

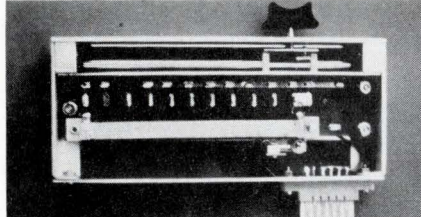

Series 1070 attenuators are available in continuously adjustable slide wire models with single and dual ladder networks. They are designed for use in applications requiring small dB increments over a wide attenuation range. Daven McGraw Edison, Grenier Field, Manchester, N.H. 03103. (603) 669-0940.

Circle 257 on Inquiry Card

TEMPERATURE INDICATOR

Has range of -20 to 400°F .

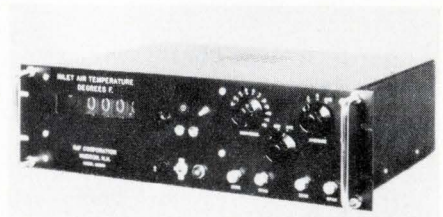

This unit gives a readout for each of 12 RTD temperature sensors. The instrument also has a thirteenth position that displays the average of all 12 measurements. Resolution is 0.1°F with an accuracy of $\pm 0.5\%$. Price is \$1,350. RdF Corporation, 23 Elm Ave., Hudson, N.H. 03051. (603) 882-5195.

Circle 260 on Inquiry Card

**Film-Met
is not a
wirewound...**

**not a
cermet.**

**Film-Met is a
whole new trimmer.**

It has an exclusive Amphenol resistance element* completely different from wirewounds and cermets.

Film-Met™ is a 100% metal element, not a cermet material. The process is different, too. We use a vacuum deposition chamber and our patented process to evaporate metal alloys onto an insulating substrate. The resistive track is then protected by a noble metal overlay.

But the big Film-Met difference is performance.

Film-Met offers both infinite resolution and a low temperature coefficient of 100 ppm/°C maximum. 50 ppm/°C is available on request.

It also provides excellent high frequency and pulse characteristics, and low current noise. In addition, Film-Met has extremely low contact resistance variation.

We're not knocking wirewound and cermet trimmers. We make them too. In many applications, their characteristics fit perfectly. But when they don't you needn't compromise. You can now use Film-Met trimmers.

Film-Met trimmers are available in 3/4" rectangular commercial—3811 series; 1/2" square military—2901 series; and 1 1/4" rectangular military—2851 series.

We'd like you to evaluate this new type of trimmer and compare it to wirewound and cermet. Then tell us if Film-Met isn't a whole new trimmer.

You'll find them at the Amphenol distributor nearest you. Or write to us for complete specs. Amphenol Controls Division, Janesville, Wisconsin 53545.

Film-Met™ by Amphenol



AMPHENOL
THE BUNKER-RAMO CORPORATION

*U.S. Patent No. 3,353,134; also foreign patents.

TRYGON power supplies are... a New systems grouping providing the utmost in flexibility and economy

OEM Modules; ¼ racks; ½ racks; full racks
—all compatible with ruggedly constructed
rack adapters for up to 161 VDC and 70 amps.

- Complete Systems Reliability
- Unattended Continuous Operation

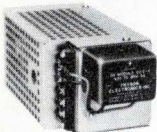

TPS
Super Trypack Series
Slot range system module
from \$56.



LVW-LVS
Liberator Sub-Rack Series
Slot and wide range modules.
from \$89.



LQS
Liberator Sub-Rack Series
¼ rack slot range,
optional metering
from \$135.



LHS
Liberator Sub-Rack Series
½ rack slot range,
optional metering
from \$219.

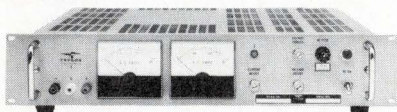

L3R/L5R
Liberator Series full rack systems power supply
from \$450.

TRYGON MEANS POWER!

Write now for complete data and pricing
of this new systems grouping.

TRYGON POWER SUPPLIES

111 Pleasant Avenue, Roosevelt, New York 11575
Tel: 516-378-2800 TWX: 510-225-3664
Trygon GmbH 8 Munchen 60, Haidelweg 20, Germany
Write for Trygon Systems Power Supply Catalog.
Prices slightly higher in Europe.

Circle 60 on Inquiry Card

NEW PRODUCTS

MINIATURE DIODE

Especially suited for hybrid ckts.



The Hybridiode permits characteristics testing prior to bonding into the circuit. Either or both of the flag-type leads may be used for contact to the pad by soldering, welding or thermocompression bonding. The flag-type leads can also be removed and contact made directly to top and bottom of the pellet. Micro-Semiconductor Corp., 11250 Playa Ct., Culver City, Calif. 90230 (213) 391-8271.

Circle 201 on Inquiry Card

MINIATURE HV CAPACITOR

Monolithic construction.

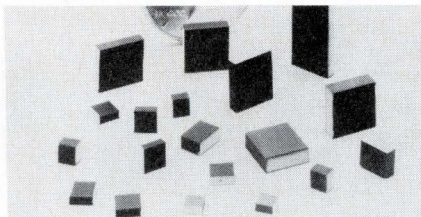

New miniature, ceramic capacitor is well suited for high package density voltage multiplier and hv power supply applications. It has a dissipation factor of < 1% at 1 kHz with an ins. res. to 3000 TΩ. TC is ±15%. Monolithic Dielectrics Inc., Box 647, Burbank, Calif. 91503. (213) 848-4465.

Circle 202 on Inquiry Card

HYBRID OP AMP

With an FET input.



Model 1405 provides high speed operation over a wide bw (up to 1 MHz at full output and 10 MHz for small signals). Slew rate is over 50 V/μs. It has a 6 db/octave rolloff, low bias currents (50 pA max.), a low offset voltage TC of 25 μV/°C typ. over the -25°C to +85°C temp. range, high open loop gain (300,000 typ.), an output voltage of ±11 V typ. and an output current of 20 mA min. Philbrick/Nexus Research, Allied Dr. at Rte 128, Dedham, Mass. 02026. (617) 329-1600.

Circle 203 on Inquiry Card

PLASTIC TRANSISTORS

Designed for audio, radio and tv ckts.

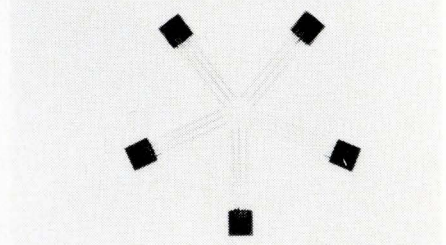

TO-92 packaged small-signal silicon transistors, types MPSA10, MPSA20 (npn), and MPSA70 (pnp), have a breakdown voltage of 40 V min., low output capacitance of 4 pF max., and (except the MPSA10) low collector-emitter saturation of 0.25 V max. The 100-up unit prices are \$0.19, 0.22, and 0.25, in the above order. Motorola Semi-Conductor Products Inc., Box 20924, Phoenix, Ariz. 85036.

Circle 204 on Inquiry Card

CdS PHOTOCELL SENSOR

For card reading purposes.

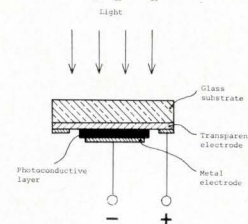

New sensor uses sandwich type cadmium sulfide cells which are enclosed in a plastic case. Photosensitivity of each unit under a given voltage is 50 times greater than normal CdS cells. The sensor aperture diameter is 0.055 in.—good for high density arrays. Masaoka-Ishikawa & Associates, 551 Fifth Ave., New York, N.Y. 10017.

Circle 205 on Inquiry Card

PLASTIC ELEMENT POTS

Essentially infinite resolution.

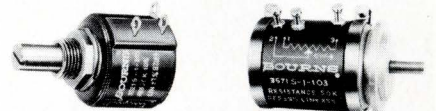

Model 3521 bushing mount and Model 3571 servo mount 7/8 in dia., five-turn pots feature the Infinitron conductive plastic element. Their op. temp. range is -55 to +105°C; resistance range, 1000 Ω to 200 kΩ and they are rated at 1.0 W at 70°C. Model 3521 has a rotational life of 20 million shaft revolutions, while the 3571's is 50 million shaft revolutions. Standard linearity is 1%. Bourns, Inc., 1200 Columbia Ave., Riverside, Calif. 92507. (714) 684-1700.

Circle 206 on Inquiry Card



Camera Shy?

Don't be. Here's a truly compact CCTV camera (2⁷/₈" head) that delivers over 1,200-line horizontal resolution.

The Fairchild TCS-950B

It's ideal for those who have shied away from high resolution cameras because of their large sizes and price tags. Fairchild's new TCS-950B gives the sharpness and clarity of over 1,200-line horizontal resolution and 700-line vertical resolution. With the smallest head on the market and exceptionally compact design, the TCS-950B is perfect for data transmission, microscopic component inspection, flight simulation, photo interpretation, medical observation and a multitude of other applications.

For specifications and performance data, contact:

FAIRCHILD

SPACE AND DEFENSE SYSTEMS

A DIVISION OF FAIRCHILD CAMERA AND INSTRUMENT CORPORATION
30 PARK PLACE, PARAMUS, NEW JERSEY 07652
TEL. 201-262-7000 / TWX 710-990-6610

If your CCTV needs are varied and sometimes unusual, you should also consider the versatility available with the TCS-950B:

- Switchable scan rates (either or both scan directions).
- Interlaced or sequential frame scan.
- Video polarity reversal.
- Scan polarity reversal.
- Militarized construction.

Reliability of the TCS-950B is ensured by Fairchild's solid-state Micrologic® circuitry. For its size and high resolution performance, it's one of the lowest priced cameras on the market.

New: The TC-177. You'll get remarkably stable, crisp, high-contrast video signals from this self-contained camera. Features Micrologic® circuitry, 800-line resolution (standard); 2:1 interlace, EIA sync remote control, high resolution (over 900-line), video polarity reversal and other options available.



What does our
muffin fan[®]
have that other
4^{11/16}" square
fans do not?



RELIABILITY

Performance in excess of 90,000 hours can be expected from 90% of all "muffin fans" manufactured. That's reliability unmatched by any other 4^{11/16}" square fan. So... where life really counts, and where 100 cfm of cooling air is required you can rely on "muffin fans" to perform longer than others, in computer equipment, copying machines, receivers and transmitters, power supplies, and countless other applications.

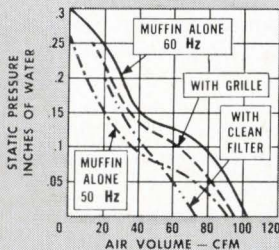

For full details on performance, application, life and other pertinent data be sure to send for our latest catalog sheet. Write to Rotron, Inc., Woodstock, New York 12498



Circle 62 on Inquiry Card

NEW PRODUCTS

HYBRID I-F LOG AMP

Compresses signals into log scale.

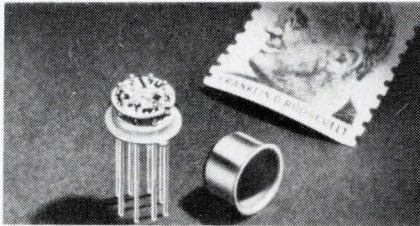

CTS Series 861 cermet hybrid IC was designed for use in cascade as a log amplifier with a mid band freq. of about 10 MHz to 100 MHz. Its basic function is to compress a wide range of signals into a log scale on a display device. It has built-in power supply decoupling and a typ. voltage gain of 0.6 dB from 30 to 100 MHz. CTS Microelectronics, Inc., West Lafayette, Ind. 47906. (317) 463-2565.

Circle 207 on Inquiry Card

METALLIC LINER

Speeds PC board assembly.

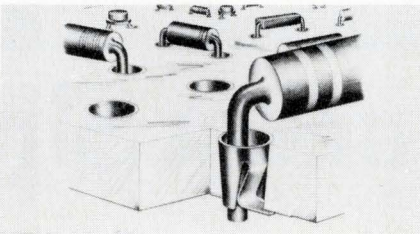

Conical-shaped fillet needs only 0.055 in. dia. holes, and permits center-to-center lead spacing as close as 0.100 in. It retains itself in std. 1/16 in. thick PC boards and firmly grips the component leads, holding components in position until soldering is completed. Bench-mounted machine can simultaneously insert up to 2000 fillets in a PC board. AMP Incorporated Harrisburg, Pa. 17105. (717) 564-0101.

Circle 208 on Inquiry Card

SHOCK MACHINE

Tests microelectronic components.

Model P4-30K uses a 60 psi shop air supply and a free piston carriage to test up to 30,000 g in accordance with MIL-STD-883. Test specimens are preassembled into pistons outside the machine. After loading, the piston is lifted into the upper tube, compressed air charges the chamber, and the piston is released and propelled down onto the pulse producing device. L.A.B. Corp., 500 Onondaga St., Skaneateles, N.Y. 13152.

Circle 209 on Inquiry Card

CERMET RESISTIVE PASTES

For tight tolerance applications.

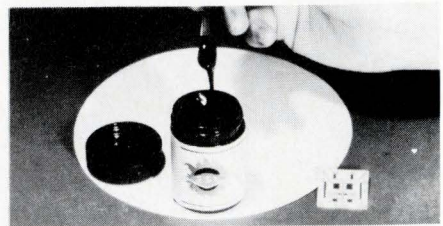

ESL 3800 Series noble metal pastes are relatively insensitive to minor changes in firing profile and may be fired at peak temps. between 980° and 1050°C. TC of resistance may be adjusted by refiring. These pastes come in nominal sheet resistivities from 100 Ω to 200,000 Ω/sq. and have typ. avg. TCR's (-55° to +125°C) of $\lt; 0 \pm 100 \text{ ppm}/^\circ\text{C}$. Electro-Science Labs., Inc., 1133 Arch St., Phila., Pa. 19107. (215) 563-2215.

Circle 210 on Inquiry Card

POWER AMP

Rated at 100 W.

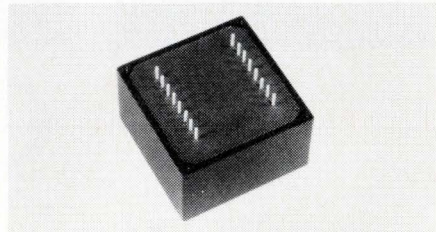

Model PA-2 is rated at 100 W with a max. output of ± 24 V and a max. current of ± 5 A. It can be used as an ac or dc servo amp., a deflection coil driver, relay driver or other application requiring precise control of high current. It has adj. current limiting, full power output from dc to 10 kHz and a low drift differential input stage. Control Systems Research, Inc., 1811 Main St., Pittsburgh, Pa. 15215. (412) 781-1887.

Circle 211 on Inquiry Card

POLYIMIDE TAPE

Dielectric strength is 4,800-5,400 V.

Lightweight Kapton[™] polyimide film tape is for critical areas where high-low temp. and/or high dielectric strength is essential. Designated as Mystik 7360, the tape measures only 1.3 to 1.7 mils in total thickness, yet retains its thermal-electrical properties between -110°F. and +550°F. Mystik Tape, Borden Inc., 1700 Winnetka Ave., Northfield, Ill. 60093. (312) 446-4000.

Circle 212 on Inquiry Card

Circle 63 on Inquiry Card →

The great digital systems kit!

Steps 6 to 12:

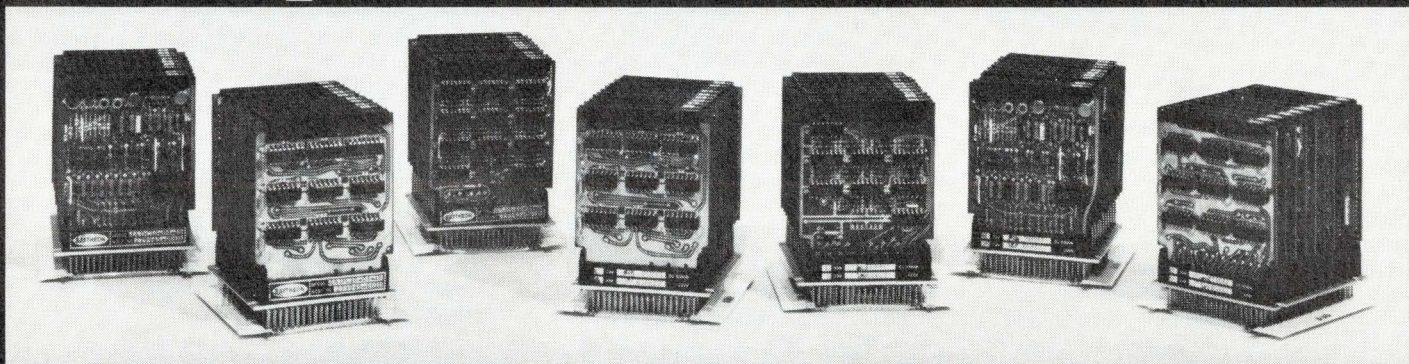

Pick data system functions, then pick Raytheon Computer's MINI-BLOCS™. They're assembled, wired, tested, ready-to-use.

These new MINI-BLOCS make system design and assembly as easy as calling Raytheon. Decide how your system will operate, then pick MINI-BLOCS to fit functions. Each one's on a compact connector block, wired, tested and guaranteed. Most are expandable, and they'll fit your mounting hardware or ours.

MINIVERTER™—Multiplexer, Sample and Hold and ADC. 10, 12-bit binary, three digit BCD. Up to 100KHz conversion rate. 16 channels/block, expandable to 64 channels when used with MINI-MUX.

MINI-DAC™—10, 12-bit binary, three digit BCD. Settling time 10 usec, accuracy to 0.05% $\pm \frac{1}{2}$ LSB. 4 channels/block.

MINI-MUX™—Up to 32 channels/block, expandable in 8-channel increments. 0.01% sample and hold accuracy. Sequence control, 20v input channel protection. Includes all analog power supplies.

MINI-SAMPLE—For simultaneous sample and hold. Up to 8 channels per block. 0.1% model has 100 nsec aperture, settles in 8 usec. 0.01% unit has 50 nsec aperture, settles in 3 usec. Input impedance 10^8 ohms.

BCD to Binary Converter—Converts 5 BCD characters to 16-bit binary word in as fast as 3 usec. Input and output are parallel form. Blocks can be combined for longer word length.

Binary to BCD Converter—Converts 16-bit binary word to 5 BCD characters in 3 usec. Parallel input and output. Expandable for greater word length.

MINI-MEM—Stores up to 32 16-bit words. Random or sequential word selection. 4 MHz transfer rate.

Write today for Data File DK177. Raytheon Computer, 2700 South Fairview Street, Santa Ana, California 92704. Phone (714) 546-7160.

RAYTHEON

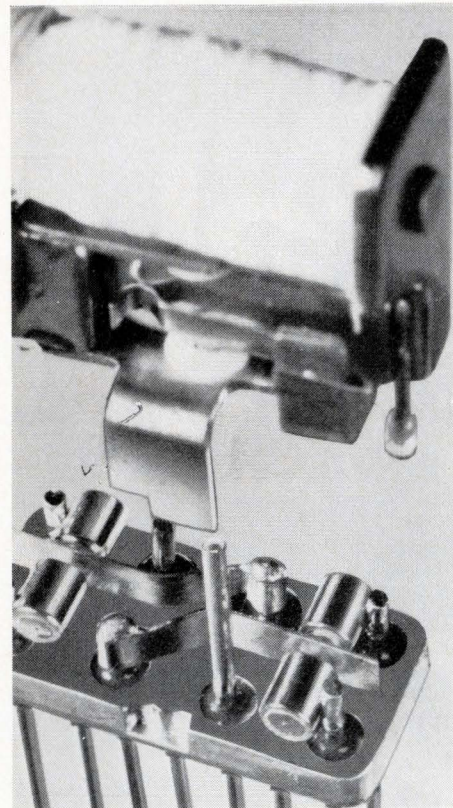

mite-size relays with macro-size contacts

Couch 2X relays are true 1/7-size, yet the contacts are as large or larger than many full and half-size crystal can units. Couch 2X relays meet MIL-R-5757D/19 and /30 specs in 1/25th of a cu. in. Design simplicity and oversize contacts assure the ultimate in performance. Each relay is fully tested. Ideal for missile and aerospace switching applications or wherever reliability in small space is of prime importance. Available in many terminal styles and a wide choice of mountings.



Write for Data Sheets No. 9 and No. 10 today.

	2X (DPDT)	1X (SPDT)
Size	0.2" x 0.4" x 0.5"	same
Weight	0.1 oz. max.	same
Coil		
Operating Power	100 mw or 150 mw	70 mw or 100 mw
Coil		
Resistance	60 to 4000 ohms	125 to 4000 ohms
Temperature	-65°C to 125°C	same
Vibration	20G	same
Shock	75G	same

RUGGED ROTARY RELAYS  Dynamically and Statically Balanced



S. H. COUCH DIVISION

ESB INCORPORATED

3 Arlington St., North Quincy, Mass. 02171

Circle 64 on Inquiry Card

NEW PRODUCTS

CARD-EDGE CONNECTORS

For use with 0.062 in. thick PC cards.

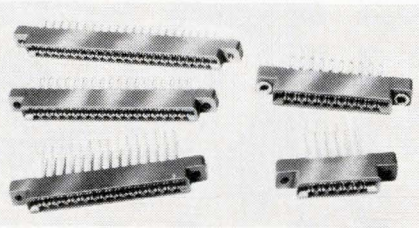

Series 6007 connectors come in five sizes and three mounting styles. All can be fitted with single- or dual-readout contacts compatible with most terminating methods. Sizes include 6/12, 10/20, 15/30, 18/36, and 22/24 contacts, while mounting styles comprise mounting holes, floating eyelets, and threaded inserts. Elco Corp., 155 Commerce Dr., Ft. Washington, Pa. 19034.

Circle 213 on Inquiry Card

DC POWER SUPPLIES

For use with DTL, TTL and MOS.



These units use 70% MIL parts, and glass epoxy boards. They have $\pm 0.1\%$ line and load reg., pk to pk ripple of < 3 mV, full rating current from 0°C to 50°C. Typical outputs are 5 V @ 5 A; 12 V @ 2.5 A; 15 V @ 2.0 A and 24 V @ 1.4 A. Powertec Div. of Airtronics Inc., 9168 De Soto Ave., Chatsworth, Calif. 91311. (213) 882-0004.

Circle 214 on Inquiry Card

PHOTOCELL

Range is from 5,000 to 7,000 Å.

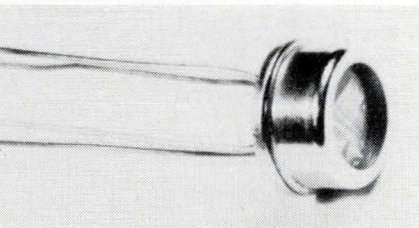

The VT 334/2's characteristics include close tracking, $\pm 5\%$ from 0.5 to 50 ft. candles; and close matching, available ± 5 to $\pm 20\%$. It also has a low r_c , close temp. tracking, and a res. of 75 K Ω at 2 ft. candles. It can be illuminated by incandescent, neon, or fluorescent light; by light emitting diodes, or any source emitting within its range. Vactec, Inc., 2423 Northline Industrial Blvd., Maryland Heights, Mo. 63042.

Circle 215 on Inquiry Card

DRAFTING AIDS

For printed circuitry.

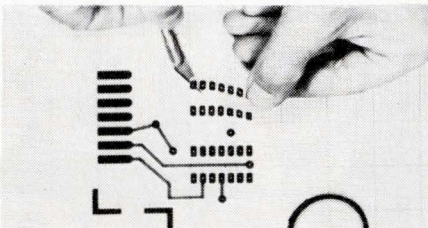

Pressure-sensitive Circuit/aids are pre-printed on 1.5 mil matte acetate. A 4 x 8 in. card is the carrier for the individually die-cut symbols. Line includes multiple transistor pads; 8, 10 and 12-pin micrologics; flatpacks and plug-ins; special configurations; die cuts, registration targets; component orientation symbols, and many others. Circuit Aids, Inc., Box 525, Westwood, N.J. 07675.

Circle 216 on Inquiry Card

ACOUSTIC DELAY LINES

With low insertion losses.

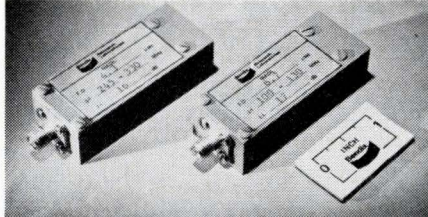

New compact, microwave acoustic delay lines use an improved cadmium sulfide evaporation-and-processing technique. The first series covers the range of 100 MHz to 500 MHz with delays of up to 10 μ s. Communications & Scientific Relations Dept., Bendix Research Labs, Southfield, Mich. 48075. (313) 352-7560.

Circle 217 on Inquiry Card

SNAP-ON SOCKET

Plugs into PC boards.

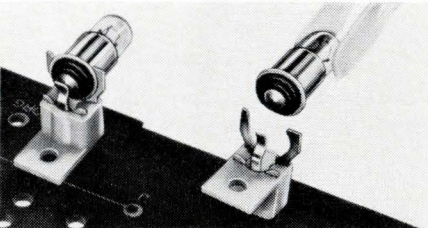

Klipsocket™ fits snugly to PC boards, and fits all T-1 1/4 midget flanged based lamps from 1-28 Vac or dc. A specially designed universal bracket can be specified to fit in any one of four directions. They accept slip-on connectors or solder without pre-treatment and cost about \$0.09 each in quantity. Chicago Switch, Inc., 2035 Wabansia Ave., Chicago, Ill. 60647. (312) 489-5500.

Circle 218 on Inquiry Card

together for the first time in one package

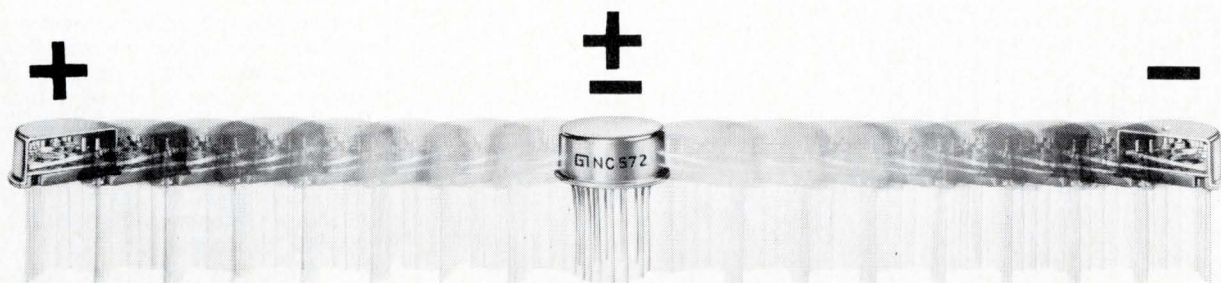

the \pm hybrid voltage regulator internally preset to ± 15 VDC

If you use Op Amps, General Instrument's Complementary/Dual Polarity IC Voltage Regulator (NC 572) is made for you. For the first time, + and - 15 V regulators are combined in one IC package providing two isolated and independent control sections of complementary polarity. The NC 572 also provides a combination of features that are superior to those available in any individual positive or negative voltage regulator . . .

For example:

- Output voltages are internally preset to the most popular Op Amp supply voltages, +15 and -15 VDC. Where required, the output voltage can be externally adjusted to any value from ± 13 to ± 38 VDC or factory preset to any voltage within this range.
 - Its high efficiency performance is demonstrated by a minimum required output/input voltage differential of only 1V for the positive regulator and 2V for the negative regulator.
 - Other features include: line regulation of 0.0005% V_o/V_{in} , load regulation of 0.0005% V_o/mA , input isolation of 74 dB min., and a full military operating temperature range.
 - The unit price at 1-24 pcs. is \$30.80; at 500-999 pcs., \$24.20 each.
- The \pm NC 572 hybrid voltage regulator in one 16-lead TO-8 style package is now in stock and immediately

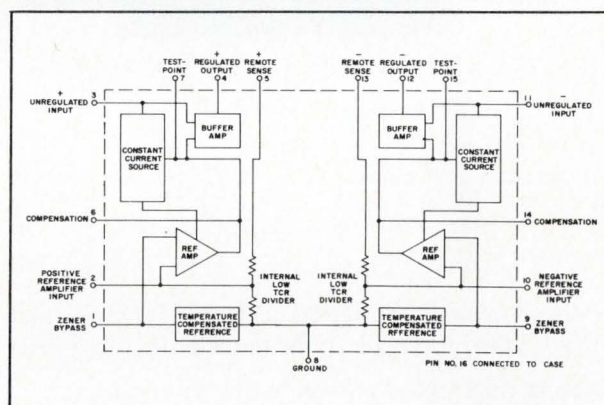

Functional Diagram

available from your authorized General Instrument Distributor.

For complete information, call (516) 733-3244 or write, General Instrument Corporation, Dept. I, 600 West John Street, Hicksville, N.Y. 11802.

(In Europe write to: General Instrument Europe, S.P.A., Piazza Amendola 9, 20149, Milano, Italy. In the U.K. to, General Instrument U.K., Ltd., Stonefield Way, Victoria Road, South Ruislip, Middlesex, England.)



GENERAL INSTRUMENT CORPORATION • 600 WEST JOHN STREET, HICKSVILLE, L. I., NEW YORK

ONLY VISHAY PACKS ALL THESE SPECS INTO ONE PRECISION RESISTOR

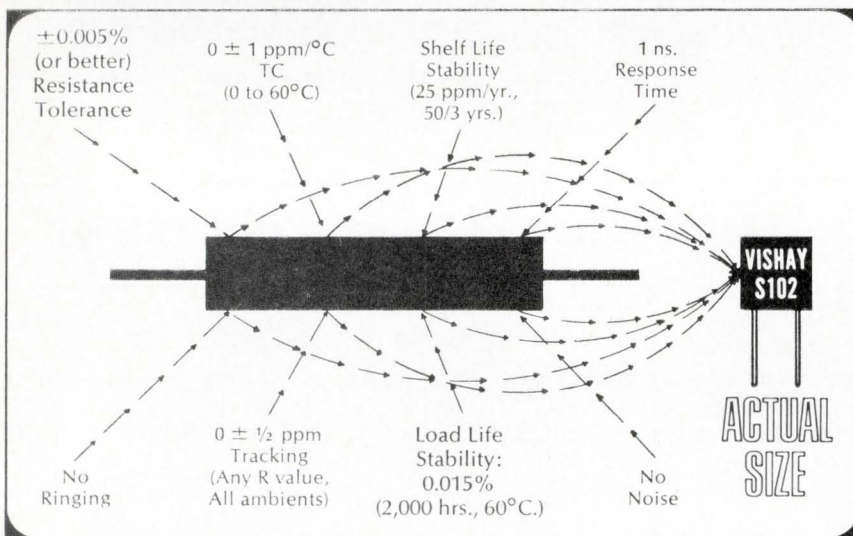

Only Vishay does it in a practical small size, available in production quantities with fast delivery. And at competitive prices too!

Precision plus speed? Never in a wirewound.

Speed plus precision and TC? Never in a conventional evaporated film.

No other precision resistor gives you all this performance in a production size unit. So, why trade-off when you don't have to? Simplify your circuit designs, avoid special compensating circuits and get better system performance.

These valuable guides to new thinking in resistor and network performance are free. Write for your copies today.

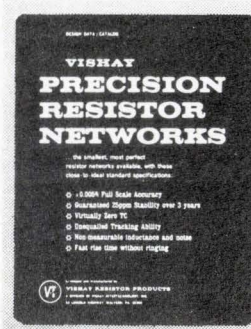
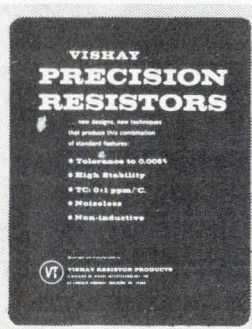



VISHAY
RESISTOR
PRODUCTS

a division of Vishay
 Intertechnology, Inc.
 63 Lincoln Highway
 Malvern, Pa. 19355

NEW PRODUCTS

CODE CONVERTOR

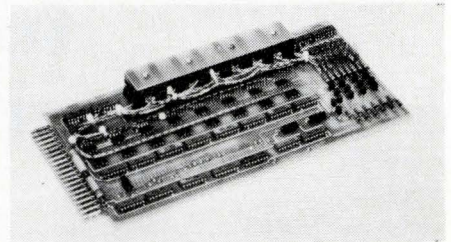
Hollerith to 8-level codes.



Compact convertor provides direct one-step translation from Hollerith to 8-level codes. Model H-8/12 has all necessary circuitry for any known conversion. Thus it can be modified in the field to suit any output code of 8 bits or less. It's a 12 V system with 10 times the noise immunity as std. 5 V ics. Electron Ohio, Inc., Dept. C-22, 1278 W. 9th, Cleveland, Ohio 44113.

Circle 219 on Inquiry Card

WAVEGUIDE TUNERS

For precision measurements.

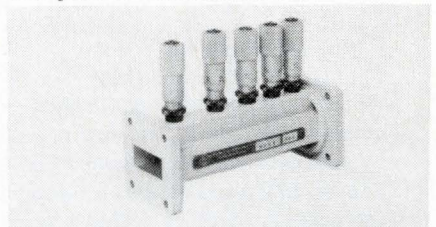

MMC Series 351 multiprobe tuners come in waveguide bands from 1.7 to 18 GHz. They consist of 5 or 6 μm probes centered on the broadwall and stagger spaced to provide ease of tuning over their respective bands. There are also 9 and 10 stub "holeless" tuners available in H, X and P bands. Maury Microwave Corp., 8610 Helms Ave., Cucamonga, Calif. 91730. (714) 987-4715.

Circle 220 on Inquiry Card

CONNECTOR BLOCK

Eliminates terminal distortion.

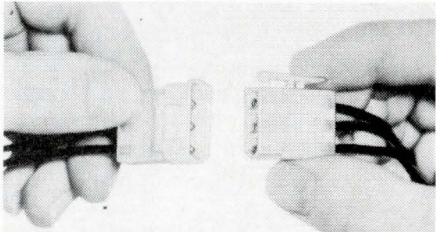

New nylon connector block for quick connecting or disconnecting of multicircuits has a locking mechanism on the block which eliminates terminal distortion. The block exceeds the established requirement rating of 10A/circuit. Essex International, Inc., Industrial Wire Products Div., 3501 W. Addison St., Chicago, Ill. 60618.

Circle 221 on Inquiry Card

CIRCUIT BOARDS

For DIL packages.

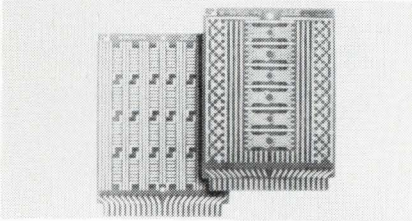

These PC boards are for mounting DIL packages, flatpacs, TO-5 cases and discrete components. They also accept IC test sockets. There are two card widths for std. 15 and 30 or 22 and 44 pin mating connectors. One ounce copper circuits are tin plated and contacts are rhodium plated. Rosemount Engineering Co., Box 35129, Minneapolis, Minn. 55435.

Circle 222 on Inquiry Card

STRIPLINE COUPLER

Maximum VSWR of 1.25.

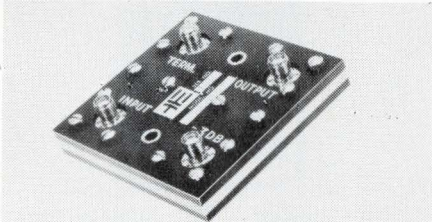

New octave band 3 dB coupler covers the range from 4 GHz to 8 GHz. Unit has a max. insertion loss of 0.25 dB. Isolation is 18 dB min., output balance ± 0.25 dB. Isolation is 18 dB min., output balance ± 0.25 dB. Other units are available from 1 GHz to 12 GHz. Elpac, Inc., RF/Microwave Div., 18651 Von Karman Ave., Irvine, Calif. 92664. (714) 833-1717.

Circle 223 on Inquiry Card

C-BAND TWTs

Deliver 1-4 kW peak for radar.

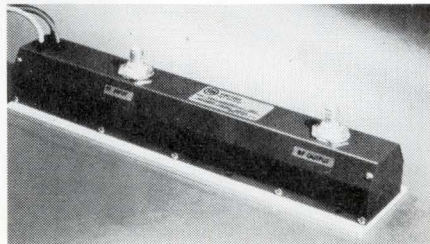

Grid-pulsed TWTs are for use as drivers or output tubes in pulse-radar systems. Gain of at least 40 dB from the VTC-5360A1 and 36 dB from the VTC-5361A1 is achieved by using a ring-loop circuit and radial-magnetic PPM focusing in each tube. Varian TWT Div., 611 Hansen Way, Palo Alto, Calif. 94303. (415) 326-4000.

Circle 224 on Inquiry Card

**NOW AVAILABLE
FOR IMMEDIATE DELIVERY:**

**FAST
SWITCHING**

**2 AMP and 5 AMP
TRANSISTORS**

from **Solitron**

Solitron has expanded its line of ultra-fast switching transistors with the introduction of 2 AMP and 5 AMP devices. These new units are the fastest switching transistors in the industry now available for "off the shelf" immediate delivery. Features include planar construction and rise time less than 10 nanoseconds.



TO-5



TO-60

2 AMP SERIES

Type Number TO-5	Type Number TO-60	BV_{CBO}	BV_{CEO}	t_{ON} max.	t_{OFF} max.
SDT6101	SDT6104	65	30	50 ns	50 ns
SDT6102	SDT6105	65	40	50 ns	50 ns
SDT6103	SDT6106	65	50	50 ns	50 ns

5 AMP SERIES

Type Number TO-5	Type Number TO-60	BV_{CBO}	BV_{CEO}	t_{ON} max.	t_{OFF} max.
SDT6110	SDT6113	65	30	65 ns	65 ns
SDT6111	SDT6114	65	40	65 ns	65 ns
SDT6112	SDT6115	65	50	65 ns	65 ns

Dial 1-800-327-3243 for a "No Charge" telephone call and further information

**Solitron
DEVICES, INC.**

1177 BLUE HERON BLVD. / RIVIERA BEACH, FLA. / (305) 848-4311 / TWX: (510) 952-6676

ASK MATHESON...

why $1 + 1 > 2$

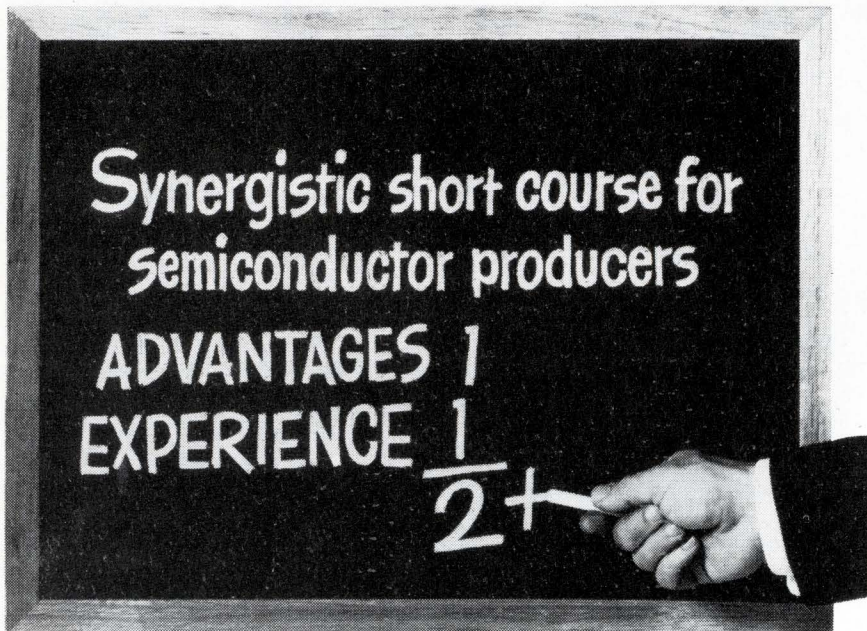

Matheson's understanding of gas technology combined with inherent advantages of gas phase processing make conversion to gas systems pay *added* dividends.

Consider the considerable advantages of gas phase processing

Contamination is minimized. For one thing, source limiting of impurities significantly reduces diffusion tube contamination. And there are no trace "heavy impurities." Troublesome vaporization processes are also eliminated.

Convenience is maximized. Introduction of vapors in high temperature processes is simplified to merely opening and adjusting a gas flow line. And gas systems are readily and conveniently adapted to automated control.

Matheson gas systems are designed with you in mind

For example, U. H. P. Ammonia for vapor deposition of silicon nitride. This grade of Ammonia has been specifically developed for use by the semiconductor industry. It affords greater reproducibility in dielectric constant of grown layers . . . a degree not normally obtainable with standard Ammonia.

Matheson can also help you with Ammonia systems. For example, High Purity, Stainless Steel Regulators for vacuum or purge systems. Or low cost Stainless Steel Gas Proportioners for blending the desired vapor concentrations in Ammonia systems.

This is just one way Matheson serves the electronics industry. Experienced, confidential, technical service is also offered. And don't worry — we'll help you with the installation.

Ask Matheson now — for our new catalog "Gases and Systems for the Electronics Industry". It contains extensive technical data on epitaxial and doping gases. Address: P. O. Box 85, East Rutherford, N. J. 07073.



MATHESON GAS PRODUCTS

A Division of Will Ross, Inc., East Rutherford, N. J.;
Cucamonga, Calif.; Gloucester, Mass.; Joliet, Ill.; LaPorte, Texas;
Morrow, Ga.; Newark, Calif.; Whitby, Ont.

5-69G

NEW PRODUCTS

MICROMINIATURE COAX.

Has a 50 Ω characteristic impedance.

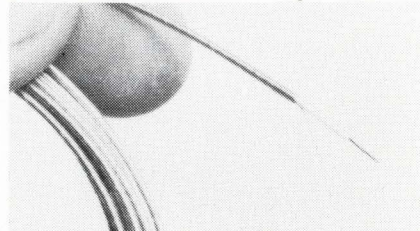

This cable has a solid center conductor and solid drain wire that can be used in solderless wrap operations. Cross talk is minimized by using an aluminized Mylar® shield. Dielectric is Teflon. Using a 30 AWG center conductor, the O.D. is under 0.050 in. A 32 AWG center conductor provides an O.D. under 0.040 in. Berk-Tek, Inc., Box 60, R.D. 1, Reading, Pa. 19607. (215) 376-8071.

Circle 225 on Inquiry Card

DIL PLASTIC PACKAGE

For high-density hybrid circuits.

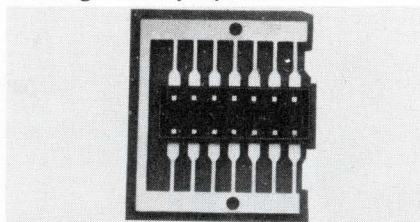

New molded plastic package comes complete, ready for production operations. Packages can be staked into PC boards using std. automatic equipment; substrates can be bonded to the packages using commercially available adhesives; and wire bonding can be completed with std. bonding methods and equipment. U.S. Electronic Services Corp., Box 78, Holgar Ind. Park, Clifton Heights, Pa. 19018. (215) 626-5200.

Circle 226 on Inquiry Card

FEEDTHRU CONNECTOR

Double-ended unit has 48 contacts.

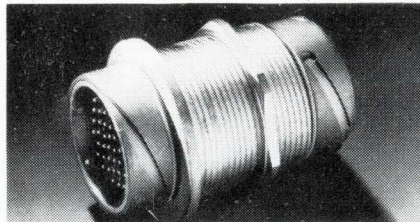

New hermetic feedthrough connector has male/male contacts for panel thicknesses to 1 in. Current rating is 10 A; voltage rating 500 Vac. Contacts are size 20 gauge. The 100-5239-05 connector withstands temps. through 257°F. Amphenol Connector Div., The Bunker-Ramo Corp., 2801 S. 25th Ave., Broadview, Ill. 60153.

Circle 227 on Inquiry Card

MERCURY RELAY

For PC boards.



The AWCN and AWDF series or the flat pack series mercury wetted contact relays use a magnetic circuit that permits a low profile dimension of 0.300 in. without solder standoffs. They are 0.562 in. long and 0.578 in. wide. Relay is encased in diallyl phthalate with an internal magnetic shield. Contact configurations are Form C and Form D. The Adams & Westlake Co., 1025 N. Michigan St., Elkhart, Ind. 46514.

Circle 228 on Inquiry Card

SILICON NPN TRANSISTOR

For high power, h-f stripline uses.

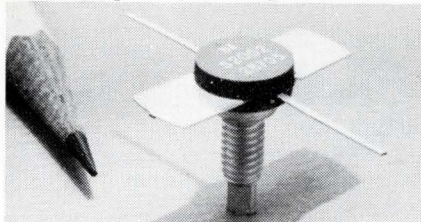

S2002 epitaxial Si transistor is for use in fund. oscillator, freq. multiplier and broadband amplifier stages. Primary use is for broadband amplifiers in the 500 MHz to 1 GHz range. Power out of 2.5 W is obtained over a > 20% BW with 6 dB gain. Narrowband gain at 1 GHz is 10dB with 1.0 W output and 6 dB at the 2.0 W level. Electronic Components, div. of United Aircraft, Trevose, Pa. 19047. (215) 355-5000.

Circle 229 on Inquiry Card

MICROSTRIP LAUNCHERS

Complete line available.

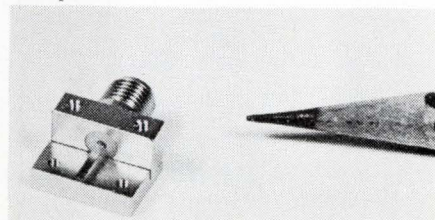

New launchers are available in connector types SMA, N and TNC for substrate thickness of 0.025 to 0.250 in. and line widths of 0.025 to 0.200 in. Both right-angle and end-launch mounting configurations are available. ESCA Div. of Solitron/Microwave, Cove Rd., Port Salerno, Fla. 33492. (305) 287-5000.

Circle 230 on Inquiry Card

HYBRID 30 MHz I-F AMPS

For communication systems.

Hermetically-sealed, ceramic-metal film amplifiers are for hf, vhf, and uhf systems. The MS500 and MS501 amplifiers have noise figures of 7 dB and 14 dB, respectively. Standard bandwidths are 5 MHz. Sylvania Electric Products Inc., 40 Sylvan, Waltham, Mass. 02154.

Circle 231 on Inquiry Card

WIDE BAND OP AMP

Has 50 dB min. open loop gain.

Model 976A provides you with ± 250 V/ μ s typical slewing rate and 300 MHz gain bandwidth product. It provides you with full operational capability from dc through video frequencies. Optical Electronics, Inc., Box 11140, Tucson, Ariz. 85706. (602) 624-8358.

Circle 232 on Inquiry Card

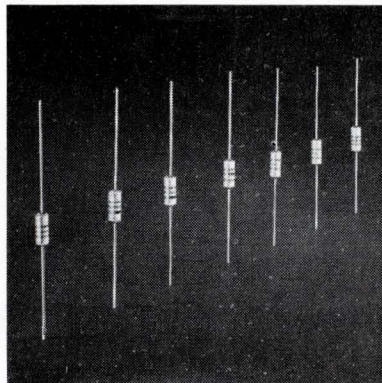

MS 90537 Molded Shielded RF Chokes

Miller Part No. 9250	MS. No. 90537	Inductance Microhenries $\pm 10\%$	Rated DC Current Milliamps	Miller Part No. 9250	MS. No. 90537	Inductance Microhenries $\pm 10\%$	Rated DC Current Milliamps
-101	-1	0.10	2900	-333	-31	33.0	490
-121	-2	.12	2800	-393	-32	39.0	410
-151	-3	.15	2750	-473	-33	47.0	400
-181	-4	.18	2200	-563	-34	56.0	380
-221	-5	.22	1700	-683	-35	68.0	370
-271	-6	.27	1500	-823	-36	82.0	360
-331	-7	.33	1300	-104	-37	100.0	325
-391	-8	.39	1100	-124	-38	120.0	290
-471	-9	.47	1000	-154	-39	150.0	275
-561	-10	.56	900	-184	-40	180.0	260
-681	-11	.68	750	-224	-41	220.0	250
-821	-12	.82	600	-274	-42	270.0	240
-102	-13	1.00	1900	-334	-43	330.0	225
-122	-14	1.20	1600	-394	-44	390.0	200
-152	-15	1.50	1300	-474	-45	470.0	180
-182	-16	1.80	1200	-564	-46	560.0	174
-222	-17	2.20	1100	-684	-47	680.0	168
-272	-18	2.70	950	-824	-48	820.0	152
-332	-19	3.30	800	-105	-49	1,000.0	135
-392	-20	3.90	750	-125	-50	1,200.0	115
-472	-21	4.70	650	-155	-51	1,500.0	110
-562	-22	5.60	550	-185	-52	1,800.0	105
-682	-23	6.80	500	-225	-53	2,200.0	99
-822	-24	8.20	475	-275	-54	2,700.0	83
-103	-25	10.0	450	-335	-55	3,300.0	80
-123	-26	12.0	400	-395	-56	3,900.0	67
-153	-27	15.0	620	-475	-57	4,700.0	63
-183	-28	18.0	610	-565	-58	5,600.0	56
-223	-29	22.0	600	-685	-59	6,800.0	54
-273	-30	27.0	500	-825	-60	8,200.0	52
				-106	-61	10,000.0	49

CALL OR WIRE FOR SHIPMENT TODAY

Get factory prices from your local distributor in quantities to 750; ask for new full line catalog.



J.W. MILLER COMPANY

19070 REYES AVE. • P.O. BOX 5825 • COMPTON, CALIF. 90224

GLASS ENCLOSED

AMPERITE

Thermostatic DELAY RELAYS

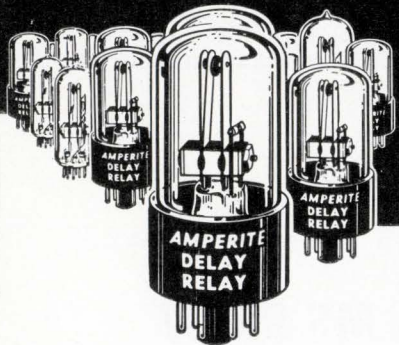

Offer true hermetic sealing
-assure maximum stability and life!

Delays: 2 to 180 seconds . . . Actuated by a heater, they operate on A.C., D.C., or Pulsating Current . . . Being hermetically sealed, they are not affected by altitude, moisture, or climate changes . . . SPST only—normally open or normally closed . . . Compensated for ambient temperature changes from -55° to $+80^{\circ}$ C . . . Heaters consume approximately 2 W. and may be operated continuously . . . The units are rugged, explosion-proof, long-lived, and—inexpensive!

TYPES: Standard Radio Octal, and 9-Pin Miniature.
List Price, \$4.00

PROBLEM? Send for Bulletin No. TR-81

AMPERITE

BALLAST REGULATORS

Hermetically sealed, they are not affected by changes in altitude, ambient temperature (-50° to $+70^{\circ}$ C.), or humidity . . . Rugged, light, compact, most inexpensive.

List Price, \$3.00

Write for 4-page Technical
Bulletin No. AB-51

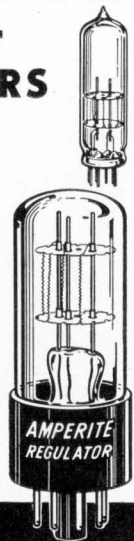
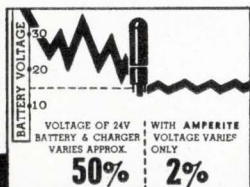

AMPERITE

600 PALISADE AVE., UNION CITY, N.J.
Telephone: 201 Union 4-9503
In Canada: Atlas Radio Corp., Ltd.,
50 Wingold Ave., Toronto 10

Circle 70 on Inquiry Card

EE NEW PRODUCTS

IR SOLDERING SYSTEM

For flat flexible cable.

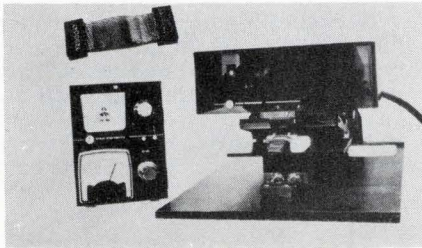

All types of soldered connections are joined with the FS series systems which use focused IR heating methods. Entire rows or groups of joints are soldered simultaneously and the heater never touches the workpiece. It takes 5 s to complete a row of terminations, often as many as 200 joints. Argus Engineering Co., Hopewell, N.J. 08525. (609) 466-1677.

Circle 233 on Inquiry Card

MULTIPLEX SWITCH

Alternative to reed relay switches.

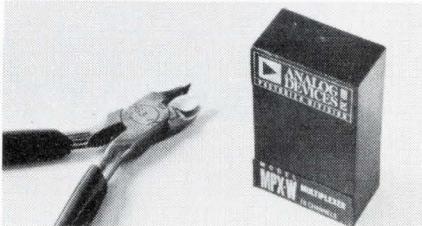

Ten channel, Model MPX-10W responds to digital selection commands in BCD code. It will connect any one of 10 analog input signals to a common output terminal. The switch handles both polarities of analog input voltage, and accepts voltage levels to ± 10 V. Overall switching time is $< 5 \mu$ s. Analog Devices, Inc., Pastorziza Div., 221 Fifth St., Cambridge, Mass. 02142. (617) 492-6000.

Circle 234 on Inquiry Card

FET AMPLIFIERS

Feature high gain and low noise.

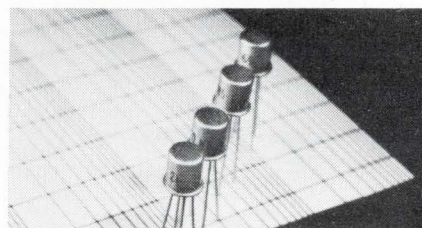

These low-noise amplifiers, 2N3684, 2N3685, 2N3686 and 2N3687, provide a 0.1 dB typ. and 0.5 dB max. noise figure. In addition, they offer low leakage, 100 pA max. and low pinch off of 1.2 V. They cost from \$1.90 to \$2.60 in 100 to 999 quantities. National Semiconductor Corp., 2975 San Ysidro Way, Santa Clara, Calif. 95051. (408) 245-4320.

Circle 235 on Inquiry Card

MICROWAVE OSCILLATORS

Minimum 100 mW cw output power.

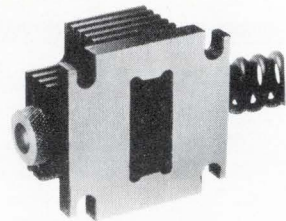

These VX2020 series Gunn-effect oscillators are mechanically tunable over a 20% BW within the freq. band ranging from 8.2 to 12.4 GHz. Output power varies < 2 dB over the entire tuning range and weighs < 3 oz. Typical input power is 12 V dc at 0.75 A. Monsanto Microwave Products, 11636 Administration Dr., St. Louis, Mo. 63141. (314) 694-4816.

Circle 236 on Inquiry Card

CHIP RESISTOR KITS

For prototyping.

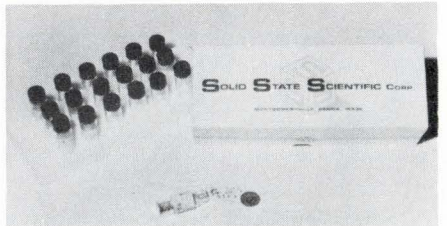

Kits contain assortments of RETMA value chips. Each is tapped to provide 3 or 4 values per chip. SD2500-17 kit contains 25 each of 18 different chips, with 58 values from 4.7 Ω to 1 m Ω . The SD2502-15 kit contains 25 each of 14 different chips, with 44 values from 22 Ω to 82 k Ω . Chip size is 0.28 x 0.038 in. typ. Solid State Scientific Inc., Montgomeryville, Pa. 18936. (215) 855-8400.

Circle 237 on Inquiry Card

WIRE TWISTER

One operator can twist multiple wires.

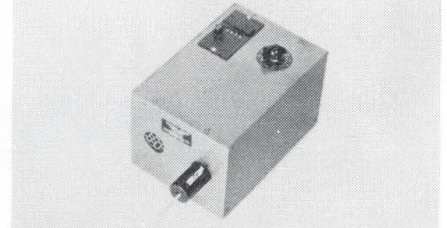

Wires are quickly attached by a screw lock. Operator then holds the other end of the wires at the required length and merely by pulling on these wires he activates the switch and twisting begins. When required tightness of twist is reached, he releases tension on the wires and twisting stops. Macdonald & Co., 213 S. Brand Blvd., Glendale, Calif. 91204. (213) 241-4131.

Circle 238 on Inquiry Card

PLASTIC PACKED FET
Only 8 mils in diameter.

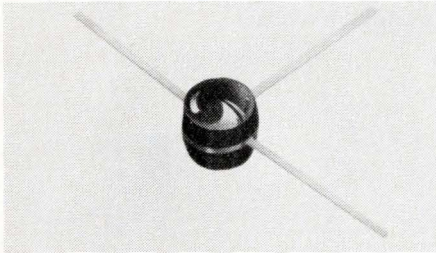

Shock resistant Micro FET assures operation at a 125°C junction temp. It has a thermal resistance as low as 350°C/W and power diss. up to 175 mW. Three radial ribbon leads allow it to be easily used in all PC board layouts, hybrid assemblies, and other high density configurations. Continental Device Components, 12515 Chadron Ave., Hawthorne, Calif. 90250.

Circle 239 on Inquiry Card

CRYSTAL OSCILLATORS
Oven controlled, high stability.



The CO-211 series of oscillators, ranges in stability from 1×10^{-9} /day through 1×10^{-7} /day. The one difference between these seven $2 \times 2 \times 3$ in. plug-in modules is freq. stability. Output freq. is in the 1-30MHz range, with lower freqs. furnished by inclusion of built-in dividers. Vectron Laboratories, Inc., 146 Selleck St., Stamford, Conn. 06902. (203) 324-9225.

Circle 240 on Inquiry Card

DELAY LINE
Low silhouette.

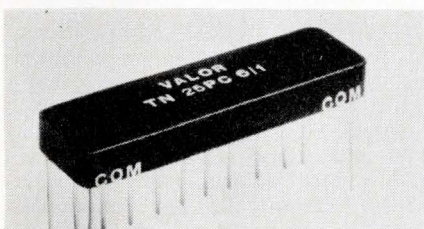

Lumped constant 5 to 200 ns delay line is 0.225 in. high, with width ranges from 0.515 to 0.765 in. Temp. range is from 55 to 125°C, with test voltage of 500 Vdc max., and working voltage of 200 Vdc max. Insulation is $>1,000 \text{ M}\Omega$. Output overshoot is $<5\%$ and output ripple is $<3\%$. Valor Electronics, 3100 Pullman Ave., Costa Mesa, Calif. 92626. (714) 540-9261.

Circle 241 on Inquiry Card

a complete digital system

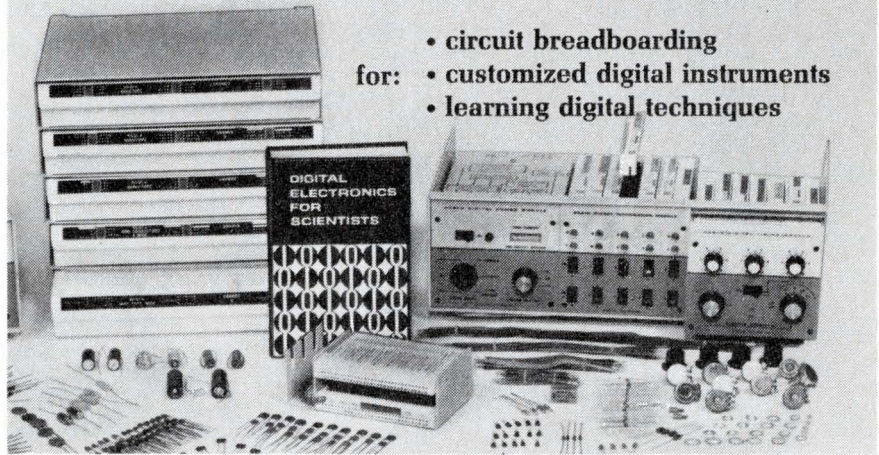

- circuit breadboarding
- for: • customized digital instruments
- learning digital techniques

HEATH 801 Digital System...

buy the complete system or discrete components

Now . . . A Complete System to Enable You to Get the Most Out of Digital Electronics. Here is a system that is revolutionizing instrumentation in labs and classrooms throughout the world. The basic design concepts of Professors H. V. Malmstadt and C. G. Enke combined with the engineering of Heath's scientific instrument group have resulted in the unique 801 Analog Digital Designer (ADD) and the EU-51A breadboard and parts group. This versatile system can perform equally well in constructing high performance research-quality instruments, in performing hundreds of experiments in the teaching laboratory, in rapid testing of new digital ideas, or in interfacing to computers.

Start . . . By Learning the New Digital Electronics. Drs. Malmstadt and Enke have written a pioneering new text "Digital Electronics for Scientists" (published by W. A. Benjamin, Inc.) that provides a systematic introduction to the digital circuits, concepts and systems that are basic to the new instrumentation — computation revolution. The book is written for engineering and science students and for practicing engineers, scientists, and technicians so that all may effectively utilize the startling recent advances in digital electronics.

Never before have the latest "state-of-the-art" methods been made so rapidly and conveniently accessible through an integrated combination of new text and versa-

tile equipment. The experimental section of the text is written specifically for utilizing the Heath 801A and 51A to provide experience and working knowledge with hundreds of digital and analog-digital circuits, instruments and systems.

Write . . . for Complete Information on Cards, Modules and Parts in the Heath Digital System. The basic Analog-Digital Designer (EU-801A) contains 3 modules (power supply, binary information, and digital timing) and 13 circuit cards including TTL gates, flip-flops, monostable MVs, relays, op amps, and V-F converter. The EU-51A Experimental Parts Group is a highly flexible breadboard system for circuit design and teaching. The group includes a desk chassis, 493 components, a patch card accepting these components, and a power patch card.

The system is open-ended. New cards and modules are continuously being introduced so you can construct your own special frequency meters, counters, timers, DVMs, rate meters, and many dozens of other instruments.

Take . . . advantage of the digital revolution — order your Heath Digital System now.

- EU-801A, Analog-Digital Designer . . . \$435.00*
- EU-51A, Experimental Parts Group . . . \$135.00*
- EUP-19, text "Digital Electronics For Scientists" by H. V. Malmstadt and C. G. Enke (published by W. A. Benjamin, Inc.) . . . \$9.50*



a Schlumberger company

FREE Heath Scientific Instrumentation Catalog



Describes these and other precision instruments for laboratory, engineering, education and R & D applications. Send for your FREE

copy now . . . just write on your school or company letterhead.

HEATH COMPANY, Dept. 586-25
Benton Harbor, Michigan 49022

Please send FREE Heath Scientific Instrumentation Catalog

Name _____

Address _____

City _____ State _____ Zip _____

Prices and specifications subject to change without notice. *Mail Order Prices; F.O.B. Factory

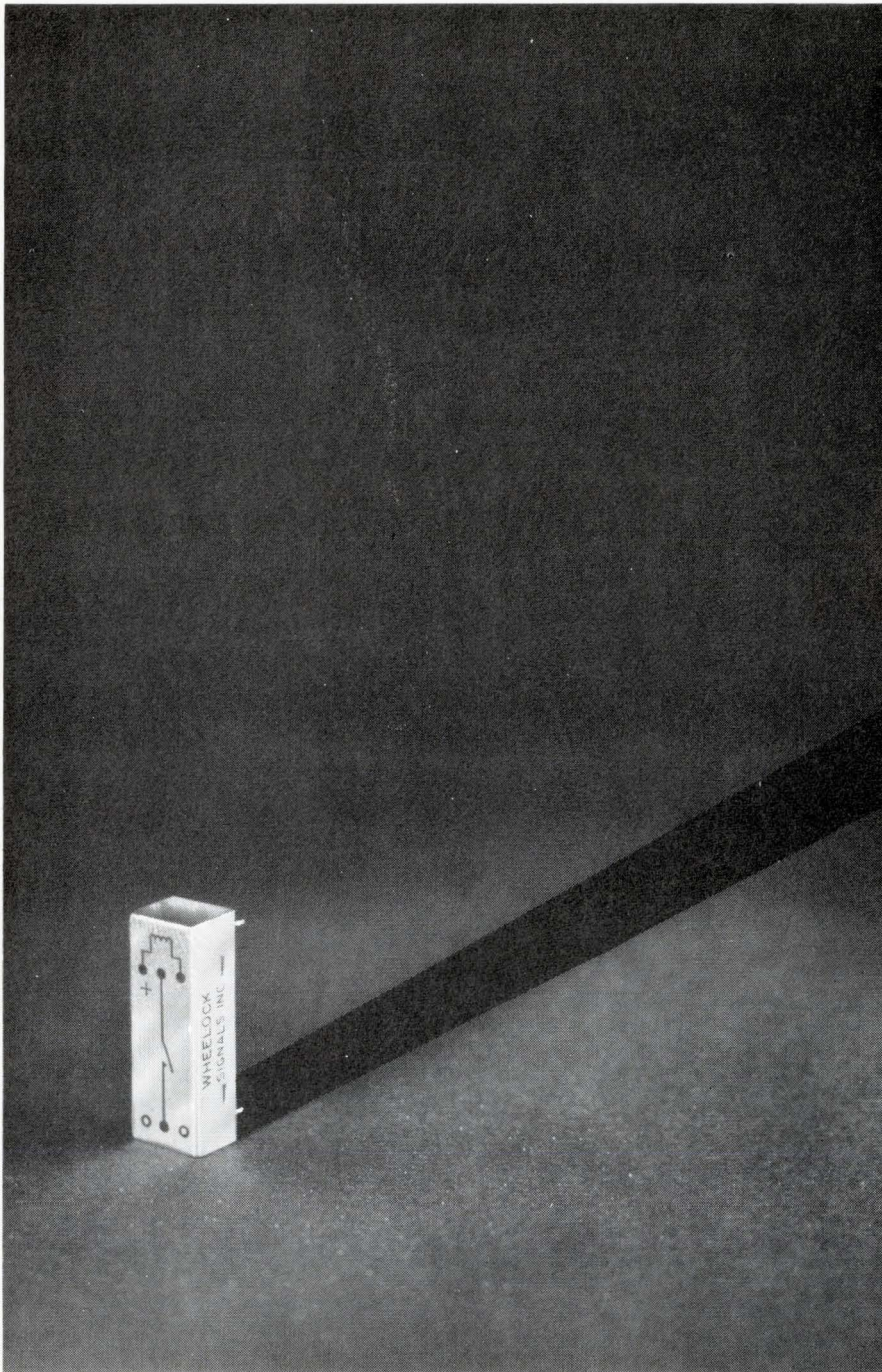

THE FIRST SIGNIFICANT STANDARD REED RELAY IN THE INDUSTRY—THE

502 BY
Wheelock

WHEELOCK SIGNALS, INC.
273 BRANCHPORT AVENUE
LONG BRANCH, N.J. 07740
(201) 222-6880

- Standard grids:
(1.00" x .100") (1.00" x .150")
- Low cost . . . immediate delivery
- Coil voltages: 6, 12, 24, 48VDC
- Contacts: Forms A, B or True C

93

NEW PRODUCTS

SCR TRIGGER TRANSFORMERS

Isolate high voltages.

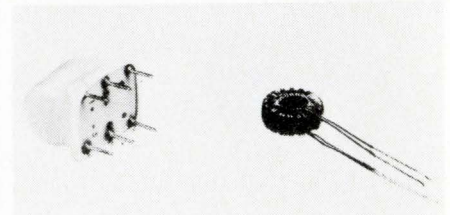

Pulse transformers are for use in SCR trigger circuits. This series is subjected to high test voltages up to 2500 Vrms to ensure reliability when used to isolate high voltages. Two basic styles are available—PC pins or axial lead mounting. Pulsar Engineering Inc., 1247 El Camino Real, Mountain View, Calif. 94040. (415) 964-1606.

Circle 242 on Inquiry Card

SILICON RECTIFIER

PRV ratings from 50 V to 1200 V.

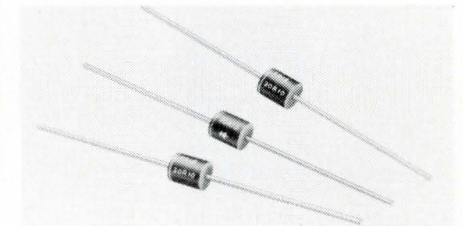

Series 30 R units use high density molding compounds and silicon polymer junction coatings to ensure long life stability in adverse environments. These 3.0 A rectifiers are useful for new designs as well as replacement for many stud-type and selenium stack assemblies. Erie Technological Products, Inc., 644 W. 12th St., Erie, Pa. 16512. (814) 453-5611.

Circle 243 on Inquiry Card

ELECTRODE COMPOSITIONS

Binary alloys of palladium and gold.

These screen-printable compositions are for use in multilayer ceramic capacitors. They cost much less than pure platinum or high platinum mixtures which they replace. First of the series is Electrode Composition 8282 (\$57 a troy ounce—500 or more ounces). It provides key functional properties previously available only in platinum compositions that sold at \$120-140 an ounce. The new compositions are printed directly on green, uncured ceramic tape, which must be fired later at temps of more than 1200°C to mature the ceramic particles—basic components of the tape. E. I. Du Pont de Nemours & Co., Inc., Wilmington, Del. 19898. (302) 774-8631.

Circle 244 on Inquiry Card

LITERATURE

Motorola's new semiconductor handbook (4th ed.)

If you have the 3rd edition (colored plaid green) of the now popular Semiconductor Data Book by Motorola, don't take this new 4th edition for granted. First of all, it won't fit in the same slot of your bookcase, because it's almost 50% bigger. Even more important, its popular listing of EIA types (which, incidentally, lists all 1N, 2N, and 3N numbers—whether Motorola makes them or not) is now arranged in numerical order, instead of by type of transistor as it was before. There is an extra cross index that relates the application (power transistors, signal transistors, switching diodes) to the EIA type number.

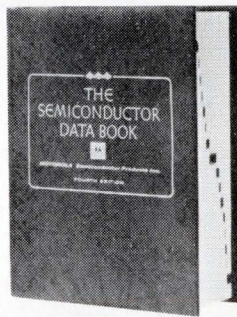

Just as you would expect, there are more data listings for ICs, both linear and digital, (although no spec sheets, because Motorola has a separate Data Book for ICs). Also, we noticed that the excellent set of application notes that appears at the end of the book has been revised. Some old ones were dropped, and there are new ap notes, especially a timely one on phototransistors. The price for this 2160-page book is \$4.95, although if you are a good customer . . . Motorola Semiconductor Products Div., Box 20912, Phoenix, Ariz.

Circle 332 on Inquiry Card

Magnetic reed switches

A selection guide offers applications and specs for a line of reed switches. Sizes of the switches range from 0.375 in. (glass length) and a diameter of 0.090 in. to standard size and mercury-wetted types. A chart which shows contact arrangement, dimensions, switch voltage, and electrical characteristics is provided. Hamlin, Inc., Lake and Grove Sts., Lake Mills, Wisc. 53551.

Circle 333 on Inquiry Card

Casting resins

A line of casting resins, including epoxy, polyurethane and polystyrene resins, are described in a folder-type brochure. The manufacturer's line of molding powders and liquids is also covered. Both applications and physical properties are listed on a chart, permitting easy selection for a particular application. Emerson & Cuming, Inc., Canton, Mass. 02021.

Circle 334 on Inquiry Card

Lugs, clips and terminals

Designed to help solve component problems by using standard parts, an up-dated 64-page catalog lists a line of lugs, clips, terminal and metal stampings. Specs and illustrations are provided for a variety of types, sizes and configurations. Zierick Mfg. Corp., 36 Radio Circle, Mount Kisco, N.Y. 10549.

Circle 335 on Inquiry Card

Lead wire for internal wiring

A line of lead wire for internal wiring of electrical appliances is outlined in a 12-page catalog. Designated L-69, the brochure provides insulation specs and application data for the line of wire. It also indexes the wire's specs by insulation type and usage. Belden Corp., Box 5070 A, Chicago, Ill. 60680.

Circle 336 on Inquiry Card

Connector terms

A glossary of connector terms with definitions of words used regularly in connector descriptions has been made available to engineers involved in connector design or specification. Intended

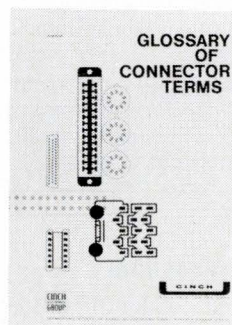

as a communications link between engineers and connector manufacturers, the glossary should eliminate the confusion that exists in connector terminology. Cinch Manufacturing Co., 1501 Morse Ave., Elk Grove Village, Ill. 60007.

Circle 337 on Inquiry Card

Precision pots

A variety of wirewound precision potentiometers are discussed in a 72-page catalog (#PD-1). Diagrams containing dimensions are included as is a discussion of linearity considerations for selecting pots. Also described in the catalog is the manufacturer's turns counting dial line



which includes digital and concentric scale types. Electrical, environmental and mechanical characteristics for both product lines are provided and include reference to military specs where applicable. Bunker-Ramo Corp., Amphenol Controls Div., 120 S. Main St., Janesville, Wisc. 53545.

Circle 338 on Inquiry Card

Auto plotting

An automatic plotting concept which combines high speed and smooth line quality of analog with the precision and reliability of digital techniques has been termed the hybrid concept. Bulletin #951504 discusses the concept and includes a description of a dataplotter that is able to produce accurate drawings with great efficiency. Specs are provided. Electronic Associates, Inc., West Long Branch, N.J.

Circle 339 on Inquiry Card

Slide rule calculators

Developed for computer programmers and systems analysts, two calculators provide an accurate means of checking computer codes by allowing the user to perform arithmetic and algebraic calculations in computer base number systems. The calculators are also capable of performing most operations of a conventional slide rule in the decimal base and converting them to the computer base. Technical leaflet S-3 describes the two instruments. Science Spectrum, Inc., 1216 State St., Santa Barbara, Calif. 93101.

Circle 340 on Inquiry Card

Find it fast! in the **FREE NEW 1970 Newark industrial electronic catalog**

A \$9,000,000 INDUSTRIAL ELECTRONIC INVENTORY
720 PAGES • OVER 70,000 ITEMS; 500 MAJOR LINES

Eliminate line transients, noise and even arrest lightning with the **WANLASS PARAFORMER™**



MODEL NO. PEC-60
ONLY \$95.00

FOR 60 VA OF
WANLASS
PARAMETRIC
POWER

AND ALSO GET
0.25% AC REGULATION!

THE WANLASS PARAFORMER is the revolutionary power transfer component that effects parametric transfer of power without solid-state or mechanical elements. Standard units rated from 60 to 5000 VA in stock.

Immediate delivery from stock—factory OEM prices
—fast efficient service from 11 Newark warehouses.
*One source for the products
you need, in the quantities
you need.*



For your free catalog write to:

Main Office & Warehouse
NEWARK ELECTRONICS CORPORATION

500 North Pulaski Chicago, Illinois 60624
(312) 638-4411

WAREHOUSES IN

- | | | |
|--|--|---|
| * Minneapolis, Minn.
(612) 331-6350 | * Los Angeles Area
(213) 678-0441 | * |
| * Cincinnati, Ohio
(513) 421-5282 | * Grand Rapids, Michigan
(616) 452-1411 | * |
| * Denver, Colorado
(303) 757-3351 | * New Orleans, Louisiana
(504) 834-9470 | * |
| * Detroit, Michigan
(313) 548-0250 | * Dallas, Texas
(214) 271-2511 | * |
| * New York City
(212) 255-4600 | * Houston, Texas
(713) 782-4800 | * |

Circle 73 on Inquiry Card

LITERATURE

Drafting aids

A 68-page illustrated design manual contains tips on the proper use and application of pressure-sensitive electronic component drafting aids. Catalog 104 covers component mounting

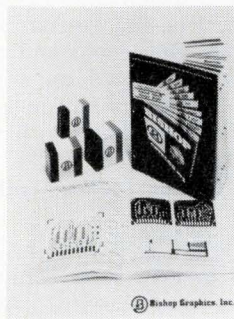

methods, preparation of printed wiring master art work, basic connector configurations and flat pack and dual in-line component mounting configurations. Bishop Graphics, Inc., 7300 Radford Ave., North Hollywood, Calif. 91605.

Circle 341 on Inquiry Card

Permanent magnet motor

A 23-frame (2¼ in. dia.) reversible motor is the subject of a 4-page bulletin. Specifications and ratings are listed for 18 standard part numbers. Other useful data, including design formulas, graphs, and dimensional drawings, are given. Indiana General Corp., Electro-Mechanical Div., Walnut St., Oglesby, Ill. 61348.

Circle 342 on Inquiry Card

Automatic measurement systems

Engineering bulletin AEB-100, titled "Precise Measurement of Spike Leakage in Gas Switching Tubes," covers TR function and spike leakage effects. MPH D operating principles are included as is descriptive data for a microwave pulse height detector's performance, attenuator settings for measuring leakage, and TR tube evaluations. Available on company letterhead from Varian, Salem Rd., Beverly, Mass. 01915.

Tantalum capacitors

Specification GR500/F describes high-reliability F-series solid tantalum capacitors and their applications. The hermetically-sealed, rectangular devices are for aerospace, military, and industrial circuit applications. Union Carbide Corp., Electronics Div., Box 5928, Greenville, S.C. 29606.

Circle 343 on Inquiry Card

Transformer guide

Catalog GEC-1090B provides selection data for a line of dry-type transformers. Application information and ordering guidelines for general purpose, buck-boost and distribution transformers are included in the 28-pager along with descriptions for machine tool transformers, integral distribution centers, ac voltage stabilizers and portable oil testers. General Electric Co., Distribution Svs., Bldg. 705, Corporation Park, Scotia, N.Y. 12302.

Circle 344 on Inquiry Card

Electromagnetic shield designing

A 48-page manual provides information for those involved in the design, specification and/or purchase of drawn and fabricated shields. Electrical and mechanical design considerations are included as is a dimensional listing of drawn and fabricated shapes. The guide also covers terms used in electromagnetic shielding. Magnetic Metals Co., Hayes Ave. at 21st St., Camden, N.J. 08101.

Circle 345 on Inquiry Card

Laser applications

Applications of laser technology, such as etching, resistor trimming, hole drilling, and welding, are the subject of a 16-page brochure. Included are more than 50 pictures that illustrate the various applications. Laser Nucleonics, Inc., 123 Moody St., Waltham, Mass. 02154.

Circle 346 on Inquiry Card

Microwave transmitters

A line of microwave transmitters, receivers and components is the subject of a 12-page short form catalog, designated 70A. Specifications for the microwave devices are provided as are descriptions



and illustrations for FM microwave relay equipment. RHG Electronics Laboratory, Inc., 94 Milbar Blvd., Farmingdale, N.Y. 11735.

Circle 347 on Inquiry Card

266 COURSES

Pick the one that can do the most for you!

266 courses—that's how many ways ICS offers you to get ahead. See partial listing below. Whatever your interests or job aspirations, whatever you'd like to be or do—from accounting to engineering—there's an ICS course for you. To help you get ahead faster in your present job. Or find a new career.

Study and learn in your spare time. Personalized guidance from experts through each step. Bedrock facts, theory, practical application. ICS makes study and learning fun. Then comes coveted ICS diploma to graduates. You're on your way!

Get started today. Clip and mail the coupon now. We'll send you free 3-booklet Success Kit that has helped thousands. No obligation. Do it today.

- Accounting**
Accounting (U.S. or Can.)
Cost Accounting
- Architecture and Building Trades**
Air Conditioning
Architecture
Arch. Drawing & Design
Building Contractor
Carpenter-Builders
Carpentry & Millwork
Heating & Air Conditioning with Drawing
House Planning, Int. Design
Plumbing & Heating
Refrigeration
- Art and Design**
Commercial Art
Commercial Cartooning
Interior Decorating
Sign Painting & Design
Sketching & Painting
- Automotive**
Auto. Electrical Techn.
Auto. Technician
Engine Tune-Up
Transmission Specialist
- Business**
Advertising
Business Administration
Creative Salesmanship
Managing a Small Store
Personnel-Labor Rel'n
Real Estate Sales
Retail Business Mgmt.
Traffic Management
- Chemical**
Chemical Engineering
Chem. Lab. Technician
General Chemistry
- Civil Engineering**
Civil Engineering
Highway Eng. Tech.
Surveying & Mapping
- College Courses**
American History
Calculus
Economics
- Computers**
COBOL Programming
Fortran Programming
Programming the 360
- Drafting**
Aircraft Drafting
Architectural Drafting
- Blueprint Reading
Electrical and Electronic Mechanical
- Electrical Engineering**
Appliance Servicing
Elec. Eng. Technician
Motor Repairman
Practical Electrician
- Engineering (Refreshers Courses)**
Civil
Electrical Industrial
Mechanical
Sanitary Structural
- High School**
High School General
High School Secretarial
College Preparatory
Preparatory Course for H.S. Equivalency Test
- Mach. Shop Practice**
Machine Shop Practice
Reading Shop Prints
Tool & Die Maker
- Mechanical**
Mechanical Engineering
Aircraft Mechanic
Hydraulic, Pneumatic Power
Industrial Engineering
Machine Design
Power Plant Engineering
Quality Control
Tool Design
- Secretarial**
Clerk-Typist
Professional Secretary
Stenographic
- TV-Radio-Electronics**
Electronics Fundamentals
Electronic Technician
General Electronics
Radiotelephone License
TV and Radio Servicing
- Writing**
English and Writing
Free-Lance Writing
Other (Please specify)

Veteran approved.
Accredited Member,
National Home Study Council
ICS, Scranton, Penna. 18515

ICS[®] International Correspondence Schools Division of Intext

ICS, DEPT. T9644K, SCRANTON, PENNA. 18515
I'm interested in a program of independent study. Send me your free 3-booklet Success Kit: (1) "How to Succeed," 30 pages of valuable job tips, (2) Sample self-instruction text showing famous ICS method, (3) Catalog for subject indicated.

Course _____
Name _____ Age _____
Home Address _____
City _____ State _____ Zip Code _____
Occupation _____
Employed by _____
Working Hours _____ A.M. to _____ P.M.

CONVENIENT PAYMENT PLAN

Circle 74 on Inquiry Card

Minimizing op amp noise

Fundamentals of op amp noise and circuit principles for minimizing noise error are discussed in a 12-page article. Topics covered include noise characteristics of representative amplifier types including bipolar input, FET input, chopper stability and varactor bridge types.

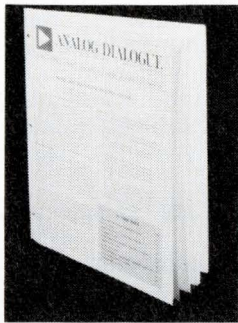

Included in the literature is a bibliography listing sources for various aspects of circuit noise, including general theory, conventional treatment and methods of minimizing noise effects. Analog Devices, Inc., 221 Fifth St., Cambridge, Mass. 02142.

Circle 348 on Inquiry Card

IC read only memory

A 26-page catalog covers a P-channel IC static 1024 bit ROM. An operational description is contained in the brochure as are application data, and mechanical and electrical characteristics. Logic, timing and bipolar system block diagrams are provided. Union Carbide, Semiconductor Dept., Box 23017, San Diego, Calif. 92123.

Circle 349 on Inquiry Card

Modem manual

A high speed data modem, designated AE-96, is the subject of a 10-page brochure. A general description of the device is included in the discussion along with its theory of operation and salient features. An operational schematic which illustrates the modem's functioning is provided. Codex Corp., 150 Coolidge Ave., Watertown, Mass. 02172.

Circle 350 on Inquiry Card

Encoders guide

Encoder technology and its applications are discussed in a 12-page booklet. Included in the guide is a section on the conversion of encoders into useable data, as in A/D conversion systems. A list of encoding definitions is also provided. Collectron Corp., 304 E. 45th St., N.Y., N.Y. 10017.

Circle 351 on Inquiry Card

Precision instrument switches

A 24-page catalog describes a line of precision instrument switches for use in computers, telemetering systems and automatic check-out equipment. Tips for selecting switches, terminal boards and multiple deck units are provided as are mechanical and electrical specs for the switches. Aerovox Corp., New Bedford, Mass. 02741.

Circle 352 on Inquiry Card

Measuring pulses precisely

Examples of digital data acquisition systems for use in scientific and industrial applications are discussed in a 15-page booklet. Tips for selecting the right system for a specific application are provided in both written and block diagram form. System options are included. Vidar, 77 Ortega Ave., Mountain View, Calif. 94040.

Circle 353 on Inquiry Card

Power sources

"Digitally Controlled Power" is the title of a 22-page brochure that deals with the characteristics and applications of digitally-controlled power sources. These sources are basically D-to-A converters followed by power amplifiers, but they can be used as

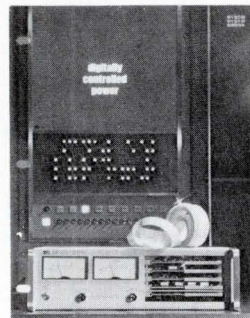

power supplies or waveform generators in computer-controlled and other automatic systems. They are designed for easy interfacing with digital controllers. Inquiries Mgr., Hewlett-Packard Co., 1501 Page Mill Rd., Palo Alto, Calif. 94304.

Circle 354 on Inquiry Card

Hybrid computing systems

Hybrid computing systems which can be built around EAI's 640 digital computer are the subject of an 18-page brochure. The publication covers hybrid computer applications and user case histories, and describes the variety of integrated systems now available. Electronic Associates, Inc., West Long Branch, N.J. 07764.

Circle 355 on Inquiry Card

High Voltage CRT Power Supplies Custom Designed

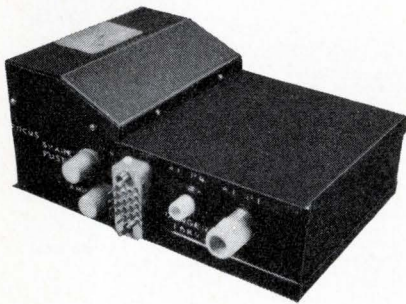

This custom designed Head-Up Display power supply met the requirements listed below and solved a unique space and weight problem as well.

- Outputs:
 - 15 KVDC, 400 μ a pk.
 - 1.7 KV (adj. 1.4 to 2.0 KV), $\pm 30 \mu$ a
 - 300 VDC, $\pm 15 \mu$ a
- Ripple: 0.5%
- Regulation $\pm 0.1\%$
- Volume: less than 50 cu. in.
- Weight: 3 $\frac{1}{4}$ lbs.
- Temperature:
 - 55°C to 110°C
- Ref. to MIL-STD-826
- MIL-E-5400
- Input:
 - 115 V, 400 cps MIL-STD-704

Try stumping us with your problem. We'll put everything we have into solving it and probably come up with a design that saves weight and space. Write or call for details today.

Capitron Division
 Elizabethtown, Pa. 17022
 717-367-1105 TWX: 510-657-4561

AMP

INCORPORATED

Circle 75 on Inquiry Card

LITERATURE

Microwave test equipment

Various standard waveguide and coaxial instruments and components which comprise a precision test equipment product line are covered in an up-dated catalog. Complete information on waveguide and coaxial devices, as noise sources, attenuators, directional couplers and phase shifters, is included as are engineering reports on noise measurement and standard waveguide data. Waveline, Inc., Box 718, W. Caldwell, N. J. 07006.

Circle 356 on Inquiry Card

Renting electronic equipment

A 48-page catalog covers a line of electronic instruments available for short term rental. The equipment includes oscilloscopes, counters, recorders, signal generators, digital voltmeters

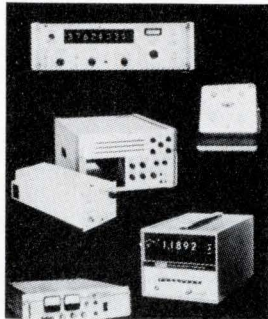

and power supplies along with general purpose test equipment and small computers and accessories. Rentronix, 11501 Huff Court, Kensington, Md. 20795.

Circle 357 on Inquiry Card

Timing instruments

A file folder contains descriptions of high resolution instruments for scintillation and germanium timing experiments. Data pertaining to constant fraction timing and instrumentation for timing experiments is printed directly on the folder. A selection guide to the manufacturer's timing instruments, including block diagrams for a variety of experiments is contained in the folder as are spec sheets for popular instruments. Ortec, 219-C Midland Rd., Oak Ridge, Tenn. 37830.

Circle 358 on Inquiry Card

CLASSIFIED ADVERTISING

GROWTH POSITIONS \$12,000-\$25,000
 MANAGEMENT — ENGINEERING — SALES
 RESEARCH — MANUFACTURING
Nationwide Coverage
 Fees company paid. Include present salary, minimum salary requirement and location flexibility with resume. Longberry Employment Service, Inc. 910 Niles Bank Bldg., Niles, Ohio 44446. (216) 632-5871.

Mini connectors

Catalog CN-5 devotes itself to a line of miniature connectors. The devices described use a one-piece molded dielectric retention system rather than metal retention clips, therefore the number of contacts is increased in a given shell size. Included in the catalog are electrical and mechanical specs in addition to performance characteristics and available accessories. Illustrations, and instructions on the assembly of the connectors are also provided. Cinch Electronics Group, 1501 Morse Ave., Elk Grove Village, Ill. 60007.

Circle 359 on Inquiry Card

Electronic components

A 100-page catalog covering electromechanical components features a transducer selection guide. The guide, which has been designed to assist the engineer in his selection of transducers, accelerometers and load cells, describes popular types, functions and applications for each. Sections on counters, flow meters, precision pots, test equipment and timers are included as are photographs and diagrams. American Relays, Electronics Div., 39 Lispenard St., New York, N.Y. 10013.

Circle 360 on Inquiry Card

Laser accessories

A comprehensive 20-page catalog covers laser accessories and components. Included in the rundown are reflex beam expanders, laser focus assemblies, corner-cube retroreflectors, laser finder goggles and laser line filters. A section on pocket cells, a practical component for laser systems, discusses the theory and applications of the cells and includes specification tables and performance curve charts. Baird-Atomic, Inc., 125 Middlesex Turnpike, Bedford, Mass. 01730.

Circle 361 on Inquiry Card

Hybrid microcircuits

This 12-page brochure discusses the make or buy philosophy in hybrid microcircuits and the necessary required skills of electrical circuit design, materials and processing, mechanical design and packaging, manufacturing and quality control. It also describes the facilities and capabilities of a specialist in custom hybrid microcircuits with emphasis on micro-power. Lansdale Microelectronics, Inc., Colmar, Pa. 18915.

Circle 362 on Inquiry Card

Light and color measurements

A 168-page volume is intended for the engineer or technologist interested in the measurement of light and color, specifically related to small light sources. The catalog provides a clear treatment of concepts of light and color that electronic engineers involved in optoelectronics need, yet are unable to find clearly defined in textbooks on the subject. It would take a good deal of browsing through several references to find the material covered in this comprehensive source. Available for \$7.50 from General Electric Inquiry Bureau, Dept. L-C, Nela Park, Cleveland, Ohio 44112.

Life test/burn-in systems

Life test/burn-in systems are the subject of Catalog 61. Those covered include power aging, thermal fatigue, free air and controlled ovens for ICs. Descriptions for the models are provided, as are illustrations, specs and available components. Wakefield Engineering, Inc., Wakefield, Mass. 01880.

Circle 363 on Inquiry Card

Analog instruments

A 1969/1970 version of Philbrick/Nexus' product catalog features op amps, non-linear function modules, power supplies, regulators and accessories. The 100-pager contains up-to-date specs on available instruments, as well as selection guidelines. Products are indexed both by function (with applications) and by model number. Philbrick/Nexus Research, 3 Allied Dr., Dedham, Mass. 02026.

Circle 364 on Inquiry Card

Power components catalog

A line of power components, systems, and instruments are outlined in a comprehensive 64-page brochure. Included in the guide are dimensional drawings for each group as well as performance data and operating characteristics. A selection guide of the manufacturer's power instruments for lab, test equipment, systems, and OEM applications is provided. Lambda Electronics Corp., 515 Broad Hollow Rd., Melville, N.Y. 11746.

Circle 365 on Inquiry Card

Silicon semiconductor devices

A 1969 product catalog contains data for silicon semiconductor devices including analog switching instruments, varactor diodes, military devices, photo sensitive instruments, hybrid circuits and power FETs. The various products are coded by device, numerical, application and military indices. Provided too is a category locating guide as well as product data sheets. Available on company letterhead from Crystalonics, 147 Sherman St., Cambridge, Mass. 02140.

CAD techniques

Some of the advantages in using computer-aided design techniques in CATV equipment design are discussed in a 6-page technical bulletin. Titled "CATV Repeater Amp Design Utilizing Digital Computer," the paper contains design examples and includes schematics. Anaconda Electronics Co., Sales Dept., 1430 S. Anaheim Blvd., Anaheim, Calif. 92803.

Circle 366 on Inquiry Card



EASILY APPLIED

Cool-Amp can be applied on the job. The only equipment needed is a clean rag, a wire brush and some water. Cool-Amp contains no cyanide and can be used in underground vaults, substations and hard to get at places by several persons at the same time.

REDUCES RESISTANCE

Cool-Amp Powder deposits a genuine coat of silver that will not peel off. It prevents oxidation, minimizes overheating, thereby reducing maintenance. Provides cool maximum conductivity for all copper, brass or bronze current-carrying connections.

FREE SAMPLE—Write today for folder and free sample of Cool-Amp. One pound will silver plate approximately 6,000 square inches. Try a test order. \$17.50 per pound—F.O.B. Portland. (Phone 503-244-2230.)

The COOL-AMP Co.

8625 S.W. 17th Avenue, Portland, Oregon 97219

Circle 76 on Inquiry Card

planning small thermoplastic parts?

get **NEW IDEAS, FAST**

from **GRC's**
DESIGNERS' GUIDES
& **WORK SHEETS**

for DELRIN, NYLON, and other thermoplastics

Make the most of the outstanding properties of Delrin Nylon, Cyclocac, Kel-f and other thermoplastics . . . and get parts **faster . . . at lower cost.**

GRC's experience plus fully automatic molding techniques give you wider design latitude than ever . . . assures accurate, uniform parts . . . mean perfection shortcuts. Extra economy, too, by inserting wires, stampings, etc., automatically in the molding cycle . . . made possible by GRC's exclusive automatic insert molding process.

NO MINIMUM SIZE! Maximum sizes: Zinc Alloy-2" long, 1/2 oz. Plastic 1 3/4" long, .05 oz.

GRIES REPRODUCER CO.

Division of Coats & Clark Inc.

world's foremost producer of small die castings & plastic moldings

165 Beechwood Ave., New Rochelle, New York 10802 • (914) 633-8600

Plants in: New Rochelle, N.Y.; Warren, R.I.; Toccoa, Ga.

In Canada: Gries Div., Dynacast Ltd., Lachine, Que.

WRITE, WIRE, PHONE today for these helpful, data-packed bulletins and samples

GRIES

Circle 77 on Inquiry Card

PRECISION CURRENT SOURCES

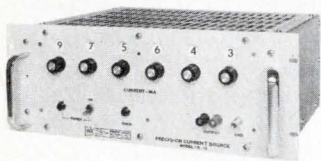

WE ARE NEVER SATISFIED!

We have secretly upgraded the performance of our Precision DC Constant Current Sources and reduced their size to boot!!

Model No.	Current Range	Compliance
CS-11	0 to 100 mA	100 V
CS-12	0 to 1 A	12.5 V

- 1 μ A resolution, 10 ppm stability
- Modulation capability
- Digital in-line readout
- Superior performance down to zero current

Complete line of general purpose, precision, and ultra-stable, ac and dc voltage/current sources and calibrators.



**NORTH HILLS
ELECTRONICS, INC.**

Glen Cove, N. Y. 11542 • Phone (516) 671-5700

Circle 78 on Inquiry Card

LITERATURE

Ferrite microwave devices, including 4-port isolators, circulators, co-isoguide devices, ferrite switches, drive electronics and mini isolators and circulators (32-pages). Advanced Microwave Labs, 611 Vaqueros Ave., Sunnyvale, Calif. 94086.

Circle 367 on Inquiry Card

Ultrasonic cleaning systems utilizing magnatrac generators with magnapak transducers—bulletin DB 80-350 (4-pages). Westinghouse Electric Corp., Box 868, Pittsburgh, Pa. 15230.

Circle 368 on Inquiry Card

Fluidic industrial control modules, available with brass fillings or with recessed O rings—data sheet FAD-935. Corning Glass Works, Corning, N.Y.

Circle 369 on Inquiry Card

Digital voltmeter with dc accuracy of 0.0025% and 10 μ V resolution has full systems capability—data sheet 959 (8-pages). Dana Laboratories, Inc., 2401 Campus Dr., Irvine, Calif. 92664.

Circle 370 on Inquiry Card

Videotape equipment, including recorders, closed circuit TV cameras, monitors, lenses and accessories—brochure V69-5. Ampex Corp, 2201 Estes Ave., Elk Grove Village, Ill.

Circle 371 on Inquiry Card

Data communication products for use in data processing terminals and data communications equipment (4-pages). Cermetek, Inc., 660 National Ave., Mountain View, Calif. 94040.

Circle 372 on Inquiry Card

Data manipulation lingo (Ommitab), developed to eliminate time spent on manual computations (2-pages). International Telecomputer Network Corp., 7315 Wisconsin Ave., Bethesda, Md. 20014.

Circle 373 on Inquiry Card

Micro-mini digital display readouts, including micro decoder/driver modules and incandescent lamps with display brightness values up to 5000 feet—catalog 1969-2 (16-pages). Pinlites, Inc., 1275 Bloomfield Ave., Fairfield, N. J. 07007.

Circle 374 on Inquiry Card

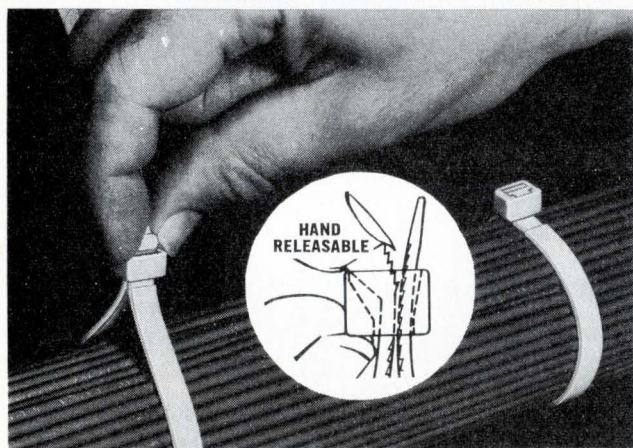

PANDUIT STA-STRAP® TIES

releasable prior to final tightening

PANDUIT Cable Ties offer you the exclusive advantages of releasability by hand prior to tool installation or final tightening by hand. Simply move the head down (see above) and pull the wedge end away from the lead end of the cable tie. This permits easy adjustments in the harness, allows you to move the cable tie. Full line of all nylon, self-locking cable ties for harnesses up to 8" diameter. No metal barbs or twisting. Meet applicable MIL Specs.

At your PANDUIT Distributor. FREE SAMPLES

PANDUIT®
CORP.

Tinley Park, Ill. 60477 • Phone: 312-532-1800 • Telex 25-4560

FROM THE MANUFACTURERS OF
PANDUCT® PLASTIC WIRING DUCT



VISIT PANDUIT AT ISA SHOW BOOTH 108

Circle 79 on Inquiry Card



Actual Size

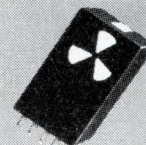

New Microminiature "BITE"* Indicators

* Built-In-Test-Equipment

Now you can design a continuous monitor into electric or electronic circuits to give a visual warning of faulty performance. These indicators provide a sharply-contrasting change in color to signal a malfunction. Even if the failure is transient, the indicator continues to register the fault by means of magnetic latching until a reset signal is applied.

You can use these indicators on a system, sub-system, module, or individual circuit card level to pinpoint malfunctions quickly. They eliminate the need for special test instruments, troubleshooting time, and highly-qualified personnel. Unnecessary downtime can be virtually eliminated.

These indicators respond to a pulse width as low as 15 milliseconds, and use power only during transition from "normal" to "malfunction" state. Several variations are available; all meet the applicable requirements of MIL-E-5400H (ASG) Class 1-A Equipment. Send for information now!

NORTH AMERICAN PHILIPS
COMPANY

AWHAYDON
THE COMPANY

232 North Elm Street
Waterbury, Conn. 06720

See EEM for local
Representatives in U. S.

In Europe s.a. Polymotor • 29 Av. Paul Henri Spaak • Brussels 7 • Tel. 23.40.83
Timing & Stepper Motors • Electromechanical & Electronic Timing Devices & Systems

Circle 80 on Inquiry Card

Advertisers—October 1969



This index is published for a convenience.
No liability is assumed for errors or omissions.

ALPHA METALS, INC. Black, Russell, Morris	15
AMELCO SEMI. Steven Jacobs Design Assoc.	26
AMERICAN MICRO-SYSTEMS INC. Jordan Adv., & Marketing Services, Inc.	53
AMP INC. CAPITRON DIV. Garceau, Hallahan & McCullough, Inc.	29 120
AMPERITE CO. H. J. Gold Co.	114
AMPHENOL CONTROL DIV. OF BUNKER-RAMO CORP. Marsteller Inc.	103
AUGAT, INC. Horton, Church & Goff, Inc.	57
BECKMAN INSTRUMENTS, INC. HELIPOT DIV. N. W. Ayer/Jorgensen/MacDonald, Inc.	74
BOURNS, INC. The Lester Co.	21, 91
BUSSMAN MFG. DIV. Henderson Adv., Co.	94, 95
C. P. CLARE & CO. Reincke, Meyer & Finn	27
CLIFTON DIV. OF LITTON INDUSTRIES Ivey Adv., Inc.	67
COOL-AMP CO. Searcy Adv. Agency	121
COORS PORCELAIN CO. Tallant/Yates Adv., Inc.	5
COUGH ORDNANCE, INC. Culver Adv., Inc.	108
CRYSTALONICS Impact Adv., Inc.	58, 59
DALE ELECTRONICS INC. Swanson, Sinkey, Ellis, Inc. Adv.	88
DANA LABORATORIES, MEASUREMENTS DIV. Rose Assoc. Adv.	31
DIALIGHT CORP. Michel-Cather, Inc.	44
ELCO CORP. Schaefer Adv., Inc.	54, 55
ELECTRO MOTIVE MFG. CO., INC., THE Culver Adv., Inc.	45
FAIRCHILD CONTROLS Hal Lawrence Inc.	97
FAIRCHILD SPACE & DEFENSE SYSTEMS Keyes, Martin & Co.	105
FERROXUBE CORP. W. H. Schneider, Inc.	11
GENERAL INSTRUMENT CORP./INTEGRATED CIRCUIT DIV. Norman Allen Assoc., Inc.	109
GRAYHILL, INC. Carr Liggett Adv., Inc.	52
GRIES REPRODUCER CO. Harold Marshall Adv. Co., Inc.	121
GUDBROD BROS. SILK CO., ELEC. DIV. Ramsdell, Buckley & Co., Inc.	8
GULTON INDUSTRIES, SERVONIC DIV. Smith-Kliffen Inc.	101
HAMILTON WATCH CO. Beaumont, Heller & Sperling, Inc.	30
A. W. HAYDON CO. J. B. Rundle Inc.	122
HEATH CO. Advance Adv. Service	115
HICKOK ELECTRICAL INSTRUMENT CO., THE Parsells Adv., Service	56
IDEAL PRECISION METER CO., INC. Fein, Silver & Soloway, Inc.	25
INDIANA GENERAL CORP. The Griswold & Eshleman Co.	14
INTERNATIONAL CORRESPONDENCE SCHOOLS N. W. Ayer & Son, Inc.	119
IRC, DIV. OF TRW INC. Gray & Rogers, Inc.	87
KEPCO, INC. Weiss Adv.	Inside Front Cover
KINETIC TECHNOLOGY, INC. Associates ad ventures	2

LEACH CORP. Chiat/Day Corp.	Insert Fol. Page 18
LTY ELECTROSYSTEMS, INC. Lennen & Newell, Inc. Adv., The Wyatt and Williams Div.	38, 39
MALCO MFG. CO., INC. Symonds, Drimilla & Co., Inc.	32
MATHESON GAS PRODUCTS, A DIV. OF WILL ROSS, INC. Cooper, Strock & Scannell, Inc.	112
MELCOR ELECTRONICS CORP. Samuel H. Goldstein Adv. Agency	4
MEPCO, INC. Gilbert, Whitney & Johns, Inc.	99
MICRO SWITCH W. W. Ayer & Son, Inc.	Inside Back Cover
J. W. MILLER CO. Schaeper Industrial Adv.	113
MOTOROLA SEMICONDUCTOR PRODUCTS, INC. Lane and Bird Adv., Inc.	77
NATIONAL SEMICONDUCTOR Hall Butler Blatherwick Inc.	72, 73
NATVAR CORP. Sanger-Funnell Inc.	14
NEWARK ELECTRONICS CORP. Stral Adv. Co., Inc.	118
NJE CORP. Keyes, Martin & Co.	Insert Fol. Page 34
NORTH HILLS ELECTRONICS, INC. N.S. Adv.	122
PANDUIT CORP. Donald L. Arends, Inc.	122
PHILCO FORD CORP. The Aitkin-Kynett Co., Inc.	81
PHILLIPS MFG. CO., ULTRASONIC DIV. Black, Russell, Morris	100
PYLON CO. INC. American Line-A-Graph Corp.	24
RCA, INDUSTRIAL RECEIVING TUBES DIV. POWER TRANSISTORS DIV. Al Paul Lefton Co., Inc.	33 Back Cover
RAYTHEON COMPUTER Martin Wolfson Adv.	107
RAYTHEON SEMICONDUCTOR Botsford, Constantine & McCarty, Inc.	82, 83
REPUBLIC ELECTRONICS CORP. Kardonne Adv. Agency	100
ROTRON INC. Lescarboura Adv. Inc.	106
SAN FERNANDO ELECTRIC MFG. CO. West-Ad Communications	28
SOLID STATE PRODUCTS, DIV. OF UNITRODE CORP. Van Christo Assoc., Inc.	16
SOLITRON DEVICES, INC. Haselmire Pearson Adv. Inc.	111
SPRAGUE ELECTRIC CO., CAPACITOR AND RESISTORS DIV. The Harry P. Bridge Co.	1
TERADYNE, INC. Quinn & Johnson, Inc.	93
TEXAS INSTRUMENTS, INC., COMPONENTS GROUP Albert Frank-Guenther Law, Inc.	79
TRIPLETT CORP. Byer & Bowman Adv. Agency, Inc.	84
TRYGON ELECTRONICS INC. Technical, Industrial & Scientific Marketing Inc., A Div. of Newmark, Posner and Mitchell, Inc.	104
UNITRODE CORP. Silton Brothers, Inc.	12
VARFLEX CORP. Barlow/Johnson Inc.	24
VARIAN ASSOC., TWT DIV. ELECTRON TUBE AND DEVICE CORP. Botsford, Constantine & McCarty, Inc.	6 25
VISHAY RESISTOR PRODUCTS Alpern Communications	110
WEMS, INC. Nova Ad	66
WENTWORTH LABS. William Bridgham Assoc.	52
WHEELLOCK SIGNALS, INC. McCarthy/Scelba/DeBiasi Adv. Agency Inc.	116

DISTRICT SALES MANAGERS

EDWARD G. SHAUD PHILADELPHIA 19139—56th & Chestnut Sts. (Area Code 215) SHERWOOD 8-2000
JOSEPH DRUCKER NEW YORK 10017—100 East 42nd St. (Area Code 212) OXFORD 7-3400
JOHN UPHUES JOHN W. BERNHARDT CHICAGO 60606—120 S. Riverside Plaza (Area Code 312) 782-1400
G. T. ALFANO NEEDHAM HEIGHTS, MASS. 02194— 570 Hillside Ave. (Area Code 617) 444-0010
TERRENCE D. BUCKLEY THOMAS R. BORIS LOS ANGELES 90015—1543 W. Olympic Blvd. (Area Code 213) DUNKIRK 7-1271
RALPH PETERSEN SAN FRANCISCO—839 Mitten Rd. BURLINGAME 94010 (Area Code 415) 697-8703
LEONARD PREYSS CLEVELAND 44114—601 Rockwell Ave. (Area Code 216) SUPERIOR 1-2860
FRANK A. SMITH HOLLYWOOD, FLA. 33020— 2419 Hollywood Blvd. (Area Code 305) 927-7829
NEWTON B. COLLINSON ATLANTA 30309—1776 Peachtree St. N.W. (Area Code 404) 872-4723
HAROLD E. MOTT WAYNE L. LOVING DALLAS 75206—Meadows Bldg. Expressway at Milton (Area Code 214) EMERSON 3-6426
JOHN F. WALLACE HOUSTON 77027—West Loop Bldg. Rm. #209, 4848 Guiton (Area Code 713) 621-3428
European Sales Offices
MAX F. HOLSINGER LONDON, S.W. (1)—67/68 Jermyn St. St. James Tel: TRafalgar 6318/9
4 DUSSELDORF—RATH, Germany United International Industrial Press Eitelstrasse 32 Tel: Dusseldorf 632031
STEPHEN BROWN-JOUSSARD PARIS 8e, France 70 Rue de Ponthieu Tel: ELysee 65-77
Far East Sales Office
CLARENCE T. SAKAGUCHI TOKYO, MARUNOUCHI, Japan C.P.O. Box #1572, Room 814 Tel: 211-3506-3509 Togin Bldg.
BUSINESS STAFF
K. ROBERT BRINK Publisher
STEPHEN A. FARKAS Marketing Services Manager
BERNARD GITTELMAN Directories Manager
DENNIS J. PERKINS Promotion Manager
THOMAS A. MORIE Eastern Advertising Manager
PAT PIEHL Advertising Production
WILLIAM M. COFFEY Circulation Director
JAMES F. NAGY Circulation Manager
JOSEPH P. BABCOCK Reader Service Manager
JOHN H. KOFRON Chilton Research Services
C. R. WILHIDE Washington Vice-President

Index to Product Information

Listed below are all products and new literature that appear in this issue, along with the page number they appear on and their Reader Service Numbers (RSN). For more information, see the appropriate page and circle the corresponding number on the reader service card.

Components	Page	RSN	Page	RSN	Page	RSN
active filters	2	6				
ballast regulators	114	70				
C-band TWTs	111	224				
capacitors	45	34				
capacitors	100	57				
card edge connectors	108	213				
CdS photocell	104	205				
chip resistor kits	114	237				
coax connectors	112	225				
connector block	110	221				
connector systems	32	28				
connectors	54, 55	38				
connectors	120	75				
converters	67	44				
crystal oscillators	115	210				
decade capacitor	102	253				
delay lines	115	211				
delay lines, acoustic	108	217				
digital display	33					
DIL plastic package	112	226				
fans, blowers	106	62				
feedthru connector	112	227				
FET amplifier	114	235				
FETs	26	22				
fluidic cable	14	15				
fuses, fuseholders	94, 95	54				
HV capacitors	104	202				
hybrid op amp	104	203				
inductors	28	24				
lighted switches	44	33				
low profile connections	92	272				
mercury relay	113	228				
meters	25	21				
microstrip launchers	113	230				
micro-system connector	29	25				
microwave oscillators	114	236				
miniature diode	104	201				
motors	14	16				
multiplex switch	114	234				
op amp, wide band	113	232				
photocell	108	215				
photomultiplier	92	275				
piezo-electric accelerometer	101	58				
plastic element pots	104	206				
plastic parts	121	77				
plastic transistors	104	204				
potentiometer	21	17				
power transistors	back cover	3				
precision resistors	110	66				
pushbutton switches	52	36				
reed relay	116	72				
relay	108	64				
relays	18	14				
relays	27	23				
relays	27	23				
relays	91	53				
resistor	87	51				
SCR low current	92	276				
SCR trigger transformer	116	242				
shielded rf chokes	113	69				
silicon rectifier	116	243				
silicon transistor	113	229				
snap-on isocket	108	218				
solid-electrolyte capacitors	4	5				
time delay relay	92	273				
toggle switches	ins. back cover	2				
trimmer	88	52				
trimmer	103	59				
trimmer pot	92	277				
trimmers	74	46				
TWTs	6	41				
wirewound resistors	4	5				
zeners	12	11				

ICs and Semiconductors	Page	RSN
bipolar scratch pad	82, 83	49
CdS photocell	104	205
FETs	26	22
FETs	115	209
FET amplifier	114	235
FET analog gates	58, 59	42
FET-input op amp	92	271
frequency divider arrays	96	290
hybrid circuits	66	43
hybrid IC	99	56
ICs for TV	94	262
microwave semiconductor	25	20
miniature diode	104	201
MOS counters	94	261
MOS dynamic shift registers	95	265
multiplier, 4-quad	77	47
op amps	97	55
op amp power booster	95	264

parity generator/checker	Page	RSN	Page	RSN
parity generator/checker	79	113		
photocell	108	215		
plastic transistors	104	204		
plug-in LSI package	95	267		
power transistors	back cover	3		
power transistors	92	278		
radiation-hardened ICs	81	48		
ROM kits	94	263		
SCR, low current	92	276		
shift registers	53	37		
silicon transistor	113	229		
switching transistors	111	67		
TTL MSI circuits	72, 73	45		
TTL MSI data selectors	96	289		
voltage regulator	109	65		
zeners	12	11		

Instrumentation	Page	RSN
attenuators	102	257
CCTV camera	105	61
decade capacitor	102	253
decade counter	100	282
dielectric defect detector	96	291
digital measuring system	56	39
digital IC tester	95	268
digital voltmeter	90	245
frequency standard	101	287
hand-held IR device	101	286
metal-film thickness monitor	101	288
meters	25	21
microcircuit prober	52	35
microwave monitor	102	254
mini connectors	120	359
multimeter	31	27
multimeter, 3 digit	90	246
oscilloscope	90	247
probes	24	18
radiation survey meter	101	285
rms ac/dc log converter	100	283
shock machine	106	209
sound level meter	102	255
temperature indicator	102	260
test set	102	252
thermometer	102	256
TV demodulator	102	258
voltage breakdown tester	100	284
VOMs	84	50

Materials and Packaging	Page	RSN
cable laser	8	9
cable ties	122	79
ceramics	5	8
circuit boards	111	222
circuit board	57	40
circuit boards	93	29
connector systems	32	28
DIL plastic package	112	226
electrode compositions	116	244
metallic liner	106	208
micro-system	29	25
plastic parts	121	77
polyimide tape	106	212
pot cores	11	10
precision parts	30	26
resistive pastes	106	210
silver plating	121	76
sleeving	24	19
solder preforms	15	12
temperature controller	102	259

Modules, Networks & Subassemblies	Page	RSN
active filters	2	6
"BITE" indicators	122	80
code converter	110	219
crystal oscillators	115	210
dc power supplies	ins. fol. p. 34	30

dc power supplies	Page	RSN
dc power supplies	108	214
digital isolator	92	270
FET-input op amp	92	271
frequency divider arrays	96	290
hybrid circuits	66	43
hybrid i-f amp	106	207
microstrip launchers	113	230
microwave oscillators	114	236
multiplex switch	114	234
op amp	4	7
op amp, wide band	113	232
power amp	106	211
power supplies	ins. front cover	1
power supplies	34	30
power supplies	104	60
power supplies	122	78
stripline coupler	111	223
TTL MSI data selectors	96	289
waveguide tuners	110	220
wideband preamp	92	274

New Literature	Page	RSN
analog instruments	121	364
auto plotting	117	339
automatic measurement systems	118	
CAD techniques	121	366
casting resins	117	334
connector terms	117	337
data communication products	122	372
data manipulation lingo	122	373
digital display readouts	122	384
digital voltmeter	122	370
drafting aids	118	341
ferrite microwave devices	118	345
fluidic modules	122	369
electronic components	120	360
encoders guide	119	351
ferrite microwave devices	122	367
fluidic modules	122	369
hybrid computing systems	119	355
hybrid microcircuits	120	362
IC read only memory	119	349
job opportunities	39	32
laser accessories	120	361
laser applications	118	346
lead wire	117	336
life test/burn-in systems	121	363
light & color measurements	121	362
lugs, clips and terminals	117	335
measuring pulses precisely	119	353
microwave test equipment	120	356
microwave transmitters	118	347
modem manual	119	350
op amp noise	119	348
parts and equipment	118	373
permanent magnet motor	118	342
power components catalog	121	365
precision pots	117	338
precision switches	119	352
professional opportunities	38	31
reed switches	117	333
renting equipment	120	357
semiconductor devices	121	
semiconductor handbook	117	332
slide rule calculators	117	340
tantalum capacitors	118	343
timing instruments	120	358
transformer guide	118	344
ultrasonic cleaning	122	368
videotape equipment	122	371

Production and Mfg.	Page	RSN
dielectric defect detector	96	291
digital IC tester	95	268
drafting aids	108	216
film production systems	95	266
gas systems	112	68
IC test handler	96	292
IR soldering system	114	233
solder preforms	15	12
ultrasonic cleaning systems	100	81
wire twister	114	238

Systems Equipment	Page	RSN
digital measuring system	56	39
digital system	115	71
digital systems kit	107	63

We had big things in mind when we developed our tiny toggle switches.



Things like airplanes,
ware, communications gear and
Things where small size
But where long-life operating
For instance, excellent

position." Our TW toggle switches provide both. The result of a 35° toggle throw and positive detent. And for aircraft applications, there's a new, large bat handle that meets your human factor requirements.

Then there's switching versatility. Both standard 1/4" and our new 15/32" bushing versions are available with a two or three-position, maintained or momentary action and in either one or two-pole circuitry. All can be obtained with standard or pull-to-unlock toggle levers to meet your needs.

Sealed, molded-in solder terminals won't pull out. Go ahead, try.

What this all adds up to is reliability. The kind that's evidenced by meeting MIL-S-3950 requirements for shock, vibration, moisture, corrosion and altitude.

There are accessories, too. Dress hardware, lever caps, boot seals, panel seals. Each improves switch effectiveness as well as panel appearance.

It's all in Product Sheet TW. Plus a lot more. You can get a copy from your MICRO SWITCH Branch Office or Distributor. (They're in the Yellow Pages under "Switches, Electric.") Or write and we'll send a copy. You're sure to find it a big help.

MICRO SWITCH

FREEPORT, ILLINOIS 61032

A DIVISION OF HONEYWELL

Circle 2 on Inquiry Card

Who's First... with 5,000,000 SILICON POWER transistors per month

- Over 300 standard types/over 500 custom types
- P-N-P and N-P-N
- From 50 mA to 100 A, 1 W to 300 W, 50 V to 500 V
- Using all the SILICON POWER technologies
 - Hometaxial Base
 - "Overlay"
 - Epitaxial
 - Plastic Power
 - Multiple Epitaxial
 - Triple Diffused
 - Diffused Planar
- Multiple packaging, including hermetic and plastic "VERSAWATT"
- Commercial, industrial, military high reliability specs
- Providing specific, versatile, economic answers to all your circuit needs

Who? The Leader in SILICON POWER

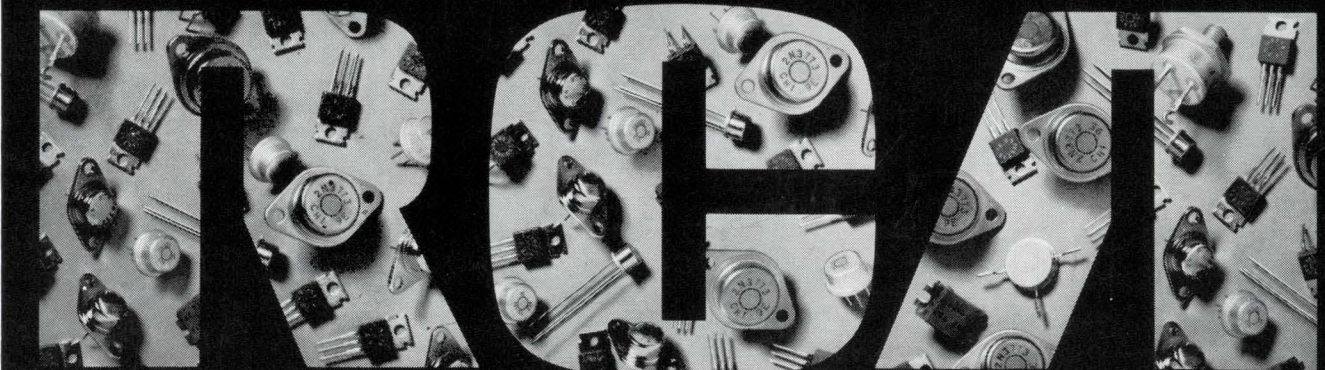

For more information, see your local RCA Representative
or your RCA Distributor. For technical data, write:
RCA Electronic Components,
Commercial Engineering, Section IJ-10, Harrison, N. J. 07029

Circle 3 on Inquiry Card