



Burroughs

BTOS Hardware Network

Planning
and Installation
Guide

Revision Level 3.0
Priced Item
October 1986

Distribution Code SA
Printed in U.S.A
1201084



Burroughs

BTOS Hardware Network

Planning
and Installation
Guide

Copyright © 1986, Burroughs Corporation, Detroit, Michigan 48232

Revision Level 3.0
Priced Item
October 1986

Distribution Code SA
Printed in U.S.A
1201084

NO WARRANTIES OF ANY NATURE ARE EXTENDED BY THIS DOCUMENT. Any product and related material disclosed herein are only furnished pursuant and subject to the terms and conditions of a duly executed Program Product License or Agreement to purchase or lease equipment. The only warranties made by Burroughs, if any, with respect to the products described in this document are set forth in such License or Agreement. Burroughs cannot accept any financial or other responsibility that may be the result of your use of the information or software material, including direct, indirect, special or consequential damages.

You should be very careful to ensure that the use of this information and/or software material complies with the laws, and regulations of the jurisdictions with respect to which it is used.

The information contained herein is subject to change without notice. Revisions may be issued to advise of such changes and/or additions.

Warning: This equipment generates, uses, and can radiate radio frequency energy and if not installed and used in accordance with the instructions manual, may cause interference to radio communications. It has been tested and found to comply with the limits for Class A computing device pursuant to Subpart J of Part 15 of FCC Rules, which are designed to provide reasonable protection against such interference when operated in a commercial environment. Operation of this equipment in a residential area is likely to cause interference in which case the user may at his own expense will be required to take whatever measure may be required to correct the interference.

Correspondence regarding this publication should be forwarded, using the Product Improvement Card at the back of this manual, or remarks may be addressed directly to Burroughs Corporation, Corporate Product Information East, 209 W. Lancaster Ave., Paoli, PA 19301, U.S.A.

About This Manual

Purpose

The purpose of this manual is to guide you in planning the cabling routes between equipment in a Burroughs workstation cluster or a Burroughs Local Area Network (B-LAN), selecting cable and connectors, and interconnecting the equipment.

Scope

This manual includes general guidelines for designing the physical layout of the cluster and LAN, excerpts from the National Electrical Code, and ordering information for cable assemblies, terminator kits, and custom cable kits.

Audience

This guide is intended for those responsible for the planning, installation, and maintenance of a Burroughs workstation cluster and/or a Burroughs Local Area Network (B-LAN). This audience includes general managers, plant engineers, computer system managers, and computer equipment installers.

How to Use This Document

Read this guide during the initial stages of planning your Burroughs workstation cluster and/or Burroughs Local Area Network. Use it as a reference when ordering cable assemblies, terminator kits, and custom cable kits.

Organization

This manual is organized into six sections. Section 1 discusses general considerations for interconnecting any equipment. Section 2 covers safety and some requirements of the National Electrical Code (United States) and the electrical codes of other countries. Section 3 describes a Burroughs workstation cluster. Section 4 describes two Burroughs Local Area Networks. Section 5 describes cabling for a variety of available printers. Section 6 describes cabling for modems. The appendix provides pinout diagrams for some standard connection arrangements.

Results

The user of this guide should be able to plan and install a Burroughs workstation cluster and/or a Burroughs Local Area Network, and properly connect a printer or modem to the system.

Contents

About this Manual	iii
Section 1: Introduction	1-1
System Configurations (Topologies)	1-2
Bus Topology	1-2
Ring Topology	1-4
Star Topology	1-5
Hierarchical Star Topology	1-6
Transmission Media	1-7
Planning and Maintenance	1-7
Section 2: Safety Requirements	2-1
Electrical Code Safety Requirements	2-1
Class 1 and 2 Circuits	2-1
Fire Stops	2-2
Wiring in Ducts, Plenums, and Other Air-Handling Spaces	2-2
Wiring under Raised Floors	2-2
Grounding	2-3
Separation from Electric Light, Power, and Class 1 Conductors	2-3
Vertical Runs (Shafts or Partitions)	2-3
Circuits Extending Beyond One Building	2-3
Lightning Surge Protectors	2-4
Circuits Extending Across the Floor	2-5
Cable and Cable Assembly Safety Requirements	2-5
Ground Potential Differences	2-5
Section 3: Cluster Configurations	3-1
Cluster Connections	3-1
Daisy-Chain Connection	3-1
Spur Connection	3-2
Cluster Connector Boxes	3-3
Maximum Cluster Cable Length	3-4
Minimum Cluster Cable Length	3-4
Mixed Clusters	3-5
Connectors	3-5
Standard Products	3-5

Section 4: Local Area Network Configurations (B-LAN)	4-1
Maximum B-LAN Network Size (Simple Network)	4-1
Expanding the B-LAN	4-2
Minimum Distance Between Nodes	4-8
Standard Network Cable (Node Interconnecting Cable)	4-8
Custom Network Cable (Node Interconnecting Cable)	4-9
LAN Module Connections	4-10
B-LAN Repeater Connections	4-12
Section 5: Printer Configurations	5-1
Section 6: Modem Cable Assemblies	6-1
Appendix A: Pinouts	A-1

Illustrations

1-1	Bus Topology	1-3
1-2	Ring Topology	1-4
1-3	Star Topology	1-5
1-4	Hierarchical Star Topology	1-6
1-5	Cable	1-8
3-1	Daisy-Chain Cluster (Master at Center of Cluster) ..	3-1
3-2	Daisy-Chain Cluster (Master at End of Cluster)	3-2
3-3	Spur Cluster (Master at Center of Cluster)	3-2
3-4	Spur Cluster (Master at End of Cluster)	3-3
3-5	Cluster Cable Assemblies	3-6
3-6	Cluster Adapter Cable	3-9
3-7	Cluster Terminators	3-10
4-1	Burroughs Local Area Network (B-LAN) (Simple Network)	4-1
4-2	Maximum B-LAN Length(Simple Network)	4-2
4-3	Expanded Network (Two Segments Connected by a Repeater)	4-3
4-4	Expanded Network (Two Segments Connected by a Repeater -- repeater in center of second segment) ..	4-4
4-5	Two Segments Connected by a Link	4-5
4-6	Three Segments Connected by Two Links	4-6
4-7	Maximum Network: A Segment of 26 Repeaters Connecting 26 Segments of 25 Workstations Each. (650 Workstations on the Network)	4-7
4-8	Minimum Node Separation	4-8
4-9	Triaxial Cable	4-8
4-10	B-LAN Cable Assembly	4-9
4-11	Triaxial Connector Supplied with Custom Kits	4-10
4-12	LAN Module Connections	4-11
4-13	B-LAN Terminator	4-11
4-14	Triaxial "Barrel" Connector Adapter	4-12
4-15	B-LAN Repeater Connections	4-13
5-1	Serial Printer Cables 3396 7514, 3396 7522	5-7
5-2	Serial Printer Cables 3384 1925, 3384 1933, 3384 1941	5-7
5-3	Serial Printer Cables 3390 7007, 3390 7015, 3390 7023, 3390 7031	5-8
6-1	Bell® Modem Cable Assemblies	6-1
6-2	SEL Modem Cable Assemblies	6-4
6-3	GPO Modem Cable Assemblies	6-6
6-4	RS-232 Cable Assembly, Male to Male, Straight Through Connections	6-8

Tables

3-1	Custom Cluster Cable Assembly Kits	3-7
3-2	Bulk Cluster Cable	3-8
4-1	Custom Triaxial Cable Kits	4-9
4-2	Bulk Triaxial Cable	4-12
5-1	Data Cable for AP 1302 and AP 1303 Letter-Quality Serial Printers	5-1
5-2	Serial Data Cables for the AP 1305 Printer	5-2
5-3	Data Cables for the AP 1311 Printer	5-2
5-4	Data Cables for AP 1312 Printer	5-3
5-5	Data Cables for the AP 1314 Printer	5-3
5-6	Data Cables for the AP 1351 Printer	5-4
5-7	Data Cables for the 1351-1 Printer	5-4
5-8	Data Cables for the AP 1354 Printer	5-5
5-9	Data Cables for the AP 9208 Printer	5-6
5-10	Data Cables for the B9251-1 Printer	5-6
5-11	Data Cables for the B9252 Printer	5-6
5-12	Data Cables for the B9253 Printer	5-7
6-1	RS-232 Cable Assembly (Null Modem) for B 27	6-10
6-2	Data Communications Adapter (DCA) Cable Assembly	6-11
A-1	Electronic Industries Association (EIA) Standard RS-232	A-1
A-2	Burroughs Direct Access Arrangement (BDAA)	A-1
A-3	(Centronics Standard) Parallel Printer Cable	A-2

Introduction

Carefully plan your installation before you order materials or begin the work. All installations requiring the interconnection of devices must meet certain standards, including:

International and national electrical safety codes

Local building and electrical safety codes

Fire safety codes

Minimum and maximum spacing requirements for the equipment being installed

Freedom from interference caused by other electrical devices found along the cable route

Electrical safety codes typically regulate grounding, lightning protection, and connection of high-voltage devices to low-voltage devices. They may also cover the types of insulating materials used in various environments.

Local building codes typically regulate the structural safety of buildings. Loss of structural safety might occur if structural members are damaged when cable is run through walls, ceilings, floors, or roofs. Similarly, the codes address preserving the moisture barriers when running cable through roofs or exterior walls.

Fire safety codes involve such matters as the environment inside the building and hazards that would prevent rapid exit in the event of fire. Among the hazards are doorways or windows blocked by cabling, and "tripping hazards" caused by cabling run across or along walkways. Fire codes may regulate the toxic byproducts of burning materials. In a cable installation, this means the toxic byproducts of burning insulation.

Spacing requirements vary and may be necessary to reduce noise interference from nearby electrical apparatus or to provide a delay on a signal cable to assure proper operation of a system.

Routing requirements typically involve keeping signal cables away from cables carrying high-power radio frequency energy and high-voltage electrical power lines.

Each of these topics is discussed in detail in Section 2, "Safety Requirements."

System Configurations (Topologies)

The components of a distributed computer system are physically arranged in an ordered structure, or *topology*. The four most common topologies are bus, star, hierarchical star and ring. Bus and ring arrangements are most often used for data applications such as local area networks. The star arrangement is most often used for voice circuit interconnections, but can also support data. Burroughs B 20 and B 25 systems use only the bus topology. The other topologies are presented here as an aid to understanding the differences. A complete transmission network may use one topology or a combination of topologies to meet varying communications requirements.

Bus Topology

In bus topology, equipment is "strung out" along a single length of cable as shown in Figure 1-1. The cable can be extended on either or both ends, and there is only one transmission path between any two devices on the bus. Some Burroughs systems provide an internal path for signals between two jacks on the equipment, as shown in Figure 1-1(b). Passing the signal through each device in this manner is called "daisy chaining." Burroughs systems may also be connected in a bus structure called a *spur*. Refer to Section 3 for information about spurs.

Figure 1-1 Bus Topology

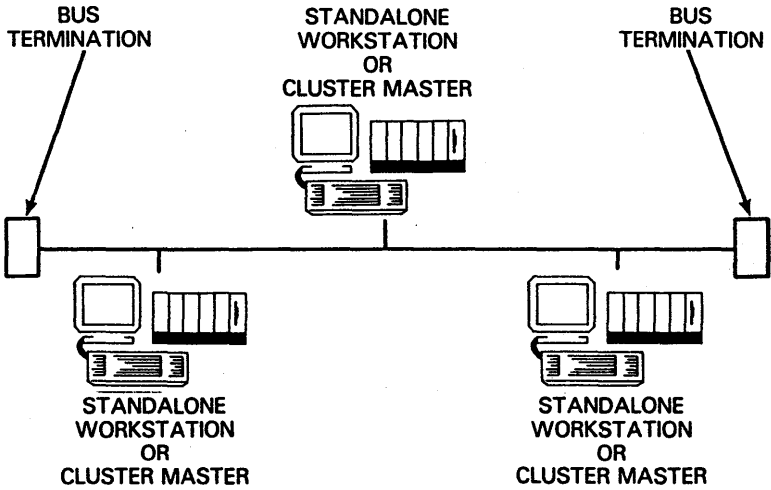

(a) The Concept
E7391

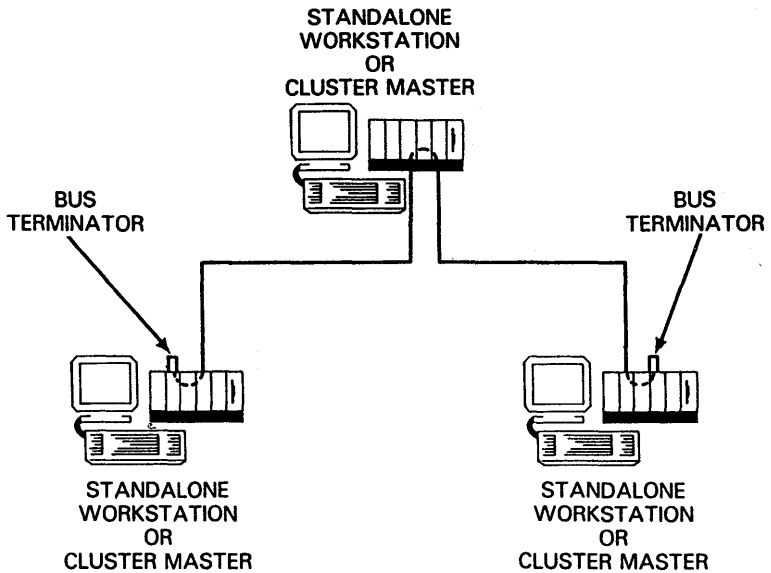

(b) Burroughs Practice
E7392

Ring Topology

In ring topology, the signal path forms a ring, or circle, with equipment connected at various points on the circle as shown in Figure 1-2(a). As in bus topology, the concept may be presented a second way, (Figure 1-2(b)) depending on the actual equipment employed. Signals typically pass through each equipment before returning to the origination point. Ring topologies use control and switching methods similar to those used for bus topologies. However, service must be interrupted to add devices to the ring.

Figure 1-2 Ring Topology

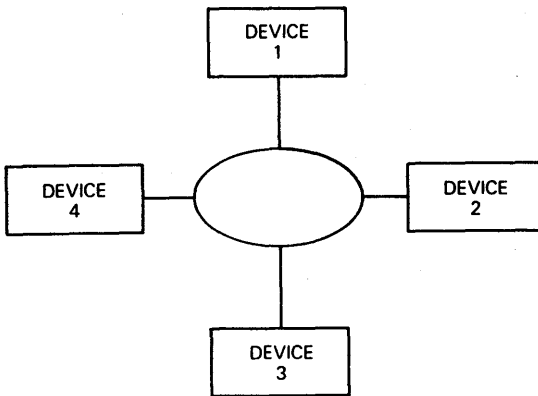

(a) The Concept
E7393

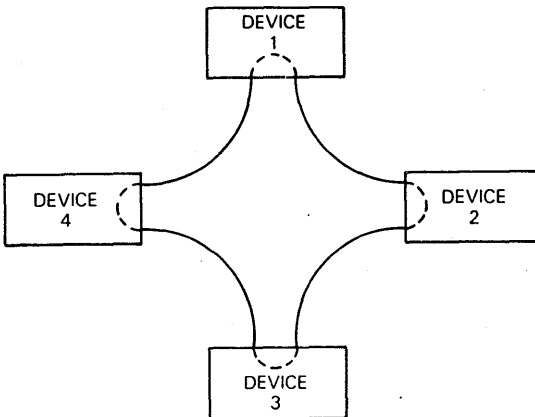

(b) The Practice
E7394

Star Topology

In star topology, a central node connects to each terminal device via a single point-to-point link. Any communication between two terminal devices must pass through the central node. A simple central node connects only two devices at a time, while a more complex central node may permit two or more separate pairs of devices to be connected simultaneously. Star topology allows devices to be added to the network without disrupting communications among other devices and allows the network to continue operating when a device (other than the central node) fails.

Figure 1-3 Star Topology

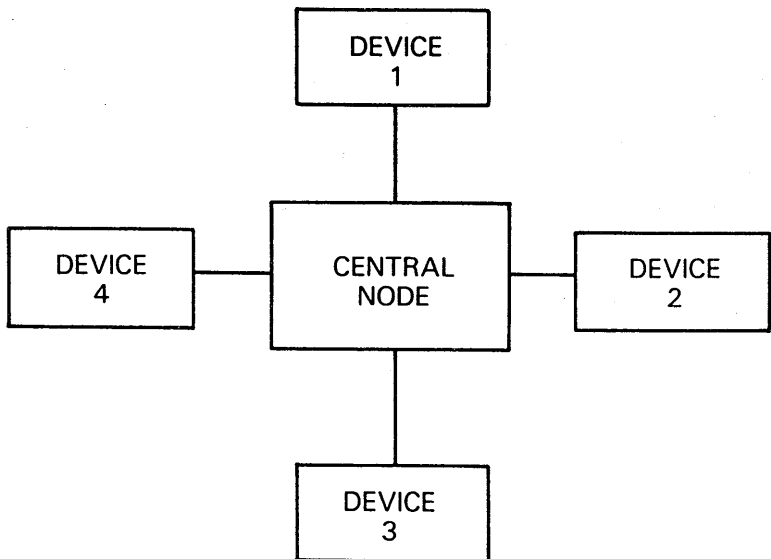

E7395

Hierarchical Star Topology

When a network becomes complex, it is often desirable to connect devices indirectly via cluster points, or nodes, which then connect to other cluster points. This system permits devices on one node to communicate with devices on another node.

Figure 1-4 Hierarchical Star Topology

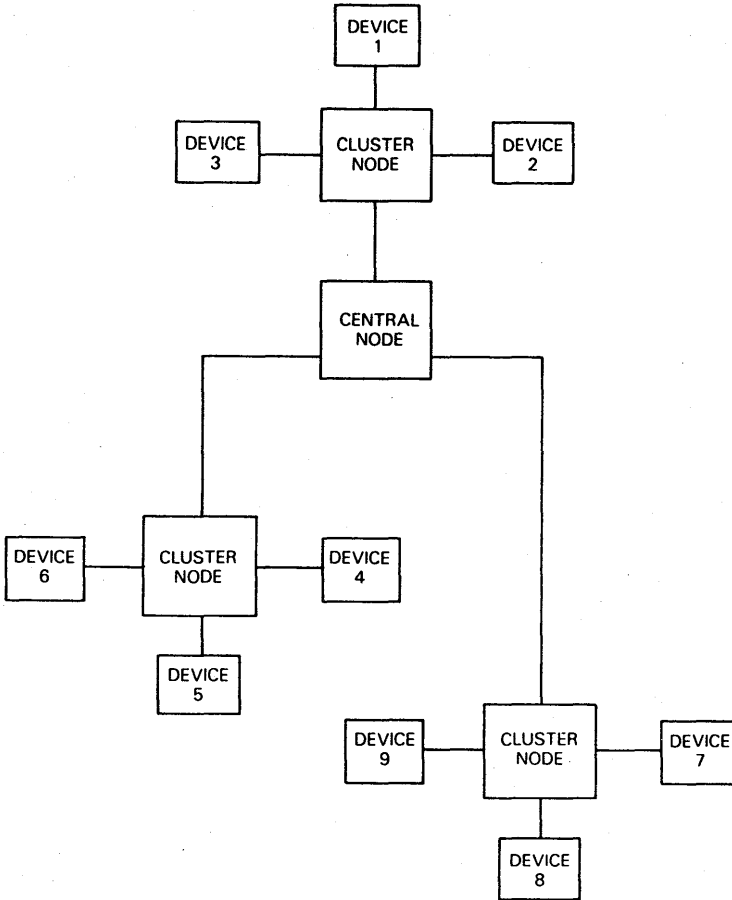

Transmission Media

The transmission medium used in Burroughs cluster networks is dual-shielded twisted-pair cable consisting of two twisted pairs and a drain wire contained within the cable shield (Figure 1-5(a)).

The transmission medium used in local area networks is either coaxial or triaxial cable. Coaxial cable (Figure 1-5(b)) consists of a center conductor surrounded by a braided conductor. Triaxial cable (Figure 1-5(c)) is like coaxial cable, but has an additional braided conductor insulated from the first braid.

In a Burroughs network, workstations within a cluster are interconnected with twisted-pair cable. Clusters (and/or standalone workstations) are interconnected via the local area network using coaxial or triaxial cable.

Planning and Maintenance

First decide where each piece of equipment in the system is to be located. Consider the desired location, availability of electrical power, and maximum and minimum distances between devices. These requirements are discussed in greater detail later in this manual.

As the system is planned and installed, keep accurate records of the physical location of each piece of equipment, its system address, and the cable number and routing from each equipment. This information will help you quickly isolate and correct a problem and will make it easier for you to expand the system.

For example, if you suspect a cable is defective, the records will indicate the next connection point in the chain, where you can see if the cable is faulty or if it has just become disconnected from the next unit. If the cable proves faulty, a diagram of the cable route through walls and ceilings will help you determine the length of replacement cable to be installed.

Figure 1-5 Cable

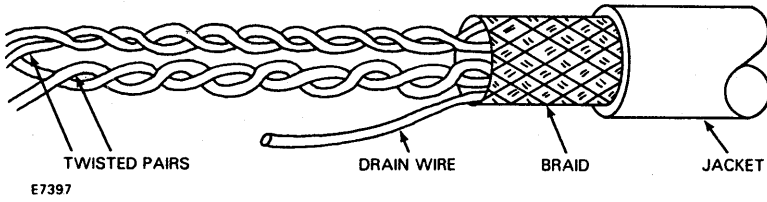

(a) Twisted-Pair Cable used for Cluster Connections

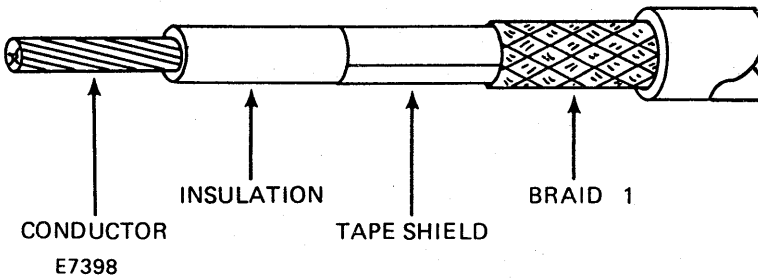

(b) Coaxial Cable (not used on B-LAN)

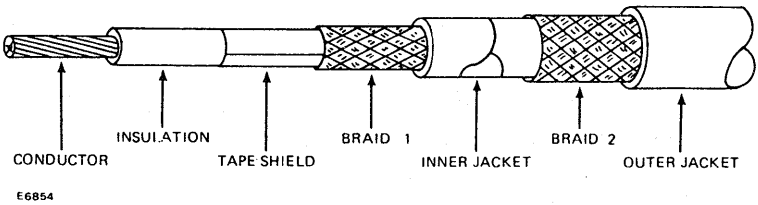

(c) Triaxial Cable

Safety Requirements

You are responsible for planning, ordering, installing, and maintaining the cabling system; however, contact the appropriate architect, engineer, consultant, or contractor for guidance and assistance when required.

In addition, be sure you:

- 1 Comply with all applicable national, state, and local safety standards. (Local codes, where applicable, take precedence over other codes and practices.)
- 2 Keep the cabling system electrically safe by attaching only equipment that complies with the voltage and current limits for Class 2 circuits as defined in:

Article 725 of the National Electrical Code (United States)

Section 16 of the Canadian Electrical Code (Canada)

Safety Extra Low Voltage (SELV) circuit requirements as defined in IEC 380, Safety of Electrically Energized Office Machines (other countries)

Electrical Code Safety Requirements

Electrical safety requirements are based on the 1984 edition of the National Electric Code (NEC) and part 1, 14th edition 1982, of the Canadian Electric Code (CEC). Installers in other countries should check the latest edition of the appropriate electrical code.

These are guidelines and do not include all requirements that may be applicable. Consult your local code enforcement officer.

Class 1 and Class 2 Circuits

Refer to the applicable electrical code for exact definitions of Class 1 and Class 2 circuits as defined by the responsible national or international authority.

Class 1 power circuits are extra-low-voltage circuits supplied from a source having a rated output of not more than 30 volts and 1000 volt-amps.

Class 1 remote-control circuits and Class 1 signal circuits are supplied from a source not exceeding 600 volts. The code does not differentiate between AC and DC for the purposes of voltage measurement.

Class 2 circuits do not exceed 150 volts. Class 2 circuits are defined for various voltage and current conditions.

Fire Stops

Conductors of Class 2 circuits extending through fire-resistance rated walls, partitions, floors, or ceilings must be firestopped using approved methods to maintain the fire-resistance rating.

Wiring in Ducts, Plenums, and Other Air-Handling Spaces

Wiring in ducts, plenums, or hollow spaces that are used to transport or move air as part of an environmental air system must be totally enclosed in a metallic raceway or have a metallic outer sheath or armor.

However, cables in Class 2 circuits that are approved (Listed) per UL 910 as having adequate fire-resistant and low-smoke-producing properties are acceptable in plenums.

Wiring under Raised Floors

Interconnecting cables associated with data processing equipment are permitted under a raised floor provided:

- 1 The raised floor is of suitable construction.
- 2 Ventilation in the underfloor area is used for the data processing equipment and data processing area only.
- 3 The cable is spaced at least 2 inches (50 millimeters) from any communications cables.

Grounding

All exposed noncurrent-carrying metal parts must be grounded in accordance with Article 250 of the NEC and Section 10 of the CEC.

Separation from Electric Light, Power, and Class 1 Conductors

Class 2 cables must be separated by at least 2 inches (50 millimeters) from conductors of any electric light, power, or Class 1 circuits.

Vertical Runs (Shafts or Partitions)

Class 2 cables in a vertical run must have a fire-resistant covering that will prevent the carrying of fire from floor to floor.

Circuits Extending Beyond One Building

Class 2 circuits that extend beyond one building must comply with the following requirements:

- 1 Class 2 cables that run aerial from one building to another must consist of an arrestor connected between each line conductor and ground.
- 2 Class 2 circuits must be separated from the following circuits by the distances indicated:
 - At least 2 inches (50 millimeters) from conductors of any electric light or power circuits or Class 1 circuits
 - At least 7 feet (2 meters) from lightning conductors
 - At least 8 feet (2.5 meters) above any roof that may be readily walked upon.
- 3 Holes in outer walls or roofs of buildings must be filled to prevent infiltration of moisture.
- 4 Cables must not be carried over buildings without special permission, and work must not be begun until approved by the local inspector or building authority.

Lightning Surge Protectors

In addition to any industry or government standards that you must meet, you should provide lightning protection for any cluster circuit that runs outside. The devices used to provide this protection are called *lightning surge protectors*. Lightning surge protectors minimize damage to the system from voltage surges caused by lightning. Lightning surge protectors will not withstand a direct lightning strike, nor will they withstand most nearby lightning strikes. Lightning surge protectors must be installed on each end of all outdoor cable runs. For one outdoor cable run, two lightning surge protectors are required.

Lightning surge protectors used with Burroughs B 20 or B 25 equipment must have the following characteristics:

Mutual capacitance (maximum)	4 picoFarads
Series resistance (maximum)	2 Ohms
Output clamp voltage	25 volts
Response Time (maximum)	10 nanoseconds
Current handling capacity	5000 amperes for 10 microseconds

A kit of suitable lightning surge protectors is available from Fischer Custom Communications, part number 55-8474-094. This device consists of two low-voltage devices, part number FCC 550-10-4-D9LV, and one high-voltage device, part number FCC 550-10-4-D9HV.

For additional information, call or write:

Fischer Custom Communications
Box 581
Manhattan Beach, California 90266
USA
Telephone (213) 642-0049

This surge protector is not currently available directly from Burroughs.

Circuits Extending Across the Floor

Cables run on the surface of the floor must be protected against mechanical damage and must not be run across walkways.

Cable and Cable Assembly Safety Requirements

United States and Canada: The cable intended for plenum use must be UL Listed to UL Standard UL 910 as having adequate fire-resistant and low-smoke-producing properties.

International: The cable must comply with IEC 227 or 245 and must not be lighter than ordinary tough rubber-sheathed flexible cord designation 245 IEC 53 or ordinary polyvinyl-chloride-sheathed flexible cord designation 227 IEC 53.

Ground Potential Differences

Ground potential differences among buildings or different areas of a single building and induced voltage on the shield of a cable can be safety hazards, can cause erratic system operation, and can damage the system.

Warning: Do not conduct the following test when there is lightning activity.

Determine if such a condition exists by connecting a voltmeter between the shield of the cable being tested and the ground terminal of the power outlet.

Note: The ground potential difference must not exceed 1 volt RMS.

Cluster Configurations

This section discusses the interconnection of workstations and cluster master workstations for the Burroughs B 20 and B 25 systems families and for the XE 520 when it is used as a cluster master.

Be sure you have read Sections 1 and 2 of this guide before planning or starting the cluster installation.

Cluster Connections

Daisy-chain Connection

In the daisy-chain cluster arrangement, each workstation is connected to the workstation on either side. The workstation at each end of the daisy-chain must have a terminator installed on the unused connector. The master workstation for the cluster is connected as though it were one of the workstations. This arrangement is shown in Figures 3-1 and 3-2.

Figure 3-1 Daisy-Chain Cluster (Master at Center of Cluster)

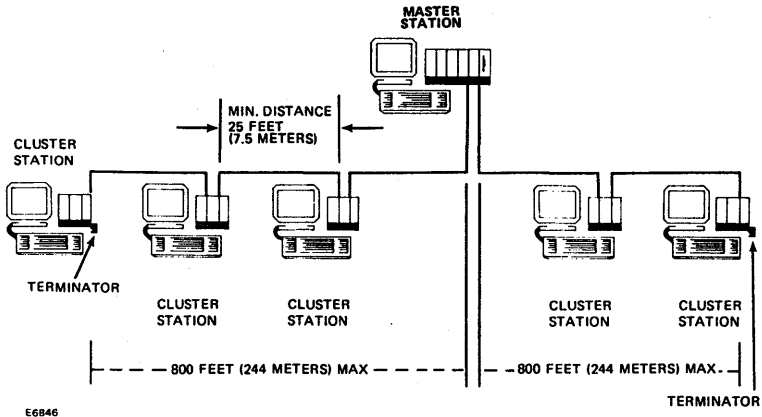

E6846

Figure 3-2 Daisy-Chain Cluster (Master at End of Cluster)

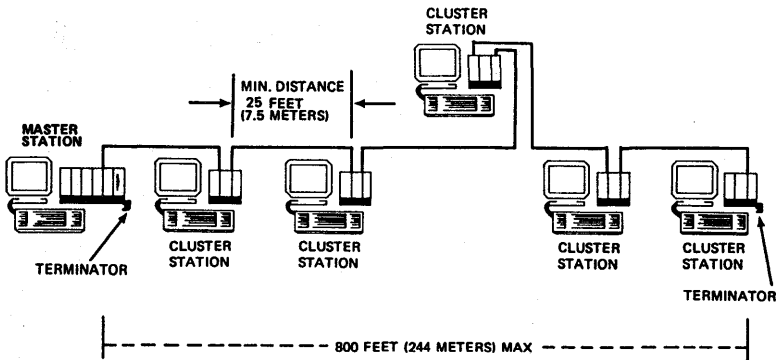

E6847

Spur Connection

In the spur cluster arrangement, each workstation is connected to the main cluster cable through a cluster connection box, as shown in Figures 3-3 and 3-4. The cable that connects the cluster connector boxes to each other is the main trunk. Each cluster connector box is connected to a workstation by a spur cable. The spur cable is a maximum of 10 feet long.

Figure 3-3 Spur Cluster (Master at Center of Cluster)

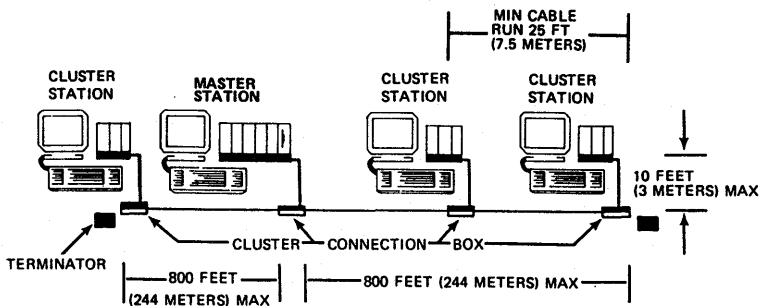

E6848

Figure 3-4 Spur Cluster (Master at End of Cluster)

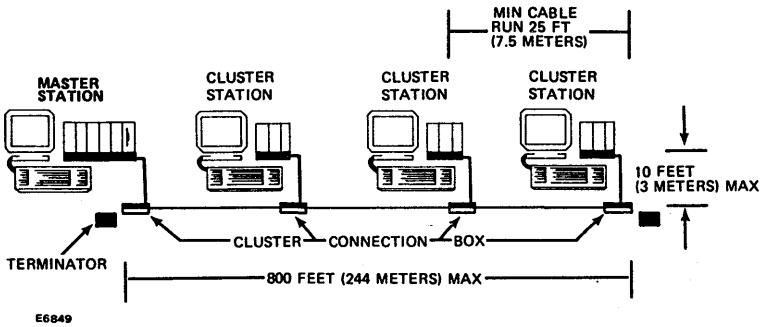

Cluster Connector Boxes

Burroughs does not manufacture cluster connector boxes. If used, they may be manufactured locally and must have the following characteristics:

- 1 Interconnections within the box must be a point contact.
- 2 The box must be a complete shield (all metal).
- 3 A means must be provided to connect cable shields to the inside of the cluster connector box.
- 4 The connection from the cable shield to the box must be as short as possible, and in no case must it exceed 0.5 inch (1.2 cm).
- 5 Cables connected to the box must have strain relief.
- 6 Pin 1 of the connectors must be connected to the connector housing and ground for both the cables and the cluster connector boxes.
- 7 The boxes must adhere to local ordinances.

Maximum Cluster Cable Length

For daisy-chain clusters communicating at either 307.2 Kb/sec (clusters with at least one B 20 workstation) or 1.8 Mb/sec (clusters with no B 20 workstation), the maximum distance from the cluster master to the last workstation on the daisy-chain is 800 feet (244 meters)(See Figures 3-1 and 3-2). That is, if the cluster master is at one end of the daisy-chain, the chain cannot exceed 800 feet. However, if the cluster master is located at the middle of the daisy-chain, the daisy-chain may be 1,600 feet (488 meters) from end to end without violating the restrictions on cluster cable length, since no station would be more than 800 feet from the cluster master.

For clusters using the spur arrangement, the maximum cable length from the master to the most distant station on the cluster is 800 feet. This means that the longest spur cluster is one with the cluster master located at the middle of the cluster, which permits a maximum cluster length of 1,600 feet from end to end.

Minimum Cluster Cable Length

The recommended minimum length of cluster cable between workstations in a cluster is 25 feet (7.5 meters). In a spur cluster arrangement, this means a minimum of 5 feet (1.5 meters) between cluster connector boxes if the maximum length (10-foot) spur cables are used.

Mixed Clusters

A mixed cluster has a B 20 workstation or cluster master and a B 25 workstation or cluster master.

All new systems should be wired using cluster cable specified for B 25 (1.8 Mb/sec) clusters. B 20 clusters that are expanded with the addition of B 25 workstations will already be cabled for 307.2 Kb/sec operation. However, the new stations should be cabled for 1.8 Mb/sec operation. This results in a mixed system. The B 20 workstations will work well with the cable specified for 1.8 Mb/sec (high-speed) operation, but the B 25 workstations do not work with the cable specified for 307.2 Kb/sec (low-speed) operation. If cable specified for low-speed operation in a mixed system is damaged, replace it with cable specified for high-speed operation.

Connectors

Cluster cables are fitted with two types of connectors: those with straight hoods and those with right-angle hoods. Both types are wired the same way, however, only right-angle hoods permit equipment covers to be closed on all B 20, B 25 and B 27 systems. Straight hoods may be used on B 20 and B 25 systems, but use of the straight-hood connector on B 27 systems does not permit the equipment cover to be closed.

Standard Products

Cluster cables are provided in 50-foot lengths with 9-pin D connectors attached. For installations where the use of standard-length cables is not desirable, a connector kit is provided. The installer must obtain the required cable in bulk quantities and attach the connectors. In addition, a 12-inch adapter cable is available for connecting two 50-foot cables.

Figure 3-5 Cluster Cable Assemblies

Description	Catalog No.	Style No.	Part No.
50 feet (15 meters), gray jacket, straight hood (cannot be used with B 27)	3668 1104	PC 051	3624 8276

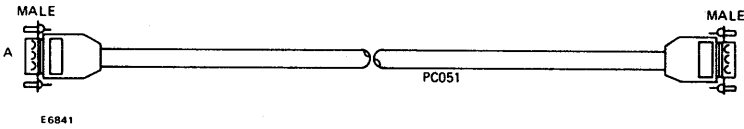

12 inches (30 cm), gray jacket, straight hood, used to join two 50-foot cables (can be used to join PC 051 to PC 053)	3719 4917	PX 051	3626 5841
---	-----------	--------	-----------

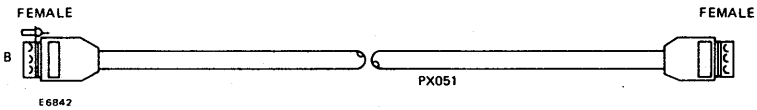

50 feet (15 meters), tan value #2 jacket, right-angle hood (can be used with all B 2x models)	3719 4891	PC 053	3396 3489
---	-----------	--------	-----------

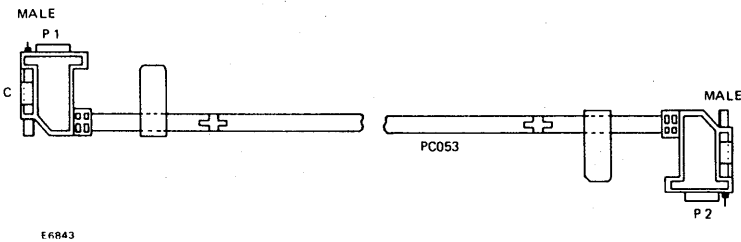

Table 3-1 Custom Cluster Cable Assembly Kits

System	Part No.	Kit Description
All except B 27	3675 2590 Style No. PC 051 CK	Kit is composed of the following: 3675 2582 - connector kit that includes all parts needed to terminate both ends of the cluster cable (vendor: Tex-Techs Int. Inc., Dallas, TX vendor part number PHGR-A1 (2 per kit)) 3675 2947 - two cable identification labels Bulk cable (length as ordered) indoor (nonplenum): 3675 1311 gray jacket indoor (plenum): 3396 5575 outdoor: 3396 5567
All including B 27	3394 9819	Kit is composed of the following: 2383 0946 10 crimp pins, AMP 66682-2 2639 1854 two identification labels 3387 9750 two 9-pin D connectors AMP number 205-204-4 TRW number 234-09-14-120 Amphenol number 17-92090-18(439) 3396 5997 two connector covers Northern Technologies number C88201000 3396 6987 visual aid drawing Bulk cable (length and type as ordered) indoor (nonplenum): 3394 3796 (tan value #2 jacket) indoor (plenum): 3396 5575 outdoor: 3396 5567

See Table 3-2 for bulk cable descriptions and vendor information.

Table 3-2 Bulk Cluster Cable

Part No. and Use	Description
3675 1311	Indoor (nonplenum) Four 24 AWG conductors (2 twisted pairs) plus drain Aluminized polyester/tinned copper braid shield Outer jacket: PVC, gray Impedance: 100 ohms Mutual capacitance: 15.5 pF/ft Outside diameter of cable: .295 in. Vendor and vendor's part number: Belden 9829
Indoor (nonplenum) 3394 3796	Four 24 AWG conductors (2 twisted pairs) plus drain Aluminized polyester/tinned copper braid shield Outer jacket: PVC, tan value #2 Impedance: 100 ohms Mutual capacitance: 15.5 pF/ft. Outside diameter of cable: .295 in. Vendor and vendor's part number: Madison 04QF18BTIA
<i>Note: 3675 1311 and 3394 3796 are functionally identical. The only difference is the color of the outer jacket.</i>	
3396 5575	Indoor (plenum) Four 24 AWG conductors (2 twisted pairs) plus drain Aluminized polyester/tinned copper braid shield Outer jacket: FEP Teflon Impedance: 100 ohms Mutual capacitance: 15.5 pF/ft. Outside diameter of cable: .220 in. Vendor and vendor's part number: Berk-Tek 1-BTPL-24-7-2SB-TT
3396 5567	Outdoor Four 24 AWG conductors (2 twisted pairs) plus drain Aluminized polyester/tinned copper braid shield Outer jacket: Sunlight resistant, outdoor PVC Impedance: 100 ohms Mutual capacitance: 15.5 pF/ft. Outside diameter of cable: .270 in. Vendor and vendor's part number: Berk-Tek 1-BTPE8M-732-1H-2DSB

Figure 3-6 Cluster Adapter Cable

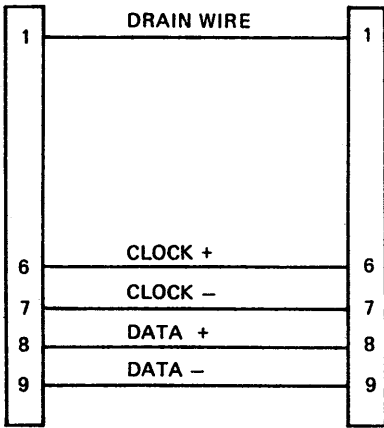

E6853

Description	Catalog No.	Style No.	Part No.
Adapter cable (4 feet), B 27 to B 25	3719 4909	PX 053	3396 3794

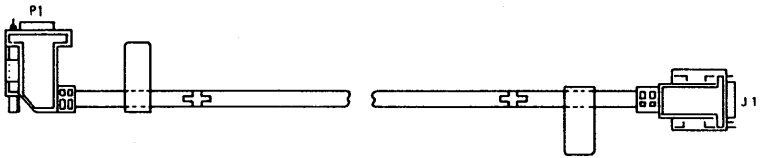
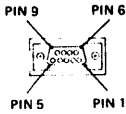

E6844

Figure 3-7 Cluster Terminators

System	Catalog No.	Style No.	Part No.
B 25	3668 1096	PT 101	3675 2376
B 27	3719 4925	PT 103	3394 9520
XE 520	3668 1096	PT 101	3675 2376

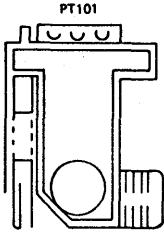

NOTE: This wiring diagram applies to both the B25 and B27 Terminators.

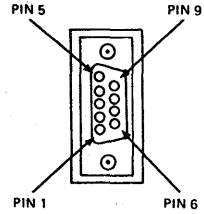
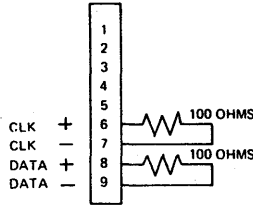

Local Area Network Configurations (B-LAN)

Be sure you read and understood Sections 1 and 2 of this guide before planning or installing your local area network.

This first part of this section describes the cabling requirements for the interconnection of devices on the Burroughs Local Area Network (B-LAN).

Figure 4-1 Burroughs Local Area Network (B-LAN) (Simple Network)

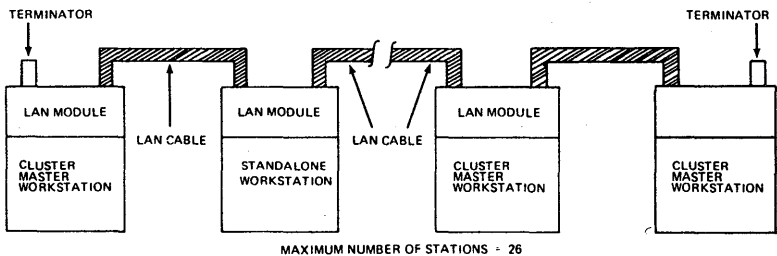

E 6855

Each logical connection point within a local area network is called a *node* (see Figure 4-1). Each node on the network contains a cluster master station or a standalone workstation and requires a LAN module, and is called a *terminal node*. LAN modules fit between the B-LAN cable system and the workstation or cluster master workstation associated with each node. *Repeaters* are non-terminal nodes used to expand the network.

Maximum B-LAN Network Size (Simple Network)

A simple B-LAN network without repeaters cannot exceed 607 feet (185 meters) between the terminators at each end (see Figure 4-2). Failure to observe the maximum network length causes improper operation of the network.

The number of nodes on the simple B-LAN network cannot exceed 26 (Figure 4-1). Connecting more than 26 nodes to the simple B-LAN network causes improper operation.

Figure 4-2 Maximum B-LAN Length (Simple Network)

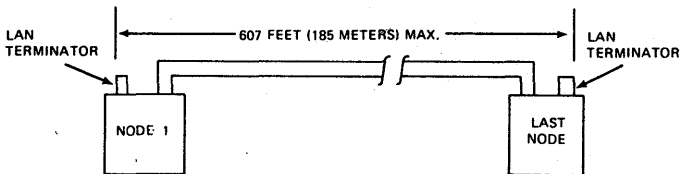

E0857

Expanding the B-LAN

If you require more than 26 nodes on your network, you must use *repeaters* to connect simple networks together to form an expanded network. The repeaters provide signal amplification and retiming.

Each repeater has two sides: *A* and *B*. The two connectors labeled with the same letter are wired together inside the repeater and have DC continuity. To pass through the repeater, the signal must pass from one side to the other (*A* to *B*, or *B* to *A*).

In counting the number of nodes on the network, each repeater counts as one node. For the purpose of counting the number of repeaters along the signal path, the repeater counts as a repeater only when the signal passes from side *A* of the repeater to side *B*, or from *B* to *A*. Otherwise, the repeater counts only as a node when the signal passes from connector *A* to *A* or *B* to *B*.

Once repeaters are used, two kinds of connections become possible: *links* and *segments*. A link is a connection between two repeaters that has no other nodes. Links are used only to increase the physical length of the network. Links are not used to add user-addressable (terminal) nodes to the network. Links are used to connect segments together when the segments must be far apart.

Segments have one or more terminal nodes. These arrangements are shown in Figures 4-3 through 4-8. In designing the system, take care that no more than four repeaters are between any two terminal nodes that communicate with each other. If more than two repeaters separate two terminal nodes, links should be used to connect the segments containing the terminal nodes.

Figure 4-3 Expanded Network (Two Segments Connected by a Repeater)

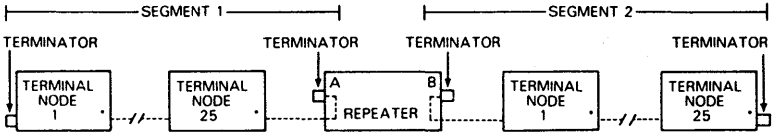

(*STANDALONE WORKSTATION OR CLUSTER MASTER)

Figure 4-4. Expanded Network (Two Segments Connected by a Repeater — repeater in center of second segment)

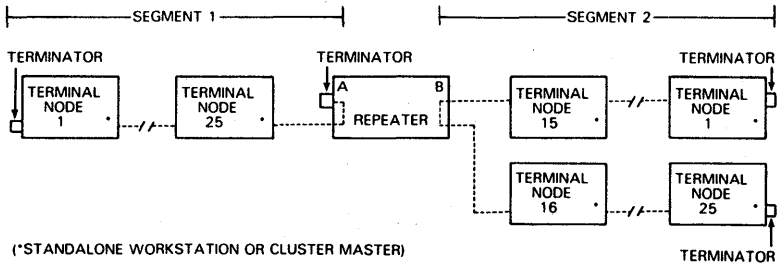

E7476

Figure 4-5 Two Segments Connected by a Link

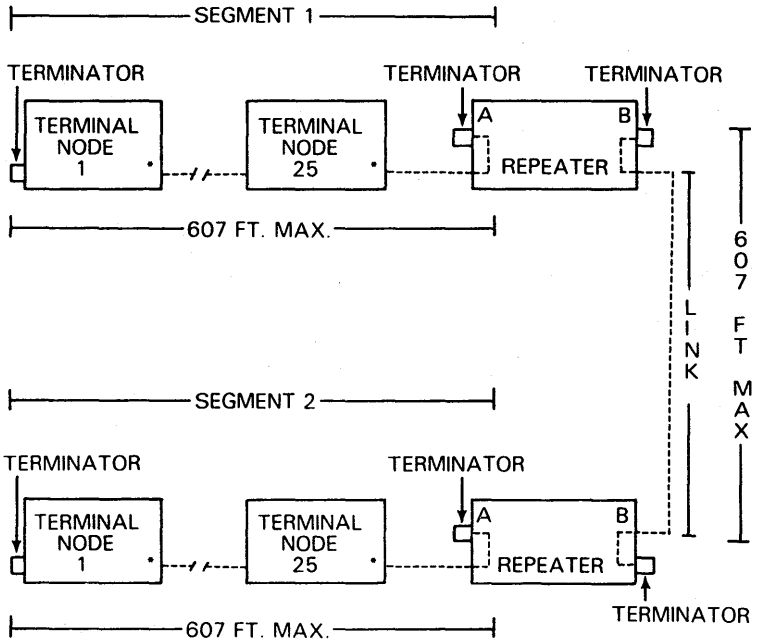

(*STANDALONE WORKSTATION OR CLUSTER MASTER)

E 7477

Figure 4-6 Three Segments Connected by Two Links

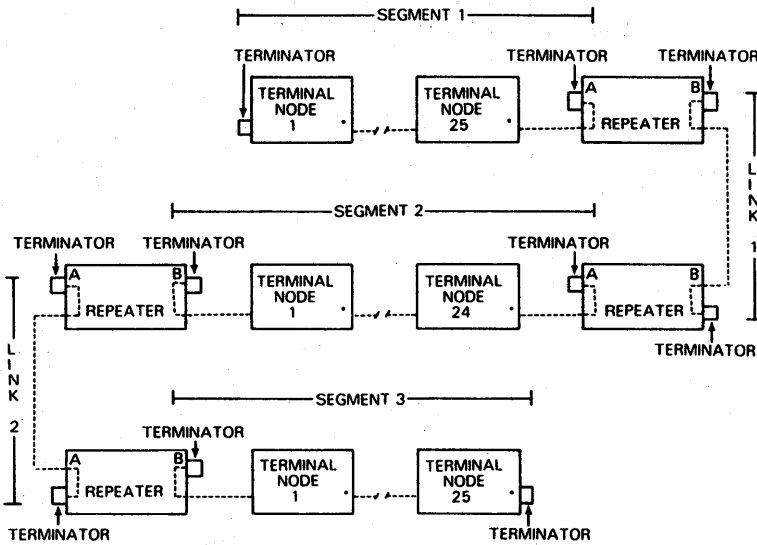

(*STANDALONE WORKSTATION OR CLUSTER MASTER)

THIS ARRANGEMENT USES THE MAXIMUM 4 REPEATERS BETWEEN ANY TWO STATIONS AND PERMITS 74 STATIONS.

Figure 4-7 Maximum Network: A Segment of 26 Repeaters Connecting 26 Segments of 25 Workstations Each. (650 Workstations on the Network)

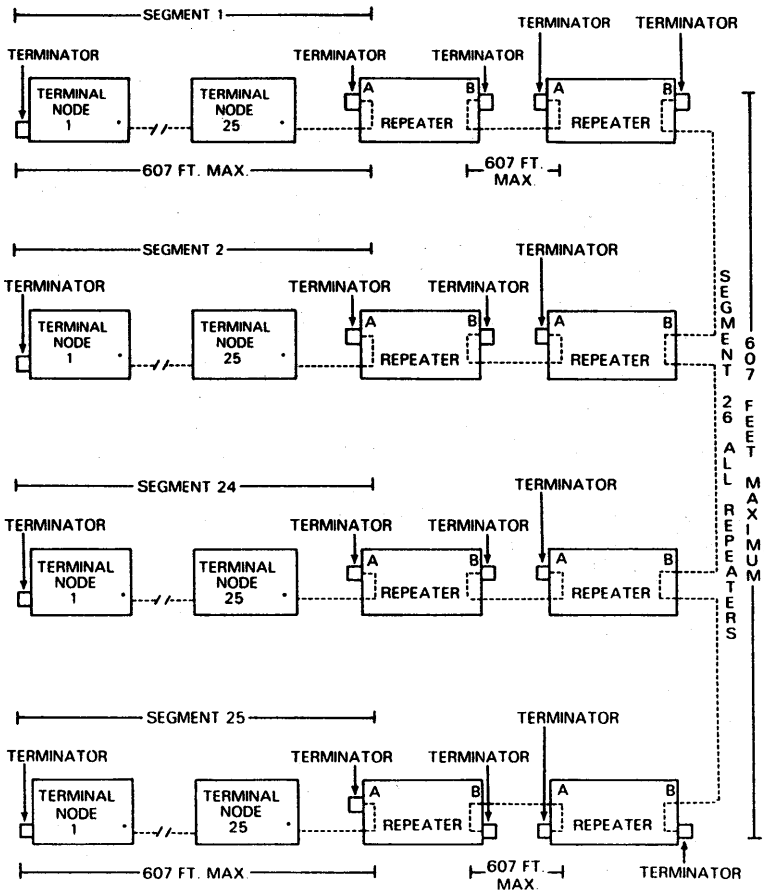

(STANDALONE WORKSTATION OR CLUSTER MASTER)

NO MORE THAN 4 REPEATERS STAND BETWEEN ANY 2 WORKSTATIONS. IF MORE THAN 2 REPEATERS STAND BETWEEN 2 WORKSTATIONS, A LINK IS EMPLOYED. THE MAXIMUM DISTANCE BETWEEN ANY 2 WORKSTATIONS IS 3035 FEET (925 METERS).

17479

Minimum Distance Between Nodes

The minimum distance between nodes is 20 inches (1/2 meter) (See Figure 4-8). Failure to observe the minimum separation between nodes causes improper operation of the network.

Figure 4-8 Minimum Node Separation

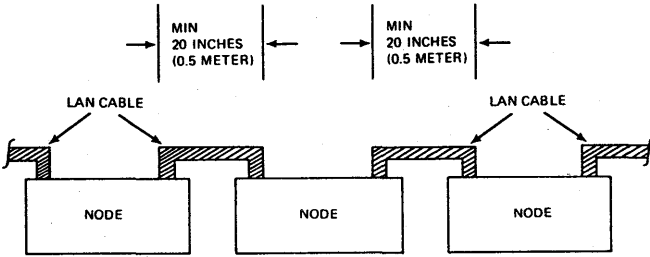

EG858

Standard Network Cable (Node Interconnecting Cable)

A triaxial cable connects the nodes in the Burroughs Local Area Network.

Figure 4-9 Triaxial Cable

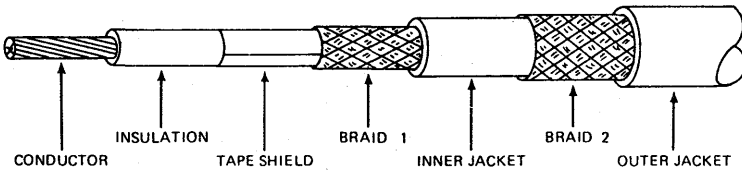

LAN cable with triaxial connectors attached is available in standard 30-foot lengths.

Figure 4-10 B-LAN Cable Assembly

System	Style No.	Catalog No.	Part No.
All	XC 782	3767 1211	3677 4925

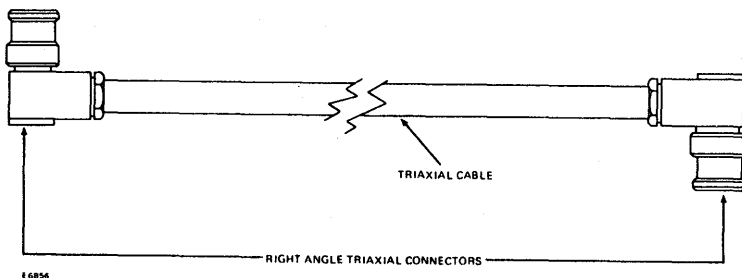

Custom Network Cable (Node Interconnecting Cable)

For installations where standard 30-foot lengths of cable are inappropriate, a kit (described in Table 4-1) is available that contains triaxial connectors and a customer-selected length of cable. Each kit contains all material necessary to make one cable.

Table 4-1 Custom Triaxial Cable Kits

Catalog No.	Style No.	Part No.	Description
3767 1245	XC 785	3396 6037	Plenum Cable Kit - cable length as ordered
3767 1203	XC 781	3677 4933	General Use Cable Kit - cable length as ordered

Figure 4-11 Triaxial Connector Supplied with Custom Kits

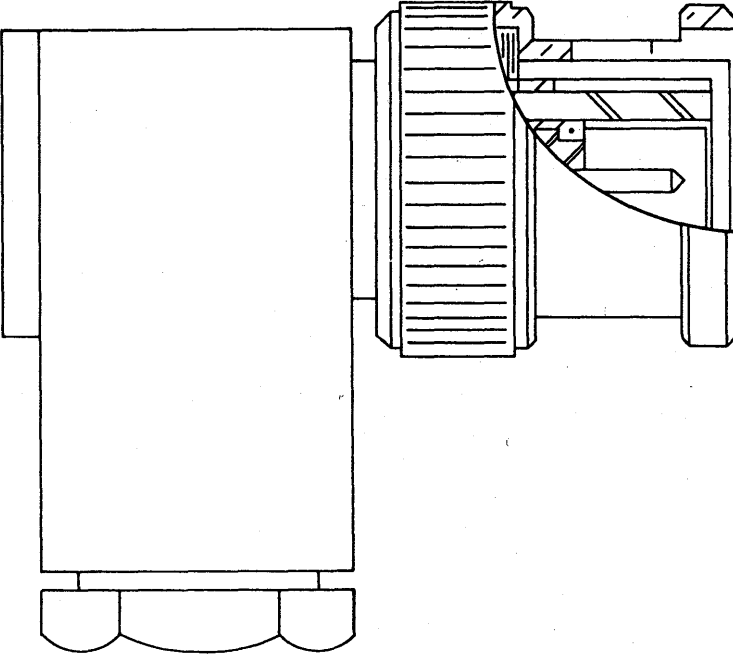

E6852

LAN Module Connections

Each LAN module has two triaxial chassis connectors (see Figure 4-12). The LAN module at each end of the network must have a 50-ohm triaxial terminator (see Figure 4-13) connected to the unused chassis connector.

Figure 4-12 LAN Module Connections

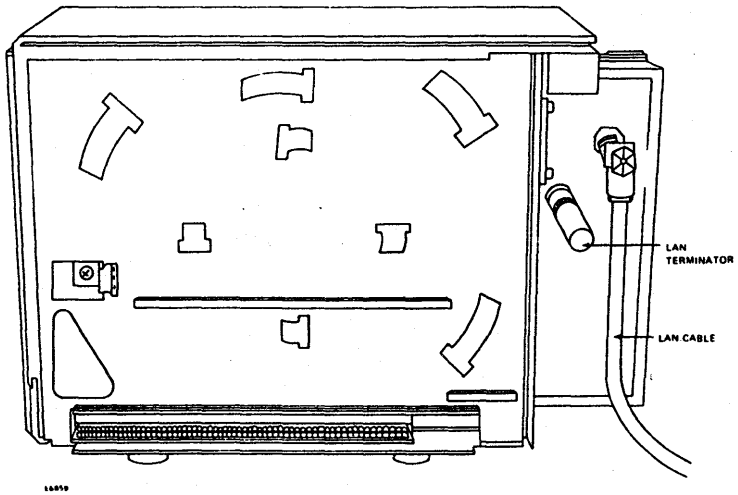
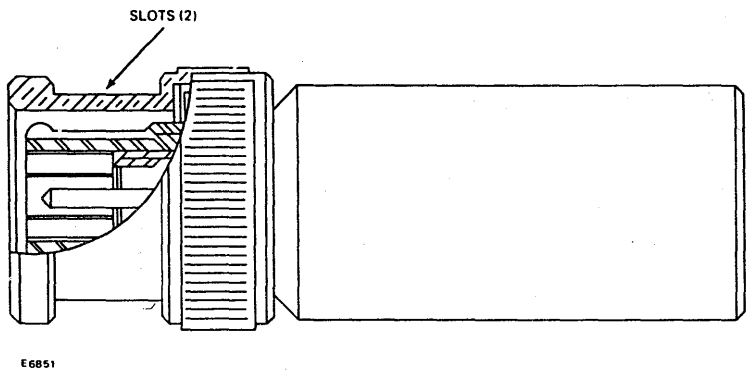

Figure 4-13 B-LAN Terminator

System	Style No.	Catalog No.	Part No.	Remarks
All	XC 783	3267 1229	3677 4974	Kit



Install B-LAN cable in accordance with the precautions given in Sections 1 and 2.

Triaxial double-female BNC "barrel" connector adapters (see Figure 4-14) are available for connecting two B-LAN cables.

Figure 4-14 Triaxial "Barrel" Connector Adapter

System	Style No.	Catalog No.	Part No.	Remarks
All	XC 784	3767 1237	3677 4982	Adapter Kit 2 LUG TYPICAL

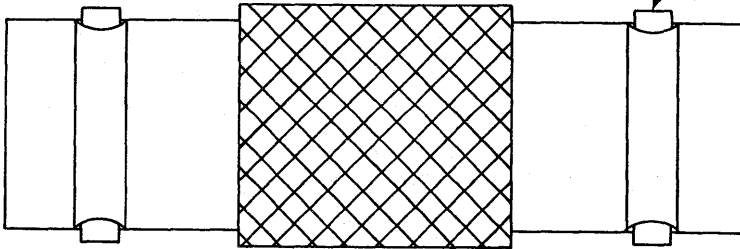

E6850

Table 4-2 Bulk Triaxial Cable

Use	Burroughs Part No.
Indoor (nonplenum)	3396 5799
Indoor (plenum)	3396 5971
Outdoor	System is not rated for outdoor use

B-LAN Repeater Connections

B-LAN Repeater connections are shown in Figure 4-15. Whenever a terminator is used on the repeater, a right-angle triaxial adapter must be used between the chassis connector and the terminator to allow the repeater cover to close properly.

Figure 4-15 B-LAN Repeater Connections

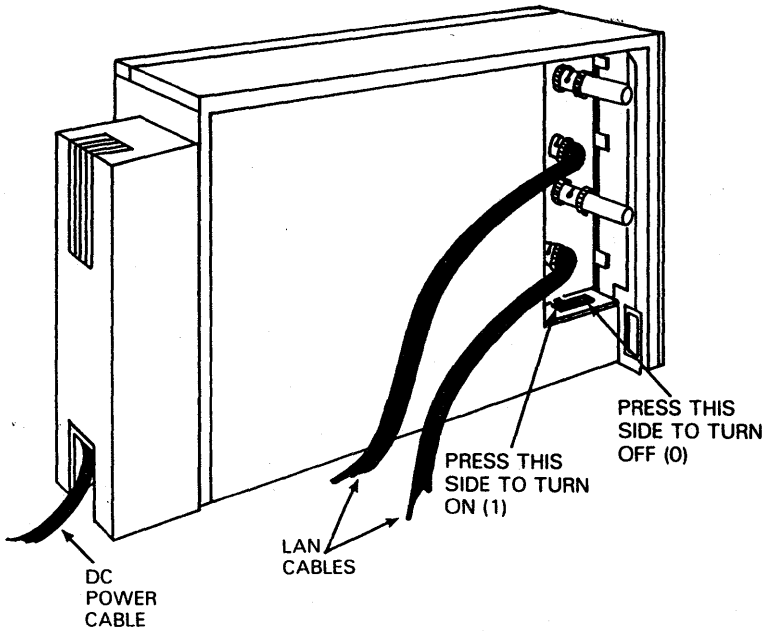

E7459

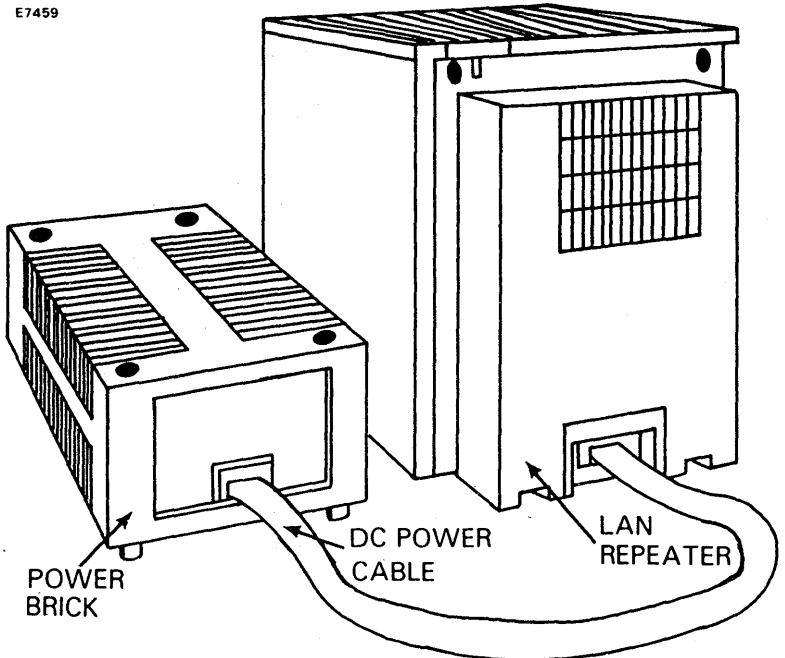

E7458

PRINTER CONFIGURATIONS

Printer connections are of two general types: *serial* and *parallel*. These types refer to both the physical connection method and the manner in which data is transferred from the host device to the printer. While some printers provide connections for both serial and parallel cables, the connectors are separate, or else a module is provided to change the data and connections from one method to another. Refer to the manual for the printer for specific connection information.

The tables in this section show which cables may be used to connect various terminals, workstations and cluster masters to a variety of printers. Figures show the approximate appearance of the cable and include wiring diagrams necessary for continuity testing.

Order cables by style number. Catalog numbers are provided as a useful cross-reference. The part number is provided to aid in cable identification, since this number is affixed to each cable manufactured by Burroughs.

Table 5-1 Data Cable for AP 1302 and AP 1303 Letter-Quality Serial Printers

Host	Length	Part No.	Style No.	Catalog No.
B 20	10 ft.	3396 7514	XC 680-1	3719 4727

Table 5-2 Serial Data Cables for the AP 1305 Printer

Host	Length/ Type	Part No.	Style No.	Catalog No.
B 20 XE 500	25 ft. serial	3386 0305	XC 692	3668 4892
B 20 XE 500	10 ft. serial	3386 0297	XC 693	3668 4900
B 25 B 27	10 ft. serial extension	3386 3317	XC 691-1	3719 6763
ET 2000 T 27	10 ft. serial extension	3386 0263	XC 694	3668 4918
ET 2000 T 27	25 ft. serial extension	3386 0271	XC 695	3668 6693

Table 5-3 Data Cables for the AP 1311 Printer

Host	Length/ Type	Part No.	Style No.	Catalog No.
B 20 XE 500	10 ft. parallel	3385 7251	XC 687-1	3681 7112
B 20 XE 500	25 ft. parallel	3384 9091	XC 687-2	3681 7120
B 25 B 27	10 ft. parallel	3385 7871	XC 687-4	3719 6755
ET 2000 T 27	10 ft. serial	3385 7269	XC 690-1	3683 6824
ET 2000 T 27	25 ft. serial	3385 7277	XC 690-2	3682 6832
ET 2000 T 27	50 ft. serial	3385 7285	XC 690-3	3682 6840

Table 5-4 Data Cables for AP 1312 Printer

Host	Length	Part No.	Style No.	Catalog No.
T 27	10 ft.	3390 7007	XC 679	3684 0031
T 27	15 ft.	3390 7015	XC 701	3628 9148
T 27	25 ft.	3390 7023	XC 702	3628 9155
T 27	50 ft.	3390 7031	XC 703	3628 9163

Table 5-5 Data Cables for the AP 1314 Printer

Host	Length/ Type	Part No.	Style No.	Catalog No.
B 20	10 ft. parallel, straight hood	3384 1925	XC 689-2	3635 0981
B 20 XE 500	10 ft. serial	3528 7663	XC 697-5	3720 4187
B 25 B 27 B 28	10 ft. parallel rt. angle hood	3528 0189	XC 689-6	3720 4179
XE 500	25 ft. parallel straight hood	3384 1933	CB 756	3684 0007
ET Series	10 ft. serial	3390 7007	XC 697-1	3695 0855
ET Series	25 ft. serial	3390 7023	XC 697-3	3695 0871
ET Series	50 ft. serial	3390 7031	XC 697-4	3695 0889
XE 500	25 ft. serial	3528 7671	XC 697-6	3720 4195

Table 5-6 Data Cables for the AP 1351 Printer

Host	Length/ Type	Part No.	Style No.	Catalog No.
B 20 XE 500	10 ft. parallel	3385 7251	XC 687-1	3681 7112
B 25 B 27	10 ft. parallel	3385 7871	XC 687-4	3719 6755
ET 2000 T 27	10 ft. serial	3385 7269	XC 690-1	3683 6824
ET 2000 T 27	10 ft. serial	3385 7277	XC 690-2	3682 6832
ET 2000 T 27	10 ft. serial	3385 7285	XC 690-3	3682 6840
ET 1100	10 ft. serial	3385 7426	XC 688-1	3681 8482
ET 1100	25 ft. serial	3385 7434	XC 688-2	3681 8490
ET 1100	50 ft. serial	3385 7442	XC 688-3	3681 8508
B 20 XE 500	25 ft. parallel	3384 1909	XC 687-2	3681 7120

Table 5-7 Data Cables for the 1351-1 Printer

Host	Length/ Type	Part No.	Style No.	Catalog No.
B 25 B 27	10 ft. parallel	3385 7871	XC 687-4	3719 6755
T 27	10 ft. serial	3385 7269	XC 690-1	3683 6824
T 27	10 ft. serial	3385 7277	XC 690-2	3682 6832
T 27	10 ft. serial	3385 7285	XC 690-3	3682 6840

Table 5-8 Data Cables for the AP 1354 Printer

Host	Length/ Type	Part No.	Style No.	Catalog No.
B 20 XE 500	10 ft. serial	3528 7663	XC 697-5	3720 4187
B 20	10 ft. parallel, straight hood	3384 1925	XC 689-2	3635 0981
B 25 B 27	10 ft. parallel	3528 0189	XC 689-6	3720 4179
ET Series	10 ft. serial	3390 7007	XC 697-1	3695 0855
ET Series	25 ft. serial	3390 7023	XC 697-3	3695 0871
ET Series	50 ft. serial	3390 7031	XC 697-4	3695 0889
XE 500	25 ft. parallel straight hood	3384 1933	CB 756	3684 0007
XE 500	25 ft. serial	3528 7671	XC 697-6	3720 4195

Table 5-9 Data Cables for the AP 9208 Printer

Host	Length	Part No. Type	Style No.	Catalog No.
B 20	10 ft. parallel	3384 1925	XC 689-2	3635 0981
B 20	10 ft. serial	3528 7663	XC 697-5	3720 4178
B 25 B 27	10 ft. parallel	3528 0189	XC 689-6	3720 4179
B 25 B 27	10 ft. serial	3528 7630	XC 697-7	3720 4203
ET Series	10 ft. serial	3390 7007	XC 697-1	3695 0855
XE 500	25 ft. parallel	3384 1933	CB 756	3684 0007
XE 500	25 ft. serial	3528 7671	XC 697-6	3720 4195

Table 5-10 Data Cables for the B9251-1 Printer

Host	Length/ Type	Part No.	Style No.	Catalog No.
B 25 B 27	10 ft. parallel	3396 3471	XC 696-1	3719 5112

Table 5-11 Data Cables for the B9252 Printer

Host Type	Length/ Type	Part No.	Style No.	Catalog No.
B 25 B 27	10 ft. parallel	3396 3471	XC 696-1	3719 5112

Table 5-12 Data Cables for the B9253 Printer

Host	Length/ Type	Part No.	Style No.	Catalog No.
B 25	10 ft.	3396 3471	XC 696-1	3719 5112
B 27	parallel			

Figure 5-1 Serial Printer Cables 3396 7514, 3396 7522

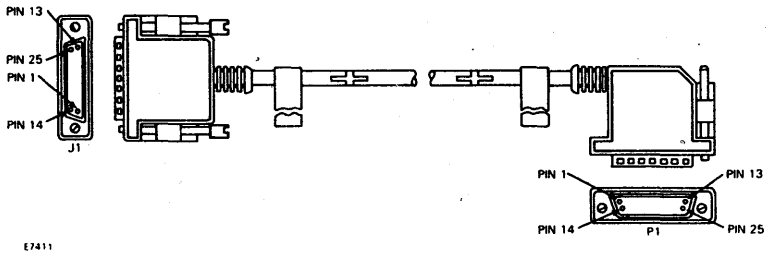

Figure 5-2 Serial Printer Cables 3384 1925, 3384 1933, 3384 1941

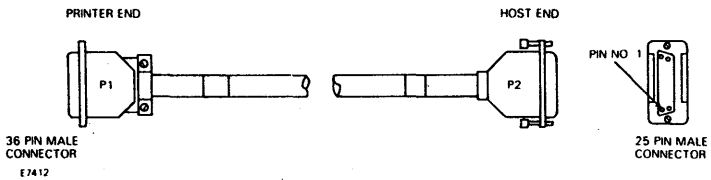
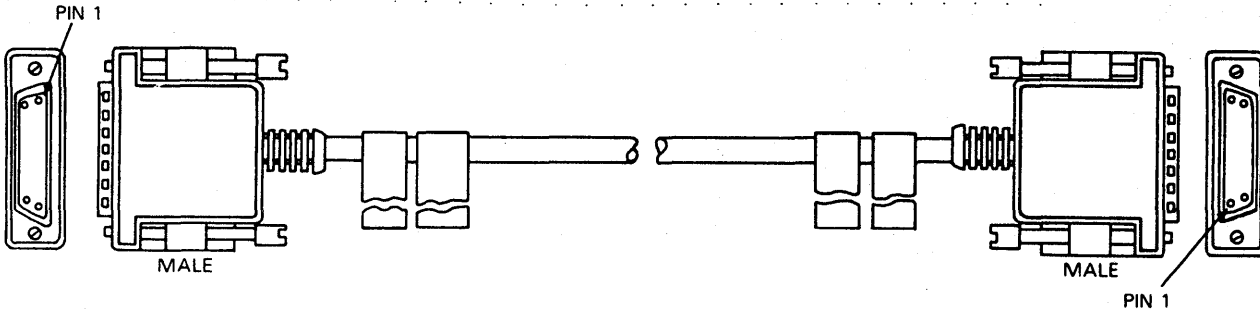

Figure 5-3 Serial Printer Cables 3390 7007, 3390 7015, 3390 7023, 390 7031



P1 Pin	P2 Pin	P1 Pin	P2 Pin
1	1	14	14
2	2	15	15
3	3	16	16
4	4	17	17
5	5	18	18
6	6	19	19
7	7	20	20
8	8	21	21
9	9	22	22
10	10	23	23
11	11	24	24
12	12	25	25
13	13		

E7421

Modem Cable Assemblies

The cable assemblies described in this section are used to connect computers to telecommunications devices, or directly to other computers or terminals via the port normally allocated to telecommunications devices. Computers and terminals are called *Data Terminal Equipment* (DTE) and the telecommunications devices are called *Data Communications Equipment* (DCE). The Data Communications Equipment described in this section is the *modem*. Modem is an acronym for modulator/demodulator, a description of the function performed by the modem.

If two data terminal equipments are to be connected directly together without the use of modems, a special cable, called a *null modem* must be used. A null modem has certain wires cross-connected so that the necessary control signals normally provided by the modem are provided instead by the data terminal equipment.

Bell[®] modem cables are designed to be used with modems that meet the standards of the telephone companies in the United States of America. GPO modem cables are designed to be used with modems that meet British General Post Office standards. SEL modem cables are designed to be used with modems that meet Swiss standards.

Figure 6-1 Bell © Modem Cable Assemblies

Host	Length	Part No.	Style No.	Catalog No.
B 25 B 27	15 ft.	3396 3778	XC 725	3719 4958
B 25 B 27	50 ft.	3396 3729	XC 729	3719 4974
T 27	5 ft.	3387 5667	XC 305	3545 5526
T 27	10 ft.	3387 5659	XC 310	3545 5518
T 27	15 ft.	3387 5642	XC 315	3545 5500
T 27	25 ft.	3387 5634	XC 325	3545 5492
T 27	50 ft.	3387 5626	XC 350	3545 5484
T 27	101 ft.	3387 5618	XC 301	3545 5476

Note: This cable is for T 27 use. The B 25/B 27 cable has a right angle hood on one end.

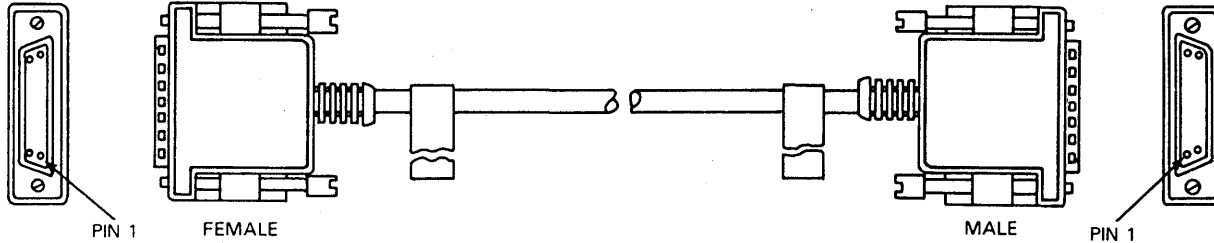

J1 PIN	P1 PIN	REMARKS	J1 PIN	P1 PIN	REMARKS
1	1		14	14	NOT USED
2	2		15	15	
3	3		16	16	NOT USED
4	4		17	17	
5	5		18	18	NOT USED
6	6		19	19	NOT USED
7	7		20	20	
8	8		21	21	NOT USED
9	9	NOT USED	22	22	
10	10	NOT USED	23	23	
11	11		24	24	
12	12	NOT USED	25	25	
13	13	NOT USED			

Figure 6-2 SEL Modem Cable Assemblies

Host	Length	Part No.	Style No.	Catalog No.
T 27	10 ft.	3387 5766	XC 706	3628 9197
T 27	15 ft.	3387 5758	XC 707	3628 9205
T 27	25 ft.	3387 5741	XC 708	3628 9213
T 27	50 ft.	3387 5733	XC 709	3628 9221
T 27	101 ft.	3387 5725	XC 710	3628 9239
B 27	25 ft.	3396 6797	XC 747	3719 5062

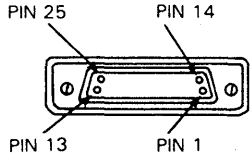

Note: This cable is for B 27 use.

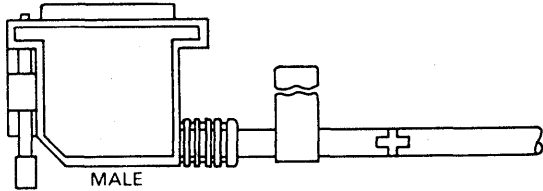

J1 PIN	P1 PIN	REMARKS	J1 PIN	P1 PIN
1	1		14	14
2	2		15	15
3	3		16	16
4	4		17	17
5	5		18	18
6	6		19	19
7	7		20	20
8	8		21	21
9	9	NOT USED	22	22
10	10	NOT USED	23	23
11	11		24	24
12	12	NOT USED	25	25
13	13	NOT USED		

REMARKS

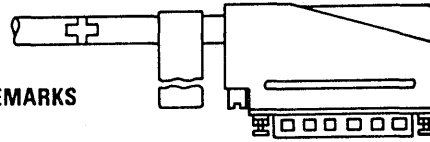

NOT USED

NOT USED

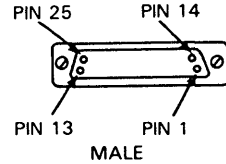

E7426

Figure 6-3 GPO Modem Cable Assemblies

Host	Length	Part No.	Style No.	Catalog No.
T 27	10 ft.	3387 5857	XC 410	3545 5575
T 27	15 ft.	3387 5840	XC 415	3545 5567
T 27	25 ft.	3387 5832	XC 425	3545 5559
T 27	50 ft.	3387 5824	XC 450	3545 5542
T 27	101 ft.	3387 5816	XC 401	3545 5534
B 27	25 ft.	3396 6862	XC 737	3719 5013

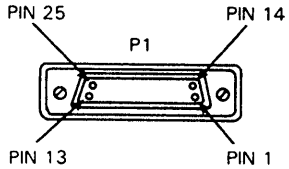

Note: This cable is for the B 27 FSA only.

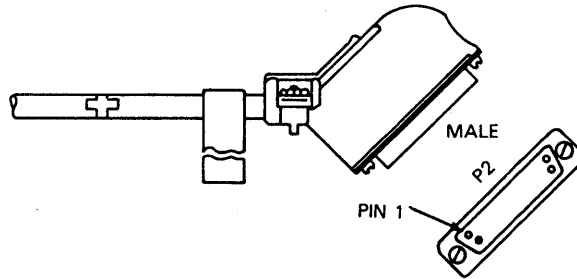
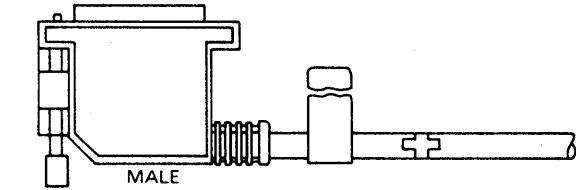

J1 PIN	P1 PIN	REMARKS	J1 PIN	P1 PIN	REMARKS	J1 PIN	P1 PIN	REMARKS
1	1		10	10	NOT USED	18	18	NOT USED
2	2		11	11		19	19	
3	3		12	12	NOT USED	20	20	
4	4		13	13	NOT USED	21	21	NOT USED
5	5		14	14		22	22	
6	6		15	15		23	23	
7	7		16	16		24	24	
8	8		17	17		25	25	
9	9	NOT USED						

E7425

Figure 6-4 RS-232 Cable Assembly, Male to Male, Straight Through Connections

Host	Length	Part No.	Style No.	Catalog No.
B 20	10 ft.	3390 7007	XC 679	3684 0031
	10 ft.	3390 7007	XC 681	3629 2423
B 20	15 ft.	3390 7015	XC 701	3628 9184
	15 ft.	3390 7015	XC 697-2	3682 3490
B 20	25 ft.	3390 7023	XC 702	3628 9155
	25 ft.	3390 7023	XC 697-3	3682 3490
B 20	50 ft.	3390 7031	XC 703	3628 9163
	50 ft.	3390 7031	XC 697-4	3682 3516

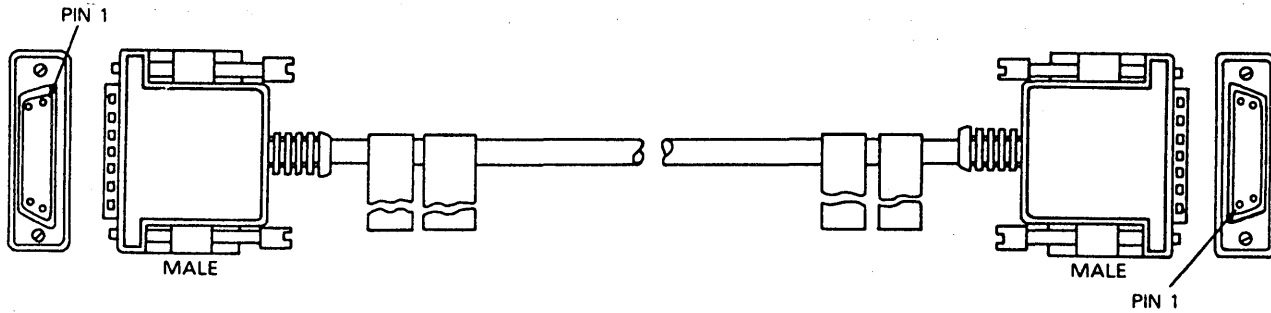

P1 Pin	P2 Pin	P1 Pin	P2 Pin
1	1	14	14
2	2	15	15
3	3	16	16
4	4	17	17
5	5	18	18
6	6	19	19
7	7	20	20
8	8	21	21
9	9	22	22
10	10	23	23
11	11	24	24
12	12	25	25
13	13		

E7421

Table 6-1 **RS-232 Cable Assembly (Null Modem) for B 27**

Host	Length	Part No.	Style No.	Catalog No.
B 27	8 in.	1116 5610	XC 505	2811 7745

Table 6-2 Data Communications Adapter (DCA) Cable Assembly

Host	Length	Part No.	Style No.	Catalog No.
B 20	15 ft.	2907 5785	XC 701	3628 9148
B 20	25 ft.	2907 5793	XC 702	3628 9155
B 20	50 ft.	2907 5801	XC 703	3628 9163
B 20	100 ft.	2907 5827	XC 704	3628 9171

Pinouts

Table A-1 Electronic Industries Association (EIA) Standard RS-232

Pin	Circuit EIA	CCITT	Description	Source
1	AA	101	Frame Ground	---
2	BA	103	Transmitted Data (TXD)	DTE (Terminal)
3	BB	104	Received Data (RXD)	DCE (Modem)
4	CA	105	Request to Send (RTS)	DTE
5	CB	106	Clear to Send (CTS)	DCE
6	CC	107	Data Set Ready (DSR)	DCE
7	AB	102	Signal Ground	---
8	CF	109	Received Line Signal Detector	DCE
9	---	---	UNASSIGNED	---
10	---	---	UNASSIGNED	---
11	CH	111/126	Rate Select (V.24)	DTE
12	SCF	122	Secondary Received Line Signal Detector	DCE
13	SCB	121	Secondary Clear to Send	DCE
14	SBA	118	Secondary Transmitted Data	DTE
15	DB	114	Transmitter Signal Element Timing	DCE
16	SBB	119	Secondary Received Data	DCE
17	DD	115	Receiver Signal Element Timing	DCE
18	---	---	UNASSIGNED	---
19	SCA	120	Secondary Request to Send	DTE
20	CD	108.2	Data Terminal Ready (DTR)	DTE
21	CG	110	Signal Quality Detector	DCE
22	CE	125	Ring Indicator	DCE
23	CH	111	Data Signal Rate Selector	DTE
24	DA	113/116	Transmit Signal Element Timing/ Select Standby	DTE
25	---	---	UNASSIGNED	---

Table A-2 Burroughs Direct Access Arrangement (BDAA)

Host (DB-25)	Description	Peripheral (4-pin)
---	Frame Ground	1
2	Transmit Data	2
3	Receive Data	3
7	Signal Ground	4

Table A-3 (Centronics standard) Parallel Printer Cable

Pin	Signal
1	Strobe
2	Data Bit 0
3	Data Bit 1
4	Data Bit 2
5	Data Bit 3
6	Data Bit 4
7	Data Bit 5
8	Data Bit 6
9	Data Bit 7
10	Acknowledge
11	Busy
12	Paper Out
13	Select
14	Unassigned
15	OSCXT
16	Signal Ground
17	Chassis Ground
18	+5 Volts DC
19	Ground
20	Ground
21	Ground
22	Ground
23	Ground
24	Ground
25	Ground
26	Ground
27	Ground
28	Ground
29	Ground
30	Ground
31	Initialize
32	Fault
33	Unassigned
34	Unassigned
35	Unassigned
36	Unassigned

Title: _____

Form Number: _____ Date: _____

Burroughs Corporation is interested in your comments and suggestions regarding this manual. We will use them to improve the quality of your Product Information.

Please check type of suggestion: Addition Deletion Revision
 Error

Comments: _____

Name _____

Title _____

Company _____

Address _____
Street City State Zip

Telephone Number () _____
Area Code

Title: _____

Form Number: _____ Date: _____

Burroughs Corporation is interested in your comments and suggestions regarding this manual. We will use them to improve the quality of your Product Information.

Please check type of suggestion: Addition Deletion Revision
 Error

Comments: _____

Name _____

Title _____

Company _____

Address _____
Street City State Zip

Telephone Number () _____
Area Code



NO POSTAGE
NECESSARY
IF MAILED
IN THE
UNITED STATES

BUSINESS REPLY CARD
FIRST CLASS PERMIT NO. 817 DETROIT, MI 48232

POSTAGE WILL BE PAID BY ADDRESSEE

Burroughs Corporation
Production Services – East
209 W. Lancaster Avenue
Paoli, Pa 19301 USA

ATTN: Corporate Product Information

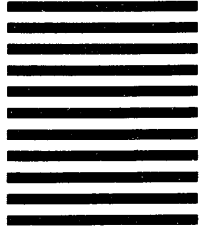

NO POSTAGE
NECESSARY
IF MAILED
IN THE
UNITED STATES

BUSINESS REPLY CARD
FIRST CLASS PERMIT NO. 817 DETROIT, MI 48232

POSTAGE WILL BE PAID BY ADDRESSEE

Burroughs Corporation
Production Services – East
209 W. Lancaster Avenue
Paoli, Pa 19301 USA

ATTN: Corporate Product Information

