

COS™ Table Descriptions
Internal Reference Manual

SM-0045 I

Cray Research, Inc.

Copyright © 1980, 1981, 1982, 1983, 1984, 1985, 1986, 1987, 1988 by Cray Research, Inc. This manual or parts thereof may not be reproduced unless permitted by contract or by written permission of Cray Research, Inc.

CRAY, CRAY-1, SSD, and UNICOS are registered trademarks and CFT, CFT77, CFT2, COS, Cray Ada, CRAY-2, CRAY X-MP, CRAY X-MP EA, CRAY Y-MP, CSIM, Delivering the power..., HSX, IOS, SEGLDR, and SUPERLINK are trademarks of Cray Research, Inc.

DEC and DECnet are trademarks of Digital Equipment Corporation. UNIX is a registered trademark of AT&T.

The UNICOS operating system is derived from the AT&T UNIX System V operating system. UNICOS is also based in part on the Fourth Berkeley Software Distribution under license from The Regents of the University of California.

Requests for copies of Cray Research, Inc. publications should be sent to the following address:

Cray Research, Inc.
Distribution Center
2360 Pilot Knob Road
Mendota Heights, MN 55120



Each time this manual is revised and reprinted, all changes issued against the previous version are incorporated into the new version and the new version is assigned an alphabetic level.

Every page changed by a reprint with revision has the revision level in the lower righthand corner. Changes to part of a page are noted by a change bar in the margin directly opposite the change. A change bar in the margin opposite the page number indicates that the entire page is new. If the manual is rewritten, the revision level changes but the manual does not contain change bars.

Requests for copies of Cray Research, Inc. publications should be directed to the Distribution Center and comments about these publications should be directed to:

CRAY RESEARCH, INC.
1345 Northland Drive
Mendota Heights, Minnesota 55120

<u>Revision</u>	<u>Description</u>
	October 1980 - Original printing. The information in this manual was previously contained in part 5 of the CRAY-OS Version 1 System Programmer's Manual, publication 2240012, which is now obsolete. This manual supports the 1.09 release.
A	July 1981 - Reprint with revision. This printing adds the Engineering Flaw Table, Partial Word Table, and revises the Queue Control Table. Several features are added including PROM, Resource Generic Names, ECHO, XMI, PMI and job lock. Miscellaneous changes were also made, and section 2 was rewritten. This manual supports the 1.10 release and obsoletes all previous printings.
B	June 1982 - Reprint with revision. This manual supports the 1.11 release and obsoletes all previous printings. This printing adds section 3, Tape Label Tables. Extensive changes have been made in the Active User Table, Channel Buffer Table, Channel Extension Table, and Data Allocation Table. The I/O Processor Disk Command Table and the IOP Station Command Table have been replaced by new sections under Any Packet Table. The System Dataset Table Queue Pointer Table has been replaced by a new section under the System Dataset Table. Miscellaneous changes were also made.
C	July 1983 - First version generated automatically. Numerous new tables and codes were added; most text for existing tables was transferred from version B.
D	May 1984 - Second version generated automatically, conforming with the initial release of COS 1.13. This is generated from PDN=COSPL, ID=V113PL with N09249A applied. Mod N09249A adds definition for AEM type 2 and type 5 tables, and minor editorial changes. Changes in the table generator software have caused some text details from version C to be lost.

- E January 1985 - This version conforms with the initial release of COS 1.14 with Bugfix 1 applied.
- F February 1986 - This version conforms with the initial release of COS 1.15 with Bugfix 1 applied.
- G October 1986 - This version conforms with the release of COS 1.15 with Bugfix 2 applied. Two tables were added, the Guest Operating System Channel Table, and the UNICOS Channel Table. In revision F of this manual, tables with prefixes in the range ST through TL were omitted because of a source directive error in a PL deck. These tables have been restored.
- H May 1987 - This version conforms with the initial release of COS 1.16 with Bugfix 1 applied.
- I October 1988 - Reprint with revision. This printing supports the 1.17 version of the Cray operating system COS. Numerous new tables and codes were added.

PREFACE

This publication is part of a set of manuals written for programmers, analysts, and field engineers who are responsible for installing, debugging, and modifying the Cray operating system COS.

This manual contains information for making the transition from the external features of the operating system as described in the COS Reference Manual, Cray Research, Inc. (CRI) publication SR-0011, to the listings.

Although a general familiarity with the concept of operating systems is assumed, this publication does not presume that the reader knows the principles or techniques of any other specific operating system.

Other CRI publications in this set are:

SM-0017	Fortran (CFT) Internal Reference Manual
SM-0036	APML Assembler Reference Manual
SR-0039	COS Message Manual
SM-0042	Front-end Protocol Internal Reference Manual
SM-0043	COS Operational Procedures Reference Manual
SM-0044	Operational Aids Reference Manual
SM-0046	IOS Software Internal Reference Manual
SM-0049	Data General Station (DGS) Internal Reference Manual
SG-0051	I/O Subsystem (IOS) Operator's Guide for COS
SD-0061	Pascal Internal Reference Manual
SM-0072	Cray Simulator (CSIM) Internal Reference Manual
SR-0085	Symbolic Machine Instructions Reference Manual
SQ-0096	COS Dump Analysis Ready Reference
SM-0114	System Library Reference Manual
SM-0140	COS Internal Reference Manual, Volume I: EXEC
SM-0141	COS Internal Reference Manual, Volume II: STP
SM-0142	COS Internal Reference Manual, Volume III: CSP
SMN-7013	A System Analyst's Guide to GOS

For a complete listing of all available manuals, including station manuals, refer to the User Publications Catalog, CRI publication CP-0099.

Manuals designated as internal describe the internal design of the software whereas the other manuals in the set define procedures and external features of tools needed for installing and maintaining CRI software.

The reader is assumed to be familiar with the contents of the COS Reference Manual, CRI publication SR-0011, and to be experienced in coding in the Cray Assembly Language (CAL) as described in the CAL Assembler Version 1 Reference Manual, CRI publication SR-0000.

Four "tables of contents" are provided. Each table of contents has four columns. The leftmost column contains the table prefix. The second column contains the table title. The third column contains the table mnemonic. The fourth (and rightmost) column contains the page number on which the table diagram begins.

The first table of contents is arranged by page number (in the normal fashion).

The second table of contents is arranged by table prefix.

The third table of contents is arranged by table name.

The fourth table of contents is arranged by table mnemonic.

READER COMMENTS

If you have any comments about the technical accuracy, content, or organization of this manual, please tell us. You can contact us in any of the following ways:

- Call our Technical Publications department at (612) 681-5729 during normal business hours (Central Time).
- Send us electronic mail from a UNICOS or UNIX system, using one of the following electronic mail addresses:

`uunet!bungia!cray!publications` or `sun!tundra!hall!publications`

- Send a facsimile of your comments to the attention of "Publications" at FAX number: 612-681-5602
- Use the postage-paid Reader Comment form at the back of this manual.
- Write to us at the following address:

Cray Research, Inc.
Technical Publications Department
1345 Northland Drive
Mendota Heights, Minnesota 55120

We value your comments and will respond to them promptly.

TABLE OF CONTENTS

IN	SYSTEM TABLE DESCRIPTIONS	INTRO	1
AC	Job Accounting Table	JAC	4
AT	Task Accounting table	TAC	9
AE	IOP Error Channel Message	AEM	10
AP	Any Packet Table	APT	21
AQ	APT(Packet) Queuing Header Table	AQT	53
AR	IOP Recovered Disk Error Message	ARM	54
AU	Active User Table	AUT	56
XR	Remount/Mount Auxiliary Information Table	XRM	60
XD	Dataset Enquiry Auxiliary Information Table	XDE	62
XD	Dataset Update Auxiliary Information Table	XDU	64
XV	Volume Access Auxiliary Information Table	XVA	65
XV	Volume Update Auxiliary Information Table	XVU	67
XT	Auxiliary Text Message Table	XTM	69
BA	Binary audit table	BAT	70
BG	Begin Code Execution Table	BGN	79
BP	Buffer Pool Table	BPT	83
Q	Buffer Pool Queue Control Word	QC	84
BRT	Loader Block Relocation Table	BRT	85
CB	Channel Buffer Table	CBT	88
CC	Chain Control Word	CMCC	91
CI	Chain Item	CI	93
CED	Catalog Entry Descriptor	CED	94
CH	Channel Table	CHT	95
CT	CIO history trace buffer	CIOT	96
CN	Configuration Table	CNT	98
CN	CPU status definition sub-entry	CNCS	102
CN	CNT Tape Sub-entry	CNT	103
CS	Class Structure Definition	CSD	105
CW	Block or Record Control Word	CW	108
CX	Channel Extension Table Header	CXT	110
DA	Dataset Allocation Table	DAT	111
DC	Dataset Catalog	DSC	118
DD	Dataset Definition List	DDL	125
DF	STP task display format control table	DF	128
DF	Loader Directory Table	DFT	130
F	Diagnostic Request Table	COMDIA	132
DI	Dataset Information Table	DIT	147
DM	System Dump Parameters	DMP	148
DM	Debug Map Table header	DMT	151
DN	Dataset Name Table	DNT	153
DP	Dataset Parameter Table	DSP	164
DPT	Loader Duplication Table	DPT	174
DQ	DQM Queue	DQ	176
DT	DQM history trace buffer	DQMT	178
DQT	Diagnostic Queue Table	DQT	179
DR	Disk Reservation Table	DRT	181
DR	F\$DRIVER parameter block	DRPB	183
DT	Disk Control Path Table	DCT	187
DV	Device Label Table	DVL	191
DX	DSC Extension Information Table	DXI	193
DX	DSC Extension page definition table	DXT	194
EFT	Engineering Flaw Table	EFT	196
EPT	Execution Profile Table	EPT	198
EQ	Equipment table	EQT	200
ER	F\$ERCL parameter block	ERP	212

TABLE OF CONTENTS

ET	Encryption Parameter Table	EPT	214
EVW		EVW	215
EW	Event Wait Table	EWT	216
EP	Event Pool Entry	EP	217
EC	J\$AWAIT Parameter Call Block	EC	218
EC	EXP Error Code Table	EXERR	219
ER	User Errors	USERR	220
ER	Queue manager error codes	QMERR	231
ET	EXP history trace buffer	EXPT	233
CT	Create task request	EXRQ	234
FGS	F\$GOS interface definition	FGS	250
FH	Front-end servicing header	FSH	254
FS	FSS Device Statistics Table	FS	256
GCH	GOS Channel Table	GCH	257
GOS	Guest operating system table for EXEC	GOS	258
GR	Generic Resource Table	GRT	261
GS	Generic Resource Statistics Table	GS	263
HP	Heap block control words	HP	264
HT	Heap statistics table	HT	265
HM	Hardware Performance Monitor Control Block	HM	267
HMR	Hardware Performance Monitor - F\$PERF request	HMR	269
HS	Simulated high-speed channel protocol	HSR	271
IA	ISP Application Level Messages	IA	272
IB	Interactive Buffer Table	IBT	286
IC	STP Inter-task Communication Table	ICT	287
IH	ISP Header block Headers	IH	289
II	ISP Dataset Definition Table	IDD	293
IJ	F\$IJMSG parameter block	IJPB	295
NC	Node Control Block	NCB	298
RCB	Receptive Control Block	RCB	299
MH	Inter-job communication message buffer	MHB	300
IL	ISP Link Table	ILT	301
IM	ISP Transport Message	IM	309
IN	Internal Station Status Table	INS	320
IO	I\O Common Function Codes	IOF	323
IPT	Inter-job communication path table	IPT	324
RIT	Registered ID table	RIT	327
DT	IQM history trace buffer	IQMT	328
IR	ISP Request Table	IR	330
IS	ISPMAIN Status Table	IST	331
IT	ISP Transport Request Block	TRB	334
IV	ISP Virtual Circuit Table	VCT	338
IX	ISP Text Record	ITX	342
JA	Job-assisted event definition table	JAE	343
JB	JCL Block Information Table	JBI	346
JC	Job Communication Block	JCB	347
JS	JCL Symbol Table	JST	354
J	Job Scheduler (JSH) Equates	JSH	355
IR	Invoke request word	JSH	358
DT	JSH history trace buffer	JSHT	359
JIE	JSH internal event trace buffer	JIET	360
JT	Job Table Area	JTA	362
JX	Job Execution Table	JXT	379
KB	BACKUP CATALOG DATASET	KB	386
KL	PDM Archiving Task Logon Table	KL	395
KM	MASTER CATALOG DATASET	KM	399

TABLE OF CONTENTS

KV	BACKUP VOLUME CATALOG	KV	407
LC	Link Configuration Table	LCT	412
LD	Label Definition Table	LDT	414
LF	Logical File Table	LFT	425
LO	Logical Request Table	LOR	426
LT	Link Interface Table	LIT	429
RD	Resource Dataset Definition Table	RDD	433
RA	Resource dataset Account Entry	RDA	440
RE	Resource dataset User Entry	RDE	445
RI	Resource dataset Information Entry	RDI	454
RER	RDM ERROR CODE VALUES.	RDMER	458
RFC	RDM FUNCITON CODES.	RDMFC	460
RL	RDM Logging Table	RLL	462
LX	Link Extension Table	LXT	464
MC		MC	472
RR	Resource Dataset Page	RDP	475
MCT	Message Control Table	MCT	476
PC	Parameter Control Table	PCT	477
PC	Parameter Control Table Entry	PCT	478
MD	Mode Parameter Word	MD	479
MDW	System Dump Memory Descriptor Words	MDW	480
NMD	New Format Memory Descriptor	NMD	482
ME	Memory Error Table	ME	483
MR	Memory Definitions	MEM	485
MP	Memory Pool	MPH	486
MS	Memory Segment Table	MST	488
MTH	MTHTC - Multitasking history trace codes	MTHTC	490
QUE	Define Multitasking Queue Header Words	MTQ	491
OD	Open Dataset Table	ODN	492
OEA	SL2 Activity Control Block	OEA	493
OEB	SL2 Buffer	OEB	495
OEC	SL2 Character pointer	OEC	497
OEG	SL2 Global Activity List	OEG	498
OEQ	SL2 Queue Table	OEQ	500
OES	SL2 State Table	OES	502
OET	SL2 Timer Block	OET	503
OIB	SL2 IPC communication block	IPCB	504
OIC	SL2 IPC connection table	ICB	507
OII	SL2 IPC queue item	OII	513
OIQ	SL2 IPC queue structure	OIQ	515
OIS	SL2 IPC server name table	OIS	516
NFPK		NFPK	517
OLA	ACB Header part	OLA	518
OLL	ACB Header part	OLL	521
OLP	SUPERLINK Link Path Table	LPT	522
OLH	SUPERLINK Link Header	OLH	534
OLS	SUPERLINK Link subheader	OLS	535
OLM	SUPERLINK Message Proper	OLM	536
OLF	SUPERLINK FCPU word	OLF	537
OLZ	Link trace - protocol message	OLZ	538
OM	F\$OPMSG parameter block	OM	540
ONR	SUPERLINK Network Routing Table	NRT	542
ONN	SUPERLINK Network Node Table	NNT	543
ONB	SUPERLINK Network Connection Request Block	NCRB	544
ONW	SUPERLINK Network Address	ONW	546
ONA	SUPERLINK NSAP Activity Table Header	NAT	547

TABLE OF CONTENTS

ONC	Connection Reference - ONC	ONC	548
ONH	Internet Header format	ONH	549
OP	Parameter Block for F\$OPT	OPT	551
OS	Inter-operating system communication table	OS	553
OTD	TPDU Disassembly block	OTD	556
OTX	Demultiplexer ACB	OTX	558
OTM	Multiplexer ACB	OTM	560
OTF	Flow control confirmation parameter	OTF	562
OTH	Handler ACB	OTH	563
OTS	Transport statistics block	OTS	572
OTU	Transport TPDU - CR/CC form	OTU	574
OTO	Transport buffer ordering	OTO	577
OTV	Transport TPDU - variable parameter	OTV	578
PA	Parameter Information Table	PAT	579
PC	Per-device accounting table	PC	580
PD	Permanent Dataset Table	PDS	581
PDL		PDL	583
PDL	Preferred device entry	PDL	584
PDT	Loader Program Description Table	PDT	585
PER	Permit DXT entry	DXPERM	597
PERT		PERT	598
PGT	PDM Page Table	PGT	599
PH	Physical Request Table	PHR	601
PI	Permanent Dataset Information	PDI	603
PP	Position Parameter List	PPL	604
PM	Permanent Dataset Definition	PDD	605
PQ	PDM Request Definitions	COMPQ	636
PR	Procedure File Stack Table	PR	637
PR	Preemption Table	PRT	639
WP	Swap Space Table	WPT	642
RA	Resource Allocation Table	RAT	645
DZ	DAT Accumulation List Information Table	DZT	647
TF	Transfer Table	TFT	648
PS	Process Save Area	PSA	650
PT	Memory Pool Table	PT	652
PW	Processor Working Storage	PWS	653
PWT	Partial Word Table	PWT	659
PX	Processor execution table	PX	660
QC	Queue Control Table	QCT	662
QD	Queued Dataset Table	QDT	665
QMP	F\$SDTQM parameter block	QMPB	666
QP	Queued Packet Table	QPT	668
QR	Queued I/O Request Table	QRT	670
RB	Receive Buffer Table	RBT	672
RJ	Rolled Job Index Table	RJ	673
RJ	Rolled job index table equates	RJCODES	675
RPV	Repreive Data Table	RPVT	678
RQ	Task Request Table	RQT	679
SA	SSD Active Channel Table	SAC	682
SAL	Station Alternative format	SAL	686
ASP	Alternate slot parameter block	ASP	687
SB	System Billing Unit Table	SBU	688
SC	Subsystem Control Table	SCT	691
LP	Link Control Package	LCP	692
LP	Link Control Package Extension	LCPE	699
LP	Link Trailer Package	LTP	700

TABLE OF CONTENTS

DQ	Task reply tables	DQREP	701
TQ	Task reply tables	TQREP	702
IQ	IQM Task Reply Table	IQREP	703
SD	System Dataset Table	SDT	704
SDP	System Dump Header Fields	SDP	711
SD	System Directory Recovery	SDR	712
SEP	SEP - control statement separator codes	COMSEP	713
AR	CFT call-by-address parameter block	ARLST	714
SF	Statistics format	SFT	719
SMT	Loader Symbol Table	SMT	721
CP	SPM CPU Utilization Report	CPR	731
TK	SPM Task Utilization Report	TKR	733
ER	SPM Executive Request Report	ERR	734
DU	SPM Disk Utilization Report	DUR	735
DC	SPM Disk Channel Utilization Report	DCR	737
LU	SPM Link Utilization Report	LUR	738
EC	SPM Executive Call Report	ECR	739
UC	SPM User Call Usage Report	UCR	740
IC	SPM Channel Interrupt Report	ICR	741
SB	SPM System Buffer Utilization Report	SBR	742
MU	SPM Memory Utilization Report	MUR	744
SQ	System Lock Queue	SLQ	745
SR0	Status Register 0	SR0	746
SRQ	SSD Request/Reply Queue Table	SRQ	748
SS	Staging Stream Table	SST	749
SSW		SSW	752
SSW	SSD Status Word	SSW	753
ST	System Task Table	STT	754
SH	Stack Control Header	SH	757
SS	Stack Segment Linkage Control	SS	758
STP	Job Card Values	STP	759
SW	Security Swap Table	SWT	762
TA	Tape Accounting Log Message	TAT	763
T	On-line Tape Parameter Definitions	COMTAPE	767
TP	Task Breakpoint Table	TBPT	769
TBL	Task Common Block Table	TBLK	770
TC	Task Control Block	TCB	773
TC	Task Control Array	TCA	785
TD	Tape Device Table	TDT	786
TE	Time Event Table	TET	803
TET	Tape Error Table	TET	805
TEV		TEV	806
TI	Task Information Block	TIB	807
CT	TIO history trace buffer	TIOT	810
TK	F\$TASK Table	TKT	812
TL	ANSI\IBM Tape Label Definitions	TLB	813
IV	IBM Standard Label - Volume Label	TLB	815
DL	First Dataset Label Group	TLB	816
ID	Second IBM Dataset Label Group	TLB	819
TL	Tape Label Table	TLT	821
TM	STP Inter-task Message Table	TMT	822
TM	Tape Label Migration Table	TMT	823
TN	Table Name Table	TNT	824
TBL	F\$TBL Call Block	TBLC	825
TNB	Traceback Name Block	TNB	826
TP	Tape Position Information Table	TPI	829

TABLE OF CONTENTS

TP	Tape Processing Table	TP	831
TPS	Tape Processing State Table	TPS	832
TPE	TPS Table Entry	TPS	833
T	Tape Queue Manager Equates	COMTQM	834
TQP		TQP	836
TB	Trace parameter block	TPB	837
TS	TQM trace sub-buffer header	TSB	838
TE	TQM snap entry header	TSE	839
TY	TQM snap body	TBY	840
TR	Track Permanent Accesses	TRA	841
OUP	T-USER to TS parameter block	OUP	843
OTP	TS to T-USER parameter block	OTP	845
TT	STP Inter-task Trace Table	TTT	847
TV	Tape Volume Table	TVT	849
TX	Task Execution Table	TXT	851
TXT	Loader Text Table	LDRTXT	856
ER	EXP User Call Table	UCT	857
UCH	Unicos Channel Table	UCH	858
UD	User Driver Table	UDT	859
UT	Utility library error message numbers	COMUER	862
UP	User Security Priviledge Table	UPT	864
UT	User task status block	UTSB	865
VP	ISP Virtual Circuit Pointer Table	VPT	866
XAT	DSC Extension high memory allocation table	XAT	868
XF	History Trace Function Table	XFT	869
XP	Exchange Package	XP	870
XRT	Loader External Relocation Table	XRT	885
XT	History Trace Table	XTT	887
ZM	Startup Managed Table	ZMTR	889
ZDV	Startup Device Label Table	ZDVLT	890
ZSB	STARTUP submitted jobs table	ZSB	891
ZMG	Startup Log Message Control	ZMGCODES	892
ZMG	Startup Permanent Dataset Recovery Message	ZMG	893
ZMH	Startup ZMG Table Header	ZMH	895
ZPA	Startup Message Parameter Control Words	ZPA	896
ZPC	Startup Message Parameter Table	ZPC	897

TABLE OF CONTENTS BY PREFIX

AC	Job Accounting Table	JAC	4
AE	IOP Error Channel Message	AEM	10
AP	Any Packet Table	APT	21
AQ	APT(Packet) Queuing Header Table	AQT	53
AR	CFT call-by-address parameter block	ARLST	714
AR	IOP Recovered Disk Error Message	ARM	54
ASP	Alternate slot parameter block	ASP	687
AT	Task Accounting table	TAC	9
AU	Active User Table	AUT	56
BA	Binary audit table	BAT	70
BG	Begin Code Execution Table	BGN	79
BP	Buffer Pool Table	BPT	83
BRT	Loader Block Relocation Table	BRT	85
CB	Channel Buffer Table	CBT	88
CC	Chain Control Word	CMCC	91
CED	Catalog Entry Descriptor	CED	94
CH	Channel Table	CHT	95
CI	Chain Item	CI	93
CN	CNT Tape Sub-entry	CNT	103
CN	CPU status definition sub-entry	CNCS	102
CN	Configuration Table	CNT	98
CP	SPM CPU Utilization Report	CPR	731
CS	Class Structure Definition	CSD	105
CT	CIO history trace buffer	CIOT	96
CT	Create task request	EXRQ	234
CT	TIO history trace buffer	TIOT	810
CW	Block or Record Control Word	CW	108
CX	Channel Extension Table Header	CXT	110
DA	Dataset Allocation Table	DAT	111
DC	Dataset Catalog	DSC	118
DC	SPM Disk Channel Utilization Report	DCR	737
DD	Dataset Definition List	DDL	125
DF	Loader Directory Table	DFT	130
DF	STP task display format control table	DF	128
DI	Dataset Information Table	DIT	147
DL	First Dataset Label Group	TLB	816
DM	Debug Map Table header	DMT	151
DM	System Dump Parameters	DMP	148
DN	Dataset Name Table	DNT	153
DP	Dataset Parameter Table	DSP	164
DPT	Loader Duplication Table	DPT	174
DQ	DQM Queue	DQ	176
DQ	Task reply tables	DQREP	701
DQT	Diagnostic Queue Table	DQT	179
DR	Disk Reservation Table	DRT	181
DR	F\$DRIVER parameter block	DRPB	183
DT	DQM history trace buffer	DQMT	178
DT	Disk Control Path Table	DCT	187
DT	IQM history trace buffer	IQMT	328
DT	JSH history trace buffer	JSHT	359
DU	SPM Disk Utilization Report	DUR	735
DV	Device Label Table	DVL	191
DX	DSC Extension Information Table	DXI	193
DX	DSC Extension page definition table	DXT	194
DZ	DAT Accumulation List Information Table	DZT	647
EC	EXP Error Code Table	EXERR	219

TABLE OF CONTENTS BY PREFIX

EC	J\$AWAIT Parameter Call Block	EC	218
EC	SPM Executive Call Report	ECR	739
EFT	Engineering Flaw Table	EFT	196
EP	Event Pool Entry	EP	217
EPT	Execution Profile Table	EPT	198
EQ	Equipment table	EQT	200
ER	EXP User Call Table	UCT	857
ER	F\$ERCL parameter block	ERPB	212
ER	Queue manager error codes	QMERR	231
ER	SPM Executive Request Report	ERR	734
ER	User Errors	USERR	220
ET	EXP history trace buffer	EXPT	233
ET	Encryption Parameter Table	EPT	214
EVW		EVW	215
EW	Event Wait Table	EWT	216
F	Diagnostic Request Table	COMDIA	132
FGS	F\$GOS interface definition	FGS	250
FH	Front-end servicing header	FSH	254
FS	FSS Device Statistics Table	FS	256
GCH	GOS Channel Table	GCH	257
GOS	Guest operating system table for EXEC	GOS	258
GR	Generic Resource Table	GRT	261
GS	Generic Resource Statistics Table	GS	263
HM	Hardware Performance Monitor Control Block	HM	267
HMR	Hardware Performance Monitor - F\$PERF request	HMR	269
HP	Heap block control words	HP	264
HS	Simulated high-speed channel protocol	HSR	271
HT	Heap statistics table	HT	265
IA	ISP Application Level Messages	IA	272
IB	Interactive Buffer Table	IBT	286
IC	SPM Channel Interrupt Report	ICR	741
IC	STP Inter-task Communication Table	ICT	287
ID	Second IBM Dataset Label Group	TLB	819
IH	ISP Header block Headers	IH	289
II	ISP Dataset Definition Table	IDD	293
IJ	F\$IJMSG parameter block	IJPB	295
IL	ISP Link Table	ILT	301
IM	ISP Transport Message	IM	309
IN	Internal Station Status Table	INS	320
IN	SYSTEM TABLE DESCRIPTIONS	INTRO	1
IO	I\O Common Function Codes	IOF	323
IPT	Inter-job communication path table	IPT	324
IQ	IQM Task Reply Table	IQREP	703
IR	ISP Request Table	IR	330
IR	Invoke request word	JSH	358
IS	ISPMMAIN Status Table	IST	331
IT	ISP Transport Request Block	TRB	334
IV	IBM Standard Label - Volume Label	TLB	815
IV	ISP Virtual Circuit Table	VCT	338
IX	ISP Text Record	ITX	342
J	Job Scheduler (JSH) Equates	JSH	355
JA	Job-assisted event definition table	JAE	343
JB	JCL Block Information Table	JB	346
JC	Job Communication Block	JCB	347
JIE	JSH internal event trace buffer	JIET	360
JS	JCL Symbol Table	JST	354

TABLE OF CONTENTS BY PREFIX

JT	Job Table Area	JTA	362
JX	Job Execution Table	JXT	379
KB	BACKUP CATALOG DATASET	KB	386
KL	PDM Archiving Task Logon Table	KL	395
KM	MASTER CATALOG DATASET	KM	399
KV	BACKUP VOLUME CATALOG	KV	407
LC	Link Configuration Table	LCT	412
LD	Label Definition Table	LDT	414
LF	Logical File Table	LFT	425
LO	Logical Request Table	LOR	426
LP	Link Control Package	LCP	692
LP	Link Control Package Extension	LCPE	699
LP	Link Trailer Package	LTP	700
LT	Link Interface Table	LIT	429
LU	SPM Link Utilization Report	LUR	738
LX	Link Extension Table	LXT	464
MC		MC	472
MCT	Message Control Table	MCT	476
MD	Mode Parameter Word	MD	479
MDW	System Dump Memory Descriptor Words	MDW	480
ME	Memory Error Table	ME	483
MH	Inter-job communication message buffer	MHB	300
MP	Memory Pool	MPH	486
MR	Memory Definitions	MEM	485
MS	Memory Segment Table	MST	488
MTH	MTHTC - Multitasking history trace codes	MTHTC	490
MU	SPM Memory Utilization Report	MUR	744
NC	Node Control Block	NCB	298
NFPK		NFPK	517
NMD	New Format Memory Descriptor	NMD	482
OD	Open Dataset Table	ODN	492
OEA	SL2 Activity Control Block	OEA	493
OEB	SL2 Buffer	OEB	495
OEC	SL2 Character pointer	OEC	497
OEG	SL2 Global Activity List	OEG	498
OEQ	SL2 Queue Table	OEQ	500
OES	SL2 State Table	OES	502
OET	SL2 Timer Block	OET	503
OIB	SL2 IPC communication block	IPCB	504
OIC	SL2 IPC connection table	ICB	507
OII	SL2 IPC queue item	OII	513
OIQ	SL2 IPC queue structure	OIQ	515
OIS	SL2 IPC server name table	OIS	516
OLA	ACB Header part	OLA	518
OLF	SUPERLINK FCPU word	OLF	537
OLH	SUPERLINK Link Header	OLH	534
OLL	ACB Header part	OLL	521
OLM	SUPERLINK Message Proper	OLM	536
OLP	SUPERLINK Link Path Table	LPT	522
OLS	SUPERLINK Link subheader	OLS	535
OLZ	Link trace - protocol message	OLZ	538
OM	F\$OPMSG parameter block	OM	540
ONA	SUPERLINK NSAP Activity Table Header	NAT	547
ONB	SUPERLINK Network Connection Request Block	NCRB	544
ONC	Connection Reference - ONC	ONC	548
ONH	Internet Header format	ONH	549

TABLE OF CONTENTS BY PREFIX

ONN	SUPERLINK Network Node Table	NNT	543
ONR	SUPERLINK Network Routing Table	NRT	542
ONW	SUPERLINK Network Address	ONW	546
OP	Parameter Block for F\$OPT	OPT	551
OS	Inter-operating system communication table	OS	553
OTD	TPDU Disassembly block	OTD	556
OTF	Flow control confirmation parameter	OTF	562
OTH	Handler ACB	OTH	563
OTM	Multiplexer ACB	OTM	560
OTO	Transport buffer ordering	OTO	577
OTP	TS to T-USER parameter block	OTP	845
OTS	Transport statistics block	OTS	572
OTU	Transport TPDU - CR/CC form	OTU	574
OTV	Transport TPDU - variable parameter	OTV	578
OTX	Demultiplexer ACB	OTX	558
OUP	T-USER to TS parameter block	OUP	843
PA	Parameter Information Table	PAT	579
PC	Parameter Control Table	PCT	477
PC	Parameter Control Table Entry	PCT	478
PC	Per-device accounting table	PC	580
PD	Permanent Dataset Table	PDS	581
PDL		PDL	583
PDL	Preferred device entry	PDL	584
PDT	Loader Program Description Table	PDT	585
PER	Permit DXT entry	DXPERM	597
PERT		PERT	598
PGT	PDM Page Table	PGT	599
PH	Physical Request Table	PHR	601
PI	Permanent Dataset Information	PDI	603
PM	Permanent Dataset Definition	PDD	605
PP	Position Parameter List	PPL	604
PQ	PDM Request Definitions	COMPQ	636
PR	Preemption Table	PRT	639
PR	Procedure File Stack Table	PR	637
PS	Process Save Area	PSA	650
PT	Memory Pool Table	PT	652
PW	Processor Working Storage	PWS	653
PWT	Partial Word Table	PWT	659
PX	Processor execution table	PX	660
Q	Buffer Pool Queue Control Word	QC	84
QC	Queue Control Table	QCT	662
QD	Queued Dataset Table	QDT	665
QMP	F\$SDTQM parameter block	QMPB	666
QP	Queued Packet Table	QPT	668
QR	Queued I/O Request Table	QRT	670
QUE	Define Multitasking Queue Header Words	MTQ	491
RA	Resource Allocation Table	RAT	645
RA	Resource dataset Account Entry	RDA	440
RB	Receive Buffer Table	RBT	672
RCB	Receptive Control Block	RCB	299
RD	Resource Dataset Definition Table	RDD	433
RE	Resource dataset User Entry	RDE	445
RER	RDM ERROR CODE VALUES.	RDMER	458
RFC	RDM FUNCITON CODES.	RDMFC	460
RI	Resource dataset Information Entry	RDI	454
RIT	Registered ID table	RIT	327

TABLE OF CONTENTS BY PREFIX

RJ	Rolled Job Index Table	RJ	673
RJ	Rolled job index table equates	RJCODES	675
RL	RDM Logging Table	RLL	462
RPV	Repreive Data Table	RPVT	678
RQ	Task Request Table	RQT	679
RR	Resource Dataset Page	RDP	475
SA	SSD Active Channel Table	SAC	682
SAL	Station Alternative format	SAL	686
SB	SPM System Buffer Utilization Report	SBR	742
SB	System Billing Unit Table	SBU	688
SC	Subsystem Control Table	SCT	691
SD	System Dataset Table	SDT	704
SD	System Directory Recovery	SDR	712
SDP	System Dump Header Fields	SDP	711
SEP	SEP - control statement separator codes	COMSEP	713
SF	Statistics format	SFT	719
SH	Stack Control Header	SH	757
SMT	Loader Symbol Table	SMT	721
SQ	System Lock Queue	SLQ	745
SR0	Status Register 0	SR0	746
SRQ	SSD Request/Reply Queue Table	SRQ	748
SS	Stack Segment Linkage Control	SS	758
SS	Staging Stream Table	SST	749
SSW		SSW	752
SSW	SSD Status Word	SSW	753
ST	System Task Table	STT	754
STP	Job Card Values	STP	759
SW	Security Swap Table	SWT	762
T	On-line Tape Parameter Definitions	COMTAPE	767
T	Tape Queue Manager Equates	COMTQM	834
TA	Tape Accounting Log Message	TAT	763
TB	Trace parameter block	TPB	837
TBL	F\$TBL Call Block	TBLC	825
TBL	Task Common Block Table	TBLK	770
TC	Task Control Array	TCA	785
TC	Task Control Block	TCB	773
TD	Tape Device Table	TDT	786
TE	TQM snap entry header	TSE	839
TE	Time Event Table	TET	803
TET	Tape Error Table	TET	805
TEV		TEV	806
TF	Transfer Table	TFT	648
TI	Task Information Block	TIB	807
TK	F\$TASK Table	TKT	812
TK	SPM Task Utilization Report	TKR	733
TL	ANSI\IBM Tape Label Definitions	TLB	813
TL	Tape Label Table	TLT	821
TM	STP Inter-task Message Table	TMT	822
TM	Tape Label Migration Table	TMT	823
TN	Table Name Table	TNT	824
TNB	Traceback Name Block	TNB	826
TP	Tape Position Information Table	TPI	829
TP	Tape Processing Table	TP	831
TP	Task Breakpoint Table	TBPT	769
TPE	TPS Table Entry	TPS	833
TPS	Tape Processing State Table	TPS	832

TABLE OF CONTENTS BY PREFIX

TQ	Task reply tables	TQREP	702
TQP		TQP	836
TR	Track Permanent Accesses	TRA	841
TS	TQM trace sub-buffer header	TSB	838
TT	STP Inter-task Trace Table	TTT	847
TV	Tape Volume Table	TVT	849
TX	Task Execution Table	TXT	851
TXT	Loader Text Table	LDRTXT	856
TY	TQM snap body	TBY	840
UC	SPM User Call Usage Report	UCR	740
UCH	Unicos Channel Table	UCH	858
UD	User Driver Table	UDT	859
UP	User Security Priviledge Table	UPT	864
UT	User task status block	UTSB	865
UT	Utility library error message numbers	COMUER	862
VP	ISP Virtual Circuit Pointer Table	VPT	866
WP	Swap Space Table	WPT	642
XAT	DSC Extension high memory allocation table	XAT	868
XD	Dataset Enquiry Auxiliary Information Table	XDE	62
XD	Dataset Update Auxiliary Information Table	XDU	64
XF	History Trace Function Table	XFT	869
XP	Exchange Package	XP	870
XR	Remount/Mount Auxiliary Information Table	XRM	60
XRT	Loader External Relocation Table	XRT	885
XT	Auxiliary Text Message Table	XTM	69
XT	History Trace Table	XTT	887
XV	Volume Access Auxiliary Information Table	XVA	65
XV	Volume Update Auxiliary Information Table	XVU	67
ZDV	Startup Device Label Table	ZDVLT	890
ZM	Startup Managed Table	ZMTR	889
ZMG	Startup Log Message Control	ZMGCODES	892
ZMG	Startup Permanent Dataset Recovery Message	ZMG	893
ZMH	Startup ZMG Table Header	ZMH	895
ZPA	Startup Message Parameter Control Words	ZPA	896
ZPC	Startup Message Parameter Table	ZPC	897
ZSB	STARTUP submitted jobs table	ZSB	891

TABLE OF CONTENTS BY TABLE NAME

EVW		EVW	215
MC		MC	472
NFPK		NFPK	517
PDL		PDL	583
PERT		PERT	598
SSW		SSW	752
TEV		TEV	806
TQP		TQP	836
OLA	ACB Header part	OLA	518
OLL	ACB Header part	OLL	521
TL	ANSI\IBM Tape Label Definitions	TLB	813
AQ	APT(Packet) Queuing Header Table	AQT	53
AU	Active User Table	AUT	56
ASP	Alternate slot parameter block	ASP	687
AP	Any Packet Table	APT	21
XT	Auxiliary Text Message Table	XTM	69
KB	BACKUP CATALOG DATASET	KB	386
KV	BACKUP VOLUME CATALOG	KV	407
BG	Begin Code Execution Table	BGN	79
BA	Binary audit table	BAT	70
CW	Block or Record Control Word	CW	108
Q	Buffer Pool Queue Control Word	QC	84
BP	Buffer Pool Table	BPT	83
AR	CFT call-by-address parameter block	ARLST	714
CT	CIO history trace buffer	CIOT	96
CN	CNT Tape Sub-entry	CNT	103
CN	CPU status definition sub-entry	CNCS	102
CED	Catalog Entry Descriptor	CED	94
CC	Chain Control Word	CMCC	91
CI	Chain Item	CI	93
CB	Channel Buffer Table	CBT	88
CX	Channel Extension Table Header	CXT	110
CH	Channel Table	CHT	95
CS	Class Structure Definition	CSD	105
CN	Configuration Table	CNT	98
ONC	Connection Reference - ONC	ONC	548
CT	Create task request	EXRQ	234
DZ	DAT Accumulation List Information Table	DZT	647
DQ	DQM Queue	DQ	176
DT	DQM history trace buffer	DQMT	178
DX	DSC Extension Information Table	DXI	193
XAT	DSC Extension high memory allocation table	XAT	868
DX	DSC Extension page definition table	DXT	194
DA	Dataset Allocation Table	DAT	111
DC	Dataset Catalog	DSC	118
DD	Dataset Definition List	DDL	125
XD	Dataset Enquiry Auxiliary Information Table	XDE	62
DI	Dataset Information Table	DIT	147
DN	Dataset Name Table	DNT	153
DP	Dataset Parameter Table	DSP	164
XD	Dataset Update Auxiliary Information Table	XDU	64
DM	Debug Map Table header	DMT	151
QUE	Define Multitasking Queue Header Words	MTQ	491
OTX	Demultiplexer ACB	OTX	558
DV	Device Label Table	DVL	191
DQT	Diagnostic Queue Table	DQT	179

TABLE OF CONTENTS BY TABLE NAME

F	Diagnostic Request Table	COMDIA	132
DT	Disk Control Path Table	DCT	187
DR	Disk Reservation Table	DRT	181
EC	EXP Error Code Table	EXERR	219
ER	EXP User Call Table	UCT	857
ET	EXP history trace buffer	EXPT	233
ET	Encryption Parameter Table	EPT	214
EFT	Engineering Flaw Table	EFT	196
EQ	Equipment table	EQT	200
EP	Event Pool Entry	EP	217
EW	Event Wait Table	EWT	216
XP	Exchange Package	XP	870
EPT	Execution Profile Table	EPT	198
DR	F\$DRIVER parameter block	DRPB	183
ER	F\$ERCL parameter block	ERPB	212
FGS	F\$GOS interface definition	FGS	250
IJ	F\$IJMSG parameter block	IJPB	295
OM	F\$OPMSG parameter block	OM	540
QMP	F\$SDTQM parameter block	QMPB	666
TK	F\$TASK Table	TKT	812
TBL	F\$TBL Call Block	TBLC	825
FS	FSS Device Statistics Table	FS	256
DL	First Dataset Label Group	TLB	816
OTF	Flow control confirmation parameter	OTF	562
FH	Front-end servicing header	FSH	254
GCH	GOS Channel Table	GCH	257
GS	Generic Resource Statistics Table	GS	263
GR	Generic Resource Table	GRT	261
GOS	Guest operating system table for EXEC	GOS	258
OTH	Handler ACB	OTH	563
HMR	Hardware Performance Monitor - F\$PERF request	HMR	269
HM	Hardware Performance Monitor Control Block	HM	267
HP	Heap block control words	HP	264
HT	Heap statistics table	HT	265
XF	History Trace Function Table	XFT	869
XT	History Trace Table	XTT	887
IV	IBM Standard Label - Volume Label	TLB	815
AE	IOP Error Channel Message	AEM	10
AR	IOP Recovered Disk Error Message	ARM	54
IQ	IQM Task Reply Table	IQREP	703
DT	IQM history trace buffer	IQMT	328
IA	ISP Application Level Messages	IA	272
II	ISP Dataset Definition Table	IDD	293
IH	ISP Header block Headers	IH	289
IL	ISP Link Table	ILT	301
IR	ISP Request Table	IR	330
IX	ISP Text Record	ITX	342
IM	ISP Transport Message	IM	309
IT	ISP Transport Request Block	TRB	334
VP	ISP Virtual Circuit Pointer Table	VPT	866
IV	ISP Virtual Circuit Table	VCT	338
IS	ISPMAIN Status Table	IST	331
IO	I\O Common Function Codes	IOF	323
MH	Inter-job communication message buffer	MHB	300
IPT	Inter-job communication path table	IPT	324
OS	Inter-operating system communication table	OS	553

TABLE OF CONTENTS BY TABLE NAME

IB	Interactive Buffer Table	IBT	286
IN	Internal Station Status Table	INS	320
ONH	Internet Header format	ONH	549
IR	Invoke request word	JSH	358
EC	J\$AWAIT Parameter Call Block	EC	218
JB	JCL Block Information Table	JBI	346
JS	JCL Symbol Table	JST	354
DT	JSH history trace buffer	JSHT	359
JIE	JSH internal event trace buffer	JIET	360
AC	Job Accounting Table	JAC	4
STP	Job Card Values	STP	759
JC	Job Communication Block	JCB	347
JX	Job Execution Table	JXT	379
J	Job Scheduler (JSH) Equates	JSH	355
JT	Job Table Area	JTA	362
JA	Job-assisted event definition table	JAE	343
LD	Label Definition Table	LDT	414
LC	Link Configuration Table	LCT	412
LP	Link Control Package	LCP	692
LP	Link Control Package Extension	LCPE	699
LX	Link Extension Table	LXT	464
LT	Link Interface Table	LIT	429
LP	Link Trailer Package	LTP	700
OLZ	Link trace - protocol message	OLZ	538
BRT	Loader Block Relocation Table	BRT	85
DF	Loader Directory Table	DFT	130
DPT	Loader Duplication Table	DPT	174
XRT	Loader External Relocation Table	XRT	885
PDT	Loader Program Description Table	PDT	585
SMT	Loader Symbol Table	SMT	721
TXT	Loader Text Table	LDRTXT	856
LF	Logical File Table	LFT	425
LO	Logical Request Table	LOR	426
KM	MASTER CATALOG DATASET	KM	399
MTH	MTHTC - Multitasking history trace codes	MTHTC	490
MR	Memory Definitions	MEM	485
ME	Memory Error Table	ME	483
MP	Memory Pool	MPH	486
PT	Memory Pool Table	PT	652
MS	Memory Segment Table	MST	488
MCT	Message Control Table	MCT	476
MD	Mode Parameter Word	MD	479
OTM	Multiplexer ACB	OTM	560
NMD	New Format Memory Descriptor	NMD	482
NC	Node Control Block	NCB	298
T	On-line Tape Parameter Definitions	TAPE	767
OD	Open Dataset Table	ODN	492
KL	PDM Archiving Task Logon Table	KL	395
PGT	PDM Page Table	PGT	599
PQ	PDM Request Definitions	COMPQ	636
OP	Parameter Block for F\$OPT	OPT	551
PC	Parameter Control Table	PCT	477
PC	Parameter Control Table Entry	PCT	478
PA	Parameter Information Table	PAT	579
PWT	Partial Word Table	PWT	659
PC	Per-device accounting table	PC	580

TABLE OF CONTENTS BY TABLE NAME

PM	Permanent Dataset Definition	PDD	605
PI	Permanent Dataset Information	PDI	603
PD	Permanent Dataset Table	PDS	581
PER	Permit DXT entry	DXPERM	597
PH	Physical Request Table	PHR	601
PP	Position Parameter List	PPL	604
PR	Preemption Table	PRT	639
PDL	Preferred device entry	PDL	584
PR	Procedure File Stack Table	PR	637
PS	Process Save Area	PSA	650
PW	Processor Working Storage	PWS	653
PX	Processor execution table	PX	660
QC	Queue Control Table	QCT	662
ER	Queue manager error codes	QMERR	231
QD	Queued Dataset Table	QDT	665
QR	Queued I/O Request Table	QRT	670
QP	Queued Packet Table	QPT	668
RER	RDM ERROR CODE VALUES.	RDMER	458
RFC	RDM FUNCITON CODES.	RDMFC	460
RL	RDM Logging Table	RLL	462
RB	Receive Buffer Table	RBT	672
RCB	Receptive Control Block	RCB	299
RIT	Registered ID table	RIT	327
XR	Remount/Mount Auxiliary Information Table	XRM	60
RPV	Repreive Data Table	RPVT	678
RA	Resource Allocation Table	RAT	645
RD	Resource Dataset Definition Table	RDD	433
RR	Resource Dataset Page	RDP	475
RA	Resource dataset Account Entry	RDA	440
RI	Resource dataset Information Entry	RDI	454
RE	Resource dataset User Entry	RDE	445
RJ	Rolled Job Index Table	RJ	673
RJ	Rolled job index table equates	RJCODES	675
SEP	SEP - control statement separator codes	COMSEP	713
OEA	SL2 Activity Control Block	OEA	493
OEB	SL2 Buffer	OEB	495
OEC	SL2 Character pointer	OEC	497
OEG	SL2 Global Activity List	OEG	498
OIB	SL2 IPC communication block	IPCB	504
OIC	SL2 IPC connection table	ICB	507
OII	SL2 IPC queue item	OII	513
OIQ	SL2 IPC queue structure	OIQ	515
OIS	SL2 IPC server name table	OIS	516
OEQ	SL2 Queue Table	OEQ	500
OES	SL2 State Table	OES	502
OET	SL2 Timer Block	OET	503
CP	SPM CPU Utilization Report	CPR	731
IC	SPM Channel Interrupt Report	ICR	741
DC	SPM Disk Channel Utilization Report	DCR	737
DU	SPM Disk Utilization Report	DUR	735
EC	SPM Executive Call Report	ECR	739
ER	SPM Executive Request Report	ERR	734
LU	SPM Link Utilization Report	LUR	738
MU	SPM Memory Utilization Report	MUR	744
SB	SPM System Buffer Utilization Report	SBR	742
TK	SPM Task Utilization Report	TKR	733

TABLE OF CONTENTS BY TABLE NAME

UC	SPM User Call Usage Report	UCR	740
SA	SSD Active Channel Table	SAC	682
SRQ	SSD Request/Reply Queue Table	SRQ	748
SSW	SSD Status Word	SSW	753
ZSB	STARTUP submitted jobs table	ZSB	891
IC	STP Inter-task Communication Table	ICT	287
TM	STP Inter-task Message Table	TMT	822
TT	STP Inter-task Trace Table	TTT	847
DF	STP task display format control table	DF	128
OLF	SUPERLINK FCPU word	OLF	537
OLH	SUPERLINK Link Header	OLH	534
OLP	SUPERLINK Link Path Table	LPT	522
OLS	SUPERLINK Link subheader	OLS	535
OLM	SUPERLINK Message Proper	OLM	536
ONA	SUPERLINK NSAP Activity Table Header	NAT	547
ONW	SUPERLINK Network Address	ONW	546
ONB	SUPERLINK Network Connection Request Block	NCRB	544
ONN	SUPERLINK Network Node Table	NNT	543
ONR	SUPERLINK Network Routing Table	NRT	542
IN	SYSTEM TABLE DESCRIPTIONS	INTRO	1
ID	Second IBM Dataset Label Group	TLB	819
SW	Security Swap Table	SWT	762
HS	Simulated high-speed channel protocol	HSR	271
SH	Stack Control Header	SH	757
SS	Stack Segment Linkage Control	SS	758
SS	Staging Stream Table	SST	749
ZDV	Startup Device Label Table	ZDVL	890
ZMG	Startup Log Message Control	ZMGC	892
ZM	Startup Managed Table	ZMTR	889
ZPA	Startup Message Parameter Control Words	ZPA	896
ZPC	Startup Message Parameter Table	ZPC	897
ZMG	Startup Permanent Dataset Recovery Message	ZMG	893
ZMH	Startup ZMG Table Header	ZMH	895
SAL	Station Alternative format	SAL	686
SF	Statistics format	SFT	719
SR0	Status Register 0	SR0	746
SC	Subsystem Control Table	SCT	691
WP	Swap Space Table	WPT	642
SB	System Billing Unit Table	SBU	688
SD	System Dataset Table	SDT	704
SD	System Directory Recovery	SDR	712
SDP	System Dump Header Fields	SDP	711
MDW	System Dump Memory Descriptor Words	MDW	480
DM	System Dump Parameters	DMP	148
SQ	System Lock Queue	SLQ	745
ST	System Task Table	STT	754
OUP	T-USER to TS parameter block	OUP	843
CT	TIO history trace buffer	TIOT	810
OTD	TPDU Disassembly block	OTD	556
TPE	TPS Table Entry	TPS	833
TY	TQM snap body	TBY	840
TE	TQM snap entry header	TSE	839
TS	TQM trace sub-buffer header	TSB	838
OTP	TS to T-USER parameter block	OTP	845
TN	Table Name Table	TNT	824
TA	Tape Accounting Log Message	TAT	763

TABLE OF CONTENTS BY TABLE NAME

TD	Tape Device Table	TDT	786
TET	Tape Error Table	TET	805
TM	Tape Label Migration Table	TMT	823
TL	Tape Label Table	TLT	821
TP	Tape Position Information Table	TPI	829
TPS	Tape Processing State Table	TPS	832
TP	Tape Processing Table	TP	831
T	Tape Queue Manager Equates	COMTQM	834
TV	Tape Volume Table	TVT	849
AT	Task Accounting table	TAC	9
TP	Task Breakpoint Table	TBPT	769
TBL	Task Common Block Table	TBLK	770
TC	Task Control Array	TCA	785
TC	Task Control Block	TCB	773
TX	Task Execution Table	TXT	851
TI	Task Information Block	TIB	807
RQ	Task Request Table	RQT	679
DQ	Task reply tables	DQREP	701
TQ	Task reply tables	TQREP	702
TE	Time Event Table	TET	803
TB	Trace parameter block	TPB	837
TNB	Traceback Name Block	TNB	826
TR	Track Permanent Accesses	TRA	841
TF	Transfer Table	TFT	648
OTU	Transport TPDU - CR/CC form	OTU	574
OTV	Transport TPDU - variable parameter	OTV	578
OTO	Transport buffer ordering	OTO	577
OTS	Transport statistics block	OTS	572
UCH	Unicos Channel Table	UCH	858
UD	User Driver Table	UDT	859
ER	User Errors	USERR	220
UP	User Security Priviledge Table	UPT	864
UT	User task status block	UTSB	865
UT	Utility library error message numbers	COMUER	862
XV	Volume Access Auxiliary Information Table	XVA	65
XV	Volume Update Auxiliary Information Table	XVU	67

TABLE OF CONTENTS BY MNEMONIC

AE	IOP Error Channel Message	AEM	10
AP	Any Packet Table	APT	21
AQ	APT(Packet) Queuing Header Table	AQT	53
AR	CFT call-by-address parameter block	ARLST	714
AR	IOP Recovered Disk Error Message	ARM	54
ASP	Alternate slot parameter block	ASP	687
AU	Active User Table	AUT	56
BA	Binary audit table	BAT	70
BG	Begin Code Execution Table	BGN	79
BP	Buffer Pool Table	BPT	83
BRT	Loader Block Relocation Table	BRT	85
CB	Channel Buffer Table	CBT	88
CED	Catalog Entry Descriptor	CED	94
CH	Channel Table	CHT	95
CI	Chain Item	CI	93
CT	CIO history trace buffer	CIOT	96
CC	Chain Control Word	CMCC	91
CN	CPU status definition sub-entry	CNCS	102
CN	CNT Tape Sub-entry	CNT	103
CN	Configuration Table	CNT	98
F	Diagnostic Request Table	COMDIA	132
PQ	PDM Request Definitions	COMPQ	636
SEP	SEP - control statement separator codes	COMSEP	713
T	On-line Tape Parameter Definitions	COMTAPE	767
T	Tape Queue Manager Equates	COMTQM	834
UT	Utility library error message numbers	COMUER	862
CP	SPM CPU Utilization Report	CPR	731
CS	Class Structure Definition	CSD	105
CW	Block or Record Control Word	CW	108
CX	Channel Extension Table Header	CXT	110
DA	Dataset Allocation Table	DAT	111
DC	SPM Disk Channel Utilization Report	DCR	737
DT	Disk Control Path Table	DCT	187
DD	Dataset Definition List	DDL	125
DF	STP task display format control table	DF	128
DF	Loader Directory Table	DFT	130
DI	Dataset Information Table	DIT	147
DM	System Dump Parameters	DMP	148
DM	Debug Map Table header	DMT	151
DN	Dataset Name Table	DNT	153
DPT	Loader Duplication Table	DPT	174
DQ	DQM Queue	DQ	176
DT	DQM history trace buffer	DQMT	178
DQ	Task reply tables	DQREP	701
DQT	Diagnostic Queue Table	DQT	179
DR	F\$DRIVER parameter block	DRPB	183
DR	Disk Reservation Table	DRT	181
DC	Dataset Catalog	DSC	118
DP	Dataset Parameter Table	DSP	164
DU	SPM Disk Utilization Report	DUR	735
DV	Device Label Table	DVL	191
DX	DSC Extension Information Table	DXI	193
PER	Permit DXT entry	DXPERM	597
DX	DSC Extension page definition table	DXT	194
DZ	DAT Accumulation List Information Table	DZT	647
EC	J\$AWAIT Parameter Call Block	EC	218

TABLE OF CONTENTS BY MNEMONIC

EC	SPM Executive Call Report	ECR	739
EFT	Engineering Flaw Table	EFT	196
EP	Event Pool Entry	EP	217
EPT	Execution Profile Table	EPT	198
ET	Encryption Parameter Table	EPT	214
EQ	Equipment table	EQT	200
ER	F\$ERCL parameter block	ERPB	212
ER	SPM Executive Request Report	ERR	734
EVW		EVW	215
EW	Event Wait Table	EWT	216
EC	EXP Error Code Table	EXERR	219
ET	EXP history trace buffer	EXPT	233
CT	Create task request	EXRQ	234
FGS	F\$GOS interface definition	FGS	250
FS	FSS Device Statistics Table	FS	256
FH	Front-end servicing header	FSH	254
GCH	GOS Channel Table	GCH	257
GOS	Guest operating system table for EXEC	GOS	258
GR	Generic Resource Table	GRT	261
GS	Generic Resource Statistics Table	GS	263
HM	Hardware Performance Monitor Control Block	HM	267
HMR	Hardware Performance Monitor - F\$PERF request	HMR	269
HP	Heap block control words	HP	264
HS	Simulated high-speed channel protocol	HSR	271
HT	Heap statistics table	HT	265
IA	ISP Application Level Messages	IA	272
IB	Interactive Buffer Table	IBT	286
OIC	SL2 IPC connection table	ICB	507
IC	SPM Channel Interrupt Report	ICR	741
IC	STP Inter-task Communication Table	ICT	287
II	ISP Dataset Definition Table	IDD	293
IH	ISP Header block Headers	IH	289
IJ	F\$IJMSG parameter block	IJPB	295
IL	ISP Link Table	ILT	301
IM	ISP Transport Message	IM	309
IN	Internal Station Status Table	INS	320
IN	SYSTEM TABLE DESCRIPTIONS	INTRO	1
IO	I\O Common Function Codes	IOF	323
OIB	SL2 IPC communication block	IPCB	504
IPT	Inter-job communication path table	IPT	324
DT	IQM history trace buffer	IQMT	328
IQ	IQM Task Reply Table	IQREP	703
IR	ISP Request Table	IR	330
IS	ISPMMAIN Status Table	IST	331
IX	ISP Text Record	ITX	342
AC	Job Accounting Table	JAC	4
JA	Job-assisted event definition table	JAE	343
JB	JCL Block Information Table	JBI	346
JC	Job Communication Block	JCB	347
JIE	JSH internal event trace buffer	JIET	360
J	Job Scheduler (JSH) Equates	JSH	355
IR	Invoke request word	JSH	358
DT	JSH history trace buffer	JSHT	359
JS	JCL Symbol Table	JST	354
JT	Job Table Area	JTA	362
JX	Job Execution Table	JXT	379

TABLE OF CONTENTS BY MNEMONIC

KB	BACKUP CATALOG DATASET	KB	386
KL	PDM Archiving Task Logon Table	KL	395
KM	MASTER CATALOG DATASET	KM	399
KV	BACKUP VOLUME CATALOG	KV	407
LP	Link Control Package	LCP	692
LP	Link Control Package Extension	LCPE	699
LC	Link Configuration Table	LCT	412
TXT	Loader Text Table	LDRTXT	856
LD	Label Definition Table	LDT	414
LF	Logical File Table	LFT	425
LT	Link Interface Table	LIT	429
LO	Logical Request Table	LOR	426
OLP	SUPERLINK Link Path Table	LPT	522
LP	Link Trailer Package	LTP	700
LU	SPM Link Utilization Report	LUR	738
LX	Link Extension Table	LXT	464
MC		MC	472
MCT	Message Control Table	MCT	476
MD	Mode Parameter Word	MD	479
MDW	System Dump Memory Descriptor Words	MDW	480
ME	Memory Error Table	ME	483
MR	Memory Definitions	MEM	485
MH	Inter-job communication message buffer	MHB	300
MP	Memory Pool	MPH	486
MS	Memory Segment Table	MST	488
MTH	MTHTC - Multitasking history trace codes	MTHTC	490
QUE	Define Multitasking Queue Header Words	MTQ	491
MU	SPM Memory Utilization Report	MUR	744
ONA	SUPERLINK NSAP Activity Table Header	NAT	547
NC	Node Control Block	NCB	298
ONB	SUPERLINK Network Connection Request Block	NCRB	544
NFPK		NFPK	517
NMD	New Format Memory Descriptor	NMD	482
ONN	SUPERLINK Network Node Table	NNT	543
ONR	SUPERLINK Network Routing Table	NRT	542
OD	Open Dataset Table	ODN	492
OEA	SL2 Activity Control Block	OEA	493
OEB	SL2 Buffer	OEB	495
OEC	SL2 Character pointer	OEC	497
OEG	SL2 Global Activity List	OEG	498
OEQ	SL2 Queue Table	OEQ	500
OES	SL2 State Table	OES	502
OET	SL2 Timer Block	OET	503
OII	SL2 IPC queue item	OII	513
OIQ	SL2 IPC queue structure	OIQ	515
OIS	SL2 IPC server name table	OIS	516
OLA	ACB Header part	OLA	518
OLF	SUPERLINK FCPU word	OLF	537
OLH	SUPERLINK Link Header	OLH	534
OLL	ACB Header part	OLL	521
OLM	SUPERLINK Message Proper	OLM	536
OLS	SUPERLINK Link subheader	OLS	535
OLZ	Link trace - protocol message	OLZ	538
OM	F\$OPMSG parameter block	OM	540
ONC	Connection Reference - ONC	ONC	548
ONH	Internet Header format	ONH	549

TABLE OF CONTENTS BY MNEMONIC

ONW	SUPERLINK Network Address	ONW	546
OP	Parameter Block for F\$OPT	OPT	551
OS	Inter-operating system communication table	OS	553
OTD	TPDU Disassembly block	OTD	556
OTF	Flow control confirmation parameter	OTF	562
OTH	Handler ACB	OTH	563
OTM	Multiplexer ACB	OTM	560
OTO	Transport buffer ordering	OTO	577
OTP	TS to T-USER parameter block	OTP	845
OTS	Transport statistics block	OTS	572
OTU	Transport TPDU - CR/CC form	OTU	574
OTV	Transport TPDU - variable parameter	OTV	578
OTX	Demultiplexer ACB	OTX	558
OUP	T-USER to TS parameter block	OUP	843
PA	Parameter Information Table	PAT	579
PC	Per-device accounting table	PC	580
PC	Parameter Control Table	PCT	477
PC	Parameter Control Table Entry	PCT	478
PM	Permanent Dataset Definition	PDD	605
PI	Permanent Dataset Information	PDI	603
PDL		PDL	583
PDL	Preferred device entry	PDL	584
PD	Permanent Dataset Table	PDS	581
PDT	Loader Program Description Table	PDT	585
PERT		PERT	598
PGT	PDM Page Table	PGT	599
PH	Physical Request Table	PHR	601
PP	Position Parameter List	PPL	604
PR	Procedure File Stack Table	PR	637
PR	Preemption Table	PRT	639
PS	Process Save Area	PSA	650
PT	Memory Pool Table	PT	652
PW	Processor Working Storage	PWS	653
PWT	Partial Word Table	PWT	659
PX	Processor execution table	PX	660
Q	Buffer Pool Queue Control Word	QC	84
QC	Queue Control Table	QCT	662
QD	Queued Dataset Table	QDT	665
ER	Queue manager error codes	QMERR	231
QMP	F\$SDTQM parameter block	QMPB	666
QP	Queued Packet Table	QPT	668
QR	Queued I/O Request Table	QRT	670
RA	Resource Allocation Table	RAT	645
RB	Receive Buffer Table	RBT	672
RCB	Receptive Control Block	RCB	299
RA	Resource dataset Account Entry	RDA	440
RD	Resource Dataset Definition Table	RDD	433
RE	Resource dataset User Entry	RDE	445
RI	Resource dataset Information Entry	RDI	454
RER	RDM ERROR CODE VALUES.	RDMER	458
RFC	RDM FUNCITON CODES.	RDMFC	460
RR	Resource Dataset Page	RDP	475
RIT	Registered ID table	RIT	327
RJ	Rolled Job Index Table	RJ	673
RJ	Rolled job index table equates	RJCODES	675
RL	RDM Logging Table	RLL	462

TABLE OF CONTENTS BY MNEMONIC

RPV	Repreive Data Table	RPVT	678
RQ	Task Request Table	RQT	679
SA	SSD Active Channel Table	SAC	682
SAL	Station Alternative format	SAL	686
SB	SPM System Buffer Utilization Report	SBR	742
SB	System Billing Unit Table	SBU	688
SC	Subsystem Control Table	SCT	691
SDP	System Dump Header Fields	SDP	711
SD	System Directory Recovery	SDR	712
SD	System Dataset Table	SDT	704
SF	Statistics format	SFT	719
SH	Stack Control Header	SH	757
SQ	System Lock Queue	SLQ	745
SMT	Loader Symbol Table	SMT	721
SR0	Status Register 0	SR0	746
SRQ	SSD Request/Reply Queue Table	SRQ	748
SS	Stack Segment Linkage Control	SS	758
SS	Staging Stream Table	SST	749
SSW		SSW	752
SSW	SSD Status Word	SSW	753
STP	Job Card Values	STP	759
ST	System Task Table	STT	754
SW	Security Swap Table	SWT	762
AT	Task Accounting table	TAC	9
TA	Tape Accounting Log Message	TAT	763
TBL	F\$TBL Call Block	TBLC	825
TBL	Task Common Block Table	TBLK	770
TP	Task Breakpoint Table	TBPT	769
TY	TQM snap body	TBY	840
TC	Task Control Array	TCA	785
TC	Task Control Block	TCB	773
TD	Tape Device Table	TDT	786
TE	Time Event Table	TET	803
TET	Tape Error Table	TET	805
TEV		TEV	806
TF	Transfer Table	TFT	648
TI	Task Information Block	TIB	807
CT	TIO history trace buffer	TIOT	810
TK	SPM Task Utilization Report	TKR	733
TK	F\$TASK Table	TKT	812
TL	ANSI\IBM Tape Label Definitions	TLB	813
IV	IBM Standard Label - Volume Label	TLB	815
DL	First Dataset Label Group	TLB	816
ID	Second IBM Dataset Label Group	TLB	819
TL	Tape Label Table	TLT	821
TM	STP Inter-task Message Table	TMT	822
TM	Tape Label Migration Table	TMT	823
TNB	Traceback Name Block	TNB	826
TN	Table Name Table	TNT	824
TP	Tape Processing Table	TP	831
TB	Trace parameter block	TPB	837
TP	Tape Position Information Table	TPI	829
TPS	Tape Processing State Table	TPS	832
TPE	TPS Table Entry	TPS	833
TQP		TQP	836
TQ	Task reply tables	TQREP	702

TABLE OF CONTENTS BY MNEMONIC

TR	Track Permanent Accesses	TRA	841
IT	ISP Transport Request Block	TRB	334
TS	TQM trace sub-buffer header	TSB	838
TE	TQM snap entry header	TSE	839
TT	STP Inter-task Trace Table	TTT	847
TV	Tape Volume Table	TVT	849
TX	Task Execution Table	TXT	851
UCH	Unicos Channel Table	UCH	858
UC	SPM User Call Usage Report	UCR	740
ER	EXP User Call Table	UCT	857
UD	User Driver Table	UDT	859
UP	User Security Priviledge Table	UPT	864
ER	User Errors	USERR	220
UT	User task status block	UTSB	865
IV	ISP Virtual Circuit Table	VCT	338
VP	ISP Virtual Circuit Pointer Table	VPT	866
WP	Swap Space Table	WPT	642
XAT	DSC Extension high memory allocation table	XAT	868
XD	Dataset Enquiry Auxiliary Information Table	XDE	62
XD	Dataset Update Auxiliary Information Table	XDU	64
XF	History Trace Function Table	XFT	869
XP	Exchange Package	XP	870
XR	Remount/Mount Auxiliary Information Table	XRM	60
XRT	Loader External Relocation Table	XRT	885
XT	Auxiliary Text Message Table	XTM	69
XT	History Trace Table	XTT	887
XV	Volume Access Auxiliary Information Table	XVA	65
XV	Volume Update Auxiliary Information Table	XVU	67
ZDV	Startup Device Label Table	ZDVLT	890
ZMG	Startup Permanent Dataset Recovery Message	ZMG	893
ZMG	Startup Log Message Control	ZMGCODES	892
ZMH	Startup ZMG Table Header	ZMH	895
ZM	Startup Managed Table	ZMTR	889
ZPA	Startup Message Parameter Control Words	ZPA	896
ZPC	Startup Message Parameter Table	ZPC	897
ZSB	STARTUP submitted jobs table	ZSB	891

INTRODUCTION

This manual graphically shows the tables used by the Cray Operating System (COS). These tables are automatically derived from the system code by a series of programs collectively known as the "table diagram generator." The Table Diagram Generator is described in Cray Research, Inc. publication SM-0075, COS Table Diagram Generator Reference Manual.

Introductions and other explanatory material are taken from SYSTXT and COSTXT.

This manual is derived from the COS 1.17 COSPL and SYSDFPL.

CONVENTIONS

Table diagrams use the following symbols:

- \$ When two appear on the same line, indicates a range of words not shown. When one appears at the end of one line and another at the beginning of the next, indicates a field crossing a word boundary.
- * Indicates that a field is too short to contain its label.
- / Indicates an unused area of a table. Hashed areas can contain information used elsewhere in the system, such as a front-end station.

Numbers in table descriptions are denoted as follows:

- O' Indicates an octal number.
- D' Indicates a decimal number.

Throughout this manual, word numbers are shown in octal. Bit numbers are decimal.

FIELDS REQUIRED FOR DIAGRAM GENERATION

Some field descriptions read "Required for table diagram generator." These fields must be defined twice to make the diagram more accurate. The first definition supplies the W@ tag; the second, at the end of the table, supplies the S@ and N@ tags. This method allows the generator to draw multiple-word fields.

Definitions are not available for the following tables:

EVW PERT SSL

The following comdecks contain no definitions:

COMEXFC	COMMENT
COMHD	COMPVC
COMIQT	COMSMC
COMLCK	
COMMATH	

Definitions from COMSEG are contained in the Front-End Protocol Internal Reference Manual, Publication No. SM-0042.

The following tables are not included:

CAT	- Channel Address Table
CLT	- Channel Limit Table
CMOD	- Communication modules
CPT	- Class Parameter Tables
ECT	- Error Code Table
FIQ	- Free input packet queue
FOQ	- Free output packet queue
ICT	- Interrupt count table
IHT	- Interrupt handler table
MCT	- Monitor Count Table (There is a "MCT - Message Control Table")
MEL	- Memory Error Log Table
ODT	- Overlay Directory Table
OLL	- Overlay Load List
PXT	- (see 'PX' in tables of contents)
RJI	- (see 'RJ' in tables of contents)
RMS	- Read Margin Select Table
STPD	- STP Dump Directory
STX	- System Task Exchange Package Table
UCT	- (see 'UCR' in tables of contents)

A relocatable binary program consists of a single record composed of a series of tables. The table type through COS Release 1.14 has been contained in bits 0 through 3 of the first word of each table. In COS Release 1.15, for table types 0, 1, 2, 3, 4, 5, and 12, the table type field is extended using bits 4 through 6 of the first word of the table.

Loader table descriptions are located in this manual according to the alphabetical order of their comdeck names. Consult the tables of contents for easy location of these tables.

Summary of loader tables

Name	Type (octal)	Name
BRT	15	Block Relocation Table
DFT	10	Directory (BUILD)
DMT	07	Debug Map Table (This table type is not used beginning with Release 1.15)
DMX	007	Debug Map Table (Extended) (This table type is first used beginning with Release 1.15)
DPT	13	Duplication Table
PDT	17	Program Description Table
PWT	06	Partial Word Table
SMT	11	Symbol Table
TXT	16	Text Table
XRT	14	External Relocation Table
	011	New SMT
	021	New (common block) SMT

The Symbol Tables (table types 011 and 021 (octal)) are described in a separate publication, SN-0225, Symbol Tables Manual.

The first table in a relocatable module is the Program Description Table.

*CALLs to most COS field definitions follow. *
 Common deck names are in alphabetical order. *

*CALL COMAC at this ident + 1

COPYRIGHT BY CRAY RESEARCH, INC. *

UNPUBLISHED - ALL RIGHTS RESERVED UNDER THE COPYRIGHT LAWS *
 OF THE UNITED STATES. *

The Job Accounting Table, illustrated in figure AC-1, defines the format of data returned to the user by the F\$ACT call.

L@ACSIT = 5

0.....+.....1.....+.....2.....+.....3.....+.....4.....+.....5.....+.....6.....

0		JN			
1		TSX			
2		TSW			
3		TSD			
4		IOB			
5		IOR			
6		USR			
7		USR1			
10		XMI			
11		DMI			
12		TID			
13		TL			
14		RSVD			
15					
16					
17		SITB			
23					
24		ACN			
25					

Figure AC-1. Job Accounting Table

	0....+	1....+	2....+	3....+	4....+	5....+	6....
26				PWD			
27						/////////	
30		MXM		MIM		OPC	
31		PFA		PFS		CLC	
32		TFS		MRD	JSP	//////////	
33		BRF		BSF		TERM	
34			JCN			PRI	
35			TSB				
36			TWJ				
37			TSBU				
40			IOF				
41			XX2				
42	DID	//////////					
43		MXFL		MIFL		JSQ	
44		MXJT		MIJT		//////////	
45			OWN				
46						/////////	
47		TACL	/////////		TACA		
50		GUTL	/////////		GUTA		
51		FUTL	/////////		FUTA		
52			IOS				
53			TSWS				
54			SMI				
55		EUSA			EUNI		
56		QUPR	//////////			UCHR	

Figure AC-1. Job Accounting Table

<u>Field</u>	<u>Word(base8)</u>	<u>Bits</u>	<u>Description</u>
ACJN	0	0-55	Job name
ACTSX	1	0-63	Timestamp units executing in CPU
ACTSW	2	0-63	Timestamp units waiting for CPU
ACTSD	3	0-63	Timestamp units waiting for I/O
ACIOB	4	0-63	Disk sectors moved
ACIOR	5	0-63	Physical I/O requests
ACUSR	6	0-63	Characters 1-8 of user number
ACUSR1	7	0-55	Character 9-15 of user number
ACXMI	10	0-63	Memory integral (execution) in units of word-seconds
ACDMI	11	0-63	Memory integral (I/O wait) in units of word-seconds
ACTID	12	0-63	Terminal ID
ACTL	13	0-63	Job time limit (timestamp units)
ACRSVD	14-16	0-63	Reserved for use by site
ACSITB	17-23	0-63	Reserved for use by site W@ACSIT1=W@ACSITB W@ACSIT2=W@ACSITB+1 W@ACSIT3=W@ACSITB+2 W@ACSIT4=W@ACSITB+3 W@ACSIT5=W@ACSITB+4
ACACN	24-25	0-63	1-15 character account number
ACACN1	24	0-63	Characters 1-8 of account number
ACACN2	25	0-55	Characters 9-15 of account number
ACPWD	26-27	0-63	1-15 Character password
ACPWD1	26	0-63	Characters 1-8 of password
ACPWD2	27	0-55	Characters 9-15 of password
ACMXM	30	0-23	Maximum job size
ACMIM	30	24-47	Minimum job size
ACOPC	30	48-63	Number of OPEN calls

<u>Field</u>	<u>Word(base8)</u>	<u>Bits</u>	<u>Description</u>
ACPFPA	31	0-23	Permanent file space accessed, in blocks
ACPFPS	31	24-47	Permanent file space saved, in blocks
ACCLC	31	48-63	Number of CLOSE calls
ACTFSS	32	0-23	Temporary file space used, in blocks
ACMRD	32	24-39	Number of memory resident datasets
ACJSP	32	40-47	P parameter from job statement
ACBRF	33	0-23	Number of sectors from front end
ACBSF	33	24-47	Number of sectors sent to front end
ACTERM	33	48-63	Termination status
ACJCN	34	0-55	Job class
ACPRI	34	56-63	Job priority
ACTSB	35	0-63	Timestamp of job submission
ACTWJ	36	0-63	Timestamp units waiting in input queue
ACTSBU	37	0-63	Total system billing units used (int)
ACIOF	40	0-63	FSS sectors moved
ACXX2	41	0-63	Spare word
ACDID	42	0-15	Destination ID
ACMXFL	43	0-23	Maximum field length used
ACMIFL	43	24-47	Minimum field length used
ACJSQ	43	48-63	Job sequence number
ACMXJT	44	0-23	Maximum JTA used
ACMIJT	44	24-47	Minimum JTA used
ACOWN	45-46	0-63	1-15 character ownership value
ACOWN1	45	0-63	Characters 1-8 of ownership value
ACOWN2	46	0-55	Characters 9-15 of ownership value
ACTACL	47	0-23	Length of Task ACcounting table buffer

<u>Field</u>	<u>Word(base8)</u>	<u>Bits</u>	<u>Description</u>
ACTACA	47	32-63	FWA of Task ACcounting table buffer
ACGUTL	50	0-23	Length of buffer for generic
ACGUTA	50	32-63	FWA of G. R. utilization buffer
ACFUTL	51	0-23	Length of buffer for FSS device
ACFUTA	51	32-63	FWA of FSS device utilization buffer
ACIOS	52	0-63	Number of I/O suspend requests
ACTSWS	53	0-63	Timestamp units waiting semaphore
ACSMI	54	0-63	Memory integral (Wait semaphore) in floating word seconds
ACEUSA	55	0-30	Job Estimated Usage
ACEUNI	55	33-63	Job Estimated Units
ACQUPR	56	0-30	Job Queuing Priority
ACUCHR	56	56-63	User Charging Rate

The task accounting table (TAC) is a logical extension to the job accounting table (JAC), and is pointed to by it. The TAC receives detailed accounting for each task initiated by a job, where the JAC contains aggregate totals for the entire job. Information in the TAC, like the JAC, is copied to the user field by the F\$ACT request.

ACTACL (in the JAC) is an entry parameter to the accounting process, and specifies the length of a buffer for TAC entries. ACTACA is the address of the buffer. If either ACTACL or ACTACA is zero, then no buffer is present.

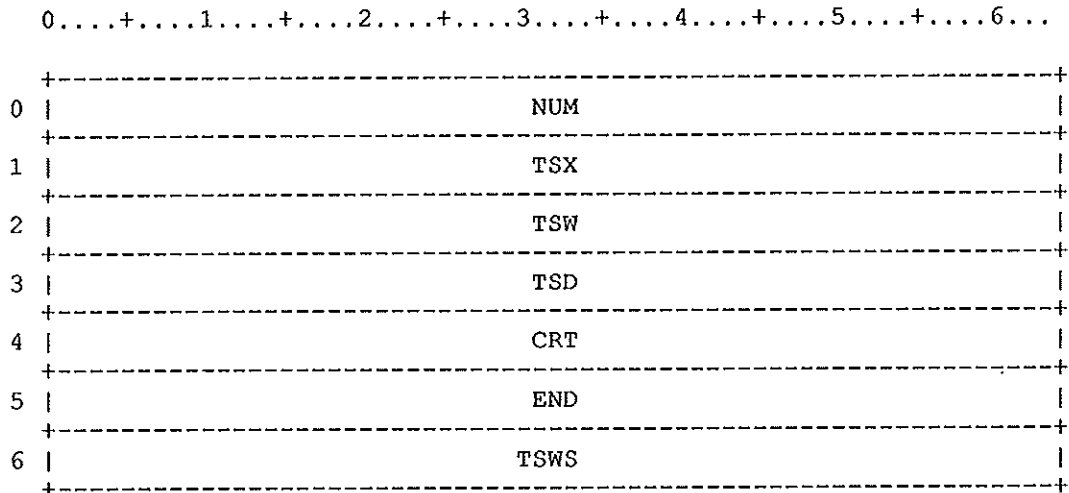

Figure AT-1. Task Accounting table

Field	Word(base8)	Bits	Description
ATNUM	0	0-63	Task number within job
ATTSX	1	0-63	Timestamp units in execution
ATTSW	2	0-63	Timestamp units waiting for CPU
ATTSD	3	0-63	Timestamp units I/O blocked
ATCRT	4	0-63	Timestamp at task creation
ATEND	5	0-63	Timestamp at task end
ATTSWS	6	0-63	Timestamp units waiting semaphore

The IOP error channel message is passed to the MEP task by EXEC for entry into the system log. This information originates in the I/O subsystem.

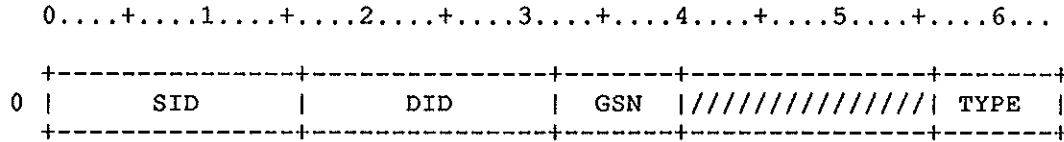

Figure AE-1. IOP Error Channel Message

Field	Word(base8)	Bits	Description
AESID	0	0-15	Source ID ('')
AEDID	0	16-31	Destination ID ('C1')
AEGSN	0	32-39	Packet group sequence number
AETYPE	0	56-63	Type of error. Governs format of words 1-5: figure AE-2 for type 1; figure AE-3 for type 2; blank for types 3 and 4; figure AE-4 for type 5. Type Meaning 1 Memory error 2 Disk error 3 Turn off error logging 4 Turn on error logging 5 Tape error logging

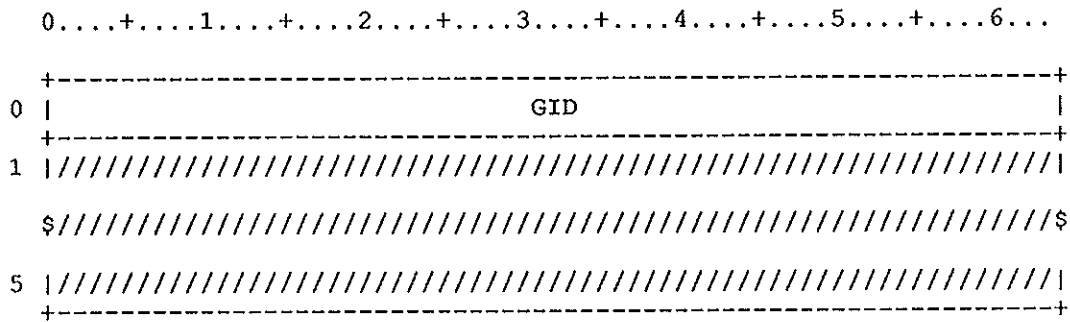

Figure AE-2. IOP Error Channel Message

Field	Word(base8)	Bits	Description
AEGID	0	0-63	Group ID field

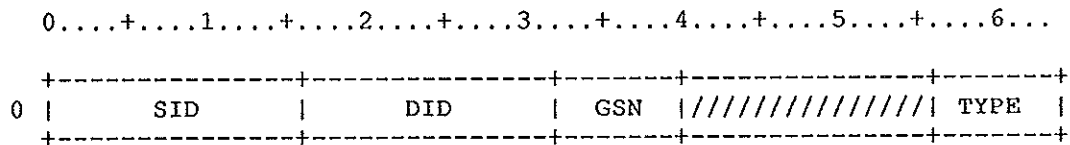

Figure AE-3. Memory Error

Field	Word(base8)	Bits	Description
AESID	0	0-15	Source ID ('')
AEDID	0	16-31	Destination ID ('C1')
AEGSN	0	32-39	Packet group sequence number
AETYPE	0	56-63	Type of error. Governs format of words 1-5: figure AE-2 for type 1; figure AE-3 for type 2; blank for types 3 and 4; figure AE-4 for type 5.

Type	Meaning
1	Memory error
2	Disk error
3	Turn off error logging
4	Turn on error logging
5	Tape error logging

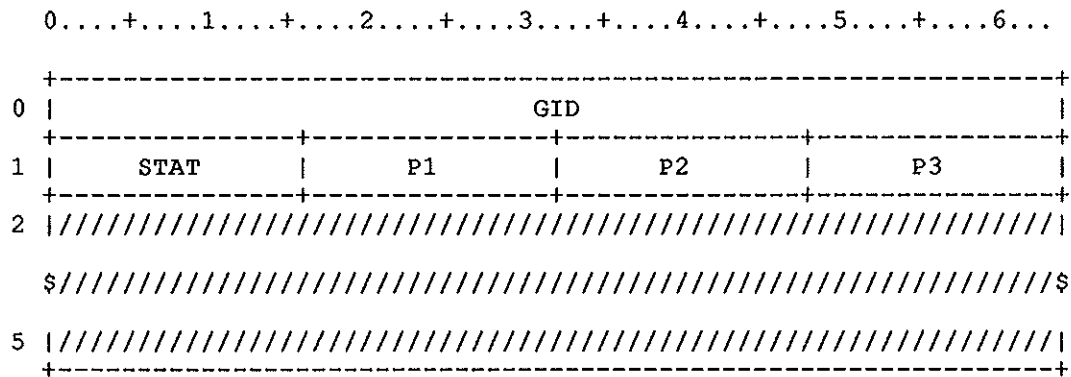

Figure AE-4. Memory Error

Field	Word(base8)	Bits	Description
AEGID	0	0-63	Group ID field 7 SSD error logging
AESTAT	1	0-15	Augmented error channel status. Find error status and parameters 1-3 in ios Software Internal Reference Manual, CRI publication SM-0046, in the description of the error channel.
AEP1	1	16-31	Error parameter 1
AEP2	1	32-47	Error parameter 2
AEP3	1	48-63	Error parameter 3

The REPORT overlay builds the disk error packet and sends it to the mainframe for logging. Line 0 contains the DAL control information.

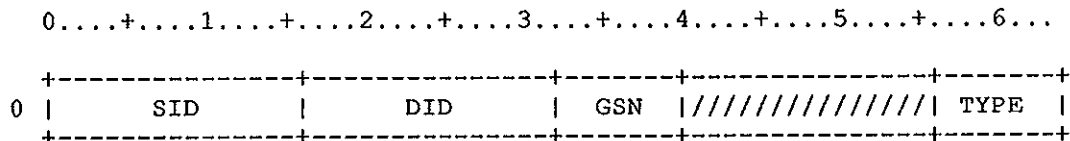

Figure AE-5. Type 2 message - disk error

<u>Field</u>	<u>Word(base8)</u>	<u>Bits</u>	<u>Description</u>
AESID	0	0-15	Source ID
AEDID	0	16-31	Destination ID
AEGSN	0	32-39	Packet group sequence number
AETYPE	0	56-63	Type of error. (3)

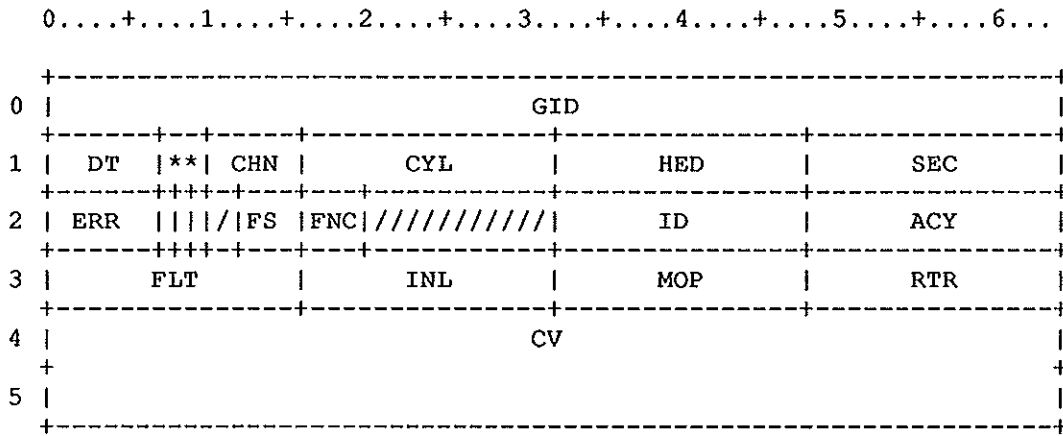

Figure AE-6. Type 2 message - disk error

Field	Word(base8)	Bits	Description
AEGID	0	0-63	Group ID field
AEDT	1	0-6	Device Type
AEIOP	1	7-9	IOP number
AECHN	1	10-15	Channel number
AECYL	1	16-31	Cylinder of request
AEHED	1	32-47	Head group
AESEC	1	48-63	Sector number
AEERR	2	0-6	Error type: 0 Interlock 1 Timeout 2 ID error 3 Read data error 4 Write data error 5 Hardware-detected seek error 6 Miscellaneous
AETD	2	8	Data transfer direction 0 Write 1 Read
AEEC	2	9	Error correction flag: 0 Error correction not used 1 Error correction used
AEFS	2	12-15	Final error status:

<u>Field</u>	<u>Word(base8)</u>	<u>Bits</u>	<u>Description</u>
AEFNC	2	16-19	Disk function in error 12 seek 13 unused 14 write 15 read
AEID	2	32-47	Cylinder number from ID field, reported on an ID error.
AEACY	2	48-63	Cylinder status register, reported on an ID error.
AEFLT	3	0-15	Original fault status
AEINL	3	16-31	Interlock status
AEMOP	3	32-47	Margin/Offset parameters 0-8 Margin select: 0 Normal 1 Early 2 Late 9-10 Offset direction: 0 Towards perimeter of disk 1 Towards center of disk 11-15 Offset magnitude
AERTR	3	48-63	Retry count
AECV	4-5	0-63	Correction vector buffer. Used by the FIRECODE overlay when attempting to correct a read data error
AECV0	4	0-31	
AECV1	4	32-63	
AECV2	5	0-31	
AECV3	5	32-63	

The ERROR overlay builds the tape error packet and sends it to the mainframe for logging. Line 0 contains the DAL control information.

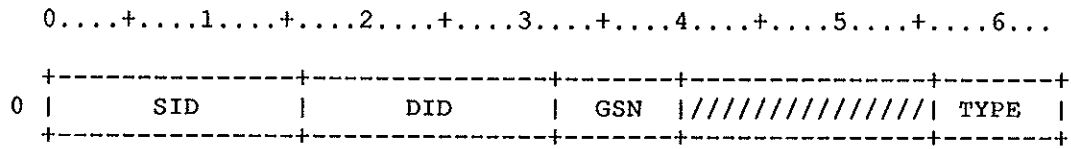

Figure AE-7. Type 5 - Tape error

<u>Field</u>	<u>Word(base8)</u>	<u>Bits</u>	<u>Description</u>
AESID	0	0-15	Source ID ('')
AEDID	0	16-31	Destination ID ('C1')
AEGSN	0	32-39	Packet group sequence number
AETYPE	0	56-63	Type of error. (5)

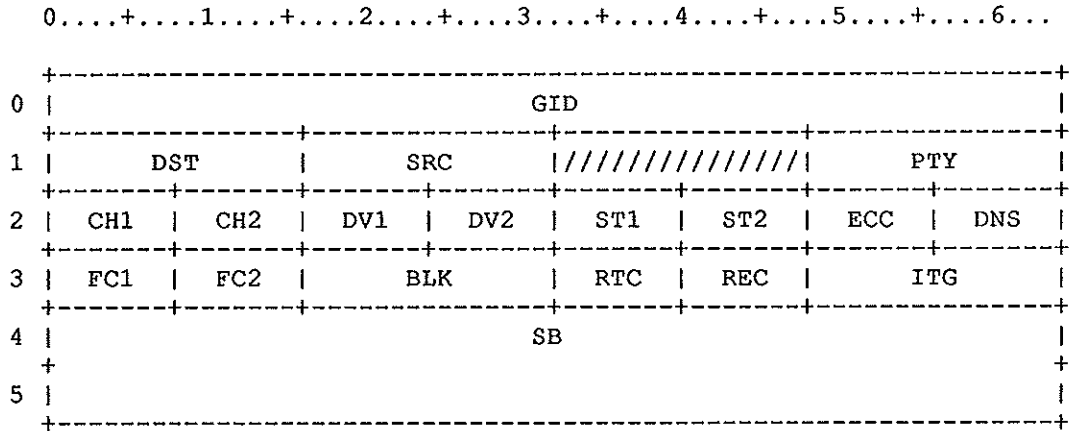

Figure AE-8. Type 5 - Tape error

Field	Word(base8)	Bits	Description
AEGID	0	0-63	Group ID field
AEDST	1	0-15	Packet destination ID
AESRC	1	16-31	Packet source ID
AEPTY	1	48-63	Packet subtype, which describes the error type
AECH1	2	0-7	Initial channel in use
AECH2	2	8-15	Last channel used during recovery
AEDV1	2	16-23	Initial device path (ie, control unit)
AEDV2	2	24-31	Last device path used in recovery
AEST1	2	32-39	Initial device status when error occurred
AEST2	2	40-47	Last status at end of recovery
AEecc	2	48-55	Error code. The error code is the actual sense bit offset.
AEDNS	2	56-63	Tape density in effect for this device
AEFC1	3	0-7	Command issued to the device before the command that caused the error.
AEFC2	3	8-15	Command issued to the device that caused the error.
AEBLK	3	16-31	Current position

<u>Field</u>	<u>Word(base8)</u>	<u>Bits</u>	<u>Description</u>
AERTC	3	32-39	Retry count. This is the number of retries attempted before the error was recovered or deemed irrecoverable.
AEREC	3	40-47	Recovery flag: ==0 Recovered !=0 Not recovered
AEITG	3	48-63	Input tags
AESB	4-5	0-63	Sense bytes read from the control unit at the time the error occurred. See Table 7-1 in the IOS Table Descriptions Manual, CRI publication SM=0007 for a description of the sense bytes.
AESB00	4	0-7	
AESB01	4	8-15	
AESB02	4	16-23	
AESB03	4	24-31	
AESB04	4	32-39	
AESB05	4	40-47	
AESB06	4	48-55	
AESB07	4	56-63	
AESB10	5	0-7	
AESB11	5	8-15	
AESB12	5	16-23	
AESB13	5	24-31	
AESB14	5	32-39	
AESB15	5	40-47	
AESB16	5	48-55	
AESB17	5	56-63	

Routine TERMTRN in the SSD driver in EXEC build the SSD error packet and sends it to MEP.

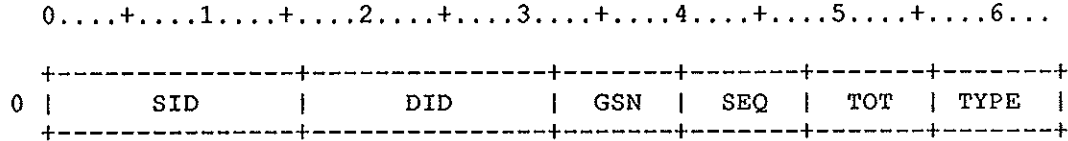

Figure AE-9. Type 7 - SSD error

<u>Field</u>	<u>Word(base8)</u>	<u>Bits</u>	<u>Description</u>
AESID	0	0-15	Source ID ('C')
AEDID	0	16-31	Destination ID ('C1')
AEGSN	0	32-39	Packet group sequence number
AESEQ	0	40-47	Sequence number
AETOT	0	48-55	Total number of packets
AETYPE	0	56-63	Type of error. (7)

This table describes the packets passed between EXEC and the MIOP.

Figure AP-1 shows the general form of the 6-word packet. The other figures describe the details of the packets for each purpose.

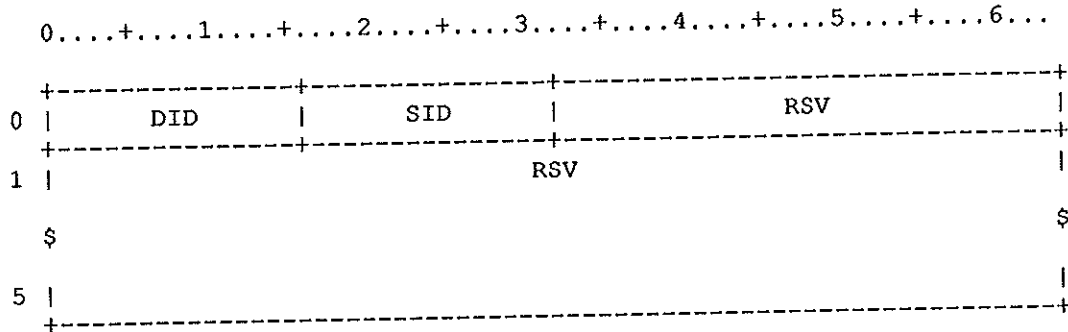

Figure AP-1. General form of IOP packets

Field	Word(base8)	Bits	Description
APDID	0	0-15	Destination ID
APDOS	0	0-1	Operating system: OS\$COS=0 COS operating system OS\$CXOS=1 Guest operating system
APDTID	0	2-7	Task ID portion of DID
APDPT	0	8-15	Packet-type portion of DID

The following values of packet type start at 0'101 to correspond to the existing packet types of 'A', 'B', etc. When the printable ASCII values are exhausted, other packet types can be used.

- PT\$MIN=0'000 Minimum allowable packet type
- PT\$A=0'101 'A' packet - disk request
- PT\$B=0'102 'B' packet - front end I/O request
- PT\$C=0'103 'C' packet - memory error correction
- PT\$D=0'104 'D' packet - tape request
- PT\$E=0'105 'E' packet - echo request
- PT\$F=0'106 'F' packet - user channel request
- PT\$G=0'107 'G' packet -
- PT\$H=0'110 'H' packet - guest HSX

activity
 PT\$I=O'111 'I' packet -down IOS
 PT\$J=O'112 'J' packet - up IOS
 PT\$K=O'113 'K' packet - Kernel
 request to EXEC
 PT\$L=O'114 'L' packet - unused
 PT\$M=O'115 'M' packet - unused
 PT\$N=O'116 'N' packet - null
 PT\$O=O'117 'O' packet - unused
 PT\$P=O'120 'P' packet - unused
 PT\$Q=O'121 'Q' packet - unused
 PT\$R=O'122 'R' packet - unused
 PT\$S=O'123 'S' packet - Kernel
 request for stats
 PT\$T=O'124 'T' packet - guest
 terminal activity
 PT\$U=O'125 'U' packet - unused
 PT\$V=O'126 'V' packet - unused
 PT\$W=O'127 'W' packet - unused
 PT\$X=O'130 'X' packet - unused
 PT\$Y=O'131 'Y' packet - unused
 PT\$Z=O'132 'Z' packet - unused

PT\$MAX=O'133 Maximum allowable
 packet type

APSID	0	16-31	Source ID
APSOS	0	16-17	Operating system
APSTID	0	18-23	Task ID
APSPT	0	24-31	Packet-type portion of SID
			PT\$C1='C1'R Universal source ID for Cray CPU
APRSV	0	32-63	Reserved for certain packets
APRSV	1-5	0-63	Other packet information

This table describes the packets passed between EXEC and the MIOP.

Figure AP-1 shows the general form of the 6-word packet. The other figures describe the details of the packets for each purpose.

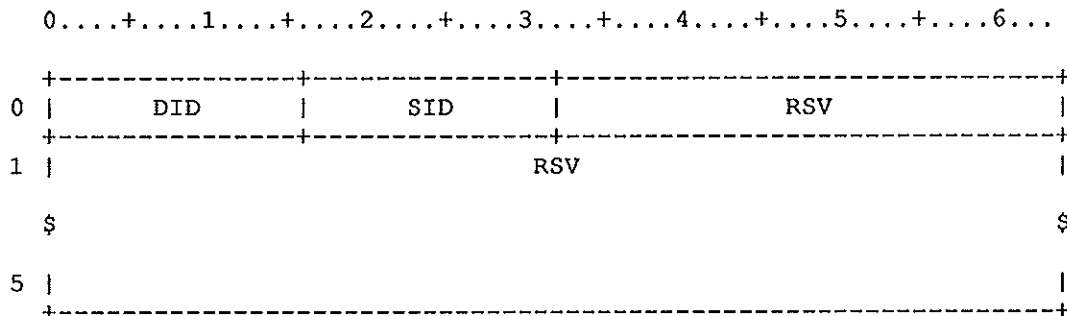

Figure AP-1. General form of IOP packets

Field	Word(base8)	Bits	Description
APDID	0	0-15	Destination ID
APDOS	0	0-1	Operating system: OS\$COS=0 COS operating system OS\$CXOS=1 Guest operating system
APDTID	0	2-7	Task ID portion of DID
APDPT	0	8-15	Packet-type portion of DID

The following values of packet type start at 0'101 to correspond to the existing packet types of 'A', 'B', etc. When the printable ASCII values are exhausted, other packet types can be used.

- PT\$MIN=0'000 Minimum allowable packet type
- PT\$A=0'101 'A' packet - disk request
- PT\$B=0'102 'B' packet - front end I/O request
- PT\$C=0'103 'C' packet - memory error correction
- PT\$D=0'104 'D' packet - tape request
- PT\$E=0'105 'E' packet - echo request
- PT\$F=0'106 'F' packet - user channel request
- PT\$G=0'107 'G' packet -
- PT\$H=0'110 'H' packet - guest HSX

activity
 PT\$I=O'111 'I' packet -down IOS
 PT\$J=O'112 'J' packet - up IOS
 PT\$K=O'113 'K' packet - Kernel
 request to EXEC
 PT\$L=O'114 'L' packet - unused
 PT\$M=O'115 'M' packet - unused
 PT\$N=O'116 'N' packet - null
 PT\$O=O'117 'O' packet - unused
 PT\$P=O'120 'P' packet - unused
 PT\$Q=O'121 'Q' packet - unused
 PT\$R=O'122 'R' packet - unused
 PT\$S=O'123 'S' packet - Kernel
 request for stats
 PT\$T=O'124 'T' packet - guest
 terminal activity
 PT\$U=O'125 'U' packet - unused
 PT\$V=O'126 'V' packet - unused
 PT\$W=O'127 'W' packet - unused
 PT\$X=O'130 'X' packet - unused
 PT\$Y=O'131 'Y' packet - unused
 PT\$Z=O'132 'Z' packet - unused

 PT\$MAX=O'133 Maximum allowable
 packet type

APSID	0	16-31	Source ID
APSOS	0	16-17	Operating system
APSTID	0	18-23	Task ID
APSPT	0	24-31	Packet-type portion of SID
			PT\$C1='C1'R Universal source ID for Cray CPU
APRSV	0	32-63	Reserved for certain packets
APRSV	1-5	0-63	Other packet information

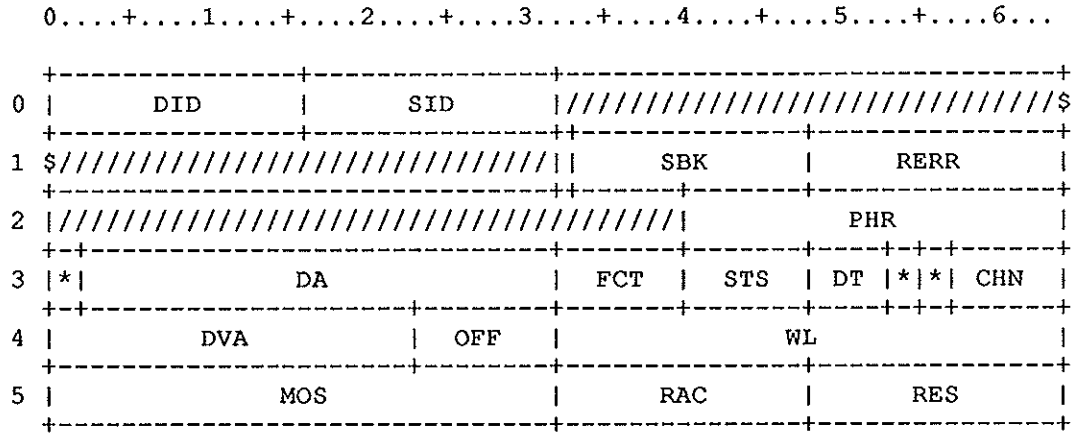

Figure AP-2. A-packet (IOS disk request)

A-packet fields (IOS disk request).

Field	Word(base8)	Bits	Description
APDID	0	0-15	Destination ID
APSID	0	16-31	Source ID
APCHK	1	32	Request block number check
APSBK	1	33-47	Low 15 bits of starting block number
APRERR	1	48-63	Number of recovered errors for req.
APPHR	2	40-63	Physical request addr (STP relative)
APTM	3	0-1	Target memory (from COMSYSEQ): TM@CM - central memory TM@EBM - extended buffer memory TM@SSD - SSD memory
APDA	3	2-31	Data buffer address (TM@ relative)
APFCT	3	32-39	Function code
APSTS	3	40-47	Status
APDT	3	48-52	Device type
APPN	3	53-54	Processor number
APUNT	3	55-56	Disk unit number
APCHN	3	57-63	Channel number

<u>Field</u>	<u>Word(base8)</u>	<u>Bits</u>	<u>Description</u>
APDVA	4	0-22	Device address
APCYL	4	0-10	Cylinder number
APHD	4	11-15	Head number
APSEC	4	16-22	Sector number
APOFF	4	23-31	Word offset
APWL	4	32-63	Transfer word length
APMOS	5	0-31	MOS address (IOP relative)
APRAC	5	32-47	Sector read-ahead count
APRES	5	48-63	Reserved for IOP

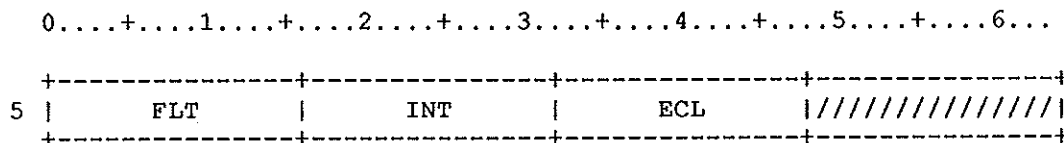

Figure AP-3. A-packet (IOS disk status)

A-packet fields (IOS disk status)

<u>Field</u>	<u>Word(base8)</u>	<u>Bits</u>	<u>Description</u>
APFLT	5	0-15	Disk status and fault status
APINT	5	16-31	Interlock status or seek response
APECL	5	32-47	Cylinder returned on seek error

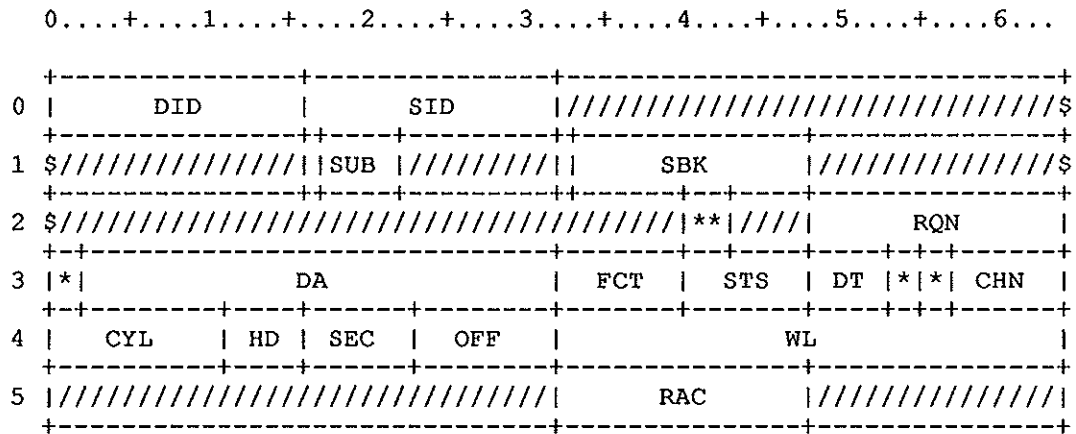

Figure AP-4. A-packet (Diagnostic disk request)

A-packet fields (Diagnostic IOS disk request, APPST=APPSTIOS)

Field	Word(base8)	Bits	Description
APDID	0	0-15	Destination ID
APSID	0	16-31	Source ID
APDIA	1	16	diagnostic mode flag
APSUB	1	17-21	diagnostic function subcode APSFRWD=0 read/write data APSFRWID=1 read/write ID APSFRWDI=2 read absolute/correc/write deftive ID APSFRWB=3 read/write buffer APSFWECC=4 write zero ECC APSFRETH=0'10 read track header
APCHK	1	32	Request block number check
APSBK	1	33-47	Low 15 bits of starting block number
APDFL	2	40-42	Diagnostic flags
APSTA	2	40	Return error record to diagnostic
APERR	2	41	Suppress normal error recovery
APREP	2	42	Suppress normal error reporting
APRQN	2	48-63	diagnostic request sequence number
APTM	3	0-1	Target memory (from COMSYSEQ): TM@CM - central memory TM@EBM - extended buffer memory TM@SSD - SSD memory
APDA	3	2-31	Data buffer address (TM@ relative)

<u>Field</u>	<u>Word(base8)</u>	<u>Bits</u>	<u>Description</u>
APFCT	3	32-39	Function code
APSTS	3	40-47	Status from IOS
APDT	3	48-52	Device type
APPN	3	53-54	Processor number
APUNT	3	55-56	Disk unit number
APCHN	3	57-63	Channel number
APCYL	4	0-10	Cylinder number
APHD	4	11-15	Head number
APSEC	4	16-22	Sector number
APOFF	4	23-31	Word offset
APWL	4	32-63	Transfer word length
APRAC	5	32-47	Sector read-ahead count

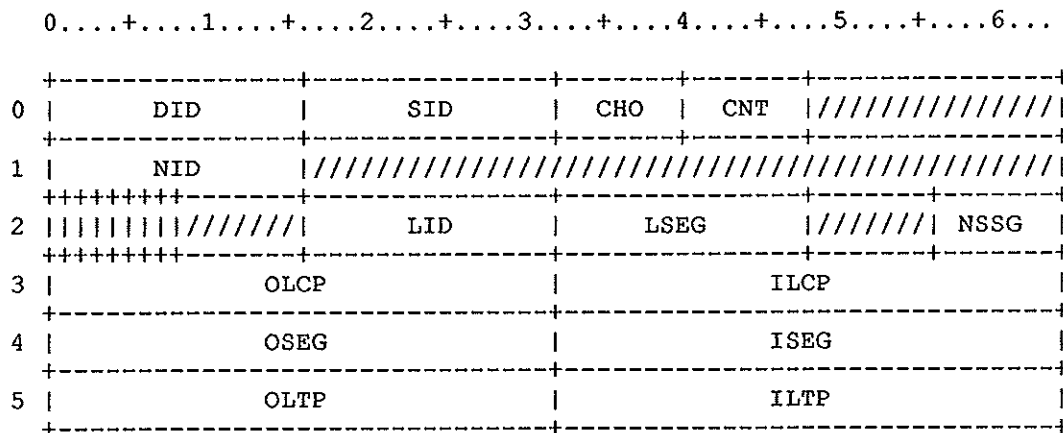

Figure AP-5. B-packet (front end I/O request)

B-packet fields (front end I/O request).

Field	Word(base8)	Bits	Description
APDID	0	0-15	Destination ID
APSID	0	16-31	Source ID
APCHO	0	32-39	Channel ordinal
APCNT	0	40-47	Message number (modulo 256)
APNID	1	0-15	Network ID
APTYPE	2	0	Address request type flag (set by IOP)
APLOG	2	1	Front end logon flag (set by IOP)
APREJ	2	2	Reject flag (set by EXEC)
APACK	2	3	Ack request flag (set by EXEC)
APDONE	2	4	Acknowledgment flag (set by IOP)
APFEI	2	5	FEI flag
APFRC	2	6	Forced off flag
APIGN	2	7	Ignore last input LCP & segment
APLID	2	16-31	Front end logical ID
APLSEG	2	32-47	Segment length (0 if only LCP)
APNSSG	2	56-63	Number of subsegments
APOLCP	3	0-31	Output LCP address (EXEC relative)

<u>Field</u>	<u>Word(base8)</u>	<u>Bits</u>	<u>Description</u>
APILCP	3	32-63	Input LCP address (EXEC relative)
APOSEG	4	0-31	Output segment address (EXEC relative)
APISEG	4	32-63	Input segment address (EXEC relative)
APOLTP	5	0-31	Output LTP address (EXEC relative)
APILTP	5	32-63	Input LTP address (EXEC relative)

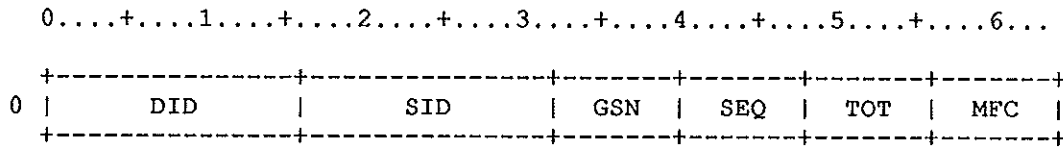

Figure AP-6. C-packet (EXEC-MEP memory error message)

C-packet fields (EXEC-MEP memory error message).

<u>Field</u>	<u>Word(base8)</u>	<u>Bits</u>	<u>Description</u>
APDID	0	0-15	Destination ID
APSID	0	16-31	Source ID
APGSN	0	32-39	Packet group sequence number
APSEQ	0	40-47	Sequence number this segment
APTOT	0	48-55	Total number of segments
APMFC	0	56-63	Function code (6)

<u>Field</u>	<u>Word(base8)</u>	<u>Bits</u>	<u>Description</u>
APMBA	4	16-39	Base address
APMP	4	40-63	Program address
APMRTC	5	0-63	Real Time Clock

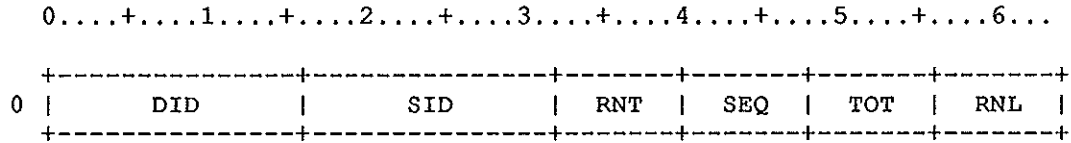

Figure AP-8. C-packet (IOS Diagnostic Disk Error Packet)

<u>Field</u>	<u>Word(base8)</u>	<u>Bits</u>	<u>Description</u>
APDID	0	0-15	Destination ID
APSID	0	16-31	Source ID
APRNT	0	32-39	Top 8 bits of request number
APSEQ	0	40-47	Sequence number this segment
APTOT	0	48-55	Total number of segments
APRNL	0	56-63	Lower 8 bits of request number

<u>Field</u>	<u>Word(base8)</u>	<u>Bits</u>	<u>Description</u>
APSTAT	4	32-47	status
APST00	4	32	
APST01	4	33	
APST02	4	34	
APST03	4	35	
APST04	4	36	
APST05	4	37	
APST06	4	38	
APST07	4	39	
APST08	4	40	
APST09	4	41	
APST10	4	42	
APST11	4	43	
APST12	4	44	
APST13	4	45	
APST14	4	46	
APDBFF	4	48	bad data flag
APUBCC	4	49-54	unused bit count
APPWCC	4	55-62	partial word count
APBCSS	5	0-15	block checksum
APVMSS	5	16-31	valid sector / block count
APPDVV	5	32-47	previous device
APMOSS	5	48-63	available mos memory

F-packet fields (user channel driver request)

F-packets contain requests for action by IOS driver overlays under the user channel shell. Such drivers are used by the ISP system and by subsystem jobs that use devices directly.

F-packets have various formats, depending on the function code of the request (APFCFN). The first word and part of the second have a standard format for all F-packets.

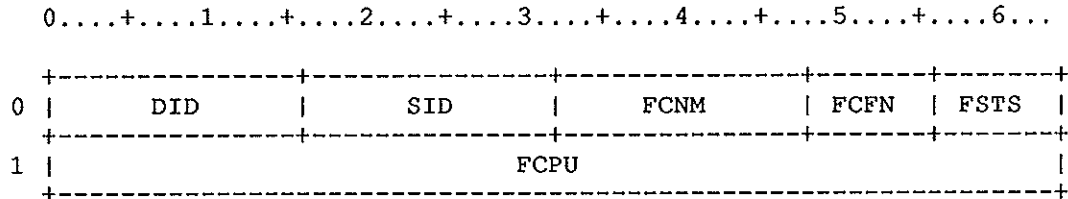

Figure AP-10. Channel Driver Request (F-packet) Header

Field	Word(base8)	Bits	Description
APDID	0	0-15	Destination ID
APSID	0	16-31	Source ID
APFCNM	0	32-47	Channel name:
APFIOS	0	32-38	Channel location: 0 = CPU nn = Chan.num. of IOS low-speed chan
APFIOP	0	39-41	IOP number (only if APFIOS # 0) 0 = MIOP, 1 = BIOP, etc.
APFCHN	0	42-47	Physical channel number
APFCFN	0	48-55	Channel function code:
APFSTS	0	56-63	Response status code
APFST2	0	56	2nd-half status on CFN\$RDD, CFN\$WTD
APFST	0	57-63	Driver status code:
APFCPU	1	0-63	Data for COS system task

The following line is a *CALL to comdeck COMAPFC.

COPYRIGHT BY CRAY RESEARCH, INC. *

UNPUBLISHED - ALL RIGHTS RESERVED UNDER THE COPYRIGHT LAWS *
OF THE UNITED STATES. *

CFN\$xxx codes are used to specify the type of request to the shell and/or driver.

If codes are added, CFN\$MIN, CFN\$RSV, CFN\$DMIN, and CFN\$DMAX must be updated accordingly.

CFN\$MIN=3 Minimum legal code
 CFN\$OPE=3 Driver Open
 CFN\$CLS=4 Driver close
 CFN\$RD=5 Read header
 CFN\$RDH=6 Read header and hold data
 CFN\$RDD=7 Read both header and data
 CFN\$WT=D'8 Write header
 CFN\$WTH=D'9 Write header and hold data
 CFN\$WTD=D'10 Write header and data
 CFN\$RSV=D'11 - D'31 Reserved
 CFN\$DMIN=D'32 Minimum legal driver function code
 CFN\$DMAX=D'127 Maximum legal driver function code

CST\$xxx codes are returned by the shell and drivers.

CST\$CMP=0 Complete
 CST\$MIN=CST\$CMP Minimum status
 CST\$PRO=3 Protocol error
 CST\$CHN=4 Illegal channel number
 CST\$FCN=5 Illegal function code
 CST\$DVN=6 Illegal driver name
 CST\$DAE=7 Data address error
 CST\$DLE=D'8 Data length error
 CST\$MAX=CST\$DLE Maximum status

D'9 - D'31 Reserved

CST\$DMIN=D'32 Min driver specific code
 CST\$DMAX=D'127 Max driver specific code

CST\$xxx codes for loopback driver.

CST\$TMO=D'32 Loopback Driver timeout

The Driver Open request (CFN\$OPE) creates a driver activity in the I/O Subsystem for a given physical channel. The activity invokes the driver overlay named in the request.

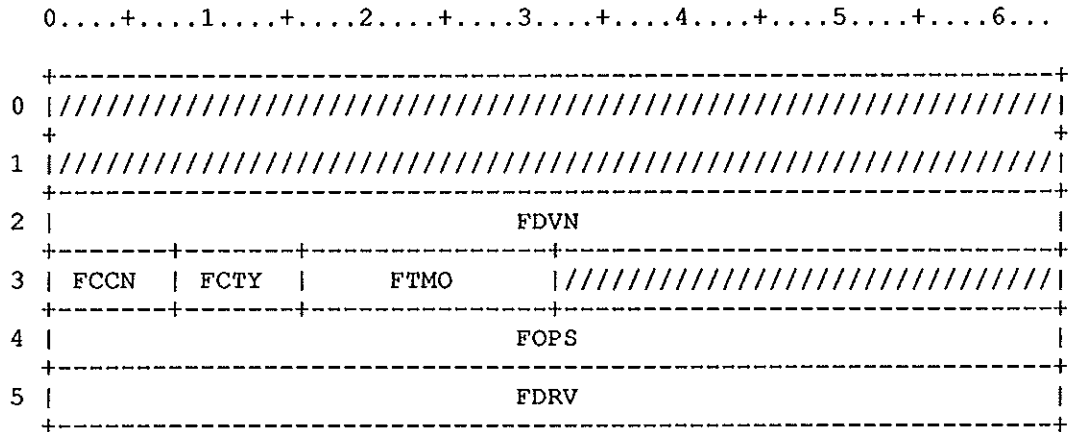

Figure AP-11. DRIVER OPEN function F-packet

Words 0-1 share general format (above)

Field	Word(base8)	Bits	Description
APFDVN	2	0-63	Driver name (ASCII)
APFCCN	3	0-7	Co-channel number
APFCTY	3	8-15	Channel type:
APFTMO	3	16-31	Channel timeout in tenth/second
APFOPS	4	0-63	Spare word for open parameters
APFDRV	5	0-63	Reserved for driver use

The ISP channel driver ISPDRV uses the APFDRV word in the driver request packet for additional parameters on the Driver Open request:

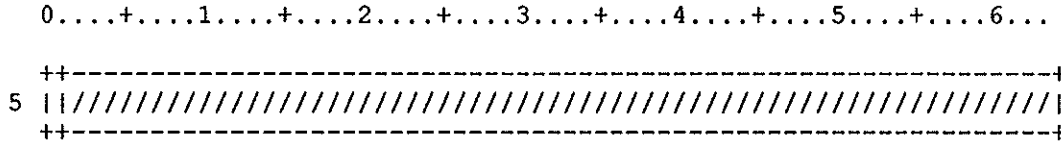

Figure AP-12. ISPDRV Driver Open request fields

Field	Word(base8)	Bits	Description
APFXB	5	0	Use double-buffering if set

The ISP channel driver ISPDRV returns the following fields in the APFDRV word of a reply to a request to read if the data contains an ISP link header:

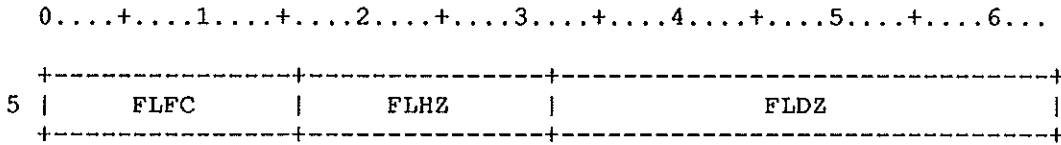

Figure AP-13. ISPDRV I/O reply fields

Field	Word(base8)	Bits	Description
APFLFC	5	0-15	Link header function code
APFLHZ	5	16-31	Header block length in words
APFLDZ	5	32-63	Data block length in words

The following packet format is used for requests to transfer data (CFN\$RD, RDH, RDD, WT, WTH and WTD). Depending on the type of request, one or two buffers may be used.

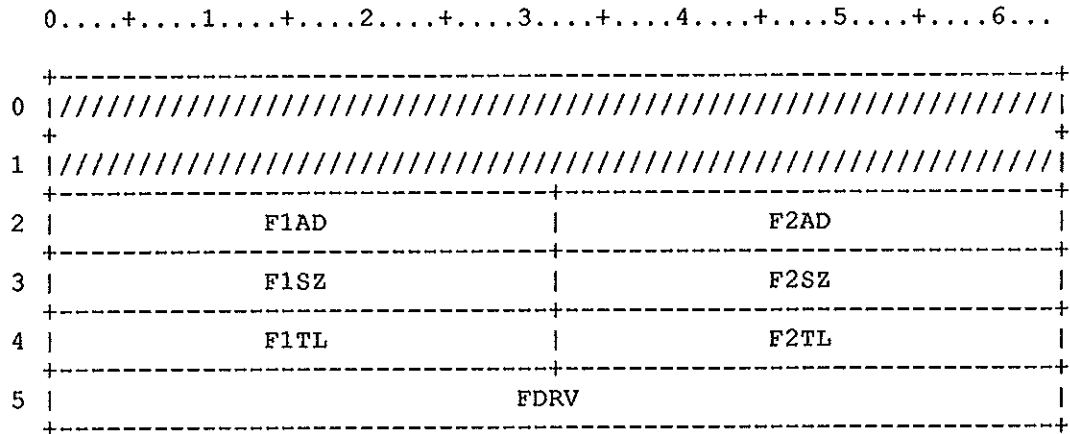

Figure AP-14. READ and WRITE function F-packet

Words 0-1 share general format (above)

Field	Word(base8)	Bits	Description
APF1AD	2	0-31	First buffer address
APF2AD	2	32-63	Second buffer address
APF1SZ	3	0-31	First buffer length (bytes)
APF2SZ	3	32-63	Second buffer length (bytes)
APF1TL	4	0-31	First transmitted length (bytes)
APF2TL	4	32-63	Second transmitted length (bytes)
APFDRV	5	0-63	Reserved for driver use

This F-packet format is used by user-defined driver functions (CFN\$DMIN through CFN\$DMAX) and the Driver Close request (CFN\$CLS). Use of the last four words is dependent on the type of driver.

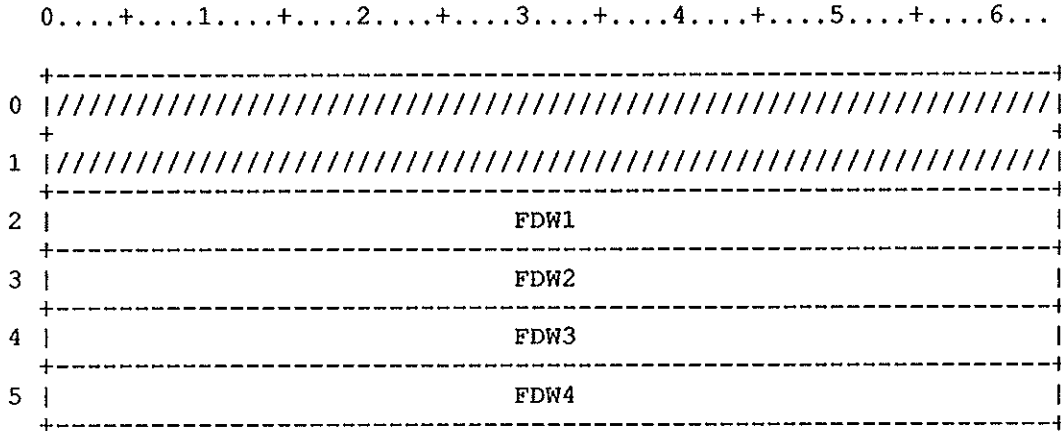

Figure AP-15. Driver request function F-packet

Words 0-1 share general format (above)

<u>Field</u>	<u>Word(base8)</u>	<u>Bits</u>	<u>Description</u>
APFDW1	2	0-63	First word available to user
APFDW2	3	0-63	Second word available to user
APFDW3	4	0-63	Third word available to user
APFDW4	5	0-63	Fourth word available to user

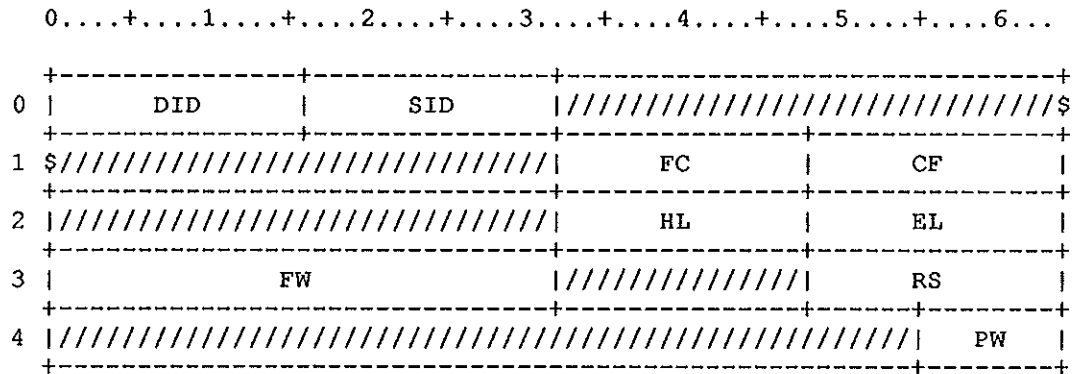

Figure AP-16. G-packet (configuration request)

Field	Word(base8)	Bits	Description
APDID	0	0-15	Destination ID
APSID	0	16-31	Source ID
APFC	1	32-47	Function code (X\$CC)
APCF	1	48-63	Configuration flags
APHL	2	32-47	Header length of COS configuration table (only when APCC=0)
APEL	2	48-63	Entry length of COS configuration table (only when APCC = 0)
APFW	3	0-31	Absolute central memory address of COS configuration table (only when APCC=0)
APRS	3	48-63	Length in sectors of table(rounded up) (only when APCC=0)
APPW	4	55-63	Partial word count of last sector of table (only when APCC=0)

K-packet fields (kernel request).

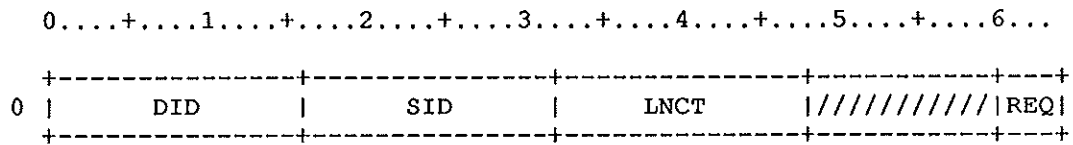

Figure AP-18. K-packet (kernel request)

Field	Word(base8)	Bits	Description
APDID	0	0-15	Destination ID
APSID	0	16-31	Source ID
APLNCT	0	32-47	Line count for panic message
APREQ	0	60-63	Request code: APREQCON=0 Channel on APREQCOF=1 Channel off APREQHLT=2 Halt I/O subsystem APDIAON=3 diagnostic channel on APDIAOF=4 diagnostic channel off

If the K-packet is a halt request (APREQHLT), a message is sent after the packet containing an ASCII text explanation.

APHLTML=D'8 Length of halt text sent after packet

This packet is used for a line of communications for DIA and the IOS kernel to drive fei/nsc.

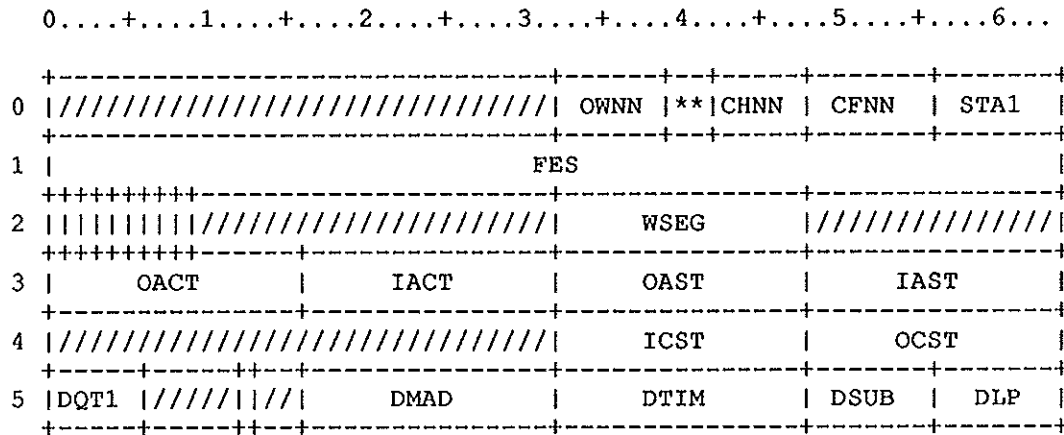

Figure AP-19. DIAGNOSTIC N-PACKET

Field	Word(base8)	Bits	Description
APOWNN	0	32-38	owner
APDIOP	0	39-41	iop
APCHNN	0	42-47	ios phs. channel
APCFNN	0	48-55	function
APSTA1	0	56-63	status
APFES	1	0-63	FEI box status
APDNSC	2	0	NSC flag
APICBZ	2	1	ichbz
APICDN	2	2	ichdn
APOCBZ	2	3	ochbz
APOCDN	2	4	ochdn
APDISC	2	5	disconnect flag
APPORT	2	6	vax port request
APIIF	2	7	input interrupt flag
APOIF	2	8	output interrupt flag

<u>Field</u>	<u>Word(base8)</u>	<u>Bits</u>	<u>Description</u>
APWSEG	2	32-47	length of segment
APOACT	3	0-15	output actual word count
APIACT	3	16-31	input actual word count
APOAST	3	32-47	output actual start count
APIAST	3	48-63	input actual start count
APICST	4	32-47	input channel status
APOCST	4	48-63	output channel status
APDQT1	5	0-5	dqt entry
APNDIA	5	12	assign nsc-non ded
APDMAD	5	16-31	max length
APDTIM	5	32-47	requested timeout
APDSUB	5	48-55	subfunc bit for open/close/assign
APDLP	5	56-63	diagnostic logical path

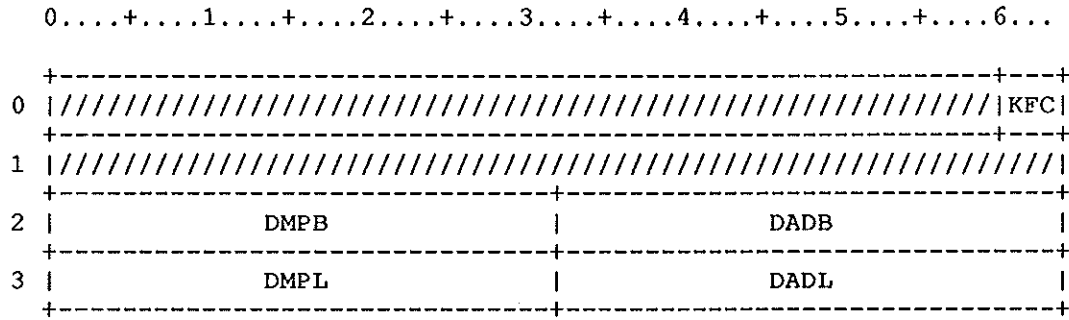

Figure AP-20. DIAGNOSTIC N-PACKET

Field	Word(base8)	Bits	Description
APKFC	0	60-63	function code
APDMPB	2	0-31	message proper buffer
APDADB	2	32-63	associated data buffer
APDMPL	3	0-31	message proper length
APDADL	3	32-63	associated data length

S-packet fields (statistics request).

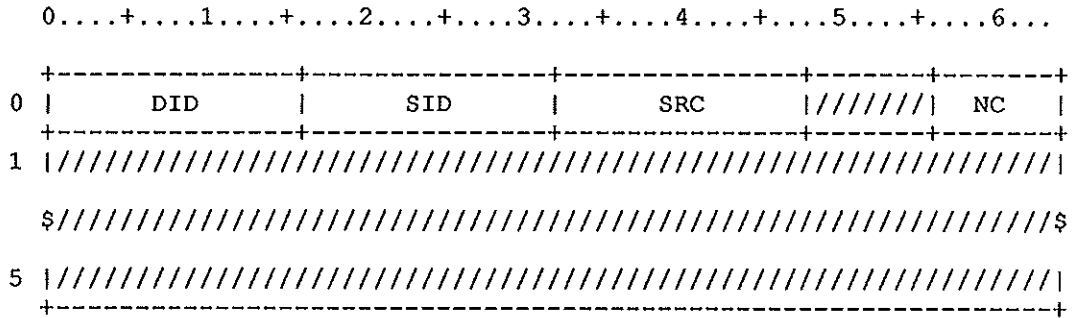

Figure AP-21. S-packet (statistics request)

<u>Field</u>	<u>Word(base8)</u>	<u>Bits</u>	<u>Description</u>
APDID	0	0-15	Destination ID
APSID	0	16-31	Source ID
APSRC	0	32-47	S-packet request subcode: APSCPU=0 CPU timing statistics APSST=1 System task statistics (global) APSMEM=2 System memory utilization APSSSD=3 SSD channel utilization
APNC	0	56-63	Number of CPUs
AP	1-5	0-63	Subcode-dependent information

CPU timing statistics

For subfunction APSCPU (CPU timing statistics), the following fields are returned.

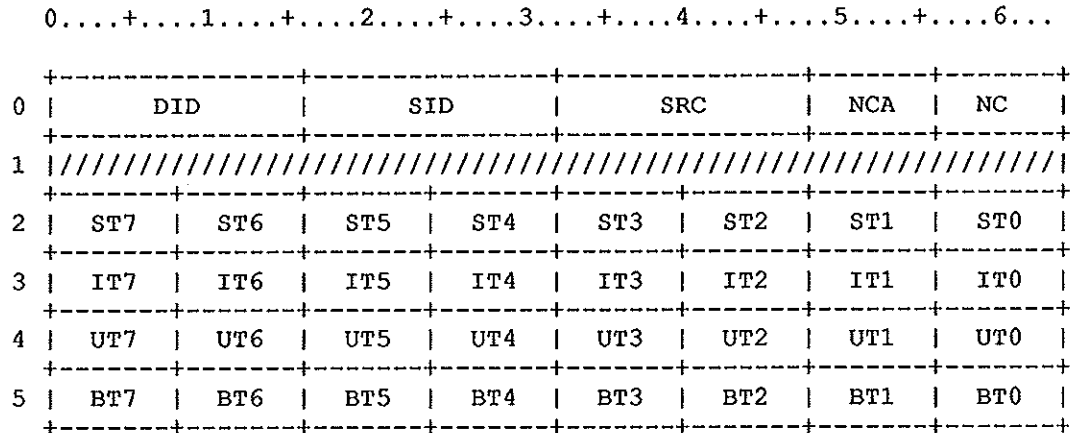

Figure AP-22. CPU timing statistics

Field	Word(base8)	Bits	Description
APDID	0	0-15	Destination ID
APSID	0	16-31	Source ID
APSRC	0	32-47	S-packet request subcode (0)
APNCA	0	48-55	Number of CPUs Active
APNC	0	56-63	Number of CPUs
APST7	2	0-7	Percent system time, CPU 7
APST6	2	8-15	Percent system time, CPU 6
APST5	2	16-23	Percent system time, CPU 5
APST4	2	24-31	Percent system time, CPU 4
APST3	2	32-39	Percent system time, CPU 3
APST2	2	40-47	Percent system time, CPU 2
APST1	2	48-55	Percent system time, CPU 1
APST0	2	56-63	Percent system time, CPU 0
APIT7	3	0-7	Percent idle time, CPU 7

<u>Field</u>	<u>Word(base8)</u>	<u>Bits</u>	<u>Description</u>
APIT6	3	8-15	Percent idle time, CPU 6
APIT5	3	16-23	Percent idle time, CPU 5
APIT4	3	24-31	Percent idle time, CPU 4
APIT3	3	32-39	Percent idle time, CPU 3
APIT2	3	40-47	Percent idle time, CPU 2
APIT1	3	48-55	Percent idle time, CPU 1
APIT0	3	56-63	Percent idle time, CPU 0
APUT7	4	0-7	Percent user time, CPU 7
APUT6	4	8-15	Percent user time, CPU 6
APUT5	4	16-23	Percent user time, CPU 5
APUT4	4	24-31	Percent user time, CPU 4
APUT3	4	32-39	Percent user time, CPU 3
APUT2	4	40-47	Percent user time, CPU 2
APUT1	4	48-55	Percent user time, CPU 1
APUT0	4	56-63	Percent user time, CPU 0
APBT7	5	0-7	Percent I/O blocked time, CPU 7
APBT6	5	8-15	Percent I/O blocked time, CPU 6
APBT5	5	16-23	Percent I/O blocked time, CPU 5
APBT4	5	24-31	Percent I/O blocked time, CPU 4
APBT3	5	32-39	Percent I/O blocked time, CPU 3
APBT2	5	40-47	Percent I/O blocked time, CPU 2
APBT1	5	48-55	Percent I/O blocked time, CPU 1
APBT0	5	56-63	Percent I/O blocked time, CPU 0

The S-packet fields must be expanded if more than eight CPUs are defined.

Task timing statistics

For subfunction APSST (task statistics) information is returned about EXEC in the reply packet to the IOS, along with addresses and values which enable the IOS to locate fields within the system task table (STT).

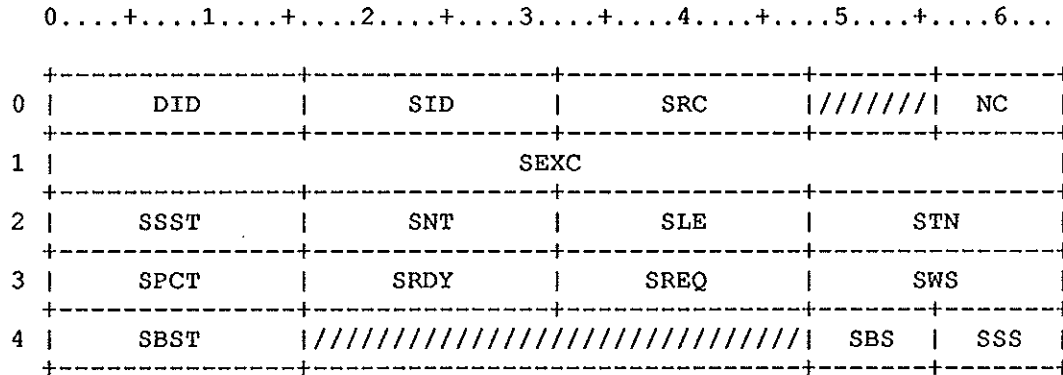

Figure AP-23. Task timing statistics

Field	Word(base8)	Bits	Description
APDID	0	0-15	Destination ID
APSID	0	16-31	Source ID
APSRC	0	32-47	Task timing statistics (subcode 1)
APNC	0	56-63	Number of CPUs
APSEXC	1	0-63	EXEC timing percentages:
APSCI	1	0-15	% of all CP time, integer portion
APSCF	1	16-31	Fract. portion
APSSI	1	32-47	% of system time, integer portion
APSSF	1	48-63	fract. portion
APSSST	2	0-15	Address of first STT entry
APSNT	2	16-31	Number of system tasks
APSLE	2	32-47	Length of each STT entry
APSTN	2	48-63	Word offset to task name
APSPCT	3	0-15	Word offset to percentage word 1 (formatted the same as EXEC timings)
APSRDY	3	16-31	Word offset to task ready count
APSREQ	3	32-47	Word offset to task request count

<u>Field</u>	<u>Word(base8)</u>	<u>Bits</u>	<u>Description</u>
APSW	3	48-63	Word offset to suspend flag
APSBST	4	0-15	Base address of STP area
APSBS	4	48-55	Parcel (0-3) in word w/suspend flag
APSSS	4	56-63	Bit (0-15) in parcel w/suspend flag (0 = high order bit in parcel)

SSD channel utilization

For SSD channel utilization (subfunction APSSSD), the following fields are used:

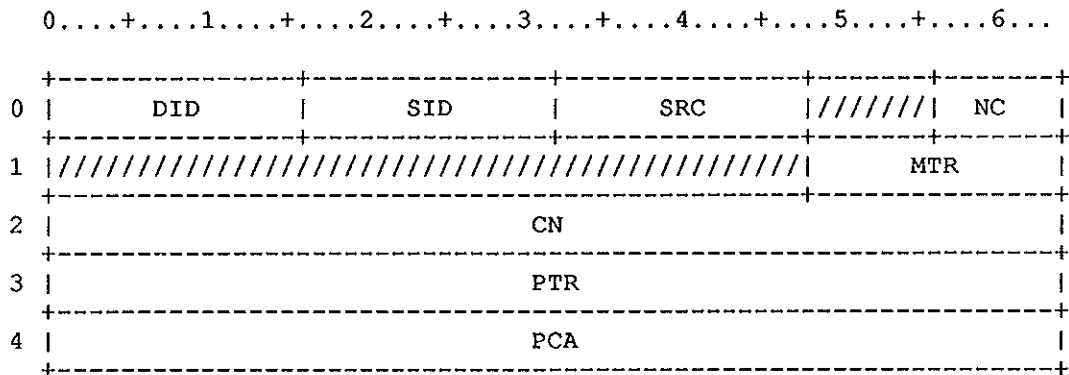

Figure AP-25. SSD Channel Utilization

Field	Word(base8)	Bits	Description
APDID	0	0-15	Destination ID
APSID	0	16-31	Source ID
APSRC	0	32-47	SSD channel utilization (subcode 3)
APNC	0	56-63	Number of channels
APMTR	1	48-63	Maximum transfer rate in mbytes/sec
APCN	2	0-63	Channel number
APCN0	2	0-15	Channel number (channel 0)
APCN1	2	16-31	Channel number (channel 1)
APCN2	2	32-47	Channel number (channel 2)
APCN3	2	48-63	Channel number (channel 3)
APPTR	3	0-63	Percent transfer rate
APPTR0	3	0-15	Percent transfer rate (channel 0)
APPTR1	3	16-31	Percent transfer rate (channel 1)
APPTR2	3	32-47	Percent transfer rate (channel 2)
APPTR3	3	48-63	Percent transfer rate (channel 3)
APPCA	4	0-63	Percent channel active
APPCA0	4	0-15	Percent channel active (channel 0)
APPCA1	4	16-31	Percent channel active (channel 1)
APPCA2	4	32-47	Percent channel active (channel 2)
APPCA3	4	48-63	Percent channel active (channel 3)

CFN\$MIN	=	3	Minimum legal code
CFN\$OPE	=	3	Driver Open
CFN\$CLS	=	4	Driver close
CFN\$RD	=	5	Read header
CFN\$RDH	=	6	Read header and hold data
CFN\$RDD	=	7	Read both header and data
CFN\$WT	=	D'8	Write header
CFN\$WTH	=	D'9	Write header and hold data
CFN\$WTD	=	D'10	Write header and data
CFN\$RSV	=	D'11	- D'31 Reserved
CFN\$DMIN	=	D'32	Minimum legal driver function code
CFN\$DMAX	=	D'127	Maximum legal driver function code
CST\$CMP	=	0	Complete
CST\$MIN	=	CST\$CMP	Minimum status
CST\$PRO	=	3	Protocol error
CST\$CHN	=	4	Illegal channel number
CST\$FCN	=	5	Illegal function code
CST\$DVN	=	6	Illegal driver name
CST\$DAE	=	7	Data address error
CST\$DLE	=	D'8	Data length error
CST\$MAX	=	CST\$DLE	Maximum status
CST\$DMIN	=	D'32	Min driver specific code
CST\$DMAX	=	D'127	Max driver specific code
CST\$TMO	=	D'32	Loopback Driver timeout

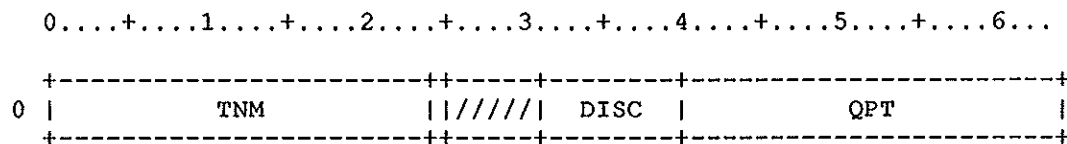

Figure AQ-1. APT(Packet) Queuing Header Table

<u>Field</u>	<u>Word(base8)</u>	<u>Bits</u>	<u>Description</u>
AQTNM	0	0-23	Task name
AQC	0	24	Crash if queue full flag
AQDISC	0	31-39	Count of discarded packets
AQQPT	0	40-63	QPT addr

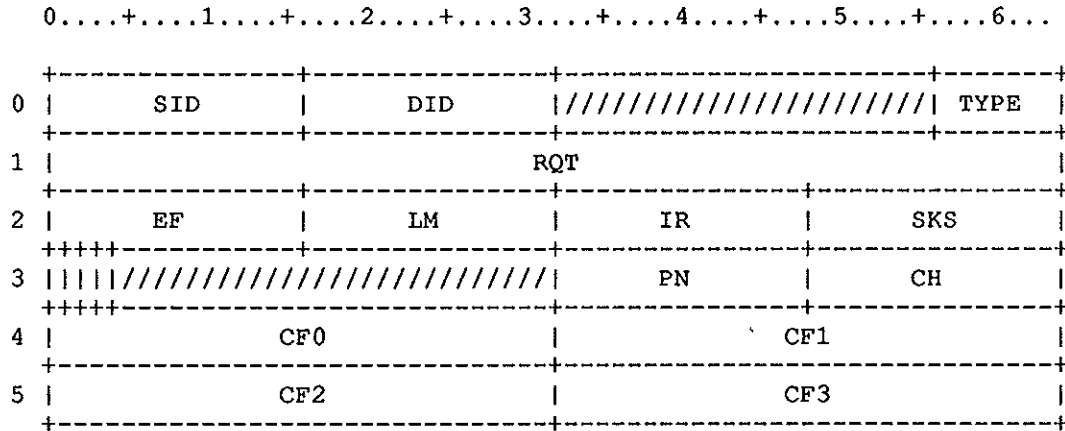

Figure AR-1. IOP Recovered Disk Error Message

Field	Word(base8)	Bits	Description
ARSID	0	0-15	Source ID
ARDID	0	16-31	Destination ID
ARTYPE	0	56-63	Type (2)
ARRQT	1	0-63	CRAY-1 request word
AREF	2	0-15	Initial disk status flags
ARLM	2	16-31	Margin that recovered the request
ARIR	2	32-47	Initial interlock register
ARSKS	2	48-63	Initial seek status
ARTO	3	0	Timeout flag
ARRE	3	1	Disk reservation error
ARCE	3	2	Error correction used flag
ARIFC	3	3	Inconsistent firecode flag
ARNPN	3	32-47	IOP processor number
ARCH	3	48-63	IOP channel number
ARCF0	4	0-31	Firecode parameter word 0
ARCF1	4	32-63	Firecode parameter word 1

<u>Field</u>	<u>Word(base8)</u>	<u>Bits</u>	<u>Description</u>
ARCF2	5	0-31	Firecode parameter word 2
ARCF3	5	32-63	Firecode parameter word 3

The Active User Table is an STP-resident table used during interactive communication. An entry is made in the AUT when the user logs on and is released when the user logs off.

There is one AUT entry for each interactive user allowed. Each entry contains the most recent message headers sent to and received from a user terminal; an SDT entry address; queue pointers into the IBT; and other information about the job and terminal state. An entry is active if AUACT=1.

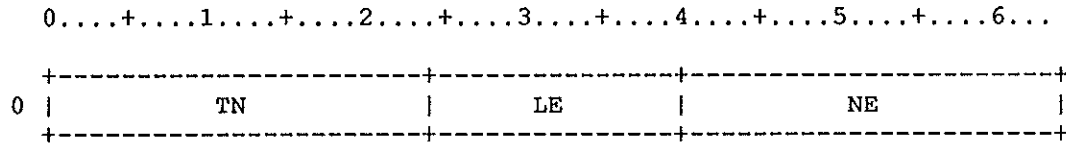

Figure AU-1. Active User Table header

<u>Field</u>	<u>Word(base8)</u>	<u>Bits</u>	<u>Description</u>
AUTN	0	0-23	Table name ('AUT' in ASCII)
AULE	0	24-39	Entry length (=LE@AUT)
AUNE	0	40-63	Number of entries (=NE@AUT)

<u>Field</u>	<u>Word(base8)</u>	<u>Bits</u>	<u>Description</u>
AUECIN	1	60-63	Last received error code
AUSID	2	0-15	Front end ID
AUNXST	2	16-19	Next state
AULSF	2	20-23	Last received logoff modifier
AUCSF	2	24-27	Last received special function code
AUMML	2	28-39	Maximum message length
AUSMID	2	40-63	Sent message buffer ID to be released
AUTID	3	0-63	Terminal ID
AUPROM	4	0-63	Current terminal prompt
AUTLIM	5	0-63	Time of last input message
AUOQC	6	0-63	Output queue control (1 word):
AUNOM	6	0-15	Number of messages
AUOHSZ	6	16-31	Size of first message
AUOMQT	6	32-47	Message queue tail
AUOMQH	6	48-63	Message queue head
AUIQC	7	0-63	Input queue control (1 word):
AUNIM	7	0-15	Number of messages
AUIHSZ	7	16-31	Size of first message
AUIMQT	7	32-47	Message queue tail
AUIMQH	7	48-63	Message queue head
AURMES	10	0-63	Last received message header (1 word):
AURPN	10	0-11	Process number
AURMN	10	12-15	Message number
AURST	10	16-19	Terminal state (receive/suspend)
AUREC	10	20-23	Error code
AURMT	10	24-31	Message type
AURSF	10	32-35	Special function/logoff modifier

<u>Field</u>	<u>Word(base8)</u>	<u>Bits</u>	<u>Description</u>
AURMOD	10	36	Mode (buffered/unbuffered)
AURCHN	10	37	Chain flag
AURFOR	10	38	Format (blocked(0) / unblocked(1))
AURWC	10	52-63	Text word count
AUSMES	11	0-63	Current send message header (1 word):
AUSPN	11	0-11	Process number (assigned at sysgen)
AUSMN	11	12-15	Message number
AUSST	11	16-19	Job state (receive/suspend)
AUSEC	11	20-23	Error code
AUSMT	11	24-31	Message type
AUSSF	11	32-35	Special function code
AUSMOD	11	36	Mode (buffered/unbuffered)
AUSCHN	11	37	Chain flag
AUSFOR	11	38	Format (blocked(0) / unblocked(1))
AUSWC	11	52-63	Text word count

USED BY:

TQM - Sent as a part of the mount and remount type 3 station messages.

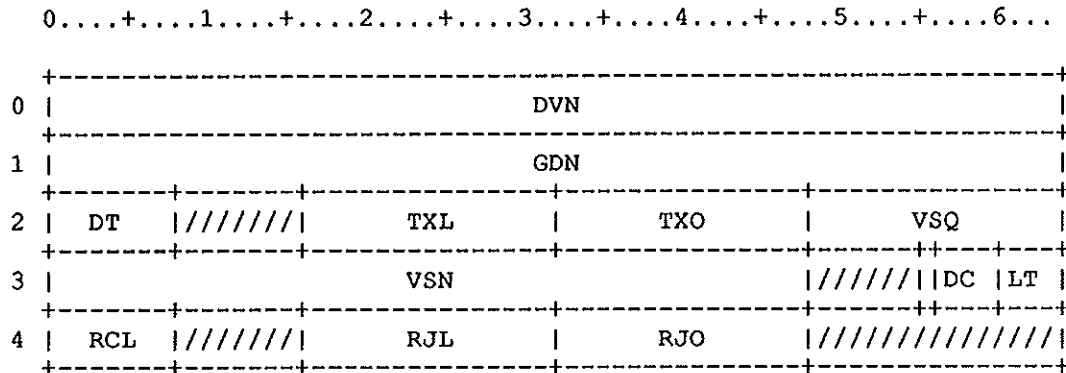

Figure XR-1. Remount/Mount Auxiliary Information Table

Field	Word(base8)	Bits	Description
XRDEVN	0	0-63	Device name
XRGDN	1	0-63	Generic device type
XRDT	2	0-7	Device type TPD62(0) = 6250 BPI tape device TPD16(1) = 1600 BPI tape device
XRTXL	2	16-31	Length of text equivalent
XRTXO	2	32-47	Offset to text equivalent
XRVSQ	2	48-63	Volume sequence number(file section)
XRVSN	3	0-47	Requested volume serial number.
XRRG	3	55	Ring status 0 = ring in 1 = ring out
XRDC	3	56-59	Volume disposition code TPOLD(0) = on existing volume TPNEW(1) = new volume
XRLT	3	60-63	Requested label type TPLNL(0) = non-labeled TPLAL(1) = ANSI standard labels TPLSS(2) = IBM standard labels

<u>Field</u>	<u>Word(base8)</u>	<u>Bits</u>	<u>Description</u>
XRRCL	4	0-7	Reject class. remount conditions only TR\$NONE(0)= no reject condition TR\$VSN (1)= wrong VSN TR\$LABL(2)= wrong label type TR\$RING(3)= ring change TR\$NSCR(4)= not scratchable TR\$PDE (5)= write label data error TR\$RESH(6)= reset button hit
XRRJL	4	16-31	Length of reject reason
XRRJO	4	32-47	Offset to reject reason

USED BY:

TQM - Sent as a part of the dataset enquiry request and reply type 3 station messages.

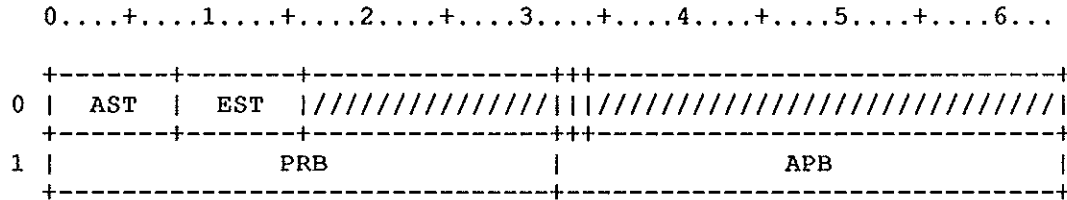

Figure XD-1. Dataset Enquiry Auxiliary Information Table

Field	Word(base8)	Bits	Description
XDAST	0	0-7	Accessibility status(reply) XR\$NIMP(0) = function not implemented XR\$YS (1) = yes and mainframe secure XR\$NO (2) = not allowed XR\$Y (3) = yes but MF is not secure
XDEST	0	8-15	Existence status(reply) XR\$NIMP(0) = function not implemented XR\$CAT (1) = dataset is cataloged XR\$NCAT(2) = dataset not in catalog XR\$NDC (3) = MF has no catalog
XDARG	0	32	Allowable ring status(reply) XR\$RIN (0) = ring in is allowed XR\$ROUT(1) = ring in is not allowed
XDECAT	0	33	Concatenated dataset (request)
XDPRB	1	0-31	Requested permission bits(request)
XDRR	1	0	Read permission
XDRW	1	1	Write permission
XDRRW	1	2	Read followed by write permission
XDRWR	1	3	Write followed by read permission
XDRAP	1	4	Extend(append/mod) permission
XDRDE	1	5	Delete permission
XDRRC	1	6	Recatalog permission
XDRCC	1	7	Characteristic change permission

<u>Field</u>	<u>Word(base8)</u>	<u>Bits</u>	<u>Description</u>
XDAPB	1	32-63	Allowable permission bit(reply)
XDAR	1	32	Read permission
XDAW	1	33	Write permission
XDARW	1	34	Read followed by write permission
XDAWR	1	35	Write followed by read permission
XDAAP	1	36	Extend(append/mod) permission
XDADE	1	37	Delete permission
XDARC	1	38	Recatalog permission
XDACC	1	39	Characteristic change permission
XR\$NIMP	= 0		Function not implemented
XR\$YS	= 1		Allow access and SFE is secure
XR\$N	= 2		Do not allow access
XR\$Y	= 3		Allow access but SFE is not secure
XR\$CAT	= 1		Dataset is cataloged on SFE
XR\$NCAT	= 2		Dataset is not cataloged on SFE
XR\$NDC	= 3		SFE has no catalog
XR\$RIN	= 0		Allow ring to be in
XR\$ROUT	= 1		Force ring to be out

USED BY:

TQM - Sent as a part of the dataset update request and reply type 3 station messages.

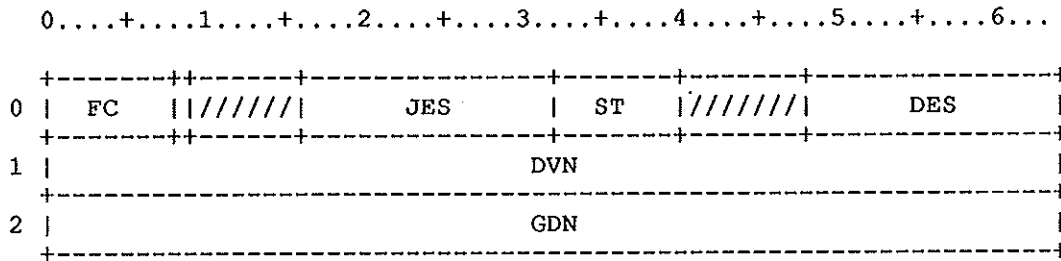

Figure XD-1. Dataset Update Auxiliary Information Table

Field	Word(base8)	Bits	Description
XDFC	0	0-7	Update function code(request/reply) XR\$NIMP(0)=Function not implemented XR\$UCAT(1)=Catalog dataset XR\$URCT(2)=Recatalog dataset XR\$UUCT(3)=Uncatalog dataset
XDUCAT	0	8	Concatenated dataset (request)
XDJES	0	16-31	Job error state(request). last abort for the job(ABxxx).
XDST	0	32-39	Update completion status(reply) XR\$NIMP(0)=Function not implemented XR\$PASS(1)=Update passed XR\$FAIL(2)=Update failed XR\$ACAT(3)=Dataset already cataloged XR\$NCAT(4)=Dataset is not cataloged
XDDES	0	48-63	Dataset error state(request). Last error reply for the dataset.
XDDVN	1	0-63	Logical device name(request)
XDGDN	2	0-63	Generic device name(request)
XR\$UCAT	= 1		Catalog dataset at release time
XR\$URCT	= 2		Re-catalog dataset at release time
XR\$UUCT	= 3		Un-catalog dataset at release time
XR\$UPAS	= 1		Catalog update passed
XR\$UFAL	= 2		Catalog update failed
XR\$UACT	= 3		Dataset is already cataloged
XR\$UNCT	= 4		Dataset is not cataloged
XR\$UNCAT	= 5		Front-end does not have a catalog

USED BY:

TQM - Sent as a part of the tape volume access request and reply (type 3 station message).

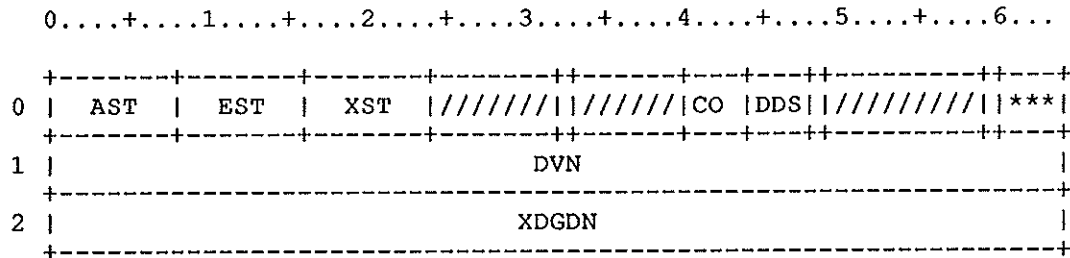

Figure XV-1. Volume Access Auxiliary Information Table

Field	Word(base8)	Bits	Description
XVAST	0	0-7	Accessabilty status(reply) XR\$NIMP(0) = Function not implemented XR\$YS (1) = Yes and mainframe secure XR\$N (2) = Not allowed XR\$Y (3) = Yes but MF is not secure
XVEST	0	8-15	Existence status(reply) XR\$NIMP(0) = Function not implemented XR\$CAT (1) = Volume is in catalog XR\$NCAT(2) = Volume is not in catalog XR\$NVC (3) = MF has no volume catalog
XVXST	0	16-23	Expiration status(reply) XR\$NIMP(0) = Function not implemented XR\$VX (1) = Volume is expired XR\$VNX (2) = Volume is not expired XR\$VIX (3) = Invalid expiration date
XVARG	0	32	Allowable ring status(reply) XR\$RIN (0) = Ring may be in volume XR\$ROUT(1) = Ring may not be in tape
XVCO	0	40-43	Current operation(request) X\$RB (1) = Read X\$WB (2) = Write
XVDDS	0	44-47	Dataset disposition(request) TPOLD (0) = Old TPNEW (1) = New
XVFAT	0	48	Fatal error on volume access
XVACAT	0	59	Concatenated dataset (request)

<u>Field</u>	<u>Word(base8)</u>	<u>Bits</u>	<u>Description</u>
XVADVS	0	60-63	Dataset volume state (request)
XVABOF	0	60	Beginning of file
XVABOV	0	61	Beginning of volume
SUBFIELD	62,1		Unused
SUBFIELD	63,1		Unused
XVDVN	1	0-63	Logical device name
XDGDN	2	0-63	Generic device name
XR\$VNC	= 3		
XR\$VX	= 1		
XR\$VNX	= 2		
XR\$VIX	= 3		

USED BY:

TQM - Sent as a part of the volume update request/reply type 3 station messages.

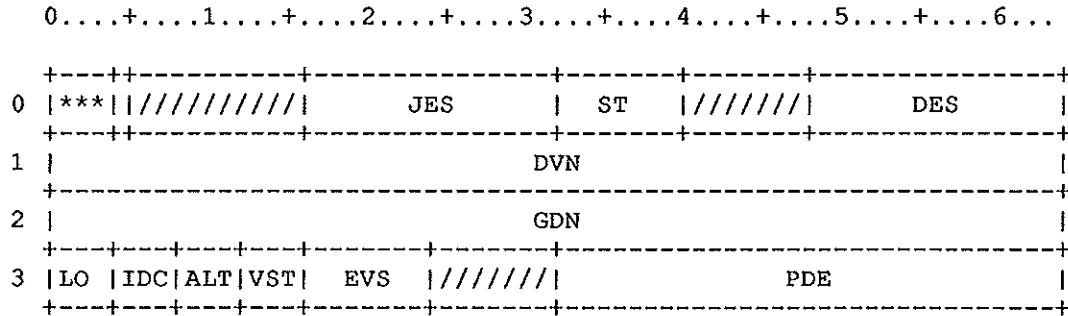

Figure XV-1. Volume Update Auxiliary Information Table

Field	Word(base8)	Bits	Description
XVUDVS	0	0-3	Dataset volume state (request)
XVUBOF	0	0	Beginning of file
XVUBOV	0	1	Beginning of volume
SUBFIELD	2,1		Unused
SUBFIELD	3,1		Unused
XVUCAT	0	4	Concatenated dataset (request)
XVJES	0	16-31	Last job error state(request)
XVST	0	32-39	Update status(reply) XR\$NIMP(0) = Function not implemented XR\$PASS(1) = Update passed XR\$FAIL(2) = Update failed
XVDES	0	48-63	Last dataset error state(request)
XVDVN	1	0-63	Logical device name
XVGDN	2	0-63	Generic device name
XVLO	3	0-3	Last I/O operation(request) X\$RB (1) = Read X\$WB (2) = Write
XVIDC	3	4-7	Dataset initial disposition(request) TPOLD (0) = Old TPNEW (1) = New

<u>Field</u>	<u>Word(base8)</u>	<u>Bits</u>	<u>Description</u>
XVALT	3	8-11	Actual label type(request) TPLNL (0) = Non-labeled TPLAL (1) = ANSI standard labels TPLSL (2) = IBM standard labels
XVVST	3	12-15	Current volume state(request) XR\$BOV (0) = Beginning of volume XR\$EOV (1) = End of volume XR\$EOF (2) = End of file XR\$CLS (3) = Close XR\$REW (4) = Rewind
XVEVS	3	16-23	Encountered volume states(request)
XVBOV	3	16	Beginning of volume processed
XVEOV	3	17	End of volume processed
XVEOF	3	18	End of file processed
XVCLS	3	19	Close processed
XVREW	3	20	Rewind processed
XVPDE	3	32-63	Permanent data error count(request)
XR\$BOV	=	0	
XR\$EOV	=	1	
XR\$EOF	=	2	
XR\$CLS	=	3	
XR\$REW	=	4	

BINARY AUDIT TABLE

The binary audit table is produced by the audit utility for use as input to local utility programs. Because these programs are generally coded in fortran, all fields except those marked as binary are left-justified and blank filled.

There are two basic formats of binary audit tables:

1. A fixed length record containing selected information from the dataset catalog entry for the dataset. There is one such record for each dataset edition in the binary audit file. (See Figure BA-1.)
2. A variable length record containing information from the dataset catalog extension table or backup catalog (BCD). There are five subtypes of these records: one each for permits, access tracks, text, notes, and BCD information. There are as many of these variable length records in the binary audit file as necessary to supply all of the dataset catalog extension information requested on the audit utility control statement.

The variable length records always follow the fixed length record with which they are associated.

Because of the varying length of binary audit records, the FORTRAN BUFFERIN statement is the usual method used to read the binary audit file. The type of record just read can be determined by testing the first word of the record for the following binary integer values (see Figure BA-2):

- 1 - Permit record (Figures BA-3 and BA-4);
- 2 - Access tracking record (Figures BA-3 and BA-5);
- 3 - Text record (Figure BA-6);
- 4 - Notes record (Figure BA-6);
- 5 - BCD information record (Figure BA-7).

If the first word is not one of these values, then it is a fixed length dataset catalog information record.

0....+....1....+....2....+....3....+....4....+....5....+....6....

0	PDN1
1	PDN2
2	ED
3	ID
4	SZ
5	RT
6	ACC
7	CRT
10	CRD
11	CRH
12	TDM
13	TDD
14	TDH
15	ACT
16	ACD
17	ACH
20	LDV
21	MFT
22	MFD
23	MFH
24	USR1
25	USR2
26	OWN
27	
30	TRA

Figure BA-1. Binary audit fixed length record

Record length = 36₁₀ Cray words

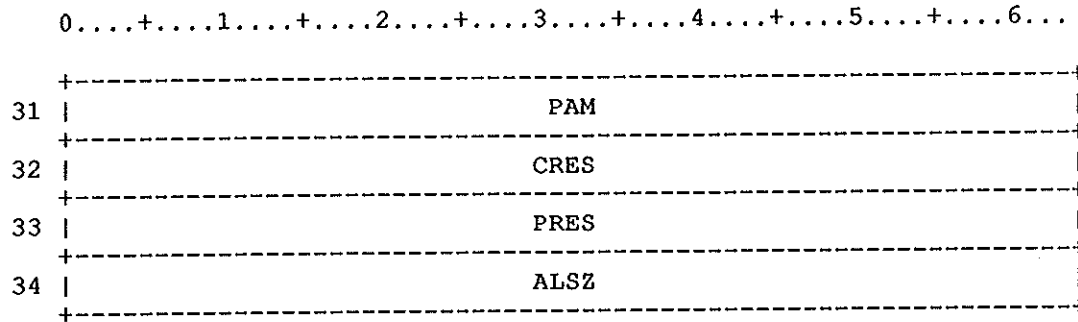

Figure BA-1. Binary audit fixed length record

Field	Word(base8)	Bits	Description
BAPDN1	0	0-63	Permanent dataset name; characters 1-8
BAPDN2	1	0-63	Permanent dataset name; characters 9-15
BAED	2	0-63	Edition number; 1-4095 represented in binary.
BAID	3	0-63	User ID, left-justified with blank fill
BASZ	4	0-63	Dataset size (in words) represented in binary integer
BART	5	0-63	Retention period; 1-4095 represented in binary integer
BAACC	6	0-63	Number of accesses represented in binary
BACRT	7	0-63	Timestamp at Creation time in(binary)
BACRD	10	0-63	Creation date as mm/dd/yy
BACRH	11	0-63	Creation time as hh:mm:ss
BATDM	12	0-63	Timestamp at last dump
BATDD	13	0-63	Date of last dump as mm/dd/yy
BATDH	14	0-63	Time of last dump as hh:mm:ss
BAACT	15	0-63	Timestamp at last access in (binary)
BAACD	16	0-63	Date of last access as mm/dd/yy
BAACH	17	0-63	Time of last access as hh:mm:ss

<u>Field</u>	<u>Word(base8)</u>	<u>Bits</u>	<u>Description</u>
BALDV	20	0-63	Logical device name
BAMFT	21	0-63	Timestamp at last modification in (binary)
BAMFD	22	0-63	Date of last modification as mm/dd/yy
BAMFH	23	0-63	Time of last modification as hh:mm:ss
BAUSR1	24	0-63	User number; characters 1-8.
BAUSR2	25	0-63	User number; characters 9-15.
BAOWN	26-27	0-63	Dataset owner
BAOWN1	26	0-63	Dataset owner; characters 1-8
BAOWN2	27	0-63	Dataset owner; characters 9-15
BATRA	30	0-63	Track access flag ('Y' or 'N')
BAPAM	31	0-63	Public access mode (any of 'NERWM')
BACRES	32	0-63	Current residency (ON/MIG/RET)
BAPRES	33	0-63	Preferred residency (ON/OFF)
BAALSZ	34	0-63	Allocated dataset size in words

The unused words at the end of this record are binary zeros.

Variable length record formats all begin with:

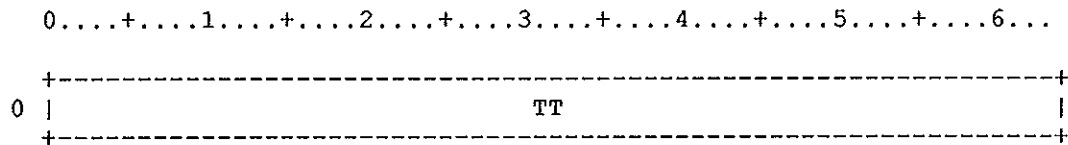

Figure BA-2. Binary audit variable length header

<u>Field</u>	<u>Word(base8)</u>	<u>Bits</u>	<u>Description</u>
BATT	0	0-63	Record type (binary integer) 1=PERMIT, 2=TRACK, 3=TEXT, 4=NOTE, 5=BCD

Permit and access tracking records share:

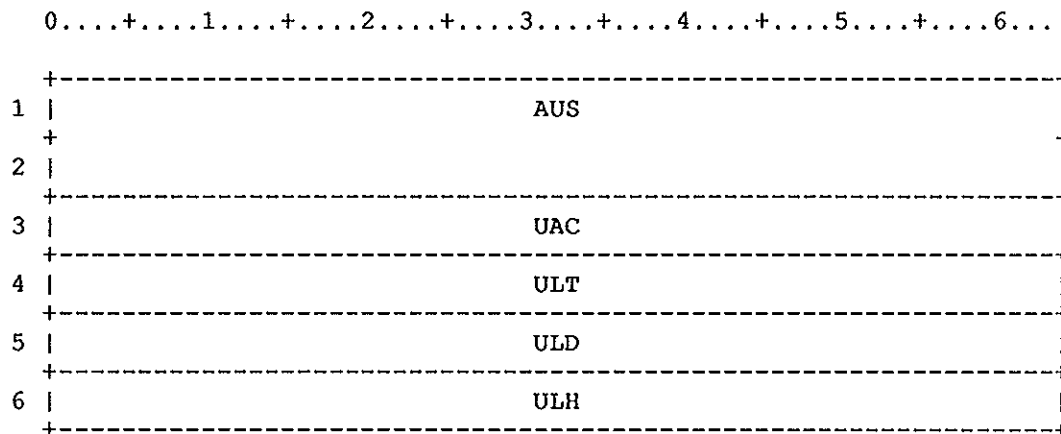

Figure BA-3. Permit and access tracking record

Field	Word(base8)	Bits	Description
BAAUS	1-2	0-63	Permitted or accessing user number
BAAUS1	1	0-63	User number; characters 1-8
BAAUS2	2	0-63	User number; characters 9-15
BAUAC	3	0-63	Access count (binary integer)
BAULT	4	0-63	Timestamp of last access (binary)
BAULD	5	0-63	Date of last access (mm/dd/yy)
BAULH	6	0-63	Time of last access (hh:mm:ss)

Permit records continue with:

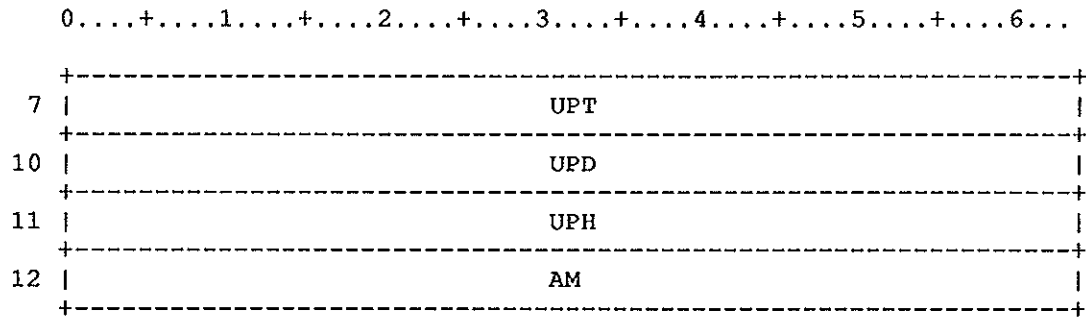

Figure BA-4. Permit continuation

<u>Field</u>	<u>Word(base8)</u>	<u>Bits</u>	<u>Description</u>
BAUPT	7	0-63	Timestamp of permit creation (binary)
BAUPD	10	0-63	Date of permit creation (mm/dd/yy)
BAUPH	11	0-63	Time of permit creation (hh:mm:ss)
BAAM	12	0-63	Permitted access mode (see bapam)

Access tracking records continue with:

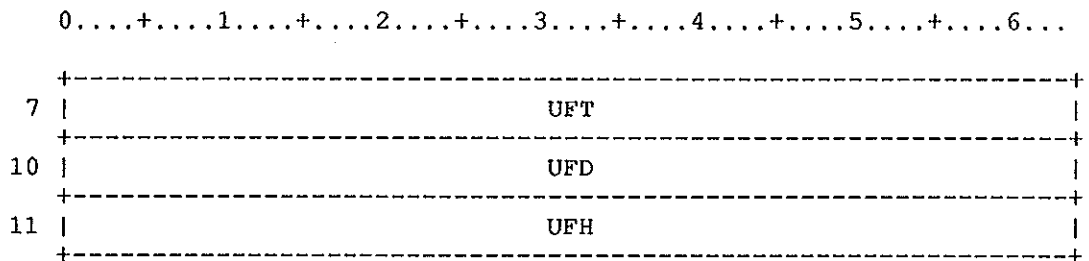

Figure BA-5. Access tracking continuation

<u>Field</u>	<u>Word(base8)</u>	<u>Bits</u>	<u>Description</u>
BAUFT	7	0-63	Timestamp of first access (binary)
BAUFD	10	0-63	Date of first access (mm/dd/yy)
BAUFH	11	0-63	Time of first access (hh:mm:ss)

Text and notes records consist only of the BATT word followed by as many words as necessary to hold the text or notes field. Unused characters in the last word are binary zero filled.

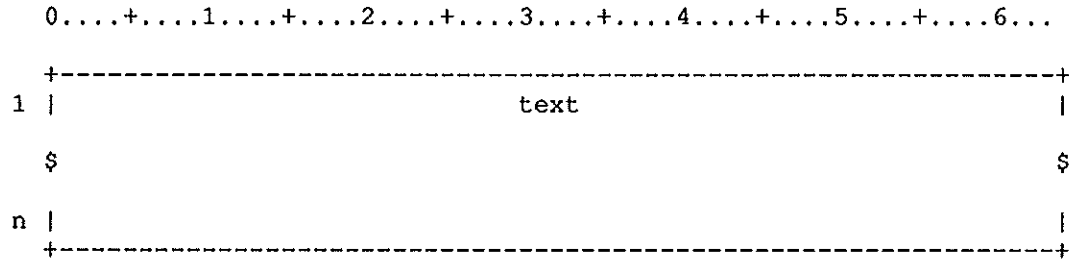

Figure BA-6. Text and notes record

<u>Field</u>	<u>Word(base8)</u>	<u>Bits</u>	<u>Description</u>
BAtext	1-n	0-63	Text or notes

BCD information record

	0....+....1....+....2....+....3....+....4....+....5....+....6....
1	VOL1
2	VOL2
3	VOL3
4	VOL4
5	MIG
6	RCL
7	RET
10	RES
11	BACR
12	RBR
13	RCLR
14	RESR
15	RETR
16	DELR

Figure BA-7. BCD information record

Field	Word(base8)	Bits	Description
BAVOL1	1	0-63	First backup volume label (starting)
BAVOL2	2	0-63	Second backup volume label (starting)
BAVOL3	3	0-63	Third backup volume label (starting)
BAVOL4	4	0-63	Fourth backup volume label (starting)
BAMIG	5	0-63	Number of migrates (binary)
BARCL	6	0-63	Nnumber of recalls (binary)
BARET	7	0-63	Number of retires (binary)
BARES	10	0-63	Number of restores (binary)

BABACR	11	0-63	Backup requested	(binary,1=yes,0=no)
BARBR	12	0-63	Rebackup requested	(binary,1=yes,0=no)
BARCLR	13	0-63	Recall requested	(binary,1=yes,0=no)
BARESR	14	0-63	Restore requested	(binary,1=yes,0=no)
BARETR	15	0-63	Retire requested	(binary,1=yes,0=no)
BADELRL	16	0-63	Delete requested	(binary,1=yes,0=no)

BGN Table. This table is input to the F\$BGN call which provides a mechanism for a user program to indicate to the Operating System the location of the executable binary and a P address which the CPU can be released to. In addition, the old BGN format is supported for this release. The following functions are currently supported with the new BGN format:

- A) Load a dataset from mass storage as specified by the DSP.
- B) Copy memory from a source base address to target base address for lengths specified.
- C) Preset memory with supplied pattern from preset base address for lengths specified.
- D) Support for target machine characteristics.

Support is included for the separation of instruction and data segments. Instruction segments are currently supported and any attempt to load a data segment will be aborted.

Define the F\$BGN Function codes:

BGNADVNC	=	O'00	Old F\$BGN formatted table; advance XPP
BGNLOAD	=	O'1	Load from dataset function code
BGNCOPY	=	O'2	Copy from source to destination
BGNSEGD	=	O'03	Load program segment from disk
BGNSEGM	=	O'04	Copy program segment from memory
BGNUCSP	=	O'05	Define version of CSP for future loads
BGNFMAX	=	BGNUCSP	

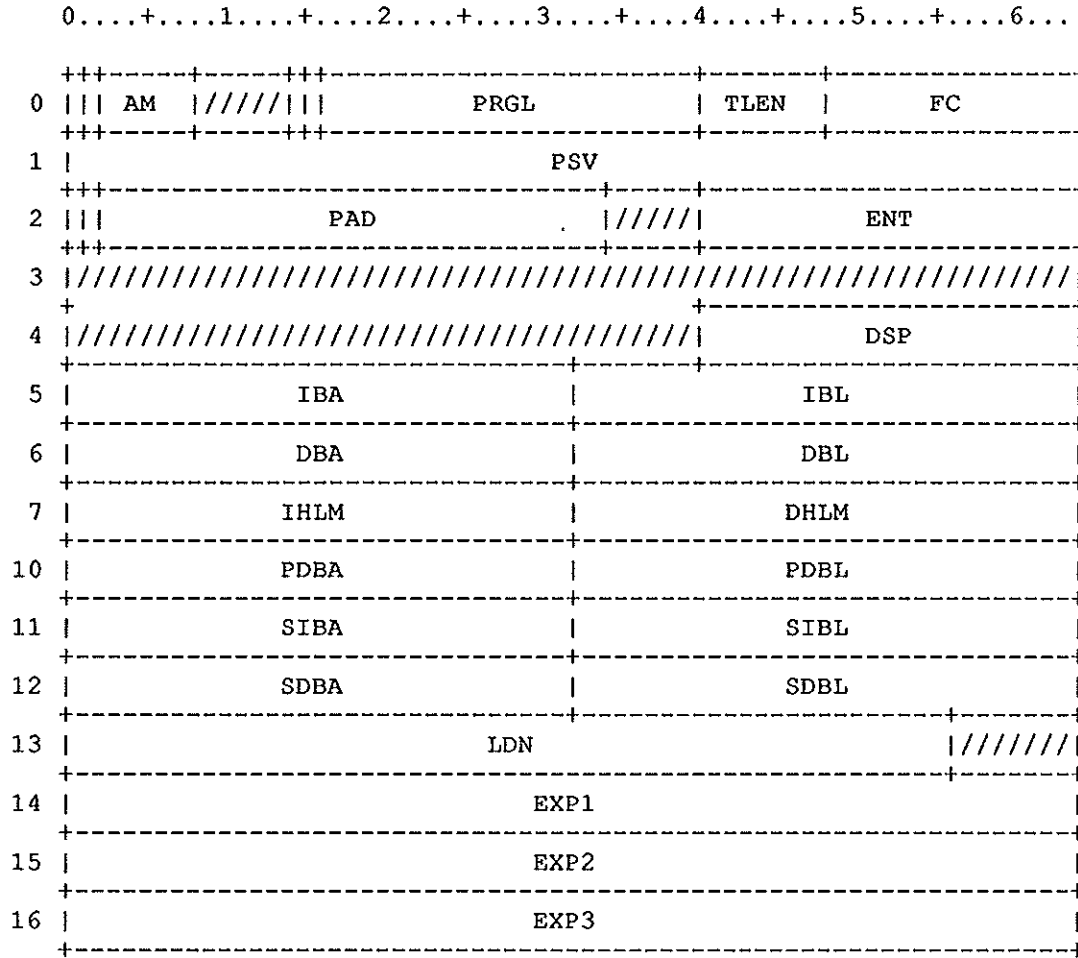

Figure BG-1. Begin Code Execution Table

Field	Word(base8)	Bits	Description
BGPSF	0	0	Preset value flag If=1, preset segment
BGEMA	0	1	EMA setting for new calls, 1=ENABLE
BGAM	0	2-7	Additional modes field
BGAMF	0	2	Additional modes flag (1=modes set)
BGBDM	0	3	Bi-directional memory 1=ENABLE
BGAVL	0	4	Additional vector logical 1=ENABLE
BGORI	0	5	Operand range interrupt 1=ENABLE
BGFI	0	6	Floating point interrupt 1=ENABLE
BGPS	0	7	Program state
BGNCSX	0	14	Defined CSP has non-COS JCL syntax
BGUDS	0	15	Load dataset is not CRAY-blocked

<u>Field</u>	<u>Word(base8)</u>	<u>Bits</u>	<u>Description</u>
BGPRGL	0	16-39	Program length (BGNADVNC only)
BGTLEN	0	40-47	Length of BGN table
BGFC	0	48-63	F\$BGN subfunction code
BGPSV	1	0-63	Preset value
BGBP	2	0	Breakpoint flag
BGNRD	2	1	No reduce bit
BGPAD	2	2-33	Pad value
BGENT	2	40-63	Entry point for instruction segment
New BGN table field definitions			
BGDSP	4	40-63	DSP address of load dataset
BGIBA	5	0-31	Instruction base address to load to
BGIBL	5	32-63	Instruction segment length
BGDBA	6	0-31	Data base address to load to
BGDBL	6	32-63	Data segment length
BGIHLM	7	0-31	Instruction segment HLM value
BGDHLM	7	32-63	Data segment HLM value
BGPDBA	10	0-31	Preset data base address for pattern
BGPDBL	10	32-63	Preset data length for pattern
BGSIBA	11	0-31	Source Instruction base address(COPY)
BGSIBL	11	32-63	Source Instruction length(COPY)
BGSDBA	12	0-31	Source Data base address(COPY)
BGSDBL	12	32-63	Source Data length(COPY)
BGLDN	13	0-55	Local dataset name of user copy of CSP
BGEXP1	14	0-63	Word reserved for EXP use only
BGDSPI	14	1-6	Relocation index for DSP supplied
BGSIIX	14	7-12	Source instruction relocation index
BGSDIX	14	13-18	Source data relocation index
BGDIIX	14	19-24	Destination instruction index
BGDDIX	14	25-30	Destination data index
BGDNT	14	40-63	DNT address, JTA relative

<u>Field</u>	<u>Word(base8)</u>	<u>Bits</u>	<u>Description</u>
BGEXP2	15	0-63	Word reserved for EXP use only
BGEXP3	16	0-63	Word reserved for EXP use only

The Buffer Pool Table, which resides in the high range of memory, is used for buffer pool management in connection with interactive communication.

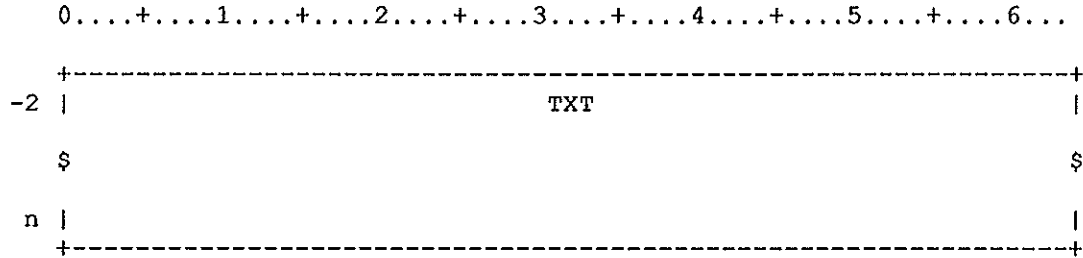

Figure BP-1. Buffer Pool Table

W@BPTXT=-2 Beginning of text

Field	Word(base8)	Bits	Description
BPTXT	-2-n	0-63	W@BPUBLK=-1 Unblocked message flag
BPUBLK	-1	0	W@BPSZ=-1 Message size
BPSZ	-1	16-31	W@BPLBID=-1 Buffer ID for continuation of message
BPLBID	-1	32-47	W@BPFBIID=-1 Buffer ID for next message
BPFBIID	-1	48-63	

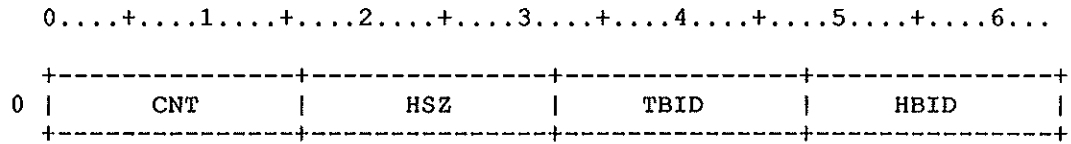
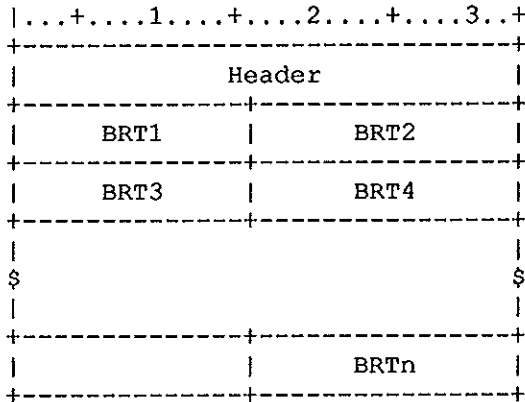

Figure Q-1. Buffer Pool Queue Control Word

<u>Field</u>	<u>Word(base8)</u>	<u>Bits</u>	<u>Description</u>
QCNT	0	0-15	Number of buffers on this string
QHSZ	0	16-31	Size of first message on queue
QTBID	0	32-47	Queue tail buffer ID
QHBID	0	48-63	Queue head buffer ID

The Block Relocation Table (BRT) contains information which enables the loader to relocate relative addresses within a program. Any number of BRT entries can appear after the heading.

In the Standard BRT format, there are two BRT entries per word, arranged as shown below:



See Figure BRT-1 for the detailed header description and Figure BRT-2 for the description of each BRT entry.

In the Extended BRT format, there is one entry per word, as shown by Figure BRT-3.

BRTTYPE = 0'15 Table type code for BRT

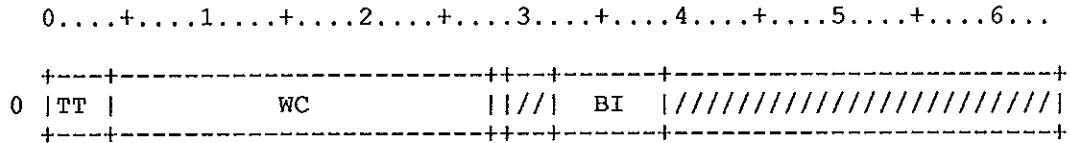

Figure BRT-1. Loader Block Relocation Table

Field	Word(base8)	Bits	Description
BRTT	0	0-3	Table type
BRTWC	0	4-27	Word count including header
BRTX	0	28	Format bit: 0 = Standard BRT format 1 = Extended BRT format

<u>Field</u>	<u>Word(base8)</u>	<u>Bits</u>	<u>Description</u>
BRTBI	0	32-38	Block index of destination; specifies a block base address to be added to the relocation field as the relocation address.

The following fields define the BRT entries for Standard BRTs. There are two entries per word.

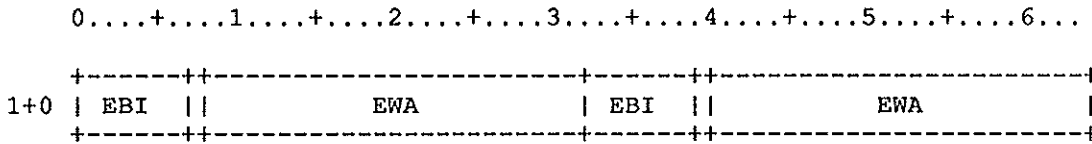

Figure BRT-2. Loader Block Relocation Table

<u>Field</u>	<u>Word(base8)</u>	<u>Bits</u>	<u>Description</u>
BRTEBI	1+0	0-6	Block index
BRTEQ	1+0	7	Relocation mode 0 = Word 1 = Parcel
BRTEWA	1+0	8-31	Parcel address to be modified (as 22-bit word address and 2-bit parcel)
BRTEBI	1+0	32-38	Block index
BRTEQ	1+0	39	Relocation mode
BRTEWA	1+0	40-63	Parcel address to be modified (as 22-

This EXEC-resident table is used for working storage by the disk driver and other channel processors.

CHNE = C@CPHCHN-C@CPLCHN+1 Number of physical CPU channels

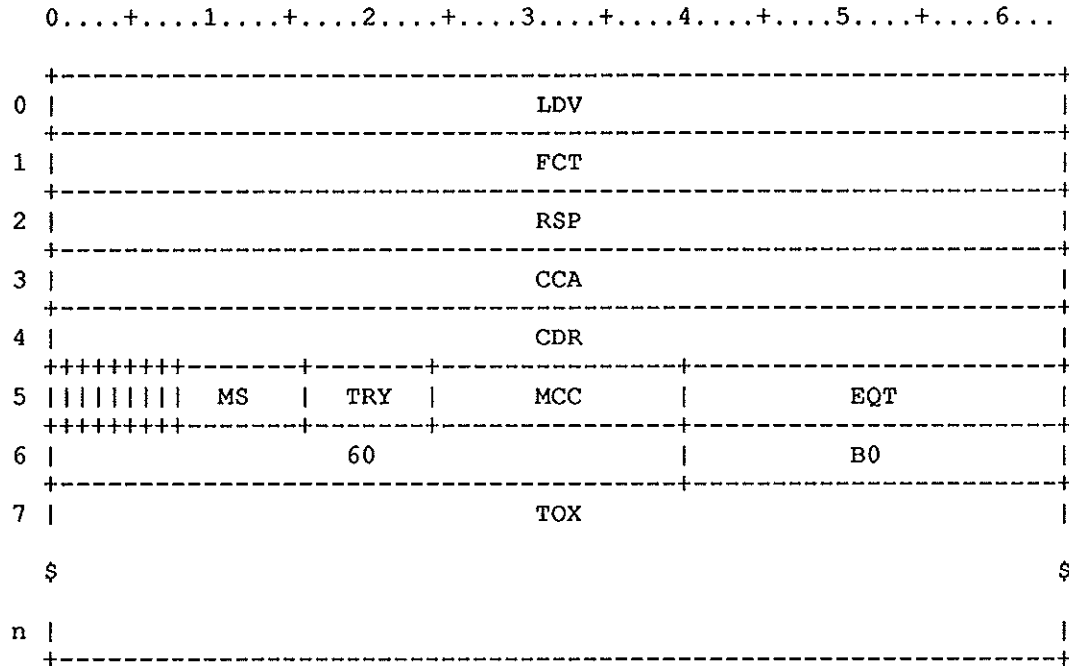

Figure CB-1. Channel Buffer Table

Field	Word(base8)	Bits	Description
CBLDV	0	0-63	Logical device name
CBFCT	1	0-63	Function word
CBUNT	1	53-54	Disk unit number
CBRSP	2	0-63	Last response word
CBSE	2	60-63	HSC error status
CBCCA	3	0-63	Current cylinder address
CBCC3	3	0-15	Current cylinder unit 3
CBCC2	3	16-31	Current cylinder unit 2
CBCC1	3	32-47	Current cylinder unit 1

<u>Field</u>	<u>Word(base8)</u>	<u>Bits</u>	<u>Description</u>
CBCC0	3	48-63	Current cylinder unit 0
CBCCR	4	0-63	Current disk request
*			Caution: The format of the following word is assumed to
*			be the same in the EQT, CBT, and RQT.
CBSC	4	0-14	Sector count
CBCA	4	15-25	Cylinder address
CBTA	4	26-31	Track address
CBSA	4	32-39	Sector address
CBMA	4	40-63	Data memory address
CBTD	5	0	Transfer direction 0 Read 1 Write
CBRWF	5	1	Read/write select flag
CBDT	5	2	Device type 0 DD19 1 DD29
CBBSY	5	3	Device busy flag
CBRM	5	4	Recovery mode flag
CBTM	5	5	Transfer mode: 0 Single 1 Multiblock
CB56	5	6	Undefined
CB57	5	7	Undefined
CBMS	5	8-15	Current margin select offset
CBTRY	5	16-23	Current try count
CBMCC	5	24-39	Master clear count
CBEQT	5	40-63	EQT Table address (EXEC-relative)
CB60	6	0-39	Undefined
CBB0	6	40-63	Subroutine return address
CBTOX	7-n	0-63	Active timeout event index

The chain control word is used in the communication module chain control (CMCC) to locate chains of communication modules (CMODs), which define all task requests in a system. Each word in the CMCC points to a string of CMODs, which define all possible requests to task 0, then to task 1, etc. A task receives and answers any requests through a CMOD. CMODs are described under table CM.

The relation between the CMCC and the chain of CMODs is illustrated in the COS EXEC/STP/CSP Internal Reference Manual, CRI publication SM-0040 (figure 3-1). Figures CC-1 and CC-2 show the formats for the two types of chain control words that form the CMCC.

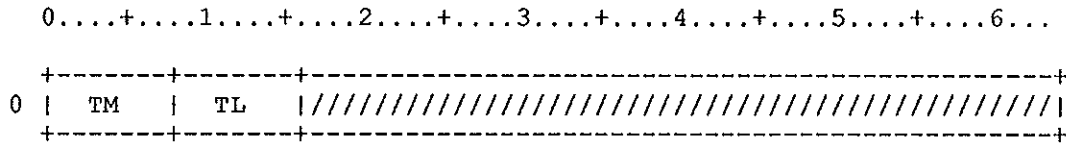

Figure CC-1. Chain Control Word

Field	Word(base8)	Bits	Description
CCTM	0	0-7	Maximum number of items to be queued to a particular task (intertask communication only)
CCTL	0	8-15	Number of items queued to a particular task (intertask communication only)

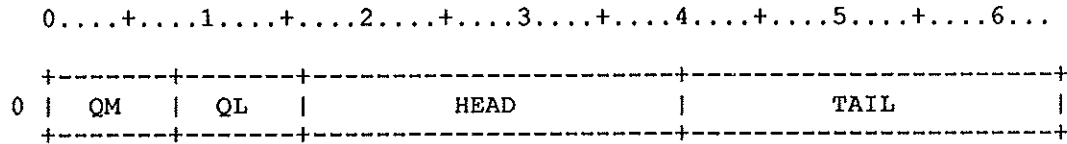

Figure CC-2. Individual Chain Control Words

<u>Field</u>	<u>Word(base8)</u>	<u>Bits</u>	<u>Description</u>
CCQM	0	0-7	Maximum number of items to be queued from one task to another (intertask communication only)
CCQL	0	8-15	Number of items currently queued from one task to another (intertask communication only)
CCHEAD	0	16-39	Address of first item on the chain
CCTAIL	0	40-63	Address of last item on the chain

Any item queued using the STP common routines CHAINZ and CHAINF must reserve the first two words of the item to be used by the common routines.

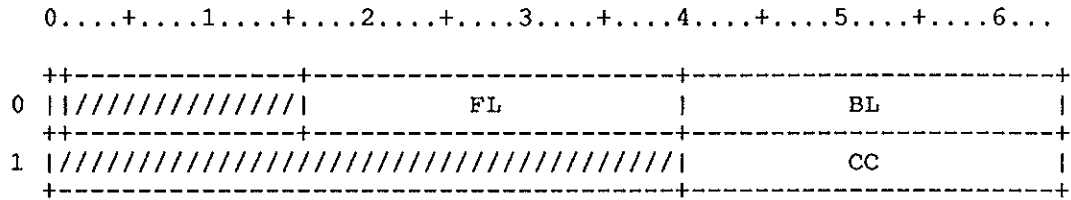

Figure CI-1. Chain Item

Field	Word(base8)	Bits	Description
CIEX	0	0	This bit, if set, indicates that the item is in execution (intertask communication only).
CIFL	0	16-39	Forward link; address of next item on the chain.
CIBL	0	40-63	Backward link; address of the preceding item on the chain.
CICC	1	40-63	Address of the chain control word for this item

The Catalog Entry Descriptor is used to locate and validate a locked catalog entry when the entry is being processed in update mode. It is returned by the READ/GET routines and supplied to the WRITE/PUT routines.

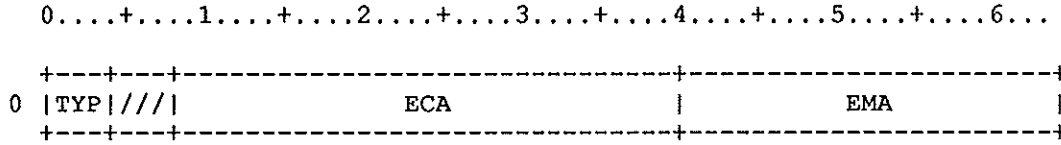

Figure CED-1. Catalog Entry Descriptor

<u>Field</u>	<u>Word(base8)</u>	<u>Bits</u>	<u>Description</u>
CEDTYP	0	0-3	Catalog entry type: CEDDSC=1 DSC entry CEDDXT=2 DXT entry CEDMCD=3 MCD entry CEDBCD=4 BCD entry
CEDECA	0	8-39	Entry Catalog Address
CEDEMA	0	40-63	Entry Memory Address

The Channel Table resides in EXEC memory and contains information for use by the interrupt handlers. There is one entry for each channel, physical or pseudo.

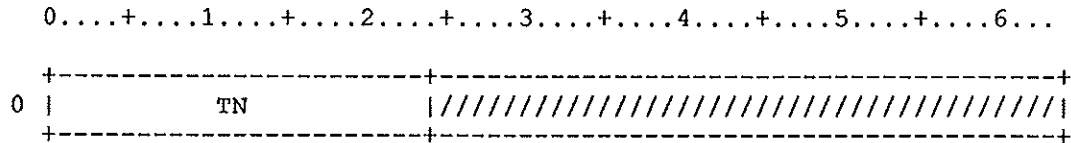

Figure CH-1. Channel Table Header

Field	Word(base8)	Bits	Description
CHTN	0	0-23	Table name; 'CHT' in ASCII.

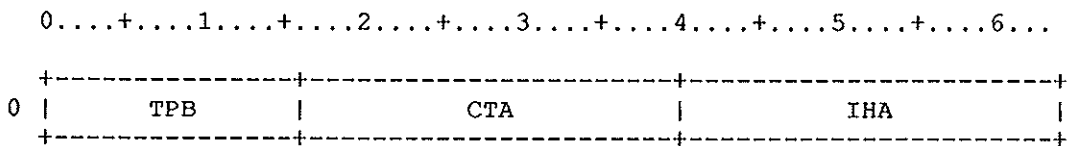

Figure CH-2. Channel Table Entry

Field	Word(base8)	Bits	Description
CHTPB	0	0-15	Address of task parameter block (on a front-end channel)
CHCTA	0	16-39	Channel table address
CHIHA	0	40-63	Interrupt handler address

The CIO history trace is STPTAB resident. This trace buffer when enabled will trace the various key points through the major sections of CIO. By default all tracing within CIO is turned off. To enable CIO tracing, redefine the number of history trace entries to a non-zero value. Note that CIO will have to be reassembled when this is done.

NE@CIOT = D'000 Do not assemble in tracing

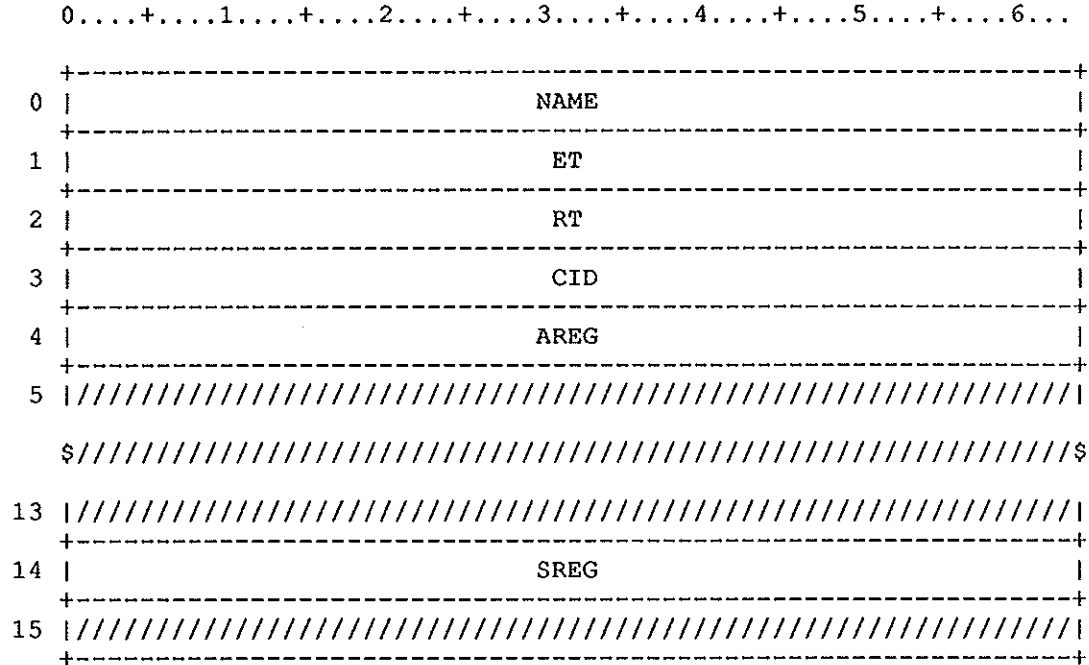

Figure CT-1. CIO history trace buffer

The follow four words are common to all history trace buffers that FDUMP can recognize and collate with other history traces of the same nature.

Field	Word(base8)	Bits	Description
CTNAME	0	0-63	ASCII name associated with the entry
CTET	1	0-63	Elapsed Real-time clock since last ent
CTRT	2	0-63	Current real-time clock
CTCID	3	0-63	Current STP task ID
CTAREG	4	0-63	Address registers
CTSREG	14	0-63	Scalar registers

Due to a software problem, page 97 was not used.
No information is missing.

CN - Configuration Table CNT

The CNT informs the operating system of the status of on-line tape and CPU devices.
 The CNT can be changed during startup by the parameter file or by operator commands.

Each entry, disk or tape, occupies 12 words:

- o A tape entry consists of a 4-word configuration table (figure CN-2) and from 0 to 4 tape subentries (each using the format shown in figure CN-4).
- o A disk entry consists of a 3-word configuration table (figure CN-3) and 9 words that contain no useful information.
- o A CPU entry consists of a 4-word configuration table (figure CN-2) and a 8 word CPU status table (using the format shown in figure CN-5).

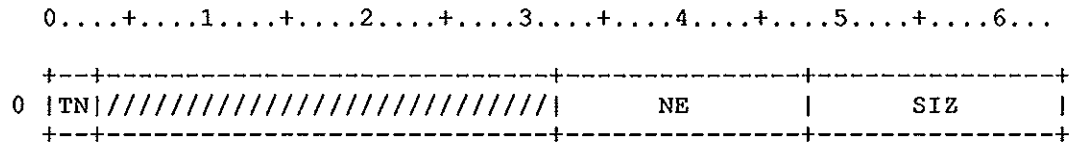

Figure CN-1. Configuration Table header

Field	Word(base8)	Bits	Description
CNTN	0	0-2	TABLE NAME: 'CNT' IN ASCII
CNNE	0	32-47	Current count of entries in use
CNSIZ	0	48-63	Maximum allowed entries

Tape entry

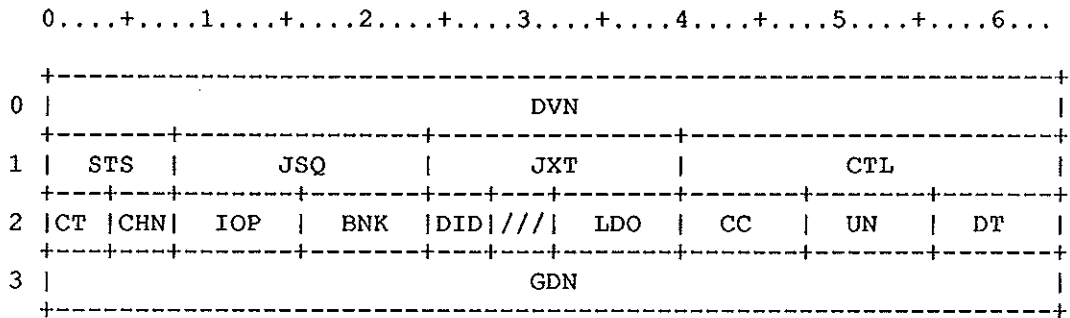

Figure CN-2. Configuration Table Entry for tape

Field	Word(base8)	Bits	Description
CNDVN	0	0-63	Device identifier (name)
CNSTS	1	0-7	Status flags. The following conditions are true if the flag bit is set to 1.
CNDWN	1	0	Device down
CNDBO	1	1	Device downed by operator
CNRDO	1	2	Device is read-only
CNMNT	1	3	Device is in maintenance mode
CNDBS	1	4	Device downed by system
CNNA	1	5	Device not available
CNDBSP	1	6	Device downed by both system and path
CNJSQ	1	8-23	Job sequence number if assigned
CNJXT	1	24-39	JXT ordinal if assigned to job
CNCTL	1	40-63	Control table address (TDT/EQT)
CNCT	2	0-3	Block mux channel type if applicable
CNCHN	2	4-7	CPU channel number if applicable
CNIOP	2	8-15	I/O Subsystem/IOP number
CNBK	2	16-23	Bank number
CNDID	2	24-27	Device ID (unit number)
FIELD	\$,29,4		- UNUSED
CNLDO	2	32-39	Loader ordinal in MLT
CNCC	2	40-47	Count of IOP channels if applicable

<u>Field</u>	<u>Word(base8)</u>	<u>Bits</u>	<u>Description</u>
CNUN	2	48-55	Device ordinal in TDT
CNDT	2	56-63	Device type or capability
CNDC	2	56-59	Device type group
CNDCC	2	60-63	Device characteristic within group
CNGDN	3	0-63	Generic device name

Configuration table entry for disk

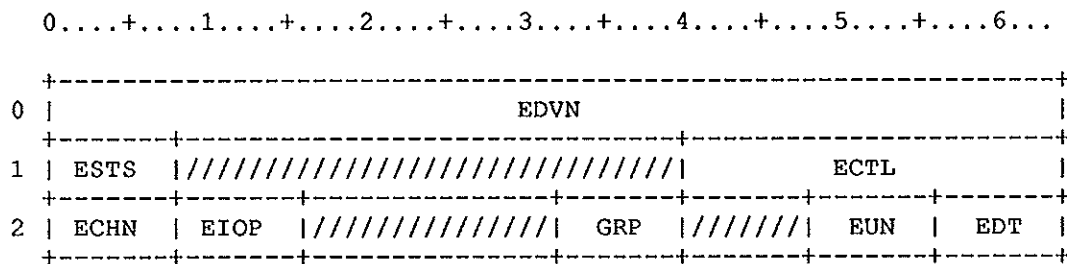

Figure CN-3. Configuration Table entry for disk

<u>Field</u>	<u>Word(base8)</u>	<u>Bits</u>	<u>Description</u>
CNEDVN	0	0-63	Device identifier
CNESTS	1	0-7	Status flags
CNENA	1	0	Device is unavailable
CNEMSD	1	2	Master device
CNEUP	1	3	Device label will be rewritten
CNERBN	1	4	Device is request by name
CNEOFF	1	5	Device is off
CNECTL	1	40-63	Pointer to EQT entry
CNECHN	2	0-7	CPU channel number
CNEIOP	2	8-15	Real I/O processor channel
CNGRP	2	32-39	Disk stripe group id this device
CNEUN	2	48-55	Unit number
CNEDT	2	56-63	Device type

Configuration table entry for CPU type devices

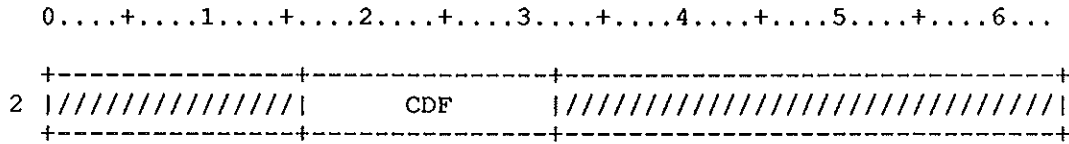

Figure CN-4. Configuration Table entry for disk

<u>Field</u>	<u>Word(base8)</u>	<u>Bits</u>	<u>Description</u>
CNCDF	2	16-31	
CNCP	2	16-19	TEMP ONLY -- REPLACED BY CNCS

CPU STATUS DEFINITION ENTRY. This table is the prototype for the eight word CPU status entry used for a CPU device in the CNT. The status words contain the current status of CPUs as known to CONFIG. Generally, the status words are used as bit masks, with the bit number corresponding to the CPU number.

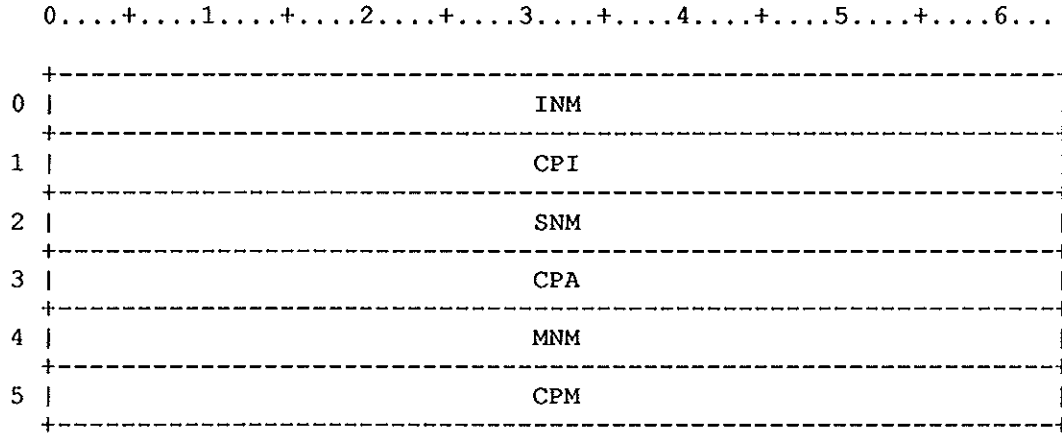

Figure CN-1. CPU status definition sub-entry

Field	Word(base8)	Bits	Description
CNINM	0	0-63	ASCII 'AVAIL'
CNCPI	1	0-63	Bit map of CPUs initialized
CNSNM	2	0-63	ASCII 'SYSTEM'
CNCPA	3	0-63	Bit map of CPUS for SYSTEM/USER
CNMNM	4	0-63	ASCII 'MAINT'
CNCPM	5	0-63	Bit map of CPUs in maintenance only
LTE@CNT	=	LE@CNT+LE@CNCS	Total CNT entry length

Tape sub-entry

Each tape sub-entry (figure CN-4) shows an IOP channel number and block mux control unit information, which allows turning off a channel or control unit. Space is provided for 8 control unit IDs, although the current maximum is 4. For each control unit that can address the device from a specific IOP channel, the following information is shown:

- o Identification
- o Whether the control unit is a host or a remote control unit
- o Whether the control unit is available (on or off)

Each control unit entry consists of a 4-bit status field and a 4-bit control unit ID, with the used entries left-justified in the word W@CNPTH. The number of applicable sub-entries for tape devices is obtained from field CNCC of the entry.

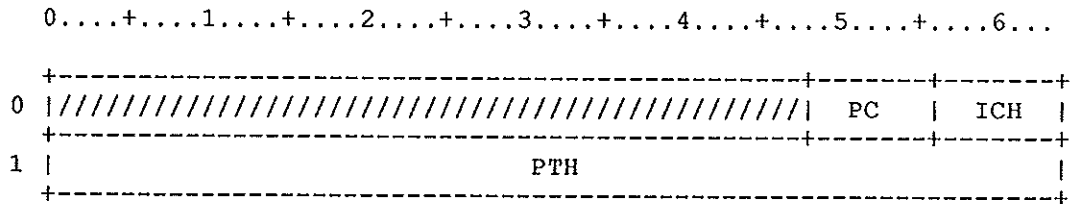

Figure CN-5. CNT Tape Sub-entry

Field	Word(base8)	Bits	Description
CNPC	0	48-55	Count of control unit paths via this IOP channel - 1 to 4
CNICH	0	56-63	IOP channel number
CNPTH	1	0-63	1-8 control unit IDs
CNAPTH	1	0-31	Group of four IDs
CNPTH1	1	0-7	Control unit ID and status
CNOFF	1	0	Control unit off flag
CNHOST	1	1	Control unit is host if set
CNOBS	1	2	Control unit deactivated by system (IOP channel off)
CNCU	1	4-7	Control unit ID
CNPTH2	1	8-15	
CNPTH3	1	16-23	
CNPTH4	1	24-31	
CNBPTH	1	32-63	Second group of four IDs
CNPTH5	1	32-39	
CNPTH6	1	40-47	
CNPTH7	1	48-55	
CNPTH8	1	56-63	

LTE@CNT = LE@CNT+4*LE@CNIPC Total CNT entry length

The job class structure definition is contained in the CSD. The CSD header, which contains general information about the structure, precedes the class maps. One CSD class map exists for each class defined in the structure. Class maps appear in descending rank order.

The variable length characteristic expressions follow the class maps, and each class contains a pointer to its expression. The CSD class expressions are variable length. The length of the CSD must be a multiple of 512 words.

**** When LH or LE are changed, the corresponding
**** parameter values in JCSDEF must also be changed.

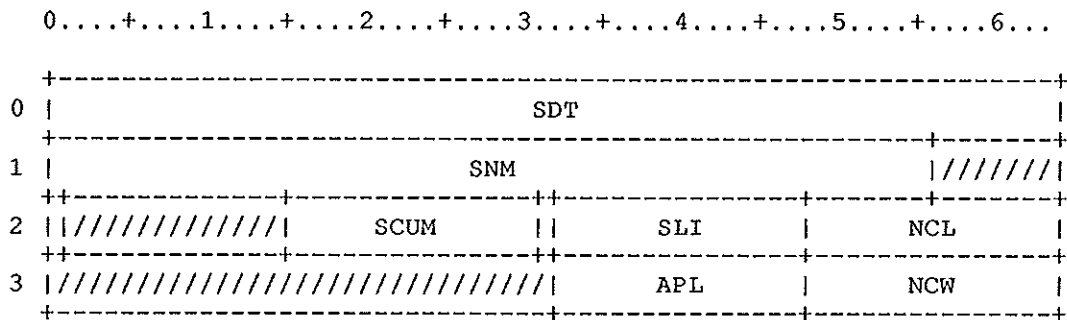

Figure CS-1. Class Structure Definition Header

Field	Word(base8)	Bits	Description
CSSDT	0	0-63	Real-time date and time of last rollout; must be in first sector of structure.
CSSNM	1	0-55	Class structure name
CSALF	2	0	if 1, CSLFF values are valid
CSSCUM	2	15-30	Structure cumulative JXTs reserved
CSAOF	2	31	If 1, all classes off
CSSLI	2	32-47	LIMIT default
CSNCL	2	48-63	Number of classes defined in structure
CSAPL	3	32-47	Number of pool JXTs allocated
CSNCW	3	48-63	Number of classes waiting for JXTs.

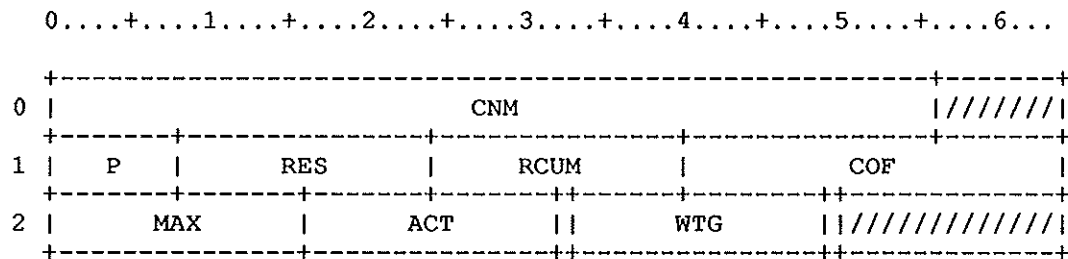

Figure CS-2. Class Structure Definition Entry

Field	Word(base8)	Bits	Description
CSCNM	0	0-55	Class name
CSP	1	0-7	Class assigned priority shifted left 4
CSRES	1	8-23	JXTs reserved by class
CSRCUM	1	24-39	JXTs reserved by all classes of a higher rank
CSCOF	1	40-63	Class offset; pointer to the cracked expression.
CSMAX	2	0-15	Class maximum
CSACT	2	16-31	Actual number of JXTs allocated to this class
CSOFF	2	32	If 1, the class is off; if 0, the class is on.
CSWTG	2	33-48	Number of jobs waiting for JXTs
CSLFF	2	49	value of CSOFF flag before last CLASS ALL OFF command

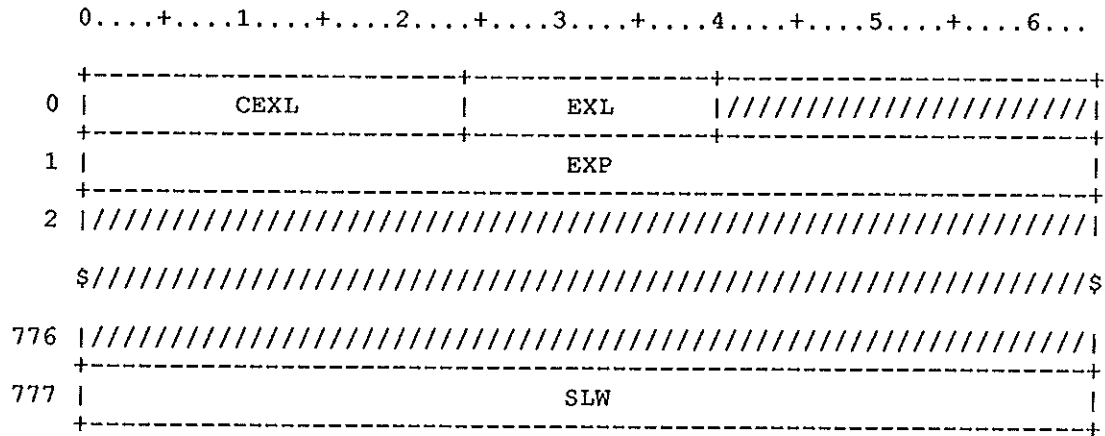

Figure CS-3. Class Structure Definition Entry

<u>Field</u>	<u>Word(base8)</u>	<u>Bits</u>	<u>Description</u>
CSCEXL	0	0-23	Length in words of cracked expression
CSEXL	0	24-39	Length in words of printable expression
CSEXP	1	0-63	Cracked class expression
CSSLW	777	0-63	Real-time date and time of last rollout of this structure. The word number (511) is relative to the last 512-word section of the table.

The formats of the block and record control words in CRAY-1 blocked format are illustrated in figures CW-1 and CW-2.

CWBCW = 0 Block control word mode field
 CWMEOR = 0'10 End of record mode field
 CWMEOF = 0'16 End of file mode field
 CWMEOD = 0'17 End of data mode field
 CWMEOI = 1 End of Input for DSP

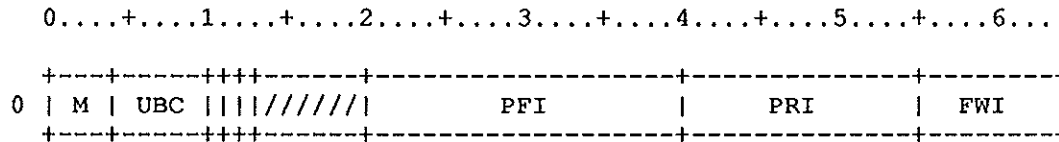

Figure CW-1. Block or Record Control Word

Field	Word(base8)	Bits	Description
CWM	0	0-3	Mode: 00 Block Control Word 10 Record Control Word (end of record) 16 RCW (end of file) 17 RCW (end of data)
CWUBC	0	4-9	Unused bit count (RCW only)
CWTRAN	0	10	Transparent record bit
CWBDF	0	11	Bad data flag
CWSRS	0	12	skip remainder of sector flag
CWPFI	0	20-39	Previous file index (RCW only)
CWPRI	0	40-54	Previous record index (RCW only)
CWFWI	0	55-63	Forward index

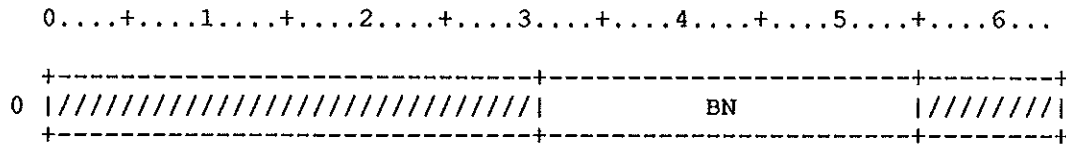

Figure CW-2. Block Control Word

<u>Field</u>	<u>Word(base8)</u>	<u>Bits</u>	<u>Description</u>
CWBN	0	31-54	Block number (for BCW only)

Name: Channel Extension Table (CXT).

Purpose: The Channel Extension Table is EXEC resident. There is one entry for each IOP channel ordinal. EXEC uses this table to communicate with the MIOP for front end I/O.

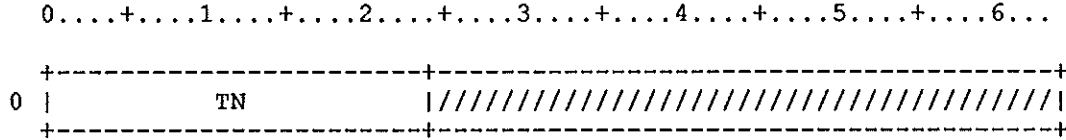

Figure CX-1. Channel Extension Table Header

Field	Word(base8)	Bits	Description
CXTN	0	0-23	Table name ('CXT')

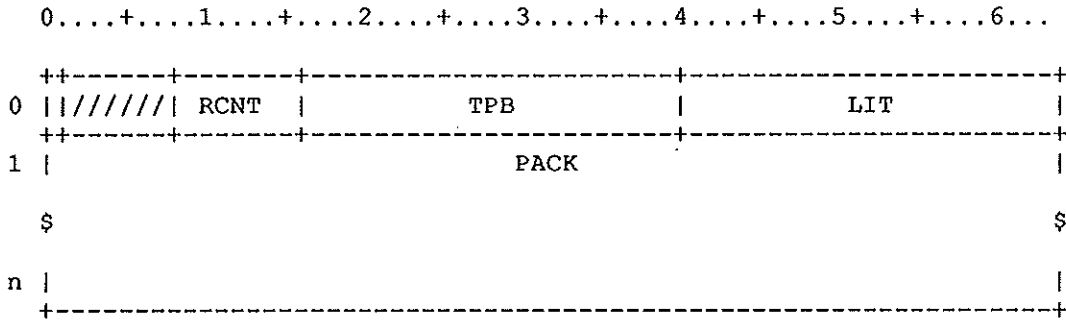
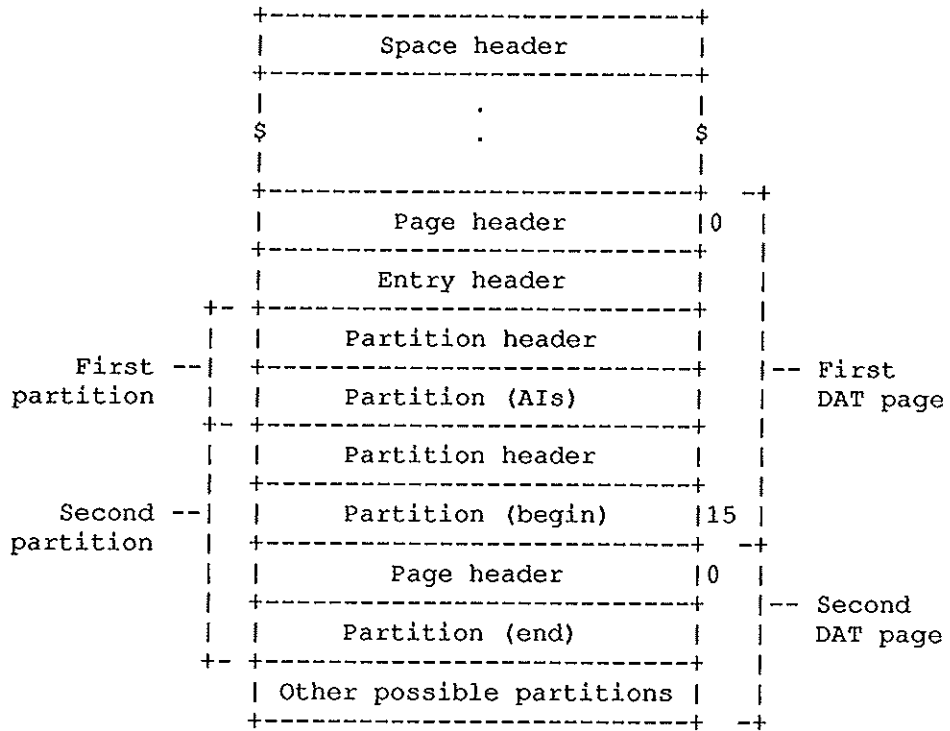

Figure CX-2. Channel Extension Table Entry

Field	Word(base8)	Bits	Description
CXON	0	0	Channel flag; on if set.
CXRCNT	0	8-15	Message number of last request
CXTPB	0	16-39	Task parameter block address (STT part A)
CXLIT	0	40-63	LIT entry address (EXEC relative)
CXPACK	1-n	0-63	Form B or K of Any Packet Table (used as a B-packet or X-packet)

A Dataset Allocation Table defines the mass storage logical location of a dataset by specifying the logical devices and the portions that are used in each device. There is one DAT for each active dataset in the system. If the dataset is permanent, the DAT is entered in the catalog and can be used by more than one user.

The DAT is composed of as many 16-word pages as necessary to represent the mass storage occupied by the dataset. The first page includes a page header, an entry header, at least one partition header, and the first 11 words of the table, which is divided into partitions. A partition represents a portion of the dataset on a single logical device. Each page after the first includes a page header and can include partition headers to begin new partitions.



The space header (figure DA-1) contains a bit map for DAT pages in STP. DAT pages for user datasets are allocated from Pool 7 in the JTA.

The page header (figure DA-2) occupies word 0 on each page. It contains a 24-bit address for the next DAT page, if there is one. DAT pages are not necessarily contiguous in memory.

The entry header (figure DA-3) contains general information about the dataset.

The DAT partition header (figure DA-4) contains general information concerning one partition of the DAT. A DAT partition header can appear anywhere on a DAT page, but the first partition header uses words 3 and 4 of the first DAT page.

The entry (figure DA-5) is divided into partitions. A partition represents a portion of a dataset on a single logical device; that is, if a dataset resides on two devices, it has two partitions. The partitions contain logical track addresses referred to as allocation indices (AIs), which are bit numbers in the respective Device Reservation Table (DRT).

LH@SDAT = 1 Length of DAT space header

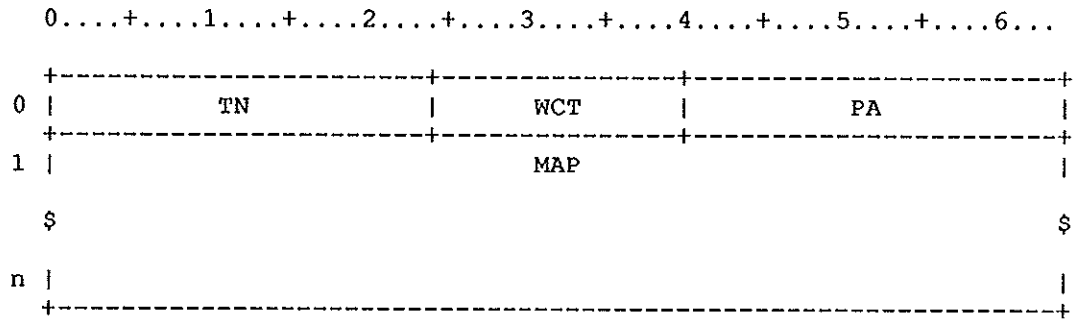

Figure DA-1. DAT Space Header (STP Only)

NAISC=2 Bits to shift to make AI parcel
 MAXPGN=D'4095 Max DAT page number
 LH@DATP=2 Length of DAT partition header
 L@DATPH=1 Length of DAT page header
 L@SDATZ=NE@DAT+D'63 Temporary for L@SDAT
 L@SDAT=L@SDATZ/D'64 Length of DAT space
 L@DATS=NE@DAT*LE@DAT Space occupied by DAT bodies
 NAIPW=4 Number of AIs per word
 NAIP0X=LE@DAT-LH@DAT-LH@DATP-L@DATP
 NAIP0=NAIP0X*NAIPW Maximum AIs in first DAT
 NAIPNX=LE@DAT-L@DATPH
 NAIPN=NAIPNX*NAIPW Maximum AIs on other pages

Field	Word(base8)	Bits	Description
DATN	0	0-23	DAT name
DAWCT	0	24-39	DAT space map length in words (unused)
DAPA	0	40-63	Number of DAT pages available
DAMAP	1-n	0-63	First word of DAT page bit map

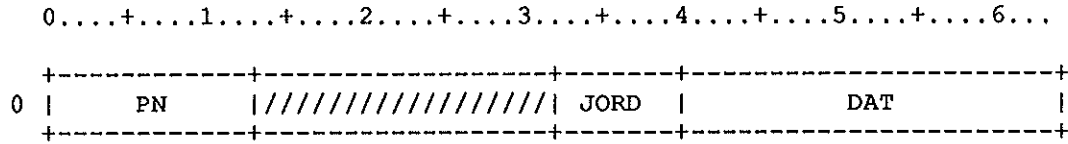

Figure DA-2. DAT Page Header

<u>Field</u>	<u>Word(base8)</u>	<u>Bits</u>	<u>Description</u>
DAPN	0	0-12	Page number
<u>DAJORD</u>	0	32-39	JXT ordinal; set to 0 if the DAT is in STP, set to the JXT ordinal if the DAT is in the JTA.
DADAT	0	40-63	Next page address; set to 0 if no continuation page exists. If the field is greater than 0, the DAT resides in STP and the field contains the STP-relative DAT address. If the field is less than and the DAT address is equal to the JTA address minus the value of the field DADAT.

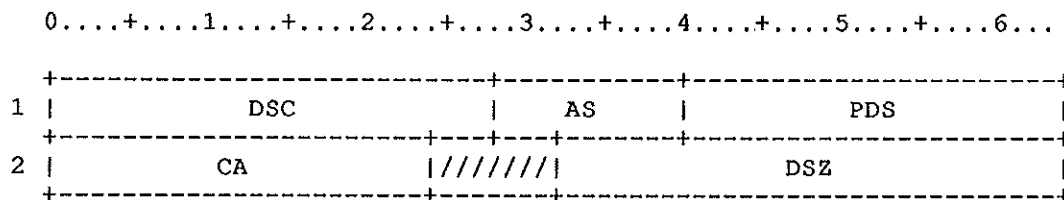

Figure DA-3. DAT entry header

Field	Word(base8)	Bits	Description
DADSC	1	0-27	DSC page pointer (only for permanent dataset)
DAAS	1	28-39	Allocation style (contiguous AUs per AI)
DAPDS	1	40-63	Permanent Dataset Table entry address (only if permanent dataset)
DACA	2	0-23	Pointer to DAT parcel to contain the next allocated AI. Bits Use 0-17 DAT page number 18-21 Word within DAT page 22-23 Parcel within word
DADSZ	2	32-63	Dataset size in words

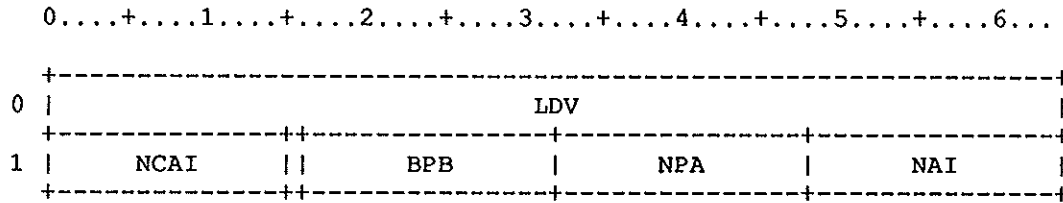

Figure DA-4. DAT Partition Header

<u>Field</u>	<u>Word(base8)</u>	<u>Bits</u>	<u>Description</u>
DALDV	0	0-63	Logical device name
DANCAI	1	0-14	number of contiguous AI's from start
DACAI	1	15	dataset contains contiguous AI's
DABPB	1	16-31	Sectors per AI for this DAT partition
DANPA	1	32-47	Pointer to the next DAT partition (relative word address)
			Bits Use
			<u>32-43</u> DAT page, offset from 1
			44-47 Word within DAT page
DANAI	1	48-63	Number of AIs in partition

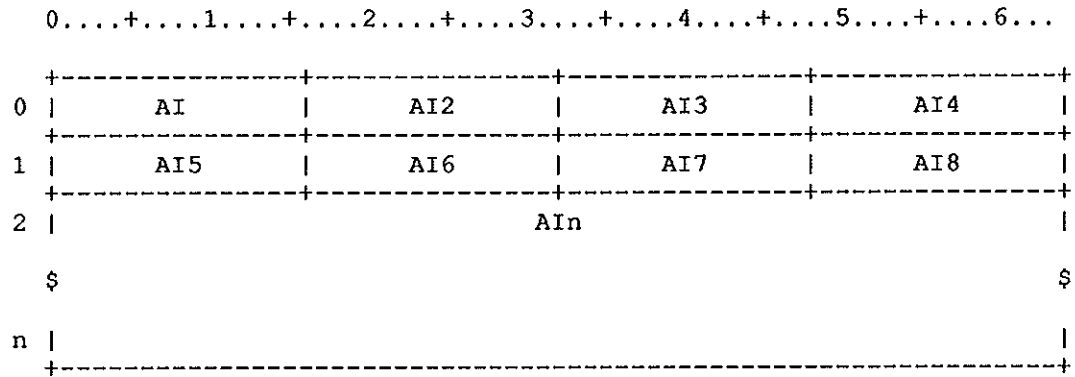

Figure DA-5. DAT Partition Entry

Field	Word(base8)	Bits	Description
DAAI	0	0-15	Allocation index (logical track address)
DAAI2	0	16-31	Second allocation index
DAAI3	0	32-47	Third allocation index
DAAI4	0	48-63	Fourth allocation index
DAAI5	1	0-15	Fifth allocation index
DAAI6	1	16-31	Sixth allocation index
DAAI7	1	32-47	Seventh allocation index
DAAI8	1	48-63	Eighth allocation index
DAAIn	2-n	0-63	Remaining allocation entries

A DSC for a permanent dataset occupies as many DSC entries as necessary to contain the DAT for the dataset. Subsequent DSC entries for the same permanent dataset contain only continuations of the DAT.

0....+....1....+....2....+....3....+....4....+....5....+....6...

0		SERR		////////////////////		SPD		TYPE	
1		PDN3		/////////		EUNI		EUSA	
2						PDN			
3								/////////	
4						RDP			
5						WTP			
6						MNP			
7						LDV			
10		INC		DTO		/// JAST		QUPR	
11						OWN			
12								/////////	
13		MML		* PAM		TXO		* /////////	
14						ID			
15						USR			
16								/////////	
17				OJSQ		**		FM	
20						OJB			
21		SID		DID		DC		JSQ	
22						TID			
23						SF			
24		ACS		MFL		TL		PR	

Figure DC-2. Dataset Catalog Entry

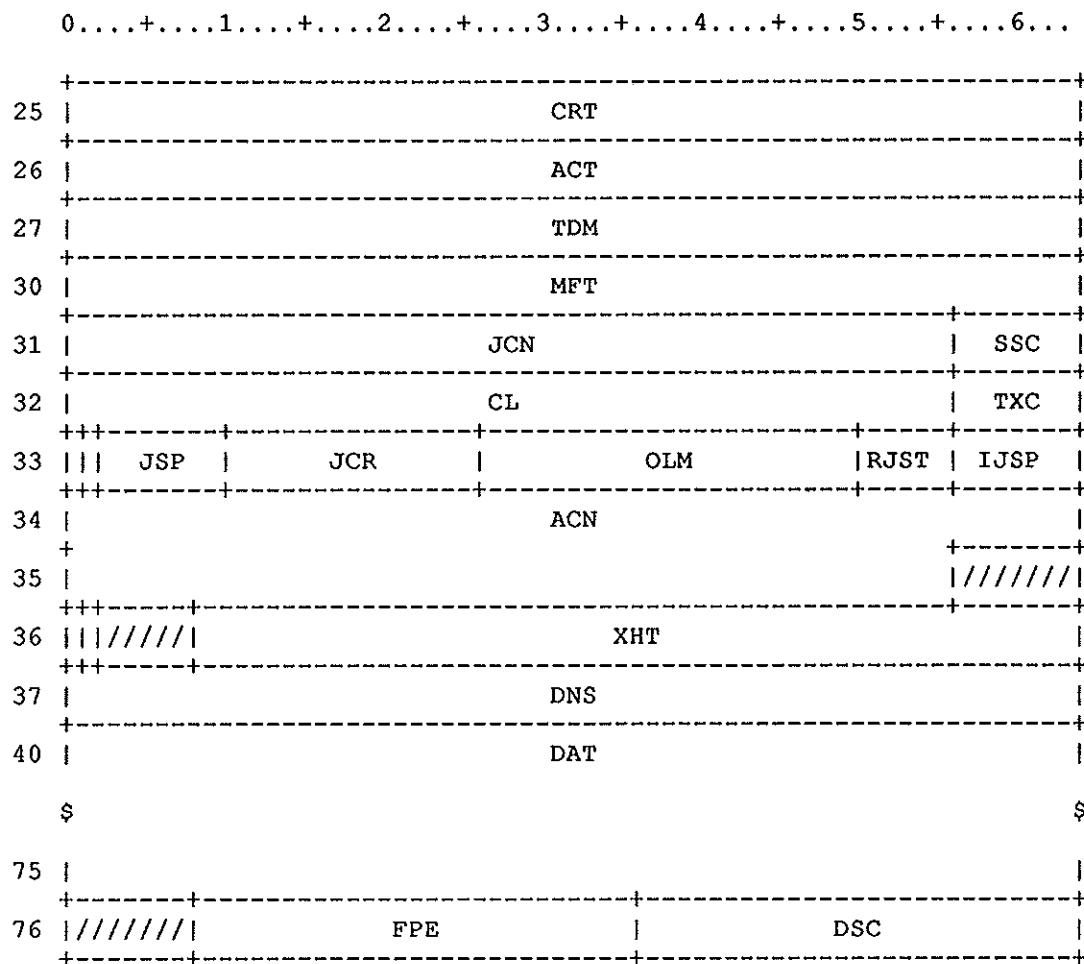

Figure DC-2. Dataset Catalog Entry

Field	Word(base8)	Bits	Description
DCC	0	0	Continuation entry flag
DCSERR	0	1-10	Dataset deactivation flags
DCDWN	0	1	Down device in DAT
DCCRS	0	2	Dataset DAT contains AI conflict
DCERR	0	3	DSC entry is invalid
DCIDA	0	4	Inconsistent disk allocation
DCIQI	0	5	Invalid QDT index
DCDXE	0	6	Startup found DXT errors
DCZSUB	0	7	STARTUP submitted job
DCARCJ	0	8	Archiving System Job
DCSPD	0	40-55	user STRIPE size

<u>Field</u>	<u>Word(base8)</u>	<u>Bits</u>	<u>Description</u>
DCTYPE	0	56-63	Dataset type (only one can be set)
DCS	0	61	User permanent dataset
DCO	0	62	System spooled output
DCI	0	63	System spooled input
DCPDN3	1	0-7	Dataset name
DCEUNI	1	16-39	Job Estimated Units
DCEUSA	1	40-63	Job Estimated Usage
DCPDN	2-3	0-63	1-15 character permanent dataset name
DCPDN1	2	0-63	Characters 1-8 of PDN
DCPDN2	3	0-55	Characters 9-15 of PDN
DCRDP	4	0-63	Read permission control word
DCWTP	5	0-63	Write permission control word
DCMNP	6	0-63	Maintenance permission control word
DCLDV	7	0-63	logical device name assigned
DCCO	10	0	must have contiguous space per
DCNOF	10	1	do not overflow onto another device
DCINC	10	2-10	minimum sectors to allocate request
DCDTO	10	11-28	Default device type for allocation
DCJAST	10	32-39	RDM Job acceptance failure code
DCQUPR	10	40-63	RDM Queue Priority
DCOWN	11-12	0-63	Dataset owner
DCOWN1	11	0-63	Dataset owner (characters 1-8)
DCOWN2	12	0-55	Dataset owner (characters 9-15)
DCEXO	13	0	Execute-only flag
DCMML	13	1-12	Interactive maximum message length
DCBACK	13	13-14	Backup preference
DCTRA	13	15	Track accesses flag
DCPAM	13	16-23	Public access mode
DCTXO	13	24-39	TXT ordinal of user task

<u>Field</u>	<u>Word(base8)</u>	<u>Bits</u>	<u>Description</u>
DCRESD	13	40-41	Preferred residency (see COMPM)
DCQDT	13	48-63	Multi-type dataset indicator/pointer
DCID	14	0-63	User ID
DCUSR	15-16	0-63	1-15 character user number
DCUSR1	15	0-63	Characters 1-8 of user number
DCUSR2	16	0-55	Characters 9-15 of user number
DCNRR	17	0	No rerun flag (input)
DCINIT	17	1	Job initiated flag (input)
DCWAIT	17	2	Dispose-wait flag (spooled)
DCIA	17	3	Interactive spooled flag (spooled)
DCDEFL	17	4	Job-used-MFL-default flag
DCOJSQ	17	5-20	Originating job seq. number (spooled)
DCTXL	17	21-23	Length of text in blocks (spooled)
DCFM	17	24-39	Format designator (output)
DCRT	17	40-51	Retention period
DCED	17	52-63	Edition number
DCOJB	20	0-55	Originating job name (spooled)
DCMFNS	20	63	MF parameter Not Specified
DCSID	21	0-15	Source ID (spooled)
DCDID	21	16-31	Destination ID (spooled)
DCDC	21	32-47	Disposition code (spooled)
DCJSQ	21	48-63	Job sequence number (spooled)
DCTID	22	0-63	Terminal ID (spooled)
DCSF	23	0-63	Special forms (output)
DCACS	24	0-15	Number of accesses
DCMFL	24	16-31	MFL parameter from job card (input)
DCSGFL	24	16	1 indicates MVL was specified with no value, requesting all available memory for a job.

DCFL	24	17-31	Field length divided by 512
DCTL	24	32-55	Time limit (input)
DCPR	24	56-63	Priority (input)
DCCRT	25	0-63	Timestamp at creation
DCACT	26	0-63	Timestamp of last access
DCTDM	27	0-63	Timestamp of last dump
DCMFT	30	0-63	Timestamp of last modification
DCJCN	31	0-55	Job class name (input)
DCSSC	31	56-63	Slot length in words
DCCL	32	0-55	CL parameter from job card (input)
DCTXC	32	56-63	Text length in words
DCOCC	33	0	Operator-changed-class flag
DCSYS	33	1	System job flag (input)
DCJSP	33	2-9	P from the job card (input)
DCJCR	33	10-25	Job class rank (input)
DCOLM	33	26-49	\$OUT size in 512-word blocks (input)
DCRJST	33	50-55	Job statement error (input)
DCIJSP	33	56-63	Original jobcard priority (input)
DCACN	34-35	0-63	1-15 character account number
DCACN1	34	0-63	Characters 1-8 of account number
DCACN2	35	0-55	Characters 9-15 of account number
DCPERM	36	0	Permit DXTs are present
DCPERP	36	1	Permit DXTs were propagated
DCXHT	36	8-63	DXT head and tail pointers
DCFDX	36	8-35	First DXT page/entry for dataset
DCFDP	36	8-31	Page number
DCFDE	36	32-35	Entry number
DCLDX	36	36-63	Last DXT page/entry for dataset
DCLDP	36	36-59	Page number
DCLDE	36	60-63	Entry number
DCDNS	37	0-63	Reserved for installations

The next two 15-word blocks are reserved for text or DATs:

<u>DCDAT</u>	40-75	0-63	DAT/text base address
DCFPE	76	8-35	First DSC page/entry for dataset
DCFPP	76	8-31	Main page number
DCFEN	76	32-35	Main entry number
DCDSC	76	36-63	Next DSC entry for continuation
DCDCP	76	36-59	Page number of DSC continuation
DCDCE	76	60-63	Entry number of DSC continuation

A Dataset Definition List in the user field must accompany any create DNT (F\$DNT) request.

```

0....+....1....+....2....+....3....+....4....+....5....+....6...
+-----+-----+-----+-----+-----+-----+-----+-----+
0 |                               DN                               |////////|
+-----+-----+-----+-----+-----+-----+-----+-----+
1 |                               LDV                               |
+-----+-----+-----+-----+-----+-----+-----+-----+
2 | ||| ||| ||| BFI || || ERC |////////| | SZ |
+-----+-----+-----+-----+-----+-----+-----+-----+
3 | ||| SPD | | DNT | | | TRC || | BFZ |
+-----+-----+-----+-----+-----+-----+-----+-----+
4 | |////////| | | INC | | DTO | | * | | DC |
+-----+-----+-----+-----+-----+-----+-----+-----+
5 | | TFMN | | TFMX | |////////| | LM |
+-----+-----+-----+-----+-----+-----+-----+-----+

```

Figure DD-1. Dataset Definition List

NUMDT=3 Max number of desired
device types

Field	Word(base8)	Bits	Description
DDDN	0	0-55	Dataset name
DDL DV	1	0-63	Logical device name
DDRDM	2	0	Random dataset flag: 0 Sequential 1 Random
DDUDS	2	1	Undefined dataset structure: 0 COS blocked dataset structure 1 Undefined structure
DDNFE	2	2	Return error if dataset does not exist. Register S0 returned nonzero if DNT does not exist; no DNT is created.
DDSTAT	2	3	Request dataset statistics; ignored unless DDNFE=1 (see DDDNT)
DDMR	2	4	Dataset is to be memory resident
DDIA	2	5	Interactive type dataset
DDTRAN	2	6	Transparent mode for interactive dataset

<u>Field</u>	<u>Word(base8)</u>	<u>Bits</u>	<u>Description</u>
DDBFI	2	7-15	Blank field indicator (octal) for character I/O: Value Symbol Meaning 000 BFI=I@BFI 1-377 This ASCII character 400 BFI@ZER BFI=<000> >400 Disabled 777 BFI@OFF Disabled
DDNA	2	16	No-Abort flag
DDERC	2	17-27	Error code if No-Abort set
<u>DDSZ</u>	2	40-63	<u>Dataset size in 512-word blocks</u>
DDSEQ	3	0	Change a dataset from random to sequential. Valid only if dataset is currently random, ignored if sequentia
DDBLK	3	1	Change a dataset form unblocked to blocked. Valid only if dataset is currently unblocked, ignored if blocke
DDSPD	3	2-15	Sectors to allocate before switching devices"STRIPING"
DDDNT	3	16-39	Address of DNT image returned by F\$DNT when DDNFE=1 and DDSTAT=1
DDTRD	3	41	Use tape retry default value
DDTRC	3	42-47	Tape recovery retry count
DDNOF	3	48	No Overflow flag
DDBFZ	3	49-63	Buffer size in 512-word blocks \$SYSTXT name
DDC	4	17	allocate contiguous space for request
DDSL	4	18	Superlink dataset flag
DDINC	4	19-27	sectors to allocate per request
DDDTO	4	28-45	Default devices wanted
DDDT1	4	28-33	Desired device type for storage
DDDT2	4	34-39	2nd preferred type for storage
DDDT3	4	40-45	3rd preferred type for storage
DDST	4	46-47	Storage type
DDSCR	4	46	Scratch storage space preferred
DDPERM	4	47	Permanent storage space necessary
DDDC	4	48-63	Disposition code (two characters):

<u>Field</u>	<u>Word(base8)</u>	<u>Bits</u>	<u>Description</u>
DDTFMN	5	0-15	Transfer minimum
DDTFMX	5	16-31	Transfer maximum
DDL	5	40-63	Dataset size limit in 512-word blocks

<u>Field</u>	<u>Word(base8)</u>	<u>Bits</u>	<u>Description</u>
DFTC	1	33-39	terminator string character count
DFTA	1	40-63	terminator string address
DI\$MLN	= D'18		Maximum line number
DI\$MCN	= D'80		Maximum column number
DI\$LIM	= DI\$MLN*DI\$MCN/D'8		length of display in words

BUILD is an operating system utility program for generating and maintaining library datasets. BUILD generates a directory file consisting of a 1-word header followed by a variable-length entry for each program in the library dataset. A program record's entry may have any length from 3 to 66,048 words.

Any of the three sets of names (block, entry, or external) can be null. Each name is 1 to 8 ASCII characters, left-justified with zero fill. No blank characters are used. Block names represent FORTRAN references to BLOCK DATA subprograms and labeled common.

Entry names correspond to names of main programs and subroutines and to names of any labeled common blocks that are initialized by DATA statements.

External names represent references to entry names in other programs.

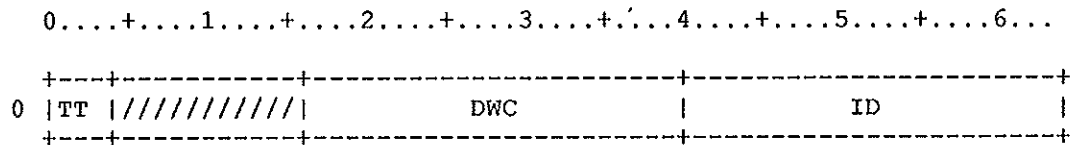

Figure DF-1. Loader Directory Table

Field	Word(base8)	Bits	Description
DFTT	0	0-3	Table type; 10 octal.
DFDWC	0	16-39	Directory's word count
DFID	0	40-63	'D01' in ASCII. The 01 indicates the BUILD revision level, thus specifying the directory format.

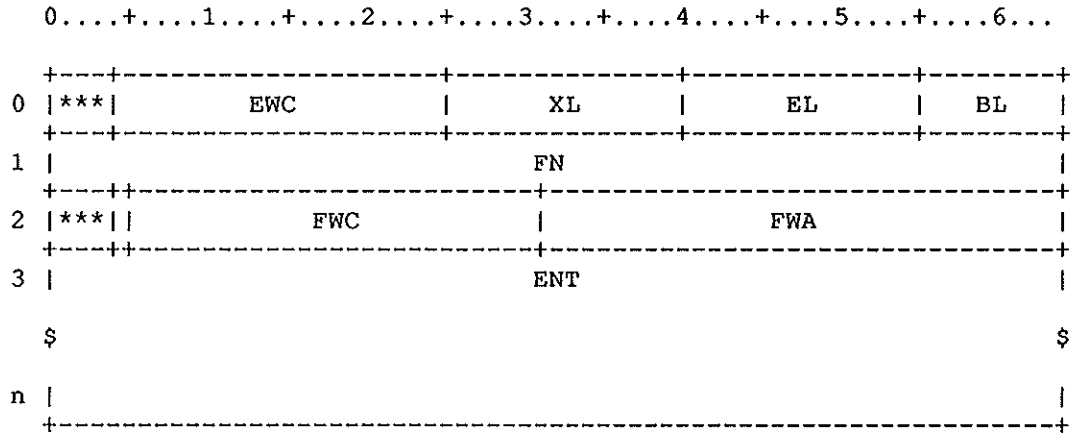

Figure BD-2. Loader Directory Table (BUILD) entry

Field	Word(base8)	Bits	Description
BDTYPE	0	0-3	Entry type. BDTYPEA=0 Absolute binary BDTYPER=1 Relocateable binary BDTYPEP=2 Control statement processor BDTYPED=3 Data or undefined
BDEWC	0	4-24	Word count of entry, maximum 66,048
BDXL	0	25-39	Number of external names, maximum
BDEL	0	40-54	Number of entry names, maximum 32,767
BDBL	0	55-63	Number of block names, maximum 511
BDFN	1	0-63	8-character name of program module
BDSTAT	2	0-3	Entry status
BDFM	2	4	Load module flag (LDR set and used)
BDFWC	2	5-30	Program module's maximum word count, for information only)
BDFWA	2	31-63	Program module's location,
BDENT	3-n	0-63	Directory entry blocks, entry names, externals

L@BDEH=W@BDENT Length of directory entry header
LH@BDT=2 Required by LDR
DIRTT=O'10 Directory table type

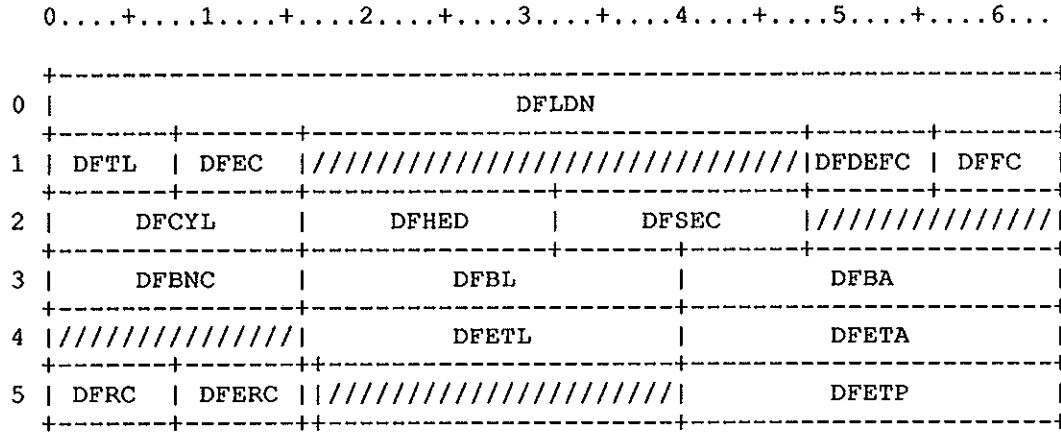

Figure F-1. Diagnostic Request Table

Field	Word(base8)	Bits	Description
DFLDN	0	0-63	Logical Device Name
DFTL	1	0-7	Table length
DFEC	1	8-15	Diagnostic task error code 0 - No error in request 1 - Device not in maintenance mode 2 - Unknown function code 3 - Invalid cylinder, head, or sector 4 - Error table address out of range 5 - Buffer table address out of range 6 - unexpected request 7 - no matching tape in CNT 10- cannot specify master device 11- device already in requested state 12- task already active 13- operator cancelled request 14- buffer length not a mult of 512 15- dqt is full 16- error table is full,errors lost 17- offloaded device cannot be brought 20- eft error 21- tape device currently assigned 22- tape device not available to syste 23- configuration request incorrect 24- block to big local/buffer memory 25- lost data / tape off end of reel 26- unrecovered error / data 27- no write ring 30- beginning of tape encountered 31- end of tape encountered

			32- device not read
			33- reset hit
			34- device not operational
			35- not capable of executing function
			36- write format error
			37- dal protocol error
			40- unexpected reply from iop
			41- address not on 40 word boundary
			42- unsafe p address
DFDEFC	1	48-55	Diagnostic flags
DFSTA	1	48	Return error record to diagnostic
DFERR	1	49	Suppress normal error recovery
DFREP	1	50	Suppress normal error reporting
DFNRA	1	51	Suppress read-ahead/write-behind
DFFC	1	56-63	Function code (octal)
			device type = 0 (disk)
			0 - Echo packet. Verify fields only.
			1 - Down device and offload
			2 - Bring up the device
			3 - Read device
			4 - Write device
			5 - Read ID on device
			6 - Write ID on device
			11- Read absolute
			12- Read buffer
			13- Write buffer
			16- Write zero ECC
			17- Write defective ID
			20 - request disk information
			device type = 1 (tape)
			0 - put tape into maintenance mode
			1 - mount tape onto device
			2 - execute (tape) subfunction
			3 - restore device to original state
			4 - request tape information (CNT)
			device type = 2 (cpu)
			0 - put cpu into maintenance mode
			1 - execute (cpu) subfunction
			2 - return cpu to original state
			3 - request cpu information (CNT)
DFCYL	2	0-15	Cylinder number
DFHED	2	16-31	Track (head) number
DFSEC	2	32-47	Sector number
DFBNC	3	0-15	Block check flag and number
DFBL	3	16-39	Buffer length (in 512 word multiples)
DFBA	3	40-63	Buffer address
DFETL	4	16-39	Error table length

<u>Field</u>	<u>Word(base8)</u>	<u>Bits</u>	<u>Description</u>
DFETA	4	40-63	Error table address
DFRC	5	0-7	IOP response code
DFERC	5	8-15	Error count
DFEOF	5	16	Error table overflow flag
DFETP	5	40-63	Error table pointer

a -1 returned implies that information is unavailable

```

0.....+.....1.....+.....2.....+.....3.....+.....4.....+.....5.....+.....6...
+-----+-----+-----+-----+-----+-----+-----+-----+
0 |           DFDT           |           DFMN           |
+-----+-----+-----+-----+-----+-----+-----+-----+
1 |           DFSN           |
+-----+-----+-----+-----+-----+-----+-----+-----+
2 |           DFREV          |
+-----+-----+-----+-----+-----+-----+-----+-----+
3 |   DFSCCT   ||           DFTRK           |           DFCLN           |
+-----+-----+-----+-----+-----+-----+-----+-----+
4 |           DFDN           |           DFNFL           |
+-----+-----+-----+-----+-----+-----+-----+-----+
5 |           DFCT           |           DFCM            |
+-----+-----+-----+-----+-----+-----+-----+-----+
6 |           DFCSN          |
+-----+-----+-----+-----+-----+-----+-----+-----+
7 |           DFCRV          |
+-----+-----+-----+-----+-----+-----+-----+-----+
10 |          DFCHN           |           DFSDP           |
+-----+-----+-----+-----+-----+-----+-----+-----+
11 |           DFST0          |
+-----+-----+-----+-----+-----+-----+-----+-----+
12 |           DFST1          |
+-----+-----+-----+-----+-----+-----+-----+-----+
13 |           DFST2          |
+-----+-----+-----+-----+-----+-----+-----+-----+
14 |          DFAAS           | ||////////////////////////////////////||
+-----+-----+-----+-----+-----+-----+-----+-----+
    
```

Figure F-2. Diagnostic Request Table

the current word is now 0'0

Field	Word(base8)	Bits	Description
DFDT	0	0-30	device type
			1 = DD-19
			2 = DD-29
			3 = DD-49
			4 = DD-39
DFMN	0	31-63	model number
DFSN	1	0-63	serial number
DFREV	2	0-63	REV
DFSCCT	3	0-14	number of sectors
DFTRK	3	16-39	number of tracks per cylinder
DFCLN	3	40-63	number of cylinders per disk

Field	Word(base8)	Bits	Description
DFDN	4	0-30	density
DFNFL	4	31-63	number of flaws
DFCT	5	0-30	controller type
DFCM	5	31-63	controller model
DFCSN	6	0-63	controller serial number
DFCRV	7	0-63	controller REV
DFCHN	10	0-30	channel number
DFSDP	10	31-63	single/dual port
DFST0	11	0-63	status word 0 dcu-3

bits/length
\$,0,16

cumulative fault status:

- | bit | description |
|-----|--------------------------------------|
| 0 | iop angular position counter failure |
| 1 | IOP disk not ready |
| 2 | IOP lost data error |
| 3 | IOP data error on channel 3 |
| 4 | IOP data error on channel 2 |
| 5 | IOP data error on channel 1 |
| 6 | IOP data error on channel 0 |
| 7 | Address error |
| 8 | Seek error |
| 9 | Write fault, channel 3 |
| 10 | Write fault, channel 2 |
| 11 | Write fault, channel 1 |
| 12 | Write fault, channel 0 |
| 13 | Multiple head select |
| 14 | Read and write conflict |
| 15 | Not on cylinder and read or wri |

\$,16,16

Cumulative interlock status:

- | bits | description |
|-------|--------------------------------|
| 16-23 | Undefined |
| 24 | Low positive voltage |
| 25 | Low negative voltage |
| 26 | Undefined |
| 27 | Start switch is off |
| 28 | Brush cycle not finished |
| 29 | Heads not fully loaded |
| 30 | Unit not up to speed |
| 31 | Logic chassis high temperature |

\$,32,16

Cumulative subsystem status:
 bits description
 32-37 Undefined
 38 Channel parity error
 (2**12 to 2**15)
 39 Channel parity error
 (2**8 to 2**11)
 40 Channel parity error
 (2**4 to 2**7)
 41 Channel parity error
 (2**0 to 2**3)
 42 Read checkword error
 43 DSU ready error
 44 DSU not on cylinder
 45 DSU index error
 46 ID verification error
 47 DSU reservation error

bits/length

\$,48,8
 48,1
 49,1
 50,1
 51,1
 52,1
 53,1
 54,1
 55,1
 \$,56,8

Cumulative extended error status:
 IOP disk error
 Permanent dataset error
 DCU inconsistent CRC error
 DCU data transfer error
 DCU channel parity error
 DCU read/write response error
 DCU subsystem status error
 DCU software time-out error
 Final status code:

value description
 000 No error
 001 Recovered disk error
 002 Unrecovered data error
 003 Angular position error
 004 Disk not ready error
 005 Lost data error
 006 Address error
 007 Seek error
 010 Multiple head select
 011 Read/write conflict
 012 Read/write off cylinder
 013 Corrected data error
 014 Uncorrected data error
 015 Unrecovered hardware error
 016 Undefined error status
 017 Software timed out
 020 Diagnostic request parameter error

bits/length

DFST1 12 0-63 Second status word

\$,0,16 Last function code
 \$,16,16 Last error status response
 \$,32,16 Last read/write response error
 \$,48,8 Last margin select
 \$,56,8 Last try count

<u>Field</u>	<u>Word(base8)</u>	<u>Bits</u>	<u>Description</u>
DFST2	13	0-63	Third status word
	\$,0,16		Offset register status response bits description 6-15 If seek is current, requested cylinder 8-15 If seek is not current, selected margin
	\$,16,16		Cylinder number status response bits description 22-31 Valid cylinder number
	\$,32,16		Head group number status response
	42,1		Bit 42 Unit connect bit. Needed for EXTRACT bits description 42 Unit connect bit 44-47 Valid head group number
	\$,48,16		Sector number status response bits description 59-63 Valid sector number
DFAAS	14	0-30	amount of unused bits
DFMTF	14	31	maintenance mode bit

```

0.....+.....1.....+.....2.....+.....3.....+.....4.....+.....5.....+.....6...
+-----+-----+-----+-----+-----+-----+-----+-----+
0 |////////////////////|                               DFVBU |
+-----+-----+-----+-----+-----+-----+-----+-----+
1 |////////////////////|**|****|****|***|DFDVN |////////////////////|
+-----+-----+-----+-----+-----+-----+-----+-----+
2 |   DFRBC   |   DFDDF   |   DFTPU   |
+-----+-----+-----+-----+-----+-----+-----+-----+
3 |////////////////////|
+-----+-----+-----+-----+-----+-----+-----+-----+
4 |   DFRSC   |////////////////////|
+-----+-----+-----+-----+-----+-----+-----+-----+
5 |////////////////////|
+-----+-----+-----+-----+-----+-----+-----+-----+
6 |   DFTBC   |   DFTSC   |   DFSTS   ||DFUBC| DFPWC ||
+-----+-----+-----+-----+-----+-----+-----+-----+
7 |   DFBCS   |   DFVMS   |   DFPDV   |   DF MOS   |
+-----+-----+-----+-----+-----+-----+-----+-----+
    
```

Figure F-3. Diagnostic Request Table

the current word is now O'0

Field	Word(base8)	Bits	Description
DFVBU	0	32-63	volume block (high)

the current word is now O'1

DFDVT	1	16-18	device type
disk = 0			
tape = 1			
cpu = 2			

<u>Field</u>	<u>Word(base8)</u>	<u>Bits</u>	<u>Description</u>
DFSFN	1	19-23	subfunction (tape function) tape subfunctions 0 - read block 1 - write tape block 3 - mount and connect device 4 - free device 5 - unload tape 6 - rewind tape 7 - continue read 10- write tapemark 11- write partial and tapemark 12- search forward file 13- space forward 14- search backward file 15- space backward 16- unsolicited iop status 17- change device configuration 20- reposition tape 21- verify tape position 22- erase tape 23- data security erase 24- remount 25- write two EOFs and rewind 26- write one EOF and unload 25- write two EOFs and unload cpu subfunctions 0 - start cpu 1 - status cpu 2 - stop cpu
DFTCN	1	24-28	channel number
DFTCT	1	29-32	contoller number
DFDVN	1	33-39	device number
the current word is now 0'2			
DFRBC	2	0-15	requested block count
DFDDF	2	16-31	dataset description flags
DFTPU	2	32-63	tape block size upper
the current word is now 0'4			
DFRSC	4	0-15	requested sector count
the current word is now 0'6			
DFTBC	6	0-15	transferred block count
DFTSC	6	16-31	transferred sector count

<u>Field</u>	<u>Word(base8)</u>	<u>Bits</u>	<u>Description</u>
DFSTS	6	32-47	status field
DFDBF	6	48	bad data flag
DFUBC	6	49-54	unused bit count
DFPWC	6	55-62	partial word count
the current word is now 0'7			
DFBCS	7	0-15	block checksum
DFVMS	7	16-31	valid sector/block count
DFPDV	7	32-47	previous device
DFMOS	7	48-63	avail buffer mem sector count
a -1 returned implies that information is unavailable			

0.....+.....1.....+.....2.....+.....3.....+.....4.....+.....5.....+.....6...

0	DFCHN0
1	DFCON0
2	DFCHN1
3	DFCON1
4	DFCHN2
5	DFCON2
6	DFCHN3
7	DFCON3
10	DFCHN4
11	DFCON4
12	DFCHN5
13	DFCON5
14	DFCHN6
15	DFCON6
16	DFCHN7
17	DFCON7

Figure F-4. Diagnostic Request Table

the current word is now 0'0

Field	Word(base8)	Bits	Description
DFCHN0	0	0-63	cnt devices channel number
DFCON0	1	0-63	controller to above channel
DFCHN1	2	0-63	cnt devices channel number
DFCON1	3	0-63	controller to above channel
DFCHN2	4	0-63	cnt devices channel number
DFCON2	5	0-63	controller to above channel
DFCHN3	6	0-63	cnt devices channel number

<u>Field</u>	<u>Word(base8)</u>	<u>Bits</u>	<u>Description</u>
DFCON3	7	0-63	controller to above channel
DFCHN4	10	0-63	cnt devices channel number
DFCON4	11	0-63	controller to above channel
DFCHN5	12	0-63	cnt devices channel number
DFCON5	13	0-63	controller to above channel
DFCHN6	14	0-63	cnt devices channel number
DFCON6	15	0-63	controller to above channel
DFCHN7	16	0-63	cnt devices channel number
DFCON7	17	0-63	controller to above channel

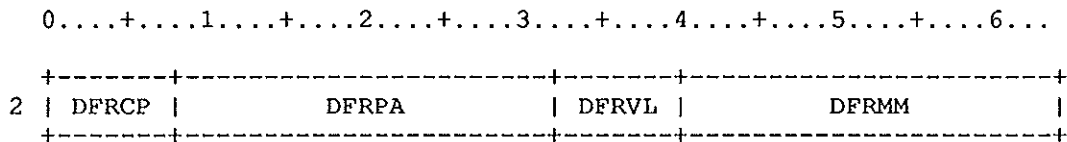

Figure F-5. Diagnostic Request Table

the current word is now 0'2

<u>Field</u>	<u>Word(base8)</u>	<u>Bits</u>	<u>Description</u>
DFRCP	2	0-7	requested cpu
DFRPA	2	8-31	requested p address
DFRVL	2	32-39	requested vl
DFRMM	2	40-63	requested memory location

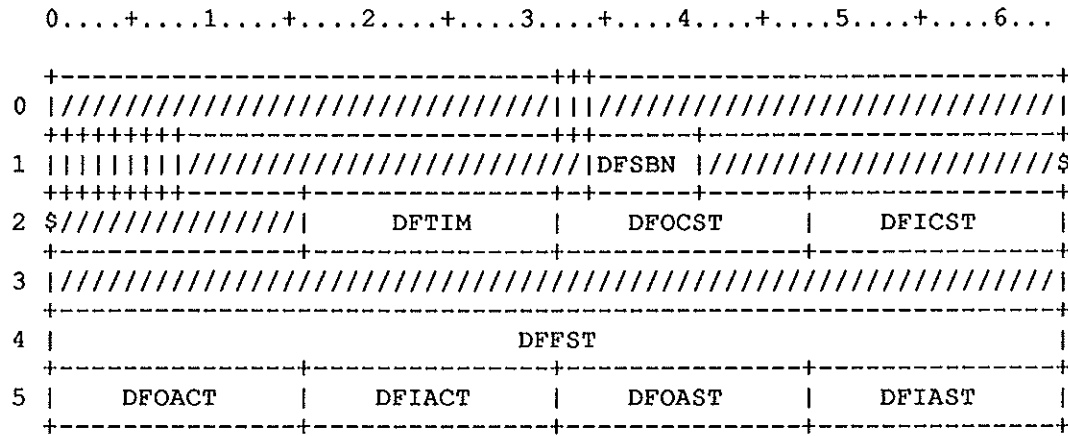

Figure F-6. Diagnostic Request Table

Field	Word(base8)	Bits	Description
DFIIF	0	32	input interrupt flag
DFOIF	0	33	output interrupt flag
DFNSC	1	0	nsc flag
DFIBZ	1	1	ichbz flag
DFIDN	1	2	icjdn flag
DFOBZ	1	3	ochbz flag
DFODN	1	4	ochdn flag
DFDIS	1	5	disconnect flag
DFPORT	1	7	vax port control
DFSBN	1	34-40	subfunction
DFTIM	2	16-31	requested timer
DFOCST	2	32-47	output channel status
DFICST	2	48-63	input channel status
DFFST	4	0-63	FEI box status
DFOACT	5	0-15	output actual
DFIACT	5	16-31	input actual
DFOAST	5	32-47	output start
DFIAST	5	48-63	input start

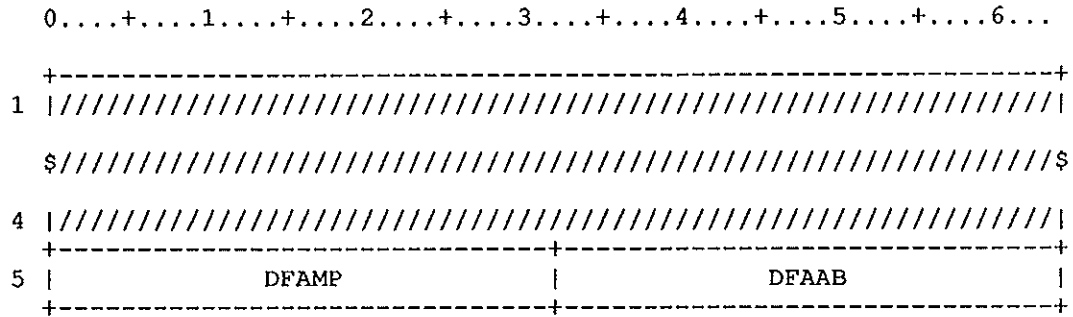

Figure F-7. Diagnostic Request Table

<u>Field</u>	<u>Word(base8)</u>	<u>Bits</u>	<u>Description</u>
DFAMP	5	0-31	accumulated message proper
DFAAB	5	32-63	accumulated associated data

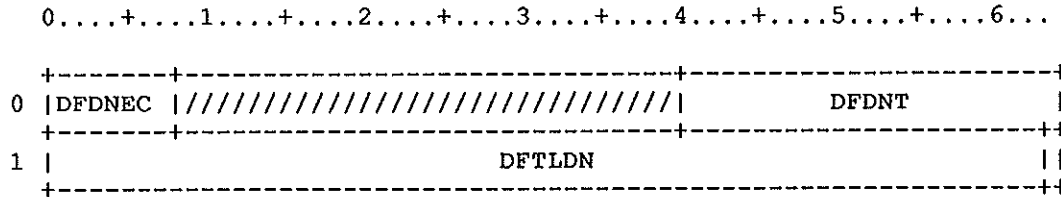

Figure F-8. Diagnostic Request Table

Field	Word(base8)	Bits	Description
DFDNEC	0	0-7	Error code
DFDNT	0	40-63	DNT address
DFTLDN	1	0-62	Name of device to receive moved data
DF\$ECHO	= 0		Echo packet. Verify fields only.
DF\$OFF	= 1		Down device and offload
DF\$UP	= 2		Bring up the device
DF\$READ	= 3		Read device
DF\$WRITE	= 4		Write device
DF\$RID	= 5		Read ID on device
DF\$WID	= 6		Write ID on device
DF\$RECC	= 0'7		read error correction code
DF\$RETH	= 0'10		read track header
DF\$RABS	= 0'11		Read absolute
DF\$RBUF	= 0'12		Read buffer
DF\$WBUF	= 0'13		Write buffer
DF\$REFT	= 0'14		read eft
DF\$WREFT	= 0'15		write eft
DF\$WZECC	= 0'16		Write zero ECC
DF\$RDID	= 0'17		Write defective ID
DF\$REQ	= 0'20		disk information request
DF\$SEEK	= 0'21		seek function
DF\$WRIM	= 0'22		dd-40 write immediate
DF\$MAXFC	= DF\$WRIM		

The Dataset Information Table resides in a jobs JTA and is used by EXP in the location of other tables needed during the time that a dataset is open for I/O. It conveys the current alias structure. The DITs are linked together as a one-way linked list.

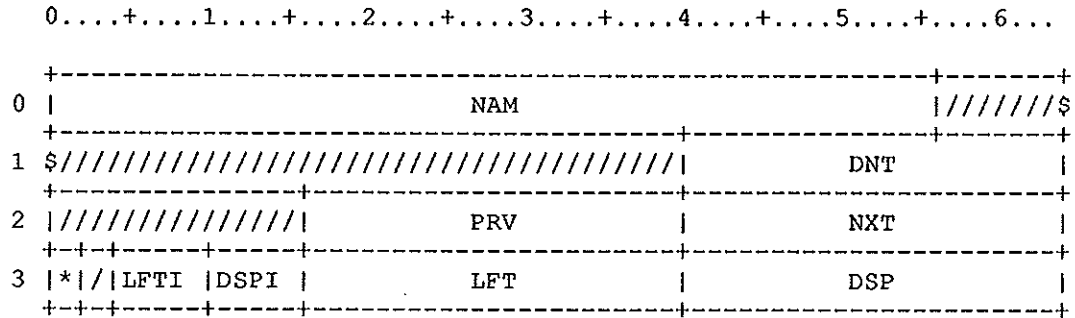

Figure DI-1. Dataset Information Table

Field	Word(base8)	Bits	Description
DINAM	0	0-55	Primary/alias name
DIDNT	1	40-63	Associated DNT address, never zero
DIPRV	2	16-39	Address of previous DIT entry REL@JTA
DINXT	2	40-63	Address of next DIT in chain, REL@JTA
DIMNGR	3	0-1	Manager of DSP (1=system, 2=user) DISYSMG=1 DIUSRMG=2
DILFTI	3	4-9	Relocation index for LFT address
DIDSPI	3	10-15	Relocation index for DSP address
DILFT	3	16-39	LFT address, relocated by DILFTI
DIDSP	3	40-63	DSP address, relocated by DIDSPI

SYSDUMP Memory type codes

MEMTYCRY	=	0	Cray main memory
MEMTYBUF	=	1	Buffer (mos) memory
MEMTYCRG	=	2	Cray registers (B/T/V/VM)
MEMTYIO0	=	3	IOP 0 Memory
MEMTYIO1	=	4	IOP 1 Memory
MEMTYIO2	=	5	IOP 2 Memory
MEMTYIO3	=	6	IOP 3 Memory
MEMTYS00	=	O' 30	SSD
MEMTYS01	=	O' 31	SSD
MEMTYS02	=	O' 32	SSD
MEMTYS03	=	O' 33	SSD
MEMTYS04	=	O' 34	SSD
MEMTYS05	=	O' 35	SSD
MEMTYS06	=	O' 36	SSD
MEMTYS07	=	O' 37	SSD
MEMTYR01	=	O' 41	CPU Registers
MEMTYR02	=	O' 42	CPU Registers
MEMTYR03	=	O' 43	CPU Registers
MEMTYR04	=	O' 44	CPU Registers
MEMTYR05	=	O' 45	CPU Registers
MEMTYR06	=	O' 46	CPU Registers
MEMTYR07	=	O' 47	CPU Registers
MEMTYR10	=	O' 50	CPU Registers
MEMTYR11	=	O' 51	CPU Registers
MEMTYR12	=	O' 52	CPU Registers
MEMTYR13	=	O' 53	CPU Registers
MEMTYR14	=	O' 54	CPU Registers
MEMTYR15	=	O' 55	CPU Registers
MEMTYR16	=	O' 56	CPU Registers
MEMTYR17	=	O' 57	CPU Registers
MEMTYC00	=	O' 100	Clusters
MEMTYC01	=	O' 101	Clusters
MEMTYC02	=	O' 102	Clusters
MEMTYC03	=	O' 103	Clusters
MEMTYC04	=	O' 104	Clusters
MEMTYC05	=	O' 105	Clusters
MEMTYC06	=	O' 106	Clusters
MEMTYC07	=	O' 107	Clusters
MEMTYC10	=	O' 110	Clusters
MEMTYC11	=	O' 111	Clusters
MEMTYC12	=	O' 112	Clusters
MEMTYC13	=	O' 113	Clusters
MEMTYC14	=	O' 114	Clusters
MEMTYC15	=	O' 115	Clusters
MEMTYC16	=	O' 116	Clusters
MEMTYC17	=	O' 117	Clusters
MEMTYC20	=	O' 120	Clusters
MEMTYC21	=	O' 121	Clusters
MEMTYC22	=	O' 122	Clusters
MEMTYC23	=	O' 123	Clusters
MEMTYC24	=	O' 124	Clusters
MEMTYC25	=	O' 125	Clusters

```

MEMTYC26 = 0'126      Clusters
MEMTYC27 = 0'127      Clusters
MEMTYC30 = 0'130      Clusters
MEMTYC31 = 0'131      Clusters
MEMTYC32 = 0'132      Clusters
MEMTYC33 = 0'133      Clusters
MEMTYC34 = 0'134      Clusters
MEMTYC35 = 0'135      Clusters
MEMTYC36 = 0'136      Clusters
MEMTYC37 = 0'137      Clusters
    
```

System dump header fields

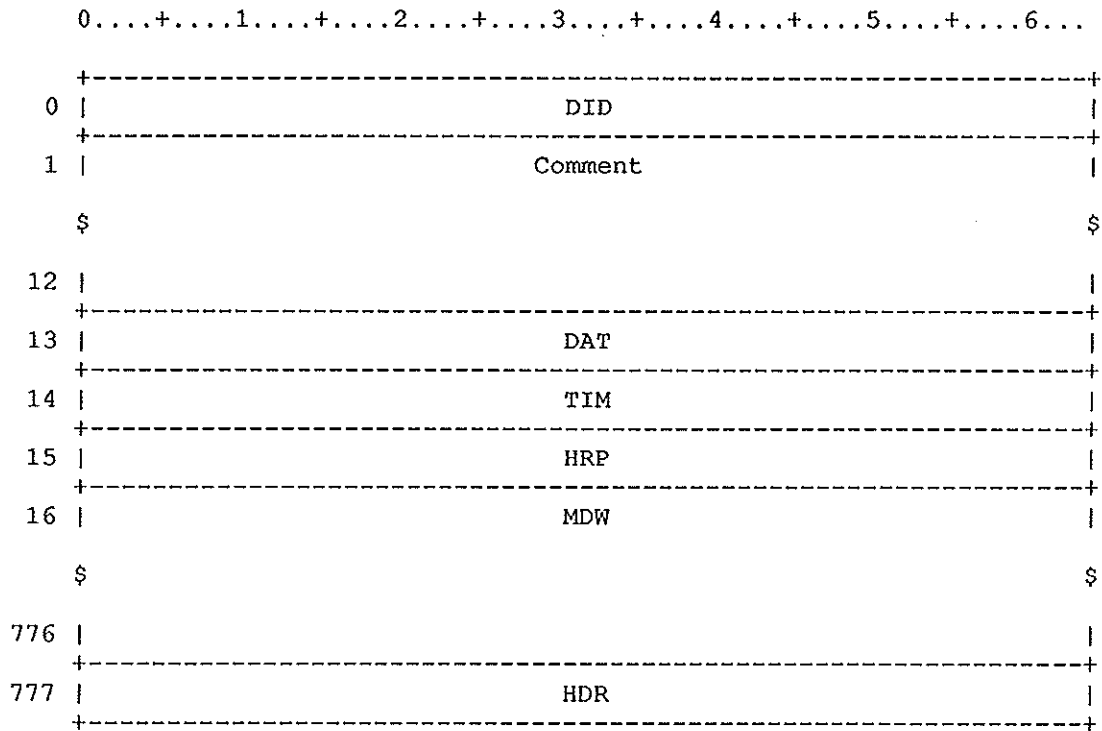

Figure DMP-1. System Dump Header Fields

<u>Field</u>	<u>Word(base8)</u>	<u>Bits</u>	<u>Description</u>
DMPDID	0	0-63	Dump identification. Set to 'SYSDUMP ' by default.
Comment	1-12	0-63	Used as a comment field; at Startup
DMPDAT	13	0-63	Date of startup. Taken from the Maintenance Control Unit (MCU) during Startup; not necessarily related to the time of actual system failure causing the dump to be taken.
DMPTIM	14	0-63	Time of startup. Taken from the Maintenance Control Unit (MCU) during Startup; not necessarily related to the time of actual system failure causing the dump to be taken.
DMPHRP	15	0-63	Header recognition pattern. The default is '*DMPHDR*'.
DMPMDW	16-776	0-63	Beginning of MDW pairs
DMPHDR	777	0-63	Dump header
MDWSYS	777	0-15	System type
MDWPRC	777	16-31	Number of processors
MDWNUM	777	32-63	Number of areas dumped

The DMT is a binary version of the load map that the loader produces. Subsequent products or job steps, such as a debugger, use DMT.

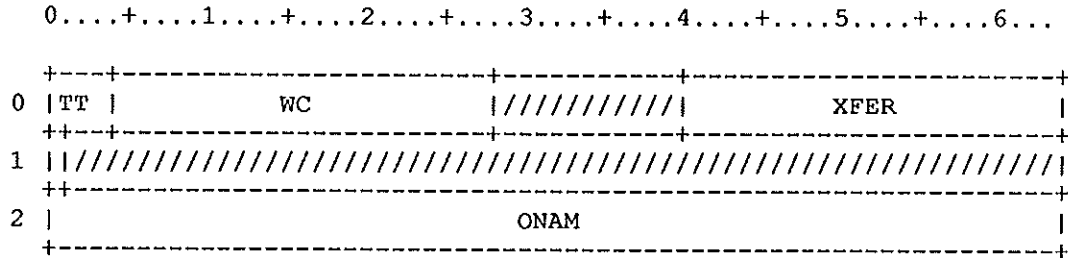

Figure DM-1. Debug Map Table header

Field	Word(base8)	Bits	Description
DMTT	0	0-3	Table type; 7.
DMWC	0	4-27	Table word count.
DMXFER	0	40-63	Transfer address. (0 if not used)
DMOVF	1	0	Overlay flag; set if overlays exist.
DMONAM	2	0-63	Overlay name in ASCII.

The following figure shows the entry format. The first entry starts after the header in word 3. The last entry is in words WC-2 and WC-1.

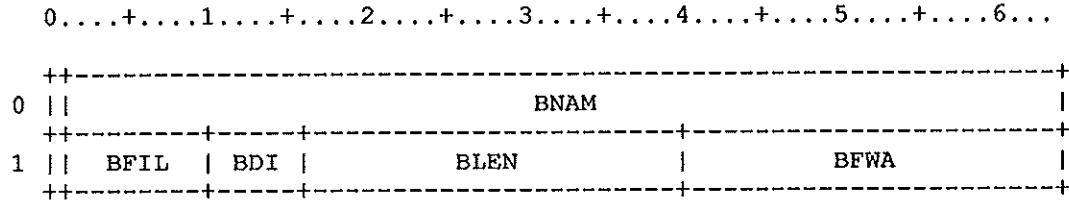

Figure DM-2. DMT entry format

Field	Word(base8)	Bits	Description
DMCBF	0	0	Common block flag
DMBNAM	0	1-63	Block name in ASCII
DMTSCM	1	0	Task common flag. Set if this is a task common block.
DMBFIL	1	1-9	Number of words of 'fill' between the previous block and the current block, This field is used by LDR when it forces blocks to start on buffer boundaries.
DMBDI	1	10-15	Dataset index, showing from which load dataset or library the block was loaded.
DMBLEN	1	16-39	Length of the block in words.
DMBFWA	1	40-63	First word address of the block.

0.....1.....2.....3.....4.....5.....6...

26		HS	DT		UD	AT		SL	PG	
27		GR	TO		SE	QT				
30		DD	RO		PS			NC		
31		ER	RS		JX	GR		ID		
32		IR			TR					
33		*			DT					
34		\$			SD			LN		
35		SS			NS					
36		EX								
37		SP			RQ			CS		
40		LD			LD					

Figure DN-2. Dataset Name Table entry

Field Word(base8) Bits Description

DNDN 0 0-55 Dataset name

The following word is modified by DQM as the result of randomly timed interrupts. No field in this word can be modified by any other task unless it is certain that such modification cannot occur while the dataset has active I/O.

DNAIO 1 0 Active I/O, set if outstanding

DNOC 1 1-2 Open/closed status:
 00 Closed
 10 Open for input
 01 Open for output
 11 Open for input or output

DNP 1 3 Type of processing; used by Disk Queue Manager:
 0 Read
 1 Write

<u>Field</u>	<u>Word(base8)</u>	<u>Bits</u>	<u>Description</u>
DNRDM	1	4	Random dataset flag: 0 Sequential 1 Random
DNUDS	1	5	Dataset structure: 0 COS-blocked dataset 1 Unblocked structure
DNIN	1	6	Subdataset; used for \$IN.
DNDTP	1	7	ISP dataset created through F\$CON
DNMEM	1	8	Dataset is memory resident
DNQMRS	1	9-10	Queue manager reply flags
DNQMFR	1	9	Final reply sent
DNQMIR	1	10	Intermediate reply sent
DNEND	1	11	Write end of dataset flag. Used in conjunction with the partial block size DNPBS. DNEND and DNPBS are set by DQM when DPEND is set. DNEND and DNPBS can also be set by a task which does not use a DSP when calling DQM.
DNOISP	1	12-13	OPEN sent to ISP
DNRISP	1	12	ISP dataset opened for read
DNWISP	1	13	ISP dataset opened for write
DNNRIR	1	14	QIO list stopped on QIO\$RR
DNPRW	1	15	Previous operation read/write: 0 Previous operation read 1 Previous operation write
DNDC	1	16-31	Disposition code (two characters): DCIN=IN Job dataset DCST=ST Staged permanent dataset DCSC=SC Scratch dataset DCPR=PR Print dataset DCPU=PU Punch dataset DCPT=PT Plot dataset DCMT=MT Magnetic tape dataset
DNJORD	1	32-39	JXT ordinal if the DNT is in the job's JTA; 0 if the DNT resides in STP.

<u>Field</u>	<u>Word(base8)</u>	<u>Bits</u>	<u>Description</u>
<u>DNDAT</u>	1	40-63	Dataset allocation table address: =0 No DAT assigned >0 Address of first page header of DAT in STP <0 Two's complement address of first page header of DAT in JTA
DNNBK	2	0-15	Number of blocks to be read or written; number of words in last block to be written if (DNEND)=1.
DNSBK	2	16-39	Starting block number
DNBUF	2	40-63	I/O buffer address
DNPDS	3	0	Permanent dataset flag
DNCAT	3	1	Dataset is a system catalog
DNUQ	3	2	Permanent dataset is uniquely accessed
DNACS	3	4-11	Dataset access flags
DNE XO	3	8	Execute-only
DNMNP	3	9	Maintenance permission flag
DNWTP	3	10	Write permission flag
DNRDP	3	11	Read permission flag
DNPDM	3	12	PERMANENT DATASET MODIFIED FLAG
DNUCSP	3	13	Dataset is users own version of CSP
<u>DNDPS</u>	3	14	Dataset is in a DISPOSE process
<u>DNDFR</u>	3	15	Dataset has a deferred dispose
DNRLS	3	16	Release dataset at job step
DNNEW	3	17	Secure dataset indicator
DNXLM	3	18	Dataset size limit exceeded flag
DNIA	3	19	Dataset assigned to interactive device
DNTRAN	3	20	Transparent mode for IA dataset
DNNOF	3	21	No overflow indicator
<u>DNSDR</u>	3	22	Dataset resides in System directory

Field	Word(base8)	Bits	Description
DNBFI	3	23-31	Blank field indicator (octal) for character I/O Value Symbol Meaning 0-377 This ASCII character 400 BFI@ZER Illegal 777 BFI@OFF Disabled
DNAS	3	32-39	Allocation style (tracks per AI)
DNSZ	3	40-63	Dataset size (in 512-word blocks)

Fields in the following word can be modified by EXP or CIO/TIO as the result of randomly timed interrupts. Because EXP and CIO/TIO are subject to interruption by other tasks, especially DQM, do not insert in this word any fields that can be modified by routines other than EXP or CIO/TIO.

DNBIO	4	0	Buffered I/O is active
DNQIO	4	1	Dataset is using queued I/O mode
DNSRIO	4	2	Internal I/O flag, suspend when CTRCL
DNRMIO	4	3	Circular I/O is in record mode
DNIOU	4	5	Circular buffer in user managed area
DNRCL	4	6	Queue manager to send intermediate rep
DNPRCL	4	7	Outstanding CTRCL return
DNUBM	4	8	Buffer is managed by the user
DNIIO	4	16-21	Interrupted I/O status flags
DNDNR	4	16	Device-not-ready
DNMRCL	4	17	JTA expansion
DNICD	4	18	Circuit-disconnected
DNITR	4	22	Queue manager reply was intermediate
DNSTAT	4	24-33	Last reply status from queue manager
DNQMID	4	34-39	Task ID of controlling queue manager
DNIADD	4	40-63	CTRCL idle address
DNTFMN	5	0-15	Minimum transfer size, in sectors
DNTFMX	5	16-31	Maximum transfer size, in sectors

<u>Field</u>	<u>Word(base8)</u>	<u>Bits</u>	<u>Description</u>
DNXFMN	5	32-47	Active transfer minimum, in sectors
DNXFMX	5	48-63	Active transfer maximim, in sectors
DNCHG	6	1	Flag for EXP to move DAT (set by DIA)
DNERR	6	2	Flag for EXP to abort job due to extended PDS during offload. (TEMPORARY)
DNDIT	6	16-39	Primary DIT address, JTA relative
DNBFZ	6	40-63	ASSIGNed I/O buffer size, in sectors
DNIODS	7	0	Unprocessed queue manager J\$IODONE req
DNSIO	7	1	User tasks entered into T%I
<u>DNDSPI</u>	10	1-6	Relocation index for DNDSP
DNDPPI	10	7-12	Relocation index for the DSP pointers
DNSTKI	10	13-15	Relocation index for I/O stack address
DNSTK	10	16-39	Current I/O stack top (-JTA relative)
<u>DNDSP</u>	10	40-63	DSP address, relative to (DNDSPI)
DNTOII	11	0-15	TXT ord. of task which initiated I/O
DNTOFR	11	16-31	TXT ord. of task which 1st entered J%I
DNTORC	11	32-47	TXT ord of task at STP's CTRL time
DNLDV	12	0-63	Requested logical device name
DNIOS	13	0-31	Number of I/O suspensions performed
DNIOR	13	32-63	Number of logical transfer request
DNIOB	14	0-39	Number of sectors transfered
DNDAA	14	40-63	Per device statistics address, JTA rel
DNTSD	15	0-63	Time spend in I/O suspend
DNPBS	16	0-8	Partial block size in words
DNDT	16	15-23	DEVICE TYPE
DNDTSC	16	15	Scratch device
DNDTCT	16	16	Controlled device
DNDTTP	16	17	Tape dataset (ONLINE/STAGED)
DNDTIS	16	18	ISP dataset
DNDTSL	16	19	Superlink dataset

<u>Field</u>	<u>Word(base8)</u>	<u>Bits</u>	<u>Description</u>
DNQDT	16	24-39	Multitype flag/QDT entry index
DNLBN	16	40-63	Number of last block written
DNDCZ	17	8-39	Dataset catalog size in words
DNLM	17	40-63	Dataset size limit in 512-word block
DNCHK	20	0	Block number checking request flag (IOS use only)
DNSNC	20	1	SYNCH TAPE DATASET
DNBSS	20	2	BUFFER SET UP FOR SYNCH
DNSCM	20	3	SYNCH IS COMPLETE
DNSIP	20	4	SYNCH IN PROGRESS
DNFLT	20	5	Field label tape
DNPDDI	20	8-12	PDD relocation index (REL@xxxx)
DNITP	20	14	INTERNAL TAPE POSITION REQUEST FLAG
DNBDF	20	15	Bad data flag
DNBBN	20	16-39	Number of bad block
DNPDD	20	40-63	PDD address, relative to (DNPDDI)
DNTPS	21	0-15	Online tape status
DNTPB	21	16-39	Tape maximum block size in bytes
DNTPV	21	40-63	Tape pointer to system label area
DNTPD	22	0-1	Tape density
DNTPL	22	2-4	Tape label type
DNTPF	22	5-6	Tape format
DNTPC	22	7	Tape cataloged dataset
DNTQR	22	8	Tape reset lockout
DNTPM	22	9	Tape online maintenance access
DNTPH	22	21	Tape hold device assignment
DNTCS	22	22-23	Tape dataset character set
DNTRC	22	24-29	Tape recovery retry count

<u>Field</u>	<u>Word(base8)</u>	<u>Bits</u>	<u>Description</u>
DNTRD	22	30	Use tape retry default value
DNTPD1	22	32-63	Tape device number (stream 1)
DNIDC	23	0-2	Tape initial disposition code
DNOST	23	3-6	OPEN STATUS
DNTVT	23	16-39	ADDR OF TVT
DNAPF	24	0	Allocation DNT pointers ok if 1
DNASIZ	24	1-30	Number of sectors allocated
DNANAI	24	31-39	AI parcel available on current page
DNAPGH	24	40-63	Current page header for allocation
DNC	25	6	Dataset requires contiguous disk space
DNINC	25	7-15	Number of sectors to allocate per request
DNPDL	25	16-39	Preferred device list
DNAPRH	25	40-63	Current partition header for allocation
DNHSDT	26	0-23	Link to HOLD queue for F\$SDTQM
DNUDAT	26	28-39	Number of unused DAT pages
DNSLPG	26	40-63	Last DAT page gotten from GETDAT
DNOVL	27	0	Overflowed desired device if set
DNNOTC	27	1	Allocate first space available
DNWRT2	27	3	Task wishes to stream this dataset
DNESA	27	4	Exact sector allocation
DNSWE	27	5	Dataset not FSS resident if set
DNCSZ	27	6	Clear DNSZ after restore if set
DNNDR	27	7	Do not release DAT's on deallocate
DNTRS	27	15	Quick transfer flag has been set up
DNGRTO	27	16-39	GRT entry ordinal
DNSEQT	27	40-63	Current EQT of current DAT partition

<u>Field</u>	<u>Word(base8)</u>	<u>Bits</u>	<u>Description</u>
DNDDRO	30	0-15	Number of data to disk replies owed
DNPSS	30	16-39	Physical starting sector of dataset
DNNCS	30	40-63	Initial contiguous sectors of dataset
DNERRS	31	0-15	Unrecoverable data to disk error
DNJXGR	31	16-39	Generic resource address
DNIDD	31	40-63	Address of the IDD
DNIRT	32	16-39	Address of IRT entry associated
DNTRB	32	40-63	Transport request block address:
DNST	33	0-1	Storage type
DNSCR	33	0	Allocate on scratch device
DNPERM	33	1	Allocate on permanet type device
DNDTO	33	32-49	Default devices wanted
DNNT1	33	32-37	Desired device type for storage
DNNT2	33	38-43	2nd preferred type for storage
DNNT3	33	44-49	3rd preferred type for storage
DNSDT	34	16-39	Dummy SDT address for front-end xfers
DNLNK	34	40-63	Link to other DNT in FSS copy request
DNSSEC	35	0-31	Starting sector number (FSS copy)
DNNSEC	35	32-63	Number of sectors to copy (FSS copy)
DNNFE	36	0	EXP supress errors for internal calls
DNIAS	36	1	EXP performed implied ASSIGN
DNSMSG	36	2	Indicate stats are to be reported
DNEXUS	36	32-63	Exclusive use flags
DNPROC	36	32	In-use as a proceedure dataset
DNXUCS	36	32	In-use as a proceedure dataset
DNXULG	36	33	In-use as a logfile dataset
DNXUCP	36	34	In-use as control statement processor
DNXUTQ	36	40	In-use for active TQM request
DNXUPD	36	41	In-use for active PDM request
DNXUFC	36	59	In-use for active fetch request
DNXUDS	36	60	In-use for active dispose request
DNXURL	36	61	In-use for active release request
DNXUCL	36	62	In-use for active close request
DNXUOP	36	63	In-use for active open request
DNSPD	37	0-15	Sectors to allocate per device

<u>Field</u>	<u>Word(base8)</u>	<u>Bits</u>	<u>Description</u>
DNRQS	37	16-39	Requested sectors yet to allocate
DNCSD	37	40-63	Current sectors allocated for strip
DNLDC	40	0-23	CURRENT LDT
DNLDF	40	24-47	FIRST LDT

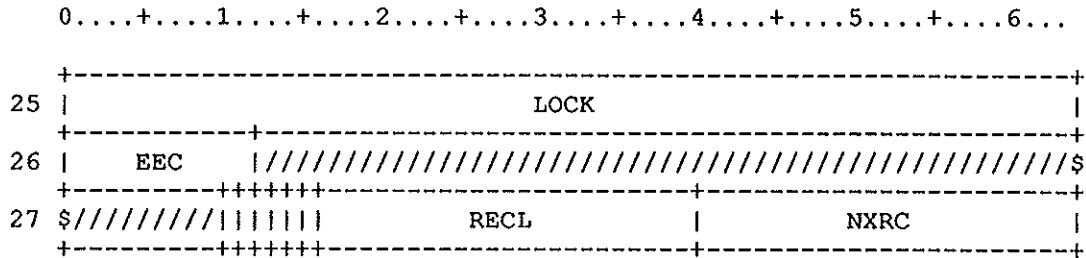

Figure DP-1. Dataset Parameter Table

Field	Word(base8)	Bits	Description
DPDN	0	0-55	Dataset name
DPBSY	1	0	Busy flag, circular I/O: 0 Not busy 1 Busy
<u>DPERR</u>	1	1-12	Error flags:
DPEOI	1	1	End of data on read; write past allocated disk space on write.
DPENX	1	2	Dataset does not exist
DPEOP	1	3	Dataset not open
DPEPD	1	4	Invalid processing direction
DPEBN	1	5	Block number error
DPEDE	1	6	Unrecovered data error
DPEHE	1	7	Unrecovered hardware error
DPERW	1	8	Attempted read after write or past EOD
DPEPT	1	9	Dataset prematurely terminated
DPELE	1	10	Unrecovered logical data error
	/	11	Reserved
<u>DPEEP</u>	1	12	Extended error (see DPEEC)
DPSTS	1	14-15	Status: 00 Closed 01 Open for output (O) 10 Open for input (I) 11 Open for I/O
DPBFI	1	16-24	Blank compression character in ASCII (BFI=0'777 implies no compression)
DPISP	1	25	ISP dataset flag
DPQIO	1	26	Queued I/O Request Flag
DPOST	1	27-30	Open status
DPABD	1	31	Accept bad data flag

<u>Field</u>	<u>Word(base8)</u>	<u>Bits</u>	<u>Description</u>
DPTP	1	32-33	Tape dataset (online/staged)
DPTRAN	1	34	Transparent mode for interactive dataset
DPIA	1	35	Dataset is interactive
DPMEM	1	36	Dataset is memory resident
DPRDM	1	37	Random dataset flag: 0 Sequential dataset 1 Random dataset
DPUDS	1	38	Undefined dataset structure: 0 COS-blocked dataset structure 1 Undefined dataset structure
DPEND	1	39	Write end-of-data flag
DPFRST	1	40-63	Address of first word of buffer
DPIBP	2	10-15	Input bit position
DPIBN	2	16-39	Block number, read request. System reads from block number until buffer is filled. DPIBN is then set to the next block number.
DPIN	2	40-63	Address of current input word
DPSPPOS	3	0	Asynchronous SETPOS busy flag
DPRBC	3	3-9	Remaining blank count
DPOBP	3	10-15	Bit position in current output word (character I/O only)
DPOBN	3	16-39	Block number, write request. System writes from block number until buffer is empty. The next block number is then in DPOBN.
DPOUT	3	40-63	Address of current output word
DPUEOF	4	0	Uncleared end-of-file (EOF)
DPBS	4	1-15	Buffer size (in D'512 word sectors)
DPTBN	4	16-39	Temporary block number; used by random I/O for last block read
DPLMT	4	40-63	Address of last word+1 of buffer. LMT minus FRST defines buffer size.

<u>Field</u>	<u>Word(base8)</u>	<u>Bits</u>	<u>Description</u>
DPCWF	5	0-3	Control word types detected
DPEOR	5	0	End Of Record
DPEOF	5	2	End Of File
DPEOD	5	3	End Of Data
DPRW	5	4	Previous operation read/write flag: 0 Read 1 Write
DPPFI	5	5-24	Previous file index; backward index to block containing previous EOF.
DPPRI	5	25-39	Previous record index; backward index to block containing previous EOR.
DPRCW	5	40-63	Control word address: Previous RCW address if in write mode Next RCW if in read mode
DPLPW	6	0-63	Last partial word; used for character mode I/O
DPBIO	7	0	Buffered I/O busy: 0 Buffered I/O operation complete 1 Buffered I/O operation incomplete
<u>DPBER</u>	7	1	Buffered I/O error flag
DPBF	7	2-9	Function code: BIOFRRP = 0 Read partial record BIOFRR = 0'10 Read record BIOFWRP = 0'40 Write partial record BIOFWR = 0'50 Write record BIOFEOF = 0'52 Write EOF BIOFEOD = 0'56 Write EOF
DPBPD	7	4	Processing direction: 0 Read 1 Write
DPBEO	7	6-9	Termination condition: 00 Partial 10 Record 12 File, write only 16 Dataset, write only
DPBUBC	7	10-15	Unused bit count; must be specified on a write record request. Value returned on a read request.

<u>Field</u>	<u>Word(base8)</u>	<u>Bits</u>	<u>Description</u>
DPBWC	7	16-39	Word count; number of words at DPBWA to read or write. Field contains actual number of words read when request is completed.
DPBWA	7	40-63	Word address of user data area
DPXV	10	0	Extended DSP validation if set
DPNSN	10	1	New sector number processing mode
DPRMIO	10	2	I/O mode is record flag
DPSL	10	3	Superlink dataset flag
DPSLCT	10	32-63	Pointer to Superlink Connection Tables
DPTFMN	11	0-15	Minimum buffer transfer size (sectors)
DPTFMX	11	16-31	Maximum buffer transfer size (sectors)
DPXFMN	12	0-15	Active transfer minimum size (sectors)
DPXFMX	12	16-31	Active transfer maximum size (sectors)
DPSSEC	13	0-31	Starting sector number (FSS copy)
DPNSEC	13	32-63	Number of sectors to copy (FSS copy)
DPLCNT	14	24-31	Number of times TASK has locked DSP
DPLOWN	14	32-63	Current Task Id holding the DSP lock
DPQFLG	15	0	DSP LOCK flag
DPQTL	15	1-31	DSP lock queue tail pointer
DPQHD	15	32-63	DSP lock queue head pointer
DPINS1	16	0-63	Reserved for installation
DPINS2	17	0-63	Reserved for installation
DPTPS	20	0-15	Online tape status
DPTPV	20	40-63	Tape pointer to label definition table
DPTPD	21	0-1	Tape density
DPTPF	21	2-3	Tape format

<u>Field</u>	<u>Word(base8)</u>	<u>Bits</u>	<u>Description</u>
<u>DPTAPE</u>	21	4-19	Tape status
DPAEV	21	4	User is at tape end of volume
DPTOR	21	5	Tape off reel
DPTMS	21	6	Tape mark status
DPBLT	21	7	Blank tape
DPEOVR	21	8	EOV READ
DPBTM	21	9	tape is before tape mark
MASKS FOR TESTING TAPE STATUS FIELD			
			TS\$EOV=O'100000 EOV mask
			TS\$TOR=O'040000 Tape off
			reel mask
			TS\$TMS=O'020000 Tape mark
			status mask
			TS\$BLT=O'010000 Blank tape
			detected mask
			TS\$EOVR=O'004000 Read
			completed in EOV processing
			TS\$BTM=O'002000 tape is
			before tape mark
DPMTF	21	48-63	Maintenance test field
DPCV	22	0	Data conversion flag
			DPCVOFF=0 Data conversion off
			DPCVON=1 Data conversion on
DPFD	22	1-4	Translation identifier
			DPFDNONE=0 NO foreign file
			translation
			DPFDIBM=1 IBM file translation
			DPFDCDC=2 CDC file translation
			DPFDVMS=3 VMS file translation
DPRF	22	5-11	Record format (if DPCT nonzero)
			DPRFUNKN=O'177 Unknown
			record format
			DPRFIU=0 IBM undefined
			DPRFIF=1 IBM fixed
			DPRFIFB=2 IBM fixed blocked
			DPRFIV=3 IBM variable
			DPRFIVB=4 IBM variable blocked
			DPRFIVBS=5 IBM variable block
			span

Values 21 through 37 are reserved for ANSI record types:

DPRFIW=0'00 I tape format, I blocks, W records
 DPRFICW=0'10 I tape format, C blocks, W records
 DPRFICZ=0'11 I tape format, C blocks, Z records
 DPRFICS=0'12 I tape format, C blocks, S records
 DPRFSIIW=0'40 SI tape format, I blocks, W records

 DPRFSICW=0'50 SI tape format, C blocks, W records

 DPRFSICZ=0'51 SI tape format, C blocks, Z records

 DPRFSICS=0'52 SI tape format, C blocks, S records

 DPRFVF=1 VMS F format
 DPRFVUF=2 VMS UF format
 DPRFVD=3 VMS D format
 DPRFVV=4 VMS V format
 DPRFVS=5 VMS S format
 DPRFVUS=6 VMS US format

DPMB5	22	16-39	Maximum block size
DPRS	22	40-63	Record length
DPBFBO	23	0-5	User data area current bit offset
DPCS	23	6-7	Character set (if DPCT nonzero) DPCSAS=0 ASCII DPCSEB=1 EBCDIC DPCSDC=2 CONTROL DATA display code
DPSCC	23	12-13	Record continuation code
DPBDF	23	14	Bad data flag
DPPCR	23	15	Process-characters-remaining flag
DPBFBL	23	16-39	User data area current bit length
DPBFBA	23	40-63	User data area current address
DPLPBL	24	0-5	Last partial word bit length
DPEOLR	24	6	Foreign dataset end of logical record
DPEOLF	24	7	Foreign dataset end of logical file
DPSBL	24	16-39	Current segment/record bit length

<u>Field</u>	<u>Word(base8)</u>	<u>Bits</u>	<u>Description</u>
DPBLBL	24	40-63	Current tape block bit length
DPLOCK	25	0-63	Multitasking lock (nonzero TIB address
<u>DPEEC</u>	26	0-11	Error code if DPEEP is set; correspond to EXP abort codes.
DPSEQ	27	10	FORTTRAN sequential access flag
DPFMT	27	11	FORTTRAN formatted I/O flag
DPDEL	27	12	FORTTRAN file status: 0 Keep 1 Delete
DPBLNK	27	13	FORTTRAN numeric input blank conversion: 0 Null 1 Zero
DPDIR	27	14	FORTTRAN direct access flag
DPUFMT	27	15	FORTTRAN unformatted I/O flag
DPRECL	27	16-39	FORTTRAN direct access record length (in number of characters)
DPNXRC	27	40-63	FORTTRAN direct access next record number

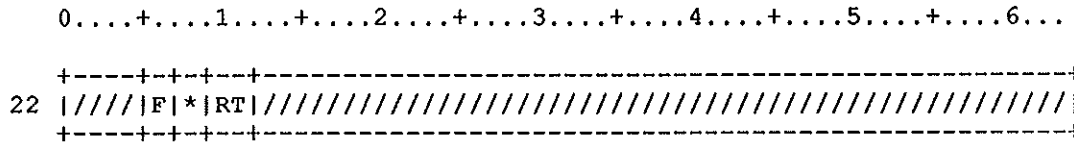

Figure DP-2. CDC record format

<u>Field</u>	<u>Word(base8)</u>	<u>Bits</u>	<u>Description</u>
DPF	22	5-6	Tape format DPFNONE=0 No tape format DPFI=1 Internal DPFSI=2 System or scope internal
DPBT	22	7-8	Block type DPBTI=0 Internal DPBTC=1 Character count
DPRT	22	9-11	Record type DPRTW=0 Control word DPRTZ=1 Zero byte DPRTS=2 System-logical

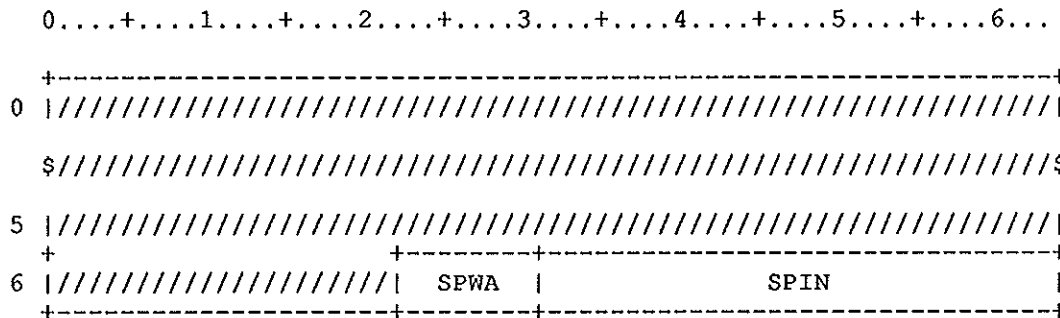

Figure DP-3. Save areas used by asynchronous SETPOS

<u>Field</u>	<u>Word(base8)</u>	<u>Bits</u>	<u>Description</u>
DPSPWA	6	22-30	Word address save areas used
DPSPIN	6	31-63	by asynchronous SETPOS

The DPT duplicates a word a given number of times. It provides a compact form for expressing a large number of words at load time without requiring a correspondingly large number of words in the relocatable dataset.

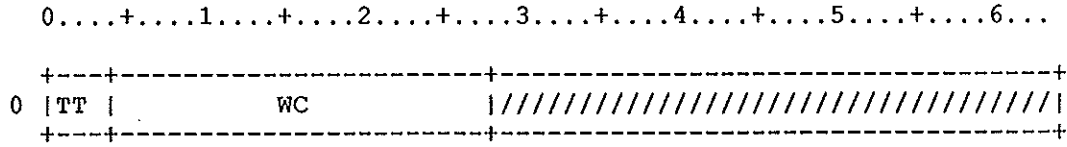

Figure DPT-1. Loader Duplication Table

Field	Word(base8)	Bits	Description
DPTTT	0	0-3	Table type (O'13)
DPTWC	0	4-27	Word count including header

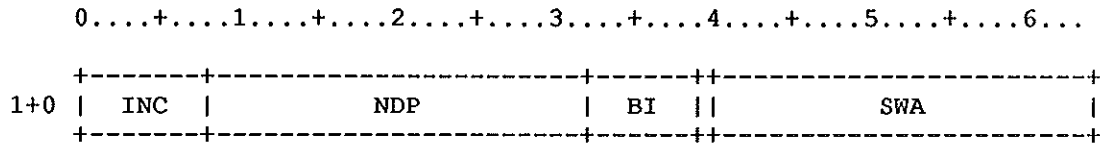

Figure DPT-2. Loader Duplication Table Entry

<u>Field</u>	<u>Word(base8)</u>	<u>Bits</u>	<u>Description</u>
DPTINC	1+0	0-7	Increment between stores of the source word. No duplication occurs if a zero increment is specified.
DPTNDP	1+0	8-31	Number of times the word at SWA is duplicated. NDP must be non-zero.
DPTBI	1+0	32-38	Block index; specifies the block whose base address is added to SWA in obtaining the word to be duplicated
DPTSWA	1+0	40-63	Source word address; the address of the word that is duplicated. Duplication is performed before relocation or external linkage in the load process.

DPTTYPE=0'13 Table type code for DPT

The DQM Queue is an STP-resident table that is used to define a generic queue structure for DQM. This structure is used for the following queues:

- Free queues: PHR free queue
 RQT free queue
- Task request queues: allocate storage request queue
 deallocate storage request queue
 transfer data request queue
- Physical request queues: EQT's system PHR queue
 EQT's user PHR queue
- Reply queues: final reply queue

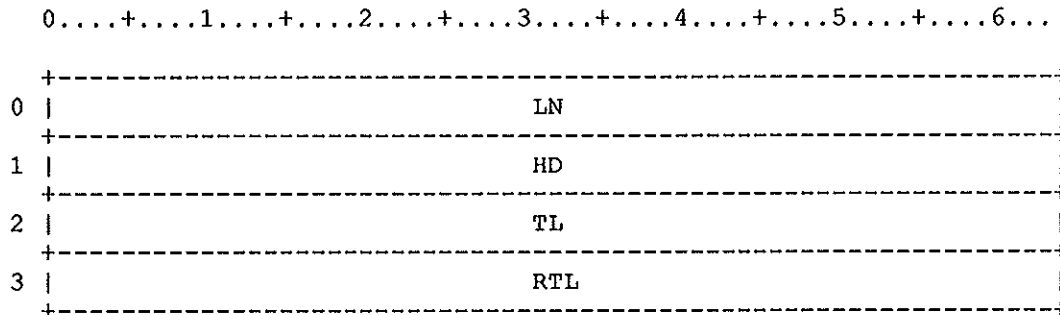

Figure DQ-1. DQM Queue header

Field	Word(base8)	Bits	Description
DQLN	0	0-63	Queue length (number of entries)
DQHD	1	0-63	Queue head
DQTL	2	0-63	Queue tail
DQRTL	3	0-63	Requeue tail

The DQM history trace is STPTAB resident. This trace buffer when enabled will trace the various key points through the major sections of DQM. By default all tracing within DQM is turned off. To enable DQM tracing, redefine the number of history trace entries to a non-zero value. Note that DQM will have to be reassembled when this is done.

NE@DQMT = D'000 Number of DQM trace entries

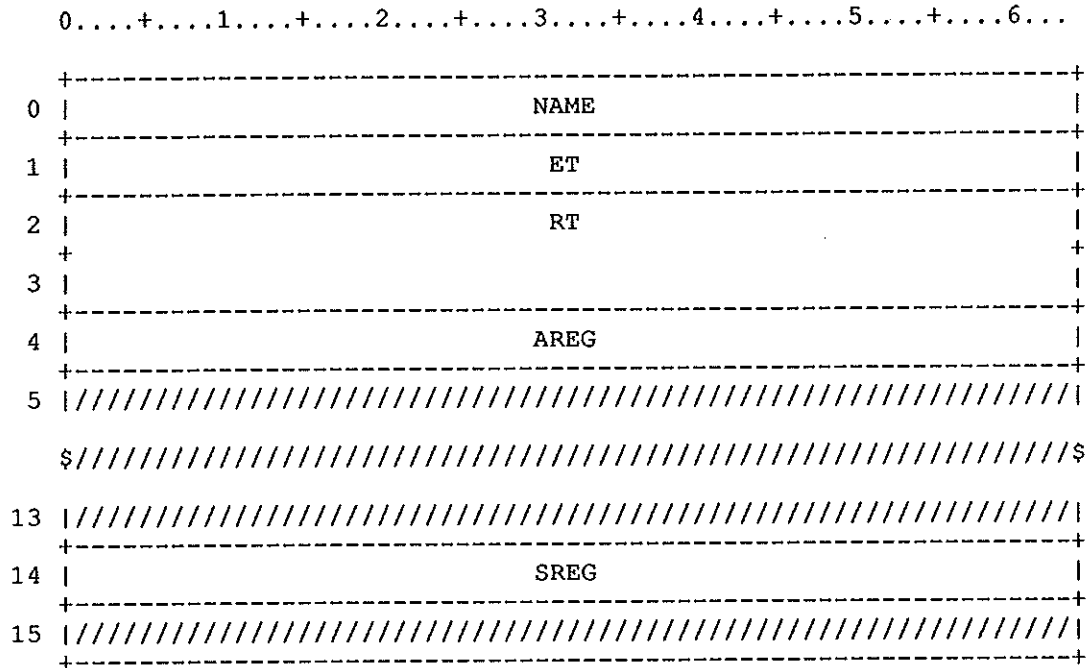

Figure DT-1. DQM history trace buffer

The follow four words are common to all history trace buffers that FDUMP can recognize and collate with other history traces of the same nature.

Field	Word(base8)	Bits	Description
DTNAME	0	0-63	ASCII name associated with the entry
DTET	1	0-63	Elapsed Real-time clock since last ent
DTRT	2-3	0-63	Current real-time clock
DTAREG	4	0-63	Address registers
DTSREG	14	0-63	Scalar registers

The DQT is used to maintain a queue of outstanding diagnostic requests to the IOS. The DQT is used to link up replies from the IOS with the appropriate diagnostic task.

The DQT consists of a one word header containing a pointer to the next available entry in the DQT and NE@DQT two-word entries.

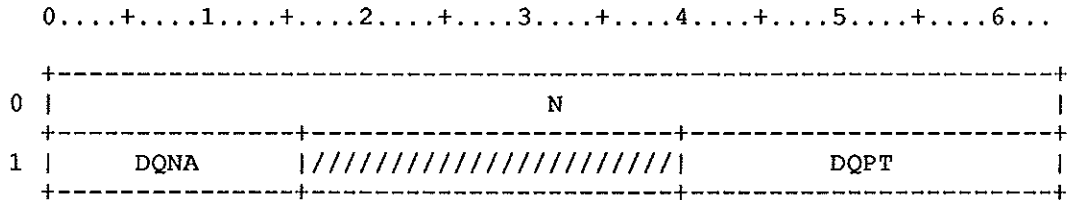

Figure DQT-1. Diagnostic Queue Table header

<u>Field</u>	<u>Word(base8)</u>	<u>Bits</u>	<u>Description</u>
DQTN	0	0-63	Table name ('DQT'L)
DQNA	1	0-15	Number of active entries
DQPT	1	40-63	Address of next available entry

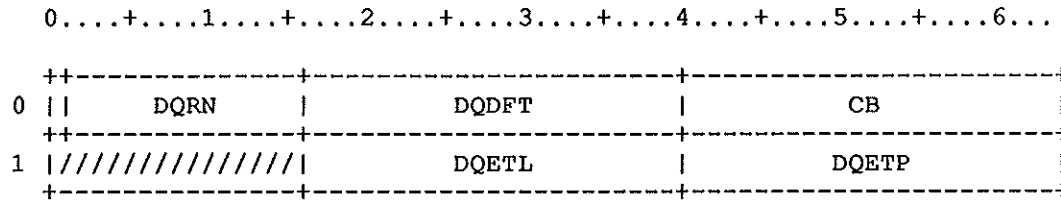

Figure DQT-2. Diagnostic Queue Table entry

Field	Word(base8)	Bits	Description
DQACT	0	0	Active flag. Nonzero if active.
DQRN	0	1-15	Request number
DQDFT	0	16-39	DFT address
DQTCB	0	40-63	TCB address for issuing task
DQETL	1	16-39	Error table limit address
DQETP	1	40-63	Error table address for next entry 0 if no error table

<u>Field</u>	<u>Word(base8)</u>	<u>Bits</u>	<u>Description</u>
DRMAP	4-n	0-63	Bit map, one bit per track

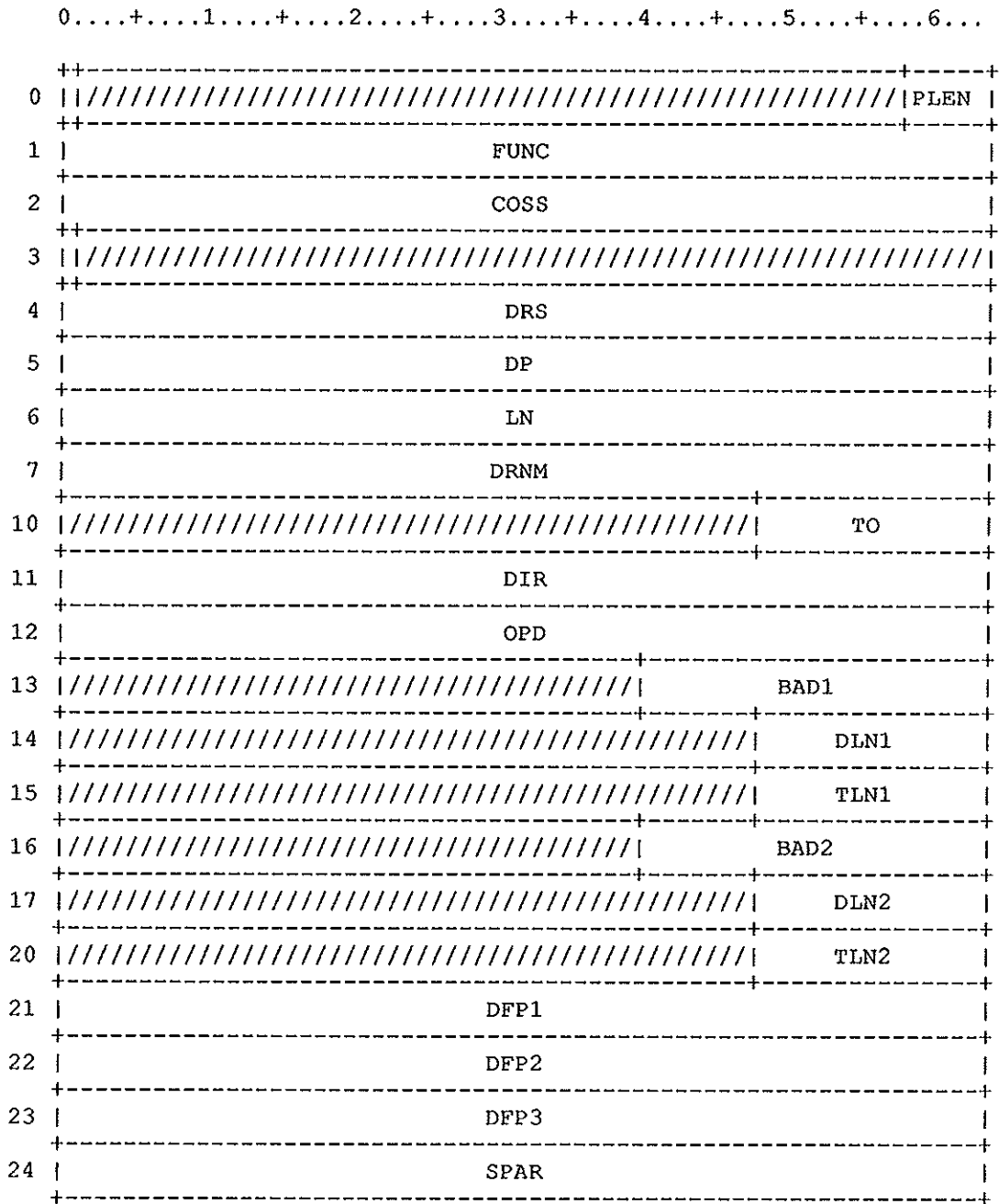

Figure DR-1. F\$DRIVER parameter block

<u>Field</u>	<u>Word(base8)</u>	<u>Bits</u>	<u>Description</u>
DRBUFL	0	0	Buffer length flag 0 = buffer lengths in bytes (normal) 1 = buffer lengths in words (NETEX)
DRPLEN	0	58-63	Parameter block length
DRFUNC	1	0-63	Subfunction code

The following line is a *CALL to comdeck COMAPFC.

COPYRIGHT BY CRAY RESEARCH, INC. *

UNPUBLISHED - ALL RIGHTS RESERVED UNDER THE COPYRIGHT LAWS *
OF THE UNITED STATES. *

CFN\$xxx codes are used to specify the type of request to the shell and/or driver.

If codes are added, CFN\$MIN, CFN\$RSV, CFN\$DMIN, and CFN\$DMAX must be updated accordingly.

CFN\$MIN=3 Minimum legal code
CFN\$OPE=3 Driver Open
CFN\$CLS=4 Driver close
CFN\$RD=5 Read header
CFN\$RDH=6 Read header and hold data
CFN\$RDD=7 Read both header and data
CFN\$WT=D'8 Write header
CFN\$WTH=D'9 Write header and hold data
CFN\$WTD=D'10 Write header and data
CFN\$RSV=D'11 - D'31 Reserved
CFN\$DMIN=D'32 Minimum legal driver function code
CFN\$DMAX=D'127 Maximum legal driver function code

CST\$xxx codes are returned by the shell and drivers.

CST\$CMP=0 Complete
CST\$MIN=CST\$CMP Minimum status
CST\$PRO=3 Protocol error
CST\$CHN=4 Illegal channel number
CST\$FCN=5 Illegal function code
CST\$DVN=6 Illegal driver name
CST\$DAE=7 Data address error
CST\$DLE=D'8 Data length error
CST\$MAX=CST\$DLE Maximum status

D'9 - D'31 Reserved

CST\$DMIN=D'32 Min driver
specific code
CST\$DMAX=D'127 Max driver
specific code

CST\$xxx codes for loopback driver.

CST\$TMO=D'32 Loopback Driver
timeout

DRCOSS	2	0-63	Status of the request.
			DRS\$OK=0 Okay
			DRS\$CNO=1 Channel is not open
			DRS\$CAO=2 Channel is already open
			DRS\$RSV=3 Channel is reserved to another task
			DRS\$CUK=4 Channel is unknown
			DRS\$OFF=5 Channel is off
			DRS\$BA1=6 Bad buffer1 address
			DRS\$BA2=7 Bad buffer2 address
			DRS\$BL1=8 Bad buffer1 length
			DRS\$BL2=9 Bad buffer2 length
			DRS\$BPS=10 Bad parameter size
			DRS\$BDI=11 Bad channel direction
			DRS\$BSY=12 Channel is busy
			DRS\$BFN=13 Bad function
			DRS\$NMT=14 Not available to multitasking jobs
			DRS\$NRS=15 Channel is not reserved to you
			DRS\$NTO=16 User Channels Not Turned On (I@UC=0)
			DRS\$MIN=DRS\$OK Min status
			DRS\$MAX=DRS\$NTO+1 Max status + 1
DRCOMS	3	0	'Driver complete' status
DRDRS	4	0-63	Driver and shell status
DRDP	5	0-63	Driver parameter
DRLN	6	0-63	Logical channel name; 1-7 chars. Left justified, blank filled.
DRDRNM	7	0-63	Driver name
DRTO	10	48-63	Driver timeout in tenths of a sec
DRDIR	11	0-63	Direction of channel DIR\$INP=0 Input DIR\$OUT=1 Output
DROPD	12	0-63	OPEN driver spare

<u>Field</u>	<u>Word(base8)</u>	<u>Bits</u>	<u>Description</u>
DRBAD1	13	40-63	Buffer1 address
DRDLN1	14	48-63	Data1 length
DRTLN1	15	48-63	Transfer1 length
DRBAD2	16	40-63	Buffer2 address. Used only with READ/READ, WRITE/WRITE, and WRITE/HOLD requests.
DRDLN2	17	48-63	Data2 length. Used only with READ/READ, READ/HOLD, WRITE/WRITE, and WRITE/HOLD requests.
DRTLN2	20	48-63	Transfer2 length. Set only with READ/READ or WRITE/WRITE requests.
DRDFP1	21	0-63	DRIVER function parameters
DRDFP2	22	0-63	
DRDFP3	23	0-63	
DRSPAR	24	0-63	Spare for future use

The Disk Control Path Table is an STP-resident table used to control the submittal of driver requests to the disk disk drivers. There is one DCT entry for each existing control path.

0.....+.....1.....+.....2.....+.....3.....+.....4.....+.....5.....+.....6...

0	TN
1	NE
2	QUE
3	SAT
4	FIN
5	ACK
6	DEFD
7	SCR
10	PERM
11	DD19
12	DD29
13	DD39
14	DD49
15	SSD
16	EBM
17	DD10
20	DD40

Figure DT-1. Disk Control Path Table header

<u>Field</u>	<u>Word(base8)</u>	<u>Bits</u>	<u>Description</u>
DTTN	0	0-63	Table name ('DCT'L)
DTNE	1	0-63	Number of entries
DTQUE	2	0-63	Queued driver requests bitmap (each bit represents a control path)
DTSAT	3	0-63	Saturated control path bitmap (each bit represents a control path)
DTFIN	4	0-63	Finished driver requests bitmap (each bit represents a control path; DCU2s and DCU3s only)
DTACK	5	0-63	Acknowledged driver requests bitmap (each bit represents a control path; DCU2s and DCU3s only)

Control path information is used by DQM for selection of a new device for a dataset

DTDEFD	6	0-63	Control paths with default devices
DTSCR	7	0-63	Control paths with scratch devices
DTPERM	10	0-63	Control paths with permanent device
DTDD19	11	0-63	Control paths with DD19 devices
DTDD29	12	0-63	Control paths with DD29 devices
DTDD39	13	0-63	Control paths with DD39 devices
DTDD49	14	0-63	Control paths with DD49 devices
DTSSD	15	0-63	Control paths with SSD devices
DTEBM	16	0-63	Control paths with EBM devices
DTDD10	17	0-63	Control paths with DD10 devices
DTDD40	20	0-63	Control paths with DD40 devices

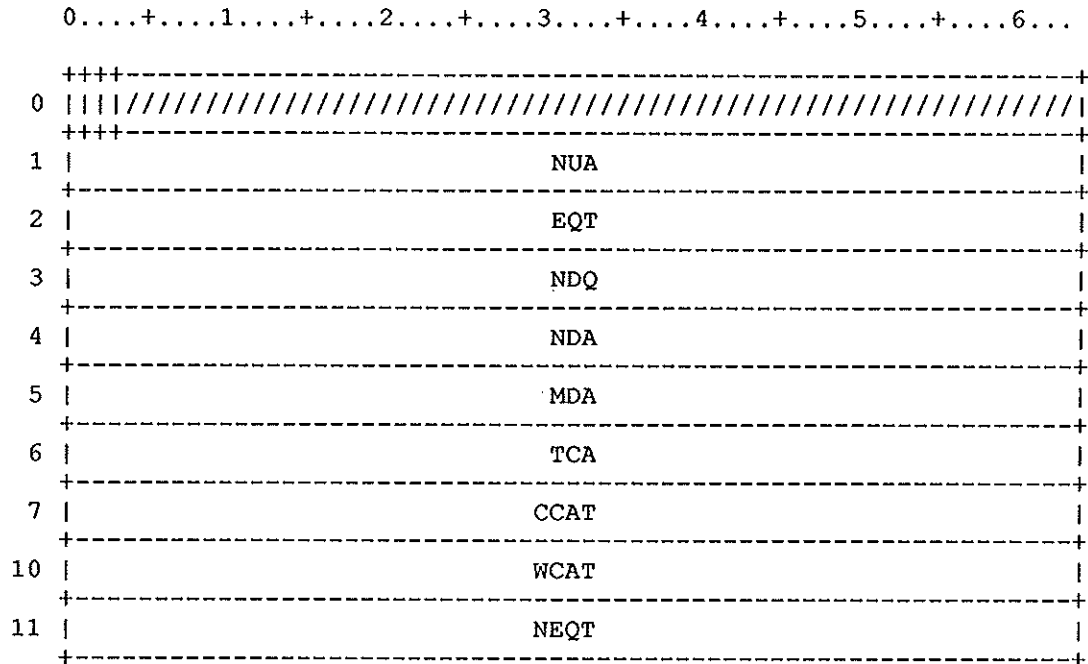

Figure DT-2. Disk Control Path Table entry

DTBS 0 0 Break streaming (0=no, 1=yes)

Field	Word(base8)	Bits	Description
DTMBT	0	1	Multi-sector transfer controller (Indicates SK/SL modules are present in a DCU-3 control unit; this allows consecutive disk sectors to be transferred without an intervening interrupt)
DTFPP	0	2	First attempt to find a device for
DTNUA	1	0-63	Number of units active
DTEQT	2	0-63	Active EQT address (STP relative)
DTNDQ	3	0-63	Number of driver requests queued
DTNDA	4	0-63	Number of driver requests active
DTMDA	5	0-63	Max # of requests that can be active
DTTCA	6	0-63	Time control path became active
DTCCAT	7	0-63	Cumulative control path active time
DTWCAT	10	0-63	Weighted control path active time

<u>Field</u>	<u>Word(base8)</u>	<u>Bits</u>	<u>Description</u>
DTNEQT	11	0-63	Next EQT for device selection

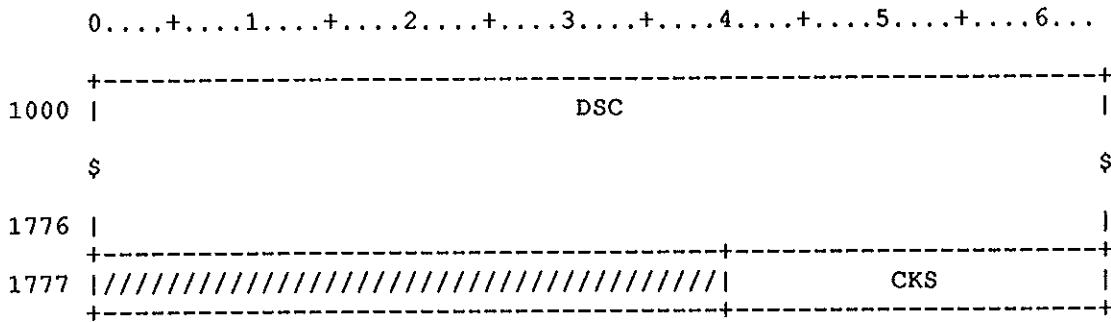

Figure DV-1. Device Label Table

Field	Word(base8)	Bits	Description
DVLBL	0	0-23	Device label indicator; 'DLB' in ASCII.
DVMD	0	63	Master device flag
DVLDV	1	0-63	Logical device name
DVRT	2	0-63	Real-time clock when DVL was written
DVSTK	3	32-47	Starting track on logical device
DVNTK	3	48-63	Number of tracks on logical device
DVSDP	4	16-31	First track of system dump area
DVOVP	4	32-47	DSC overflow pages if DVMD<>0 (master device)
DVHSP	4	48-63	DSC hash pages if DVMD<>0 (master device)
DVFLC	5	48-63	Number of used AIs (if master)
DVLCOS	6	0-63	Used only for backward compatibility
DVGRP	12	0-3	Group ID of stripe to which this device belongs, in range 0-9. If zero, device is not in stripe.
DVFLT	400	0-15	List of reserved AIs such as flaws, FE tracks, etc.
DVDSC	1000-1776	0-63	Dataset Catalog DAT page images if DVMD<>0 (master device)
DVCKS	1777	40-63	Checksum

The Permanent Dataset Catalog Extension Information Table (DXI) contains information used by the Permanent Dataset Manager (PDM) such as the number of pages in the DXT.

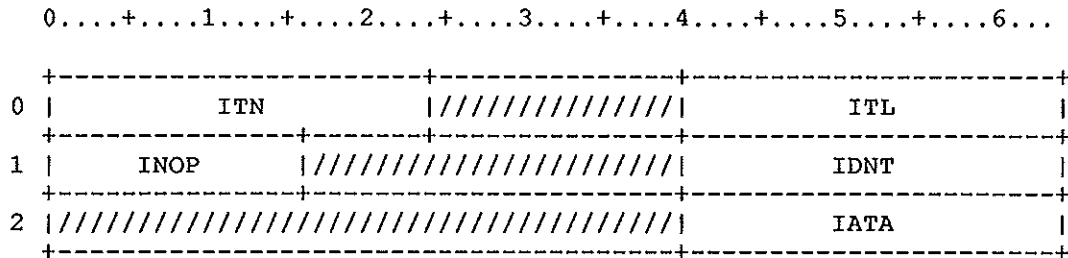

Figure DX-1. DSC Extension Information Table

Field	Word(base8)	Bits	Description
DXITN	0	0-23	Table name
DXITL	0	40-63	Table length in words
DXINOP	1	0-15	Number of pages in the DXT.
DXIDNT	1	40-63	Address of DXT's DNT.
DXIATA	2	40-63	Address of DXT Allocation Table.

The DXT serves as a repository for information that does not fit conveniently into the DSC. The DXT is a system dataset similar to the DSC itself. It is located or created during Deadstart; or it can be created during an Install. It is a permanent dataset with the name \$DSC-EXTENSION and edition number 4095.

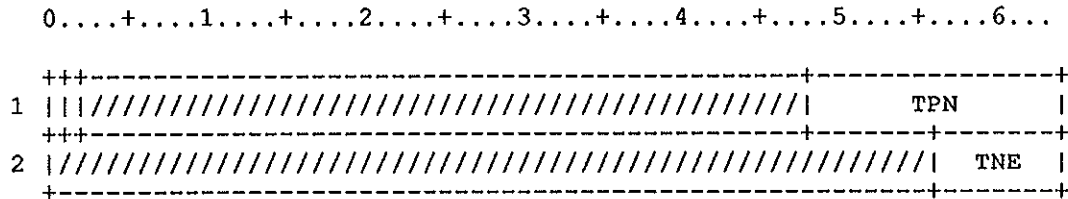

Figure DX-1. DSC Extension page definition table

DSC Extension Page header definition

<u>Field</u>	<u>Word(base8)</u>	<u>Bits</u>	<u>Description</u>
DXTPF	1	1	Page is currently full.
DXTPN	1	48-63	Page number.
DXTNE	2	56-63	Number of entries in use on this page.

DSC Extension page entry header definition

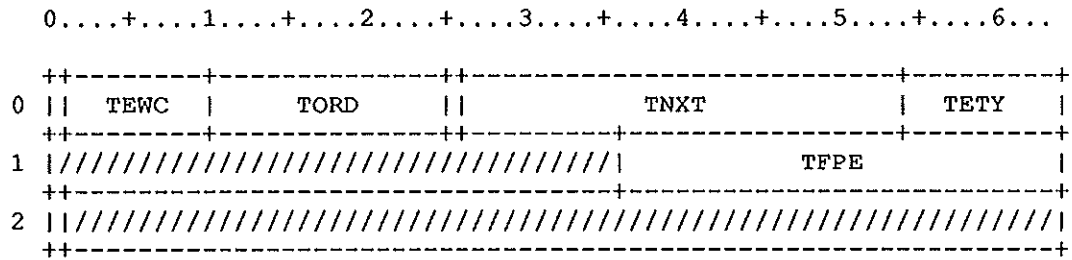

Figure DX-2. DSC Extension page entry header
LH@DXEH=3

DXTUSE 0 0 In use flag (1= entry in use)

Field Word(base8) Bits Description

DXTEWC	0	1-9	Entry word count
DXTORD	0	10-24	DXT ordinal (0-D'32767)
DXTNXT	0	26-53	Next DXT pointer.
DXTNXP	0	26-49	page number
DXTNXE	0	50-53	entry number
DXTETY	0	54-63	Entry type.
DXTCOS	0	54	CRI or Site flag (0=CRI)
DXTETV	0	55-63	entry type value

DXT entry type definitions

- DXPERM=1 Permanent dataset permit info.
- DXTRAC=2 Permanent dataset track accesses info.
- DXTEXT=3 Text entry type
- DXNOTE=4 Notes entry type

DXTFPE	1	36-63	First DSC page/entry of owning DXT
DXTACT	2	0	Active/Inactive flag (1=Inactive)

Engineering diagnostics use this disk-resident table to record flaws encountered during a surface analysis of a disk pack. Startup uses the table to make flawed tracks unavailable to COS.

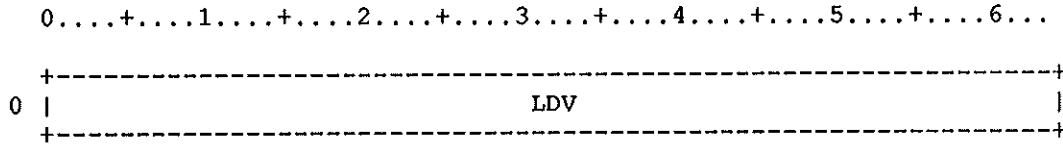

Figure EFT-1. Engineering Flaw Table Header

<u>Field</u>	<u>Word(base8)</u>	<u>Bits</u>	<u>Description</u>
EFTLDV	0	0-63	Logical device name as known to COS

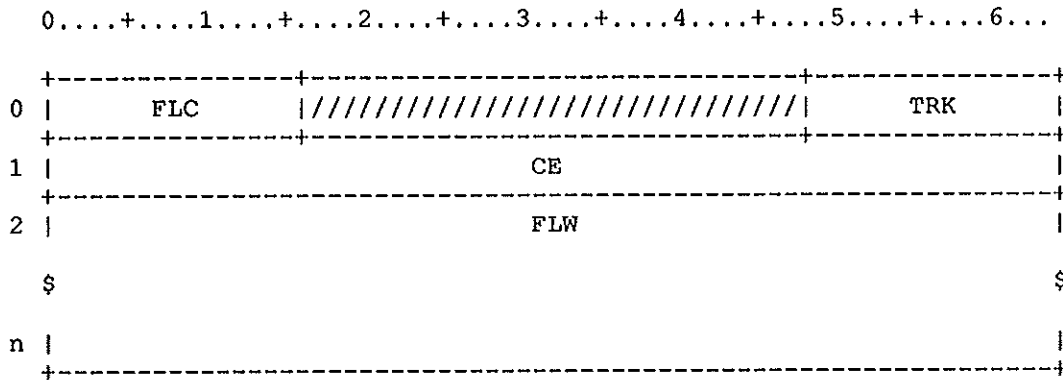

Figure EFT-2. Engineering Flaw Table Entry

<u>Field</u>	<u>Word(base8)</u>	<u>Bits</u>	<u>Description</u>
EFTFLC	0	0-15	Count of flaw entries in list
EFTTRK	0	48-63	Track number where EFT was found
EFTCE	1	0-63	Reserved for use by engineering
EFTFLW	2-n	0-63	Flaw list written by diagnostic

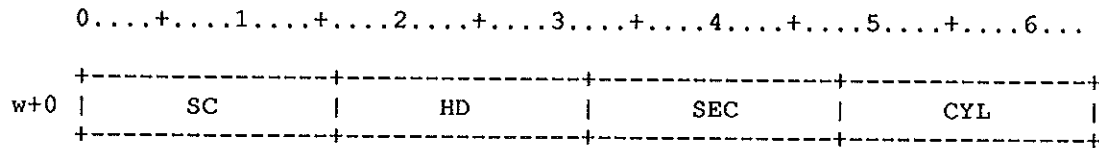

Figure EFT-3. Subfields in each word of flaw

<u>Field</u>	<u>Word(base8)</u>	<u>Bits</u>	<u>Description</u>
EFTSC	w+0	0-15	Count of contiguous flawed sectors
EFTHD	w+0	16-31	Head group number of flawed sectors
EFTSEC	w+0	32-47	First sector with flawed track
EFTCYL	w+0	48-63	Cylinder number of flawed track

Execution profile table, used for F\$SPY and F\$PROF

EPT - Execution Profile Table

The Execution Profile Table (EPT) contains the following:

- o Time slice for interrupts (in microseconds)
- o First and last addresses of the code area to be monitored
- o Bucket size (number of words to be mapped into each bucket)
- o Values specified on the enable call (EPFW, EPTS, and EPBS are returned)
- o Buffer length

Subfunction SPY\$ON enables EPT; SPY\$OFF disables EPT and returns the accumulated information to a buffer specified by the user.

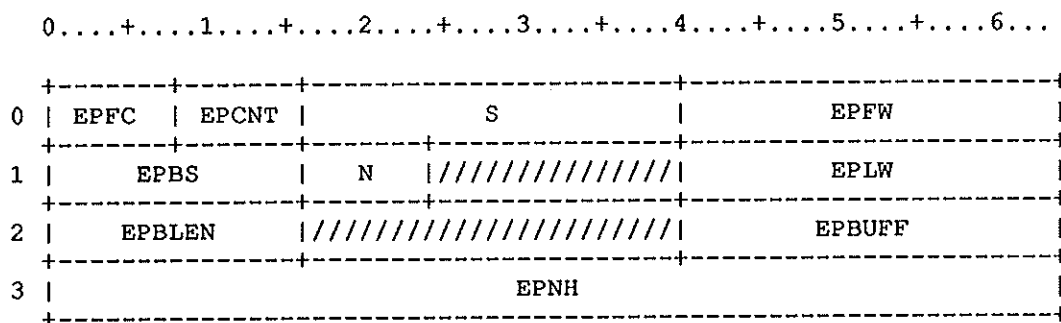

Figure EPT-1. Execution Profile Table

Field	Word(base8)	Bits	Description
EPFC	0	0-7	Function code
EPCNT	0	8-15	Count of remaining
EPTS	0	16-39	Time-slice (in micro-seconds)
EPFW	0	40-63	BA of area to be watched(in words)
EPBS	1	0-15	Number of words/bucket
EPTN	1	16-23	STP task number to monitor (F\$PROF only)
EPLW	1	40-63	LA of area to be watched(in words)
EPBLEN	2	0-15	Length of receive buffer
EPBUFF	2	40-63	Address of receive buffer

<u>Field</u>	<u>Word(base8)</u>	<u>Bits</u>	<u>Description</u>
EPNH	3	0-63	Total samples while task connected (F\$PROF only)

This STP-resident table is used for working storage by the disk driver, for disk allocation, for passing requests to the disk driver, and for queue management. This table is also written to the system log to record disk errors. EXTRACT must be modified if any field definition in the first 8 EQT words is changed. This is for disk error logging.

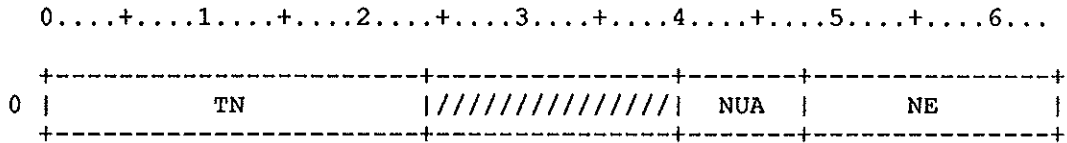

Figure EQ-1. Equipment table header

<u>Field</u>	<u>Word(base8)</u>	<u>Bits</u>	<u>Description</u>
EQTN	0	0-23	Equipment table identifier: A'EQT'
EQNUA	0	40-47	Next unit to be allocated
EQNE	0	48-63	Number of entries in table

0.....+.....1.....+.....2.....+.....3.....+.....4.....+.....5.....+.....6...

31	SPQ			
32				
33				
34	UPQ			
35				
36				
37	LDL	STK	NTK	/////////
40	FST			
41	FTS			
42	FSCY			
43	FCS			
44	MCY	NBR		
45	ADJ	NBW		
46	GRO	//////////		THR
47	TR			
50	BF0			
51	BF1			
52	BF2			
53	BF3			
54	BF4			
55	BF5			
56	BF6			
57	BF7			

Figure EQ-2. Equipment table entry

<u>Field</u>	<u>Word(base8)</u>	<u>Bits</u>	<u>Description</u>
EQLDV	0	0-63	Logical device name
EQJN	1	0-63	Job name of last error
EQDN	2	0-63	Dataset name of last error
EQCDR	3	0-63	Current physical disk request
* CAUTION: The format of the following word is assumed to * be the same in EQT and CBT.			
EQSC	3	0-14	Sector count
EQDA	3	15-39	Current disk address
EQCA	3	15-25	Current cylinder address
EQTA	3	26-31	Current track address
EQSA	3	32-39	Current sector address
EQMA	3	40-63	Current memory address
EQLR	4	0-63	Logical request of last error
EQINB	4	0-15	Number of blocks to transfer
EQISB	4	16-39	Starting block number
EQIBF	4	40-63	Buffer address
EQST0	5	0-63	First status word
EQFLT	5	0-15	Cumulative fault status:
		bit	description
		0	IOP angular position counter failure
		1	IOP disk not ready
		2	IOP lost data error
		3	IOP data error on channel 3
		4	IOP data error on channel 2
		5	IOP data error on channel 1
		6	IOP data error on channel 0
		7	Address error
		8	Seek error
		9	Write fault, channel 3
		10	Write fault, channel 2
		11	Write fault, channel 1
		12	Write fault, channel 0
		13	Multiple head select
		14	Read and write conflict
		15	Not on cylinder and read or write

<u>Field</u>	<u>Word(base8)</u>	<u>Bits</u>	<u>Description</u>
EQINT	5	16-31	Cumulative interlock status: bits description 16-23 Undefined 24 Low positive voltage 25 Low negative voltage 26 Undefined 27 Start switch is off 28 Brush cycle not finished 29 Heads not fully loaded 30 Unit not up to speed 31 Logic chassis high temperature
EQSST	5	32-47	Cumulative subsystem status: bits description 32-37 Undefined 38 Channel parity error (2**12 to 2**15) 39 Channel parity error (2**8 to 2**11) 40 Channel parity error (2**4 to 2**7) 41 Channel parity error (2**0 to 2**3) 42 Read checkword error 43 DSU ready error 44 DSU not on cylinder 45 DSU index error 46 ID verification error 47 DSU reservation error
EQUEST	5	48-55	Cumulative extended error status:
EQIDE	5	48	IOP disk error
EQPDS	5	49	Permanent dataset error
EQCRC	5	50	DCU inconsistent CRC error
EQDTE	5	51	DCU data transfer error
EQCPE	5	52	DCU channel parity error
EQRWE	5	53	DCU read/write response error
EQSSE	5	54	DCU subsystem status error
EQTOE	5	55	DCU software time-out error

<u>Field</u>	<u>Word(base8)</u>	<u>Bits</u>	<u>Description</u>
EQFSC	5	56-63	Final status code: value description 000 No error 001 Recovered disk error 002 Unrecovered data error 003 Angular position error 004 Disk not ready error 005 Lost data error 006 Address error 007 Seek error 010 Multiple head select 011 Read/write conflict 012 Read/write off cylinder 013 Corrected data error 014 Uncorrected data error 015 Unrecovered hardware error 016 Undefined error status 017 Software timed out 020 Diagnostic request parameter erro
EQST1	6	0-63	Second status word
EQLFC	6	0-15	Last function code
EQLSR	6	16-31	Last error status response
EQLRW	6	32-47	Last read/write response error
EQLMS	6	48-55	Last margin select
EQTRY	6	56-63	Last try count
EQST2	7	0-63	Third status word
EQOFR	7	0-15	Offset register status response bits description 6-15 If seek is current, requested cylinder 8-15 If seek is not current, selected margin
EQCYN	7	16-31	Cylinder number status response bits description 22-31 Valid cylinder number
EQHDN	7	32-47	Head group number status response
EQCON	7	42	Bit 42 Unit connect bit. Needed for EXTRACT bits description 42 Unit connect bit 44-47 Valid head group number

<u>Field</u>	<u>Word(base8)</u>	<u>Bits</u>	<u>Description</u>
EQSCN	7	48-63	Sector number status response bits description 59-63 Valid sector number
EQDDF	10	0-39	Device definition word
EQMSD	10	0	Master device flag
EQOFF	10	1	Unit off if set
EQNA	10	2	Unit not available if set
EQRLS	10	3	Release datasets on this unit if set
EQUP	10	4	Unit up if set (*UP in parameter file)
EQRBN	10	5	Request by name (allocation control)
EQCHN	10	6-13	Channel number off which device hangs
EQDT	10	14-21	Device type (DT@--- defs in COMSYSEQ)
EQDTG	10	14-17	Device type group
EQDTC	10	18-21	Device characteristic within group
EQSCR	10	22	Device contains only scratch dataset
EQVOL	10	23	Dataset for volatile device exists
EQCTL	10	24	Controlled device flag
EQDWN	10	25	Device down flag
EQDCT	10	30-37	DCT entry ordinal
EQUNT	10	38-39	Disk unit number
EQDRT	10	40-63	Disk reservation table address
EQGRN	11	0-63	Generic resource name
EQCPD	12	0-15	Cylinders per disk
EQTPC	12	16-23	Tracks per cylinder
EQIOP	12	25-26	IOP number
EQAU	12	27-39	Blocks per allocation unit
EQLNK	12	40-63	Link to next equipment on channel
EQDMA	13	0	Device is memory addressable flag
EQCR	13	1	Accepts compound requests flag

<u>Field</u>	<u>Word(base8)</u>	<u>Bits</u>	<u>Description</u>
EQSCX	13	2	Shared channel exception flag
EQMBT	13	3	Multi-sector transfer controller flag (Indicates SK/SL modules are present in a DCU-3 control unit; this allows consecutive disk sectors to be transferred without an intervening interrupt)
EQFDRT	14	0-23	Flaw pseudo DRT address
EQMMF	14	24-39	Maintenance flags
EQMTM	14	24	Maintenance mode flag
EQMTI	14	25	Place device in maintenance mode
EQMTS	14	26	Place device in system mode
EQCYL	14	40-51	Last cylinder position
EQTRK	14	52-57	Last track position
EQSEC	14	58-63	Last sector position
EQTD	15	0	Transfer direction
EQRET	15	1	Resume transfer flag
EQDEF	15	2	Disk error flag
EQSTS	15	32-39	Reply status
EQDB0	15	40-63	Saved return address
EQACT	16	0-63	Anticipated on-cylinder time
EQCST	17	0-63	Cumulative seek time
EQNPR	20	0-63	Number of physical requests
EQNRT	21	0-63	Number of requests
EQRSC	22	0-63	Number of requests not requiring seek
EQCPT	23	0-7	Control path type (defs in COMSYSEQ): CPT@DCU CPT@IOS CPT@SSD
EQTRT	24	0-63	Cumulative transfer time
EQNBK	25	0-63	Cumulative block count
EQEFT	26	0	EFT found flag
EQEFTK	26	1-4	EFT track on device

<u>Field</u>	<u>Word(base8)</u>	<u>Bits</u>	<u>Description</u>
EQCNA	26	5	CONFIGURED NAVAIL BY STARTUP
EQDEFT	26	6	Default device already tried
EQNDEF	26	7	Not a default space device
EQEFT1	26	8	EFT found flag 840 spindle one
EQEFT2	26	9	EFT found flag 840 spindle two
EQEFT3	26	10	EFT found flag 840 spindle three
EQEFT4	26	11	EFT found flag 840 spindle four
EQDSP	26	16-39	Dataset parameter table address
EQERR	26	40-63	Cumulative unrecovered error count
EQGRP	27	0-3	Group id for striped disks
EQGCHG	27	4	Stripe has changed flag
EQGCNT	27	5-15	Count of members in stripe
EQRER	27	16-39	Cumulative recovered error count
EQECYL	27	40-51	Last cylinder error address
EQEHD	27	52-57	Last head error address
EQESCT	27	58-63	Last sector error address
EQRQT	30	16-39	RQT of last packet sent
EQPHR	30	40-63	Address of active PHR (DCU only)
EQSPQ	31-33	0-63	System's physical request (PHR) queue
EQSPQL	31	0-63	System's PHR queue length
EQSPQH	32	0-63	System's PHR queue head
EQSPQT	33	0-63	System's PHR queue tail
EQUPO	34-36	0-63	User's physical request (PHR) queue
EQUPQL	34	0-63	User's PHR queue length
EQUPOH	35	0-63	User's PHR queue head
EQUPOQ	36	0-63	User's PHR queue tail
EQLDL	37	0-23	Link to next logical device

<u>Field</u>	<u>Word(base8)</u>	<u>Bits</u>	<u>Description</u>
EQSTK	37	24-39	First track on this logical device
EQNTK	37	40-55	Number of tracks this logical device
EQFST	40	0-63	Floated sectors per track
EQFTS	41	0-63	Floated tracks per sector
EQFSCY	42	0-63	Floated sectors per cylinder
EQFCS	43	0-63	Floated cylinders per sector
EQMCY	44	0-15	Microseconds per cylinder for seek time
EQNBR	44	16-63	Number of blocks read
EQADJ	45	0-15	Time in microseconds to move 1 cylinder
EQNBW	45	16-63	Number of blocks written
EQGRO	46	0-3	GRT ordinal when controlled
EQFSS	46	4	FSS device flag (GT@SSD or GT@EBM)
EQNFL	46	5	Volatile device - no flush space
EQPSD	46	6	Preferred swap device if set
EQTHR	46	40-63	Streaming threshold sector count
EQTR	47	0-63	Xfer rate (cycles/word) set by STARTUP

When I/O is done through an IOS, words EQBF0-EQBF5 are an IOS packet, as defined by the APT A-packet.

When I/O is done through a DCU-3 attached directly to the CPU, tables IB1 and IB2 occupy the space.

EQBF0	50	0-63	I/O buffer word 0 (also EQIB1)
EQBF1	51	0-63	I/O buffer word 1
EQBF2	52	0-63	I/O buffer word 2
EQBF3	53	0-63	I/O buffer word 3 (also EQIB4)
EQBF4	54	0-63	I/O buffer word 4 (also EQIB2)
EQBF5	55	0-63	I/O buffer word 5
EQBF6	56	0-63	I/O buffer word 6
EQBF7	57	0-63	I/O buffer word 7

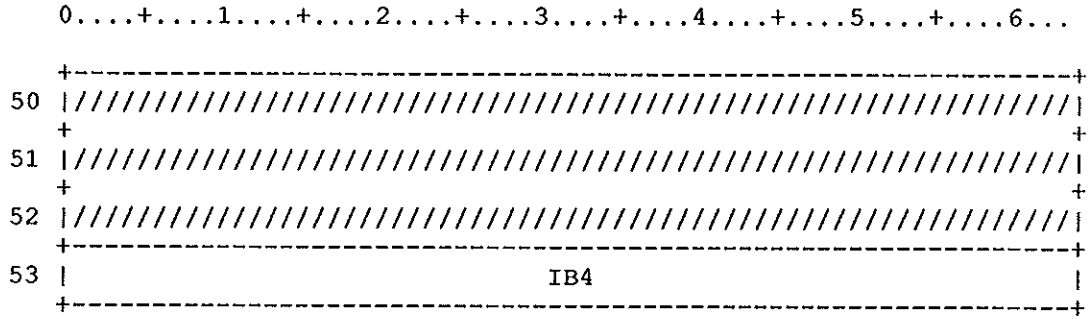

Figure EQ-4. Equipment table entry

<u>Field</u>	<u>Word(base8)</u>	<u>Bits</u>	<u>Description</u>
EQIB4	53	0-63	
EQIB4	53	0-63	Required by table diagram generator

<u>Field</u>	<u>Word(base8)</u>	<u>Bits</u>	<u>Description</u>
ERMAP	1	40-63	Occurred-events map
ERMPIJ	1	40	Inter-job message arrived
ERMPUO	1	41	Unsolicited oper msg arrived
ERMPOR	1	42	Operator reply arrived
ERMPIP	1	43	IPC request done
ERMPSE	1	44	Site defined Event (for local code)
ERMPCH	1	50	Channel function done
ERMPIQ	1	51	SDT placed in INPUT queue
ERMPOQ	1	52	SDT placed in OUTPUT queue
ERMPAE	1	53	Archiving System Event

On return from F\$ERCL,
S0 can have the following
values.

ERER=00 Okay
ERER\$MT=01 Prohibited to
multitasking job
ERER\$PV=02 Not a privileged job
ERER\$BFN=03 Bad function
ERER\$UDB=04 Mask contains
undefined bits
ERER\$MDI=05 Monitoring not enabled

The Encryption Parameter Table, residing in the user field, is used to pass parameters to the password encryption routine which replaces unencrypted passwords with encrypted passwords.

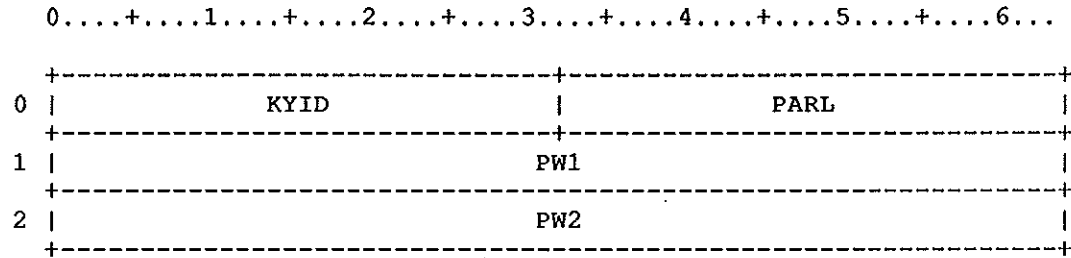

Figure ET-2. Encryption Parameter Table

Field	Word(base8)	Bits	Description
ETKYID	0	0-31	Encryption keyword index
ETPARL	0	32-63	Length of parameter table
ETPW1	1	0-63	First 8 characters of password
ETPW2	2	0-63	Last 7 characters of password

EVW - EVW

[215]

N O D E F I N I T I O N A V A I L A B L E

Figure EVW-1.

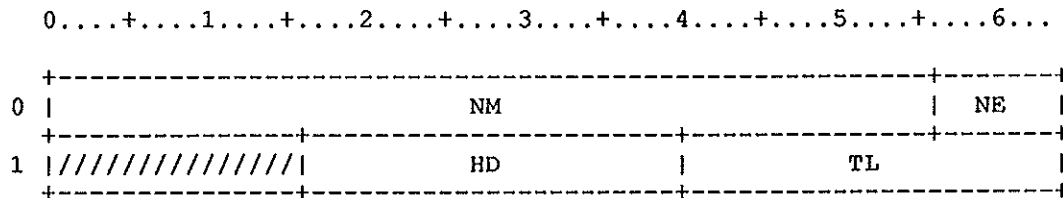

Figure EW-1. Event Wait Table Header

Field	Word(base8)	Bits	Description
EWNM	0	0-55	Table name in ASCII
EWNE	0	56-63	Number of entries
EWHD	1	16-39	Head of the event chain
EWTL	1	40-63	Tail of the event chain

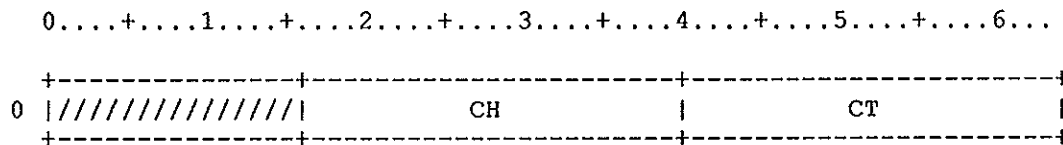

Figure EW-2. Event Wait Table Entry

Field	Word(base8)	Bits	Description
EWCH	0	16-39	Head of event catagory queue
EWCT	0	40-63	Tail of event catagory queue

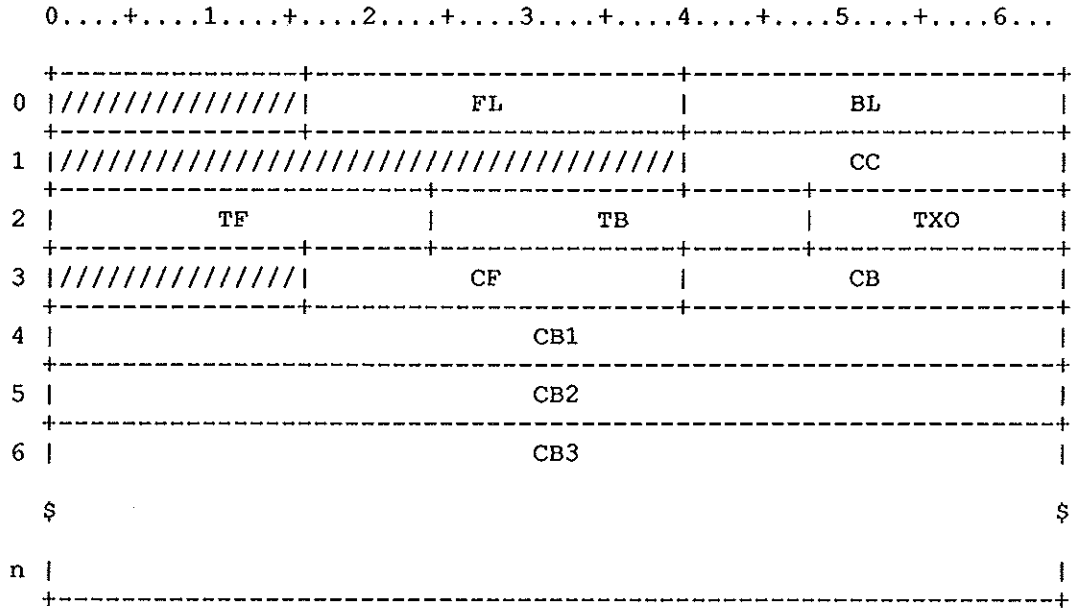

Figure EP-1. Event Pool Entry

Field	Word(base8)	Bits	Description
EPFL	0	16-39	Event chain forward link
EPBL	0	40-63	Event chain backward link
EPCC	1	40-63	Event chain control word address
EPTF	2	0-23	TXT queue forward link
EPTB	2	24-47	TXT queue backward link
EPTXO	2	48-63	TXT ordinal
EPCF	3	16-39	Catagory queue forward link
EPCB	3	40-63	Catagory queue backward link
EPCB1	4	0-63	Parameter block word 0
EPCB2	5	0-63	Parameter block word 1
EPCB3	6-n	0-63	Parameter block word 2

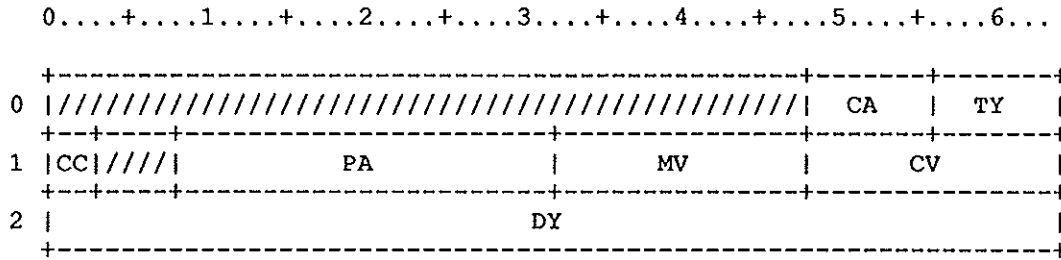

Figure EC-1. J\$AWAIT Parameter Call Block

Field	Word(base8)	Bits	Description
ECCA	0	48-55	Event catagory
ECTY	0	56-63	Call type
ECCC	1	0-2	Event completion condition code
ECPA	1	8-31	Event parcel (STP relative)
ECPWA	1	8-29	Word address of event
ECPPI	1	30-31	Parcel indicator of event word
ECMV	1	32-47	Event mask
ECCV	1	48-63	Event comparison value
ECDY	2	0-63	Delay interval in milliseconds
J\$AWD	= 1		Delay task for interval
J\$AWE	= 2		Wait on event
J\$AWDE	= 4		Wait on event or delay interval
J\$AWI	= 0'10		Wait on I/O quiet
N@NECT	= 0'16		Number of permissible event catagories
J\$CTCOS	= 0		General event catagory
J\$CTPDM	= 1		Events from PDM
J\$CTIQM	= 2		Events from IQM
J\$CTSLT	= 3		Events from SLT
J\$CTCLM	= 0'10		Largest COS event catagory
J\$CTSUB	= 0'11		Events created by subsystems
J\$CTLIM	= N@NECT		Maximum catagory

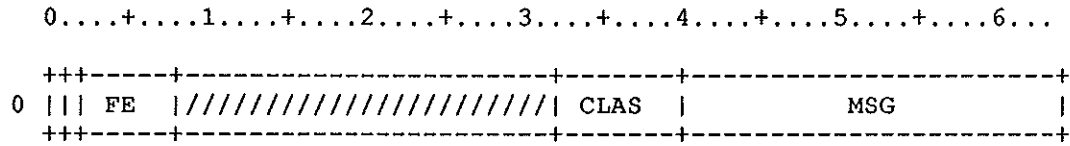

Figure EC-1. EXP Error Code Table

<u>Field</u>	<u>Word(base8)</u>	<u>Bits</u>	<u>Description</u>
ECDN	0	0	DN in message flag
ECRF	0	1	'ERROR REPRIEVABLE?' flag
ECFE	0	2-7	FEFW BIT number
ECCLAS	0	32-39	Major error class
ECMSG	0	40-63	Message address (must be bits 40-63)

EREFR	= 1	EOF on read
ERIOA	= 2	Invalid lock or unlock indication
ERNDT	= 3	No DAT space
ERENO	= 4	File not open
ERINO	= 5	Invalid open
ERINR	= 6	Invalid read
ERINW	= 7	Invalid write
ERRFL	= D'8	Illegal bits in RFL request word
ERDOP	= D'9	Attempt to delete memory outside progr
ERNDS	= D'10	Out of disk space
ERMEM	= D'11	System directory is full
ERJOF	= D'12	JTA overflow
ERGSY	= D'13	FL requested beyond system size
ERGAL	= D'14	FL requested beyond allowable size
ERAQR	= D'15	Unknown acquire error
ERDIN	= D'16	Invalid to dispose \$in
ERINC	= D'17	Invalid close
ERDPO	= D'18	Data set previously opened
ERPOR	= D'19	Parameters out of range
ERINP	= D'20	Invalid parameter
ERDNT	= D'21	No DNT entry for name
ERBGRN	= D'22	Dispose of SDR dataset is invalid
ERTLE	= D'23	Time limit exceeded
EROPD	= D'24	Operator dropped the job
ERABT	= D'25	F\$ABT call from user
ERIUC	= D'26	Invalid (undefined) user call
EROVL	= D'27	Call not between user's BA and LA
ERXPE	= D'28	Exchange package error (fp, parity, ee
ERLDV	= D'29	Logical device name not found
ERIBN	= D'30	Block number error reading dataset
ERDE	= D'31	Data error on disk i/o
ERHE	= D'32	Hardware error on disk i/o
ERRW	= D'33	Read after write or past EOD
ERUKN	= D'34	Unknown error
ERIPD	= D'35	Invalid processing direction
EREPT	= D'36	
ERBDP	= D'37	Invalid DSP
ERKIL	= D'38	Operator kill
ERRRN	= D'39	Operator rerun
ERIDC	= D'40	Invalid disposition code
ERLGSLX	= D'41	\$LOG size limit, messages disabled
ERDSDR	= D'42	Dispose of SDR dataset is invalid
ERLGFULL	= D'43	User log size exceeded I@LGUSZ
ERIDN	= D'44	Invalid dataset name
ERSLM	= D'45	LM parameter too large
ERXLM	= D'46	Dataset size limit exceeded
ERDNA	= D'47	Dataset transfer not possible
ERCAN	= D'48	Dataset can t be saved on front-end
=	D'49	***UNASSIGNED

ERULFT	=	D'50	User-area LFTs destroyed
ERCLFT	=	D'51	User-area LFT continuation addr bad
	=	D'52	***UNASSIGNED
ERD53	=	D'53	XP error - floating point error
ERD54	=	D'54	XP error - operand range error
ERD55	=	D'55	XP error - program range error
ERMER	=	D'56	XP error - uncorrected memory error
ERCINT	=	D'57	ERCINT
ERD58	=	D'58	XP error - error exit
ERDPS	=	D'59	Dispose failed
ERCSPMEM	=	D'60	Not enough memory for csp
ERNIRW	=	D'61	No invoke request word specified
ERIAP	=	D'62	Invoke request already pending
ERILM	=	D'63	Invoke length not multiple of o'1000
ERILMX	=	D'64	Invoke length exceed max allowed
ERCHK	=	D'65	Checksums don't match
ERODC	=	D'66	Can t open has outstanding disposes
ERIPC	=	D'67	Invalid procedure dataset
ERPLX	=	D'68	Maximum procedure level exceeded
ERWEX	=	D'69	PDS-full wait counter exceeded
ERATTN	=	D'70	Attention for interactive
ERBINV	=	D'71	Bad class structure invoke
ERDSP	=	D'72	DSP area has been destroyed
ERUFC	=	D'73	
ERIDJ	=	D'74	Dumpjob processing inhibited
ERENP	=	D'75	No permission granted for execute-only
ERDAL	=	D'76	Dataset is already local to the job
ERCSP	=	D'77	Internal CSP error
ERPRV	=	D'78	Privileged system request
ERUAS	=	D'79	Ref to unassigned jcl symbol
ERRBO	=	D'80	Receive buffer too small
ERUDF	=	D'81	Undefined jcl symbol referenced
ERNJM	=	D'82	Jcl symbol cant be modified by the job
ERIMC	=	D'83	Invalid message class for F\$MSG call
ERIMP	=	D'84	
ERDIQ	=	D'85	Dispose to cray input queue disallowed
ERBSU	=	D'86	Buffer size invalid with unblocked
ERIAO	=	D'87	Invalid F\$DNT param with dataset open
ERIAC	=	D'88	Invalid F\$DNT param with dataset close
ERRTL	=	D'89	I/A I/O Request too long
ERBTL	=	D'90	Text addr and/or text length bad
ERTTL	=	D'91	Text length exceeds max allowed

EREPD	=	D'92	Cannot 'enter' empty dataset in sdr
EROPBCP	=	D'93	Bad CPU number on OPTION,CPU=n req.
ERLGHE	=	D'94	HARDWARE ERROR WHILE WRITING \$LOG
ERILFR	=	D'95	Invalid LFT supplied for F\$LFT request
ERITRM	=	D'96	INTERACTIVE JOB TERMINATION
ERRTS	=	D'97	Interactive blocked record too short
ERIMF	=	D'98	Mainframe does not support bt mode
ERAMD	=	D'99	Ambiguous MODE values
ER100	=	D'100	Nonsequential write illegal
ERICI	=	D'101	Interchange is invalid with unblocked
ERUDT	=	D'102	Tape datasets may not be disposed
ERVRE	=	D'103	VSN required for existing dataset
ERTRE	=	D'104	Generic resource limit exceeded
ERLDR	=	D'105	LDT required for labeled dataset
ERILD	=	D'106	Invalid LDT or LDT address
ERUWT	=	D'107	Unable to write trailer label group
ERWPV	=	D'108	Write attempt on protected volume
ERDFE	=	D'109	Data Format Error
ERWPE	=	D'110	Write protocol error
ERBTM	=	D'111	tape is before a tape mark
ERVPT	=	D'112	Tape volume is protected
ERDPT	=	D'113	Tape dataset is protected
ERNEW	=	D'114	New tape datasets must be written to
ERFID	=	D'115	File id not found in volume set
ERFSC	=	D'116	File section not in volume set
ERLDT	=	D'117	LDT is in an improper format
ERIBC	=	D'118	Corrupted tape label group
ERTFD	=	D'119	Tape label feature not supported
ERNH1	=	D'120	No HDR1 label in label group
ERFMT	=	D'121	Invalid record format specifier
ERBAT	=	D'122	Invalid block attribute specifier
ERBRL	=	D'123	Invalid specified record length
ERBBL	=	D'124	Invalid specified block length
ERBFO	=	D'125	Invalid buffer offset specifier
EROID	=	D'126	Owner id mismatch
ERIVL	=	D'127	Incomplete volume serial list
ERXPR	=	D'128	Attempt to read expired dataset
ERNXP	=	D'129	Attempt to write on non-expired dataset
ERIXP	=	D'130	Dataset has invalid expiration date
ERVBM	=	D'131	Volume block count mismatch
ERLTS	=	D'132	Label type not scratchable
ERPNT	=	D'133	Position illegal for non-tape
ERLBK	=	D'134	Large tape block read
ERTRS	=	D'135	Resources not available
ERACD	=	D'136	Access denied by servicing front-end

ERSNS	=	D'137	Servicing front-end is not secure
ERDAE	=	D'138	Dataset already in front-end catalog
ERDNC	=	D'139	Dataset not in front-end catalog
ERCLF	=	D'140	Front-end catalog update failed
ERDNO	=	D'141	Device is not open for user i/o
ERVNC	=	D'142	Volume not in front-end catalog
ERMCO	=	D'143	Mount cancelled by operator
ERMBS	=	D'144	Maximum block size exceeded on write
ERIMG	=	D'145	Invalid servicing reply message
ERRES	=	D'146	Operator reset device
ERFGV	=	D'147	FSEC > number of VSN'S
ERNTV	=	D'148	No TVT address in DNT
ERTNF	=	D'149	F\$TBL - table name not found
ERDOF	=	D'150	Device overflow with nof declared
ERNAR	=	D'151	Synch input request; dataset not at eor
ERNIC	=	D'152	Synch req; not interchange format
ERRSQ	=	D'153	Random/sequential bits both set in DDL
ERUBB	=	D'154	Blocked/unblocked bits both set in DDL
EREOV	=	D'155	end of tape volume
ERTMS	=	D'156	tape mark status
ERTOR	=	D'157	tape off reel
ERBLT	=	D'158	blank tape detected
EREVR	=	D'159	end of volume read
EREMAJ	=	D'160	FL exceeds non-EMA maximum
=		D'161	***UNASSIGNED
EREMAMT	=	D'162	Can't set EMA while multitasking
ERNEMA	=	D'163	Extended memory address not available
ERNAVL	=	D'164	Add'l vector logical not available
ERNORI	=	D'165	Operand range int. can't be disabled
ERBLM	=	D'166	AB166-F\$BGN-Premature end of program
ERBIW	=	D'167	AB167-F\$BGN-Invalid user write area
ERBNE	=	D'168	AB168-F\$BGN-User did not expand mem
ERBCN	=	D'169	AB169-F\$BGN-CSP not loaded
ERJRC	=	D'170	JSH request cancelled
ERDRV	=	D'171	Can't pass channel driver reply back
ERDNCS	=	D'172	insufficient contiguous disk space
=		D'173	***UNASSIGNED
ERNULS	=	D'174	No USER LFT space found
ERSFC	=	D'175	Invalid F\$xxxx Subfunction.

ERHMNP	=	D'176	Performance monitor not available
ERHMIGN	=	D'177	Invalid group number for F\$PERF/PM\$ON
=		D'178	***UNASSIGNED
ERDNBB	=	D'179	IN/OUT not on a block boundary
ERDILF	=	D'180	Limit less than first
ERDBO	=	D'181	Buffer overlaps LFT/DSP area
ERDII	=	D'182	IN not between first and limit
ERDIO	=	D'183	OUT not between first and limit
ERDIF	=	D'184	FIRST out of bounds
ERDIL	=	D'185	LIMIT out of bounds
ERDIR	=	D'186	RCW out of bounds
ERDIBR	=	D'187	BIO record address out of bounds
ERDIBF	=	D'188	Unknown BIO function
ERDBLM	=	D'189	Buffer not multiple of 512
ERDUE	=	D'190	Uncleared error
ERDBUSY	=	D'191	Attempt to start i/o on busy dataset
ERMIO	=	D'192	Record mode I/O invalid for device
ERALLDEA	=	D'193	All user tasks deactivated
ERDDL	=	D'194	User deadlock detected
ERTAI	=	D'195	Try to deactivate inactive task
ERTAA	=	D'196	Try to activate active task
ERCAS	=	D'197	Try to activate self
ERBID	=	D'198	Bad task id
ERXJT	=	D'199	Maximum tasks/job exceeded
ERD200	=	D'200	**** RESERVED FOR SITE ****
ERD201	=	D'201	**** RESERVED FOR SITE ****
ERD202	=	D'202	**** RESERVED FOR SITE ****
ERD203	=	D'203	**** RESERVED FOR SITE ****
ERD204	=	D'204	**** RESERVED FOR SITE ****
ERD205	=	D'205	**** RESERVED FOR SITE ****
ERD206	=	D'206	**** RESERVED FOR SITE ****
ERD207	=	D'207	**** RESERVED FOR SITE ****
ERD208	=	D'208	**** RESERVED FOR SITE ****
ERD209	=	D'209	**** RESERVED FOR SITE ****
ERD210	=	D'210	**** RESERVED FOR SITE ****
ERD211	=	D'211	**** RESERVED FOR SITE ****
ERD212	=	D'212	**** RESERVED FOR SITE ****
ERD213	=	D'213	**** RESERVED FOR SITE ****
ERD214	=	D'214	**** RESERVED FOR SITE ****
ERD215	=	D'215	**** RESERVED FOR SITE ****
ERD216	=	D'216	**** RESERVED FOR SITE ****
ERD217	=	D'217	**** RESERVED FOR SITE ****
ERD218	=	D'218	**** RESERVED FOR SITE ****
ERD219	=	D'219	**** RESERVED FOR SITE ****
ERD220	=	D'220	**** RESERVED FOR SITE ****
ERD221	=	D'221	**** RESERVED FOR SITE ****
ERD222	=	D'222	**** RESERVED FOR SITE ****
ERD223	=	D'223	**** RESERVED FOR SITE ****
ERD224	=	D'224	**** RESERVED FOR SITE ****
ERCPY	=	D'225	AB225-F\$BGN-source out of range
ERDBL	=	D'226	AB226-F\$BGN-Data base/limit not

ERDHL	=	D'227	zero
ERIBL	=	D'228	AB227-F\$BGN-Data HLM not zero
EROHL	=	D'229	AB228-F\$BGN-Instruction limit zer
ERZFC	=	D'230	AB229-F\$BGN-Requested length out HLM
ERLLB	=	D'231	AB230-F\$BGN-Zero/Invalid Function code
ERQMOB	=	D'232	AB231-F\$BGN-Instruction limit LE base
ERQDOB	=	D'233	QIO memory address out of bounds
ERQUSF	=	D'234	QIO dataset address out of bounds
ERQNPA	=	D'235	Undefined QIO subfunction
ERQMR	=	D'236	QIO dataset not pre-allocated
ERQISC	=	D'237	QIO dataset cannot be memory-resident
ERDLK	=	D'238	invalid sector count in queued I/O req
ERSVW	=	D'239	TASK NOT AT TEST AND SET
ERUNAV	=	D'240	Dataset security violation on write
ERERDO	=	D'241	Device for allocation is unavailable
EREMA	=	D'242	Device is read only with NOF declared
ERTPLB	=	D'243	EMA can't be changed on this machine
ERDIRT	=	D'244	AB243 LABEL TYPE NOT SUPPORTED
ERNIST	=	D'245	DUPLICATE MFID'S SPECIFIED
ERISPER	=	D'246	NO CORRESPONDING IST MF EXISTS
ERJTRC	=	D'247	ERROR RETURNED FROM IQM
ERUOI	=	D'248	JOBTERM MESSAGE RECEIVED
ERNIRT	=	D'249	UNABLE TO OPEN ISP DATASET
ERCONER	=	D'250	NO CORESPONDING IRT MF EXISTS
ERTTRC	=	D'251	ERROR RETURNED FROM IQM DURING CONNECT
ERURI	=	D'252	TASKTERM MESSAGE RECEIVED
ERIEI	=	D'253	UNABLE TO RECOVER ISP CIRCUIT
ERDNI	=	D'254	Internal error processing ISP dataset
ERIGRE	=	D'255	Dataset not an ISP dataset
ERIGRN	=	D'256	ISP generic resource limit exceeded
ERICD	=	D'257	IST generic resource name bad
ERIOVF	=	D'258	ISP dataset circuit disconnected
ERINVX	=	D'259	ISP device overflow
ERDIA	=	D'260	Invoke currently not accepted
ERDSPAE	=	D'261	Cannot access dataset after offload
ERFCPY	=	D'262	unable to move user DSP to system area
ERIDR	=	D'263	invalid FSS copy request
ERQINI	=	D'264	invalid dataset residency for FSS copy
			invalid # inc. in queued I/O request

ERQRAM	=	D' 265	QIO on non-random dataset
ERIRQ	=	D' 266	Invalid request received by IOS
ERSLOT	=	D' 267	Unable to copy slot into JTA
ERHEP	=	D' 268	HARDWARE ERROR OR PREVIOUS WRITE
ERBKDR	=	D' 269	SSD backdoor not available
ERWPT	=	D' 270	write prematurely terminated (FSS cpy)
ERSWAP	=	D' 271	Disk error during FSS sweep or restore
ERSNF	=	D' 272	Pre-allocation disallowed for FETCH
ERLFTAE	=	D' 273	Unable to move user area lft
ERTQM	=	D' 274	TQM requested abort
ERTCL	=	D' 275	Tape drive released by TCLEAR command
ERTQR	=	D' 276	TQM reset
ERTO C	=	D' 277	Operation canceled
ERSDTQM	=	D' 278	Function not allowed on F\$SDTQM d.s.
ERQMRER	=	D' 279	Unable to move F\$SDTQM reply to p.b.
ERUNB	=	D' 280	Action is invalid for Unblocked dataset
ERTIO	=	D' 281	Dataset in invalid I/O state for TIO
ERICW	=	D' 282	Invalid control word or bad DSP
ERXSZ	=	D' 283	Invalid Transfer maximum in DSP
ERNBSY	=	D' 284	DPBSY and DNAIO differ
ERDIBL	=	D' 285	DSP resides in the I/O buffer
ERDIBD	=	D' 286	Invalid selection of DPABD
EREXT	=	D' 287	Attempt to extend permanent dataset
ERDNR	=	D' 288	Device in not-ready state
ERNSW	=	D' 289	Non-sequential write is illegal
ER290	=	D' 290	Security ST200 (F\$XXX)
ER291	=	D' 291	Security ST201 (F\$PDM)
ER292	=	D' 292	Security ST202 (F\$SDR)
ER293	=	D' 293	Security ST203 (F\$PRV)
ER294	=	D' 294	Security ST204 (F\$PRV-PRV\$SDR)
ER295	=	D' 295	Security ST205 (F\$PRV-PRV\$SPF)
ER296	=	D' 296	Security ST206 (F\$PRV-PRV\$SWP)
ER297	=	D' 297	Security ST207 (USER DISABLED)
ER298	=	D' 298	Security ST208 (F\$RDM)
ER299	=	D' 299	Security ST209 (T\$PDM)
ER300	=	D' 300	Security message - Privilege violation
ER301	=	D' 301	Security message - No Permission
	=	D' 302	**** RESERVED SECURITY ****
	=	D' 303	**** RESERVED SECURITY ****
	=	D' 304	**** RESERVED SECURITY ****
	=	D' 305	**** RESERVED SECURITY ****
	=	D' 306	**** RESERVED SECURITY ****
ERDJS	=	D' 307	Dumpjob not allowed to Superlink d.s.
ERBIS	=	D' 308	F\$BIO not allowed for Superlink

ERQIS	=	D'309	d.s. F\$QIO not allowed for Superlink
ERRCS	=	D'310	d.s. F\$RCL not allowed for Superlink
ERRWS	=	D'311	d.s. F\$RDC/F\$WDC not allowed for Superlink
ERDSS	=	D'312	DISPOSE not allowed for Superlink
ERIPCP	=	D'313	Error in F\$IPC parameter block field
ERIPCE	=	D'314	Uncleared error in F\$IPC block
ERIPCR	=	D'315	Abort on F\$IPC exception condition
ERIPCRQ	=	D'316	F\$IPC request code error
ERIPCRC	=	D'317	F\$IPC recall code error
	=	D'318	**** UNASSIGNED ****
	=	D'319	**** UNASSIGNED ****
ERLBS	=	D'320	F\$LBN not permitted for Superlink
ERNBP	=	D'321	No break point established
ERBPS	=	D'322	Breakpoint has already been set
ERBBP	=	D'323	Bad breakpoint processing addr.
ERBSA	=	D'324	Bad XP save area address
ERMAXD	=	D'325	Too many DAT pages
ERTCPA	=	D'326	Task create aborted due to job abort
ERNFCH	=	D'327	Attempt to fetch null dataset
ERLDSP	=	D'328	Invalid DSP pointer in user LFT
ERTADV	=	D'329	Task suspend aborted for active advnce
ERODSP	=	D'330	Invalid DSP address in ODN
ERODOC	=	D'331	Invalid open code in ODN
ERLNIU	=	D'332	Local dataset name already in use
ERIBSY	=	D'333	Invalid value given to DPBSY
ERIBIO	=	D'334	Invalid setting of DPBIO
ERIRTA	=	D'335	Invalid reference to alias name
EREXUS	=	D'336	Dataset exclusively used by COS
ERNDSP	=	D'337	DSP supplied differs from DIT value
ERBDPN	=	D'338	DPDN differs from DNDN
ERRLFT	=	D'339	LFT entry has zero name
ERRDSP	=	D'340	LFT entry has zero name
ERIRTP	=	D'341	Invalid reference to primary name
ERNDDP	=	D'342	No DSP defined in open request
ERIDPL	=	D'343	Invalid location of destination DSP
ERCDPA	=	D'344	DSPs from ODN and LFT are in conflict
ERNDPD	=	D'345	DSP not defined for F\$LFT change req
ERDBTS	=	D'346	Destination buffer too small
ERIULF	=	D'347	Existing user LFT in conflict with OPN
ERISLF	=	D'348	Existing sys LFT in conflict with OPN

ERJESK	= D' 349	Stackable not enabled for F\$RPV call
ERNAEV	= D' 350	Invalid F\$RPV, no handler active
ERPGOC	= D' 351	Propagate-only cannot cancel events
ERIEHPA	= D' 352	Invalid event-handler P address
ERIEHBA	= D' 353	Invalid event-handler buffer address
ERDEMR	= D' 354	Deadly embrace on memory request
ERDPLK	= D' 355	DPLOCK destroyed
ERDSPF	= D' 356	DSP's for FFSCPY must be different
	= D' 357	**** UNASSIGNED ****
	= D' 358	**** UNASSIGNED ****
	= D' 359	**** UNASSIGNED ****
	= D' 360	**** UNASSIGNED ****
	= D' 361	**** UNASSIGNED ****
	= D' 362	**** UNASSIGNED ****
	= D' 363	**** UNASSIGNED ****
	= D' 364	**** UNASSIGNED ****
	= D' 365	**** UNASSIGNED ****
	= D' 366	**** UNASSIGNED ****
	= D' 367	**** UNASSIGNED ****
	= D' 368	**** UNASSIGNED ****
	= D' 369	**** UNASSIGNED ****
	= D' 370	**** UNASSIGNED ****
	= D' 371	**** UNASSIGNED ****
	= D' 372	**** UNASSIGNED ****
	= D' 373	**** UNASSIGNED ****
	= D' 374	**** UNASSIGNED ****
	= D' 375	**** UNASSIGNED ****
	= D' 376	**** UNASSIGNED ****
	= D' 377	**** UNASSIGNED ****
	= D' 378	**** UNASSIGNED ****
	= D' 379	**** UNASSIGNED ****
	= D' 380	**** UNASSIGNED ****
	= D' 381	**** UNASSIGNED ****
	= D' 382	**** UNASSIGNED ****
	= D' 383	**** UNASSIGNED ****
	= D' 384	**** UNASSIGNED ****
	= D' 385	**** UNASSIGNED ****
	= D' 386	**** UNASSIGNED ****
	= D' 387	**** UNASSIGNED ****
	= D' 388	**** UNASSIGNED ****
	= D' 389	**** UNASSIGNED ****
	= D' 390	**** UNASSIGNED ****
	= D' 391	**** UNASSIGNED ****
	= D' 392	**** UNASSIGNED ****
	= D' 393	**** UNASSIGNED ****
	= D' 394	**** UNASSIGNED ****
	= D' 395	**** UNASSIGNED ****
	= D' 396	**** UNASSIGNED ****
	= D' 397	**** UNASSIGNED ****

ER User Errors - USERR

[229]

= D'398
= D'399

**** UNASSIGNED ****
**** UNASSIGNED ****

Due to a software problem, page 230 was not used.
No information is missing.

Queue manager error reply codes

ERUNK	=	ERIUC	Unknown request
ERNMT	=	ERNDT	No more DAT space available in JTA
ERNMS	=	ERNDS	No more physical disk space available
ERNLD	=	ERLDV	Logical device not found/available
ERNCS	=	ERDNCS	No more contiguous disk space
EREOI	=	ERRW	Attempted read past physical allocation
ERUHE	=	ERHE	Unrecovered hardware error
ERUDE	=	ERDE	Unrecovered data error
ERIDP	=	ERBDP	Invalid Dataset Parameter Table(DSP)
EREXT	=	EREXT	Attempt to extend permanent dataset
ERDNR	=	ERDNR	Device is not ready for I/O
ERNSW	=	ERNSW	Non-sequential write is illegal
ERXLM	=	ERXLM	Dataset size limit exceeded
ERDLW	=	ERSVW	Security violation on write
ERMAXD	=	ERMAXD	Too many DAT pages
ERUAV	=	ERUNAV	Device is not available
ERRDO	=	ERERDO	Device is read-only with NOF declared
ERIRQ	=	ERIRQ	Invalid request received by IOS
ERHEP	=	ERHEP	Hardware error on previous write

ERRORS RETURNED TO TASKS

ERNTS	=	1	No task space left
ERIDA	=	2	<R011> invalid disk address
ERTNX	=	3	Task does not exist
ERGOSAA	=	4	CPU already assigned to GOS
ERCHA	=	5	Channel already active
ERITN	=	6	Illegal task call
ERGOSTA	=	7	<R013> Guest O.S. cannot be started
ERGOSTO	=	0'10	Guest O.S. cannot be stopped
ERBPN	=	0'11	Illegal breakpoint number
ERBPB	=	0'12	Address already has a breakpoint
ERBFD	=	0'13	Bad field definition
ERNCP	=	0'14	<R016> CPU already in use by user
ERIPS	=	0'16	Breakpoint instruction parcel smashed
ERGOSMR	=	0'17	GOS memory request already in progress
ERIRN	=	0'20	Illegal register name
ERGOSNM	=	0'21	No GOS memory request in progress
ERGOSSE	=	0'22	<R013> Unknown subfunction
ERIMR	=	0'24	Invalid memory display request
ERINB	=	0'25	Insufficient buffer length
ERTALC	=	0'26	Task already created
ERNIM	=	0'27	CPU not in maintenance mode
ERMPB	=	0'30	Maintenance processor busy
ERURS	=	0'31	Unknown monitor request subfunction
ERNTC	=	0'33	<R017> No user task connected
ERMT	=	0'34	<R042> Request illegal on this machine
ERCLN	=	0'35	<R042> Invalid cluster number
ERIA	=	0'36	<R042> Invalid address specified
ERCNR	=	0'37	<R010> illegal request

ERROR STATUS RETURNED FROM EQSD2/DQSD2

EQERRLK	=	1	SDT lock bit set
DQERRNA	=	1	No SDT entries available
DQERRNL	=	2	SDT lock bit not set for specific entry dequeue
DQERRWQ	=	3	Wrong queue specified for specific entry dequeue

*CALL COMEXPT at this ident + 1

COPYRIGHT BY CRAY RESEARCH, INC. *

UNPUBLISHED - ALL RIGHTS RESERVED UNDER THE COPYRIGHT LAWS OF THE UNITED STATES. *

STARTCOM at ident-1

The EXP history trace is STPTAB resident. This trace buffer when enabled will trace the various key points through the major sections of EXP. By default all tracing within EXP is turned off. To enable EXP tracing, redefine the number of history trace entries to a non-zero value. Note that EXP will have to be reassembled when this is done.

NE@EXPT = D'000 Do not assemble in tracing

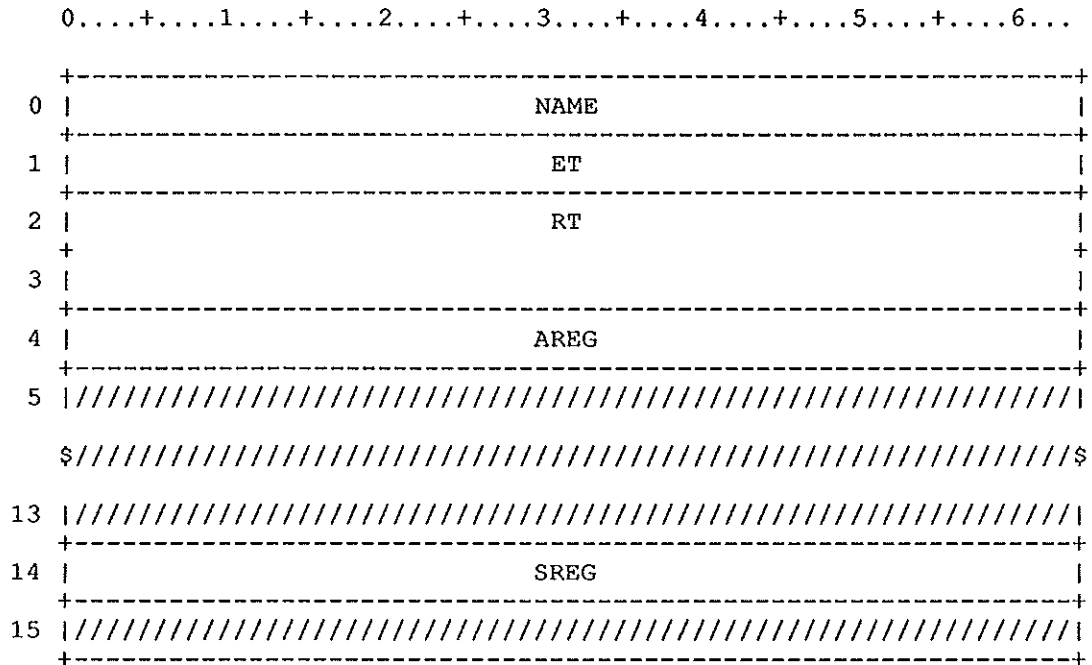

Figure ET-1. EXP history trace buffer

The follow four words are common to all history trace buffers that FDUMP can recognize and collate with other history traces of the same nature.

Field	Word(base8)	Bits	Description
ETNAME	0	0-63	ASCII name associated with the entry
ETET	1	0-63	Elapsed Real-time clock since last ent
ETRT	2-3	0-63	Current real-time clock
ETAREG	4	0-63	Address registers
ETSREG	14	0-63	Scalar registers

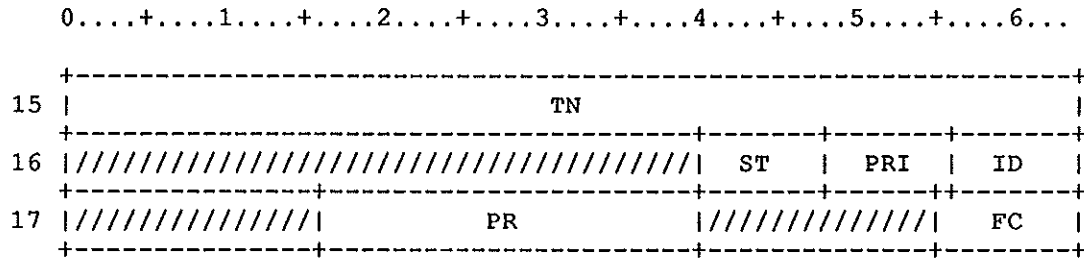

Figure CT-1. Create task request

CTSK request -- create system task

Field	Word(base8)	Bits	Description
CTTN	15	0-63	Task name
CTST	16	40-47	Task status
CTPRI	16	48-55	Task priority
CTID	16	56-63	Task id
CTPR	17	16-39	Task P-register value
CTFC	17	55-63	Function code

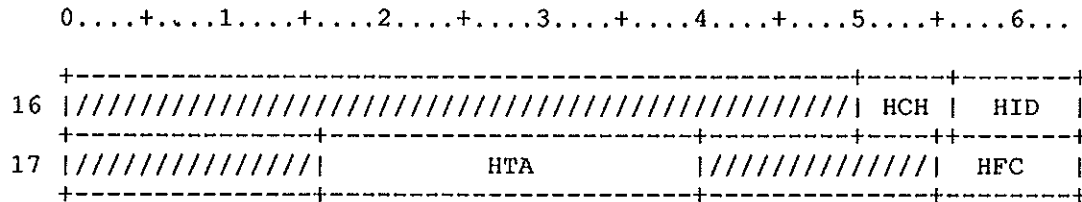

Figure AC-2. Assign channel request

Field	Word(base8)	Bits	Description
ACHCH	16	50-55	Software channel number
ACHID	16	56-63	Task id
ACHTA	17	16-39	Control table for channel
ACHFC	17	55-63	Function code

SHPM (004) request - System hardware performance monitor

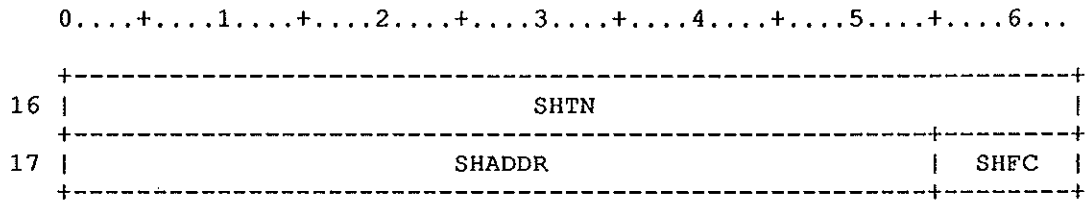

Figure SP-3. System Hardware Performance Monitor request

<u>Field</u>	<u>Word(base8)</u>	<u>Bits</u>	<u>Description</u>
SHTN	16	0-63	System task number
SHADDR	17	0-54	STP-rel HPM control blk addr, or 0
SHFC	17	55-63	Function code (=SHPM)

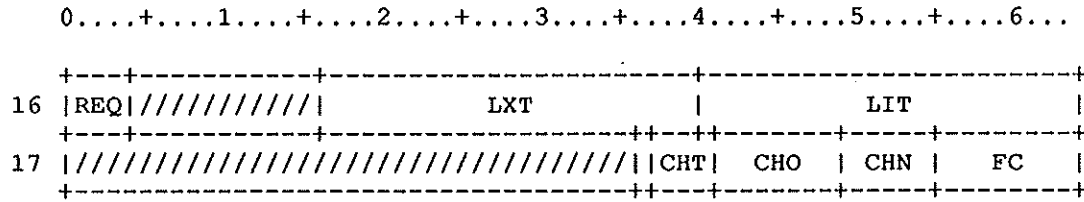

Figure FET-4. Front end driver request

Field	Word(base8)	Bits	Description
FETREQ	16	0-3	Operation request code: FETCON=0 Channel on FETCOF=1 Channel off FETOUT=2 Output operation
FETLXT	16	16-39	LXT entry address (FETOUT only)
FETLIT	16	40-63	LIT entry address (FETCON, FETCOF)
FETFRC	17	36	Force station off flag
FETCHT	17	37-40	Channel type (see LCCHT)
FETCHO	17	41-48	Channel ordinal
FETCHN	17	49-54	Channel pair number
FETFC	17	55-63	Function code (005)

CCPUS (010) request -- change CPU status

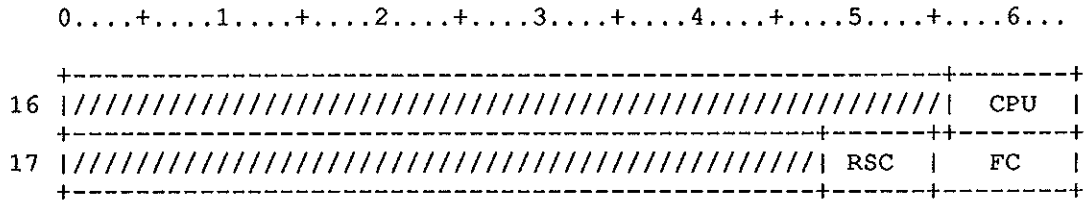

Figure CS-5. Change CPU status

Field	Word(base8)	Bits	Description
CSCPU	16	56-63	Processor number to change
CSRSC	17	48-54	Function Sub-code CSFSCUP=0 Up specified CPU CSFSCDN=1 Down specified CPU CSFSCSY=2 Specified CPU to SYSTEM mode CSFSCMA=3 Specified CPU to MAINT mode
CSFC	17	55-63	Function code (O'10)

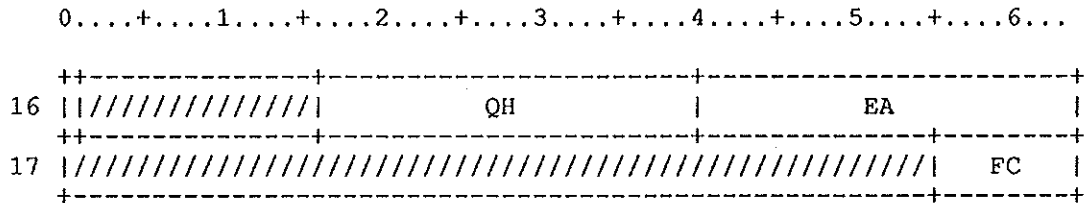

Figure DQS-6. Dequeue

Field	Word(base8)	Bits	Description
DQSDQ	16	0	Type of dequeue
DQSQH	16	16-39	Queue head address
DQSEA	16	40-63	Entry address
DQSFC	17	55-63	Function code

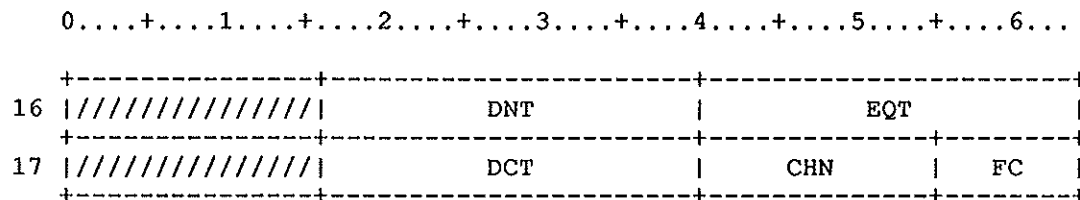

Figure IO-7. Disk block I/O request

Field	Word(base8)	Bits	Description
IODNT	16	16-39	DNT address
IOEQT	16	40-63	EQT address
IODCT	17	16-39	DCT address
IOCHN	17	40-54	Software channel number
IOFC	17	55-63	Function code

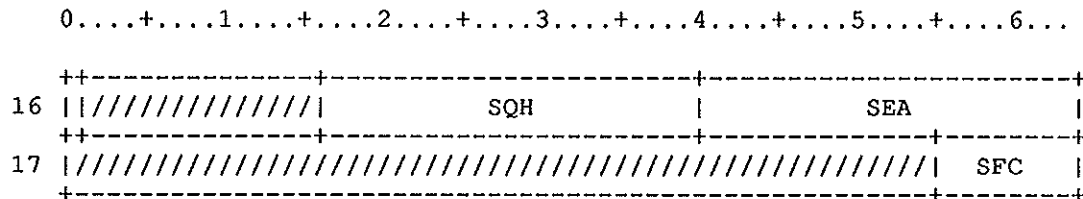

Figure EQ-8. Enqueue

Field	Word(base8)	Bits	Description
EQSEQ	16	0	Type of enqueue
EQSQH	16	16-39	Queue head address
EQSEA	16	40-63	Entry address
EQSFC	17	55-63	Function code

STARTOS (013) request - start guest operating system

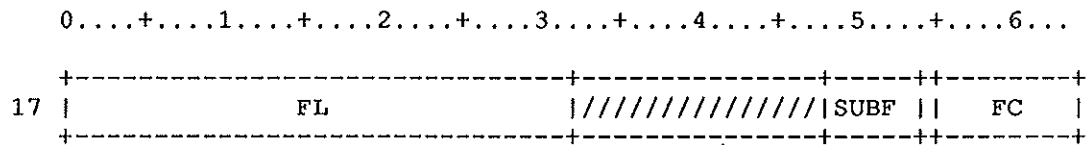

Figure SO-9. Start guest operating system

Field	Word(base8)	Bits	Description
SOFL	17	0-31	Number of words allocated to GOS
SOSUBF	17	48-53	Sub-function code SO\$STRT=0 Start guest O.S. SO\$STOP=1 Stop guest O.S. SO\$RMEM=2 Request memory size change SO\$CMEM=3 Memory size change completed SO\$CCPU=4 Request CPU percentage change
SOFC	17	55-63	Function code (=STARTOS)

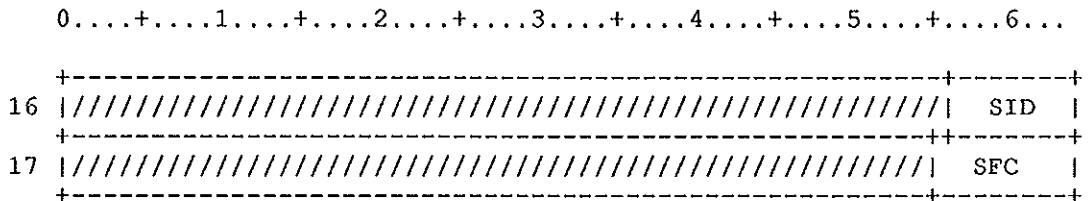

Figure RTS-10. Ready task and suspend self request

Field	Word(base8)	Bits	Description
RTSSID	16	56-63	Task id
RTSSFC	17	55-63	Function code

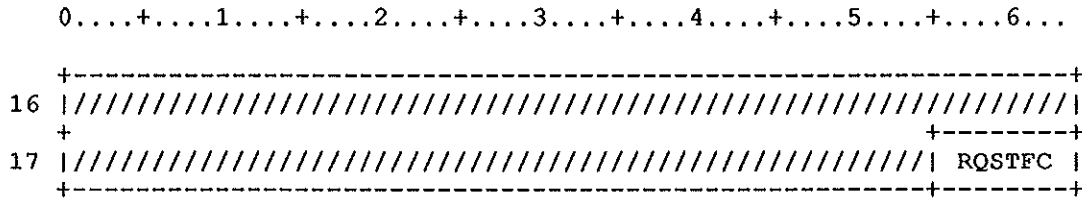

Figure RTS-11. Ready task and suspend self request

Field	Word(base8)	Bits	Description
RQSTFC	17	55-63	Function code

RCP (016) request -- connect user task to CPU

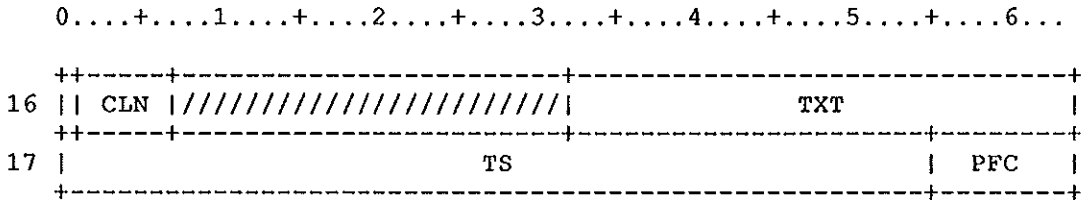

Figure RC-12. Connect user task to CPU

RCLDCL	16	0	=0 to not touch cluster; =1 to load
--------	----	---	-------------------------------------

Field	Word(base8)	Bits	Description
RCCLN	16	1-6	Cluster number to insert into XP
RCTXT	16	32-63	TXT entry address to connect
RCTS	17	0-54	Time slice, in CPU cycles
RCPFC	17	55-63	Request code (=RCP)

DCP (017) request -- disconnect user from CPU

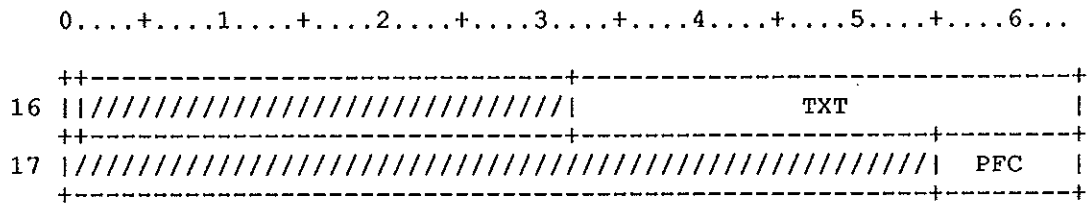

Figure DC-13. Disconnect user from CPU

DCSTCL 16 0 =1 to store cluster in JTA

Field	Word(base8)	Bits	Description
DCTXT	16	32-63	TXT address of user task to disconnect
DCPFC	17	55-63	Request code (=DCP)

R022/PIO

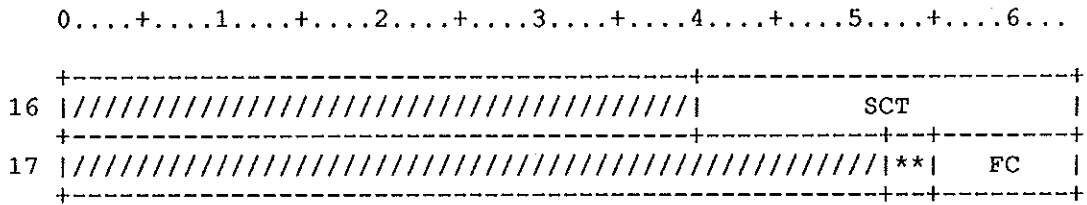

Figure PI-14. Packet I/O request (not for MEP)

Field	Word(base8)	Bits	Description
PISCT	16	40-63	Subsystem control table address
PIOFC	17	52-54	PIO function code
PIFC	17	55-63	Monitor request function code

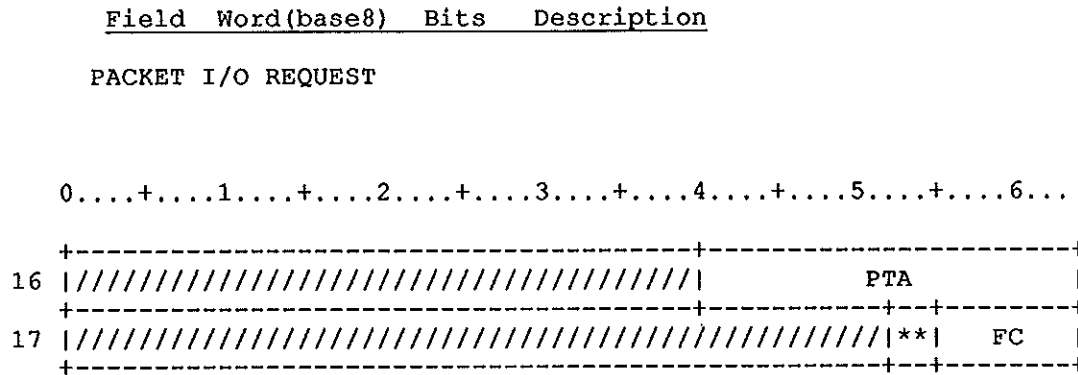

Figure PR-15. Packet I/O request (MEP only)

Field	Word(base8)	Bits	Description
PRPTA	16	40-63	Parameter table address
PRFSC	17	52-54	Function subcode PRINIT=0 Initialize subcode PRSEND=1 Send subcode PRRCV=2 Receive subcode
PRFC	17	55-63	Function code

R023 - Boot a new system.

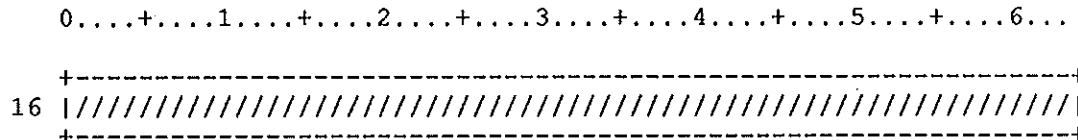

Figure B00-16. Boot a new system

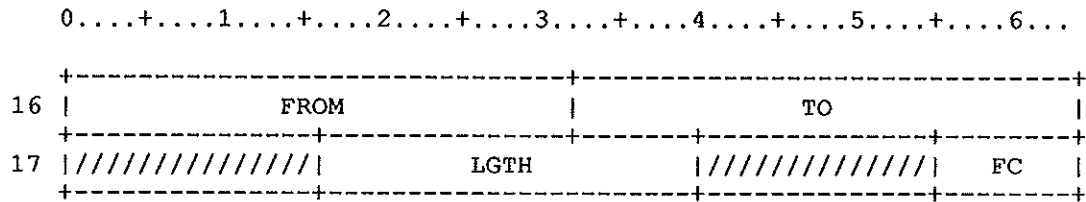

Figure DM-17. Display Memory Request

Field	Word(base8)	Bits	Description
DMFROM	16	0-31	FWA of display area (EXEC relative)
DMTO	16	32-63	FWA of buffer area (STP relative)
DMLGTH	17	16-39	Display area word length
DMFC	17	55-63	Function code

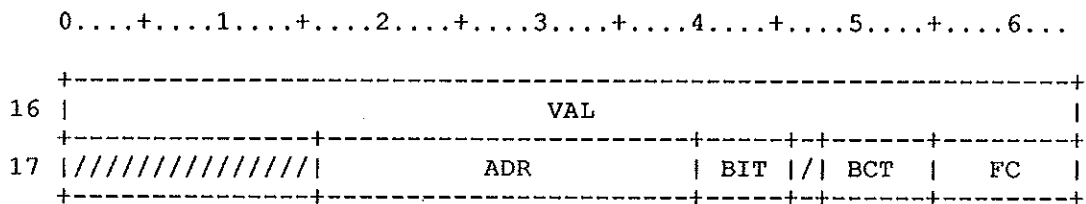

Figure EM-18. Enter memory request

Field	Word(base8)	Bits	Description
EMVAL	16	0-63	Value to be entered
EMADR	17	16-39	Absolute memory word address
EMBIT	17	40-45	Bit number
EMBCT	17	48-54	Bit count
EMFC	17	55-63	Function code

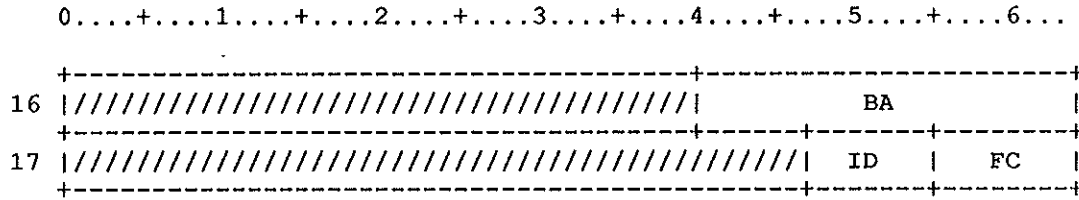

Figure DX-19. Display XP request

Field	Word(base8)	Bits	Description
DXBA	16	40-63	FWA of buffer area
DXID	17	47-54	Task id
DXFC	17	55-63	Function code

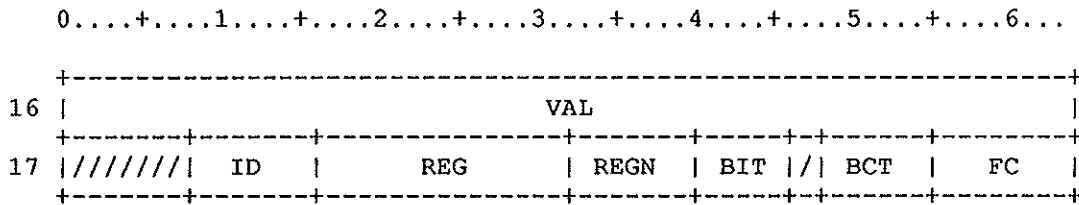

Figure EX-20. Enter XP register request

Field	Word(base8)	Bits	Description
EXVAL	16	0-63	Value to be entered
EXID	17	8-15	Task id
EXREG	17	16-31	Register designator EXREGA=A'AA'R A Register EXREGB=A'BB'R B Register EXREGP=A'PP'R P Register EXREGS=A'SS'R S Register
EXREGN	17	32-39	Register number
EXBIT	17	40-45	Bit number
EXBCT	17	48-54	Bit count
EXFC	17	55-63	Function code

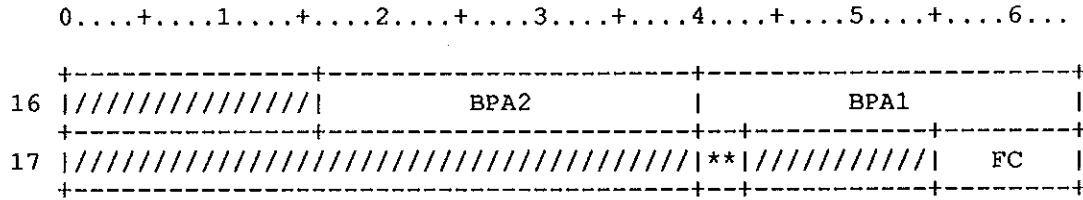

Figure SB-21. Set system breakpoint request

Field	Word(base8)	Bits	Description
SBBPA2	16	16-39	Breakpoint parcel address 2
SBBPA1	16	40-63	Breakpoint parcel address 1
SBBPN	17	40-42	Breakpoint number
SBFC	17	55-63	Function code

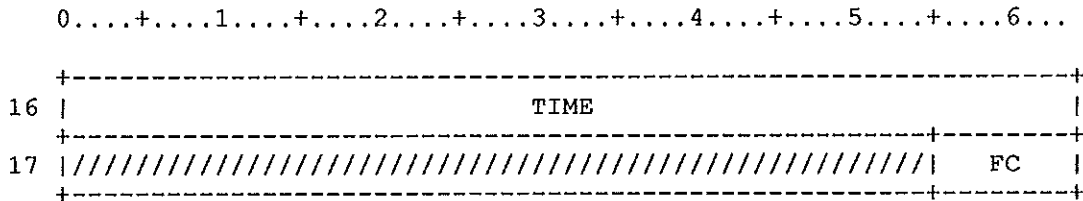

Figure TD-22. Set time delay request

Field	Word(base8)	Bits	Description
TDTIME	16	0-63	Time at which task is to be readied
TDFC	17	55-63	Time delay function code

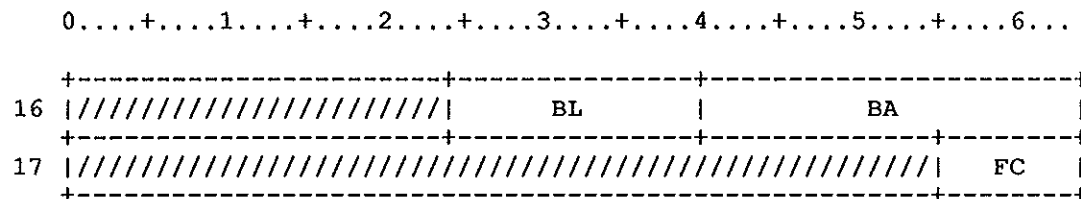

Figure CP-23. CPU utilization request

Field	Word(base8)	Bits	Description
CPBL	16	24-39	Buffer length
CPBA	16	40-63	Buffer address
CPFC	17	55-63	Function code

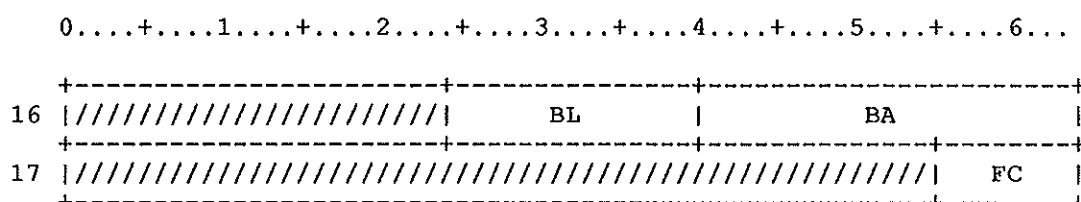

Figure TK-24. Task utilization request

Field	Word(base8)	Bits	Description
TKBL	16	24-39	Buffer length
TKBA	16	40-63	Buffer address
TKFC	17	55-63	Function code

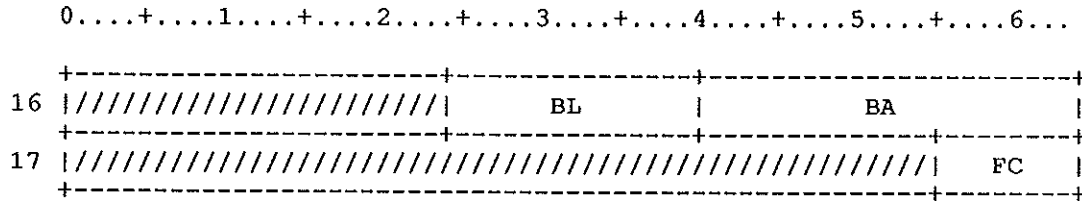

Figure ER-25. Report EXEC requests request

Field	Word(base8)	Bits	Description
ERBL	16	24-39	Buffer length
ERBA	16	40-63	Buffer address
ERFC	17	55-63	Function code

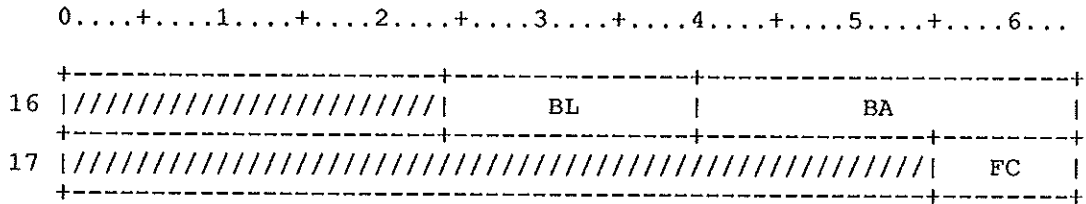

Figure EC-26. Report EXEC call counts request

Field	Word(base8)	Bits	Description
ECBL	16	24-39	Buffer length
ECBA	16	40-63	Buffer address
ECFC	17	55-63	Function code

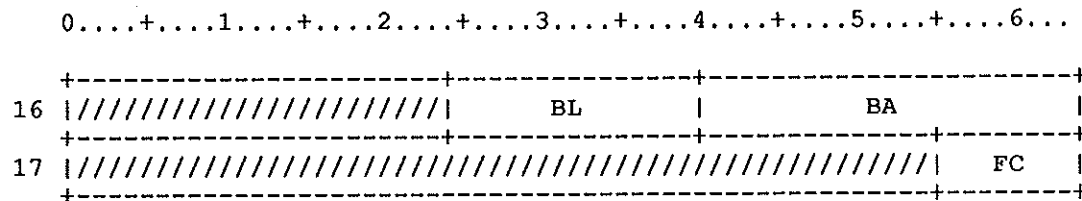

Figure IC-27. Report interrupt counts request

Field	Word(base8)	Bits	Description
ICBL	16	24-39	Buffer length
ICBA	16	40-63	Buffer address
ICFC	17	55-63	Function code

DUMPCL (042) request -- dump registers in specified cluster

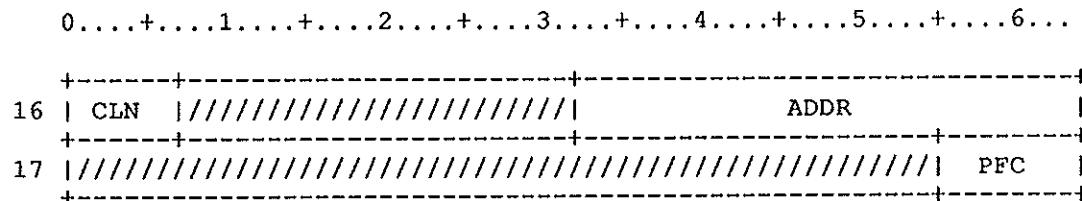

Figure DU-28. Dump registers in specified cluster request

Field	Word(base8)	Bits	Description
DUCLN	16	0-6	Cluster number to dump
DUADDR	16	32-63	STP-relative address to start dump at
DUPFC	17	55-63	Request code (=DUMPCL)

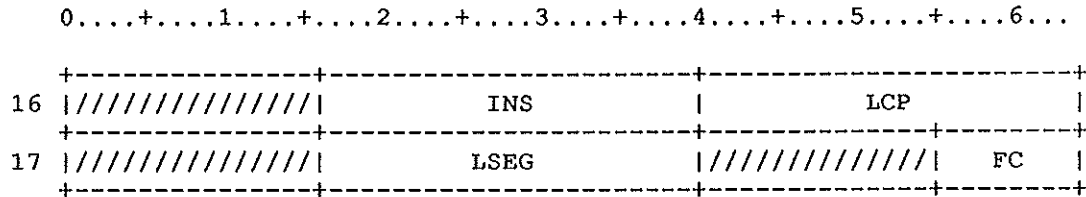

Figure AL-29. Allocate LXT Entry

Field	Word(base8)	Bits	Description
ALINS	16	16-39	INS address, STP-relative
ALLCP	16	40-63	LCP address, STP-relative
ALLSEG	17	16-39	Logon segment address, STP-relative
ALFC	17	55-63	Function code

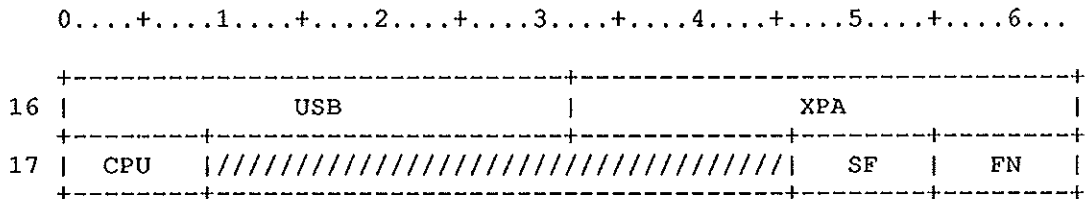

Figure DI-30. Execute a diagnostic XP

Field	Word(base8)	Bits	Description
DIUSB	16	0-31	User status buffer address
DIXPA	16	32-63	Diagnostic XP address
DICPU	17	0-8	Requested processor number
DISF	17	46-54	Diagnostic subfunction DISTRT=0 Start CPU DISTAT=1 Status CPU DISTOP=2 Stop CPU
DIFN	17	55-63	Function code

This interface is used to perform the Guest Operating System control functions from a COS program.

0....+....1....+....2....+....3....+....4....+....5....+....6...

0		FCN	
1		TAT	
2		GST	
3		EXS	
4		PBA	
5		PLA	
6		KBA	
7		KLA	
10		UBA	
11		ULA	
12		CPU	
13		JOB	
14		SGN	
15		MSG	
	\$		\$
n			

Figure FGS-1. F\$GOS interface definition

<u>Field</u>	<u>Word(base8)</u>	<u>Bits</u>	<u>Description</u>
FGSFCN	0	0-63	subfunction request (see COMEXPFC) GOS\$DUMP=0 dump GOS GOS\$LOAD=1 load GOS GOS\$STAT=2 return status of GOS GOS\$STRT=3 start GOS GOS\$STOP=4 stop GOS GOS\$ALLO=5 allocate GOS field length GOS\$RLSE=6 release GOS field length GOS\$CHNG=7 change GOS field length GOS\$MAX=D'8 max+1 subfunction value
FGSTAT	1	0-63	status reply FGS\$\$OK=D'0 function complete FGS\$\$AC=D'1 GOS already active FGS\$\$GB=D'2 addresses not within GOS BA, LA FGS\$\$NA=D'3 GOS not active FGS\$\$NC=D'4 no CPU available for GOS FGS\$\$NP=D'5 GOS area not present FGS\$\$PR=D'6 privilege required for F\$GOS FGS\$\$UB=D'7 buffer not within user's BA, LA FGS\$\$UF=D'8 undefined subfunction FGS\$\$AP=D'9 GOS area already present FGS\$\$MR=D'10 requested size > available space FGS\$\$NM=D'11 JSH could not get the memory FGS\$\$NR=D'12 JSH could not release the memory FGS\$\$CL=D'13 communication block size mismatch FGS\$\$AD=D'14 GOS assembled at the wrong offset FGS\$\$UK=D'15 GOS name not in supported list FGS\$\$PW=D'16 GOS PWS doesn't line up with COS FGS\$\$IM=D'17 insufficient memory allocated FGS\$\$RT=D'18 GOS in middle of startup/shutdown FGS\$\$NL=D'19 GOS has not been loaded FGS\$\$TS=D'20 allocated size >

assembled size
 FGS\$BC=D'21 GOS assembled with bad
 CPU count
 FGS\$CT=D'22 cannot find the
 communication block
 FGS\$CI=D'23 memory size cannot be
 changed
 FGS\$MP=D'24 memory change already
 in progress

 FGS\$MX=D'25 max+1 status reply

Return fields for GOS\$STAT.

FGSGST	2	0-63	GOS status GOS\$NA=0 no GOS space has been allocated GOS\$AL=1 space allocated, GOS not yet loaded GOS\$LD=2 GOS is loaded, not yet running GOS\$AC=3 GOS is active and running GOS\$ST=4 GOS stopped, memory still allocated GOS\$MX=5 max+1 GOS status
FGSEXS	3	0-63	EXEC status on last request EXS\$NST=0 no status EXS\$STA=1 GOS startup in progress EXS\$STO=2 GOS shutdown in progress EXS\$MAX=3 max+1 EXEC status
FGSPBA	4	0-63	Base address of guest PWS area
FGSPLA	5	0-63	LWA+1 of guest PWS area
FGSKBA	6	0-63	Base address of guest kernel area
FGSKLA	7	0-63	LWA+1 of guest kernel area
FGSUBA	10	0-63	Base address of guest user area
FGSULA	11	0-63	LWA+1 of guest user area
FGSCPU	12	0-63	Number of CPUs reserved for GOS
FGSJOB	13	0-63	Memory currently available to COS jobs
FGSSGN	14	0-63	COS name of GOS (ASCII-L) (zero if not initiated) L@FGSMMSG=D'9 EXEC stop message length

<u>Field</u>	<u>Word(base8)</u>	<u>Bits</u>	<u>Description</u>
FGSMMSG	15-n	0-63	EXEC stop message Request fields for the GOS\$LOAD and GOS\$DUMP subfunctions.
FGSUFW	26	0-63	FWA of user buffer
FGSULN	27	0-63	length of user buffer
FGSGFW	30	0-63	FWA of GOS area Request fields for the GOS\$ALLO subfunction.
FGSLWA	31	0-63	requested LWA+1 for GOS field length
FGSGBL	32	0-63	Guest O.S. binary length Request fields for the GOS\$STRT subfunction.
FGSPFL	33	0-63	Guest O.S. parameter file length Request fields for the GOS\$CHNG subfunction.
FGSCMN	34	0-63	Minimum COS CPU percentage when busy
FGSMME	35	0-63	Maximum size GOS can grow to

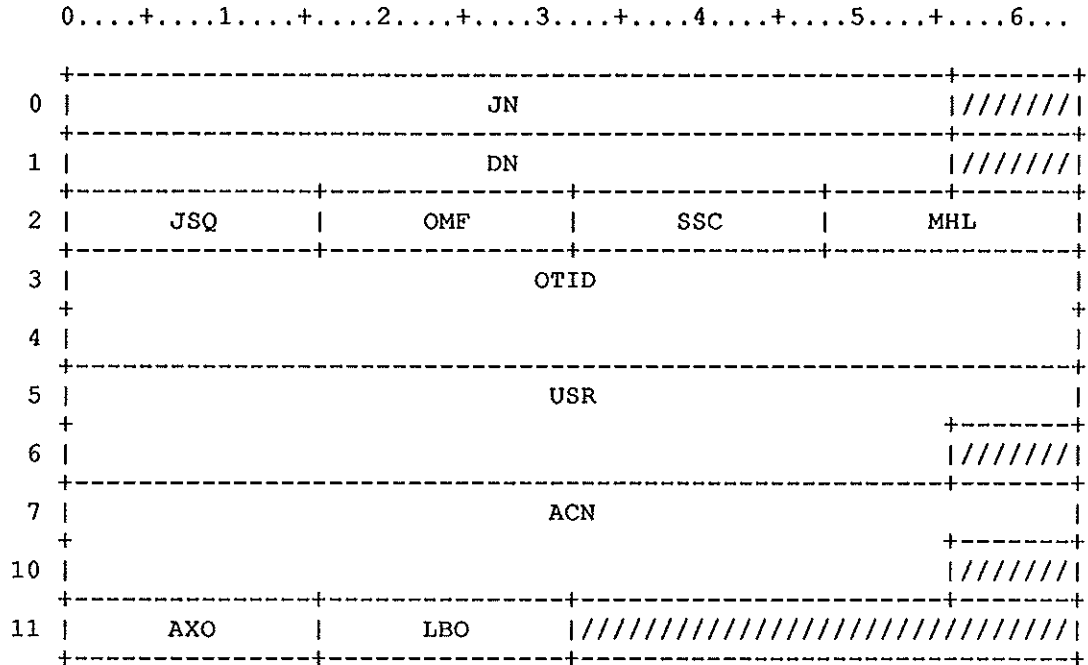

Figure FH-1. Front-end servicing header

Field	Word(base8)	Bits	Description
FHJN	0	0-55	Job name
FHDN	1	0-55	Local dataset name
FHJSQ	2	0-15	Job sequence number
FHOMEF	2	16-31	Mainframe of job origin
FHSSC	2	32-47	Station slot (word) count
FHMHL	2	48-63	Overall fsh length(slot included)
FHOTID	3-4	0-63	Terminal id of job origin
FHOTI1	3	0-63	Characters 1 - 8
FHOTI2	4	0-63	Characters 9 - 16
FHUSR	5-6	0-63	Job user number
FHUSR1	5	0-63	Characters 1 - 8
FHUSR2	6	0-55	Characters 9 - 15

<u>Field</u>	<u>Word(base8)</u>	<u>Bits</u>	<u>Description</u>
FHACN	7-10	0-63	Job account number
FHACN1	7	0-63	Characters 1 - 8
FHACN2	10	0-55	Characters 9 - 15
FHAXO	11	0-15	Auxiliary information table offset
FHLBO	11	16-31	Label group offset (request side)

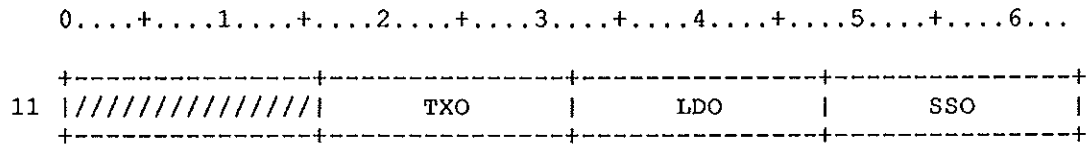

Figure FH-2. Text message offset (reply side)

<u>Field</u>	<u>Word(base8)</u>	<u>Bits</u>	<u>Description</u>
FHTXO	11	16-31	Text message offset (reply side)
FHLDO	11	32-47	LDT offset
FHSSO	11	48-63	Station slot offset

FST FSS DEVICE STATISTICS TABLE - FST

The FST is a JTA resident table which is created at job initiation. The table resides in the dynamic portion of the JTA. Space for L@NFSS FST entries is reserved.

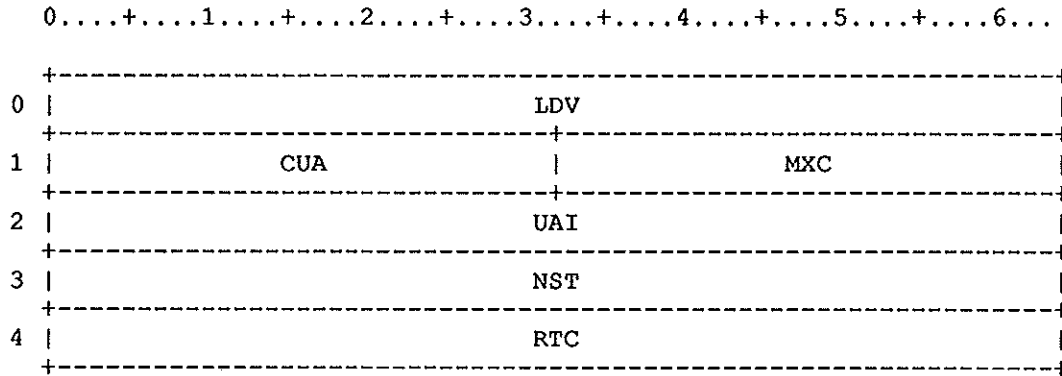

Figure FS-1. FSS Device Statistics Table

Field	Word(base8)	Bits	Description
FSLDV	0	0-63	Logical device name (from EQT)
FSCUA	1	0-31	Current allocation
FSMXC	1	32-63	Maximum concurrent allocation
FSUAI	2	0-63	Unit allocation integral
FSNST	3	0-63	Number of sectors transferred
FSRTC	4	0-63	RTC at last allocation

There is a one GCH entry for every configure channel. Each entry contains a pointer to the corresponding entry in the UNICOS channel table and an address of where to start processing the function request from UNICOS.

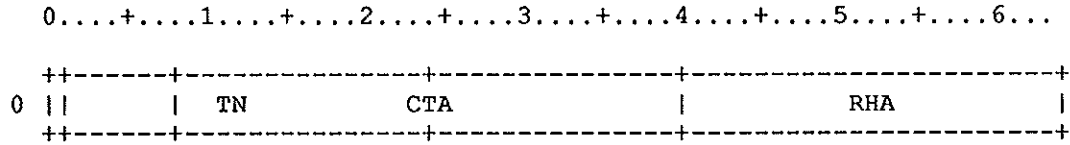

Figure GCH-1. GOS Channel Table Header

Header.

<u>Field</u>	<u>Word(base8)</u>	<u>Bits</u>	<u>Description</u>
GCHTN	0	0-23	Table name ('GCH' in ASCII)

Entry.

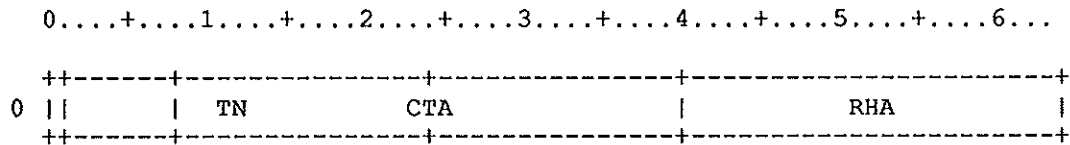

Figure GCH-1. GOS Channel Table Header

<u>Field</u>	<u>Word(base8)</u>	<u>Bits</u>	<u>Description</u>
GCHACT	0	0	Channel active on UNICOS side
GCHCTA	0	8-39	UNICOS channel table entry address
GCHRHA	0	40-63	Address of code to process request

The guest operating system table is used within COS EXEC to record information about guest operating systems.

0....+....1....+....2....+....3....+....4....+....5....+....6....

0	NAM
1	PBA
2	PLA
3	KBA
4	KLA
5	UBA
6	ULA
7	CPU
10	MSK
11	CMN
12	CWK
13	MME
14	TAT
15	EXS
16	MTX
\$	\$
n	

Figure GOS-1. Guest operating system table for EXEC

<u>Field</u>	<u>Word(base8)</u>	<u>Bits</u>	<u>Description</u>
GOSNAM	0	0-63	Name of guest operating system (ASCII)
GOSPBA	1	0-63	Base address of guest PWS (EXEC-rel)
GOSPLA	2	0-63	LWA+1 of guest PWS area (EXEC-rel)
GOSKBA	3	0-63	Base address of kernel (EXEC-rel)
GOSKLA	4	0-63	LWA+1 of kernel area (EXEC-rel)
GOSUBA	5	0-63	Base address of user area (EXEC-rel)
GOSULA	6	0-63	LWA+1 of user area (EXEC-rel)
GOSCPU	7	0-63	Number of CPUs in GOS configuration
GOSMSK	10	0-63	Bit mask of CPUs assigned to GOS
GOSCMN	11	0-63	Minimum COS CPU percentage when busy
GOSCWK	12	0-63	COS user work available
GOSMME	13	0-63	Maximum size GOS can grow to
GOSTAT	14	0-63	Status of guest operating system GOS\$\$NA=0 no GOS memory is allocated GOS\$\$AL=1 memory allocated, GOS not yet loaded GOS\$\$LD=2 GOS is being loaded, not yet running GOS\$\$AC=3 GOS is active and running GOS\$\$ST=4 GOS stopped, memory still allocated GOS\$\$MX=5 max+1 GOS status
GOSEXS	15	0-63	EXEC status on last request EXS\$\$NST=0 no status EXS\$\$STA=1 GOS startup in progress EXS\$\$STO=2 GOS shutdown in progress EXS\$\$MAX=3 max+1 EXEC status L@GOSMTX=D'9 length of EXEC stop message
GOSMTX	16-n	0-63	EXEC stop message text
GOSSBL	27	0-63	Guest O.S. binary length
GOSPFL	30	0-63	Guest O.S. parameter file length
GOSMRQ	31	0	Guest O.S. memory request active

Due to a software problem, page 260 was not used.
No information is missing.

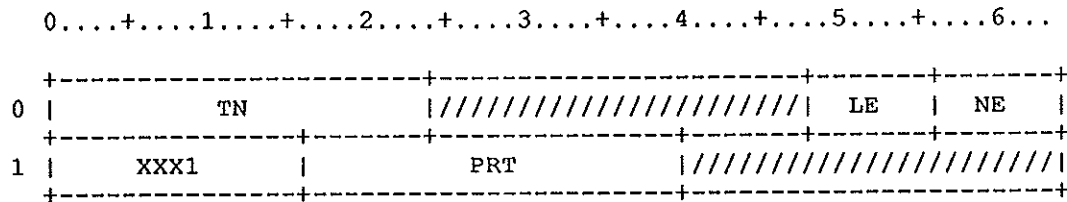

Figure GR-1. Generic Resource Table Header

Field	Word(base8)	Bits	Description
GRTN	0	0-23	Table name
GRLE	0	48-55	GRT entry length
GRNE	0	56-63	Number of GRT entries
GRXXX1	1	0-15	Spare field
GRPRT	1	16-39	Preemption table address

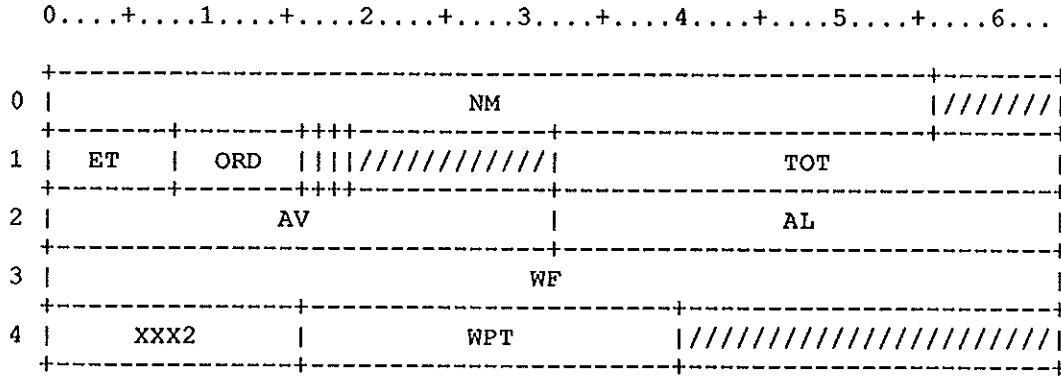

Figure GR-2. Generic Resource Table Entry

Field	Word(base8)	Bits	Description
GRNM	0	0-55	Generic resource name
GRET	1	0-7	Generic resource equipment type
GRORD	1	8-15	GRT entry ordinal
GRAVR	1	16	Resource uses AVR device allocation
GRNFL	1	17	Flush space not allocated if set
GRDC	1	18	Resource category (tape/nontape)
GRTOT	1	32-63	Total number of configured units
GRAV	2	0-31	Number of available units
GRAL	2	32-63	Number of allocated units
GRWF	3	0-63	Weighting factor for SBU accounting
GRXXX2	4	0-15	Spare field
GRWPT	4	16-39	WPT address if preemptable resource
SZ@GRT = NE@GRT*LE@GRT+LH@GRT			

GST GENERIC RESOURCE STATISTICS TABLE - GST

The GST is a JTA resident table which is created at job initiation. The table resides in the dynamic portion of the JTA. A GST is created for each generic resource used by the job.

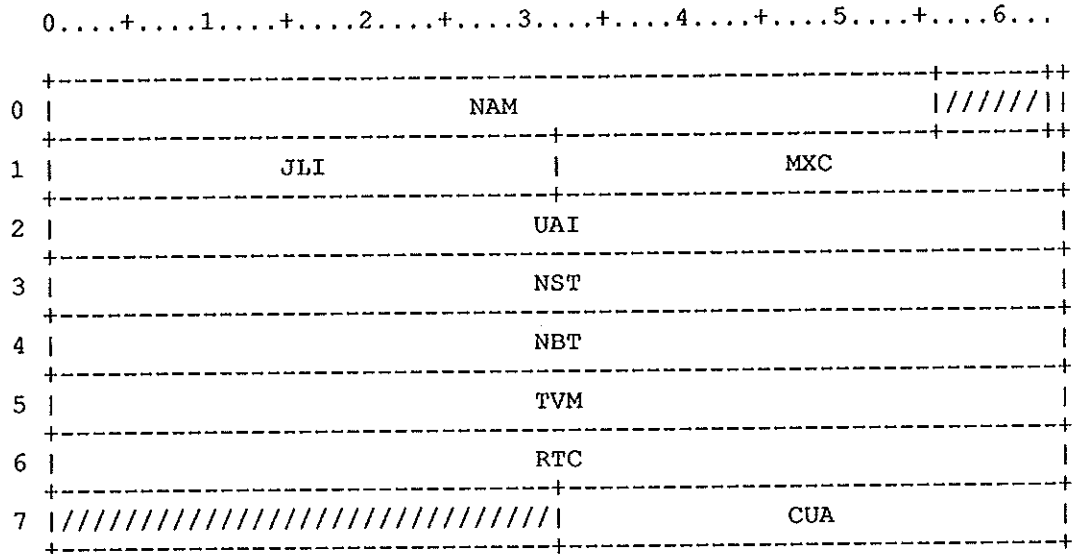

Figure GS-1. Generic Resource Statistics Table

Field	Word(base8)	Bits	Description
GSNAM	0	0-55	Generic resource name
GS DT	0	63	Device type from GRT (0=disk,1=tape)
GSJLI	1	0-31	Job limit from JOB command
GSMXC	1	32-63	Maximum concurrent allocation
GSUAI	2	0-63	Unit allocation integral
GSNST	3	0-63	Number of sectors transferred
GSNBT	4	0-63	Number of tape blocks transferred
GSTVM	5	0-63	Number of tape volumes mounted
GSRTC	6	0-63	RTC at last allocation
GSCUA	7	32-63	Current allocation

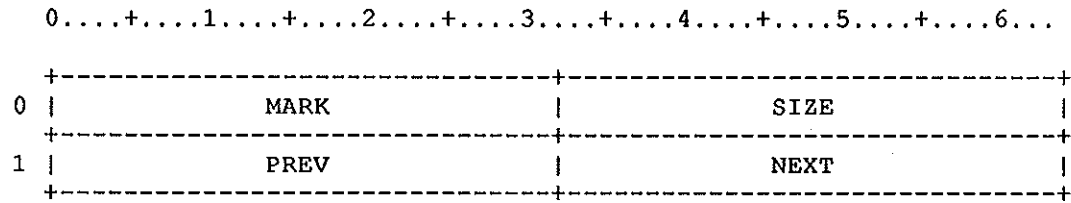

Figure HP-1. Heap block control words

Field	Word(base8)	Bits	Description
HPMARK	0	0-31	Tells if block is allocated or free
HPSIZE	0	32-63	Number of words in the block
HPPREV	1	0-31	Address of previous free block
HPNEXT	1	32-63	Address of next free block

0....+....1....+....2....+....3....+....4....+....5....+....6....

2	LEN
3	HWM
4	LWM
5	GROW
6	SHRK
7	NABL
10	ALWD
11	ALLC
12	CSTK
13	TSTK
14	MSTK
15	STKW
16	SHWM
17	SLWM
20	NSG
21	NTSG
22	MULT
23	BUF
24	HRTN
25	CALR
26	ADDR

Figure HT-1. Heap statistics table

<u>Field</u>	<u>Word(base8)</u>	<u>Bits</u>	<u>Description</u>
HTLEN	2	0-63	Current heap length
HTHWM	3	0-63	High water mark
HTLWM	4	0-63	Low water mark
HTGROW	5	0-63	Number of times heap has grown
HTSHRK	6	0-63	Number of times heap has shrunk
HTNABL	7	0-63	Number of allocated blocks
HTALWD	10	0-63	Number of words allocated
HTALLC	11	0-63	Number of allocations
HTCSTK	12	0-63	current number of stacks
HTTSTK	13	0-63	total number of stacks
HTMSTK	14	0-63	most stacks at one time
HTSTKW	15	0-63	number of words allocated for stacks
HTSHWM	16	0-63	highest stack high water mark
HTSLWM	17	0-63	lowest stack high water mark
HTNSG	20	0-63	number of stacks that grew
HTNTSG	21	0-63	number of times stacks grew
HTMULT	22	0-63	pointer to multitasking statistics
HTBUF	23	0-63	pointer to mult. buffer data area
HTHREN	24	0-63	Last routine that changed the heap
HTCALR	25	0-63	Return address of last caller
HTADDR	26	0-63	Address of heap area changed last
HTADDR	26	0-63	(Required for table diagram generator)

* COMHM Hardware Performance Monitor

COMHM defines a control block, identified by task number, containing the active monitor group number, as well as a block of counters for each possible performance monitor group. Blocks are created by EXP, and are filled in by EXEC.

The format of the F\$PERF request block, which gives users access to the performance monitor for user-mode tasks, is also defined by COMHM.

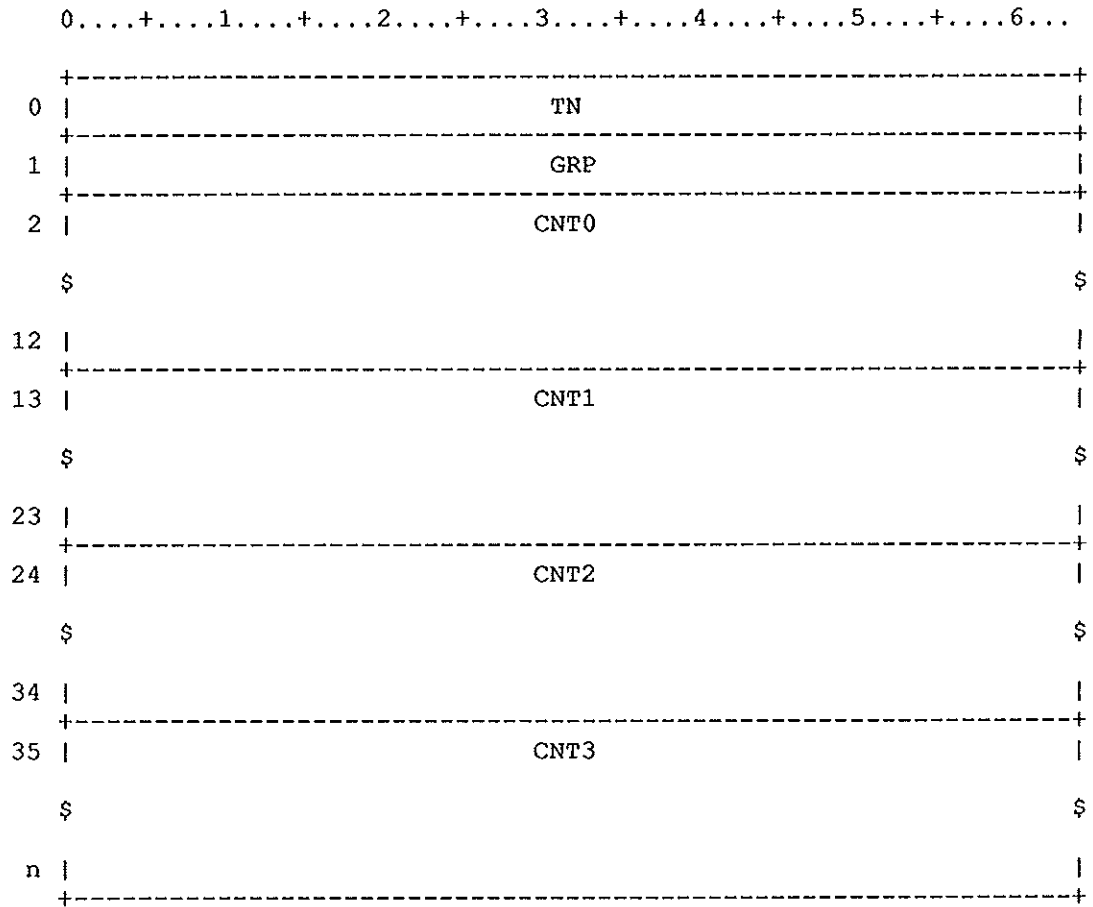

Figure HM-1. Hardware Performance Monitor Control Block

<u>Field</u>	<u>Word(base8)</u>	<u>Bits</u>	<u>Description</u>
HMTN	0	0-63	Task ID number (user or system)
HMGRP	1	0-63	Active group number NE@HMCNT=D'8 Number of counters in an HPM group
HMCNT0	2-12	0-63	Counters in group 0
HMCCY0	12	0-63	Accounted clock periods for group 0
HMCNT1	13-23	0-63	Counters in group 1
HMCCY1	23	0-63	Accounted clock periods for group 1
HMCNT2	24-34	0-63	Counters in group 2
HMCCY2	34	0-63	Accounted clock periods for group 2
HMCNT3	35-n	0-63	Counters in group 3
HMCCY3	45	0-63	Accounted clock periods for group 3 LE@HMGE=W@HMCNT1-W@HMCNT0 Length of each counter group entry

In the description below, fields marked with "*" are set by the system on each F\$PERF request; other fields must be set by the user prior to the request.

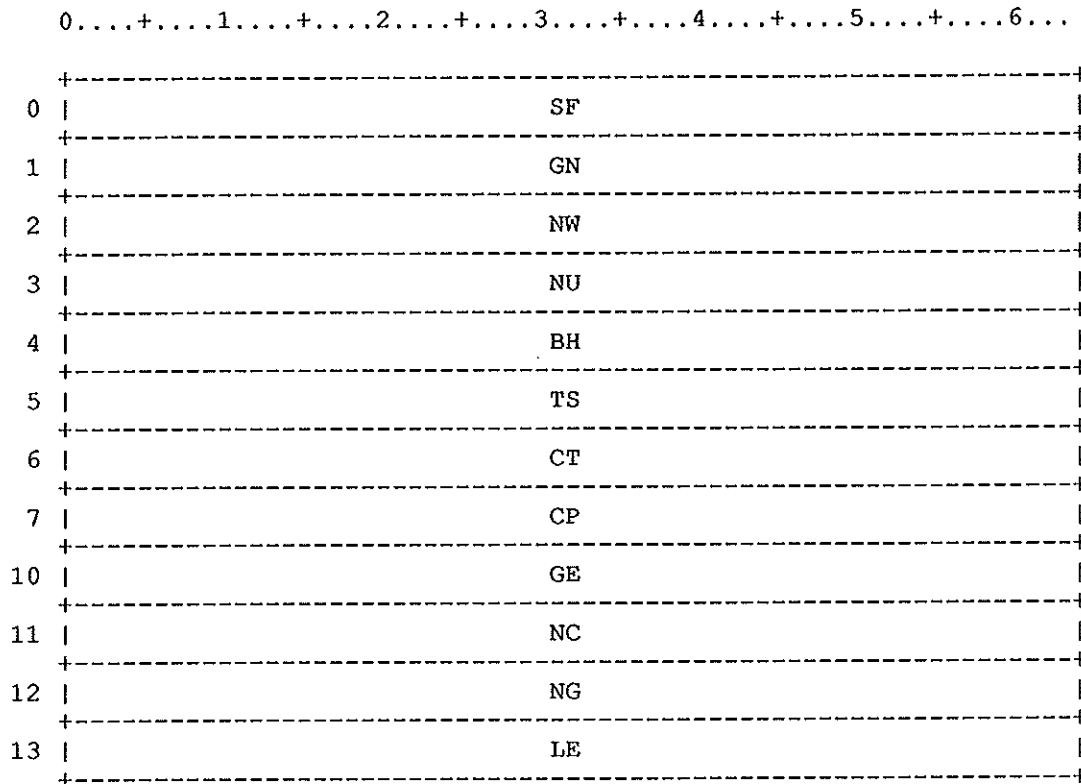

Figure HMR-1. Hardware Performance Monitor - F\$PERF request

<u>Field</u>	<u>Word(base8)</u>	<u>Bits</u>	<u>Description</u>
HMRSF	0	0-63	Subfunction (PM\$...)
HMRGN	1	0-63	Group number (for PM\$ON)
HMRNW	2	0-63	Total num. words in block
HMRNU	3	0-63	* Total num. words used in block
HMRBH	4	0-63	* Num. words in block header (LE@HMR)
HMRTS	5	0-63	* NZ if block too small
HMRCT	6	0-63	* Offset to first counter in subblk
HMRCP	7	0-63	* Offset to accounted cycles in subblk

<u>Field</u>	<u>Word(base8)</u>	<u>Bits</u>	<u>Description</u>
HMRGE	10	0-63	* Num words in group entry
HMRNC	11	0-63	* Num counters in each group (NE@HMCNT)
HMRNG	12	0-63	* Number of counter groups (C@CPHPG+1)
HMRLE	13	0-63	* Length of subblock entries (LE@HM)

First subblock begins at FWA+(@HMRBN)
 Next is at FWA+(@HMRBN)+(@HMRLE)

Group 0 counters are at . . .
 (subblock) + (@HMRCT)
 (next begins (@HMRGE) words later)

Group 0 accounted clock time is at...
 (subblock) + (@HMRCP)
 (next is (@HMRGE) words later)

Timing subblocks have the same format
 as the HM table entries.

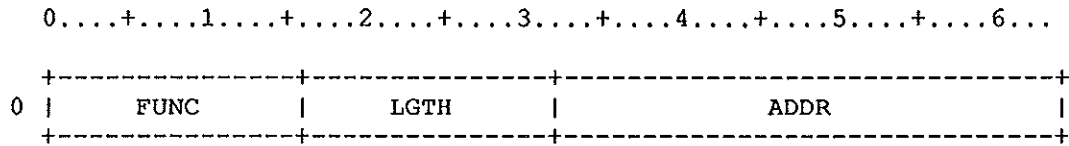

Figure HS-1. Simulated high-speed channel protocol

<u>Field</u>	<u>Word(base8)</u>	<u>Bits</u>	<u>Description</u>
HSFUNC	0	0-15	Function code 0 Read >0 Write
HSLGTH	0	16-31	Transfer length; max=A local memory
HSADDR	0	32-63	Bipolar transfer address

The ISP Application Level consists of three protocols,

- 1) ISP Control Protocol, ICP
- 2) Job Control Protocol, JCP
- 3) Dataset Transmission Protocol, DTP

Communication between the ISP and COS at this level consists of messages being sent by the Transport Service. Each of these messages begin with the following word of information.

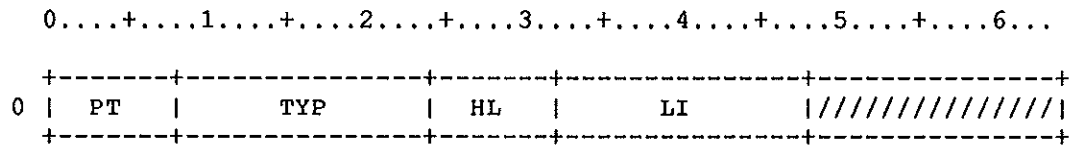

Figure IA-1. ISP Application Level Message Header

<u>Field</u>	<u>Word(base8)</u>	<u>Bits</u>	<u>Description</u>
IAPT	0	0-7	Application Protocol Type IAL\$ICP=A'I'R I = ICP, ISP control protocol IAL\$JCP=A'J'R J = JCP, Job control protocol IAL\$DTP=A'D'R D = DTP, Dataset transmission protocol

Field	Word(base8)	Bits	Description
IATYP	0	8-23	Application level message type
			IAM\$NL=A'NL'R message NL - Null
			IAM\$LG=A'LG'R LG - Logon
			IAM\$LR=A'LR'R LR - Logon Reply
			IAM\$JI=A'JI'R JI - Job Init
			IAM\$SL=A'SL'R SL - System Log
			IAM\$QU=A'QU'R QU - Quiesce
			IAM\$RE=A'RE'R RE - Resume
			IAM\$LF=A'LF'R LF - Logoff
			IAM\$JT=A'JT'R JT - Job Term
			IAM\$RS=A'RS'R RS - COS Restart
			IAM\$TI=A'TI'R TI - Task Init
			IAM\$EA=A'EA'R EA - Enable
			IAM\$JL=A'JL'R JL - Job Log
			IAM\$TT=A'TT'R TT - Task Term
			IAM\$TE=A'TE'R TE - Task Enable
			IAM\$AC=A'AC'R AC - Access
			IAM\$AR=A'AR'R AR - Access Reply
			IAM\$OP=A'OP'R OP - Open
			IAM\$CL=A'CL'R CL - Close
			IAM\$RL=A'RL'R RL - Release
			IAM\$OR=A'OR'R OR - Open Reply
			IAM\$NR=A'NR'R NR - No Rerun
			IAM\$RW=A'RW'R RW - Rewind
IAHL	0	24-31	Header length
IALI	0	32-47	Total message length includes header

ICP level messages of the type:

LG - Logon

LR - Logon Reply

LF - Logoff

SL - System Log Messages

have the following form

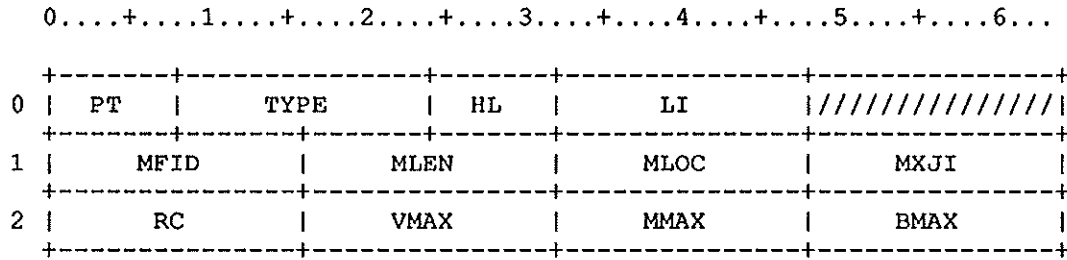

Figure IA-2. ISP ICP Messages LG,LR,LF,SL

Field	Word(base8)	Bits	Description
IAPT	0	0-7	Application Protocol type
IATYPE	0	8-23	Application level message type
IAHL	0	24-31	Header length
IALI	0	32-47	Total message length including header
IAMFID	1	0-15	Mainframe identifier
IAMLEN	1	16-31	Length of ASCII message
IAMLOC	1	32-47	Location, starting word, of message
IAMXJI	1	48-63	Maximum number of job initiators
IARC	2	0-15	Return code IARC\$LG=0 LOGON message accepted IARC\$MF=4 MFID's do not match
IAVMAX	2	16-31	Maximum connections for a circuit
IAMMAX	2	32-47	Maximum length of a message
IABMAX	2	48-63	Maximum data block length
			LE@IAMLG=3 Length of the logon message
			LE@IAMLR=3 Length of the logon reply message
			LE@IAMLF=3 Length of logoff message minus text
			LE@IAMSL=3 Length of system log message minus text

ICP level messages of the type:
 JT - Job Term
 JCP level messages of the type
 EA - Job Enable
 JT - Job Term
 JL - Job Log Messages
 DTP level messages of the type:
 TE - Task Enable
 TT - Task Term
 have the following form

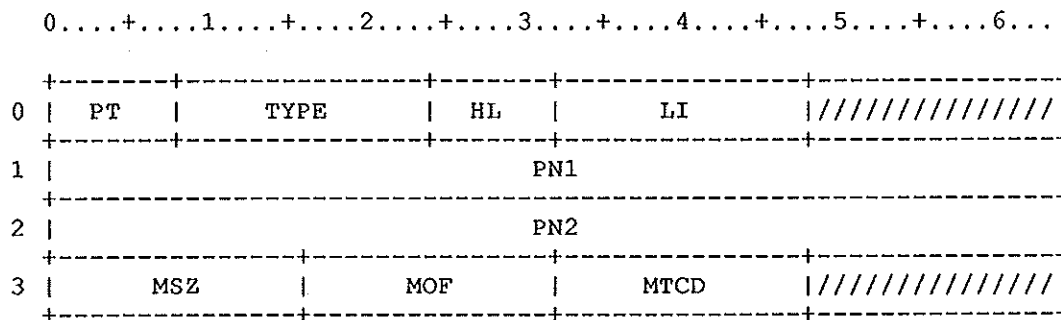

Figure IA-3. ISP ICP Messages JT, JCP EA, JT, JL,

Field	Word(base8)	Bits	Description
IAPT	0	0-7	Application protocol type
IATYPE	0	8-23	Application level message type
IAHL	0	24-31	Header length
IALI	0	32-47	Total message length including header
IAPN1	1	0-63	First word of the process name
IAPN2	2	0-63	Second word of the process name
IAMSZ	3	0-15	Size of the message text
IAMOF	3	16-31	Offset of the message text
IAMTCD	3	32-47	Termination code LE@IAMJT=4 LE@IAMEA=4 LE@IAMJL=4 LE@IAMTE=4 LE@IAMTT=4

ICP level messages of the type
 JI - Job Init
 have the following form

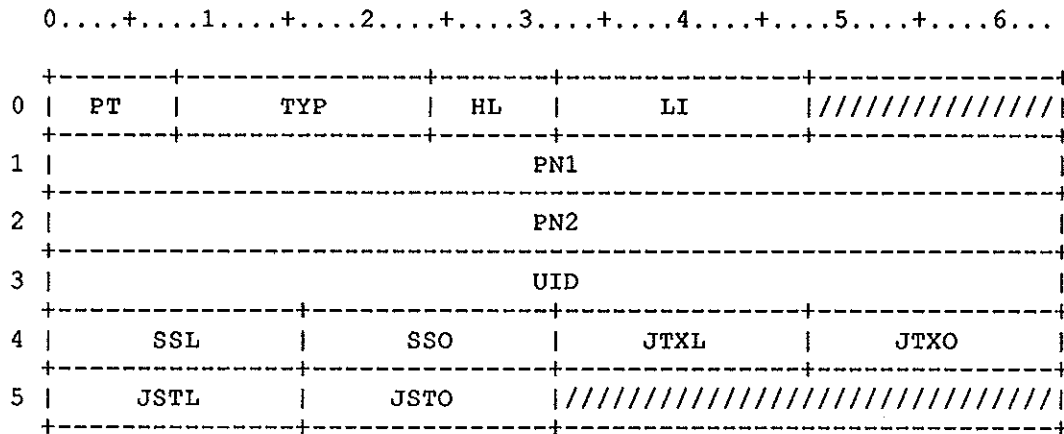

Figure IA-4. ISP ICP Messages JI

Field	Word(base8)	Bits	Description
IAPT	0	0-7	Application Protocol type
IATYP	0	8-23	Application level message type
IAHL	0	24-31	Header length
IALI	0	32-47	Total message length including header
IAPN1	1	0-63	First word of process name
IAPN2	2	0-63	Second word of process name
IAUID	3	0-63	User ID from dataset header
IASSL	4	0-15	Length of job's system slot
IASSO	4	16-31	Offset to job's system slot
IAJTXL	4	32-47	Length of job init's text
IAJTXO	4	48-63	Offset to job init's text
IAJSTL	5	0-15	Length of job init's secured text
IAJSTO	5	16-31	Offset to job init's secured text LE@IAMJI=6

JCP level messages of the type
 TI - Task Init
 have the following form

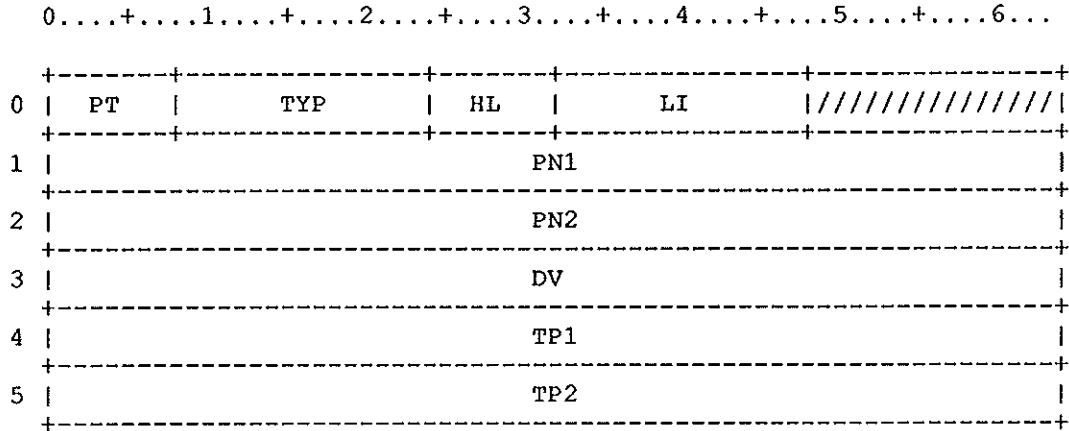

Figure IA-5. ISP JCP Messages TI

Field	Word(base8)	Bits	Description
IAPT	0	0-7	Application Protocol type
IATYP	0	8-23	Application level message type
IAHL	0	24-31	Header length
IALI	0	32-47	Total message length including header
IAPN1	1	0-63	First word of process name
IAPN2	2	0-63	Second word of process name
IADV	3	0-63	Device descriptor word
IATP1	4	0-63	First word of task process name
IATP2	5	0-63	Second word of task process name

LE@IAMTI=6 Length of the Taskinit message

DTP level messages of the type
 AC - Access
 have the following form

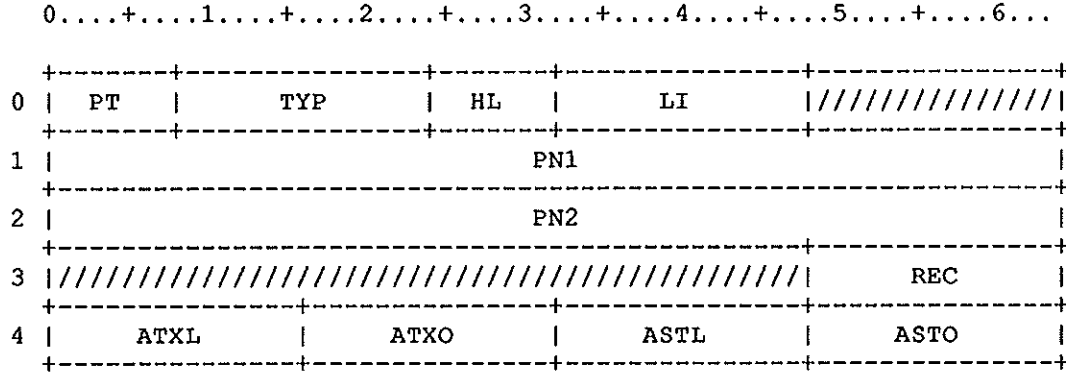

Figure IA-6. ISP DTP Messages AC

Field	Word(base8)	Bits	Description
IAPT	0	0-7	Application protocol type
IATYP	0	8-23	Application level message type
IAHL	0	24-31	Header length
IALI	0	32-47	Total message length including header
IAPN1	1	0-63	First word of process name
IAPN2	2	0-63	Second word of process name
IAREC	3	48-63	Flag indicating RE-ACCESS
IAATXL	4	0-15	Access text length
IAATXO	4	16-31	Access text offset
IAASTL	4	32-47	Access secured text length
IAASTO	4	48-63	Access secured text offset

LE@IAMAC=5 ACCESS message length
 excluding text

DTP level messages of the type
 AR - Access Reply
 have the following form

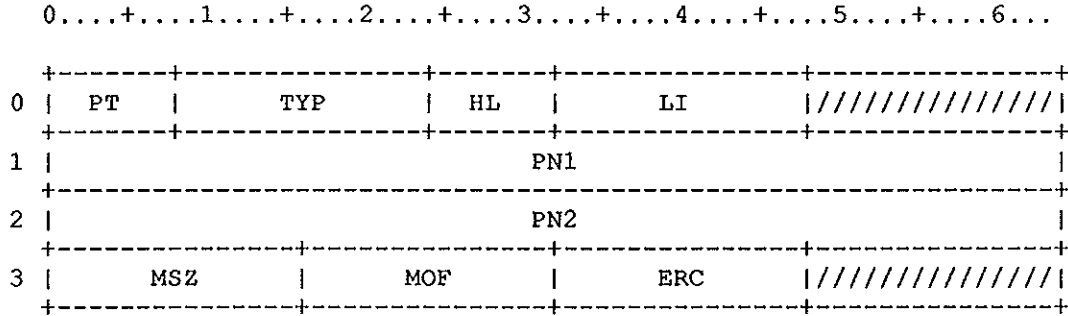

Figure IA-7. ISP DTP Messages AR

<u>Field</u>	<u>Word(base8)</u>	<u>Bits</u>	<u>Description</u>
IAPT	0	0-7	Application protocol type
IATYP	0	8-23	Application level message type
IAHL	0	24-31	Header length
IALI	0	32-47	Total message length including header
IAPN1	1	0-63	First word of the process name
IAPN2	2	0-63	Second word of the process name
IAMSZ	3	0-15	Size of the message text
IAMOF	3	16-31	Offset of the message text
IAERC	3	32-47	Error code if ACCESS failed LE@IAMAR=4

DTP level messages of the type
 OP - Open
 have the following form

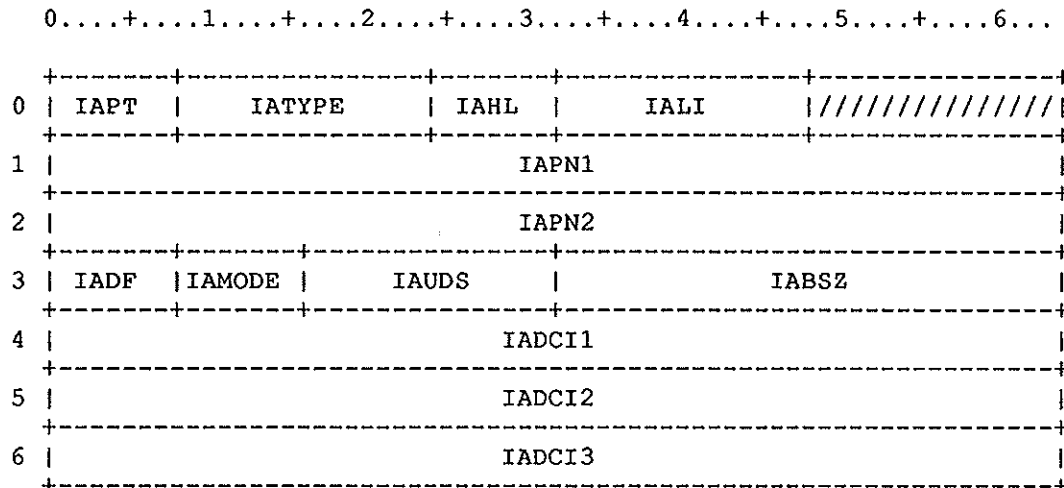

Figure AI-8. ISP DTP Messages OP

Field	Word(base8)	Bits	Description
IAPT	0	0-7	Application protocol type
IATYPE	0	8-23	Application level message type
IAHL	0	24-31	Header length
IALI	0	32-47	Total message length including header
IAPN1	1	0-63	First word of process name
IAPN2	2	0-63	Second word of process name
IADF	3	0-7	Dataset format 0 = Transparent 1 = Blocked binary 2 = Blocked character
IAMODE	3	8-15	Transfer mode 0 = Read 1 = Write
IAUDS	3	16-31	Dataset structure
IABSZ	3	32-63	Buffer size
IADCI1	4	0-63	First dataset control word

<u>Field</u>	<u>Word(base8)</u>	<u>Bits</u>	<u>Description</u>
IADCI2	5	0-63	Second dataset control word
IADCI3	6	0-63	Third dataset control word LE@IAMOP=7 Length of the OPEN message

DTP level messages of the type
 OR - Open Reply
 have the following form

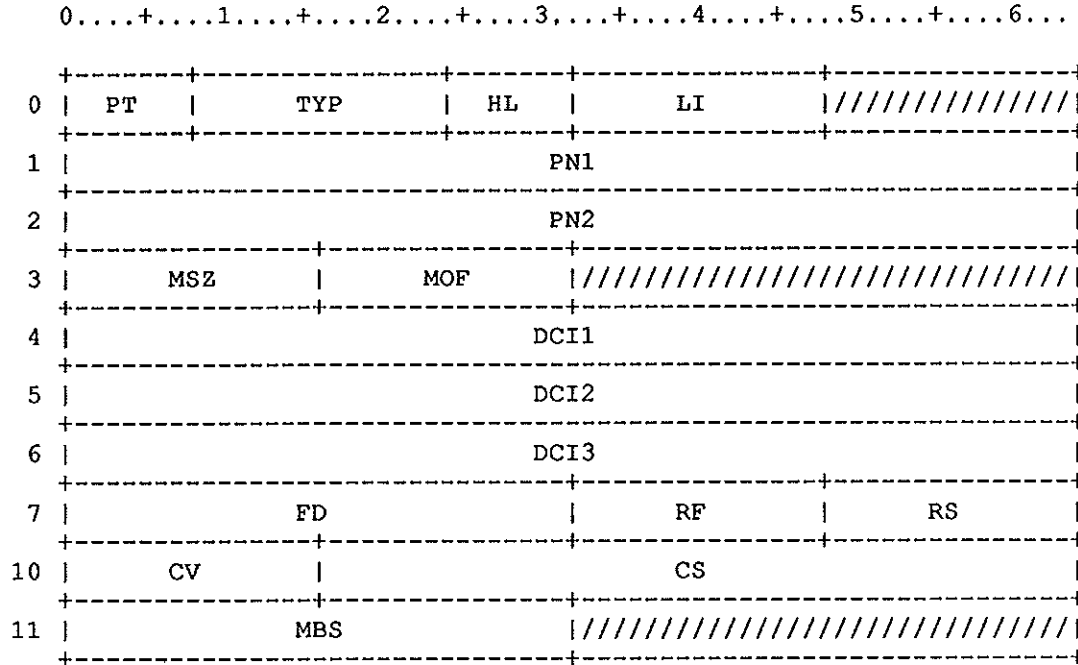

Figure IA-9. ISP DTP Message OR

Field	Word(base8)	Bits	Description
IAPT	0	0-7	Application protocol type
IATYP	0	8-23	Application level message type
IAHL	0	24-31	Header length
IALI	0	32-47	Total message length including header
IAPN1	1	0-63	First word of process name
IAPN2	2	0-63	Second word of process name
IAMSZ	3	0-15	Size of message text
IAMOF	3	16-31	Offset of message text
IADCI1	4	0-63	First dataset control word
IADCI2	5	0-63	Second dataset control word
IADCI3	6	0-63	Third dataset control word

<u>Field</u>	<u>Word(base8)</u>	<u>Bits</u>	<u>Description</u>
IAFD	7	0-31	Foreign data type
IARF	7	32-47	Record format
IARS	7	48-63	Record size
IACV	10	0-15	Access code
IACS	10	16-63	Character set
IAMBS	11	0-31	Maximum block size LE@IAMOR=D'10 Length of the Open Reply message

DTP level messages of the type
 CL - Close
 RL - Release
 have the following form

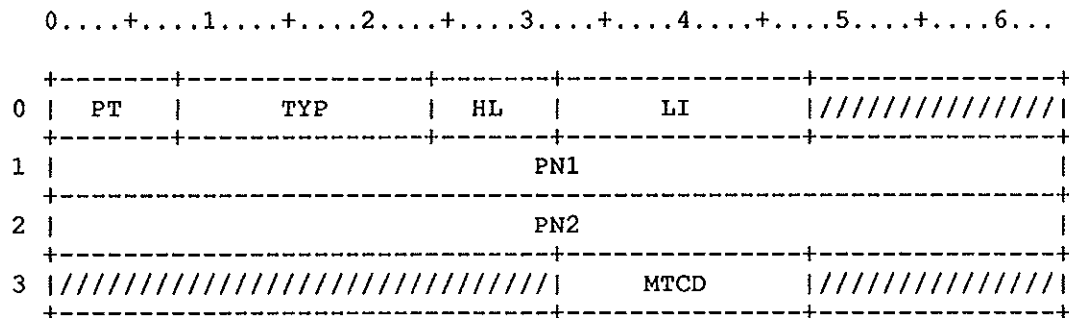

Figure IA-10. ISP DTP Messages CL,RL

Field	Word(base8)	Bits	Description
IAPT	0	0-7	Application protocol type
IATYP	0	8-23	Application level message type
IAHL	0	24-31	Header length
IALI	0	32-47	Total message length including header
IAPN1	1	0-63	First word of process name
IAPN2	2	0-63	Second word of process name
IAMTCD	3	32-47	Termination code LE@IAMCL=4 Length of the CLOSE message LE@IAMRL=4 Length of the RELEASE message

DTP level messages of the type
 NR - Norerun
 RW - Rewind
 have the following form

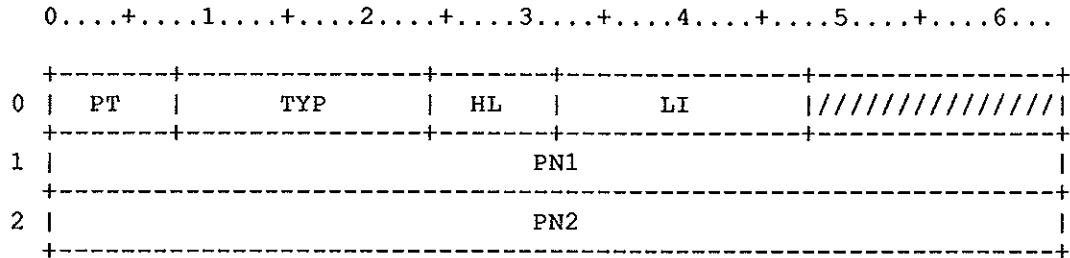

Figure IA-11. ISP DTP Message NR

Field	Word(base8)	Bits	Description
IAPT	0	0-7	Application protocol type
IATYP	0	8-23	Application level message type
IAHL	0	24-31	Header length
IALI	0	32-47	Total message length including header
IAPN1	1	0-63	First word of process name
IAPN2	2	0-63	Second word of process name LE@IAMNR=3 Length of the No Rerun message LE@IAMRW=3 Length of the Rewind message

The Interactive Buffer Table is STP resident and is used to manage the Interactive Buffer Pool Table.

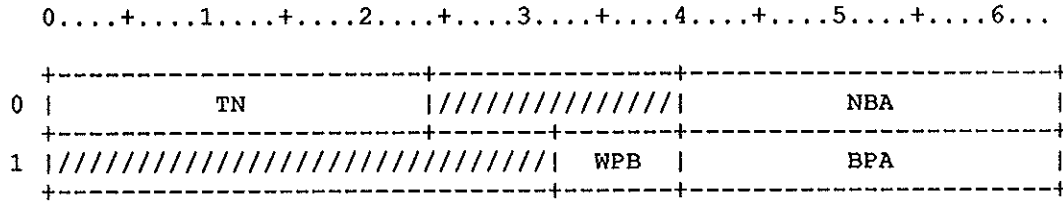

Figure IB-1. Interactive Buffer Table Header

Field	Word(base8)	Bits	Description
IBTN	0	0-23	Table name
IBNBA	0	40-63	Number of available buffers
IBWPB	1	32-39	Words per bit
IBBPA	1	40-63	Buffer pool beginning address

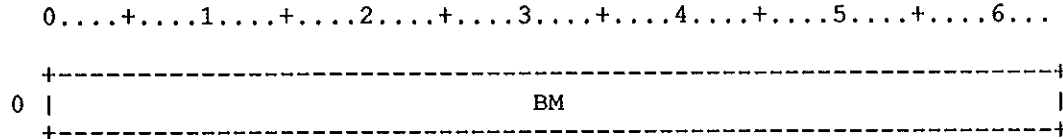

Figure IB-2. Interactive Buffer Table Entry

Field	Word(base8)	Bits	Description
IBBM	0	0-63	Bit map

The Inter-task Communication Table is STP-resident and is used to queue requests and replies between STP tasks.

Since inter-task queues are circular in nature, the ICT strongly resembles a Dataset Parameter Table (DSP), with the familiar FIRST, IN, OUT, and LIMIT pointers. These pointers refer to a block of one or more TMT entries, the definition of which can be found in COMTM. Messages are placed in the queue at IN, and removed from OUT, thus producing a First-in First-out ordering. In addition, a count is kept in the ICT of the number of active messages on the queue; this count is used to distinguish between queue empty and queue full conditions when IN equals OUT. It could also be collected for statistical purposes by SPM or other performance measuring tools.

As seen in memory, the format of the ICT entries appears different depending on whether the ICT is for a request or a reply queue. For request queues, the ICT entries for the tasks are contiguous. For reply queues, there is a single TMT entry following each reply ICT entry, which makes the reply ICTs appear larger. This single TMT entry associated with each reply ICT is used exclusively for replies from TSKREQ requests.

Some tasks have zero-length queues. These can be readily identified in memory by an ICUSED field of -1, and that FIRST=IN=OUT=LIMIT=0.

0.....+.....1.....+.....2.....+.....3.....+.....4.....+.....5.....+.....6...

0		TNQT	
1		USED	
2		FRST	
3		IN	
4		OUT	
5		LMT	

Figure IC-1. STP Inter-task Communication Table

Field	Word(base8)	Bits	Description
ICTNQT	0	0-63	Task name and queue type (ascii)
ICUSED	1	0-63	Number of messages in queue
ICFRST	2	0-63	FWA of message queue
ICIN	3	0-63	Word address for next message IN
ICOUT	4	0-63	Word address for next message OUT
ICLMT	5	0-63	LWA+1 of message queue

ISP Transport Messages are transmitted in a block of up to 512 Cray words, containing as many messages as are queued for transmission. The block begins with a six-word link header.

There are two formats of the header, depending on the message code. The first is for a Link Control Header, which contains protocol for control of the channel. The second the Link Data Header, which precedes ISP data on the channel. Both header formats are checksummed, and contain bit patterns which are used as a continuous diagnostic on the channels and interface units. They are differentiated by the contents of the IHFC field, which is zero for a Link Data Header, and nonzero for Link Control Headers.

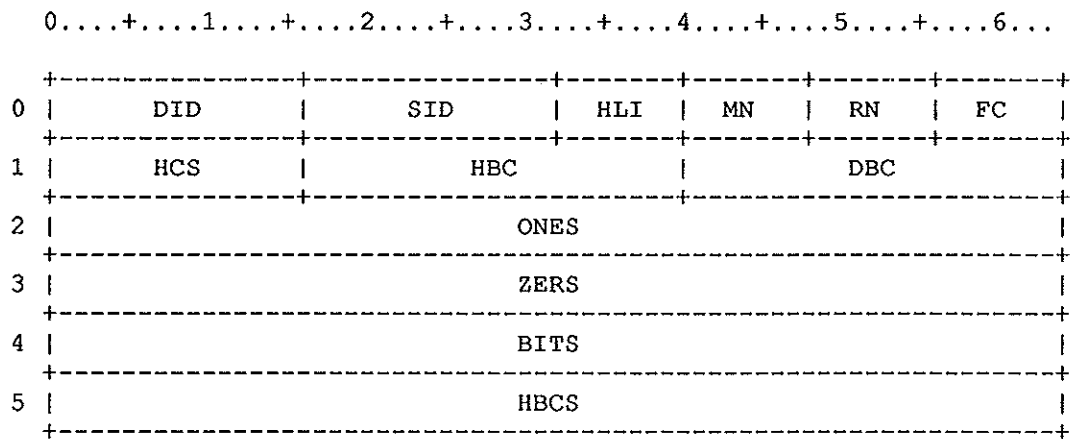

Figure IH-1. ISP Link Header

Field	Word(base8)	Bits	Description
IHDID	0	0-15	Destination I.D. (2 ASCII chars)
IHSID	0	16-31	Source I.D. (2 ASCII characters)
IHHLI	0	32-39	Header length (D'48 bytes)
IHMN	0	40-47	Message number
IHRN	0	48-55	Received message number (deferred)
IHFC	0	56-63	Link function code: IHFC\$DAT=0 Data header IHFC\$RST=1 RESET command IHFC\$RDY=2 READY command
IHHCS	1	0-15	Header checksum
IHHBC	1	16-39	Header block bit count

Field	Word(base8)	Bits	Description
IHDBC	1	40-63	Data block bit count
IHONES	2	0-63	O'17777777777777777777
IHZERS	3	0-63	O'00000000000000000000
IHBITS	4	0-63	O'01111111111106666644444
IHHBCS	5	0-63	Header block checksum

LE@IHL=6 Length of link-level header only

Some of these definitions are duplicated in the IOS driver overlay for the ISP, ISPDRV. If you change any of the following definitions, the driver must be modified as well. In addition, the driver assumes that the first LE@IHL words of the header have a 16-bit checksum of zero.

In the RESET header, the IHZERS word (word 3), which contains zeros for error diagnostic purposes in other type headers, holds information about the last fatal error, if any, encountered on any link to the same remote transport service.

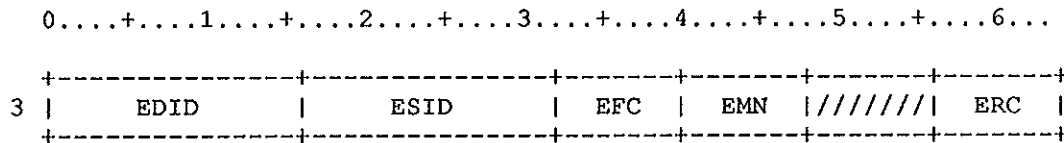

Figure IH-2. RESET Reason Code

Field	Word(base8)	Bits	Description
IHEDID	3	0-15	DID from header of error block
IHESID	3	16-31	SID from header of error block
IHEFC	3	32-39	FC from header of error block
IHEMN	3	40-47	MN from header of error block
IHERC	3	56-63	Error reason code (CST\$xxx)

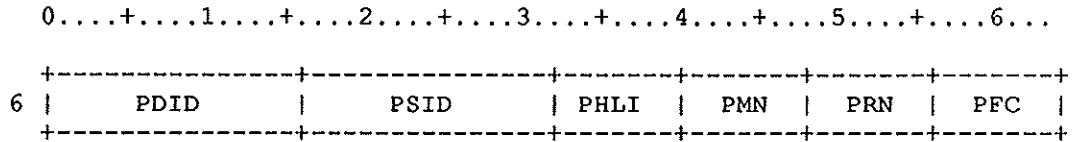

Figure IH-3. ISP Path Header

<u>Field</u>	<u>Word(base8)</u>	<u>Bits</u>	<u>Description</u>
IHPDID	6	0-15	Path destination I.D.
IHPSID	6	16-31	Path source I.D.
IHPHLI	6	32-39	Path header length (8 bytes)
IHPMN	6	40-47	Path message number (unused)
IHPRN	6	48-55	Path received number (unused)
IHPFC	6	56-63	Path function code: IHPF\$DAT=0 Data LE@IHP=1 Length of path-level header

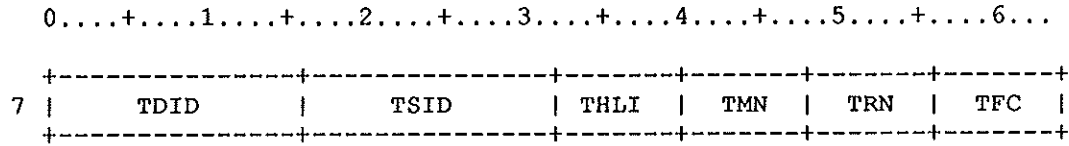

Figure IH-4. ISP Transport Header

<u>Field</u>	<u>Word(base8)</u>	<u>Bits</u>	<u>Description</u>
IHTDID	7	0-15	Transport destination I.D.
IHTSID	7	16-31	Transport source I.D.
IHTHLI	7	32-39	Transport header length (8 bytes)
IHTMN	7	40-47	Transport message number (unused)
IHTRN	7	48-55	Transport received number (unused)
IHTFC	7	56-63	Transport function code: IHTF\$TMG=1 Transport-level messages LE@IHT=1 Length of transport-level header

The ISP Dataset Definition table (IDD) is constructed during the CONNECT statement processing by EXP, and sent to the ISP as part of the ACCESS and REACCESS messages in the Dataset Transmission Protocol.

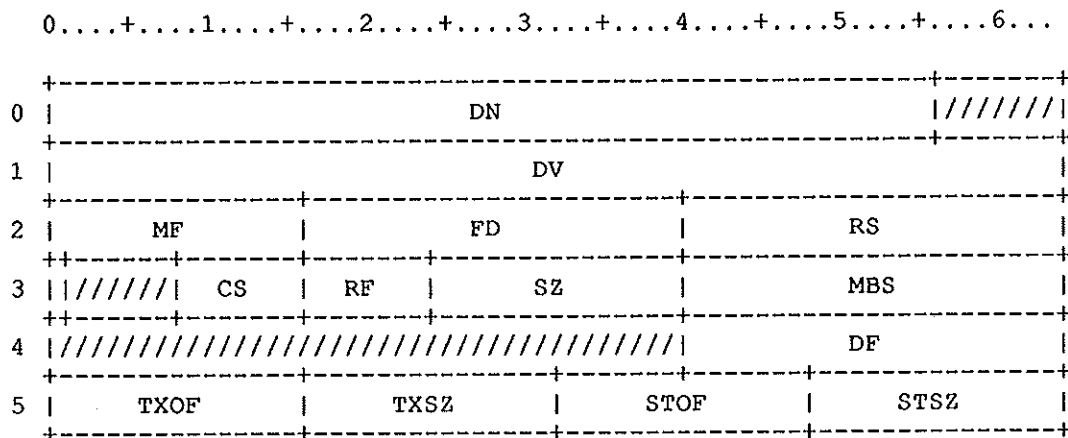

Figure II-1. ISP Dataset Definition Table

Field	Word(base8)	Bits	Description
IIDN	0	0-55	Dataset name (1-7 ASCII characters)
IIDV	1	0-63	Logical ISP device type (8 characters)
IIMF	2	0-15	ISP mainframe ID (2 ASCII characters)
IIFD	2	16-39	File format type (3 ASCII characters - IBM, CDC, etc.)
IIRS	2	40-63	Record length in bytes
IICV	3	0	Conversion enable flag (1 enables conversion by \$IOLIB)
IICS	3	8-15	Character-set code 0 = ASCII 1 = EBCDIC
IIRF	3	16-23	Record format 0 = none 1 = IBM undefined 2 = IBM fixed 3 = IBM fixed blocked 4 = IBM variable 5 = IBM variable blocked 6 = IBM variable blocked span

<u>Field</u>	<u>Word(base8)</u>	<u>Bits</u>	<u>Description</u>
IISZ	3	24-39	Total size of this IDD
IIMBS	3	40-63	Maximum block size in bytes
IIDF	4	40-63	Datset format 0 = Transparent (TR) 1 = Binary blocked (BB) 2 = Character blocked (CB)
IITXOF	5	0-15	Offset to the user text
IITXSZ	5	16-31	Size of the user text
IISTOF	5	32-47	Offset to the user secured text
IISTSZ	5	48-63	Size of the user secured text W@IITXT=6 Beginning of text (one or more ISP text records may follow)

IJMS\$AR=01	ID is already receptive
IJMS\$AU=02	ID is in use
IJMS\$BA=03	buffer address or length bad
IJMS\$BN=04	NCB is bad
IJMS\$BNA=05	NCB address is bad
IJMS\$BP=06	path is busy
IJMS\$HL=07	HLEN error
IJMS\$IF=08	IPT full
IJMS\$INR=09	ID not registered
IJMS\$INS=10	ID not specified
IJMS\$MC=11	bad log message class
IJMS\$ML=12	bad message length
IJMS\$NA=13	ID is not attached
IJMS\$NE=14	path is not open
IJMS\$NO=15	no outstanding open request
IJMS\$NP=16	path does not exist
IJMS\$NR=17	ID is not receptive
IJMS\$OO=18	outstanding OPEN was found
IJMS\$PE=19	path is already established
IJMS\$PF=20	memory pool is full
IJMS\$PR=21	ID is privileged
IJMS\$RB=22	bad RCB address
IJMS\$RF=23	RIT full
IJMS\$TA=24	target's buffer address is bad
IJMS\$TL=25	target's buffer length is bad

The following responses terminate a request chain.

IJMS\$BE=32	IJPB length error
IJMS\$BF=33	undefined function
IJMS\$LA=34	bad link address
IJMS\$MT=35	more than one active TXT
IJMS\$NC=36	RIT or IPT has zero entries
IJMS\$PV=37	privileged function
IJMS\$TP=38	more than I@MPBS parameter blocks
IJMS\$MAX=39	maximum status value + 1

IJFUNC 3 0-63 subfunction code

If any values are changed, SYSLIB must be changed also.

IJM\$NOP=00 no op
 IJM\$REC=01 request receptivity
 state
 IJM\$OPEN=02 open a communication
 path
 IJM\$ACCE=03 accept an IJM\$OPEN
 request
 IJM\$REJE=04 reject an IJM\$OPEN
 request
 IJM\$SNDM=05 send a message
 IJM\$CLOS=06 close a communication
 path
 IJM\$END=07 ends the receptivity
 state

IJM\$\$HNP=07+1 maximum
 value + 1 of unprivileged
 subfunctions

IJM\$\$MIP=32 minimum privileged
 function value

IJM\$SNDL=32 send a logfile message
 (privileged)

IJM\$\$MAX=32+1 maximum
 subfunction value + 1

IJRID	4	0-63	ID of the requesting job
IJTID	5	0-63	ID of the target job
IJRCB	6	40-63	RCB address
IJNCB	7	40-63	NCB address
IJBLEN	10	48-63	message buffer length
IJBADD	11	40-63	message buffer address
IJOVR	12	0-63	log message over-ride flag
IJFCS	13	0-63	log message to system log
IJFCU	14	0-63	log message to user log
IJCLS	15	0-63	log message class

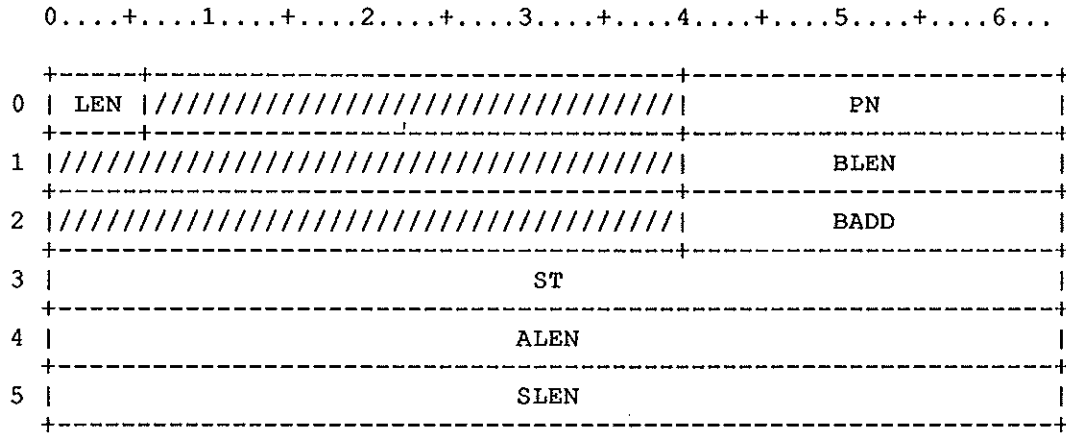

Figure NC-1. Node Control Block

Field	Word(base8)	Bits	Description
NCLLEN	0	0-5	length of the NCB (L@NCB)
NCPN	0	40-63	IPT offset for this path
NCBLEN	1	40-63	length of the node buffer
NCBADD	2	40-63	address of the node buffer
NCST	3	0-63	status
NCMS	3	0	message status
NCOS	3	48-63	open status

If any values are changed, SYSLIB must be changed also.

		NCB\$ACC='AC'R	open request
		accepted	
		NCB\$REJ='RJ'R	open request
		rejected	
		NCB\$CLO='CL'R	path was
		closed	
NCALEN	4	0-63	length of message put into buffer
NCSLEN	5	0-63	length of the message sent
		L@NCMH=2	length of the message
		header	

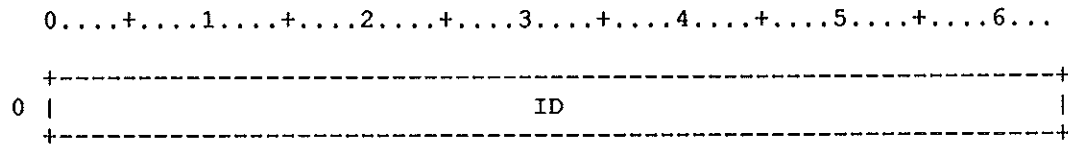

Figure RCB-1. Receptive Control Block

<u>Field</u>	<u>Word(base8)</u>	<u>Bits</u>	<u>Description</u>
RCBID	0	0-63	ID of the job requesting connection

The ISP Link Table is used by the Integrated Support Processor communication task, IQM, to control communication links to the ISPs. There is one ILT entry for each input or output FEI box.

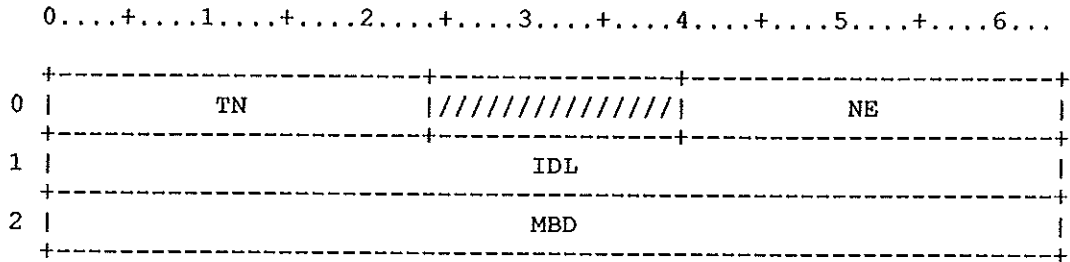

Figure IL-1. ISP Link Table Header

<u>Field</u>	<u>Word(base8)</u>	<u>Bits</u>	<u>Description</u>
ILTN	0	0-23	Table name -- ASCII 'ILT'
ILNE	0	40-63	Number of entries
ILIDL	1	0-63	Idling interval in clock periods
ILMBD	2	0-63	Message block delay interval

<u>Field</u>	<u>Word(base8)</u>	<u>Bits</u>	<u>Description</u>
ILRT	3	0-63	Real-time clock at last transmission
ILPUDL	4	0-31	User data length
ILLBA	4	32-63	Link buffer address

The following ILT entry fields hold data about link I/O performance.

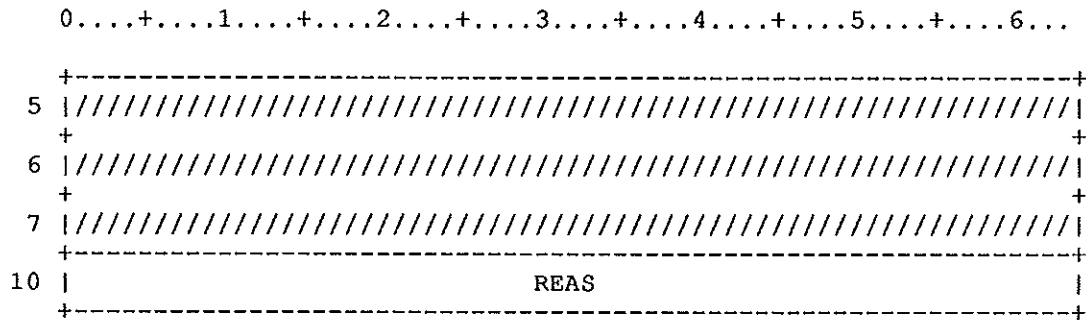

Figure IL-3. ISP Link Table (Link Statistics)

<u>Field</u>	<u>Word(base8)</u>	<u>Bits</u>	<u>Description</u>
ILREAS	10	0-63	Reset reason code
ILEDID	10	0-15	DID from header of error block
ILESID	10	16-31	SID from header of error block
ILEFC	10	32-39	FC from header of error block
ILEMN	10	40-47	MN from header of error block
ILERC	10	56-63	Error reason code (CST\$xxx)

Fields in this portion of the ILT entry are used by IQM to manage I/O driver request activity.

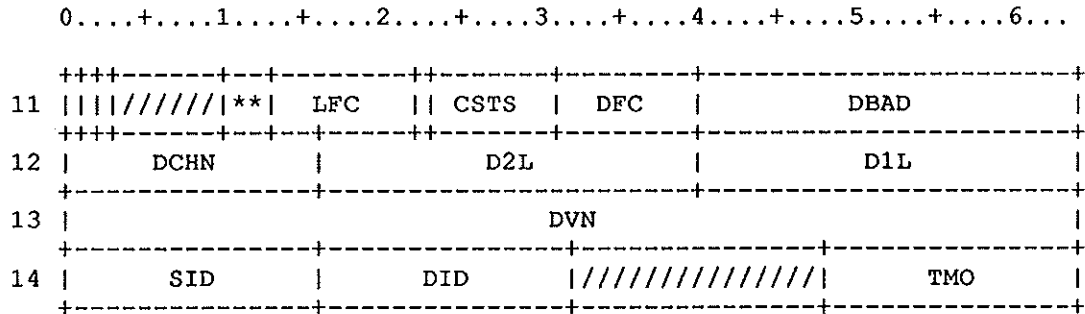

Figure IL-4. ISP Link Table (Driver Control)

Field	Word(base8)	Bits	Description
ILDBZ	11	0	Driver request busy
ILDDN	11	1	Driver request done
ILDOPN	11	2	Driver open
ILPLST	11	10-12	Link state prior to last driver reply
ILLFC	11	13-21	Last link header function code (IHFC)
ILCSTS	11	23-30	Channel status code (CST\$xxx)
ILCST2	11	23	Status of 2nd half of RDD and WTD
ILCST	11	24-30	Driver request status: CST\$xxx codes < 0'40 are returned by the driver shell, and are defined in COMAP. Codes between 0'40 and 0'77 are returned by the driver. Codes 0'100 through 0'177 come from verification of link-layer headers.

CST\$TMO=0'40 Driver request timeout
 CST\$HWE=0'41 Driver hardware error
 CST\$CTY=0'42 Illegal channel type
 on driver open
 CST\$DFC=0'43 Illegal driver
 function code
 CST\$LEN=0'44 Driver detected data
 length error
 CST\$NOI=0'60 Noise record (< 48
 bytes)
 CST\$HCS=0'61 Invalid link header
 checksum
 CST\$HSZ=0'62 Incorrect transmission
 length
 CST\$BCS=0'63 Invalid header block
 checksum
 CST\$ONE=0'64 Dropped bits in IHONES
 field
 CST\$ZER=0'65 Picked bits in IHZERS
 field
 CST\$BIT=0'66 Invalid IHBITS field
 CST\$HLI=0'67 Invalid IHHLI field
 CST\$MN=0'70 Incorrect message
 number (IHMN)
 CST\$HFC=0'71 Invalid link function
 code (IHFC)
 CST\$OFF=0'72 Link turned off
 CST\$OLD=0'73 Couldn't find output
 link to send on
 CST\$RST=0'74 RESET message received
 while UP
 CST\$MTYP=0'101 Invalid
 transport message type field
 CST\$DCN=0'102 Missing DCN
 in transport message
 CST\$MLI=0'103 Bad
 transport message length field
 CST\$SCN=0'104 Missing SCN
 in CON or CNF message
 CST\$MHL=0'105 Bad
 transport message header length
 CST\$FLC=0'106 FLC message
 too short
 CST\$MX=0'106 Maximum link error
 message code

ILDFC	11	31-39	Driver function code
ILDBAD	11	40-63	1st Buffer address from last I/O W@ILIQY3=W@ILDBAD 3rd word of HTIQY history trace record
ILDCHN	12	0-15	Driver channel number
ILD2L	12	16-39	2nd data length on last I/O

<u>Field</u>	<u>Word(base8)</u>	<u>Bits</u>	<u>Description</u>
ILD1L	12	40-63	1st data length on last I/O W@ILIQY4=W@ILDCHN 4th word of HTIQY history trace record
ILDVN	13	0-63	Driver name (ASCII)
ILSID	14	0-15	Link source ID
ILDID	14	16-31	Link Destination ID
ILTMO	14	48-63	Channel default timeout

This section of the ILT entry contains fields used by IQM to control the ISP transport layer's use of the link.

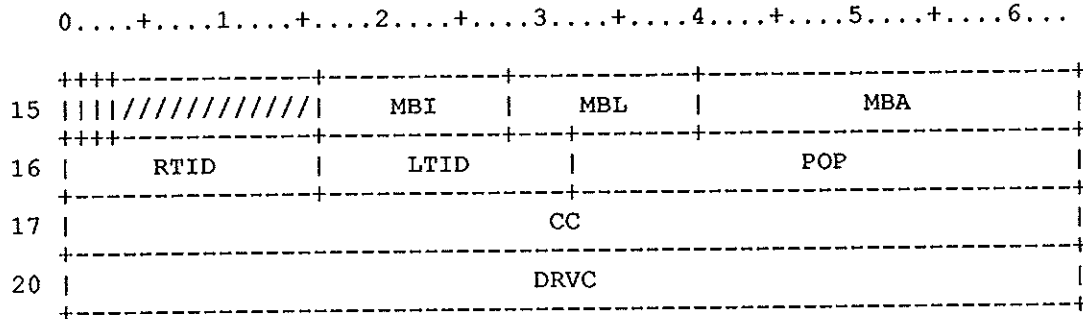

Figure IL-5. ISP Link Table (Transport Control)

Field	Word(base8)	Bits	Description
ILSMB	15	0	Must-send message block flag
ILPRI	15	1	Data path information to transmit
ILWAIT	15	2	Circuits waiting for this link
ILMBI	15	16-27	Message buffer index
ILMBL	15	28-39	Message buffer length
ILMBA	15	40-63	Message buffer address
ILRTID	16	0-15	Remote Transport I.D.
ILLTID	16	16-31	Local Transport I.D.
ILPOP	16	32-63	Number of circuits on this ILT
ILCC	17	0-63	Chain control (queue of VCTs)
ILREQP	17	8-15	Nonzero if data request pending
ILVCT	17	16-39	Address of first VCT on queue
ILDRVC	20	0-63	Next VCT for DATA I/O

The Transport Message is a unit of information (usually control information) that passes between the two halves of the transport service in the Integrated Support Processor system. One half is the COS task IQM. The other is a mirror-image process in the ISP. Transport messages consist of a header followed by optional user data. The user data normally comes from operating system components such as EXP. To the transport service, this is user data in the sense that it is transmitted as a meaningless transparent bit string. Only the MSG and DIS messages (see below) may carry user data.

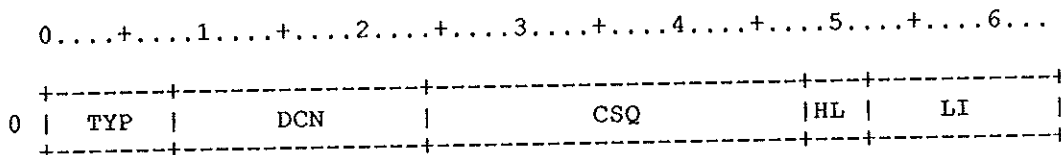

Figure IM-1. ISP Transport Message Header

The header that precedes all Transport Messages (TPDUs) begins with this word, regardless of message type.

Field	Word(base8)	Bits	Description
IMTYP	0	0-7	Message type code: IMT\$NUL=0 NULL message IMT\$CON=1 CONNECT IMT\$CNF=2 CONFIRM IMT\$DIS=3 DISCONNECT IMT\$MSG=4 USER MESSAGE IMT\$RD=5 READ DATA request IMT\$WD=6 WRITE DATA IMT\$DPE=7 DATA PATH END IMT\$NRDY=D'8 Data path NOT READY IMT\$RDY=D'9 Data path READY IMT\$FLC=D'10 Message FLOW CONTROL IMT\$DPB=D'11 DATA PATH BEGIN IMT\$MAX=D'11 Highest legal code
IMDCN	0	8-23	Destination connection number
IMCSQ	0	24-47	Connection sequence number

<u>Field</u>	<u>Word(base8)</u>	<u>Bits</u>	<u>Description</u>
IMHL	0	48-51	Message header length IML\$CON=4 CONNECT IML\$CNF=2 CONFIRM IML\$DIS=2 DISCONNECT IML\$MSG=1 MESSAGE IML\$RD=5 READ DATA IML\$WD=5 WRITE DATA IML\$DPE=1 DATA PATH END IML\$NRDY=1 NOT READY IML\$RDY=1 READY IML\$FLC=1 FLOW CONTROL IML\$DPB=2 DATA PATH BEGIN
IMLI	0	52-63	TPDU length indicator

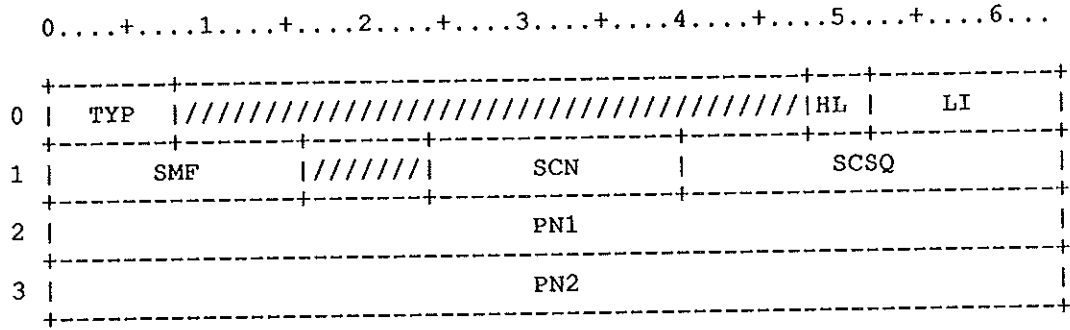

Figure IM-2. CONNECT Message

The CONNECT Message consists of a four-word header with no user data. The header specifies who is calling and who is being called.

Field	Word(base8)	Bits	Description
IMTYP	0	0-7	Message type code
IMHL	0	48-51	Message header length
IMLI	0	52-63	TPDU length indicator
IMSMF	1	0-15	Source mainframe I.D.
IMSCN	1	24-39	Source (caller's) connection number
IMSCSQ	1	40-63	Source connection sequence number
IMPN1	2	0-63	Destination name (1st 8 characters)
IMPN2	3	0-63	Destination name (2nd 8 characters)

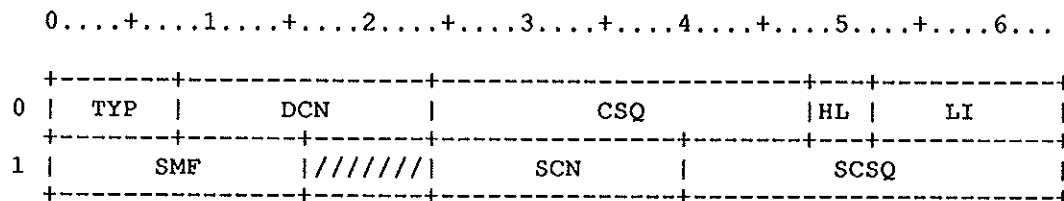

Figure IM-3. CONFIRM Message

The CONFIRM message is 2 words long, with no user data. It sends the local connection number to a remote caller.

Field	Word(base8)	Bits	Description
IMTYP	0	0-7	Message type code
IMDCN	0	8-23	Destination connection number
IMCSQ	0	24-47	Connection sequence number
IMHL	0	48-51	Message header length
IMLI	0	52-63	TPDU length indicator
IMSMF	1	0-15	Source mainframe I.D.
IMSCN	1	24-39	Source (called) connection number
IMSCSQ	1	40-63	Source connection sequence number

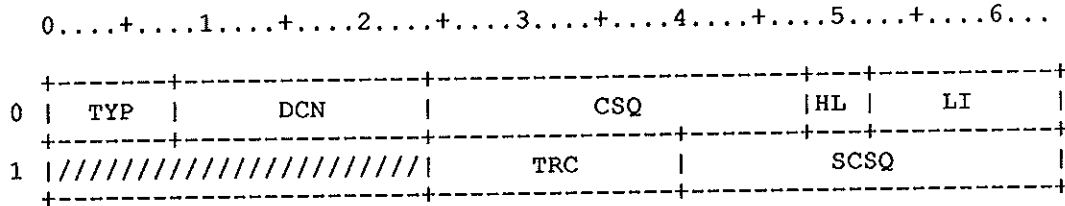

Figure IM-4. DISCONNECT Message

The DISCONNECT message has a 2-word header, and can carry user data as well.

Field	Word(base8)	Bits	Description
IMTYP	0	0-7	Message type code
IMDCN	0	8-23	Destination connection number
IMCSQ	0	24-47	Connection sequence number
IMHL	0	48-51	Message header length
IMLI	0	52-63	TPDU length indicator
IMTRC	1	24-39	Transport disconnect reason code
IMSCSQ	1	40-63	Source connection sequence number

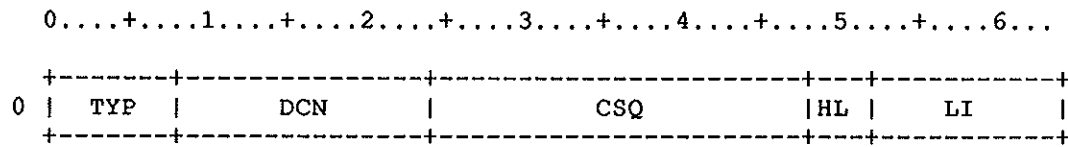

Figure IM-5. MESSAGE Message

The MESSAGE Message carries a user message after a one-word header.

<u>Field</u>	<u>Word(base8)</u>	<u>Bits</u>	<u>Description</u>
IMTYP	0	0-7	Message type code
IMDCN	0	8-23	Destination connection number
IMCSQ	0	24-47	Connection sequence number
IMHL	0	48-51	Message header length
IMLI	0	52-63	TPDU length indicator

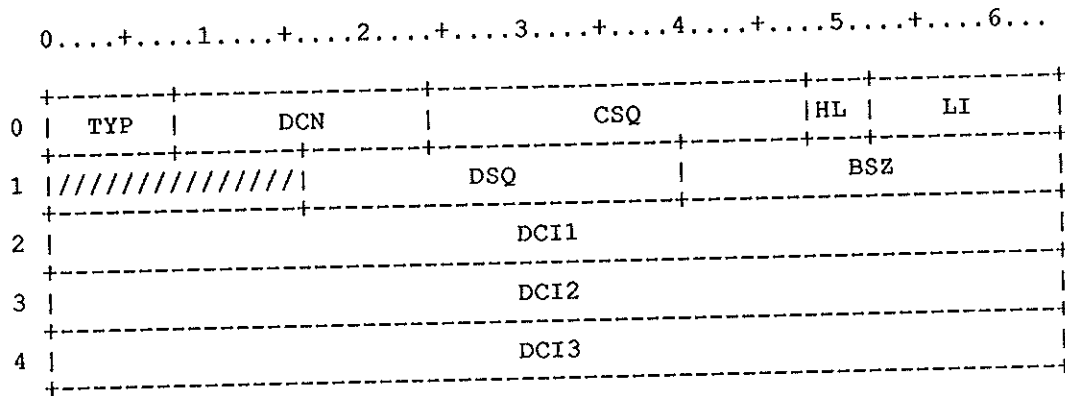

Figure IM-6. READ DATA Message

The READ DATA message has no associated user message, but has a 5-word header containing information about the READ DATA request.

Field	Word(base8)	Bits	Description
IMTYP	0	0-7	Message type code
IMDCN	0	8-23	Destination connection number
IMCSQ	0	24-47	Connection sequence number
IMHL	0	48-51	Message header length
IMLI	0	52-63	TPDU length indicator
IMDSQ	1	16-39	Data request sequence number
IMBSZ	1	40-63	Read buffer size in 64-bit words
IMDCI1	2	0-63	Data control information
IMDCI2	3	0-63	Data control information
IMDCI3	4	0-63	Data control information

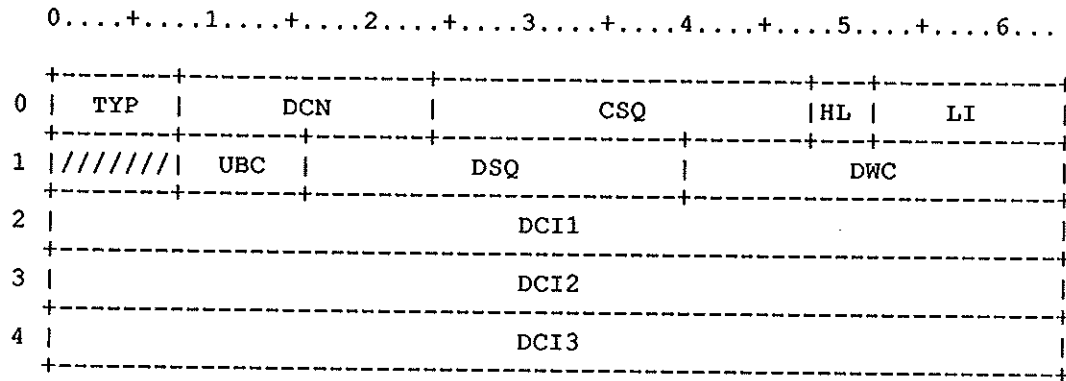

Figure IM-7. WRITE DATA Message

The WRITE DATA message has no user data attached. It describes the contents of the next data block.

Field	Word(base8)	Bits	Description
IMTYP	0	0-7	Message type code
IMDCN	0	8-23	Destination connection number
IMCSQ	0	24-47	Connection sequence number
IMHL	0	48-51	Message header length
IMLI	0	52-63	TPDU length indicator
IMUBC	1	8-15	Number of unused bits in last word
IMDSQ	1	16-39	Data request sequence number
IMDWC	1	40-63	Data length in 64-bit words
IMDCI1	2	0-63	Data control information
IMDCI2	3	0-63	Data control information
IMDCI3	4	0-63	Data control information

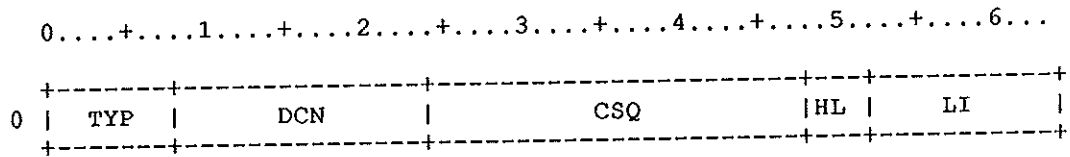

Figure IM-8. DATA PATH END Message

The DATA PATH END message terminates a data transfer sequence. It has a one-word header and no user message.

Field	Word(base8)	Bits	Description
IMTYP	0	0-7	Message type code
IMDCN	0	8-23	Destination connection number
IMCSQ	0	24-47	Connection sequence number
IMHL	0	48-51	Message header length
IMLI	0	52-63	TPDU length indicator

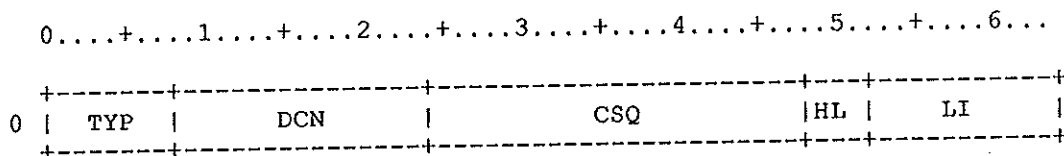

Figure IM-9. NOT READY Message

The NOT READY message suspends a data transfer sequence. It has a one-word header and no user message.

Field	Word(base8)	Bits	Description
IMTYP	0	0-7	Message type code
IMDCN	0	8-23	Destination connection number
IMCSQ	0	24-47	Connection sequence number
IMHL	0	48-51	Message header length
IMLI	0	52-63	TPDU length indicator

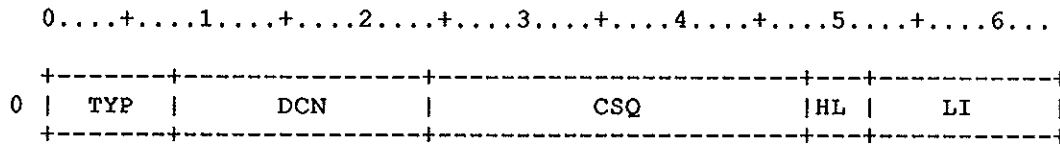

Figure IM-10. READY Message

The READY message resumes a data transfer sequence. It has a one-word header and no user message.

Field	Word(base8)	Bits	Description
IMTYP	0	0-7	Message type code
IMDCN	0	8-23	Destination connection number
IMCSQ	0	24-47	Connection sequence number
IMHL	0	48-51	Message header length
IMLI	0	52-63	TPDU length indicator

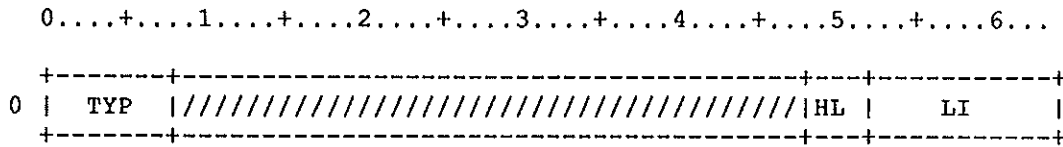

Figure IM-11. FLOW CONTROL Message

The FLOW CONTROL message has a one-word header followed by a vector of flow-control bits, using as many words as are necessary to cover all the virtual circuit table entries.

Field	Word(base8)	Bits	Description
IMTYP	0	0-7	Message type code
IMHL	0	48-51	Message header length
IMLI	0	52-63	TPDU length indicator

L@IMFLC=%%SCR/D' 64 Length of a COS flow control message

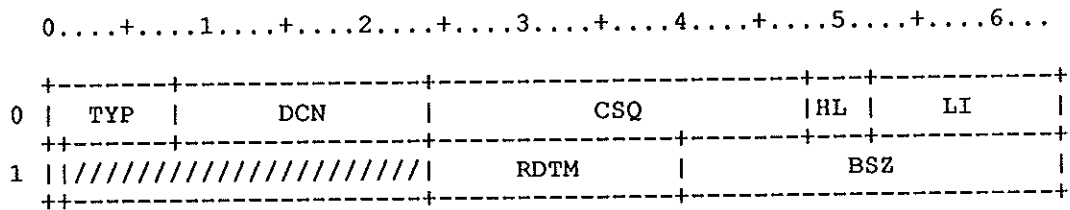

Figure IM-12. DATA PATH BEGIN Message

The DATA PATH BEGIN message opens the data path for a data transfer. It gives the direction of transfer from the point of view of the sender of the DPB message, and the size of the largest data block that will be sent or received. It allows the receiver to allocate buffers for the transfer before beginning. The acknowledgement of a DPB message is a READ DATA or WRITE DATA message.

Field	Word(base8)	Bits	Description
IMTYP	0	0-7	Message type code
IMDCN	0	8-23	Destination connection number
IMCSQ	0	24-47	Connection sequence number
IMHL	0	48-51	Message header length
IMLI	0	52-63	TPDU length indicator
IMTD	1	0	Transfer direction (1 = write)
IMRDTM	1	24-39	READ DATA not-ready timeout value
IMBSZ	1	40-63	Maximum transfer length in words

The Internal Station Status Table is used by SCP to hold information pertaining to the internal station circuits. A fixed number (I@INST) of INS entries are allocated. Each entry contains an input DNT and TRB, an output DNT and TRB, and miscellaneous flags. Note that input and output are defined relative to SCP.

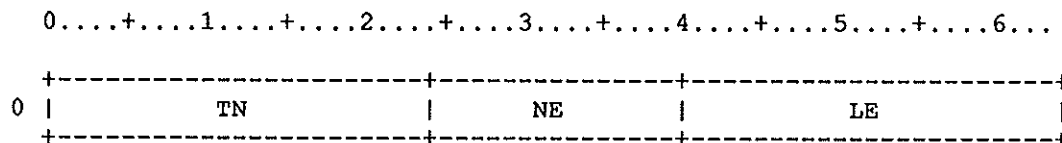

Figure IN-1. Internal Station Status Table Header

Header:

Field	Word(base8)	Bits	Description
INTN	0	0-23	Table name -- ASCII 'INS'
INNE	0	24-39	Number of entries
INLE	0	40-63	Length of an entry

<u>Field</u>	<u>Word(base8)</u>	<u>Bits</u>	<u>Description</u>
INITRB	2-21	0-63	(required by table diagram generator)
INIDNT	22-55	0-63	Input Dataset Name Table
INIDNT	22-55	0-63	(required by table diagram generator)
INOTRB	63-102	0-63	Output Transport Request Block
INOTRB	63-102	0-63	(required by table diagram generator)
INODNT	103-136	0-63	Output Dataset Name Table
INODNT	103-136	0-63	(required by table diagram generator)

RWDP	= 0	Read record partial
RWDR	= 0'10	Read words record
WWDP	= 0'40	Write words,partial
WWDR	= 0'50	Write words,record
WWDS	= 0'51	Write record with UBC
WEOF	= 0'52	Write EOF
WEOD	= 0'56	Write EOD
REWD	= 0'60	Rewind
DPEOI	= 0'4000	DSP EOI encountered flag
DPEDE	= 0'100	DSP Data error flag
DPEHE	= 0'40	DSP Hardware error flag
DPNUL	= 0	DSP Null

*CALL COMIP at this ident + 1

COPYRIGHT BY CRAY RESEARCH, INC.

UNPUBLISHED - ALL RIGHTS RESERVED UNDER THE COPYRIGHT LAWS
OF THE UNITED STATES.

The Path table (IPT) resides in STPTAB and contains
an entry for every inter-job communication path currently
established in the system.

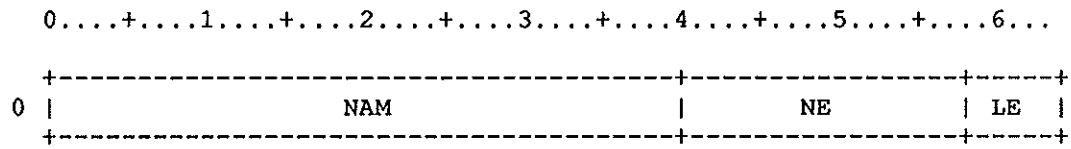

Figure IPT-1. Inter-job communication path table

<u>Field</u>	<u>Word(base8)</u>	<u>Bits</u>	<u>Description</u>
IPTNAM	0	0-39	table name
IPTNE	0	40-57	number of entries
IPTLE	0	58-63	entry length

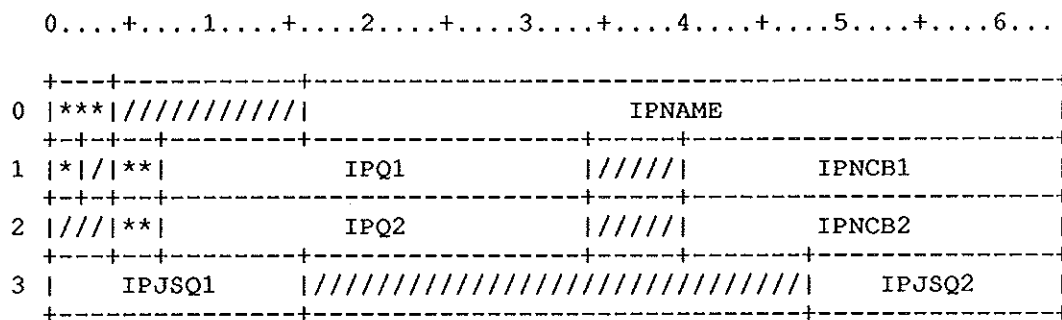

Figure IPT-2. Inter-job communication path table

Field	Word(base8)	Bits	Description
IPSTAT	0	0-3	path status IPT\$AV=00 path is unoccupied IPT\$OO=01 path OPEN request outstanding IPT\$OR=02 path OPEN request rejected IPT\$OA=03 path OPEN request accepted IPT\$OP=04 path opened IPT\$CL=05 path closed
IPNAME	0	16-63	path name
IPRO1	0	16-39	lower node RIT offset - ID1
IPRO2	0	40-63	upper node RIT offset - ID2 IPRO1 < IPRO2
IPA	1	0-1	attached flag
IPA1	1	0	if 1, ID1 attached to ID2
IPA2	1	1	if 1, ID2 attached to ID1
IPHLN1	1	4-6	header length of ID1's buffer
IPQ1	1	7-33	queue field for ID1
IPCQ1	1	7	CLOSE queued for ID1
IPOQ1	1	8	OPEN queued for ID1
IPDQ1	1	9	waiting to drop message queue
IPMQ1	1	10-33	message queue pointer for ID1
IPNCB1	1	40-63	NCB address for ID1
IPHLN2	2	4-6	header length for ID2's buffer
IPQ2	2	7-33	queue field for ID2
IPCQ2	2	7	CLOSE queued for ID2
IPOQ2	2	8	OPEN queued for ID2
IPDQ2	2	9	waiting to drop message queue
IPMQ2	2	10-33	message queue pointer for ID2

<u>Field</u>	<u>Word(base8)</u>	<u>Bits</u>	<u>Description</u>
IPNCB2	2	40-63	NCB address for ID2
IPJSQ1	3	0-15	job sequence number for ID1
IPJSQ2	3	48-63	job sequence number for ID2
L@IPT	=	LH@IPT+LE@IPT*NE@IPT	

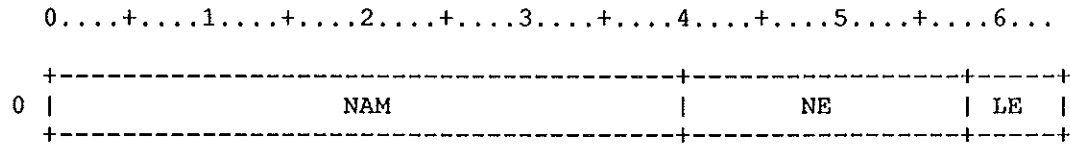

Figure RIT-1. Registered ID table

Field	Word(base8)	Bits	Description
RITNAM	0	0-39	table name
RITNE	0	40-57	number of entries
RITLE	0	58-63	entry length

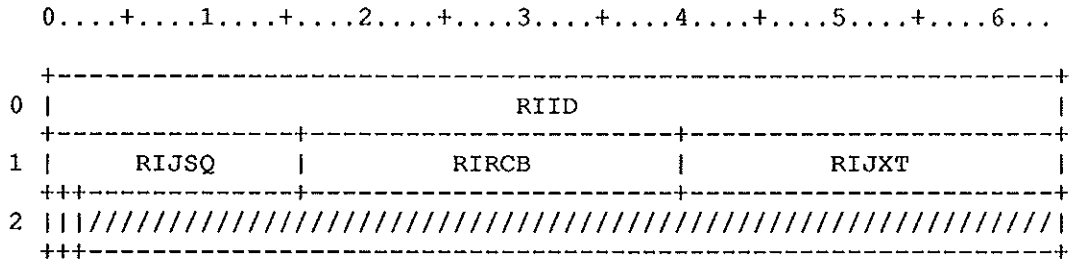

Figure RIT-2. Registered ID table

Field	Word(base8)	Bits	Description
RIID	0	0-63	ID
RIJSQ	1	0-15	JSQ of registered job
RIRCB	1	16-39	RCB address if ID is receptive
RIJXT	1	40-63	JXT address of job
RIR	2	0	reserved ID flag
RIEND	2	1	IJM\$END pending
L@RIT	= LH@RIT+LE@RIT*NE@RIT		

The IQM history trace is STPTAB resident. This trace buffer when enabled will trace the various key points through the major sections of IQM. By default all tracing within IQM is turned off. To enable IQM tracing, redefine the number of history trace entries to a non-zero value. Note that IQM will have to be reassembled when this is done.

NE@IQMT = D'000 Do not assemble in tracing

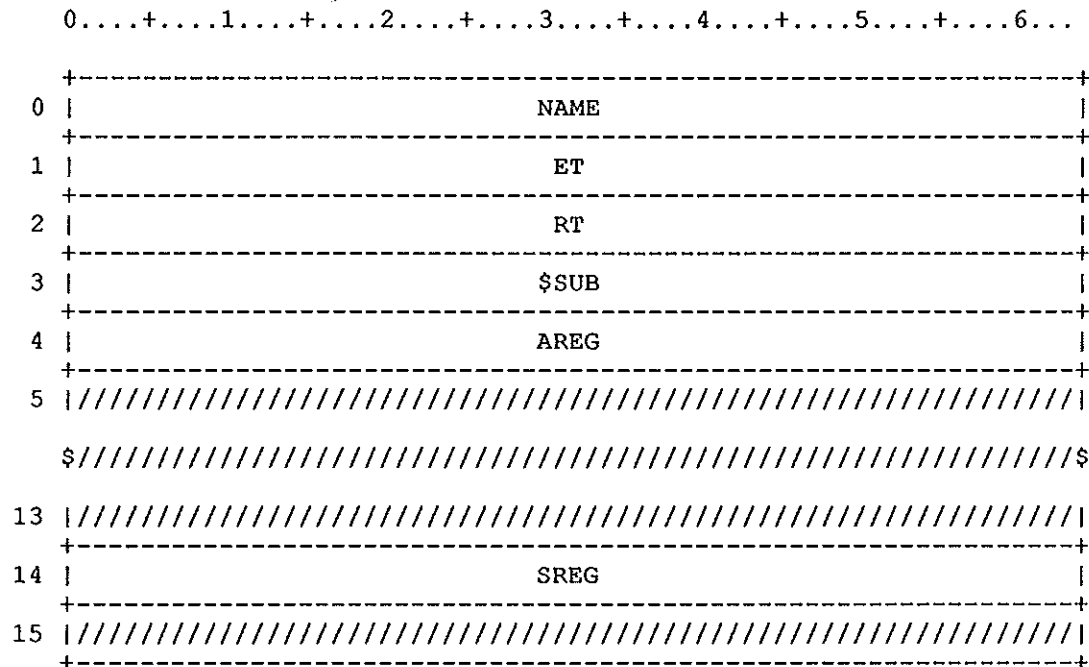

Figure DT-1. IQM history trace buffer

The follow four words are common to all history trace buffers that FDUMP can recognize and collate with other history traces of the same nature.

Field	Word(base8)	Bits	Description
DTNAME	0	0-63	ASCII name associated with the entry
DTET	1	0-63	Elapsed Real-time clock since last ent
DTRT	2	0-63	Current real-time clock
DT\$SUB	3	0-63	\$SUB routine name and return address
DTAREG	4	0-63	Address registers
DTSREG	14	0-63	Scalar registers

Every time a job initiates a new Job Control Protocol, JCP, connection a new IRT entry is created to contain the TRB and other pertinent information about that connection. The IRT is maintained in the job's JTA and entries are chained together

The IRT contains a complete transport request block, TRB, definitions of which are defined in COMIT. All new words for the IRT should be defined before the IRTRB word.

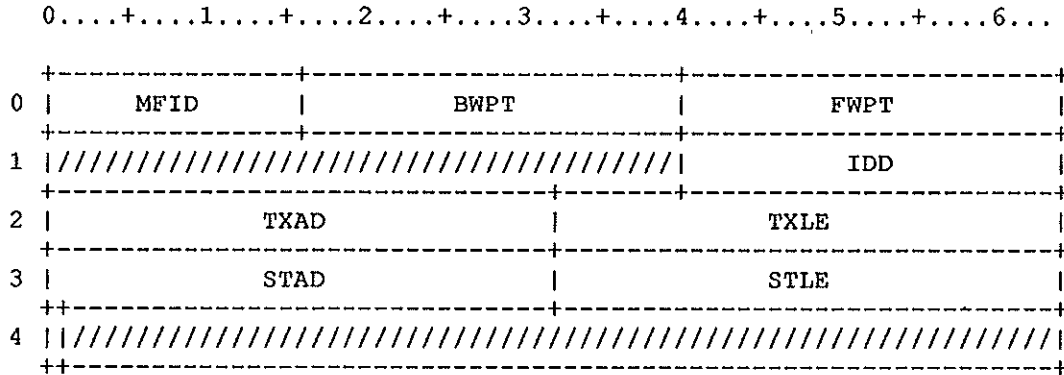

Figure IR-1. ISP Request Table Entry

Field	Word(base8)	Bits	Description
IRMFID	0	0-15	Mainframe Identifier
IRBWPT	0	16-39	Backward pointer to IRT entry
IRFWPT	0	40-63	Forward pointer to IRT entry
IRIDD	1	40-63	IDD address in JTA
IRTXAD	2	0-31	Address of text in IDD
IRTXLE	2	32-63	Length of text
IRSTAD	3	0-31	Address of secured text in IDD
IRSTLE	3	32-63	Length of secured text
IRTRB	4	0	IRT Transport Request Block
IRTRB FIELD		\$,0,1024	(Required by table diagram generator

The ISPMMAIN Status Table is used by IQM to initiate and maintain connections between COS and the ISPMMAIN's which exist on other mainframes. Each entry contains a complete TRB which is used by the Transport Service.

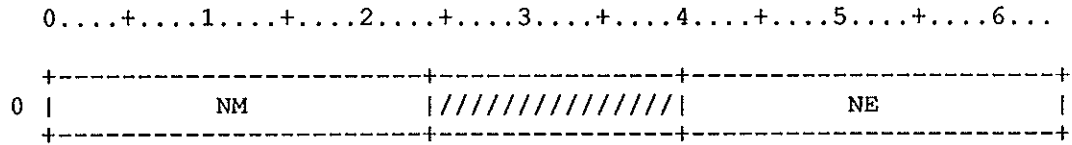

Figure IS-1. ISPMMAIN Status Table Header

Header:

<u>Field</u>	<u>Word(base8)</u>	<u>Bits</u>	<u>Description</u>
ISNM	0	0-23	Table name -- ASCII 'IST'
ISNE	0	40-63	Number of entries

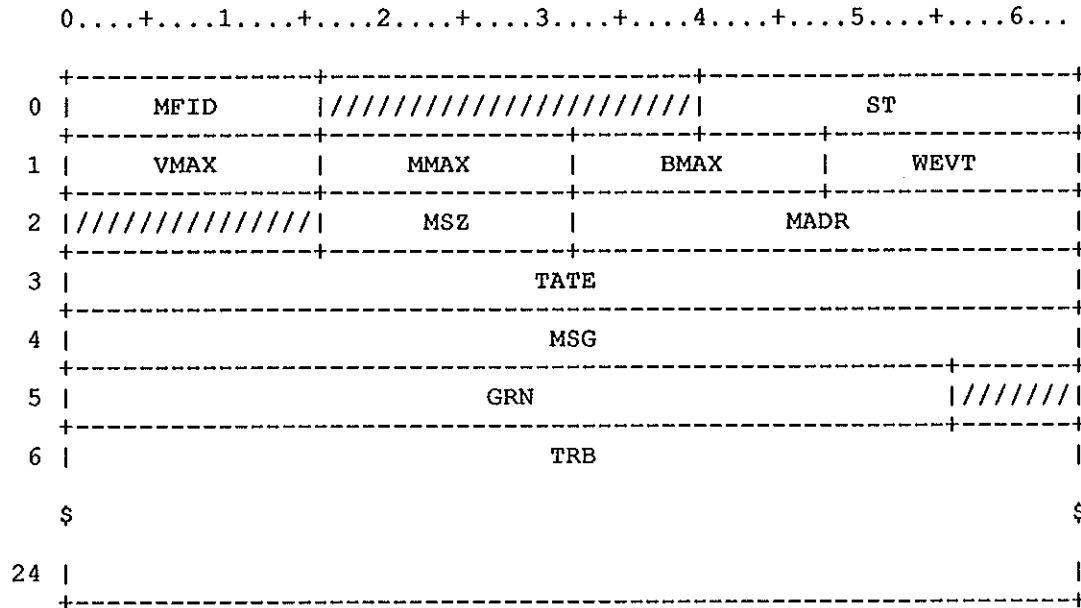

Figure IS-2. ISPMAIN Status Table Entry

Field	Word(base8)	Bits	Description
ISMFID	0	0-15	Mainframe Identifier
ISST	0	40-63	ISPMAIN Connection Status IST\$DIS=1 Disconnected IST\$OFR=2 Offer outstanding IST\$LGW=3 Awaiting Logon IST\$LGO=4 Logged On IST\$QUI=5 Quiesce received IST\$ADS=6 Attempting to disconnect IST\$LGF=7 Logged off IST\$ALF=D'8 Attempting to logoff IST\$ALR=D'9 Attempting to issue logoff reply
ISVMAX	1	0-15	Maximum number of connections
ISMMAX	1	16-31	Maximum message size
ISBMAX	1	32-47	Maximum block size
ISWEVT	1	48-63	Event being waited on
ISMSZ	2	16-31	Length of text for message
ISMADR	2	32-63	Location of text for message
ISTATE	3	0-63	ASCII state of this IST entry
ISMSG	4	0-63	First word of last message read

<u>Field</u>	<u>Word(base8)</u>	<u>Bits</u>	<u>Description</u>
ISGRN	5	0-55	Generic Resource name
ISTRB	6-24	0-63	IST Transport request block
ISTRB	6-24	0-63	(Required by table diagram generator)

The IST contains a complete transport request block, field definitions of which are described in COMIT. All new words for the IST should be defined before the ISTRB word and adequate space must be reserved for the TRB when allowing for the IST entries.

The Transport Request Block is part of the Integrated Support Processor system. It is a block of data, constructed by a task that communicates with the ISP, containing parameters needed to transfer messages or user data between COS and the ISP. It is the means by which a task passes requests to the ISP transport service (ISPCOM and IQM).

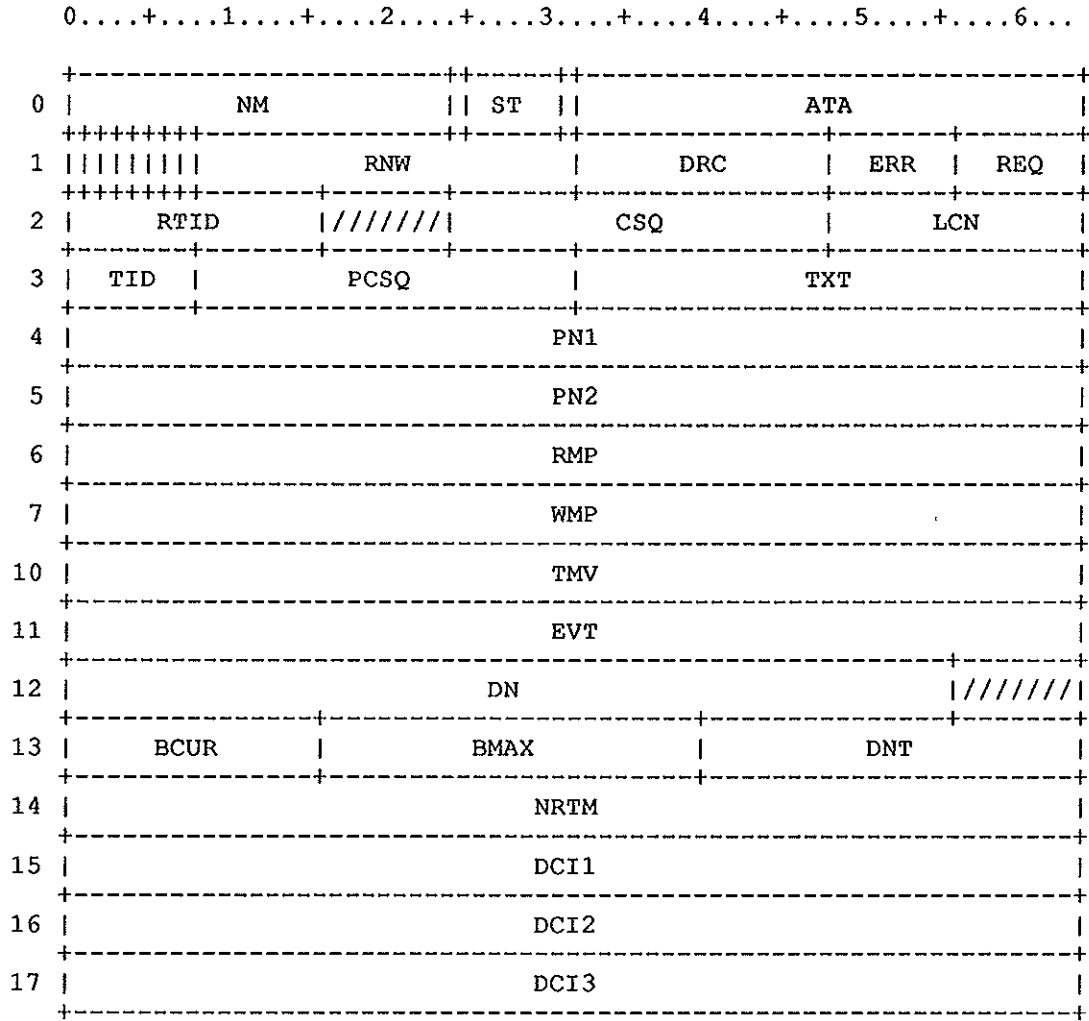

Figure IT-1. ISP Transport Request Block

Field	Word(base8)	Bits	Description
ITNM	0	0-23	Table name - 'TRB'
ITST	0	25-30	Current state of this circuit: JCP circuit states JST\$DIS=0 Disconnected JST\$JI=1 Job Init issued JST\$OFR=2 Offer outstanding JST\$CON=3 Connect received JST\$JE=4 Job Enable received JST\$ABT=0'77 Connection abnormally terminated
			DTP circuit states DST\$DIS=0 Disconnected DST\$TI=1 Task Init issued DST\$OFR=2 Offer outstanding DST\$CON=3 Connect received DST\$TE=4 Task Enable received DST\$AC=5 Access message sent DST\$AR=6 Access reply received DST\$OP=7 Open message sent DST\$OR=D'8 Open reply received DST\$ABT=0'77 Connection abnormally terminated
ITATA	0	32-63	Associated table address
ITBSY	1	0	Request busy
ITCN	1	1	Connected
ITMWT	1	2	Message waiting to be read
ITTMO	1	3	Request timed out
ITNRDY	1	4	Data path not ready
ITDPE	1	5	Data path end
ITRDA	1	6	Read active from other side
ITMBSY	1	7	Remote message buffer busy
ITRNW	1	8-31	Size of read from other side

<u>Field</u>	<u>Word(base8)</u>	<u>Bits</u>	<u>Description</u>
ITDRC	1	32-47	Disconnect reason code: ITD\$LU=1 Local user disconnect ITD\$RU=2 Remote user disconnect ITD\$LT=3 Local transport disconnect ITD\$RT=4 Remote transport disconnect
ITERR	1	48-55	Error code: ITE\$ILL=1 Illegal request ITE\$LCN=2 Invalid LCN field in TRB ITE\$DIS=3 Circuit disconnected ITE\$IMP=4 Invalid message address or length ITE\$TID=5 Invalid transport destination I.D. ITE\$MSG=6 Illegal message received ITE\$DN=6 Invalid data path dataset (ITDN) ITE\$DNT=7 Invalid data path DNT address (ITDNT)
ITREQ	1	56-63	Transport request code: ITR\$OFR=1 OFFER ITR\$CON=2 CONNECT ITR\$DIS=3 DISCONNECT ITR\$ST=4 STATUS ITR\$WM=5 WRITE MESSAGE ITR\$RM=6 READ MESSAGE ITR\$WD=7 WRITE DATA ITR\$RD=D'8 READ DATA ITR\$DPE=D'9 DATA PATH END ITR\$MAX=D'9 Maximum legal code
ITRTID	2	0-15	Destination transport I.D.
ITCSQ	2	24-47	Connection sequence number
ITLCN	2	48-63	Local connection number
ITTID	3	0-7	Requesting task I.D.
ITPCSQ	3	8-31	Previous CSQ indicates need to re-initialize the circuit
ITTXT	3	32-63	User TXT address
ITPN1	4	0-63	Process name (first 8 characters)
ITPN2	5	0-63	Process name (characters 9-16)

<u>Field</u>	<u>Word(base8)</u>	<u>Bits</u>	<u>Description</u>
ITRMP	6	0-63	READ MESSAGE parameter word
ITRSTP	6	0	1 if ITRMA is STP-REL
ITRSRQ	6	1	1 if system request (use system buffer where the message currently exists)
ITRML	6	16-31	Read message length
ITRMA	6	32-63	Read message address
ITWMP	7	0-63	WRITE MESSAGE parameter word
ITWSTP	7	0	1 if ITWMA is STP-REL
ITWML	7	16-31	Write message length
ITWMA	7	32-63	Write message address
ITTMV	10	0-63	Request timeout value
ITEVT	11	0-63	Event descriptor for JSH J\$AWAIT call
ITDN	12	0-55	Data path dataset name
ITBCUR	13	0-15	Current data block size in sectors
ITBMAX	13	16-39	Max data block size in words
ITDNT	13	40-63	DNT address (if not job-related)
ITNRTM	14	0-63	Data path not-ready timer value
ITDCI1	15	0-63	Data control information
ITDCI2	16	0-63	Data control information
ITDCI3	17	0-63	Data control information

This table is part of the Integrated Support Processor system. It is used by the ISP communication task, IQM, and by its interface subroutine, ITREQ.

In the ISP, each COS dataset or job is represented by a virtual circuit, or an independent logical connection between COS and the ISP. Control protocol and data are transmitted by the ISP transport service (IQM and its mirror image in the ISP) over these connections. Many virtual circuits are multiplexed over a physical channel pair. This table is the data structure for control of the virtual circuit at the COS end.

0....+....1....+....2....+....3....+....4....+....5....+....6...

0	CI			
1				
2	NM		RCN	LCN
3		RSQ		CSQ
4	VPT			
5	TXT		TRB	
6	JSQ			
7	PN1			
10	PN2			
11	MBL	RML		MBA
12	TMR			
13	DMSG	TMT		IIL
14	RTID	DRC		OIL
15		UBC	TID	RNW
16				DSQ
17	DMA			
20	DL			

Figure IV-1. ISP Virtual Circuit Table

	0....+....1....+....2....+....3....+....4....+....5....+....6....
21	TRW
22	DCI1
23	DCI2
24	DCI3
25	BMAX
26	LNRT
27	RNRT
30	DTMR
31	EQRT

Figure IV-1. ISP Virtual Circuit Table

Field	Word(base8)	Bits	Description
IVCI	0-1	0-63	Chain item (2 words)
IVNM	2	0-23	Table name - 'VCT'
IVRCN	2	32-47	Remote connection number
IVLCN	2	48-63	Local connection number
IVCN	3	0	Connected to the ISP
IVDSC	3	1	Disconnected
IVCNF	3	2	CONFIRM message needs to be sent
IVMBSY	3	3	Remote message buffer busy
IVRFC	3	4	Remote flow control flag
IVMWT	3	5	Received message waiting
IVTMO	3	6	Request timed out
IVRSQ	3	16-39	Remote connection sequence number
IVCSQ	3	40-63	Connection sequence number
IVVPT	4	0-63	VPT entry address
IVTXT	5	0-31	TXT address

<u>Field</u>	<u>Word(base8)</u>	<u>Bits</u>	<u>Description</u>
IVTRB	5	32-63	TRB address (JTA-REL if IVTXT nonzero)
IVJSQ	6	0-15	JSQ of owner job (if any)
IVPN1	7	0-63	Process name (16 characters)
IVPN2	10	0-63	
IVMBL	11	0-15	Message buffer length
IVRML	11	16-31	Received message length
IVMBA	11	32-63	Message buffer address
IVTMR	12	0-63	Request timer
IVDMSG	13	0-15	Disconnect message code
IVTMT	13	16-31	Timer type code: ITT\$OFR=1 OFFER timeout ITT\$WM=2 WRITE MESSAGE timeout ITT\$RM=3 READ MESSAGE timeout ITT\$DR=4 DATA request timeout
IVIIL	13	32-63	Input ILT entry address
IVRTID	14	0-15	Remote transport I.D.
IVDRC	14	16-31	Disconnect reason code
IVOIL	14	32-63	Output ILT entry address
IVDBSY	15	0	Data transfer request busy
IVDDN	15	1	Data transfer request done
IVTD	15	2	Transfer direction (1 = out)
IVRDA	15	3	Read Data active (sent to remote)
IVNRDY	15	4	Data path not ready
IVRDY	15	5	Data path ready
IVDPE	15	6	Data Path End
IVDNR	15	7	ERDNR status returned to user
IVDPB	15	8	DATA PATH BEGIN sent or received
IVDPW	15	9	Data path waiting for local buffer
IVUBC	15	16-23	Unused bit count

<u>Field</u>	<u>Word(base8)</u>	<u>Bits</u>	<u>Description</u>
IVTID	15	24-39	ID of task for reply
IVRNW	15	40-63	Number of data words requested
IVDSQ	16	40-63	Request sequence number from RD msg
IVDMA	17	0-63	Data buffer memory address
IVDL	20	0-63	Data transfer length
IVTRW	21	0-63	Task reply word
IVRCL	21	24	Intermediate reply flag
IVTXO	21	25-39	Requesting user task TXT offset
IVDNT	21	40-63	DNT address
IVDCI1	22	0-63	Data control information from RD msg
IVDCI2	23	0-63	.
IVDCI3	24	0-63	.
IVBMAX	25	0-63	Maximum data block size
IVLNRT	26	0-63	Local user's not-ready timeout value
IVRNRT	27	0-63	Remote user's not-ready timeout value
IVDTMR	30	0-63	Data path timer
IVEQRT	31	0-63	Time entry linked to the req queue

This table is part of the Integrated Support Processor system. It is a multi-purpose structure, designed to hold a variable-length text record. Text may be ASCII characters, binary data, or something else. It is treated as transparent data by the lower levels of the ISP software that use this table.

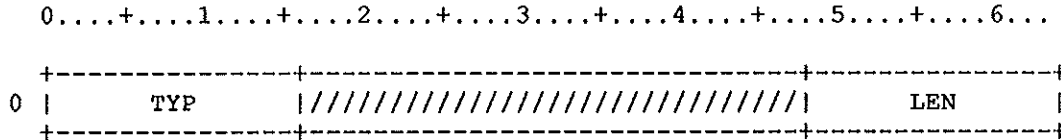

Figure IX-1. ISP Text Record

Field	Word(base8)	Bits	Description
IXTYP	0	0-15	Text type (2 ASCII characters - ST = Secure Text TX = Text)
IXLEN	0	48-63	Text length in CRAY words Text body follows immediately, zero-filled in the last word.

W@IXTXT=1 ISP text (I@IMTXT words maximum)

The JAE is used by both the user program and EXP. On the user level its first half is used to define the parameters passed to EXP during the F\$RPV request. It defines the major type of the event and all selected sub-types, at what user address processing is to be initiated, and various mode options available.

EXP will store the definition in the JTA pool and link it up via a simple chaining scheme. The list that the definition resides on depends upon if it is active or not. If not active (simply defined) it will reside in the JTA chain of pending definitions. If the definition was invoked, then it is removed from the definition chain and placed on the active chain for the task (TCB) which is executing it.

Stackable mode allows individual events to be saved independent of any other events of the same type. This allows the user to have self contained event-handlers which may be invoked by the same event, though the process each handler performs is independent of the other handlers. For example a program may define and delete individual event-handlers as different logic paths are invoked and deleted.

The propagate-only mode defines the event-handler as not being able to change the outcome of an event (i.e., they can not cancel the abort sequence). These types of definitions can be considered as a second line of event-handlers, since they are invoked only if all of the front-line handlers decide not to discard the event. Facilities such as the superlink library routines use propagate-only events so as not to step on any user defined events, yet insuring that the event-handler is invoked before the program ends (normal or abortive).

The task-specific mode gives multi-tasked programs a bit of flexibility when it comes to event processing. When selected at definition time, the specified definition will only be invoked if the given user task encounters the event. If the mode flag is not selected at definition time, then any user task (for the job) which encounters the specified event will force the event-handler to be activated.

The auto-task flag indicates that new user task is to be created when the desired event is encountered, regardless of the task-specific mode. This allows the event handlers to take on an asynchronous aspect in the processing of the event. When the created task ends event processing it will be deleted.

The multi-thread flag allows the event-handler to be invoked without placing the job in a single-threaded state. If this flag is not set, the default is to single-thread the job.

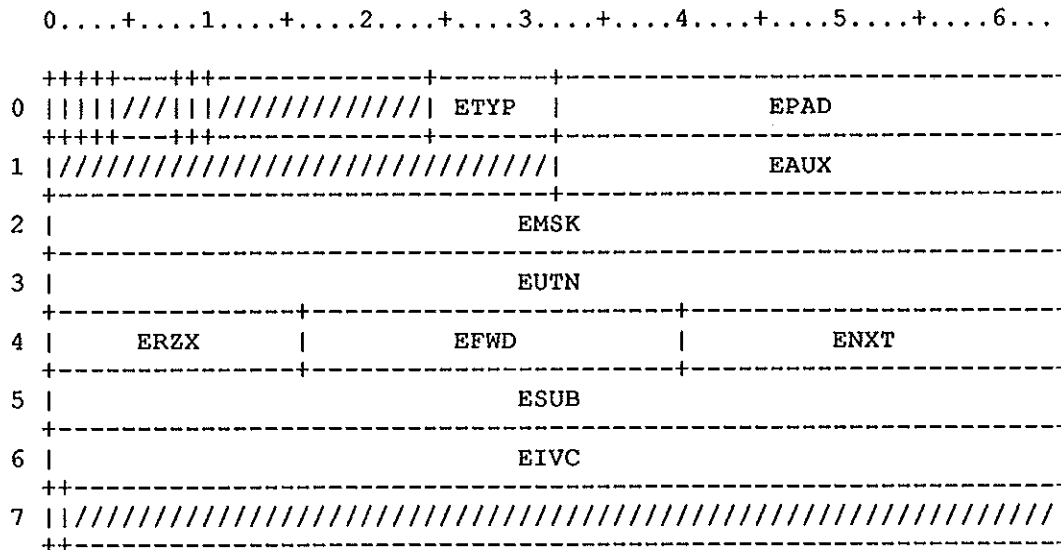

Figure JA-1. Job-assisted event definition table

Field	Word(base8)	Bits	Description
JAEPGO	0	0	Propigate-only mode
JAESTK	0	1	Stackable definition
JAETSP	0	2	User-task specific(not job global)
JAENMG	0	3	Disable EP006 messages
JAEAUT	0	8	Auto-task. Implied task create
JAEMLT	0	9	Allow multi-threading of event-handlin
JAETYP	0	24-31	Event type (JAE\$xxxx)
JAEPAD	0	32-63	Processing address, JCB relative
JAEAUX	1	32-63	Auxiliary address, JCB relative
JAEMSK	2	0-63	Sub-type selection mask
JAEUTN	3	0-63	User assigned task number

The remaining definitions are setup for the exclusive use of STP and are not required to be part of the user call.

JAERZX	4	0-15	Resume index (EXP resume location)
JAEFWD	4	16-39	Forward(older) entry pointer
JAENXT	4	40-63	Next(newer) entry pointer

<u>Field</u>	<u>Word(base8)</u>	<u>Bits</u>	<u>Description</u>
JAESUB	5	0-63	Actual sub-type encountered
JAEIVC	6	0-63	Event-specific code (actual abt code)
JAESGL	7	0	Required single-threading performed
JAE\$RPV	= 0'000		Program advance (normal/abortive)
JAE\$NEP	= 0'001		User normal exchange

The 1-word JCL Block Information Table (JBI) is generated in the user field and has two formats: one for conditional information (figure JB-1) and the other for iterative information (figure JB-2).

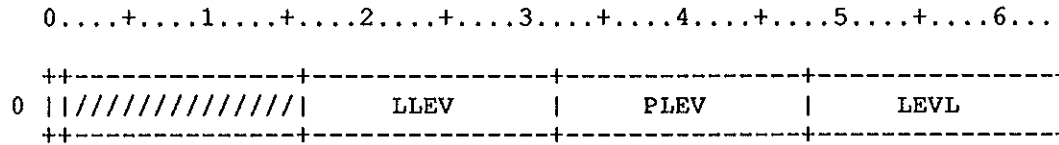

Figure JB-1. JBI Conditional Format

Field	Word(base8)	Bits	Description
JBEXC	0	0	Conditional sequence is in execution
JBLLEV	0	16-31	Conditional is contained in this iterative nesting level
JBPLEV	0	32-47	Iterative is contained in this procedure level
JBLEVL	0	48-63	Current iterative nesting level

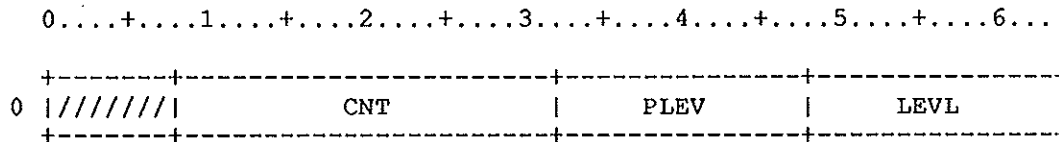

Figure JB-2. JBI Iterative Format

Field	Word(base8)	Bits	Description
JBCNT	0	8-31	Iteration count
JBPLEV	0	32-47	Iterative is contained in this procedure level
JBLEVL	0	48-63	Current iterative nesting level

The first 128 words of each user field comprise the Job Communication Block. The JCB is accessible to the user.

0....+....1....+....2....+....3....+....4....+....5....+....6...

5	CCI			
\$	\$			
17				
20	CPR			
\$	\$			
77				
100	JN			
101	LPP	U	HLM	FL
102	NPF		BFB	DSP
103	NLE		MFL	LFT
104			ULFT	PNST STRM
105		CYCL	CPTP MCP NLCP	IAC
106	CRL			
107	ACN			
110				
111	PWD			
112				
113	PROM			
114	NULE	PLEV	ILEV	CLEV
115	MMIN		MMIS	
116	MMBA		MMEP	
117	STIN		STIS	

Figure JC-1. Job Communication Block

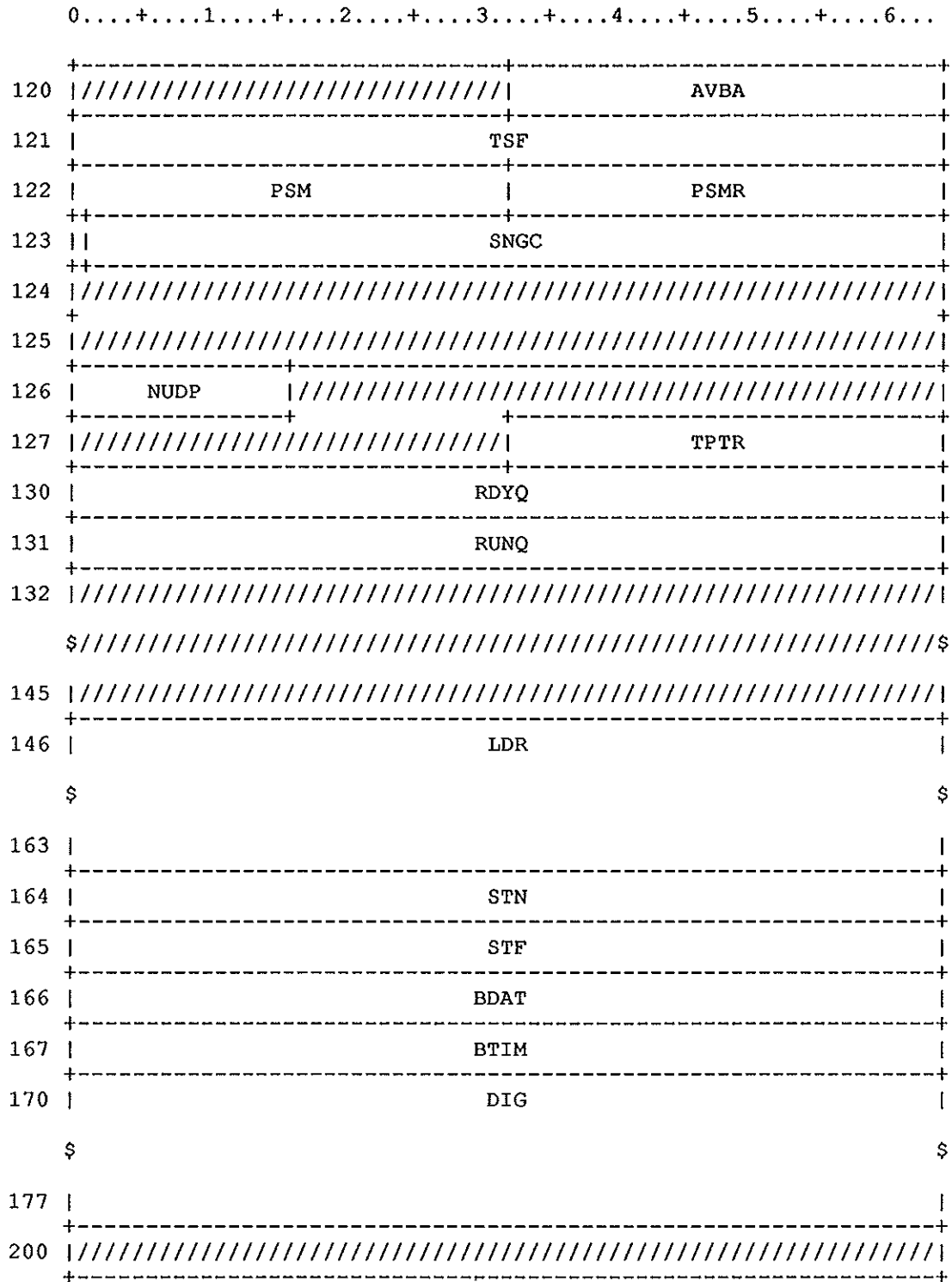

Figure JC-1. Job Communication Block

B@JCB=0 Symbol for JCB base,
relative to BA

The first five words of the JCB are assigned as a save area for the BGN table that is used by F\$BGN.

<u>Field</u>	<u>Word(base8)</u>	<u>Bits</u>	<u>Description</u>
JCCCI	5-17	0-63	Control statement image packed 8 characters per word
JCCPR	20-77	0-63	Control statement parameters, expanded to two words per parameter
JCJN	100	0-55	Job name; bits 56-63 must be 0.
JCLPP	101	0-7	Lines per page
JCRMSG	101	11	RFL message sent
JCU	101	14-15	User mode indicator:
JCUL	101	14	Local
JCUG	101	15	Global
JCHLM	101	16-39	High limit of user code
JCFL	101	40-63	Current field length
JCNPF	102	0-15	Number of physical buffers and datasets
JCBFB	102	16-39	Base address of I/O buffers
JCDSP	102	40-63	Base address of DSP area
<u>JCNLE</u>	103	0-15	Number of entries in LFT
JCMFL	103	16-39	Maximum FL allowed
<u>JCLFT</u>	103	40-63	Base of LFT
JCDCS	104	0	CSP dynamic control statement flag
JCCSDB	104	1	CSP debug flag
JCBP	104	2	JOB statement breakpoint (BP) flag
JCNTB	104	3	CSP traceback suppression flag
JCIOAC	104	4	I/O area current status flag: 0 User's I/O area is unlocked 1 User's I/O area is locked

<u>Field</u>	<u>Word(base8)</u>	<u>Bits</u>	<u>Description</u>
JCIOAP	104	5	I/O area previous status flag: 0 User's I/O area is unlocked 1 User's I/O area is locked
JCIA	104	6	Interactive flag
JCCHG	104	7	Execute CHARGES utility for trailer message.
JCJBS	104	8	JOB statement flag (if set, JOB statement just processed)
JCCSIM	104	9	Flag is set when CRAY-1 simulator is running.
JCDLIT	104	10	Display literal delimiters in control statement crack.
JCRPRN	104	11	Retain level 1 parentheses.
JCVSEP	104	12	Last character was valid separator.
JCSDM	104	13	NOECHO of current control statement
JCPDMS	104	14	Suppress PDM user logfile messages
JCCSQ	104	15	New CFT calling sequence in effect
JCOVT	104	16	Overlay type
JCULFT	104	17-47	Base of user LFTs (JCB-REL)
JCPNST	104	48-55	Parentheses nesting level for current control statement
JCSTRM	104	56-63	Statement termination for current control statement
JCEFI	105	0	Enable floating-point interrupt flag; used by \$ARLIB math routines to reset floating-point interrupt flag
JCOVL	105	1	Overlay flag
JCSBC	105	2	SBCA flag
JCBDM	105	3	Enable bidirectional mode flag
JCORI	105	4	Interrupt on operand range flag
JCCYCL	105	5-20	CPU cycle time, in picoseconds
JCCPTP	105	21-29	CPU type, @CRAYxxx

<u>Field</u>	<u>Word(base8)</u>	<u>Bits</u>	<u>Description</u>
JCMCP	105	30-34	Maximum number of logical CPUs that
JCNLCP	105	35-39	Current number of logical CPUs asg'd
JCEMA	105	40	1=Extended memory addressing enabled
JCAVL	105	41	1=Additional vector logical unit enab.
JCIAC	105	42-49	Number of account processing retries allowed for an interactive job
JCACRQ	105	50	Accounting mandatory flag
JCPWRQ	105	51	Password mandatory flag
JCRYPT	105	52	Encryption flag
JCSLVL	105	53	Security level flag
JCSJOB	105	54	S on job card
JCFRLS	105	55	Flag set when FRLS executes at jobend
JCSLDA	105	56	Flag set when SL dataset active in job
JCCRL	106	0-63	COS revision level
JCCRLS	106	32-63	COS revision number
JCACN	107-110	0-63	1 through 15 character account number
JCACN1	107	0-63	Characters 1 through 8 of account number
JCACN2	110	0-55	Characters 9 through 15 of account number
JCPWD	111-112	0-63	1 through 15 character password
JCPWD1	111	0-63	Characters 1 through 8 of password
JCPWD2	112	0-55	Characters 9 through 15 of password
JCPROM	113	0-63	Current user job interactive prompt, justified, zero-filled. 64 bits of binary zeroes disables user job prompt. Set to system default at beginning of each job step.
<u>JCNULE</u>	114	0-15	Number of user LFT entries (below HLM)
JCPLEV	114	16-31	Current procedure nesting level
JCILEV	114	32-47	Current iterative nesting level

<u>Field</u>	<u>Word(base8)</u>	<u>Bits</u>	<u>Description</u>
JCCLEV	114	48-63	Current conditional nesting level
The next four words are used by the run-time memory manager:			
JCMMIN	115	0-31	Size of increments to the managed memo
JCMMIS	115	32-63	Initial size of memory to be managed
JCMMBA	116	0-31	Base address of managed space
JCMMEP	116	32-63	Size of smallest block added to availa
JCSTIN	117	0-30	Size of increments to a stack
JCSTRF	117	31	Flag to indicate stack for root task
JCSTIS	117	32-63	Initial size of a stack
JCAVBA	120	32-63	Base of available space
JCTSF	121	0-63	Task scheduling flag
JCPSM	122	0-31	Pseudo semaphore registers 1-A,B,S,M
JCPSMR	122	32-63	Required zeroes following pseudo sems
JCSNGL	123	0	Single threading flag for 1-A,B,S,M
JCSNGC	123	1-63	Reserved for use in single thread code
JCNUDP	126	0-15	Number of system DSPs in user
JCTPTR	127	32-63	Pointer to list of all tasks
JCRDYQ	130	0-63	Multitasking ready queue header
JCRUNQ	131	0-63	Multitasking run queue header
JCLDR	146-163	0-63	Unsatisfied externals
JCSTN	164	0-63	Job step count
JCSTF	165	0-63	Job step failure flag
JCBDAT	166	0-63	Date of absolute load module generation
JCBTIM	167	0-63	Time of absolute load module generation
JCDIG	170-177	0-63	Reserved for diagnostics

The presence of this figure adds no information. It is required by the table diagram generator to improve the appearance of the table while still supplying the S@JCDIG and N@JCDIG tags.

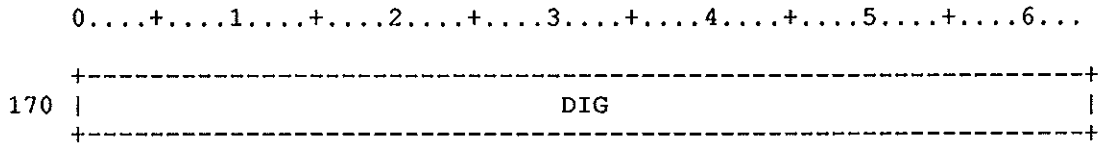

Figure JC-2. Additional tags for diagnostics

<u>Field</u>	<u>Word(base8)</u>	<u>Bits</u>	<u>Description</u>
JCDIG	170	0-63	

The 4-word JST contains information about system and user symbols.

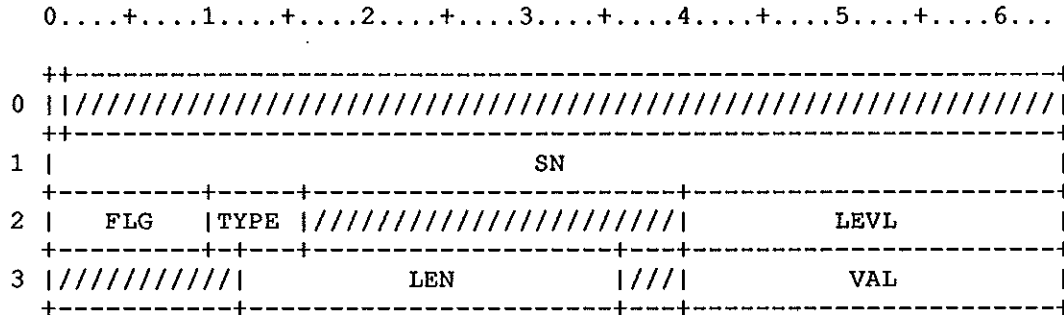

Figure JS-1. JCL Symbol Table

Field	Word(base8)	Bits	Description
JSCRE	0	0	Create if not found. Available only for system use.
JSSN	1	0-63	Symbol name
JSFLG	2	0-9	Symbol flag fields
JSLOC	2	0	Local or global. If set, symbol is
JSCON	2	1	Constant or variable. If set,
JSSRS	2	2	System reserved. If set, the symbol
JSUSR	2	3	User settable. If set, symbol may
JSSYS	2	4	System settable. If set, the symbol
JSTYPE	2	10-15	One of the following symbol types: SYMTUND=O'00 Undefined - no type SYMTBOO=O'01 Boolean - logical SYMTINT=O'02 Decimal integer SYMTLIT=O'03 ASCII literal; 1-8 characters. SYMTBIN=O'04 Binary
JSLEVL	2	40-63	Procedure definition level
JSLEN	3	12-35	Length of value
JSVAL	3	40-63	Base of value buffer

JSH function code definitions

J%STEP	=	O'4000	
J\$ALLOC	=	J%STEP	Allocate or release memory for a
J\$AWAIT	=	J%STEP+J\$ALLOC	Suspend until given event occurs
J\$OPREQ	=	J%STEP+J\$AWAIT	Operator request
J\$SUSP	=	J%STEP+J\$OPREQ	Suspend a task momentarily
J\$SUSPK	=	J%STEP+J\$SUSP	Suspend a job momentarily (system
J\$RESOUR	=	J%STEP+J\$SUSPK	Suspend pending resource
			availability
J\$CLEAR	=	J%STEP+J\$RESOUR	Perform clean-up functions on
			abort
J\$ABORT	=	J%STEP+J\$CLEAR	Cancel a job for a given reason
J\$RERUN	=	J%STEP+J\$ABORT	Move a job from executing to input
J\$DELETE	=	J%STEP+J\$RERUN	Move a job from executing to
			available
J\$IOSUSP	=	J%STEP+J\$DELETE	Suspend a job pending an I/O
			completion
J\$IODONE	=	J%STEP+J\$IOSUSP	Resume an I/O-suspended job
J\$RESUME	=	J%STEP+J\$IODONE	End a momentary (system)
			suspension
J\$GOSMEM	=	J%STEP+J\$RESUME	De/allocate GOS memory
J\$INDEX	=	J%STEP+J\$GOSMEM	Set job's nonrecoverable bit in
			RJI
J\$SPARE3	=	J%STEP+J\$INDEX	Spare function
J\$SPARE4	=	J%STEP+J\$SPARE3	Spare function
J\$SPARE5	=	J%STEP+J\$SPARE4	Spare function
J\$SPARE6	=	J%STEP+J\$SPARE5	Spare function
J\$SPARE7	=	J%STEP+J\$SPARE6	Spare function
J\$INVOKE	=	J%STEP+J\$SPARE7	Invoke new class structure
J\$UROLL	=	J%STEP+J\$INVOKE	User job roll request
J\$CPU	=	J%STEP+J\$UROLL	Change CPU status function
J\$READY	=	J%STEP+J\$CPU	Suspend a task momentarily
J\$GETM	=	J%STEP+J\$READY	Get buffer memory
J\$RETM	=	J%STEP+J\$GETM	Return buffer memory
J\$TINIT	=	J%STEP+J\$RETM	Initialize a user task
J\$ACT	=	J%STEP+J\$TINIT	Activate a user task
J\$DEACT	=	J%STEP+J\$ACT	Deactivate a user task
J\$SINGLE	=	J%STEP+J\$DEACT	Single thread users tasks
J\$DEADLK	=	J%STEP+J\$SINGLE	Possible deadlock detected

J\$OPREQ subfunction code definitions

J%SFSTEP	=	1	
J\$OPRCV	=	J%SFSTEP	Recover all jobs (operator)
J\$OPSTA	=	J%SFSTEP+J\$OPRCV	Start all jobs (operator)
J\$OPSTR	=	J%SFSTEP+J\$OPSTA	End an indefinite (operator)
			suspension
J\$OPSPA	=	J%SFSTEP+J\$OPSTR	Stop all jobs (operator)
J\$OPSTP	=	J%SFSTEP+J\$OPSPA	Suspend a job indefinitely
			(operator)
J\$OPSDW	=	J%SFSTEP+J\$OPSTP	Shutdown (operator)
J\$OPCHP	=	J%SFSTEP+J\$OPSDW	Operator request - change priority
J\$OPRMK	=	J%SFSTEP+J\$OPCHP	Remove the K bit

J\$OPRES = J\$SFSTEP+J\$OPRMK Restore preemptable generic resource
 J\$OPSWE = J\$SFSTEP+J\$OPRES Sweep preemptable generic resource

Define job status characters. Not to exceed D'22 bits.

J%B = D'1S0 Suspended by operator SHUTDOWN
 J%C = D'1S1 Forced memory allocation pending
 J%D = D'1S2 Job delete pending
 J%G = D'1S3 Job class invoke pending
 J%J = D'1S4 Job in memory with JTA only
 J%K = D'1S5 Job is frozen in memory
 J%L = D'1S6 Job is rolling in or out
 J%M = D'1S7 Memory request outstanding
 J%N = D'1S8 Job is not in memory (JXJTA invalid)
 J%O = D'1S9 Suspended by operator SUSPEND
 J%P = D'1S10 Job contending for resource
 J%Q = D'1S11 Job is waiting for initiation
 J%R = D'1S12 Roll image is complete
 J%U = D'1S13 User requested roll pending
 J%V = D'1S14 Rolled job index write pending
 J%Y = D'1S15 Suspended for I/O quiet

J%ALLSUS = J%B+J%O+J%U+J%V+J%Y+J%G+J%P Multistep suspend states

Define task status characters. Not to exceed D'22 bits.

T%A = D'1S0 Task abort pending
 T%D = D'1S1 Task delete pending
 T%E = D'1S2 Suspended for event
 T%F = D'1S3 Suspended to single thread tasks
 T%H = D'1S4 Suspended by user deactivate
 T%I = D'1S5 Suspended for I/O
 T%K = D'1S6 Task is frozen in memory
 T%S = D'1S7 Suspended for system
 T%T = D'1S8 Suspended for time delay
 T%X = D'1S9 Task is connected to CPU

T%ALLSUS = T%F+T%H+T%E+T%T+T%S Task suspend states

Define JSH error codes.

JR\$JXO = 1 Invalid JXT offset supplied
 JR\$FC = 2 Invalid function code supplied
 JR\$ADR = 3 Bad address or code specified
 JR\$MBUSY = 5 Previous memory request outstanding
 JR\$REJCT = 6 Can not change priority yet
 JR\$AIM = 7 Job already in memory
 JR\$CBIG = D'8 Specified code too large
 JR\$DOP = ERDOP Attempt to delete memory outside progr
 JR\$JOF = ERJOF JTA overflow
 JR\$GSY = ERGSY Job size would exceed the total in

JR\$GAL	=	ER\$GAL	the Job size would exceed that allowed by
JR\$NIRW	=	ERNIRW	No invoke request word specified
JR\$IAP	=	ERIAP	Invoke request already specified
JR\$IILM	=	ERILM	Invoke len not multiple of 0'1000
JR\$IILMX	=	ERILMX	Invoke len greater than max allowed
JR\$BINV	=	ERBINV	Bad class structure invoke
JR\$CAN	=	ERJRC	JSH request cancelled

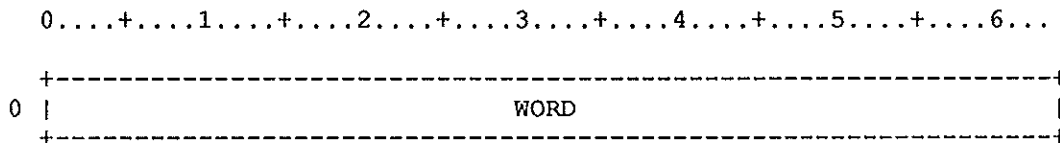

Figure JF-1. Fields within JSH Request Word

Field	Word(base8)	Bits	Description
JFWORD	0	0-63	
JFAUX	0	0-23	Unused (1-81) auxiliary information
JFADR	0	24-47	Address part of request word
JFABC	0	24-47	Abort code field
JFFNC	0	48-52	Function code
JFSFC	0	48-52	Subfunction code
JFTXO	0	53-63	TXT ORDINAL
JFJXO	0	53-63	JXT ordinal (inaccurate field size)

Old labels to save a patch to UEP:

		N@JXO=N@JFJXO	
		N@JFC=N@JFFNC	
L@JTAEXP	=	0'1000	Symbolic size of JTA expansions
\$TMP1	=	1S"\$TMP0"	
L@DSPINC	=	\$TMP2/\$TMP1*\$TMP1	Standard DSP area increment
L@LFTINC	=	0'200	Default LFT expand request size
JSHDEBUG	=	0	Disable validate call
JSHTRACE	=	1	Enable TRACECP and TRACEMP
VNUM	=	0	Disable vector traces

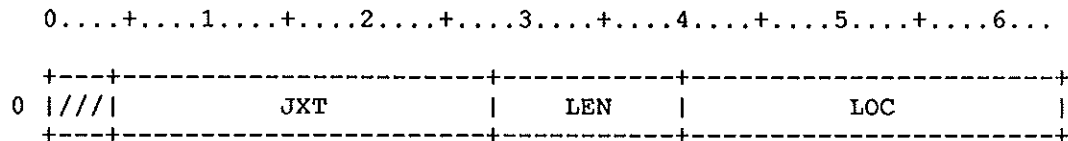

Figure IR-2. Invoke request word

<u>Field</u>	<u>Word(base8)</u>	<u>Bits</u>	<u>Description</u>
IRJXT	0	4-27	
IRLEN	0	28-39	
IRLOC	0	40-63	

The JSH history trace is STPTAB resident. This trace buffer when enabled will trace the various key points through the major sections of JSH. By default all tracing within JSH is turned off. To enable JSH tracing, redefine the number of history trace entries to a non-zero value. Note that JSH will have to be reassembled when this is done.

NE@JSHT = D'000 Number of JSH trace entries

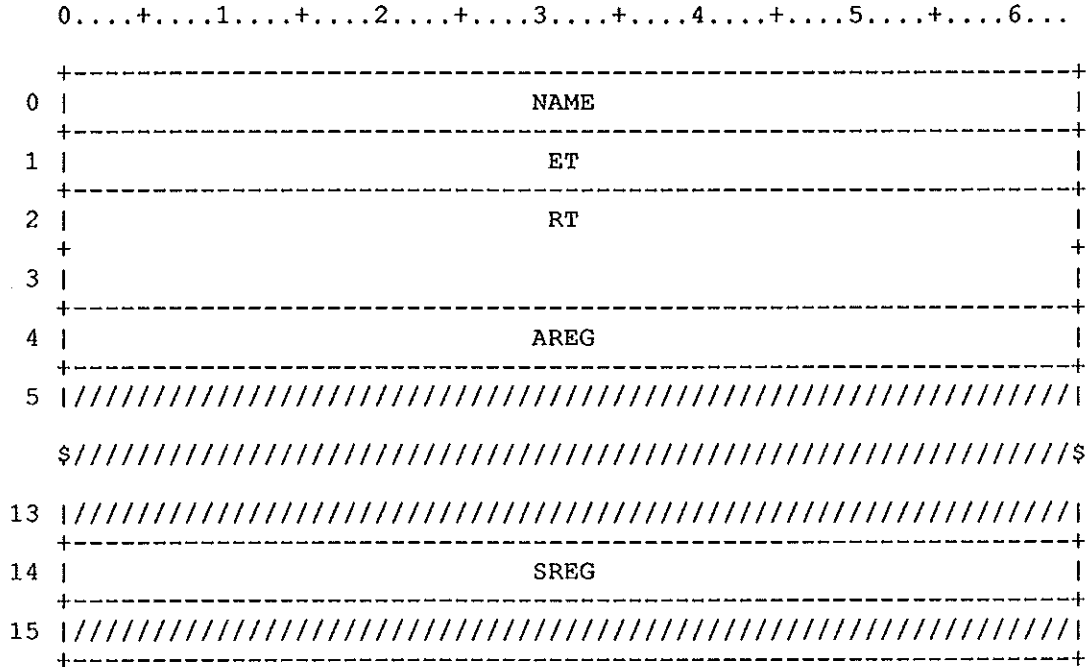

Figure DT-1. JSH history trace buffer

The follow four words are common to all history trace buffers that FDUMP can recognize and collate with other history traces of the same nature.

Field	Word(base8)	Bits	Description
DTNAME	0	0-63	ASCII name associated with the entry
DTET	1	0-63	Elapsed Real-time clock since last ent
DTRT	2-3	0-63	Current real-time clock
DTAREG	4	0-63	Address registers
DTSREG	14	0-63	Scalar registers

The JSH internal event trace is STPTAB resident. This trace buffer is used to track events that are internal to JSH.

NE@JIET = D'64 Number of internal event trace entries

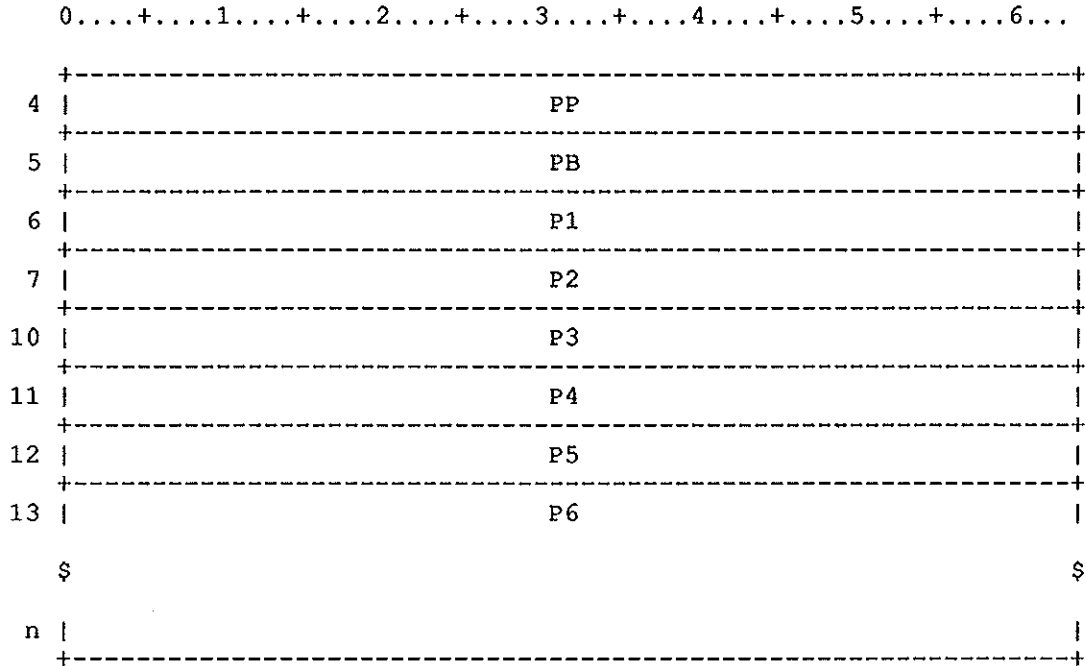

Figure JIE-1. JSH internal event trace buffer

JIET uses a standard 4 word header that is common to all history trace buffers that FDUMP can recognize and collate with other history traces of the same nature.

Field	Word(base8)	Bits	Description
JIEPP	4	0-63	P register
JIEPB	5	0-63	B00 register
JIEP1	6	0-63	Parameter 1
JIEP2	7	0-63	Parameter 2
JIEP3	10	0-63	Parameter 3
JIEP4	11	0-63	Parameter 4
JIEP5	12	0-63	Parameter 5

<u>Field</u>	<u>Word(base8)</u>	<u>Bits</u>	<u>Description</u>
JIEP6	13-n	0-63	Parameter 6

* Job Table Area (JTA)

The Job Table Area records all information about a job which needs to be present whenever the job is rolled into memory.

There is a fixed portion, followed by a memory pool which holds entries allocated as the jobs needs grow.

Figure JT-1 shows the JTA. The display of field JTDTM is in error. JTDTM is shown as one word, while it in fact occupies the apparently undefined words below it as well.

Figure JT-2 shows the detailed structure of the user breakpoints (JTBKP).

Figure JT-3 shows the detailed structure of the pointer fields within the memory pool areas for the JTA DNTs.

Figures JT-4 and JT-5 provide additional tags for the JTUSR and JTGRN fields. They provide no additional information and exist only for the convenience of the table diagram generator.

Assumed sizes of other tables referenced.

LE@SCTR	=	D'512	Disk sector length in words
C@CLSIZE	=	D'17	XMP cluster register save area size
LH@DNT	=	D'01	Length of DNT linkage word
LE@DNTSK	=	D'40	I/O stack length

	0	1	2	3	4	5	6
0	JN				////////		
1	TCB						
2	FTCB						
3	JXT						
4	L						
5	SID		DID	//////////			
6	TID						
7	ACN						
10					////////		
11	PWD						
12					////////		
13	USR						
14					////////		
15	AVAL						
	\$						\$
161							
162	SHB						
	\$						\$
171							
172	SHT						
	\$						\$
201							
202	OWN1						
203	OWN2				////////		
204	GSC0						

Figure JT-1. Job Table Area

	0	1	2	3	4	5	6
251	////////////////////						
252	IOC						
253	BIOR						
254	LMC						
255	IOSC						
256	CCNT						
257	ARCL						
260	*	DTO		SPD	////////////////////		
261	BFI	BFZ		////////////////////		DNSZ	
262	TFMN	TFMX		////////////////////		DNLM	
263	////////////////////						
264	CCI						
	\$						\$
275							
276	MSG						
	\$						\$
315							
316	INS						
	\$						\$
335							
336	JCB						
337							
340							
341	////////////////////						
342	HLD	FRE	RATS	RAT			

Figure JT-1. Job Table Area

	0	1	2	3	4	5	6
343	SSC	////////////////////				SLOT	
344	ALEN		APTR		ASLT		
345			DSPD				
	\$						\$
374							
375			DSPI				
	\$						\$
424							
425			DNTC				
	\$						\$
465							
466			STKC				
	\$						\$
535							
536			DSPC				
	\$						\$
565							
566			BGNC				
	\$						\$
605							
606			JCBC				
	\$						\$
705							

Figure JT-1. Job Table Area

	0.....	1.....	2.....	3.....	4.....	5.....	6.....
706	GRN						
	\$						\$
725	NRPD						
726	NRPD						
	\$						\$
1021	DIPD						
1022	DIPD						
	\$						\$
1115	JXTI						
1116	JXTI						
	\$						\$
1262	LFL						
1263	LFL						
1264	LFL						
1265	RDAT						
	\$						\$
2224	CDP						
2225	CDP						
	\$						\$
2254	LDP						
2255	LDP						
	\$						\$
2304							

Figure JT-1. Job Table Area

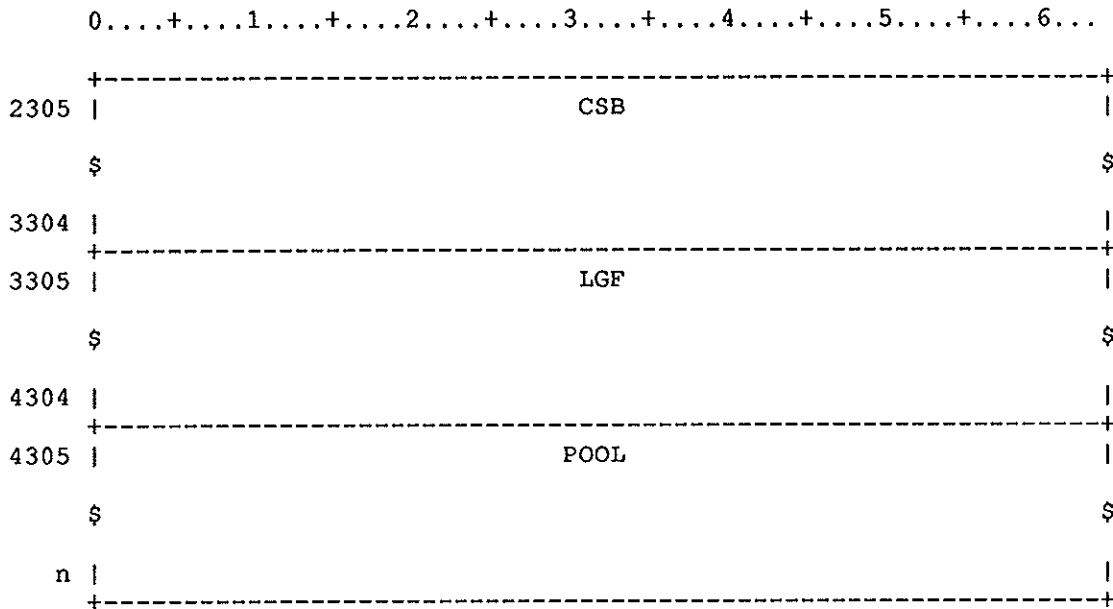

Figure JT-1. Job Table Area

Identifying information.

Field	Word(base8)	Bits	Description
JTJN	0	0-55	Job name
JTTCB	1	0-63	JTA offset of first TCB
JTFTCB	2	0-63	JTA offset of free TCB chain
JTJXT	3	0-63	JXT entry address, STP relative
JTL	4	0-63	Length of the JTA, in words
JTSID	5	0-15	Two character source ID
JTDID	5	16-31	Two character destination ID
JTTID	6	0-63	Terminal ID
JTACN	7-10	0-63	Fifteen character account number
JTACN1	7	0-63	First eight characters
JTACN2	10	0-55	Last seven characters
JTPWD	11-12	0-63	Fifteen character password:
JTPWD1	11	0-63	First eight characters
JTPWD2	12	0-55	Last seven characters

<u>Field</u>	<u>Word(base8)</u>	<u>Bits</u>	<u>Description</u>
JTCLC	134	48-63	Number of close calls by user
JTBRF	135	0-23	No. of sectors received from front end
JTBSF	135	24-47	No. of sectors sent to front end
JTDDRO	135	48-63	Number of data to disk replies owed
JTTFS	136	0-23	Temporary file space used
JTMRD	136	24-39	Number of memory resident datasets
JTMXFL	137	0-23	Maximum field length used
JTMIFL	137	24-47	Minimum field length used
JTMXJT	140	0-23	Maximum JTA used
JTMIJT	140	24-47	Minimum JTA used

EXP flag word.

Since many of these flags control the state of a user job within EXP, other STP task should avoid using this word, since EXP does not LOCK its modification.

JTTRM	141	0	Job is in termination
JTADV	141	1	Job is in program advance
JTABT	141	2	Job is in abortive advance
JTSEC	141	3	CSP is executing program
JTETRM	141	4	Internal termination flag
JTTRM2	141	5	Termination at a point of no return
JTVFLG	141	8	Security violation occurred
JTEOF	141	9	EOF on \$CS, no more control statements
JTKIL	141	10	Job has been killed by operator
JTRRN	141	11	Job reran by operator
JTTLE	141	12	Time limit has been reached
JTLSX	141	13	\$LOG size limit has been exceeded
JTINIT	141	16	Job has been initiated
JTIA	141	17	Job is interactive
JTDIAG	141	18	Diagnostic job flag

<u>Field</u>	<u>Word(base8)</u>	<u>Bits</u>	<u>Description</u>
JTIPC	141	19	Job has Superlink activity (F\$IPC)
JTSDR	141	24	Module is from the SDR
JTSSM	141	25	Module loaded wants secure datasets
JTIDP	141	26	DUMPJOB processing inhibited
JTEXO	141	27	Execute-only dataset open
JTNRO	141	28	NORERUN checks are disabled
JTOSUP	141	32	Suspended on interactive output
JTISUP	141	33	Suspended on interactive input
JTOMR	141	34-35	Pending memory requests to JSH
JTIIMR	141	34	Interrupted I/O JTA expansion pending
JTMR	141	35	Outstanding J\$ALLOC request
JTSTAT	141	40	Dataset statistics requested
JTCMSG	141	41	Conditional dataset messages requested
JTO2L	141	42	Copy \$OUT to \$LOG if set
JTCSIJ	141	45	SKP2DMP: Use JTCCI before reading \$CS
JTABEX	141	46	Skip to EXIT pending for ADVANCE
JTRCSP	141	47	Force a reload of CSP in ADVANCE
JTADVC	141	48-63	Current job-advance step number
JTAVS0	142	0-63	Value of S0 passed to CSP
JTAVS1	143	0-63	Value of S1 passed to CSP
Inter-task flag word for EXP. EXP will LOCK when modifying this word.			
JTEPD	144	0	DAT changed by DIA task
JTDLM	144	2	Writes to \$LOG are disabled
JTALM	144	3	Abandon outstanding \$LOG messages
JSH to EXP communication word.			
JTNRR	145	0	Job is not rerunable
JTMAC	145	1	Account/password move to JTA pending
JTJSQ	145	16-31	Job sequence number

<u>Field</u>	<u>Word(base8)</u>	<u>Bits</u>	<u>Description</u>
JTNBA	145	32-63	New buffer address (JSH reply)
JTLAC	146	0-15	Last abort code
JTTERM	146	16-31	Termination status
JTADVT	146	32-47	Task sequence number of advancing task
JTABTC	146	48-63	Error code last processed
JTSGL	147	0-15	Single-thread nesting level
JTMFL	147	16-39	Maximum FL
JTPJAE	147	40-63	Pending invoke of JAE(retrieve)
JTDTS	150	0-63	Real time clock at last rollout
JTSSF	151	16-33	Subsystem feature flags
JTIJF	151	16	Set if any F\$IJMSG function is used
JTIJC	151	18-33	Inter-job connection count
JTIRT	151	40-63	POINTER TO IRT CHAIN
JTVIO	MUST BE A FULL WORD		
JTVIO	152	0-63	Number of security violations
JTRCVC	153	0-11	Starting Security Violation Count
JTLPP	153	47-54	User Default LPP
JTPAM	153	55-63	User Default PAM
JTUSBU	154	0-63	User Chargable SBUs
JTUGRP	155	0-55	User Group Name
JTUGPC	155	0-15	User Group Code
JTUCFC	155	56-63	User Charging Factor Class
JTUDPM	156	0-63	User Disk Permit Map
JTCMMX	157	0-30	User CM maximum/job
JTTLMX	157	33-63	User Time limit maximum/job
JTFEFW	160	0-63	Fatal error flags
JTFE03	160	1	No available DAT space
JTFE10	160	2	No available disk space
JTFE11	160	3	System directory is full
JTFE23	160	4	Job time limit exceeded
JTFE24	160	5	Operator dropped the job
JTFE41	160	6	Enter only allowed on ACCESS

SUBFIELD	07,01	Unassigned	
JTFE51	160	8	LFT chain pointer is invalid
JTFE43	160	9	User \$LOG size limit exceeded
JTFE94	160	10	Hardware error while writing \$LOG
JTF260	160	11	Dataset not recoverable after offload
JTFENR	160	63	Not retrievable

Cluster registers for job.

JTSEM	161	0-31	Semaphore registers
JTSHB	162-171	0-63	Shared B registers
JTSHT	172-201	0-63	Shared T registers

Security information

JTOWN1	202	0-63	Dataset owner ID, characters 1-8
JTOWN2	203	0-55	Dataset owner ID, characters 9-15
JTGSC0	204	0-63	Global security flags
JTGSC1	205	0-63	
JTGSC2	206	0-63	
JTUSF	SUBFIELD 00,64		Local Security Flags (Reserved site)
JTGSC3	207	0-63	
JTSSC0	210	0-63	Job step security flags
JTSSC1	211	0-63	
JTSSC2	212	0-63	
JTUSF	SUBFIELD 00,64		Local Security Flags (Reserved site)
JTSSC3	213	0-63	

Breakpoint control information.

			L@JTBKP=D'8 Length of breakpoint information
JTBKP	214-223	0-63	User breakpoints
			MAXPRLVL=7 Maximum nesting level, with \$CS
JTCSTK	224	0-63	Control statement file stack base
JTNCSP	235	8-15	CSP load attempts resulting in error

<u>Field</u>	<u>Word(base8)</u>	<u>Bits</u>	<u>Description</u>
JTLIB	235	16-39	Library search list, JTA relative
JTDAA	235	40-63	Device name table, JTA relative
JTFST	236	0-63	FSS accounting table, JTA relative
Chain control headers.			
JTDNCC	237	0-63	DNT chain control
JTDNNE	237	0-15	Number of DNTs
JTDNTL	237	16-39	Tail of DNT chain, JTA relative
JTDNHD	237	40-63	Head of DNT chain, JTA relative
JTDICC	240	0-63	DIT chain control
JTDINE	240	0-15	Number of DITs
JTDITL	240	16-39	Tail of DIT chain, JTA relative
JTDIHD	240	40-63	Head of DIT chain, JTA relative
JTJACC	241	0-63	Jobassisted event definition q control
JTJANE	241	0-15	Number of definitions queued
JTJATL	241	16-39	Tail of definition list (oldest)
JTJAHD	241	40-63	Head of definition list (newest)
JTJSL	242	0-63	JCL symbol list chain control word
JTIBS	243	0-63	Iterative block stack chain control
JTCBS	244	0-63	Conditional block stack chain control
JTHMCC	245-250	0-63	Hardware perf.mon. chain control
JTATCC	246	0-63	Active TCB chain control
JTFTCC	247	0-63	Free TCB chain control
JTTACC	250	0-63	Task accounting chain control
JTIOC	252	0-63	Count of active I/O requests/functions
JTBIOR	253	0-63	Number of active F\$BIO requests
JTLMC	254	0-63	Lock-in-memory counter
JTIOSC	255	0-63	Number of tasks in I/O suspend
JTCCNT	256	0-63	Number pending channel driver requests
JTARCL	257	0-63	Recall-on-any user task bit map DNTMSK

The following fields were setup via the OPTION statement or from installation parameters in routine INJTA50 in EXP. The user can set up default dataset characteristics for all future opened datasets without doing a specific ASSIGN. A parameter on the ASSIGN statement will override the default set up by the OPTION statement.

JTRDM	260	0	Random dataset flag: 0 Sequential 1 Random
JTUDS	260	1	Undefined dataset structure: 0 COS blocked dataset structure 1 Undefined structure
JTNOF	260	4	No Overflow flag
JTSTYP	260	5-6	Job Storage type
JTSCR	260	5	Scratch strage space preferred
JTPERM	260	6	Permanent storage space necessary
JTDTO	260	7-24	Job Default devices wanted
JTDT1	260	7-12	Desired device type
JTDT2	260	13-18	2nd preferred device type
JTDT3	260	19-24	3rd preferred device type
JTSPD	260	25-38	Sectors to allocate before switching devices"STRIPING"
JTBFI	261	0-8	BFI indicator
JTBFZ	261	9-23	Buffer size in 512 wrds
JTDFDN	261	24	OPTION statement has a dataset par.
JTDNSZ	261	40-63	Dataset size in 512-wrd blocks
JTTFMN	262	0-15	Transfer minimum
JTTFMX	262	16-31	Transfer maximum
JTDNLM	262	40-63	Dataset size limit in 512-wrd blocks
			L@JTCCI=D'80/D'8 80 character buffer for control stmt L@JTMSG=D'128/D'8 128 character buffer for last \$LOG msg L@JTINS=O'20 JTA installation words
JTCCI	264-275	0-63	Control statement being prescanned
JTMSG	276-315	0-63	Last logfile message issued
JTINS	316-335	0-63	Reserved for installation
JTJCB	336-340	0-63	JCB save area

<u>Field</u>	<u>Word(base8)</u>	<u>Bits</u>	<u>Description</u>
JTCHLM	336	16-39	End of user code, JCB relative
JTCFL	336	40-63	Current field length, in words
JTCNDP	337	0-15	Number of DSPs in system area
JTCBFB	337	16-39	Base of system buffers, JCB relative
JTCDSP	337	40-63	Base of sytem DSPs, JCB relative
JTCNLE	340	0-15	Number of LFTs in system area
JTCMFL	340	16-39	Maximum field length, in words
JTCLFT	340	40-63	Base of system LFTs, JCB relative
JTHLD	342	0-15	Implicit hold bit map
JTFRE	342	16-31	G.R. - first request encountered
JTRATS	342	32-39	Size if RAT save area
JTRAT	342	40-63	RAT save area in JTA pool
JTSSC	343	0-15	Station slot word count
JTSLOT	343	40-63	Station slot address, JTA relative
JTALEN	344	0-15	Alternate slot definitions word count
JTAPTR	344	16-39	Current alternate slot entry, JTA rela
JTASLT	344	40-63	Base of alternate slots, JTA relative

Allocate DNT/DSP space for the datasets that the system performs the I/O on.

JTDSPD	345-374	0-63	\$DUMP Dataset parameter table (DSP)
JTDSPI	375-424	0-63	Submit dataset parameter table (DSP)
JTDNTC	425-465	0-63	\$CSP Dataset Name Table (DNT)
JTSTKC	466-535	0-63	I/O stack for CSP reads
JTDSPC	536-565	0-63	\$CSP Dataset parameter table (DSP)
JTBGNC	566-605	0-63	CSP BGN table
JTJCBC	606-705	0-63	JCB values for CSP loads

Allocate space for various tables.

JTGRN	706-725	0-63	Pointers to G. R. accounting tables
-------	---------	------	-------------------------------------

Field	Word(base8)	Bits	Description
JTNRPD	726-1021	0-63	PDD for NORERUN
JTDIPD	1022-1115	0-63	PDD for diagnostic requests
			L@JTRDAT=D'16*D'30 Length of roll image DAT space
JTJXTI	1116-1262	0-63	JXT image at time of rollout
JTLFL	1264	0-63	Last word of roll image
JTRDAT	1265-2224	0-63	DAT for roll dataset

Allocate the space for \$CS and \$LOG DSPs and circular buffers.

JTCDP	2225-2254	0-63	\$CS Dataset parameter table (DSP)
JTLDP	2255-2304	0-63	\$LOG Dataset parameter table (DSP)
JTCSB	2305-3304	0-63	\$CS Circular buffer base
JTLGF	3305-4304	0-63	\$LOG Circular buffer base

Dynamic area of JTA. Initialize with the DNTs for \$CS (control statements) and \$LOG (logfile messages).

JTPOOL	4305-n	0-63	First word of JTA pool, header word
--------	--------	------	-------------------------------------

The POOL initially contains DNTs for \$CS and \$LOG. These are not shown due to problems with the table diagram generator.

Detailed structure of user breakpoints

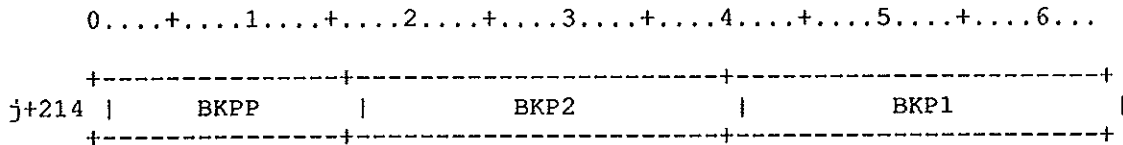

Figure JT-2. JTA User breakpoints

Field	Word(base8)	Bits	Description
JTBKPP	j+214	0-15	Contents of replaced parcel
JTBKP2	j+214	16-39	Breakpoint reset address
JTBKP1	j+214	40-63	Breakpoint address

DEFINE THE POINTER FIELDS WITHIN THE MEMORY POOL
AREAS FOR THE JTA DNT'S

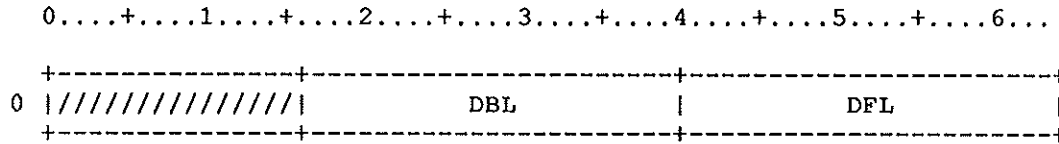

Figure JT-3. JTA DNTs

Field	Word(base8)	Bits	Description
JTDBL	0	16-39	DNT BACKWARD LINK
JTDFL	0	40-63	DNT FORWARD LINK

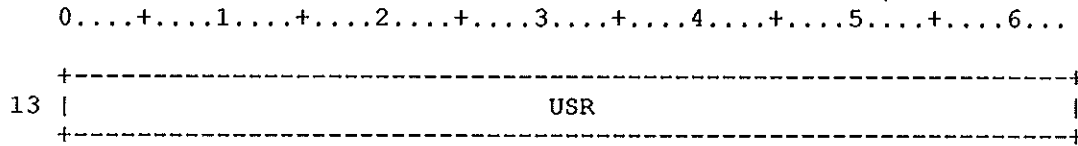

Figure JT-4. Provide tags for JTUSR

Field	Word(base8)	Bits	Description
JTUSR	13	0-63	

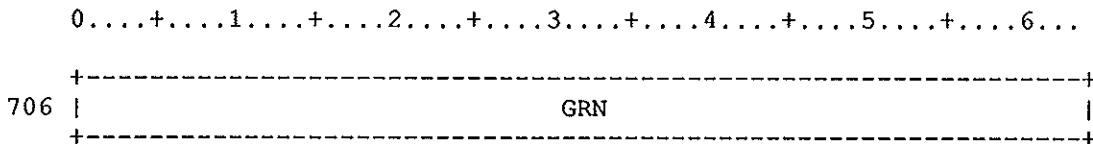

Figure JT-5. Provide tags for JTGRN

Field	Word(base8)	Bits	Description
JTGRN	706	0-63	

JOB EXECUTION TABLE

Figure JX-1 displays the Job Execution Table (JXT). NOTE that the representation of JXGRID and JXGRN is incomplete in the generated diagram. The words immediately following the word containing JXGRID and JXGRN are not undefined (as shown). They are copies of the JXGRID/JXGRN word, repeated L@NGRN times.

0....+....1....+....2....+....3....+....4....+....5....+....6...

0	JN				
1	STAT		POA		ORD
2	AST				
3	AST1				
4				JTA	
5	NT	CLN		TXT	
6	Q1				
7	Q2				
10	TSX				
11	RDY				NR
12	SDT		RJS		CJS
13	JSQ				TUC
14	MEM				
15	FMP				
16	LSC				
17	TL				
20	LCS				
\$					\$
31					

Figure JX-1. Job Execution Table

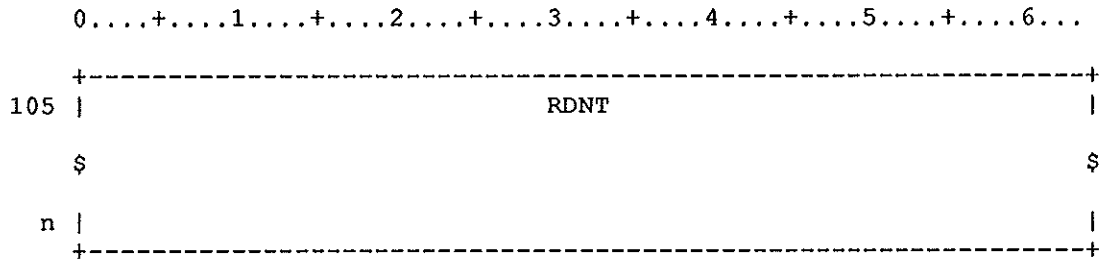

Figure JX-1. Job Execution Table

Field	Word(base8)	Bits	Description
JXJN	0	0-55	Job name
JXSTAT	1	0-21	Job status
JXPOA	1	24-45	Pending job status
JXORD	1	48-63	Ordinal of this JXT entry
JXAST	2	0-63	Ascii status (2 words)
JXAST1	3	0-63	

Eventually JXJTA will fill the entire word:

JXJTA	4	40-63	Address of the Job Table Area
JXNT	5	0-11	Number of active TXTs for job
JXCLN	5	12-17	Cluster number assigned to this job
JXATS	5	18	All tasks suspended
JXTXT	5	32-63	Addr of 1st Task eXecution Table entry
JXQ1	6	0-63	First queue word in JXT
JXQ1F	6	1-7	Job is in a Q1 queue
JXQMS	6	3	Job is in multi-step queue
JXQMR	6	4	Job is in memory request queue
JXBL1	6	8-19	Queue back link as JXT ordinal
JXFL1	6	20-31	Queue fore link as JXT ordinal
JXPR1	6	32-63	Execute address in Q1 word
JXQ2	7	0-63	Second queue word in JXT
JXQ2F	7	1-7	Job is in a Q2 queue
JXQPO	7	1	Job awaiting operator action
JXBL2	7	8-19	Q2 back link as JXT ordinal
JXFL2	7	20-31	Q2 fore link as JXT ordinal
JXPR2	7	32-63	Execute address in Q2 word
<u>JXTSX</u>	10	0-63	<u>Cycles executing in CPU</u>

<u>Field</u>	<u>Word(base8)</u>	<u>Bits</u>	<u>Description</u>
JXRDY	11	0-17	Bit map of system tasks to ready when job rolls in (bit 0 = task 0, etc.)
JXNR	11	40-63	Number of successful rollouts
JXSDT	12	0-15	SDT offset of Q@EXECUTE entry
JXRJS	12	16-39	Requested job size
JXCJS	12	40-63	Current job size
JXJSQ	13	0-15	Job sequence number
JXTUC	13	40-63	Address of task using software cluster
JXMEM	14	0-63	Memory request word from J\$ALLOC
JXFMP	15	0-63	Floating mem pr, (0=suspend, SB=demand)
JXLSC	16	0-63	RT at last job status change
JXTL	17	0-63	Time limit (in cycles) L@JXLCS=D'10 Max length of last control stmt in JXT
JXLCS	20-31	0-63	Last control statement issued for job L@JXLFM=D'10 Max length of \$LOG message in JXT
JXLFM	32-43	0-63	Job's last \$LOG message, for station
JXAMTS	44	0-63	RT for MEMAGED variable
JXMPM	45	1	Memory priority at minimum flag
JXJAR	45	3	Job awaiting resource flag
JXP	45	5-12	Priority from JOB stmt, (1st 4 bits)
JXPRI	45	5-8	Priority of job (integer)
JXPCH	45	13	Priority changed by JCM
JXDERR	45	16-24	Status from last DQM roll request
JXDNT	45	32-63	DNT address for roll image
JXBAND	46	0-63	Job's band entry
JXMBSV	46	32-47	Job's memory band save area
JXMEMB	46	48-63	Job's memory band priority
JXDTI	47	0-63	RT at job initiation
JXLRC	50	0-63	RT at last residence change

<u>Field</u>	<u>Word(base8)</u>	<u>Bits</u>	<u>Description</u>
JXROLL	51	0-63	Real time in-mem thrash lock expires
JXFMP1	52	0-63	Floating mem priority, at JXLRC
JXNRR	53	0	Not rerunable if set
JXTRM	53	1	Job in termination if set
JXWOP	53	2	Waiting for operator response
JXLOCK	53	3-5	Job locked out
JXLMEM	53	3	-- Due to memory change
JXLSYS	53	4	-- Due to system change
JXNS	53	5	-- Due to job on unavailable device
JXRPV	53	7	Job in reprieve code flag
JXDMMR	53	8	Don't-mark-recoverable flag
JXIA	53	9	Interactive job if set
JXACNV	53	10	Account not validated flag
JXDORR	53	13	Flags a rerun at job delete time
JXURLM	53	14	System log message indicator
JXCFL	53	15	Recovered job needs FL update
JXSW	53	16-21	Sense switches
JXLVL	53	22-24	Control statement procedure level
JXEMA	53	25	1=Extended memory addressing (XPEMA)
JXIPR	53	26	IPC access while job rolled out
JXAUT	53	32-63	Address of AUT for interactive job
JXJTL	54	0-63	Length of Job Table Area
JXTMB	55	0-63	Max MOS/Job for tape I/O
JXMTN	56	0-63	Highest task # assigned in job
JXERCL	57	0	Event recall flag
JXERMO	57	1	Event monitoring flag
JXIJQ	57	2	Inter-job messages are queued

<u>Field</u>	<u>Word(base8)</u>	<u>Bits</u>	<u>Description</u>
JXERMS	57	16-39	Event recall mask
JXMSIJ	57	16	Inter-job message arrived
JXMSUO	57	17	Unsolicited oper msg arrived
JXMSOR	57	18	Operator reply arrived
JXMSIP	57	19	IPC request done
JXMSSE	57	20	Site defined Event (for local code)
JXMSCH	57	26	Channel function done
JXMSIQ	57	27	SDT placed in INPUT queue
JXMSOQ	57	28	SDT placed in OUTPUT queue
JXMSAE	57	29	Archiving System Event
JXERMP	57	40-63	Event recall map
JXMPIJ	57	40	Inter-job message arrived
JXMPUO	57	41	Unsolicited oper msg arrived
JXMPOR	57	42	Operator reply arrived
JXMPIP	57	43	IPC request done
JXMPSE	57	44	Site defined Event (for local code)
JXMPCH	57	50	Channel function done
JXMPIQ	57	51	SDT placed in INPUT queue
JXMPQO	57	52	SDT placed in OUTPUT queue
JXMPAE	57	53	Archiving System Event
JXPRST	60	0-15	Preemption status
JXPRTQ	60	0	Job is a PRTQ element
JXPOIS	60	1	Operator initiated SWEEP outstanding
JXPIS	60	2	Initiate SWEEP
JXPSIP	60	3	SWEEP in progress
JXPSC	60	4	SWEEP complete
JXPOIR	60	5	Operator initiated RESTORE outstanding
JXPIR	60	6	Initiate RESTORE
JXPRIP	60	7	RESTORE in progress
JXPRC	60	8	RESTORE complete
JXPTLE	60	9	FSS thrash lock expired
JXPDAT	60	10	DAT's in STP after data movement
JXPGO	60	11	Job awaiting restart through REENT
JXRAT	60	16-39	Preemptable resource allocation queue
JXPQFL	60	40-51	PRTQ forward link
JXPQBL	60	52-63	PRTQ backward link
JXGRID	61	0-31	Folded generic resource name
JXGRN	61	32-63	Generic resource counter
<p>The following two words are used by the Operator Message code and are cleared by EXP during SCP reply processing. Do NOT add non-operator message related fields to them.</p>			
JXOMMF	101	0-15	Mainframe ID for message
JXOMMN	101	16-23	Message number

<u>Field</u>	<u>Word(base8)</u>	<u>Bits</u>	<u>Description</u>
JXOMST	101	24-31	Message status
JXOMUF	101	32	Unsolicited operator message flag
JXOMRA	101	40-63	Message address for queued message
JXOMQ	102	0	Message queued flag
JXOMCA	102	40-63	Call address (JCB rel)
JXEXPW	103	0-63	EXP word, can modify w/o STPLK
JXECHO	103	0-15	Logfile message exclusion mask
JXPSIU	103	16	PAD space is in exclusive use
JXWUC	103	17	EXP is currently advance user channels
JXMSGW	104	0-63	MSG word, can modify w/o STPLK
JXMCNT	104	0-15	Number of messages queued for writting
JXRDNT	105-n	0-63	Roll file DNT entry
SZ@JXT	=	LE@JXT*NE@JXT	

The Backup Catalog dataset is used by the archiving system to record various information about backed-up datasets. Most of this information concerns the location and technique used to recall or restore a dataset when it has been migrated or retired to the backup media. Some information is duplicated from the Master Catalog and/or the Dataset Catalog, primarily for recovery and validation purposes. Some information is also required for the AUDIT utility when reporting on migrated or retired datasets.

The Backup Catalog is organized in 512 word blocks, each containing eight 64 word entries. There is no logical order in this catalog, since access to individual entries is entirely through pointers in the Master Catalog. There are four types of entries in the catalog: Main, Continuation, Permit DXT, and Other DXT.

Main entries are essentially "trailer records" with a fixed length part followed by a variable length part. The fixed portion contains basic identification information for the dataset edition as well as pointers to any associated other types of entries. The variable length portion contains three types of data: a list of devices the dataset resides (or resided) on, the recall text, and the delete text. Continuation entries are allocated to hold any of the variable length information which does not fit in the main entry. Continuation entries use the same four word header format as the main entry; the remaining 60 words are considered logically contiguous with the last word of the previous entry.

When a dataset edition is migrated or retired, all associated DXT entries are copied to the Backup Catalog. Permits are chained separately from all other types of DXTs to facilitate access validation prior to recall or restore. Both types of DXT copies consist of the four word header used by main and continuation entries, followed by the 60 data words of the original DXT.

Entries available for allocation are linked in a chain by the field KBCEA, starting with the first entry in the catalog. This first entry, at address 1000 (octal), is used exclusively as the pointer to the available entry chain. Since the chain is linked in only one direction, the most recently released entry will be the first to be reallocated.

0....+....1....+....2....+....3....+....4....+....5....+....6....

0	TYP	STAT	////////	VER		ADDR		
1		MEA				CEA		
2		CKS				MCA		
3	////////////////////////////////////							
4				PDN				
5								
6			////////////////////////////////////					
7				ID				
10				OWN				
11							////////	
12	PAM	* ///		ACS		RT	ED	
13				USR				
14							////////	
15				ACN				
16							////////	
17				RDP				
20				WTP				
21				MNP				
22				CRT				
23				ACT				
24				TDM				
25				MFT				
26				DSZ				
27	////////////////////////////////////			SSC	////////////////////////////////////			TXC
30				DNS				

Figure KB-1. BACKUP CATALOG MAIN ENTRY

0...+...1...+...2...+...3...+...4...+...5...+...6...

31	CRI			
	\$			\$
37				
40	DXT		PER	
41	BACT			
42	MIGT			
43	RETT			
44	RCLT			
45	NMIG		NRCL	
46	NRET		NRES	
47	IDSN			
50	LIDN	CPYS	//////////	FSEQ
51	VOL1		//////////	
52	VOL2		//////////	
53	VOL3		//////////	
54	VOL4		//////////	
55	LDVL		LDV	
56	LRCL		RCL	
57	LDEL		DEL	

Figure KB-1. BACKUP CATALOG MAIN ENTRY

Backup Catalog Entry

<u>Field</u>	<u>Word(base8)</u>	<u>Bits</u>	<u>Description</u>
KB TYP	0	0-7	Entry Type KBMAIN=1 Main entry type
KB STAT	0	8-15	Entry Status
KB MIG	0	8	Dataset Edition is Migrated
KB RET	0	9	Dataset Edition is Retired
KB VER	0	24-31	Backup Catalog Version
KB ADDR	0	32-63	Entry Address
KB MEA	1	0-31	Main entry address
KB CEA	1	32-63	Continuation entry address
KB CKS	2	0-31	Entry Checksum
KB MCA	2	32-63	Master Catalog Address
KB PDN	4-6	0-63	Permanent Dataset Name
KB PDN1	4	0-63	PDN characters 1-8
KB PDN2	5	0-55	PDN characters 9-16
KB PDN3	6	0-7	PDN character 17
KB ID	7	0-63	Permanent Dataset ID
KB OWN	10-11	0-63	Permanent Dataset Owner
KB OWN1	10	0-63	OWN characters 1-8
KB OWN2	11	0-55	OWN characters 9-15
KB PAM	12	0-7	Public Access Mode
KB TRA	12	9	Track Access Flag
KB RESD	12	10-11	Preferred Residency (see COMPM)
KB ACS	12	16-31	Access count
KB RT	12	32-47	Retention time (days)
KB ED	12	48-63	Permanent Dataset Edition
KB USR	13-14	0-63	Permanent Dataset User
KB USR1	13	0-63	USR characters 1-8

<u>Field</u>	<u>Word(base8)</u>	<u>Bits</u>	<u>Description</u>
KBUSR2	14	0-55	USR characters 9-15
KBACN	15-16	0-63	Permanent Dataset Account
KBACN1	15	0-63	ACN characters 1-8
KBACN2	16	0-55	ACN characters 9-15
KBRDP	17	0-63	Read Permission Password
KBWTP	20	0-63	Write Permission Password
KBMNP	21	0-63	Maintenance Permission Password
KBCRT	22	0-63	Creation Time
KBACT	23	0-63	Last Access Time
KBTDI	24	0-63	Last Dump Time (PDSDUMP only)
KBMFT	25	0-63	Last Modification Time
KBDSZ	26	0-63	Dataset size in words
KBSSC	27	24-31	Text length in words
KBTXC	27	56-63	Station Slot length in words
KBDNS	30	0-63	Reserved for Sites
KBCRI	31-37	0-63	Reserved for CRI extensions
KBDXT	40	0-31	Other DXT's Address
KBPER	40	32-63	Permit DXT Address
KBBACT	41	0-63	Backup Time
KBMIGT	42	0-63	Migration Time
KBRETT	43	0-63	Retirement Time
KBRCLT	44	0-63	Recall/Restore/Reload Time
KBNMIG	45	0-31	Number of Migrations
KBNRCL	45	32-63	Number of Recalls
KBNRET	46	0-31	Number of Retirements
KBNRES	46	32-63	Number of Restores
KBIDSN	47	0-63	Invented Dataset Name (LJZF)

<u>Field</u>	<u>Word(base8)</u>	<u>Bits</u>	<u>Description</u>
KBLIDN	50	0-7	Length of Invented Dataset Name
KBCPYS	50	8-15	Number of Backup Copies Required
KBFSEQ	50	32-63	File Sequence Number (4 characters)
KBVOL1	51	0-47	First Backup Volume Label (starting)
KBVOL2	52	0-47	Second Backup Volume Label (starting)
KBVOL3	53	0-47	Third Backup Volume Label (starting)
KBVOL4	54	0-47	Fourth Backup Volume Label (starting)
KBLDVL	55	0-31	Length of Logical Device List
KBLDV	55	32-63	Logical Device List Address
KBLRCL	56	0-31	Length of Recall TEXT (words)
KBRCL	56	32-63	Recall TEXT address
KBLDEL	57	0-31	Length of Delete TEXT (words)
KBDEL	57	32-63	Delete TEXT address

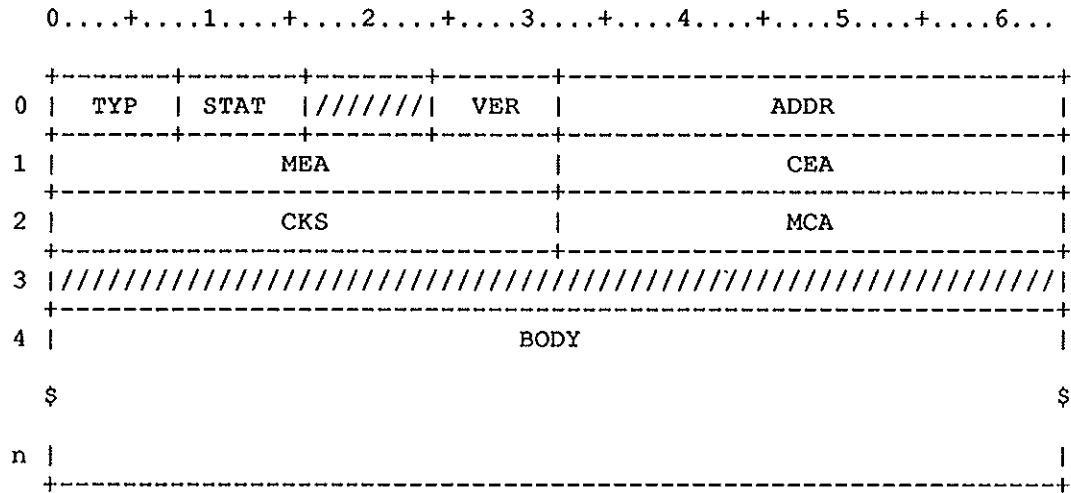

Figure KB-2. BACKUP CATALOG CONTINUATION ENTRY

Field	Word(base8)	Bits	Description
KB TYP	0	0-7	Entry Type KBCONT=2 Continuation entry type
KB STAT	0	8-15	Entry Status
KB VER	0	24-31	Backup Catalog Version
KB ADDR	0	32-63	Entry Address
KB MEA	1	0-31	Main entry address
KB CEA	1	32-63	Continuation entry address
KB CKS	2	0-31	Entry Checksum
KB MCA	2	32-63	Master Catalog Address
KB BODY	4-n	0-63	Body of Continuation

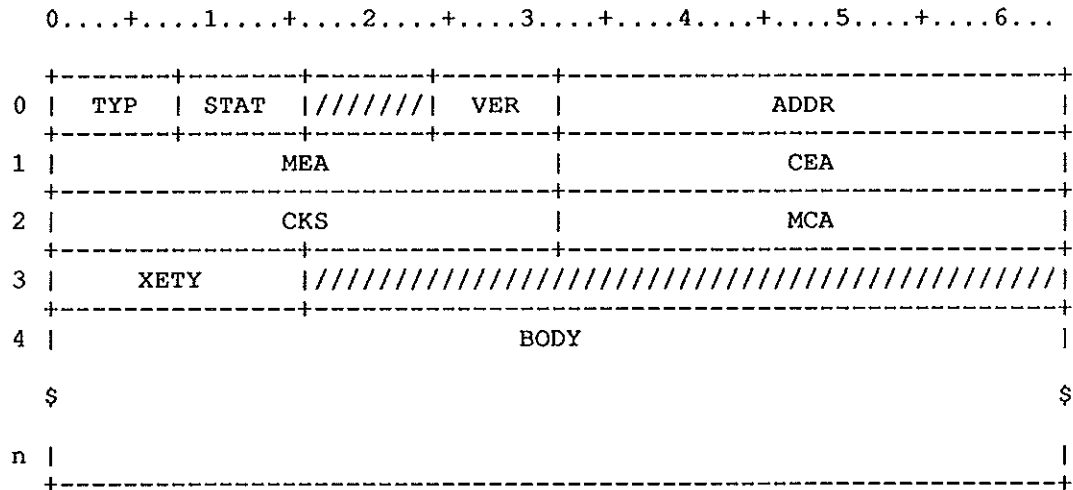

Figure KB-3. BACKUP CATALOG PERMIT DXT ENTRY

Field	Word(base8)	Bits	Description
KB TYP	0	0-7	Entry Type KBPERM=3 Permit DXT type
KB STAT	0	8-15	Entry Status
KB VER	0	24-31	Backup Catalog Version
KB ADDR	0	32-63	Entry Address
KB MEA	1	0-31	Main entry address
KB CEA	1	32-63	Continuation entry address
KB CKS	2	0-31	Entry Checksum
KB MCA	2	32-63	Master Catalog Address
KB XETY	3	0-15	DXT entry type (DXPERM)
KB BODY	4-n	0-63	Body of Permit DXT

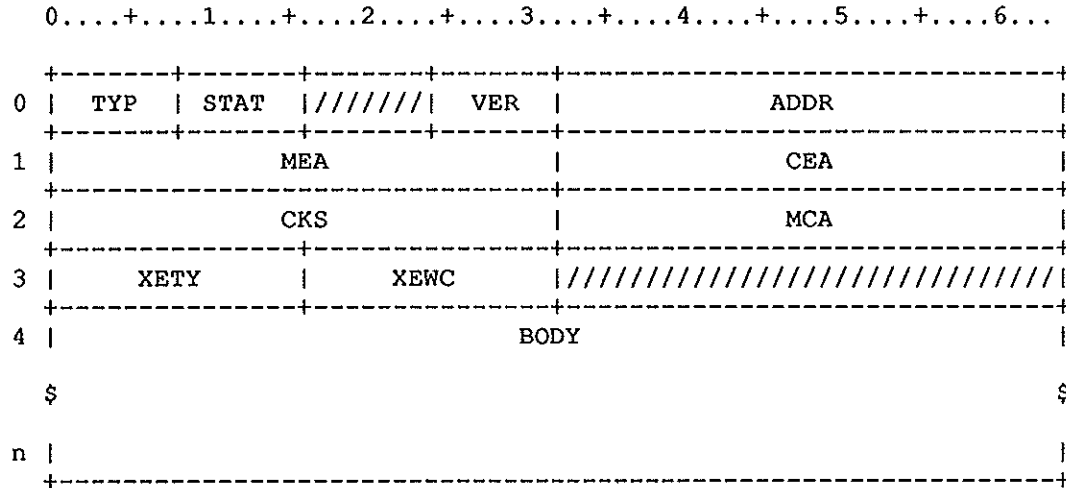

Figure KB-4. BACKUP CATALOG OTHER DXT ENTRY

Field	Word(base8)	Bits	Description
KB TYP	0	0-7	Entry Type KBODXT=4 Other DXT type
KB STAT	0	8-15	Entry Status
KB VER	0	24-31	Backup Catalog Version
KB ADDR	0	32-63	Entry Address
KB MEA	1	0-31	Main entry address
KB CEA	1	32-63	Continuation entry address
KB CKS	2	0-31	Entry Checksum
KB MCA	2	32-63	Master Catalog Address
KB XETY	3	0-15	DXT entry type (DXTEXT,DXNOTE,DXTRAC)
KB XEWC	3	16-31	DXT entry word count (Text/Note DXTs)
KB BODY	4-n	0-63	Body of Text/Note/Tracking DXT

PDM archiving tasks log on to PDM when they are active. This table is used to keep track of which tasks are doing backup, space management, recall, or cleanup. The table also determine how many tasks of each type can be running at any one time.

0....+....1....+....2....+....3....+....4....+....5....+....6...

0	TN				////////////////////////////////////											
1	***	***	***	***	***	***	***	***	NBU	NSM	NRC	NCU	NBH	NSH	NRH	NCH
2	BU0			BU1			BU2			BU3						
3	BU4			BU5			BU6			BU7						
4	BU8			BU9			BU10			BU11						
5	BU12			BU13			BU14			BU15						
6	SM0			SM1			SM2			SM3						
7	SM4			SM5			SM6			SM7						
10	SM8			SM9			SM10			SM11						
11	SM12			SM13			SM14			SM15						
12	RC0			RC1			RC2			RC3						
13	RC4			RC5			RC6			RC7						
14	RC8			RC9			RC10			RC11						
15	RC12			RC13			RC14			RC15						
16	CU0			CU1			CU2			CU3						
17	CU4			CU5			CU6			CU7						
20	CU8			CU9			CU10			CU11						
21	CU12			CU13			CU14			CU15						

Figure KL-1. PDM Archiving Task Logon Table

<u>Field</u>	<u>Word(base8)</u>	<u>Bits</u>	<u>Description</u>
KLTN	0	0-23	Table Name 'KL'
KLMXBU	1	0-3	Maximum Backup Main Tasks
KLMXSM	1	4-7	Maximum Space Manager Main Tasks
KLMXRC	1	8-11	Maximum Recall Main Tasks
KLMXCU	1	12-15	Maximum Cleanup Main Tasks
KLMXBH	1	16-19	Maximum Backup Helper Tasks
KLMXSH	1	20-23	Maximum Space Manager Helper Tasks
KLMXRH	1	24-27	Maximum Recall Helper Tasks
KLMXCH	1	28-31	Maximum Cleanup Helper Tasks
KLNU	1	32-35	Logged on Backup Main Tasks
KLNSM	1	36-39	Logged on Space Manager Main Tasks
KLNR	1	40-43	Logged on Recall Main Tasks
KLNCU	1	44-47	Logged on Cleanup Main Tasks
KLNBH	1	48-51	Logged on Backup Helper Tasks
KLNSH	1	52-55	Logged on Space Manager Helper Tasks
KLNRH	1	56-59	Logged on Recall Helper Tasks
KLNCH	1	60-63	Logged on Cleanup Helper Tasks
KLBU0	2	0-15	Task Ordinal - Backup Task 0
KLBU1	2	16-31	Task Ordinal - Backup Task 1
KLBU2	2	32-47	Task Ordinal - Backup Task 2
KLBU3	2	48-63	Task Ordinal - Backup Task 3
KLBU4	3	0-15	Task Ordinal - Backup Task 4
KLBU5	3	16-31	Task Ordinal - Backup Task 5
KLBU6	3	32-47	Task Ordinal - Backup Task 6
KLBU7	3	48-63	Task Ordinal - Backup Task 7
KLBU8	4	0-15	Task Ordinal - Backup Task 8
KLBU9	4	16-31	Task Ordinal - Backup Task 9

<u>Field</u>	<u>Word(base8)</u>	<u>Bits</u>	<u>Description</u>
KLBU10	4	32-47	Task Ordinal - Backup Task 10
KLBU11	4	48-63	Task Ordinal - Backup Task 11
KLBU12	5	0-15	Task Ordinal - Backup Task 12
KLBU13	5	16-31	Task Ordinal - Backup Task 13
KLBU14	5	32-47	Task Ordinal - Backup Task 14
KLBU15	5	48-63	Task Ordinal - Backup Task 15
KLSM0	6	0-15	Task Ordinal - Space Manager 0
KLSM1	6	16-31	Task Ordinal - Space Manager 1
KLSM2	6	32-47	Task Ordinal - Space Manager 2
KLSM3	6	48-63	Task Ordinal - Space Manager 3
KLSM4	7	0-15	Task Ordinal - Space Manager 4
KLSM5	7	16-31	Task Ordinal - Space Manager 5
KLSM6	7	32-47	Task Ordinal - Space Manager 6
KLSM7	7	48-63	Task Ordinal - Space Manager 7
KLSM8	10	0-15	Task Ordinal - Space Manager 8
KLSM9	10	16-31	Task Ordinal - Space Manager 9
KLSM10	10	32-47	Task Ordinal - Space Manager 10
KLSM11	10	48-63	Task Ordinal - Space Manager 11
KLSM12	11	0-15	Task Ordinal - Space Manager 12
KLSM13	11	16-31	Task Ordinal - Space Manager 13
KLSM14	11	32-47	Task Ordinal - Space Manager 14
KLSM15	11	48-63	Task Ordinal - Space Manager 15
KLRC0	12	0-15	Task Ordinal - Recall Task 0
KLRC1	12	16-31	Task Ordinal - Recall Task 1
KLRC2	12	32-47	Task Ordinal - Recall Task 2
KLRC3	12	48-63	Task Ordinal - Recall Task 3
KLRC4	13	0-15	Task Ordinal - Recall Task 4

<u>Field</u>	<u>Word(base8)</u>	<u>Bits</u>	<u>Description</u>
KLRC5	13	16-31	Task Ordinal - Recall Task 5
KLRC6	13	32-47	Task Ordinal - Recall Task 6
KLRC7	13	48-63	Task Ordinal - Recall Task 7
KLRC8	14	0-15	Task Ordinal - Recall Task 8
KLRC9	14	16-31	Task Ordinal - Recall Task 9
KLRC10	14	32-47	Task Ordinal - Recall Task 10
KLRC11	14	48-63	Task Ordinal - Recall Task 11
KLRC12	15	0-15	Task Ordinal - Recall Task 12
KLRC13	15	16-31	Task Ordinal - Recall Task 13
KLRC14	15	32-47	Task Ordinal - Recall Task 14
KLRC15	15	48-63	Task Ordinal - Recall Task 15
KLCU0	16	0-15	Task Ordinal - Cleanup Task 0
KLCU1	16	16-31	Task Ordinal - Cleanup Task 1
KLCU2	16	32-47	Task Ordinal - Cleanup Task 2
KLCU3	16	48-63	Task Ordinal - Cleanup Task 3
KLCU4	17	0-15	Task Ordinal - Cleanup Task 4
KLCU5	17	16-31	Task Ordinal - Cleanup Task 5
KLCU6	17	32-47	Task Ordinal - Cleanup Task 6
KLCU7	17	48-63	Task Ordinal - Cleanup Task 7
KLCU8	20	0-15	Task Ordinal - Cleanup Task 8
KLCU9	20	16-31	Task Ordinal - Cleanup Task 9
KLCU10	20	32-47	Task Ordinal - Cleanup Task 10
KLCU11	20	48-63	Task Ordinal - Cleanup Task 11
KLCU12	21	0-15	Task Ordinal - Cleanup Task 12
KLCU13	21	16-31	Task Ordinal - Cleanup Task 13
KLCU14	21	32-47	Task Ordinal - Cleanup Task 14
KLCU15	21	48-63	Task Ordinal - Cleanup Task 15

The Master Catalog contains an entry for each unique dataset PDN, ID, and OWN known to the system whether on-line, migrated, or retired. Pointers in the Master Catalog entry locate the Dataset Catalog (DSC) and/or Backup Catalog (BCD) entries for each edition of the dataset.

The Master Catalog is a user dataset owned by the system. Its organization is very similar to REGIONAL(3) found in the PL/I programming language. This organization was chosen because it has reasonably good search characteristics, is relatively simple to implement, and allows I/O streaming in many cases.

In this organization, the catalog is divided into a number of equal-sized units called regions; each region consists of a number of contiguous sectors. The site specifies both the number and size of the regions within certain constraints: the number of regions should be prime, and the number of sectors per region should be an even fraction or a multiple of device track size.

A dataset is assigned to a particular region by hashing its OWNER value. Thus all of the datasets for a given owner are normally cataloged in the same region. However, if the region has no space, the dataset will be cataloged on the next sequential region which does have space. A catalog full condition will arise only when all regions are full, since the first region is considered to follow the last.

Each region is logically divided into 32-word entries, the first several of which are taken up by the Region Index Table. The Region Index Table begins on a sector boundary, and may span multiple sectors; its total size is always a multiple of 32 words. Each sector containing Region Index Table has a fixed size (4 word) header followed by a maximum of 508 64-bit index words. Each index word has two subfields: a set of eight flag bits and a 48-bit key. The flag bits indicate how the entry is being used. The 48-bit key is derived from the dataset's PDN, ID, and OWN.

The Region Index Table is used for both entry allocation and for entry searches. When doing entry allocation, the first available entry is assigned. When doing searches, the desired PDN, ID, and OWN are hashed to generate the key which is then compared against the keys in the index table.

The rest of the region entries are of two types: main and continuation. Main entries consist of identification information for a dataset and four edition records. An edition record contains the status and DSC/BCD addresses for a single edition of the dataset. Continuation entries consist of seven edition records. A main entry will have

as many continuation entries as are required to record the status and location of all editions of the dataset. Main and continuation entries are linked by pointers.

Addresses within the catalog are 32 bits long, consisting of a 23 bit logical block number and a 9 bit block word offset. The logical block numbers run from 1 to the number of blocks in the catalog; the word offset runs from 0 to 511.

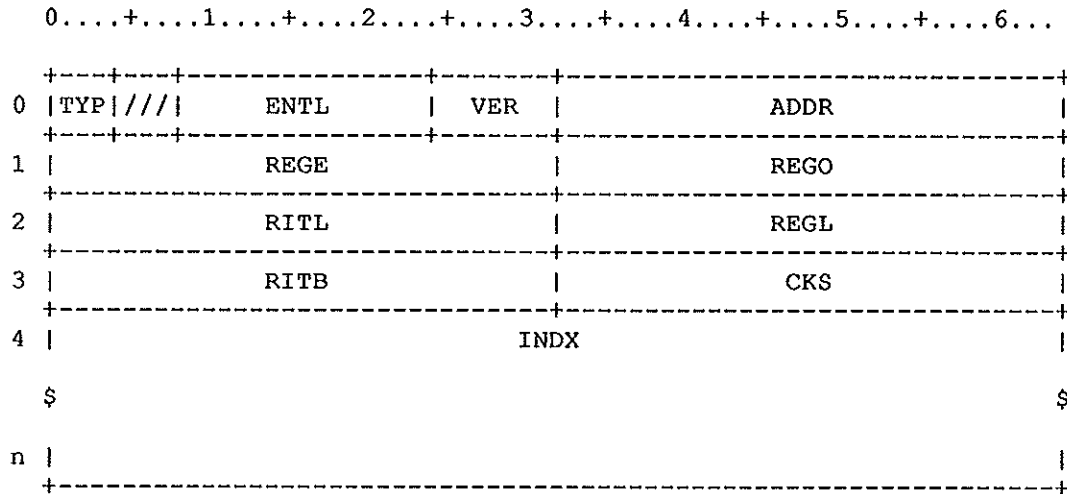

Figure KM-1. MASTER CATALOG REGION INDEX TABLE

MASTER CATALOG REGION INDEX TABLE

KMTYP 0 0-3 Entry type = 1

Field	Word(base8)	Bits	Description
KMENTL	0	8-23	Entry Length in words (multiple of 32)
KMVER	0	24-31	Catalog version number
KMADDR	0	32-63	Entry address
KMREGE	1	0-31	Number of assignable region entries
KMREGO	1	32-63	Number of region overflow entries
KMRITL	2	0-31	Total length of region index table
KMREGL	2	32-63	Length of region in words
KMRITB	3	0-31	Region index table base address
KMCKS	3	32-63	Entry Checksum

Field Word(base8) Bits Description

KMINDX 4-n 0-63 Region Index words

Note that when KMADDR is the region first word address, then the address of the first entry in the region is KMADDR+KMRITL and that the address of the first word of the next region is KMADDR+KMREGL. The MCD entry address for a given index word is the word offset (0-507)*32+KMRITB. KMRITB contains the MCD entry address for the first index word following the header.

MASTER CATALOG INDEX FIELD

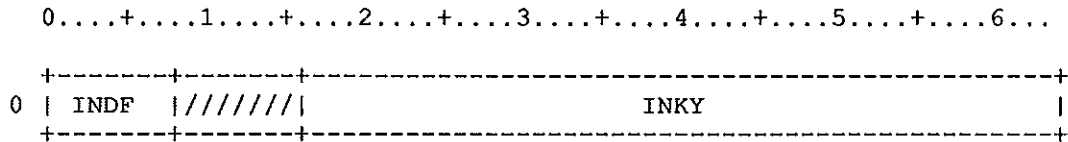

Figure KM-2. MASTER CATALOG INDEX FIELD

Field Word(base8) Bits Description

KMINDF	0	0-7	Index Flags:
KMINNA	0	0	Set if entry has never been allocated
KMINIT	0	1	Set if index table entry
KMINME	0	2	Set if main entry
KMINCE	0	3	Set if continuation entry
KMINRO	0	4	Set if entry is not on home region
KMINKY	0	16-63	Key derived from PDN, ID, OWN
KMKEY1	0	16-31	Part of key derived from OWN
KMKEY2	0	32-63	Part of key derived from PDN and ID

MASTER CATALOG MAIN ENTRY

0....+....1....+....2....+....3....+....4....+....5....+....6....

0	TYP	///	ENTL		VER		ADDR	
1		ENF		////////	ERM		CEA	
2		//////////		//////////		ME	A	
3		//////////		//////////		CK	S	
4					PDN			
5								
6		//////////		//////////		//////////	//////////	
7					ID			
10					OWN			
11							////////	
12					CAT			
13							////////	
14		\$/	//////////		LED		HED	
15		//////////		//////////		//////////	//////////	
16		//////////		//////////		//////////	//////////	
17					INS1			
20					MEDR			
n								

Figure KM-3. MASTER CATALOG MAIN ENTRY

KMTYP	0	0-3	Entry type = 2
<hr/>			
<u>Field</u>	<u>Word(base8)</u>	<u>Bits</u>	<u>Description</u>
KMENTL	0	8-23	Entry Length in words (32)
KMVER	0	24-31	Catalog version number
KMADDR	0	32-63	Entry address
KMENF	1	0-15	Entry flags
KMTYPU	1	0	Set if user saved dataset
KMTYPO	1	1	Set if output dataset
KMTYPI	1	2	Set if input dataset
KMENTM	1	3	Set if main entry
KMENTC	1	4	Set if continuation entry
KMERM	1	24-31	Edition record map
KMCEA	1	32-63	Continuation address
KMMEA	2	32-63	Main entry address
KMCKS	3	32-63	Entry checksum
KMPDN	4-6	0-63	Permanent dataset name
KMPDN1	4	0-63	PDN characters 1-8
KMPDN2	5	0-55	PDN characters 9-15
KMPDN3	6	0-7	Reserved
KMID	7	0-63	ID (8 characters)
KMOWN	10-11	0-63	Permanent dataset owner
KMOWN1	10	0-63	OWN characters 1-8
KMOWN2	11	0-55	OWN characters 9-15
KMCAT	12-13	0-63	Catalog name
KMCAT1	12	0-63	CAT characters 1-8
KMCAT2	13	0-55	CAT characters 9-15
KMLED	14	32-47	Lowest edition number
KMHED	14	48-63	Highest edition number
KMINS1	17	0-63	Reserved for installations
KMMEDR	20-n	0-63	Main entry edition records (4)

MASTER CATALOG CONTINUATION ENTRY

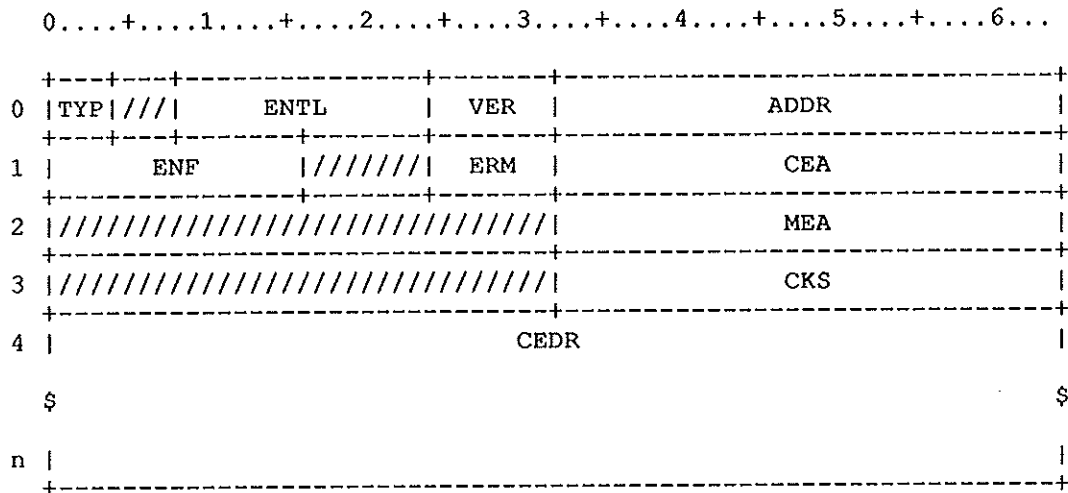

Figure KM-4. MASTER CATALOG CONTINUATION ENTRY

KMTYP 0 0-3 Entry type = 3

Field	Word(base8)	Bits	Description
KMENTL	0	8-23	Entry Length in words (32)
KMVER	0	24-31	Catalog version number
KMADDR	0	32-63	Entry address
KMENF	1	0-15	Entry flags
KMTYPU	1	0	Set if user saved dataset
KMTYPO	1	1	Set if output dataset
KMTYPI	1	2	Set if input dataset
KMENTM	1	3	Set if main entry
KMENTC	1	4	Set if continuation entry
KMERM	1	24-31	Edition record map
KMCEA	1	32-63	Continuation address
KMMEA	2	32-63	Main entry address
KMCKS	3	32-63	Entry checksum
KMCEDR	4-n	0-63	Continuation edition records (7)

MASTER CATALOG EDITION RECORD

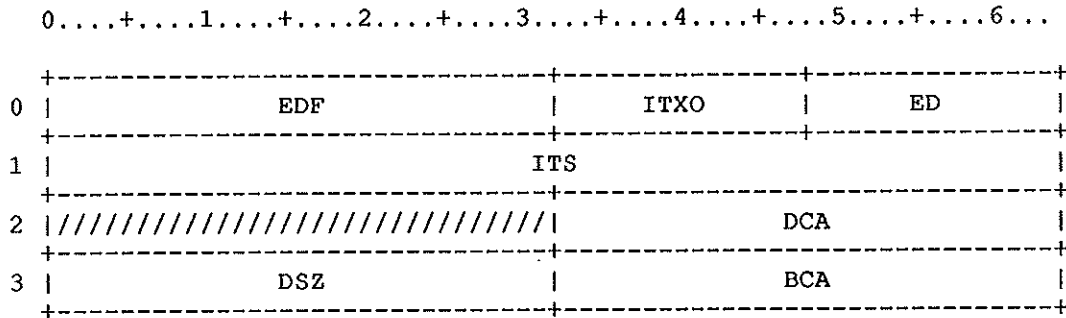

Figure KM-5. MASTER CATALOG EDITION RECORD

LE@KMEDR=4 Length of an edition record
 NE@KMMER=4 Number of edition records, main entry
 NE@KMCEP=7 Number of edition records, cont entry

Field	Word(base8)	Bits	Description
KMEDF	0	0-31	Edition Flags
KMMIG	0	0	Dataset Edition Migrated
KMRET	0	1	Dataset Edition Retired
KMBACR	0	2	Backup Required
KMRBR	0	3	Reset Backup Required
KMRCLR	0	4	Recall Requested
KMRESR	0	5	Restore Requested
KMRELR	0	6	Reload Requested
KMRETR	0	7	Retirement Requested
KMDELR	0	8	Delete Requested
KMBIP	0	9	Backup-in-progress
KMMIP	0	10	Migrate/Retire-in-progress
KMRIP	0	11	Recall/Restore/Reload-in-progress
KMDCEP	0	13	DSC entry has error flags set
KMDCEL	0	14	DSC entry has been lost
KMRESD	0	15-16	Preferred Residency (see COMPM)
KMMIGR	0	17	Migration requested
KMITXO	0	32-47	Interlocking TXT Ordinal
KMED	0	48-63	Edition Number
KMITS	1	0-63	Identifying Timestamp
KMDCA	2	32-63	Dataset Catalog Address
KMDSZ	3	0-31	Dataset size in 512 word blocks
KMBCA	3	32-63	Backup Catalog Address

Due to a software problem, page 406 was not used.
No information is missing.

The Backup Volume Catalog contains an entry for every volume which is or can be used for backup copies of on-line datasets. The Backup Volume Catalog is created and maintained by the BVCEdit utility program, and is accessed by the BACKUP, RECALL, and CLEANUP jobs whenever a new volume is needed for assignment or when the volume status and/or characteristics are needed for processing. Because several jobs share this catalog serially, the jobs accessing it are designed to keep job attachment times to a minimum.

Each entry in the catalog is 16 words long. Entries are assigned sequentially, but are linked circularly by forward pointers when, for example, a dataset spans multiple volumes. The first entry in the dataset is a dummy entry used primarily to link a list of available volumes together. When volumes are returned to the available list, they are added to the end of the list, thus assuring as much as possible that volumes are assigned in a round-robin fashion. The dummy entry also links a list of free (empty) entries which become reserved as available volume entries when a volume name is added to the BVCD.

* * * * *
* This organization may be replaced by one with better *
* search characteristics in the future. *
* * * * *

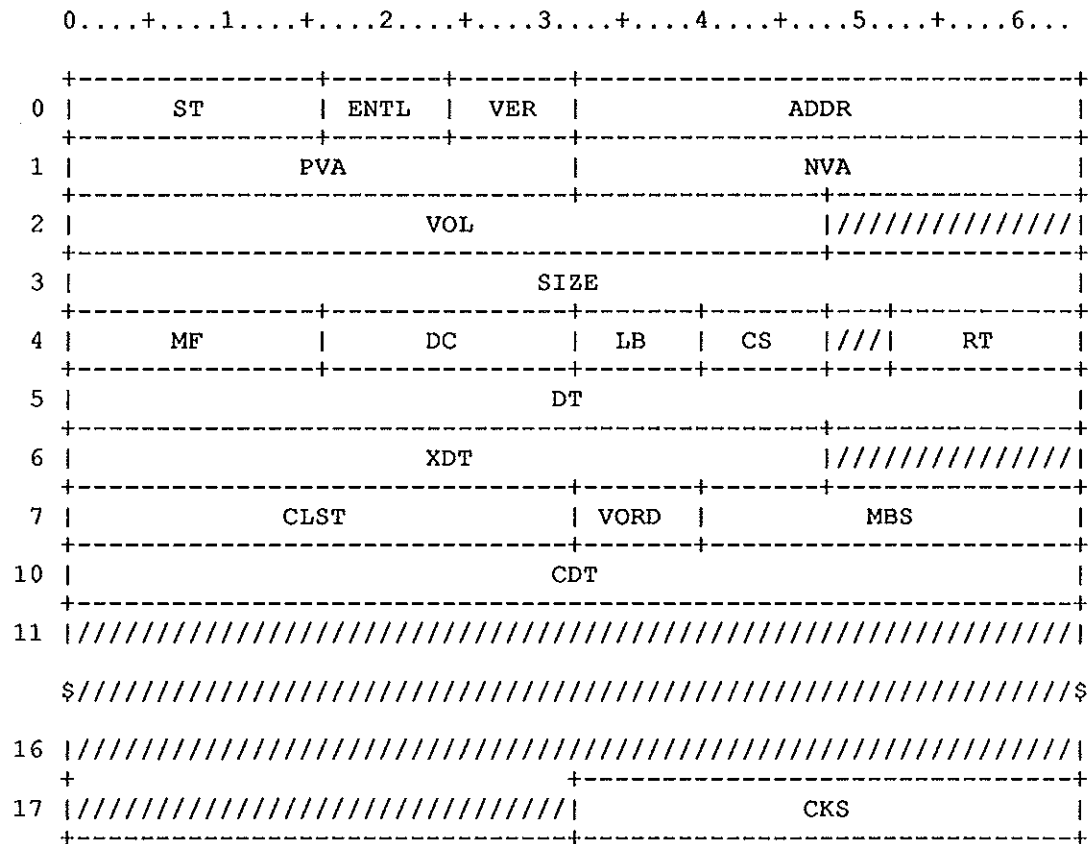

Figure KV-1. BACKUP VOLUME CATALOG

Backup Volume Catalog Entry

Field	Word(base8)	Bits	Description
KVST	0	0-15	Volume status
KVFREE	0	0	Entry has no volume data
KVUSED	0	1	Volume is in use
KVFEDV	0	2	Volume is on a front-end device
KVONDV	0	3	Volume is on an on-line device
KVSQDV	0	4	Volume is sequential
KVDADV	0	5	Volume is direct access
KVHOLD	0	6	Volume is on hold
KVCRPT	0	7	Volume data is corrupt
KVLMBO	0	8	Volume in-use request not complete
KVCATV	0	9	Volume in-use as catalog backup
KVENTL	0	16-23	Entry length in words
KVVER	0	24-31	Catalog version number
KVADDR	0	32-63	Entry address
KVPVA	1	0-31	Previous available address

<u>Field</u>	<u>Word(base8)</u>	<u>Bits</u>	<u>Description</u>
KVNVA	1	32-63	Next volume address (free, avail, use)
KVVOL	2	0-47	Volume name (6 bytes, blank filled)
<u>KVSIZE</u>	3	0-63	<u>Volume capacity in megabytes</u>
KVMF	4	0-15	Mainframe code
KVDC	4	16-31	Disposition code
KVLB	4	32-39	Label type
KVCS	4	40-47	Character set
KVRT	4	52-63	Retention period
KVDT	5	0-63	Device type
KVXDT	6	0-47	Expiration date (yyyddd)
KVCLST	7	0-31	Circ list length (dummy or multiple)
KVVORD	7	32-39	Multi-volume ordinal
KVMBS	7	40-63	Maximum block size in bytes
KVCDT	10	0-63	Timestamp entry made permanent
KVCKS	17	32-63	Entry checksum

Backup Volume Catalog DUMMY Entry

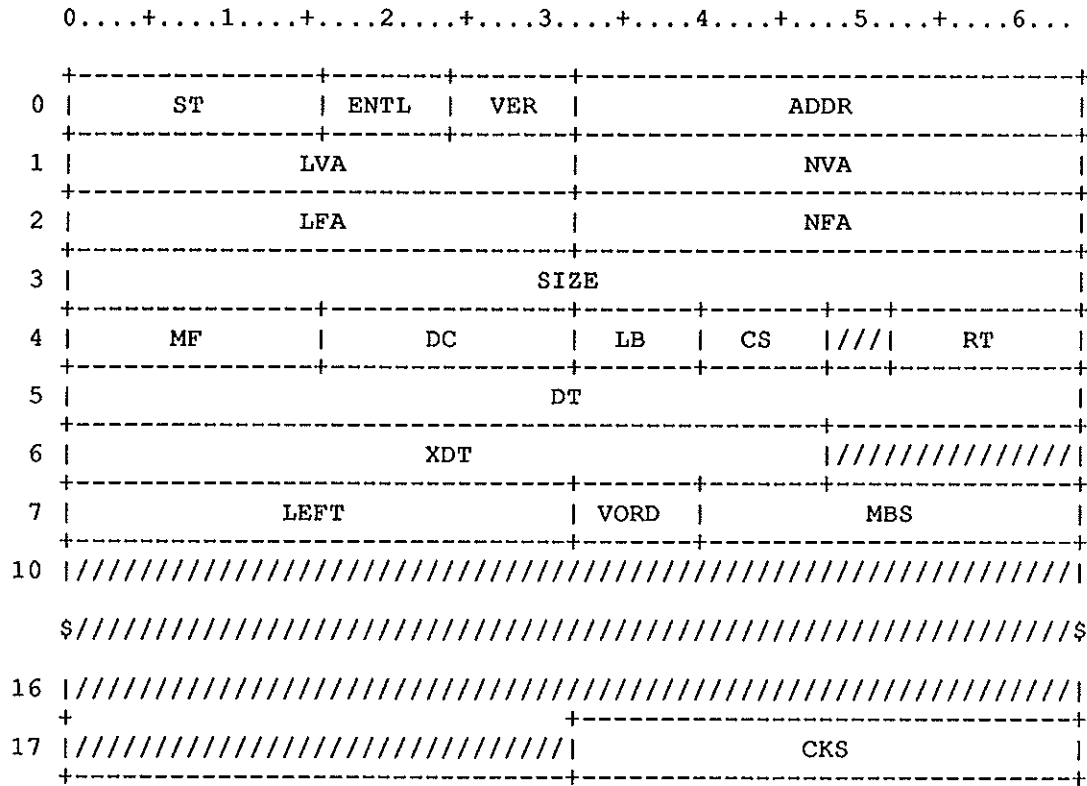

Figure KV-2. BACKUP VOLUME CATALOG

Field	Word(base8)	Bits	Description
KVST	0	0-15	Volume status
KVFREE	0	0	Entry has no volume data
KVUSED	0	1	Volume is in use
KVFEDV	0	2	Volume is on a front-end device
KVONDV	0	3	Volume is on an on-line device
KVSQDV	0	4	Volume is sequential
KVDADV	0	5	Volume is direct access
KVHOLD	0	6	Volume is on hold
KVCRPT	0	7	Volume data is corrupt
KVLMBO	0	8	Volume in-use request not complete
KVENTL	0	16-23	Entry length in words
KVVER	0	24-31	Catalog version number
KVADDR	0	32-63	Entry address
KVLVA	1	0-31	Last available volume address
KVNVA	1	32-63	Next available volume address
KVLFA	2	0-31	Last free entry address

<u>Field</u>	<u>Word(base8)</u>	<u>Bits</u>	<u>Description</u>
KVNFA	2	32-63	Next free entry address
KVSIZE	3	0-63	Volume capacity in megabytes
KVMF	4	0-15	Mainframe code
KVDC	4	16-31	Disposition code
KVLB	4	32-39	Label type
KVCS	4	40-47	Character set
KVRT	4	52-63	Retention period
KVDT	5	0-63	Device type
KVXDT	6	0-47	Expiration date (yyyddd)
KVLEFT	7	0-31	Available list length
KVVORD	7	32-39	Multi-volume ordinal
KVMBS	7	40-63	Maximum block size in bytes
KVCKS	17	32-63	Entry checksum

There is one LCT entry per channel configured for front-end I/O. The ordinal defines whether the channel is on the CPU or I/O subsystem; the type defines the channel's characteristics. The channel may be configured as 'on', which will simulate a CHANNEL ON operator command during COS startup.

The MCU channel should be configured 'on.'

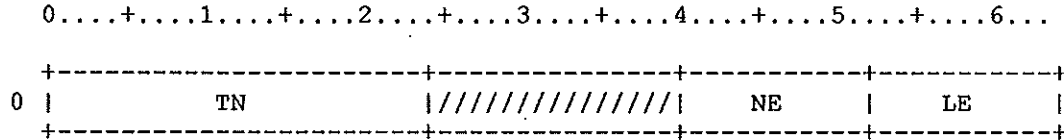

Figure LC-1. Link Configuration Table Header

Header.

<u>Field</u>	<u>Word(base8)</u>	<u>Bits</u>	<u>Description</u>
LCTN	0	0-23	Table name ('LCT' in ASCII)
LCNE	0	40-51	Number of entries (=NE@LCT)
LCLE	0	52-63	Length of entries (=LE@LCT)

Entry.

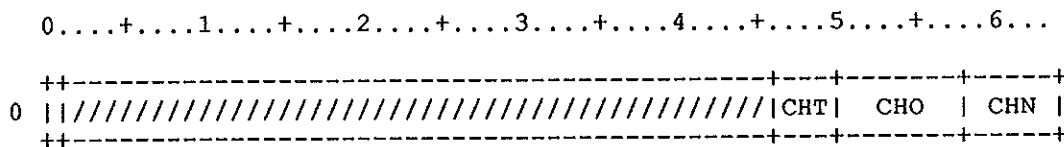

Figure LC-2. Link Configuration Table Entry

Field	Word(base8)	Bits	Description
LCON	0	0	Channel configured on flag
LCCHT	0	46-49	Channel type (if CHO=0): LCCHTIFC=0 IFC (channel coupler) LCCHTNSC=1 NSC Hyperchannel LCCHTVAX=2 VAX version of IFC, A side LCCHTVBX=3 VAX version of IFC, B side LCCHTGST=4 GOS station pseudo channel
LCCHO	0	50-57	Largest channel ordinal
LCCHN	0	58-63	Channel pair number

The Label Definition Table describes the tape label, and consists of four parts: the LDT header, volume header, header which points to the other entries, these entries are optional and can appear anywhere after the header. The following conditions must be met for constructing a Label Definition Table (LDT):

- o The header must be present.
- o The header must precede each entry.
- o Each entry must be pointed to by the offset value in the LDT header. Zero is used for absent fields.
- o The lengths of the whole LDT and of each entry must be set in the proper fields.
- o The length value for volume 1 must be at least the length of the entire first VSN. The length value for either header 1 or header 2 must be at least the defined length of the respective entry.

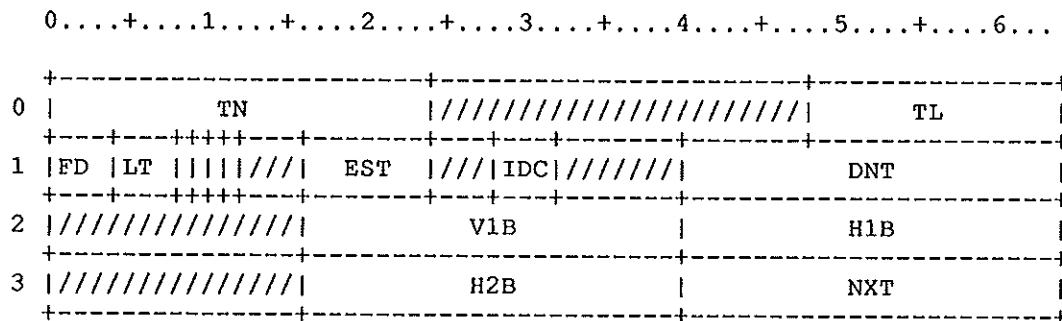

Figure LD-1. Label Definition Table Header

Field	Word(base8)	Bits	Description
LDTN	0	0-23	Table name ('LDT' in ASCII)
LDTL	0	48-63	Table length (variable)
LDFD	1	0-3	Foreign dataset translation identifier This field is used to indicate whether run time foreign dataset translation should be performed on this dataset.

<u>Field</u>	<u>Word(base8)</u>	<u>Bits</u>	<u>Description</u>
LDLT	1	4-7	Requested label type: 0 TPLNL Non-labeled 1 TPLAL ANSI-standard label 2 TPLSL IBM standard labels 3 TPLBP BY-PASS LABEL 4 TPLFR UNSUPPORTED LABEL 5 TPLFAL FIELD ANSI LABELED 6 TPLFNL FIELD NON LABELED 7 TPLFSL FIELD IBM LABELED
LDPROT	1	8	Protected access indicator. If non-zero for a new tape dataset then the dataset is to be protected on the servicing front-end.
LDCAT	1	9	Cataloged dataset indicator
LDCV	1	10	Dataset data conversion flag. This field is used to indicate whether implicit data conversion shall be done by the run time library.
LDDEC	1	11	Dataset enquiry completed
LDEST	1	16-23	Dataset existance status 0 XR\$NIMP not implemented 1 XR\$CAT dataset is cataloged 2 XR\$NCAT dataset is not cataloged 3 XR\$NDC MF has no catalog
LDIDC	1	28-31	Initial dataset desposition 0 TPOLD Old dataset 1 TPNEW New dataset
LDNNT	1	40-63	Dataset name table (DNT) pointer. The field value is JTA-relative.
LDV1B	2	16-39	Offset of volume 1 entry, relative to LDT base. If the LDT does not contain a VOL1 entry, this field must be zero.
LDH1B	2	40-63	Offset of header 1 entry, relative to LDT base; must be zero if there is no HDR1 entry
LDH2B	3	16-39	Offset of header 2 entry, relative to LDT base; must be zero if there is no HDR2 entry
LDNXT	3	40-63	PTR TO NEXT LDT FOR CONCATENATION

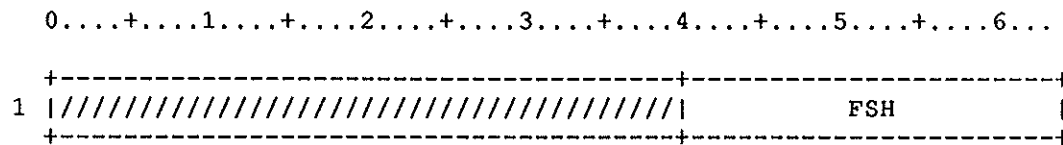

Figure LD-2. Header redefiniton of LDDNT

<u>Field</u>	<u>Word(base8)</u>	<u>Bits</u>	<u>Description</u>
LDFSH	1	40-63	Front-end service header offset

VOLUME 1 ENTRY

The volume 1 entry corresponds to volume 1 labels for all volumes in the dataset. The volume 1 entry can be placed anywhere after the header, as long as the LDV1B header field points to it properly. The volume 1 entry is optional.

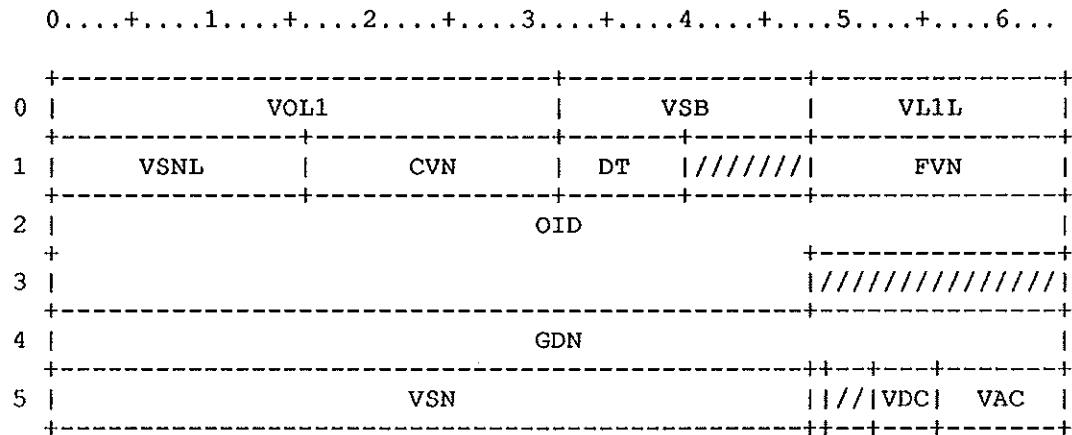

Figure LD-3. VOL1 Entry Description

Field	Word(base8)	Bits	Description
LDVOL1	0	0-31	Entry name ('VOL1' in ASCII)
LDVSB	0	32-47	Volume serial list base offset
LDVL1L	0	48-63	Volume 1 length
LDVSNL	1	0-15	Number of VSNs in entry
LDCVN	1	16-31	Current VSN ordinal
LDDT	1	32-39	Device type LDDT6250=0 0 TPD62 6250 BPI LDDT1600=1 1 TPD16 1600 BPI LDDT3480=2 2 3480 DEVICE
LDFVN	1	48-63	Final VSN ordinal: ordinal of VSN corresponding with the volume sequence number in access condition
LDOID	2-3	0-63	Owner identifier
LDOID1	2	0-63	Characters 1-8
LDOID2	3	0-47	Characters 9-14
LDGDN	4	0-63	Generic device name

<u>Field</u>	<u>Word(base8)</u>	<u>Bits</u>	<u>Description</u>
LDVSN	5	0-47	Beginning VSN
LDVRG	5	48	Volume-registered flag, set by a servicing front-end. When set, the VSN is from front-end catalog.
LDVDC	5	52-55	Volume disposition 0 TPOLD Existing dataset 1 TPNEW New volume to dataset
LDVAC	5	56-63	Volume accessibility character, obtained from the label group

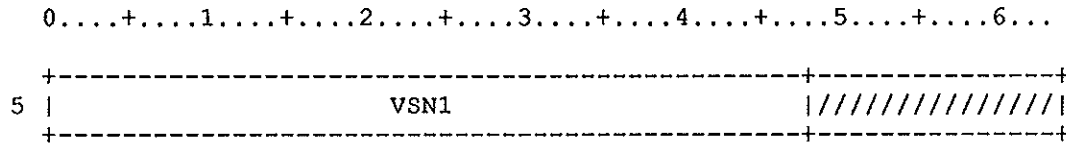

Figure LD-4. Redefinition of LDVSN?

<u>Field</u>	<u>Word(base8)</u>	<u>Bits</u>	<u>Description</u>
LDVSN1	5	0-47	LE@VOL1=W@LDVSN+I@TMV

HEADER 1 ENTRY

The header 1 entry describes dataset attributes and corresponds to the HDR1, EOF1, and EOV1 labels for all volumes in the dataset. Header 1 shows numeric fields in both binary and ASCII. COS uses ASCII for generating and validating the label group. If a field is changed, both versions must be changed. ASCII fields are right-justified with leading zeros. The header 1 entry is optional and can be placed anywhere after the header, provided it is pointed to by header field LDH1B.

0....+....1....+....2....+....3....+....4....+....5....+....6....

0	HDR1		////////////////		HR1L
1	FID1				
2	FID2				
3	FID3				
4	FID4				
5	FID5				
6	FID6	CVSQ	FVSQ		
7	FSEC	CSEC			
10	FSEQ	DAC	VN	FSQ	
11	GEN	GN	GVN		
12	CDT		////////////////		
13	XDT				RT
14	BLK		////////////////		
15	SET		////////////////		
16	FBC	VBC			
17	SCOD				
20	////////////////				

Figure LD-5. HDR1 Entry Description

<u>Field</u>	<u>Word(base8)</u>	<u>Bits</u>	<u>Description</u>
LDHDR1	0	0-31	Entry name ('HDR1' in ASCII)
LDHR1L	0	48-63	Header 1 length
LDFID1	1	0-63	Characters 1-8
LDFID2	2	0-63	Characters 9-16
LDFID3	3	0-63	Characters 17-24
LDFID4	4	0-63	Characters 25-32
LDFID5	5	0-63	Characters 33-40
LDFID6	6	0-31	Characters 41-44
LDCVSQ	6	32-47	Current volume sequence number (file section number), binary equivalent of LDCSEC
LDFVSQ	6	48-63	First volume sequence number (file section number), binary equivalent of LDFSEC
LDFSEC	7	0-31	First file section number (volume sequence number) in ASCII, the ordinal number of the volume to be mounted first
LDCSEC	7	32-63	Current file section number (volume sequence number) in ASCII, the ordinal number of the currently mounted volume
LDFSEQ	10	0-31	File sequence number (ASCII) ordinal of the dataset being accessed. If FSEQ > 1, volume should have more than one dataset.
LDDAC	10	32-39	Dataset accessibility character.
LDVN	10	40-47	Generation version number, numeric equivalent of LDGVN
LDFSQ	10	48-63	File sequence number, numeric equivalent of LDFSEQ
LDGEN	11	0-31	Generation number. Any value other than one indicates that a dataset is in a generation data group.
LDGN	11	32-47	Generation number, numeric equivalent of LDGEN

<u>Field</u>	<u>Word(base8)</u>	<u>Bits</u>	<u>Description</u>
LDGVN	11	48-63	Generation version number (ASCII). Any value other than 0 indicates that the dataset is in a generation data group.
LDCDT	12	0-47	Creation date (ASCII). This field indicates the creation date of the dataset in the julian form: 'yyddd'. Note the space (LDCSP) must be present.
LDCSP	12	0-7	Space
LDCYR	12	8-23	Year
LDCDY	12	24-47	Day
LDXDT	13	0-47	Expiration date; same format as creation date above
LDXSP	13	0-7	Space
LDXYR	13	8-23	Year
LDXDY	13	24-47	Day
LDUXD	13	48	User specified XDT (expiration date) flag
LDRT	13	49-63	Retention period, integer days
LDBLK	14	0-47	Volume block count (ASCII): number of user data blocks present, read from or written into the label. Can be inaccurate because overflow causes it to be cleared; see LDVBC for an accurate count.
LDSET	15	0-47	File set identifier, normally set to the serial number of first volume in the dataset
LDFBC	16	0-31	File block count (binary)
LDVBC	16	32-63	Volume block count (binary), number of blocks written on volume so far
LDSCOD	17-20	0-63	System identification code, to identify the operating system or computer system that generated the tape
LDSCD1	17	0-63	Character 1-8
LDSCD2	20	0-39	Character 9-13 identify the operating system or computer system that generated the tape

LD Label Definition Table - LDT

[422]

LE@HDR1=W@LDSCD2+1

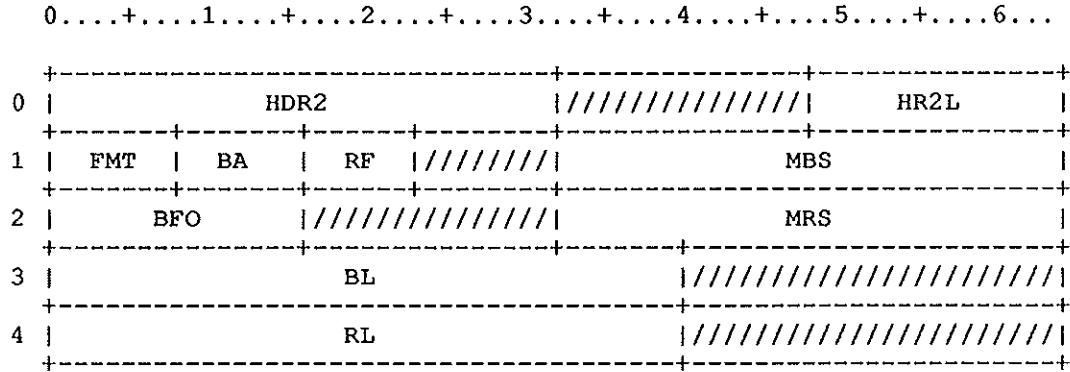

Figure LD-6. HDR2 Entry Description

Field	Word(base8)	Bits	Description
LDHDR2	0	0-31	Entry name ('HDR2' in ASCII)
LDHR2L	0	48-63	Header 2 length
LDFMT	1	0-7	Record format, two types IBM label types: F Fixed-length records V Variable-length records U Undefined record format ANSI label types: F Fixed-length records D Variable-length records S Records span tape blocks
LDBA	1	8-15	Blocking attributes, IBM label types only: B Blocks are an integral multiple of the record size S Records span tape blocks R Records span tape blocks, and the blocks are an integral multiple of the record size
LDRF	1	16-22	Record format.
LDMBS	1	32-63	Maximum block size (binary), maximum size of any tape block that can be read or written
LDBFO	2	0-15	Buffer offset, ANSI only (not currently supported by COS)
LDMRS	2	32-63	Maximum record size (binary), maximum size of any record that can be read or written

<u>Field</u>	<u>Word(base8)</u>	<u>Bits</u>	<u>Description</u>
LDBL	3	0-39	Maximum block size (ASCII), maximum number of bytes in a tape block, read from or written into the label. Can be inaccurate because overflow causes it to be cleared; see LDMBS for an accurate count.
LDRL	4	0-39	Maximum record size (ASCII), maximum number of bytes in a tape record, read from or written into the label. Can be inaccurate because overflow causes it to be cleared; see LDMRS for an accurate count.

LE@HDR2=W@LDRL+1

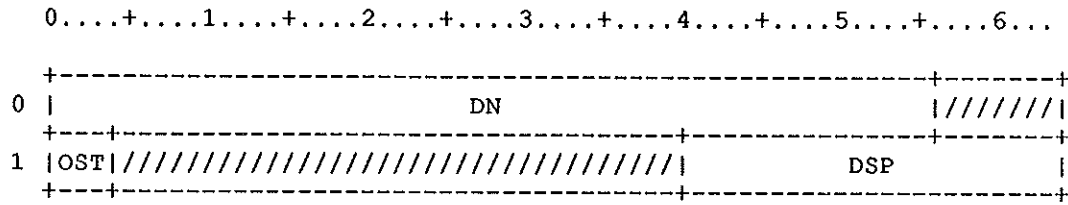

Figure LF-1. Logical File Table

<u>Field</u>	<u>Word(base8)</u>	<u>Bits</u>	<u>Description</u>
LFDN	0	0-55	Dataset name
LFOST	1	0-3	DATASET OPEN STATUS
LFDSP	1	40-63	DSP address

The Logical Request Table is an STP-resident table primarily used for disk queue management.

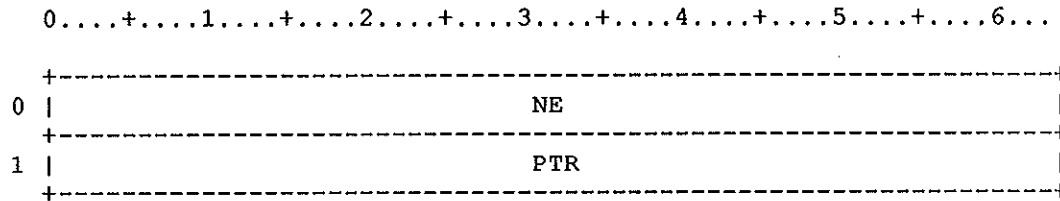

Figure LO-1. Logical Request Table header

<u>Field</u>	<u>Word(base8)</u>	<u>Bits</u>	<u>Description</u>
LONE	0	0-63	Number of entries to process
LOPTR	1	0-63	Pointer to first entry

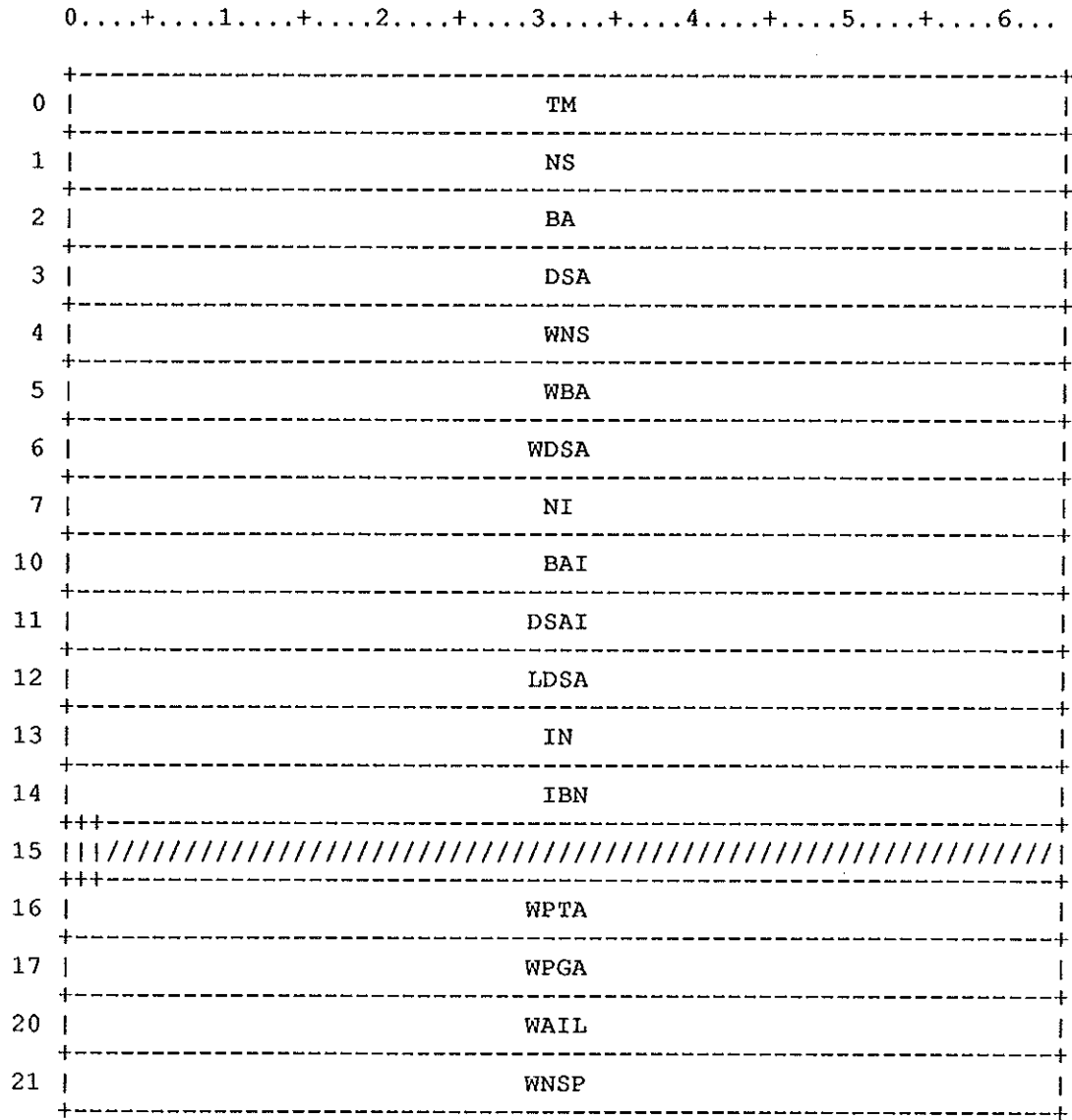

Figure LO-2. Logical Request Table entry

Field	Word(base8)	Bits	Description
LOTM	0	0-63	Target memory type
LONS	1	0-63	Number of sectors to transfer
LOBA	2	0-63	Buffer address (STP relative)
LODSA	3	0-63	Dataset address (dataset relative)
LOWNS	4	0-63	Working number of sectors to transfer
LOWBA	5	0-63	Working buffer address (STP relative)

<u>Field</u>	<u>Word(base8)</u>	<u>Bits</u>	<u>Description</u>
LOWDSA	6	0-63	Working dataset address (dataset rel)
LONI	7	0-63	Number of increments
LOBAI	10	0-63	Buffer address increment
LODSAI	11	0-63	Dataset address increment
LOLDSA	12	0-63	Largest dataset word address if error
LOIN	13	0-63	New DPIN/DPOUT if error (DPIN, if read; DPOUT, if write)
LOIBN	14	0-63	New DPIBN/DPOBN if error (DPIBN, if read; DPOBN, if write)
LOAC	15	0	Allocation is contiguous flag
LOTD	15	1	
LOWPTA	16	0-63	Working partition address
LOWPGA	17	0-63	Working page address
LOWAIL	20	0-63	Working AI location
LOWWDO	20	0-15	Word offset on page
LOWPAO	20	16-31	Parcel offset within word
LOWAIN	20	32-63	Current AI sequence number
LOWNSP	21	0-63	Working number of sectors preceding AI

The Link Interface Table is STP resident. It is used by both the Station Call Processor and EXEC and contains SCP-EXEC communication areas, working storage, and channel buffers. An LIT entry is assigned by SCP at deadstart to each channel which is to be used by SCP for link interface communications.

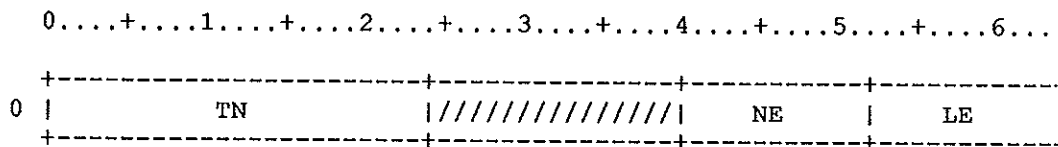

Figure LT-1. Link Interface Table Header

<u>Field</u>	<u>Word(base8)</u>	<u>Bits</u>	<u>Description</u>
LTTN	0	0-23	Table name; 'LIT' in ASCII.
LTNE	0	40-51	Number of entries (=NE@LIT)
LTLE	0	52-63	Length of entries (=LE@LIT)

0....+....1....+....2....+....3....+....4....+....5....+....6...

0	CST	CHN	CHT		TPB
1		PCNT		ILX	OLX
2		IERC		ITE	ITM
3		OERC		OTE	OTM
4				NTC	NCC
5				NIRE	NORE
6					NUIC
7				NEW	
10				STAT	
11				ILCE	
12					
13				ILCP	
	\$				\$
20					
21				XLCE	
22					
23				XLCP	
	\$				\$
30					
31				XLTP	
32					
33					
34				LSEG	
	\$				\$
41					

Figure LT-2. Link Interface Table Entry

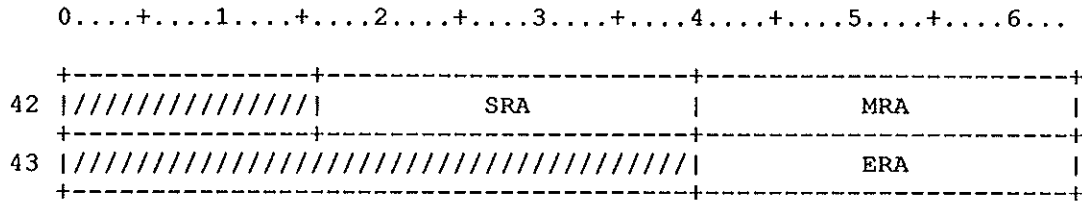

Figure LT-2. Link Interface Table Entry

Field	Word(base8)	Bits	Description
LTCST	0	0-3	Channel state: LTCSTOFF=O'00 Off LTCSTON=O'10 On LTCSTHNG=O'17 Hung (error retry limit exceeded)
LTCHN	0	4-9	Channel pair number
LTCHT	0	10-13	Channel type (see LCCHT)
LTPEND	0	14	Error-message-pending flag
LTPPB	0	40-63	Task parameter block address
LTPCNT	1	0-15	Output pending count
LTILX	1	16-39	Input LXT entry address
LTOLX	1	40-63	Output LXT entry address
LTIERC	2	0-15	Input error retry count
LTITE	2	16-39	Input total error message count
LTITM	2	40-63	Input total valid message count
LTOERC	3	0-15	Output error retry count
LTOTE	3	16-39	Output total error message count
LTOTM	3	40-63	Output total valid message count
LTNTF	4	0	Network timeout flag
LTNTC	4	16-39	Network timeout count
LTNCC	4	40-63	Network collision count
LTNIRE	5	16-39	Network input retry count exceeded
LTNORE	5	40-63	Network output retry count exceeded
LTNUIC	6	40-63	Network unknown interrupt count

<u>Field</u>	<u>Word(base8)</u>	<u>Bits</u>	<u>Description</u>
LTNFW	7	0-63	Network function word:
LTNFC	7	56-61	Function code
LTNMD	7	62-63	Mode
LTSTAT	10	0-62	Network status word
LTILCE	11-12	0-63	Input LCPE
LTILCP	13-20	0-63	Input LCP
LTXLCE	21-22	0-63	Error LCPE
LTXLCP	23-30	0-63	Error LCP
LTXLTP	31-33	0-63	Error LTP
LTLSEG	34-41	0-63	Logon segment
LTSRA	42	16-39	Status subroutine return address
LTMRA	42	40-63	Master clear subroutine return address
LTERA	43	40-63	END OP subroutine return addr (EXEC)

<u>Field</u>	<u>Word(base8)</u>	<u>Bits</u>	<u>Description</u>
RDFWRD	3	37-45	Field word W@
RDFPOS	3	46-54	Field position S@
RDFLEN	3	55-63	Field length N@
RDPAGE	4	0-15	Page number
RDBLEN	4	16-39	Buffer length
RDBADD	4	40-63	Buffer address
RDINS	5	0-63	Reserved for installation

RSF\$ADN Set User Attributes Dataset information.

RSF\$NRD Set New Resource Dataset information.

RSF\$PROC Set User Procedure Dataset information.

RDPDN	6-7	0-63	PDN
RDPDN1	6	0-63	PDN 1 (char 1-8)
RDPDN2	7	0-55	PDN 2 (char 9-15)
RDID	10	0-63	IDentifier
RDOWN	11-12	0-63	OWNer
RDOWN1	11	0-63	OWNer 1 (char 1-8)
RDOWN2	12	0-55	OWNer 2 (char 9-15)
RDED	13	52-63	EDition

RSF\$AIAC process Accept for Interactive job.

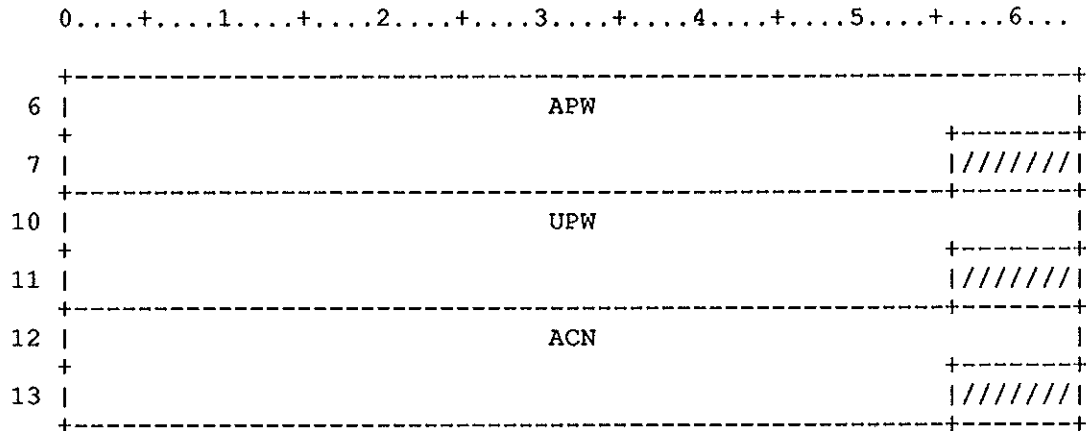

Figure RD-2. Resource Dataset Definition Table

<u>Field</u>	<u>Word(base8)</u>	<u>Bits</u>	<u>Description</u>
RDAPW	6-7	0-63	Account Password
RDAPW1	6	0-63	Account Password (char 1-8)
RDAPW2	7	0-55	Account Password (char 9-15)
RDAPWF	7	56-63	Account Password change flag
RDUPW	10-11	0-63	User Password
RDUPW1	10	0-63	User Password (char 1-8)
RDUPW2	11	0-55	User Password (char 9-15)
RDUPWF	11	56-63	User Password change flag
RDACN	12-13	0-63	Account Number
RDACN1	12	0-63	Account Number (char 1-8)
RDACN2	13	0-55	Account Number (char 9-15)

RSF\$CSID Change SID maintainer.

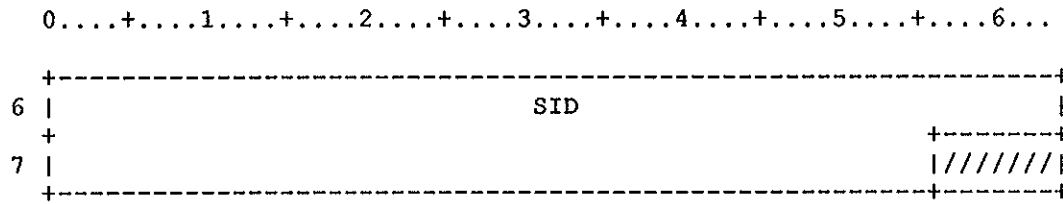

Figure RD-3. Resource Dataset Definition Table

<u>Field</u>	<u>Word(base8)</u>	<u>Bits</u>	<u>Description</u>
RDSID	6-7	0-63	SID maintainer
RDSID1	6	0-63	SID1
RDSID2	7	0-55	SID2

RSF\$CUP Change User Password.

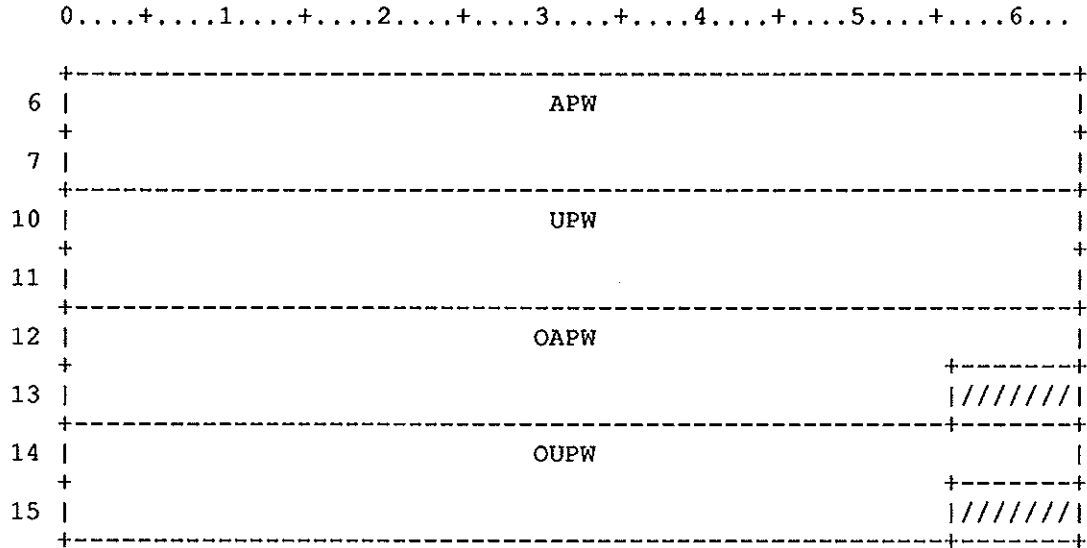

Figure RD-4. Resource Dataset Definition Table

Field	Word(base8)	Bits	Description
RDAPW	6-7	0-63	Account Password
RDAPW1	6	0-63	Account Password (char 1-8)
RDAPW2	7	0-55	Account Password (char 9-15)
RDAPWF	7	56-63	Account Password change flag
RDUPW	10-11	0-63	User Password
RDUPW1	10	0-63	User Password (char 1-8)
RDUPW2	11	0-55	User Password (char 9-15)
RDUPWF	11	56-63	User Password change flag
RDOAPW	12-13	0-63	Old Account Password
RDOAP1	12	0-63	Old Account Password (char 1-8)
RDOAP2	13	0-55	Old Account Password (char 9-15)
RDOUPW	14-15	0-63	Old User Password
RDOUP1	14	0-63	Old User Password (char 1-8)
RDOUP2	15	0-55	Old User Password (char 9-15)

RSF\$LPP Change User LPP.

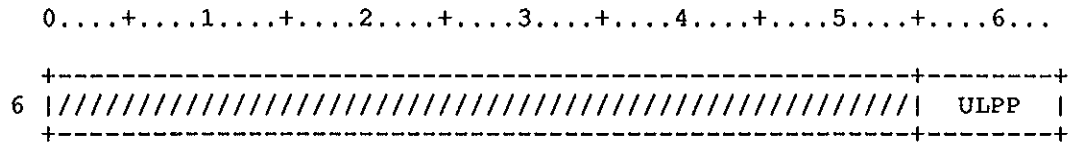

Figure RD-5. Resource Dataset Definition Table

<u>Field</u>	<u>Word(base8)</u>	<u>Bits</u>	<u>Description</u>
RDULPP	6	55-63	User LPP value
RSF\$PAM Change User PAM.			

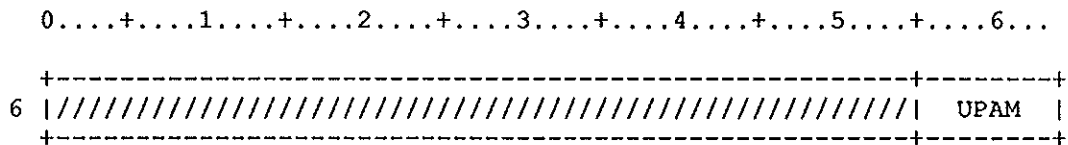

Figure RD-6. Resource Dataset Definition Table

<u>Field</u>	<u>Word(base8)</u>	<u>Bits</u>	<u>Description</u>
RDUPAM	6	55-63	User PAM value
RSF\$PMNS Change User Procedure names.			

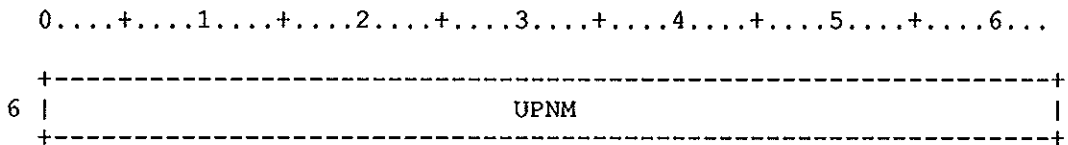

Figure RD-7. Resource Dataset Definition Table

<u>Field</u>	<u>Word(base8)</u>	<u>Bits</u>	<u>Description</u>
RDUPNM	6	0-63	User procedure names
RSF\$HASH Hash text string.			

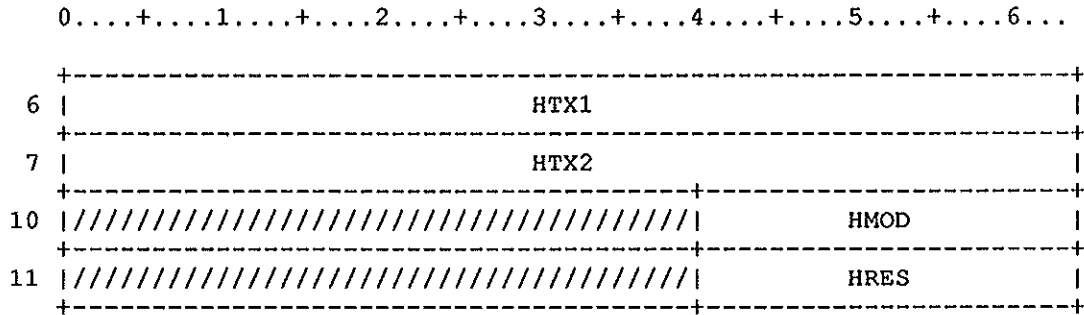

Figure RD-8. Resource Dataset Definition Table

Field	Word(base8)	Bits	Description
RDHTX1	6	0-63	(char 1-8) of text string
RDHTX2	7	0-63	(char 9-15) of text string
RDHMOD	10	40-63	Hash modulus
RDHRES	11	40-63	Hash result

RSF\$VLB Validate Library password.
 RSF\$CLB Change Library password.

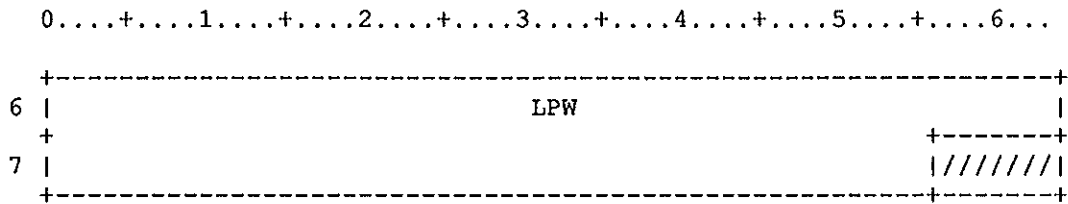

Figure RD-9. Resource Dataset Definition Table

Field	Word(base8)	Bits	Description
RDLPW	6-7	0-63	Library password
RDLPW1	6	0-63	LB1
RDLPW2	7	0-55	LB2

Resource Dataset ACCOUNT Entry Definitions.

0.....+.....1.....+.....2.....+.....3.....+.....4.....+.....5.....+.....6...

0		ENT		CHK			BN	
1	////////////////////						ESF	
2				MKEY				
3								
4				APW				
5								
6	////////////////////							
	\$////////////////////\$							
11	////////////////////							
12				TCR				
13				TCH				
14				TRD				
15				NDNM				
16								
17				GRP				
20	////////////////////							
	\$////////////////////\$							
37	////////////////////							
40	////////////////////						FSQT	
41		FSMX					FSUS	
42				FAV				
43				TLA				

Figure RA-1. Resource dataset Account Entry

```

0.....+.....1.....+.....2.....+.....3.....+.....4.....+.....5.....+.....6...
+-----+-----+-----+-----+-----+-----+
44 |          PDMX          | / |          PDUS          |
+-----+-----+-----+-----+-----+
45 |          ASMX          | / |          ASUS          |
+-----+-----+-----+-----+-----+
46 |          ADMX          | / |          ADUS          |
+-----+-----+-----+-----+-----+
47 | //////////////////////////////////////////////////////////////////// |
   | $////////////////////////////////////////////////////////////////// $
71 | //////////////////////////////////////////////////////////////////// |
+-----+-----+-----+-----+-----+
72 |                      SINT                      |
+-----+-----+-----+-----+-----+
73 |                      STRM                      |
+-----+-----+-----+-----+-----+
74 |                      PDD                      |
+-----+-----+-----+-----+-----+
75 |                      | ////////////// |
+-----+-----+-----+-----+-----+
76 |                      PID                      |
+-----+-----+-----+-----+-----+
77 |                      POW                      |
+-----+-----+-----+-----+-----+
100 |                      | ////////////// |
+-----+-----+-----+-----+-----+
101 |                      PINT                      |
+-----+-----+-----+-----+-----+
102 |                      PTRM                      |
+-----+-----+-----+-----+-----+
103 | //////////////////////////////////////////////////////////////////// | PED | AED |
+-----+-----+-----+-----+-----+
104 |                      APD                      |
+-----+-----+-----+-----+-----+
105 |                      | ////////////// |
+-----+-----+-----+-----+-----+
106 |                      AID                      |
+-----+-----+-----+-----+-----+
107 |                      AOW                      |
+-----+-----+-----+-----+-----+
110 |                      | ////////////// |
+-----+-----+-----+-----+-----+
111 |                      LPW                      |
+-----+-----+-----+-----+-----+
112 |                      | ////////////// |
+-----+-----+-----+-----+-----+

```

Figure RA-1. Resource dataset Account Entry

<u>Field</u>	<u>Word(base8)</u>	<u>Bits</u>	<u>Description</u>
RAKEYT	3	56-63	Master key Type (char 16)
RAAPW	4-5	0-63	Account number Password
RAAPW1	4	0-63	Account Password word 1 (encrypted)
RAAPW2	5	0-55	Account Password word 2 (char 9-15)
RATCR	12	0-63	Entry creation time (ts)
RATCH	13	0-63	Entry last change time (ts)
RATRD	14	0-63	Time of 'delete pending' (ts)
RANDNM	15-16	0-63	Node Name - 1-15 characters
RANDN1	15	0-63	Node Name word 1 (char 1-8)
RANDN2	16	0-55	Node Name word 2 (char 9-15)
RAGRP	17	0-55	Group Name - 2-7 characters
RAGRC	17	0-15	Group Code - 2 characters
RACFCL	FIELD	\$,60,4	Charging factor class (0-15)
RAFSQT	40	33-63	Filespace quota (blocks)
RAFSQF	40	33	Filespace quota NODE flag
RAFSMX	41	0-30	Filespace maximum (blocks)
RAFSMF	41	0	Filespace maximum NODE flag
RAFSUS	41	33-63	Filespace usage (blocks)
RAFAV	42	0-63	Filespace average (fp - blocks)
RATLA	43	0-63	Time of last FS average (ts)
RAPDMX	44	0-30	Permanent datasets maximum
RAPDUS	44	33-63	Permanent datasets usage
RAASMX	45	0-30	Archive space maximum (blocks)
RAASUS	45	33-63	Archive space usage (blocks)
RAADMX	46	0-30	Archive dataset maximum
RAADUS	46	33-63	Archive datasets usage
RASINT	72	0-63	SYSTEM procedure initialization name
RASTRM	73	0-63	SYSTEM procedure termination name
RAPDD	74-75	0-63	Account procedure PDN

<u>Field</u>	<u>Word(base8)</u>	<u>Bits</u>	<u>Description</u>
RAPPD1	74	0-63	Account procedure PDN 1
RAPPD2	75	0-55	Account procedure PDN 2
RAPID	76	0-63	Account procedure ID
RAPOW	77-100	0-63	Account procedure OWNER
RAPOW1	77	0-63	Account procedure OWN 1
RAPOW2	100	0-55	Account procedure OWN 2
RAPINT	101	0-63	User procedure initialization name
RAPTRM	102	0-63	Account procedure Termination name
RAPED	103	40-51	Account procedure EDition
RAAED	103	52-63	Attributes dataset EDition
RAAPD	104-105	0-63	Attributes dataset PDN
RAAPD1	104	0-63	Attributes dataset PDN 1
RAAPD2	105	0-55	Attributes dataset PDN 2
RAAID	106	0-63	Attributes dataset ID
RAAOW	107-110	0-63	Attributes dataset OWNER
RAAOW1	107	0-63	Attributes dataset OWN 1
RAAOW2	110	0-55	Attributes dataset OWN 2
RALPW	111-112	0-63	Library password
RALPW1	111	0-63	LB word 1 (char 1-8)
RALPW2	112	0-55	LB word 2 (char 9-15)
RASID	113-114	0-63	Security Officer ID
RASID1	113	0-63	Security Officer (char 1-8)
RASID2	114	0-55	Security Officer (char 9-15)
			L@RAINS=D'6 Number of words for installation area
RAINS	120-n	0-63	Reserved for installation

Resource Dataset User Entry Definitions.

0....+....1....+....2....+....3....+....4....+....5....+....6...

0		ENT		CHK		BN	
1				EPF		ESF	
2				MKEY			
3							
4				UPW			
5							
6				ACN			
7							
10				APW			
11							
12				TCR			
13				TCH			
14				TRD			
15				NDNM			
16						*** ***	
17				GRP		*** ***	
20				SC0			
21				SC1			
22				SC2			
23				SC3			
24		PWED		PWVL		PWVC	
						SCVL	
							SCVC
25				TLPW			

Figure RE-1. Resource dataset User Entry

0....+....1....+....2....+....3....+....4....+....5....+....6...

26			TLPV	
27			TLSV	
30		JCTF		JCTO
31		JBMX		CJBR
32			CUN	
33			CMON	
34			***	LOGS
35			TLLG	
36			TLJB	
37				
40				FSQT
41		FSMX		FSUS
42			FAV	
43			TLA	
44		PDMX		PDUS
45		ASMX		ASUS
46		ADMX		ADUS
47		CMMX		BMMX
50		TPMX		TCMX
51		SDMX		SDUS
52		ODMX		ODUS
53			CSI	
54			SHAR	
55			DUSE	
56			TLD	

Figure RE-1. Resource dataset User Entry

0....+....1....+....2....+....3....+....4....+....5....+....6...

57	EUSE		EUSO
60	EUNF		EUNO
61		EUMX	
62	TLMX		TLUS
63	CTMX		CTUS
64	ITMX		IPMX
65	////////////////////		
	\$////////////////////\$		
71	////////////////////		
72		SINT	
73		STRM	
74		PDD	
75			////////
76		PID	
77		POW	
100			////////
101		PINT	
102		PTRM	
103	////////	PAM	LPP PED AED
104		APD	
105			////////
106		AID	
107		AOW	
110			////////

Figure RE-1. Resource dataset User Entry

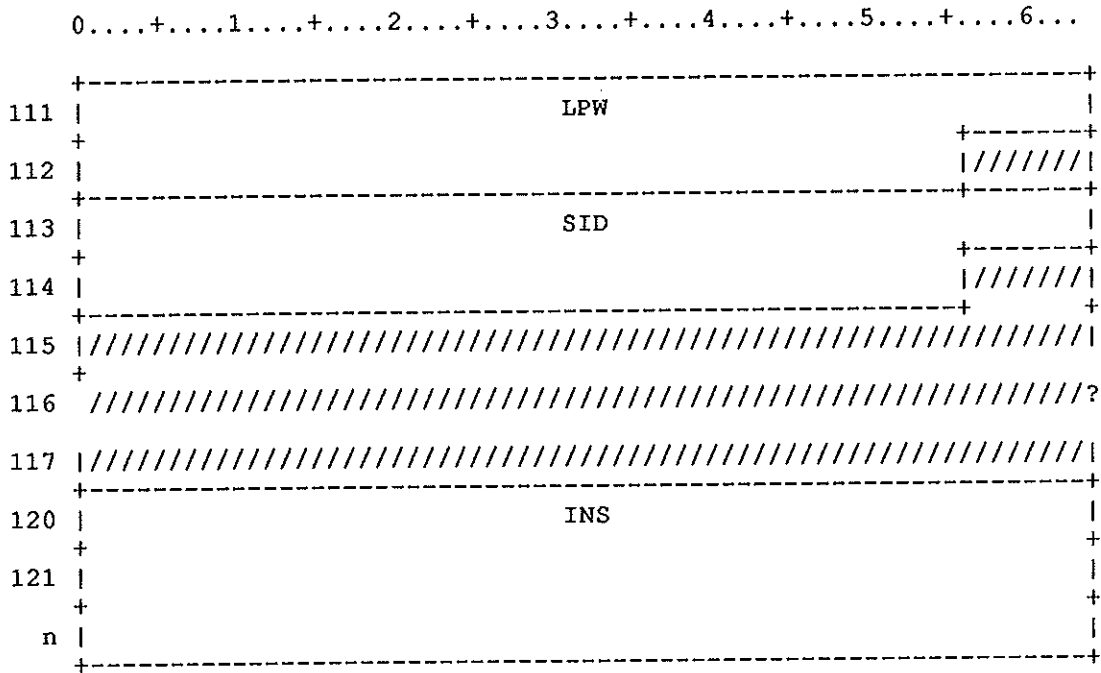

Figure RE-1. Resource dataset User Entry

Field	Word(base8)	Bits	Description
REENT	0	4-15	Entry number
RECHK	0	16-39	Entry Checksum
REBN	0	40-63	Block number of RD page (sector)
REPEPF	1	16-39	Entry permit flags
REAEPF	1	20-39	Active entry permit flags
RESOC	1	21	Security Officer
REMTR	1	22	Monitor
RENDS	1	23	Non Disabable
RENPW	1	24	No Password Required
RENB	1	25	No Bound Checking
REPINS	1	35-39	Reserved for Site
REESF	1	40-63	Entry status flags
REAEMF	1	40-51	Active entry Mode flags
RERDMI	1	40	RDM Information entry
REACNT	1	41	ACCOUNT entry
REUSER	1	42	USER entry
REOWN	1	43	OWNership entry
RENODE	1	44	NODE entry
REEINS	1	50-51	Reserved for Site

REAESF	1	52-63	Active entry status flags
RESUS	1	52	Entry suspended
REAXP	1	53	Entry expired
REXPX	1	54	Password expired
REDLP	1	55	Delete pending
REDEL	1	56	Entry deleted
REALNS	1	62-63	Reserved for Site
REMKEY	2-3	0-63	Master key
REKEY1	2	0-63	Master key (char 1-8)
REUSN1	2	0-63	User number (char 1-8)
REULCC	2	0-55	ULCC User number (char 1-8)
REKEY2	3	0-55	Master key (char 9-15)
REUSN2	3	0-55	Account number (char 9-15)
REKEYT	3	56-63	Master key Type (char 16)
REUPW	4-5	0-63	User number Password
REUPW1	4	0-63	User Password word 1 (encrypted)
REUPW2	5	0-55	User Password word 2 (char 9-15)
REACN	6-7	0-63	Default Account number
REACN1	6	0-63	Account number (char 1-8)
REACN2	7	0-55	Account number (char 9-15)
REAPW	10-11	0-63	Account number Password
REAPW1	10	0-63	Account Password word 1 (encrypted)
REAPW2	11	0-55	Account Password word 2 (char 9-15)
RETCR	12	0-63	Entry creation time (ts)
RETCR	13	0-63	Entry last change time (ts)
RETRD	14	0-63	Time of Delete Pending (ts)
RENDNM	15-16	0-63	Node Name - 1-15 characters
RENDN1	15	0-63	Node name word 1 (char 1-8)
RENDN2	16	0-55	Node name word 2 (char 9-15)
RECFC4	16	56-59	Charging factor class 4 (0-15)
RECFC3	16	60-63	Charging factor class 3 (0-15)
REGRP	17	0-55	Group Name - 2-7 characters
REGRC	17	0-15	Group Code - 2 characters

<u>Field</u>	<u>Word(base8)</u>	<u>Bits</u>	<u>Description</u>
RECFC2	17	56-59	Charging factor class 2 (0-15)
RECFC1	17	60-63	Charging factor class 1 (0-15)
RECFC1 RECFC1	17	60-63	Charging factor class 1 (0-15)
RESC0	20	0-63	GLOBAL SECURITY FLAGS 1
RESC1	21	0-63	Global security flags 2
RESC2	22	0-63	Global security flags 3
RESC3	23	0-63	Global security flags 4
REUSF	23	0-63	User security flags (Reserved Site)
<u>REPWD</u>	<u>24</u>	<u>0-15</u>	<u>Password Change Extended Days</u>
REPWVL	24	16-27	Password violation limit
REPWVC	24	28-39	Password violation count - RDM
RESCVL	24	40-51	Security violation limit
RESCVC	24	52-63	Security violation count - COS
RETLPW	25	0-63	Time of last Password Change (ts)
RETLPV	26	0-63	Time of last Password violation (ts)
RETLV	27	0-63	Time of last Security violation (ts)
REJCTF	30	0-30	Job count (offline)
REJCTO	30	33-63	Job count (online)
REJBMX	31	0-30	Job maximum in system
RECJBR	31	33-63	Cumulative number of jobs run
RECUN	32	0-63	Cumulative milli-units used
RECMON	33	0-63	Cumulative milli-money charged
REEUMF	34	0	Estimated usage NODE flag
RESHRF	34	1	Shares NODE flag
REUDMF	34	32	User Disk Permit Map NODE flag
REUDPM	34	33-36	User Disk Permit Map index
RELOGS	34	40-63	Count of LOGONs
RETLG	35	0-63	Time of last LOGON (ts)

<u>Field</u>	<u>Word(base8)</u>	<u>Bits</u>	<u>Description</u>
RETLJB	36	0-63	Time of last Job (ts)
REFSQT	40	33-63	Filespace quota (blocks)
REFSQF	40	33	Filespace quota NODE flag
REFSMX	41	0-30	Filespace maximum (blocks)
REFSMF	41	0	Filespace maximum NODE flag
REFSUS	41	33-63	Filespace usage (blocks)
REFAV	42	0-63	Filespace average (fp - blocks)
RETLA	43	0-63	Time of last FS average (ts)
REPDMX	44	0-30	Permanent datasets maximum
REPDUS	44	33-63	Permanent datasets usage
REASMX	45	0-30	Archive space maximum (blocks)
REASUS	45	33-63	Archive space usage (blocks)
READMX	46	0-30	Archive dataset maximum
READUS	46	33-63	Archive datasets usage
<u>RECMMX</u>	<u>47</u>	<u>0-30</u>	<u>User CM maximum/job</u>
REBMMX	47	33-63	User BMR Limit maximum/job
RETPMX	50	0-30	User Tape Limit maximum/job
<u>RETCMX</u>	<u>50</u>	<u>33-63</u>	<u>User Tape Cartrage Limit maximum/job</u>
RESDMX	51	0-30	User SSD maximum
RESDUS	51	33-63	User SSD usage
REODMX	52	0-30	User OUTPUT dataset maximum
REODUS	52	33-63	User OUTPUT dataset usage
RECSI	53	0-63	Component share index (fp)
RESHAR	54	0-63	Shares
REDUSE	55	0-63	Decayed usage (fp - weighted d-units)
RETLD	56	0-63	Time of last decay (ts)
REEUSF	57	0-30	Estimated usage (offline)
REEUSO	57	31-63	Estimated usage (online)

<u>Field</u>	<u>Word(base8)</u>	<u>Bits</u>	<u>Description</u>
REEUNF	60	0-30	Estimated units (offline)
REEUNO	60	31-63	Estimated units (online)
REEUMX	61	0-63	Estimated units maximum (deci-units)
RETLMX	62	0-30	User Time Limit max/Job
RETLUS	62	33-63	User Time Limit max/Job in system usag
RECTMX	63	0-30	User Time Limit max/Total
RECTUS	63	33-63	User Time Limit max/Total usage
REITMX	64	0-30	Interactive job Time limit maximum
REIPMX	64	33-63	Interactive job queue priority
RESINT	72	0-63	SYSTEM procedure initialization name
RESTRM	73	0-63	SYSTEM procedure termination name
REPDD	74-75	0-63	User procedure PDN
REPPD1	74	0-63	User procedure PDN 1
REPPD2	75	0-55	User procedure PDN 2
REPID	76	0-63	User procedure ID
REPOW	77-100	0-63	User procedure OWNer
REPOW1	77	0-63	User procedure OWN 1
REPOW2	100	0-55	User procedure OWN 2
REPINT	101	0-63	User procedure initialization name
REPTRM	102	0-63	User procedure Termination name
REPAM	103	16-27	User default PAM (as in DSC)
RELPP	103	28-39	User default LPP
REPED	103	40-51	User procedure EDition
REAED	103	52-63	Attributes dataset EDition
REAPD	104-105	0-63	Attributes dataset PDN
REAPD1	104	0-63	Attributes dataset PDN 1
REAPD2	105	0-55	Attributes dataset PDN 2

<u>Field</u>	<u>Word(base8)</u>	<u>Bits</u>	<u>Description</u>
READID	106	0-63	Attributes dataset ID
REAOW	107-110	0-63	Attributes dataset OWNeR
REAOW1	107	0-63	Attributes dataset OWN 1
REAOW2	110	0-55	Attributes dataset OWN 2
RELPW	111-112	0-63	Library password
RELPW1	111	0-63	LB word 1 (char 1-8)
RELPW2	112	0-55	LB word 2 (char 9-15)
RESID	113-114	0-63	Security Officer ID
RESID1	113	0-63	Security Officer (char 1-8)
RESID2	114	0-55	Security Officer (char 9-15)
			L@REINS=D'6 Number of words for installation area
REINS	120-n	0-63	Reserved for installation

Resource Dataset Information Entry Definitions.

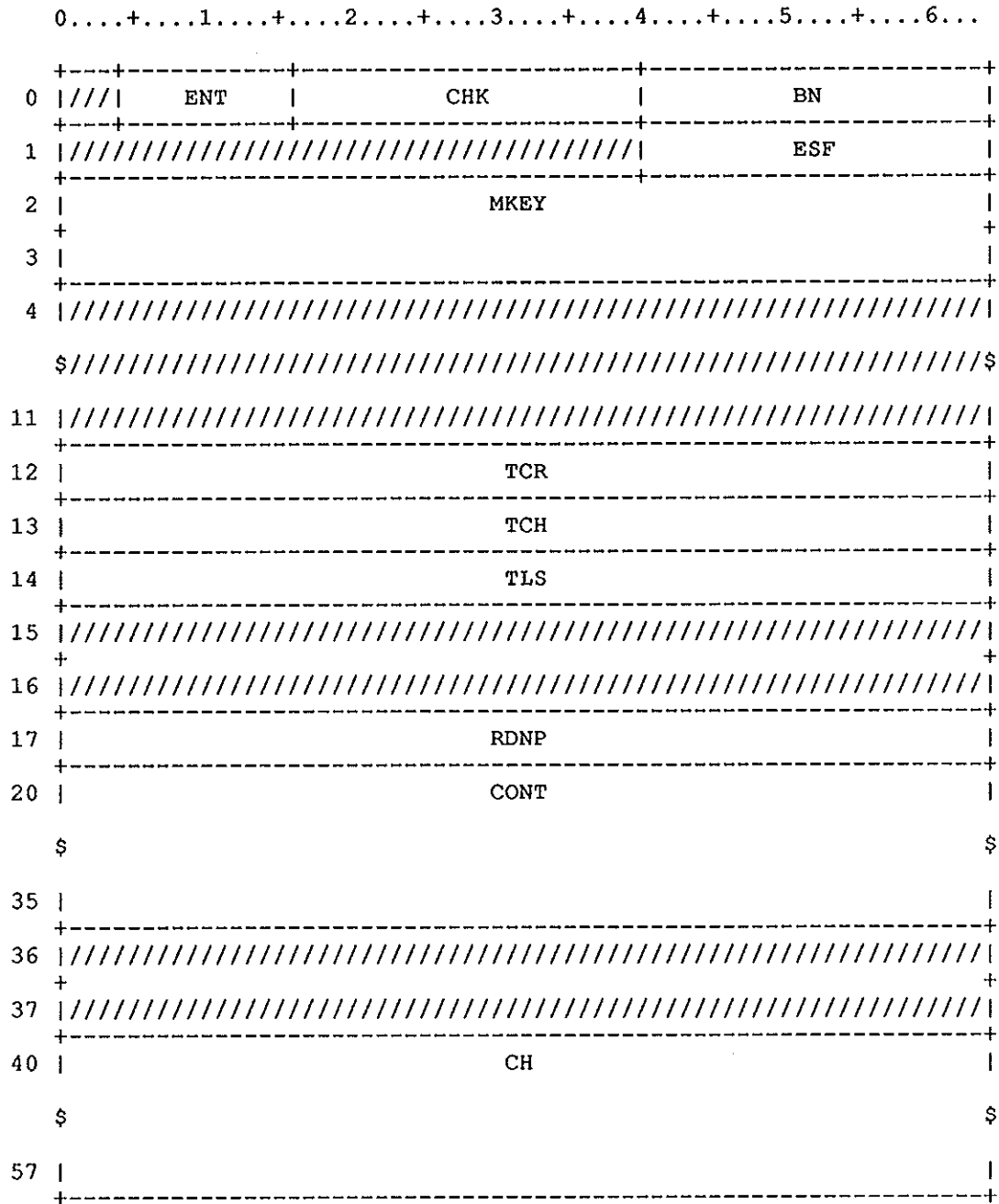

Figure RI-1. Resource dataset Information Entry

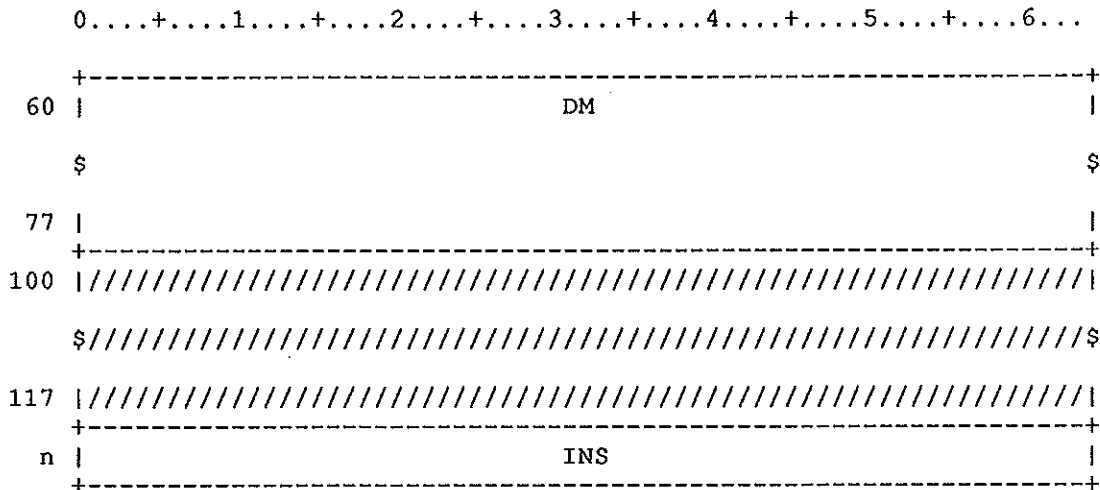

Figure RI-1. Resource dataset Information Entry

Field	Word(base8)	Bits	Description
RIENT	0	4-15	Entry Number
RICHK	0	16-39	Entry Checksum
RIBN	0	40-63	Block number of RD page (sector)
RIESF	1	40-63	Entry status flags
RIRDMI	1	40	RDM Information entry
RIMKEY	2-3	0-63	Master key (**RDM*I*)
RIKEY1	2	0-63	Master key 1 (char 1-8)
RIKEY2	3	0-55	Master key 2 (char 9-15)
RIKEYT	3	56-63	Master key Type (char 16)
RITCR	12	0-63	Entry creation time (ts)
RITCH	13	0-63	Entry last change time (ts)
RITLS	14	0-63	Time of last restart (ts)
RIRDNP	17	0-63	Size of Resource Dataset in pages
RICONT	20-35	0-63	RDM Control Variables
RICRI	20	0-63	Charge Rate Index (1-4)
RIDCO	21	0-63	Disk control checking flag (1=OFF)
RILOG	22	0-63	Logging control word (0=OFF)

RIPCO	23	0-63	Password checking flag (1=OFF)
RIDKF	24	0-63	Decay factor (fp)
RIFAV	25	0-63	Filespace averaging constant (fp)
RIGUMX	26	0-63	Global units limit
RIJBMX	27	0-63	Global job limit
RIQAR	30	0-63	Queue aging rate shift value (<64)
RIQK1	31	0-63	Q.P. calculation constant 1 (fp)
RIQK2	32	0-63	Q.P. calculation constant 2 (fp)
RIQK3	33	0-63	Q.P. calculation constant 3 (fp)
RISJU	34	0-63	Small Job est. usage bound (w.d-unit)
RIJOB	35	0-63	Job control flag (off Nzero) L@RDCONT=D'16 Number of words of tuning values
RICH	40-57	0-63	RDM Charging Rates
RICH0	40	0-63	Charging Rate 0
RICH1	41	0-63	Charging Rate 1
RICH2	42	0-63	Charging Rate 2
RICH3	43	0-63	Charging Rate 3
RICH4	44	0-63	Charging Rate 4
RICH5	45	0-63	Charging Rate 5
RICH6	46	0-63	Charging Rate 6
RICH7	47	0-63	Charging Rate 7
RICH8	50	0-63	Charging Rate 8
RICH9	51	0-63	Charging Rate 9
RICH10	52	0-63	Charging Rate 10
RICH11	53	0-63	Charging Rate 11
RICH12	54	0-63	Charging Rate 12
RICH13	55	0-63	Charging Rate 13
RICH14	56	0-63	Charging Rate 14

<u>Field</u>	<u>Word(base8)</u>	<u>Bits</u>	<u>Description</u>
RICH15	57	0-63	Charging Rate 15 L@RDCHG=D'16 Number of words of Charge Rates
RIDM	60-77	0-63	RDM User Disk Maps
RIDM0	60	0-63	User Disk Map 0
RIDM1	61	0-63	User Disk Map 1
RIDM2	62	0-63	User Disk Map 2
RIDM3	63	0-63	User Disk Map 3
RIDM4	64	0-63	User Disk Map 4
RIDM5	65	0-63	User Disk Map 5
RIDM6	66	0-63	User Disk Map 6
RIDM7	67	0-63	User Disk Map 7
RIDM8	70	0-63	User Disk Map 8
RIDM9	71	0-63	User Disk Map 9
RIDM10	72	0-63	User Disk Map 10
RIDM11	73	0-63	User Disk Map 11
RIDM12	74	0-63	User Disk Map 12
RIDM13	75	0-63	User Disk Map 13
RIDM14	76	0-63	User Disk Map 14
RIDM15	77	0-63	User Disk Map 15 L@RDUDM=D'16 Number of words of User Disk Maps L@RIINS=D'6 Number of words for installation area
RIINS	120	0-63	Reserved for installation

RERILLN	=	O'1	Illegal function number
RERILLF	=	O'2	Illegal request format
RERPERR	=	O'3	Request parameter error
RERDSKR	=	O'4	Request failed due to disk error
RERIRDM	=	O'5	Internal RDM error
RERDTER	=	O'6	RDM detected date error (used in RDM)
RERDCHG	=	O'7	Change Resource Dataset

RDM - SDRJST Job Acceptance Reject values

RMRACNT	=	O'10000	RD Entry mode = ACCOUNT
RMRNODE	=	O'20000	RD Entry mode = NODE
RMRUSER	=	O'40000	RD Entry mode = USER
RARUNK	=	D'1	RD Entry not registered
RARAXP	=	D'2	RD Entry expired
RARSUS	=	D'3	RD Entry suspended
RARPWER	=	D'4	Password incorrect
RARPTRY	=	D'5	Password try count exceeded
RARJLIM	=	D'6	Total job limit exceeded (number)
RARRLIM	=	D'7	Total job resource limit exceeded
RARNBAT	=	D'8	RD Entry not registered for batch
RARNODE	=	D'9	Node entry not found
RARCORE	=	D'10	RD Entry corrupt
RARIOE	=	D'11	I/O error on Resource Dataset
RARJCE	=	D'12	Job statement error (SDJCE)
RARTLE	=	D'13	Time Limit error
RARACE	=	D'14	ACCOUNT statement error (SDACE)

RDM - to PDM Error Code values.

RUPUNK	=	D'1	RD Entry not known
RUPAXP	=	D'2	RD Entry expired
RUPSUS	=	D'3	RD Entry suspended
RUPOVIO	=	D'4	Use of 'override' not authorised
RUPALIM	=	D'5	Archive limits exceeded
RUPFLIM	=	D'6	Filespace limits exceeded
RUPFINH	=	D'7	RD Entry inhibited (average>quota)
RUPNUNK	=	D'8	New OWN not known (MODIFY)
RUPNODE	=	D'9	Node entry not found
RUPCORE	=	D'10	RD Entry corrupt
RUPIOE	=	D'11	I/O error on Resource Dataset

RDM - User Error Code values.

RUEOK	=	O'001	Successful completion
RUEENF	=	O'011	RD Entry not found
RUEEUN	=	O'021	RD Entry unusable
RUEVIOL	=	O'031	Not authorised for function
RUEPERR	=	O'041	Parameter error
RUEBALA	=	O'051	Buffer outside BA-LA
RUEBTS	=	O'061	Buffer too small for data
RUEFOB	=	O'071	Specified field out-of-bounds

RUEFOV	=	O'101	Field overflow (new value or change)
RUERDNF	=	O'111	New Resource Dataset not found
RUEENEX	=	O'121	RD Entry already exists
RUEEBAD	=	O'131	New RD Entry is invalid
RUEPNF	=	O'141	RD page not found
RUEOFF	=	O'151	RDM inactive
RUEIOE	=	O'161	I/O error on Resource Dataset
RUEFULL	=	O'171	Resource Dataset Full
RUESYS	=	O'201	System error inside RDM
RUENXF	=	O'211	Non existant sub-function
RUERREJ	=	O'221	Remove RD Entry request rejected
RUELBER	=	O'231	LIBSAVE/LIBPERM not authorized
RUESBAD	=	O'241	Specified SID maintainer invalid
RUERLIM	=	O'251	Request rejected for limits exceeded
RUEINS	=	O'401	- O'471 Reserved for installation

*CALL COMRDMFC at this IDENT +1.

COPYRIGHT BY CRAY RESEARCH, INC. *

UNPUBLISHED - ALL RIGHTS RESERVED UNDER THE COPYRIGHT LAWS *
OF THE UNITED STATES. *

RF\$ACCP	=	O'01	Accept job
RF\$TERM	=	O'02	Job termination
RF\$DSACT	=	O'03	Permanent dataset action
RF\$MODFY	=	O'04	Permanent dataset modify OWN (ID)
RF\$QUEUE	=	O'05	Queue functions
RF\$INS1	=	O'06	Installation defined function 1
RF\$INS2	=	O'07	Installation defined function 2
RF\$INS3	=	O'10	Installation defined function 3
RF\$INIT	=	O'11	Job initiation
RF\$RDD	=	O'12	Process RDD request
RDMMFC	=	O'12	Maximum function code value

RDD Subfunction Codes.

RDNE	=	O'400	Flag for not user entry request
RDNR	=	O'200	Flag for user not Rerunable
RSF\$AFV	=	O'01+RDNR	Add to field in entry
RSF\$ADN	=	O'02	Set user ADN data
RSF\$AIAC	=	O'03	Accept for Interactive job
RSF\$CCHR	=	O'04+RDNR+RDNE	Change Charging Rates
RSF\$CLB	=	O'05+RDNR	Change LB (Library) password
RSF\$CONT	=	O'06+RDNE	Set RDM control parameters
RSF\$CSID	=	O'07+RDNR	Change SID maintainer
RSF\$CUDEM	=	O'10+RDNR+RDNE	Change User Disk Maps
RSF\$CUE	=	O'11+RDNR+RDNE	Create User Entry
RSF\$CUP	=	O'12+RDNR	Change user password
RSF\$DATA	=	O'13+RDNE	Return RDM data
RSF\$HASH	=	O'14+RDNE	Hash text string
RSF\$LPP	=	O'15	Set user LPP value
RSF\$NRD	=	O'16+RDNR+RDNE	New Resource Dataset
RSF\$PAM	=	O'17	Set user PAM value
RSF\$PINT	=	O'20	Set user Init Procedure
RSF\$PNMS	=	O'20	Set user Procedure Names
RSF\$PROC	=	O'21	Set user Procedure name
RSF\$RDM	=	O'22+RDNE	Return RDM active status
RSF\$RDP	=	O'23+RDNE	Read RD page(s)
RSF\$RFV	=	O'24	Read field in entry
RSF\$RSTC	=	O'25+RDNR	Request Status Change
RSF\$RUE	=	O'26	Read user entry
RSF\$SFV	=	O'27+RDNR	Subtract from field in entry
RSF\$VLB	=	O'30	Validate LIBSAVE / LIBPERM
RSF\$WFEV	=	O'31+RDNR	Write to field
RSF\$RS1	=	O'32	RESERVED
RSF\$RS2	=	O'33	RESERVED
RSF\$RS3	=	O'34	RESERVED
RSF\$RS4	=	O'35	RESERVED

RSF\$INS1 = 0'36 Installation sub-function 1
RSF\$INS2 = 0'37 Installation sub-function 2
RSF\$INS3 = 0'40 Installation sub-function 3

RDMM\$FC = 0'40 Maximum subfunction code value

*CALL COMRL at this IDENT +1.

COPYRIGHT BY CRAY RESEARCH, INC. *

UNPUBLISHED - ALL RIGHTS RESERVED UNDER THE COPYRIGHT LAWS *
OF THE UNITED STATES. *

<u>Field</u>	<u>Word(base8)</u>	<u>Bits</u>	<u>Description</u>
RLKEY1	7	0-63	Master key 1 (char 1-8)
RLKEY2	10	0-55	Master key 2 (char 9-15)
RLKEYT	10	56-63	Master key Type (char 16)
RLJSQ	11	0-15	JSQ of job issuing request
RLEUSA	11	16-39	Estimated Usage of current job
RLEUNI	11	40-63	Estimated Units of current job
RLJSPR	12	0-3	Job Priority of current job
RLJAST	12	16-39	Job Acceptance status
RLQUPR	12	40-63	Queuing priority of current job W@RLRDD=W@RLQUPR+1 First word of RDD (subtype 2) This must be last field in table.

LXT - Link Extension Table

The Link Extension Table (LXT) is used for communication between EXEC and STP. It contains an entry for each configured logical front-end ID; each entry is allocated by FED on receipt of a logon message, and released after an output operation if the OFF bit is set. Receipt of a front-end message is signaled by FED with the INT (interrupt) bit. FED does not modify an entry after setting INT until the next output request is received for that entry.

Note: An LXT entry can be deallocated by SCP if a channel/ordinal is turned off while the LXT entry is active.

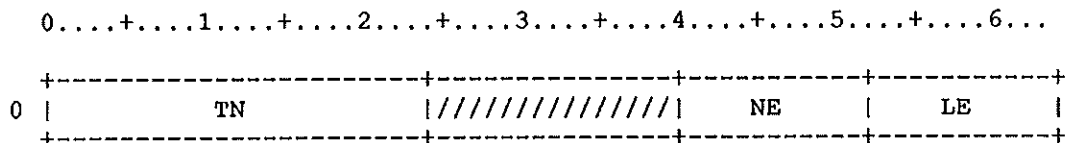

Figure LX-1. Link Extension Table header

Header.

Field	Word(base8)	Bits	Description
LXTN	0	0-23	Table name ('LXT' in ASCII)
LXNE	0	40-51	Number of entries (=NE@LXT)
LXLE	0	52-63	Length of entries (=LE@LXT)

Entry.

0....+....1....+....2....+....3....+....4....+....5....+....6...

0	LID						ORD
1	CHN	CHO	CHT	SEQ			LT
2	NDB		OMIS	OMOS	OMAS	SGZ	
3	OSTR		AIST	AOST	AAST	DSZ	
4	*	CKSZ	LMIS	LMOS	LMAS	MSSG	SSGZ
5				RQH	SQH		
6	EMN			WQH	EMC	EMSC	
7	BTIM						
10				ISL	ISB		
11				ISAL	ISAB		
12	ISSN		ISSL		ISSB		
13				OLB	OLAB		
14				OSL	OSB		
15				OSAL	OSAB		
16	OSSN		OSSL		OSSB		
17	SMSC	XMN	PDD		PSMA		
20				KSD	KPD		
21	STOP						
22	ILCE						
23							
24	ILCP						
	\$						\$
31							

Figure LX-2. Link Extension Table entry

	0	1	2	3	4	5	6
32	OLCE						
33							
34	OLCP						
	§						§
41							
42	XLCE						
43							
44	XLCP						
	§						§
51							
52	NMSG						
53	NWR						
54	NWS						
55	TBT						
56	////////////////////					IACT	
57	RSTQ						
60	////////////////////			INS	MMX	MLM	
61	SMCW						
62	TSK						
63	INSL						
64	INSS						
65	////////////////////		FAD		OERC		
66	ONSL						
67	ONSS						
70	OLLC						

Figure LX-2. Link Extension Table entry

	0.....+	1.....+	2.....+	3.....+	4.....+	5.....+	6.....
71	ILTP						
72							
73							
74	OLTP						
75							
76							
77	XLTP						
100							
101							
102	LSEG						
\$							\$
107							
110	SSEG						
\$							\$
137							
140	////////////////////				STKP		
141	STK						
\$							\$
227							
230	ISST						
\$							\$
367							
370	OSST						
\$							\$
n							

Figure LX-2. Link Extension Table entry

<u>Field</u>	<u>Word(base8)</u>	<u>Bits</u>	<u>Description</u>
LXLID	0	0-15	Logical front end ID (SCP, EXEC)
LXINT	0	16	Channel interrupt (set/EXEC, clear/SCP)
LXRDY	0	17	Ready for input flag (EXEC)
LXOFF	0	18	Entry deallocation request (SCP, EXEC)
LXIAST	0	19	Interactive request received (SCP)
LXRLOG	0	20	Relog flag (EXEC, SCP)
LXPEND	0	21	Output pending flag (EXEC)
LXPBAL	0	22	Pool buffer allocated flag
LXVARS	0	23	Variable segment size enable flag
LXERR	0	24	Processing error LCP flag
LXFRCE	0	25	Force segment transfer on LCP(s)
LXOFRC	0	26	Operator force off flag
LXORD	0	56-63	LXT entry ordinal (SCP, EXEC)
LXCHN	1	1-6	Channel pair number (SCP, EXEC)
LXCHO	1	7-14	Channel ordinal (SCP, EXEC)
LXCHT	1	15-18	Channel type (SCP, EXEC)
LXSLOT	1	19	Station Slot (set if present)
LXSEQ	1	20-27	Task request/reply sequence
LXISLT	1	28	Interactive station slot flag
LXLT	1	40-63	LIT entry address (SCP, EXEC)
LXNDB	2	10-15	Number of disk buffers for streams
LXOMIS	2	16-23	Operator maximum input streams (SCP)
LXOMOS	2	24-31	Operator maximum output streams (SCP)
LXOMAS	2	32-39	Operator maximum active streams (SCP)
LXSGZ	2	40-63	Segment size in words (SCP)
LXOSTR	3	8-15	Next output stream to transfer
LXAIST	3	16-23	Current active input streams (SCP)

<u>Field</u>	<u>Word(base8)</u>	<u>Bits</u>	<u>Description</u>
LXAOST	3	24-31	Current active output streams (SCP)
LXAAST	3	32-39	Current total active streams (SCP)
LXDSZ	3	40-63	Maximum output dataset size, in
LXSTYP	4	0-1	Station type (SCP): LXSTYPB=0 Batch only LXSTYPI=1 Interactive only LXSTYPBI=2 Both batch and interactive
LXCKSZ	4	8-15	Checksum width (SCP)
LXMLIS	4	16-23	Logon maximum input streams (SCP)
LXMLOS	4	24-31	Logon maximum output streams (SCP)
LXMLAS	4	32-39	Logon maximum active streams (SCP)
LXMSSG	4	40-47	Number of subsegments (SCP)
LXSSGZ	4	48-63	Subsegment size in words (SCP)
LXRQH	5	16-39	Receiving SDT queue head (SCP)
LXSQH	5	40-63	Sending SDT queue head (SCP)
LXEMN	6	0-7	
LXWQH	6	16-39	Waiting SDT queue head (SCP)
LXEMC	6	40-47	
LXEMSC	6	50-57	
LXBTIM	7	0-63	Time interval to exchange buffers
LXISL	10	16-39	Input segment limit addr (SCP, EXEC)
LXISB	10	40-63	Input segment base addr (SCP, EXEC)
LXISAL	11	16-39	Input segment absolute limit address
LXISAB	11	40-63	Input segment absolute base address
LXISSN	12	8-15	Current input subsegment number (EXEC)
LXISSL	12	16-39	Input subsegment abs limit addr (EXEC)
LXISSB	12	40-63	Input subsegment abs base addr (EXEC)
LXOLB	13	16-39	Output/error LCP entry address (SCP)

<u>Field</u>	<u>Word(base8)</u>	<u>Bits</u>	<u>Description</u>
LXOLAB	13	40-63	Output LCP abs base addr (SCP, EXEC)
LXOSL	14	16-39	Output segment limit addr (SCP, EXEC)
LXOSB	14	40-63	Output segment base addr (SCP, EXEC)
LXOSAL	15	16-39	Output segment absolute limit address
LXOSAB	15	40-63	Output segment absolute base address
LXOSSN	16	8-15	Current output subsegment number (EXEC)
LXOSSL	16	16-39	Output subsegment abs limit addr (EXEC)
LXOSSB	16	40-63	Output subsegment abs base addr (EXEC)
LXSMSC	17	0-7	Send message subcode
LXXMN	17	8-15	Expected message number
LXPDD	17	16-39	Address of temporary PDD
LXPSMA	17	40-63	Process send message address
LXKSD	20	16-39	Saved SDT for KILL
LXKPD	20	40-63	Saved PDD for KILL
LXSTOP	21	0-63	Station Operator identifier
LXILCE	22-23	0-63	Input LCPE (2 words) (EXEC)
LXILCP	24-31	0-63	Input LCP (6 words) (SCP, EXEC)
LXOLCE	32-33	0-63	Output LCPE (2 words) (EXEC)
LXOLCP	34-41	0-63	Output LCP (6 words) (SCP, EXEC)
LXXLCE	42-43	0-63	Error LCPE (2 words) (EXEC)
LXXLCP	44-51	0-63	Error LCP (6 words) (SCP, EXEC)
LXNMSG	52	0-63	Number of messages (SCP, SPM)
LXNWR	53	0-63	Number of words received (SCP, SPM)
LXNWS	54	0-63	Number of words sent (SCP, SPM)
LXTBT	55	0-63	Total number of bits xferred (SCP)
LXIACT	56	48-63	Interactive message count (SCP)
LXRSTQ	57	0-63	Interactive restart queue control

<u>Field</u>	<u>Word(base8)</u>	<u>Bits</u>	<u>Description</u>
LXNRM	57	0-15	Number of messages
LXHSZ	57	16-31	Size of first message
LXRSQT	57	32-47	Queue head
LXRSQH	57	48-63	Queue tail
LXINS	60	24-47	Internal station SIT address
LXMMX	60	48-55	Maximum message count/segment (SCP)
LXMLM	60	56-63	Current limit count/segment (SCP)
LXSMCW	61	0-63	Station message control (1 word) (SCP)
LXMQC	61	0-15	Station message queue count
LXTSK	62	0-63	Station message task flags (SCP)
LXINSL	63	0-63	Input net status after LCP (EXEC)
LXINSS	64	0-63	Input net status after segment (EXEC)
LXFAD	65	16-39	FIT address (EXEC)
LXOERC	65	40-63	Output error count
LXONSL	66	0-63	Output net status after LCP (EXEC)
LXONSS	67	0-63	Output net status after segment (EXEC)
LXOLLC	70	0-63	Last net output LCP+0 (EXEC)
LXILTP	71-73	0-63	Input LTP (3 words) (SCP, EXEC)
LXOLTP	74-76	0-63	Output LTP (3 words) (SCP, EXEC)
LXXLTP	77-101	0-63	Error LTP (3 words) (SCP, EXEC)
LXLSEG	102-107	0-63	Logon segment (6 words) (SCP, EXEC) Z@LXSSEG=D'24
LXSSEG	110-137	0-63	Sync request segment (24 words) (SCP)
LXSTKP	140	40-63	Stack pointer (SCP) LXSTKZ=D'55
LXSTK	141-227	0-63	Stack
LXISST	230-367	0-63	Start of input SSTs
LXOSST	370-n	0-63	Start of output SSTs

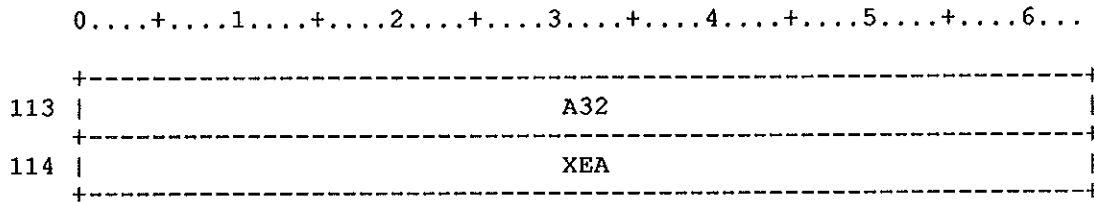

Figure MC-1.

Field	Word(base8)	Bits	Description
MCPMT	0	0-63	Name of primary machine type
MCBANK	1	0-63	Number of memory banks
MCNCPU	2	0-63	Number of physical processors
MCIBSZ	3	0-63	Number of words in instruction buffer
MCMSZ	4	0-63	Number of words of main memory MC500K=D'524288 Half meg memory size MC1MEG=D'1048576 One megaword memory size MC2MEG=MC1MEG*D'2 Two megaword memory size MC4MEG=MC1MEG*D'4 Four megaword memory size MC8MEG=MC1MEG*D'8 Eight megaword memory size MC16MEG=MC1MEG*D'16 Sixteen megaword memory size MC32MEG=MC1MEG*D'32 Thirty-two megaword memory size MC64MEG=MC1MEG*D'64 Sixty-four megaword memory size
MCMSPD	5	0-63	Number of clocks for memory read
MCCLK	6	0-63	Clock period in picoseconds
MCNCL	7	0-63	Number of clusters
MCBBSY	10	0-63	Memory bank busy time in clocks
MCEMA	100	0-63	Extended Memory Addressing
MCCI GS	101	0-63	Compress Index/Gather Scatter
MCVPOP	102	0-63	Vector Population count unit
MCPC	103	0-63	Programmable Clock
MCRDVL	104	0-63	Vector Length can be read

<u>Field</u>	<u>Word(base8)</u>	<u>Bits</u>	<u>Description</u>
MCVRCR	105	0-63	Vector recursion does not occur
MCAVL	106	0-63	Additional Vector Logical available
MCHPM	107	0-63	Hardware Performance Monitor
MCBDM	110	0-63	Bidirectional memory available
MCSTR	111	0-63	Status register (SR0)
MCCORI	112	0-63	Control Operand Range Intrpts (ERI/DRI)
MCA32	113	0-63	YMP 32-bit addressing required
MCXEA	114	0-63	CRAY-XMP EA instruction timings

This table is used by INSASCI to control the insertion of parameters into a message.

The header, which must be first, is followed by one entry for Each message defined. There must be MCNM entries. The entries are ordered so that the message number can be used as an offset into the MCT. (The header's position has been taken into account in INSASCI).

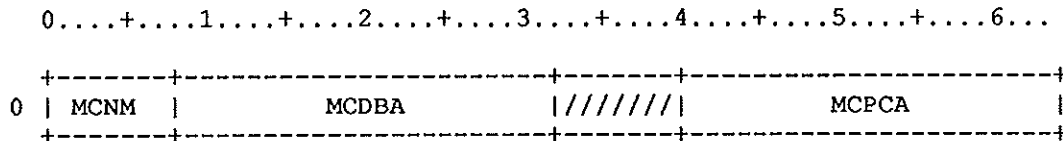

Figure MCT-1. Message Control Table Header

HEADER

Field	Word(base8)	Bits	Description
MCNM	0	0-7	Number of messages (1..256)
MCDBA	0	8-31	Destination buffer address in words
MCPCA	0	40-63	Base address of param control table

ENTRY

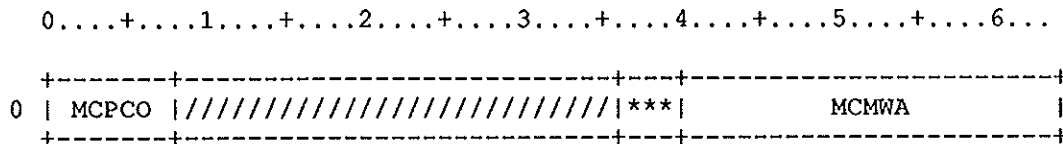

Figure MCT-2. Message Control Table Entry

Field	Word(base8)	Bits	Description
MCPCO	0	0-7	Offset into PCT
MCMWL	0	36-39	Length of message in words
MCMWA	0	40-63	Message address in words

PARAMETER CONTROL TABLE

The PCT has one entry for each different message format. I.e., if two or more messages have the same number of parameters which are inserted into the same places, they could share the same PCT entry. If a message does not have parameters, then the PCNP and PCPCA fields for that message should be set to zero.

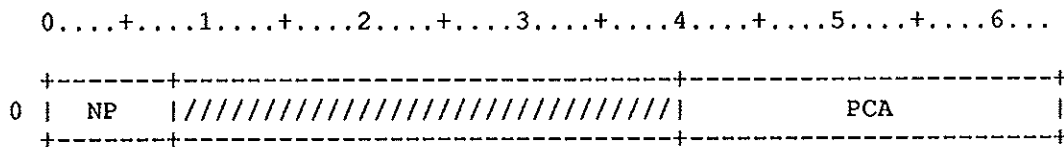

Figure PC-1. Parameter Control Table Header

<u>Field</u>	<u>Word(base8)</u>	<u>Bits</u>	<u>Description</u>
PCNP	0	0-7	Number of params to be inserted
PCPCA	0	40-63	Base addr of param control entry

PARAMETER CONTROL ENTRY

One parameter control entry should be constructed for each PCT entry defined. If a PCT entry's PCNP field is zero, then no PCE should be constructed for it. The number of entries must equal the number of parameters specified in the corresponding PCT entry's PCNP field.

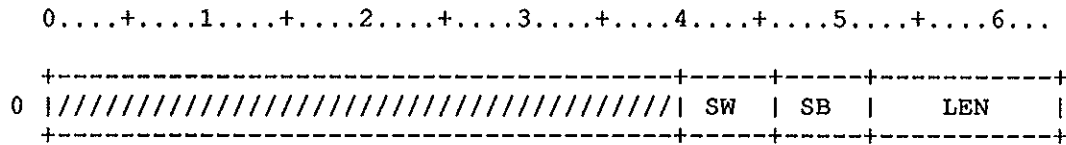

Figure PC-2. Parameter Control Table Entry

<u>Field</u>	<u>Word(base8)</u>	<u>Bits</u>	<u>Description</u>
PCSW	0	40-45	Start word within text (0,1,...)
PCSB	0	46-51	Start bit within start word (0..d'63)
PCLLEN	0	52-63	Length in bits (max is d'64)

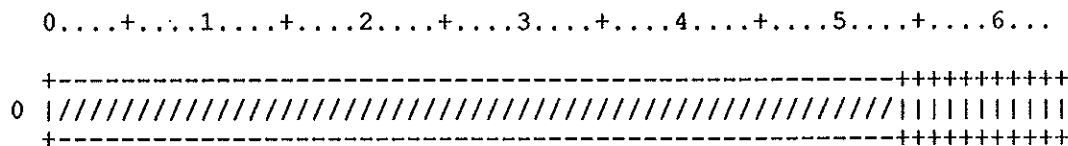

Figure MD-1. Mode Parameter Word

<u>Field</u>	<u>Word(base8)</u>	<u>Bits</u>	<u>Description</u>
MDEORI	0	54	Enable operand range interrupts
MDDORI	0	55	Disable operand range interrupts
MDEEMA	0	56	Enable extended memory addressing
MDEEMA	0	57	Disable extended memory addressing
MDEAVL	0	58	Enable additional vector logical unit
MDDAVL	0	59	Disable additional vector logical unit
MDEBT	0	60	Enable bidirectional transfer flag
MDDBT	0	61	Disable bidirectional transfer flag
MDEFI	0	62	Enable floating interrupt flag
MDDFI	0	63	Disable floating interrupt flag

This table shows memory descriptor word pair fields for system dumps. The header word ID is stored in word 511 decimal of the first sector of the dump file. The information is constructed by STARTUP from the SDP entries.

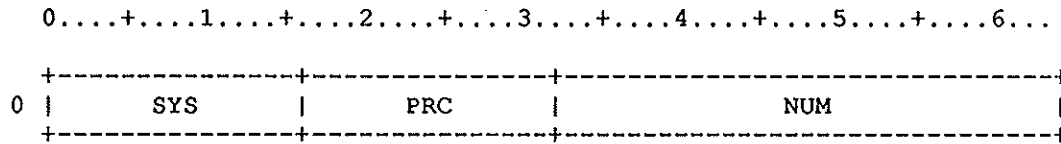

Figure MDW-1. System Dump Memory Descriptor Words

<u>Field</u>	<u>Word(base8)</u>	<u>Bits</u>	<u>Description</u>
MDWSYS	0	0-15	System type
MDWPRC	0	16-31	Number of processors
MDWNUM	0	32-63	Number of areas that have been dumped

MDW pairs are stored in words D'14 through D'509 of the first sector of the dump:

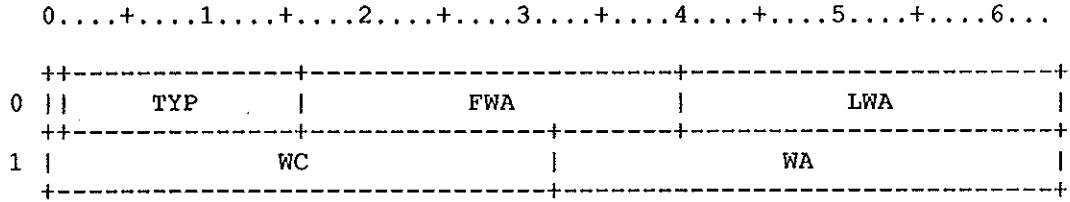

Figure MDW-2. MDW Pairs

<u>Field</u>	<u>Word(base8)</u>	<u>Bits</u>	<u>Description</u>
MDWC	0	0	Compressed dump if nonzero
MDWTYP	0	1-15	Memory type
MDWFWA	0	16-39	FWA of following memory, or words/parcels of following data if it is registers or IOPs
MDWLWA	0	40-63	LWA of following memory, or zero
MDWWC	1	0-31	Number of words on the disk used by the following data
MDWWA	1	32-63	Word address on disk of first data word

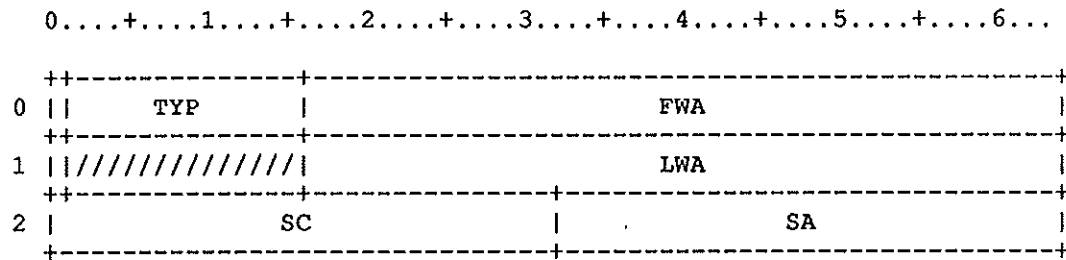

Figure NMD-1. New Format Memory Descriptor

Field	Word(base8)	Bits	Description
NMDC	0	0	Compression flag
NMDTYP	0	1-15	Memory type
NMDFWA	0	16-63	FWA of memory
NMDF	1	0	Format flag
NMDLWA	1	16-63	LWA of memory
NMDSC	2	0-31	Sector count
NMDSA	2	32-63	Sector address

MET - Memory Error Table

The Memory Error Table (ME) is used to log multiple occurrences of correctable memory errors. A multiple occurrence is defined as one which occurs on the same memory chip as another error. The ME table is an Exec based table.

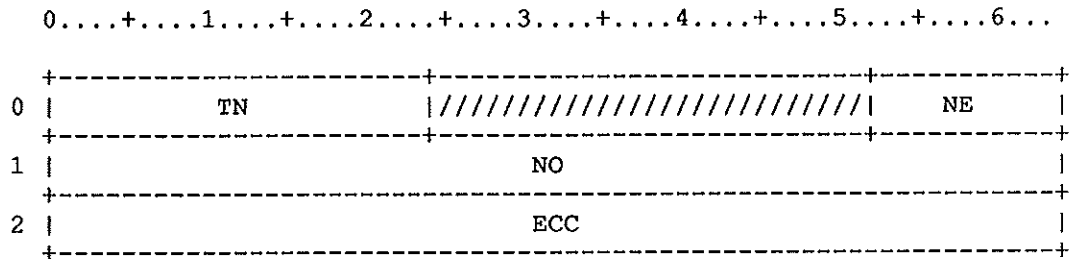

Figure ME-1. Memory Error Table header

Field	Word(base8)	Bits	Description
METN	0	0-23	Table Name ('MET' in ASCII)
MENE	0	52-63	Number of entries (=I@CMETL)
MENO	1	0-63	Number of entries in use
MEECC	2	0-63	Error correction count

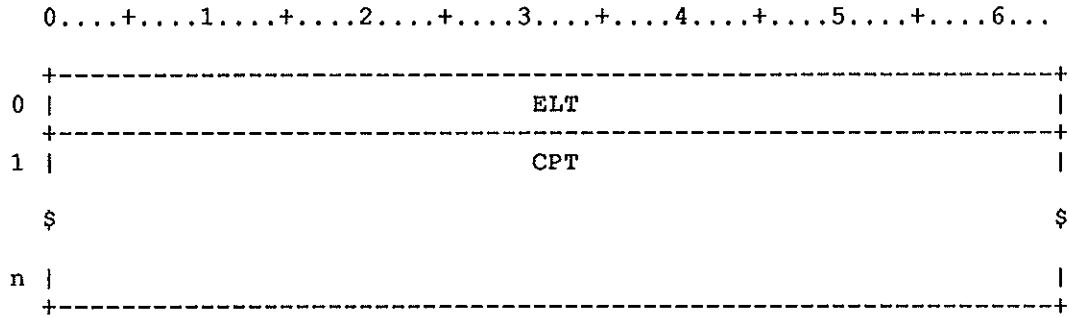

Figure ME-2. Memory Error Table entry

Field	Word(base8)	Bits	Description
MEELT	0	0-63	Error Location Template
MEEU	0	0	Entry in use flag
MECS	0	4-33	Chip select
MEBK	0	34-63	Bank
			Made up of the Bank and Chip Select fields of the error address.
MECPT	1-n	0-63	Copy of Exec-MEP C-Packet

NAME: COMMEM
 PURPOSE MEMORY DEFINITIONS
 SET BY CALLER

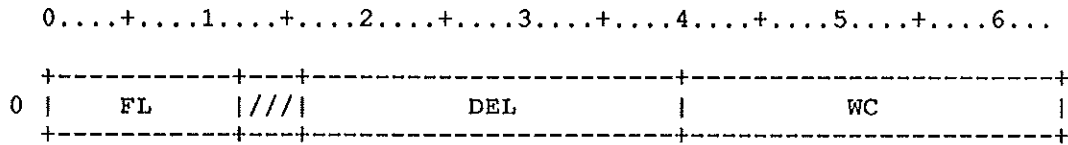

Figure MR-1. Memory Definitions

Field	Word(base8)	Bits	Description
MRFL	0	0-11	Flags field
MRB	0	4	Inc buffer area
MRD	0	5	Inc DSP area
MRF	0	7	Field length
MRJ	0	8	Inc JTA
MRO	0	9	Force job to roll out
MRR	0	10	Release WC words if 1
MRU	0	11	UC request on EMA levels of COS (Set on COS level 1.15 and after)
MRDEL	0	16-39	Deletion flag/pointer
MRWC	0	40-63	Words to add or delete

Memory pool areas are surrounded by (identical) header and trailer words that control the allocation and deallocation of the areas. A memory pool is depicted in figure MP-1.

```

MAXPOOL = 6

LGPOOL = 1           Memory pool number for message
                    queue
SPMPOOL = 1         Performance monitor buffer pool
TXTPOOL = 1         Pool number for dispose texts
MEPOOL = 2          Pool for memory error logging
LBLPOOL = 3         Tape label pool
ISPPOOL = I@IPOOL  POOL FOR ISP TABLES
QUEPOOL = 5         JSH queues pool
PRPOOL = 6          Pool for preemptable resource
                    tables

JMEMID = 0'07070707 Memory pool pattern for JTA
MISTAKE1 = 1
MISTAKE2 = 2
MISTAKE3 = 3
    
```

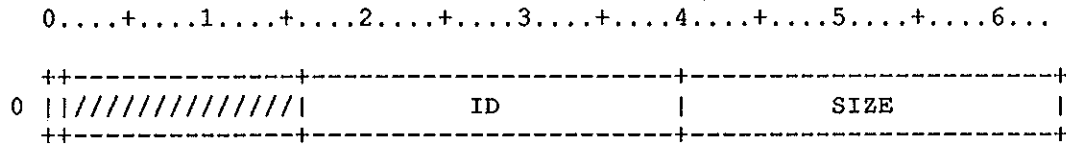

Figure MP-1. Memory Pool

Field	Word(base8)	Bits	Description
MPST	0	0	Status of the memory area: 0 Available 1 In use
MPID	0	16-39	Memory pool identification (octal): 01010101 Pool 1 0x0x0x0x Poolx. Current values are 1, 2, 3, 4, 5 or 7.
MPSIZE	0	40-63	Size of the memory area MPHT=2 Combined memory size, header and trailer

MP1S=I@MP1SZ Size of memory pool1
MP2S=I@MP2SZ Size of memory pool2
MP3S=I@MP3SZ Size of memory pool3
MP4S=I@MP4SZ+MPHT Size of
memory pool4
MP5S=I@MP5SZ Size of memory pool 5
MP6S=I@MP6SZ Size of memory pool 6

The MST in STP memory contains a 1-word entry for each segment of memory that has been allocated by the Job Scheduler plus additional entries that describe free and if necessary, 4MW boundary segments. MST entries are organized in ascending order according to the beginning address of the segment (MSADDR). Any free space between two allocated segments is consolidated and is represented by a single entry stored in the MST between entries for the two allocated segments. The last entry in the table is always followed by a zero word. To provide for the case where every allocated segment is surrounded by free segments, the MST must have twice as many words in it as the maximum number of allocated segments, plus two more. In addition space must be provided for up to three boundary segments, each of which could split a free segment into two parts adding an additional 9 words to the size of the MST. One additional entry must be provided for GOS support. The allocation requirement in total is $I@JXTSIZ*2+14$ for a maximum memory of 16MW. Each additional increment of 4MW beyond 16MW adds three words to the MST.

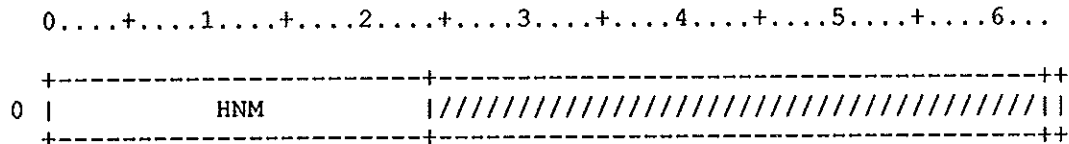

Figure MS-1. Memory Segment Table

Field	Word(base8)	Bits	Description
MSHNM	0	0-23	table name
MSHAM	0	63	addressing mode 0 = not in extended addressing mode 1 = extended addressing mode

Define symbolic codes for actions recorded in the multitasking history trace buffer.

%TSKST	=	D'0	start task
%TSKCM	=	D'1	complete task
%TSKWT	=	D'2	TSKWAIT, no wait
%TSKWTB	=	D'3	begin wait for task
%TSKWTE	=	D'4	run after wait for task
%TSKTST	=	D'5	test task
%LCKASN	=	D'6	assign lock
%LCKREL	=	D'7	release lock
%LCKSET	=	D'8	set lock
%LCKWTB	=	D'9	begin wait to set lock
%LCKWTE	=	D'10	run after wait for lock
%LCKCLR	=	D'11	clear lock
%LCKTST	=	D'12	test lock
%EVASGN	=	D'13	assign event
%EVREL	=	D'14	release event
%EVPOST	=	D'15	post event
%EVCLR	=	D'16	clear event
%EVWAIT	=	D'17	EVWAIT, no wait
%EVWTB	=	D'18	begin wait for event
%EVWTE	=	D'19	run after wait for event
%EVTEST	=	D'20	test event
%CPUATT	=	D'21	attach to logical CPU
%CPUDET	=	D'22	detach from logical CPU
%CPUREQ	=	D'23	request a logical CPU
%CPUACQ	=	D'25	acquire a logical CPU
%CPUDEL	=	D'26	delete a logical CPU
%CPUSUS	=	D'28	suspend a logical CPU
%CPUACT	=	D'30	activate a logical CPU
%CPUHLD	=	D'32	delay a logical CPU
%BRASGN	=	D'33	assign barrier
%BRREL	=	D'34	release barrier
%BRSYNC	=	D'35	BARSYNC, no wait
%BRWTB	=	D'36	begin wait at barrier
%BRWTE	=	D'37	run after wait at barrier

*CALL COMMTQ at this ident + 1

Copyright Cray Research Inc.

UNPUBLISHED - all rights reserved under the copyright laws of the United States.

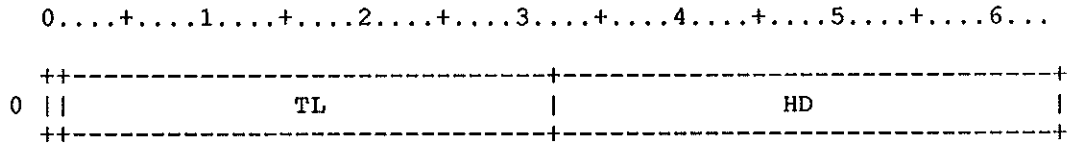

Figure QUE-1. Define Multitasking Queue Header Words

Field	Word(base8)	Bits	Description
QUEFLG	0	0	Switch setting for locks or events
QUETL	0	1-31	Pointer field for tail of queue
QUEHD	0	32-63	Pointer field for head of queue
NSC\$ALP	= 1		Assign logical path
NSC\$RLP	= 2		Release logical path
NSC\$ODS	= 3		Obtain driver statistics
NSC\$OK	= 0		Normal status
NSC\$LPN	= 1		Logical path not available
NSC\$LAN	= 2		Logical adapter not available
NSC\$RTO	= 3		Read time out
NSC\$RDE	= 4		Read error
NSC\$WTO	= 5		Write time out
NSC\$WTE	= 6		Write error
NSC\$RPE	= 7		Release logical path error

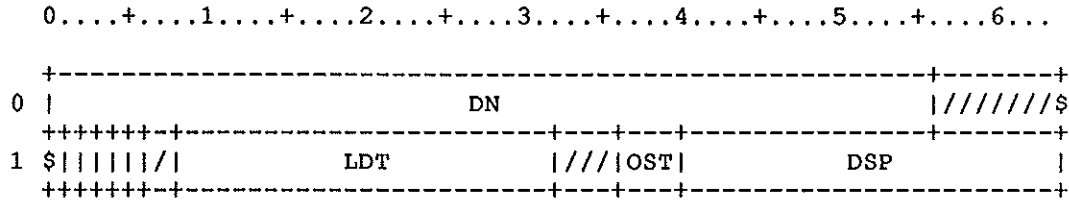

Figure OD-1. Open Dataset Table

Field	Word(base8)	Bits	Description
ODDN	0	0-55	Dataset name
ODV	1	1	Close volume
ODM	1	2	Open for 'mod' (append)
ODS	1	3	Close or open with saved position
ODH	1	4	Hold resources
ODUDS	1	5	Open as unblocked flag
ODLDT	1	8-31	LDT address
ODOST	1	36-39	TYPE OF OPEN REQUESTED
ODDSP	1	40-63	DSP pointer: Negative: negative offset Positive: absolute address
OSTDEF	= D'00		Default: 1.15 and eariler versions
OSTSA	= D'00		Open system-managed system-resident
OSTUA	= D'01		Open with user-managed user-resident
OSTMSY	= D'02		Open system-managed user-resident
OSTS2U	= D'03		Switch system-managed to user-managed
OSTS2S	= D'04		Switch user-managed to system-managed.

The Activity Control Block is a data structure used by the SLT main loop to control the execution of activities. It consists of a header containing fields common to all activities, followed by a variable-length user area which contains fields particular to the kind of activity. Only the header is defined here. The ACB begins with a two word chain item. It is queued on the SLT system queue whenever an event has occurred that the activity must handle.

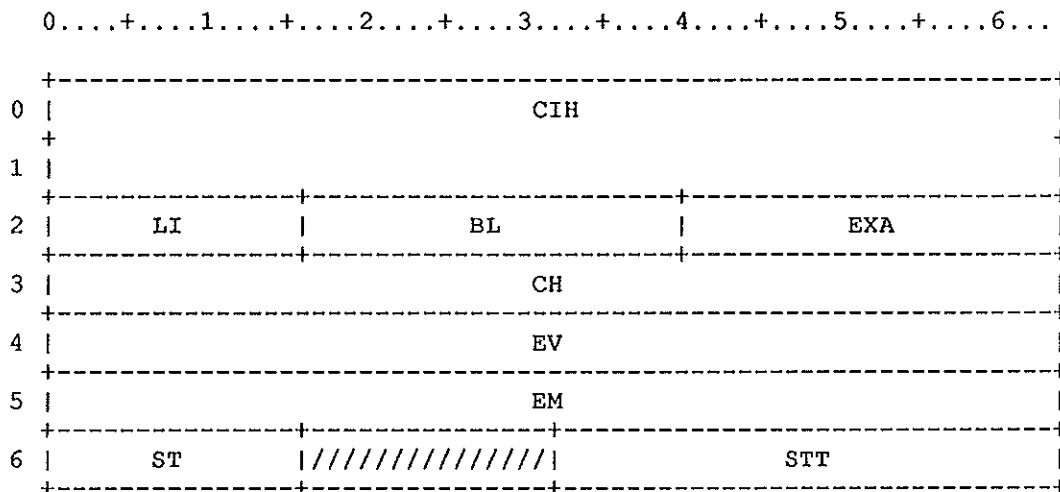

Figure OEA-1. SL2 ACB header

Field	Word(base8)	Bits	Description
OEACIH	0-1	0-63	Chain item for system queue
OEACIH	0-1	0-63	(Required by table diagram generator)
OEALI	2	0-15	Global activity list index (from 0)
OEABL	2	16-39	ACB length in words
OEAEXA	2	40-63	Execution address
OEACH	3	0-63	Channel chain control word
OEAEV	4	0-63	Event bit vector
OEAEM	5	0-63	Event mask
OEA ST	6	0-15	State
OEA STT	6	32-63	State table address

W@OEAUA=7 User area starts here

Globally-defined event codes:

OEAEVINI=0 Initialization
OEAEVBAV=1 Buffer may be
available
OEAEVCHN=2 Object arrived on
channel
OEAEVBSB=3 Buffer shortage begins
OEAEBSE=4 Buffer shortage ends
OEAEVUSE=D'10 First
activity-specific code

The SL2 buffer is used for building protocol units which are passed between layers. Going downward toward the datalink layer, headers are added toward the beginning of the buffer. In the other direction, headers are removed. The buffer format allows buffer content information to be saved on a stack within the buffer, to accomodate layers which must save messages for retransmission.

The SL2 buffer consists of a header area which is used only by the buffer management routines, followed by the user area. The buffer address given to a buffer user by GETBUF is the address of the user area.

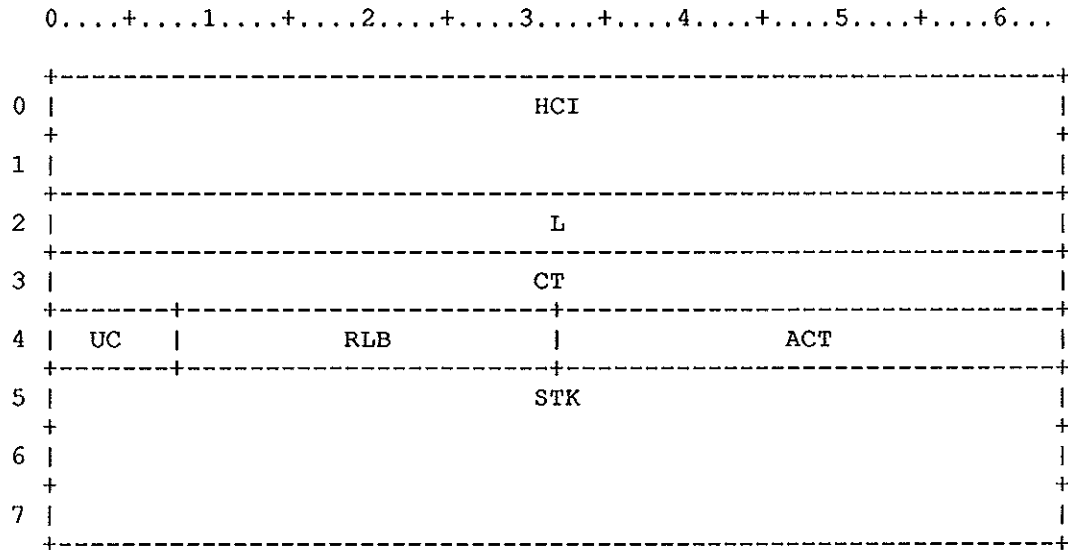

Figure OEB-1. SL2 buffer - buffer manager header

Field	Word(base8)	Bits	Description
OEBHCI	0-1	0-63	Chain item for buffer manager
OEBHCI	0-1	0-63	(Required by table diagram generator)
OEBL	2	0-63	Buffer length in words
OEBCT	3	0-63	Creation time
OEBUC	4	0-7	Use count (stack pointer)
OEBRLB	4	8-31	B00 contents as buffer is released

Field	Word(base8)	Bits	Description
OEBACT	4	32-63	Owner activity address NE@OEBST=1 Number of stack entries LE@OEBST=3 Length of a stack entry L@OEBSTK=NE@OEBST*LE@OEBST Length of stack in words
OEBSTK	5-7	0-63	Beginning of stack
OEBSTK	5-7	0-63	(Required by table diagram generator)

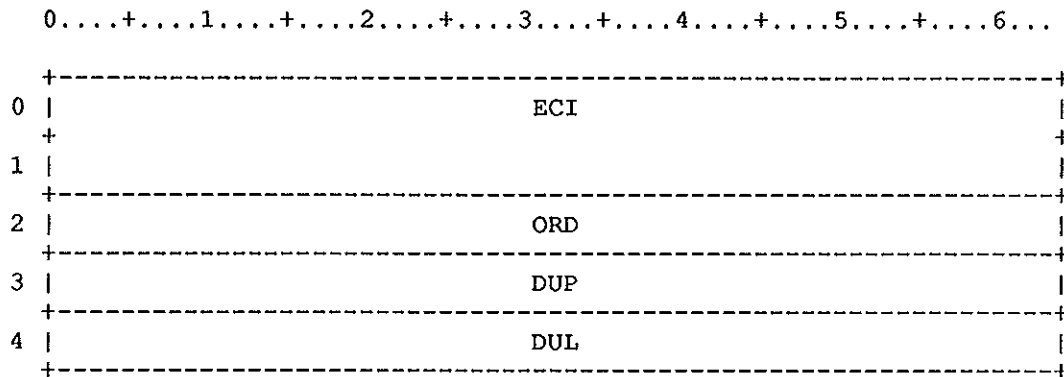

Figure OEB-2. SL2 buffer - user area

Field	Word(base8)	Bits	Description
OEBECI	0-1	0-63	Chain item for buffer user
OEBECI	0-1	0-63	(Required by table diagram generator)
OEBORD	2	0-63	Sequence number for chain ordering
OEBDUP	3	0-63	PDU pointer (character pointer)
OEBDUL	4	0-63	PDU length in bytes W@OEBUA=5 User area starts here
OSI\$NONE	= 0		Raw buffer mode
OSI\$PH	= 1		Physical layer number
OSI\$DL	= 2		Datalink layer number
OSI\$NW	= 3		Network layer number
OSI\$TS	= 4		Transport layer number
OSI\$NUML	= 5		Number of layers defined

All Superlink code in COS uses this format to point to a character at a byte-offset within a 64-bit word. Byte positions are numbered from zero (leftmost) to seven.

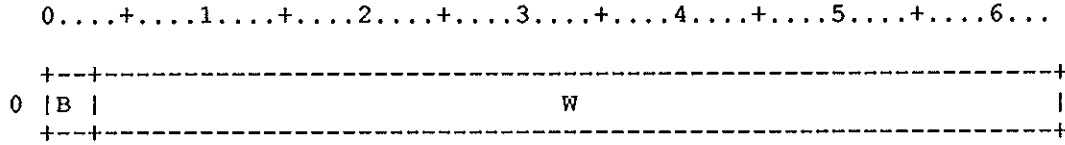

Figure OEC-1. SL2 Character pointer

<u>Field</u>	<u>Word(base8)</u>	<u>Bits</u>	<u>Description</u>
OECB	0	0-2	Byte offset within word
OECW	0	3-63	Word address

The Global Activity List is fixed-size array of one-word entries allocated in STPTAB. Each nonzero entry points to an activity control block (ACB). There is an accompanying bit-vector for locating available entries. If a bit is set, the entry is available. The list header also contains fields of global significance to the Superlink transport service.

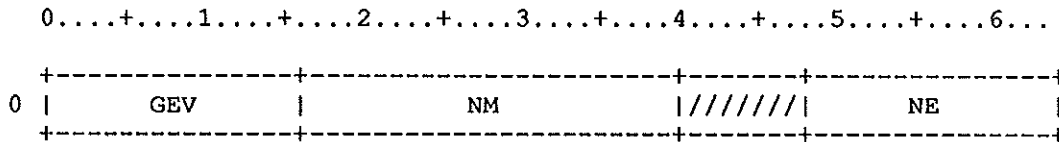

Figure OEG-1. SL2 Global Activity List Header

<u>Field</u>	<u>Word(base8)</u>	<u>Bits</u>	<u>Description</u>
OEGGEV	0	0-15	Global event-wait field
OEGWBF	0	14	ACCREATE waiting for buffer
OEGACW	0	15	Activity waiting for creation
OEGNM	0	16-39	Table name - 'GAL' in ASCII
OEGNE	0	48-63	Number of table entries configured

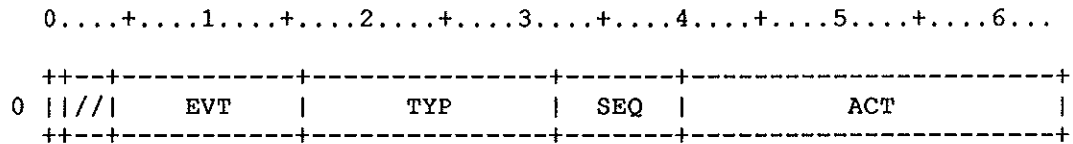

Figure OEG-2. SL2 Global Activity List Entry

Field	Word(base8)	Bits	Description
OEGWB	0	0	Wait-buffer flag
OEGEVT	0	4-15	Event-wait field (used for J\$AWAIT)
OEGTYP	0	16-31	Activity type: OEGT\$T4='T4'R ISO class 4 transport connection OEGT\$MX='MX'R Multiplexor OEGT\$DX='DX'R Demultiplexor OEGT\$BM='BM'R Buffer Monitor OEGT\$LP='LP'R Link Path monitor OEGT\$LT='LT'R Link timeout activity OEGT\$NL='NL'R Connectionless Network Layer activity OEGT\$IO='IO'R IPC offer outstanding OEGT\$IC='IC'R IPC connection
OEGSEQ	0	32-39	Entry use sequence number
OEGACT	0	40-63	ACB address of activity

The queue table is a general purpose fixed-length queue structure, implemented as a circular list of queue items (QI). All items in the queue are the same length, equal to the contents of the header field OEQLE. Parallel processes can enqueue and dequeue simultaneously without interlock. The queue operates in FIFO manner, except that the receiving process can reorder items in the queue. A queue must include N*LE words following the header. By convention, the queue is empty when IN = OUT. One entry's worth of free space is always present.

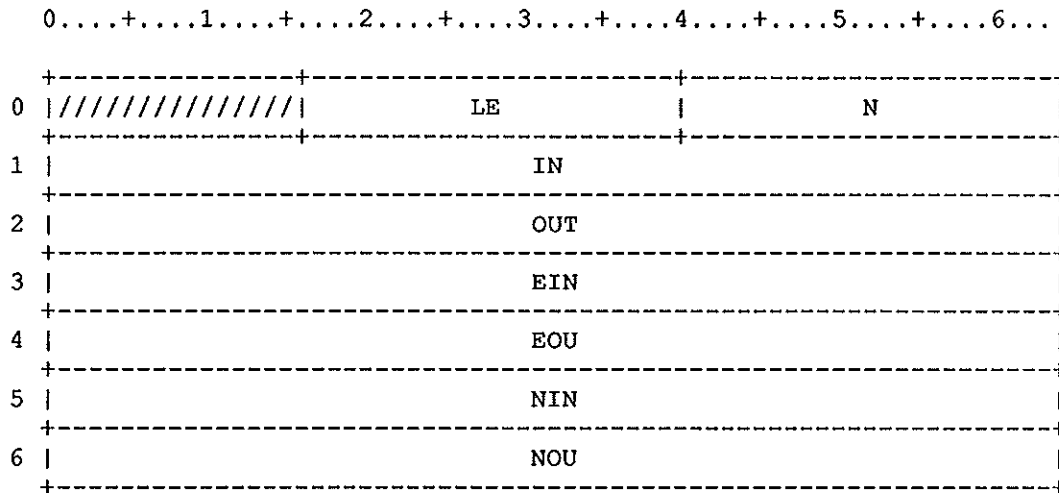

Figure OEQ-1. SL2 Queue Table Header

Field	Word(base8)	Bits	Description
OEQLE	0	16-39	Length of an entry
OEQN	0	40-63	Queue size (number of entries)
OEQIN	1	0-63	Word offset of next free entry
OEQOUT	2	0-63	Word offset of first queue item
OEQEIN	3	0-63	Count of ED's placed in queue
OEQEOU	4	0-63	Count of ED's read from queue
OEQNIN	5	0-63	Count of non-ED's placed in queue
OEQNOU	6	0-63	Count of non-ED's read from queue NE@OEQMX=D' 64 Largest allowable queue

LE@OEQMX must be no greater than 6 words.
The transport interface requires that LE@OEQMX
be no less than 6 words.

LE@OEQMX=D'6 Largest allowable QI

The SL2 state table is a general-purpose structure for state-event driven processes. It is a two-dimensional look-up table containing the address of a processor for each possible combination of a certain number of states and a certain number of events. The two-word header is followed by a NST*NEV-word array, each word containing a processor address. All the event processor addresses for the first state come first, then all the processors for the second state, and so on.

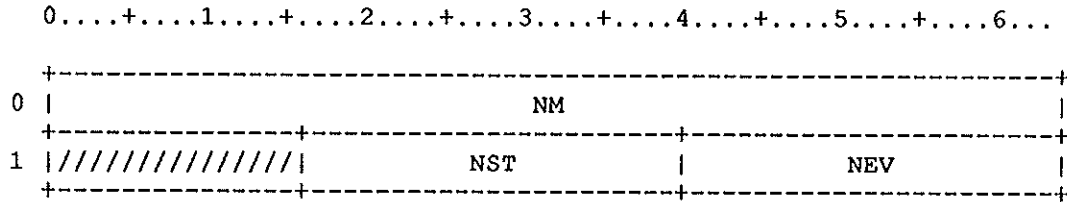

Figure OES-1. SL2 State Table Header

Field	Word(base8)	Bits	Description
OESNM	0	0-63	Table name in ASCII
OESNST	1	16-39	Number of states
OESNEV	1	40-63	Number of events

Each active timer in the Superlink transport service is represented by a timer block. The timer block begins with a chain item, so it can be placed on the timer queue. Following the chain item is the expiration time. The timer block is queued in ascending order according to this word. The timer block contains the address of an activity to be readied on expiration and an event code to be posted to it. All times are expressed in clock periods.

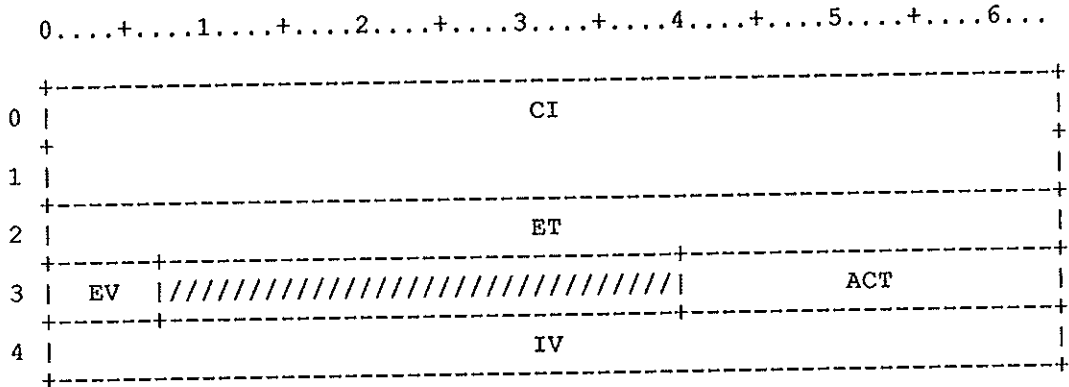

Figure OET-1. SL2 Timer Block

Field	Word(base8)	Bits	Description
OETCI	0-1	0-63	Chain item for timer chain
OETCI	0-1	0-63	(Required by table diagram generator)
OETET	2	0-63	Expiration time (must be in word 2)
OETEV	3	0-6	Event code associated with this timer
OETACT	3	40-63	Address of owner activity
OETIV	4	0-63	Timer interval (for debugging only)

This table resides in the user field for job-resident users of Superlink interprocess communication. S1 points to it when the F\$IPC system call is made. It contains parameters for a single IPC connection or offer, as well as pointers to user's parameter block, send queue, receive queue and buffer queue.

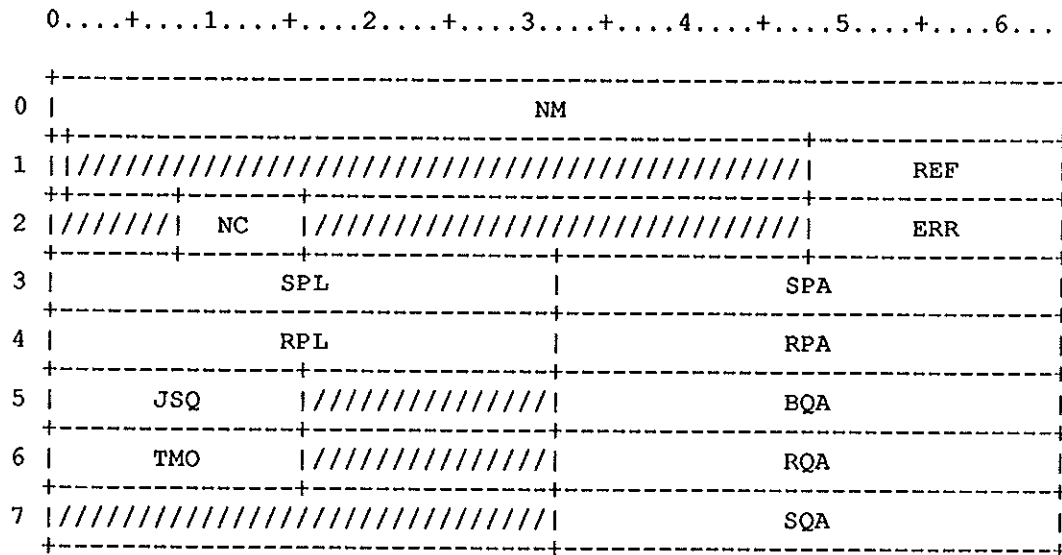

Figure OIB-1. SL2 IPC communication block

Field	Word(base8)	Bits	Description
OIBNM	0	0-63	Server-name (1-8 ASCII characters)
OIBEXC	1	0	Request abort on exception condition
OIBREF	1	48-63	Connection reference assigned by IPC
OIBNC	2	8-15	Number of queued connections
OIBERR	2	48-63	Error code returned by IPC
OIBSPL	3	0-31	Send parameter block length in words
OIBSPA	3	32-63	Send parameter block address
OIBRPL	4	0-31	Receive parameter block buffer length
OIBRPA	4	32-63	Rcv parameter block buffer address
OIBJSQ	5	0-15	Target job sequence number (handoff)
OIBBQA	5	32-63	Buffer queue address

Field	Word(base8)	Bits	Description
OIBTMO	6	0-15	Recall timer value (seconds/10)
OIBRQA	6	32-63	Receive queue address
OIBSQA	7	32-63	Send queue address
OIRQ\$ADV	= 0		Advance queues
OIRQ\$OFR	= 1		Server offer
OIRQ\$CON	= 2		Client connect request
OIRQ\$CLO	= 3		Close connection request
OIRQ\$SPB	= 4		Send parameter block
OIRQ\$RPB	= 5		Receive parameter block
OIRQ\$HLT	= 6		Halt connection activity
OIRQ\$HND	= 7		Hand off connection to another job
OIRQ\$ACC	= D'8		Accept incoming connect
OIRQ\$MAX	= D'8		Maximum legal request code
OIRC\$NO	= 0		No event, no recall
OIRC\$RCV	= 1		Message arrival event
OIRC\$SND	= 2		Message sent event
OIRC\$CON	= 4		Connection event
OIRC\$CLS	= D'8		Connection closed event
OIRC\$MAX	= D'15		Maximum recall code value
OIERREQ	= O'1		Invalid request code in F\$IPC request
OIERRCL	= O'2		Invalid recall code in F\$IPC request
OIERERR	= O'3		Uncleared OIBERR field in IPCB
OIERNVO	= O'4		Request not valid on OFFER reference
OIERFTL	= O'77		Highest fatal error code
OIERREF	= O'100		Invalid IPC connection reference
OIERBSY	= O'101		Server busy on connect request
OIERCLS	= O'102		Connection is closed
OIERGON	= O'103		User is gone
OIERNC	= O'104		Too many connections to this server
OIERSNIU	= O'105		Server name already in use (offer)
OIERSNNE	= O'106		Server name not found (connect)
OIERJSQ	= O'107		Handoff target job does not exist
OIERHLT	= O'110		Connection not halted on handoff
OIERSNM	= O'111		Invalid server name
OIERSPL	= O'112		Send parameter block too long
OIERSPA	= O'113		Invalid send parameter block address
OIERRPL	= O'114		Receive parameter block length error *
OIERRPA	= O'115		Invalid receive parameter block addr.
OIERBQ	= O'116		Invalid buffer queue
OIERBQI	= O'117		Invalid queue item in buffer queue
OIERSQ	= O'120		Invalid send queue
OIERSQI	= O'121		Invalid queue item in send queue
OIERRQ	= O'122		Invalid receive queue

OIB SL2 IPC communication block - IPCB

[506]

OIERDLS = 0'123

Halt unable to flush to receive
queue

The IPC connection table describes a connection for data transfer between processes in COS. A process can be either a user task or an STP task. IPC allows communication job-to-job, job-to-STP, or STP-to-STP.

A connection serves two users -- the server and the client, known as the A-side and the B-side of the connection, respectively. During connection establishment, the server makes an OFFER request, giving a well-known server name. The client makes a CONNECT request giving the same name, and IPC software constructs this table to represent the connection. Once the connection is made, there is no further distinction between client and server.

The connection table has a header and two entries, one for each side of the connection. Each entry points to a queue of incoming messages and a queue of buffers supplied by the user for incoming data.

An OFFER is a special case of an ICB, like a one-sided one without queues. It has a header, one entry and one parameter block buffer.

The ICB contains an ACB (Activity Control Block - see COMOE). Each ICB has an entry in the GAL (Global Activity List) which is used to find it in memory. Each user is given a connection reference number which contains the GAL index for the ICB.

Lengths of various ICB components:

NE@ICBQ	=	D'18	Number of entries in ICB queues
NE@OICNQ	=	4	Max number of connects to queue
NE@OICME	=	2	Max queue space resv'd for expedited
L@OIBUF	=	D'1024	Length of IPC intermediate buffer
L@ICBBQI	=	3	Length of buffer queue item
L@ICBQI	=	6	QI length for send & receive queues
L@ICBPB	=	I@OIPBMX	Parameter block length
L@OIEDMX	=	D'32	Maximum expedited data length
L@ICBBQ	=	L@ICBBQI*NE@ICBQ+LH@OEQ	Buffer queue size
L@ICBRQ	=	L@ICBQI*NE@ICBQ+LH@OEQ	Receive queue size

References are a composite of the index of the GAL (Global Activity List - see COMOE) entry that points to the ICB, the sequence number in the GAL entry, and a bit to distinguish between the A and B sides:

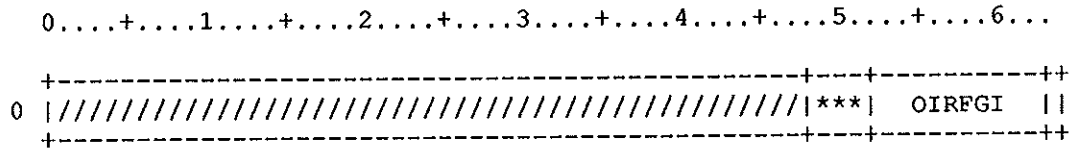

Figure OIC-2. SL2 IPC reference number

<u>Field</u>	<u>Word(base8)</u>	<u>Bits</u>	<u>Description</u>
OIRFSQ	0	48-51	Sequence number part
OIRFGI	0	52-62	GAL-index part
OIRFAB	0	63	A/B side designator

0....+....1....+....2....+....3....+....4....+....5....+....6...

0	TID	VJS	JSQ	REF
1	FLG	REA	EVT	PBL
2		PBA		
3	ICB		OS	
4		BQA		
5		RQA		
6		EPW		
7	JXT		TXT	
10		FBQ		
11		FSQ		
12		FRQ		
13		FIC		
14		AMX		
15		DQI		
16				
17				
20		AQI		
21				
22				

Figure OIC-3. SL2 IPC connection table entry

<u>Field</u>	<u>Word(base8)</u>	<u>Bits</u>	<u>Description</u>
OICTID	0	0-15	Task ID if owned by STP task
OICVJS	0	16-31	JSQ of allowed connect
OICJSQ	0	32-47	JSQ of owner if job-owned
OICREF	0	48-63	This side's reference number
OICFLG	1	0-15	Flags field:
OICCL	1	0	1 if closed from this side
OICHLT	1	1	1 if connection halted by user
OICAQR	1	2	1 if AQI is ready to deliver
OICDQE	1	3	1 if DQI is completely emptied
OICSRT	1	4	1 if ICB queue is sorted
OICLOK	SUBFIELD 5,1		ICB queue lock (set by IADV)
OICREA	1	16-31	Close reason code (OIERxx)
OICEVT	1	32-39	Pending event flags
OICPBL	1	40-63	Parameter block length
OICPBA	2	0-63	Parameter block address
OICICB	3	0-31	ICB header address
OICOS	3	32-63	Other side's ICB entry address
OICBQA	4	0-63	Buffer queue address
OICRQA	5	0-63	Receive queue address
OICEPW	6	0-63	Event parameter word
OICJXT	7	0-31	JXT address if owner is a job
OICTXT	7	32-63	TXT address if owner is a job
OICFBQ	10	0-63	Address of buffer queue in user field
OICFSQ	11	0-63	Address of send queue in user field
OICFRQ	12	0-63	Address of receive queue in user field
OICFIC	13	0-63	Address of IPCB in user field
OICAMX	14	0-63	Max size of current assembly buffer
OICDQI	15-17	0-63	
OICDQI	15-17	0-63	(Required by table diagram generator)
OICAQI	20-22	0-63	

Field Word(base8) Bits Description

OICAQI 20-22 0-63 (Required by table diagram generator)

L@OFRICB = LH@ICB+LE@ICB+L@ICBPB OFFER ICB size

L@CONICB = LH@ICB+2*LE@ICB+2*L@ICBBQ+2*L@ICBRQ+2*L@ICBPB

A queue item is a table that can be placed on a queue. Queues (prefix OEQ) are defined in comdeck COMOE. It describes a string of data bytes in a buffer. All queue items begin with a three-word header. They can be larger according to the maximum length of an expedited message (a three-word queue item allows for up to eight bytes of expedited data). All queue items on a queue are the same size, fixed by the OEQLE field in the queue header.

Queue items have two formats: buffer and direct. In buffer format, the queue item points to a buffer which contains data. In direct format, the queue item itself contains a small amount of data starting in the third word.

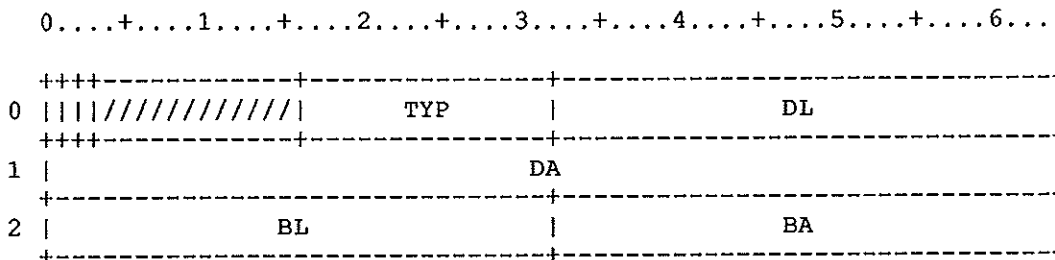

Figure OII-1. Queue item header, buffer format

OIIF 0 0 Format identifier (1 = buffer format)

Field	Word(base8)	Bits	Description
OIIEOT	0	1	End of data unit flag
OIIED	0	2	Expedited data flag
OIITYP	0	16-31	Message type
OIIDL	0	32-63	Data length in bytes
OIIDA	1	0-63	Start address of data (char pointer)
OIIB	1	0-2	Byte offset part of address
OIIW	1	3-63	Word address
OIIBL	2	0-31	Buffer length in words
OIIBA	2	32-63	Buffer address

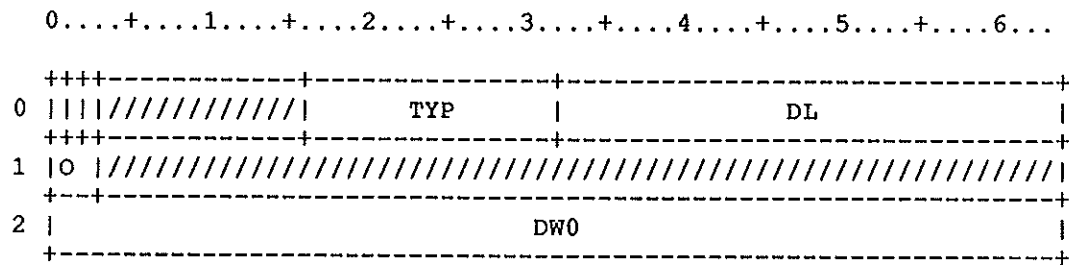

Figure OII-2. Queue item header, direct format

OIIF 0 0 Format identifier (0 = direct format)

Field	Word(base8)	Bits	Description
OIIEOT	0	1	End of data unit flag
OIIED	0	2	Expedited data flag
OIITYP	0	16-31	Message type
OIIDL	0	32-63	Data length in bytes
OIIO	1	0-2	Byte offset to start of data
OIIDW0	2	0-63	First word of data

This queue structure is identical to the SLT environment queue (prefix OEQ) defined in comdeck COMOE. The IPC tables IPCB (in the user field) and ICB (internal to IPC) point to a number of these queues for buffers, send data and receive data. Queues contain queue items (prefix OII, defined above) in a circular-list format.

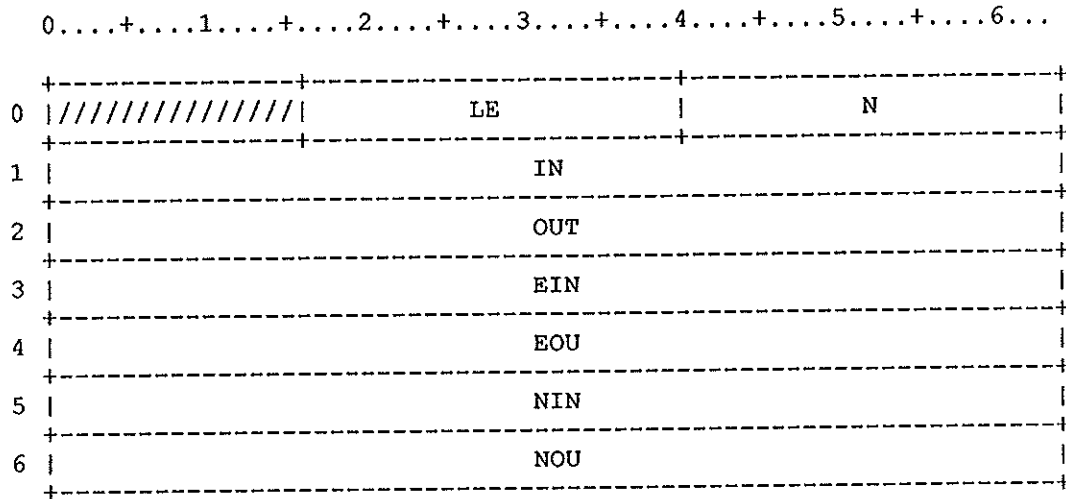

Figure OIQ-1. SL2 IPC queue header

Field	Word(base8)	Bits	Description
OIQLE	0	16-39	Length of an entry
OIQN	0	40-63	Queue size (number of entries)
OIQIN	1	0-63	Word offset of next free entry
OIQOUT	2	0-63	Word offset of first queue item
OIQEIN	3	0-63	Count of ED's placed in queue
OIQEOU	4	0-63	Count of ED's read from queue
OIQNIN	5	0-63	Count of non-ED's placed in queue
OIQNOU	6	0-63	Count of non-ED's read from queue

The server name table is a list of server names which are reserved for use by the system or privileged jobs. Server names are 1-8 character ASCII strings which identify processes which users can connect to via the Superlink interprocess communication feature.

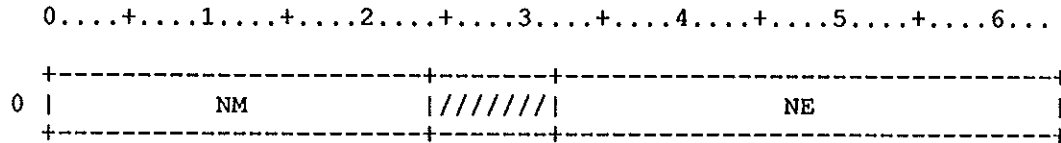

Figure OIS-1. SL2 IPC server name table header

Field	Word(base8)	Bits	Description
OISNM	0	0-23	Table name -- 'OIS' in ASCII
OISNE	0	32-63	Number of entries in table

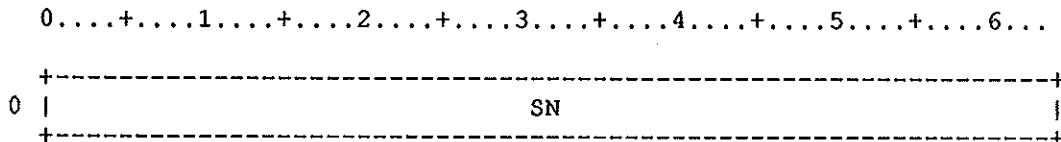

Figure OIS-2. SL2 IPC server name table entry

Field	Word(base8)	Bits	Description
OISSN	0	0-63	Server name, ASCII, UC, LJZF

N O D E F I N I T I O N A V A I L A B L E

Figure NFPK-1.

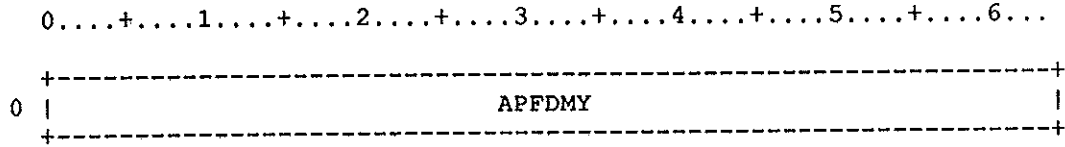

Figure NFPK-2.

<u>Field</u>	<u>Word(base8)</u>	<u>Bits</u>	<u>Description</u>
APFDMY	0	0-63	

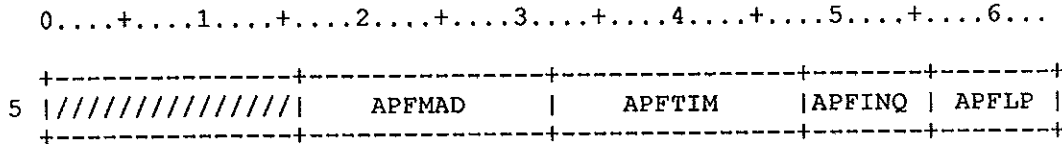

Figure NFPK-3.

<u>Field</u>	<u>Word(base8)</u>	<u>Bits</u>	<u>Description</u>
APFMAD	5	16-31	
APFTIM	5	32-47	NSC HYPERchannel fields
APFINQ	5	48-55	Should be defined in
APFLP	5	56-63	COMAP

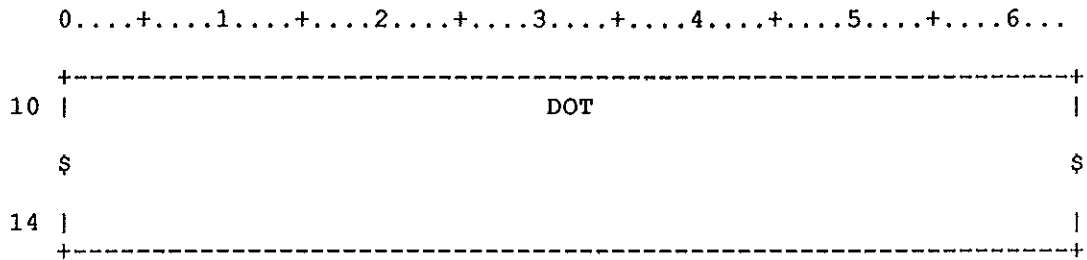

Figure OLA-4. LPT pointer and timers

<u>Field</u>	<u>Word(base8)</u>	<u>Bits</u>	<u>Description</u>
OLADOT	10-14	0-63	Output timer
OLADOT	10-14	0-63	(Required by table diagram generator)

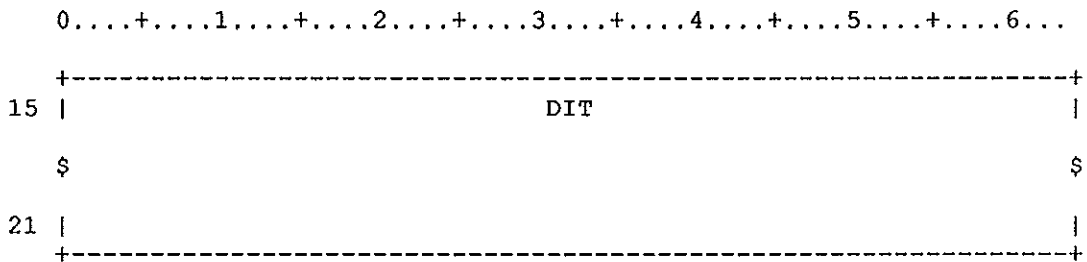

Figure OLA-5. LPT pointer and timers

<u>Field</u>	<u>Word(base8)</u>	<u>Bits</u>	<u>Description</u>
OLADIT	15-21	0-63	Input timer
OLADIT	15-21	0-63	(Required by table diagram generator)

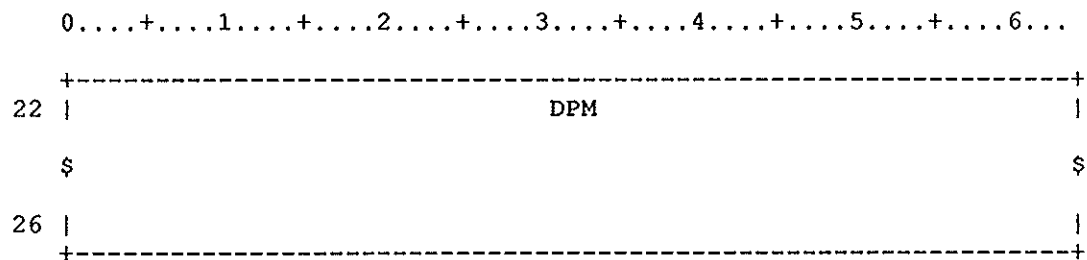

Figure OLA-6. LPT pointer and timers

<u>Field</u>	<u>Word(base8)</u>	<u>Bits</u>	<u>Description</u>
OLADPM	22-26	0-63	Performance monitor
OLADPM	22-26	0-63	(Required by table diagram generator)

N O D E F I N I T I O N A V A I L A B L E

Figure OLL-1. ACB Header part

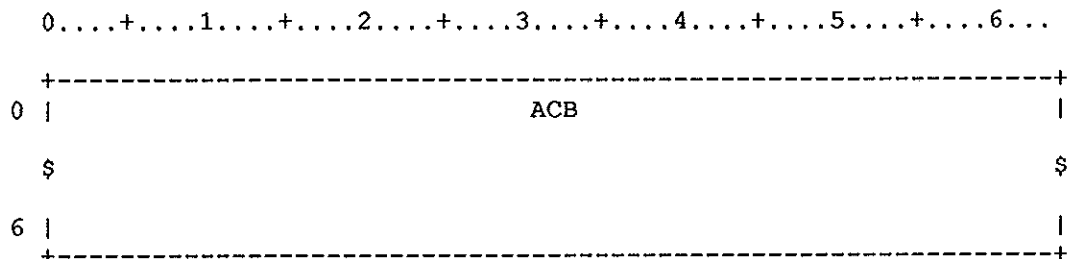

Figure OLL-2. ACB Header part

<u>Field</u>	<u>Word(base8)</u>	<u>Bits</u>	<u>Description</u>
OLLACB	0-6	0-63	ACB Header part
OLLACB	0-6	0-63	(Required by table diagram generator)

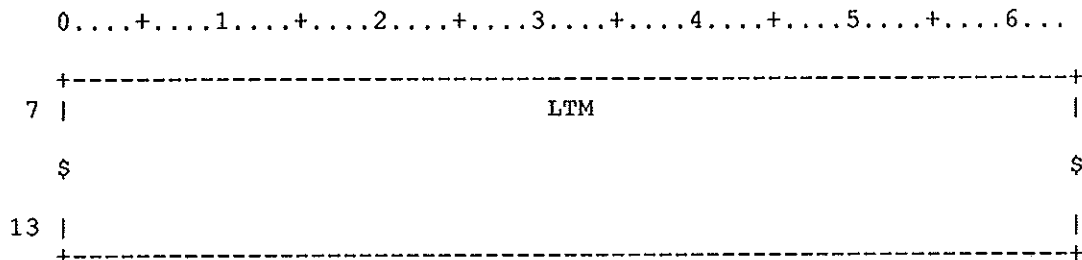

Figure OLL-3. LPT pointer and timers

<u>Field</u>	<u>Word(base8)</u>	<u>Bits</u>	<u>Description</u>
OLLTLM	7-13	0-63	Output timer
OLLTLM	7-13	0-63	(Required by table diagram generator)

The Link Path Table is used by SLT to manage activity on physical links. There is one LPT entry per physical link, i.e. FEI or DSI box or per local adapter on an NSC HYPERchannel trunk.

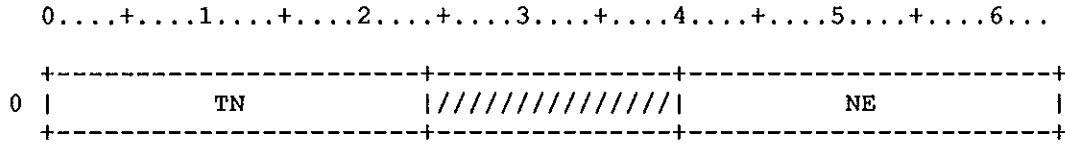

Figure OLP-1. Link Path Table Header

OLPTN 0 0-23 Table name = LPT in ASCII

Field Word(base8) Bits Description

OLPNE 0 40-63 Number of entries

```

0....+....1....+....2....+....3....+....4....+....5....+....6...
+-----+-----+-----+-----+-----+-----+-----+-----+
0 |                                     NAM                                     |////////|
+-----+-----+-----+-----+-----+-----+-----+-----+
1 | ||||| MOD || TYP || POP |*|| NSD |////////|STA|
+-----+-----+-----+-----+-----+-----+-----+-----+
2 |          DNA          |          SNA          | MBL |          QDS          |
+-----+-----+-----+-----+-----+-----+-----+-----+
3 |                                     ORT                                     |
+-----+-----+-----+-----+-----+-----+-----+-----+
4 |                                     IRT                                     |
+-----+-----+-----+-----+-----+-----+-----+-----+
5 |                                     OCP                                     |
+-----+-----+-----+-----+-----+-----+-----+-----+
6 |                                     ICP                                     |
+-----+-----+-----+-----+-----+-----+-----+-----+
7 |                                     MOR                                     |
+-----+-----+-----+-----+-----+-----+-----+-----+
10 |          DLC          |          NBA          |
+-----+-----+-----+-----+-----+-----+-----+-----+
11 |                                     DVN                                     |
+-----+-----+-----+-----+-----+-----+-----+-----+

```

Figure OLP-2. Link Path Table - Link control

Field	Word(base8)	Bits	Description
OLPNAM	0	0-55	Channel name
OLPON	1	0	Channel turned on
OLPCS	1	1	Able to send flag
OLPCR	1	2	Able to receive flag
OLPORO	1	4	Output ready to move to OPEN
OLPIRO	1	5	Input ready to move to OPEN
OLPLBC	1	6	Loopback channel
OLPCHK	1	7	Data checksum required
OLPMOD	1	8-15	Channel operation mode OLMO\$ISM=1 input simplex OLMO\$OSM=2 output simplex OLMO\$HDP=3 half-duplex OLMO\$FDP=4 full duplex
OLPTYP	1	17-24	Channel type OLCT\$FEI=1 FEI OLCT\$DSI=2 DSI OLCT\$NSC=3 NSC HYPERchannel

Field	Word(base8)	Bits	Description
OLPPOP	1	26-33	Population of queued NPDU'S
OLPTDF	1	34-35	Throttle delay flags
OLPOTD	1	34	Override throttle delay
OLPNTD	1	35	Never use throttle delay
OLPNSD	1	38-53	NSC source adapter address
OLPNTA	1	38-45	Local trunk address
OLPNLP	1	46-53	Logical path id
OLPSTA	1	60-63	Link state OLST\$OFF=1 OFF OLST\$CLS=2 CLOSED OLST\$OPN=3 OPEN OLST\$RDY=4 READY
OLPDNA	2	0-15	Destination node name (ASCII)
OLPSNA	2	16-31	Source node name(ASCII)
OLPMBL	2	32-39	Max block factor (if nonzero)
OLPQDS	2	40-63	Queued data size (CRAY words)
OLPORT	3	0-63	Output real time throttle
OLPIRT	4	0-63	Input-expected real time
OLPOCP	5	0-63	Output timer interval (CP'S)
OLPICP	6	0-63	Input timer interval (CP'S)
OLPMOR	7	0-63	Move to OPEN or OFF reason code
OLPMDR	7	0	Direction causing move 0 = Input channel 1 = Output channel
OLPMPO	7	2-9	Population at move
OLPMFC	7	10-18	Last driver function code
OLPMST	7	21-24	Channel state before move
OLPMCS	7	27-33	Channel status code
OLPECA	7	48-63	Error category OLPE\$NT=-1 Normal transition OLPE\$DE=-2 Driver error code returned OLPE\$OF=-3 Channel turned OFF by operator OLPE\$PE=-4 Protocol error OLPE\$IE=-5 Internal Error OLPE\$FP=-6 Error in F-packet OLPE\$WT=-7 Write timeout OLPE\$IU=-D'8 Channel in use by another link

Values -D'128 and more negative are DLC\$XXX codes

OLPDLC	10	0-31	Maximum DLPDU's before M-bit
OLPNBA	10	32-63	Last buffer sent over NSC HYPERchannel
OLPDVN	11	0-63	Driver name in ASCII

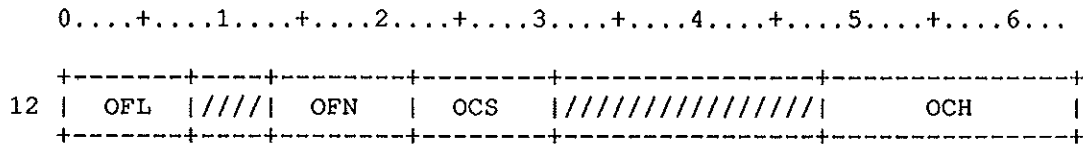

Figure OLP-3. LPT Output channel control

Field	Word(base8)	Bits	Description
OLPOFL	12	0-7	Output flags
OLPOBS	12	0	Driver busy
OLPODN	12	1	Driver done
OLPOOP	12	2	Driver open
OLPOLP	12	3	Logical path assigned
OLPOFB	12	4	F-bit sent with last message
OLPOFN	12	13-21	Driver function code
OLPOCS	12	22-30	Channel status from driver
OLPOCH	12	48-63	Driver channel number

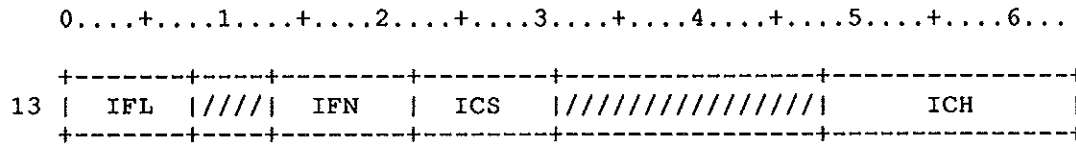

Figure OLP-4. LPT Input channel control

Field	Word(base8)	Bits	Description
OLPIFL	13	0-7	Input flags
OLPIBS	13	0	Driver busy
OLPIDN	13	1	Driver done
OLPIOP	13	2	Driver open
OLPILP	13	3	Logical path assigned
OLPIMB	13	4	M-bit received with last message
OLPIFN	13	13-21	Driver function code
OLPICS	13	22-30	Channel status from driver
OLPICH	13	48-63	Driver channel number

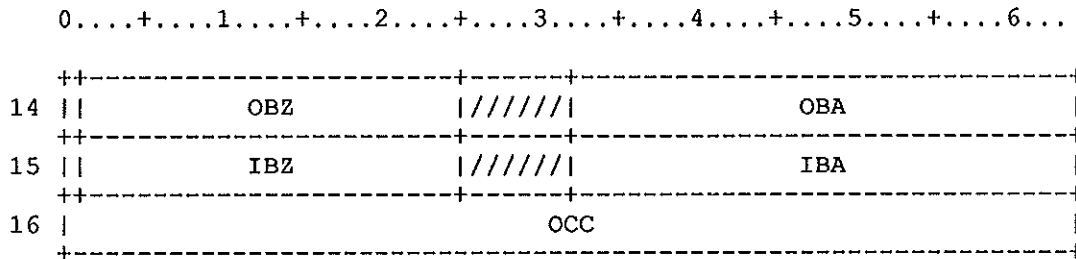

Figure OLP-5. LPT buffer control

Field	Word(base8)	Bits	Description
OLPOBZ	14	1-24	Output link buffer size (Words)
OLPOBA	14	32-63	Output link buffer address
OLPIBZ	15	1-24	Input link buffer size (Words)
OLPIBA	15	32-63	Input link buffer address
OLPOCC	16	0-63	Output DLSDU chain control word

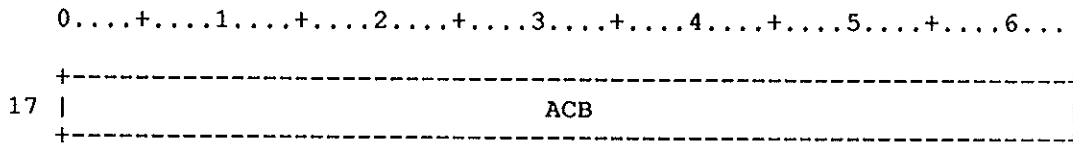

Figure OLP-6. LPT Activity pointer

<u>Field</u>	<u>Word(base8)</u>	<u>Bits</u>	<u>Description</u>
OLPACB	17	0-63	Activity ACB address

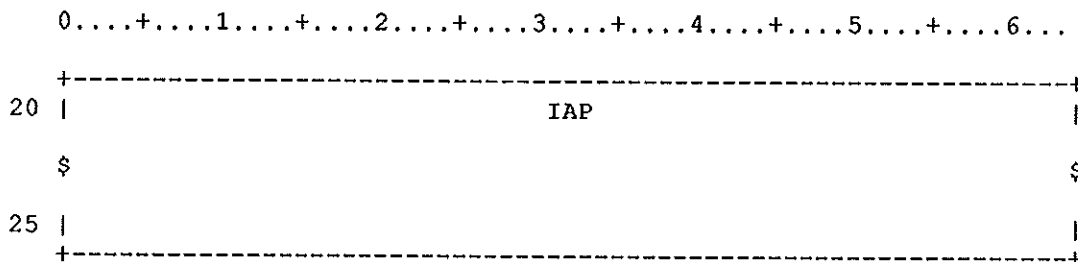

Figure OLP-7. LPT Input channel F-packet buffer

<u>Field</u>	<u>Word(base8)</u>	<u>Bits</u>	<u>Description</u>
OLPIAP	20-25	0-63	Input side F-packet buffer
OLPIAP	20-25	0-63	(Required by table diagram generator)

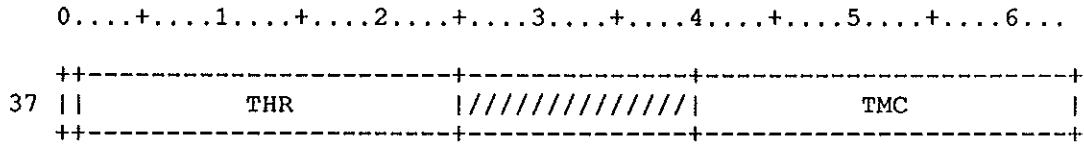

Figure OLP-10. LPT Write Timeout Count

<u>Field</u>	<u>Word(base8)</u>	<u>Bits</u>	<u>Description</u>
OLPTHR	37	1-24	'Buffer full' threshold (words)
OLPTMC	37	40-63	Successive write timeouts

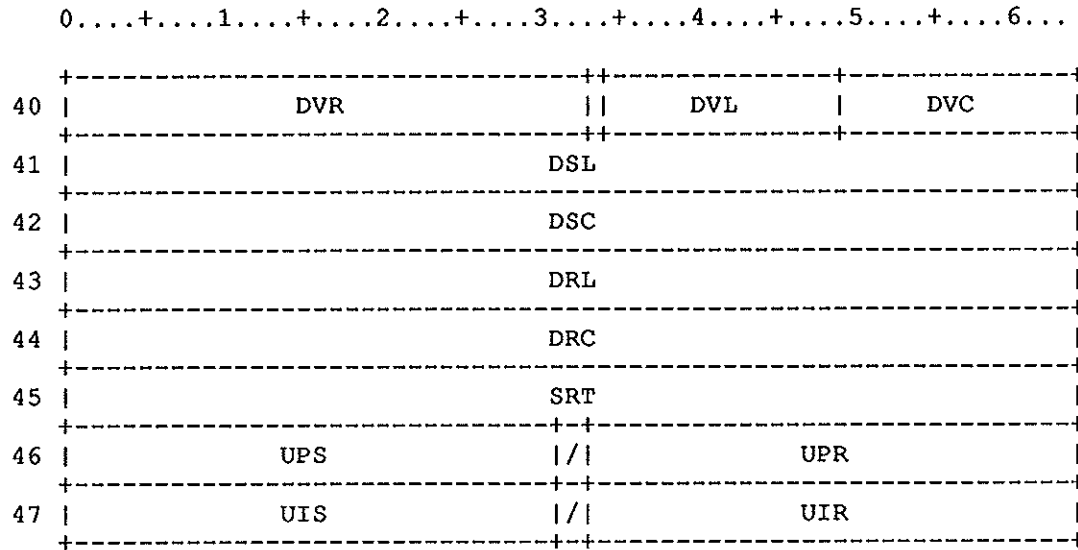

Figure OLP-11. LPT Performance statistics

Field	Word(base8)	Bits	Description
OLPDVR	40	0-32	Number of driver requests
OLPDVL	40	34-48	Driver requests in last second
OLPDVC	40	49-63	Driver requests this second so far
OLPDSL	41	0-63	Data sent in last second
OLPDSC	42	0-63	Data sent this second so far
OLPDRL	43	0-63	Data received in last second
OLPDRC	44	0-63	Data received this second so far
OLPSRT	45	0-63	RT at next second boundary
OLPUPS	46	0-30	UP's sent
OLPUPR	46	33-63	UP's received
OLPUIS	47	0-30	UI's sent
OLPUIR	47	33-63	UI's received

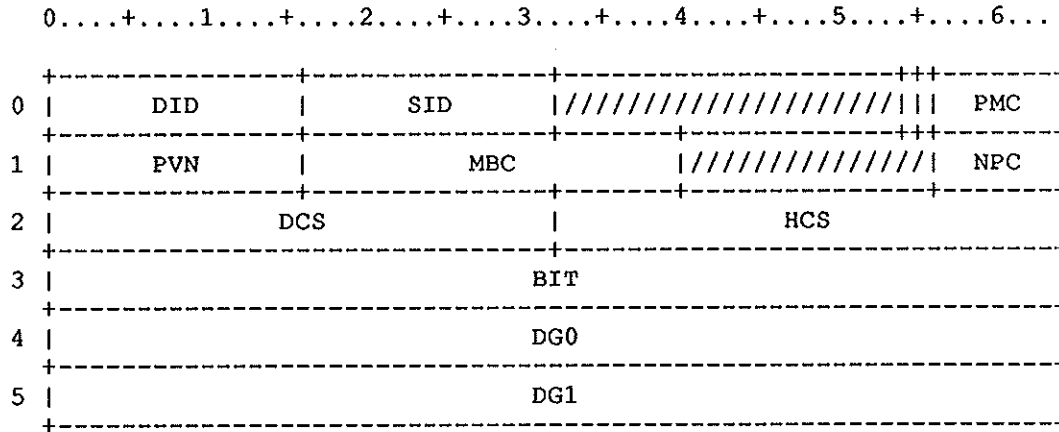

Figure OLH-1. SUPERLINK Link Header

Field	Word(base8)	Bits	Description
OLHDID	0	0-15	Destination node name (ASCII)
OLHSID	0	16-31	Source node name (ASCII)
OLHM	0	54	More data bit
OLHF	0	55	Final bit
OLHPMC	0	56-63	Protocol message code OLHPM\$ID=0 Idle packet OLHPM\$SUP=1 Unnumbered Poll OLHPM\$UI=2 Unnumbered Information
OLHPVN	1	0-15	Protocol version number
OLHMBC	1	16-39	Total message size in bytes
OLHNPC	1	56-63	Number of NPDU's in this DLPDU
OLHDCS	2	0-31	Data checksum (DLPDU less header)
OLHHCS	2	32-63	Header checksum
OLHBIT	3	0-63	Diagnostic bit pattern Value is octal 01111111111106666644444
OLHDG0	4	0-63	Software diagnostic word
OLHDG1	5	0-63	Software diagnostic word

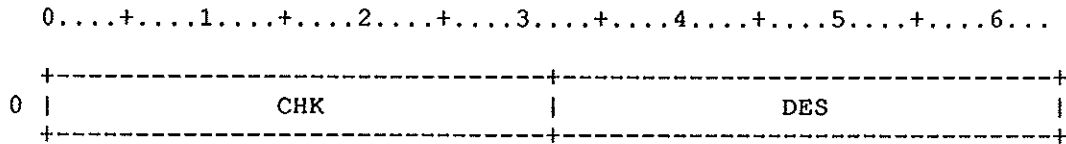

Figure OLS-1. SUPERLINK Link subheader

<u>Field</u>	<u>Word(base8)</u>	<u>Bits</u>	<u>Description</u>
OLSCHK	0	0-31	Checksum field
OLSDES	0	32-63	NPDU descriptor
OLSTPD	0	37-39	Trailing pad size in bytes
OLSNSZ	0	40-63	NPDU size in bytes including pad

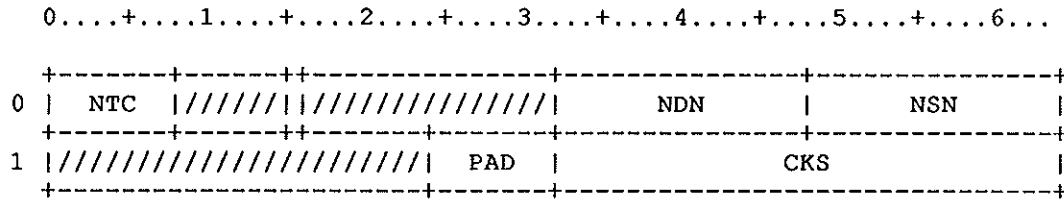

Figure OLM-1. SUPERLINK Message Proper

<u>Field</u>	<u>Word(base8)</u>	<u>Bits</u>	<u>Description</u>
OLMNTC	0	0-7	Network Control (trunks to try)
OLMNAD	0	15	Associated data flag
OLMNDN	0	32-47	Destination adapter address
OLMNSN	0	48-63	Source adapter address
OLMPAD	1	24-31	Trailing pad, in bytes
OLMCKS	1	32-63	Data checksum

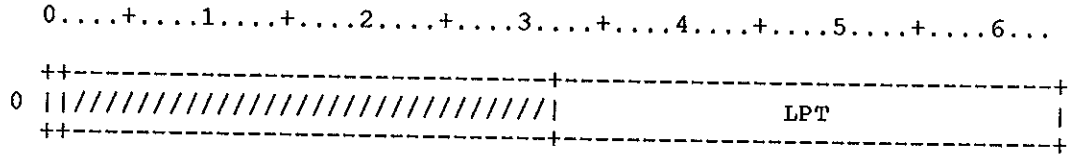

Figure OLF-1. SUPERLINK FCPU word

OLFDIR 0 0 Direction (0 = Input)

<u>Field</u>	<u>Word(base8)</u>	<u>Bits</u>	<u>Description</u>
OLFLPT	0	32-63	LPT address

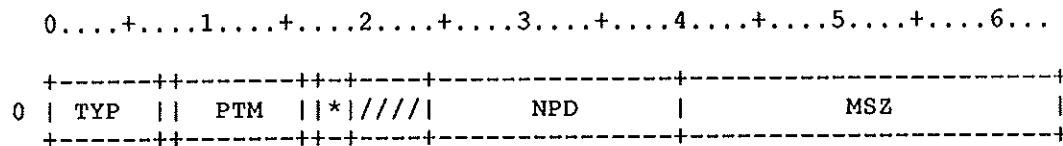

Figure OLZ-1. Link trace - protocol message

Field	Word(base8)	Bits	Description
OLZTYP	0	0-6	Trace type
OLZPTM	0	8-15	Message type
OLZFLG	0	17-18	F and M bits
OLZNPD	0	24-39	Number of NPDU's
OLZMSZ	0	40-63	Message total size

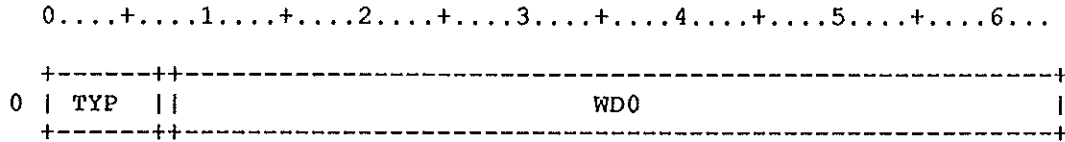

Figure OLZ-2. Link trace - NSC message

Field	Word(base8)	Bits	Description
OLZTYP	0	0-6	Trace type
OLZWDO	0	8-63	NSC protocol header
OLZ\$SUP	= 0'01		Sending UP
OLZ\$SUI	= 0'02		Sending UI
OLZ\$RUX	= 0'03		Received protocol message
OLZ\$SNM	= 0'04		Sending NSC message
OLZ\$RNM	= 0'05		Received NSC message
LDA\$SIL	= -1		
LDA\$NRD	= LDA\$SIL-1		
LDA\$BKP	= LDA\$NRD-1		
DLC\$MLE	= -D'128		Message length error
DLC\$HCK	= DLC\$MLE-1		Header checksum fail
DLC\$DCK	= DLC\$HCK-1		Data checksum fail
DLC\$PVN	= DLC\$DCK-1		Protocol version incorrect
DLC\$PMC	= DLC\$PVN-1		Illegal protocol message code
DLC\$NPC	= DLC\$PMC-1		Incorrect number of NPDU's
DLC\$IFB	= DLC\$NPC-1		Illegal use of F-bit
DLC\$NOB	= DLC\$IFB-1		No buffer to deliver NPDU
DLC\$IML	= DLC\$NOB-1		MBC in link header wrong
DLC\$UXN	= DLC\$IML-1		NPDU count not consistent with data
DLC\$LSC	= DLC\$UXN-1		Link subheader checksum failed
DLC\$NTL	= DLC\$LSC-1		NPDU too long for DLPDU
DLC\$TMN	= DLC\$NTL-1		NPDU count larger than number sent
DLC\$NOT	= DLC\$TMN-1		Link trailer missing or incorrect
DLC\$IMB	= DLC\$NOT-1		Illegal use of M-bit
CFN\$DALP	= D'32		NSC Assign logical path
CFN\$DRLP	= D'33		NSC Release logical path
NS\$TMR	= 0'41		Read timeout
NS\$TMW	= 0'43		Write timeout
NS\$NLBR	= 0'45		No read for loopback write
NS\$RAN	= 0'53		Remote adapter not available
OEADLAWK	= D'57		Awaken event
OEADLPMT	= D'58		Performance monitor timer
OEADLOTE	= D'59		Output timer event
OEADLITE	= D'60		Input timer event
OEADLTRN	= D'62		Do transfer request
OEADLDVD	= D'63		Device done event
DL\$PVN	= 1		FEI protocol version 1
NSCMPSZ	= D'8		NSC Message proper size
DL\$QMAX	= 0		Items before backpressure

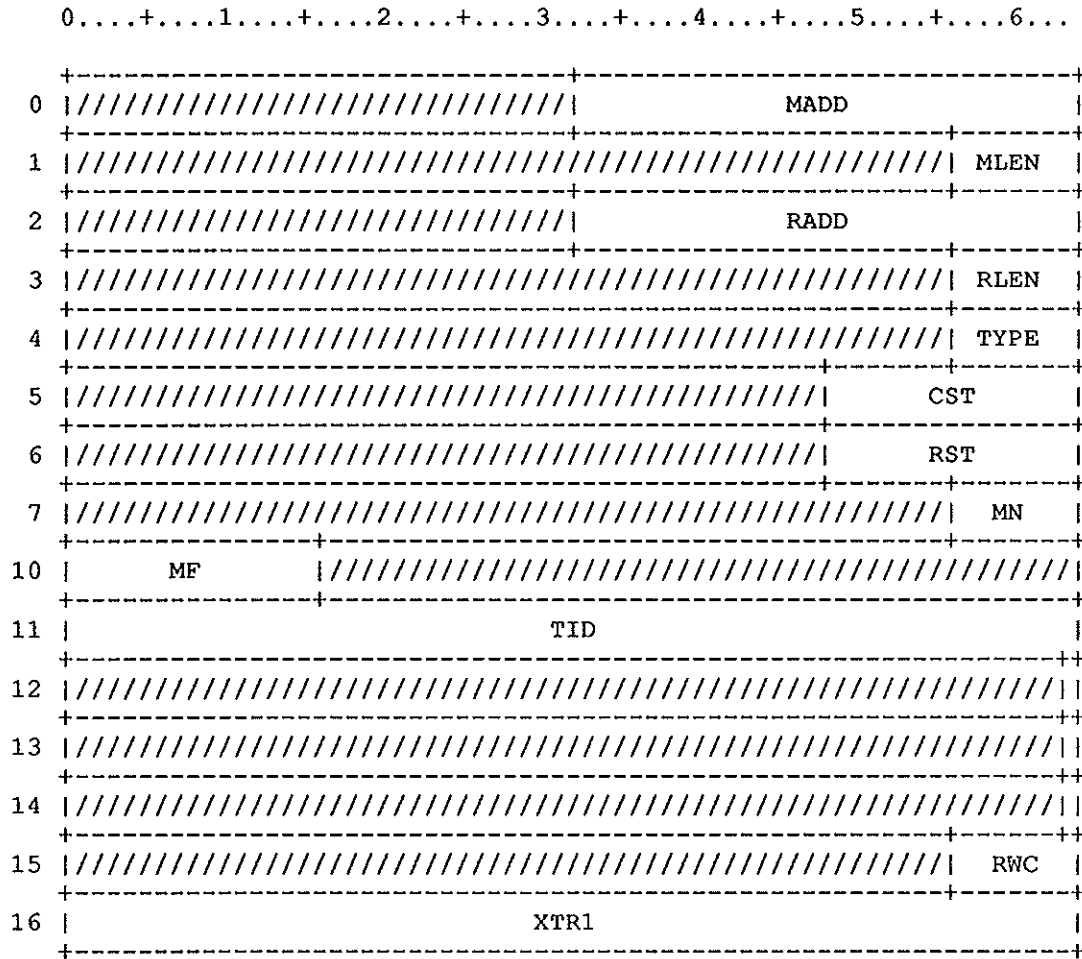

Figure OM-1. F\$OPMSG parameter block

Field	Word(base8)	Bits	Description
OMMADD	0	32-63	Message address
OMMLEN	1	56-63	Message length
OMRADD	2	32-63	Reply address
OMRLEN	3	56-63	Reply length
OMTYPE	4	56-63	Message type
OMCST	5	48-63	Call status
OMRST	6	48-63	Reply status

<u>Field</u>	<u>Word(base8)</u>	<u>Bits</u>	<u>Description</u>
OMMN	7	56-63	Message number
OMMF	10	0-15	Mainframe ID
OMTID	11	0-63	Station TID
OML	12	63	Log flag
OMU	13	63	Urgent request flag
OMW	14	63	Wait for reply flag
OMRWC	15	56-63	Words in reply
OMXTR1	16	0-63	Extra word for future

Functions and constants

OMF\$INF=D'0 STM I message
 OMF\$REP=D'1 STM message
 OMF\$CAN=D'2 CANCEL outstanding STM
 message
 OMF\$UNS=D'3 Setup for UNSOLICITED
 opmsg
 OMF\$MIN=OMF\$INF
 OMF\$MAX=OMF\$UNS

LE@OMSG=D'112 Maximum
 message length

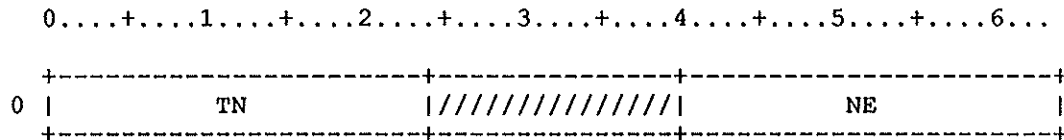

Figure ONR-1. Network Routing Table Header

ONRTN 0 0-23 Name in ASCII = NRT

Field Word(base8) Bits Description

ONRNE 0 40-63 Number of entries

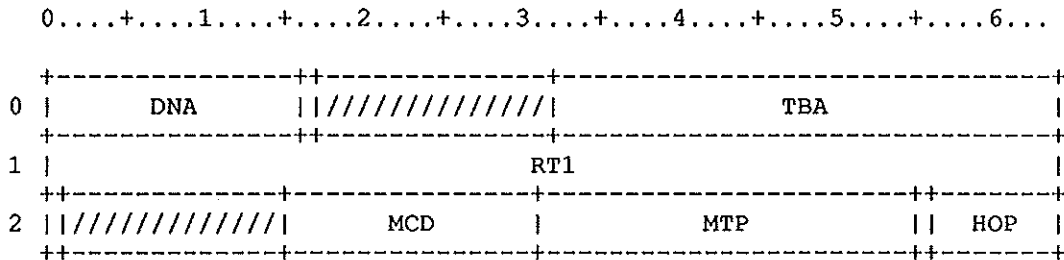

Figure ONR-2. Network Routing Table Entry

Field Word(base8) Bits Description

ONRDNA 0 0-15 Destination node name

ONRREM 0 16 Remote or local flag (0 if local)

ONRTBA 0 32-63 NNT or NAT address

ONRRT1 1 0-63 Retransmission timer

ONREXT 2 0 Use extended format

ONRMCD 2 15-30 Maximum credit to/from node

ONRMTP 2 31-54 Maximum TPDU size for node

ONRHOP 2 56-63 Hop count to destination

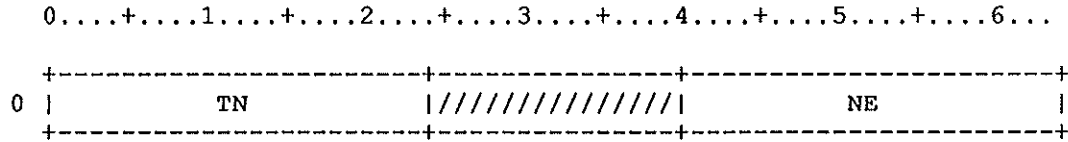

Figure ONN-1. Network Node Table header

Field	Word(base8)	Bits	Description
ONNTN	0	0-23	Table name in ASCII
ONNNE	0	40-63	Number of entries

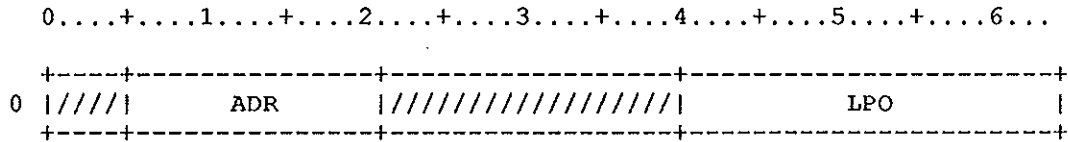

Figure ONN-2. Network Node Table entry

Field	Word(base8)	Bits	Description
ONNADR	0	5-20	NSC HYPERchannel adapter reference
ONNLPO	0	40-63	LPT ordinal

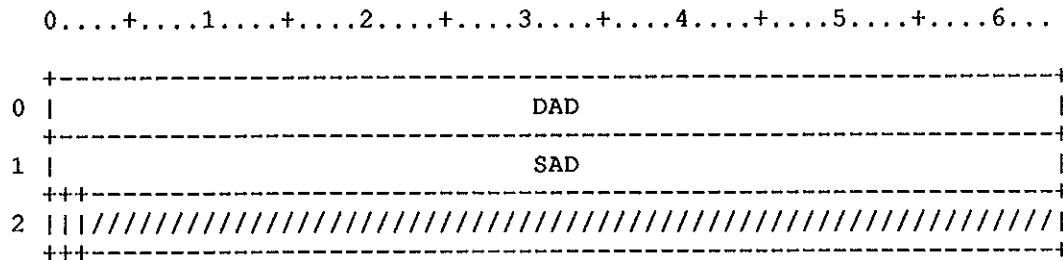

Figure ONB-1. SUPERLINK Network Connection Request Block

Field	Word(base8)	Bits	Description
ONBDAD	0	0-63	Address of called NSAP address
ONBSAD	1	0-63	Address of calling NSAP address
ONBNLT	2	0	No local transmit (when set)
ONBDIA	2	1	Diagnostic connection flag

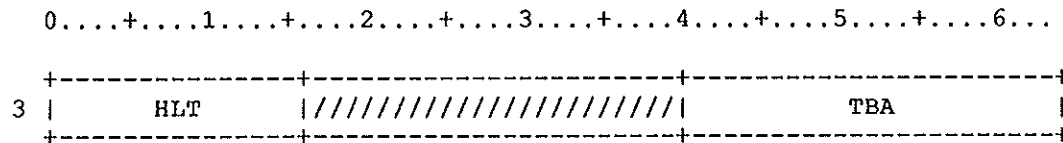

Figure ONB-2. SUPERLINK Network Connection Request Block

Field	Word(base8)	Bits	Description
ONBHLT	3	0-15	Header size (less variable part)
ONBTBA	3	40-63	NNT base or NAT entry address

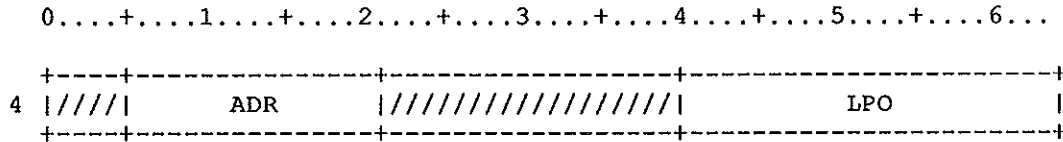

Figure ONB-3. SUPERLINK Network Connection Request Block

<u>Field</u>	<u>Word(base8)</u>	<u>Bits</u>	<u>Description</u>
ONBADR	4	5-20	NSC HYPERchannel adapter reference
ONBLPO	4	40-63	LPT ordinal

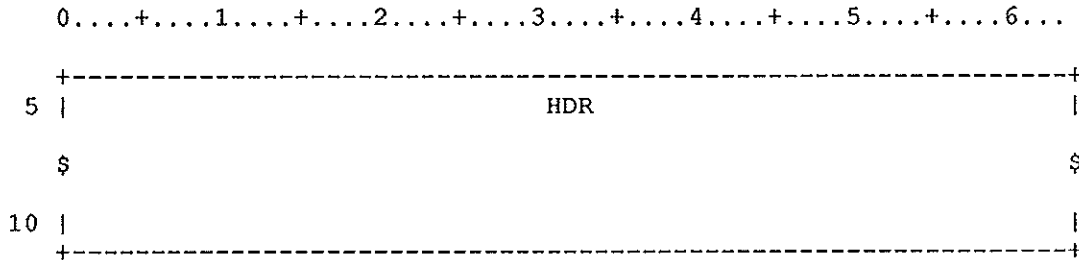

Figure ONB-4. SUPERLINK Network Connection Request Block

<u>Field</u>	<u>Word(base8)</u>	<u>Bits</u>	<u>Description</u>
ONBHDR	5-10	0-63	
ONBHDR	5-10	0-63	(Required by table diagram generator)

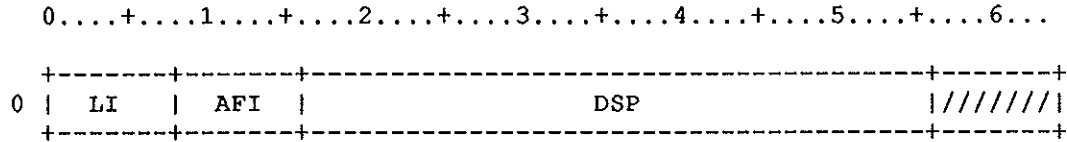

Figure ONW-1. SUPERLINK Network Address

Field	Word(base8)	Bits	Description
ONWLI	0	0-7	Total length of network address
ONWAFI	0	8-15	AFI (Authority and Format ID)
ONWDSP	0	16-55	DSP (Domain Specific part)
ONWOI	0	16-31	Organisation Id
ONWNN	0	32-47	Node Name
ONWNS	0	48-55	NSAP Suffix

NW\$LAFI=X'49 Local AFI
 NW\$SLOR=X'00 SL organisation ID

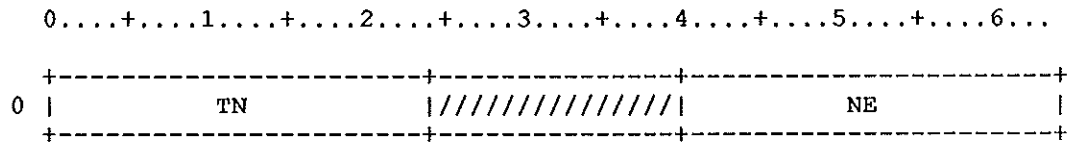

Figure ONA-1. SUPERLINK NSAP Activity Table Header

ONATN 0 0-23 Table name in ASCII = 'NAT'

Field	Word(base8)	Bits	Description
ONANE	0	40-63	Number of entries

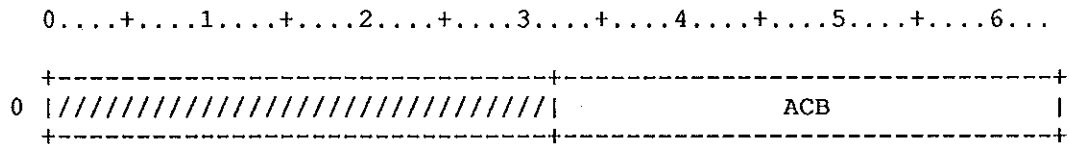

Figure ONA-2. SUPERLINK NSAP Activity Table Entry

Field	Word(base8)	Bits	Description
ONAACB	0	32-63	Owning activity ACB address

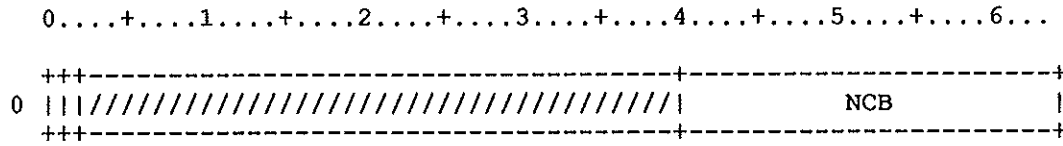

Figure ONC-1. Connection Reference - ONC

<u>Field</u>	<u>Word(base8)</u>	<u>Bits</u>	<u>Description</u>
ONCLR	0	0	Local or Remote flag (0 if local)
ONCDIA	0	1	Diagnostic flag
ONCNCR	0	40-63	NCRB address

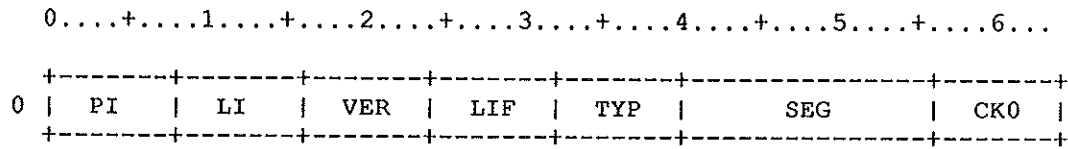

Figure ONH-1. Internet Header format

Field	Word(base8)	Bits	Description
ONHPI	0	0-7	Protocol id
ONHLI	0	8-15	Length of header
ONHVER	0	16-23	Protocol version
ONHLIF	0	24-31	Lifetime
ONHTYP	0	32-39	PDU type
ONHSEG	0	40-55	PDU total size
ONHCK0	0	56-63	Checksum (1st byte(

NDI\$UNA	=	-1	
NDI\$QNAT	=	NDI\$UNA-1	
NDI\$QNAP	=	NDI\$QNAT-1	
NDI\$RNA	=	NDI\$QNAP-1	
NDI\$BKP	=	NDI\$RNA-1	Backpressure
NDI\$AFI	=	NDI\$BKP-1	Illegal AFI
NDI\$ORG	=	NDI\$AFI-1	Illegal ORG Id
NDI\$NLI	=	NDI\$ORG-1	LI with network address incorrect
NHV\$OK	=	0	
NHV\$IPI	=	-1	Incorrect protocol Id
NHV\$IIL	=	-2	Incorrect length indicator
NHV\$IPV	=	-3	Incorrect protocol version
NHV\$IPT	=	-4	Illegal PDU type
NHV\$ICS	=	-5	Incorrect checksum
NHV\$IDN	=	-6	Illegal dest net. address length
NHV\$ISN	=	-7	Illegal source net. address length
NHV\$IPS	=	-D'8	Incorrect PDU size in header
NHV\$CCN	=	-D'9	PDU size from link layer illegal
NHV\$APM	=	-D'10	Address part missing
NHV\$IOP	=	-D'11	Illegal option
NHV\$IPZ	=	-D'12	Header size inconsistent
NHV\$LTE	=	-D'13	Lifetime expired
NH\$PID	=	X'81	Protocol ID
NH\$LIMX	=	D'254	Max length indicator
NH\$PV	=	O'1	Protocol version
NH\$LIFE	=	D'32	Default lifetime
NH\$OLIF	=	D'03	Offset to lifetime field (from 0)
NH\$CHK	=	D'08	Offset to checksum field (from 1)
NH\$DT	=	X'1C	Data NPDU
NH\$ERR	=	X'01	Error PDU
NH\$FSZ	=	D'09	Length of fixed header part
NH\$MASZ	=	D'40	Max network address size
NH\$PAD	=	X'CC	Pad option

This table is passed for an F\$OPT call.

NUMDT = 3 Max number of desired device types

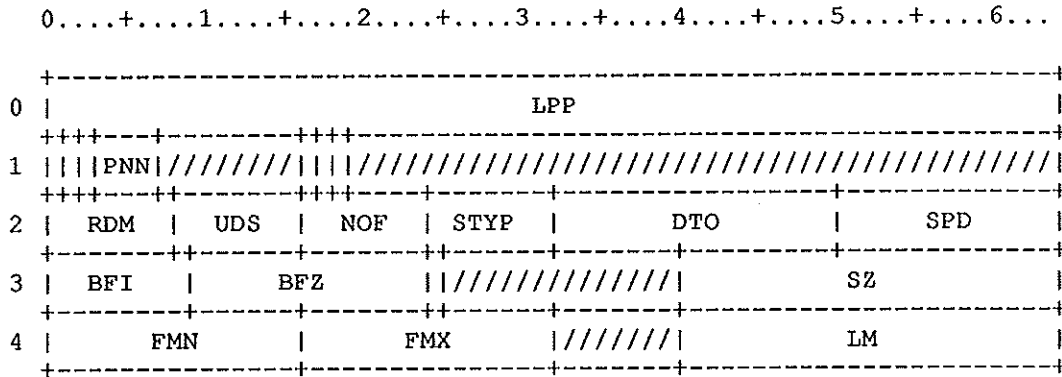

Figure OP-1. Parameter Block for F\$OPT

Field	Word(base8)	Bits	Description
OPLPP	0	0-63	Page length
OPIOON	1	0	Dataset I/O statistics enabled
OPPNCH	1	1	NZ if OPTION,PN selected
OPPNAS	1	2	NZ if PN=n, ZR if PN=ANY
OPPNN	1	3-6	Processor number (if @OPPNAS NZ)
OPIOOF	1	16	Disable I/O statistics
OPOPNN	1	17	Dataset open statistics enabled(=FULL)
OPOPNF	1	18	Disable open statistics
OPRDM	2	0-7	Random dataset flag: 0 Sequential 1 Random
OPUDS	2	8-15	Undefined dataset structure: 0 COS blocked dataset structure 1 Undefined structure
OPNOF	2	16-23	No Overflow flag
OPSTYP	2	24-31	Job Storage type
OPSCR	2	24	Scratch storage space preferred
OPPERM	2	25	Permanent storage space necessary

<u>Field</u>	<u>Word(base8)</u>	<u>Bits</u>	<u>Description</u>
OPDTC	2	32-49	Job Default devices wanted
OPDT1	2	32-37	Desired device type for storage
OPDT2	2	38-43	2nd preferred type for storage
OPDT3	2	44-49	3rd preferred type for storage
OPSPD	2	50-63	Sectors to allocate before switching devices"STRIPING"
OPBFI	3	0-8	BFI initiator
OPBFZ	3	9-23	Buffer size in 512 wrds
OPDFDN	3	24	OPTION statement has a dataset par.
OPSZ	3	40-63	Dataset size in 512-wrd blocks
OPFMN	4	0-15	Transfer minimum
OPFMX	4	16-31	Transfer maximum
OPLM	4	40-63	Dataset size limit in 512-wrd blocks

The Inter-O.S. communication table is the first LE@OS words of each operating system which can be run under the COS guest operating system facility.

It contains fields for passing information between COS and the guest operating system, used to control user and system processes, as well as the passing of I/O Subsystem packets.

The fields OSXDMP and OSMSG point to space for an exchange package and a stop message which will be written by EXEC if the guest O.S. is stopped.

0.....+.....1.....+.....2.....+.....3.....+.....4.....+.....5.....+.....6...

0	ADDR
1	COML
2	NAME
3	PWSF
4	PWSE
5	PWSL
6	CPUN
7	CIUS
10	MSIZ
11	IFLG
12	INIT
13	PARK
14	CAVL
15	CHAN
16	XDMP
17	MSG
20	GPI

Figure OS-1. Inter-operating system communication table

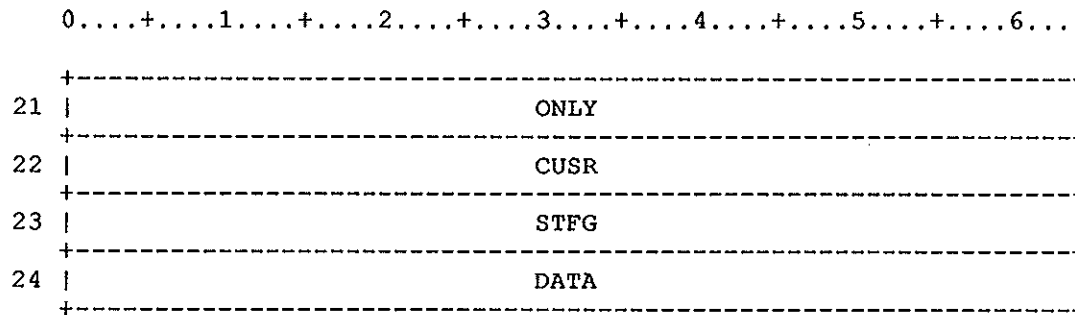

Figure OS-1. Inter-operating system communication table

Field	Word(base8)	Bits	Description
OSADDR	0	0-63	Origin of table as known by guest O.S.
OSCOML	1	0-63	LE@OS as known by the guest O.S.
OSNAME	2	0-63	Operating system name, LJZF
OSPWSF	3	0-63	FWA of configured GOS PWS
OSPWSE	4	0-63	Length of one CPU entry in GOS PWS
OSPWSL	5	0-63	Length of configured GOS PWS
OSCPUN	6	0-63	Address of # of CPUs configured
OSCLUS	7	0-63	Address of # of clusters configured
OSMSIZ	10	0-63	Address of GOS configured memory size
OSIFLG	11	0-63	Address of GOS pseudo-interrupt mask
OSINIT	12	0-63	Entry point address for master CPU
OSPARK	13	0-63	Entry point address for non-master CPU
OSCAVL	14	0-63	Address of GOS available cluster mask
OSCHAN	15	0-63	Address of GOS low speed channel table
OSXDMP	16	0-63	Offset of stop XP dump area
OSMSG	17	0-63	Address of 9-word stop message
OSGPI	20	0-63	COS pseudo-interrupt table pointer
OSONLY	21	0-63	Address of mask of GOS-only channels
OSCUR	22	0-63	COS user work available pointer addr
OSSTFG	23	0-63	CPU forced-return flag address

<u>Field</u>	<u>Word(base8)</u>	<u>Bits</u>	<u>Description</u>
OSDATA	24	0-63	Pointer to data structure within EXEC
L@NWA	= D'4		Maximum network address size (words)
L@TSAP	= D'5		TSAP-ID size (words)
L@TST	= D'15		Statistics block size
L@QIST	= D'6		Length of session/transport QI

The TPDU Disassembly block is used to receive the results of TPDU analysis.

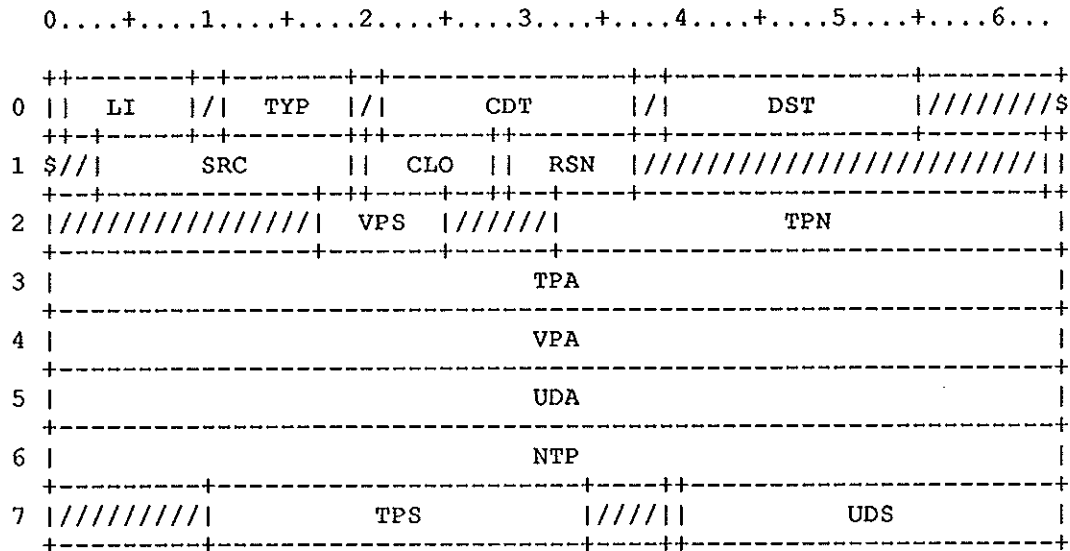

Figure OTD-1. TPDU Disassembly block

Field	Word(base8)	Bits	Description
OTDUDP	0	0	User data may be present if set
OTDLI	0	1-8	LI from header
OTDTYP	0	11-18	PDU type code
OTDCDT	0	21-36	Credit
OTDDST	0	39-54	DST-REF
OTDSRC	1	3-18	SRC-REF
OTDCLO	1	20-27	Class option
OTDRSN	1	29-36	DR/ER Reason code
OTDEOT	1	63	EOT flag
OTDVPS	2	17-24	Variable part size
OTDTPN	2	32-63	TPDU-NR
OTDTPA	3	0-63	This TPDU start address
OTDVPA	4	0-63	Variable part address

<u>Field</u>	<u>Word(base8)</u>	<u>Bits</u>	<u>Description</u>
OTDUDA	5	0-63	User data address
OTDNTP	6	0-63	Next TPDU address
OTDTPS	7	10-33	This TPDU total size
OTDUDV	7	39	User data is present
OTDUDS	7	40-63	User data size

The transport DEMUX activity is represented by this ACB. There is one DEMUX per local instance of the transport service.

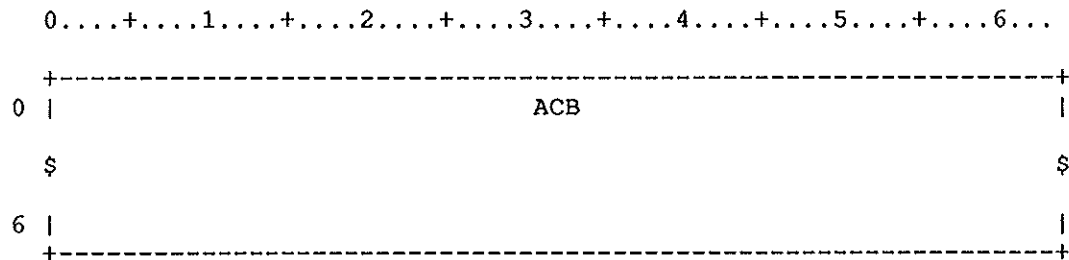

Figure OTX-1. Demultiplexer ACB

Field	Word(base8)	Bits	Description
OTXACB	0-6	0-63	OEA header
OTXACB	0-6	0-63	(Required by table diagram generator)

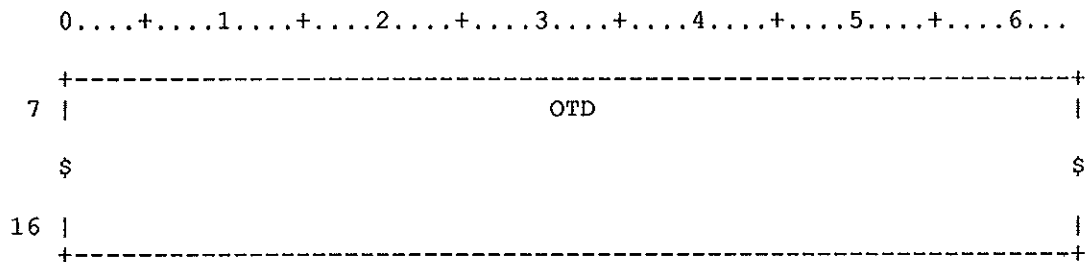

Figure OTX-2. Demultiplexer ACB

Field	Word(base8)	Bits	Description
OTXOTD	7-16	0-63	Inline OTD
OTXOTD	7-16	0-63	(Required by table diagram generator)

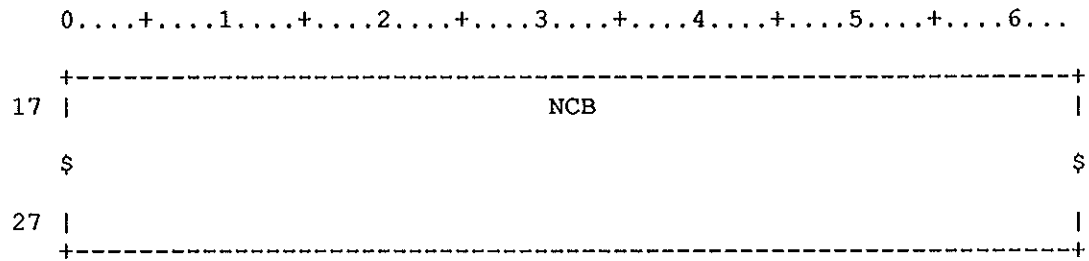

Figure OTX-3. Demultiplexer ACB

<u>Field</u>	<u>Word(base8)</u>	<u>Bits</u>	<u>Description</u>
OTXNCB	17-27	0-63	Inline NCRB
OTXNCB	17-27	0-63	(Required by table diagram generator)

The multiplexer combines TPDU's for the same remote transport service provider.

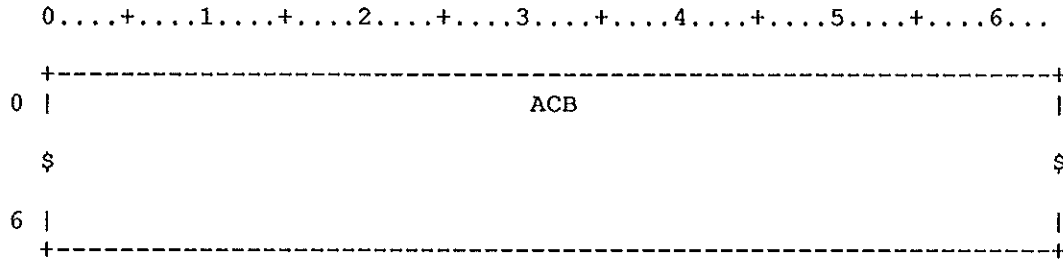

Figure OTM-1. Multiplexer ACB

Field	Word(base8)	Bits	Description
OTMACB	0-6	0-63	OEA header
OTMACB	0-6	0-63	(Required by table diagram generator)

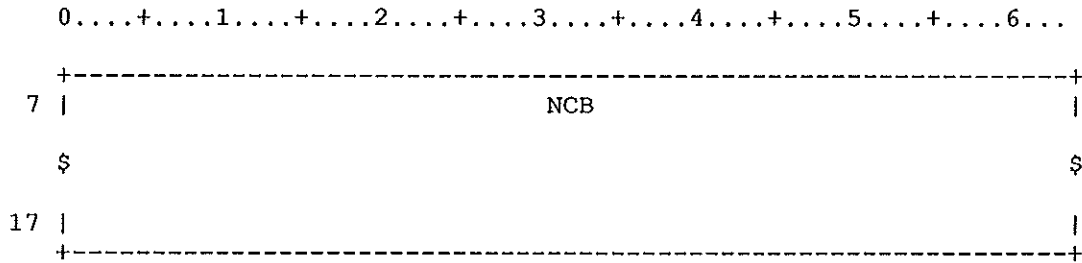

Figure OTM-2. Multiplexer ACB

Field	Word(base8)	Bits	Description
OTMNCB	7-17	0-63	Inline NCRB
OTMNCB	7-17	0-63	(Required by table diagram generator)

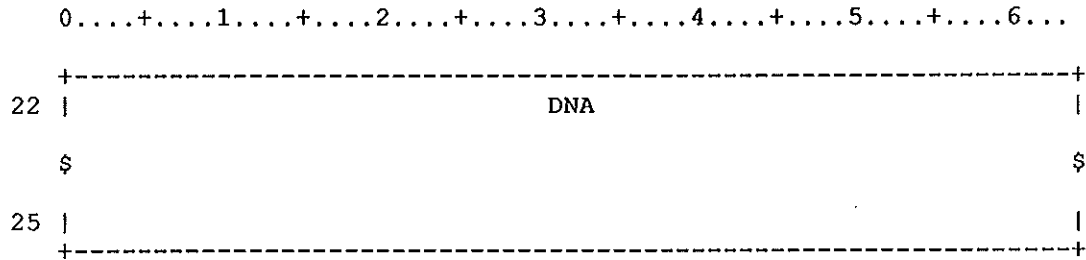

Figure OTM-3. Multiplexer ACB

Field	Word(base8)	Bits	Description
OTMDNA	22-25	0-63	Destination network address
OTMDNA	22-25	0-63	(Required by table diagram generator)

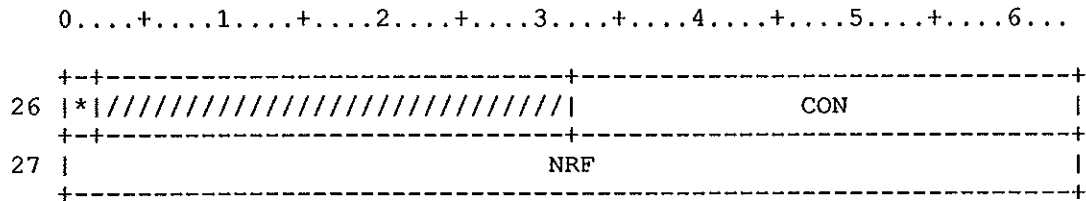

Figure OTM-4. Multiplexer ACB

Field	Word(base8)	Bits	Description
OTMTYP	26	0-1	MUX type
OTMDIA	26	0	Diagnostic (unshareable) MUX flag
OTMNLT	26	1	No local transmit
OTMCON	26	32-63	Active connections
OTMNRF	27	0-63	Network route reference

The flow control confirmation parameter is sent under certain circumstances in an AK TPDU.

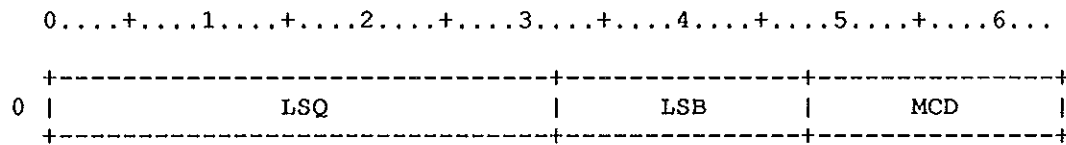

Figure OTF-1. Flow control confirmation parameter

Field	Word(base8)	Bits	Description
OTFLSQ	0	0-31	LAST-AK-SEQ-R
OTFLSB	0	32-47	LAST-AK-SUB-R
OTFMCD	0	48-63	MY-CDT

Each end of each transport connection is represented by a handler activity. The handler communicates with its peer through the network layer and with the session layer through IPC.

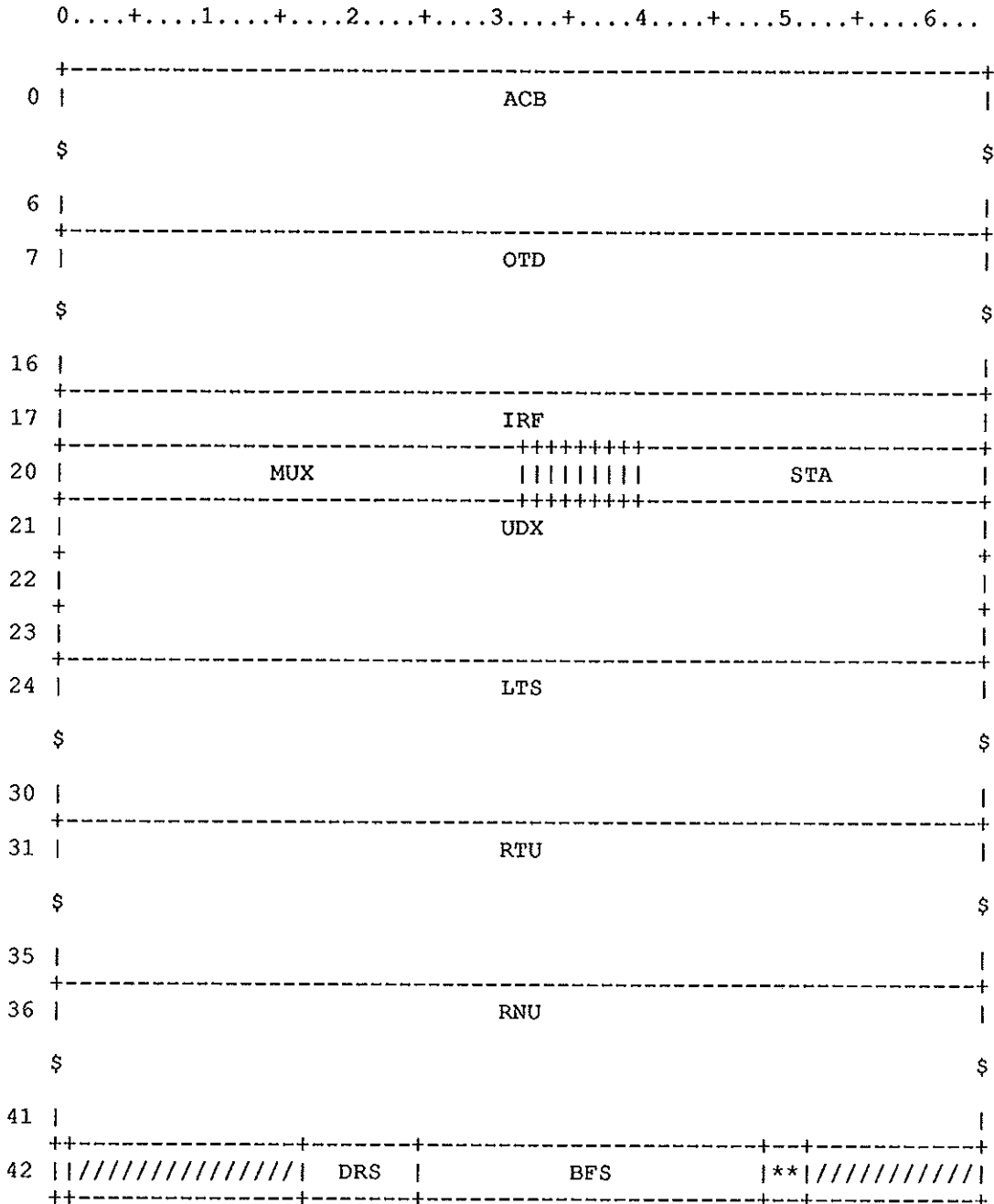

Figure OTH-1. Handler ACB

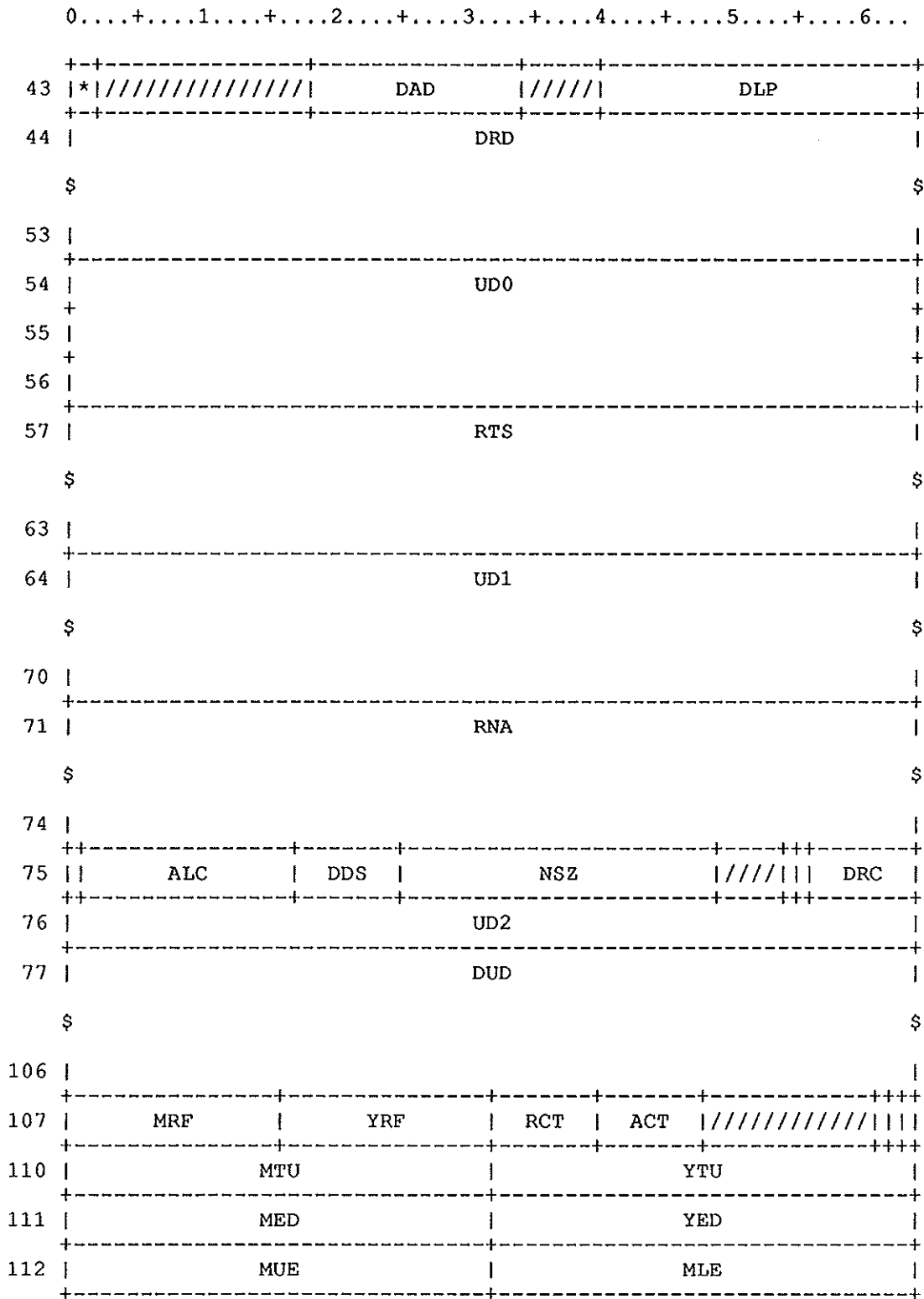

Figure OTH-1. Handler ACB

0....+....1....+....2....+....3....+....4....+....5....+....6....

113		YUE		YLE	
114		MUR		YKU	
115		YCD		MCD	
116		ABR		ABS	
117		AQR		AQS	
120		PCL ///		LCS	
121				HLS	
122				ELS	
123				OLS	
124				ILS	
125				RLS	
126				SVP	
127				AKT	
	\$				\$
133					
134				RTT	
	\$				\$
140					
141				INT	
	\$				\$
145					
146				FRT	
	\$				\$
152					

Figure OTH-1. Handler ACB

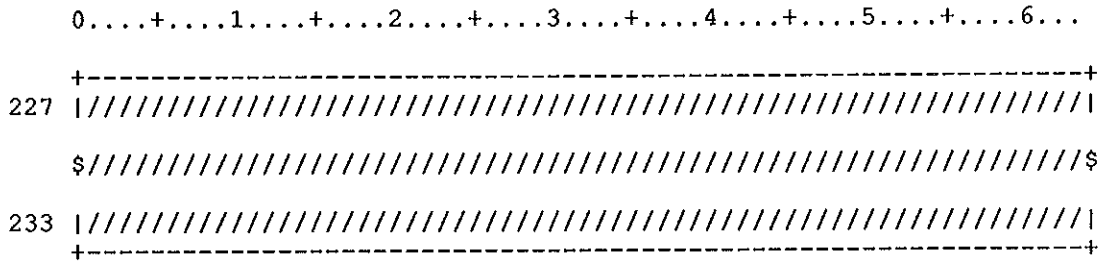

Figure OTH-1. Handler ACB

Field	Word(base8)	Bits	Description
OTHACB	0-6	0-63	OEA header
OTHACB	0-6	0-63	(Required by table diagram generator)
OTHOTD	7-16	0-63	Inline OTD
OTHOTD	7-16	0-63	(Required by table diagram generator)
OTHIRF	17	0-63	I-REF
OTHMUX	20	0-31	MUX activity address
OTHDES	20	33	Destroy activity flag
OTHDIS	20	34	Connection released
OTHDRR	20	35	DR has been received
OTHRST	20	36	SL2 TPDU size received (boolean)
OTHNRC	20	37	Revise peer credit
OTHCLS	20	38	Client (0) or server (1)
OTHBSH	20	39	Buffer shortage notified (1)
OTHSTA	20	40-63	ASCII state (3 characters)
OTHUDX	21-23	0-63	Undefined content
OTHUDX	21-23	0-63	(Required by table diagram generator)
OTHLTS	24-30	0-63	Local TSAP-ID including LI
OTHLTS	24-30	0-63	(Required by table diagram generator)
OTHRTU	31-35	0-63	Remote TSAP-ID including LI
OTHRTU	31-35	0-63	(Required by table diagram generator)
OTHRNU	36-41	0-63	Remote network address including LI

<u>Field</u>	<u>Word(base8)</u>	<u>Bits</u>	<u>Description</u>
OTHRNU	36-41	0-63	(Required by table diagram generator)
OTHEDU	42	0	Expedited data option
OTHDRS	42	17-24	Outbound DR data size (bytes)
OTHBFS	42	25-48	TS-user inbound buffer size
OTHTPL	42	49-51	Throughput level
OTH TYP	43	0-1	Handler type
OTHDIA	43	0	Diagnostic
OTHNLT	43	1	No local transmit
OTHDAD	43	18-33	Diagnostic NSC adapter address
OTHDLP	43	40-63	Diagnostic LPT ordinal
OTHDRD	44-53	0-63	DR user data
OTHDRD	44-53	0-63	(Required by table diagram generator)
OTHUD0	54-56	0-63	Undefined content
OTHUD0	54-56	0-63	(Required by table diagram generator)
OTHRTS	57-63	0-63	Remote TSAP-ID including LI
OTHRTS	57-63	0-63	(Required by table diagram generator)
OTHUD1	64-70	0-63	Undefined content
OTHUD1	64-70	0-63	(Required by table diagram generator)
OTHRNA	71-74	0-63	Remote network address including LI
OTHRNA	71-74	0-63	(Required by table diagram generator)
OTHEDO	75	0	Expedited data option
OTHALC	75	1-16	Allocated credit
OTHDDS	75	17-24	Size of user data on disconnect ind
OTHNSZ	75	25-48	Max permitted TIDU size in bytes
OTHLTD	75	54	Disconnect was from local provider
OTHDRP	75	55	Persisent reason for disconnect
OTHDRC	75	56-63	Disconnect reason code
OTHUD2	76	0-63	Undefined content

<u>Field</u>	<u>Word(base8)</u>	<u>Bits</u>	<u>Description</u>
OTHDUD	77-106	0-63	DR user data
OTHDUD	77-106	0-63	(Required by table diagram generator)
OTHMRF	107	0-15	MY-REF
OTHYRF	107	16-31	YR-REF
OTHRCT	107	32-39	R-COUNT
OTHACT	107	40-47	A-COUNT
OTHTDT	107	61	Time to deliver DT's to user
OTHBOF	107	62	BACKOFF-FLAG
OTHUWS	107	63	UWE-REDUCED-S
OTHMTU	110	0-31	MY-TU-NR
OTHYTU	110	32-63	YR-TU-NR
OTHMED	111	0-31	MY-ED-NR
OTHYED	111	32-63	YR-ED-NR
OTHMUE	112	0-31	MY-UWE
OTHMLE	112	32-63	MY-LWE
OTHYUE	113	0-31	YR-UWE
OTHYLE	113	32-63	YR-LWE
OTHMUR	114	0-31	MY-UWE-REDUCED
OTHYKU	114	32-63	YR-KUWE
OTHYCD	115	0-31	YR-CDT
OTHMCD	115	32-63	MY-CDT
OTHABR	116	0-31	LAST-AK-SUB-R
OTHABS	116	32-63	LAST-AK-SUB-S
OTHAQR	117	0-31	LAST-AK-SEQ-R
OTHAQS	117	32-63	LAST-AK-SEQ-S
OTHPCL	120	0-3	Protocol class in use
OTHLCS	120	8-39	Last credit sent to peer

<u>Field</u>	<u>Word(base8)</u>	<u>Bits</u>	<u>Description</u>
OTHCKS	120	62	Checksum in use (when 1)
OTHEXT	120	63	Extended format in use
OTHHLS	121	0-63	H-LIST (CCW)
OTHEL5	122	0-63	ED-LIST (CCW)
OTHOLS	123	0-63	REORDER-LIST (CCW)
OTHILS	124	0-63	INORDER-LIST (CCW)
OTHRLS	125	0-63	R-LIST (CCW)
OTHSVP	126	0-63	Saved TPDU (CR/DR/CC etc)
OTHAKT	127-133	0-63	Acknowledgement timer
OTHAKT	127-133	0-63	(Required by table diagram generator)
OTHRTT	134-140	0-63	Retransmission timer
OTHRTT	134-140	0-63	(Required by table diagram generator)
OTHINT	141-145	0-63	Inactivity timer
OTHINT	141-145	0-63	(Required by table diagram generator)
OTHFRT	146-152	0-63	Frozen reference timer
OTHFRT	146-152	0-63	(Required by table diagram generator)
OTHUTQ	153-160	0-63	User->transport QI
OTHUTQ	153-160	0-63	(Required for table diagram generator)
OTHUQ	161-166	0-63	Transport->user QI
OTHUQ	161-166	0-63	(Required for table diagram generator)
OTHCRR	167	0	CR TPDU received
OTHDLU	167	1	DR pending is from TDISreq
OTHFCV	167	2	FCCP present in last received AK
OTHCKA	167	32-63	Address of checksum parameter
OTHASB	170	0-15	Subsequence of last AK
OTHBFA	170	32-63	Address of buffer holding TPDU
OTHALW	171	0-31	LWE from FCCP in AK

<u>Field</u>	<u>Word(base8)</u>	<u>Bits</u>	<u>Description</u>
OTHAYS	171	32-47	Subsequence from FCCP in AK
OTHAYC	171	48-63	YR-CDT from FCCP in AK
OTHTSZ	172	0-31	Maximum TPDU size in bytes
OTHMXN	172	32-63	Max NSDU size in bytes
OTHBLM	173	0-31	Maximum buffers for T-user
OTHBII	173	32-63	Buffers currently holding send data
OTHIRT	174	0-63	Retransmission interval
OTHIAK	175	0-63	Ack timer interval
OTHIIA	176	0-63	Inactivity interval
OTHIFZ	177	0-63	Frozen ref interval
OTHMSK	200	32-63	Mask for sequence number
OTHST	201-217	0-63	Statistics block
OTHST	201-217	0-63	(Required by table diagram generator)
OTHBCD	220	0-63	Baseline credit
OTHSCD	221	0-63	Standard credit
OTHDLT	222-226	0-63	Delivery timer
OTHDLT	222-226	0-63	(Required by table diagram generator)

The statistics block is returned in response to a T-STATISTICS request. It contains information relating to the transport connection on which it was issued.

0....+....1....+....2....+....3....+....4....+....5....+....6...

0	RTI
1	RTC
2	RTS
3	DBS
4	DBR
5	DTS
6	DTR
7	EDS
10	EDR
11	RET
12	DUP
13	DSC
14	AKS
15	AKR
16	CNG

Figure OTS-1. Transport statistics block

<u>Field</u>	<u>Word(base8)</u>	<u>Bits</u>	<u>Description</u>
OTSRTI	0	0-63	RT at I-CONNECT time
OTSRTC	1	0-63	RT at connection establishment
OTSRTS	2	0-63	Current real time
OTSDBS	3	0-63	Data bytes sent
OTSDBR	4	0-63	Data bytes received
OTSDTS	5	0-63	DT TPDU's sent
OTSDTR	6	0-63	DT TPDU's received
OTSEDS	7	0-63	ED TPDU's sent
OTSEDR	10	0-63	ED TPDU's received
OTSRET	11	0-63	DT's retransmitted
OTSDUP	12	0-63	Duplicate TPDU's received
OTSDSC	13	0-63	Discarded TPDU's
OTSAKS	14	0-63	AK's sent
OTSAKR	15	0-63	AK's received
OTSCNG	16	0-63	Network congestion events

Various TPDU header formats are defined here.

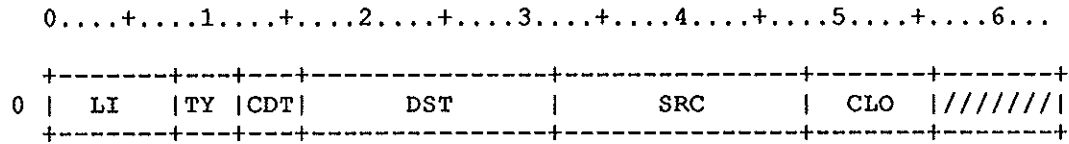

Figure OTU-1. Transport TPDU - CR/CC form

Field	Word(base8)	Bits	Description
OTULI	0	0-7	LI
OTUTY	0	8-11	Type code
OTUCDT	0	12-15	CDT
OTUDST	0	16-31	DST-REF
OTUSRC	0	32-47	SRC-REF
OTUCLO	0	48-55	Class/Option

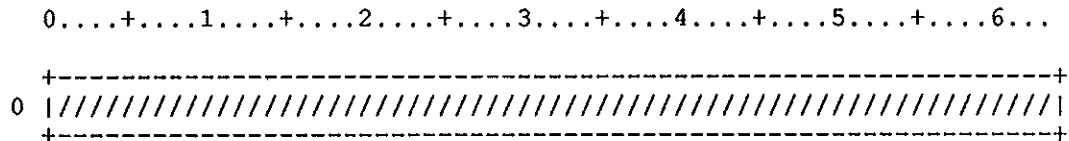

Figure OTU-2. Transport TPDU - CR/CC form

Field	Word(base8)	Bits	Description
OTULI	0	0-7	LI
OTUTY	0	8-11	Type code
OTUUDF	0	12-15	Undefined
OTUDST	0	16-31	DST-REF
OTUSRC	0	32-47	SRC-REF
OTURS	0	48-55	Reason code

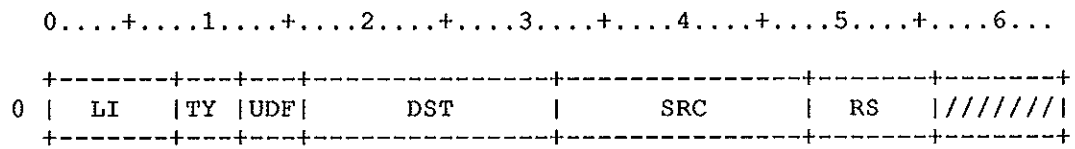

Figure OTU-3. Transport TPDU - DR form

Field	Word(base8)	Bits	Description
OTULI	0	0-7	LI
OTUTY	0	8-11	Type code
OTUUDF	0	12-15	Undefined
OTUDST	0	16-31	DST-REF
OTUCAU	0	32-39	Cause

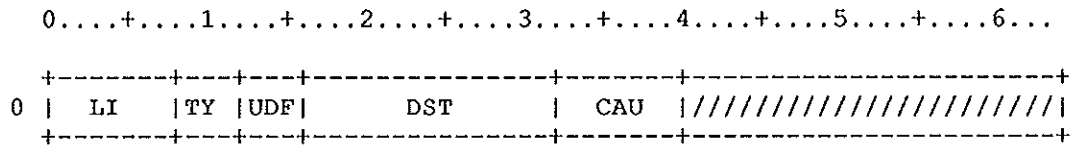

Figure OTU-4. Transport TPDU - ER form

<u>Field</u>	<u>Word(base8)</u>	<u>Bits</u>	<u>Description</u>
OTULI	0	0-7	LI
OTUTY	0	8-11	Type code
OTUUDF	0	12-15	Undefined
OTUDST	0	16-31	DST-REF
OTUTNR	0	32-39	TPDU-NR

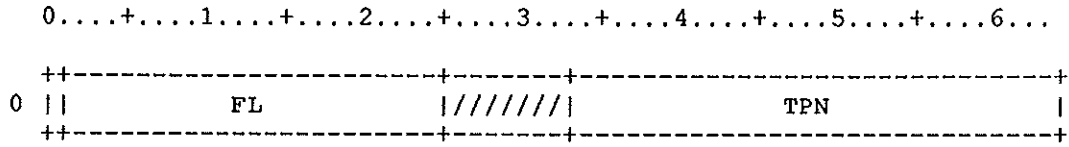

Figure OTO-1. Transport buffer ordering

<u>Field</u>	<u>Word(base8)</u>	<u>Bits</u>	<u>Description</u>
OTOEOT	0	0	EOT flag
OTOFL	0	1-24	Forward link (R-LIST)
OTOTPN	0	33-63	TPDU-NR

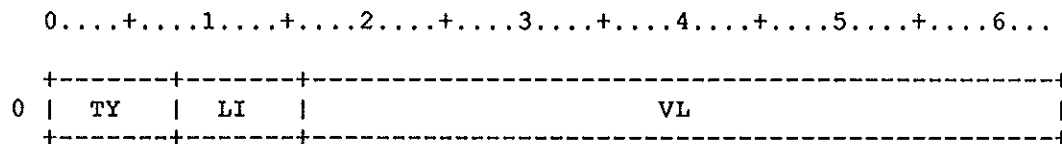

Figure OTV-1. Transport TPDU - variable parameter

<u>Field</u>	<u>Word(base8)</u>	<u>Bits</u>	<u>Description</u>
OTV TY	0	0-7	Type
OTV LI	0	8-15	Length
OTV VL	0	16-63	Value (variable size)

The Per-device Accounting Table is used by EXP and DQM to keep dataset statistics by device.

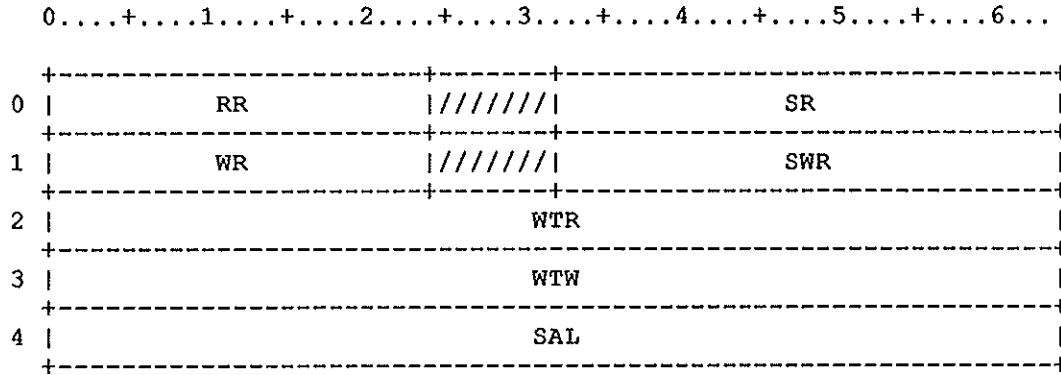

Figure PC-1. Per-device accounting table

Field	Word(base8)	Bits	Description
PCRR	0	0-23	Read requests
PCSR	0	32-63	Sectors read
PCWR	1	0-23	Write requests
PCSWR	1	32-63	Sectors written
PCWTR	2	0-63	Time spent waiting on device read
PCWTW	3	0-63	Time spent waiting on device write
PCSAL	4	0-63	Sectors allocated (used by FSMSG)

The PDS is STP resident and contains an entry for each active permanent dataset edition. A PDS entry indicates how an edition is accessed and how many users have access to the edition. This information is used to control multiple accesses to a dataset edition, and to provide a location for event wait purposes when conflicting access modes are desired or users are waiting for a migrated or retired dataset to be recalled to online disk.

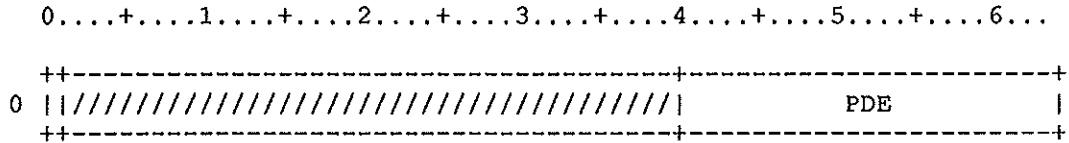

Figure PD-1. Permanent Dataset Table Header

<u>Field</u>	<u>Word(base8)</u>	<u>Bits</u>	<u>Description</u>
PDFULL	0	0	PDS full indicator.
PDPDE	0	40-63	Number of table entries in use.

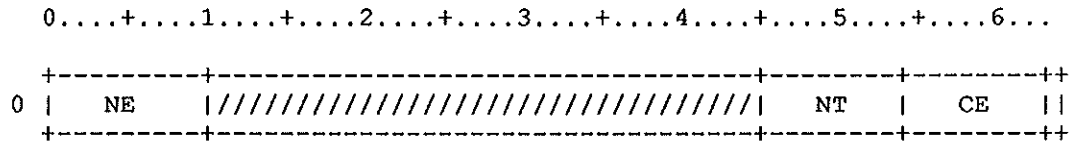

Figure PDL-1.

<u>Field</u>	<u>Word(base8)</u>	<u>Bits</u>	<u>Description</u>
PDLNE	0	0-9	number of entries
PDLNT	0	45-53	next entry to try
PDLCE	0	54-62	current entry of allocation

PDL Preferred device entry - PDL.

[584]

*CALL COMPDT at this ident + 1

Copyright Cray Research Inc.
UNPUBLISHED - all rights reserved under the copyright laws
of the United States.

The Program Description Table (PDT) is the first table of a program binary, and can be the first table on a dataset. The PDT contains information needed for relocation, such as entry points, externals, blocks, indexes, and the date and time of assembly.

The table has two formats: old and new. They are differentiated by bit 8 in the second word. This book describes only the new format. The old format does not include the header entry (figure PDT-2); the following fields from that entry are in the same bit positions in the program entry (figure PDT-3): TMT, TCSQ, TTYP, and TMOD. Starting addresses for table sections in the old format use the following numbers and variables cumulatively: 3, BL, EL, XL. These are added in the same way as in the new format, below:

Table organization:

SIZE	DESCRIPTION	OFFSET
1	header word	0
HL	header entry	1
BL	blocks	HL+1
EL	entry points	HL+BL+1
XL	externals	HL+BL+EL+1
WC-(HL+BL+EL+XL+1)	trailer	HL+BL+EL+XL+1

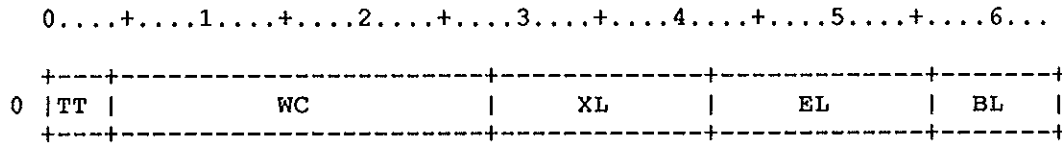

Figure PDT-1. Loader PDT Header Word

Field	Word(base8)	Bits	Description
PDTT	0	0-3	Table type (0'17)
PDTWC	0	4-27	Word count including header word
PDTXL	0	28-41	Number of words-external descriptors
PDTEL	0	42-55	Number of words-entry point descriptor
PDTBL	0	56-63	Number of words-block name descriptors

0....+....1....+....2....+....3....+....4....+....5....+....6...

1+0	* MOD	HL
1+1	SIS	SIN
1+2	MIS	MIN
1+3	R\$1	
1+4	BCI	
1+5	SC0	
1+6	SC1	
1+7	SC2	
1+10	SC3	
1+11	UD1	
1+12	UD2	
1+13	* MOD	HLM
1+14	PAD	BC
1+15	MBA	MAV
1+16	MEP	BCP
1+17	CTP	ATP
1+20	MCL	
1+21	PMT	
1+22	* MOD	
1+23	* MOD	

Figure PDT-2. Loader PDT Header entry

<u>Field</u>	<u>Word(base8)</u>	<u>Bits</u>	<u>Description</u>
PDTHL	1+0	50-63	Word length of header entry
PDTOVL	1+1	2	Overlay flag
PDTSBC	1+1	3	SBCA flag
PDTMTX	1+1	4	Machine type extension fields present
PDTMT	1+1	5-6	Machine type (obsolete)
PDTCSQ	1+1	7	Calling sequence flag
PDTTYP	1+1	8	PDT type - 0=old PDT, 1=new PDT
PDTSTK	1+1	9	Stack flag
PDTOVT	1+1	10	Overlay type - 0=type1, 1=type2
PDTMOD	1+1	12-15	Relocatable overlay module type
PDTSSM	1+1	16	Secure memory flag
PDTSDR	1+1	17	SDR module flag
PDTSDM	1+1	18	Special job - implies no echo
PDTEMA	1+1	19	EMA flag 0 - no extended memory 1 - extended memory (Cray X-MP)
PDTSIS	1+2	0-31	Initial stack size
PDTSIN	1+2	32-63	Stack increment size
PDTMIS	1+3	0-31	Initial managed memory size
PDTMIN	1+3	32-63	Managed memory increment size
PDTR\$1	1+4	0-63	Reserved for future use
PDTBCI	1+5	0-63	Blank common initialization value
PDTSC0	1+6	0-63	Privilege word
PDTSC1	1+7	0-63	Privilege word
PDTSC2	1+10	0-63	Privilege word
PDTSC3	1+11	0-63	Privilege word
PDTUD1	1+12	0-63	User definable word 1
PDTUD2	1+13	0-63	User definable word 2

<u>Field</u>	<u>Word(base8)</u>	<u>Bits</u>	<u>Description</u>
PDTNRD	1+14	0	NORED flag
PDTHLM	1+14	40-63	HLM for binary
PDTPAD	1+15	0-31	Pad increment for field length
PDTBC	1+15	32-63	Blank common increment
PDTMBA	1+16	0-31	Managed memory base address
PDTMAV	1+16	32-63	Managed memory available base address
PDTMEP	1+17	0-31	Managed memory epsilon
PDTBCP	1+17	32-63	B.%STKBBCP value
PDTCTP	1+20	0-31	B.%STKCTP value
PDTATP	1+20	32-63	B.%STKATP value
PDTMCL	1+21	0-63	Machine characteristics entry length
PDTPMT	1+22	0-63	Primary machine type code
PDTA32	1+23	50	YMP 32-bit addressing required
PDTCOR	1+23	51	Control Operand Range Intrpts(ERI/DRI)
PDTCLS	1+23	52	Cluster registers required
PDTSTR	1+23	53	Status register required
PDTBDM	1+23	54	Bidirectional memory must be disabled
PDTHPM	1+23	55	Hardware performance monitor required
PDTAVL	1+23	56	Additional vector logical unit assumed
PDTNVR	1+23	57	No vector recursion permitted
PDTVRR	1+23	58	Vector recursion required
PDRVL	1+23	59	Ability to read vector length required
PDTPC	1+23	60	Programmable clock required
PDTCIG	1+23	61	Compress/index gather/scatter required
PDTEMR	1+23	62	Extended memory addressing required
PDTVP	1+23	63	Vector population count unit required PDTMLE=W@PDTVP-W@PDTMCL+1 Compute length of mach char entry

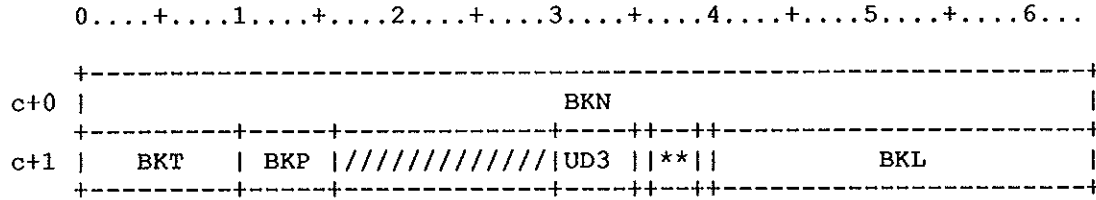

Figure PDT-4. Loader PDT common block entry

Field	Word(base8)	Bits	Description
PDTBKN	c+0	0-63	Block name
PDTBKT	c+1	0-9	Block type: 0 - common 1 - mixed (code/data) 2 - code 3 - data 4 - const 5 - dynamic 6 - task common
PDTBKP	c+1	10-15	Block placement: 0 - global memory 1 - reserved for Cray 2 local memory 2 - extended memory (Cray X-MP)
PDTUD3	c+1	30-34	Reserved for customer use
PDTBKD	c+1	35	Dynamic common flag-not used by COS
PDTUD4	c+1	36-38	Reserved for customer use
PDTALC	c+1	39	Common block ALIGN flag
PDTBKL	c+1	40-63	Block length

LE@PDTBK=2 word length of block entry

EL/3 = number of entries

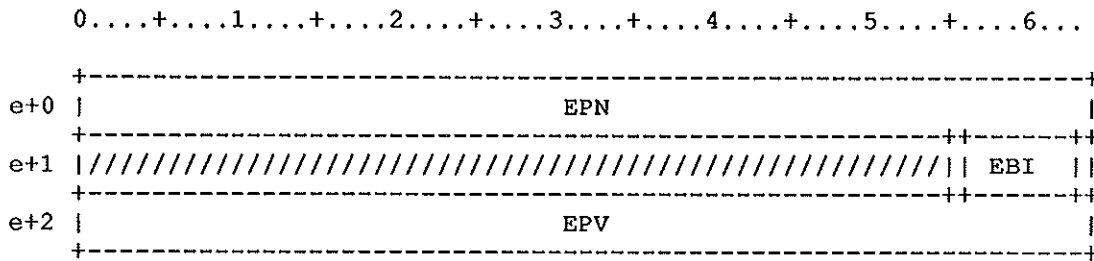

Figure PDT-5. Loader PDT entry point entry

Field	Word(base8)	Bits	Description
PDTEPN	e+0	0-63	Entry point name
PDTEPE	e+1	55	Primary entry type. If this bit is set, this entry is the primary entry of the current load. The loader transfers control to the first encountered primary entry.
PDTEBI	e+1	56-62	Block index; specifies the block containing the named entry. Associated with the block is a block address used to modify the entry value when it is used to satisfy externals of the same name. The entries define a relocation quantity as follows: 0 None 1 Negative to the program block 2 Positive to the program block 3 Positive to common block 1 4 Positive to common block 2 : : : 127 Positive to common block 125
PDTEPQ	e+1	63	Relocation mode
PDTEPV	e+2	0-63	A quantity associated with the entry name. For satisfying externals, an entry relocation quantity is determined by adding an EBI block address to the entry value

LE@PDTEP=3 word length of entry point entry

XL = number of entries

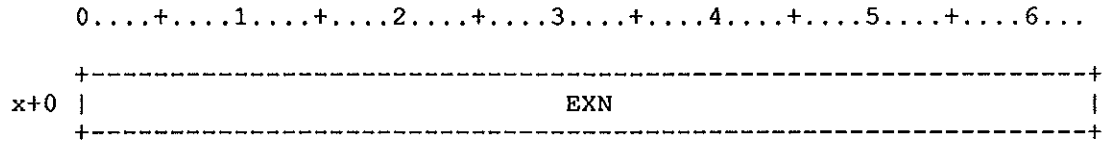

Figure PDT-6. Loader PDT external entry

<u>Field</u>	<u>Word(base8)</u>	<u>Bits</u>	<u>Description</u>
PDTEXN	x+0	0-63	External name
			LE@PDTEX=1 word length of external entry

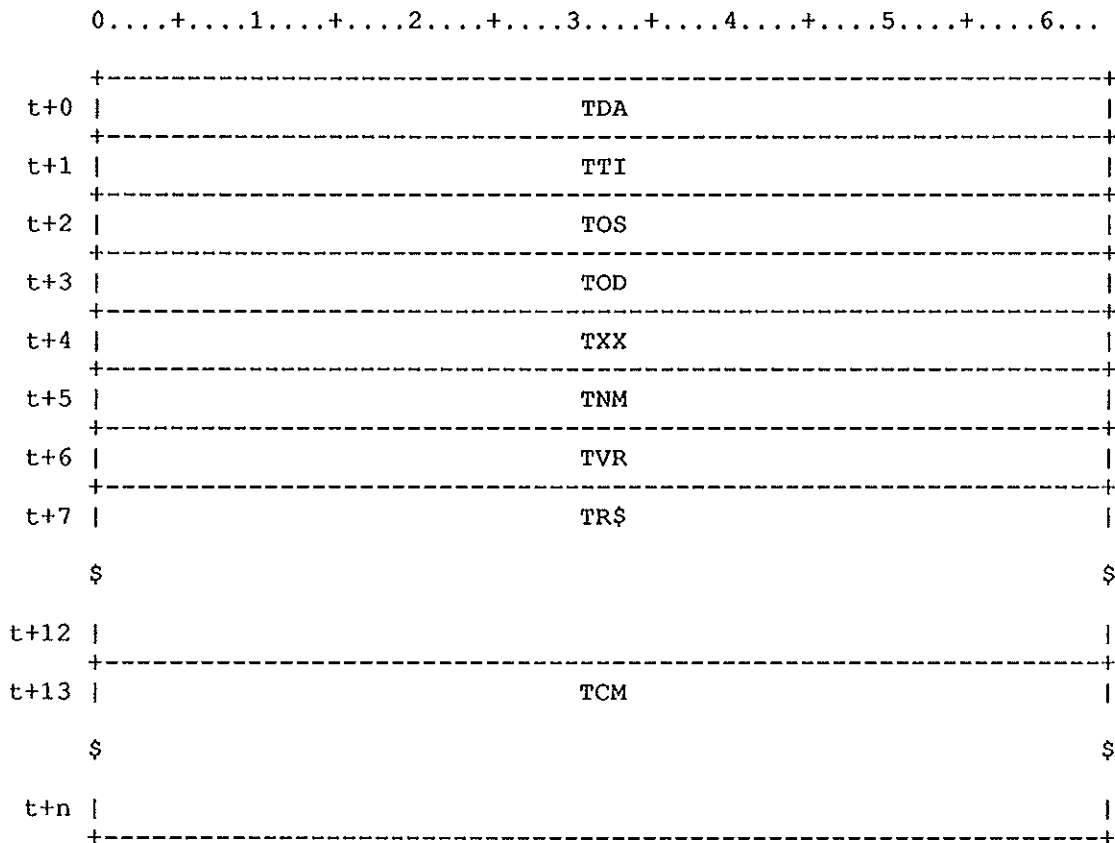

Figure PDT-7. Loader PDT trailer entry

Field	Word(base8)	Bits	Description
PDTTDA	t+0	0-63	Date of PDT generation
PDTTTI	t+1	0-63	Time of PDT generation
PDTTOS	t+2	0-63	Operating system version
PDTTOD	t+3	0-63	Operating system assembly date
PDTTXX	t+4	0-63	Reserved
PDTTNM	t+5	0-63	Name of generating product
PDTTVR	t+6	0-63	Version of generating product
PDTTR\$t+7 to t+12		0-63	Reserved for future use L@PDTTR\$=4 Word length of reserved field
PDTTCMt+13 to n		0-63	comments

(In earlier documentation, this segment was called the PDT "header", even though it was the last entry in the PDT.)

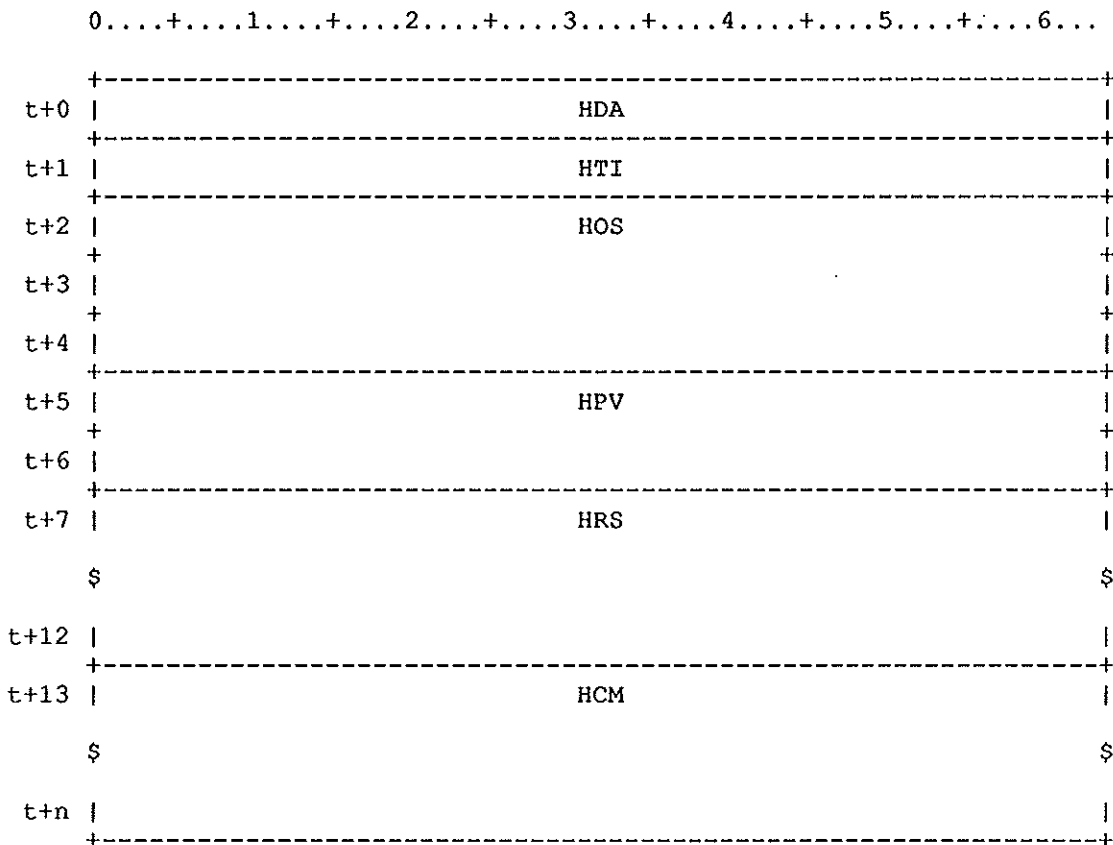

Figure PDT-8. Loader PDT old trailer (header)

<u>Field</u>	<u>Word(base8)</u>	<u>Bits</u>	<u>Description</u>
PDTHDA	t+0	0-63	Date of compilation
PDTHTI	t+1	0-63	Time of compilation
PDTHOST+2 to t+4		0-63	Operating system id L@PDTHOS=3 word length of os id
PDTHPVt+5 to t+6		0-63	Processor name and version L@PDTHPV=2 word length of name and version
PDTHRSt+7 to t+12		0-63	Reserved for expansion L@PDTHRS=4 word length of reserved section
PDTHCMT+13 to n		0-63	optional comments

table type

PDTTYPE=O'17 table type for PDT

relocatable overlay module type definitions

MODROVL=O'1 relocatable overlay

Permit DXT entry type - DXPERM

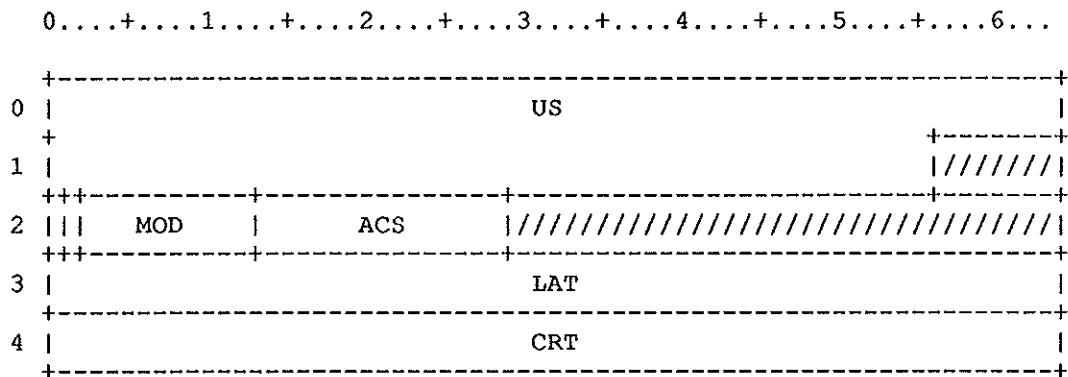

Figure PER-1. Permit DXT entry

Entry definition

Field	Word(base8)	Bits	Description
PERUS	0-1	0-63	Permitted User Number
PERUS1	0	0-63	Permitted user number (1-8)
PERUS2	1	0-55	Permitted user number (9-15)
PERACT	2	0	Active entry flag (1=entry is active)
PERMOD	2	2-12	Permitted access mode
PERACS	2	13-28	Number of accesses (binary)
PERLAT	3	0-63	Time of last access (cycles)
PERCRT	4	0-63	Permit creation time (cycles)

PERT - PERT

[598]

N O D E F I N I T I O N A V A I L A B L E

Figure PERT-1.

PDM Page Table Definition:

The page table consists of a header word and two word entries equivalent to the number of page buffers defined for PDM by the installation parameter I@PDMBUF.

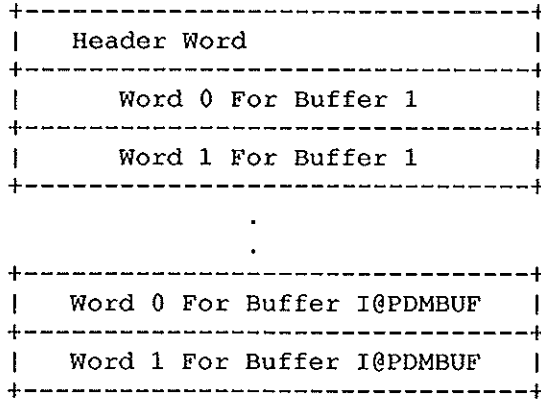

The page table is used to associate a particular buffer with a particular page of either the DSC, DXT, MCD, or BCD. It also provides I/O locking facilities.

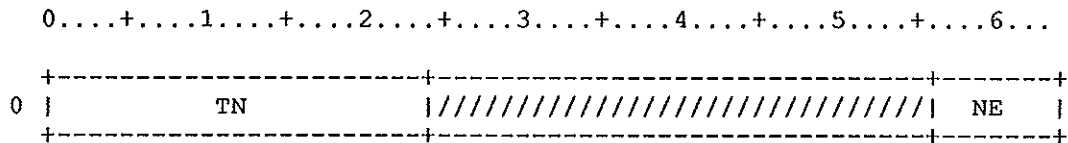

Figure PGT-1. Page Table Header Definition

Field	Word(base8)	Bits	Description
PGTTN	0	0-23	Table Name 'PGT'
PGTNE	0	56-63	Number of Page Table Entries

Definition of Page Table Entries:

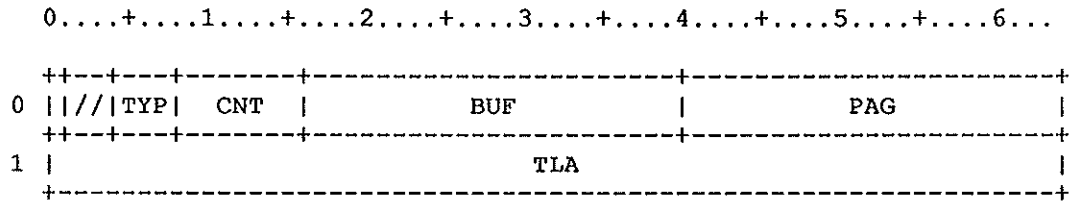

Figure PGT-2. Page Table Entry Definition

Field	Word(base8)	Bits	Description
PGTLCK	0	0	Page Lock
PGTTYP	0	4-7	Page Type PGTDSC=1 DSC Page PGTDXT=2 DXT Page PGTMCD=3 MCD Page PGTBCD=4 BCD Page
PGTCNT	0	8-15	Page Lock Count
PGTBUF	0	16-39	Page Buffer Address
PGTPAG	0	40-63	Page Number
PGTTLA	1	0-63	Time Page Last Accessed

The Physical Request Table is an STP-resident table primarily used for disk queue management.

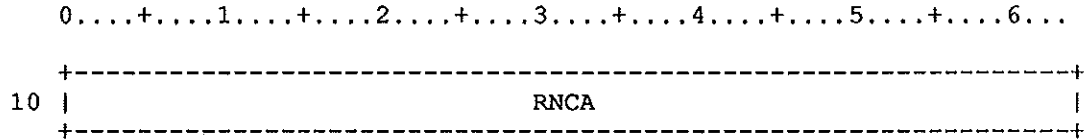

Figure PH-1. Physical Request Table entry

Field	Word(base8)	Bits	Description
PHEN	0	0-63	Entry name ('PHR'L)
PHPTR	1	0-63	Pointer to next PHR entry
PHSN	2	0-63	PHR sequence number (0..RQNPG-1)
PHRQT	3	0-63	RQT address (STP relative)
PHEQT	4	0-63	EQT address (STP relative)
PHTPQ	5	0-63	Time PHR was queued to EQT
PHTDA	6	0-63	Time data path was active
PHTD	7	0	Transfer direction (0=read, 1=write)
PHSK	7	1	Seek issued flag
PHWR2	7	2	WRT2 function code sent
PHWDD	7	3	Waiting for data to disk reply
PHTM	10	0-63	Target memory type
PHNS	11	0-63	Number of sectors to transfer
PHMA	12	0-63	Memory address (EXEC relative)
PHDVA	13	0-63	Device address (device relative)
PHCA	13	0-15	Cylinder address
PHTA	13	16-31	Track address
PHSA	13	32-63	Sector address
PHNI	14	0-63	Number of increments
PHMAI	15	0-63	Memory address increment
PHDVAI	16	0-63	Device address increment

The PDI is a 1-word STP-resident table generated during system startup for use by the Permanent Dataset Manager.

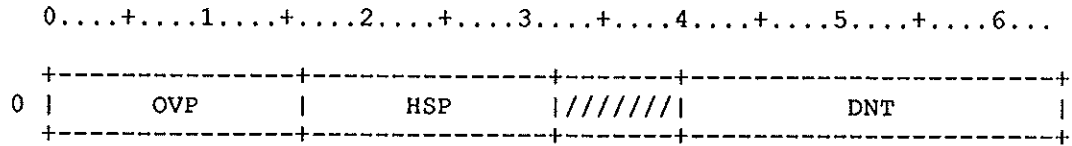

Figure PI-1. Permanent Dataset Information

<u>Field</u>	<u>Word(base8)</u>	<u>Bits</u>	<u>Description</u>
PIOVP	0	0-15	Number of overflow pages
PIHSP	0	16-31	Number of hash pages
PIDNT	0	40-63	DNT for DSC

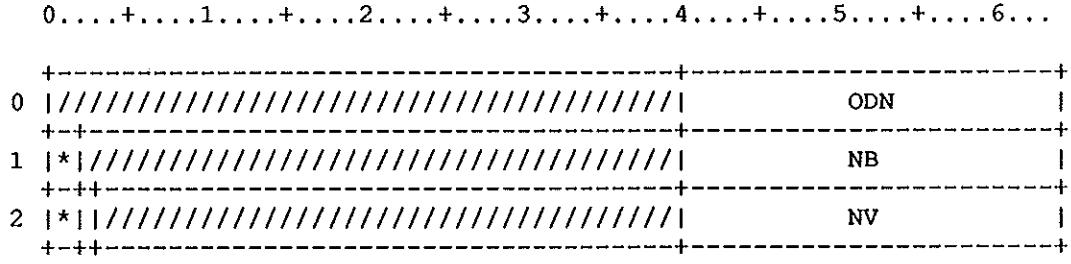

Figure PP-1. Position Parameter List

Field	Word(base8)	Bits	Description
PPODN	0	40-63	ODN addr
PPBD	1	0-1	Block position direction 0 - Absolute block number 2 - Position forward 3 - Position backward
PPNB	1	40-63	Number of blocks / block number
PPVD	2	0-1	Volume direction 0 - Absolute volume number 2 - Position forward 3 - Position backward
PPVF	2	2	Volume number/vol flag 0 - Position by volume number 1 - Position by volume serial number
PPNV	2	40-63	Volume number

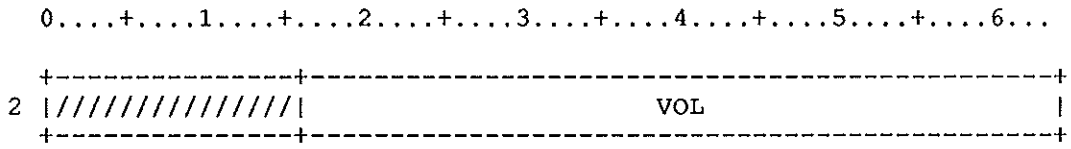

Figure PP-2. Position Parameter List

Field	Word(base8)	Bits	Description
PPVOL	2	16-63	Volume serial number

A PDD is a parameter list that accompanies a Permanent Dataset Management request.

The PDD illustrated in figure PM-1 is used for all save, access, dump access, load, modify, permit, rewrite SDT, pseudo-access, and permanent dataset name requests.

The PDD illustrated in figure PM-2 is used for both DSC and DXT page requests, and for dump time requests.

The PDD illustrated in figure PM-3 is used for all delete, release, and adjust requests.

The PDD illustrated in figure PM-4 is used for queue and dequeue SDT requests, and for get and link DXT requests.

The PDDs starting with figure PM-5 are function oriented; most are used for archive feature support.

Chart PM-1. Permanent dataset function codes

Symbol	Octal Code	Function
PMFCSU	10	Save user dataset
PMFCSI	12	Save input dataset
PMFCSO	14	Save output dataset
PMFCAU	20	Access user dataset
PMFCAI	22	Access input dataset
PMFCAO	24	Access output dataset
PMFCDU	30	Delete user dataset
PMFCDI	32	Delete input dataset
PMFCDO	34	Delete output dataset
PMFCPG	40	DSC Page request
PMFCPX	41	DXT Page request
PMFCLU	50	Load user dataset
PMFCLI	52	Load input dataset
PMFCLO	54	Load output dataset
PMFCRL	60	PDS/Release request
PMFCPN	70	PDN request
PMFCPNI	72	PDN request - input datasets
PMFCPNO	74	PDN request - output datasets
PMFCDT	100	Dump time request
PMFCDQ	110	Dequeue SDT
PMFCEA	120	Queue SDT to available queue
PMFCEI	122	Queue SDT to input queue
PMFCEO	124	Queue SDT to output queue
PMFCAD	130	Adjust user dataset
PMFCMD	140	Modify user dataset
PMFCRSDT	150	Rewrite input SDT entry
PMFCPSAC	160	Pseudo-access for RRJ
PMFCPU	170	Access user saved dataset for PDSDUMP
PMFCPI	172	Access input dataset for PDSDUMP
PMFCPO	174	Access output dataset for PDSDUMP

PMFCPE	200	Permit Request
PMFCLKDX	210	Link DXT Request
PMFCCTXT	221	Copy Text to buffer
PMFCCSLT	222	Copy Station Slot to buffer
PMFCCTAS	223	Copy Text and Station Slot to buffer
PMFCACDC	231	Access Dataset Catalog
PMFCACDX	232	Access Dataset Catalog Extension
PMFCACMC	233	Access Master Catalog
PMFCACBC	234	Access Backup Catalog
PMFCLDMC	243	Load Master Catalog
PMFCLDBC	244	Load Backup Catalog
PMFCONBU	250	Logon Backup System Job
PMFCONSM	251	Logon Space Manager System Job
PMFCOFRB	252	Logon Recall System Job
PMFCONCU	253	Logon Cleanup System Job
PMFCONBH	254	Logon Backup Helper Job
PMFCONSH	255	Logon Space Manager Helper Job
PMFCONRH	256	Logon Recall Helper Job
PMFCONCH	257	Logon Cleanup Helper Job
PMFCOFBU	260	Logoff Backup System Job
PMFCOFSM	261	Logoff Space Manager System Job
PMFCOFRB	262	Logoff Recall System Job
PMFCOFCU	263	Logoff Cleanup System Job
PMFCOFBH	264	Logoff Backup Helper Job
PMFCOFSH	265	Logoff Space Manager Helper Job
PMFCOFRH	266	Logoff Recall Helper Job
PMFCOFCH	267	Logoff Cleanup Helper Job
PMFCSDEI	270	Set Dataset Edition Interlock
PMFCCDEI	300	Clear Dataset Edition Interlock
PMFCRET	311	Retire Dataset Edition
PMFCMIG	312	Migrate Dataset Edition
PMFCDEL	313	Delete Dataset Edition
PMFCSBRS	321	Set Backup Required Status
PMFCCBRS	322	Clear Backup Required Status
PMFCSRLD	330	Set Reload Requested Status
PMFCBUAC	340	Backup Access
PMFCRLD	350	Reload Dataset Edition
PMFCWRBC	360	Write Backup Catalog
PMFCGLDV	370	Get Logical Device Information
PMFCGRRL	400	Get Recall/Restore List
PMFCSRET	411	Set Retirement Requested Status
PMFCSRES	412	Set Restore Requested Status
PMFCSDEL	413	Set Delete Requested Status
PMFCSMIG	414	Set Migration Requested Status
PMFCARCL	420	Abort Recall Requests
PMFCGKEY	430	Return hash key and region FWA
PMFCDAU	440	Copy DAT to STP and place address in DNT (User permanent dataset) (System request only)
PMFCDAI	441	Copy DAT to STP and place address in DNT (Input spooled dataset) (System request only)
PMFCDAO	442	Copy DAT to STP and place address in DNT (Output spooled dataset) (System request only)

0.....+.....1.....+.....2.....+.....3.....+.....4.....+.....5.....+.....6...

22	JSP	JCR	OLM	RJST	IJSP
23	* ** * /////	TPB	TPV		
24	** ** /////				
25		JAST	QUPR		
26	EUNI	EUSA			
27	*		TXO		
30		LSD		FPE	
31	ACS	DSZ	OJSQ		
32		CRT			
33		ACT			
34		TDM			
35		MOD			
36	SSC	TXC	MML		
37	* * *	PAM	ADNM		
40		ADN			
41	NOTL	NOTE			
42		CHG			
43		OWN			
44					
45		DNS			
46		ACN			
47					
50		REF			

Figure PM-1. Permanent Dataset Definition

LE@MPDD=1 Minimum PDD size
 LE@PDD11=D'31 COS 1.11 PDD
 size

<u>Field</u>	<u>Word(base8)</u>	<u>Bits</u>	<u>Description</u>
PMMSG	0	0	Normal completion message suppression indicator
PMERR	0	1	Error message suppression indicator
PMWAIT	0	2	WAIT flag for a disposed dataset
PMNRLS	0	3	No release of dataset on DISPOSE
PMAQR	0	4	Acquire flag for accounting
PMTP	0	5-6	Tape dataset (online/staged)
PMTCS	0	7-8	Tape dataset character set
PMEXO	0	9-10	Execute only
PMDTR	0	11	Update dump-time on PDSDUMP access
PMSMT	0	12	Submit flag
PMDFFL	0	13	Job-used-MFL-default flag
PMFSOV	0	14	Override FS allocation for RDM
PMJLWT	0	15-16	Job Limit wait flag
PMINX	0	19-23	Relocation index (REL@xxxx). Used for generating STP relative address of TXT
PMVER	0	24-31	PDD version number
PMSIZE	0	32-39	PDD size in words
PMST	0	40-51	Return status
PMFC	0	52-63	Function code (see chart PM-1)
PMDN	1	0-55	Local dataset name
PMPDN	2-3	0-63	Permanent dataset name
PMPDN1	2	0-63	Characters 1-8
PMPDN2	3	0-55	Characters 9-15
PMID	4	0-63	User identification
PMUSR	5-6	0-63	User number

<u>Field</u>	<u>Word(base8)</u>	<u>Bits</u>	<u>Description</u>
PMUSR1	5	0-63	Characters 1-8
PMUSR2	6	0-55	Characters 9-15
PMTXT	7	0-23	Address of optional text field
PMFM	7	24-39	Format designator (two characters) FMCD=CD Character/deblocked FMCB=CB Character/blocked FMBD=BD Binary/deblocked FMBB=BB Binary/blocked
PMRT	7	40-51	Retention period; 0-4095 days.
PMED	7	52-63	Edition number (0-4095)
PMOJB	10	0-55	Originating job name
PMDWN	10	62	New state of DCDWN bit (FX=45x)
PMMFNS	10	63	MF parameter Not Specified
PMSID	11	0-15	Source ID; 2 characters.
PMDID	11	16-31	Destination ID; 2 characters.
PMDC	11	32-47	Disposition code; 2 characters. DCIN=IN Job dataset DCST=ST Dataset to be staged DCSC=SC Scratch dataset DCPR=PR Print dataset DCPU=PU Punch dataset DCPT=PT Plot dataset DCMT=MT Magnetic tape dataset
PMJSQ	11	48-63	Job sequence number
PMTID	12	0-63	Terminal ID; 1-8 characters.
PMSF	13	0-63	Special forms
PMUQ	14	0	Unique access required
PMENT	14	1	Enter in System Directory
PMIR	14	2	Immediate reply requested
PMTXL	14	3-10	Number of words of text
PMNRR	14	11	Job rerun flag; set if job cannot rerun (input entries only).
PMINIT	14	12	Job initiate flag; set if job has been initiated.

<u>Field</u>	<u>Word(base8)</u>	<u>Bits</u>	<u>Description</u>
PMIA	14	13	Interactive flag
PMDFR	14	14	Deferred disposition indicator
PMNA	14	15	No abort flag. If set, processing continues even if an error is encountered.
PMMFL	14	16-31	MFL parameter from job card (input
PMSGFL	14	16	All available memory requested
PMFL	14	17-31	Field length/512
PMTL	14	32-55	Time limit (input datasets)
PMPR	14	56-63	Priority (input datasets)
PMRD	15	0-63	Read permission control word
PMWT	16	0-63	Write permission control word
PMMN	17	0-63	Maintenance permission control wor
PMJCN	20	0-55	Job class name
PMCL	21	0-55	CL parameter from JOB statement
PMSYS	22	0	System job
PMJSP	22	1-8	JOB statement priority
PMJCR	22	9-24	Job class rank
PMOLM	22	25-48	Size of \$OUT in 512-word block
PMRJST	22	49-54	Job status flag
PMIJSP	22	56-63	Original job card priority
PMTPD	23	0-1	Tape density
PMTPL	23	2-4	Tape label type
PMTPF	23	5-6	Tape format
PMTAW	23	13	Tape abort on write error flag
PMTRV	23	14	Tape retain volume flag
PMTPC	23	15	Tape cataloged dataset
PMTPB	23	16-39	Tape maximum block size in bytes
PMTPV	23	40-63	Tape pointer to label definition table

<u>Field</u>	<u>Word(base8)</u>	<u>Bits</u>	<u>Description</u>
PMTPM	24	0	Tape online maintenance access
PMTPP	24	1-3	Tape parallel device count
PMT2	24	4	Tape second device assignment
PMTPH	24	5	Tape hold assigned device
PMIDC	24	6-8	Tape initial disposition code
PMJAST	25	34-39	Job acceptance status
PMQUPR	25	40-63	Job Queuing priority
PMEUNI	26	0-23	Job Estimated units
PMEUSA	26	24-47	Job Estimated usage
PMTSCV	27	0-1	Timestamp conversion specification TSCVTHIS=0 Convert to current COS system TSCVRT=1 Convert to RT-based timestamp TSCVNS=2 Convert to NS-based timestamp TSCVSAME=3 No conversion -- leave timestamp alone
PMTXO	27	48-63	TXT ORDINAL OF USER TASK
PMOCC	30	0	Operator-changed-class flag
PMLSD	30	8-31	Temporary SDT address for load input/output
PMFPE	30	36-63	First DSC page/entry for dataset
PMFPP	30	36-59	First DSC page for dataset
PMFEN	30	60-63	First entry for dataset
PMACS	31	0-15	Number of accesses (load saved datasets only)
PMDSZ	31	16-47	Size of dataset as reflected by DS DAT bodies (used only when a pse access is performed during the recovery of rolled jobs)
PMOJSQ	31	48-63	Originating job sequence number
PMCRT	32	0-63	Creation time in cycles (load request only)

<u>Field</u>	<u>Word(base8)</u>	<u>Bits</u>	<u>Description</u>
PMACT	33	0-63	Time of last access in cycles (load request only)
PMTDM	34	0-63	Time of last dump in cycles (load request only)
PMMOD	35	0-63	Time of last modification in cycle (load request only)
PMSSC	36	0-7	Station slot word length
PMTXC	36	8-15	Text field word length
PMMML	36	16-27	Interactive maximum message length
PMPDE	37	0	Partial delete flag
PMREM	37	1	Remove permit flag
PMTRA	37	2-3	Track accesses flag: TRAKNO=1 Do not track accesses TRAKYE=2 Do track accesses
PMRESD	37	4-5	Preferred residency RESON=1 Online residency preferred RESOF=2 Offline residency preferred RESNP=3 No residency preference
PMBACK	37	6-7	Backup requirement BACKNO=2 No backup required BACKYE=3 Backup is required
PMPAM	37	8-15	Public/permit access mode: PAMEX=O'011 Execute only PAMRE=O'001 Read permission PAMWR=O'002 Write permission PAMMA=O'004 Maintenance permission PAMNO=O'200 No permissions MAXPAM=5

<u>Field</u>	<u>Word(base8)</u>	<u>Bits</u>	<u>Description</u>
PMADNM	37	16-31	ADN propagate attributes mask: PACW=O'000001 Control words PAPAM=O'000002 Public access mode PATRK=O'000004 Track accesses PAPER=O'000010 Permits PATXT=O'000020 Text PANTS=O'000040 Notes PAALL=O'000077 All of the above PANO=O'100000 None MAXPA=D'8 Maximum allowable attributes
PMADN	40	0-55	Attributes dataset name
PMNOTL	41	0-7	Notes length in words
PMNOTE	41	8-31	Pointer to notes text LE@NOTE=D'60 Allow 480 characters for notes
PMCHG	42	0-63	Last modification time (PDSLOAD)
PMOWN	43-44	0-63	Dataset Owner
PMOWN1	43	0-63	Owner (char 1-8)
PMOWN2	44	0-55	Owner (char 9-15)
PMDNS	45	0-63	Reserved for installation
PMACN	46-47	0-63	Account Number
PMACN1	46	0-63	Characters 1-8 of account number
PMACN2	47	0-55	Characters 9-15 of account number
PMREF	50	0-55	Referback dataset name

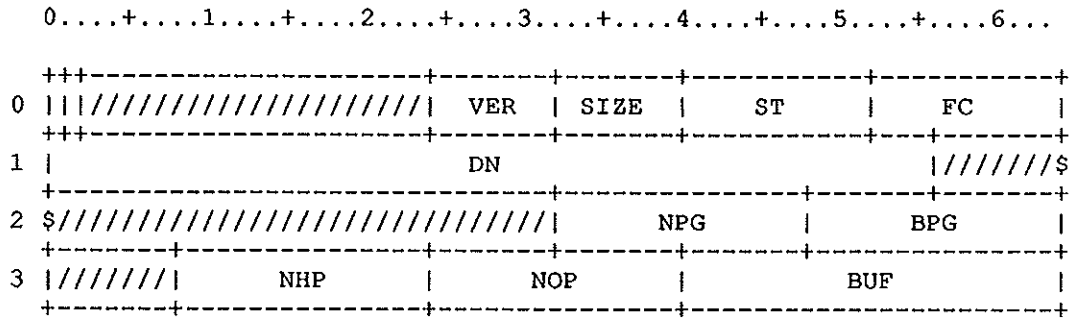

Figure PM-2. PDD Format 2

Field	Word(base8)	Bits	Description
PMSG	0	0	Normal completion message suppression indicator
PMERR	0	1	Error message suppression indicator
PMVER	0	24-31	PDD Version number
PMSIZE	0	32-39	PDD size in words
PMST	0	40-51	Return status
PMFC	0	52-63	Function code (see chart PM-1)
PMDN	1	0-55	Local Dataset Name (PMFCDT)
PMNPG	2	32-47	Number of pages (PMFCPG,PMFCPX)
PMBPG	2	48-63	Beginning page number (PMFCPG,PMFCPX)
PMNHP	3	8-23	Number of hash pages (returned by PDM for PMFCPG requests) for PMFCPX requests)
PMNOP	3	24-39	Number of overflow pages (returned by PDM for PMFCPG requests)
PMBUF	3	40-63	Buffer address

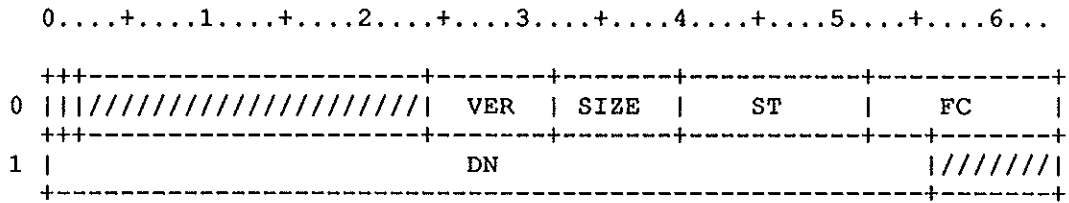

Figure PM-3. PDD Format 3

<u>Field</u>	<u>Word(base8)</u>	<u>Bits</u>	<u>Description</u>
PMSG	0	0	Normal completion message suppression indicator
PMERR	0	1	Error message suppression indicator
PMVER	0	24-31	PDD Version number
PMSIZE	0	32-39	PDD size in words
PMST	0	40-51	Return status
PMFC	0	52-63	Function code (see chart PM-1)
PMDN	1	0-55	Local dataset name

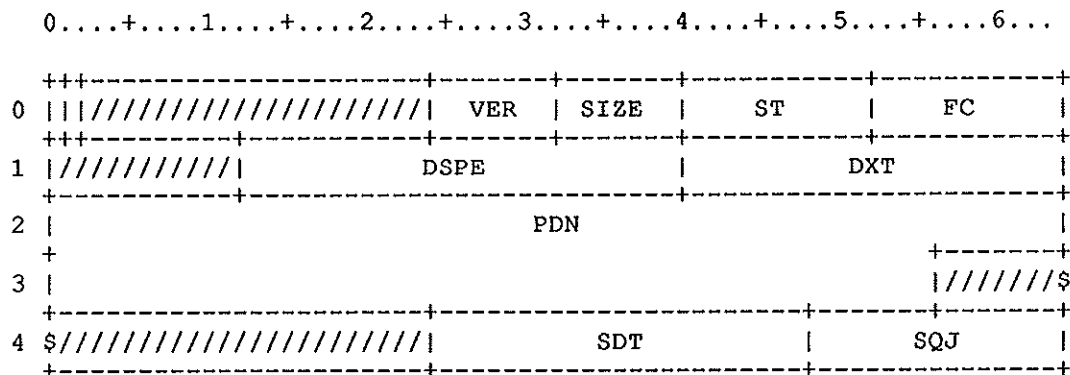

Figure PM-4. PDD Format 4

Field	Word(base8)	Bits	Description
PMSG	0	0	Normal completion message suppression indicator
PMERR	0	1	Error message suppression indicator
PMVER	0	24-31	PDD Version number
PMSIZE	0	32-39	PDD size in words
PMST	0	40-51	Return status
PMFC	0	52-63	Function code (see chart PM-1)
PMDSPE	1	12-39	Page/entry of main DSC entry (PMFCLKDX, PMFCRTDX requests)
PMDSP	1	12-35	Page number of main DSC entry (PMFCLKDX, PMFCRTDX requests)
PMDSE	1	36-39	Entry number of main DSC entry (PMFCLKDX, PMFCRTDX requests)
PMDXT	1	40-63	Pointer to DXT information buffer (PMFCLKDX, PMFCRTDX requests)
PMPDN	2-3	0-63	Permanent dataset name
PMPDN1	2	0-63	Characters 1-8
PMPDN2	3	0-55	Characters 9-15
PMSDT	4	24-47	SDT address Returned by PDM for PMFCDQ request Input for PMFCEA, PMFCEI, PMFCEO
PMSQJ	4	48-63	Job sequence number (PMFCDQ request)

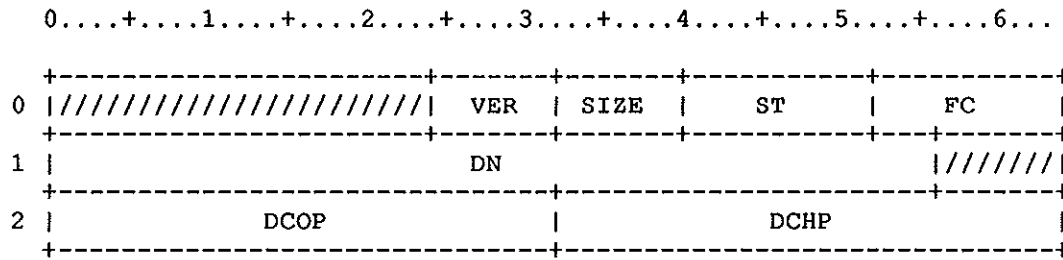

Figure PM-5. PDD For PMFCACDC
 L@PMACDC=3 PDD size for PMFCACDC

Field	Word(base8)	Bits	Description
PMVER	0	24-31	PDD Version number
PMSIZE	0	32-39	PDD size in words
PMST	0	40-51	Return status
PMFC	0	52-63	Function code (see chart PM-1)
PMDN	1	0-55	Local Dataset Name
PMDCOP	2	0-31	Number of DSC overflow pages
PMDCHP	2	32-63	Number of DSC hash pages

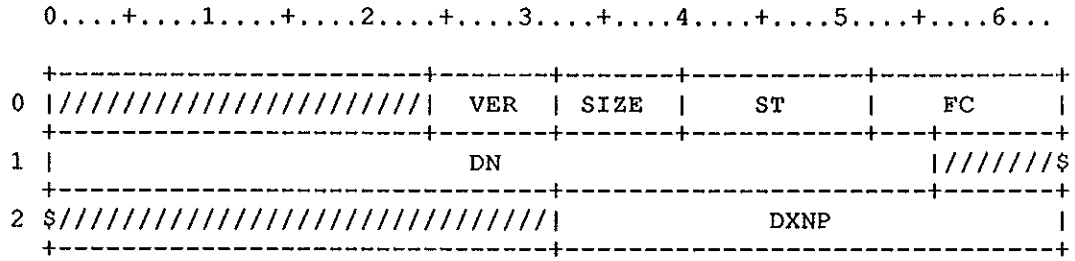

Figure PM-6. PDD For PMFCACDX
 L@PMACDX=3 PDD size for PMFCACDX

<u>Field</u>	<u>Word(base8)</u>	<u>Bits</u>	<u>Description</u>
PMVER	0	24-31	PDD Version number
PMSIZE	0	32-39	PDD size in words
PMST	0	40-51	Return status
PMFC	0	52-63	Function code (see chart PM-1)
PMDN	1	0-55	Local Dataset Name
PMDXNP	2	32-63	Number of DXT pages

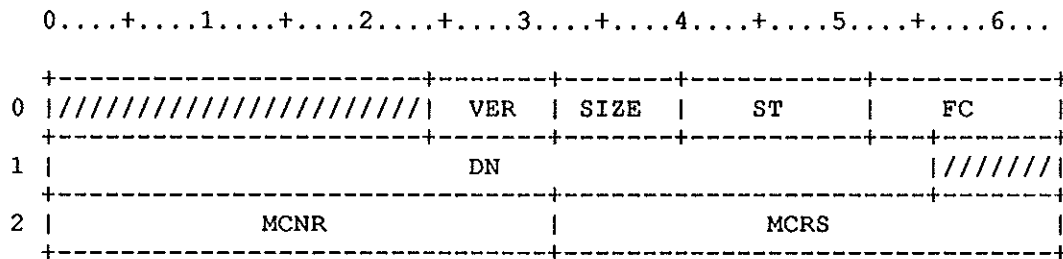

Figure PM-7. PDD For PMFCACMC, PMFCLDMC
 L@PMACMC=3 PDD size for PMFCACMC
 L@PMLDMC=3 PDD size for PMFCLDMC

Field	Word(base8)	Bits	Description
PMVER	0	24-31	PDD Version number
PMSIZE	0	32-39	PDD size in words
PMST	0	40-51	Return status
PMFC	0	52-63	Function code (see chart PM-1)
PMDN	1	0-55	Local Dataset Name
PMMCNR	2	0-31	Number of MCD regions
PMMCRS	2	32-63	Size of each MCD region (sectors)

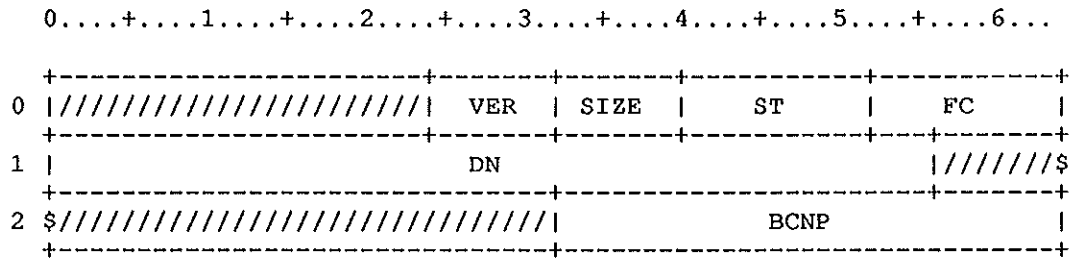

Figure PM-8. PDD For PMFCACBC, PMFCLDBC
 L@PMACBC=3 PDD size for PMFCACBC
 L@PMLDBC=3 PDD size for PMFCLDBC

Field	Word(base8)	Bits	Description
PMVER	0	24-31	PDD Version number
PMSIZE	0	32-39	PDD size in words
PMST	0	40-51	Return status
PMFC	0	52-63	Function code (see chart PM-1)
PMDN	1	0-55	Local Dataset Name
PMBCNP	2	32-63	Number of BCD pages

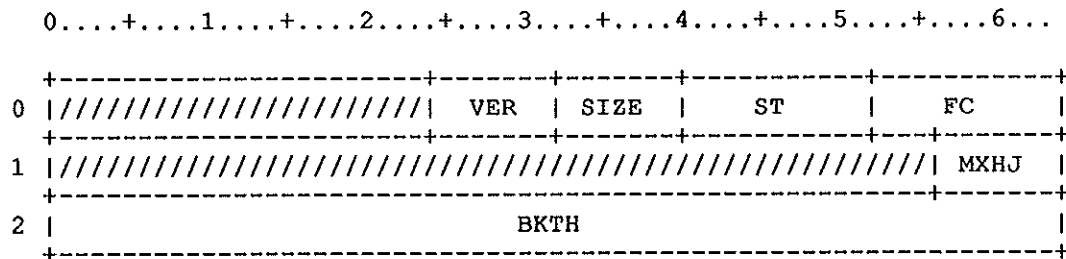

Figure PM-9. PDD For PMFCONBU
 L@PMONBU=3 PDD size for PMFCONBU

Field	Word(base8)	Bits	Description
PMVER	0	24-31	PDD Version number
PMSIZE	0	32-39	PDD size in words
PMST	0	40-51	Return status
PMFC	0	52-63	Function code (see chart PM-1)
PMMXHJ	1	56-63	Maximum number of helper jobs
PMBKTH	2	0-63	Backup threshold (integer words)

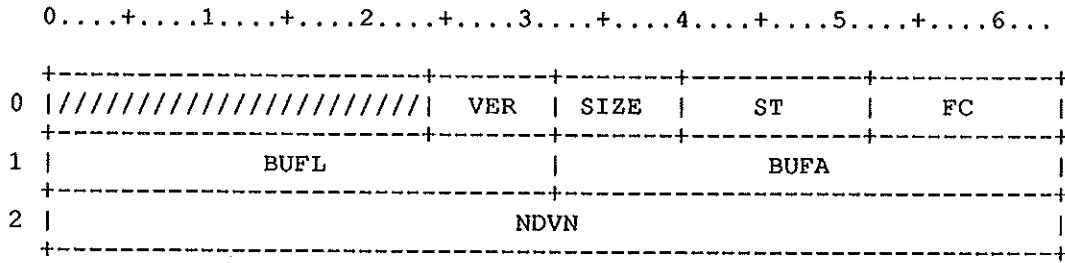

Figure PM-10. PDD For PMFCONSM
 L@PMONSM=3 PDD size for PMFCONSM
 (minimum)

Field	Word(base8)	Bits	Description
PMVER	0	24-31	PDD Version number
PMSIZE	0	32-39	PDD size in words
PMST	0	40-51	Return status
PMFC	0	52-63	Function code (see chart PM-1)
PMBUFL	1	0-31	Buffer length
PMBUFA	1	32-63	Buffer address
PMNDVN	2	0-63	Number of devices in device threshold list (two words per device, see below)

The device list is passed in a buffer pointed to by PMBUFA and must be at least LE@PMDVL*PMNDVN words in length.

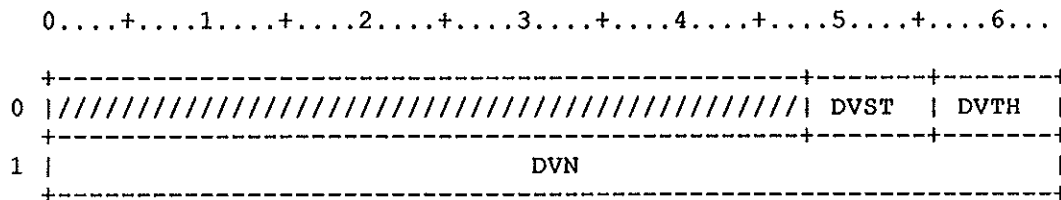

Figure PM-11. Device List Entry for PMFCONSM
 LE@PMDVL=2 Length of device list entry

Field	Word(base8)	Bits	Description
PMDVST	0	48-55	Device status
PMDVTH	0	56-63	Device threshold percentage (0-100)
PMDVN	1	0-63	Device name, LJZF

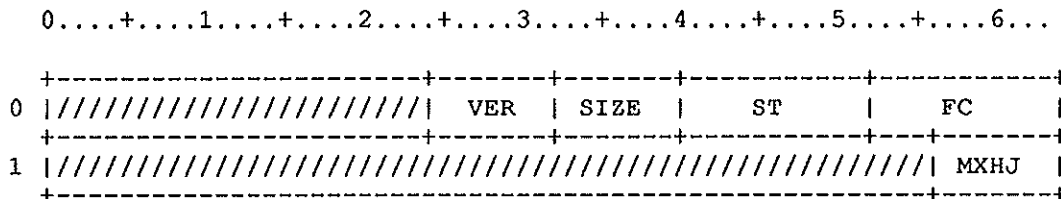

Figure PM-12. PDD For PMFCONRC and PMFCONCU
 L@PMONRC=2 PDD size for PMFCONRC
 L@PMONCU=2 PDD size for PMFCONCU

Field	Word(base8)	Bits	Description
PMVER	0	24-31	PDD Version number
PMSIZE	0	32-39	PDD size in words
PMST	0	40-51	Return status
PMFC	0	52-63	Function code (see chart PM-1)
PMMXHJ	1	56-63	Maximum number of helper jobs

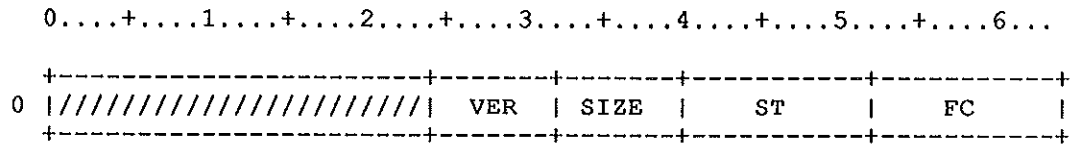

Figure PM-13. PDD For PMFCONxH through PMFCOFxx

- L@PMONBH=1 PDD size for PMFCONBH
- L@PMONSH=1 PDD size for PMFCONSH
- L@PMONRH=1 PDD size for PMFCONRH
- L@PMONCH=1 PDD size for PMFCONCH
- L@PMOFBU=1 PDD size for PMFCOFBU
- L@PMOFSM=1 PDD size for PMFCOFSM
- L@PMOFRC=1 PDD size for PMFCOFRC
- L@PMOFUCU=1 PDD size for PMFCOFUCU
- L@PMOFBH=1 PDD size for PMFCOFBH
- L@PMOFSH=1 PDD size for PMFCOFSH
- L@PMOFRH=1 PDD size for PMFCOFRH
- L@PMOFCH=1 PDD size for PMFCOFCH

Field	Word(base8)	Bits	Description
PMVER	0	24-31	PDD Version number
PMSIZE	0	32-39	PDD size in words
PMST	0	40-51	Return status
PMFC	0	52-63	Function code (see chart PM-1)

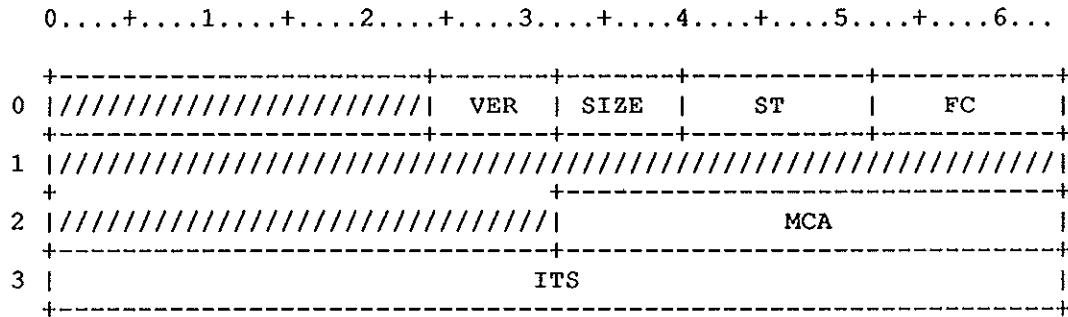

Figure PM-14. PDD For PMFCSDEI
L@PMSDEI=4 PDD size for PMFCSDEI

Field	Word(base8)	Bits	Description
PMVER	0	24-31	PDD Version number
PMSIZE	0	32-39	PDD size in words
PMST	0	40-51	Return status
PMFC	0	52-63	Function code (see chart PM-1)
PMCA	2	32-63	Master Catalog address
PMITS	3	0-63	Identifying Timestamp

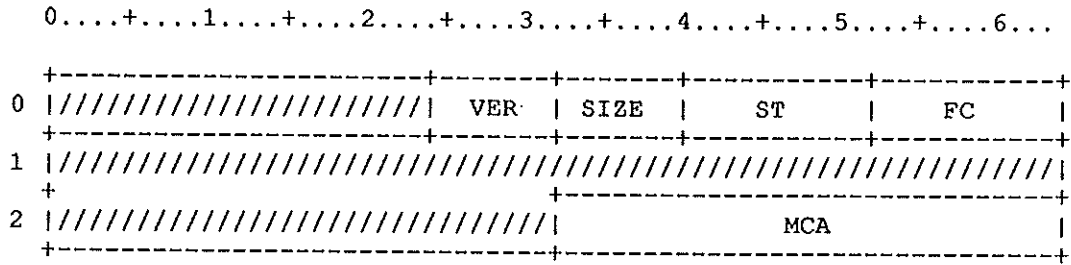

Figure PM-15. PDD For PMFCCDEI
 L@PMCCDEI=3 PDD size for PMFCCDEI

Field	Word(base8)	Bits	Description
PMVER	0	24-31	PDD Version number
PMSIZE	0	32-39	PDD size in words
PMST	0	40-51	Return status
PMFC	0	52-63	Function code (see chart PM-1)
PMMCA	2	32-63	Master Catalog address

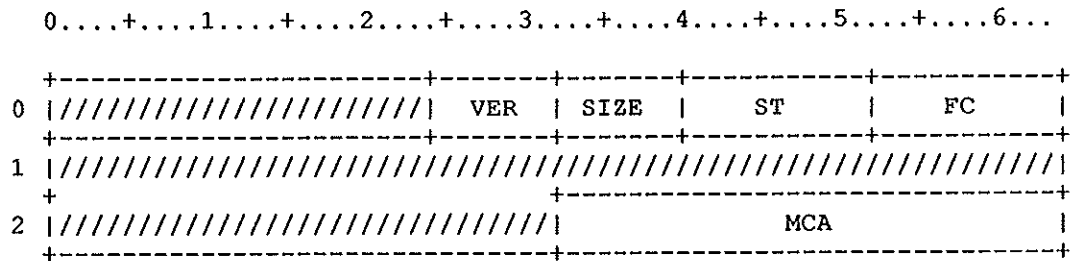

Figure PM-16. PDD For PMFCRET thru PMFCSRLD
 L@PMRET=3 PDD size for PMFCRET
 L@PMMIG=3 PDD size for PMFCMIG
 L@PMDEL=3 PDD size for PMFCDEL
 L@PMSBRS=3 PDD size for PMFCSBRS
 L@PMCBRS=3 PDD size for PMFCCBRS
 L@PMSRLD=3 PDD size for PMFCSRLD

<u>Field</u>	<u>Word(base8)</u>	<u>Bits</u>	<u>Description</u>
PMVER	0	24-31	PDD Version number
PMSIZE	0	32-39	PDD size in words
PMST	0	40-51	Return status
PMFC	0	52-63	Function code (see chart PM-1)
PMMCA	2	32-63	Master Catalog address

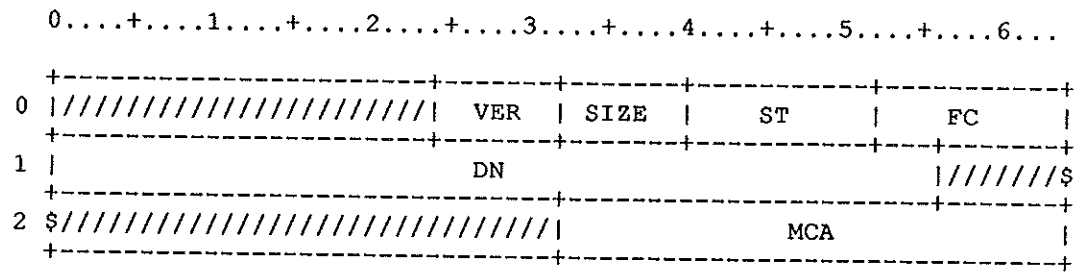

Figure PM-17. PDD For PMFCBUAC
 L@PMBUAC=3 PDD size for PMFCBUAC

Field	Word(base8)	Bits	Description
PMVER	0	24-31	PDD Version number
PMSIZE	0	32-39	PDD size in words
PMST	0	40-51	Return status
PMFC	0	52-63	Function code (see chart PM-1)
PMDN	1	0-55	Local dataset name
PMMCA	2	32-63	Master Catalog address

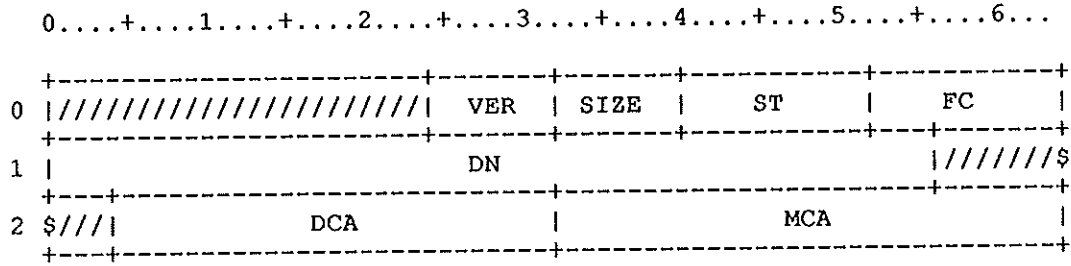

Figure PM-18. PDD For PMFCRLD
L@PMRLD=3 PDD size for PMFCRLD

Field	Word(base8)	Bits	Description
PMVER	0	24-31	PDD Version number
PMSIZE	0	32-39	PDD size in words
PMST	0	40-51	Return status
PMFC	0	52-63	Function code (see chart PM-1)
PMDN	1	0-55	Local dataset name
PMDCA	2	4-31	Dataset Catalog address
PMMCA	2	32-63	Master Catalog address

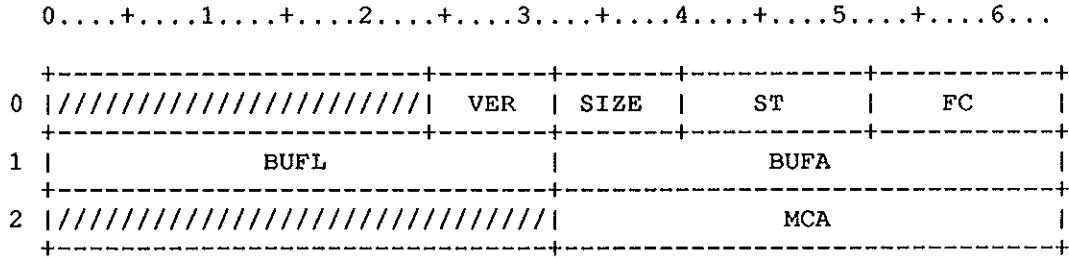

Figure PM-19. PDD For PMFCWRBC
 L@PMWRBC=3 PDD size for PMFCWRBC

<u>Field</u>	<u>Word(base8)</u>	<u>Bits</u>	<u>Description</u>
PMVER	0	24-31	PDD Version number
PMSIZE	0	32-39	PDD size in words
PMST	0	40-51	Return status
PMFC	0	52-63	Function code (see chart PM-1)
PMBUFL	1	0-31	Buffer length
PMBUFA	1	32-63	Buffer address
PMMCA	2	32-63	Master Catalog address

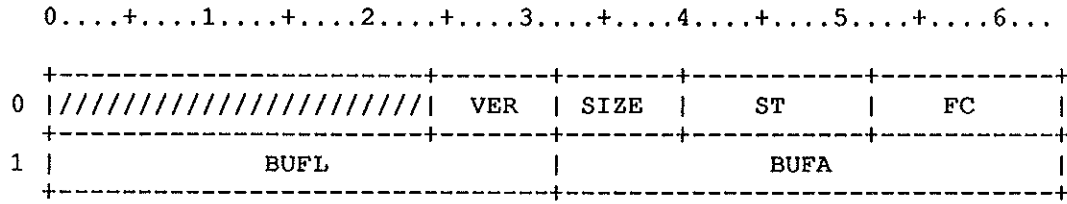

Figure PM-20. PDD For PMFCGLDV and PMFCGRRL
 L@PMGLDV=2 PDD size for PMFCGLDV
 L@PMGRRL=2 PDD size for PMFCGRRL

Field	Word(base8)	Bits	Description
PMVER	0	24-31	PDD Version number
PMSIZE	0	32-39	PDD size in words
PMST	0	40-51	Return status
PMFC	0	52-63	Function code (see chart PM-1)
PMBUFL	1	0-31	Buffer length
PMBUFA	1	32-63	Buffer address

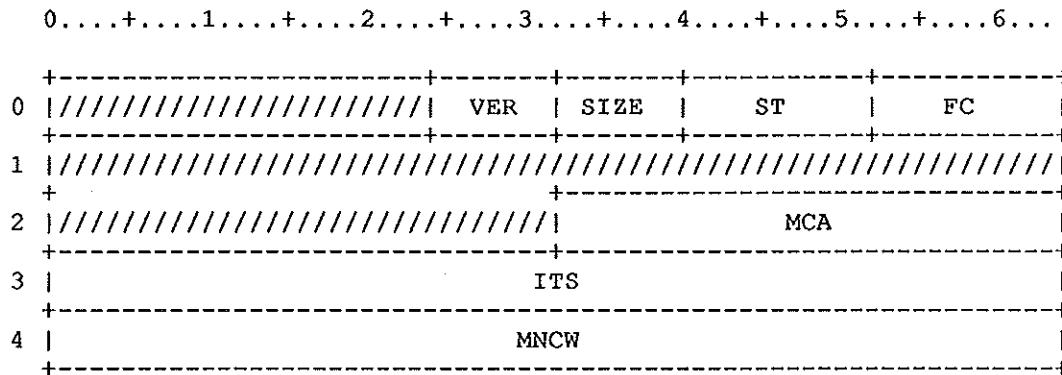

Figure PM-21. PDD For PMFCSRET, PMFCSRES, PMFCSDEL, PMFCSMIG
 L@PMSRET=5 PDD size for PMFCSRET
 L@PMSRES=5 PDD size for PMFCSRES
 L@PMSDEL=5 PDD size for PMFCSDEL
 L@PMSMIG=5 PDD size for PMFCSMIG

Field	Word(base8)	Bits	Description
PMVER	0	24-31	PDD Version number
PMSIZE	0	32-39	PDD size in words
PMST	0	40-51	Return status
PMFC	0	52-63	Function code (see chart PM-1)
PMMCA	2	32-63	Master Catalog address
PMITS	3	0-63	Identifying Timestamp
PMMNCW	4	0-63	Maintenance Control Word

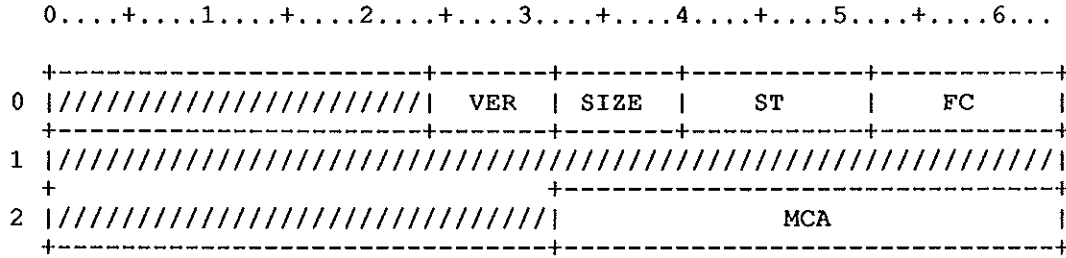

Figure PM-22. PDD For PMFCARCL
 L@PMARCL=3 PDD size for PMFCARCL

<u>Field</u>	<u>Word(base8)</u>	<u>Bits</u>	<u>Description</u>
PMVER	0	24-31	PDD Version number
PMSIZE	0	32-39	PDD size in words
PMST	0	40-51	Return status
PMFC	0	52-63	Function code (see chart PM-1)
PMMCA	2	32-63	Master Catalog address

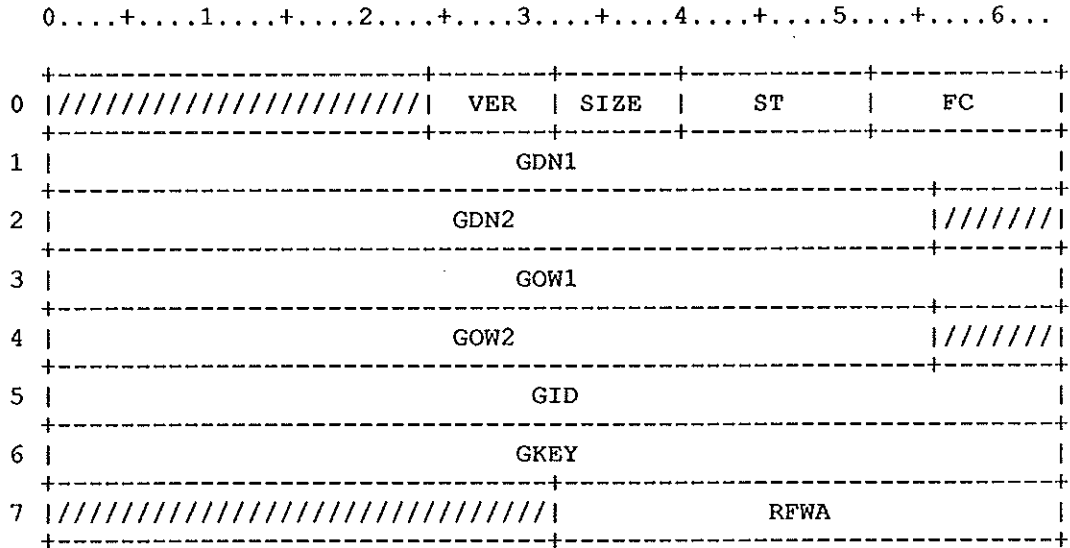

Figure PM-23. PDD for PMFCGKEY
 L@PMGKEY=D'8 PDD size for PMFCGKEY

Field	Word(base8)	Bits	Description
PMVER	0	24-31	PDD version number
PMSIZE	0	32-39	PDD size in words
PMST	0	40-51	Return status
PMFC	0	52-63	Function code (see chart PM-1)
PMGDN1	1	0-63	Permanent dataset name (1-8)
PMGDN2	2	0-55	Permanent dataset name (9-15)
PMGOW1	3	0-63	Owner (1-8)
PMGOW2	4	0-55	Owner (9-15)
PMGID	5	0-63	ID
PMGKEY	6	0-63	Return hash key
PMRFWA	7	32-63	Owner's region FWA

This comdeck defines symbols to be used in making requests of the permanent dataset manager, PDM.

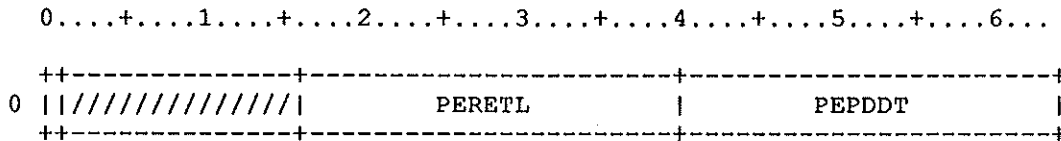

Figure PQ-1. PDM Request Definitions

Input+0

Field Word(base8) Bits Description

PQRET	0	16-39	Return address
PQPDD	0	40-63	PDD address

Input+1

PQSYS	1	0	=1 if system call, =0 if user call
PQTXO	1	1-15	TXT ordinal, if task-related request
PQDT	1	16-39	DAT/DNT address
PQJTA	1	40-63	JTA address, if job-related request

Define the error message lookup table format. Do the definition of this table format in a common deck, since EXP also uses the error message table.

PEMPDN	0	0	PDN informative line required
PEMTXL	0	16-39	Message length, in words
PEMTXT	0	40-63	Message address

The Procedure File Stack Table is JTA resident and serves as a stack for the nesting of control statement datasets. The F\$PRC and F\$RTN calls add entries to and delete them from this stack.

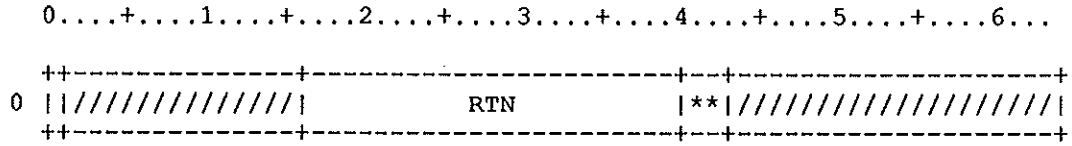

Figure PR-1. Procedure File Stack Table header

<u>Field</u>	<u>Word(base8)</u>	<u>Bits</u>	<u>Description</u>
PRABT	0	0	RTN abort flag
PRRTN	0	16-39	RTN return address
PRLVL	0	40-42	Current stack level (0-7)

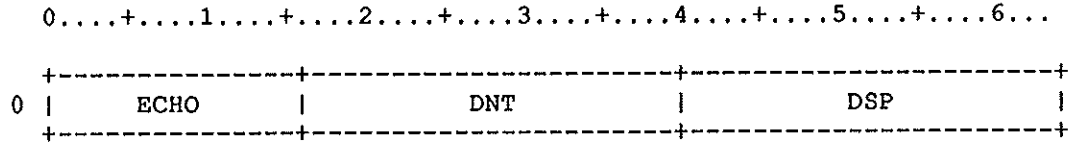

Figure PR-2. Procedure File Stack Table entry

Field	Word(base8)	Bits	Description
PRECHO	0	0-15	ECHO status of message classes
PRDNT	0	16-39	\$CS DNT address (JTA relative)
PRDSP	0	40-63	\$CS JTA save area address (JTA relative)
N@NLRT	= D'10		
N@SUFR	= D'512		
N@LSIZ	= D'5000		
S%S	= 1S0		Job is swapped off device
S%R	= 1S1		Job is device resident
S%L	= 1S2		Job is loading to or from device
S%I	= 1S3		Job is waiting initial allocation
S%U	= 1S4		Job has unaligned swap space allocatio
S%Q	= 1S5		Job is waiting initial request

The Preemption Table is built whenever preemptable resources are declared in the startup parameter file. The table is stored in memory pool PRPOOL in the STP tables area. The PRT is used to store universal information related to preemptable resources such as minimum residence time (thrash lock) and a list of preferred devices for holding swapped dataset images.

0....+....1....+....2....+....3....+....4....+....5....+....6....

0	NM	////////////////////////////////////				
1	NWP	WPT	PRL			
2	TQH	TQT	////////////////////////////////////			
3	TL					
4	NBTF					
5	OMR					
6	EVR					
7	TOM					
10	TEV					
11	////////////////////////////////	OMN	////////	OMA		
12	////////////////////////////////	SWR	////////////////////////////////			
13	TCS	TAL				
14	SSN	/////////////////////////////////\$				
15	\$\$\$	ADS	ADR	JLP	SWS	RES

Figure PR-1. Preemption Table

<u>Field</u>	<u>Word(base8)</u>	<u>Bits</u>	<u>Description</u>
PRNM	0	0-23	Table name in ASCII (PRT)
PRNWP	1	0-15	Number of WPT entries
PRWPT	1	16-39	Address of first WPT entry (STP rel)
PRPRL	1	40-63	Address of preferred swap device list
PRTQH	2	0-15	Head of PRTQ
PRTQT	2	16-31	Tail of PRTQ
PRTL	3	0-63	Thrash lock in cycles
PRNBTF	4	0-63	Time between DAT space acquisition
PROMR	5	0-63	Operator message refresh in cycles
PREVR	6	0-63	Environmental check refresh in cycles
PRTOM	7	0-63	Time of next operator message
PRTEV	10	0-63	Time of next environmental check
PRMRI	11	0	Operator message reissue flag
PROMN	11	16-31	Operator message number reply pending
PROMA	11	40-63	Address of last FSS warning message
PRNPS	12	0	No pool space if set
PRISS	12	1	Insufficient swap space if set
PRNSW	12	2	SWEEP not possible if set
PRTGR	12	3	PGR scheduling trigger
PRSWR	12	16-39	Address of SWAP display segment
PRTCS	13	0-31	Total configured size of swap space
PRTAL	13	32-63	Total swap space allocated
PRSSN	14	0-31	Current swap space needs (TCS-TAL)
PRADS	15	4-15	Number of job aborts during sweep
PRADR	15	16-27	Number of job aborts during restore
PRJLP	15	28-39	Number of JTA loads
PRSWS	15	40-51	Number of sweeps

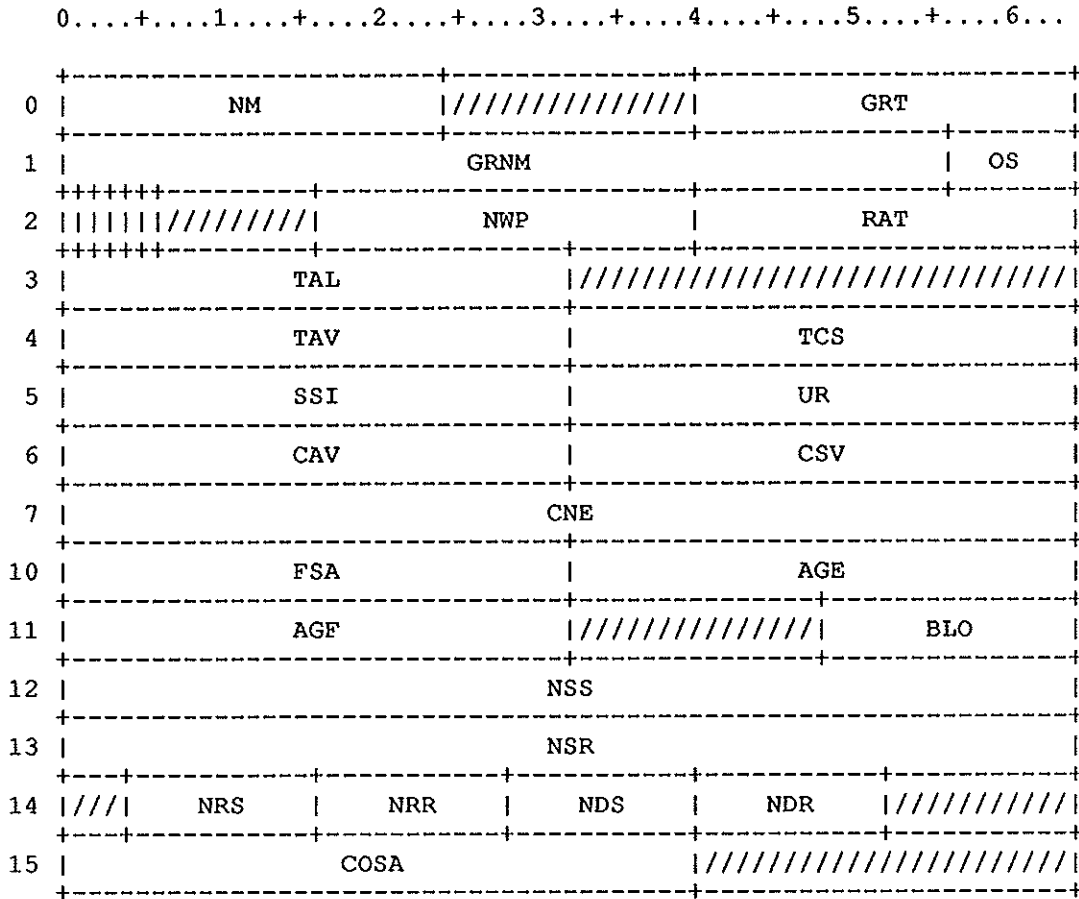

Figure WP-1. Swap Space Table

Field	Word(base8)	Bits	Description
WPNM	0	0-23	Table name in ASCII (WPT)
WPGRT	0	40-63	GRT entry address for this resource
WPGRNM	1	0-55	Generic resource name in ASCII
WPOS	1	56-63	Oversubscription factor
WPSWE	2	0	Resource in SWEEP mode if set
WPCD	2	1	Resource configured down if set
WPSSR	2	2	Swap space released if set
WPUSP	2	3	Unaligned swap space present

<u>Field</u>	<u>Word(base8)</u>	<u>Bits</u>	<u>Description</u>
WPSST	2	4	Sweep status toggled if set
WPBLK	2	5	Resource blocked if set
WPNWP	2	16-39	Address of next WPT
WPRAT	2	40-63	Head of RAT queue for this resource
WPTAL	3	0-31	Total swap sectors allocated
WPTAV	4	0-31	Current size of swap space - sectors
WPTCS	4	32-63	Configured size of swap space
WPSSI	5	0-31	Current system infringement
WPUR	5	32-63	Current uninitiated OIR's
WPCAV	6	0-31	Current space available on resource
WPCSV	6	32-63	Current sweep volume
WPCNE	7	0-63	Current space needs
WPFSA	10	0-31	Space available after sweeps complete
WPAGE	10	32-63	Space associated with jobs JXPTLE
WPAGF	11	0-31	Space associated with jobs ~JXPTLE
WPBLO	11	48-63	Block limit ordinal
WPNSS	12	0-63	Number of sectors swept
WPNSR	13	0-63	Number of sectors restored
WPNRS	14	4-15	Number of RAT's swept
WPNRR	14	16-27	Number of RAT's restored
WPNDS	14	28-39	Number of datasets swept
WPNDR	14	40-51	Number of datasets restored
WPCOSA	15	0-39	Current oversub. ratio (ASCII xx.xx)

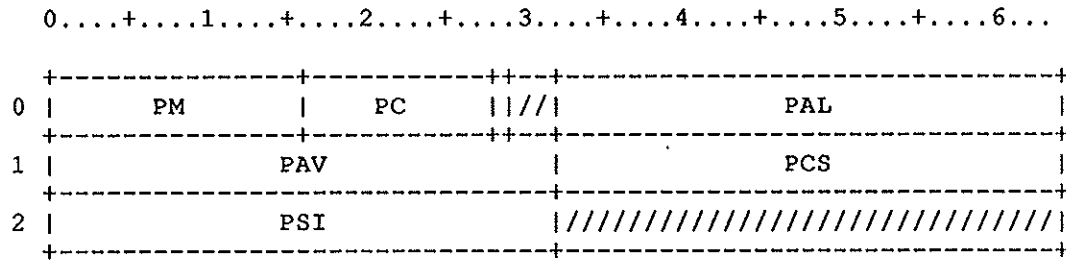

Figure WP-2. Swap Space Table Entry

Field	Word(base8)	Bits	Description
WPPM	0	0-15	Partition priority mask
WPPC	0	16-27	Partition size as percent of swap spac
WPU DP	0	28	Undeclared partition if set
WPPAL	0	32-63	Partition sectors allocated
WPPAV	1	0-31	Current partition size (sectors)
WPPCS	1	32-63	Configured size of partition
WPPSI	2	0-31	Current system infringement

The Preemptable Resource Allocation Table (RAT) is created whenever a job needing preemptable generic resources is initiated. One RAT is created for each resource needed. RAT's are linked together in two ways. All RAT's associated with a specific generic resource comprise a list with header in the WPT. All RAT's associated with a JXT comprise a list with header in the JXT. The RAT indicate swap space allocation by partition along with swap status.

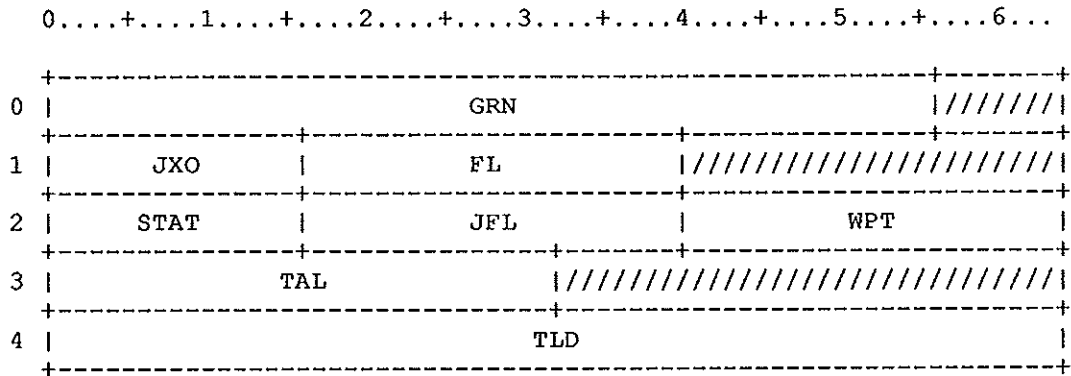

Figure RA-1. Resource Allocation Table

Field	Word(base8)	Bits	Description
RAGRN	0	0-55	Generic resource name
RAJXO	1	0-15	JXT ordinal
RAFL	1	16-39	RAT queue forward link
RASTAT	2	0-15	RAT status (binary)
RASEGS	2	11-15	RAT statuses relevant to RSTAT segment
RAJFL	2	16-39	JXT RAT list forward link
RAWPT	2	40-63	WPT address
RATAL	3	0-31	Total swap space allocated
RATLD	4	0-63	Thrash lock destination time

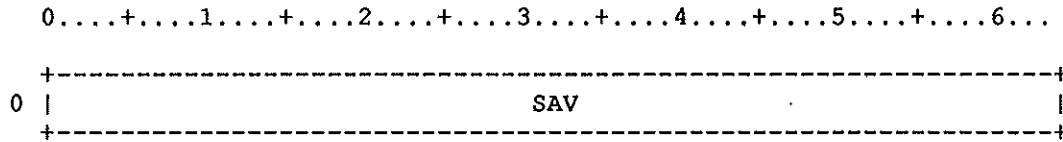

Figure RA-2. Resource Allocation Table Entry

<u>Field</u>	<u>Word(base8)</u>	<u>Bits</u>	<u>Description</u>
RASAV	0	0-63	Swap space allocation vector element
N@MPRPSZ = SZ@PRT+N@NPRD*SZ@WPT+20*SZ@RAT			

The Transfer Table (TFT) is used by JSH during the data movement process. The table is built in the user field. Some of the address information in the TFT can be stored either as STP-relative or as JTA-relative. The TFMODE field indicates which way addresses are currently represented.

0.....+.....1.....+.....2.....+.....3.....+.....4.....+.....5.....+.....6...

0		MODE	
1		NAD	
2		FDAL	
	\$		\$
6			
7		NDAL	
	\$		\$
13			
14		SOUR	
	\$		\$
54			
55		DEST	
	\$		\$
n			

Figure TF-1. Transfer Table

TFMODE	0	0-63	Table address mode (0=STP, 1=JTA)
<u>Field</u>	<u>Word(base8)</u>	<u>Bits</u>	<u>Description</u>
TFNAD	1	0-63	Address of next available local DAT
TFFDAL	2-6	0-63	DZT for FSS DAT accumulation list
TFNDAL	7-13	0-63	DZT for non-FSS DAT accumulation list
TFSOUR	14-54	0-63	DNT for \$SOURCE
TFDEST	55-n	0-63	DNT for \$DEST
TFRAT	116	0-63	Current RAT address
TFDNT	117	0-63	Address of current candidate
TFTFRT	120	0-63	Transfer failure retry counter
TFRTIM	121	0-63	Next time to retry transfer
TFNBC	122	0-63	Number of sectors left to copy
TFDAT	123	0-63	First DAT of candidate in JTA
TFNDAT	124	0-63	Number of DAT pages in STP
TFMEM	125	0-63	Memory request if JTA must expand
TFSZ	126	0-63	Sectors allocated during data movement
TFDSZ	127	0-63	Written size of candidate

Name: Process Save Area (PSA).

Purpose: The Process Save Area is a block defined for each process in the operating system. The PSA includes the process Exchange Package, register save areas for B and T registers, and additional storage needed on a per-process basis. PSA entries exist in EXEC in the PWXS for user, idle, GOS and diagnostic processes, and in the STXS for each system task.

Note: The Process Save Area must be a multiple of LE@XP, since they will be stacked in the PWXS and STXS.

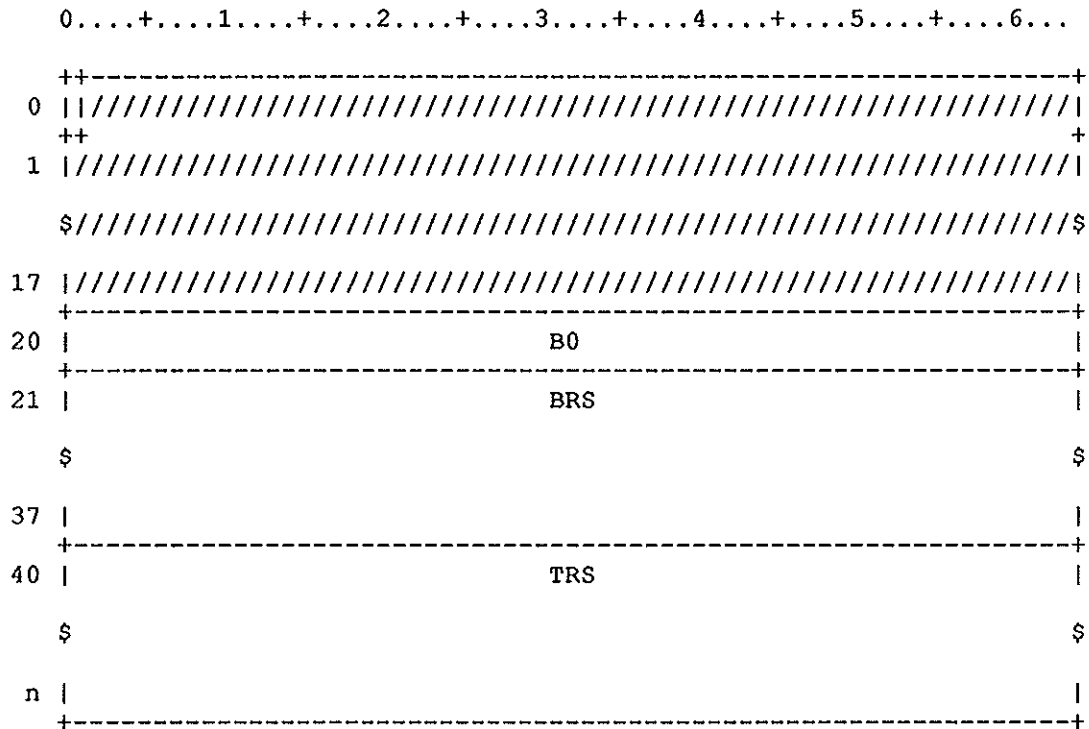

Figure PS-1. Process Save Area

<u>Field</u>	<u>Word(base8)</u>	<u>Bits</u>	<u>Description</u>
PSXP	0	0	Process Exchange Package
PSB0	20	0-63	Process B0
PSBRS	21-37	0-63	Additional B register save area
PSTRS	40-n	0-63	T register save area

The following series of SETs ensures that the PSA entry is a multiple of LE@XP in length.

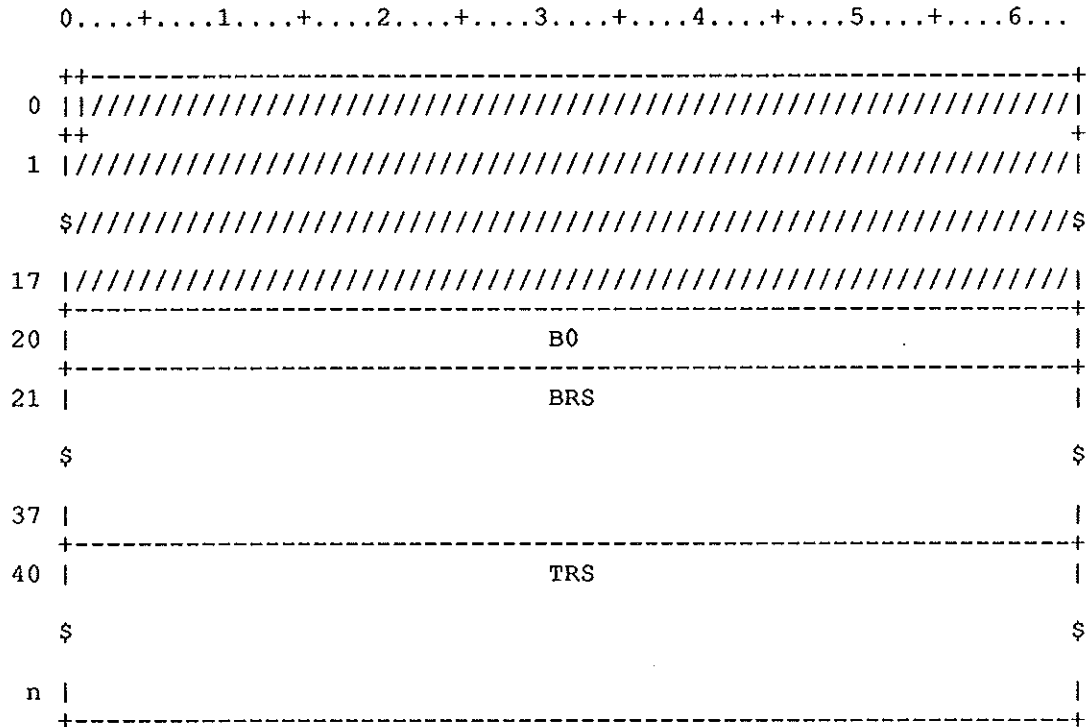

Figure PS-1. Process Save Area

<u>Field</u>	<u>Word(base8)</u>	<u>Bits</u>	<u>Description</u>
PSEND	57	0-63	Define last word of the entry

The Pool Table is an STP-resident table used for memory pool management.

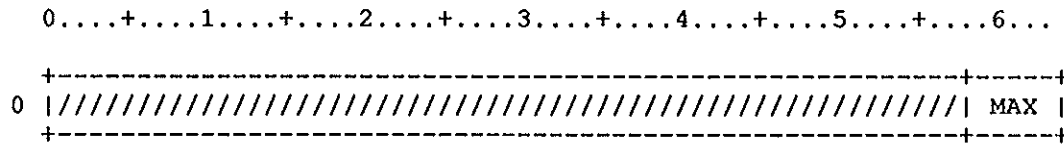

Figure PT-1. Memory Pool Table header

Field	Word(base8)	Bits	Description
PTMAX	0	58-63	Maximum valid pool number

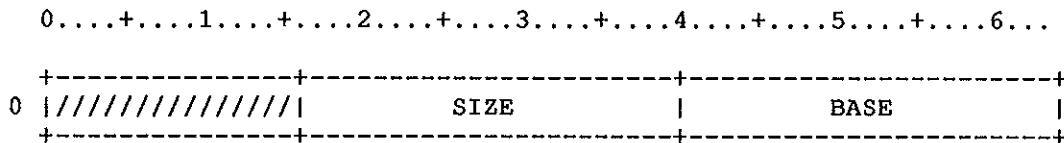

Figure PT-2. Memory Pool Table Entry

Field	Word(base8)	Bits	Description
PTSIZE	0	16-39	Size of the memory pool
PTBASE	0	40-63	Base address of the memory pool

Name: Processor Working Storage (PWS).

Purpose: There is one PWS entry in EXEC memory for each CPU configured. It contains CPU-specific data and pointers to Process Save Areas (PSAs).

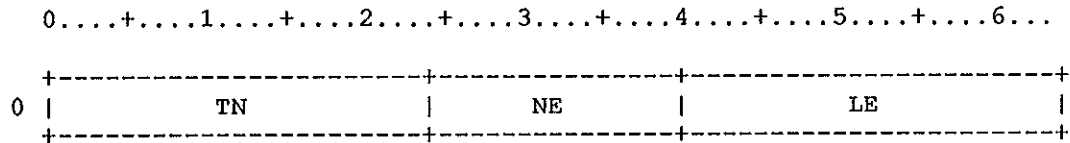

Figure PW-1. Processor Working Storage header

Header.

<u>Field</u>	<u>Word(base8)</u>	<u>Bits</u>	<u>Description</u>
PWTN	0	0-23	Table name (ASCII 'PWS')
PWNE	0	24-39	Number of entries (=NE@PWS)
PWLE	0	40-63	Length of entry (=LE@PWS)

Entry. First word is identification and CPU status.
 Comments start in column 40.

0....+....1....+....2....+....3....+....4....+....5....+....6...

0	HEAD	STAT
1	UXP	
2	UTXT	
3	UTCB	
4	UJTA	
5	UTSB	
6	UCL	
7	PMGN	
10	PMCB	
11	SAEF	
12	SXTC	
13	AID	
14	IHT	
15	ICT	
16	CSH	
17	OSID	
20	APB	
21	PXT	
22	UXPA	
23	IXPA	
24	GXPA	
25	DXPA	

Figure PW-2. Processor Working Storage entry

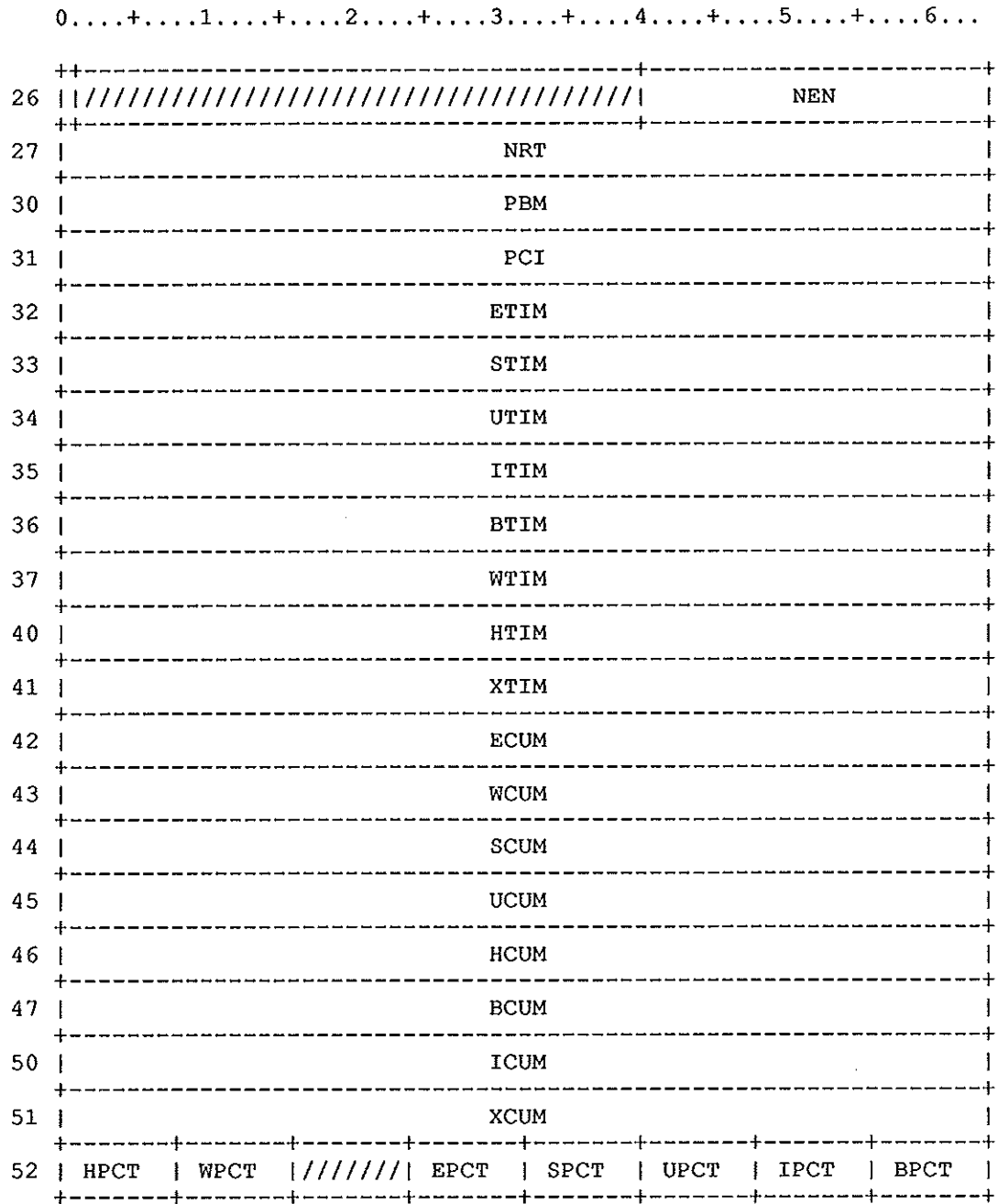

Figure PW-2. Processor Working Storage entry

<u>Field</u>	<u>Word(base8)</u>	<u>Bits</u>	<u>Description</u>
PWHEAD	0	0-31	Entry header (ASCII 'CPUn')
PWSTAT	0	32-63	Processor status
PWGINI	0	51	NZ if GOS init. incomplete
PWHPMS	0	52	NZ if a perf. monitor selected
PWUPMA	0	53	NZ if user task is using the hardware performance mon.
PWCUMT	0	54	NZ if connected user task is a member of a multitasking job
PWTASK	0	55	NZ if STP task to exec./excting
PWUSER	0	56	NZ if user to execute/executing
PWDOWN	0	57	NZ if CPU is DOWN or MAINT
PWUTSF	0	58	NZ if user has a TSB defined
PWSUXC	0	59	NZ if user XP in TCB; ZR if PWS
PWGOC	0	60	NZ if CPU on-call for GOS use
PWGOS	0	61	CPU is hosting a guest O.S.
PWINIT	0	62	CPU requested to start
PWEXEC	0	63	CPU has started execution
User job information.			
PWUXP	1	0-63	EXEC address of connected user XP (NZ if any user connected)
PWUTXT	2	0-63	EXEC-rel address of connected TXT
PWUTCB	3	0-63	EXEC-rel address of connected TCB
PWUJTA	4	0-63	EXEC-rel address of JTA for user task connected.
PWUTSB	5	0-63	EXEC-rel addr of user's task status block (0 if none)
PWUCL	6	0-63	XMP cluster assigned to user task
PWPMGN	7	0-63	Perf. mon. group no.
PWPMCB	10	0-63	Perf. mon. control block addr or TCB field TCTSWS addr (EXEC-rel)
PWSAEF	11	0-63	W@XPF from XP for some requests
PWSXTC	12	0-63	RT at start of EXEC interval
PWAID	13	0-63	ASCII ID of process currently in CPU: USER/IDLE/MEM-COR/task/EXEC/MAINT/DOWN.
PWIHT	14	0-63	Interrupt handler table addr
PWICT	15	0-63	Interrupt count table addr

<u>Field</u>	<u>Word(base8)</u>	<u>Bits</u>	<u>Description</u>
PWCSH	16	0-63	CPU scheduler addr
PWOSID	17	0-63	Operating system name
PWAPB	20	0-63	Active STT entry address
PWPXT	21	0-63	EXEC-rel PXT address for this CPU

Process Save Area pointers.

PWUXPA	22	0-63	User task XP address
PWIXPA	23	0-63	Idle task XP address
PWGXPA	24	0-63	Guest task XP address
PWDXPA	25	0-63	Diagnostic task XP address

Time event and programmable clock information.

PWCAN	26	0	Event cancelled flag
PWNEN	26	40-63	Event number (-1 if none)
PWNRT	27	0-63	Real time of event (if NEN > 0)
PWPBM	30	0-63	Processor-specific bit map
PWPCI	31	0-63	Last PCI value set

Processor execution time information.

PWETIM	32	0-63	EXEC time in interval
PWSTIM	33	0-63	STP time in interval
PWUTIM	34	0-63	User time in interval
PWITIM	35	0-63	Idle time in interval
PWBTIM	36	0-63	I/O blocked time in interval
PWWTIM	37	0-63	SYSWAIT time in interval
PWHTIM	40	0-63	USER WS time in interval
PWXTIM	41	0-63	New SYSWAIT time in interval
PWECUM	42	0-63	EXEC time since last SPM call
PWWCUM	43	0-63	SYSWAIT time since last SPM call
PWSCUM	44	0-63	STP time since last SPM call

<u>Field</u>	<u>Word(base8)</u>	<u>Bits</u>	<u>Description</u>
PWUCUM	45	0-63	User time since last SPM call
PWHCUM	46	0-63	USER WS time since last SPM call
PWBCUM	47	0-63	Blocked time since last SPM call
PWICUM	50	0-63	Idle time since last SPM call
PWXCUM	51	0-63	New SYSWAIT time since last SPM call
PWHPCT	52	0-7	USER WS percent time in interval
PWWPCT	52	8-15	SYSWAIT percent time in interval
PWEPCT	52	24-31	EXEC percent time in interval
PWSPCT	52	32-39	STP percent time in interval
PWUPCT	52	40-47	User percent time in interval
PWIPCT	52	48-55	Idle percent time in interval
PWBPCT	52	56-63	Blocked percent time in interval

The PWT contains data from the program to be loaded. The data is specified as a starting bit of a word and a number of bits. The loading can cross boundaries.

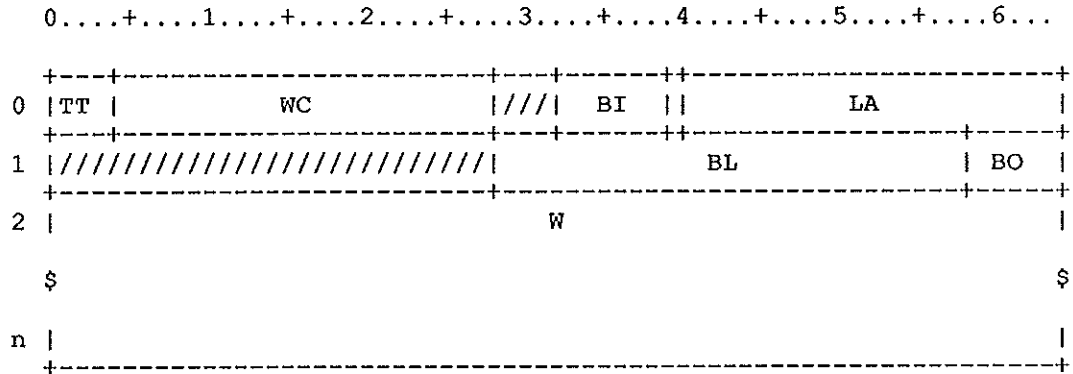

Figure PWT-1. Partial Word Table

<u>Field</u>	<u>Word(base8)</u>	<u>Bits</u>	<u>Description</u>
PWTTT	0	0-3	Table type; 6
PWTWC	0	4-27	Table word count
PWTBI	0	32-38	Block index; specifies the block into which text will be loaded.
PWTQ	0	39	Relocation mode of the entry name; this field is always 0.
PWTLA	0	40-63	Relative load address in block BI; LA is always specified as a word address.
PWTBL	1	28-57	Number of bits to be loaded
PWTBO	1	58-63	Bit offset; the leftmost bit of the field to be loaded
PWTW	2-n	0-63	Text words to be loaded into the program field in contiguous location starting at an address determined by adding LA to the base address indicated for block BI

COMPX

Processor Execution table

The processor execution table is contained in the system task area, and is used by the job scheduler to determine which physical CPUs are available for user scheduling. As CPUs are brought online by EXEC, the corresponding entries in the PX table are updated. All other uses of the table are controlled by system tasks.

The address of the first entry is contained in STP pointer word CPSTAT. Subsequent entries follow at LE@PXT intervals.

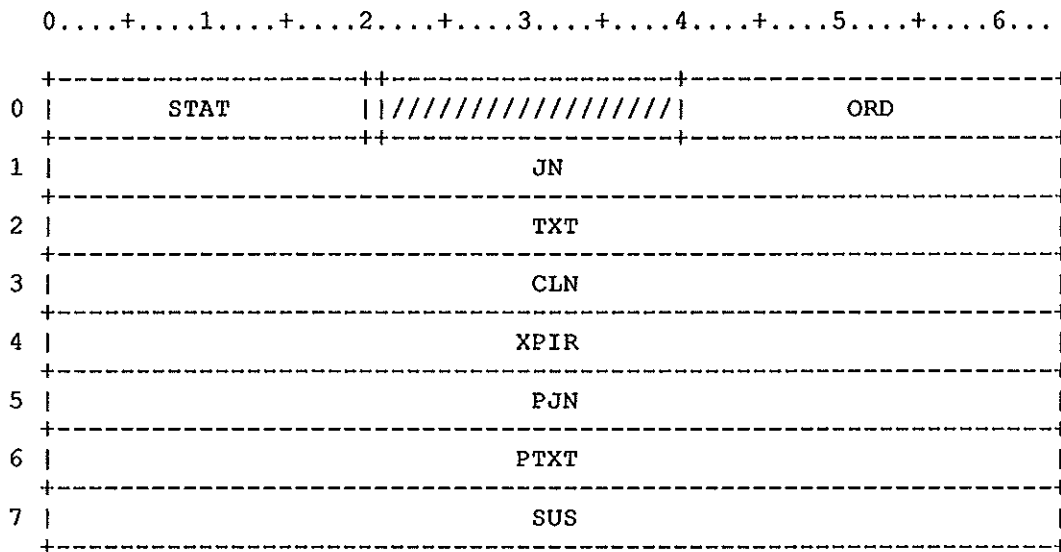

Figure PX-1. Processor execution table

Field	Word(base8)	Bits	Description
PXSTAT	0	0-19	CPU status information:
PXINIT	0	0	CPU initialization has completed
PXPVT	0	1	CPU available only by specific rqst.
PXIDLE	0	2	Operator has requested CPU be idled
PXGOS	0	3	CPU in use by guest O.S.
PXDOWN	0	4	CPU is DOWN if set PXDOWN set by JSH on a down request; cleared by EXEC on an up request
PXPEND	0	5-7	Status change pending (not available for COS users)
PXGRSV	0	20	CPU is on-call for use by guest O.S.

<u>Field</u>	<u>Word(base8)</u>	<u>Bits</u>	<u>Description</u>
PXORD	0	40-63	PXT entry ordinal (CPU number)
PXJN	1	0-63	Name of connected job
PXTXT	2	0-63	TXT address of connected task
PXCLN	3	0-63	Cluster number assigned to task
PXXPIR	4	0-63	NZ if time slice has expired for user.
PXPJN	5	0-63	Previously connected job name
PXPXT	6	0-63	Previously connected TXT address
PXSUS	7	0-63	CPU is in a hold state, do not connect
PX\$UP	= 1		CPU is UP
PX\$DOWN	= 2		CPU is DOWN
PX\$MNCP	= 3		CPU is in MAINTENANCE mode
PX\$SYCP	= 4		Return CPU to SYSTEM usage
PX\$GOSGO	= 5		Start the guest O.S.

This EXEC-resident table is used by the I/O Processor driver and time event scheduler. This table is manipulated by EXEC routines CLRQ, ENQ, and DEQ.

This is the table header for tables manipulated by the EXEC queue manager, specifically, FIQ, FOQ, and SCT.

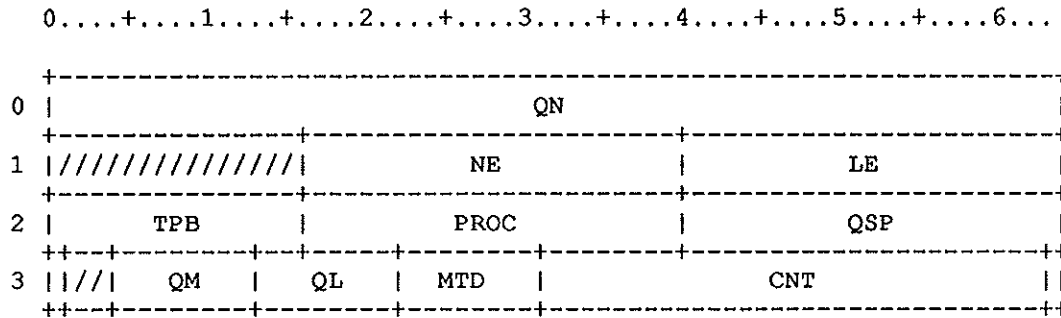

Figure QC-1. Queue Control Table header

Field	Word(base8)	Bits	Description
QCQN	0	0-63	Queue name
QCNE	1	16-39	Initial number of entries in queue
QCLE	1	40-63	Initial length of each queue entry
QCTPB	2	0-15	Task parameter block address
QCPROC	2	16-39	Queue processor address
QCQSP	2	40-63	Pointer to SCT table in STP task
QCINH	3	0	Inhibit enqueueing flag
QCQM	3	4-12	Maximum allowable queue length
QCQL	3	13-21	Current number of items in the queue
QCMTD	3	22-30	Maximum queue length to date
QCCNT	3	31-62	Total items ever queued

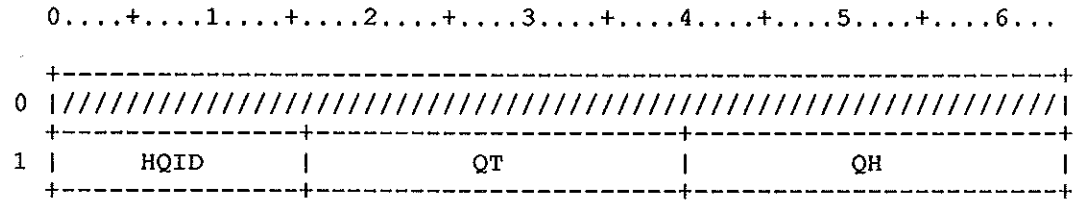

Figure QC-2. Word 1 After Initialization

Field	Word(base8)	Bits	Description
QCQID	1	0-15	Queue head ID
QCQT	1	16-39	Queue tail link address
QCQH	1	40-63	Queue head link address

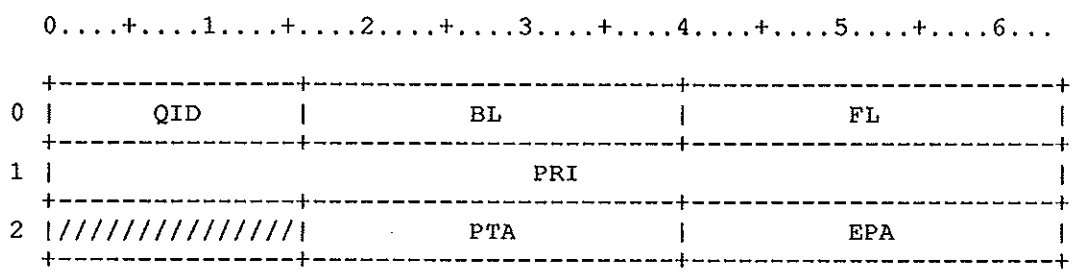

Figure QC-3. Priority and time event queue entry

Field	Word(base8)	Bits	Description
QCQID	0	0-15	Queue ID (two ASCII characters)
QCBL	0	16-39	Backward link address
QCFL	0	40-63	Forward link address
QCPRI	1	0-63	Priority level (for priority enqueue)
QCPTA	2	16-39	Parameter table address
QCEPA	2	40-63	Event processor address

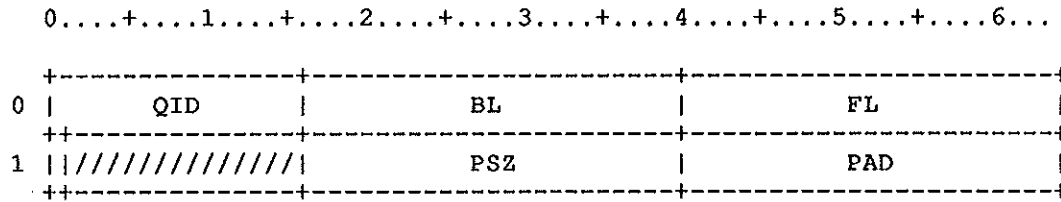

Figure QC-4. IOP driver packet queue Entry

Field	Word(base8)	Bits	Description
QCQID	0	0-15	Queue ID (two ASCII characters)
QCBL	0	16-39	Backward link address
QCFL	0	40-63	Forward link address
QCFREE	1	0	Free packet after output
QCPSZ	1	16-39	Packet size in words
QCPAD	1	40-63	EXEC relative packet address

The Queued Dataset Table is an STP-resident table that describes the multitype attributes for a dataset that has been disposed. This table is managed by PDM and EXP. The number of entries in the QDT equals the SDT entry count.

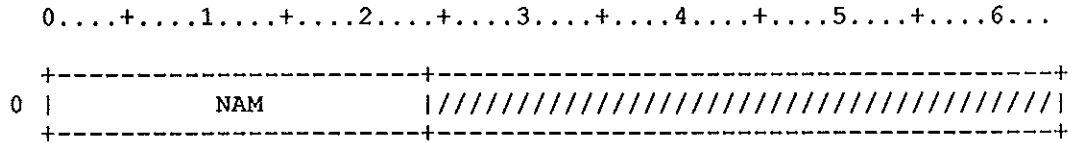

Figure QD-1. Queued Dataset Table header

Field	Word(base8)	Bits	Description
QDNAM	0	0-23	ASCII name of table, 'QDT'

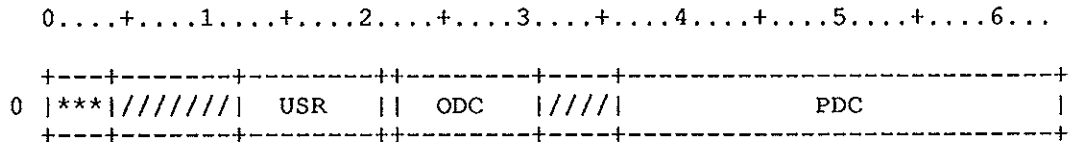

Figure QD-2. Queued Dataset Table entry

Field	Word(base8)	Bits	Description
QDSERR	0	0-3	STARTUP entry deactivation flags
QDDWN	0	0	Down device encountered
QDCRS	0	1	Cross allocation found
QDCAT	0	2	Catastrophic error in DSC entry
QDIDA	0	3	Inconsistent multitype allocation
QDUSR	0	12-20	Number of users who have disposed the dataset with no release
QDODC	0	22-30	Outstanding dispose count
QDPDC	0	36-63	DSC entry of permanent version
QDPDP	0	36-59	DSC page number
QDPDE	0	60-63	DSC entry number

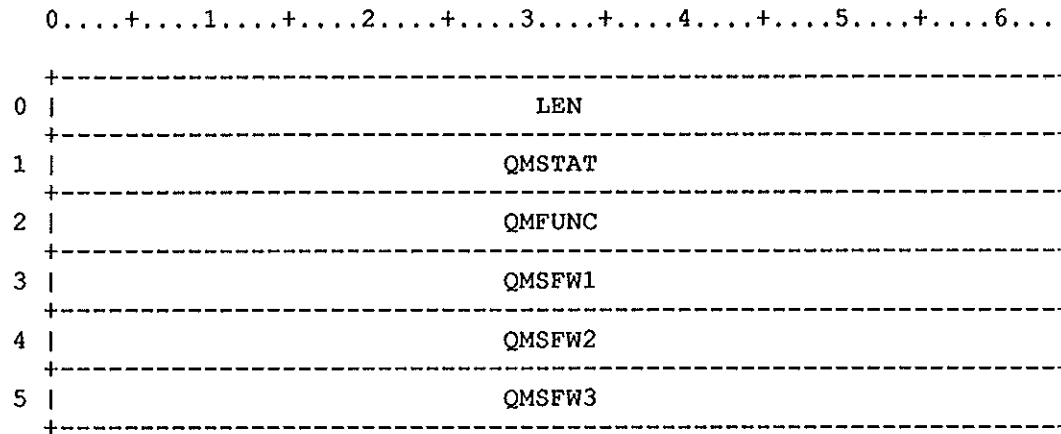

Figure QMP-1. F\$SDTQM parameter block

<u>Field</u>	<u>Word(base8)</u>	<u>Bits</u>	<u>Description</u>
QMPLEN	0	0-63	Length of the parameter block
QMSTAT	1	0-63	F\$SDTQM call status
QMFUNC	2	0-63	Subfunction
QMSFW1	3	0-63	Subfunction dependent word 1
QMSFW2	4	0-63	Subfunction dependent word 2
QMSFW3	5	0-63	Subfunction dependent word 3

QMF\$MIN	=	D'00	Minimum subfunction
QMF\$CHA	=	QMF\$MIN	Change an SDT entry
QMF\$ACC	=	QMF\$CHA+1	Access an SDT dataset
QMF\$REL	=	QMF\$ACC+1	Release an SDT dataset
QMF\$TXT	=	QMF\$REL+1	Read the text for a SDT entry
QMF\$SLT	=	QMF\$TXT+1	Read the slot for a SDT entry
QMF\$TAS	=	QMF\$SLT+1	Read text and slot for SDT entry
QMF\$MAX	=	QMF\$TAS	Maximum function
QMS\$MIN	=	D'00	Minimum status
QMS\$AOK	=	QMS\$MIN	Good call status
QMS\$BSF	=	QMS\$AOK+1	Bad subfunction
QMS\$NSJ	=	QMS\$BSF+1	No such JSQ
QMS\$INA	=	QMS\$NSJ+1	Invalid attribute
QMS\$INV	=	QMS\$INA+1	Invalid value
QMS\$BDN	=	QMS\$INV+1	Bad dataset name
QMS\$DNA	=	QMS\$BDN+1	Dataset not accessed
QMS\$DIU	=	QMS\$DNA+1	Dataset name already in use
QMS\$EDR	=	QMS\$DIU+1	Error occurred on dataset release
QMS\$IQR	=	QMS\$EDR+1	Invalid queue for request
QMS\$SYS	=	QMS\$IQR+1	System error (PDM returned an error)
QMS\$DAA	=	QMS\$SYS+1	Dataset already accessed (ie Access)
QMS\$BLN	=	QMS\$DAA+1	Bad parameter block length
QMS\$IBA	=	QMS\$BLN+1	Invalid text/slot buffer address
QMS\$BTS	=	QMS\$IBA+1	Text/slot buffer too small
QMS\$JCP	=	QMS\$BTS+1	Reissue - job class invoke pending
QMS\$MAX	=	QMS\$JCP	Maximum status

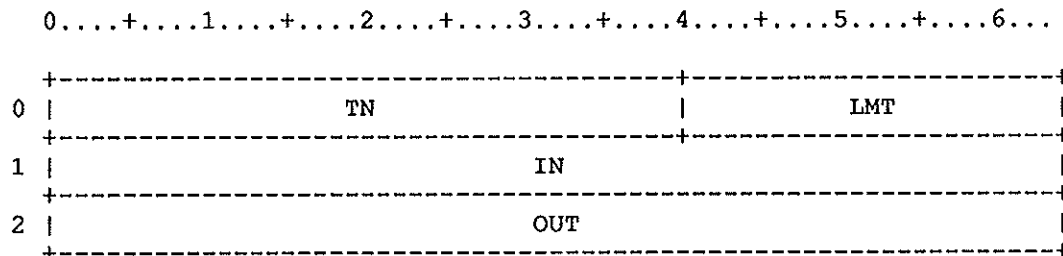

Figure QP-1. Queued Packet Table

Define the header

Field	Word(base8)	Bits	Description
QPTN	0	0-39	Table name in ASCII
QPLMT	0	40-63	LA+1 of entry area
QPIN	1	0-63	IN pointer (modified by sender)
QPOUT	2	0-63	OUT pointer (modified by receiver)

IN and OUT control the amount of valid information in the buffer. If IN == OUT the buffer is empty. If IN+LE@QPT == OUT the buffer is full. Note that the entry just before OUT can never be used, and hence for k usable entries, the queue must contain k+1 entries.

Note also that LMT, IN, and OUT are relative to the base of the QPT header, and hence should be initialized to (e.g., LMT) LH@QPT + LE@QPT*(number of entries).

Now define the entries

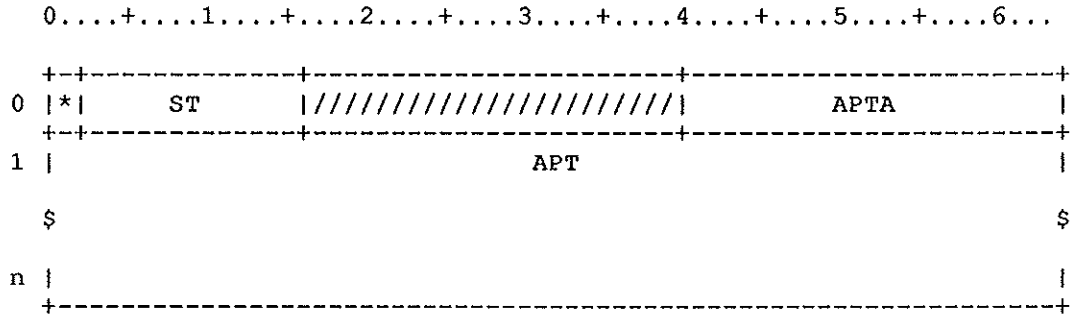

Figure QP-2. Queued Packet Table

Field	Word(base8)	Bits	Description
QPQST	0	0-1	Queue status flags
QPACTV	0	0	Active flag
QPDONE	0	1	Done flag
QPST	0	2-15	Status returned by EXEC
QPAPTA	0	40-63	APT addr (if not in queue)
QPAPT	1-n	0-63	Body of the packet (if QPAPTA zero)

<u>Field</u>	<u>Word(base8)</u>	<u>Bits</u>	<u>Description</u>
QRNSC	5	0-63	Number of sectors
QRNI	6	0-63	Number of increments

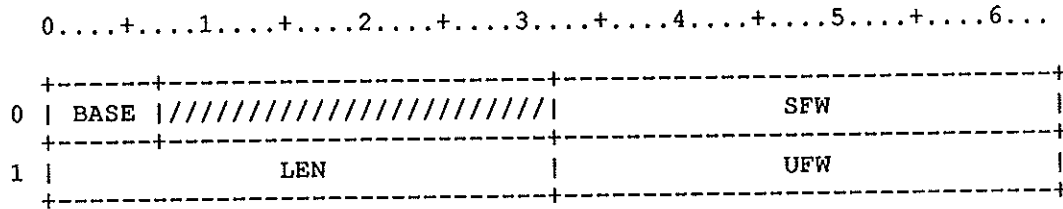

Figure RB-1. Receive Buffer Table

Field	Word(base8)	Bits	Description
RBBASE	0	0-6	Bias of system memory address RBB\$ABS=1 Absolute RBB\$STP=2 STP RBB\$JTA=3 JTA (of this user)
RBSFW	0	32-63	FW of system memory to copy from
RBLEN	1	0-31	Length of memory to copy
RBUFW	1	32-63	FW of user are to copy to
REL@STP	= D'01		Relative to STP base address
REL@JTA	= D'02		Relative to Users JTA address
REL@JCB	= D'03		Relative to Users JCB address
REL@SLFT	= D'04		Relative to Users system LFT area
REL@SDSP	= D'05		Relative to Users system DSP area
REL@SBUF	= D'06		Relative to Users system Buffer area
REL@IBAU	= D'07		Relative to Users Instruction Base
REL@DBAU	= D'08		Relative to Users Data base Address
REL@MAXI	= O'37		Maximum relocation index

The RJI table contains entries for each defined JXT entry describing the job assigned to the JXT entry and controlling the recovery of jobs from mass storage entries. Entry zero is used mainly to validate the roll index dataset. Other entries indicate which JXT entries have active jobs, and hold information used to locate roll images.

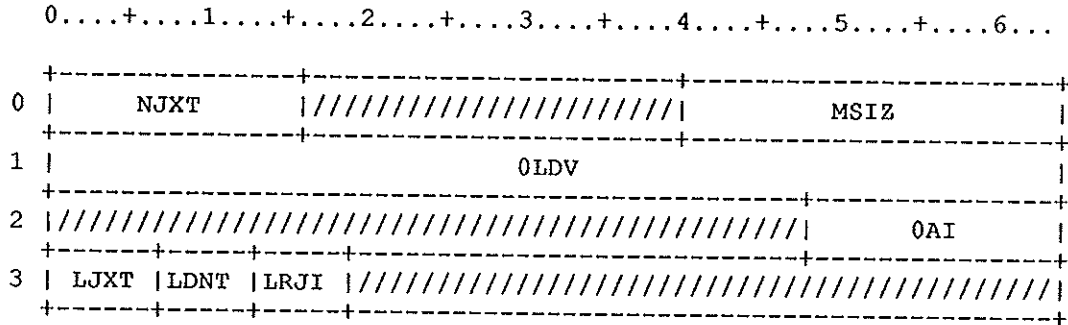

Figure RJ-1. RJ Entry Zero Only

Field	Word(base8)	Bits	Description
RJNJXT	0	0-15	Number of JXT entries in the last deadstarted system
RJMSIZ	0	40-63	Memory size at last deadstart
RJOLDV	1	0-63	Device name containing index for \$ROLL dataset
RJ0AI	2	48-63	First (or only) AI in \$ROLL index
RJLJXT	3	0-6	Length of JXT entry in old system
RJLDNT	3	7-12	Length of DNT entry in old system
RJLRJI	3	13-18	Length of RJ index entry in old system

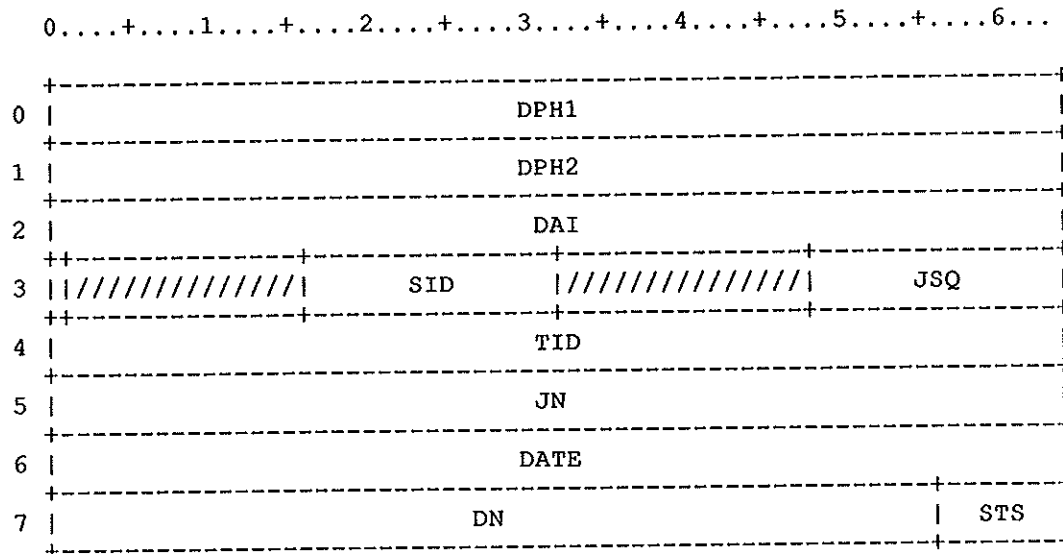

Figure RJ-2. Rolled Job Index Table entry

Field	Word(base8)	Bits	Description
RJDPH1	0	0-63	Word 0 of job roll DAT partition header
RJDPH2	1	0-63	Word 1 of job roll DAT partition header
RJDAI	2	0-63	First AI word from roll DAT (1-4 AIs)
RJNRCV	3	0	Job irrecoverable flag
RJSID	3	16-31	Station ID of job origin
RJJSQ	3	48-63	Job sequence number
RJTID	4	0-63	Terminal ID of job origin
RJJN	5	0-63	Jobname
RJDATE	6	0-63	Date/time (system generated)
RJDN	7	0-55	Dataset name for irrecoverable action
RJSTS	7	56-63	Status causing irrecoverability

Roll index is read and written using buffer RJINDEX. Sizes are as follows:

L@RJNDX = NE@RJ*LE@RJ Amount of index that can be used
 SZ@RJNX = L@RJNDX+D'511
 SZ@RJNDX = SZ@RJNX/O'1000*O'1000
 (Must be a multiple of disk sector)

MAXRRJ = 1 Maximum code for type of RJ
 MAXLOCK = 2 Maximum value for lockout option

Status set by RRJ into input SDTs:

RJCDNINI = 0 Job not previously initiated
 RJCRRN = 1 Job rerun by system recovery
 RJCRRR = 2 System recovery, job not rerunnable
 SDJCE = 3 Job statement error code set by system job card interpreter (IND)
 SDRIER = 4 Roll-in error is rerunnable
 SDRIEN = 5 Roll-in error is not rerunnable
 SDCJSE1 = 6 Job fits no class
 SDCJSE2 = 7 Class specified by CL doesn't exist
 SDCJSE3 = D'8 Job doesn't fit class specified by CL
 SDCJSE4 = D'9 MFL param exceeds maximum allowed
 SDCJSE5 = D'10 MFL param increased minimum allowed
 SDACE = D'11 Account statement error code set by system job card interpreter (IND)
 SDTLE = D'12 Job Time Limit Error code set by RDM

The following codes are values saved in the rolled job index as to why a job is declared not-recoverable at run-time.

RJSTNR = 1 Job was never rolled out
 RJSTWR = 2 Write to random dataset
 RJSTNSW = 3 Non-sequential write
 RJSTSV = 4 Save of a dataset
 RJSTDJ = 5 Delete of a dataset
 RJSTADJ = 6 Adjust of a dataset
 RJSTMOD = 7 Modify of a dataset
 RJSTFCH = D'8 Fetch of a dataset
 RJSTQIO = D'9 Queued I/O on a dataset

Message codes:

RJCD0 = 0 Unexpected status on access
 RJCD1 = 1 Recovery of rolled jobs aborted
 RJCD2 = 2 Old system JXT count error

RJCD3	=	3	Index zero device name error
RJCD4	=	4	Index zero AI error
RJCD5	=	5	I/O error on \$ROLL
RJCD6	=	6	Job not recoverable (index)
RJCD7	=	7	Missing device in roll dataset
RJCD8	=	D' 8	Down device in roll dataset
RJCD9	=	D' 9	Job too large for memory
RJCD10	=	D' 10	I/O error on roll dataset
RJCD11	=	D' 11	JTA/JXT length error
RJCD12	=	D' 12	JTA/user time/date error
RJCD13	=	D' 13	JTA/JXT name error
RJCD14	=	D' 14	Bad DNT chain
RJCD15	=	D' 15	STP DAT not \$CS or \$IN
RJCD16	=	D' 16	Error on pseudo-access
RJCD17	=	D' 17	No input SDT
RJCD18	=	D' 18	DAT space full
RJCD19	=	D' 19	DAT page number error in roll DAT
RJCD20	=	D' 20	Ordinal error in roll DAT
RJCD21	=	D' 21	Bad page pointer in roll DAT
RJCD22	=	D' 22	DAT validation error
RJCD23	=	D' 23	Job recovered
RJCD24	=	D' 24	RRJ impossible in deadstart
RJCD25	=	D' 25	Mismatch in DAT and JTL for roll size
RJCD29	=	D' 29	Unexpected status access class in roll dataset
RJCD30	=	D' 30	Class roll dataset does not exist
RJCD31	=	D' 31	Job class structure recovery OK
RJCD32	=	D' 32	Cannot access dataset from *JCLASS
RJCD33	=	D' 33	Class structure loaded from *JCLASS
RJCD34	=	D' 34	Default class structure used
RJCD35	=	D' 35	Date/time error on JC roll dataset
RJCD36	=	D' 36	Date/time error on JCLASS dataset
RJCD37	=	D' 37	Not recoverable dure to EXP resume
RJCD38	=	D' 38	System mismatch, nonrecoverable job
RJCD39	=	D' 39	Job resumable after system mismatch
RJCD40	=	D' 40	Job locked out after system mismatch
RJCD41	=	D' 41	Job not rerunnable
RJCD42	=	D' 42	Job will be rerun
RJCD43	=	D' 43	Invalid QDT index
RJCD44	=	D' 44	Tape dataset not recoverable
RJCD45	=	D' 45	Resource profile changed by restart
RJCD46	=	D' 46	Dataset has DATs or TEXT in STP memory

System directory recovery message codes:

SDCD25	=	D' 25	Access failed for \$SDR
SDCD26	=	D' 26	Adjust failed for \$SDR

SDCD27	=	D'27	Access failed for SDR entry
SDCD28	=	D'28	# of resident SDR entries decreased

Error codes for errors encountered during validation of
DATs for datasets in rolled jobs:

RJVDBOFF	=	1	Bad JTA offset for first page
RJVDBPN	=	2	Bad first page number
RJVDDORD	=	3	Bad JXT ordinal first page
RJVDNSD	=	4	Device not in configuration
RJVDDWN	=	5	Down device
RJVDBAI	=	6	Bad allocation index in DAT
RJVDAIC	=	7	AI conflict
RJV DIA	=	D'8	Inconsistent multi-type allocation
RJVDBNP	=	D'9	Bad next page offset
RJVDBCP	=	D'10	Bad continuation page pointer
RJVDBCO	=	D'11	Bad continuation page JXT ordinal
RJVDSRC	=	D'12	Inconsistent DAT page source
RJVDBCA	=	D'13	Bad continuation page offset address
RJVDBPP	=	D'14	Bad next partition pointer
RJVDEOD	=	D'15	Premature end-of-DAT
RJVDMSTR	=	D'16	Stripe grouping has been modified
RJVLDLDBE	=	D'17	AI exceeds logical device boundaries

*CALL COMRPV at this ident + 1

COPYRIGHT BY CRAY RESEARCH, INC. *

UNPUBLISHED - ALL RIGHTS RESERVED UNDER THE COPYRIGHT LAWS *
OF THE UNITED STATES. *

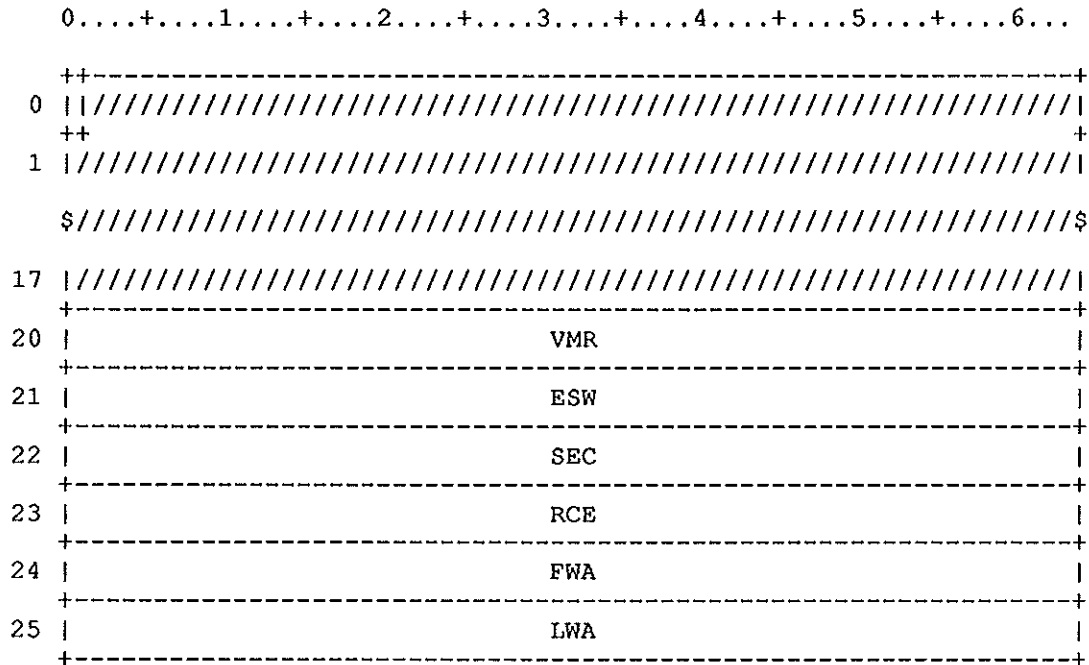

Figure RPV-1. Reprise Data Table

<u>Field</u>	<u>Word(base8)</u>	<u>Bits</u>	<u>Description</u>
RPVXP	0	0	Exchange package save area
RPVVMR	20	0-63	Vector mask register
RPVESW	21	0-63	Error status word
RPVSEC	22	0-63	System error code
RPVRCE	23	0-63	Reprise code entry point
RPVFWA	24	0-63	First word address of reprise code
RPVLWA	25	0-63	Last word address of reprise code

The Task Request Table is an STP-resident table primarily used for disk queue management.

0.....+.....1.....+.....2.....+.....3.....+.....4.....+.....5.....+.....6.....

0	EN
1	PTR
2	INP0
3	INP1
4	TID
5	JTA
6	DNT
7	DSP
10	TD
11	SDSA
12	LDSA
13	IN
14	IBN
15	NPG
16	NPQ
17	NPA
20	TRS
21	SNE
22	CPTA
23	CPGA
24	CWDO
25	CPAO

Figure RQ-1. Task Request Table entry

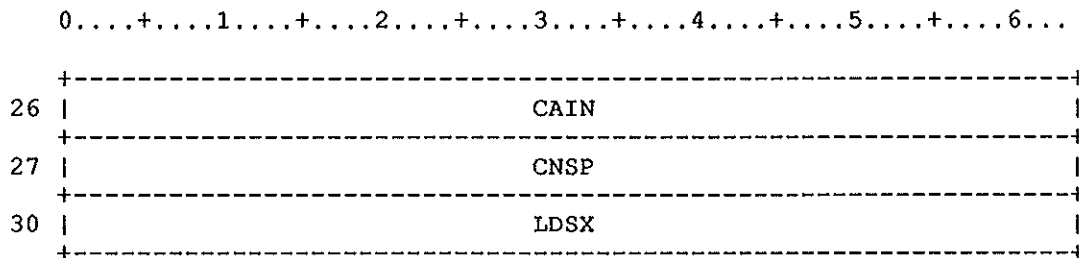

Figure RQ-1. Task Request Table entry

Field	Word(base8)	Bits	Description
RQEN	0	0-63	Entry name ('RQT'L)
RQPTR	1	0-63	Pointer to next RQT entry
RQINP0	2	0-63	Input+0
RQIRET	2	0-23	Caller's return address
RQIRCL	2	24	Recall (intermediate) reply flag
RQITXO	2	25-39	TXT offset (0, if not job related)
RQIDNT	2	40-63	DNT address (JTA relative, if job related; STP relative, if not)
RQINP1	3	0-63	Input+1
RQIFC	3	56-63	Function code
RQTID	4	0-63	Task ID of requesting task
RQJTA	5	0-63	JTA address (0, if not job related)
RQDNT	6	0-63	DNT address (STP relative)
RQDSP	7	0-63	DSP address (STP relative; 0, if no associated DSP)
RQNFT	10	1	not first time of xfer queue flag
RQQIO	10	2	Queued I/O flag
RQAC	10	3	Allocation is contiguous flag
RQFCPY	10	4	FSS copy flag
RQNSW	10	5	Queued I/O req. has a non-sequential w
RQTD	10	60-62	transfer direction RQRD=0 read request RQWR=1 write request RQRDWR=3 read/write request
RQSDSA	11	0-63	Smallest dataset word address in xfer
RQLDSA	12	0-63	Largest dataset word address in xfer

<u>Field</u>	<u>Word(base8)</u>	<u>Bits</u>	<u>Description</u>
RQIN	13	0-63	New DPIN/DPOUT after transfer (DPIN, if read; DPOUT, if write)
RQIBN	14	0-63	New DPIBN/DPOBN after transfer (DPIBN, if read; DPOBN, if write)
RQNPG	15	0-63	Number of PHRs generated
RQNPQ	16	0-63	Number of PHRs queued
RQNPA	17	0-63	Number of PHRs active
RQTRS	20	0-63	Task reply status
RQSNE	21	0-63	Sequence # of lowest PHR in error (equals RQNPG, if no errors)

The following fields are used by GETDA to shortcut the procedure of finding the first AI in the transfer. These fields represent the assumed starting position of the next transfer. They indicate the current AI position in the DAT.

RQCPTA	22	0-63	DAT partition address
RQCPGA	23	0-63	DAT page address of AI
RQCWDO	24	0-63	Word offset on DAT page of AI
RQCPAO	25	0-63	Parcel offset within word of AI
RQCAIN	26	0-63	AI sequence number
RQCNSP	27	0-63	Number of sectors preceding AI
RQLDSX	30	0-63	Largest read dataset address for QIO

The SSD Active Channel Table is an STP-resident table used to manage the SSD channels.

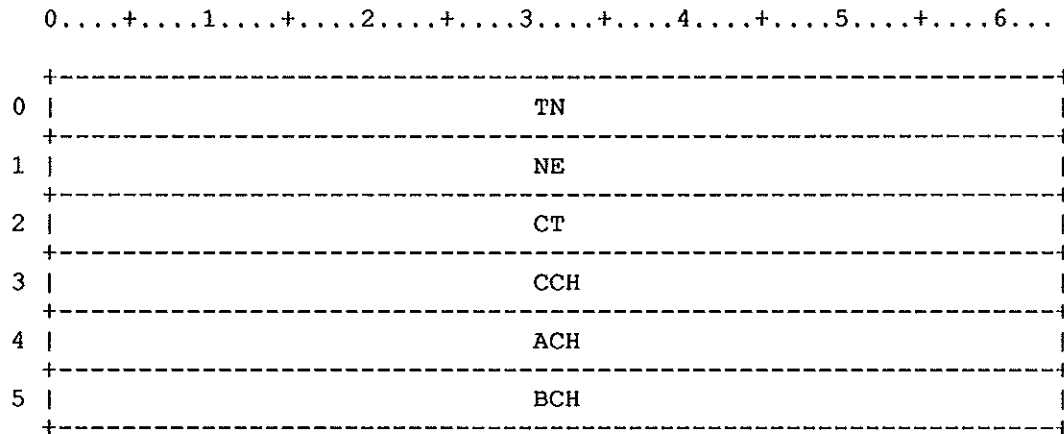

Figure SA-1. SSD Active Channel Table header

Field	Word(base8)	Bits	Description
SATN	0	0-63	Table name ('SAC'L)
SANE	1	0-63	Number of entries (one per channel)
SACT	2	0-63	Channel type, as defined in CONFIG@P
SACCH	3	0-63	Configured channels bitmap
SAACH	4	0-63	Available channels bitmap
SABCH	5	0-63	Active channels bitmap

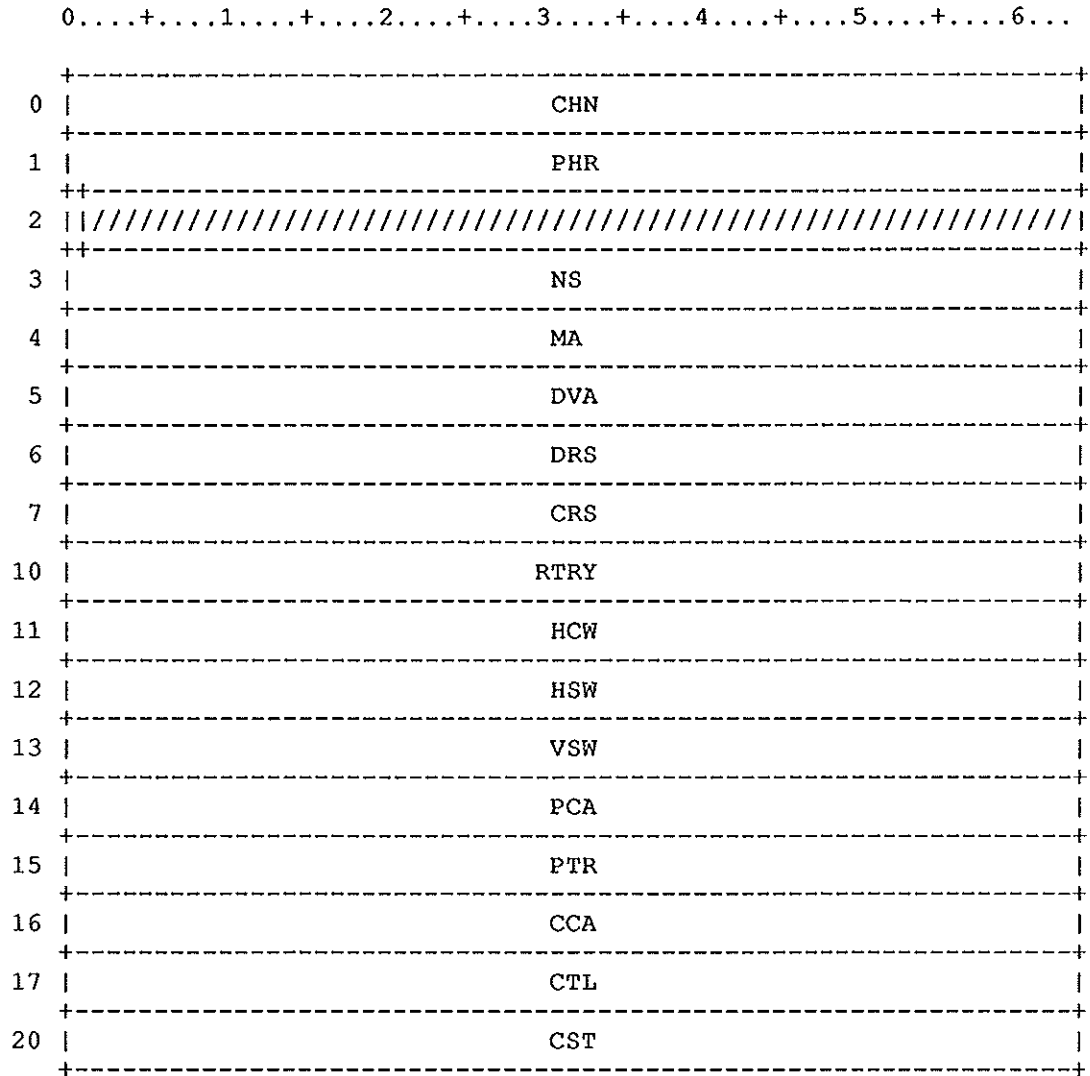

Figure SA-2. SSD Active Channel Table entry

Field	Word(base8)	Bits	Description
SACHN	0	0-63	Channel number
SAPHR	1	0-63	Address of PHR (EXEC rel)
SATD	2	0	Transfer direction
SANS	3	0-63	Number of sectors to transfer
SAMA	4	0-63	CPU memory address
SADVA	5	0-63	Device address

<u>Field</u>	<u>Word(base8)</u>	<u>Bits</u>	<u>Description</u>
SADRS	6	0-63	Driver reply status: RCERR (0'01) recovered error COERR (0'13) corrected data error URERR (0'15) unrecovered error
SACRS	7	0-63	Controller reply status: SDSTO (0'01) SSD time-out detected SDHSCE (0'02) HSP status channel err SDESRH (0'03) err status ret by HSP SDESRV (0'04) err status ret by VHSP
SARTRY	10	0-63	Retry count

HSP Command Word represents the format of the request to be sent to the High-Speed Controller (HSC) for an SSD with a channel type of @SSDHSP.

The HNS and HDA fields in the command word are set up so that, although the values inserted are in sectors, the High-Speed Controller interprets them as in 64-word blocks.

SAHCW	11	0-63	HSP command word
SAHTD	11	0	Transfer direction
SAHNS	11	8-12	Number of sectors to transfer
SAHDA	11	18-36	Device address
SAHMA	11	40-63	CPU memory address

HSP Status Word represents the format of the status word received from the High-Speed Controller (HSC) for an SSD with a channel type of @SSDHSP.

SAHSW	12	0-63	HSP status word
SAHSR	12	58-59	Source
SAHST	12	60-63	Status code

VHSP Status Word represents the format of the error flags returned by executing a 033ijl instruction for an SSD with a channel type of @SSDVHSP.

SAVSW	13	0-63	VHSP status word
SAVFE	13	40	Fatal error (CDB, DB, or BLE set)
SAVCDB	13	41	Central memory double-bit error
SAVDB	13	42	Double-bit error SSD memory (read) channel (write)
SAVBLE	13	43	Block length error
SAVSB	13	44	Single-bit error SSD memory (read) channel (write)
SAVRIP	13	45	Request in progress
SAVRBL	13	46-63	Remaining block length

The following fields are used to maintain statistical information.

SAPCA	14	0-63	Percent of interval channel active
SAPTR	15	0-63	Percent of max transfer rate
SACCA	16	0-63	Cumulative channel active time (CPs)
SACTL	17	0-63	Cumulative transfer lengths (sectors)
SACST	20	0-63	Channel start time

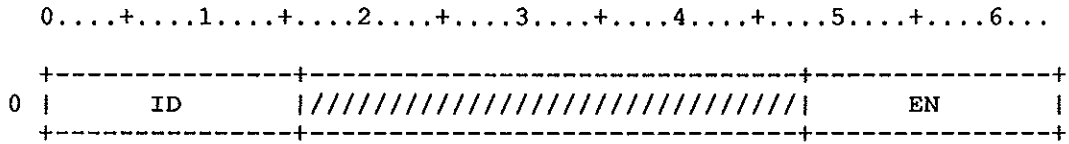

Figure SAL-1. Station Alternative format

<u>Field</u>	<u>Word(base8)</u>	<u>Bits</u>	<u>Description</u>
SALID	0	0-15	Station Id
SALEN	0	48-63	Length of slot

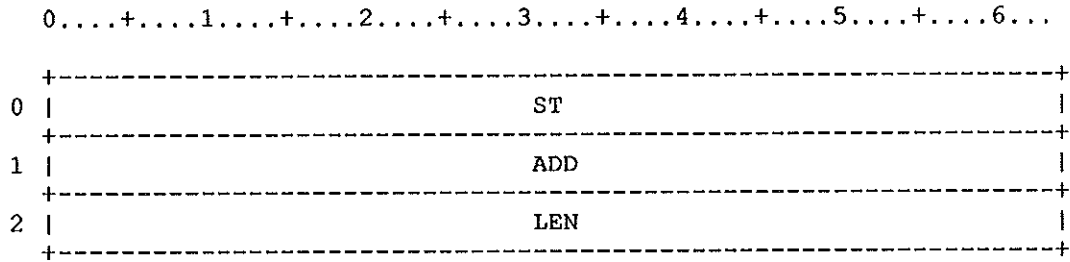

Figure ASP-1. Alternate slot parameter block

Field	Word(base8)	Bits	Description
ASPST	0	0-63	Call status (returned to user)
ASPADD	1	0-63	Slot address
ASPLEN	2	0-63	Slot length
SA\$AOK	= 0		OK status
SA\$LEN	= 1		Bad length
SA\$SAE	= 2		Slot already exists
SA\$REC	= 3		Bad records

SBU SYSTEM BILLING UNIT TABLE - SBU

The SBU table is an STP-resident table which contains the values obtained when system billing units are calculated for system resources.

0....+....1....+....2....+....3....+....4....+....5....+....6...

0	UTSX
1	UTSW
2	UTSD
3	TSWS
4	USMI
5	UTWJ
6	UIOB
7	UIOF
10	UIOR
11	UMXM
12	UMIM
13	UOPC
14	UCLC
15	UMRD
16	UPFA
17	UPFS
20	UTFS
21	UBRF
22	UBSF
23	UXMI

Figure SB-1. System Billing Unit Table

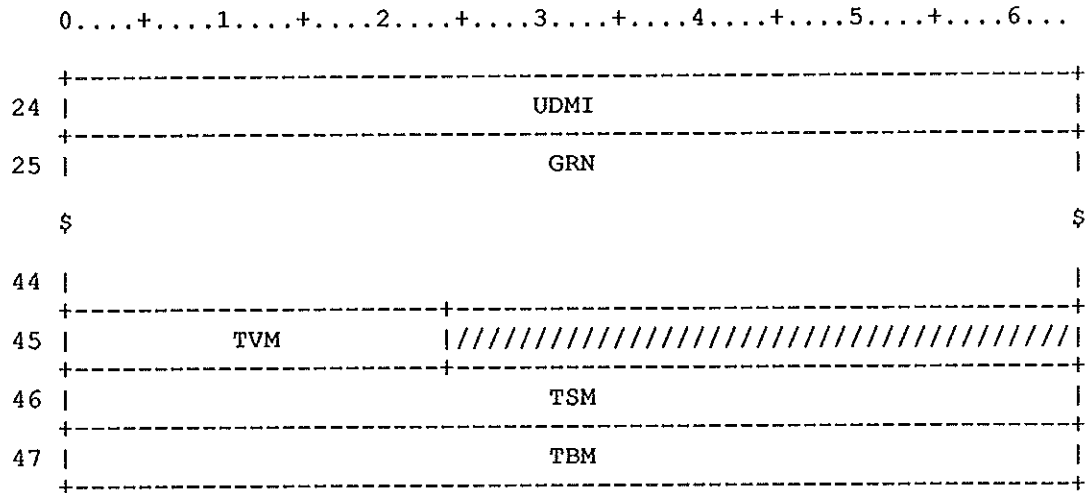

Figure SB-1. System Billing Unit Table

Field	Word(base8)	Bits	Description
SBUTSX	0	0-63	Timestamp units executing in CPU
SBUTSW	1	0-63	Timestamp units waiting for CPU
SBUTSD	2	0-63	Timestamp units waiting for I/O
SBTSWS	3	0-63	SBU factor for waiting semaphore
SBUSMI	4	0-63	SBU factor for semaphore mem integral
SBUTWJ	5	0-63	Timestamp units in input queue
SBUIOB	6	0-63	Disk sectors moved
SBUIOF	7	0-63	FSS sectors moved
SBUIOR	10	0-63	Physical I/O requests
SBUMXM	11	0-63	Maximum memory used
SBUMIM	12	0-63	Minimum memory used
SBUOPC	13	0-63	Open calls
SBUCLC	14	0-63	Close calls
SBUMRD	15	0-63	Memory resident datasets
SBUPFA	16	0-63	Permanent dataset space accessed
SBUPFS	17	0-63	Permanent dataset space saved
SBUTFS	20	0-63	Temporary dataset space used

This table is resident in both STP and EXEC. The I/O Subsystem driver uses the EXEC-resident table to control the flow of control packets between the CRAY-1 and the IOS.

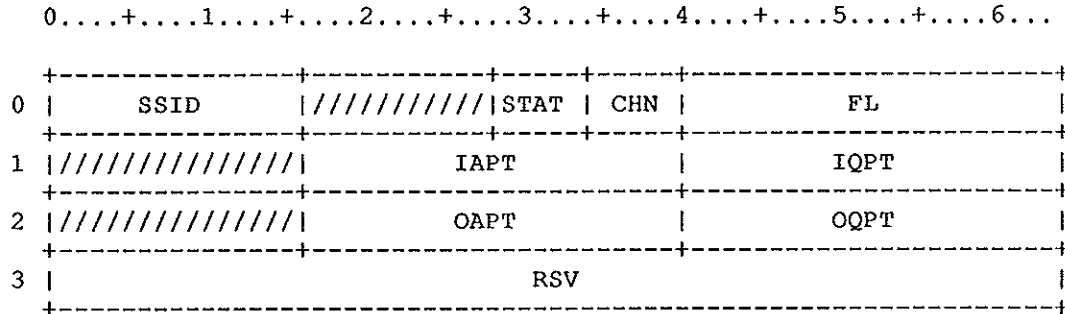

Figure SC-1. Subsystem Control Table

Field	Word(base8)	Bits	Description
SCSSID	0	0-15	Subsystem interface ID (two ASCII characters that must match the packet's destination ID)
SCSTAT	0	28-33	Subsystem status (STP read only)
SCUP	0	28	Subsystem up flag (1==UP)
SCIPR	0	29	I-packet received flag
SCJPR	0	30	J-packet received flag
SCIR	0	31	Input ready flag
SCRST	0	32	Subsystem restart flag
SCDOWN	0	33	Subsystem down flag: 0 Up 1 Down
SCCHN	0	34-39	Input channel number
SCFL	0	40-63	Forward link to another SCT
SCIAPT	1	16-39	Input packet addr
SCIQPT	1	40-63	Input QPT header addr
SCOAPT	2	16-39	Output packet addr
SCOQPT	2	40-63	Output QPT header addr
An STP task uses the STP-resident table to interface to the EXEC I/O Subsystem driver.			
SCRSV	3	0-63	Reserved for expansion

Name: Link Control Package (LCP).

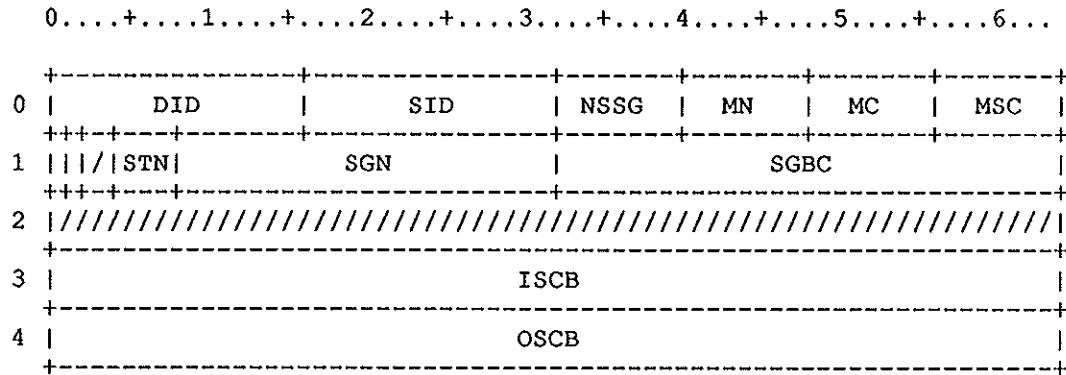

Figure LP-1. Link Control Package

Field	Word(base8)	Bits	Description
LPDID	0	0-15	Destination identifier (2 char)
LPSID	0	16-31	Source identifier (2 char)
LPNSSG	0	32-39	Number of subsegments
LPMN	0	40-47	Message number (modulo 16)

<u>Field</u>	<u>Word(base8)</u>	<u>Bits</u>	<u>Description</u>
LPMC	0	48-55	Message code: LPMCLON=O'1 Logon LPMCRON=O'2 Relog LPMCLOF=O'3 Logoff LPMCSTR=O'4 Start LPMCRST=O'5 Restart LPMCDHR=O'6 Dataset header LPMCDSG=O'7 Dataset segment LPMCTL=O'11 Control LPMCSTP=O'11 Stop (logoff reply) LPMCERR=O'12 Message error LPMCDTQ=O'13 Dataset transfer request LPMCDTR=O'14 Dataset transfer reply LPMCLEQ=O'15 Log entry request LPMCLER=O'16 Log entry reply LPMCURQ=O'17 Unsolicited Operator Request LPMCURY=O'20 Unsolicited Operator Reply LPMCJSQ=O'21 Job status request LPMCSSQ=O'22 System status request LPMCDSQ=O'23 Dataset status request LPMCLSQ=O'24 Link status request LPMCMSQ=O'25 Mass storage status request LPMCOFQ=O'26 Operator function request LPMCDFQ=O'27 Debug function request LPMCJSR=O'31 Job status reply LPMCSSR=O'32 System status reply LPMCDSR=O'33 Dataset status reply LPMCLSR=O'34 Link status reply LPMCMSR=O'35 Mass storage status reply LPMCOFR=O'36 Operator function reply LPMCDFR=O'37 Debug function reply LPMCDEQ=O'40 Diagnostic echo request LPMCDER=O'41 Diagnostic echo reply LPMCIAQ=O'42 Interactive request LPMCIAR=O'43 Interactive reply LPMCCCQ=O'44 Job class status request LPMCCCR=O'45 Job class status reply LPMCSTM=O'46 Station message LPMCSR=O'47 Station message reply LPMCTCQ=O'50 Tape configuration request LPMCTCR=O'51 Tape configuration reply LPMCTJQ=O'52 Tape system status

request
 LPMCTJR=O'53 Tape system status
 reply
 LPMCCFQ=O'54 Configure request
 LPMCCFR=O'55 Configure reply
 LPMCDQ=O'56 Data ownership request
 LPMCDOR=O'57 Data ownership reply
 LPMCJYQ=O'60 Job information
 request
 LPMCJYR=O'61 Job information reply
 LPMCSIQ=O'62 Stream status request
 LPMCSIR=O'63 Stream status reply
 LPMCGRQ=O'64 Generic Resource
 Status Request
 LPMCGRR=O'65 Generic Resource
 Status Reply
 LPMCDIQ=O'66 Task display request
 LPMCDIR=O'67 Task display reply
 LPMCRSVF=O'70 Lowest code
 reserved for site

.
 . Codes 70-77 reserved for site
 .

LPMCRSVL=O'77 Highest code
 reserved for site
 LPMCSWQ=O'100 Swap status
 request
 LPMCSWR=O'101 Swap status
 reply

= O'102 UNICOS file status request
 = O'103 UNICOS file status reply
 = O'104 UNICOS information display request
 = O'105 UNICOS information display reply
 = O'106 UNICOS list directory request
 = O'107 UNICOS list directory reply
 = O'110 UNICOS get & put request
 = O'111 UNICOS get & put reply

Field	Word(base8)	Bits	Description
LPMSC	0	56-63	Message subcode:
			LPMSCOK=O'0 OK
			LPMSCNA=O'10 Function not available
			LPMSCCLCP=O'100 LCP field error
			LPMSCDID=O'101 Destination ID error
			LPMSCSID=O'102 Source ID error
			LPMSCNSS=O'103 Number of subsegments error
			LPMSCMN=O'104 Message number error
			LPMSCMC=O'105 Message code error
			LPMSCMSC=O'106 Message subcode error
			LPMSCSTN=O'107 Stream number error
			LPMSCSGN=O'110 Segment number error
			LPMSCSBC=O'111 Segment bit count error
			LPMSCSCB=O'112 Stream control byte error
			LPMSCSSS=O'113 Segment size error
			LPMSCMLE=O'114 Station message limit error
			LPMSCLP=O'115 Logon parameter error
			LPMSCRES=O'116 Resource not available for logon
			LPMSCIoT=O'120 Unable to terminate active I/O
			LPMSCCS=O'140 Checksum error
			LPMSCJCP=O'141 Job class invoke pending
			LPMSCSEG=O'200 Segment data error
			LPMSCOFN=O'201 operator function not available
			LPMSCDFN=O'202 debug function not available
			LPMSCFRO=O'203 function restricted to COS operator
			LPMSCEDE=O'204 EXEC detected error
			LPMSCUID=O'205 undefined ID
			LPMSCUCH=O'206 undefined channel
			LPMSCIMC=O'207 illegal for

MCU	
LPMSCUDV=O' 210	undefined
device	
LPMSCBNL=O' 211	breakpoint
number too large	
LPMSCBB=O' 212	breakpoint
busy	
LPMSCATL=O' 213	address too
large	
LPMSCCTMB=O' 214	too many
bits	
LPMSCRNL=O' 215	register
number too large	
LPMSCURD=O' 216	unknown
register designator	
LPMSCBAL=O' 217	breakpoint
address too large	
LPMSCBNS=O' 220	breakpoint
not set	
LPMSCBAB=O' 221	breakpoint
address busy	
LPMSCBNA=O' 222	breakpoint
not active	
LPMSCNJX=O' 223	no JXT
offset in SDT	
LPMSCBSD=O' 224	bad SDT
pointer in JXT	
LPMSCOSE=O' 226	operator
function segment error	
LPMSCKDL=O' 227	attempt to
KILL or DROP locked job	
LPMSCJNF=O' 230	Job not
found	
LPMSCTNF=O' 231	Task not
found in job	
LPMSCANV=O' 232	Account not
validated for job	
LPMSCDRE=O' 233	Dump range
exceeds segment size	
LPMSCFLG=O' 240	Unsolicited
Operator Flag not set	
LPMSCJSQ=O' 241	JSQ not
found for unsolicited msg	
LPMSCMM=O' 242	Pool memory
not available	
LPMSCZZZ=O' 243	Zero jsq #
LPMSCSER=O' 244	Segment bit
error	
LPMSCWER=O' 245	Word count
error	
LPMSCNAU=O' 246	User not
authorized	
LPMSCSNC=O' 251	STARTUP not
complete	
LPMSCDQE=O' 252	Error

detected by DQM
 LPMSCPDE=O'253 Error
 detected by PDM
 LPMSCGNP=O'254 Generic
 resource not preemptable
 LPMSCGNE=O'255 Generic
 resource not found
 LPMSCHDW=O'300 Hardware
 error
 LPMSCLEN=O'301 Transfer
 length error
 LPMSCCHN=O'302 Channel
 error
 LPMSCNLO=O'303 Not logged
 on
 LPMSCFUL=O'304 Max front
 ends already logged on
 LPMSCALO=O'305 Already
 logged on another channel
 LPMSCSEQ=O'306 Attempted to
 send out of sequence
 LPMSCNSC=O'307 NSC
 Hyperchannel adapter error
 LPMSCLOG=O'310 Logon
 parameter error
 LPMSCNDE=O'311 No data
 expected
 LPMSCWPC=O'312 Waiting
 process completion
 LPMSCNST=O'313 Message lost
 LPMSCEXX=O'314 Exec error
 on Allocate LXT

LPRQP	1	0	Request pending flag
LPIRQP	1	1	Interactive data pending flag
LPSTN	1	4-7	Stream number
LPSGN	1	8-31	Segment number
LPSGBC	1	32-63	Segment bit count
LPISCB	3	0-63	Input stream control bytes:

<u>Field</u>	<u>Word(base8)</u>	<u>Bits</u>	<u>Description</u>
LPOSCB	4	0-63	Output stream control bytes: LPSCBIDL=O'0 Idle LPSCBRTS=O'1 Request to send LPSCBPTR=O'2 Preparing to receive LPSCBSND=O'3 Sending LPSCBRCV=O'4 Receiving LPSCBSUS=O'5 Suspend LPSCBEND=O'6 End LPSCBSVG=O'7 Saving LPSCBSVD=O'10 Saved LPSCBPPN=O'11 Postpone LPSCBCAN=O'12 Cancel LPSCBMCL=O'13 Master clear LPSCBHLD=O'14 Hold LPSCBMAX=O'14 Maximum valid SCB

Name: Link Trailer Package (LTP).

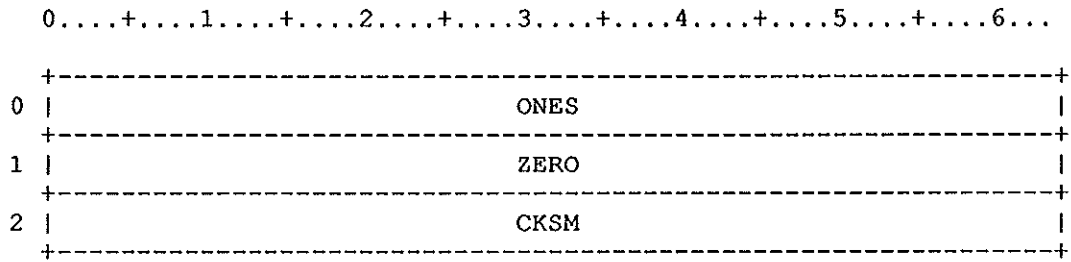

Figure LP-1. Link Trailer Package

Field	Word(base8)	Bits	Description
LPONES	0	0-63	Contains all ones
LPZERO	1	0-63	Contains all zeroes
LPCKSM	2	0-63	Checksum

```

*
NAME: Task replies as tables for use in determining
      LXT addresses and comparing request and reply
      sequence numbers.
*
*
**

```

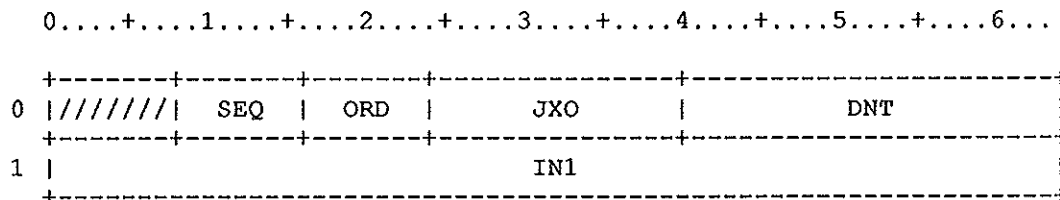

Figure DQ-1. Task reply tables

Field	Word(base8)	Bits	Description
DQSEQ	0	8-15	Request sequence number
DQORD	0	16-23	LXT ordinal
DQJXO	0	24-39	JXT address
DQDNT	0	40-63	DNT address
DQIN1	1	0-63	Input+1

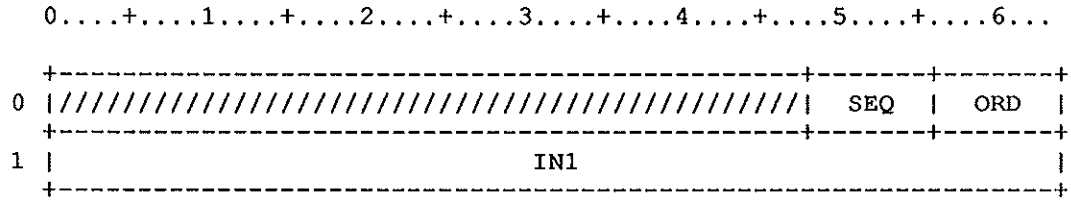

Figure TQ-1. Task reply tables

<u>Field</u>	<u>Word(base8)</u>	<u>Bits</u>	<u>Description</u>
TQSEQ	0	48-55	Request sequence number
TQORD	0	56-63	LXT ordinal
TQIN1	1	0-63	Input+1

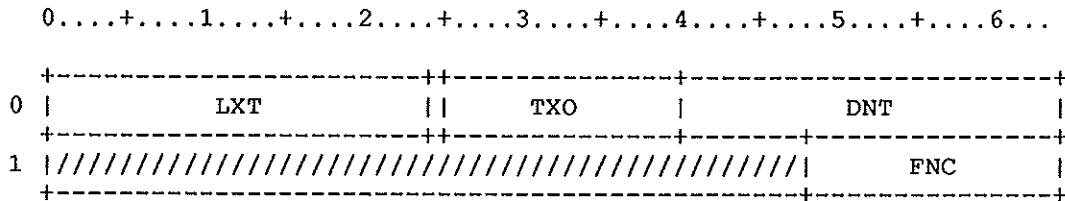

Figure IQ-1. IQM Task Reply Table

<u>Field</u>	<u>Word(base8)</u>	<u>Bits</u>	<u>Description</u>
IQLXT	0	0-23	LXT entry address, 0 if none
IQRCL	0	24	Intermediate reply flag (reply only)
IQTXO	0	25-39	Requesting user task TXT offset
IQDNT	0	40-63	DNT address
IQFNC	1	48-63	Request Function Code

An SDT entry is created in System Task Processor (STP) resident memory for each dataset that is spooled to or from a front-end system, or submitted for execution by an executing job.

For datasets that are submitted as jobs to the CRAY-1, the first control statement (the JOB statement) must be cracked to obtain job scheduling information.

```

0....+....1....+....2....+....3....+....4....+....5....+....6...
+-----+
0 |                               DNT                               |
$                               $
23 |                               |
+-----+
24 | //////////////////////////////////////////////////////////////////// |
$ //////////////////////////////////////////////////////////////////// $
40 | //////////////////////////////////////////////////////////////////// |
+-----+
41 |                               PDN1                              |
+-----+
42 |                               PDN2                              |
+-----+
43 |                               ID                                |
+-----+
44 |                               USR                               |
+-----+
45 |                               USRN                              |
+-----+
46 |                               | TXL |
+-----+
47 |                               | ED |
+-----+
47 |                               | PR |
+-----+
50 |                               TSB                               |
+-----+
51 |                               RD                                |
+-----+
52 |                               WT                                |
+-----+
53 |                               MN                                |
+-----+
54 |                               OJB                               |
+-----+
55 |                               | // |
+-----+
55 |                               | JSQ |
+-----+

```

Figure SD-1. System Dataset Table

```

0.....+....1.....+....2.....+....3.....+....4.....+....5.....+....6...
+-----+-----+-----+-----+-----+-----+-----+-----+
56 |                                     TID                                     |
+-----+-----+-----+-----+-----+-----+-----+-----+
57 |                                     SF                                     |
+-----+-----+-----+-----+-----+-----+-----+-----+
60 |||C||||||| OLM | LST | RJST |
+-----+-----+-----+-----+-----+-----+-----+-----+
61 |                                     JCN                                     | IJSP |
+-----+-----+-----+-----+-----+-----+-----+-----+
62 |                                     CL                                     | JSP |
+-----+-----+-----+-----+-----+-----+-----+-----+
63 |          SST          |          AUT          |          JCR          |
+-----+-----+-----+-----+-----+-----+-----+-----+
64 |                                     PDLY                                     |
+-----+-----+-----+-----+-----+-----+-----+-----+
65 |                                     ACN1                                     |
+-----+-----+-----+-----+-----+-----+-----+-----+
66 |                                     ACN2                                     |////////|
+-----+-----+-----+-----+-----+-----+-----+-----+
67 |                                     APW1                                     |
+-----+-----+-----+-----+-----+-----+-----+-----+
70 |                                     APW2                                     |////////|
+-----+-----+-----+-----+-----+-----+-----+-----+
71 |                                     UPW1                                     |
+-----+-----+-----+-----+-----+-----+-----+-----+
72 |                                     UPW2                                     |/////////$
+-----+-----+-----+-----+-----+-----+-----+-----+
73 $//////////|*|//////////|JAST |          EUSA          |
+-----+-----+-----+-----+-----+-----+-----+-----+
74 |          QUPR          |          EUNI          |//////////|
+-----+-----+-----+-----+-----+-----+-----+-----+
75 $///| RENT |          HASH          |          RBN          |
+-----+-----+-----+-----+-----+-----+-----+-----+
76 |                                     CUS1                                     |
+-----+-----+-----+-----+-----+-----+-----+-----+
77 |                                     CUS2                                     |////////|
+-----+-----+-----+-----+-----+-----+-----+-----+
100 |                                     GRN                                     |
+-----+-----+-----+-----+-----+-----+-----+-----+
101 |//////////|
$//////////|
+-----+-----+-----+-----+-----+-----+-----+-----+
121 |//////////|
+-----+-----+-----+-----+-----+-----+-----+-----+
122 | SSC | TXC | MML |//////////| TXO |
+-----+-----+-----+-----+-----+-----+-----+-----+
123 |          QC          |//////////|
+-----+-----+-----+-----+-----+-----+-----+-----+
124 || QF ||*|///|          BLP          |          FLP          |
+-----+-----+-----+-----+-----+-----+-----+-----+

```

Figure SD-1. System Dataset Table

SDADN=LE@DNT Equate to SDT FWA
beyond DNT

Field	Word(base8)	Bits	Description
SDDNT	0-23	0-63	DNT area
SDDNT	0-23	0-63	Required by table diagram generator
SDPDN1	41	0-63	Characters 1-8 of PDN
SDPDN2	42	0-55	Characters 9-15 of PDN
SDORPH	42	56	Orphan job flag
SDSYS	42	57	System job flag
SDIA	42	58	Interactive job flag
SDWAIT	42	59	WAIT flag for a disposed dataset
SDTRA	42	60	Transfer request issued flag
SDTR	42	61	Transfer request flag
SDUQ	42	62	Unique access flag
SDENT	42	63	Enter System Directory flag
SDID	43	0-63	User ID; 1-8 characters.
SDUSR	44	0-63	Characters 1-8 of user number
SDUSN1	44	0-63	User number (char 1-8)
SDUS1	44	0-7	
SDUS2	44	8-15	
SDUS3	44	16-23	
SDUS4	44	24-31	
SDUS5	44	32-39	
SDUS6	44	40-47	
SDUS7	44	48-55	
SDUS8	44	56-63	
SDUSRN	45	0-55	
SDUSN2	45	0-55	User number (char 9-15)
SDUS9	45	0-7	
SDUS10	45	8-15	
SDUS11	45	16-23	
SDUS12	45	24-31	
SDUS13	45	32-39	
SDUS14	45	40-47	
SDUS15	45	48-55	
SDTXL	45	56-63	Text field length in blocks
SDTXT	46	0-23	Location of text area

<u>Field</u>	<u>Word(base8)</u>	<u>Bits</u>	<u>Description</u>
SDFM	46	24-39	Format designator (2 characters): FMCD=CD Character/deblocked FMCB=CB Character/blocked FMBD=BD Binary/deblocked FMBB=BB Binary/blocked
SDRT	46	40-51	Retention period (0-4095 days)
SDED	46	52-63	Edition number (0-4095)
SDJXO	47	0-15	JXT offset
SDMFL	47	16-31	MFL parameter from job card
SDSGFL	47	16	no value, requesting all the memory available for a job.
SDFL	47	17-31	Field length/512
SDTL	47	32-55	Time limit
SDPR	47	56-63	Priority
SDTSB	50	0-63	Time submitted
SDRD	51	0-63	Read permission control word
SDWT	52	0-63	Write permission control word
SDMN	53	0-63	Maintenance permission control word
SDOJB	54	0-55	Originating job name
SDMFNS	54	63	MF paramater Not Specified
SDSID	55	0-15	Source ID; 2 characters.
SDDID	55	16-31	Destination ID; 2 character
SDOJSQ	55	32-47	Originating job sequence number
SDJSQ	55	48-63	Job sequence number
SDNJSQ	55	48-63	Maximum JSQ number in system with B@JSQBM
SDTID	56	0-63	Terminal ID; 8 characters.
SDSF	57	0-63	Special forms
SDNRR	60	0	Job rerun flag; set if job cannot be rerun.
SDINIT	60	1	Job initiation flag; set if job has been initiated.

<u>Field</u>	<u>Word(base8)</u>	<u>Bits</u>	<u>Description</u>
SDC	60	2-3	Job was locked out by Startup flag. It cannot be rolled in on the current system.
SDDFFL	60	4	Job-used-MFL-default flag
SDNDR	60	5	No devices required flag
SDOPP	60	6	Operator raised priority to 15 flag
SDOCC	60	7	Operator changed class flag
SDHELD	60	8	Held output file flag
SDZSUB	60	9	STARTUP submitted job flag
SDOLM	60	10-33	Size of \$OUT in 512-word blocks
SDLST	60	34-57	Pointer to current LST address
<u>SDRJST</u>	60	58-63	<u>Status flag</u> Set by recovery of rolled job: 0 Never initiated 1 Rerun by system recover 2 Job not recoverable or rerunnable 3 Job statement error Set by Job Scheduler or Job Class Manager: 4 Roll-in error; rerun 5 Roll-in error; not rerunnable 6 Class error: fits not class 7 Class error: no class CL 8 Class error: does not fit CL
SDJCN	61	0-55	JJob class name
SDIJSP	61	56-63	Initial P parameter from job statement
SDCL	62	0-55	CCL parameter from JOB statement
SDJSP	62	56-63	P parameter from job statement
SDSST	63	0-23	SST address if file is transferring
SDAUT	63	24-47	AUT pointer (interactive jobs only)
SDJCR	63	48-63	Job class rank
SDPDLY	64	0-63	Postpone delay time: the realtime after which the dataset may be sent
RDM fields in the SDT.			
SDACN1	65	0-63	Job Account (char 1-8)

<u>Field</u>	<u>Word(base8)</u>	<u>Bits</u>	<u>Description</u>
SDACN2	66	0-55	Job Account (char 9-15)
SDAPW1	67	0-63	Encrypted Account password
SDAPW2	70	0-55	Password (char 9-15)
SDUPW1	71	0-63	Encrypted User password
SDUPW2	72	0-55	Password (char 9-15)
<u>SDJLWT</u>	73	15-16	<u>Job Limit wait flag</u>
<u>SDJAST</u>	73	34-39	<u>Job Acceptance Status</u>
SDEUSA	73	40-63	Job Estimated Usage
SDQUPR	74	0-23	Job Queuing Priority
SDEUNI	74	24-47	Job Estimated Units
SDRENT	75	4-15	RDM Entry Number
SDHASH	75	16-39	RDM Hash Index
SDRBN	75	40-63	RDM Block Number
SDCUS1	76	0-63	Job statement \JS parameter
SDCUS2	77	0-55	Job statement \JS part 2
L@NRGN must reflect number of SDRG entries that follow:			
SDGRN	100	0-63	GENERIC RESOURCES (L@NRGN words) SDGRN=W@SDGRN+L@NRGN
SDSSC	122	0-7	Station slot length in words
SDTXC	122	8-15	Text field length in words
SDMML	122	16-27	Interactive max message length
SDTXO	122	48-63	Associated TXT ordinal
SDQC	123	0-15	Queue count
SDLK	124	0	Lock flag

Field	Word(base8)	Bits	Description
SDQF	124	1-7	Queue flag
SDH	124	1	Entry is on the hold queue
SDI	124	2	Entry is on the input queue
SDO	124	3	Entry is on the output queue
SDE	124	4	Entry is on the executing queue
SDW	124	5	Entry is on the wait queue
SDQ	124	5	Entry is on the request queue
SDD	124	5	Event is on the event queue
SDR	124	6	Entry is on the receiving queue
SDS	124	7	Entry is on the sending queue
SDSJOB	124	8	'S' on JOB statement
SDOLDQ	124	9-10	Old queue (used by F\$SDTQM)
SDOQI	124	9	Entry was on INPUT queue
SDOQO	124	10	Entry was on OUTPUT queue
SDBLP	124	16-39	Backward link pointer
SDFLP	124	40-63	Forward link pointer

The queue control word (header) and W@SDLK of each STD entry create a circular linked list. FLP contains the address of the next SDT entry or points to the queue header. BLP contains the address of the previous SDT entry or points back to the queue header. Starting at any entry, the circular linked list can be searched backward or forward, stopping at any entry.

When a queue is empty, the pointer points to itself minus W@SDLK. When a queue is not empty, the first and last entries in the queue point to the header word minus W@SDLK.

Ensure that the number of SDT's does not exceed field width.

SZ@SDT = LH@SDT+LE@SDT*NE@SDT
SDQFO = 0'20 SDT OUTPUT QUEUE PARAMETER
SDQFI = 0'40 SDT INPUT QUEUE PARAMETER

SDP fields are placed before a memory dump by DDC/IOP to identify the following memory and addresses.

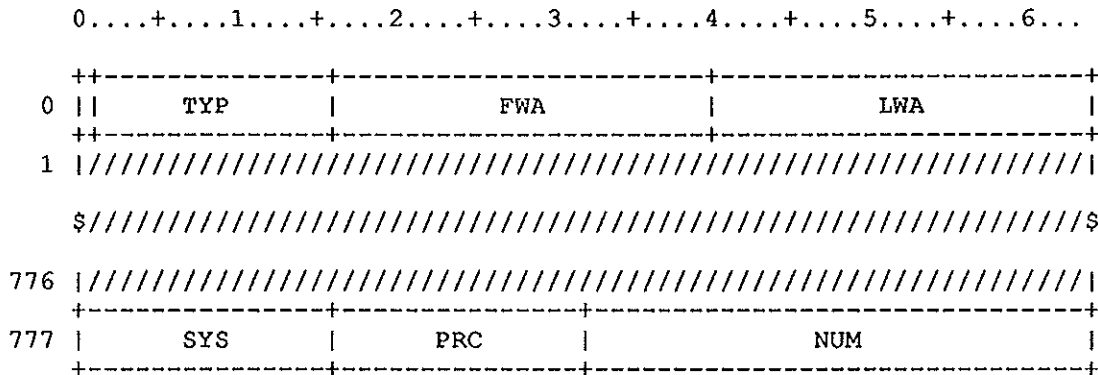

Figure SDP-1. System Dump Header Fields

Field	Word(base8)	Bits	Description
SDPTYP	0	1-15	Memory type
SDPFWA	0	16-39	FWA of Cray or MOS memory, or number of words or parcels if this is a register or IOP dump
SDPLWA	0	40-63	LWA of Cray or MOS memory
Control word, word 511 of first sector of the memory dump:			
SDPSYS	777	0-15	System type
SDPPRC	777	16-31	Number of processors
SDPNUM	777	32-63	Number of areas that have been dumped

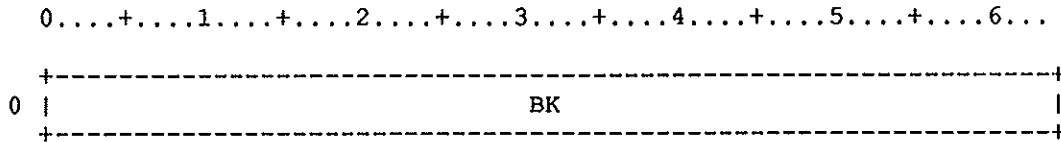

Figure SD-1. System Directory Recovery

Field	Word(base8)	Bits	Description
SDBK	0	0-63	Block number stored in each block

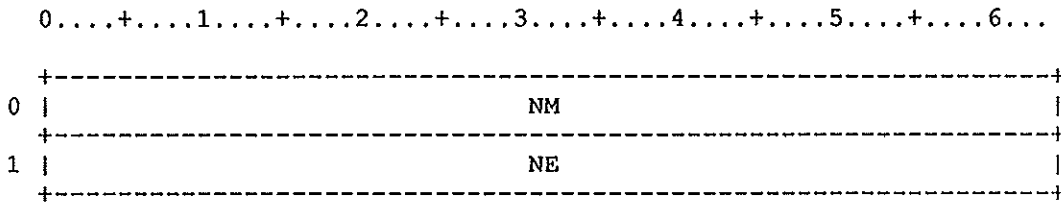

Figure SD-2. System Directory Recovery

Field	Word(base8)	Bits	Description
SDNM	0	0-63	\$SDR
SDNE	1	0-63	Number of resident SDR entries

*
Separator codes used by the CRACK and GETPARAM routines
*

**
*
**

LSEP	=	0'1	<'>	Literal
CSEP	=	0'3	<:>	Concatenation
ESEP	=	0'7	<=>	Equivalence
NSEP	=	0'17	<(> <,>	Normal separator
SSEP	=	0'37	<)> <.>	Stop separator

*CALL COMSEQ at this ident + 1

Copyright Cray Research Inc.
UNPUBLISHED - all rights reserved under the copyright laws
of the United States.

Define the B registers to be used for stack-sequence support

```
%STKCBP = 0'02      Set stack current base pointer to
                    B02
%STKCTP = 0'66      Set stack current top pointer to
                    B66
%STKATP = 0'67      Set stack absolute top pointer to
                    B67
```

Define a table for the CFT calling sequence argument list

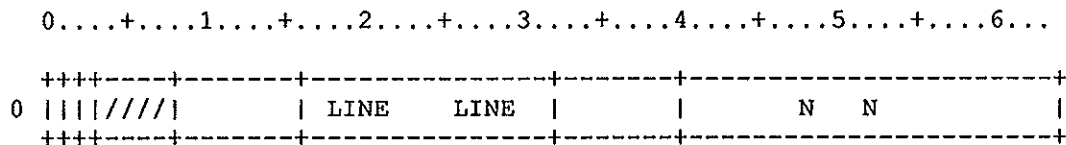

Figure AR-1. Argument List Header

Field definitions.

Argument list header:
 In XMP mode (24 bit)...
 VWD 1/FLAG,1/VAL,1/CHR,13/(reserved),24/LINE,24/N
 In YMP mode (32 bit)...
 VWD 1/FLAG,1/VAL,1/CHR,5/(reserved),24/LINE,32/ARN
 Old sequence did not use an argument list header.
 "D" is used so both \$SYSTXT and \$COSTXT can use this deck.

Field	Word(base8)	Bits	Description
ARFLAG	0	0	Non-standard sequence flag
ARVAL	0	1	Call-by-value(1)/call-by-address(0) flg
ARCHR	0	2	Character function(1)/non-character(0)
ARLINE	0	16-39	Sequence number of call
ARN	0	40-63	Number of arguments
ARLINE	0	8-31	Sequence number of call
ARN	0	32-63	Number of arguments

Character argument descriptors:
 In XMP mode (24 bit)...
 VWD 17/(reserved),17/LEN,6/OFF,24/ADD
 In YMP mode (32 bit)...
 VWD 06/offset,26/LEN,32/ADD
 Each descriptor is one full word of the above form.

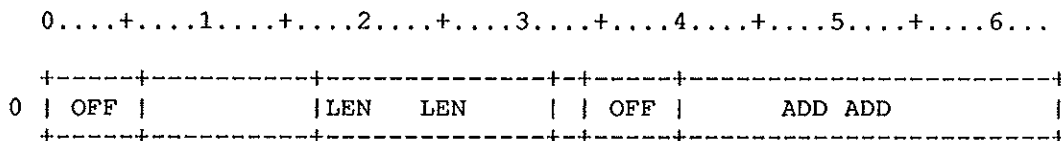

Figure AR-2. Argument Descriptors

<u>Field</u>	<u>Word(base8)</u>	<u>Bits</u>	<u>Description</u>
ARLEN	0	17-33	in bits
AROFF	0	34-39	Offset to first character (in bits) for character argument
ARADD	0	40-63	Address of argument
AROFF	0	0-5	Offset to first character (in bits) for character argument
ARLEN	0	6-31	in bits
ARADD	0	32-63	Address of argument

Maximum bit length for a character entity is 131064 (decimal) bits. This is 16383 characters.

MAXCHL=131064

SL001	=	1	I/O system error
SL002	=	2	Unrecovered hardware error
SL003	=	3	Disk data error
SL004	=	4	Block number error
SL005	=	5	Read on write only dataset
SL006	=	6	Dataset prematurely terminated
SL007	=	7	Dataset not open
SL008	=	D' 8	Dataset does not exist
SL009	=	D' 9	Read after write
SL010	=	D' 10	Read past end of data
SL011	=	D' 11	Write on read only dataset
SL012	=	D' 12	Write past end of allocated area
SL013	=	D' 13	Random record must end on boundary
SL014	=	D' 14	Random buffer must be 2 blocks long
SL015	=	D' 15	Character write illegal on random
SL016	=	D' 16	Write past end of data
SL017	=	D' 17	Uncleared end of file
SL018	=	D' 18	Invalid processing direction
SL019	=	D' 19	Undefined I/O error
SL020	=	D' 20	Unit no. < 0 or > 102
SL021	=	D' 21	Error on open
SL022	=	D' 22	Request invalid for unblocked dataset
SL023	=	D' 23	Invalid word address
SL024	=	D' 24	Invalid BIO function for unblocked ds
SL025	=	D' 25	Invalid or duplicate class specified
SL026	=	D' 26	Invalid keyword specified
SL027	=	D' 27	Buffer size invalid for unblocked req
SL028	=	D' 28	Mem res invalid for unblocked dataset
SL029	=	D' 29	Invalid device type
SL030	=	D' 30	Invalid expiration date
SL031	=	D' 31	Illegal BFI character
SL032	=	D' 32	Invalid label type
SL033	=	D' 33	PDN too large
SL034	=	D' 34	ENTER invalid for tape
SL035	=	D' 35	Mutually exclusive parms; NEW:MOD
SL036	=	D' 36	Invalid file section number
SL037	=	D' 37	Invalid character set
SL038	=	D' 38	MBS too large
SL039	=	D' 39	Invalid file sequence number
SL040	=	D' 40	Invalid expiration date
SL041	=	D' 41	nnnnnnn is BS of already opened DS
SL042	=	D' 42	Dataset name xxxxxxxx already used
SL043	=	D' 43	Invalid dataset density
SL044	=	D' 44	Random dataset cannot extend
SL045	=	D' 45	Unknown public access mode
SL046	=	D' 46	Syntax error in ADN argument
SL047	=	D' 47	ADN has more than 7 characters
SL048	=	D' 48	Unknown ADN attribute parameter
SL049	=	D' 49	Bad argument to TRACK parameter

SL050	=	D'50	Blank field compress count out of rang
SL051	=	D'51	PACK, nbits has an invalid value
SL052	=	D'52	UNPACK, nbits has an invalid value
SL053	=	D'53	PACK, nbits*nw not multiple of 64
SL054	=	D'54	UNPACK, nbits*nw not multiple of 64
SL055	=	D'55	BKSP invalid for tape
SL056	=	D'56	Invalid conversion type
SL057	=	D'57	Invalid record format
SL058	=	D'58	Invalid record length
SL059	=	D'59	XDT and RT illegal together
SL061	=	D'61	'ED' parameter out of range
SL062	=	D'62	'RT' parameter out of range
SL060	=	D'60	Invalid data format
SL063	=	D'63	Dataset can not be found
SL064	=	D'64	Premature end of program module
SL065	=	D'65	Invalid program load table
SL066	=	D'66	Fatal program compilation errors
SL067	=	D'67	Program is not an absolute module
SL068	=	D'68	Illegal program load address
SL069	=	D'69	Foreign dataset request not supported
SL070	=	D'70	Invalid foreign dataset block size
SL071	=	D'71	DSPLOCK conflict (multitasking job)
SL072	=	D'72	S and SZ are both present
SL073	=	D'73	USER and ADN both missing
SL074	=	D'74	Invalid RCW in blocked dataset
SL075	=	D'75	Processor number out of range
SL076	=	D'76	Unknown performance monitor function
SL077	=	D'77	Invalid RING option
SL078	=	D'78	Ring/disposition conflict on access
SL079	=	D'79	ASSIGN parm BS too large
SL080	=	D'80	Access a catalog dataset error
SL081	=	D'81	Read a catalog dataset error
SL082	=	D'82	Bad edition number
SL083	=	D'83	xxxxxxx yyyyyyy is too long
SL084	=	D'84	Heap manager failed
SL085	=	D'85	xxxxxxx illegal parameter
SL086	=	D'86	Region length is zero
SL087	=	D'87	Requested dataset not found
SL088	=	D'88	Bad argument to RESIDE parameter
SL089	=	D'89	Bad argument to BACKUP parameter
SL090	=	D'90	DN or PDN is required (for DELETE)
SL091	=	D'91	xxxxxxx Option invalid for non-XMP
SL092	=	D'92	xxxxxxx Illegal value for MODE parm
SL093	=	D'93	xxxxxxx Hardware not avail on host
SL094	=	D'94	xxxxxxx Cannot execute on this machine
SL095	=	D'95	xxxxxxx xxxxxxx PDM hash key failed

SL096	=	D'96	DEVICE TYPE not valid
SL097	=	D'97	STORAGE TYPE must be SCR or PERM
SL098	=	D'98	*** NOT USED AT PRESENT ***
SL099	=	D'99	*** NOT USED AT PRESENT ***
SL100	=	D'100	*** NOT USED AT PRESENT ***
SL101	=	D'101	*** NOT USED AT PRESENT ***
SL102	=	D'102	*** NOT USED AT PRESENT ***
SL103	=	D'103	*** NOT USED AT PRESENT ***
SL104	=	D'104	*** NOT USED AT PRESENT ***
SL105	=	D'105	*** NOT USED AT PRESENT ***
SL106	=	D'106	*** NOT USED AT PRESENT ***
SL107	=	D'107	*** NOT USED AT PRESENT ***
SL108	=	D'108	*** NOT USED AT PRESENT ***
SL109	=	D'109	*** NOT USED AT PRESENT ***
SL110	=	D'110	*** NOT USED AT PRESENT ***
SL111	=	D'111	*** NOT USED AT PRESENT ***
SL112	=	D'112	*** NOT USED AT PRESENT ***
SL113	=	D'113	*** NOT USED AT PRESENT ***
SL114	=	D'114	*** NOT USED AT PRESENT ***
SL115	=	D'115	*** NOT USED AT PRESENT ***
SL116	=	D'116	*** NOT USED AT PRESENT ***
SL117	=	D'117	*** NOT USED AT PRESENT ***
SL118	=	D'118	*** NOT USED AT PRESENT ***
SL119	=	D'119	*** NOT USED AT PRESENT ***
SL120	=	D'120	*** NOT USED AT PRESENT ***
SL121	=	D'121	*** NOT USED AT PRESENT ***
SL122	=	D'122	*** NOT USED AT PRESENT ***
SL123	=	D'123	*** NOT USED AT PRESENT ***
SL124	=	D'124	*** NOT USED AT PRESENT ***
SL125	=	D'125	*** NOT USED AT PRESENT ***
SL126	=	D'126	*** NOT USED AT PRESENT ***
SL127	=	D'127	*** NOT USED AT PRESENT ***
SL128	=	D'128	*** NOT USED AT PRESENT ***
SL129	=	D'129	*** NOT USED AT PRESENT ***
SL130	=	D'130	*** NOT USED AT PRESENT ***
SL131	=	D'131	*** NOT USED AT PRESENT ***
SL132	=	D'132	*** NOT USED AT PRESENT ***
SL133	=	D'133	*** NOT USED AT PRESENT ***
SL134	=	D'134	*** NOT USED AT PRESENT ***
SL135	=	D'135	*** NOT USED AT PRESENT ***
SL136	=	D'136	*** NOT USED AT PRESENT ***
SL137	=	D'137	*** NOT USED AT PRESENT ***
SL138	=	D'138	*** NOT USED AT PRESENT ***
SL139	=	D'139	*** NOT USED AT PRESENT ***

```

0....+....1....+....2....+....3....+....4....+....5....+....6...
+-----+
0 |                                     DIR                                     |
+-----+
1 |                                     PDN1                                    |
+-----+
2 |                                     PDN2                                    |
+-----+
3 |                                     ID                                     |
+-----+
4 |                                     USR                                     |
+-----+
5 |                                     USRN                                    |
+-----+
6 |      SID      |      DID      |      JSQ      |
+-----+
7 |                                     TID                                    |
+-----+
10 |                                     SZ                                     |
+-----+

```

Figure SF-1. Statistics format

<u>Field</u>	<u>Word(base8)</u>	<u>Bits</u>	<u>Description</u>
SFDIR	0	0-63	direction: 'RECEIVED' or 'TRANSMIT'
SFPDN1	1	0-63	dataset name, characters 1-8
SFPDN2	2	0-55	dataset name, characters 9-15
SFID	3	0-63	user ID
SFUSR	4	0-63	user number, characters 1-8
SFUSRN	5	0-55	user number, characters 9-15
SFSID	6	0-15	source mainframe ID
SFDID	6	16-31	destination mainframe ID
SFJSQ	6	32-63	job sequence number
SFTID	7	0-63	terminal ID
SFSZ	10	0-63	dataset size, in words

SM@GRDFR	=	SM@ACTFR	Change of state of guard bit ST
			reg
%%SMNUM	=	%%SMNUM	First user semaphore will be 16
%%SBNUM	=	%%SBNUM	First user shared B reg will be 4
%%STNUM	=	%%STNUM	First user shared T reg will be 4

A relocatable file can contain symbol table information for each program unit in a compilation. The information is a sequence of tables of type 11. The sequence always includes a subroutine table and can include one or more common block tables.

The Subroutine Table contains information about the subroutine block, the common block(s) referenced by the subroutine, and the local symbols. The organization of the Subroutine Table is shown below. The header format is shown in figure SMT-1. Symbol descriptor format is shown in figure SMT-3. The dimension descriptor format is shown in figure SMT-7.

0	+-----+
	Header
CML	+-----+
	Symbol
	descriptors
CML+SYL	+-----+
	Dimension
	descriptors
	+-----+
	Auxiliary
	data
WC-1	+-----+

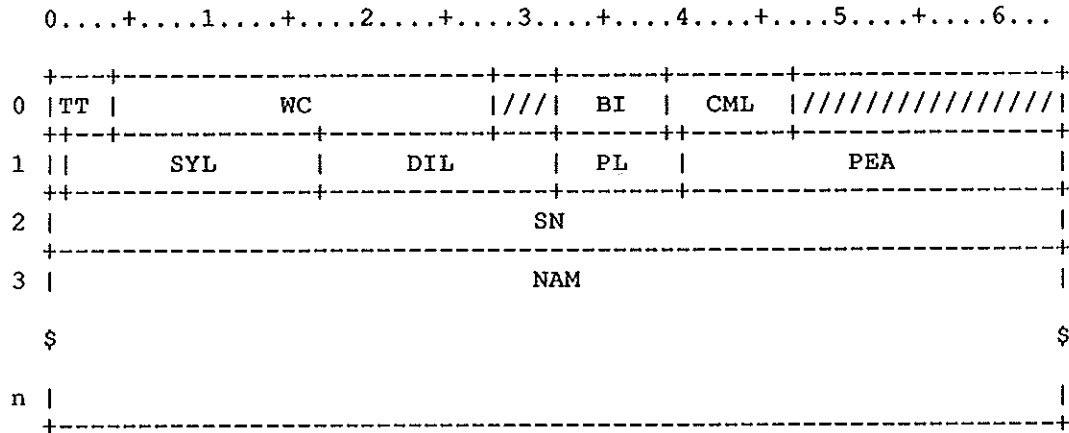

Figure SMT-1. Subroutine Table Header

Field	Word(base8)	Bits	Description
SMTTT	0	0-3	Table type (0'11)
SMTWC	0	4-27	Table word count
SMTBI	0	32-38	Block index. This is an index into the Subroutine Table common block name list (the same list as contained in the PDT table.)
SMTCML	0	39-46	Length in words of table header
SMTDBF	1	0	Dynamic block flag: 0 Static 1 Dynamic
SMTSYL	1	1-16	
SMTDIL	1	17-31	Dimension block length
SMTPL	1	32-39	Prologue length (parcel)
SMTPEA	1	40-63	Primary entry address (parcel)
SMTSN	2	0-63	Subroutine name
SMTNAM	3-n	0-63	Name(s) of common block(s) referenced by this routine.

The Common Block Table contains information about a specific common block referenced within a subroutine and the symbols that the common block contains. A Symbol Table contains one Common Block Table for each common block named in the Subroutine table. The final word of the Common Block Table, field THC, gives the Common Block Table checksum. The over-all organization of the Common Block Table is shown below. The header format is shown in figure SM.1-2. Symbol descriptor format is shown in figure SM.1-3. The dimension descriptor format is shown in figure SM.1-7.

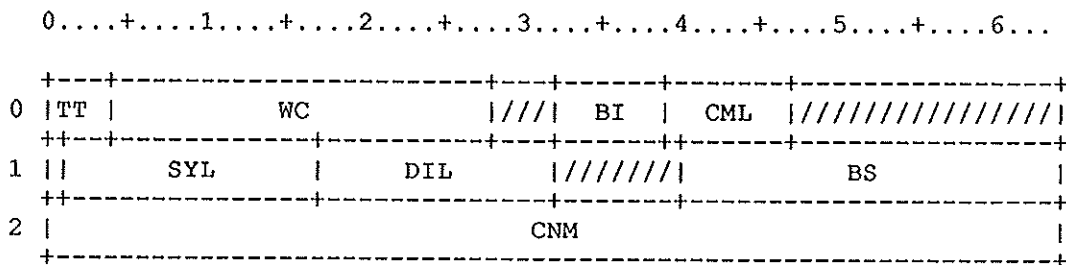
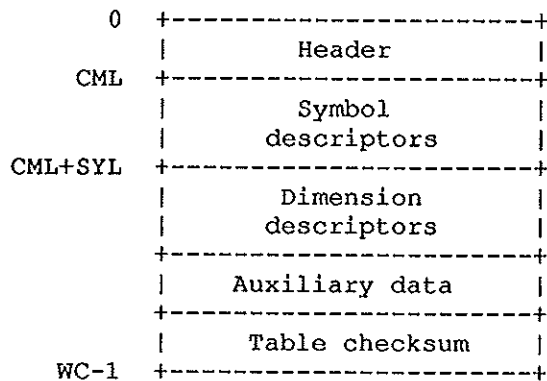

Figure SMT-2. Common Block Table Header

Field	Word(base8)	Bits	Description
SMTTT	0	0-3	Table type; 11 octal
SMTWC	0	4-27	Word count (number of words occupied by this table)
SMTBI	0	32-38	Block index
SMTCML	0	39-46	Common block length. This field is always 3 for a common block.
SMTDBF	1	0	Dynamic block flag: 0 Static 1 Dynamic

<u>Field</u>	<u>Word(base8)</u>	<u>Bits</u>	<u>Description</u>
SMTSYL	1	1-16	Symbol block length (words)
SMTDIL	1	17-31	Dimension block length (words)
SMTBS	1	40-63	Block size; storage size of the named common block in words.
SMTCNM	2	0-63	Name of common block; ASCII, left-justified, zero-filled.

Words CML through CML+SYL-1 contain descriptors of local symbols. Each descriptor (figure SM.1-3) may be 3 through 6 words long, depending on the symbol length. In addition, a dimensioned variable symbol points to a group of words in the dimension block for its dimension information.

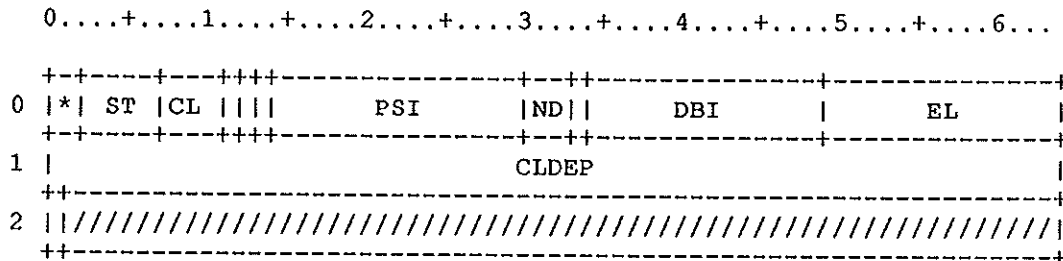

Figure SMT-3. Symbol Descriptor Format

Field	Word(base8)	Bits	Description
SMTSL	0	0-1	Symbol name length-1 in words
SMTST	0	2-6	Symbol type: 0 Unknown 1 Program (external) 2 Entry point 3 Label 4 Integer 5 Real 6 Complex 7 Logical 8 Character 9 Bit (Boolean) 10 File 11 Pointer 12 DP integer 13 DP real 14 DP complex 15 Structure 16 Address
SMTCL	0	7-10	Symbol class: 0 Constant 1 Register 2 Normal 3 Stack 4 Based pointer 5 Based descriptor
SMTDA	0	11	Dummy argument (parameter). If non-zero, the symbol is a dummy argument.

Field	Word(base8)	Bits	Description
SMTAM	0	12	Argument mode: 0 Address 1 Value
SMTEQ	0	13	Equivalence. If non-zero, the symbol is equivalenced.
SMTPSI	0	14-29	Parent symbol index. If nonzero, the index is within SYL of the top parent.
SMTND	0	30-32	Number of dimensions
SMTASM	0	33	Array storage mode: 0 By column 1 By row
SMTDBI	0	34-48	Dimension block index
SMTEL	0	49-63	Element length (in bits)
CLDEF	1	0-63	Symbol class-dependent information: Class Figure 0 SM.1-4 1 SM.1-5 2-5 SM.1-6
SMTSNM	2	0	Symbol name; 1-4 words (32 character maximum) in 8-bit ascii, left-justified, null-filled to end of word.

The contents of word S2 of the symbol descriptor are determined by the class of the symbol. Class type may be found in field CL of the Subroutine Table, word CML, bits 7-10.

Classes are as follows:

- 0 Constant value
- 1 Register
- 2 Normal
- 3 Stack
- 4 Based pointer
- 5 Based descriptor

Figures SM.1-4, SM.1-5, and SM.1-6 describe the formats that word 2 of the symbol descriptor can take, based on the symbol class.

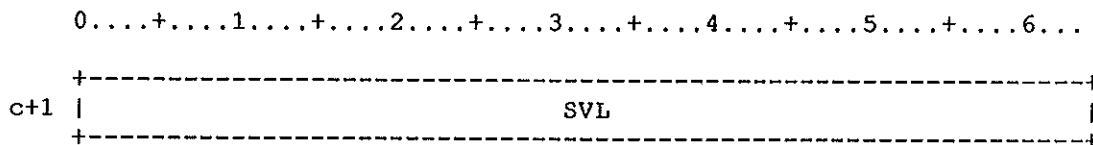

Figure SMT-4. Word S2 for class 0

Field	Word(base8)	Bits	Description
SMTSVL	c+1	0-63	

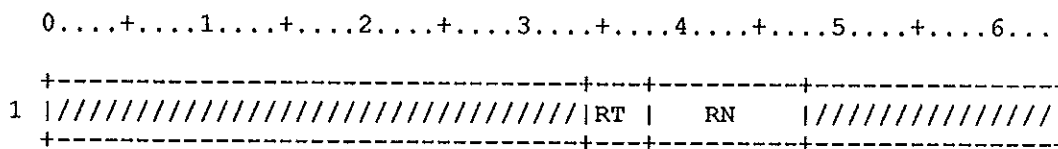

Figure SMT-5. Word S2 for class 1

Field	Word(base8)	Bits	Description
SMTRT	1	34-37	Register type: 1 A 2 B 3 S 4 T 5 V 6 Special
SMTRN	1	38-47	Register number or subtype. For register types 1 through 5, RN contain a register number. For register type RN contains one of the following value right-justified with zero fill. 0 Vector length register 1 Vector mask register 2-31 Channel address register 32 P register

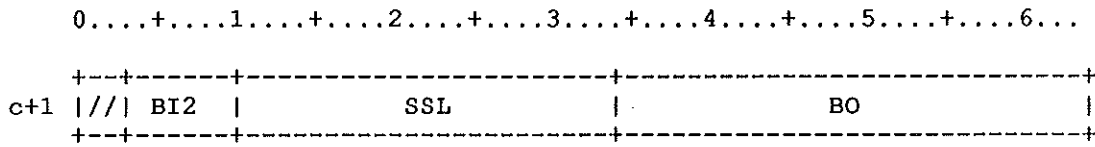

Figure SMT-6. Word S2 for class 2-5

<u>Field</u>	<u>Word(base8)</u>	<u>Bits</u>	<u>Description</u>
SMTBI2	c+1	3-9	Block index
SMTSSL	c+1	10-33	Symbol storage length; words occupied in storage.
SMTBO	c+1	34-63	Bit offset; offset in bits from the block base or from the parent symbol base.

The dimension descriptor portion of the Subroutine or Common Block Table contains a dimension descriptor for each dimensioned variable symbol ($ND > 0$). Each descriptor consists of an n-word entry, where n is the dimension of the variable. Figure SM.1-7 illustrates a dimension descriptor entry.

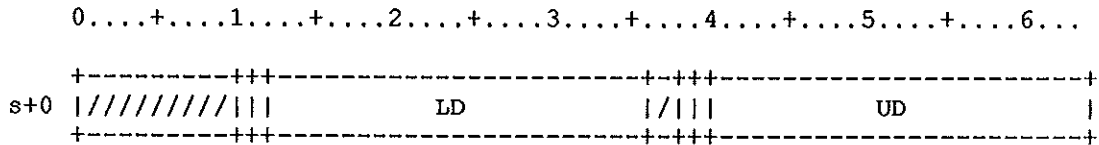

Figure SMT-7. Dimension Descriptor Format

<u>Field</u>	<u>Word(base8)</u>	<u>Bits</u>	<u>Description</u>
SMTLDE	s+0	10	Lower dimension expression. If LDE is nonzero, the lower dimension field (LD) contains an index into the dimension block of the expression definition required to evaluate the lower dimension. (See description of L field.)
SMTLDI	s+0	11	Lower dimension indirect. If LDI is nonzero, the lower dimension contains an index into a symbol list of the symbol that contains the lower dimension value. (See description of LD field.)

Field	Word(base8)	Bits	Description
SMTLD	s+0	12-35	<p>Lower dimension. The contents of LD depend on the values of LDE and LDI. If LDE and LDI equal 0, then LD is the lower dimension value. If LDE is not 0, then LD consists of the following subfields:</p> <pre> 1....+....2....+....3....+ ---+-----+-----+ .. ACCL DIMI ---+-----+-----+ </pre> <p>ACCL 12-19 The length in half words of the access function</p> <p>DIMI 20-35 Index into DIL of the dimension expression</p> <p>If LDI><0, then LD consists of the following subfields:</p> <pre> 1....+....2....+....3....+ ---+-----+-----+ ... BI DSI ---+-----+-----+ </pre> <p>BI 13-19 Block index</p> <p>DSI 20-35 Dimension symbol index</p> <p>DSI is an origin=1 index into the symbol descriptors. For example, DSI=1 is word CML of SMT. Where LDI is nonzero, DSI points to the first word of a descriptor whose symbol holds the lower dimension bound. Where UDI is nonzero, DSI points to the first word of a descriptor whose symbol holds the dimension length.</p> <p>Example: Given SUBROUTINE S(M,N) DIMENSION A(M:M+N), where M=3 and N=8, LDI=UDI=1, DSI for LD points to a symbol whose value is 3, and DSI for UD point to a symbol whose value is 9.</p>
SMTUDE	s+0	38	Upper dimension expression (same as LDE, for upper dimension)
SMTUDI	s+0	39	Upper dimension indirect
SMTUD	s+0	40-63	Upper dimension. The contents of UD depend on the values of UDE and UDI. UDI=0 then UD is the dimension upper bound. If UDE is nonzero, it has the same format as LD. If UDI is nonzero, UD is the same as LD when LDI is nonzero, and points to a symbol containing the dimension extent (not an upper dimension).

PERFORMANCE MONITOR REPORT FORMATS

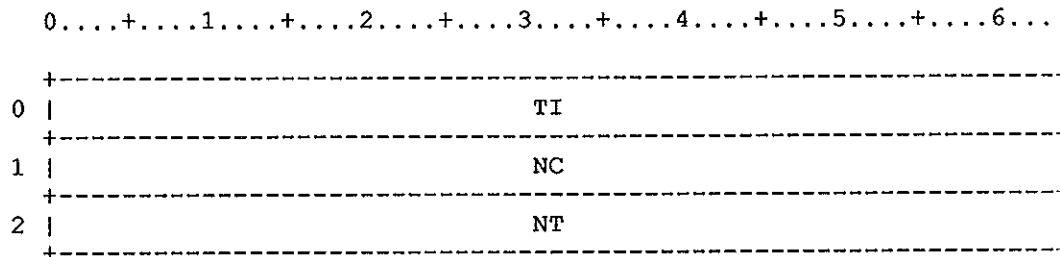

Figure CP-1. SPM CPU Utilization Report header

Header.

<u>Field</u>	<u>Word(base8)</u>	<u>Bits</u>	<u>Description</u>
CPPI	0	0-63	Time interval
CPNC	1	0-63	Number of CPUs
CPNT	2	0-63	Number of tasks

Entries (CPU utilization; one entry per CPU).

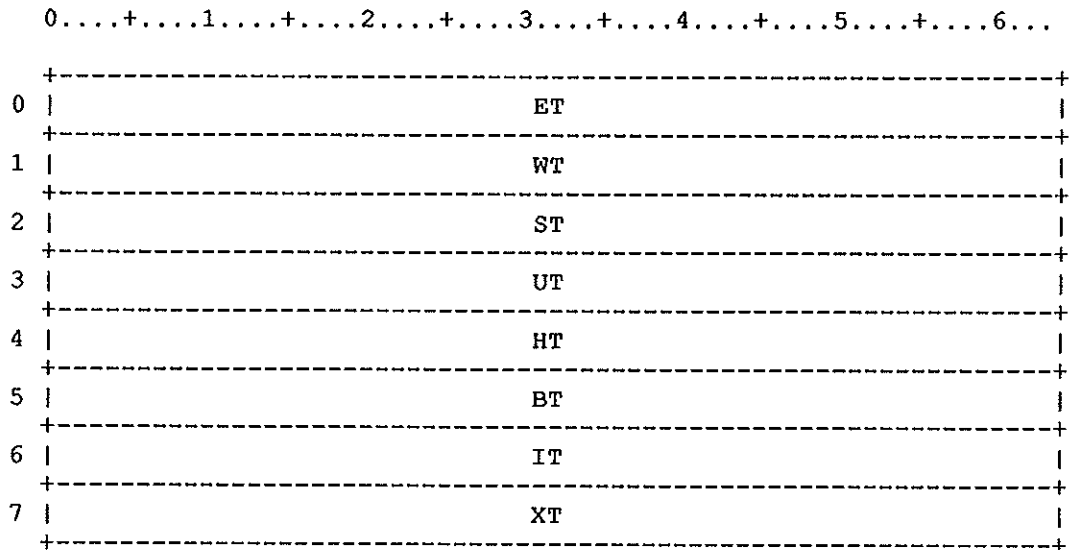

Figure CP-2. SPM CPU Utilization Report entry

Field	Word(base8)	Bits	Description
CPET	0	0-63	EXEC time, CPU n
CPWT	1	0-63	SYSWAIT time, CPU n
CPST	2	0-63	STP time, CPU n
CPUT	3	0-63	User time, CPU n
CPHT	4	0-63	User wait semaphore time, CPU n
CPBT	5	0-63	Blocked time, CPU n
CPIT	6	0-63	Idle time, CPU n
CPXT	7	0-63	New SYSWAIT time, CPU n

The following table is appended to the CPR table. It contains a breakdown of the STP utilization.

CPTT	0	0-63	Task time in cycles, task 0
------	---	------	-----------------------------

TASK UTILIZATION REPORT

```

0....+....1....+....2....+....3....+....4....+....5....+....6...
+-----+
0 |                                     TI                                     |
+-----+
1 |                                     NT                                     |
+-----+
2 |                                     TR                                     |
+-----+

```

Figure TK-1. SPM Task Utilization Report

<u>Field</u>	<u>Word(base8)</u>	<u>Bits</u>	<u>Description</u>
TKTI	0	0-63	Time interval
TKNT	1	0-63	Number of tasks
TKTR	2	0-63	Task requests for task 0

EXECUTIVE REQUEST REPORT

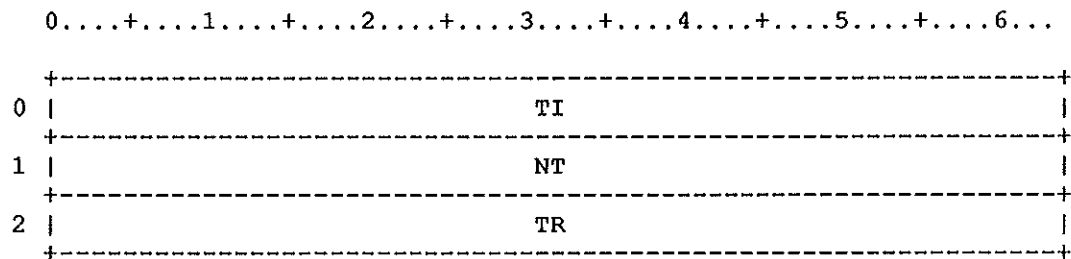

Figure ER-1. SPM Executive Request Report

<u>Field</u>	<u>Word(base8)</u>	<u>Bits</u>	<u>Description</u>
ERTI	0	0-63	Time interval
ERNT	1	0-63	Number of tasks
ERTR	2	0-63	Number of exec requests from task 0

DISK UTILIZATION REPORT

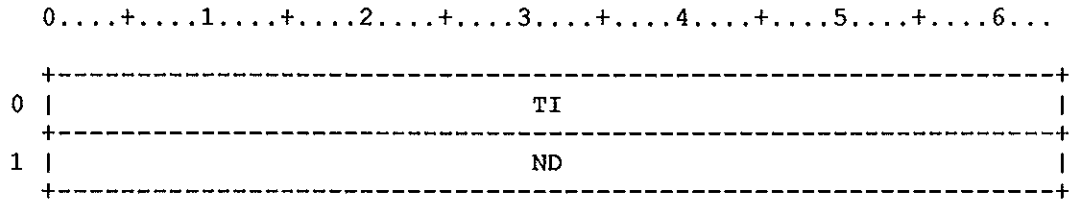

Figure DU-1. SPM Disk Utilization Report

<u>Field</u>	<u>Word(base8)</u>	<u>Bits</u>	<u>Description</u>
DUTI	0	0-63	Time interval
DUND	1	0-63	Number of disks

```

0.....+.....1.....+.....2.....+.....3.....+.....4.....+.....5.....+.....6...
+-----+-----+-----+-----+-----+-----+-----+-----+
0 |                               LDV                               |
+-----+-----+-----+-----+-----+-----+-----+-----+
1 |                               BT                                |
+-----+-----+-----+-----+-----+-----+-----+-----+
2 |                               SKT                               |
+-----+-----+-----+-----+-----+-----+-----+-----+
3 |                               TRT                               |
+-----+-----+-----+-----+-----+-----+-----+-----+
4 |                               NPR                               |
+-----+-----+-----+-----+-----+-----+-----+-----+
5 |                               NSR                               |
+-----+-----+-----+-----+-----+-----+-----+-----+
6 |      MAU      |      PDA      |////////////////////|      AIA      |
+-----+-----+-----+-----+-----+-----+-----+-----+
7 |                               NBR                               |
+-----+-----+-----+-----+-----+-----+-----+-----+
10 |                               NBW                              |
+-----+-----+-----+-----+-----+-----+-----+-----+
    
```

Figure DU-2. SPM Disk Utilization Disk Entry

Field	Word(base8)	Bits	Description
DULDV	0	0-63	Logical device name
DUBT	1	0-63	Blocks transfered
DUSKT	2	0-63	Seek time
DUTRT	3	0-63	Transfer time
DUNPR	4	0-63	Number of physical requests
DUNSR	5	0-63	Number of on-cylinder requests
DUMAU	6	0-15	Maximum allocation units
DUPDA	6	16-31	Number of permanent AI
DUAIA	6	48-63	Number of free AI
DUNBR	7	0-63	Number of blocks read
DUNBW	10	0-63	Number of blocks written

DISK CHANNEL UTILIZATION REPORT

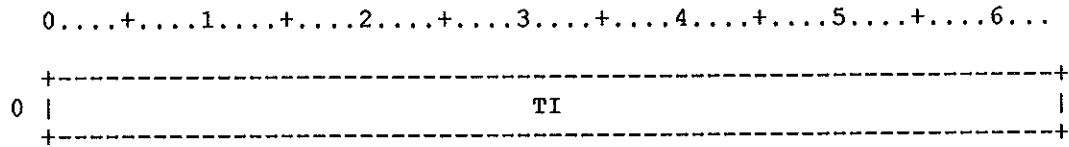

Figure DC-1. SPM Disk Channel Utilization Report

<u>Field</u>	<u>Word(base8)</u>	<u>Bits</u>	<u>Description</u>
DCTI	0	0-63	Time interval

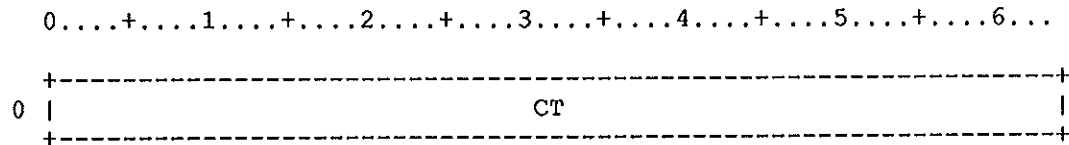

Figure DC-2. SPM Disk Channel Utilization Report

<u>Field</u>	<u>Word(base8)</u>	<u>Bits</u>	<u>Description</u>
DCCT	0	0-63	Channel time

LINK UTILIZATION REPORT

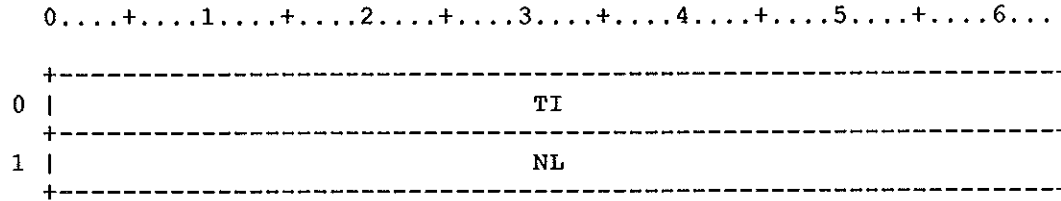

Figure LU-1. SPM Link Utilization Report

Field	Word(base8)	Bits	Description
LUTI	0	0-63	Time interval
LUNL	1	0-63	Number of links

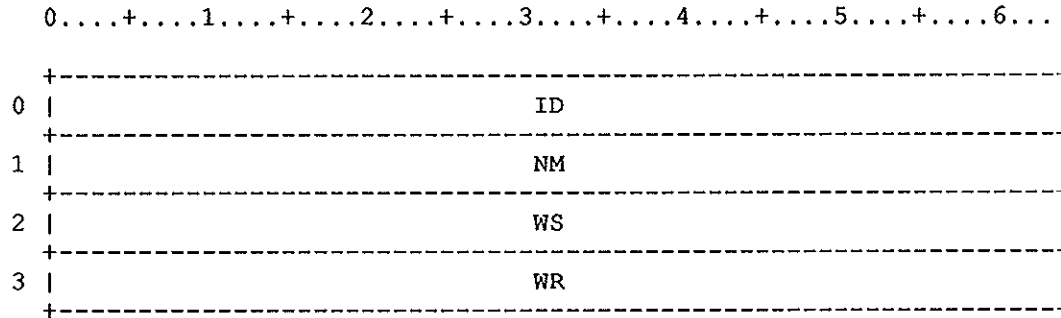

Figure LU-2. SPM Link Utilization Report

Field	Word(base8)	Bits	Description
LUID	0	0-63	Link id
LUNM	1	0-63	Number of messages
LUWS	2	0-63	Words sent
LUWR	3	0-63	Words received

EXECUTIVE CALL REPORT

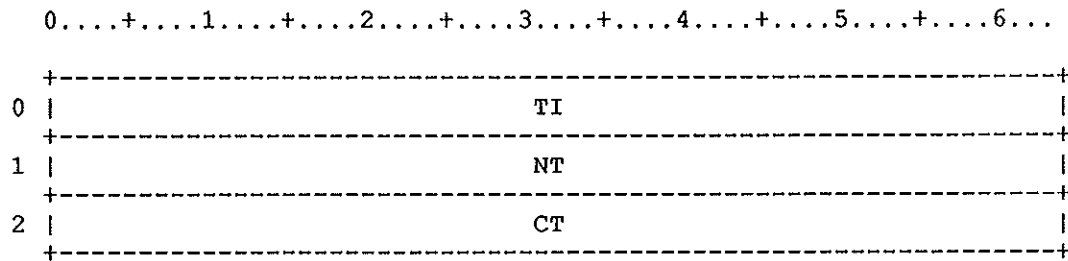

Figure EC-1. SPM Executive Call Report

<u>Field</u>	<u>Word(base8)</u>	<u>Bits</u>	<u>Description</u>
ECTI	0	0-63	Time interval
ECNT	1	0-63	Number of call types
ECCT	2	0-63	Number of type 0 calls

USER CALL USAGE REPORT

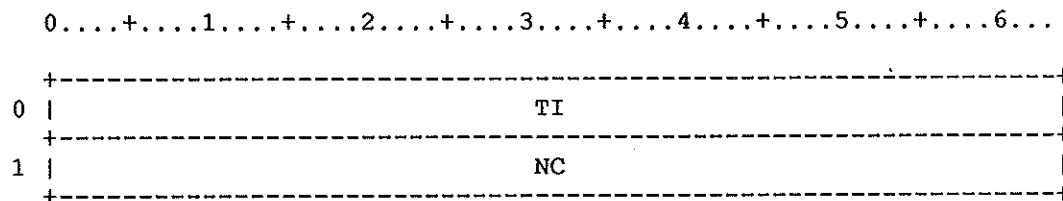

Figure UC-1. SPM User Call Usage Report

<u>Field</u>	<u>Word(base8)</u>	<u>Bits</u>	<u>Description</u>
UCTI	0	0-63	Time interval
UCNC	1	0-63	Number of calls

CHANNEL INTERRUPT REPORT

ICNE = C@CPHCHN+1+D'11+D'11

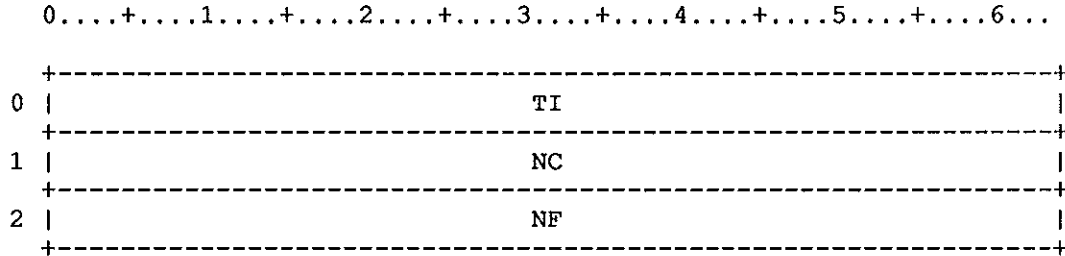

Figure IC-1. SPM Channel Interrupt Report

Header.

Field	Word(base8)	Bits	Description
ICTI	0	0-63	Time interval
ICNC	1	0-63	Highest channel number +1
ICNF	2	0-63	Number of flags

Entries. There are ICNC + 2*ICNF entries; channel entries first, then flag entries, then flag descriptors.

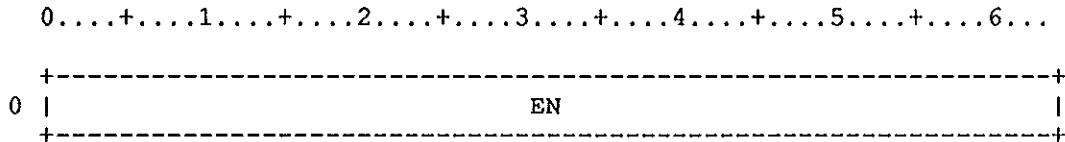

Figure IC-2. SPM Channel Interrupt Report

Field	Word(base8)	Bits	Description
ICEN	0	0-63	Entry word:

SYSTEM BUFFER UTILIZATION REPORT.

```

0.....+.....1.....+.....2.....+.....3.....+.....4.....+.....5.....+.....6...
+-----+-----+-----+-----+-----+-----+-----+
0 |                PTII                |
+-----+-----+-----+-----+-----+-----+
1 |                PTZP                |
+-----+-----+-----+-----+-----+-----+
2 |                PSZL                |
+-----+-----+-----+-----+-----+-----+
3 |                PHZWS                |
+-----+-----+-----+-----+-----+-----+
4 |                PAZES                |
+-----+-----+-----+-----+-----+-----+
5 |                PRCDS                |
+-----+-----+-----+-----+-----+-----+
6 |                PUADR                |
+-----+-----+-----+-----+-----+-----+
    
```

Figure SB-1. SPM System Buffer Utilization Report

<u>Field</u>	<u>Word(base8)</u>	<u>Bits</u>	<u>Description</u>
SBTI	0	0-63	Time interval
SBTZ	1	0-63	Total size of system buffer
SBSZ	2	0-63	Total size of unused space in sys buff
SBHZ	3	0-63	Total size of holes in system buffer
SBAZ	4	0-63	Total size of active buffers in system
SBRC	5	0-63	Memory request count

PREEMPTABLE GENERIC RESOURCE USAGE REPORT

Header.

PUTI	0	0-63	Time interval
PUNP	1	0-63	Number of PGR's (entries)
PUJL	2	0-63	Number of JTA loads
PUSWS	3	0-63	Number of jobs swept
PURES	4	0-63	Number of jobs restored
PUADS	5	0-63	Number of job aborts during sweep

<u>Field</u>	<u>Word(base8)</u>	<u>Bits</u>	<u>Description</u>
PUADR	6	0-63	Number of job aborts during restore Entry.

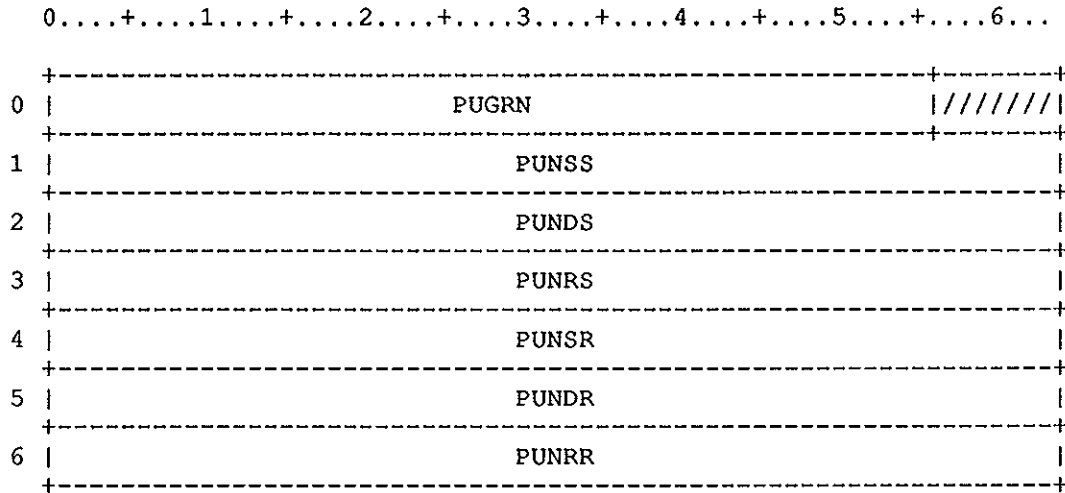

Figure SB-2. SPM System Buffer Utilization Report

<u>Field</u>	<u>Word(base8)</u>	<u>Bits</u>	<u>Description</u>
PUGRN	0	0-55	Generic resource name
PUNSS	1	0-63	Number of sectors swept
PUNDS	2	0-63	Number of datasets swept
PUNRS	3	0-63	Number of jobs swept (RAT's)
PUNSR	4	0-63	Number of sectors restored
PUNDR	5	0-63	Number of datasets restored
PUNRR	6	0-63	Number of jobs restored (RAT's)

MEMORY UTILIZATION REPORT

0....+....1....+....2....+....3....+....4....+....5....+....6...

0		TI	
1		AM	
2		IW	
3		CW	
4		CX	
5		WS	

Figure MU-1. SPM Memory Utilization Report

Field	Word(base8)	Bits	Description
MUTI	0	0-63	Time interval
MUAM	1	0-63	Available memory integral
MUIW	2	0-63	I/O wait integral
MUCW	3	0-63	CPU wait integral
MUCX	4	0-63	CPU executing integral
MUWS	5	0-63	CPU wait semaphore integral

SPM CONSTANTS

SPMTYPE=6 Log manager message type
of spm
SPMNSUBT=D'15 Number of
subtypes for SPM

Name: System Lock Queue (SLQ).

Purpose: The SLQ is a ordered list of processors waiting for the O.S. lock.

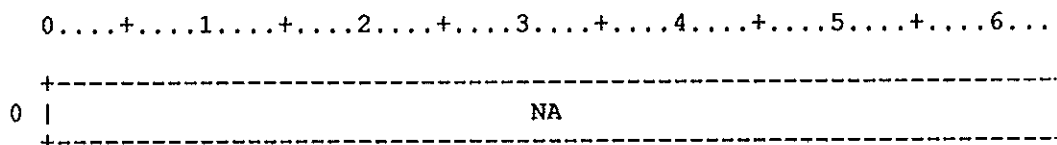

Figure SQ-1. System Lock Queue Header

Header Definitions.

Field	Word(base8)	Bits	Description
SQNA	0	0-63	Number of Active entries

Entry Definition.

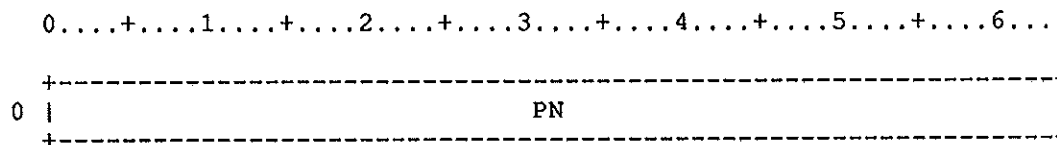

Figure SQ-2. System Lock Queue Entry

Field	Word(base8)	Bits	Description
SQPN	0	0-63	Processor number

Bit definitions for the Cray X-MP status register.

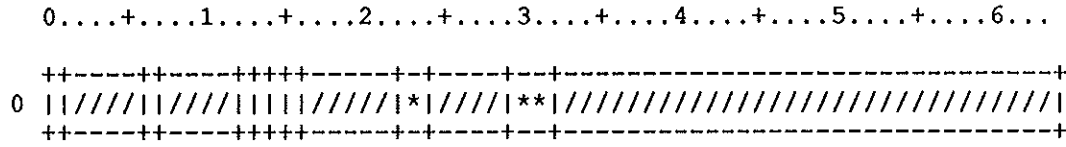

Figure SR0-1. Cray X-MP Status Register 0

Field	Word(base8)	Bits	Description
SR0CLX	0	0	Clustered if set
.SR0PS	0	6	Processor state
SR0FPE	0	12	Floating point error occurred
SR0FPI	0	13	Floating point interrupt enabled
SR0ORI	0	14	Operand range interrupt enabled
SR0BM	0	15	Bidirectional memory enabled
SR0PN	0	22-23	Processor number
SR0CLN	0	29-31	Cluster number

The SSD Request/Reply Queue Table is an STP-resident table that is used to send driver requests to the SSD driver and receive driver replies from the SSD driver.

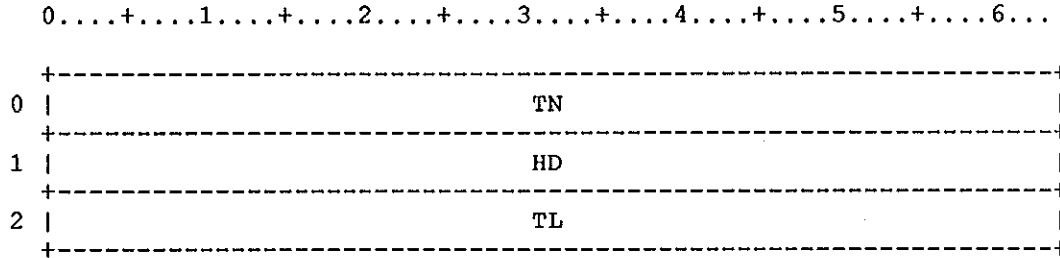

Figure SRQ-1. SSD Request/Reply Queue Table header

Field	Word(base8)	Bits	Description
SRQTN	0	0-63	Table name (ASCII, left-justified)
SRQHD	1	0-63	Queue head
SRQTL	2	0-63	Queue tail

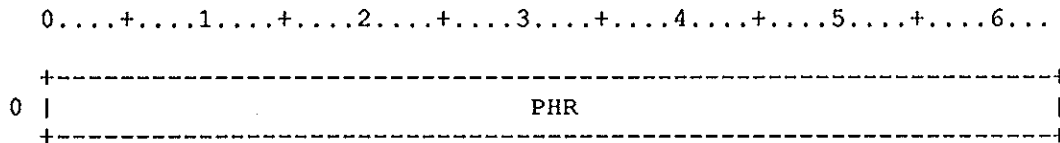

Figure SRQ-2. SSD Request/Reply Queue Table entry

Field	Word(base8)	Bits	Description
SRQPHR	0	0-63	Pointer to PHR entry

Name: Staging stream table (SST).

Purpose: The Staging stream tables are contained in the LXT and hold information concerning the state of streams for an ID. They are also used for communication between SCP and STG.

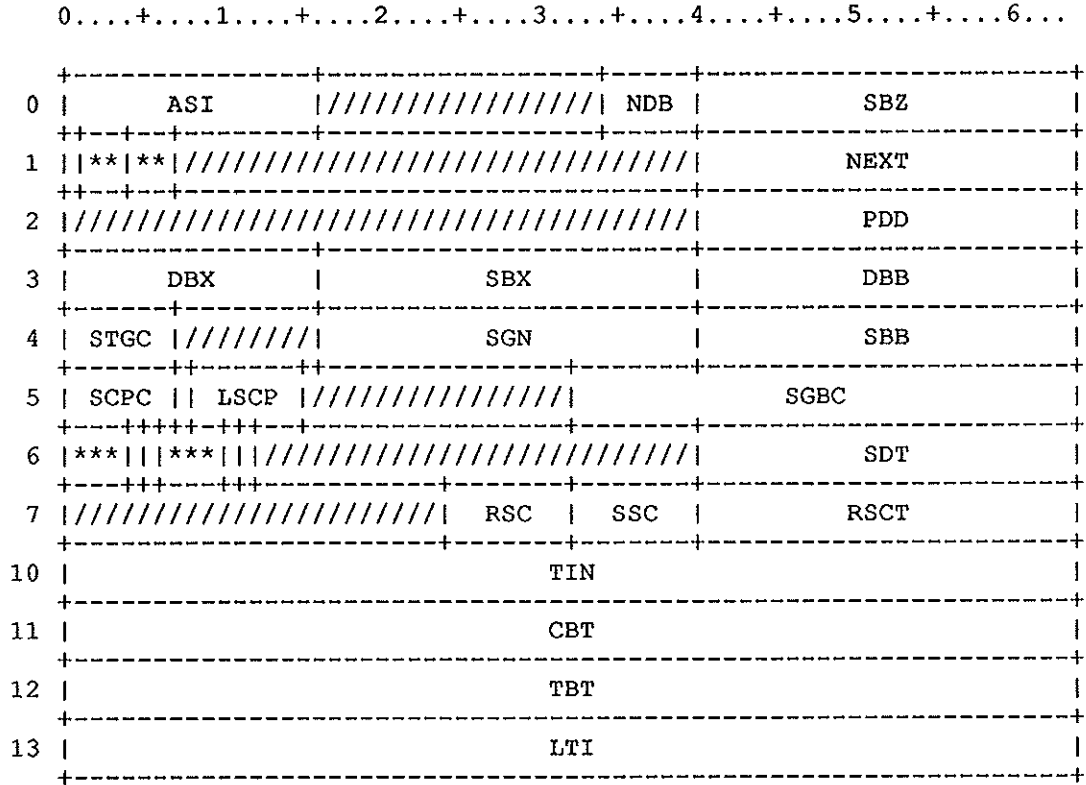

Figure SS-1. Staging Stream Table

Field	Word(base8)	Bits	Description
SSASI	0	0-15	ASCII stream identifier
SSOFLG	0	5	Output stream flag
SSSTN	0	12-15	Stream number
SSNDB	0	34-39	Number of disk buffers
SSSBZ	0	40-63	Segment buffer size
SSEOI	1	0	End of information in buffer flag

<u>Field</u>	<u>Word(base8)</u>	<u>Bits</u>	<u>Description</u>
SSSTAT	1	1-3	Status of dataset SSSTAOK=0 OK, request complete SSSTAEND=1 EOI or file already exists SSSTAERR=2 Error SSSTABFW=4 Buffer wait (no buffers available) SSSTABSY=7 Busy(I/O active)
SSSRT	1	4-6	PDM delay error retry count
SSNEXT	1	40-63	Next entry on BUSYQ or WAITQ
SSPDD	2	40-63	PDD address
SSDBX	3	0-15	Disk buffer index
SSSBX	3	16-39	Segment buffer index
SSDBB	3	40-63	Disk buffer base address
SSSTGC	4	0-6	STG message code SSMACK=1 Acknowledge SSMCFRD=2 Buffer ready SSMCCAN=3 Cancel SSMCEND=4 End SSMCPN=5 Postpone SSMCPBF=6 Process buffer SSMCSTR=7 Start SSMCFW=D'8 Buffer wait (no buffers available)
SSSGN	4	16-39	Segment number
<u>SSSBB</u>	4	40-63	<u>Segment buffer base address</u>
SSSCPC	5	0-6	SCP message code
SSLSCP	5	8-14	Last SCP request (if STG response BFW)
SSSGBC	5	32-63	Segment bit count
SSTERM	6	0-3	Stream termination code SSTCEND=1 End the stream SSTCPPN=2 Postpone the stream SSTCABT=3 Abort the stream
SSBSF	6	4	Buffer sent flag
SSBRF	6	5	Buffer ready flag
SSATRM	6	6-9	Asynchronous termination code
SSASTG	6	10	Need to notify STG of asynch term flag

<u>Field</u>	<u>Word(base8)</u>	<u>Bits</u>	<u>Description</u>
SSTR	6	11	Dataset transfer flag
SSSDT	6	40-63	SDT address
SSRSC	7	24-31	Received SCB
SSSSC	7	32-39	Next send SCB
SSRSCT	7	40-63	Received SCB table address
SSTIN	10	0-63	Real time of stream initialization
SSCBT	11	0-63	Current number of bits xferred
SSTBT	12	0-63	total bits transferred this period
SSLTI	13	0-63	Length of last time interval
LABEL	= *		\$SUB changes A0, A_SCRA, A_PTR, S6, S7
LABEL	= *		\$SUB changes A0, A_PTR, S6, S7

N O D E F I N I T I O N A V A I L A B L E

Figure SSW-1.

SSD memory (read)
channel (write)

SSD memory (read)
channel (write)

*CALL COMST at this ident + 1

COPYRIGHT BY CRAY RESEARCH, INC.

*

UNPUBLISHED - ALL RIGHTS RESERVED UNDER THE COPYRIGHT LAWS
OF THE UNITED STATES.

*

*

The System Task Table (STT) is an EXEC-resident table used by EXEC for scheduling and controlling tasks. The table has three parts: the header, the task parameter block (which contains a parameter area for each task), and a part containing the exchange packages for each task. The STT header is illustrated in figure ST-1; the STT entry is shown in figure ST-2.

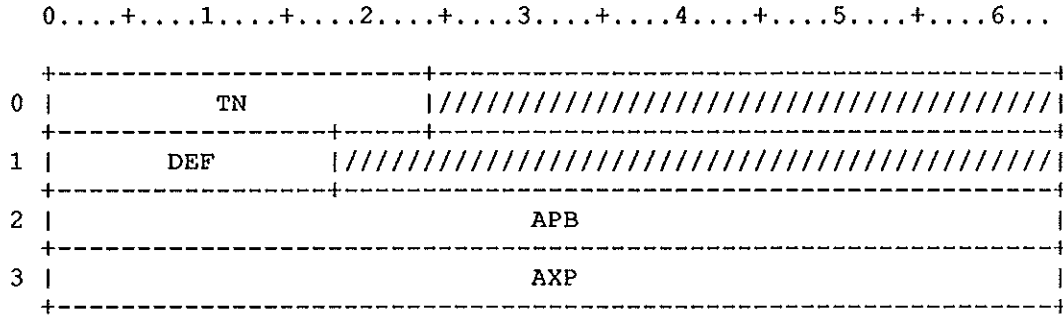

Figure ST-1. System Task Table

Field	Word(base8)	Bits	Description
STTN	0	0-23	Table name; 'STT' in ASCII.
STDEF	1	0-17	Defined task flags
STAPB	2	0-63	Active task parameter block address
STAXP	3	0-63	Active Exchange Package address

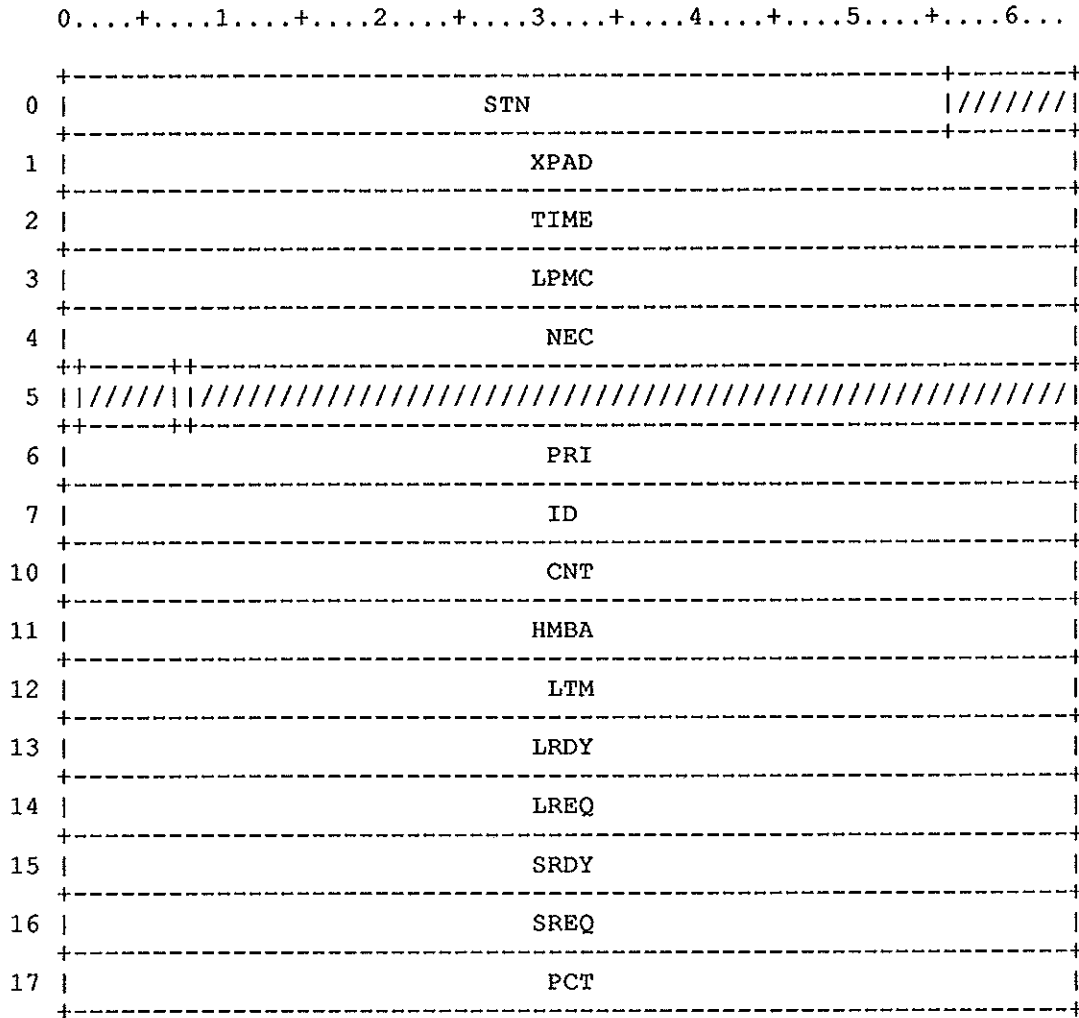

Figure ST-2. System Task Table

Field	Word(base8)	Bits	Description
STSTN	0	0-55	Task name in ASCII
STXPAD	1	0-63	Task XP and save area address
STTIME	2	0-63	Cumulative execution time
STLPMC	3	0-63	Last performance monitor call
STNEC	4	0-63	Count of normal exits from task
STSUS	5	0	Task suspend bit
STRDY	5	7	Re-ready bit (task ready request)
STPRI	6	0-63	Task priority

<u>Field</u>	<u>Word(base8)</u>	<u>Bits</u>	<u>Description</u>
STID	7	0-63	Task ID
STCNT	10	0-63	Task startup count
STHMBA	11	0-63	H'ware perf.mon. ctl block addr, or 0
Timers and counters as of last statistics event:			
STLTM	12	0-63	Task time (cycles)
STLRDY	13	0-63	Task readies count
STLREQ	14	0-63	Task request count
Data for IOP task monitor display:			
STSRDY	15	0-63	Number of task readies in last intrvl
STSREQ	16	0-63	Number of task requests, last intrvl
STPCT	17	0-63	Task statistics in last interval:
STSCI	17	0-15	% of all CP time, XX in XX.YY
STSCF	17	16-31	YY in XX.YY
STSSI	17	32-47	% of system time, XX in XX.YY
STSSF	17	48-63	YY in XX.YY

Stack control Header

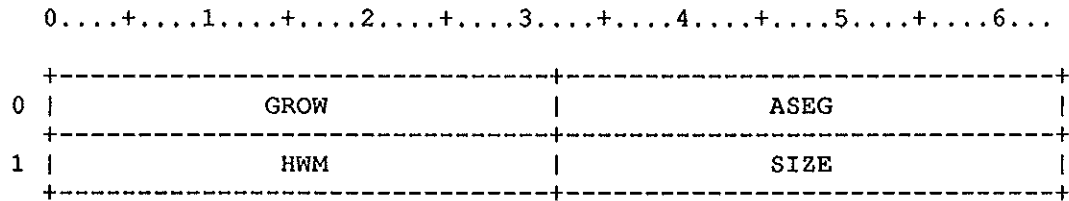

Figure SH-1. Stack Control Header

Field	Word(base8)	Bits	Description
SHGROW	0	0-31	Number of times the stack has grown
SHASEG	0	32-63	Size of increments to stack
SHHWM	1	0-31	High water mark of stack
SHSIZE	1	32-63	Current size of stack (all segments)

Stack Segment linkage control

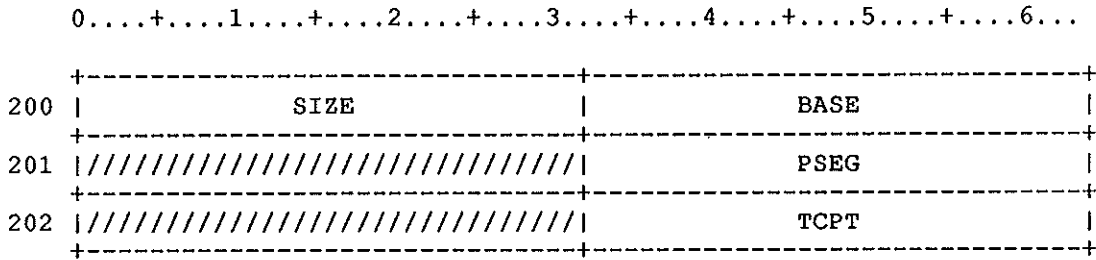

Figure SS-1. Stack Segment Linkage Control

Field	Word(base8)	Bits	Description
SSSIZE	200	0-31	Number of words in this segment
SSBASE	200	32-63	Offset to stack base
SSPSEG	201	32-63	Offset to linkage control of previous segment of stack
SSTCPT	202	32-63	Pointer to task common address block (\$TASKCOM)

The following job values are from cracked job card.

0....+....1....+....2....+....3....+....4....+....5....+....6...

0	JN		\$
1		TL	
2		PR	
3		MFL	
4	OLM		
5	USR		
6	US2		
7	BP		
10	CL		
11	SJ		
12	G		
13			
			\$
31			
32	B0		
33	B1		
34	CW	SEG	
35	AC1		
36	AC2		
37	UN1		
40	UN2		
41	ETA		

Figure STP-1. Job Card Values

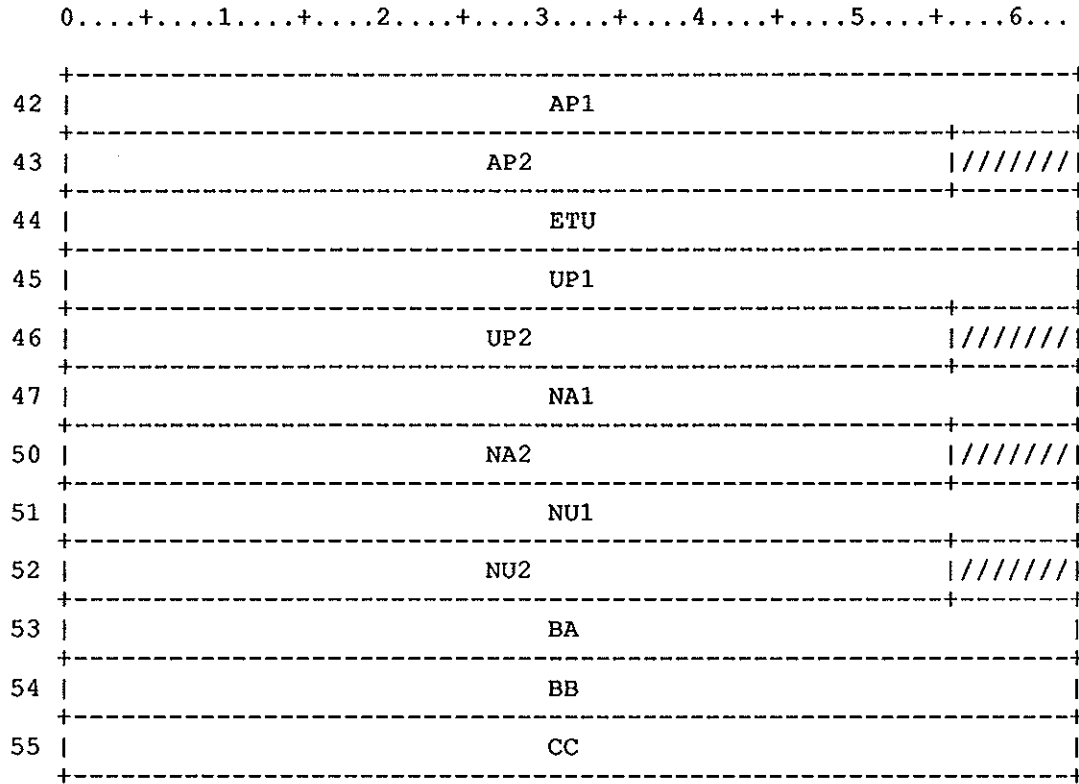

Figure STP-1. Job Card Values

Field	Word(base8)	Bits	Description
STPJN	0	0-55	Job name
STPTL	1	52-63	Time limit
STPPR	2	40-63	Priority
STPMFL	3	49-63	Maximum field length
STPOLM	4	0-63	Output limit
STPUSR	5	0-63	User number
STPUS2	6	0-55	
STPBP	7	0-63	Breakpoint parameter
STPCL	10	0-63	Class assignment
STPSJ	11	0-63	System job
STPG	12	0-63	Generic resource names
STPB0	32	0-63	IND B0 save

<u>Field</u>	<u>Word(base8)</u>	<u>Bits</u>	<u>Description</u>
STPB1	33	0-63	IND B1 save
STPCW	34	16-39	IND SAVE CONTROL-WORD ADDRESS
STPSEG	34	40-63	IND save segment address

The following job values are from cracked ACCOUNT statement.

STPAC1	35	0-63	Account (char 1-8)
STPAC2	36	0-55	Account (char 9-15)
STPUN1	37	0-63	User (char 1-8)
STPUN2	40	0-55	User (char 9-15)
STPETA	41	0-63	ACCOUNT password encryption table
STPAP1	42	0-63	Account password
STPAP2	43	0-55	
STPETU	44	0-63	USER password encryption table
STPUP1	45	0-63	User password
STPUP2	46	0-55	
STPNA1	47	0-63	New Account Password (compatibility)
STPNA2	50	0-55	
STPNU1	51	0-63	New User Password (compatibility)
STPNU2	52	0-55	
STPBA	53	0-63	SCJS B0 save
STPBB	54	0-63	SCJS B1 save
STPCC	55	0-63	Cracked control card buffer

user security privilege table

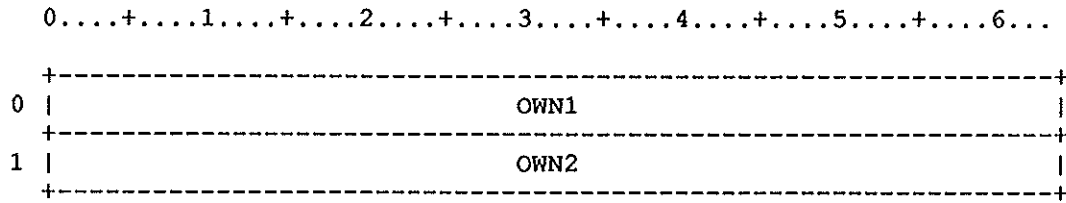

Figure SW-1. Security Swap Table

<u>Field</u>	<u>Word(base8)</u>	<u>Bits</u>	<u>Description</u>
SWOWN1	0	0-63	Dataset owner ID (characters 1-8)
SWOWN2	1	0-63	Dataset owner ID (characters 9-15)

<u>Field</u>	<u>Word(base8)</u>	<u>Bits</u>	<u>Description</u>
TADN	0	0-55	Local dataset name
T AFC	0	56-63	Function code: 0 Beginning of volume 1 End of volume 2 Rewind 3 End of data 4 Release 5 Close
TALT	1	0-3	Verified label type: 0 Non-labeled 1 ANSI-standard labeled 2 IBM-standard labeled 3 Bypass label processing 4 Foreign label (LMT, not capable)
TACDC	1	4-6	Current disposition code: 0 Old 1 New 2 Mod
TAUF	1	7	Cray blocked format flag, 1=unblocked
TADF	1	8	Tape format (0=TR, 1=IC)
TAABT	1	9	Abort flag
TARW	1	10-11	Last I/O operation (X\$RB, X\$WB)
TADEN	1	12-13	Tape density (0=6250, 1=1600)
TACC	1	14-15	IOP channel access count
TAODC	1	16-18	Original disposition
TAMF	2	0-15	Mainframe ID of job origin
TATID	3-4	0-63	Terminal identification of job origin
TATID1	3	0-63	Character 1-8
TATID2	4	0-63	Character 9-16
TAACN	5-6	0-63	CRAY account number
TAACN1	5	0-63	Character 1-8
TAACN2	6	0-55	Character 9-15
TAUSR	7-10	0-63	CRAY user number
TAUSR1	7	0-63	Character 1-8

<u>Field</u>	<u>Word(base8)</u>	<u>Bits</u>	<u>Description</u>
TAUSR2	10	0-55	Character 9-15
TADSN	11-16	0-63	IBM-compatible dataset name
TADSN1	11	0-63	Character 1-8
TADSN2	12	0-63	Character 9-16
TADSN3	13	0-63	Character 17-24
TADSN4	14	0-63	Character 25-32
TADSN5	15	0-63	Character 33-40
TADSN6	16	0-31	Character 41-44
TAMBS	16	32-63	Maximum block size in bytes
TADV N	17	0-63	Cray device name
TAVSN	20	0-47	VSN currently mounted
TAERR	20	48-63	Error count
TASET	21	0-47	File set identifier
TAVOL	21	48-63	Volume section number
TABLK	22	0-31	Volume block count
TADVO	22	32-39	Cray device ordinal
TAIOP	22	40-47	IOP subsystem ID
TACDT	23	0-47	Creation date
TAXDT	24	0-47	Expiration date (ASCII, Julian)
TARF	24	48-63	Record/block format (ASCII)
TAOID	25-26	0-63	Owner identification
TAOID1	25	0-63	Character 1-8
TAOID2	26	0-47	Character 9-14
TAAC1	27	0-31	Access path first channel
TACU1	27	0-3	First control unit id
TACU2	27	4-7	Second control unit id (optional)
TACU3	27	8-11	Third control unit id (optional)
TACU4	27	12-15	Fourth control unit id (optional)
TACUC	27	16-23	Number of valid CU id present
TACHN	27	24-31	IOP channel number

<u>Field</u>	<u>Word(base8)</u>	<u>Bits</u>	<u>Description</u>
TAAC2	27	32-63	Access path second channel
TAAC3	30	0-31	Access path third channel
TAAC4	30	32-63	Access path fourth channel

Transparent dataset blocking factors.

TPB16	=	4	Sectors/block at 1600 bpi
TPB62	=	8	Sectors/block at 6250 bpi

Write ring settings.

TPRD	=	0	No ring desired
TPWRT	=	1	Write ring requested

Tape density.

TPD62	=	0	6250 bpi
TPD16	=	1	1600 bpi

Label types.

TPLNL	=	0	Non-labeled
TPLAN	=	1	ANSI labeled
TPLSL	=	2	IBM standard labeled
TPLBP	=	3	By-pass labeled
TPLSY	=	4	SEG-Y non-labeled
TPLFAL	=	5	Field ANSI labeled
TPLFNL	=	6	Field non-labeled
TPLFSL	=	7	Field IBM standard labeled
TPLFR	=	8	Foreign label

Dataset format.

TPFTR	=	0	Transparent format
TPFIC	=	1	Interchange format

Character sets.

TCSAN	=	0	ANSI character set
TCSEB	=	1	EBCDIC character set
TCSDC	=	2	Control Data display code

Disposition codes.

TPOLD	=	0	Old dataset
TPNEW	=	1	New dataset
TPMOD	=	2	Extend old dataset (mod)

Default retry counts.

TQRRC	=	41	Read recovery retry value
TQWRC	=	15	Write recovery retry value

Other constants.

TPJMB	=	$2 * I @ TMBS / 8 + 1$	Max mos/job for tape I/O (words)
		*CALL COMTB	at this ident + 1

T On-line Tape Parameter Definitions - COMTAPE

[768]

COPYRIGHT BY CRAY RESEARCH, INC.

*

UNPUBLISHED - ALL RIGHTS RESERVED UNDER THE COPYRIGHT LAWS
OF THE UNITED STATES.

*

*

TASK BREAKPOINT TABLE

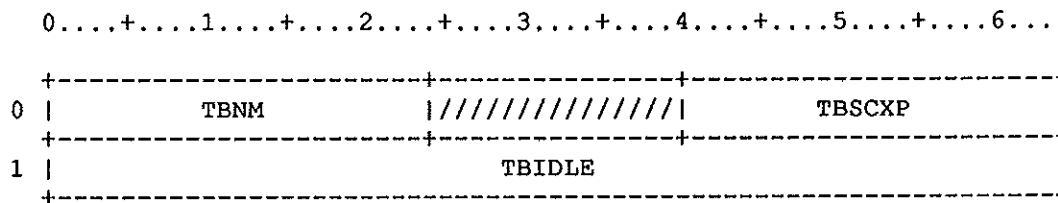

Figure TP-1. Task Breakpoint Table header

<u>Field</u>	<u>Word(base8)</u>	<u>Bits</u>	<u>Description</u>
TBNM	0	0-23	Task breakpoint table identifier
TBSCXP	0	40-63	SCP exchange package address
TBIDLE	1	0-63	Alternate scheduler request word

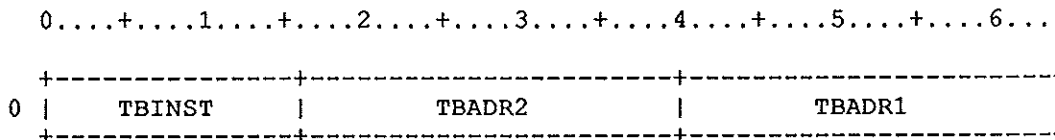

Figure TP-2. Task Breakpoint Table entry

<u>Field</u>	<u>Word(base8)</u>	<u>Bits</u>	<u>Description</u>
TBINST	0	0-15	Breakpoint instruction parcel
TBADR2	0	16-39	Breakpoint parcel address 2
TBADR1	0	40-63	Breakpoint parcel address 1

TBLK - Define the table for all the task common blocks. *
 SEGLDR and LDR generate this table into the absolute binary *
 when the external routine \$TASKCOM is called. *

*****VERSION 0 FORMAT*****

		-- 24 bits --		-- 24 bits --	
header		length of all blocks		# of entries	
		ascii task common block name			
per entry		length of the block		offset/address	
		-- 24 bits --		-- 24 bits --	

*****VERSION 1 FORMAT*****

Header word:

	version		///		nblks		tlen	
	(7)		(9)		(16)		(32)	

version - \$TASKCOM version id, see \$TASKVER below
 nblks - number of task common blocks
 tlen - total length of all blocks

Block entry:

	blen			offset				
	(32)			(32)				
	ival		////		nlen		nameptr	
	(1)		(23)		(8)		(32)	
	preset							
	(64)							

blen - number of words in this block
 offset - X-MP, Y-MP: \$TASKCOM index of block entry (filled in at runtime by actual address)
 CRAY-2: local memory address of base address word for block
 ival - block initialization flag: 0 = no initialization, 1 = initialization
 nameptr - index within \$TASKCOM of name entry for this block (0 if no name present)
 nlen - number of characters in block name
 preset - initialization value

Name entry:

Define block entry content

Version 0 format for COS

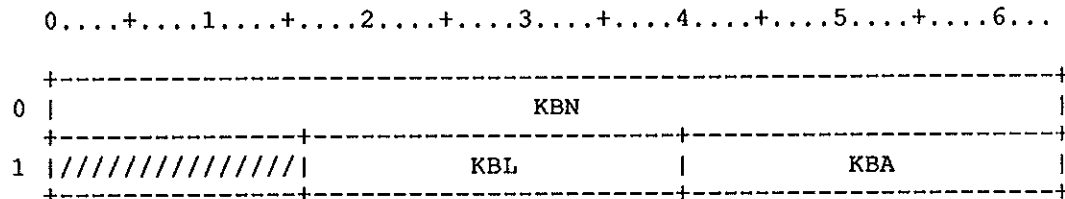

Figure TBL-2. Task Common Block Entry

Field	Word(base8)	Bits	Description
TBLKBN	0	0-63	ASCII task common block name
TBLKBL	1	16-39	Length of task common block
TBLKBA	1	40-63	Offset or address of the block

* Task Control Block (TCB)

The task control block is located in the Job Table Area (JTA). There is one TCB entry allocated for each user task known to COS. The TCB entry is used for storage of information specific to each task within a job such as the exchange package, vector registers, timings, I/O request information, and other save areas.

Assumed sizes of other tables referenced.

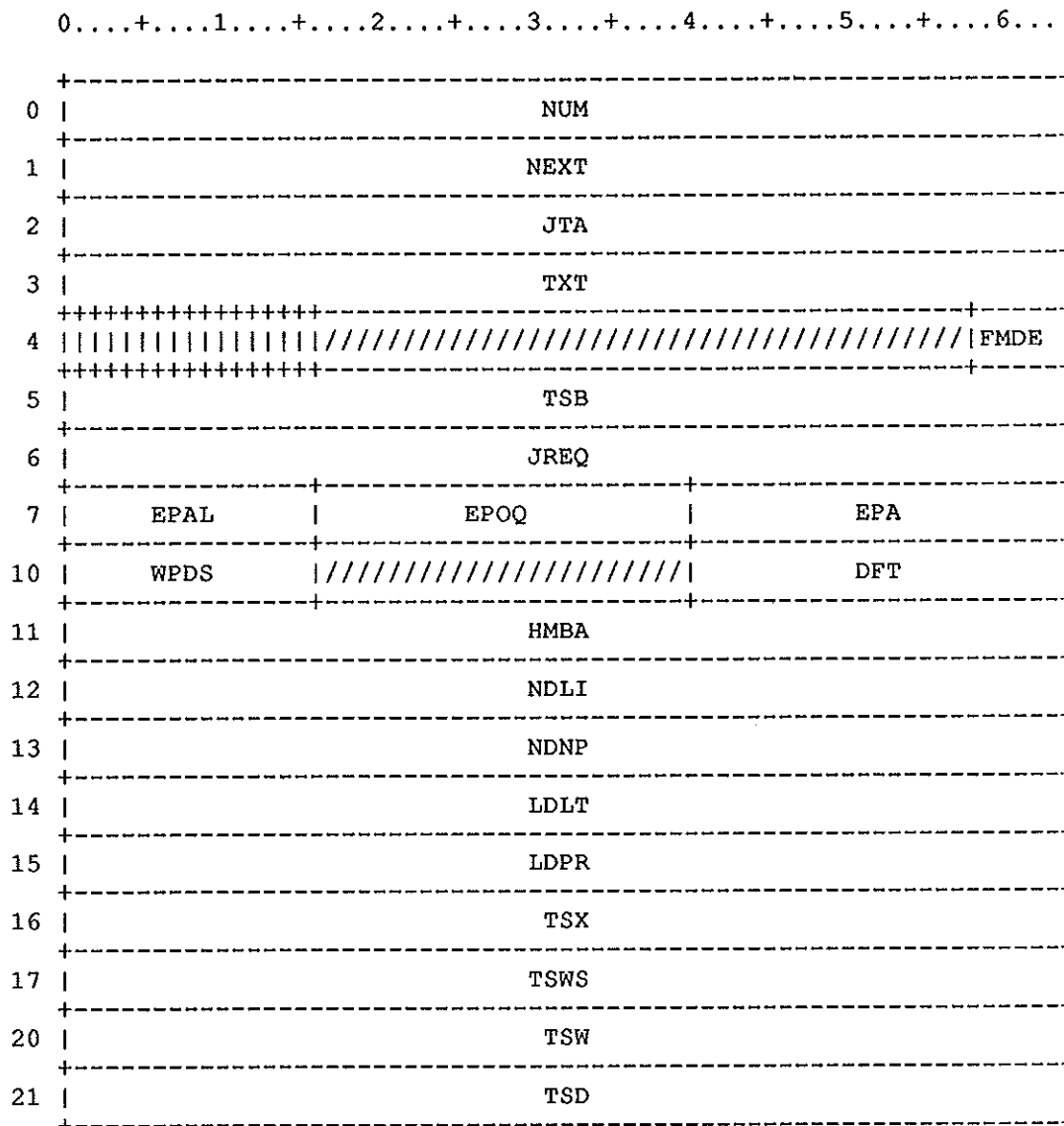

Figure TC-1. Task Control Block

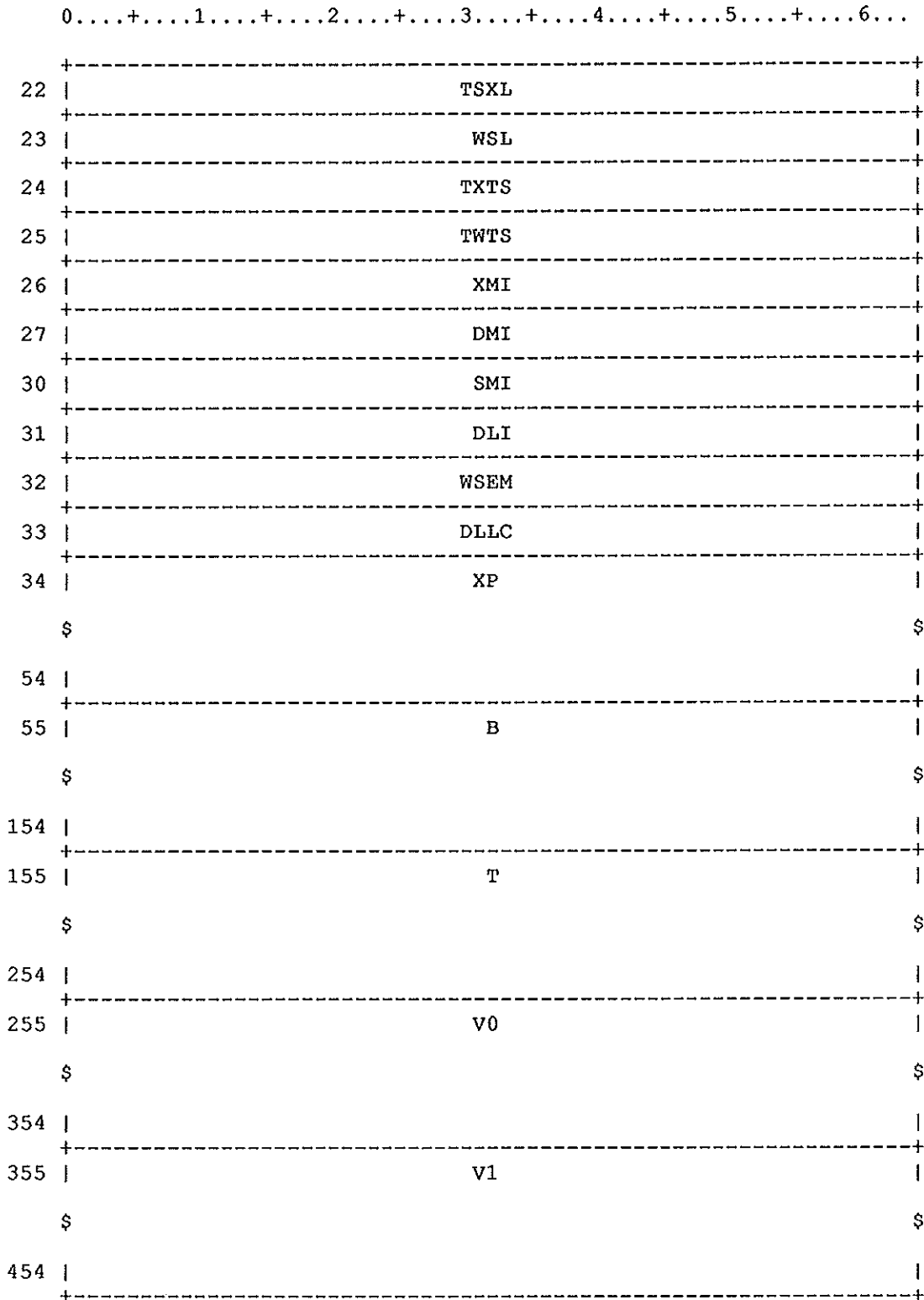

Figure TC-1. Task Control Block

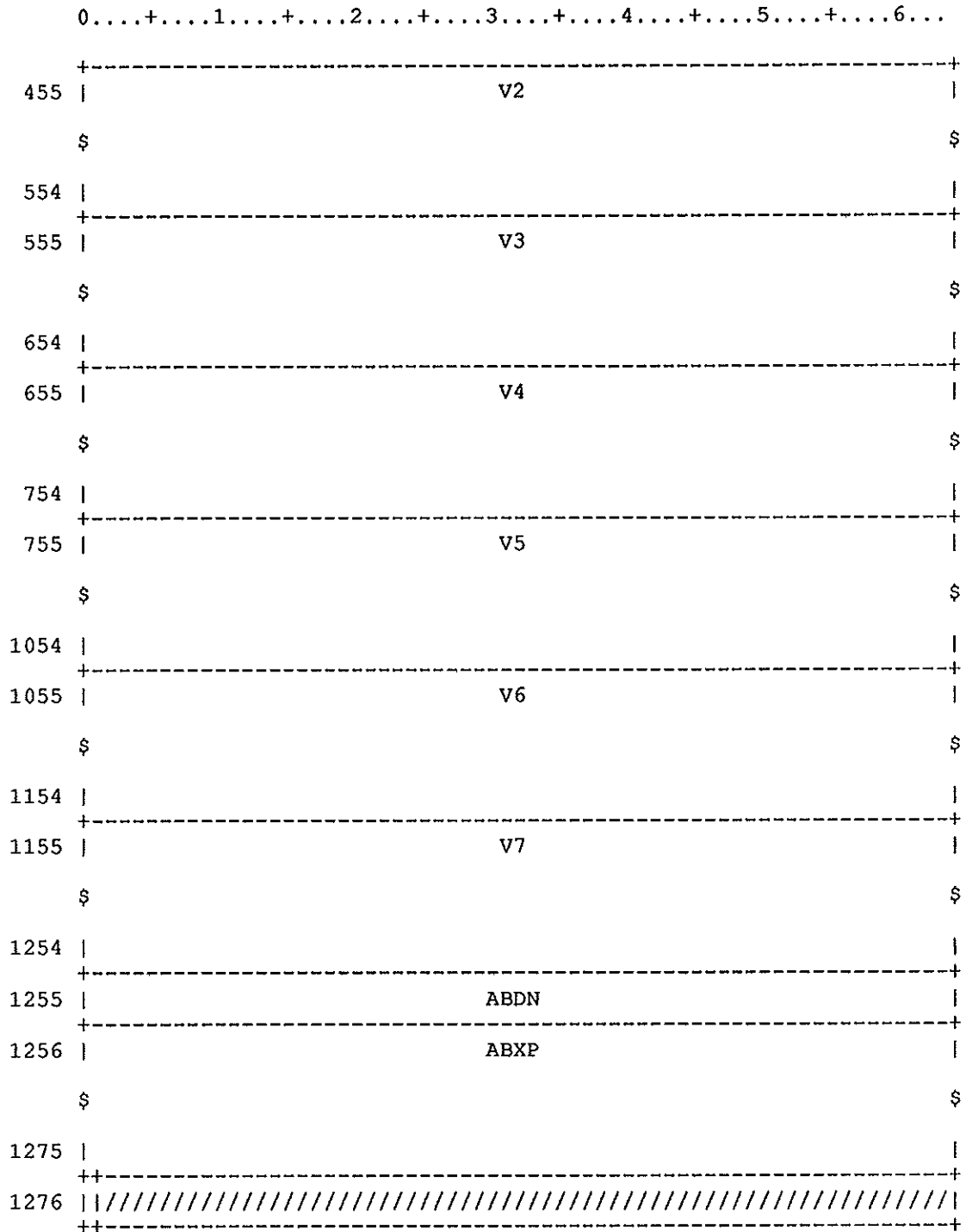

Figure TC-1. Task Control Block

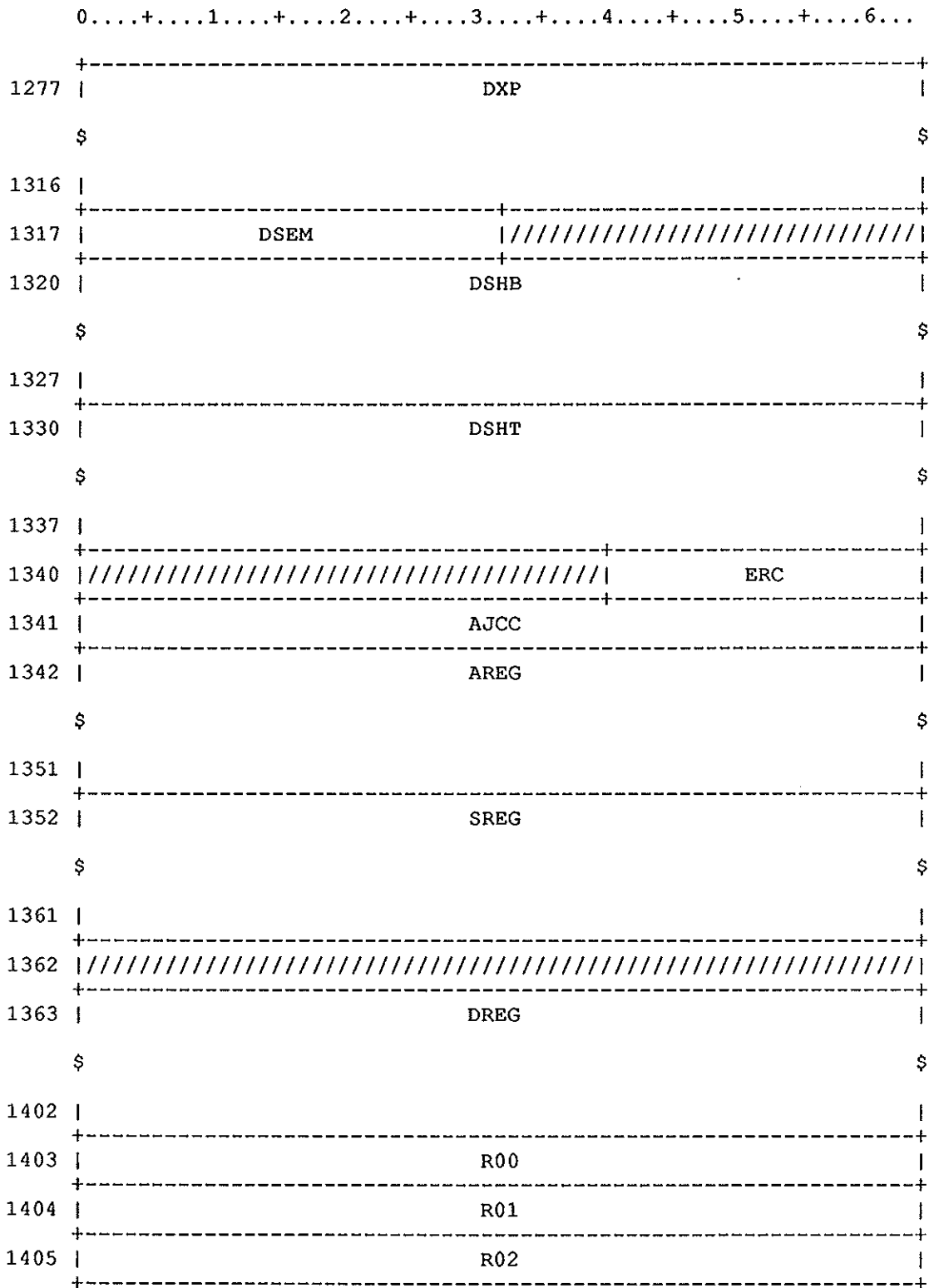

Figure TC-1. Task Control Block

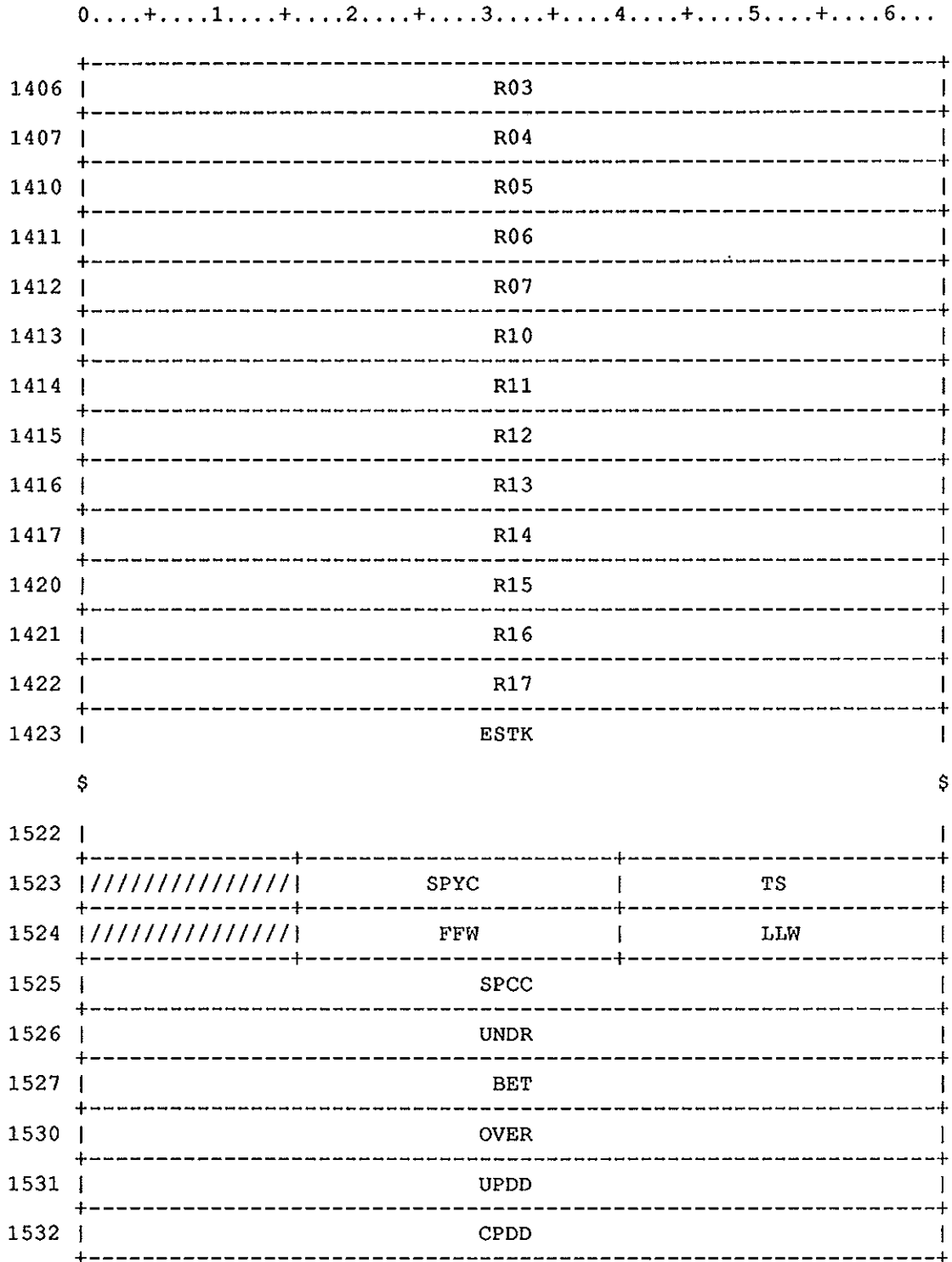

Figure TC-1. Task Control Block

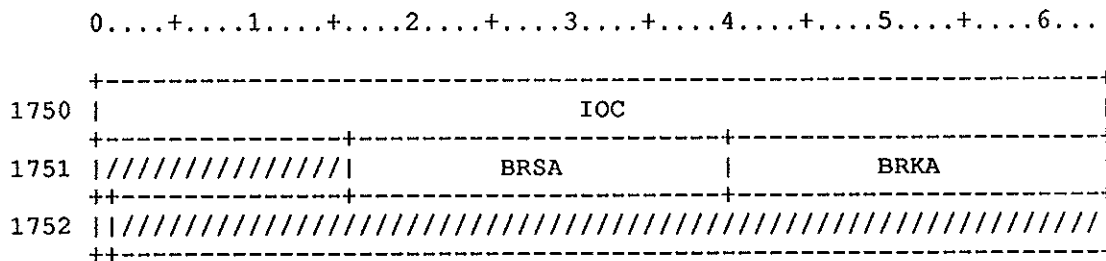

Figure TC-1. Task Control Block

TCB - Task control block.

Field	Word(base8)	Bits	Description
TCNUM	0	0-63	Task number within job
TCNEXT	1	0-63	Next TCB pointer [offset from JTA(0)]
TCJTA	2	0-63	Offset of TCB from JTA(0)
TCTXT	3	0-63	Address of associated TXT entry
TCEFI	4	0	Enable floating interrupts
TCIOAC	4	1	Current IOAREA status
TCIOAP	4	2	Previous IOAREA status
TCBDM	4	3	Enable bidirectional mode flag
TCORI	4	4	Interrupt on operand range flag
TCSPY	4	5	SPY enabled when <> 0
TCACTV	4	6	ACTIVE-DURING-CURRENT-JOB-STEP FLAG
TCFGR	4	7	Force another GETREPLY before EPTK1
TCEMA	4	8	1=Extended memory addressing enabled
TCAVL	4	9	1=Additional vector logical unit enab.
TCPS	4	10	Program State Register
TCFUA	4	12	Force unique access for F\$AQR access
TCJ\$D	4	13	Pending delete of the task
TCITCS	4	14	Task J\$SUSP during inter-task commun.
TCABT	4	15	Abort condition detected for task

Field	Word(base8)	Bits	Description
TCFMDE	4	58-63	XP bit settings changed via F\$MDE
TCEFI	4	58	Floating interrupts changed
TCBDMF	4	59	Bidirectional memory changed
TCORIF	4	60	Operand range interrupts changed
TCEMAF	4	61	Extended memory addressing changed
TCAVLF	4	62	Additional vector logical changed
TCPSF	4	63	Program state register changed
TCTSB	5	0-63	Task Status Block addr (JTA-rel), or 0
TCJREQ	6	0-63	Word for JSH requests

The following word is used in the coordination of user task CPU scheduling. If non-zero EXEC will not connect the user to a CPU, regardless of what JSH has requested. EXEC will halt the system when there are no flags set (EPAL) and the rest of the word is non-zero (STOP059). The flags are maintained by EXP and indicate what process is to start or resume once the user task has been connected to a CPU.

The EPOQ field indicates what STP tasks are active for this user task. While any of these are set the user task can not be deleted. Each bit in the field corresponds to an STP task ID.

The EPA field is the address of the process within EXP that last made a call to WAITJSH. Initially this field is set to minus one upon processing of an F\$ request and is cleared upon completion of the request.

TCEPAL	7	0-15	
TCEPFG	7	0-9	Flags that EXP clears on specific events:
TCEPN	7	0	Set on normal exchange
TCEPE	7	1	Set on error exchange
TCEPC	7	2	Set if TCEPA is valid
TCEPJ	7	3	Set on JSH-to-EXP request
TCEPII	7	4	Interrupted I/O exists
TCEPDL	7	6	Set on deadlock-error exchange
TCEDIA	7	8	Set by EXEC for diagnostic request
TCEPWR	7	9	Set when awaiting a reply from SLT
TCEXPF	7	15	Set by EXEC when EXP should examine Cleared by EXP to allow user execution
TCEPOQ	7	16-39	Outstanding STP requests
TCEPA	7	40-63	Resume address for WAITJSH sequence
TCWPDS	10	0-15	PDS-full delay counter
TCDFT	10	40-63	DFT address for diagnostic task
TCHMBA	11	0-63	H'ware perf.mon. blk addr (JTA offset)

The following fields are used by Exec during deadlock interrupt processing.

TCNDLI	12	0-63	No. of deadlock interrupts (DLI)
TCNDNP	13	0-63	No. of DLI without progress
TCLDLT	14	0-63	(PWUTIM) of last DLI
TCLDPR	15	0-63	(P register) of last DLI

Task statistics. Times are in cycles unless noted otherwise.

TCTSX	16	0-63	Time spent executing
TCTSWS	17	0-63	Time spent waiting semaphore
TCTSW	20	0-63	Time spent waiting to execute
TCTSD	21	0-63	Time spend waiting for I/O
TCTSXL	22	0-63	(TCTSX) at last CONNECT request
TCWSL	23	0-63	(TCTSWS) last time sl. computation
TCTXTS	24	0-63	CPU cycles used in last time slice
TCTWTS	25	0-63	Wait sem cycles in last time slice
TCXMI	26	0-63	(CPU time)*(memory size) floating
TCDMI	27	0-63	(I/O wait time)*(memory size) floating
TCSMI	30	0-63	(Wait sem) * (Memory size) floating
TCDLI	31	0-63	Total # of deadlock interrupts
TCWSEM	32	0-63	Semaphore number task is waiting for
TCDLLC	33	0-63	Count of deadlocks to ignore before scheduling EXP. (EXEC-use only)

Task registers.

TCXP	34-54	0-63	Exchange package
TCVM	54	0-63	Vector mask
TCB	55-154	0-63	B registers
TCT	155-254	0-63	T registers
TCV0	255-354	0-63	V0 register
TCV1	355-454	0-63	V1 register

Field	Word(base8)	Bits	Description
TCV2	455-554	0-63	V2 register
TCV3	555-654	0-63	V3 register
TCV4	655-754	0-63	V4 register
TCV5	755-1054	0-63	V5 register
TCV6	1055-1154	0-63	V6 register
TCV7	1155-1254	0-63	V7 register

Abort save areas

TCABDN	1255	0-63	Dataset name for abort
TCABXP1256-1275		0-63	Abort exchange package save

Debug register save area.

These fields are used to take a snapshot of the current state of the task when a DEBUG request is made by the user. The debugging utility in the user space can then make another request to retrieve the information.

TCDACT	1276	0	Debug information is active flag
TCDXP	1277-1316	0-63	Exchange package
TCDB00	1277	32-63	Register B00
TCDSEM	1317	0-31	Semaphore registers
TCDSHB1320-1327		0-63	Shared B registers
TCDSHT1330-1337		0-63	Shared T registers

Reprive control information.

TCERC	1340	40-63	TASK ERROR CODE
TCAJCC	1341	0-63	Active job-assistd event q control
TCAJNE	1341	0-15	Number of active definitions
TCAJTL	1341	16-39	Tail of active JAE queue (oldest)
TCAJHD	1341	40-63	Head of active JAE queue (newest)

Register save area for resume/continue

TCAREG1342-1351		0-63	A register save area
TCSREG1352-1361		0-63	S register save area
TCDREG1363-1402		0-63	Save WAITJSH data area for DIA request

Register save area for EXP

<u>Field</u>	<u>Word(base8)</u>	<u>Bits</u>	<u>Description</u>
TCR00	1403	0-63	Register save area 00
TCR01	1404	0-63	Register save area 01
TCR02	1405	0-63	Register save area 02
TCR03	1406	0-63	Register save area 03
TCR04	1407	0-63	Register save area 04
TCR05	1410	0-63	Register save area 05
TCR06	1411	0-63	Register save area 06
TCR07	1412	0-63	Register save area 07
TCR10	1413	0-63	Register save area 10
TCR11	1414	0-63	Register save area 11
TCR12	1415	0-63	Register save area 12
TCR13	1416	0-63	Register save area 13
TCR14	1417	0-63	Register save area 14
TCR15	1420	0-63	Register save area 15
TCR16	1421	0-63	Register save area 16
TCR17	1422	0-63	Register save area 17
			L@TCESTK=D' 64 size
			EXP stack size
TCESTK1423-1522		0-63	Stack for EXP
F\$SPY fields			
TCSPYC	1523	16-39	# SPY areas enabled
TCTS	1523	40-63	User requested time slice
TCFFW	1524	16-39	First of SPY FW's
TCLLW	1524	40-63	Last of SPY LW's
TCSPCC	1525	0-63	Chain control for user profile
TCUNDR	1526	0-63	'under' counter
TCBET	1527	0-63	'between' counter
TCOVER	1530	0-63	'over' counter

<u>Field</u>	<u>Word(base8)</u>	<u>Bits</u>	<u>Description</u>
TCUPDD	1531	0-63	Users PDD address (index + offset)
TCCPDD	1532	0-63	Current PDD address (index + offset)
TCDDL	1533-1540	0-63	DDL for FETCH/ACQUIRE
TCPDD	1541-1634	0-63	PDD for FETCH/ACQUIRE
TCAPT	1635-1644	0-63	F-PACKET for user driver requests
TCCCNT	1643	0-63	Count of outstanding channel requests
TCOCNT	1644	0-63	Count of open channels
TCTXTI	1645-1710	0-63	Copy of TXT at rollout
			L@TCPMSG=D'10 Length of pending message
TCMSG	1711	0	Text of pending message
TCB Copy of F\$BGN table:			
TCBGN	1723	0	BGN for F\$BGN Call
Installation reserved space			
			L@TCINS=O'4 Installation reserved words
TCINS	1743	0	Reserved for installation use
TCIIOC	1747	0-63	Count of interrupted I/O datasets
TCIOIC	1750	0-63	Count of active I/O requests
Fields used by Dynamic Runtime Debugger (F\$ESB)			
TCBRSA	1751	16-39	User XP save area address
TCBRKA	1751	40-63	Breakpoint address
Define a save area for EXP when issuing logfile messages.			
			L@TCMSG=D'17
TCMSG	1752	0	Save area for current \$LOG message

Define an array for user multitasking task control information

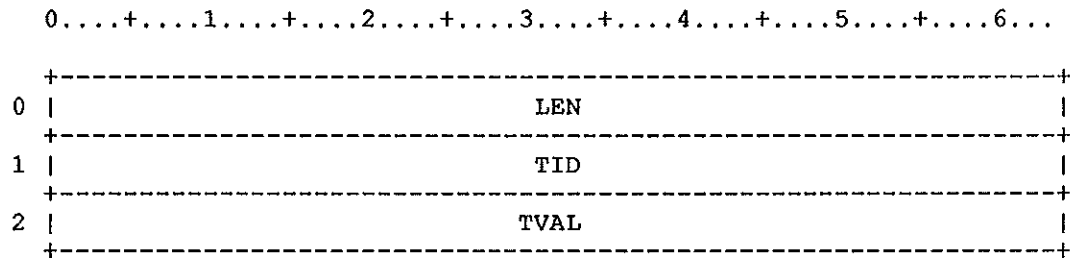

Figure TC-1. Task Control Array

Field Definitions.

<u>Field</u>	<u>Word(base8)</u>	<u>Bits</u>	<u>Description</u>
TCLLEN	0	0-63	Task Control Array Length
TCTID	1	0-63	Task Identification Code
TCTVAL	2	0-63	Task value passed to created task

The TDT is used by the Tape Queue Manager (TQM) task to control tape devices. It can be changed by Startup as the result of changes made in the CNT.

LE%TSTK = 3*D/17+1 Stack length

0....+....1....+....2....+....3....+....4....+....5....+....6....

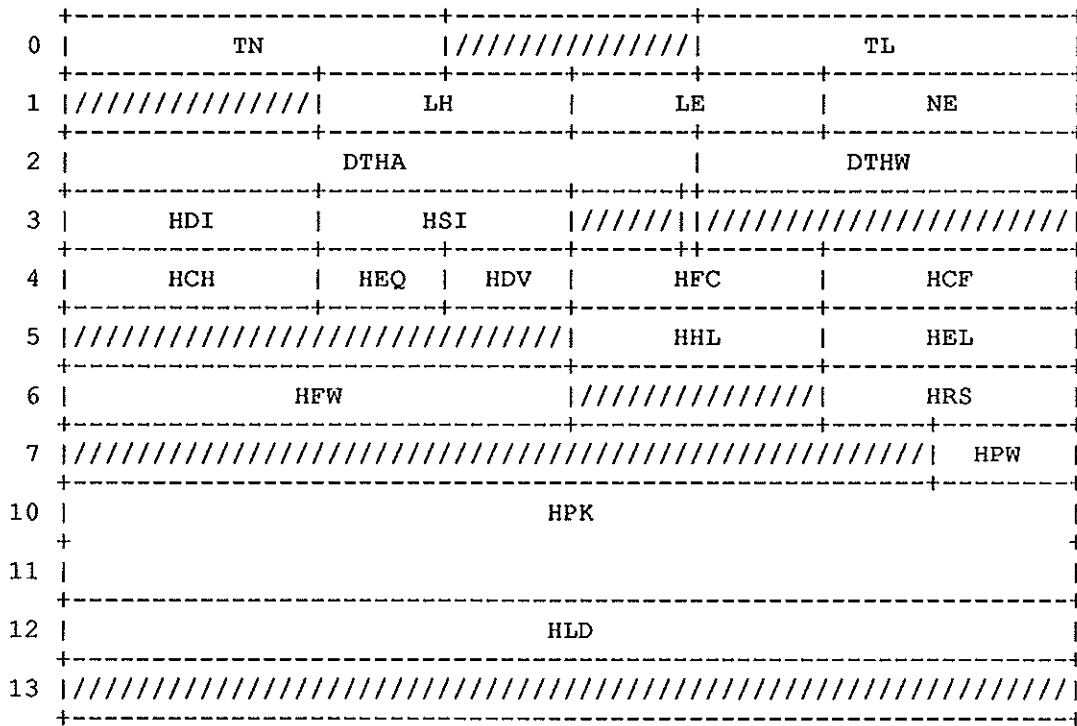

Figure TD-1. Tape Device Table header

Field	Word(base8)	Bits	Description
TDTN	0	0-23	Table name (TDT)
FIELD	\$,24,16		- UNUSED
TDTL	0	40-63	Total length (SZ@TDT)
FIELD	+,0,16		- UNUSED
TDLH	1	16-31	Header length (LH@TDT)
TDLE	1	32-47	Entry length (LE@TDT)
TDNE	1	48-63	Number of entries (NE@TDT)

<u>Field</u>	<u>Word(base8)</u>	<u>Bits</u>	<u>Description</u>
TDDTHA	2	0-39	ASCII 'DUMMY'
TDDTHW	2	40-63	Pointer to dummy TDT header word
TDHDI	3	0-15	Destination ID
TDHSI	3	16-31	Source ID
TDHBS	3	39	Packet I/O is outstanding
TDHCH	4	0-15	Channel ID (octal 20-37)
TDHEQ	4	16-23	Equipment ID (one hex digit)
TDHDV	4	24-31	Device ID (ordinal)
TDHFC	4	32-47	X\$CC function code
TDHCF	4	48-63	Configuration flags
TDHAV	4	58	Device available flag
TDHOP	4	59	Operation (0=on, 1=off)
TDHDR	4	60	Device Request; if set, command applies to a specific tape drive.
TDHER	4	61	Equipment Request; if set, command applies to a specific control unit.
TDHCR	4	62	Channel Request; if set, command applies to an IOP channel.
TDHCC	4	63	Configuration change request if 1; Startup Configuration Table if 0.
TDHHL	5	32-47	Header length of COS configuration table (meaningful when TDHCC=0)
TDHEL	5	48-63	Entry length of COS configuration table (meaningful when TDHCC=0)
TDHFW	6	0-31	Absolute Cray address of COS configuration table (meaningful when TDHCC=0)
TDHRS	6	48-63	Sector length of table (rounded up) (meaningful when TDHCC=0)
TDHPW	7	55-63	Partial word count of last sector of table (meaningful when TDHCC=0)
TDHPK	10-11	0-63	Last word of CONFIG packet
TDHTS	11	0-63	CONFIG packet time stamp
TDHLD	12	0-63	Last device assigned in tape bank

0.....+.....1.....+.....2.....+.....3.....+.....4.....+.....5.....+.....6...

23	DVS	CIW PB	STSP	EBC
24	* * *			
25	CAT *** ***	IDC LCH ODC PFC *** PSC TPL VLT		
26	COS	CSF	CTI	CVS
27	LCSF	MFC	MSG	NDV
30	PBS		CBZ	CFSQ
31	MFE	MID	SFE	SMN
32	EVF	WMSC	WMBC	ETMC
33	FTS	IOER	LDE	
34	SDF		NVS	
35	SSC		VSN	
36	VFSQ		WVS	
37	ARL		ARTN	
40	AVB0		BTS	
41	CLRT		DNT	
42	EPS		SBS	
43	ERA		FBC	
44	INB		TXT	
45	JAR		JRA	
46	JXT		LBER	
47	LBF		LBSV	
50	LDA		LDH1	
51	LDH2		LDV1	
52	LINK		LPA	
53	LPH1		LPH2	

Figure TD-2. Tape Device Table Entry

0.....1.....2.....3.....4.....5.....6...

54	LPV1	LRC
55	MRA	MRIA
56	NEWT	NTDT
57	OBS	OLDT
60	OUT	PB00
61	PB01	PB02
62	PB03	PB04
63	PERT	PRT
64	PSQ	RBS
65	RVS	SBC
66	SFB0	SLOT
67	SMB	SS2
70	SS3	SSAD
71	TET	TEVD
72	TLT	TPT
73	CS1	
74	CS2	
75	DLW	
76	QCT	
77	SF1	
100	ESFS	
101	ESSS	
102	PTST	
103	PTQI	
104	QHE	

Figure TD-2. Tape Device Table Entry

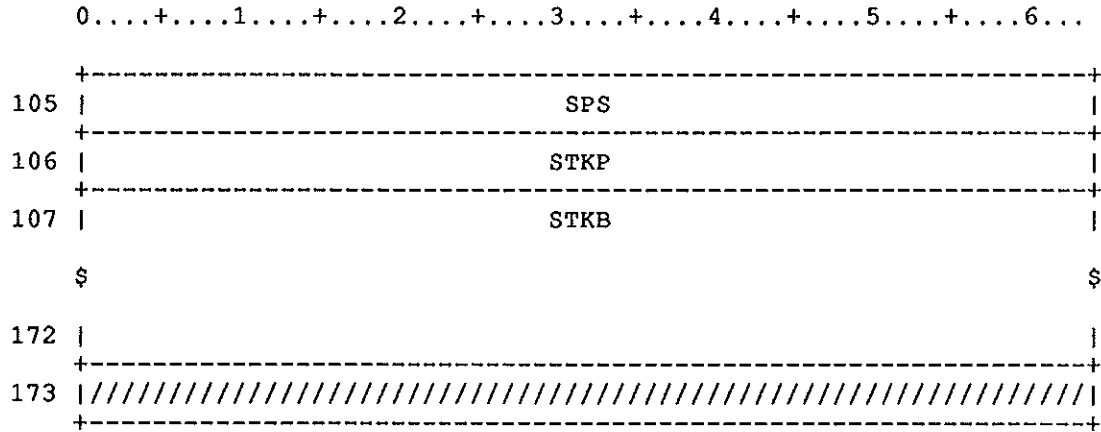

Figure TD-2. Tape Device Table Entry

Field	Word(base8)	Bits	Description
TDSP0	0	0-63	Transmitted packet - Word 0
TDDID	0	0-15	Destination ID
TDSID	0	16-31	Source ID
TDSP1	1	0-63	Transmitted packet - Word 1
TDDVD	1	0-47	Device descriptor
<u>TDJXO</u>	1	0-15	<u>JXT offset</u>
TDDVN	1	16-31	Device number
TDFCN	1	32-47	Function code
TDDDF	1	48-63	Dataset flags
TDNRR	1	50	Do not perform read recovery
TDUPW	1	51	Read buffer size in field TDPWC
TDAPP	1	52	Append MOS data to input
TDWLB	1	53	Write last tape block (partial block)
TDNVP	1	54	Next valid packet
TDDEN	1	55-56	Dataset density code
TDDFM	1	57-58	Dataset format code
TDDUD	1	59	Discard user data
TDDIS	1	60	Discard system data
TDDHL	1	61	System/user data stream flag
TDSNC	1	62	Synchronize tape dataset
TDNWR	1	63	Do not write data to tape
TDSP2	2	0-63	Transmitted packet - Word 2
TDFPB	2	0-31	Maximum tape block size
TDVBC	2	32-63	Volume block count
TDSP3	3	0-63	Transmitted packet - Word 3
TDDD1	3	0-63	Device display message 1
TDBFA	3	0-31	Bipolar buffer FWA
TDRBC	3	32-47	Requested block count
TDRSC	3	48-63	Requested count of 512-word sectors

Field	Word(base8)	Bits	Description
TDSP4	4	0-63	Transmitted packet - Word 4
TDDD2	4	0-63	Device display message 2
TDSTSS	4	32-47	Status from XIOP
TDPWC	4	55-63	Read buffer size (overlap TDPWCR)
TDSP5	5	0-63	Transmitted packet - Word 5
TDDDC	5	0-7	Device display control byte
TDDDV	5	8-15	Device display valid flag
TDSTRC	5	26-31	Read/Write retry count
TDPDV	5	32-47	Previous device number for X\$RM
TDTPTS	6	0-63	Transmitted packet time stamp
TDRP0	7	0-63	Received packet - Word 0
TDRP1	10	0-63	Received packet - Word 1
TDRFCN	10	32-47	Function code
TDRP2	11	0-63	Received packet - Word 2
TDRP3	12	0-63	Received packet - Word 3
TDRP4	13	0-63	Received packet - Word 4
TDRS	13	0-63	Reply status word from XIOP
TDTBC	13	0-15	Count of tape blocks was transferred
TDTSC	13	16-31	Count of 512-word sectors transferred
TDSTS	13	32-47	Status from XIOP
TDBFN	13	32	Tape block finished
TDDTR	13	33	Data transferred
TDTMS	13	34	Tape mark status
TDLBK	13	35	Large tape block read
TDLSD	13	36	Lost data
TDPDE	13	37	Permanent data error
TDNOR	13	38	No ring in reel
TDBOT	13	39	Beginning of tape
TDEOT	13	40	End of tape
TDNTR	13	41	Not ready
TDRES	13	42	Reset hit
TDNOP	13	43	Not operational
TDNCD	13	44	Not capable device
TDWFE	13	45	Write format error
TDBTD	13	46	Blank tape detected
TDPEC	13	47	Protocol error
TDDBF	13	48	Bad data transferred
TDUBC	13	49-54	Unused bit count
TDPWCR	13	55-63	Partial sector word count
TDRP5	14	0-63	Received packet - Word 5
TDVSB	14	16-31	Valid sectors (read), blocks (write)
TDMOS	14	48-63	Unallocated MOS sector count
TDRPTS	15	0-63	Received packet time stamp
TDLDV	16	0-63	Logical device name

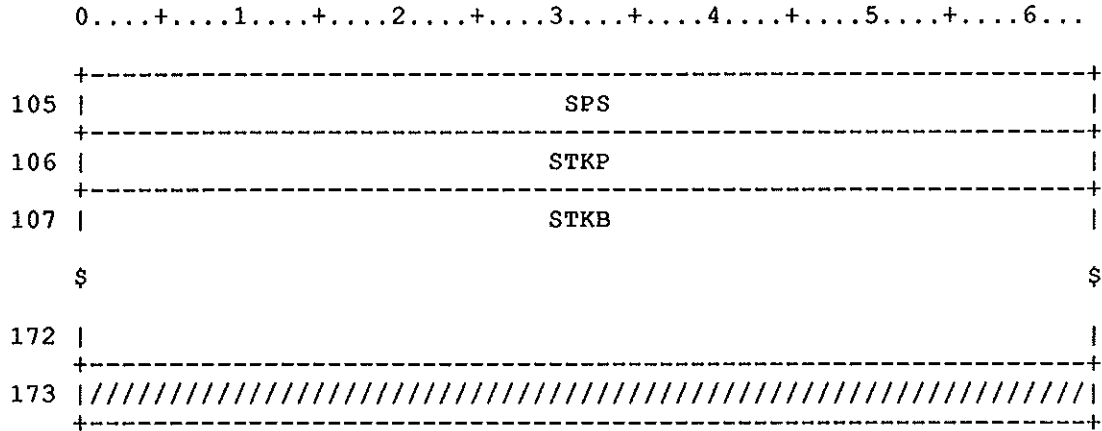

Figure TD-2. Tape Device Table Entry

Field	Word(base8)	Bits	Description
TDSP0	0	0-63	Transmitted packet - Word 0
TDDID	0	0-15	Destination ID
TDSID	0	16-31	Source ID
TDSP1	1	0-63	Transmitted packet - Word 1
TDDVD	1	0-47	Device descriptor
TDJXQ	1	0-15	JXT offset
TDDVN	1	16-31	Device number
TDFCN	1	32-47	Function code
TDDDF	1	48-63	Dataset flags
TDNRR	1	50	Do not perform read recovery
TDUPW	1	51	Read buffer size in field TDPWC
TDAPP	1	52	Append MOS data to input
TDWLB	1	53	Write last tape block (partial block)
TDNVP	1	54	Next valid packet
TDDEN	1	55-56	Dataset density code
TDDFM	1	57-58	Dataset format code
TDDUD	1	59	Discard user data
TDDIS	1	60	Discard system data
TDDHL	1	61	System/user data stream flag
TDSNC	1	62	Synchronize tape dataset
TDNWR	1	63	Do not write data to tape
TDSP2	2	0-63	Transmitted packet - Word 2
TDTPB	2	0-31	Maximum tape block size
TDVBC	2	32-63	Volume block count
TDSP3	3	0-63	Transmitted packet - Word 3
TDDD1	3	0-63	Device display message 1
TDBFA	3	0-31	Bipolar buffer FWA
TDRBC	3	32-47	Requested block count
TDRSC	3	48-63	Requested count of 512-word sectors

<u>Field</u>	<u>Word(base8)</u>	<u>Bits</u>	<u>Description</u>
TDSP4	4	0-63	Transmitted packet - Word 4
TDDD2	4	0-63	Device display message 2
TDSTSS	4	32-47	Status from XIOP
TDPWC	4	55-63	Read buffer size (overlap TDPWCR)
TDSP5	5	0-63	Transmitted packet - Word 5
TDDDC	5	0-7	Device display control byte
TDDDV	5	8-15	Device display valid flag
TDSTRC	5	26-31	Read/Write retry count
TDPDV	5	32-47	Previous device number for X\$RM
TDTPTS	6	0-63	Transmitted packet time stamp
TDRP0	7	0-63	Received packet - Word 0
TDRP1	10	0-63	Received packet - Word 1
TDRFCN	10	32-47	Function code
TDRP2	11	0-63	Received packet - Word 2
TDRP3	12	0-63	Received packet - Word 3
TDRP4	13	0-63	Received packet - Word 4
TDRS	13	0-63	Reply status word from XIOP
TDTBC	13	0-15	Count of tape blocks was transferred
TDTSC	13	16-31	Count of 512-word sectors transferred
TDSTS	13	32-47	Status from XIOP
TDBFN	13	32	Tape block finished
TDDTR	13	33	Data transferred
TDTMS	13	34	Tape mark status
TDLBK	13	35	Large tape block read
TDLSL	13	36	Lost data
TDPDE	13	37	Permanent data error
TDNOR	13	38	No ring in reel
TDBOT	13	39	Beginning of tape
TDEOT	13	40	End of tape
TDNTR	13	41	Not ready
TDRES	13	42	Reset hit
TDNOP	13	43	Not operational
TDNCD	13	44	Not capable device
TDWFE	13	45	Write format error
TDBTD	13	46	Blank tape detected
TDPEC	13	47	Protocol error
TDDBF	13	48	Bad data transferred
TDUBC	13	49-54	Unused bit count
TDPWCR	13	55-63	Partial sector word count
TDRP5	14	0-63	Received packet - Word 5
TDVSB	14	16-31	Valid sectors (read), blocks (write)
TDMOS	14	48-63	Unallocated MOS sector count
TDRPTS	15	0-63	Received packet time stamp
TDDLVD	16	0-63	Logical device name

<u>Field</u>	<u>Word(base8)</u>	<u>Bits</u>	<u>Description</u>
TDUPS	17	0-5	Up/assigned status
TDOFF	17	0	Device is off
TDASN	17	1	Device is assigned
TDDWN	17	2	Device is down
TDPDN	17	3	Down of device is pending
TDMNT	17	4	Maintenance flag
TDPNA	17	5	Off of device is pending
TDCLR	17	6	TCLEAR operation in progress
TDAVVS	17	7	AVR VSN verification
TDPC	17	8-15	IOP-3 channel path count
FIELD	\$,16,4		- UNUSED
TDAVI	17	20-23	AVR mount interlocks
TDMIP	17	20	Tape mount in progress
TDTMN	17	21	Tape pre-mounted on device
SUBFIELD	22,1		- UNUSED
SUBFIELD	23,1		- UNUSED
TDDTY	17	24-31	Device Type (from field CNDT)
TDCNFF	17	32-35	Configuration flags
TDCCP	17	32	X\$CC needs to be sent
TDCRP	17	33	X\$CC reply is pending
TDFDR	17	34	X\$FD reply is pending
SUBFIELD	35,1		- UNUSED
TDKEEP	17	36-37	Retain volume after release
TDKES	17	36	Retain requested by operator
TDKEU	17	37	Retain requested by user
FIELD	\$,38,18		- UNUSED
TDLDO	17	56-63	Loader ordinal in MLT
TDCNT	20	0-31	CNT entry address
<u>TDGRT</u>	<u>20</u>	<u>32-63</u>	<u>GRT entry address</u>
TDGDN	21	0-63	Generic resource name

Installation area 1. (Not cleared by X\$FD replies)

To make upgrades easier, place locally added TDT fields in one more full words within this block of line idents. Other unused fields in the TDT are reserved for CRI.

--- add local words here ---

The following words are cleared when an X\$FD reply is received:

TDPSW	22	0-63	Packet status word
TDMSC	22	0-15	Count of 512-word units count in Buffer Memory
TDMBC	22	16-31	Count of tape blocks in buffer memory
TDOSC	22	32-47	Count of outstanding 512-word units
TDOBC	22	48-63	Count of outstanding tape blocks
TDDVS	23	0-23	Device status flags:
TDCLT	23	0	Labels processed
TDCNR	23	1	Device not ready
TDDEC	23	2	Dataset enquiry complete
TDDMR	23	3	Discard mount/remount reply packets
TDDNRL	23	4	Do not read labels
TDEIR	23	5	End of information returned
TDEND	23	6	End of data processing
TDFIP	23	7	IOP flush in progress
TDPSL	23	8	Packet set up for label I/O
TDQHV	23	9	Queued reply pending in TDQHE
TDQRD	23	10	Queued read request (MOS empty)
TDQWT	23	11	Queued write request (MOS full)
TDRMF	23	12	Remount failed
TDRNG	23	13	Ring state (IN/0, OUT/1)
TDSDP	23	14	Discard any reply packets
TDSL A	23	15	SFE logon request aborted
TDVAC	23	16	Volume access complete
TDVMI	23	17	Volumes mounted increment
TDWMN	23	18	Wait on volume mount
TDWTL	23	19	Enable trailer label writes
TDRIO	23	20	Restart I/O on exit from TQ\$RB/TQ\$WB
TDWLBA	23	21	Last block write in progress
TDRRI	23	22	Release/retain in progress
SUBFIELD	23,1		- UNUSED
TDCIW	23	24-27	Control words detected during write:
SUBFIELD	24,1		- UNUSED
TDEOR	23	25	EOR control word detected
TDEOF	23	26	EOF control word detected
TDEOD	23	27	EOD control word detected
TDPB	23	28-31	Pending status flags:
TDBDP	23	28	Transfer of bad data
TDLBP	23	29	Last transparent block
SUBFIELD	30,1		- UNUSED
SUBFIELD	31,1		- UNUSED

<u>Field</u>	<u>Word(base8)</u>	<u>Bits</u>	<u>Description</u>
TDSTSP	23	32-47	Pending XIOP status bits:
TDBFNP	23	32	Tape block finished
TDDTRP	23	33	Data transferred
TDTMSP	23	34	Tape mark status
TDLBKP	23	35	Large tape block read
TDLSDP	23	36	Lost data
TDPDEP	23	37	Permanent data error
TDNORP	23	38	No ring in reel
TDBOTP	23	39	Beginning of tape
TDEOTP	23	40	End of tape
TDNTRP	23	41	Not ready
TDRESP	23	42	Reset hit
TDNOFP	23	43	Not operational
TDNCDP	23	44	Not capable device
TDFWEP	23	45	Write format error
TDBTDP	23	46	Blank tape detected
TDPECP	23	47	Protocol error
TDEBC	23	48-63	Excess MOS block count
TDAAVM	24	0	Awaiting AVR mount
TDARS	24	1	Automatic reselect pending
TDBEVL	24	2	Before an EOVS label
TDBTM	24	3	Before a user Tape Mark
TDBTMP	24	4	Before TM reply pending
TDBTRP	24	5	Blank-Tape reply pending
TDCDS	24	6	Dataset is part of concatenated group
TDCON	24	7	Concatenated dataset switch
TDDMY	24	8	Dummy TDT Flag
TDEOFFP	24	9	EOF reply pending
TDEOI	24	10	End of information during position
TDEOV	24	11	EOV pending (read)
TDEPLK	24	12	Error reposition in progress
TDFLT	24	13	Field label format
TGGRS	24	14	Generic resource held by system
TDLBE	24	15	Large block error
TDLRO	24	16	Label read at open

<u>Field</u>	<u>Word(base8)</u>	<u>Bits</u>	<u>Description</u>
TDMCO	24	17	Mount cancelled by operator
TDMDA	24	18	Multi-Dataset Access
TDNRA	24	19	Do not do read ahead
TDNSNP	24	20	No SNAP
TDNSS	24	21	Non-specific volume scratch
TDOERP	24	22	Off-End-Of-Reel reply pending
TDPEV	24	23	Position to EOY
TDRSI	24	24	Restart synch I/O
TDSEGY	24	25	SEG-Y (NL/single tapemark) labels
TDSSA	24	26	Sequencer active flag
TDTPS	24	27	Wait for tape positioning tape switch
TDUOP	24	28	Un operational
FIELD	\$,29,1		- UNUSED
TDVLS	24	30	Volume switch has occurred
TDVSNV	24	31	AVR/NL VSN verified by operator
TDWRT	24	32	Write ring requested by user
TDAWE	24	33	Abort on write error requested
TDUHE	24	34	Unrecoverable hardware error
TDRSD	24	35	Remount to same device
FIELD	\$,36,12		- UNUSED (12 1-bit fields)
TDCS	24	48-49	Character set
TDOC	24	50-51	Current open code (in/out)
TDSBD	24	52-53	Space block direction
FIELD	\$,54,10		- UNUSED (5 2-bit fields)
TDCAT	25	0-3	Current SFE catalog request (XR\$uxxx)
TDEPFC	25	4-7	Error save function
TDEPSC	25	8-11	Error save state

<u>Field</u>	<u>Word(base8)</u>	<u>Bits</u>	<u>Description</u>
TDIDC	25	12-15	Current volume/dataset disposition
TDLCH	25	16-19	Label character set (0=ASCII, 1=EBCDIC)
TDODC	25	20-23	Original disposition code
TDPFC	25	24-27	TPT function code
TDPFCI	25	28-31	Initial TPT processing function
TDPSC	25	32-35	TPT state code
TDTPL	25	36-39	Requested label type (TPL...)
TDVLT	25	40-43	Verified label type of volume mounted
FIELD	\$,44,20		- UNUSED (5 4-bit fields)
TDCOS	26	0-7	Current COS function code
TDCSF	26	8-15	Current COS subfunction code
TDCTI	26	16-23	Calling task ID
TDCVS	26	24-31	Current volume state
TDDSF	26	32-39	Dataset/volume state flags:
TDDVB	26	32	Begining of volume processed
TDDVE	26	33	End of volume processed
TDDFE	26	34	End of file processed
TDDCL	26	35	Close processed
TDDRW	26	36	Rewind processed
SUBFIELD	37,3		- UNUSED
TDIOP	26	40-47	I/O operation in progress
TDLCF	26	48-55	Last COS function
FIELD	\$,56,8		- UNUSED (1 8-bit field)
TDLCSF	27	0-7	Last COS subfunction
TDMFC	27	8-15	Subtype of last station msg (TF\$xxx)
TDMSG	27	16-23	Type of last station message (TF\$xxx)
TDNDV	27	24-31	New device number for reselect
TDRRC	27	32-39	Read retry count
TDSMM	27	40-47	Save area for XVOL
TDTRRC	27	48-55	XIOP read retry count

<u>Field</u>	<u>Word(base8)</u>	<u>Bits</u>	<u>Description</u>
TDTWRC	27	56-63	XIOP write retry count
TDPBS	30	0-8	Partial sector word count
FIELD	\$,9,7		- UNUSED (pad)
TDCBZ	30	16-31	Circular buffer size (sectors)
TDCFSQ	30	32-47	Current file sequence number
TDESC	30	48-63	Excess MOS sector count
TDMFE	31	0-15	Master operator logon ID
TDMID	31	16-31	Current message number to master
TDSFE	31	32-47	Servicing front-end logon ID
TDSMN	31	48-63	Current message number to SFE
TDEVF	32	0-15	Special EOVS flags:
TDSPO	32	0	EOV Special Processing option
TDAEV	32	1	Tape is at EOVS
TDISP	32	2	In user EOVS Special Processing
TDCLSV	32	3	Processing CLOSEV request
TDRTEV	32	4	Replied to end of volume
TDTLO	32	5-6	Write trailer label option
TDOEV	32	7	Dataset is output when EOVS occurs
TD1MB	32	8	Allow one more block to be written
TD1BW	32	9	One block written
TDCLVE	32	10	CLOSEV trailer option for input
SUBFIELD	11,5		- UNUSED
TDWMSC	32	16-31	Save area of write TDMSC at STARTSP
TDWMBC	32	32-47	Save area of write TDMBC at STARTSP
TDEPMC	32	48-63	EOVS tape mark count
TDFTS	33	0-15	Files to skip counter
TDIOER	33	16-31	Mask for expected I/O status
TDLDE	33	32-47	Most recent error for dataset
FIELD	\$,48,16		- UNUSED (1 16-bit field)
TDSDF	34	0-15	Saved dataset definition flags (TDDDF)
TDNVS	34	16-63	Next volume serial number
TDSSC	35	0-15	Length of station slot

<u>Field</u>	<u>Word(base8)</u>	<u>Bits</u>	<u>Description</u>
TDVSN	35	16-63	Current volume serial number
TDVFSQ	36	0-15	File sequence in volume
TDWVS	36	16-63	VSN of volume to be rejected
TDARL	37	0-31	Accumulated record length
TDARTN	37	32-63	AVR saved resume address
TDAVB0	40	0-31	AVR routine B0 save word
TDBTS	40	32-63	Number of blocks to skip from bod
TDCLRT	41	0-31	CLE return address
TDDNT	41	32-63	DNT address (JTA relative)
TDEPS	42	0-31	Number of blocks to re-position
TDSBS	42	32-63	Saved user block size
TDERA	43	0-31	Error re-position return address
TDFBC	43	32-63	Dataset tape block count
TDINB	44	0-31	IN pointer for bad data
TDTXT	44	32-63	TXT address
TDJAR	45	0-31	Active JAR entry address
TDJRA	45	32-63	Job in memory resume address
TDJXT	46	0-31	JXT address
TDLBER	46	32-63	Label validation error flags
TDLBF	47	0-31	Label buffer address
TDLBSV	47	32-63	Label mask save field
TDLDA	50	0-31	LDT address in memory pool
TDLDH1	50	32-63	HDR1 address in LDT
TDLDH2	51	0-31	HDR2 address in LDT
TDLDV1	51	32-63	VOL1 address in LDT
TDLINK	52	0-31	Dummy TDT chain link
TDLPA	52	32-63	Label group address in memory pool

<u>Field</u>	<u>Word(base8)</u>	<u>Bits</u>	<u>Description</u>
TDLPH1	53	0-31	HDR1 address in LPA
TDLPH2	53	32-63	HDR2 address in LPA
TDLPV1	54	0-31	VOL1 address in LPA
TDLRC	54	32-63	Last return code
TDMRA	55	0-31	Job in memory resume address
TDMRIA	55	32-63	Operator/SFE message reissue address
TDNEWT	56	0-31	Address of new TDT for reselect
TDNTDT	56	32-63	Save TDT address w/mounted tape
TDOBS	57	0-31	Original block size
TDOLDT	57	32-63	Address of old TDT for RESELECT
TDOUT	60	0-31	Out pointer for queued read
TDPB00	60	32-63	LEVEL 0 return address
TDPB01	61	0-31	LEVEL 1 return address
TDPB02	61	32-63	LEVEL 2 return address
TDPB03	62	0-31	LEVEL 3 return address
TDPB04	62	32-63	LEVEL 4 return address
TDPERT	63	0-31	TET return address
TDPRT	63	32-63	TPT return address
TDPSQ	64	0-31	Current TPT sequence address (TPS)
TDRBS	64	32-63	Read block scanned
TDRVS	65	0-31	Return address for message reply
TDSBC	65	32-63	Space block count
TDSFB0	66	0-31	Return address for SFE message subs
TDSL0T	66	32-63	Address of station slot copy
TDSMB	67	0-31	Number of bad/EOF sectors moved
TDSS2	67	32-63	End-of-sequence return address
TDSS3	70	0-31	Intermediate reply address

<u>Field</u>	<u>Word(base8)</u>	<u>Bits</u>	<u>Description</u>
TDSSAD	70	32-63	Sequencer string address
TDJET	71	0-31	Pointer to the current TET
TDJEVD	71	32-63	Address of current delay descriptor
TDJLT	72	0-31	TLT address
TDJPT	72	32-63	TPT address
TDJCS1	73	0-63	INPUT+0 of current COS request:
TDRRTN	73	16-39	Caller return address
TDRTXO	73	40-55	TXT ordinal
TDRFC	73	56-63	Function code of request
TDJCS2	74	0-63	INPUT+1 of current COS request:
TDRDNT	74	16-39	DNT address JTA relative
TDRAUX	74	40-63	Auxiliary address
TDJDLW	75	0-63	Delayed function control word
TDJDLF	75	0-31	Delayed function flags:
TDJJIM	75	0	Waiting for job in memory
TDJULD	75	1	Pending JTA LDT update
TDJLPL	75	32-63	Address of next TDT in the delay list
<u>TDJQCT</u>	76	0-63	JTA counter updates
<u>TDJNVM</u>	76	0-15	<u>Number of volumes mounted</u>
SUBFIELD	16,16		- UNUSED
TDJQBC	76	32-63	Number of tape blocks moved
TDJSF1	77	0-63	Sequencer function string:
TDJSCF	77	0-15	Current sequencer function
TDJSNXF	77	0	Not an XIOP function
SUBFIELD	1,6		- UNUSED
TDJSAC	77	7-9	Advance code
TDJSFC	77	10-15	Function code
TDJSNF	77	16-31	Next function
TDJESFS	100	0-63	Error simulator function string:
TDJESAC	100	0	Advance-only flag
TDJESCF	100	1-15	Function code
TDJESSS	101	0-63	Error simulator status string:
TDJESCS	101	0-15	Simulated status
TDJPTST	102	0-63	Physical I/O start time
TDJPTQI	103	0-63	Physical I/O queued interval
TDJQHE	104	0-63	Queued COS response

Field Word(base8) Bits Description

TDSPS 105 0-63 Saved packet status word (TDPSW)

Installation area 2. (Cleared by X\$FD replies)

To make upgrades easier, place locally added TDT fields in one more full words within this block of line idents. Other unused fields in the TDT are reserved for CRI.

--- add local words here ---

TDSTKP 106 0-63 Stack pointer (offset)

TDSTKB 107-172 0-63 Stack base

SZ@TDT = NE@TDT*LE@TDT+LH@TDT

Name: Time Event Table (TET).

Purpose: This table is used by EXEC to schedule and manage time events.

Note: Time events are assigned numbers. The number is the bit position (0=sign bit) in the bit map. For global events, the number is also the TET entry ordinal. The entry ordinal for processor specific events = event number + (CPU number * TENPSE).

Bit map layout for global events.

TEUTIL	= 0	Utilization event interval
TECHAN	= C@CPLCHN	Entries for hardware channels
TETASK	= C@CPHCHN+1	Entries for STP tasks
TEPROF	= TETASK+NE@STT	Entry for system execution profile
TEMEMI	= TEPROF+1	Memory correction/detection
TETICK	= TEMEMI+1	Entry for guest O.S. clock events
TENAGE	= TETICK+1	Next available global entry

Bit map layout for processor specific events.

TEDEFL	= TENAGE	Entries for default events
TEUSER	= TEDEFL+1	Entries for user jobs
TESPY	= TEUSER+1	Entries for user spy
TENAPE	= TESPY+1	Next avail processor specific entry
TENPSE	= TENAPE-TENAGE	Number of processor specific events

Check assumptions.

Table description.

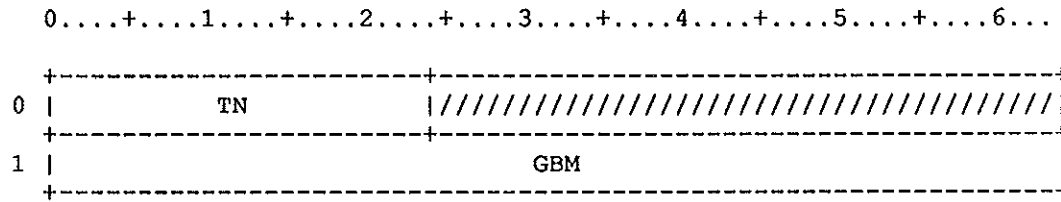

Figure TE-1. Time Event Table

Table header.

Field	Word(base8)	Bits	Description
TETN	0	0-23	Table name ('TET' in ASCII)
TEGBM	1	0-63	General event bit map

Event entry (one per event).

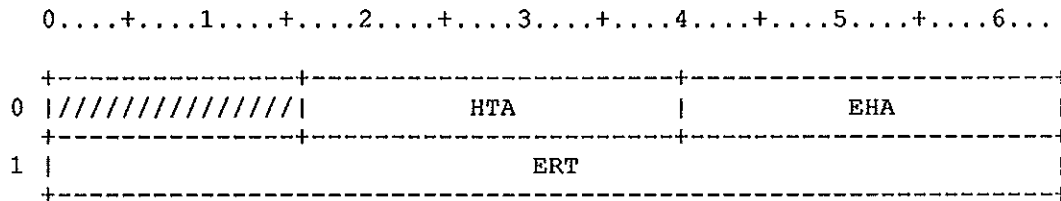

Figure TE-2. Time Event Table

Field	Word(base8)	Bits	Description
TEHTA	0	16-39	Event handler table address
TEEHA	0	40-63	Event handler address
TEERT	1	0-63	Event real time

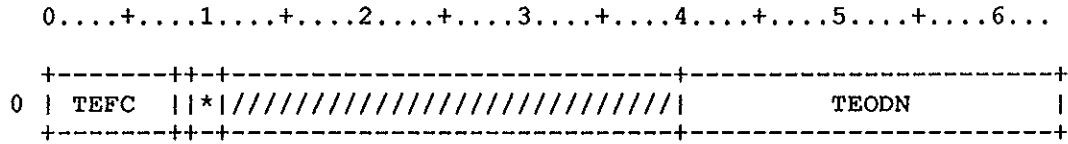

Figure TEV-1.

Field	Word(base8)	Bits	Description
TEFC	0	0-7	FUNCTION CODE TE\$SVP=0 Set special processing TE\$SSP=1 Start special processing TE\$ESP=2 End special processing TE\$CLSV=3 CLOSEV request
TESPO	0	8	1 - set EOv processing on
TEWLB	0	9-10	Write trailer label option for CLOSEV TE\$NTL=0 0 - DO NOT WRITE TRAILER LABEL TE\$EOV=1 1 - Write EOv trailer label
TEODN	0	40-63	ODN address

Define a table for user multitasking task information

```

0....+....1....+....2....+....3....+....4....+....5....+....6...
+-----+-----+-----+-----+-----+-----+-----+
0 |                                     TID                                     |
+-----+-----+-----+-----+-----+-----+-----+
1 |                                     LCPU                                     |
+-----+-----+-----+-----+-----+-----+-----+
2 |                                     VAL                                     |
+-----+-----+-----+-----+-----+-----+-----+
3 | //////////////////////////////////////|                                     EXP |
+-----+-----+-----+-----+-----+-----+-----+
4 ||           QPD           |           QSC           |
+-----+-----+-----+-----+-----+-----+-----+
5 ||           TQT           |           TQH           |
+-----+-----+-----+-----+-----+-----+-----+
6 | //////////////////////////////////////|           TWC           |
+-----+-----+-----+-----+-----+-----+-----+
7 | //////////////////////////////////////|           NTIB          |
+-----+-----+-----+-----+-----+-----+-----+
10| //////////////////////////////////////|           PRNT          |
+-----+-----+-----+-----+-----+-----+-----+
11| //////////////////////////////////////|           CHLD          |
+-----+-----+-----+-----+-----+-----+-----+
12| //////////////////////////////////////|           SIB           |
+-----+-----+-----+-----+-----+-----+-----+
13| //////////////////////////////////////|           ARP           |
+-----+-----+-----+-----+-----+-----+-----+
14| //////////////////////////////////////|           STKB          |
+-----+-----+-----+-----+-----+-----+-----+
15| //////////////////////////////////////|           STKT          |
+-----+-----+-----+-----+-----+-----+-----+
16| //////////////////////////////////////|           STKL          |
+-----+-----+-----+-----+-----+-----+-----+
17| //////////////////////////////////////|                       |
+-----+-----+-----+-----+-----+-----+-----+
20|           LCNT           |           LDSP          |
+-----+-----+-----+-----+-----+-----+-----+
21| //////////////////////////////////////|           CCSTKP        |
+-----+-----+-----+-----+-----+-----+-----+
22| //////////////////////////////////////|                       |
+-----+-----+-----+-----+-----+-----+-----+
$/////////////////////////////////////$
61| //////////////////////////////////////|                       |
+-----+-----+-----+-----+-----+-----+-----+
62|           CCSTK          |                       |
+-----+-----+-----+-----+-----+-----+-----+

```

Figure TI-1. Task Information Block

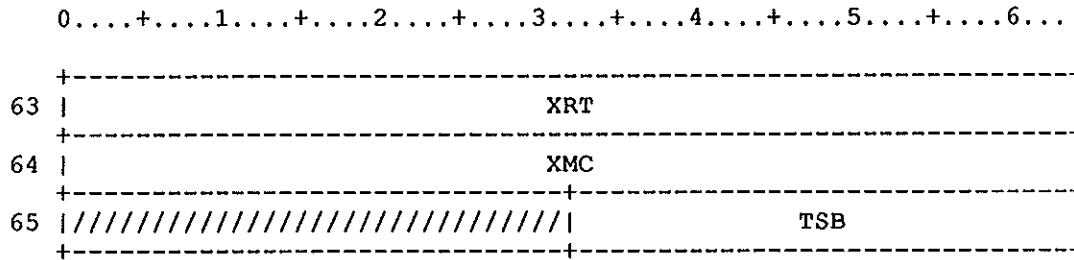

Figure TI-1. Task Information Block

Field definitions.

Field	Word(base8)	Bits	Description
TITID	0	0-63	Task ID
TILCPU	1	0-63	Logical CPU assigned to task
TIVAL	2	0-63	User defined task value
TIEXP	3	40-63	Execution point address for task
TIQPD	4	1-31	Run/ready/wait queue predecessor ptr
TIQSC	4	32-63	Run/ready/wait queue successor ptr
TITQT	5	1-31	Task completion queue tail
TITQH	5	32-63	Task completion queue header
TITWC	6	32-63	Count of tasks waiting for this task
TINTIB	7	32-63	Pointer to next assigned TIB
TIPRNT	10	32-63	Pointer to parent TIB
TICHLD	11	32-63	Pointer to first child's TIB
TISIB	12	32-63	Pointer to next siblings TIB
TIARP	13	32-63	Pointer to current argument list (B01)
TISTKB	14	32-63	Current base of stack for task (B02)
TISTKT	15	32-63	Current top of stack for task (B66)
TISTKL	16	32-63	Current limit of stack for task (B67)
TIFIM	17	0	Current floating interrupt mode
TIBDM	17	1	Current bidirectional memory mode
TIFLO	17	2	Flow trace initialized flag

<u>Field</u>	<u>Word(base8)</u>	<u>Bits</u>	<u>Description</u>
TILCNT	20	0-31	Locked DSP count, i.e. number of
TILDSP	20	32-63	Locked DSP address (STP relative)
CCSTKP	21	32-63	Stack pointer for character concatenation routines
CCSTK	62	0-63	Static stack for concatenation routine
TIXRT, TIXMC, and TITSB are used by Flow Trace routines			
TIXRT	63	0-63	Last real-time clock value observed
TIXMC	64	0-63	Machine cycles charged to this TIB at last connection to a TSB
TITSB	65	32-63	Address of TSB currently associated with this TIB or zero if none

The TIO history trace is STPTAB resident. This trace buffer when enabled will trace the various key points through the major sections of TIO. By default all tracing within TIO is turned off. To enable TIO tracing, redefine the number of history trace entries to a non-zero value. Note that TIO will have to be reassembled when this is done.

NE@TIOT = D'000 Do not assemble in tracing

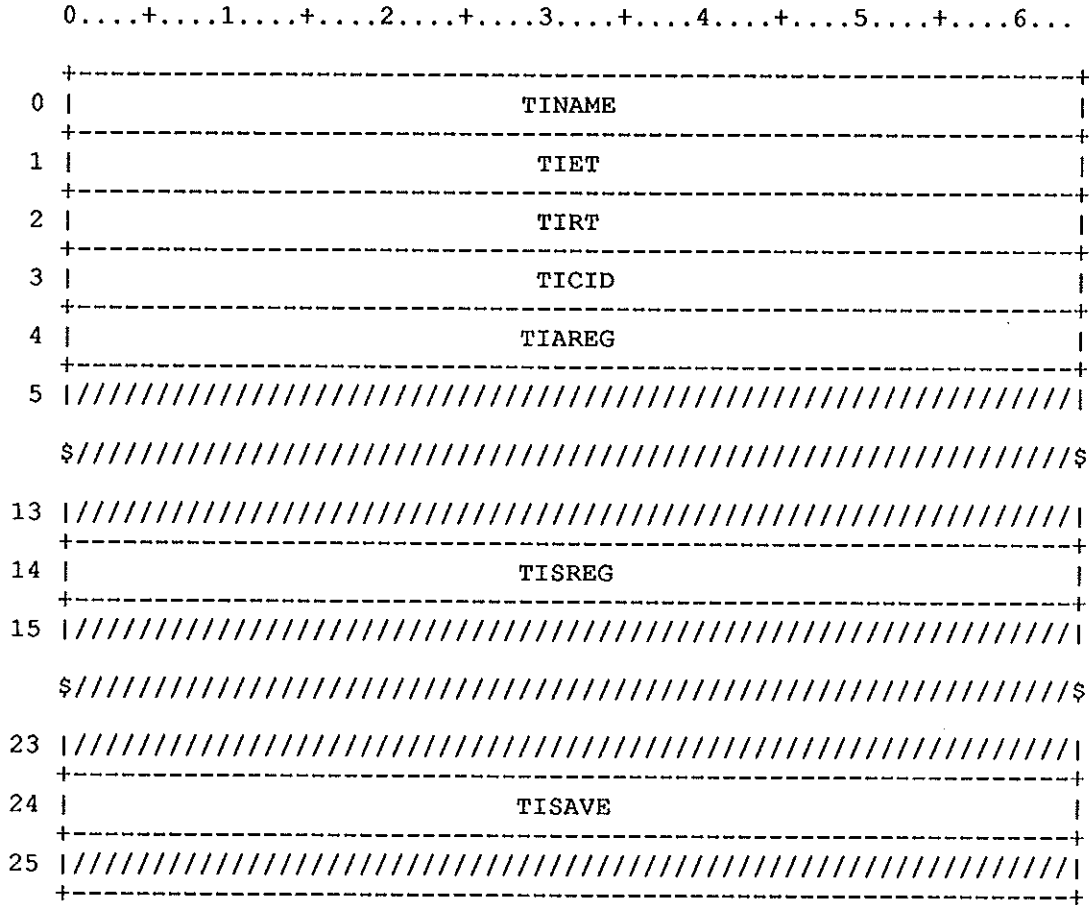

Figure CT-1. TIO history trace buffer

The follow four words are common to all history trace buffers that FDUMP can recognize and collate with other history traces of the same nature.

<u>Field</u>	<u>Word(base8)</u>	<u>Bits</u>	<u>Description</u>
TINAME	0	0-63	ASCII name associated with the entry
TIET	1	0-63	Elapsed Real-time clock since last ent
TIRT	2	0-63	Current real-time clock
TICID	3	0-63	Current STP task ID
TIAREG	4	0-63	Address registers
TISREG	14	0-63	Scalar registers
TISAVE	24	0-63	TIO stack-resident save area

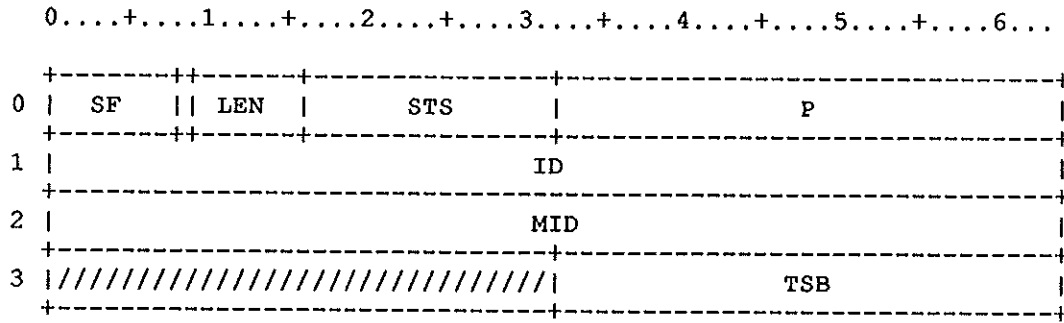

Figure TK-1. F\$TASK Table

Field	Word(base8)	Bits	Description
TKSF	0	0-7	Sub-function code
TKNA	0	8	No-abort flag
TKLEN	0	9-15	Length of TK table
TKSTS	0	16-31	Return status

POSSIBLE VALUES OF RETURN STATUS

			TK\$ERXJT=1	Maximum tasks/job exceeded
			TK\$ERBID=2	Bad task id
			TK\$ERCAS=3	Attempt to activate self
			TK\$ERTAA=4	Attempt to activate active task
			TK\$ERTAI=5	Attempt to deactivate inactive task
			TK\$ERMEM=6	Not enough memory for new TCB
			TK\$ERBP=7	Bad P-addr for new task
			TK\$ERBTS=D'9	Bad TSB address
			TK\$ERADE=D'8	All tasks for job deactivated
TKP	0	32-63		P-Addr for new task
TKID	1	0-63		ID of task to be operated on
TKMID	2	0-63		ID of task requesting operation
TKTSB	3	32-63		Task Status Block(TSB) addr (OPTIONAL)

This table defines magnetic tape label volume 1. It is constructed using the complex table definition macros. All values are expressed in characters; no binary equivalent is used.

Note that the VLOID field is drawn in the tables manual using special comments interpreted only by the table diagram generator. The table as it is now defined cannot be drawn by the table diagram generator with its present capabilities.

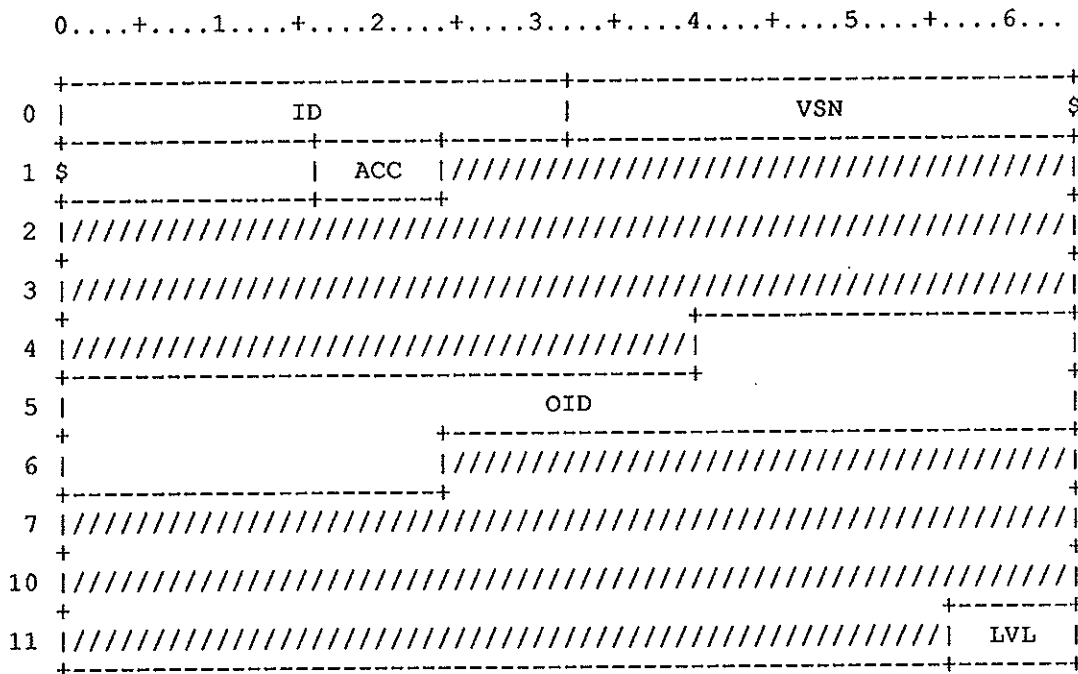

Figure VL-1. Volume Label Group

Field	Word(base8)	Bits	Description
VLID	0	0-31	Label name (VOL 1)
VLLID	0	0-23	Label identifier (VOL)
VLNUM	0	24-31	Label group number (1)
VLVSN	0-1	0-63	Volume serial number
VLACC	1	16-23	Volume accessibility character
VLOID	4-6	0-63	Owner identification VLOID1 tags word 4, bit 40 through word 5, bit 39 VLOID2 tags word 5, bit 40 through word 6, bit 23

<u>Field</u>	<u>Word(base8)</u>	<u>Bits</u>	<u>Description</u>
VLLVL	11	56-63	ANSI standards level

Note that the IDOID field is drawn in the tables manual using special comments interpreted only by the table diagram generator. The table as it is now defined cannot be drawn by the table diagram generator with its present capabilities.

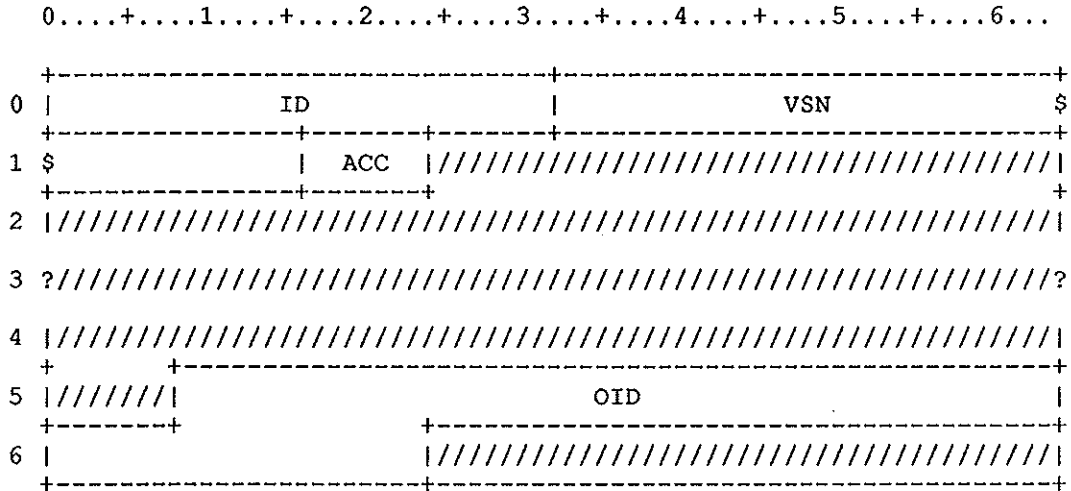

Figure IV-2. IBM Standard Label - Volume Label

Field	Word(base8)	Bits	Description
IVID	0	0-31	Label name (VOL 1)
IVLID	0	0-23	Label identifier (VOL)
IVNUM	0	24-31	Label group number (1)
IVVSN	0-1	0-63	Volume serial number
IVACC	1	16-23	Volume accessibility character
IVOID	5-6	0-63	Owner identification IVOID1 tags word 5, bit 8 through word 6, bit 7 IVOID2 tags word 6, bit 8 through word 6, bit 23

The dataset label group has two formats, one for label group 1, and one for label group 2. These tables are constructed by the complex table definition macros. All values are in characters; no binary equivalent is used.

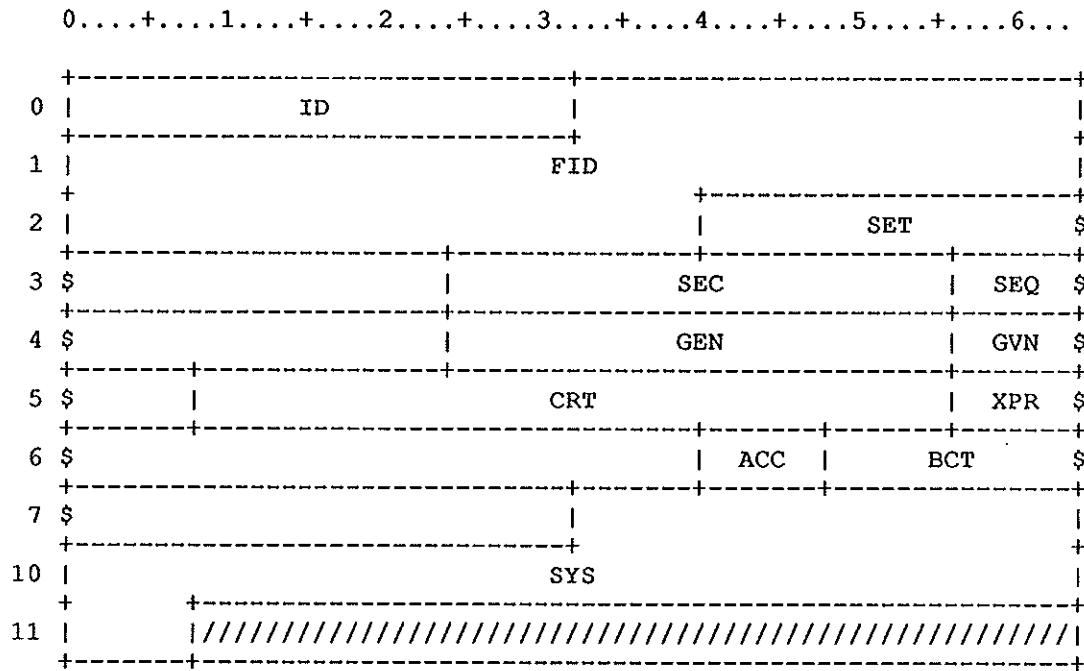

Figure DL-3. First Dataset Label Group

Field	Word(base8)	Bits	Description
DLID	0	0-31	Label name (HDR1, EOF1, EOVI) Label name (HDR2, EOF2, EOVI)
DLLID	0	0-23	Label identifier (HDR, EOF, EOVI) Label identifier (HDR, EOF, EOVI)
DLNUM	0	24-31	Label group number (1), ASCII Label group number (2), ASCII
DLFID	0-2	0-63	File identifier (dataset name) DLFID1 tags word 0, bit 32 through word 1, bit 31 DLFID2 tags word 1, bit 32 through word 2, bit 31 DLFID3 tags word 2, bit 32 through word 2, bit 39
DLSET	2-3	0-63	Set identifier

<u>Field</u>	<u>Word(base8)</u>	<u>Bits</u>	<u>Description</u>
DLSEC	3	24-55	File section number (volume sequence number)
DLSEQ	3-4	0-63	File sequence number
DLGEN	4	24-55	File generation number
DLGVN	4-5	0-63	File generation version number
DLCRT	5	8-55	File creation date
DLCRS	5	8-15	Space
DLCRY	5	16-31	Creation year
DLCRD	5	32-55	Creation day of year
DLXPR	5-6	0-63	File expiration date
DLXPS	5	56-63	Space
DLXPY	5	0-15	Expiration year
DLXPD	5	16-39	Expiration day of year
DLACC	6	40-47	File accessibility character
DLBCT	6-7	0-63	Tape block count
DLSYS	7-11	0-63	System code DLSYS1 tags word 7, bit 32 through word 8, bit 31 DLSYS2 tags word 8, bit 32 through word 9, bit 7

The IDLG is the IBM equivalent of the DLG format 2. This definition is for tape dataset label group two. It is constructed using the complex table definition macros. All values are expressed in characters; no binary equivalent is used.

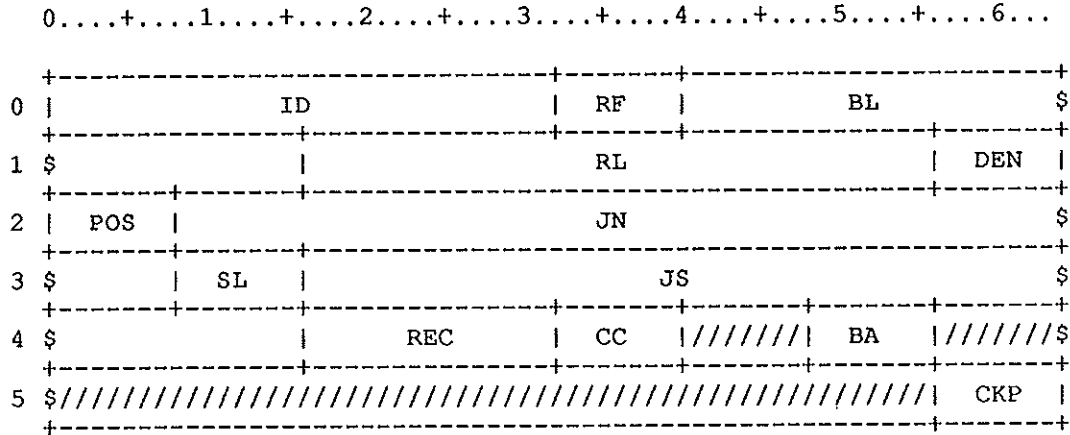

Figure ID-5. Second IBM Dataset Label Group

Field	Word(base8)	Bits	Description
IDID	0	0-31	Label name (HDR2, EOF2, EOVS)
IDLID	0	0-23	Label identifier (HDR, EOF, EOVS)
IDNUM	0	24-31	Label group number (2)
IDRF	0	32-39	Record fmt is one of the following: 'F' = Fixed length 'V' = Variable 'U' = Undefined
IDBL	0-1	0-63	Tape block length
IDRL	1	16-55	Record length
IDDEN	1	56-63	Recording density
IDPOS	2	0-7	Dataset position (volume switch flag)
IDJN	2-3	0-63	Job name
IDSL	3	8-15	Slash '/'
IDJS	3-4	0-63	Job step name
IDREC	4	16-31	Recording technique
IDCC	4	32-39	Control characters present flag

<u>Field</u>	<u>Word(base8)</u>	<u>Bits</u>	<u>Description</u>
IDBA	4	48-55	Block attributes; one of the following: B Tape blocked records S Spanned records M Tape blocked and spanned records
IDCKP	5	56-63	Checkpoint dataset identifier

The TLT table is used to describe parameters for label classes used by the system during label validation. Current label classes are ANSI standard and IBM standard.

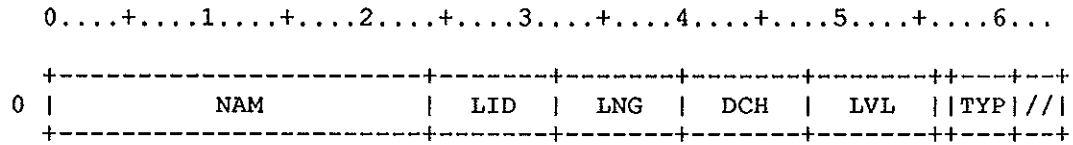

Figure TL-1. Tape Label Table

Field	Word(base8)	Bits	Description
TLNAM	0	0-23	Label name
TLID	0	24-31	Label number
TLNG	0	32-39	Length of label in bytes
TLDCH	0	40-47	Default character
TLVL	0	48-55	Standard level (ansi)
TLFXD	0	56	Length fixed if set
TLTYP	0	57-60	Label type (TLT\$...)
TLT\$VL1	= 1		VOL1
TLT\$HR1	= 2		HDR1
TLT\$HR2	= 3		HDR2
TLT\$EV1	= 4		EOV1
TLT\$EV2	= 5		EOV2
TLT\$EF1	= 6		EOF1
TLT\$EF2	= 7		EOF2

The Inter-task Message Table is STP-resident. Each entry contains an intertask message plus control information.

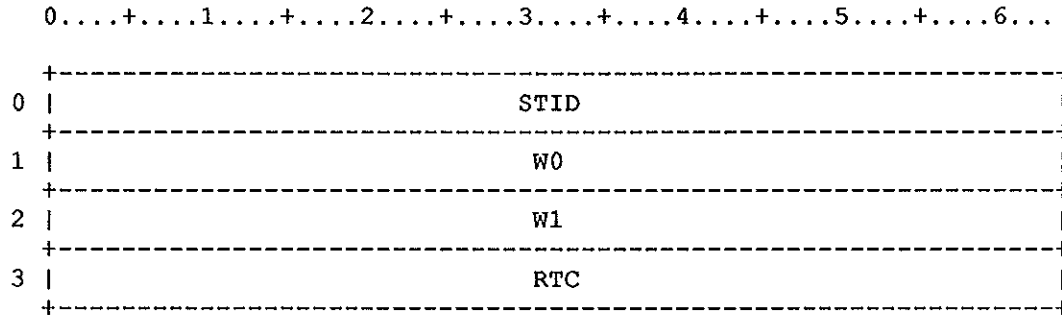

Figure TM-1. STP Inter-task Message Table

Field	Word(base8)	Bits	Description
TMSTID	0	0-63	Sending task's ID
TMACT	0	0	Set if message is active
TMW0	1	0-63	Inter-task message word 0
TMW1	2	0-63	Inter-task message word 1
TMRTC	3	0-63	Real time clock when message queued

The tape label migration table is used when a tape mounted for a write is labeled differently than that requested. The table is scanned to see if the mounted tape can migrate to the requested label type.

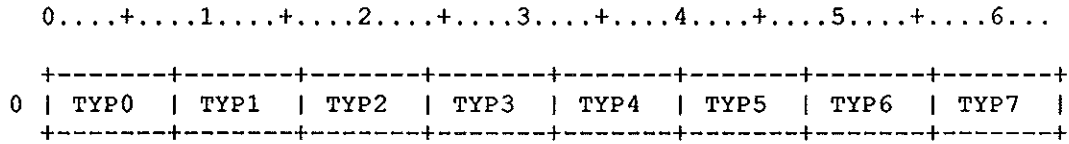

Figure TM-2. Tape Label Migration Table

<u>Field</u>	<u>Word(base8)</u>	<u>Bits</u>	<u>Description</u>
TMTYP0	0	0-7	ENTRY 0
TMTYP1	0	8-15	ENTRY 1
TMTYP2	0	16-23	ENTRY 2
TMTYP3	0	24-31	ENTRY 3
TMTYP4	0	32-39	ENTRY 4
TMTYP5	0	40-47	ENTRY 5
TMTYP6	0	48-55	ENTRY 6
TMTYP7	0	56-63	ENTRY 7
TMT\$END	= 0'377		TERMINATOR

COMTN

Table Name Table

The Table Name Table (TNT) is contained in the system task area and is used by EXP to service the F\$TBL function. This deck is also used to define fields for the F\$TBL call block.

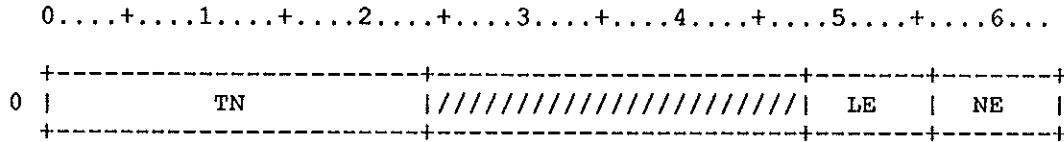

Figure TN-1. Table Name Table

Define TNT header.

Field	Word(base8)	Bits	Description
TNTN	0	0-23	Table name
TNLE	0	48-55	TNT entry length
TNNE	0	56-63	Number of TNT entries (set by BUILD)

Define TNT entry.

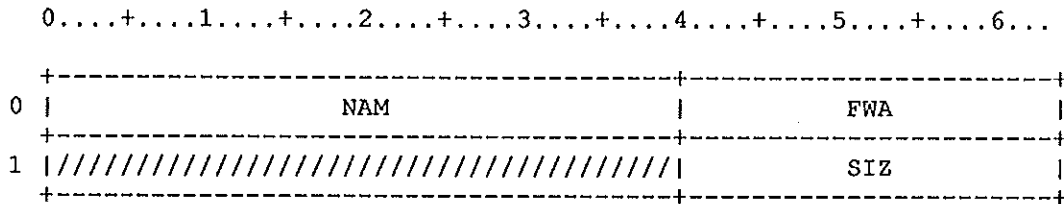

Figure TN-2. Table Name Table

Field	Word(base8)	Bits	Description
TNNAM	0	0-39	Table name ('ASCII'L)
TNFWA	0	40-63	Starting address of table
TNSIZ	1	40-63	Table size

Define fields for the F\$TBL call block.

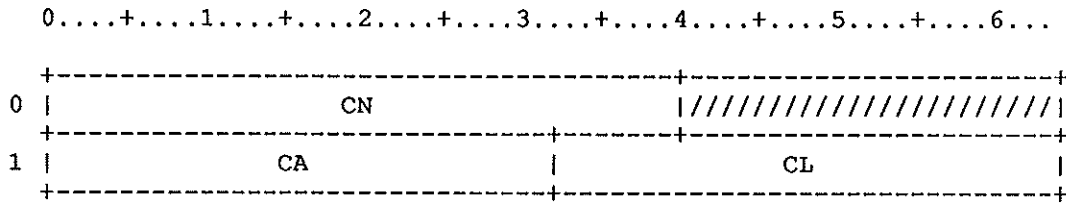

Figure TBL-1. F\$TBL Call Block

<u>Field</u>	<u>Word(base8)</u>	<u>Bits</u>	<u>Description</u>
TBLCN	0	0-39	Table name ('ASCII'L)
TBLCA	1	0-31	Receive buffer address
TBLCL	1	32-63	Receive buffer length

The 'Traceback Name Block' permits language processors to put names longer than 8 characters in the traceback information. Traceback information is used by the error traceback routines, by the flow trace routines, and by debug programs.

Language processors add traceback information in the form of a TNB to a local block for each entry point. During program execution, register B02 points to a B/T register save area. The first word of the save area points to the TNB for the entry point.

Existing code sets B77 to the address of the word containing the first instruction of the program. In the word immediately preceding the entry point are the first eight characters of the name.

Routines referencing the TNB can inspect the bits 0-32 of the word pointed to by the first word of the B/T save area. If non-zero, the entry point is an old form entry point, without a TNB. If zero, the first word of the save area points to a TNB.

The TNB is as shown below.

The word provided for "language specific information" is otherwise unspecified.

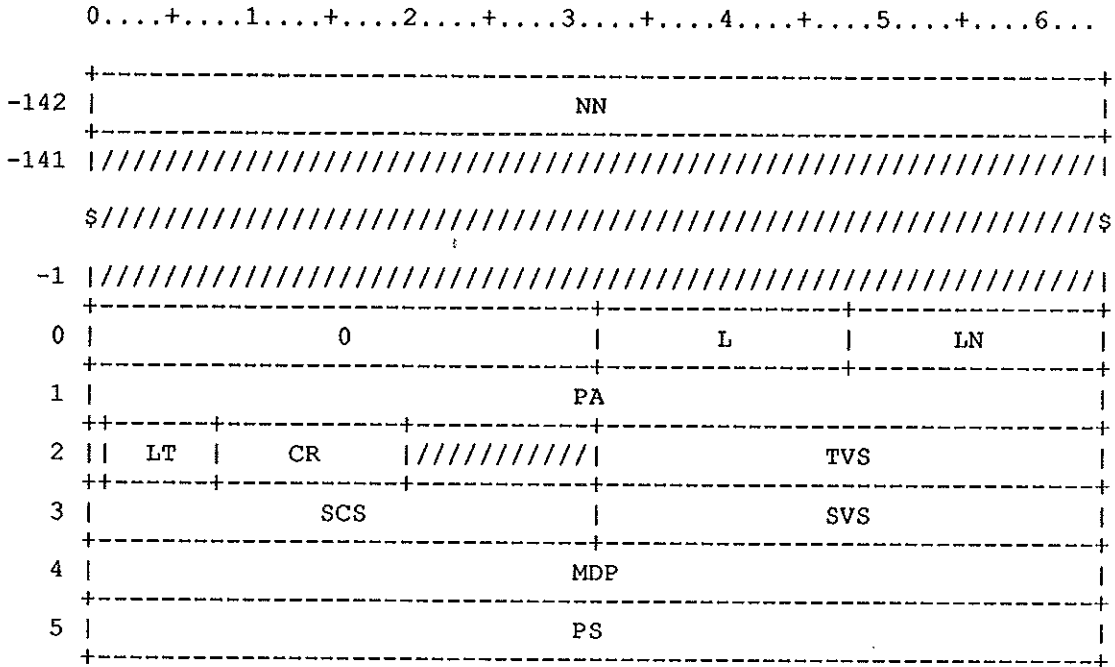

Figure TNB-1. Traceback Name Block

Field	Word(base8)	Bits	Description
TNBNN	-142	0-63	Last (or only) eight characters of name.
TNB0	0	0-31	Mandatory zero
TNBL	0	32-47	Number of following words (excluding this one.)
TNBLN	0	48-63	Number of characters in the name. The first character of the name is contained in the -1-ICEIL(TNBLN,8) word of the table.
TNBPA	1	0-63	Parcel address of entry point
TNBBL	2	0	Base level flag; set if this subprogram makes no calls
TNBLT	2	1-7	Language type 0 = unknown 1 = CAL 2 = CFT 3 = Pascal 4 = CFT77 5 = C

Field	Word(base8)	Bits	Description
TNBCR	2	8-19	Maximum size of parameter list built by this subprogram
TNBTVS	2	32-63	Size of stack temporary variable store
TNBSCS	3	0-31	Size of static constant space
TNBSVS	3	32-63	Size of static variable space
TNBMDP	4	0-63	Machine dependent parameters
TNBPS	5	0-63	Language specific information

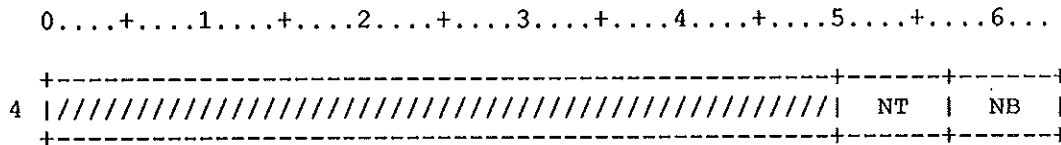

Figure TNB-2. CRAY-1, X-MP Machine dependent information

Field	Word(base8)	Bits	Description
TNBNT	4	50-56	Number of T registers
TNBNB	4	57-63	Number of B registers

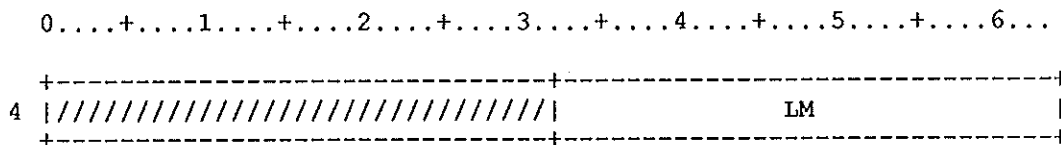

Figure TNB-3. CRAY-2 Machine dependent information

Field	Word(base8)	Bits	Description
TNBLM	4	32-63	Size of local memory

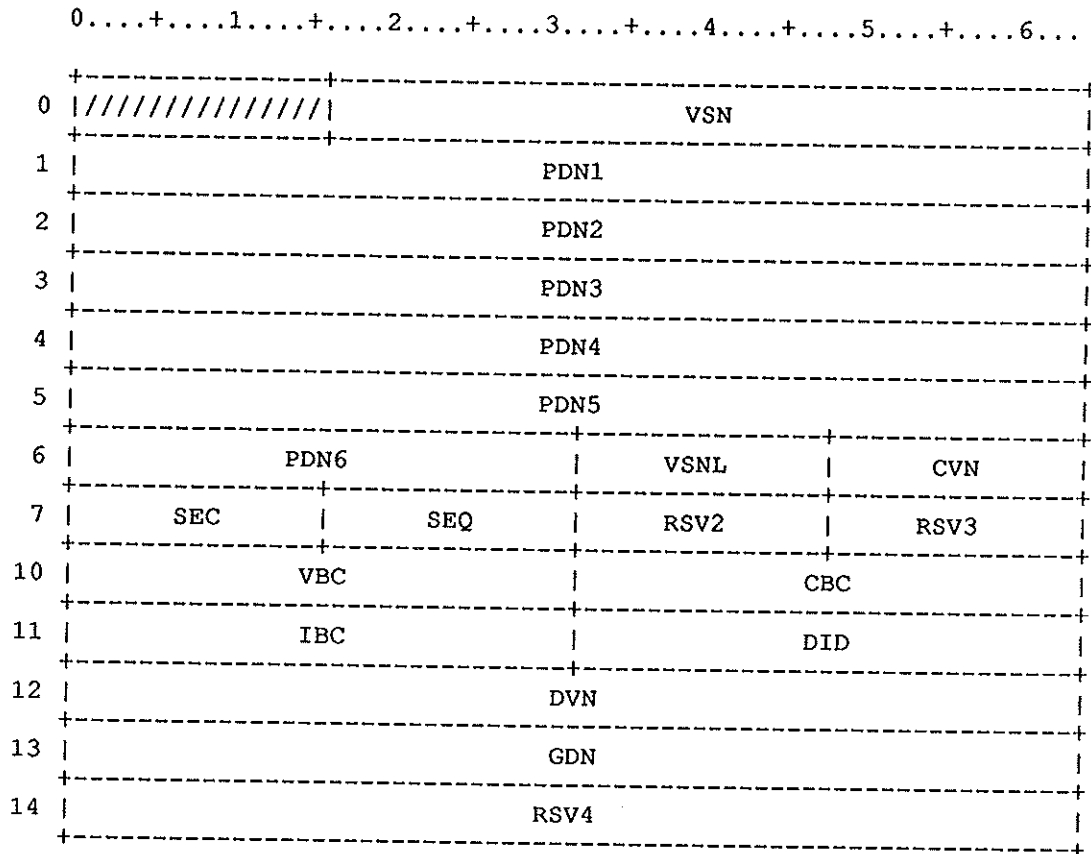

Figure TP-1. Tape Position Information Table

Field	Word(base8)	Bits	Description
TPVSN	0	16-63	VSN of last block processed
TPPDN1	1	0-63	Characters 1 - 8 of PDN
TPPDN2	2	0-63	Characters 9 - 16 of PDN
TPPDN3	3	0-63	Characters 17 - 24 of PDN
TPPDN4	4	0-63	Characters 25 - 32 of PDN
TPPDN5	5	0-63	Characters 33 - 40 of PDN
TPPDN6	6	0-31	Characters 41 - 44 of PDN
TPVSNL	6	32-47	length of VSN list
TPCVN	6	48-63	current VSN offset

<u>Field</u>	<u>Word(base8)</u>	<u>Bits</u>	<u>Description</u>
TPSEC	7	0-15	File section number
TPSEQ	7	16-31	File sequence number
TPRSV2	7	32-47	Reserved- for concatenation
TPRSV3	7	48-63	Reserved
TPVBC	10	0-31	Block number
TPCBC	10	32-63	Number of blocks in circular buffer Output - blocks not sent to IOP Input - always 0
TPIBC	11	0-31	Number of blocks in IOP buffer
TPDID	11	32-63	Device Id (unit no.)
TPDVN	12	0-63	Device Identifier(name)
TPGDN	13	0-63	Generic Device Name
TPRSV4	14	0-63	Reserved

This table defines routines which are called for processing based on the current function (TPF\$...) and the current state (TPS\$...). Each defined label type has an associated TPT table during access, TQM links the appropriate TPT to the TDT based on the requested label type.

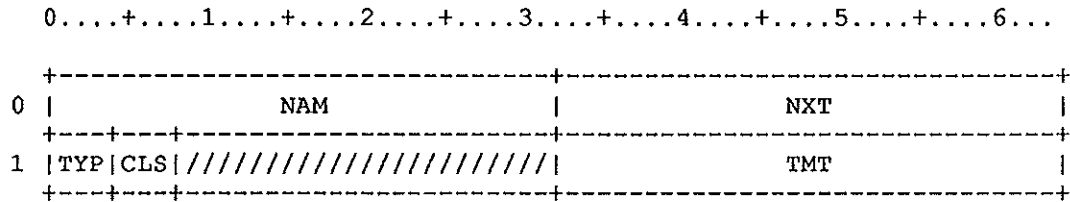

Figure TP-1. Tape Processing Table

<u>Field</u>	<u>Word(base8)</u>	<u>Bits</u>	<u>Description</u>
TPNAM	0	0-31	Table name in ascii (TPT)
TPNXT	0	32-63	Link to next TPT
TPTYP	1	0-3	Label format. 'LB' on access.
TPCLS	1	4-7	Label class. TPSL/TPAN/TPNL
TPTMT	1	32-63	Pointer to tape migration table

There is one TPS entry built for each defined state (TPS\$...) Each TPS entry contains a processing routine address which is dependent on the current function. The functions are READ,WRITE and position. Additionally, there is information relating to label verification and error processing.

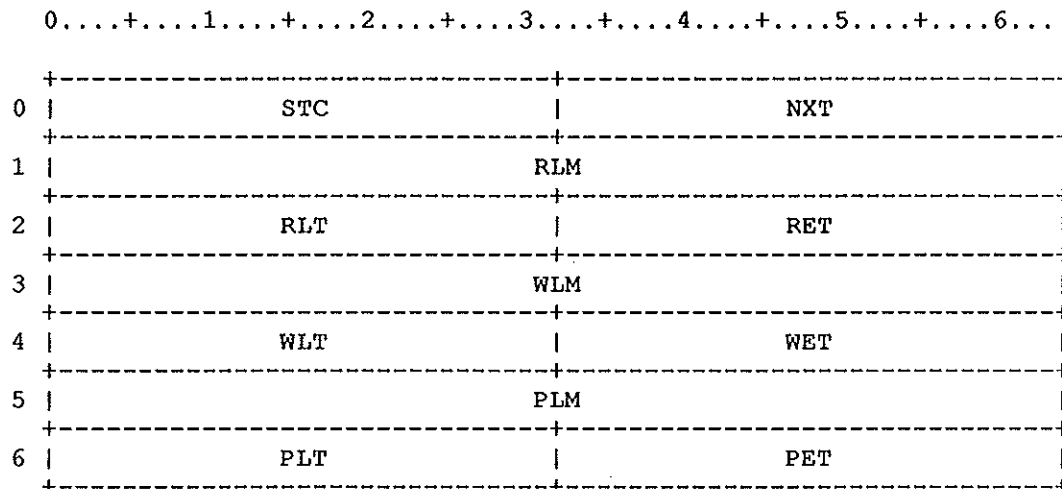

Figure TPS-1. TPS Table Header

Field	Word(base8)	Bits	Description
TPSSTC	0	0-31	State code for following sequence
TPSNXT	0	32-63	Pointer to next sequence
TPSRML	1	0-63	READ: label verification mask
TPSRLT	2	0-31	READ: label processing table
TPSRET	2	32-63	READ: error processing table
TPSWLM	3	0-63	WRITE: label verification mask
TPSWLT	4	0-31	WRITE: label processing table
TPSWET	4	32-63	WRITE: error processing table
TPSPLM	5	0-63	POSITION: label verification mask
TPSPLT	6	0-31	POSITION: label processing table
TPSPET	6	32-63	POSITION: error processing table

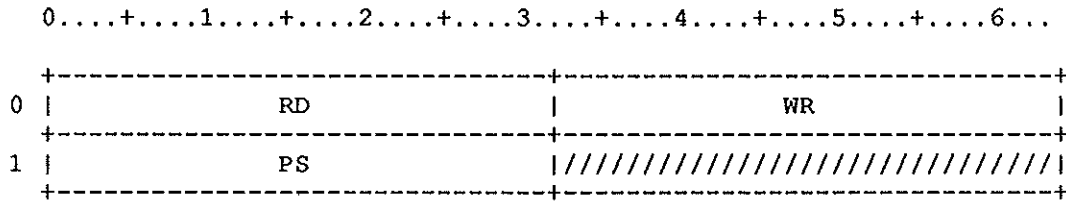

Figure TPE-2. TPS Table Entry

Field	Word(base8)	Bits	Description
TPERD	0	0-31	Read sequence routine address
TPEWR	0	32-63	Write sequence routine address
TPEPS	1	0-31	Position sequence routine address
TPS\$BOT	= 1		Beginning-of-tape sequence
TPS\$TM	= 2		Tape mark sequence
TPS\$EOT	= 3		End-of-tape sequence
TPS\$ERR	= 4		Tape error sequence
TPS\$URW	= 5		User rewind to bod
TPS\$UCL	= 6		User close
TPF\$RD	= 1		Read
TPF\$WR	= 2		Write
TPF\$PS	= 3		Position

TAPE QUEUE MANAGER FUNCTION CODES (EXP TO TQM)

T\$CIO	=	1	CIO request
T\$OPN	=	2	Open dataset
T\$POS	=	3	Rewind dataset
T\$CLO	=	4	Close dataset
T\$RLS	=	5	Release dataset
T\$PDM	=	6	Tape PDM call
T\$TPOS	=	7	Tape position request
T\$TEOV	=	10	Special EOVB/OV processing request
T\$ILL	=	11	Maximum valid request + 1

TQM TO XIOP FUNCTION CODES

X\$RB	=	01	Read block
X\$WB	=	02	Write block
X\$MN	=	03	Mount and connect device
X\$FD	=	04	Free device
X\$UL	=	05	Unload
X\$RW	=	06	Rewind
X\$CR	=	07	End of Data continue read
X\$WT	=	10	Write TM
X\$1TR	=	11	Write 1 TM and rewind
X\$SF	=	12	Search TM forward
X\$PF	=	13	Position forward
X\$SB	=	14	Search TM backward
X\$PB	=	15	Position backward
X\$US	=	16	Unsolicited XIOP status
X\$CC	=	17	Configuration change
X\$RP	=	20	Reposition tape
X\$VP	=	21	Verify position
X\$ET	=	22	Erase tape
X\$DE	=	23	Data security erase
X\$RM	=	24	Remount device
X\$2TR	=	25	Write 2 TM's and rewind
X\$1TU	=	26	Write 1 TM and unload
X\$2TU	=	27	Write 2 TM's and unload
X\$VR	=	30	End of Volume continue read
X\$FR	=	31	End of File continue read
X\$NO	=	32	No-op
X\$DD	=	33	Display message on device
X\$ILL	=	34	Maximum valid function + 1

Field definitions for TQM requests.

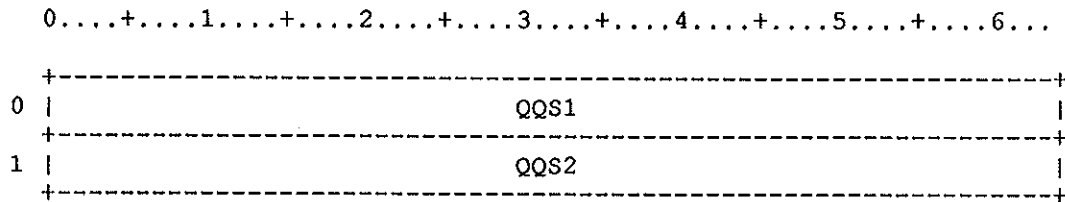

Figure T-1. Tape Queue Manager Equates

<u>Field</u>	<u>Word(base8)</u>	<u>Bits</u>	<u>Description</u>
TQQS1	0	0-63	S1 of request, input to PUTREQ
TQQSFC	0	8-15	Sub-function code of request
TQQSFC	0	8-15	Subfunction code
TQQB00	0	16-39	Address to process TQMs reply
TQQT XO	0	40-55	TXT ordinal
TQQFC	0	56-63	Function code of request (T\$xxx)
TQQS2	1	0-63	S2 of request, input to PUTREQ
TQQDNT	1	16-39	DNT address, STP relative
TQQAUX	1	40-63	Auxiliary address, PDDs and such

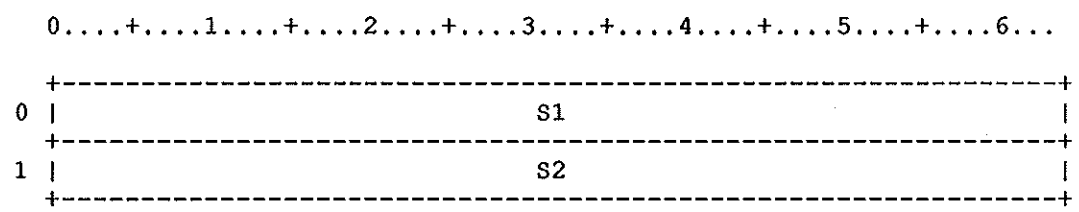

Figure TQP-1.

Field	Word(base8)	Bits	Description
TQPS1	0	0-63	S1 of request, input to PUTREPLY
TQPDNT	0	16-39	DNT address, STP relative
TQPST	0	40-63	Reply status
TQPS2	1	0-63	S2 of request, input to PUTREPLY
TQPSFC	1	8-15	Subfunction code
TQPB00	1	16-39	Address to process TQMs reply
TQPRCL	1	40	Intermediate recall reply
TQPTXO	1	41-55	TXT ordinal
TQPFC	1	56-63	Function code of request (T\$xxx)
TT\$NONE	= 0		Trace type - No tracing
TT\$SYS	= 1		Trace type - System trace
TT\$DEV	= 2		Trace type - Device trace
TRTY\$D	= TT\$DEV		Default trace type
TRSZ\$L	= 0'3		Minimum trace entries per device
TRSZ\$D	= 0'74		Default trace entries per device
TRSZ\$M	= 0'400		Maximum trace entries per device

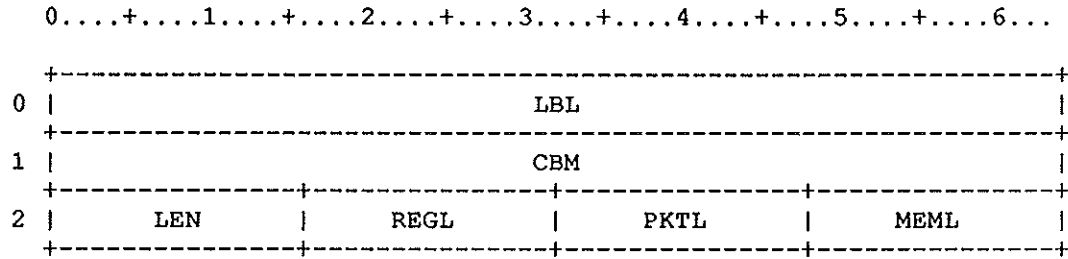

Figure TB-1. Trace parameter block

Field	Word(base8)	Bits	Description
TBLBL	0	0-63	ASCII label name
TBCBM	1	0-63	Snap component bit map
TBREG	1	0	Copy B0, A0-A7, and S0-S7 to trace
TBPKT	1	1	Copy XIOP reply packet to trace
SUBFIELD	2,61		- UNUSED
TBMEM	1	63	Copy memory from (A5)
TBLEN	2	0-15	Total snap length
TBREGL	2	16-31	Number of words for registers
TBPKTL	2	32-47	Number of words for reply packet
TBMEML	2	48-63	Number of words to copy from (A5)

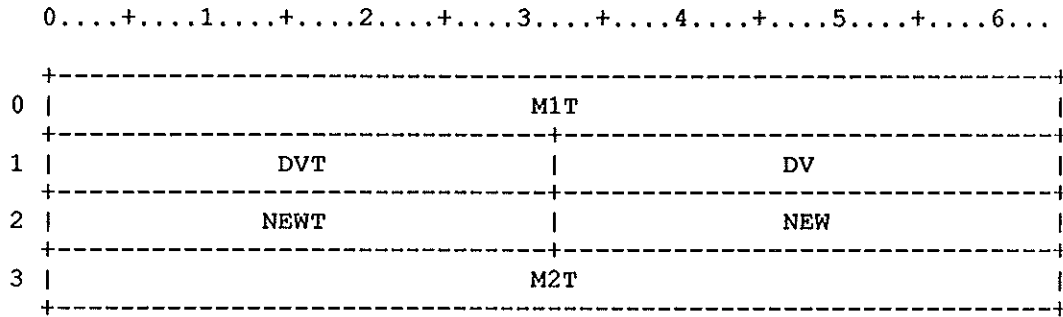

Figure TS-1. TQM trace sub-buffer header

Field	Word(base8)	Bits	Description
TSM1T	0	0-63	ASCII tag '<<<<>>>>'
TSDVT	1	0-31	ASCII tag 'DEV='
TSDV	1	32-63	Device ordinal
TSNEWT	2	0-31	ASCII tag 'NEW='
TSNEW	2	32-63	FWA of most recent snap entry
TSM2T	3	0-63	ASCII tag '-----'
LT@TSB	= 1		Length of sub-buffer trailer

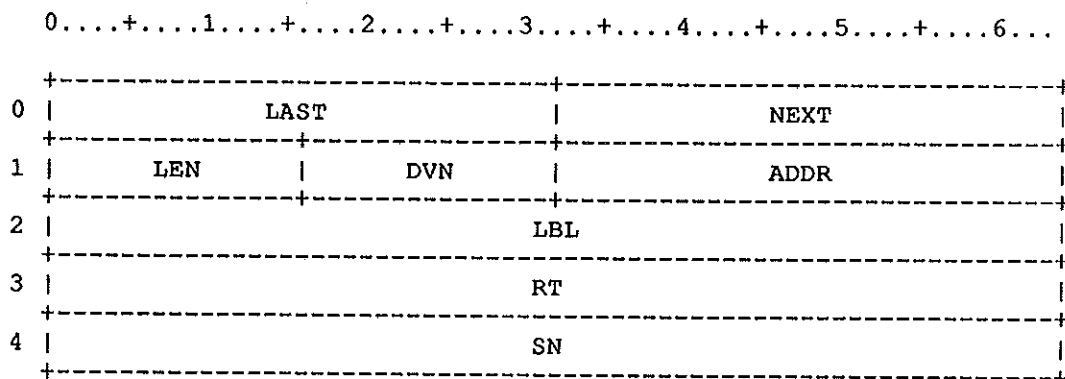

Figure TE-1. TQM snap entry header

Field	Word(base8)	Bits	Description
TELAST	0	0-31	Address of previous entry
TENEXT	0	32-63	Address of next entry
TELEN	1	0-15	Total length of this entry
TEDVN	1	16-31	Device ordinal of TDT addressed by A5
TEADDR	1	32-63	TQM address where TQSNAP called
TELBL	2	0-63	TQM ASCII label name
TERT	3	0-63	Real time of snap
TESN	4	0-63	Snap number
LT@TSE	= 1		Length of entry trailer

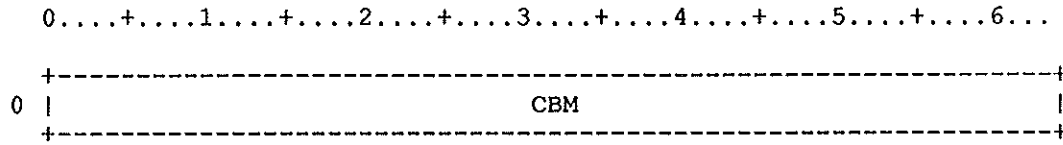

Figure TY-1. TQM snap body

<u>Field</u>	<u>Word(base8)</u>	<u>Bits</u>	<u>Description</u>
TYCBM	0	0-63	Snap component bit map
TYREG	0	0	Registers
TYPKT	0	1	XIOP reply packet
SUBFIELD	2,61		- UNUSED
TYMEM	0	63	Memory

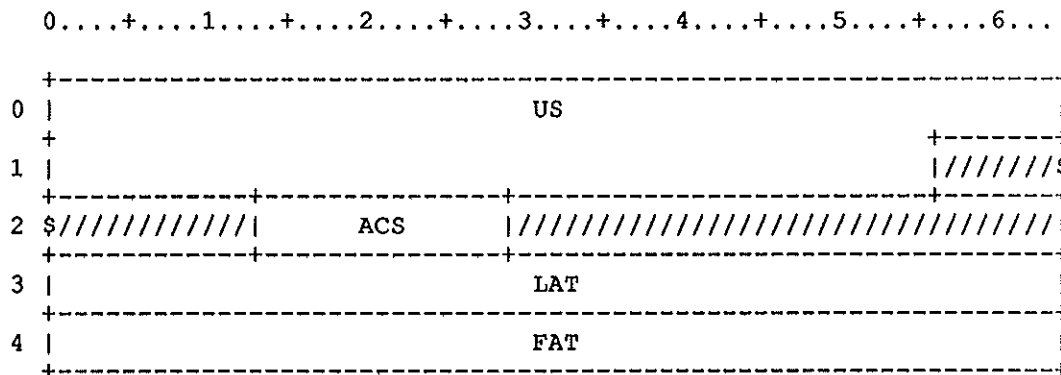

Figure TR-1. Track Permanent Accesses

Entry definition

Field	Word(base8)	Bits	Description
TRUS	0-1	0-63	User Number
TRUS1	0	0-63	User number (1-8)
TRUS2	1	0-55	User number (9-15)
TRACS	2	13-28	Number of accesses (binary)
TRLAT	3	0-63	Time of last access (cycles)
TRFAT	4	0-63	Time of first access (cycles)

TCON\$REQ	=	D'1	T-CONNECT request
TCON\$RES	=	D'2	T-CONNECT response
TDIS\$REQ	=	D'3	T-DISCONNECT request
TDAT\$REQ	=	D'4	T-DATA request
TEXD\$REQ	=	D'5	T-EXPEDITED-DATA request
TSTA\$REQ	=	D'6	T-STATISTICS request
TCON\$IND	=	D'1	T-CONNECT indication
TCON\$CNF	=	D'2	T-CONNECT confirm
TDIS\$IND	=	D'3	T-DISCONNECT indication
TDAT\$IND	=	D'4	T-DATA indication
TEXD\$IND	=	D'5	T-EXPEDITED-DATA indication
TSTA\$IND	=	D'6	T-STATISTICS indication
TDR\$NS	=	X'0	No reason specified
TDR\$ACG	=	X'1	Congestion at TSAP
TDR\$SNA	=	X'2	Session entity not attached
TDR\$AU	=	X'3	Address unknown
TDR\$ND	=	X'80	Normal release by session entity
TDR\$RTC	=	X'81	Remote congestion at connect time
TDR\$CNF	=	X'82	Connection negotiation failed
TDR\$DSR	=	X'83	Duplicate SRC-REF
TDR\$MMR	=	X'84	Mismatched references
TDR\$PE	=	X'85	Protocol error
TDR\$RO	=	X'87	Reference overflow
TDR\$NCR	=	X'88	Connect request rejected
TDR\$IILI	=	X'8A	Header or parameter length invalid
TDR\$LMIN	=	X'C0	Minimum local value
TDR\$IR	=	TDR\$LMIN	Invalid request for server/client
TDR\$NR	=	TDR\$IR+1	No route to remote entity
TDR\$NM	=	TDR\$NR+1	Unable to create a MUX
TDR\$ER	=	TDR\$NM+1	ER TPDU received
TDR\$RF	=	TDR\$ER+1	Retransmission limit exceeded
TDR\$USP	=	TDR\$RF+1	Unknown service primitive
TDR\$SPE	=	TDR\$USP+1	Primitive parameter in error
TDR\$SNN	=	TDR\$SPE+1	Expedited data not in use
TDR\$RES	=	TDR\$SNN+1	Unable to create handler
TDR\$INA	=	TDR\$RES+1	Inactivity timer expired
L@TSAP	=	D'5	TSAP block size
L@NWA	=	D'4	Network address block size

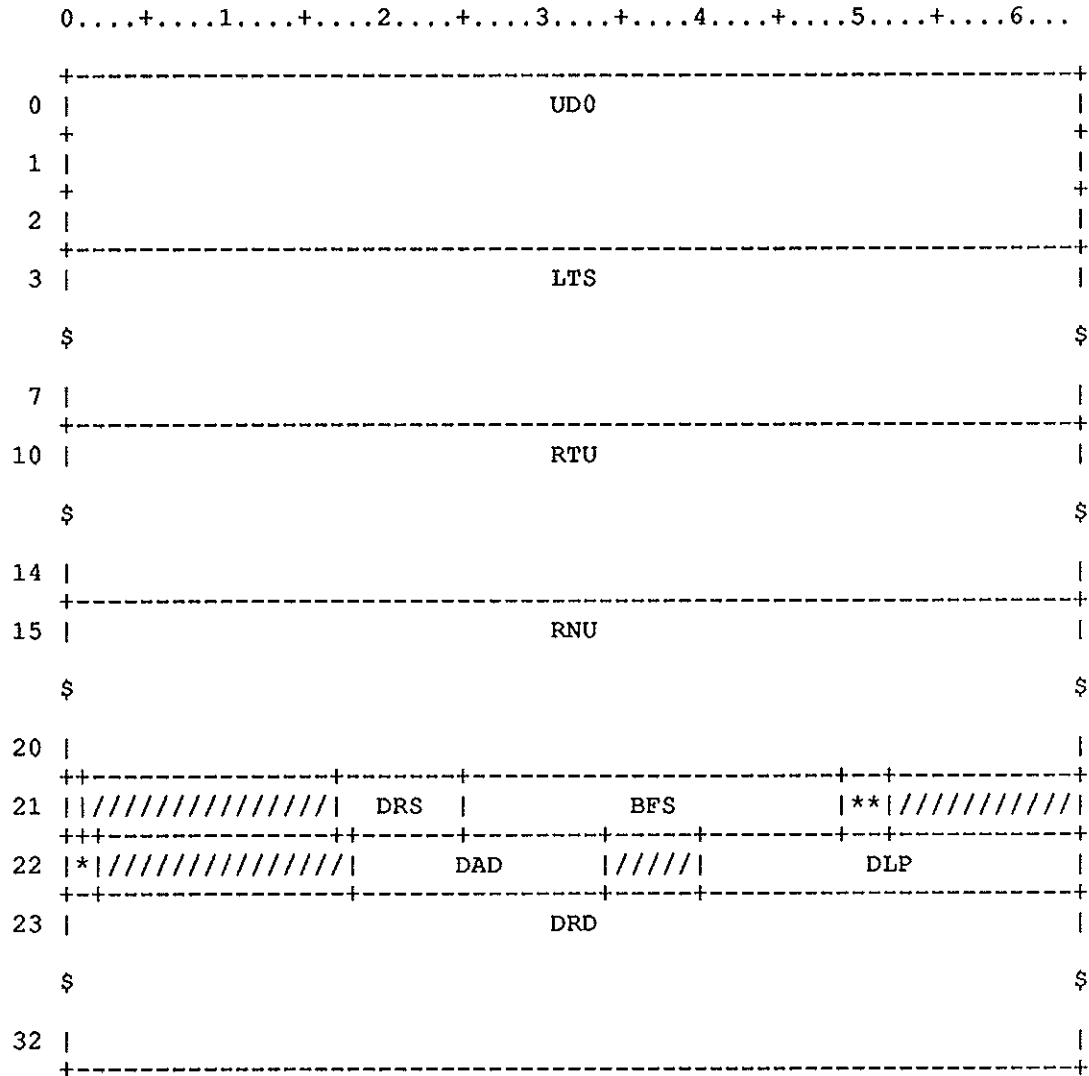

Figure OUP-1. T-USER to TS parameter block

Field	Word(base8)	Bits	Description
OUPUD0	0-2	0-63	Undefined; for use by T-user
OUPUD0	0-2	0-63	(Required by table diagram generator)
OUPLTS	3-7	0-63	Local TSAP-ID including LI
OUPLTS	3-7	0-63	(Required by table diagram generator)
OUPRTU	10-14	0-63	Remote TSAP-ID including LI

<u>Field</u>	<u>Word(base8)</u>	<u>Bits</u>	<u>Description</u>
OUPRTU	10-14	0-63	(Required by table diagram generator)
OUPRNU	15-20	0-63	Remote network address including LI
OUPRNU	15-20	0-63	(Required by table diagram generator)
OUPEDU	21	0	Expedited data option
OUPDRS	21	17-24	Outbound DR data size (bytes)
OUPBFS	21	25-48	TIDU size requested
OUPTPL	21	49-51	Throughput level TP\$DEF=0 Default throughput TP\$LOW=1 Low throughput TP\$HIGH=7 High throughput
OUP TYP	22	0-1	Handler type
OUPDIA	22	0	Diagnostic
OUPNLT	22	1	No local transmit
OUPDAD	22	18-33	Diagnostic NSC adapter address
OUPDLP	22	40-63	Diagnostic LPT ordinal
OUPDRD	23-32	0-63	DR user data
OUPDRD	23-32	0-63	(Required by table diagram generator)

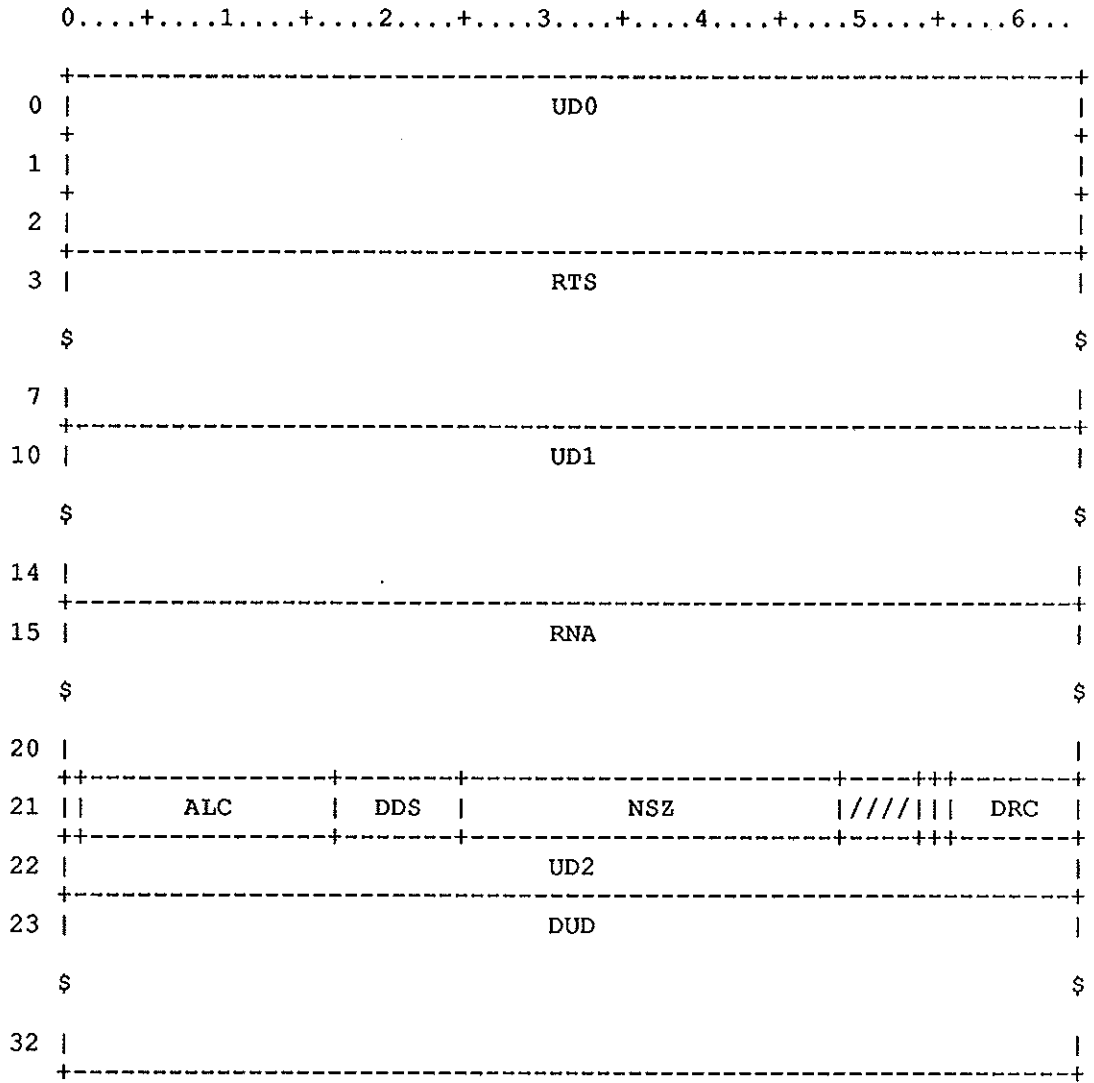

Figure OTP-1. TS to T-USER parameter block

Field	Word(base8)	Bits	Description
OTPUD0	0-2	0-63	Reserved for transport provider
OTPUD0	0-2	0-63	(Required by table diagram generator)
OTPRTS	3-7	0-63	Remote TSAP-ID including LI
OTPRTS	3-7	0-63	(Required by table diagram generator)
OTPUD1	10-14	0-63	Undefined

<u>Field</u>	<u>Word(base8)</u>	<u>Bits</u>	<u>Description</u>
OTPUD1	10-14	0-63	(Required by table diagram generator)
OTPRNA	15-20	0-63	Remote network address including LI
OTPRNA	15-20	0-63	(Required by table diagram generator)
OTPEDO	21	0	Expedited data option
OTPALC	21	1-16	Allocated credit
OTPDDS	21	17-24	Size of user data on disconnect ind
OTPN SZ	21	25-48	Max permitted TIDU size in bytes
OTPLTD	21	54	Disconnect was from local provider
OTPD RP	21	55	Persisent reason for disconnect
OTPD RC	21	56-63	Disconnect reason code
OTPUD2	22	0-63	Undefined
OTPDUD	23-32	0-63	DR user data
OTPDUD	23-32	0-63	(Required by table diagram generator)

The Inter-task Trace Table is STP-resident. Each entry contains trace information for one inter-task message.

```

0....+....1....+....2....+....3....+....4....+....5....+....6...
+-----+
0 |                               NAME                               |
+-----+
1 |                               ET                               |
+-----+
2 |                               RT                               |
+-----+
3 |                               CID                               |
+-----+
4 |                               S1                               |
+-----+
5 |                               S2                               |
+-----+
6 |                               A2                               |
+-----+
$                               $
n |
+-----+
    
```

Figure TT-1. STP Inter-task Trace Table

The follow four words are common to all history trace buffers that FDUMP can recognize and collate with other history traces of the same nature.

Field	Word(base8)	Bits	Description
TTNAME	0	0-63	ASCII name associated with the trace e
TTET	1	0-63	Elapsed Real-time clock since last ent
TTRT	2	0-63	Current real-time clock
TTCID	3	0-63	Current STP task ID

The following words are specific to the Inter-Task Communicatio history Trace buffer. The information contained here is reflec an actual inter-task communication of some sorts, such as a request or a reply.

TTS1	4	0-63	Current value of S1 (input+0/output+0)
TTS2	5	0-63	Current value of S2 (input+1/output+1)
TTA2	6-n	0-63	Current value of A2 (TID requested/req

Due to a software problem, page 848 was not used.
No information is missing.

TAPE VOLUME TABLE

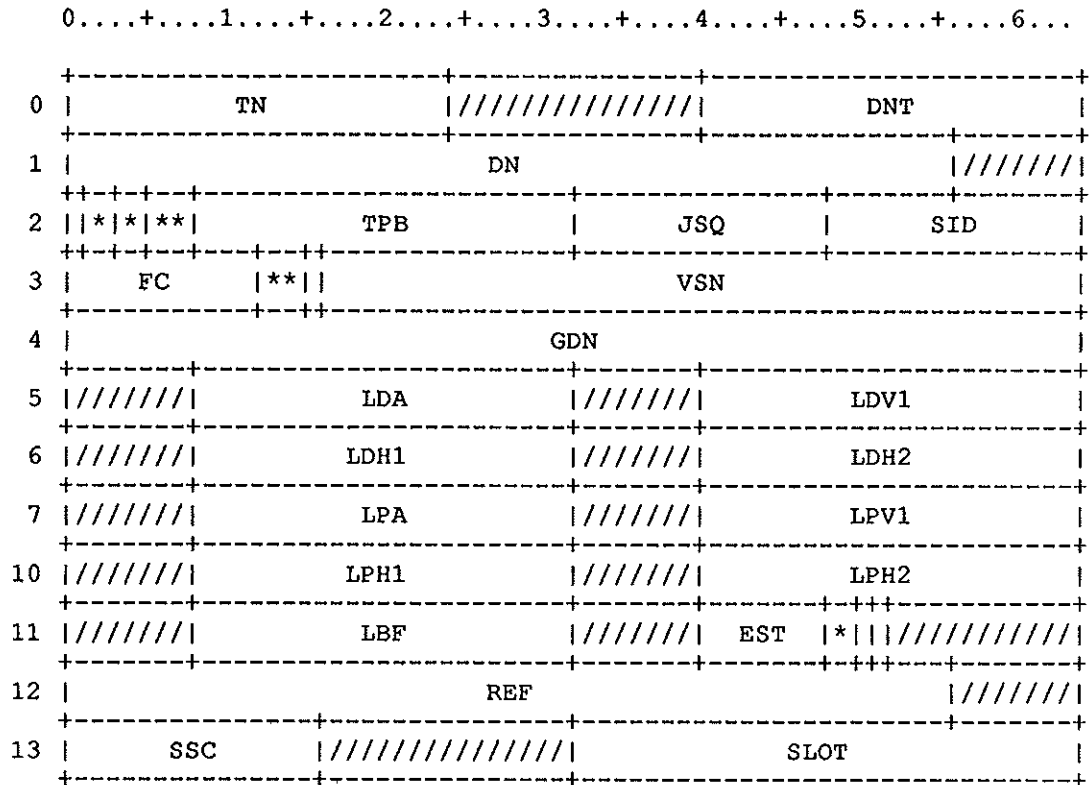

Figure TV-1. Tape Volume Table

Field	Word(base8)	Bits	Description
TVTN	0	0-23	TVT name
TVDNT	0	40-63	DNT address
TVDN	1	0-55	DATASET NAME
TVUQ	2	0	Unique access
TVTPD	2	1-2	Tape density
TVTPF	2	3-4	Tape format
TVTPL	2	5-7	Tape label type
TVTPB	2	8-31	Tape max block size in bytes
TVJSQ	2	32-47	Job sequence number

<u>Field</u>	<u>Word(base8)</u>	<u>Bits</u>	<u>Description</u>
TVSID	2	48-63	Source ID, 2 characters
TVFC	3	0-11	Function code
TVIDC	3	12-14	Initial disposition code
TVMDA	3	15	Multi file access
TVVSN	3	16-63	VSN
TVGDN	4	0-63	Generic device name
TVLDA	5	8-31	LDT address in memory pool
TVLDV1	5	40-63	LDT VOL1 entry
TVLDH1	6	8-31	LDT HDR1 entry
TVLDH2	6	40-63	LDT HDR2 entry
TVLPA	7	8-31	LDT HDR1 entry
TVLPV1	7	40-63	LDT HDR2 entry
TVLPH1	10	8-31	LDT HDR1 entry
TVLPH2	10	40-63	LDT HDR2 entry
TVLBF	11	8-31	LDT HDR1 entry
TVEST	11	40-47	Dataset in sfe catalog flag
TVCS	11	48-49	Character set
TVTRV	11	50	Retain volume flag
TVawe	11	51	Abort on write error flag
TVREF	12	0-55	Referback dataset name
TVSSC	13	0-15	Length of station slot
TVSLOT	13	32-63	Address of station slot copy

* TXT Task execution table

The task execution table (TXT) contains information needed to schedule physical CPUs to user tasks.

A TXT entry exists for every task known to the system, without regard for the rolled/in memory status of the initiating job. The TXT is consulted when performing CPU scheduling, and is used in generating the task status display for stations.

TXT ordinals, offsets, and addresses are used to uniquely identify the requestor of system services.

0....+....1....+....2....+....3....+....4....+....5....+....6...

0	JN	
1	STAT	
2	ORD	
3	EPC	
4	TN	
5	AST	
6	AST1	
7	TCBF	
10	TCB	
11	LINK	
12	PXT	
13	Q1	
14	Q2	
15	BAND	
16	RQ0	
17	RQ1	

Figure TX-1. Task Execution Table

	0	1	2	3	4	5	6
20	RQ2						
21	TSX						
22	CRTC						
23	TS						
24	LSC						
25	LISC						
26	TSW						
27	TSD						
30	EXP	////////////////////////////////////					
31	**	DCLN	////////////////////////////////////				
32	JTA						
33	JXT						
34	**	CLUN	////////////////////////////////////			XPA	
35	TQM1						
36	TQM2						
\$							\$
n							

Figure TX-1. Task Execution Table

<u>Field</u>	<u>Word(base8)</u>	<u>Bits</u>	<u>Description</u>
TXJN	0	0-55	Job name initiating task
TXSTAT	1	0-21	Task status
TXINIT	1	23	Task is initiating flag
TXORD	2	0-63	Ordinal of this TXT entry
<p>EXP abort communication word. If non-zero, then EXP is to initiate a job step abort sequence. The abort code assigned is the value contained within this word. If zero then JSH can continue with the abort process by clearing T%A.</p>			
TXEPC	3	0-63	EXP abort communication word.
TXTN	4	0-63	Task number
TXAST	5	0-63	Ascii status (2 words)
TXAST1	6	0-63	
TXTCBF	7	0-63	TCB offset from JTA(0)
TXTCB	10	0-63	TCB address (STP-relative)
TXLINK	11	0-63	Address of next TXT entry for job
TXPXT	12	0-63	PXT entry address if task connected
TXQ1	13	0-63	First task queue word
TXQ1F	13	1-7	Task is in a Q1 queue
TXQCP	13	1	Task is in CPU queue
TXQSP	13	2	Task is in suspend queue (in memory)
TXQMS	13	3	Task is in multi-step queue
TXQRE	13	5	Task is in CPU queue reenter queue
TXQDL	13	6	Task is in deadlock queue (DLKQ)
TXBL1	13	8-19	Queue back link as TXT ordinal
TXFL1	13	20-31	Queue fore link as TXT ordinal
TXPR1	13	32-63	Execute address in Q1 word
TXQ2	14	0-63	Second task queue word
TXQ2F	14	1-7	Task is in a Q2 queue
TXQAB	14	1	Task is in abort queue
TXQTE	14	2	Task is in timer/event queue
TXBL2	14	8-19	Q2 back link as TXT ordinal
TXFL2	14	20-31	Q2 fore link as TXT ordinal
TXPR2	14	32-63	Execute address in Q2 word
TXBAND	15	0-63	Task's CPU and I/O bands
TXIBSV	15	0-15	Task's I/O band save area
TXCBSV	15	16-31	Task's CPU band save area
TXIOB	15	32-47	Task's I/O band priority
TXCPUB	15	48-63	Task's CPU band priority

<u>Field</u>	<u>Word(base8)</u>	<u>Bits</u>	<u>Description</u>
TXRQ0	16	0-63	Request words used by EXP/CIO for
TXRQ1	17	0-63	JSH requests which need call block
TXRQ2	20	0-63	
TXTSX	21	0-63	CPU cycles executing in CPU
TXCRTC	22	0-63	RT at task creation
TXTS	23	0-63	Time slice
TXLSC	24	0-63	RT at last status change
TXLISC	25	0-63	RT at last I/O status change
TXTSW	26	0-63	CPU cycles waiting for CPU
TXTSD	27	0-63	CPU cycles spent I/O blocked

TXEXP is modified only by EXEC. The size and order of TXEFLG must be the same as the subfield UXEFLG defined in common deck COMUX.

TXEXP	30	0-3	Goto EXP before user gets connected
TXERDY	30	0	EXP readied before user connect
TXEFLG	30	1-3	Exchange flags
TXEPN	30	1	Normal exchange
TXEPE	30	2	Error exchange
TXEPDL	30	3	Deadlock exchange
TXDCP	31	0	=1 if specific CPU requested
TXDCPN	31	1-3	Requested CPU number
TXDCL	31	4	=1 if specific XMP cluster requested
TXDCLN	31	5-9	Requested cluster number
TXSYS	31	10	=1 if system task; 0 if user task
TXJTA	32	0-63	JTA address (STP relative)
TXJXT	33	0-63	JXT address (STP relative)

the following word is write only by EXEC between RCP/DCP requests:

TXRCP	34	0	Set if task is connected to CPU
TXCPUN	34	1-3	Physical CPU number assigned to
TXCLUN	34	4-9	Physical cluster number assigned
TXXP	34	52-63	Exchange package address in EXEC

<u>Field</u>	<u>Word(base8)</u>	<u>Bits</u>	<u>Description</u>
TXTQM1	35	0-63	EXP storage for TQM reply
TXTQM2	36-n	0-63	
TXDSIO	37	0-63	Addr of DNT task is suspended I/O on
TXSCP	40	0-63	Word that SCP can modify w/o STPLK
TXIAI	40	0	Suspended for interactive input
TXIAO	40	1	Suspended for interactive output
TXDTR	40	4	Suspended for active fetch/acquire
TXISDT	40	40-63	SDT address of pending fetch/acquire

General purpose word. Users of this word should STPLK prior to changing its contents.

TXDNR	43	0	Task suspended on device-not-ready
-------	----	---	------------------------------------

The TXT contains the code or data of the program to be loaded.

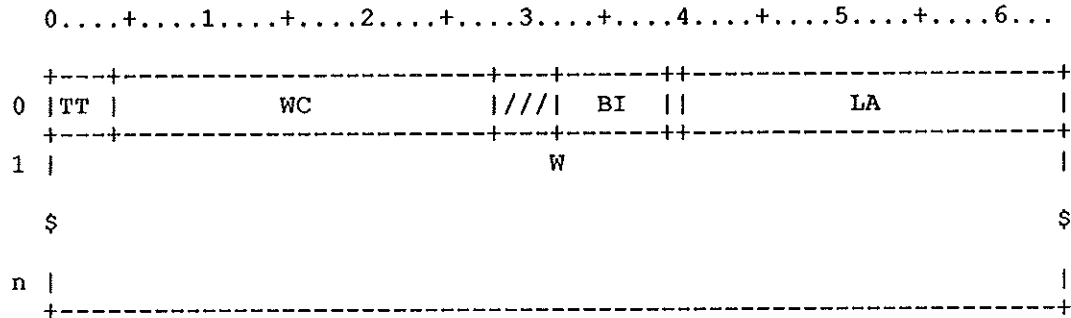

Figure TXT-1. Loader Text Table

Field	Word(base8)	Bits	Description
TXTTT	0	0-3	Table type; 16.
TXTWC	0	4-27	Table word count
TXTBI	0	32-38	Block index; specifies the block into which the text will be loaded.
TXTQ	0	39	Relocation mode of the entry name; this field is always 0.
TXTLA	0	40-63	Relative load address in block BI. LA is always specified as a word address.
TXTW	1-n	0-63	Text words to be loaded into the program field in contiguous locations starting at an address determined by adding LA to the base address indicated for block BI

TXTTYPE=O'16 Table type for TXT

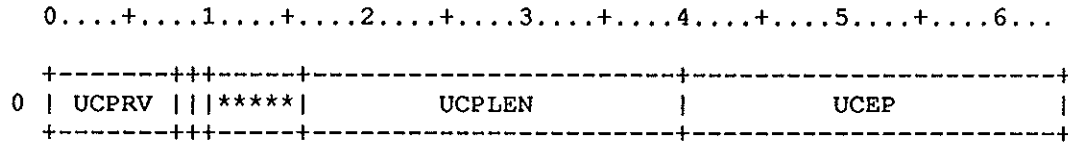

Figure ER-1. EXP User Call Table

<u>Field</u>	<u>Word(base8)</u>	<u>Bits</u>	<u>Description</u>
UCPRV	0	0-7	Index of job privilege (if privileged)
UCPDD	0	8	Flag for PDD as param
UCCSP	0	9	Flag for CSP special privilege
UCXXXX	0	10-15	**** UNUSED ****
UCPLEN	0	16-39	Length of param table
UCEP	0	40-63	EXP Entry point addr

The Unicos Channel Table describes the structure of the mainframe channel table used by the UNICOS operating system. COS EXEC uses these definitions when UNICOS is running as a guest operating system.

N O D E F I N I T I O N A V A I L A B L E

Figure UCH-1. Unicos Channel Table

UCHOPN	0	0	Channel open flag
UCHMAJ	0	1-31	Major device number NODEV=O'1777777777 REAL=O'12 PSEUDO=O'13
UCHRCN	0	32-63	Real channel number
UCHUPP	1	0-63	Connected user process pointer
UCHCA	2	0-63	Mainframe channel address
UCHCL	3	0-63	Mainframe channel limit
UCHCI	4	0-63	Mainframe channel interrupt
UCHCE	5	0-63	Mainframe channel error
UCHECT	6	0-63	Mainframe channel error count
UCHICT	7	0-63	Mainframe channel interrupt count
UCHACT	10	0-63	Mainframe channel active count
UCHSSD	11	0-63	SSD memory address
UCHRTC	12	0-63	Mainframe channel initial time
UCHIH	13	0-63	Channel interrupt handler
UCIOPC	14	0-63	IOP channel number

The User Driver Table is used by the User Channel driver interface routines to control activities on user channels. It has one entry for each user channel, two entries for a channel pair.

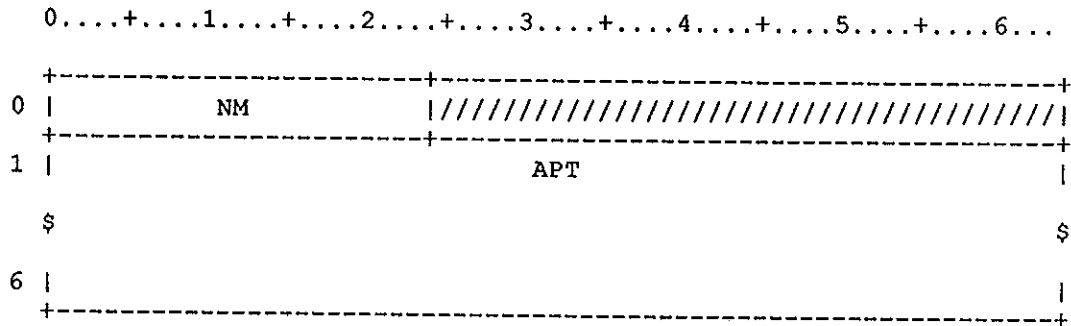

Figure UD-1. User Driver Table Header

Header:

<u>Field</u>	<u>Word(base8)</u>	<u>Bits</u>	<u>Description</u>
UDNM	0	0-23	Table name -- ASCII 'UDT'
UDAPT	1-6	0-63	F-packet reply buffer
UDAPT	1-6	0-63	(Required by table manual generator)

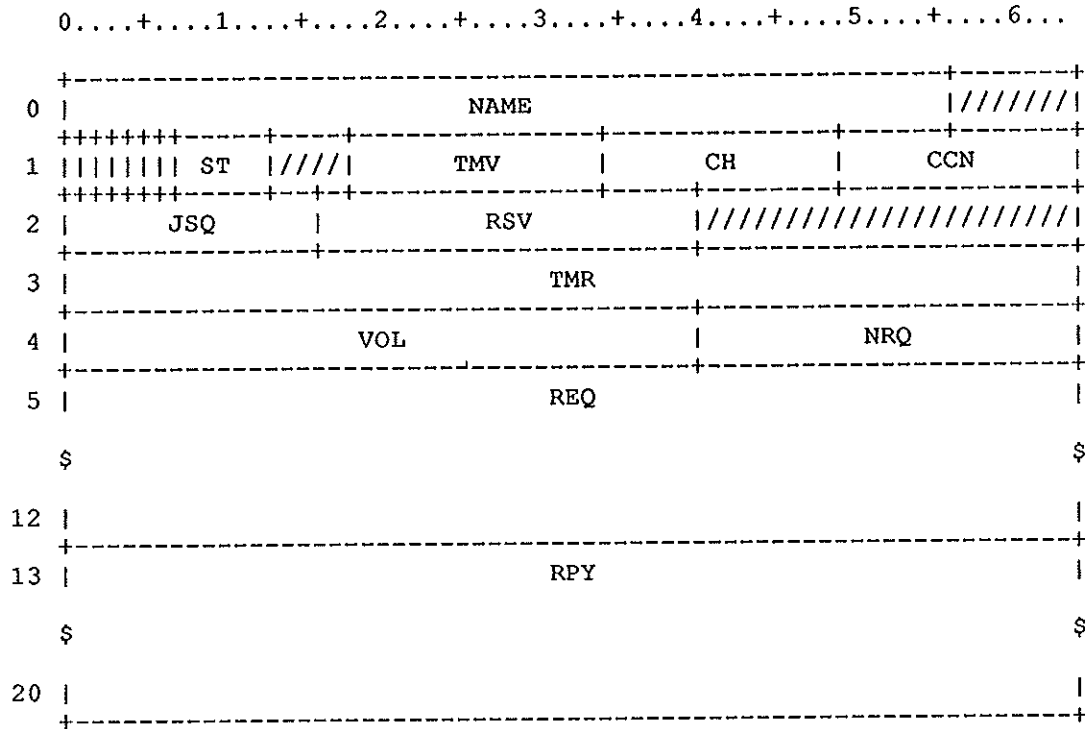

Figure UD-2. User Driver Table Entry

Field	Word(base8)	Bits	Description
UDNAME	0	0-55	Logical channel name
UDON	1	0	Channel turned on
UDRQA	1	1	Request active on channel
UDRPW	1	2	Reply waiting on channel
UDLL	1	4	Local loopback channel
UDLLR2	1	5	Loop to 2nd part of request
UDST	1	7-12	Channel state: UDST\$CLS=0 Closed UDST\$OPG=1 Opening UDST\$OPN=2 Open UDST\$IO=3 I/O active UDST\$CLG=5 Closing
UDTMV	1	18-33	Channel timer interval (tenths)
UDCH	1	34-48	Channel specification
UDDIR	1	48	Channel direction
UDCCN	1	49-63	Co-channel number

<u>Field</u>	<u>Word(base8)</u>	<u>Bits</u>	<u>Description</u>
UDJSQ	2	0-15	JSQ of job that owns this entry
UDRSV	2	16-39	Task ID or JXT offset of owner
UDTMR	3	0-63	Channel timer
UDVOL	4	0-39	Cumulative channel volume in words
UDNRQ	4	40-63	Cumulative number of requests
UDREQ	5-12	0-63	Request F-packet buffer
UDREQ	5-12	0-63	(Required by table manual generator)
UDRPY	13-20	0-63	Reply F-packet buffer
UDRPY	13-20	0-63	(Required by table manual generator)
UDEROFF	= 1		Channel is turned off
UDERRSV	= 2		Channel reservation error
UDERBUF	= 3		I/O buffer address is zero
UDERDIR	= 4		Illegal I/O direction
UDERFNC	= 5		Illegal driver function code
UDERCHN	= 6		Illegal or nonexistent channel
UDERSEQ	= 7		Driver operation out of sequence
UDERBSY	= D'8		Request queue full

UT000	=	D'0	Bad call to UTLIB error processor
UT001	=	D'1	Illegal character in decimal convert
UT002	=	D'2	Illegal character in octal convert
UT003	=	D'3	EXIT called by XXXXXXXX
UT004	=	D'4	PDUMP: abort after completion
UT005	=	D'5	PDUMP: LWA < FWA, dump ignored
UT006	=	D'6	PDUMP: F < 0 or > 7
UT007	=	D'7	PDUMP: incorrect number of arguments
UT008	=	D'8	User remark
UT009	=	D'9	User remark
UT010	=	D'10	STOP XXXXXXXX in YYYYYYYY
UT011	=	D'11	PAUSE not supported, STOP substituted
UT012	=	D'12	PAUSE XXXXXXXX in YYYYYYYY
UT013	=	D'13	Fatal stack overflow
UT014	=	D'14	No space available for stack creation
UT015	=	D'15	EVREL called with task wait for event
UT016	=	D'16	LOCKREL called with lock set
UT017	=	D'17	Invalid lock identifier or non-empty
UT018	=	D'18	Invalid heap block length
UT019	=	D'19	Heap is full
UT020	=	D'20	Address is not within the heap
UT021	=	D'21	Heap block is free
UT022	=	D'22	Bad control word for allocated block
UT023	=	D'23	Bad control word in following block
UT024	=	D'24	Deadlock - all tasks waiting
UT025	=	D'25	Unrecognized scheduler parameter name
UT026	=	D'26	Invalid input to conversion routine
UT027	=	D'27	Module requires more than 8MW of stack
UT028	=	D'28	Increment for stack exceeds 8MW
UT029	=	D'29	Initial size for stack exceeds 8MW
UT030	=	D'30	Flowtrace: name limit exceeded
UT031	=	D'31	Flowtrace: active routine limit exceed
UT032	=	D'32	MAXCALLR parameter value invalid
UT033	=	D'33	Flowtrace: bad status from TRBKLVL
UT034	=	D'34	Incorrect # of args to VAX conversion
UT035	=	D'35	BUFUSER: action code < D'64
UT036	=	D'36	BUFTUNE: action code < D'64
UT037	=	D'37	BUFTUNE: illegal keyword
UT038	=	D'38	Maximum calling tree depth exceeded
UT039	=	D'39	Issued directly by ARGPLIMQ
UT040	=	D'40	Issued directly by FLOWLIM

UT041	=	D'41	Response to PAUSE was ABORT
UT042	=	D'42	EOF encountered - Program aborted
UT043	=	D'43	Invalid response - reply RESUME/ABORT
UT044	=	D'44	Issued directly by FLOWSTOP
UT045	=	D'45	FLOWTRACE postprocessing stack overflo
UT046	=	D'46	FLOWEXIT called out of sequence
UT047	=	D'47	P6460 ISB PARAMETER INVALID
UT048	=	D'48	P6460 OVERLAPPING ARRAYS INVALID
UT049	=	D'49	INVALID PARAMETERS PASSED TO TR
UT050	=	D'50	MULTIPLE CALLS TO FLOWSTOP ARE ILLEGAL
UT051	=	D'51	HEAP ROUTINE CALLED WITH HEAP DESTROYE

*CALL COMUP at this ident + 1

COPYRIGHT BY CRAY RESEARCH, INC. *

UNPUBLISHED - ALL RIGHTS RESERVED UNDER THE COPYRIGHT LAWS *
OF THE UNITED STATES. *

The User Security Privilege Table, which resides in the user field, contains user privileges, user number, and the number of remaining violations allowed. This information is put into the user JTA at account time and transferred back to the user area when CHARGES is executed.

0....+....1....+....2....+....3....+....4....+....5....+....6...

0		SC0	
1		SC1	
2		SC2	
3		SC3	
4		USR	
5		USR2	
6		VIO	

Figure UP-1. User Security Priviledge Table

<u>Field</u>	<u>Word(base8)</u>	<u>Bits</u>	<u>Description</u>
UPSC0	0	0-63	Security privileges word 0
UPSC1	1	0-63	Security privileges word 1
UPSC2	2	0-63	Security privileges word 2
UPSC3	3	0-63	Security privileges word 3
UPUSR	4	0-63	User number (characters 1-8)
UPUSR2	5	0-63	User number (characters 9-15)
UPVIO	6	0-63	User violations

User task status block

The user task status block resides in the user field and provides a mechanism for keeping the run-time library aware of the various aspects of CPU accounting data for the associated software process.

Various UTSB fields are dynamically updated by EXEC as the logical CPU becomes associated with a physical CPU.

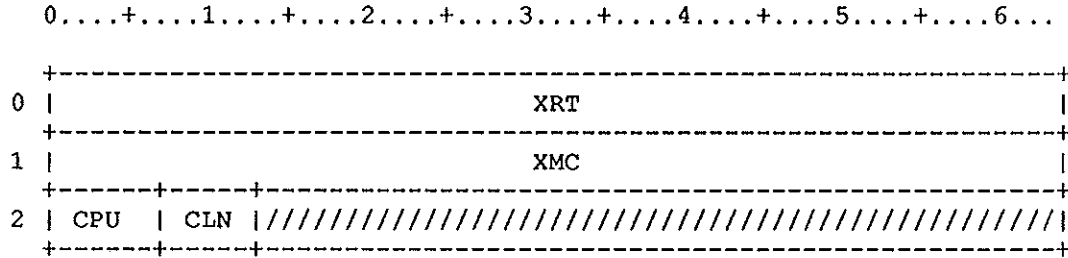

Figure UT-1. User task status block

<u>Field</u>	<u>Word(base8)</u>	<u>Bits</u>	<u>Description</u>
UTXRT	0	0-63	RT at last exchange to task
UTXMC	1	0-63	Time used as of last exchange (cycles)
UTCPU	2	0-6	Number of assigned CPU
UTCLN	2	7-12	Number of assigned X-MP cluster

The VPT is part of the Integrated Support Processor system. In the ISP system, COS tasks communicate with applications in the ISP over Virtual Circuits, which are software paths multiplexed by IQM over the physical channels. Each circuit requires a Virtual Circuit Table (VCT) to manage it. The VCT is dynamically allocated in a memory pool when the circuit is created. The VPT is fixed in STPTAB, and contains a list of the active VCTs. The IVLCN (Local Connection Number) field in the VCT contains the ordinal of the VPT entry that points to it.

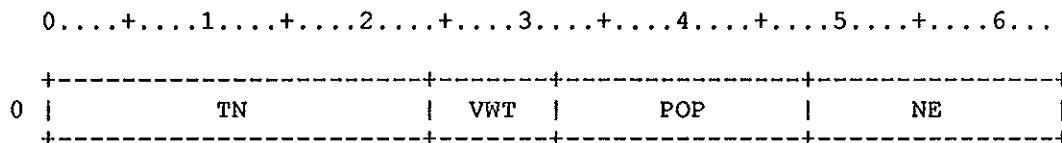

Figure VP-1. ISP Virtual Circuit Pointer Table Header

<u>Field</u>	<u>Word(base8)</u>	<u>Bits</u>	<u>Description</u>
VPTN	0	0-23	Table name (ASCII 'VPT')
VPVWT	0	24-31	Waiting for VCT assignment: IEV\$VB=1 VCT space available IEV\$VC=2 Free circuit available
VPPOP	0	32-47	Number of entries in use
VPNE	0	48-63	Number of entries in the table

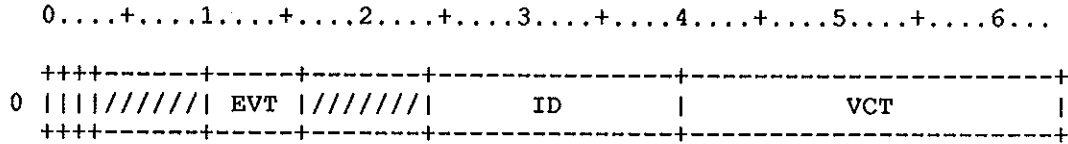

Figure VP-2. ISP Virtual Circuit Pointer Table Entry

Field	Word(base8)	Bits	Description
VPASG	0	0	Entry assigned to a user
VPOFR	0	1	OFFER request outstanding
VPLFC	0	2	Local flow-control bit
VPEVT	0	10-15	Waiting for event:
VPID	0	24-39	Identification of owner: JSQ if owned by job, MFID otherwise.
			IEV\$CON=3 CONNECT message IEV\$CNF=4 CONFIRM message IEV\$MSG=5 MSG message IEV\$LFC=6 Local flow control IEV\$RFC=7 Remote flow control
VPVCT	0	40-63	VCT address
L@VPT	= LH@VPT+LE@VPT*NE@VPT		Length of VPT table in words

DXT Allocation Table

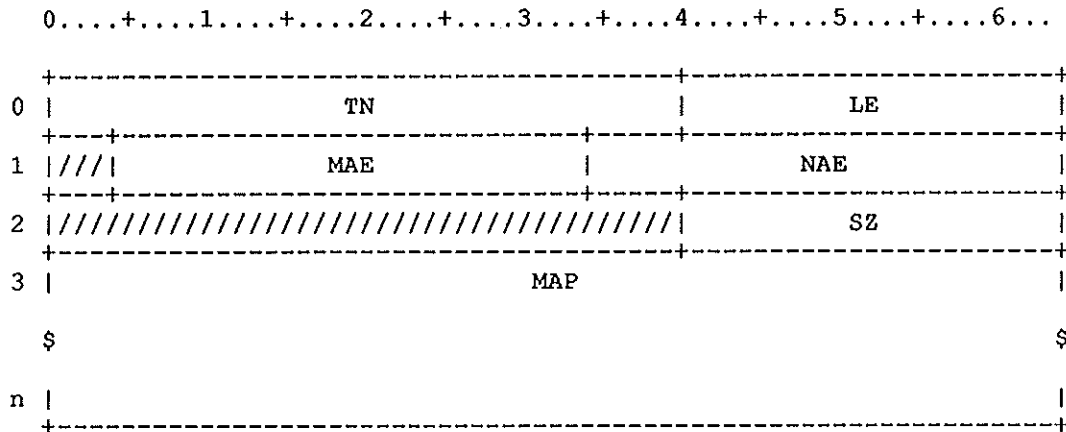

Figure XAT-1. DSC Extension high memory allocation table
XAT table header definition

Field	Word(base8)	Bits	Description
XATTN	0	0-39	Table name (*XAT*)
XATLE	0	40-63	Length of XAT bit map in words
XATMAE	1	4-33	Maximum allocatable DXT entries.
XATNAE	1	34-63	Number of available DXT entries.
XATSZ	2	40-63	Size of XAT table (header + map).

XAT table map definition

XATMAP	3-n	0-63	Map words - one bit per DXT entry.
--------	-----	------	------------------------------------

The History Trace Function Table contains one entry for each possible history trace function, plus a global-enable entry. It is used to manage the History Trace Table (XTT).

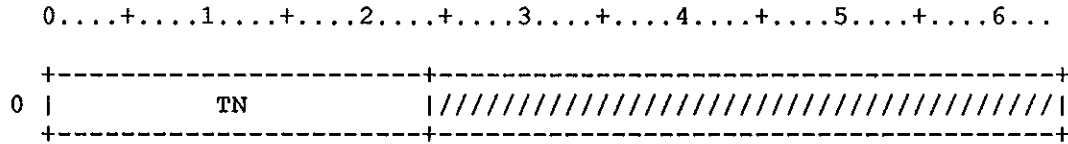

Figure XF-1. History Trace Function Table header

Field	Word(base8)	Bits	Description
XFTN	0	0-23	Table name ('XFT' in ASCII)

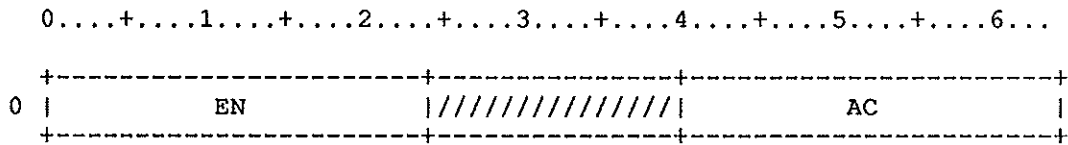

Figure XF-2. History Trace Function Table entry

Field	Word(base8)	Bits	Description
XFEN	0	0-23	Entry name (3 ASCII characters)
XFAC	0	40-63	Active entry (active if nonzero)

Define exchange package for each mainframe type.

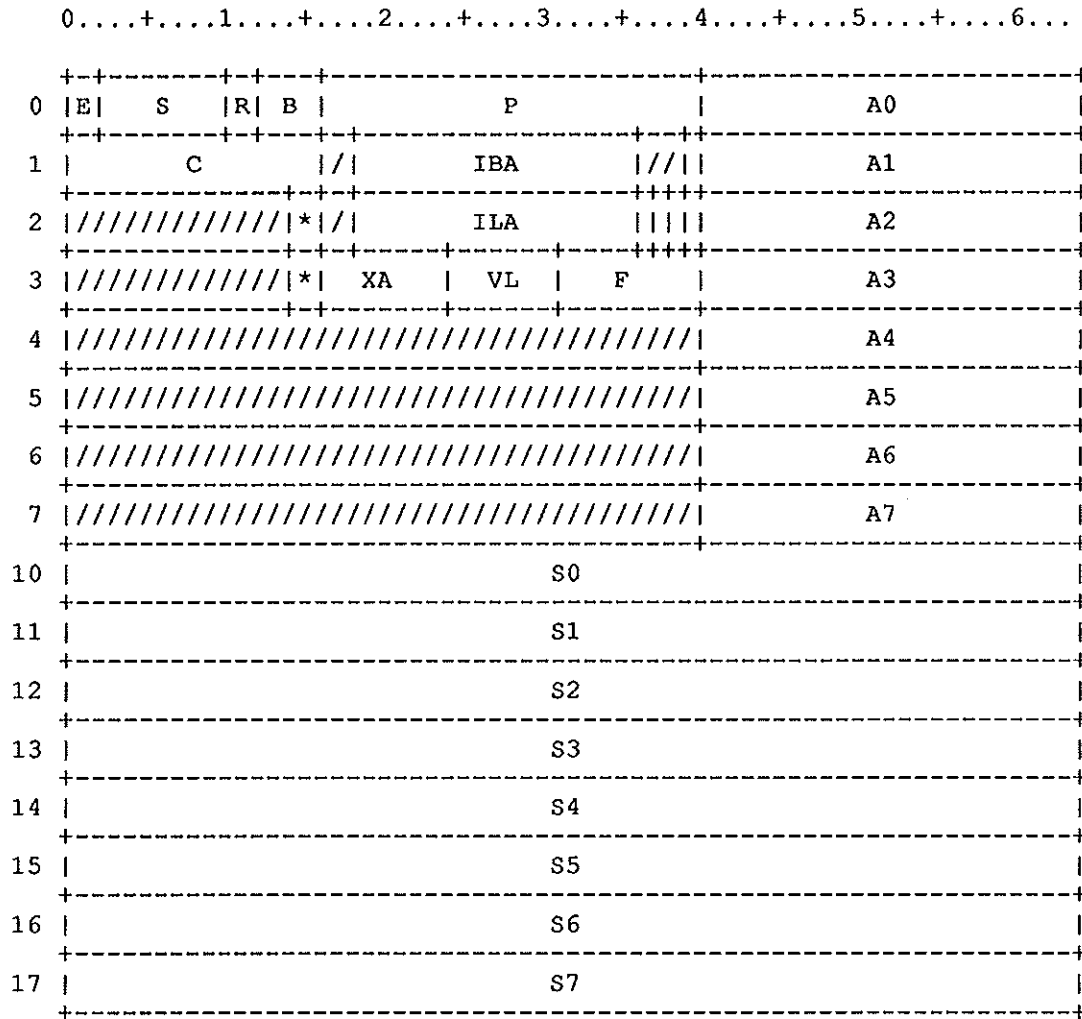

Figure XP-1. CRAY-1 (1A, 1B, 1S and 1M)

Field	Word(base8)	Bits	Description
XPE	0	0-1	Error type
XPS	0	2-9	Syndrome bits
XPR	0	10-11	Read mode
XPB	0	12-15	Memory error bank address
XPP	0	16-39	Program register

<u>Field</u>	<u>Word(base8)</u>	<u>Bits</u>	<u>Description</u>
XPA0	0	40-63	Register A0
XPC	1	0-15	Memory error read address (partial)
XPIBA	1	18-35	Instruction base address
XPIMM	1	39	Interrupt monitor-mode bit
XPA1	1	40-63	Register A1
XPRH	2	14-15	High-order bits of memory error read address (1S or 1M only)
XPILA	2	18-35	Instruction limit address
XPICM	2	36	Interrupt on correctable memory error
XPIFP	2	37	Interrupt on floating point error
XPIUM	2	38	Interrupt on uncorrectable mem. error
XPMM	2	39	Monitor mode
XPA2	2	40-63	Register A2
XPNF	3	14-15	Dummy new flags definition
XPICP	3	14	Dummy interprocessor interrupt
XPDL	3	15	Dummy deadlock interrupt
XPXA	3	16-23	Exchange address
XPVL	3	24-30	Vector length
XPF	3	31-39	Flags
XPCCI	3	31	Programmable clock interrupt
XPMCU	3	32	MCU interrupt
XPFPE	3	33	Floating point error
XPORE	3	34	Operand range error
XPPRE	3	35	Program range error
XPME	3	36	Memory error
XPIOI	3	37	I/O interrupt
XPEE	3	38	Error exit
XPNE	3	39	Normal exit
XPA3	3	40-63	Register A3
XPA4	4	40-63	Register A4
XPA5	5	40-63	Register A5
XPA6	6	40-63	Register A6
XPA7	7	40-63	Register A7

<u>Field</u>	<u>Word(base8)</u>	<u>Bits</u>	<u>Description</u>
XPS0	10	0-63	Register S0
XPS1	11	0-63	Register S1
XPS2	12	0-63	Register S2
XPS3	13	0-63	Register S3
XPS4	14	0-63	Register S4
XPS5	15	0-63	Register S5
XPS6	16	0-63	Register S6
XPS7	17	0-63	Register S7

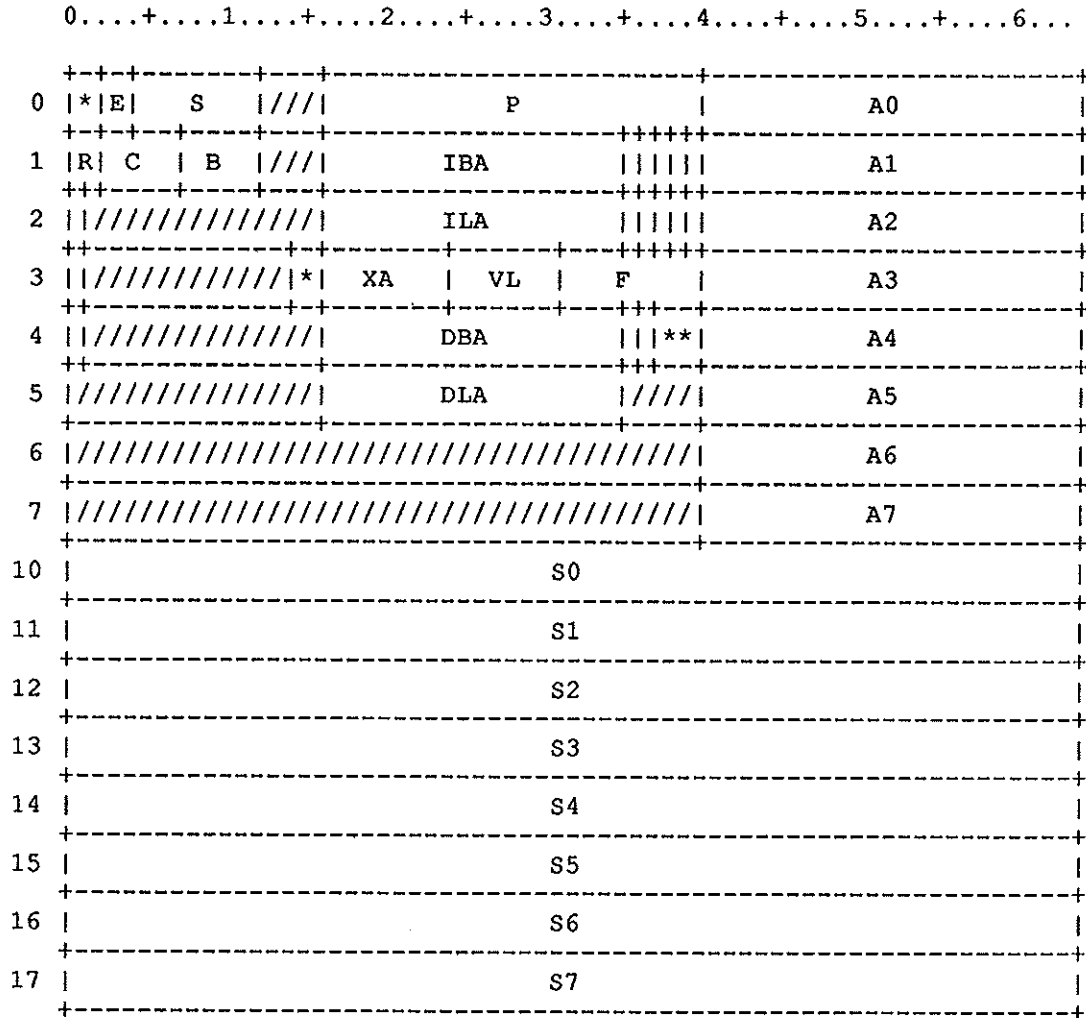

Figure XP-2. CRAY X-MP (X-MP/1 and X-MP/2)

Field	Word(base8)	Bits	Description
XPPN	0	0-1	Processor number
XPE	0	2-3	Error type
XPS	0	4-11	Syndrome bits
XPP	0	16-39	Program register
XPA0	0	40-63	Register A0
XPR	1	0-1	Read mode
XPC	1	2-6	Memory error read address (partial) (Chip select)

<u>Field</u>	<u>Word(base8)</u>	<u>Bits</u>	<u>Description</u>
XPB	1	7-11	Memory error bank address
XPIBA	1	16-34	Instruction base address
XPWS	1	35	Waiting on semaphore flag
XPFPS	1	36	Floating point error status flag
XPBDM	1	37	Bidirectional memory status flag
XPSEI	1	38	Select for external interrupt flag
XPIMM	1	39	Interrupt monitor-mode bit
XPA1	1	40-63	Register A1
XPVNU	2	0	Vector register not used bit
XPILA	2	16-34	Instruction limit address
XPIOR	2	35	Interrupt on operand range error mode
XPICM	2	36	Interrupt on correctable memory error
XPIFP	2	37	Interrupt on floating point error
XPIUM	2	38	Interrupt on uncorrectable mem. error
XPMM	2	39	Monitor mode
XPA2	2	40-63	Register A2
XPAVL	3	0	Additional vector logical unit bit (1 = enabled)
XPNF	3	14-15	New flags
XPICP	3	14	Interprocessor interrupt
XPDL	3	15	Deadlock on semaphore
XPXA	3	16-23	Exchange address
XPVL	3	24-30	Vector length
XPF	3	31-39	Flags
XPPCI	3	31	Programmable clock interrupt
XPMCU	3	32	MCU interrupt
XPFPE	3	33	Floating point error
XPORE	3	34	Operand range error
XPPRE	3	35	Program range error
XPME	3	36	Memory error
XPIOI	3	37	I/O interrupt
XPPEE	3	38	Error exit
XPNE	3	39	Normal exit

<u>Field</u>	<u>Word(base8)</u>	<u>Bits</u>	<u>Description</u>
XPA3	3	40-63	Register A3
XPEMA	4	0	Extended memory addressing bit (1 = enabled)
XPDBA	4	16-34	Data base address
XPPS	4	35	User program state (master/slave) flag
XPCLN	4	37-39	Cluster number
XPA4	4	40-63	Register A4
XPDLA	5	16-34	Data limit address
XPA5	5	40-63	Register A5
XPA6	6	40-63	Register A6
XPA7	7	40-63	Register A7
XPS0	10	0-63	Register S0
XPS1	11	0-63	Register S1
XPS2	12	0-63	Register S2
XPS3	13	0-63	Register S3
XPS4	14	0-63	Register S4
XPS5	15	0-63	Register S5
XPS6	16	0-63	Register S6
XPS7	17	0-63	Register S7

<u>Field</u>	<u>Word(base8)</u>	<u>Bits</u>	<u>Description</u>
XPB	1	6-11	Memory error bank address
XPIBA	1	16-33	Instruction base address
XPWS	1	35	Waiting on semaphore flag
XPFPS	1	36	Floating point error status flag
XPBDM	1	37	Bidirectional memory status flag
XPSEI	1	38	Select for external interrupt flag
XPIMM	1	39	Interrupt monitor-mode bit
XPA1	1	40-63	Register A1
XPVNU	2	0	Vector register not used bit
XPILA	2	16-33	Instruction limit address
XPIOR	2	35	Interrupt on operand range error mode
XPICM	2	36	Interrupt on correctable memory error
XPIFP	2	37	Interrupt on floating point error
XPIUM	2	38	Interrupt on uncorrectable mem. error
XPMM	2	39	Monitor mode
XPA2	2	40-63	Register A2
XPAVL	3	0	Additional vector logical unit bit (1 = enabled)
XPNF	3	14-15	New flags
XPICP	3	14	Interprocessor interrupt
XPDL	3	15	Deadlock on semaphore
XPXA	3	16-23	Exchange address
XPVL	3	24-30	Vector length
XPF	3	31-39	Flags
XPPCI	3	31	Programmable clock interrupt
XPMCU	3	32	MCU interrupt
XPFPPE	3	33	Floating point error
XPPORE	3	34	Operand range error
XPPRE	3	35	Program range error
XPME	3	36	Memory error
XPIOI	3	37	I/O interrupt
XPPE	3	38	Error exit
XPNE	3	39	Normal exit

<u>Field</u>	<u>Word(base8)</u>	<u>Bits</u>	<u>Description</u>
XPA3	3	40-63	Register A3
XPEMA	4	0	Extended memory addressing bit (1 = enabled)
XPDBA	4	16-33	Data base address
XPPS	4	35	User program state (master/slave) flag
XPCLN	4	37-39	Cluster number
XPA4	4	40-63	Register A4
XPDLA	5	16-33	Data limit address
XPA5	5	40-63	Register A5
XPA6	6	40-63	Register A6
XPA7	7	40-63	Register A7
XPS0	10	0-63	Register S0
XPS1	11	0-63	Register S1
XPS2	12	0-63	Register S2
XPS3	13	0-63	Register S3
XPS4	14	0-63	Register S4
XPS5	15	0-63	Register S5
XPS6	16	0-63	Register S6
XPS7	17	0-63	Register S7

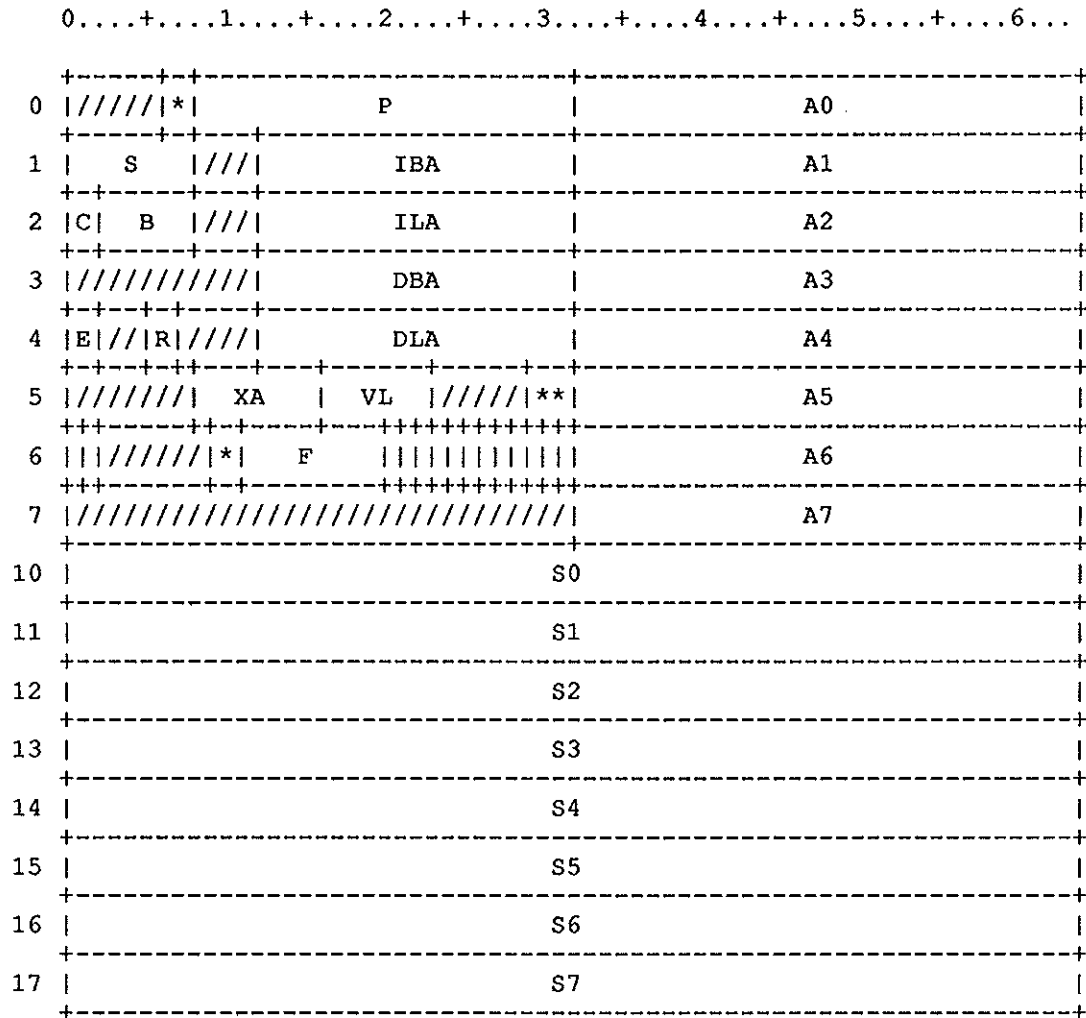

Figure XP-4. CRAY X-MP EA/464 exchange package

Field	Word(base8)	Bits	Description
XPPN	0	6-7	Processor number
XPP	0	8-31	Program register
XPA0	0	32-63	Register A0
XPS	1	0-7	Syndrome bits
XPIBA	1	12-31	Instruction base address
XPA1	1	32-63	Register A1
XPC	2	0-1	Memory error read address (partial) (Chip select)

<u>Field</u>	<u>Word(base8)</u>	<u>Bits</u>	<u>Description</u>
XPB	2	2-7	Memory error bank address
XPILA	2	12-31	Instruction limit address
XPA2	2	32-63	Register A2
XPDBA	3	12-31	Data base address
XPA3	3	32-63	Register A3
XPE	4	0-1	Error type
XPR	4	5-6	Read mode
XPDLA	4	12-31	Data limit address
XPA4	4	32-63	Register A4
XPXA	5	8-15	Exchange address
XPVL	5	16-22	Vector length
XPCLN	5	29-31	Cluster number
XPA5	5	32-63	Register A5
XPVNU	6	0	Vector register not used flag
XPWS	6	1	Waiting on semaphore flag
XPNF	6	9-10	Flags
XPICP	6	9	Interprocessor interrupt
XPDL	6	10	Deadlock interrupt
XPF	6	11-19	Flags
XPPCI	6	11	Programmable clock interrupt
XPMCU	6	12	MCU interrupt
XPFFE	6	13	Floating point error
XPORE	6	14	Operand range error
XPPRE	6	15	Program range error
XPME	6	16	Memory error
XPIOI	6	17	I/O interrupt
XPPEE	6	18	Error exit
XPNE	6	19	Normal exit
XPAVL	6	20	Additional vector logical unit bit
XPPS	6	21	Program state
XPFPS	6	22	Floating point error status flag
XPBDM	6	23	Bidirectional memory status flag
XPIOR	6	24	Interrupt on operand range error

<u>Field</u>	<u>Word(base8)</u>	<u>Bits</u>	<u>Description</u>
XPIFP	6	25	Interrupt on floating point error
XPIUM	6	26	Interrupt on uncorrectable mem. error
XPICM	6	27	Interrupt on correctable memory error
XPYAM	6	28	Y-MP (32 bit) addressing mode
XPSEI	6	29	Select for external interrupt flag
XPIMM	6	30	Interrupt monitor-mode bit
XPMM	6	31	Monitor mode
XPA6	6	32-63	Register A6
XPA7	7	32-63	Register A7
XPS0	10	0-63	Register S0
XPS1	11	0-63	Register S1
XPS2	12	0-63	Register S2
XPS3	13	0-63	Register S3
XPS4	14	0-63	Register S4
XPS5	15	0-63	Register S5
XPS6	16	0-63	Register S6
XPS7	17	0-63	Register S7

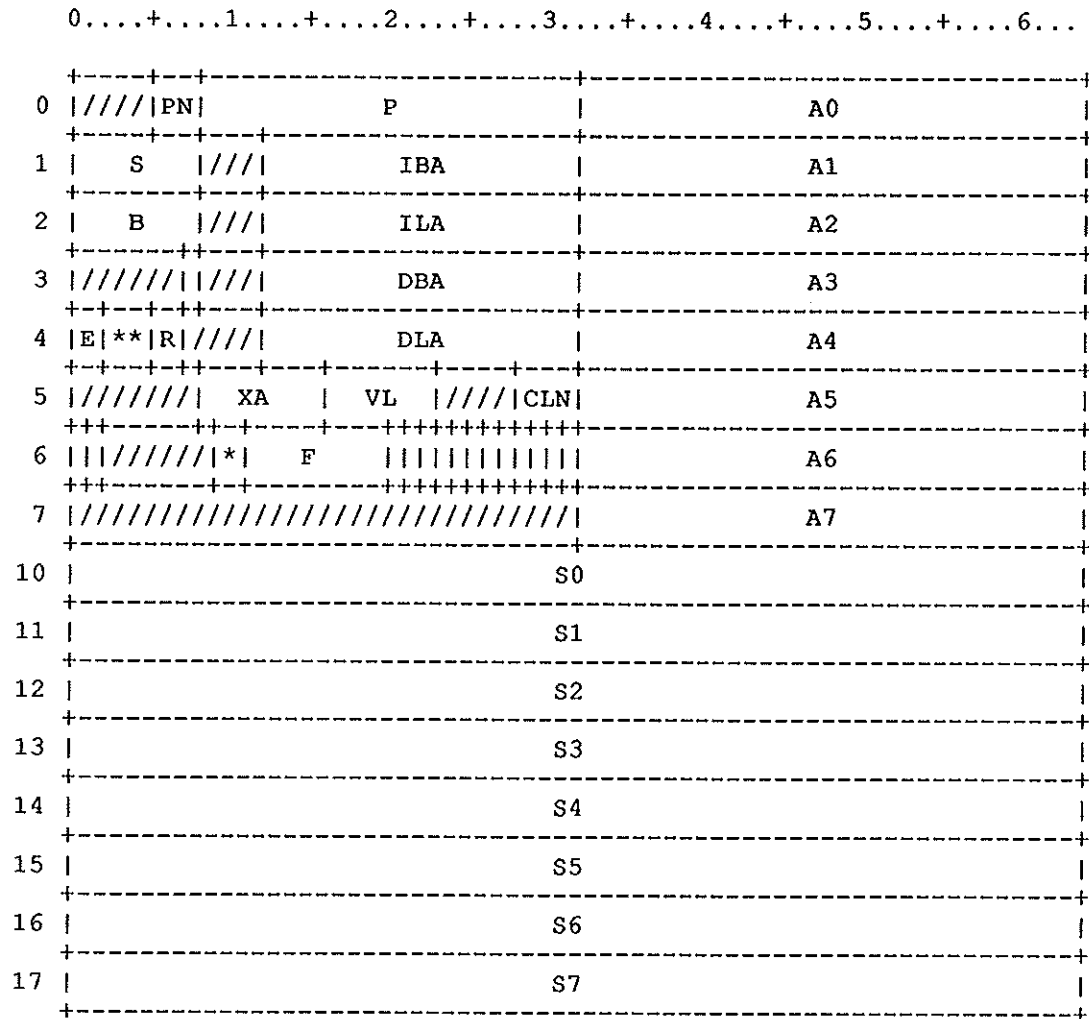

Figure XP-5. CRAY Y-MP exchange package

Field	Word(base8)	Bits	Description
XPPN	0	5-7	Processor number
XPP	0	8-31	Program register
XPA0	0	32-63	Register A0
XPS	1	0-7	Syndrome bits
XPIBA	1	12-31	Instruction base address
XPA1	1	32-63	Register A1
XPB	2	0-7	Memory error bank address
XPILA	2	12-31	Instruction limit address

<u>Field</u>	<u>Word(base8)</u>	<u>Bits</u>	<u>Description</u>
XPA2	2	32-63	Register A2
XPC	3	7	Memory error read address (partial) (Chip select)
XPDBA	3	12-31	Data base address
XPA3	3	32-63	Register A3
XPE	4	0-1	Error type
XPPRT	4	2-4	Port number
XPR	4	5-6	Read mode
XPDLA	4	12-31	Data limit address
XPA4	4	32-63	Register A4
XPXA	5	8-15	Exchange address
XPVL	5	16-22	Vector length
XPCLN	5	28-31	Cluster number
XPA5	5	32-63	Register A5
XPVNU	6	0	Vector register not used flag
XPWS	6	1	Waiting on semaphore flag
XPNF	6	9-10	Flags
XPICP	6	9	Interprocessor interrupt
XPDL	6	10	Deadlock interrupt
XPF	6	11-19	Flags
XPPCI	6	11	Programmable clock interrupt
XPMCU	6	12	MCU interrupt
XPFPE	6	13	Floating point error
XPORE	6	14	Operand range error
XPPRE	6	15	Program range error
XPME	6	16	Memory error
XPIOI	6	17	I/O interrupt
XPEE	6	18	Error exit
XPNE	6	19	Normal exit
XPAVL	6	20	Additional vector logical unit bit
XPPS	6	21	Program state
XPFPS	6	22	Floating point error status flag
XPBDM	6	23	Bidirectional memory status flag

<u>Field</u>	<u>Word(base8)</u>	<u>Bits</u>	<u>Description</u>
XPIOR	6	24	Interrupt on operand range error
XPIFP	6	25	Interrupt on floating point error
XPIUM	6	26	Interrupt on uncorrectable mem. error
XPICM	6	27	Interrupt on correctable memory error
XPYAM	6	28	Y-MP (32 bit) addressing mode
XPSEI	6	29	Select for external interrupt flag
XPIMM	6	30	Interrupt monitor-mode bit
XPMM	6	31	Monitor mode
XPA6	6	32-63	Register A6
XPA7	7	32-63	Register A7
XPS0	10	0-63	Register S0
XPS1	11	0-63	Register S1
XPS2	12	0-63	Register S2
XPS3	13	0-63	Register S3
XPS4	14	0-63	Register S4
XPS5	15	0-63	Register S5
XPS6	16	0-63	Register S6
XPS7	17	0-63	Register S7

The XRT contains information that enables the loader to relocate external references.

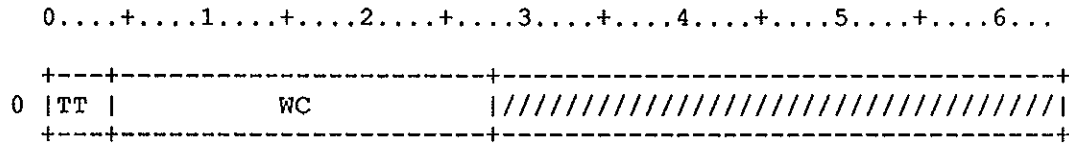

Figure XRT-1. Loader External Relocation Table

<u>Field</u>	<u>Word(base8)</u>	<u>Bits</u>	<u>Description</u>
XRTTT	0	0-3	Table type (0'14)
XRTWC	0	4-27	Word count

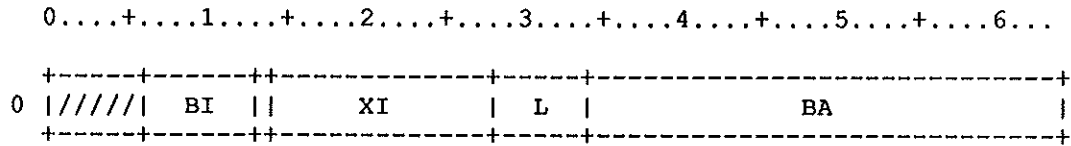

Figure XRT-2. External relocation table entry

Field	Word(base8)	Bits	Description
XRTBI	0	6-12	Block index; defines a block address to be added to a BA in obtaining the field to be relocated (linked).
XRTQ	0	13	Q flag; indicates attribute of the field to be linked. Q is set if the field requires a parcel address. Q is zero if a word address is desired. The loader adjusts the entry values in links where the respective Q flags do not match.
XRTXI	0	14-27	External index. This is an index into the externals list of the PDT. The entry value corresponding to the entry name that matches the named external in the PDT table is used to relocate the field.
XRTL	0	28-33	Length of bits of the relocation field. If L=0, the relocation field is assumed to be 64 bits; otherwise, it is the length specified by L.
XRTBA	0	34-63	Bit address within (BI) of rightmost bit to be modified

XRTTYPE=O'14 TABLE TYPE FOR XRT

Name: History Trace Table (XTT).

Purpose: This table is an EXEC-resident circular buffer that logs system activity. Entries are made by DEBUG subroutine calls in EXEC. (STP can make a monitor request via the POST macro to use DEBUG.)

Note: The header is variable-length so the entries begin on a 4-word boundary.

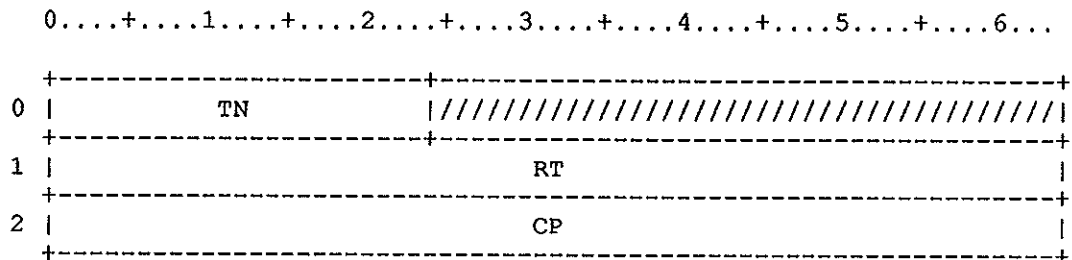

Figure XT-1. History Trace Table Header

Header (may be padded so entries are on 4-word boundary).

Field	Word(base8)	Bits	Description
XTTN	0	0-23	Table name ('XTT' in ASCII)
XTRT	1	0-63	Real time of last trace entry
XTCP	2	0-63	Current position in buffer

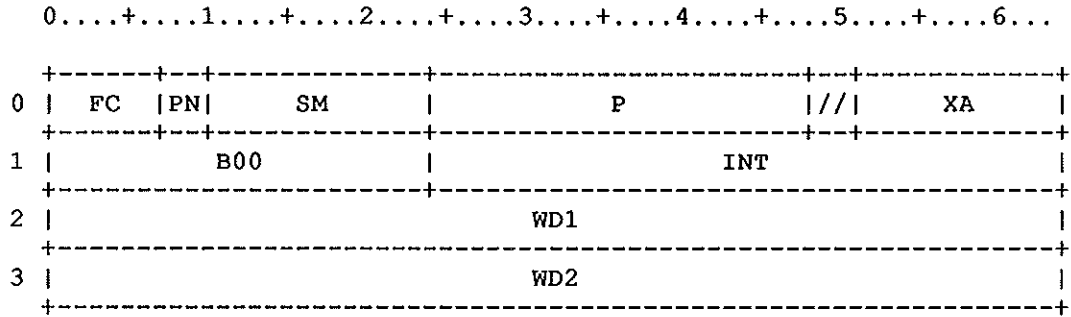

Figure XT-2. History Trace Table Entry

Field	Word(base8)	Bits	Description
XTFC	0	0-6	Function code
XTPN	0	7-9	Processor number
XTSM	0	10-23	First 14 semaphores
XTP	0	24-47	Current exchange package P-register
XTXA	0	51-63	Current exchange package address
XTB00	1	0-23	Last B00 value (if task related)
XTINT	1	24-63	Interval since last entry in cycles
XTWD1	2	0-63	Caller supplied word 1
XTWD2	3	0-63	Caller supplied word 2

This one-word table describes multitype datasets that are in error. It is associated with the corresponding QDT.

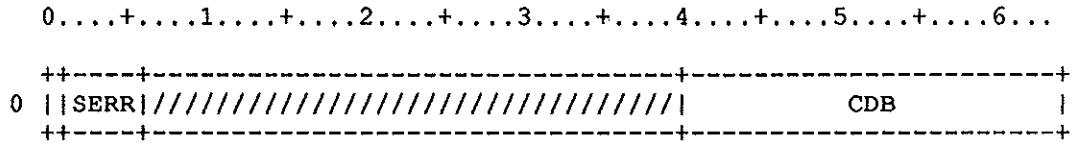

Figure ZM-1. Startup Managed Table

<u>Field</u>	<u>Word(base8)</u>	<u>Bits</u>	<u>Description</u>
ZMUSE	0	0	Entry is in use
ZMSERR	0	1-5	Error flags
ZMRLS	0	1	Released device in DAT chain
ZMDWN	0	2	Downed device in DAT chain
ZMERR	0	3	Catastrophic error in DAT chain
ZMIDA	0	4	Inconsistent disk allocation
ZMLDO	0	5	Logical device overflow
ZMCDB	0	40-63	FWA of current STP DAT body but PDM will deny access.

This table contains a copy of the device label in the first 2000-octal words of the table, and STARTUP information in the remaining words.

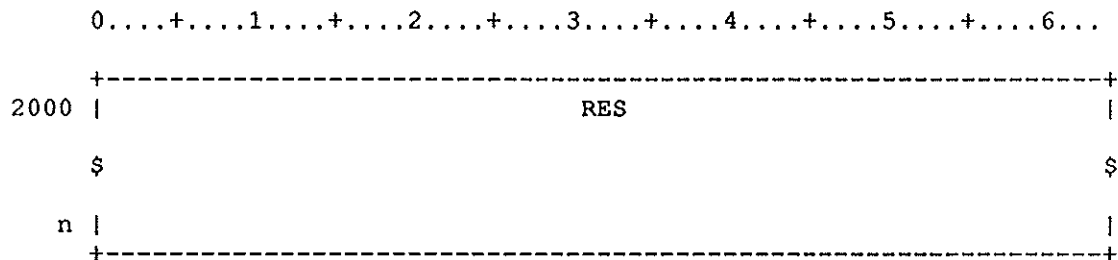

Figure ZDV-1. Startup Device Label Table

<u>Field</u>	<u>Word(base8)</u>	<u>Bits</u>	<u>Description</u>
ZDVRES	2000-n	0-63	
ZDVUPD	2003	0	Update label flag
ZDVOL	2003	1	Old label read flag
ZDVGP	2003	2	Stripe group processed flag
ZDVPGP	2003	3-6	Previous stripe ID if any
ZDVLTK	2003	40-63	Track containing label

This table contains an entry for each valid *SUBMIT directive found in the parameter file.

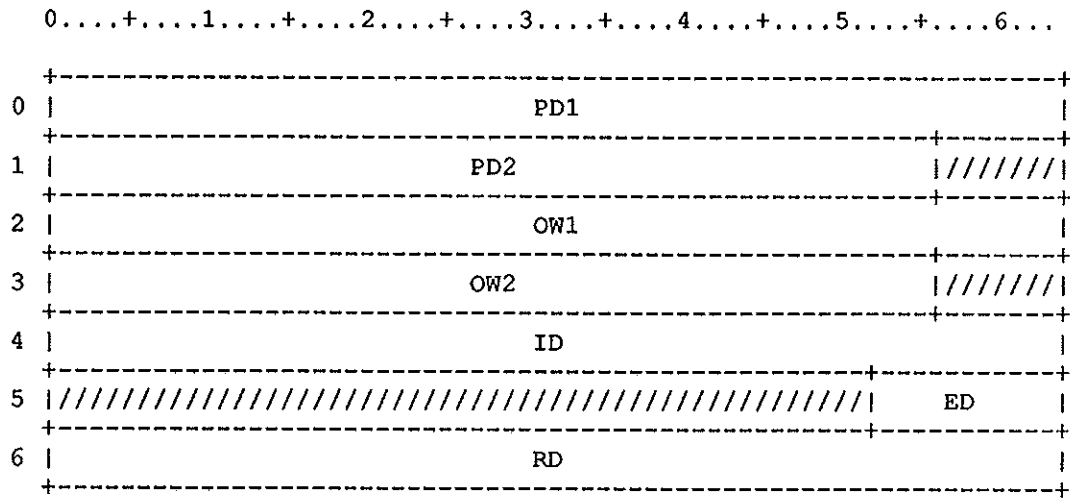

Figure ZSB-1. STARTUP submitted jobs table

<u>Field</u>	<u>Word(base8)</u>	<u>Bits</u>	<u>Description</u>
ZSBPD1	0	0-63	PDN chars 1-8
ZSBPD2	1	0-55	PDN chars 9-15
ZSBOW1	2	0-63	OWN chars 1-8
ZSBOW2	3	0-55	OWN chars 9-15
ZSBID	4	0-63	ID
ZSBED	5	52-63	ED
ZSBRD	6	0-63	Read control word

The following definitions are used for STARTUP messages to be written to the system log.

W@ZLGSTY	= 0	Word offset of message subtype in buf
W@ZLGLTH	= 1	Word offset of message length in buf
ZMG0CD	= 0	Dataset on released/missing device
ZMG1CD	= 1	Dataset resides on down device
ZMG2CD	= 2	Dataset DAT contains AI conflict
ZMG3CD	= 3	DSC DAT contains AI conflict
ZMG4CD	= 4	System dump DAT contains AI conflict
ZMGCD5	= 5	SYS DUMP not saved
ZMGCD6	= 6	SYS DUMP successfully saved
ZMGCD7	= 7	Catastrophic error in DSC entry
ZMGCD8	= D' 8	Multi-type inconsistent allocation
ZMGCD9	= D' 9	Multi-type out of bounds QDT index
ZMGCD10	= D' 10	Dataset recovered on scratch device
ZMGCD11	= D' 11	System dump copy abandoned
ZMGCD12	= D' 12	DXT's DAT contains AI conflicts.
ZMGCD13	= D' 13	Invalid DXT pointer in DSC entry.
ZMGCD14	= D' 14	DXT entry has a bad forward pointer.
ZMGCD15	= D' 15	DXT crossed allocation.
ZMGCD16	= D' 16	Conflicting DXT tail pointers.
ZMGCD17	= D' 17	Conflicting 'in use' flag
ZMGCD18	= D' 18	DXT creation time error
ZMGCD19	= D' 19	DXMISC contains owner value error
ZMGCD20	= D' 20	DXT contains a bad ordinal (DXTORD)
ZMGCD21	= D' 21	Reason for taking system dump
ZMGCD22	= D' 22	Dataset deleted message
ZMGCD23	= D' 23	Dataset contains out-of-range AI
ZMGCD24	= D' 24	Error on reallocation of dump
ZMGCD25	= D' 25	Reallocation of dump successful
ZMGCD26	= D' 26	Error writing system dump header
ZMGCD27	= D' 27	DCTXC+DCSSC > DXT TEST LENGTH
ZPDRMXN	= D' 28	maximum error code + 1

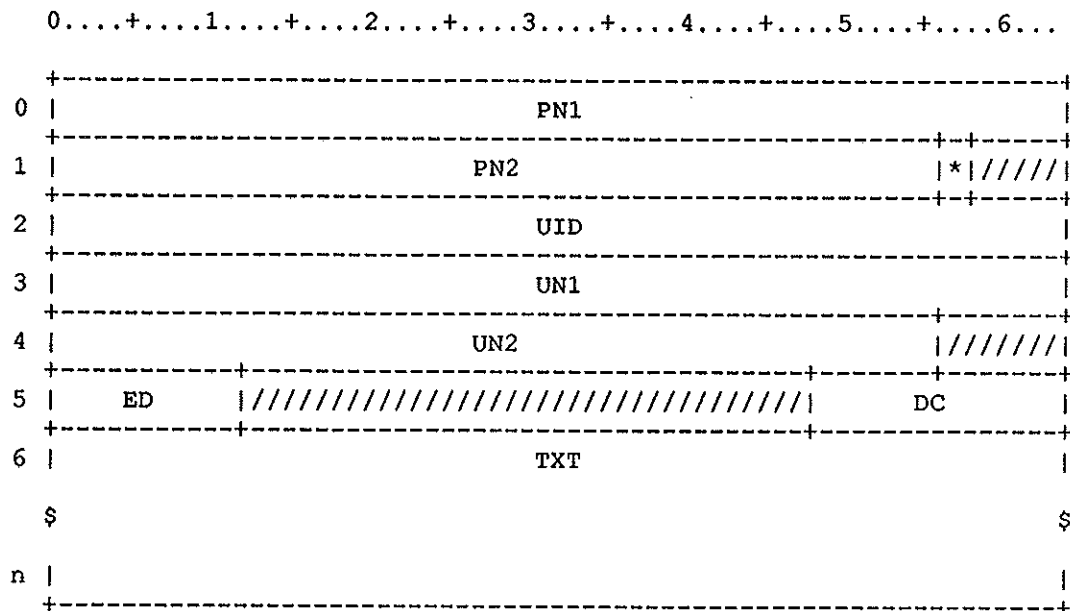

Figure ZMG-1. Startup Permanent Dataset Recovery Message

Field	Word(base8)	Bits	Description
ZMGPN1	0	0-63	PDN part 1
ZMGPN2	1	0-55	PDN part 2
ZMGSPPL	1	56-57	Spooled flags (DCI + DCO)
ZMGUID	2	0-63	User id
ZMGUN1	3	0-63	User number part 1
ZMGUN2	4	0-55	User number part 2
ZMGED	5	0-11	Edition number
ZMGDC	5	48-63	Disposition code
ZMGTXT	6-n	0-63	Beginning of variable text

<u>Field</u>	<u>Word(base8)</u>	<u>Bits</u>	<u>Description</u>
ZMGDBA	0	0-23	Destination address in bits
ZMGSWA	0	24-47	Source address in words
ZMGJSQ	0	48	JSQ needed for this message
ZMGLBT	0	49-63	Length of message in bits

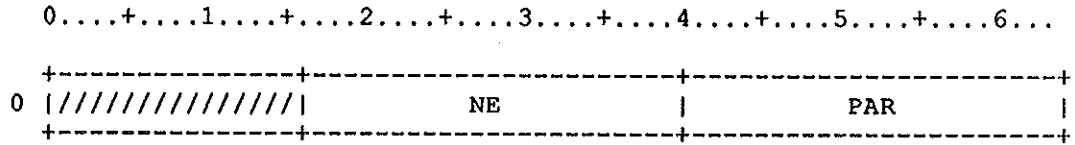

Figure ZMH-1. Startup ZMG Table Header

Field	Word(base8)	Bits	Description
ZMHNE	0	16-39	Length of message control table (ZMG)
ZMHPAR	0	40-63	Parameter control table base

L@ZMSGBK=D'16 LENGTH OF
MESSAGE BUFFER (WORDS)

The following field definitions define the message parameter control words for startup. The ZPA fields define each individual parameter, and the ZPC fields define the parameters expected for each message. If the ZPC entry for a message code is zero, there are no parameters expected for that message. One ZPC entry must be provided for each defined message code, and one ZPA entry must be provided for each parameter which is expected for a message. If no parameters are expected, no ZPA entries should be provided.

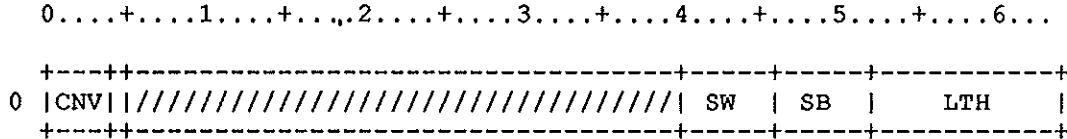

Figure ZPA-1. Startup Message Parameter Control Words

Field	Word(base8)	Bits	Description
ZPACNV	0	0-3	Conversion mode 0 ASCII, right-justified 1 Octal with leading zeroes 2 Decimal with leading zeroes 3 ASCII, no shifting done
ZPAZB	0	4	Source ends on zero byte flag
ZPASW	0	40-45	Start word within text
ZPASB	0	46-51	Start bit within (ZPASW)
ZPALTH	0	52-63	Length in bits (maximum is D'64)

LE@ZPA=1

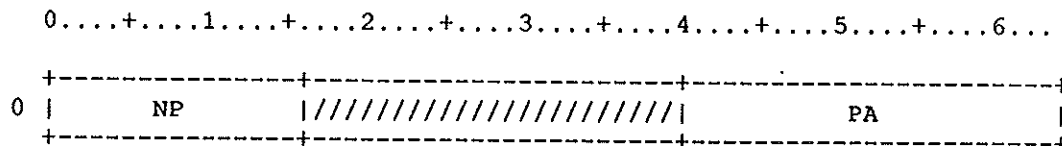

Figure ZPC-1. Startup Message Parameter Table

<u>Field</u>	<u>Word(base8)</u>	<u>Bits</u>	<u>Description</u>
ZPCNP	0	0-15	Number of parameters expected
ZPCPA	0	40-63	Address of first ZPA entry

LE@ZPC=1

The ZSUB macro is defined below to assist in automatically updating the ZDIRECT block whenever a new subroutine is defined. The purpose of the ZDIRECT block is to allow an analyst to locate any subroutine quickly in a dump, or during a debugging session. The ZDIRECT block consists of an assembly-time block which contains the names and first word address of all subroutines whose entry points are defined via the ZSUB macro. Format of the macro is

ZSUB [wordflag]

where: wordflag = Optional parameter indicating that the symbol defined is to have 'word' attribute. If 'wordflag' is non-blank, the symbol is defined via 'BSS 0' and has word attribute. Otherwise, it is defined via '= *' and has parcel attribute.

LOC=*

(

(

(

(

(

(

(