

# Sperry DCP Series Communications Processors

## MANAGEMENT SUMMARY

**UPDATE:** *This report is being updated to reflect changes that have occurred in the Sperry DCP Series of communications processors since the last update. The DCP/10A, which replaces the DCP/10 is discussed in this report. Other changes that have been made include increased memory for the DCP/20, discontinuation of certain DCP models and price changes to the hardware and software. The 1985 Network Users survey results for the DCP communications processors are also shown in this report.*

Sperry Corporation introduced its DCP/40 communications processor in 1979; the DCP/20 followed in 1981. Two years later, they introduced the entry level DCP/10, which has since been replaced by the DCP/10A. These communications processors are multiprocessor-based systems that can be used as front-end processors, remote intelligent concentrators, or nodal processors in a Sperry or multiple-vendor network. The processors can simultaneously support transaction, time-sharing, distributed processing, and remote job entry applications.

The system architecture used in the DCP Series communications processors distributes processing operations between one general-purpose processor, multiple I/O processors (except for the DCP/10A), and microprogrammed line modules. The general-purpose processor handles general communications tasks. The I/O processors are physically identical to the general-purpose processor and are dedicated to I/O handling tasks. Each I/O processor supports up to 16 line modules. Connections to remote devices, to local peripherals, and to on-site host computer channels are accommodated by various line modules. Each line module provides interfacing for a specific type of channel or device.

The DCP Series processors are incorporated with Telcon software to form the DCP/Telcon system. The Telcon system uses the Sperry Distributed Communications Architecture (DCA). It is a modular system, both in its hardware and software. The DCP/Telcon system can be used in redundant configurations; offers distributed network management services, security maintenance, monitoring, and control; can manage various configurations of synchronous, asynchronous, and wideband communications lines; supports devices for unattended operation, local initialization, and redundant applications; and utilizes a powerful instruction set that is designed for communications programming.

The options and capabilities of the DCP Series communications processors can be better appreciated when its role in Sperry's DCA is kept in mind. Basically, DCA is a set of ground rules that defines the functions that each element within a communications network should perform. Furthermore, DCA defines the standards for interfacing between elements. The goal is to permit interconnection of

The DCP Series of communications processors from Sperry can be used as front ends to a Sperry 1100 Series or Series 90 mainframe, or as nodal processors or remote concentrators in a Sperry or multivendor environment. The DCP Series consists of the DCP/40, DCP/20, and the DCP/10A. The DCP/10A replaces the DCP/10, which is no longer being marketed. The DCP/40 is the largest member of the DCP family and can support up to 16 I/O processors; the DCP/20 is the middle member and can support a total of three I/O processors, with the first handling both the communications processor and I/O processing functions. The DCP/10A is the entry level processor and does not support independent IOPs, but does have a single processor that provides the functions of each.

**FUNCTION:** Front-end processor, nodal processor, remote concentrators.

**HOST COMPUTERS SUPPORTED:** Sperry 1100 Series, Series 90.

**ARCHITECTURE SUPPORTED:** Sperry Distributed Communications Architecture (DCA).

**OPERATING SOFTWARE:** Telcon Operating System software.

**COMPETITION:** Burroughs Corporation, International Business Machines, NCR Comten.

**PRICE:** Prices vary depending on configuration.

## CHARACTERISTICS

**VENDOR:** Sperry Corporation, Computer Systems Division, P.O. Box 500, Blue Bell, PA 19424. Telephone (215) 542-4011.

**DATE OF ANNOUNCEMENT:** DCP/40—1979; DCP/20—1981; DCP/10A—1983.

**DATE OF FIRST DELIVERY:** DCP/40—1979; DCP/20—1982; DCP/10A—1983.

**NUMBER DELIVERED TO DATE:** Information not available.

**SERVICED BY:** Sperry Corporation.

## CONFIGURATION

### DCP/40

The Distributed Communications Processor/40 (DCP/40) is a multiprocessor, multitasking system that can serve as a front-end processor to an 1100 Series or Series 90 host computer, or as a nodal processor or remote intelligent

## Sperry DCP Series Communications Processors

**TABLE 1. SERIAL COMMUNICATIONS LINE MODULE OPTIONS FOR THE DCP SERIES COMMUNICATIONS PROCESSORS**

Feature No.	Line Module	Interfaces	Protocols	Data Rates
F1942-00	Synchronous (half- or full-duplex)	EIA RS-232-C, CCITT V.24 and V.28	Synchronous; Uniscope	Up to 9600 bps
F1941-00	Asynchronous (half- or full-duplex)	EIA RS-232-C, CCITT V.24 and V.28	Asynchronous; Uniscope or teletypewriter	Up to 2400 bps
F3165-00	Multiline asynchronous (half- or full-duplex)	EIA RS-232-C, CCITT V.24 and V.28	Teletypewriter**	Up to 2400 bps
F1945-00	Automatic dialing	EIA RS-366 (Bell 801) CCITT V.24 and V.25	Protocol independent	—
F1945-01 (DCP/20 only)	Automatic dialing	NTT (Japanese) compatible	Protocol independent	—
F3163-00	Medium-speed loadable* (half- or full-duplex)	EIA RS-232-C, CCITT V.24 and V.28	Basic asynchronous** Basic synchronous UDLC BSC REM 1 NTR	Up to 19,200 bps, except up to 9600 bps for BSC
F3163-04	Medium-speed loadable* (half- or full-duplex)	EIA RS-449	Basic synchronous UDLC BSC REM 1 NTR	Up to 9600 bps
F3163-01	Medium-speed loadable* (half- or full-duplex)	CCITT X.21	Basic synchronous UDLC BSC NTR	Up to 9600 bps
F3164-01	High-speed loadable* (half- or full-duplex)	CCITT V.35	Basic synchronous UDLC BSC REM 1 NTR	Up to 64,000 bps
F3164-00	High-speed loadable (half- or full-duplex)	Bell 303	Basic synchronous UDLC BSC REM 1 NTR	Up to 64,000 bps

\* Program-loadable protocols.

\*\*Includes auto baud rate detection.

➤ dissimilar hardware/software into one communications network in compliance with DCA ground rules. Under DCA, the interconnection of a vast array of line disciplines, supporting an even larger array of terminal types, is permitted. Not unexpectedly, therefore, the range of line interfaces provided with the DCP Series communications processors is rather extensive. Table 1, in this report, lists the DCP interfaces supported by Sperry's network architecture.

Another DCA concept is to produce hardware (e.g., the DCP/40) that operates under software (e.g., Telcon), not software operating under hardware. Portions of the DCA software reside in the DCP processors, portions in the host computers, and still other portions in a DCA intelligent terminal in the network. Within Telcon, the DCP performs the specific functions of communications processing and line concentration, providing the user with no programmatic tools to alter the assigned function. However, within the assigned function, the hardware options and own-coding provisions provide significant flexibility.

➤ concentrator in a Sperry or multivendor network. All functional characteristics are provided in microcode, which is loaded into system memory.

The basic DCP/40 includes a communications processor; the basic DCP/40 microprograms (stored on an integral diskette); a storage controller and one 512K-byte RAM storage module; an input/output controller and one input/output processor (IOP); a line module chassis with space for up to 16 line modules for connection of host computers, local peripherals, and communications lines (line modules are priced separately); power supplies and a power controller; an integrated diskette drive and controller (separately priced but required); an operator's panel; and a maintenance panel. All of these components are contained in a single freestanding cabinet. The basic configuration also includes an external dual-drive disk subsystem that provides a total of 6MB of storage (separately priced).

The contents of the basic cabinet can be expanded to include up to three additional 512K-byte storage modules, for a single cabinet capacity of 2M bytes, plus up to three additional IOPs and three additional line module chassis, for a single cabinet capacity of 64 line modules. (If more than two IOPs are contained in the basic cabinet, a storage port expander, which permits multiple IOPs and I/O devices to share storage access ports, is also required.)

## Sperry DCP Series Communications Processors

### DCP/40 Configuration

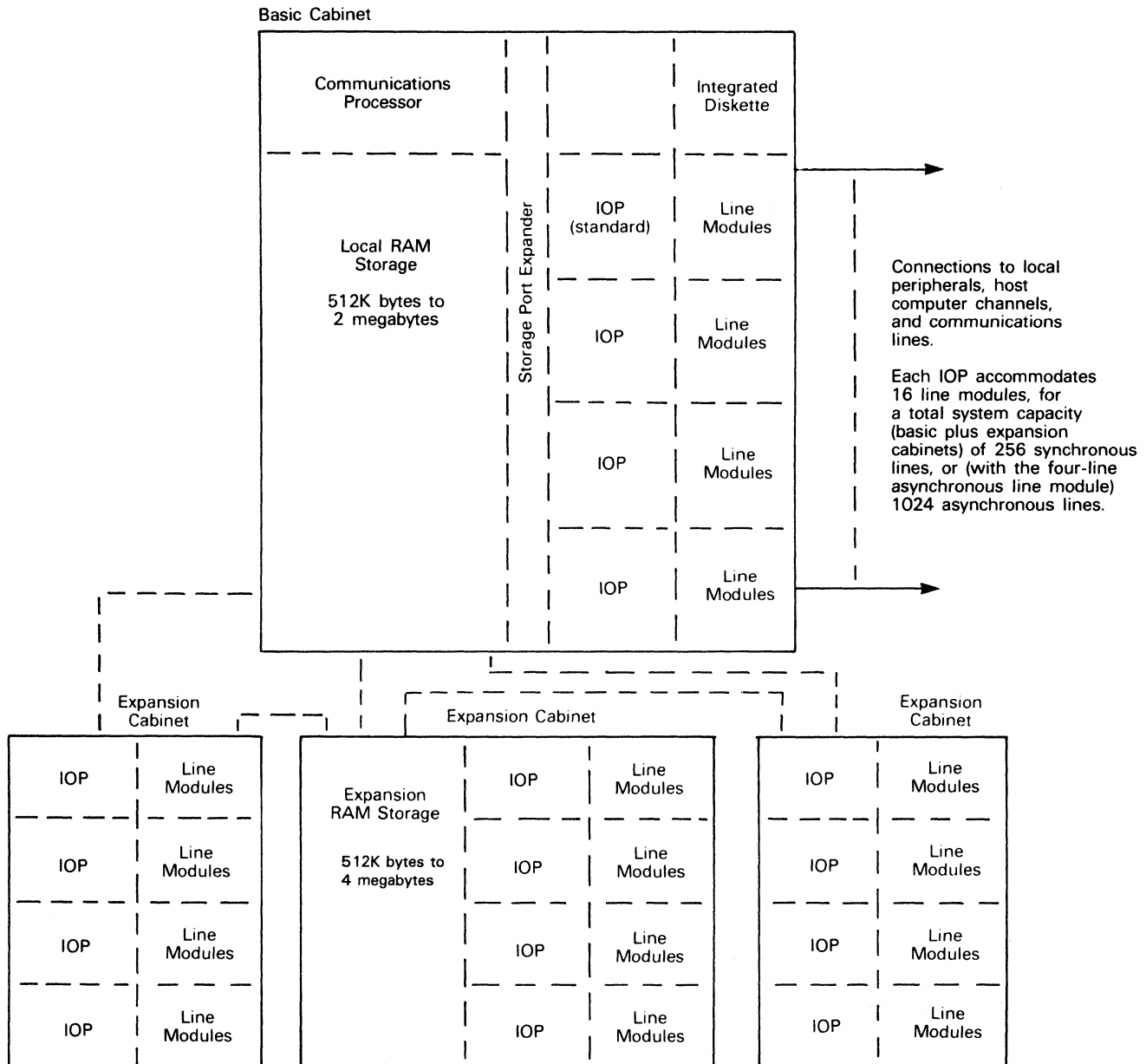

#### ▷ COMPETITIVE POSITION

The DCP Series communications processors can perform functions similar to those handled by a Burrough's CP 3680 Data Communications System, an IBM 3705-II and/or 3705-80, or an NCR Comten 721 Communications Processor. The DCP systems utilize the X.25 gateway from DCA to other networks, and the BSC and SNA gateways to IBM systems. The DCP networks can also support various public data networks.

While Sperry's DCP communications processors offer comparable functions to other vendors products, they are basically designed to work within the Sperry framework. These processors do go farther than other mainframe vendor's processors in offering host-independent networking. ▷

▶ If further expansion is required, up to three expansion cabinets can be configured with the system. (If more than two expansion cabinets are added to the basic system, a storage port expander is required in the basic cabinet.) Each expansion contains its own power supplies and power controller, and can accommodate one I/O controller, up to four IOPs, storage port expanders as needed, and associated line module chassis and line modules. In addition, one (but only one) expansion cabinet per system may also contain up to 12 128K-byte RAM storage modules, grouped into three 512K-byte storage banks; each bank has its own controller.

Additional disk subsystems may be added to the first. One or two magnetic tape drives can also be added to the system.

A UTS/20 display station and a serial printer may optionally be attached for use as a local system console. The host system console can also function as a local DCP/40 console if it is configured as a terminal to the network. An optional freestanding desk-type work surface, on which the console can be placed, is also available. ▶

## Sperry DCP Series Communications Processors

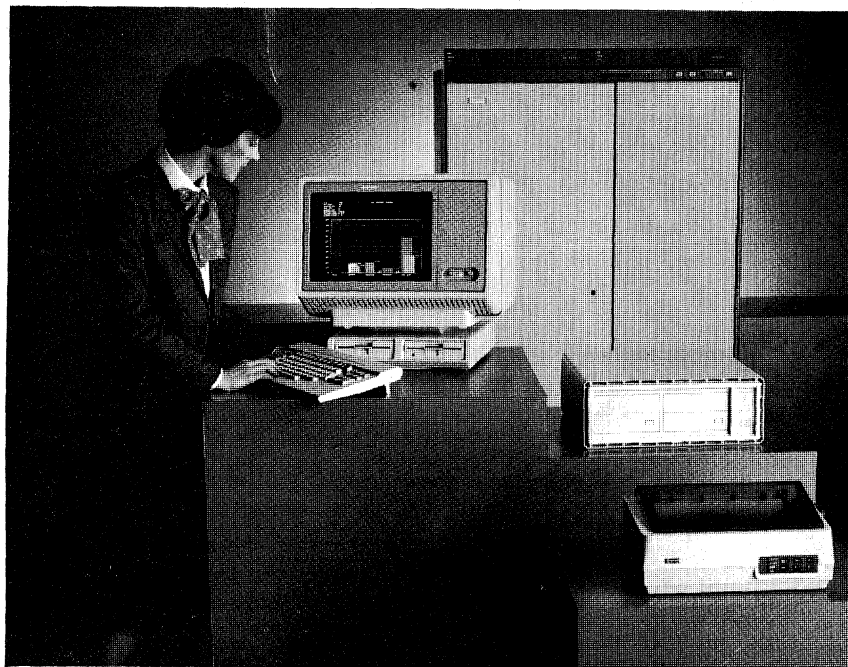

*Sperry's DCP/40 includes a communications processor, a storage controller and 512K-byte RAM storage module, basic microprograms, a line module chassis, an input/output controller and one input/output processor, peripherals, an operator's panel, and more.*

### ▷ ADVANTAGES AND RESTRICTIONS

Sperry designed the DCP Series communications processors to operate within its DCA architecture and to do network processing. They were not designed to operate as distributed processing systems or as independent stand-alone systems. As communications processors within a network, they offer a variety of functions including network control, multiple terminal support, line cost savings, a broad range of data transmission rates, modularity and growth capabilities, multiple terminal type support, and the ability to design communications networks to meet data processing and data transmission needs. The processors offer host independent communications network operation; have the ability to accommodate non-Sperry communications protocols; and network management capabilities. The DCP Series provides a range of communications processors that are capable of performing as either front-end processors, remote concentrators, or nodal processors.

Sperry designed the communications processors to meet the needs of a small data comm center as well as a large communications center. The modularity and compatibility of the systems allows growth from the entry level DCP/10A to the largest member, the DCP/40.

The processors offer large storage capabilities with the DCP/40 providing up to 6M bytes. Security measures built into the software and the hardware safeguard the system's data from unwarranted intrusion, error, and tampering.

### USER REACTION

In Datapro's 1985 Network Users Survey, 19 users of the Sperry DCP Series communications processors responded. Of these, 10 used the Sperry DCP/40 and 9 did not specify ▷

▶ The communications processor performs general-purpose processing tasks, as well as functions specific to network and local-site operations, under the control of microcoded programs loaded into local RAM storage. The processor includes a microcontroller that supports the internal bus structure, timing mechanism, control storage, dual arithmetic logic units (for comparing and checking computations), error checking and logging schemes, automatic instruction retry routines for microinstruction failure, and automatic restart and recovery procedures.

Local RAM storage consists of 512K bytes of integrated circuit, multibank, error correcting storage that can be expanded in 512K-byte increments up to 2M bytes. An expansion cabinet can be added that provides an additional 4M bytes in 512K-byte increments. Error checking logic provides for correction of all single-bit errors and flagging of double-bit errors. All errors are automatically logged so that the processor can analyze the frequency of hardware failures and take any necessary recovery actions.

The communications processor and each device connected to the system through an IOP has direct, independent access to local storage. Storage is accessed via multiple storage ports. Four ports are provided in the basic cabinet, and four additional ports are provided in the expansion cabinet if any expansion storage is configured. If all available ports are occupied, cascaded storage port expanders are used to multiplex groups of requesters to each of the storage ports. Priority schemes in system logic handle simultaneous request for storage access.

The system's I/O processors manage all input/output tasks. Each IOP provides programmed control for up to 16 line modules, and performs data exchanges, buffer allocation, message formatting, message recovery and retransmission, status reporting, statistics gathering, and polling.

Optional active line indicators can provide a visual display of line activity on data sets connected to an IOP. Each active line indicator displays activity for up to 16 lines on a single IOP, or, with an optional switching feature, for up to 64 lines on four IOPs. Each active line indicator is mounted on the top of the cabinet containing the IOP(s) to which it is connected. ▶

## Sperry DCP Series Communications Processors

the model used. The ten users of the DCP/40 reported on 23 units. The other nine users reported on 32 units, for an installed base of 55 units. The ratings on the DCP/40 are listed below:

	Excellent	Good	Fair	Poor	WA*
Overall performance	4	5	1	0	3.3
Ease of installation	1	7	1	0	3.0
Ease of operation	1	6	1	1	2.8
Ease of expansion	2	6	0	1	3.0
Hardware reliability	3	5	2	0	3.1
Quality of manufacturer's software/firmware	2	3	2	2	2.6
Ease of programming	0	3	4	1	2.3
Quality of manufacturer's maint. svc./tech. support	2	5	1	1	2.9

\*Weighted Average based on a scale of 4.0 for Excellent.

We were unable to contact any of the respondents for additional comments. □

► The line modules are plug-in programmed interfaces that provide for connection of all external devices to the DCP/40 system. Various modules accommodate half- or full-duplex communications lines, host computer channel interfaces, or local peripheral interfaces. Each module is loaded with a microcoded program that supports the specific data format, transmission method, and other requirements of the line to be connected. The line modules also perform such functions as: data conversion (from parallel to serial and vice versa), data buffering, character parity and block check sequence generation and checking, character counting and control character recognition, and line timing and asynchronous clocking. Up to 256 line modules can be configured with a DCP/40 system, since, in general, each line module occupies a single IOP port. The exception is the byte-channel host interface line module, which provides for connection to a Series 90 or 1100/80 host computer and requires two IOP ports.

Local peripherals are attached to the system through the IOPs via the Sixteen-Bit Peripheral Line Module for the disk and magnetic tape drives.

Line modules for connection of host computer interface channels and communications lines are described under "Transmission Specifications."

Reliability features are built into each layer of the DCP/40's architecture. In addition to the error detection, logging, and correction schemes already mentioned, the system can support: configurational redundancy in both internal elements such as local storage, I/O processors, and line modules, as well as in the external network; virtual storage mapping that prevents software errors in any single system module from causing total system failure; and diagnostic programs in both macrocode and microcode that provide both online and offline tests of system and network components. DCP/40 dumps, as well as error logs and statistics reports, can be transmitted to the host upon demand by the host or DCP/40 console operator.

### DCP/20

The DCP/20 is a smaller version of the DCP/40. The basic configuration includes a general-purpose processor, I/O processor, 512K bytes of main memory, and support for up to 16 line modules. The main memory can be expanded in 512K-byte increments to a maximum of 2M bytes. Up to two

optional I/O processors may be added to the basic system, each of which can support up to 16 line modules, for a system maximum of 48 line modules.

Available peripherals to the DCP/20 include: 10MB or 20MB cartridge disk subsystem; up to four dual-flexible disk subsystems, for a total diskette storage capacity of 8MB; one or two Uniservo 10 magnetic tape drives; an operator's control console, which may be a Uniscope 200, UTS 400, or UTS 4000 CRT terminal; and an optional slave console printer, available in either 80-dps impact or 200-cps bidirectional impact models. The Sixteen-Bit Peripheral Line Module is used to connect the cartridge tape and magnetic tape subsystems to the DCP/20; the Byte I/O Line Module is used to connect the flexible disk subsystems.

### DCP/10A

The DCP/10A is the entry level member of the DCP family. It supercedes the DCP/10, but can be used in the same network where a DCP/10 is already installed, as well as the DCP/20 and DCP/40. The basic configuration includes a general-purpose processor, local storage, 512K bytes of main memory (expandable to 2M bytes), and support for up to eight line modules.

Peripherals for the DCP/10A include a cartridge disk subsystem, an integrated disk drive for mass storage, a remote control module, and a line switch module. The remote control module can be used to control the DCP/10 in an unattended, remote environment. The line switch module is used to support unattended operation of the communications subsystem.

### TRANSMISSION SPECIFICATIONS

Line modules that connect remote devices, local peripherals, and host computers to the system are attached to the DCP via the IOP ports. Each IOP provides 16 ports. Up to 16 IOPs may be configured with a DCP/40, so that a maximum of 256 line modules can be accommodated. On the DCP/20, both the general-purpose processor and the IOPs provide line module ports. The DCP/20 supports up to three IOPs, with the first handling both communications processor and I/O processor functions. The DCP/20 can accommodate a maximum of 48 line modules. The DCP/10A uses a single processor which offers both communications processor and I/O processor functions. The DCP/10A supports eight ports.

A number of serial line modules are offered to support connection of remote devices to the system over communications lines. RS-232-C, CCITT V.24/V.28, RS-449, AT&T 303, RS-366, Japan NTT, and X.21 interfaces are supported in half- or full-duplex mode at speeds up to 64K bps. The processors can also interface to both X.21 (circuit) and X.25 (packet) public data networks.

A remote control module, using microprograms, allows remote control of the power on/off, IPL, and other functions of up to four DCP/40, DCP/20, or DCP/10A processors via communications lines.

With an optional line switch module (LSM) operation under microprograms, the communications lines or peripherals can be switched from a local or remote source via a direct connection or communications line connection. The LSM consists of a cabinet, power supply and control, and control logic. One communication interface feature (F3163-00 or -04) is required to attach the LSM to a modem.

Various switches are available that provide the capability to switch eight RS-232-C communication links, eight V.35 lines, four RS-449 lines, four wideband lines, or four 16-bit peripheral interfaces from one communications controller to another. ►

## Sperry DCP Series Communications Processors

► Protocols supported by the communications line modules include teletypewriter, asynchronous or synchronous UNISCOPE protocol, Universal Data Link Control (UDLC), 1100 full-duplex (FDX—used with Series 1100 equipment), REM1 (used with Sperry 9200, 9300, or 90/30 Series processors and the 10004 card processor), Nine Thousand Remote (NTR—also used with 9000 Series Processors), 3270, 2780, SNA 3270, 3770, and IBM Binary Synchronous Communications (BSC). Two types of line modules, the Medium-Speed Line Module and the High-Speed Line Module, can be loaded with microprograms for specific line protocols.

**CONNECTION TO THE HOST:** A DCP/40, DCP/20, or DCP/10A system may be connected to a host computer remotely via communications lines or directly through a host processor channel. Remote connections can be made to Sperry 1100 Series and Series 90 mainframes (DCP/10A connects only to the 1100 Series), IBM computers, and other systems compatible with the line protocols supported by the DCP/40, DCP/20, or DCP/10A communications line modules.

Five parallel line modules are provided for direct-channel connection: the Host Byte Channel Module provides an interface to a Sperry Series 90 or 1100/80 processor through its byte multiplexer, block multiplexer, or selector channel; the Host Word Channel Module provides an interface to an 1100 Series processor with its 32-bit internally specified index (ISI) word channel; the Sixteen-bit Peripheral Module provides an interface to a peripheral subsystem in either an 8- or 16-bit mode (DCP/40 and DCP/20); Byte I/F Module provides an 8-bit interface to an 8409 disk and a flexible disk (DCP/10A and DCP/20); and the Front End Processor Interface (FEP) module that connects a System 11/Mapper 10 system to a standalone DCP/10A. Up to four channel interface modules (either type) can be accommodated per DCP/40, DCP/20, or DCP/10A cabinet. The Word-Channel Line Module occupies one line module port; the Byte-Channel Line Module occupies two line module ports.

### SOFTWARE

Data Communications Architecture (DCA) is a set of rules and guidelines that permits users who comply to be able to tie their scattered electronic data processing elements into an interconnected network. In effect, Sperry has identified the necessary tasks, separated the tasks into functions, and standardized the rules for interfaces. This permits the interconnection of network elements with dissimilar hardware and support software. One component of DCA is the Telcon system, a combination of hardware and software to interconnect remote terminals with Sperry mainframe processors. The software portion of Telcon includes the software operative in the DCP/40, DCP/20, or DCP/10A, the related support software in the host, and the software to provide standardized DCA interfaces for certain intelligent terminals.

Telcon supports interactive, batch, and transaction-oriented data transfers. Under Telcon, all data is processed concurrently and is interleaved on UDLC circuits between nodes. In a multinode environment, any terminal has access to any host in the network, and can be switched from one application or operational mode to another.

The DCP/40, DCP/20, or DCP/10A, with its resident Telcon software, can serve as a front-end processor to one or more Sperry 1100 Series or Series 90 hosts (DCP/10A is supported on the 1100 Series only), or as a nodal processor or a remote concentrator to one or more 1100 Series, Series 90, Series 80, V77, IBM or compatible systems, or to another DCP/40, DCP/20, or DCP/10A system.

Telcon provides the DCP Series processors with comprehensive network management facilities for distributed or hierarchical networks, through which it can maintain, control, monitor, and protect the network. Through Telcon, the DCP controls the establishment of sessions, access to various network systems, and allocation and use of network resources. As the network grows or changes, the DCP can be dynamically reconfigured to support new network components.

The major tasks performed by the Telcon operating system within the DCP/40, DCP/20, or DCP/10A are:

- **Basic Executive**—Schedules processor time based on user priority. Equal priority users are handled on a first-in, first-out basis. Dispatches time-related functions, including suspension of a user for a specific time period. Also provides administrative functions, such as loading, deactivation, and buffer management.
- **Hardware Interface Routines**—Provides the software support for the IOPs and line modules.
- **File management**—Provides device-independent control of disk, diskette, and magnetic tape drives.
- **I/O Control**—Manages the queuing of all incoming and outgoing messages, including passing messages from one DCP to another. When possible and necessary, the software can seek alternate routing and performs pacing of the number of messages to a given user.
- **Network Management Services**—Provides fundamental control and monitoring of the system, dynamic addition and deletion of communications lines and terminals, gathering of network statistics, control of security, and the establishment of session links.
- **Loading and Initialization**—The integrated diskette contains the first load block, which calls in the bootstrap loader from local mass storage, the host computer, or another DCP system. The bootstrap performs initialization functions and loads the system's operating software to complete the initialization process.

Sperry also provides DCA support for access to several European and Canadian public data networks. The X.25 packet switching and X.21 circuit switching support takes the form of line modules for DCP Series processors and software packages that run under the Telcon system. Such modules are available for the following packet switching services: the Nordic PDN in Scandinavia; PSS in the United Kingdom; Datex-P in West Germany; Transpac in France; Datapac in Canada; GTE Telenet in the United States; DN-1 in the Netherlands; Austpac in Australia; Iberpac/Arpac in Spain and Argentina; and Datex-P in Austria.

### COMPONENTS

**COMMUNICATIONS PROCESSOR:** The communications processor utilizes a 32-bit microinstruction format plus byte parity. The processor provides 128 general-purpose 16-bit registers, plus several specialized registers. The communications processor instruction set contains approximately 300 instructions for native mode operations. Microinstruction execution cycle time is 65 nanoseconds for the DCP/40, 80 nanoseconds for the DCP/20, and 250 nanoseconds for the DCP/10A.

Maximum local RAM storage capacity is up to 2M bytes in increments of 512K bytes for the DCP/20 and DCP/10A. Maximum storage for the DCP/40 is up to 2M bytes in increments of 512K bytes, with an expansion cabinet offering an additional 4M bytes in 512K bytes for a total storage capacity of 6M bytes. In the DCP/40 and DCP/20, data is

## Sperry DCP Series Communications Processors

▶ formatted in storage as a 32-bit word with seven bits designated for error correction. The read-cycle time and full-word write-cycle time is 450 ns for the DCP/40. The read-cycle time for the DCP/20 is 400 ns and a full-word write-cycle time is 450 ns. The DCP/10A has a read-cycle time of 1000 nanoseconds and a full-word write cycle of 750 ns.

**I/O PROCESSORS (IOP):** The IOP is designed to handle input/output for the DCP Series processors. The IOPs used with the DCP/40 and DCP/20 each provide control for up to 16 ports. The DCP/10A provides eight ports. Virtual addressing is used by the IOPs to access the full storage of the DCPs. The DCP/40 can use a total of 16 IOPs, the DCP/20 uses a total of three IOPs, while the DCP/10A has a single processor providing both communications processor and I/O processor functions.

The IOP for the DCP/40 and DCP/20 uses a 16-bit micro-instruction, an 8-bit data path, a 32-bit storage address plus byte parity, a 24-bit byte addressing system and 1024 internal registers that use 32-bit stacks with byte parity. Up to 85 macroinstructions can be used to control the IOPs.

**INTEGRATED DISKETTE:** A 256K-byte diskette drive and a diskette controller are required for initial system loading. It can also be used to store diagnostic programs, statistics, error logs, network control tables, and additional downloaded functions. The diskette controller interfaces with the system through an IOP and occupies the space of one line module.

**DISK SUBSYSTEMS:** The Model 8408 cartridge disk subsystem can provide up to 10 megabytes of mass storage in a single cabinet for the DCP/40 or the DCP/20 system; it can also be used as a system loading device in lieu of a diskette subsystem. The subsystem consists of a controller and one or two top-loading dual-spindle disk drives. Each drive provides 5MB of fixed and 5MB of removable disk storage. The data transfer rate for a Model 8408 drive is 2.5MB per second, and the average access time is 50 milliseconds. The cartridge disk subsystem is connected to the DCP through an IOP via a 16-bit peripheral interface. A dual I/O interface option permits the subsystem to be

shared by two different channels of one DCP or by two separate DCP systems. Multiple drives can be attached through separate line modules.

The 8409 disk subsystem is a standalone mass storage device. The 8409 can be used as a storage device for the Telcon system, for network database files, and for distributed data processing applications. The disk subsystem can be ordered with one or two disk drive assemblies that initially support either 4.75, 14.25, and 23.8 megabytes of storage each.

**MAGNETIC TAPE SUBSYSTEM (DCP/40 and DCP/20):** The Model 0871 Uniservo 10 magnetic tape subsystem contains a tape controller and a single 9-track 800/1600 bpi tape drive; a second, separately cabinet drive can be added. The data transfer rate is 40K bytes per second for the PE formats or 20K bytes per second for NRZI formats; the tape speed is 25 ips. An automatic threading function is standard. The magnetic tape subsystem connects to the DCP using an IOP through a 16-bit peripheral interface.

**CONSOLE:** A UTS 20 display terminal may be used optionally as a local display console. The UTS 20 is a fully featured editing/formatting terminal that provides a maximum screen capacity of 1,920 characters, a typewriter keyboard, and a full upper-/lowercase ASCII character set. An optional auxiliary interface is available for the UTS 20 for attachment of a slave printer.

### PRICING

The Sperry DCP/40, DCP/20, and DCP/10A are available for purchase or on a one-year or five-year lease. Sperry also offers a 7-year lease to state and local governments and to educational institutions. Educational institutions are eligible for an additional 10 percent discount. The discount does not apply to maintenance service charges. The basic maintenance charge covers maintenance of the equipment for nine consecutive hours a day between the hours of 7 a.m. and 6 p.m., Monday through Friday. Extended periods of maintenance are available at premium rates.

## EQUIPMENT PRICES

		Monthly Charges*			
		1-Year Lease (\$)	5-Year Lease (\$)	Purchase Price (\$)	Monthly Maint. (\$)
<b>DCP/40</b>					
8596-96	Basic DCP/40; includes freestanding cabinet, communications processor, first storage controller, 512K bytes of storage, first I/O controller module, first I/O processor, ROM memory, and microprograms; requires integrated flexible disk drive, (F1939-00/01), line modules, and cartridge disk subsystem	2,305	1,843	84,245	452
1945-00	DCP/40 Expansion Cabinet; includes freestanding cabinet, power supply, and power controller; max. 3 per system, only one of which may contain storage; third expansion cabinet requires storage port expander (F1936-00)	740	593	27,060	146
F1930-00	Storage Expansion; provides additional 128K bytes of storage; for expansion memory through DCP/40 expansion cabinet (1945-00)	152	121	5,570	32
K1930-01	Storage Expansion; provides additional 512K bytes of storage; up to three K1930-01 modules may be added to basic DCP/40; additional 128K-byte (F1930-00) modules may be added to DCP/40 expansion cabinet through F2942-00 and F1929-99; max. 3.5M bytes total storage per system	410	325	15,600	126
F2942-00	Second Storage Controller; mounts in expansion cabinet; includes 128K bytes of storage plus support for three additional 128K storage expansion modules; max. 1 per system	735	588	26,880	145
F1929-99	Third/Fourth Storage Controller; mounts in expansion cabinet; includes 128K bytes of storage plus support for three additional 128K storage expansion modules; requires F2942-00; max. 2 per system	365	290	13,950	77

\*Lease prices do not include maintenance.

\*\*Preconfigured DCP/40 models require the following separately priced options in addition to the components listed in each model description; UTS 20 or UTS 400 console; direct connect cable, modems, or DCM to connect console to DCP.

## Sperry DCP Series Communications Processors

		Monthly Charges*			
		1-Year Lease (\$)	5-Year Lease (\$)	Purchase Price (\$)	Monthly Maint. (\$)
F1933-00	I/O Processor Controller Module; mounts in expansion cabinet; includes one I/O processor, one storage port expander and space for mounting three additional I/O processors; max. 3 per system (1 in each expansion cabinet)	399	320	14,680	78
F2941-99	Second I/O Processor; may be added to basic DCP/40, or to DCP/40 expansion cabinet already containing F1933-00; includes power supply for third and fourth I/O processors	410	326	14,920	81
F1932-99	Third I/O Processor; may be added to basic DCP/40 or to DCP/40 expansion cabinet; requires F2941-99; includes storage port expander	389	310	14,185	76
F1932-98	Fourth I/O Processor; may be added to basic DCP/40 or to DCP/40 expansion cabinet; requires F1932-99	294	231	10,635	57
F1825-05	Active Line Indicator; provides a visual display of line activity on up to 16 communication line modules in a single IOP. Mounts on top of cabinet containing the IOP	26	21	960	4
F1936-00	Storage Port Expander; provides multiplexed interface to a single storage port for up to four requestors	95	75	3,550	19
F1939-00	Integrated Flexible Disk; includes controller and one drive; required for basic DCP/40; may also be added to DCP/40 expansion cabinet in which at least one I/O processor is installed; requires microprogram diskette (1931-98)	53	42	1,920	12
F1931-98	Flexible Disk; contains DCP/40 Processor and I/O Processor microprograms for operation in primary mode	4	3	144	1
<b>Preconfigured DCP/40 Models**</b>					
8596-79	DCP/40 Model I/1100; preconfig. cart. disk-based DCP/40 for Series 1100 host; accom. up to 11 comm. line modules; includes basic DCP/40, 4.6M bytes disk storage, 512K bytes main storage, integrated disk., Series 1100 host I/F, 8-bit peripheral I/F, cartridge disk contrl. & drive, act. line indic., fld. expd.	2,809	2,225	102,635	584
8596-91	DCP/40 Model I/90; preconfigured cartridge disk-based DCP/40 for Series 90 host; same as 8596-95 except accommodates up to 9 communications line modules and includes Series 90 host interface instead of Series 1100 interface	3,033	2,383	117,439	664
8596-77	DCP/40 Model II/1100; preconfigured cartridge disk-based DCP/40 for Series 1100 host, same as 8596-95 except accommodates up to 27 communications line modules; has 14M-byte disk storage; includes DCP/40 and second IOP	3,324	2,629	119,651	674
8596-83	DCP/40 Model II/90; preconfigured cartridge disk-based DCP/40 for Series 90 host; same as 8596-91 except accommodates up to 25 communications line modules; includes DCP/40 and second IOP	3,448	2,713	133,319	749
<b>DCP/20</b>					
8597-78	Basic DCP/20; includes freestanding cabinet, communications processor, 512K bytes of storage (can be expanded in 512K-byte increments to a max. of 2048K bytes), microprogram storage, microprograms, integrated flexible diskette. May require a Host Interface; does not include a mass storage subsystem	1,458	972	35,000	229
8597-76	Same as 8597-78 except includes 1024K bytes	1,755	1,170	42,110	355
8597-01	DCP/20 Expansion Cabinet; includes freestanding cabinet, power supply, and processor capable of I/O functions; provides mounting for 8 line modules (up to 16 line modules with F2894-00); requires 1936-00	656	525	24,000	119
F3539-00	Storage Expansion; provides additional 128K bytes storage, max. of 2 can be added to DCP/20	131	105	4,500	24
F3539-99	Storage Expansion; provides additional 256K bytes of storage; max. of 1 can be added to DCP/20	225	150	8,650	48
F1939-00	Integrated Flexible Disk; provides control and one flexible disk drive for 256K-byte diskettes; required for basic DCP/20	53	42	1,920	12
1936-00	Storage Port Expander; provides a multiplexed interface to a single local storage access port for up to four requestors	95	75	3,550	19
F2894-00	Line Module Expansion; provides expansion for additional 8 line modules in 8597-01	460	250	12,000	60
F2895-00	Active line Indicators; provides the capability to monitor up to 16 half-/ full-duplex lines in 8597-01.	25	20	890	4
<b>DCP/10A</b>					
1986-75	Basic DCP/10A; freestanding cabinet, communications processor, 512K bytes of storage expandable to 2048K bytes, power supply, active line indicators, microprogram storage, microprograms, multiple device line module, diskette drive with controller. Works with Mapper 10, System 11, or Series 1100 hosts	623	415	14,950	159
1986-73	DCP/10A; same as 1986-75 but includes processor with 1024K bytes	852	568	20,450	229
1986-71	DCP/10A; same as 1986-75 but also includes an integrated 10MB rigid disk drive	740	493	17,750	210
1986-69	DCP/10A; same as 1986-75 but includes processor with 1024K bytes and a 10MB integrated rigid disk drive	939	646	23,250	939
2005-75	DCP/10A; same as 1986-75 but does not include cabinet; requires housing in a customer-provided, industry-standard cabinet	587	386	13,716	152
2005-73	Same as 2005-75 except includes processor with 1,024K bytes	816	539	19,216	222

\*Lease prices do not include maintenance.

\*\*Preconfigured DCP/40 models require the following separately priced options in addition to the components listed in each model description; UTS 20 or UTS 400 console; direct connect cable, modems, or DCM to connect console to DCP.



## Sperry DCP Series Communications Processors

		Monthly Charges*			
		1-Year Lease (\$)	5-Year Lease (\$)	Purchase Price (\$)	Monthly Maint. (\$)
2005-71	DCP/10A; same as 2205-75 except also includes a 10MB integrated rigid disk drive	704	464	16,516	203
2005-69	DCP/10A; same as 2005-75 except includes processor with 1024K bytes and a 10MB integrated rigid disk drive	903	617	22,016	273
F3891-03	Storage expansion; expands DCP/10A with 512K bytes from 512K bytes to 1024K bytes. Can be expanded up to a max. 2048K bytes by adding F4427-00	433	289	10,400	70
F4443-99	DCP/10A Storage Conversion; provides conversion of an installed DCP/10 to allow storage expansion above 512K bytes	433	289	10,400	70
F4427-00	Storage expansion; expands DCP/10A or DCP/10 with F4443-99 installed, from 1024K bytes to 1536K bytes, or from 1536K bytes to a max. of 2048K bytes	433	289	10,400	70
8409-99	8409 Disk subsystem; provides cabinet, control, and one 4.6M-byte disk drive; may be expanded to 14.0M bytes by the addition of F4085-00	376	280	9,650	82
F4085-00	Expands the capacity of one 4.6M-byte drive from 4.6MB to 14.0M bytes	100	74	1,096	12
<b>Options</b>					
8590-00	Remote Control Module (RCM); provides remote control of DCP/40s, DCP/20s, or DCP/10As through communications line for power on/off, IPL, and other control functions	355	280	13,526	61
F1937-00	Remote Control Adapter; provides RCM with interface to DCP/40	48	38	1,824	11
F2893-00	Remote Control Adapter; provides RCM with interface to DCP/20	48	38	1,824	11
F3898-00	Remote Control Adapter; provides RCM with interface to DCP/10A	50	40	1,915	11
2523-00	Line Switch Module (LSM); provides capability to switch communications lines and/or peripherals from a local or remote source under program control through a direct or communications line DCP/40, DCP/20, or DCP/10A connection	748	597	28,750	112
F3556-00	RCM/LSM Local Control Interface	95	75	3,600	16
F3557-00	RCM/LSM Microprograms	9	7	350	1
1962-00	LSM Auxiliary Cabinet (for DCP/40 and DCP/20)	197	143	6,872	39
F3105-00	Modem Expander, RS-232-C	38	30	1,440	4
F3109-00	LSM Switch; RS-232-C; controls up to 8 lines	132	102	4,930	22
F3110-00	LSM Switch; CCITT V.35; controls up to 8 lines	245	195	9,325	43
F3112-00	LSM Switch, RS-449, controls up to 4 lines	156	125	6,000	27
F3113-00	LSM Switch, 16-bit I/O, controls up to 4 channels (DCP/40 and DCP/20)	188	150	7,200	33
F3559-00	LSM Switch, AT&T 303; controls up to 4 lines	440	350	16,800	82
F3835-00	Remote Partitioning Feature; for Series 1100 Multiprocessor partitioning	25	20	960	5
<b>Line Modules</b>					
F1946-02	Word Channel Interface; provides full-duplex interface to Series 1100 host processor word channel; max. 2 per basic or expansion cabinet	110	89	4,000	23
F1947-02	Byte Channel Interface; for connection to Series 90 host processor byte multiplexer or block multiplexer channel (DCP/40 and DCP/20)	105	85	4,000	23
F1947-03	8-bit Peripheral Interface to a Series 1100 host processor block multiplexer channel (DCP/10A)	105	85	4,000	23
F1948-01	16-bit Peripheral Interface; operates in 8-bit or 16-bit mode	84	68	3,000	16
F1949-00	Byte I/O Line Module; provides 8-bit interface for flexible diskette subsystem; for DCP/20 only	30	25	1,045	4
F1941-00	Asynchronous Interface; provides full-duplex RS-232-C/V.24/V.28 interface for data rates of 45.5 to 2400 bps	25	20	960	3
F1942-00	Synchronous Interface; provides full-duplex RS-232-C/V.24/V.28 interface for data rates up to 9600 bps	26	21	960	3
F3165-00	Multiline Asynchronous Interface; provides full-duplex support for four communications lines up to 2400 bps with RS-232-C/V.24/V.28 interface; Automatic Data Rate Detection (ADRD) is provided	79	63	2,880	14
F1945-00	Auto Dialing Line Module; provides interface to AT&T 801 and V.24/V.25 compatible automatic calling units; requires F1941-00, F1942-00, or F3163-00	25	20	1,005	4
F1945-01	Auto Dialing Line Module; conforms to NTT (Japan) requirements	25	20	1,005	4
F3163-00	Medium Speed Loadable Interface; provides full-duplex asynchronous and synchronous RS-232-C/V.24/V.28 interface; also operates with AT&T DDS; data rate depends on protocol used; up to 19.2K bps; async provides auto baud rate detect	35	30	1,275	8
F3163-01	Same as F3163-00 except with X.21 interface up to 9600 bps	63	50	2,500	14
F3163-04	Same as F3163-00 except with RS-449 interface up to 9600 bps	50	40	1,920	11
F3164-01	High-Speed Loadable Interface; provides V.35 interfacing; data rate depends on protocol used; up to 64K bps	100	80	3,745	21
F3164-00	Same as F3164-01 except with AT&T 303 interface	188	150	7,200	38
<b>Peripherals</b>					
8408-02	Cartridge Disk Control; houses up to 2 F2380-04/06 drives	146	109	5,564	32
8409-99	8409 Disk Subsystem; provides cabinet, control, and one 4.6M-byte disk drive; may be expanded to 14.0M bytes by the addition of F4085-00	378	280	9,650	82
F4085-00	4.6MB to 14.0MB expansion	100	74	1,096	12

\*Lease prices do not include maintenance.

\*\*Preconfigured DCP/40 models require the following separately priced options in addition to the components listed in each model description; UTS 20 or UTS 400 console; direct connect cable, modems, or DCM to connect console to DCP.

## Sperry DCP Series Communications Processors

		Monthly Charges*			
		1-Year Lease (\$)	5-Year Lease (\$)	Purchase Price (\$)	Monthly Maint. (\$)
F2380-04	Cartridge Disk Drive; 10MB; 100/120 volt	461	330	17,750	124
F2380-06	Cartridge Disk Drive; 10MB; 220/240 volt	461	330	17,750	124
F2187-00	Dual I/O Interface for Cartridge Disk	39	29	1,568	9
0871-01	Uniservo 10 Magnetic Tape Unit; requires F2721-00; second 0871-01 requires F2879-00	318	239	13,962	93
F2721-00	Uniservo 10 Controller; provides control for up to two Uniservo 10 tape units; requires F1948-00	284	215	10,320	56
F2879-00	AC Power Switch	32	25	1,200	5
3560-93	UTS/20 Console; 120 V, 60 Hz. Requires synchronous communications interface	128	97	3,225	33
3560-92	UTS/20 Console; 100/120/220/240 V, 50/60 Hz. Requires synchronous communications interface	128	97	3,225	33
0797-99	Console Printers; 80 cps; 80-column matrix impact printer	67	50	750	29
0798-99	Console Printer; 200-cps, bidirectional 132-column matrix printer	188	156	4,000	70
F3145-00/	Also F3145-03; Diskette Expansion; provides expanded 1M bytes of storage for the flexible diskette; for DCP/20 only	67	44	1,500	11
01/02		67	44	1,500	11

\*Lease prices do not include maintenance.

\*\*Preconfigured DCP/40 models require the following separately priced options in addition to the components listed in each model description; UTS 20 or UTS 400 console; direct connect cable, modems, or DCM to connect console to DCP.

## SOFTWARE PRICES

		Single Extended Term (\$)	Monthly Rent (\$)	Monthly LSS Charge (\$)
<b>Software</b>				
6136-02	DCP/40 O/S; provides for DCP/40 operation under Telcon	13,500	300	—
6136-95	DCP/20 O/S; provides for DCP/20 operation under Telcon	9,000	200	—
6136-92	DCP/10A O/S; provides for DCP/10A operation under Telcon	6,750	150	—
6257-00	X.25 packet switching software for DATEX-P (German) PDN	7,875	175	35
6257-01	X.25 packet switching software for PSS (United Kingdom) PDN	7,875	175	35
6258-00	X.21 circuit switching software for Nordic public circuit switched data network	7,875	175	26
6276-00	3270 BSC Terminal Handler	6,750	150	—
6276-01	3270 BSC Inverted Terminal Handler	4,500	100	—
6277-00	2780/3780 Inverted Terminal Handler	3,375	75	—
F6124-00	SNA/UTS Gateway; for use with Telcon O/S (Level 5 or higher) and Telcon/IBM SNA base (6843-00), both of which are a prerequisite; provides access to IBM SNA hosts by UTS terminals	4,500	100	15
F6124-01	SNA/3270 Gateway; for use with Telcon O/S (Level 5 or higher) and Telcon/IBM SNA base; provides access in either point-to-point or multipoint configurations	7,875	175	26

\*Does not include software support service, which must be ordered separately. ■

# Sperry Univac DCP/40 and DCP/20 Communications Processors

## MANAGEMENT SUMMARY

Sperry Univac released its DCP/40 communications processor in June 1979. Two years later, in June 1981, they introduced a smaller version, the DCP/20, to the product line. Both models are multiprocessor-based systems that can act as front-end processors to a Sperry Univac 1100 Series or Series 90 mainframe, or as remote intelligent concentrators or nodal processors in a Sperry Univac or multiple-vendor network.

The system architecture used in the DCP/40 and DCP/20 distributes processing operations between one general-purpose processor, multiple I/O processors, and microprogrammed line modules. The general-purpose processor handles general communications tasks. In the DCP/20, the general-purpose processor can also support up to 16 line modules; in the DCP/40, all line modules must be supported by I/O processors. The I/O processors are physically identical to the general-purpose processor and are dedicated to I/O handling tasks. Each I/O processor supports up to 16 line modules.

Connections to remote equipment via data communications lines, to local peripheral devices, and to on-site host computer channels are accommodated by various line modules. Each line module provides interfacing for a specific type of channel or device.

The DCP/40 supports up to 16 I/O processors and up to 256 synchronous, full-duplex communications lines. With the use of asynchronous interface cards, which accommodate up to four lines per card, the DCP/40 can support up to 1024 asynchronous lines. Maximum main memory for the DCP/40 is 3.5 megabytes.

The DCP/20 is a scaled-down version of the DCP/40, offering most DCP/40 features to the smaller user at considerable cost savings. The DCP/20 supports up to ➤

Communications processors that act as front-ends to a Sperry Univac 1100 Series or Series 90 mainframe, or as nodal processors or remote concentrators in a Sperry Univac or multi-vendor network.

The DCP/40 supports up to 256 synchronous or 1024 asynchronous connections to host processor channels, local peripherals, and communications lines. The DCP/20 supports up to 48 synchronous lines or 192 asynchronous lines. Any mix of speeds, up to 64K bps, and a broad range of protocols are supported via program-loadable line modules.

Purchase price for a basic DCP/40 system that supports 16 asynchronous communications lines is \$155,919; this price includes the required integrated flexible disk drive, 16 line modules, interfaces, and cartridge disk subsystem; the monthly price for a five-year lease is \$2,853.

Purchase price for a basic DCP/20 system serving up to 16 ports is \$39,524; this includes the required integrated flexible disk and controller and cartridge disk with peripheral interface; the monthly price for a five-year lease is \$814.

## CHARACTERISTICS

**VENDOR:** Sperry Univac Division, Sperry Corporation, P.O. Box 500, Blue Bell, Pennsylvania 19422. Telephone (215) 542-4011.

**DATE OF ANNOUNCEMENT:** DCP/40—June 1979; DCP/20—June 1981. ➤



*The DCP/20 Processor (center) is shown in configuration with (from left to right) the cartridge disk subsystem, one Uniservo 10 tape drive, and the optional operator's control console and impact console printer.*

## Sperry Univac DCP/40 and DCP/20 Communications Processors

**TABLE 1. DCP/40 AND DCP/20 SERIAL COMMUNICATIONS LINE MODULE OPTIONS**

Feature No.	Line Module	Interfaces	Protocols	Data Rates
F1942-00	Synchronous (half- or full-duplex)	EIA RS-232-C, CCITT V.24 and V.28	Synchronous; Uniscope	Up to 9600 bps
F1941-00	Asynchronous (half- or full-duplex)	EIA RS-232-C, CCITT V.24 and V.28	Asynchronous; Uniscope or teletypewriter	Up to 2400 bps
F3165-00	Multiline asynchronous (half- or full-duplex)	EIA RS-232-C, CCITT V.24 and V.28	Teletypewriter**	Up to 2400 bps
F1945-00	Automatic dialing	EIA RS-366 (Bell 801) CCITT V.24 and V.25	Protocol independent	—
F1945-01	Automatic dialing	NTT (Japanese) compatible	Protocol independent	—
F3163-00	Medium-speed loadable* (half- or full-duplex)	EIA RS-232-C, CCITT V.24 and V.28	Basic asynchronous** Basic synchronous UDLC BSC REM 1 NTR	Up to 19,200 bps, except up to 9600 bps for BSC
F3163-04	Medium-speed loadable* (half- or full-duplex)	EIA RS-449	Basic synchronous UDLC BSC REM 1 NTR	Up to 9600 bps
F3163-01	Medium-speed loadable* (half- or full-duplex)	CCITT X.21	Basic synchronous UDLC BSC NTR	Up to 9600 bps
F3164-01	High-speed loadable* (half- or full-duplex)	CCITT V.35	Basic synchronous UDLC BSC REM 1 NTR	Up to 64,000 bps
F3164-00	High-speed loadable (half- or full-duplex)	Bell 303	Basic synchronous UDLC BSC REM 1 NTR	Up to 64,000 bps

\* Program-loadable protocols.  
\*\*Includes auto baud rate detection.

➤ two I/O processors and up to 48 synchronous, full-duplex communications lines. With the use of the four-line asynchronous interface cards, up to 192 asynchronous lines can be supported. Maximum main memory is 512K bytes.

The options and capabilities of the DCP/40 and DCP/20 can be better appreciated when its role in Sperry Univac's Distributed Communications Architecture (DCA) is kept in mind. Essentially, DCA is a set of ground rules that defines the functions that each element within a communications network should perform. Furthermore, DCA defines the standards for interfacing between elements. The goal is to permit interconnection of dissimilar hardware/software into one communications network in compliance with DCA ground rules. Under DCA, interconnection of a vast array of line disciplines, supporting an even larger array of terminal types, is permitted. Not unexpectedly, therefore, the range of line interfaces provided with the DCP/40 and DCP/20 is rather extensive. Table 1 in this report lists the DCP interfaces supported by Sperry Univac's network architecture.

➤ **DATE OF FIRST DELIVERY: DCP/40—July 1979; DCP/20—early 1982.**

**NUMBER DELIVERED TO DATE: DCP/40 and DCP/20 combined total—approximately 500.**

**SERVICED BY: Sperry Univac.**

### CONFIGURATION

#### DCP/40

The Distributed Communications Processor/40 (DCP/40) is a multiprocessor, multitasking system that can serve as a front-end processor to an 1100 Series or Series 90 host computer, or as a nodal processor or remote intelligent concentrator in a Sperry Univac or multi-vendor network. All functional characteristics are provided in microcode, which is loaded into system memory.

The basic DCP/40 includes a communications processor; the basic DCP/40 microprograms (stored on an integral diskette); a storage controller and one 512K-byte RAM storage module; an input/output controller and one input/output processor (IOP); a line module chassis with space for up to 16 line modules for connection of host computers, local peripherals, and communications lines (line modules are priced separately); power supplies and a power

## Sperry Univac DCP/40 and DCP/20 Communications Processors

### Configuration

DCP/40

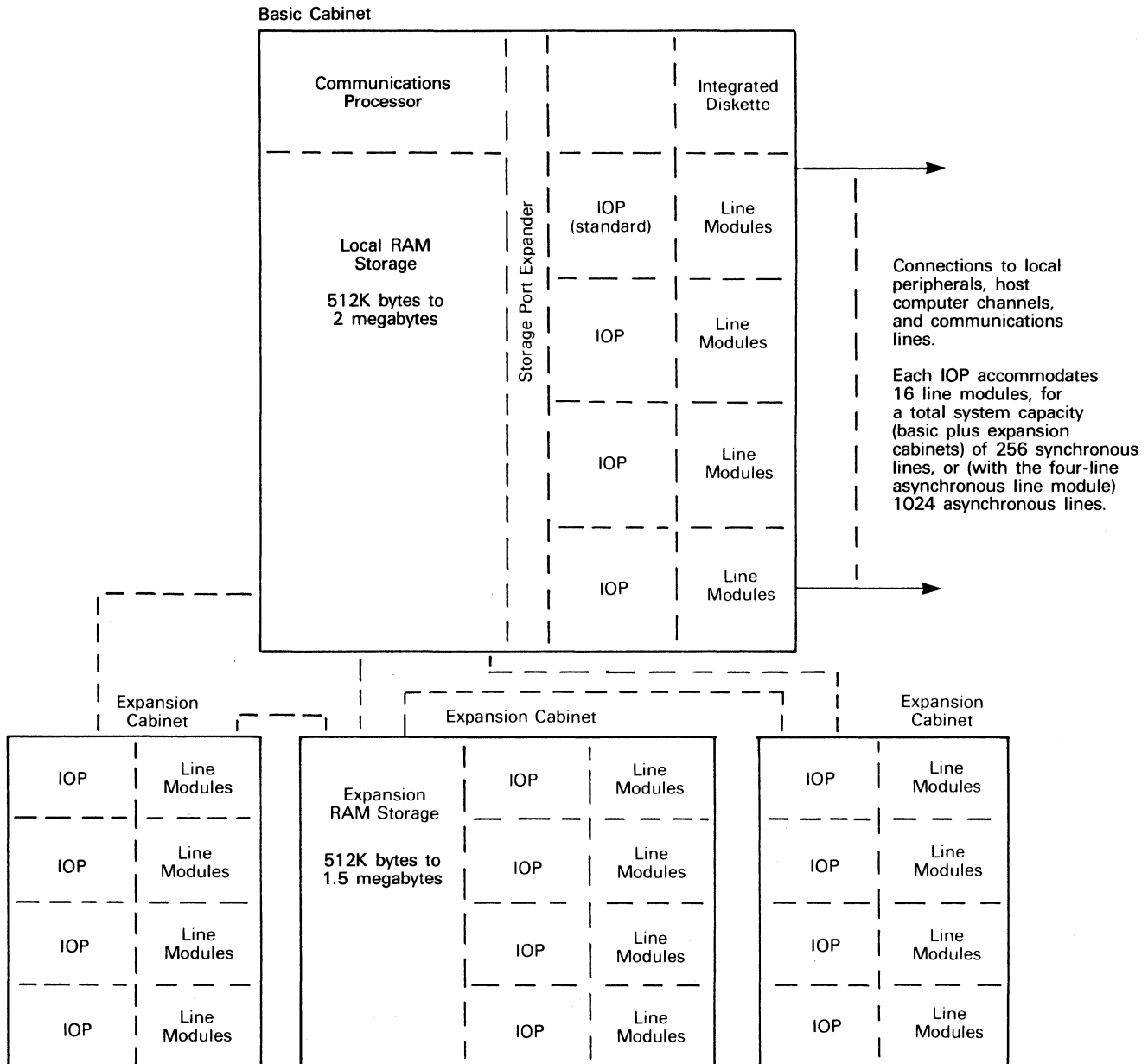

➤ Another DCA concept is to produce hardware (e.g., the DCP/40) that operates under software (e.g., Telcon), not software operating under hardware. Portions of the DCA software reside in the DCP/40 or DCP/20, portions in the host computers, and still other portions in a DCA intelligent terminal in the network. Within Telcon, the DCP performs the specific functions of communications processing and line concentration, providing the user with no programmatic tools to alter the assigned function. However, within the assigned function, the hardware options and own-coding provisions provide significant flexibility.

➤ controller; an integrated diskette drive and controller (separately priced but required); an operator's panel; and a maintenance panel. All of these components are contained in a single free-standing cabinet. The basic configuration also includes an external dual-drive disk subsystem that provides a total of 10MB of storage (separately priced).

The contents of the basic cabinet can be expanded to include up to three additional 512K-byte storage modules, for a single-cabinet capacity of 2M bytes, plus up to three additional IOPs and three additional line module chassis, for a single-cabinet capacity of 64 line modules. (If more than two IOPs are contained in the basic cabinet, a storage port expander, which permits multiple IOPs and I/O devices to share storage access ports, is also required.)

## Sperry Univac DCP/40 and DCP/20 Communications Processors

➤ New options available for the DCP/40 and DCP/20 include a remote control module, a line switch module, and a switch for high speed communications lines. The remote control module provides the capability to control the power on/off and other functions of up to four DCP/40 or DCP/20 processors via communications lines; the module requires microprograms, also supplied by Sperry, for operation. The line switch module provides the capability to switch communications lines or peripherals from a local or remote source under program control via a direct connection or a communications line connection. The high speed switch enables four wideband communications lines to be switched from one communications controller to another.

### USER REACTION

In November 1982, Datapro interviewed Sperry Univac DCP/40 users at a large eastern university and a southern service bureau. They each lease one DCP/40 from the vendor, who services it, and use the DCP/40 as a communications front-end processor interfaced to a Sperry Univac 1100 mainframe.

The DCP/40 was installed in the service bureau about 18 months ago. At the time of selection, it was the only communications processor available that could handle the service bureau's load, the user said. Currently serving 35 lines, the DCP/40 is being expanded to accommodate 108; interfacing the system with an IBM mainframe is also planned.

In this user's experience, one advantage of the DCP/40 is its relative compactness compared to other communications devices. A weakness is that its cartridge disk is not reliable; "It powers itself off," he said, "It's not too stable."

The university contacted in the interview has been using a DCP/40 for about a year. The DCP/40 serves 96 lines using single-line cards.

A notable advantage, according to this user, is the fact that the DCP/40 accommodates speed-selectable line modules, and the user doesn't have to worry about communicating with different terminals. Another advantage stated is the ease of expanding the system: a single cabinet was obtained initially; when the user decided to add an expansion cabinet, the installation was completed in only one day instead of the three days he had expected. The only disadvantage of the DCP/40 noted by this user is that when something goes wrong, it takes a long time, about a half hour, to restart the system; he would like to shorten the restart time. "On the whole, we've been quite pleased with its performance," the user commented, adding that a few bugs present at the beginning have been corrected.

These two users were given the opportunity to rate various elements of the DCP/40 as Excellent, Good, Fair, or Poor. Both users rated the DCP/40 Good in ➤

➤ If further expansion is required, up to three expansion cabinets can be configured with the system. (If more than two expansion cabinets are added to the basic system, a storage port expander is required in the basic cabinet.) Each expansion contains its own power supplies and power controller, and can accommodate one I/O controller, up to four IOPs, storage port expanders as needed, and associated line module chassis and line modules. In addition, one (but only one) expansion cabinet per system may also contain up to 12 128K-byte RAM storage modules, grouped into three 512K-byte storage banks; each bank has its own controller.

Thus, the total maximum RAM storage capacity per DCP/40 system is just over 3.5 megabytes, while the total maximum I/O capacity is 256 synchronous or 1024 asynchronous line modules.

Additional disk subsystems may be added to the first. One or two magnetic tape drives can also be added to the system.

A UTS/20 display station and a serial printer may optionally be attached for use as a local system console. The host system console can also function as a local DCP/40 console if it is configured as a terminal to the network. An optional free-standing desk-type work surface, on which the console can be placed, is also available.

The communications processor performs general-purpose processing tasks, as well as functions specific to network and local-site operations, under the control of microcoded programs loaded into local RAM storage. The processor includes a microcontroller that supports the internal bus structure, timing mechanism, control storage, dual arithmetic logic units (for comparing and checking computations), error checking and logging schemes, automatic instruction retry routines for microinstruction failure, and automatic restart and recovery procedures.

Local RAM storage is organized into one to four storage banks. Each bank contains 512K bytes of storage, for a system total of over 3.5 megabytes. Error checking logic provides for correction of all single-bit errors and flagging of all double-bit errors. All errors are automatically logged so that the processor can analyze the frequency of hardware failures and take any necessary recovery actions.

The communications processor and each device connected to the system through an IOP has direct, independent access to local storage. Storage is accessed via multiple storage ports. Four ports are provided in the basic cabinet, and four additional ports are provided in the expansion cabinet if any expansion storage is configured. If all available ports are occupied, cascaded storage port expanders are used to multiplex groups of requesters to each of the storage ports. Priority schemes in system logic handle simultaneous requests for storage access.

The system's I/O processors manage all input/output tasks. Each IOP provides programmed control for up to 16 line modules, and performs data exchanges, buffer allocation, message formatting, message recovery and retransmission, status reporting, statistics gathering, and polling.

Optional active line indicators can provide a visual display of line activity on data sets connected to an IOP. Each active line indicator displays activity for up to 16 lines on a single IOP, or, with an optional switching feature, for up to 64 lines on four IOPs. Each active line indicator is mounted on the top of the cabinet containing the IOP(s) to which it is connected.

The line modules are plug-in programmed interfaces that provide for connection of all external devices to the DCP/40 system. Various modules accommodate half- or full-duplex communications lines, host computer channel interfaces, or ➤

## Sperry Univac DCP/40 and DCP/20 Communications Processors

▷ overall performance and in quality of manufacturer's software/firmware. From these two users, the DCP/40 received one Excellent and one Fair rating for ease of installation, one Good and one Fair for ease of operation, one Excellent and one Good for ease of expansion, one Excellent and one Good for hardware reliability, one Good and one Poor for ease of programming, one Excellent and one Good for quality of manufacturer's maintenance service, and one Excellent and one Good for quality of manufacturer's technical support. □

▶ local peripheral interfaces. Each module is loaded with a microcoded program that supports the specific data format, transmission method, and other requirements of the line to be connected. The line modules also perform such functions as: data conversion (from parallel to serial and vice versa), data buffering, character parity and block check sequence generation and checking, character counting and control character recognition, and line timing and asynchronous clocking. Up to 256 line modules can be configured with a DCP/40 system, since in general, each line module occupies a single IOP port. The exception is that the byte-channel host interface line module, which provides for connection to a Series 90 or 1100/80 host computer, requires two IOP ports.

Local peripherals are attached to the system through the IOPs via the Sixteen-Bit Peripheral Line Module for the disk and magnetic tape drives.

Line modules for connection of host computer interface channels and communications lines are described under "Transmission Specifications."

Reliability features are built into each layer of the DCP/40's architecture. In addition to the error detection, logging, and correction schemes already mentioned, the system can support: configurational redundancy in both internal elements such as local storage, I/O processors, and line modules, as well as in the external network; virtual storage mapping that prevents software errors in any single system module from causing total system failure; and diagnostic programs in both macrocode and microcode that provide both online and offline tests of system and network components. DCP/40 dumps, as well as error logs and statistics reports, can be transmitted to the host upon demand by the host or DCP/40 console operator.

### DCP/20

The DCP/20 is a smaller version of the DCP/40. The basic configuration includes a general-purpose processor, 256K bytes of main memory, and support for up to 16 line modules. The main memory can be expanded in two 128K- or 256K-byte increments to a maximum of 512K bytes. Up to two optional I/O processors may be added to the basic system, each of which can support up to 16 line modules, for a system maximum of 48 line modules.

Available peripherals to the DCP/20 include: 10MB or 20MB cartridge disk subsystem; up to four dual flexible disk subsystems, for a total diskette storage capacity of 8MB; one or two Uniservo 10 magnetic tape drives; an operator's control console, which may be a Uniscope 200, UTS 400, or UTS 4000 CRT terminal; and an optional slave console printer, available in either 80-cps impact or 200-cps bidirectional impact models. The Sixteen-Bit Peripheral Line Module is used to connect the cartridge tape and magnetic tape subsystems to the DCP/20; the Byte I/O Line Module is used to connect the flexible disk subsystems.

### TRANSMISSION SPECIFICATIONS

Line modules that connect remote devices, local peripherals, and host computers to the system are attached to the DCP via the IOP ports. Each IOP provides 16 ports. Up to 16 IOPs may be configured with a DCP/40, so that a maximum of 256 line modules can be accommodated. On the DCP/20, both the general-purpose processor and the IOPs provide line module ports. The DCP/20 supports up to two IOPs and up to 48 ports.

A number of serial line modules are offered to support connection of remote devices to the system over communications lines. RS-232-C, CCITT V.24/V.28, RS-449, and X.21 interfacing is supported in half- or full-duplex mode at speeds up to 19.2K bps. Wideband V.35 interfacing is supported at speeds up to 48K bps (Europe) or 64K bps (U.S.). Bell Digital Dataphone Service (DDS) connections are supported at up to 56K bps. An automatic dialing line module provides interfacing to a Bell 801 or equivalent or CCITT V.24/V.25-compatible automatic calling unit, permitting placement of dialed calls under program control.

A remote control module, using microprograms, allows remote control of the power on/off, IPL, and other functions of up to four DCP/40 or DCP/20 processors via communications lines.

With an optional line switch module (LSM) operating under microprograms, the communications lines or peripherals can be switched from a local or remote source via a direct connection or communications line connection. The LSM consists of a cabinet, power supply and control, and control logic. One communication interface feature (F3163-00 or -04) is required to attach the LSM to a modem.

Various switches are available that provide the capability to switch eight RS-232-C communication links, eight V.35 lines, four RS-449 lines, four wideband lines, or four 16-bit peripheral interfaces from one communications controller to another.

Protocols supported by the communications line modules include teletypewriter, asynchronous or synchronous UNISCOPE protocol, Universal Data Link Control (UDLC), 1100 full-duplex (FDX—used with Series 1100 equipment), REM1 (used with Sperry Univac 9200, 9300, or 90/30 Series processors and the 1004 card processor), Nine-Thousand Remote (NTR—also used with 9000 Series Processors), and IBM Binary Synchronous Communications (BSC). Two types of line modules, the Medium Speed Line Modules and the High Speed Line Module, can be loaded with microprograms for specific line protocols.

**CONNECTION TO THE HOST:** A DCP/40 or DCP/20 system may be connected to a host computer remotely via communications lines or directly via a host processor channel. Remote connections can be made to Sperry Univac 1100 Series and Series 90 mainframes, IBM computers, and other systems compatible with the line protocols supported by the DCP/40 or DCP/20 communications line modules.

Two parallel line modules are provided for direct-channel connection: the Byte-Channel Line Module provides an interface to a Sperry Univac Series 90 or 1100/80 processor via its byte multiplexer, block multiplexer, or selector channel; the Word-Channel Line Module provides an interface to an 1100 Series processor via its 32-bit internally specified index (ISI) word channel. Up to four channel interface modules (either type) can be accommodated per DCP/40 or DCP/20 cabinet. The Word-Channel Line Module occupies one line module port; the Byte-Channel Line Module occupies two line module ports. The maximum data transfer rate is 1.2 megabytes per second. Maximum cable length is 200 feet. ▶

## Sperry Univac DCP/40 and DCP/20 Communications Processors

### ► SOFTWARE

Data Communications Architecture (DCA) is a set of rules and guidelines that permits users who comply to be able to tie their scattered electronic data processing elements into an interconnected network. In effect, Sperry Univac has identified the necessary tasks, separated the tasks into functions, and standardized the rules for interfaces. This permits the interconnection of network elements with dissimilar hardware and support software. One component of DCA is the Telcon system, a combination of hardware and software to interconnect remote terminals with Sperry Univac mainframe processors. The software portion of Telcon includes the software operative in the DCP/40 or DCP/20, the related support software in the host, and the software to provide standardized DCA interfaces for certain intelligent terminals.

Telcon supports interactive, batch, and transaction-oriented data transfers. Under Telcon, all data is processed concurrently and is interleaved on UDLC circuits between nodes. In a multinode environment, any terminal has access to any host in the network, and can be switched from one application or operational mode to another.

The DCP/40 or DCP/20 with its resident Telcon software can serve as a front-end processor to one or more Sperry Univac 1100 Series or Series 90 hosts, or as a nodal processor or a remote concentrator to one or more 1100 Series, Series 90, Series 80, V77, IBM, or compatible systems or to another DCP/40 or DCP/20 system.

Telcon provides the DCP/40 or /20 with comprehensive network management facilities for distributed or hierarchical networks, through which it can maintain, control, monitor, and protect the network. Through Telcon, the DCP controls the establishment of sessions, access to various network systems, and allocation and use of network resources. As the network grows or changes, the DCP can be dynamically reconfigured to support new network components.

The major tasks performed by the Telcon operating system within the DCP/40 or /20 are:

- **Basic Executive**—Schedules processor time based on user priority. Equal priority users are handled on a first-in, first-out basis. Dispatches time-related functions, including suspension of a user for a specific time period. Also provides administrative functions, such as loading, deactivation, buffer management.
- **Hardware Interface Routines**—Provides the software support for the IOPs and line modules.
- **File management**—provides device-independent control of disk, diskette, and magnetic tape drives.
- **I/O Control**—Manages the queuing of all incoming and outgoing messages, including passing messages from one DCP to another. When possible and necessary, the software can seek alternate routing and performs pacing of the number of messages to a given user.
- **Network Management Services**—Provides fundamental control and monitoring of the system, control of security, and the establishment of session links.
- **Loading and Initialization**—The integrated diskette contains the first load block, which calls in the bootstrap loader from local mass storage, the host computer, or another DCP system. The bootstrap performs initialization functions and loads the system's operating software to complete the initialization process.

Recently, Sperry Univac has also announced DCA support for access to several European and Canadian public data networks. This X.25 packet switching and X.21 circuit switching support takes the form of line modules for DCP Series processors and software packages that run under the Telcon system. Such modules are available for the following packet-switching services: the Nordic PDN in Scandinavia, PSS in the United Kingdom, Datex-P in West Germany, Transpac in France, and Datapac in Canada. Future support is expected for packet-switching services provided by GTE Telenet in the U.S., DN-1 in the Netherlands, DDX in Japan, Austpac in Australia, Telepac in Switzerland, and Datex-P in Austria.

### COMPONENTS

**COMMUNICATIONS PROCESSOR:** The communications processor utilizes a 32-bit microinstruction format and a 17-bit virtual byte address, which is translated to a 24-bit real address by the processor. The processor provides 128 general-purpose 16-bit registers, plus several specialized registers. The communications processor instruction set contains approximately 285 unique instructions for native mode operations. Microinstruction execution cycle time is 65 nanoseconds.

Maximum local RAM storage capacity is 512K bytes (DCP/20) to just over 3.5 megabytes (DCP/40), expandable in 128K, 256K (DCP/20 only), or 512K (DCP/40 only) increments. Data is formatted in storage as a 32-bit word, made up of 8-bit bytes. Read cycle time for a 32-bit word is 400 nanoseconds. Read access time is 300 nanoseconds. Single-bit, 4-bit, 8-bit, 16-bit, or 32-bit data quantities may be accessed from storage; the write cycle for partial or full words is 450 nanoseconds.

**I/O PROCESSORS:** The IOPs utilize a 16-bit microinstruction format and a 14-bit virtual byte address, which is translated to a 24-bit real address by the processor. An IOP can transfer data at up to 1.2 megabytes per second. The IOP instruction set contains approximately 83 unique instructions. Microinstruction execution cycle time is 80 nanoseconds.

**INTEGRATED DISKETTE:** A 256K-byte diskette drive and a diskette controller are required for initial system loading. It can also be used to store diagnostic programs, statistics, error logs, network control tables, and additional downloaded functions. The diskette controller interfaces with the system through an IOP and occupies the space of one line module.

**CARTRIDGE DISK:** The Model 8408 cartridge disk subsystem can provide up to 10 megabytes of mass storage in a single cabinet for the DCP/40 or DCP/20 system; it can also be used as a system loading device in lieu of a diskette subsystem. The subsystem consists of a controller and one or two top-loading dual-spindle disk drives. Each drive provides 5MB of fixed and 5MB of removable disk storage. The data transfer rate for a Model 8408 drive is 2.5MB per second, and the average access time is 50 milliseconds. The cartridge disk subsystem is connected to the DCP through an IOP via a 16-bit peripheral interface. A dual I/O interface option permits the subsystem to be shared by two different channels of one DCP or by two separate DCP systems. Multiple drives can be attached via separate line modules.

**MAGNETIC TAPE SUBSYSTEM:** The Model 0871 Uniservo 10 magnetic tape subsystem contains a tape controller and a single 9-track 800/1600 bpi tape drive; a second, separately cabinet drive can be added. The data transfer rate is 40K bytes per second for PE formats or 20K



## Sperry Univac DCP/40 and DCP/20 Communications Processors

► bytes per second for NRZI formats; the tape speed is 25 ips. An automatic threading function is standard. The magnetic tape subsystem connects to the DCP through an IOP via a 16-bit peripheral interface.

**CONSOLE:** A UTS 20 display terminal may be used optionally as a local display console. The UTS 20 is a fully-featured editing/formatting terminal that provides a maximum screen capacity of 1920 characters, a typewriter keyboard, and a full upper/lower case ASCII character set. An optional auxiliary interface is available for the UTS 20 for attachment of a slave printer.

### PRICING

The Sperry Univac DCP/40 and DCP/20 are available for purchase or on a one-year or five-year lease. Sperry Univac also offers a 7-year lease to state and local governments and to educational institutions. Educational institutions are eligible for an additional 10 percent discount. The discount does not apply to maintenance service charges. The basic maintenance charge covers maintenance of the equipment for nine consecutive hours a day between the hours of 7 a.m. and 6 p.m., Monday through Friday. Extended periods of maintenance are available at premium rates.

		Monthly Charges*			
		1-Year Lease	5-Year Lease	Purchase Price	Monthly Maint.
<b>DCP/40</b>					
8596-96	Basic DCP/40; includes free-standing cabinet, communications processor, first storage controller, 512K bytes of storage, first I/O controller module, first I/O processor, ROM memory, and microprograms; requires integrated flexible disk drive, (F1939-00), line modules, and cartridge disk subsystem (8408 plus F2380)	\$2,195	\$1,755	\$84,245	\$415
1945-00	DCP/40 Expansion Cabinet; includes free-standing cabinet, power supply, and power controller; max. 3 per system, only one of which may contain storage; third expansion cabinet requires storage port expander (F1936-00)	705	565	27,060	134
F1930-00	Storage Expansion; provides additional 128K bytes of storage; for expansion memory via DCP/40 expansion cabinet (1945-00)	145	115	5,570	29
F1930-01	Storage Expansion; provides additional 512K bytes of storage; up to 3 F1930-01 modules may be added to basic DCP/40; additional 128K-byte (F1930-00) modules may be added to DCP/40 expansion cabinet via F2942-00 and F1929-99; max. 3.5M bytes total storage per system	410	325	15,600	116
F1930-00	Storage Expansion; provides additional 128K bytes of storage; for expansion of memory via expansion cabinet (1945-00)	145	115	5,570	29
F2942-00	Second Storage Controller; mounts in expansion cabinet; includes 128K bytes of storage plus support for three additional 128K storage expansion modules; max. 1 per system	700	560	26,880	133
F1929-99	Third/Fourth Storage Controller; mounts in expansion cabinet; includes 128K bytes of storage plus support for three additional 128K storage expansion modules; requires F2942-00; max. 2 per system	365	290	13,950	71
F1933-00	I/O Processor Controller Module; mounts in expansion cabinet; includes one I/O processor, one storage port expander and space for mounting three additional I/O processors; max. 3 per system (1 in each expansion cabinet)	380	305	14,680	72
F2941-99	Second I/O Processor; may be added to basic DCP/40, or to DCP/40 expansion cabinet already containing F1933-00; includes power supply for third and fourth I/O processors	390	310	14,920	74
F1932-99	Third I/O Processor; may be added to basic DCP/40 or to DCP/40 expansion cabinet; requires F2941-99; includes storage port expander	370	295	14,185	70
F1932-98	Fourth I/O Processor; may be added to basic DCP/40 or to DCP/40 expansion cabinet; requires F1932-99	280	220	10,635	52
F1825-05	Active Line Indicator	25	20	960	4
F1936-00	Storage Port Expander; provides multiplexed interface to a single storage port for up to four requestors	95	75	3,550	17
F1939-00	Integrated Flexible Disk; includes controller and one drive; required for basic DCP/40; may also be added to DCP/40 expansion cabinet in which at least one I/O processor is installed; requires microprogram diskette (F1931-98)	50	40	1,920	11
F1931-98	Flexible Disk; contains DCP/40 Processor and I/O Processor microprograms for operation in primary mode	4	3	144	1
F1928-00	Operator Station; free-standing work surface 60 inches wide by 30 inches deep by 38 inches high	30	25	1,200	0
<b>DCP/20</b>					
8597-99	Basic DCP/20; includes free-standing cabinet, communications processor, 256K bytes of storage, microprogram storage, and microprograms; requires integrated flexible disk and controller (F1939-00); requires cartridge disk (T8408)	756	605	29,040	133
8597-01	DCP/20 Expansion Cabinet; includes free-standing cabinet, power supply, and processor capable of I/O functions; provides mounting for 8 line modules (up to 16 line modules with F2894-00); requires F1936-00	625	500	24,000	109

\*Lease prices do not include maintenance.

## Sperry Univac DCP/40 and DCP/20 Communications Processors

		Monthly Charges*			
		1-Year Lease	5-Year Lease	Purchase Price	Monthly Maint.
<b>DCP/20 (continued)</b>					
F3539-00	Storage Expansion; provides additional 128K bytes storage; max. of 2 can be added to DCP/20	\$131	\$105	\$ 4,500	\$ 22
F3539-99	Storage Expansion; provides additional 256K bytes of storage; max. of 1 can be added to DCP/20	225	180	8,560	44
F1939-00	Integrated Flexible Disk; provides control and 1 flexible disk drive for 256K byte diskettes; requires for basic DCP/20	50	40	1,920	11
F1936-00	Storage Port Expander	95	75	3,550	17
F2894-00	Line Module Expansion; provides expansion for additional 8 line modules in 8597-01	460	250	12,000	55
F2895-00	Active Line Indicators; provides the capability to monitor up to 16 half-/full-duplex lines in 8594-01 or 8597-99	25	20	890	4
<b>Options</b>					
8590-00	Remote Control Module (RCM); provides remote control of DCP/40(s) or DCP/20s via communications line for power on/off, IPL and other necessary control functions	355	280	13,526	56
F1937-00	Remote Control Adapter; provides RCM with interface to DCP/40	48	38	1,824	10
F2893-00	Remote Control Adapter; provides RCM with interface to DCP/20	48	38	1,824	10
2523-00	Line Switch Module (LSM); provides capability to switch communications lines and/or peripherals from a local or remote source under program control via a direct or communications line DCP/40 or DCP/20 connection	748	597	28,750	103
F3556-00	RCM/LSM Local Control Interface	95	75	3,600	15
F3557-00	RCM/LSM Microprograms	9	7	350	1
1962-00	LSM Auxiliary Cabinet	197	143	6,872	36
F3105-00	Modem Expander, RS-232-C	38	30	1,440	40
F3109-00	LSM Switch; RS-232-C; controls up to 8 lines	132	102	4,930	20
F3110-00	LSM Switch; CCITT V.35; controls up to 8 lines	245	195	9,325	39
F3112-00	LSM Switch, RS-449, controls up to 4 lines	156	125	6,000	25
F3113-00	LSM Switch, 16 bit I/O, controls up to 4 channels	186	150	7,200	30
F3559-00	LSM Switch, Bell 303; controls up to 4 lines	440	350	16,800	75
F3835-00	Remote Partitioning Feature; for Series 1100 multi-processor partitioning	25	20	960	5
<b>Line Modules</b>					
F1946-02	Word Channel Interface; provides full-duplex interface to Series 1100 host processor word channel; max. 2 per basic or expansion cabinet	105	85	4,000	21
F1947-00	Byte Channel Interface; for connection to Series 90 host processor byte multiplexer or block multiplexer channel	105	85	4,000	21
F1948-01	16-Bit Peripheral Interface; operates in 8-bit or 16-bit mode	80	65	3,000	15
F1949-00	Byte I/O Line Module; provides 8-bit interface for flexible diskette subsystem; for DCP/20 only	30	25	1,045	—
F1941-00	Asynchronous Interface; provides full-duplex RS-232-C/V.24/V.28 interface for data rates of 45.5 to 2400 bps	25	20	960	3
F1942-00	Synchronous Interface; provides full-duplex RS-232-C/V.24/V.28 interface for data rates up to 9600 bps	25	20	960	3
F3165-00	Multiline Asynchronous Interface; provides full-duplex support for four communications lines up to 2400 bps with RS-232-C/V.24/V.25 interface, provides for auto baud rate direct	75	60	2,800	13
F1945-00	Auto Dialing Line Module; provides interface to Bell 801 and V.24/V.25-compatible automatic calling units; requires F1941-00, F1942-00, or F3163-00	25	20	1,005	4
F1945-01	Auto Dialing Line Module; conforms to NTT (Japan) requirements	25	20	1,005	4
F3163-00	Medium Speed Loadable Interface; provides full-duplex asynchronous and synchronous RS-232-C/V.24/V.28 interface; also operates with Bell DDS; data rate depends on protocol used; up to 19.2K bps; async provides auto baud rate detect	35	30	1,275	7
F3163-01	Same as F3163-00 except with X.21 interface up to 9600 bps	63	50	2,500	13
F3163-04	Same as F3163-00 except with RS-449 interface up to 9600 bps	35	30	1,275	7
F3164-01	High Speed Loadable Interface; provides V.35 interfacing; data rate depends on protocol used; up to 64K bps	100	80	3,745	19
F3164-00	Same as F3164-01 except with Bell 303 interface	188	150	7,200	35
<b>Peripherals</b>					
8408-02	Cartridge Disk Control; houses up to 2 F2380-04/06 drives	139	104	5,564	29
F2380-04	Cartridge Disk Drive; 10MB; 100/120 volt	439	314	17,750	114
F2380-06	Cartridge Disk Drive; 10MB; 220/240 volt	439	314	17,750	114
F2187-00	Dual I/O Interface for Cartridge Disk	39	29	1,568	8
0871-01	Uniservo 10 Magnetic Tape Unit; requires F2721-00; second 0871-01 requires F2879-00	318	239	13,962	85
F2721-00	Uniservo 10 Controller; provides control for up to two Uniservo 10 tape units; requires F1948-00	284	215	10,320	51
F2879-00	AC Power Switch	32	25	1,200	5
3560-93	UTS/20 Console; 120V, 60 Hz. Requires synchronous communications interface	128	97	3,225	30

\*Lease prices do not include maintenance.

**Sperry Univac DCP/40 and DCP/20  
Communications Processors**

		Monthly Charges*			
		<u>1-Year Lease</u>	<u>5-Year Lease</u>	<u>Purchase Price</u>	<u>Monthly Maint.</u>
<b>▶ Peripherals (continued)</b>					
3560-92	UTS/20 Console; 100/120/220/240V, 50/60 Hz. Requires syn- chronous communications interface	\$ 128	\$ 97	\$ 3,225	\$ 30
0797-99	Console Printers; 80 cps; 80 column matrix impact printer	84	63	1,900	27
0798-99	Console Printer; 200 cps bidirectional 132 column matrix printer	188	156	6,650	64
8406-04/05/ 06/07	Flexible Diskette, freestanding system, 1M bytes of storage; for DCP/ 20 only	103	79	3,602	22
F3145-00/ 01/02/03	Diskette Expansion; provides expanded 1M bytes of storage for the flexible diskette; for DCP/20 only	61	47	2,160	11

**Monthly  
License Fee\*\***

**Software**

6136-02	DCP/40 O/S; provides for DCP/40 operation under Telcon 4	\$185
6136-01	DCP/20 O/S; provides for DCP/20 operation under Telcon 4	100
6257-00	X.25 packet switching software for DATEX-P (German) PDN	175
6257-01	X.25 packet switching software for PSS (United Kingdom) PDN	175
6257-02	X.25 packet switching software for DATAPAC (Canada) PDN	175
6258-00	X.21 circuit switching software for Nordic public circuit-switched data network	150
6276-00	3270 BSC Terminal Handler	150
6276-01	3270 BSC Inverted Terminal Handler	100
6277-00	2780/3780 Inverted Terminal Handler	75

\*Lease prices do not include maintenance.

\*\*Does not include software support service, which must be ordered separately. ■



## Sperry Univac DCP/40 and DCP/20 Communications Processors

► bytes per second for NRZI formats; the tape speed is 25 ips. An automatic threading function is standard. The magnetic tape subsystem connects to the DCP through an IOP via a 16-bit peripheral interface.

**CONSOLE:** A UTS 20 display terminal may be used optionally as a local display console. The UTS 20 is a fully-featured editing/formatting terminal that provides a maximum screen capacity of 1920 characters, a typewriter keyboard, and a full upper/lower case ASCII character set. An optional auxiliary interface is available for the UTS 20 for attachment of a slave printer.

### PRICING

The Sperry Univac DCP/40 and DCP/20 are available for purchase or on a one-year or five-year lease. Sperry Univac also offers a 7-year lease to state and local governments and to educational institutions. Educational institutions are eligible for an additional 10 percent discount. The discount does not apply to maintenance service charges. The basic maintenance charge covers maintenance of the equipment for nine consecutive hours a day between the hours of 7 a.m. and 6 p.m., Monday through Friday. Extended periods of maintenance are available at premium rates.

		Monthly Charges*			
		1-Year Lease	5-Year Lease	Purchase Price	Monthly Maint.
<b>DCP/40</b>					
8596-96	Basic DCP/40; includes free-standing cabinet, communications processor, first storage controller, 512K bytes of storage, first I/O controller module, first I/O processor, ROM memory, and microprograms; requires integrated flexible disk drive, (F1939-00), line modules, and cartridge disk subsystem (8408 plus F2380)	\$2,195	\$1,755	\$84,245	\$452
1945-00	DCP/40 Expansion Cabinet; includes free-standing cabinet, power supply, and power controller; max. 3 per system, only one of which may contain storage; third expansion cabinet requires storage port expander (F1936-00)	705	565	27,060	134
F1930-00	Storage Expansion; provides additional 128K bytes of storage; for expansion memory via DCP/40 expansion cabinet (1945-00)	145	115	5,570	32
F1930-01	Storage Expansion; provides additional 512K bytes of storage; up to 3 F1930-01 modules may be added to basic DCP/40; additional 128K-byte (F1930-00) modules may be added to DCP/40 expansion cabinet via F2942-00 and F1929-99; max. 3.5M bytes total storage per system	410	325	15,600	116
F2942-00	Second Storage Controller; mounts in expansion cabinet; includes 128K bytes of storage plus support for three additional 128K storage expansion modules; max. 1 per system	700	560	26,880	145
F1929-99	Third/Fourth Storage Controller; mounts in expansion cabinet; includes 128K bytes of storage plus support for three additional 128K storage expansion modules; requires F2942-00; max. 2 per system	365	290	13,950	77
F1933-00	I/O Processor Controller Module; mounts in expansion cabinet; includes one I/O processor, one storage port expander and space for mounting three additional I/O processors; max. 3 per system (1 in each expansion cabinet)	380	305	14,680	78
F2941-99	Second I/O Processor; may be added to basic DCP/40, or to DCP/40 expansion cabinet already containing F1933-00; includes power supply for third and fourth I/O processors	390	310	14,920	81
F1932-99	Third I/O Processor; may be added to basic DCP/40 or to DCP/40 expansion cabinet; requires F2941-99; includes storage port expander	370	295	14,185	76
F1932-98	Fourth I/O Processor; may be added to basic DCP/40 or to DCP/40 expansion cabinet; requires F1932-99	280	220	10,635	57
F1825-05	Active Line Indicator	25	20	960	4
F1936-00	Storage Port Expander; provides multiplexed interface to a single storage port for up to four requestors	95	75	3,550	19
F1939-00	Integrated Flexible Disk; includes controller and one drive; required for basic DCP/40; may also be added to DCP/40 expansion cabinet in which at least one I/O processor is installed; requires microprogram diskette (F1931-98)	50	40	1,920	12
F1931-98	Flexible Disk; contains DCP/40 Processor and I/O Processor microprograms for operation in primary mode	4	3	144	1
F1928-00	Operator Station; free-standing work surface 60 inches wide by 30 inches deep by 38 inches high	30	25	1,200	0
<b>Preconfigured DCP/40 Models**</b>					
8596-95	DCP/40 Model I/1100; preconfigured cartridge disk-based DCP/40 for Series 1100 host; accommodates up to 11 communications line modules; includes basic DCP/40, 10M bytes disk storage, 512K bytes main storage, integrated diskette, Series 1100 host interface, 16-bit peripheral interface, cartridge disk control & drive, & active line indicators; field expandable	\$ 3,033	\$ 2,383	\$ 117,439	\$ 609

\*Lease prices do not include maintenance.

\*\*Preconfigured DCP/40 models require the following separately priced options in addition to the components listed in each model description: UTS 20 or UTS 400 console; direct connect cable, modems, or DCM to connect console to DCP; and DCP/40 or DCP/20 OS, depending on model.

## Sperry Univac DCP/40 and DCP/20 Communications Processors

		Monthly Charges*			
		1-Year Lease	5-Year Lease	Purchase Price	Monthly Maint.
<b>Preconfigured DCP/40 Models** (Continued)</b>					
8596-91	DCP/40 Model I/90; preconfigured cartridge disk-based DCP/40 for Series 90 host; same as 8596-95 except accommodates up to 9 communications line modules and includes Series 90 host interface instead of Series 1100 interface	\$3,033	\$2,383	\$117,439	\$609
8596-87	DCP/40 Model II/1100; preconfigured cartridge disk-based DCP/40 for Series 1100 host, same as 8596-95 except accommodates up to 27 communications line modules; includes DCP/40 and second IOP	3,448	2,713	133,319	687
8596-83	DCP/40 Model II/90; preconfigured cartridge disk-based DCP/40 for Series 90 host; same as 8596-91 except accommodates up to 25 communications line modules; includes DCP/40 & second IOP	3,448	2,713	133,319	687
<b>DCP/20</b>					
8597-99	Basic DCP/20; includes free-standing cabinet, communications processor, 256K bytes of storage, microprogram storage, and microprograms; requires integrated flexible disk and controller (F1939-00); or requires cartridge disk (T8408)	756	605	29,040	145
8597-01	DCP/20 Expansion Cabinet; includes free-standing cabinet, power supply, and processor capable of I/O functions; provides mounting for 8 line modules (up to 16 line modules with F2894-00); requires F1936-00	625	500	24,000	119
F3539-00	Storage Expansion; provides additional 128K bytes storage; max. of 2 can be added to DCP/20	131	105	4,500	22
F3539-99	Storage Expansion; provides additional 256K bytes of storage; max. of 1 can be added to DCP/20	225	180	8,560	44
F1939-00	Integrated Flexible Disk; provides control and 1 flexible disk drive for 256K byte diskettes; required for basic DCP/20	50	40	1,920	12
F1936-00	Storage Port Expander	95	75	3,550	19
F2894-00	Line Module Expansion; provides expansion for additional 8 line modules in 8597-01	460	250	12,000	55
F2895-00	Active Line Indicators; provides the capability to monitor up to 16 half-/full-duplex lines in 8594-01 or 8597-99	25	20	890	4
<b>Preconfigured DCP/20 Models**</b>					
8597-98	DCP/20 Model I/1100; preconfigured diskette-based DCP/20 for Series 1100 host; accommodates up to 13 communications line modules; includes basic DCP/20, 384K bytes main storage, integrated diskette, Series 1100 host interface, 8-bit peripheral interface, freestanding diskette and expansion cabinet (2MB storage), and an active line indicator	\$1,242	\$ 991	\$46,980	\$249
8597-94	DCP/20 Model I/90; preconfigured diskette-based DCP/20 for Series 90 host; same capabilities as 8597-98 except accommodates up to 12 communication line modules and includes Series 90 host interface instead of Series 1100 interface	1,242	991	46,980	249
8597-90	DCP/20 Model II/1100; preconfigured cartridge disk-based DCP/20 for Series 1100 host; accommodates up to 12 communications line modules; includes basic DCP/20, 384K bytes main storage, integrated diskette, Series 1100 interface, 16-bit peripheral interface, disk controller, disk drive (10 M bytes), and active line indicator	1,706	1,323	66,489	380
8597-86	DCP/20 Model II/90; preconfigured cartridge disk-based DCP/20 for Series 90 host; same as 8597-90 except accommodates up to 11 communications line modules and includes Series 90 host interface instead of Series 1100 interface	1,706	1,323	66,489	380
<b>Options</b>					
8590-00	Remote Control Module (RCM); provides remote control of DCP/40(s) or DCP/20s via communications line for power on/off, IPL and other necessary control functions	355	280	13,526	61
F1937-00	Remote Control Adapter; provides RCM with interface to DCP/40	48	38	1,824	11
F2893-00	Remote Control Adapter; provides RCM with interface to DCP/20	48	38	1,824	10
2523-00	Line Switch Module (LSM); provides capability to switch communications lines and/or peripherals from a local or remote source under program control via a direct or communications line DCP/40 or DCP/20 connection	748	597	28,750	112
F3556-00	RCM/LSM Local Control Interface	95	75	3,600	16
F3557-00	RCM/LSM Microprograms	9	7	350	1
1962-00	LSM Auxiliary Cabinet	197	143	6,872	39
F3105-00	Modem Expander, RS-232-C	38	30	1,440	40

\*Lease prices do not include maintenance.

\*\*Preconfigured DCP/40 models require the following separately priced options in addition to the components listed in each model description: UTS 20 or UTS 400 console; direct connect cable, modems, or DCM to connect console to DCP; and DCP/40 or DCP/20 OS, depending on model.

## Sperry Univac DCP/40 and DCP/20 Communications Processors

### Monthly Charges\*

		<u>1-Year Lease</u>	<u>5-Year Lease</u>	<u>Purchase Price</u>	<u>Monthly Maint.</u>
<b>Options (Continued)</b>					
F3109-00	LSM Switch; RS-232-C; controls up to 8 lines	\$132	\$102	\$4,930	\$22
F3110-00	LSM Switch; CCITT V.35; controls up to 8 lines	245	195	9,325	43
F3112-00	LSM Switch, RS-449, controls up to 4 lines	156	125	6,000	27
F3113-00	LSM Switch, 16 bit I/O, controls up to 4 channels	186	150	7,200	33
F3559-00	LSM Switch, Bell 303; controls up to 4 lines	440	350	16,800	82
F3835-00	Remote Partitioning Feature; for Series 1100 multi-processor partitioning	25	20	960	5
<b>Line Modules</b>					
F1946-02	Word Channel Interface; provides full-duplex interface to Series 1100 host processor word channel; max. 2 per basic or expansion cabinet	105	85	4,000	23
F1947-00	Byte Channel Interface; for connection to Series 90 host processor byte multiplexer or block multiplexer channel	105	85	4,000	23
F1948-01	16-Bit Peripheral Interface; operates in 8-bit or 16-bit mode	80	65	3,000	16
F1949-00	Byte I/O Line Module; provides 8-bit interface for flexible diskette subsystem; for DCP/20 only	30	25	1,045	—
F1941-00	Asynchronous Interface; provides full-duplex RS-232-C/V.24/V.28 interface for data rates of 45.5 to 2400 bps	25	20	960	3
F1942-00	Synchronous Interface; provides full-duplex RS-232-C/V.24/V.28 interface for data rates up to 9600 bps	25	20	960	3
F3165-00	Multiline Asynchronous Interface; provides full-duplex support for four communications lines up to 2400 bps with RS-232-C/V.24/V.25 interface; provides for auto baud rate direct	75	60	2,800	14
F1945-00	Auto Dialing Line Module; provides interface to Bell 801 and V.24/V.25-compatible automatic calling units; requires F1941-00, F1942-00, or F3163-00	25	20	1,005	4
F1945-01	Auto Dialing Line Module; conforms to NTT (Japan) requirements	25	20	1,005	4
F3163-00	Medium Speed Loadable Interface; provides full-duplex asynchronous and synchronous RS-232-C/V.24/V.28 interface; also operates with Bell DDS; data rate depends on protocol used; up to 19.2K bps; async provides auto baud rate detect	35	30	1,275	8
F3163-01	Same as F3163-00 except with X.21 interface up to 9600 bps	63	50	2,500	14
F3163-04	Same as F3163-00 except with RS-449 interface up to 9600 bps	35	30	1,275	11
F3164-01	High Speed Loadable Interface; provides V.35 interfacing; data rate depends on protocol used; up to 64K bps	100	80	3,745	21
F3164-00	Same as F3164-01 except with Bell 303 interface	188	150	7,200	38
<b>Peripherals</b>					
8408-02	Cartridge Disk Control; houses up to 2 F2380-04/06 drives	139	104	5,564	32
F2380-04	Cartridge Disk Drive; 10MB; 100/120 volt	439	314	17,750	124
F2380-06	Cartridge Disk Drive; 10MB; 220/240 volt	439	314	17,750	124
F2187-00	Dual I/O Interface for Cartridge Disk	39	29	1,568	9
0871-01	Uniservo 10 Magnetic Tape Unit; requires F2721-00; second 0871-01 requires F2879-00	318	239	13,962	93
F2721-00	Uniservo 10 Controller; provides control for up to two Uniservo 10 tape units; requires F1948-00	284	215	10,320	56
F2879-00	AC Power Switch	32	25	1,200	5
3560-93	UTS/20 Console; 120V, 60 Hz. Requires synchronous communications interface	128	97	3,225	33
3560-92	UTS/20 Console; 100/120/220/240V, 50/60 Hz. Requires synchronous communications interface	128	97	3,225	\$33
0797-99	Console Printers; 80 cps; 80 column matrix impact printer	84	63	1,900	29
0798-99	Console Printer; 200 cps bidirectional 132 column matrix printer	188	156	6,650	70
8406-04/05/06/07	Flexible Diskette, freestanding system, 1M bytes of storage; for DCP/20 only	103	79	3,602	22
F3145-00/01/02/03	Diskette Expansion; provides expanded 1M bytes of storage for the flexible diskette; for DCP/20 only	61	47	2,160	12

\*Lease prices do not include maintenance.

		<u>Monthly License Fee*</u>
<b>Software</b>		
6136-02	DCP/40 O/S; provides for DCP/40 operation under Telcon 4	\$185
6136-01	DCP/20 O/S; provides for DCP/20 operation under Telcon 4	100
6257-00	X.25 packet switching software for DTEX-P (German) PDN	175
6257-01	X.25 packet switching software for PSS (United Kingdom) PDN	175
6257-02	X.25 packet switching software for DATAPAC (Canada) PDN	175
6258-00	X.21 circuit switching software for Nordic public circuit-switched data network	150
6276-00	3270 BSC Terminal Handler	150
6276-01	3270 BSC Inverted Terminal Handler	100
6277-00	2780/3780 Inverted Terminal Handler	75

\*Does not include software support service, which must be ordered separately. ■





# Sperry Univac Distributed Communications Processor/40 (DCP/40)

## MANAGEMENT SUMMARY

Sperry Univac released its newest communications processor, the DCP/40, in June 1979 as a part of a major Series 1100 announcement. The DCP/40 is a multiprocessor-based system that can act as a front-end processor to a Sperry Univac 1100 Series or Series 90 mainframe, or as a remote intelligent concentrator or nodal processor in a Sperry Univac or multiple-vendor network.

The DCP/40 offers a number of capabilities and technological improvements not supported by its predecessor, the DCP. For example, the DCP/40 handles up to full-duplex 256 lines, as compared to the DCP's maximum of 192 full-duplex lines, and can contain up to 2 megabytes of main memory, whereas the DCP was limited to 128K bytes. The DCP/40 also has higher throughput rates and faster processor execution times than the DCP.

As an alternative to its native mode of operation, the DCP/40 can operate in "compatible mode," in which it can emulate its predecessor or a Series 90 Multi-Channel Communications Controller (MCC). In compatible mode, the DCP/40 utilizes the DCP's Type II-E Scanner to interface serial communications lines, and supports the DCP's and MCC's channel interface requirements, address structure, and instruction repertoire. DCP memory and line capacity restrictions are retained, and little or no change in existing hardware is required. However, the user gains the advantage of using the DCP/40's improved throughput rates and execution times, as well as an easier migration path to the full-scale DCP/40 architecture.

A communications processor that can act as a front-end to a Sperry Univac 1100 Series or Series 90 mainframe, or as a nodal processor or remote concentrator in a Sperry Univac or multi-vendor network.

In native mode, the DCP/40 supports up to 256 connections to host processor channels, local peripherals, and communications lines. Any mix of speeds, up to 64K bps, and a broad range of protocols are supported via program-loadable line modules.

In compatible mode, the DCP/40 can emulate its predecessor DCP system or a Series 90 MCC.

Prices start at \$75,695 (purchase), or \$2,342 per month (one-year lease including maintenance), for a basic DCP/40 system that supports 16 asynchronous communications lines.

## CHARACTERISTICS

**VENDOR:** Sperry Univac Division, Sperry Corporation, P.O. Box 500, Blue Bell, Pennsylvania 19422. Telephone (215) 542-4011.

**DATE OF ANNOUNCEMENT:** June 1979.

**DATE OF FIRST DELIVERY:** July 1979.



This DCP/40 configuration includes (counterclockwise) the double-doored basic DCP/40 cabinet, one expansion cabinet with its active light indicators mounted on top, a Uniscope 200 display console on top of the operator station work surface, a single-drive Model 0871 Uniservo 10 magnetic tape subsystem, a Model 0786 console printer, and the top-loading Model 8408 cartridge disk subsystem.

Sperry Univac Distributed Communications  
Processor/40 (DCP/40)

Table 1. DCP/40 Native Mode: Serial Communications Line Module Options

Type of Line Interface	Timing	Speed	Feature Number	Remarks
RS-232-C, V.24, V.28	Asynchronous, full-duplex	45.5 to 2400 bps (17 data rates)	F1941-00	Auto data rate direction for 110, 134.5, 150, or 300 bps data optional
RS-232-C, V.24, V.28	Synchronous, full-duplex	Up to 9600 bps	F1942-00	Also provides direct connect interface to system console or terminal multiplexer
RS-232-C, V.24, V.28, Bell DDS	Asynchronous or synchronous, full-duplex	Up to 2400 bps (basic async.), 9600 bps (BSC or Bell DDS), or 19,200 bps (basic sync., UDLC, REM 1 or 1100 FDX)	F3163-00	Program-loadable protocols
V.35, Bell DDS and DSDS	Synchronous, full-duplex	Up to 48K bps (European V.35), 56K bps (Bell DDS or DSDS), or 64K bps (basic sync., UDLC, 1100 FDX, BSC, or REM 1)	F3164-01	Program-loadable protocols
Automatic dialing	Asynchronous or synchronous	—	F1945-00	Interfaces to RS-366-, V.24- and V.25-compatible automatic calling units

➤ The options and capabilities of the DCP/40 can be better appreciated when its role in Sperry Univac's Distributed Communications Architecture (DCA) is kept in mind. Essentially, DCA is a set of ground rules that defines the functions that each element within a communications network should (and should not) perform. Furthermore, DCA defines the standards for interfacing between elements. The goal is to permit interconnection of dissimilar hardware/software into one communications network in compliance with DCA ground rules. Under DCA, interconnection of a vast array of line disciplines, supporting an even larger array of terminal types, is permitted. Not unexpectedly, therefore, the range of line interfaces provided with the DCP/40 is rather extensive. Tables 1 and 2 in this report list the DCP/40 interfaces supported by Sperry Univac's network architecture. (You can see that a wider range of choices is currently available in compatible mode than in native mode.)

Another DCA concept is to produce hardware (e.g. the DCP/40) that operates under software (e.g. TELCON)—not software operating under hardware. Portions of the TELCON software reside in the DCP/40, portions in the host computers, and still other portions in any intelligent terminals in the network. Within TELCON, the DCP/40 performs the specific functions of communications processing and line concentration, providing the user with no programmatic tools to alter the assigned function. However, within the assigned function, the hardware options and own-coding provisions provide significant flexibility.

Sperry Univac preferred not to provide Datapro with a list of DCP/40 users, and no DCP/40 users responded to our survey on communications processors, so we could not report on how well it is working in the field. □

➤ **NUMBER DELIVERED TO DATE:** Information not available.

**SERVICED BY:** Sperry Univac.

**CONFIGURATION**

The Distributed Communications Processor/40 (DCP/40) is a multiprocessor, multitasking system that can serve as a front-end processor to an 1100 Series or Series 90 host computer, or as a nodal processor or remote intelligent concentrator in a Sperry Univac or multi-vendor network. All functional characteristics are provided in microcode, which is loaded into system memory. Microprograms support either DCP/40 native mode operation or emulation of predecessor DEC/Telcon or Series 90 MCC communications systems.

**DCP/40—Native Mode**

The basic DCP/40 in native mode includes a communications processor; the basic DCP/40 microprograms (stored on an integral diskette); a storage controller and one 128K-byte RAM storage module; an input/output controller and one input/output processor (IOP); a line module chassis with space for up to 16 line modules for connection of host computers, local peripherals, and communications lines; power supplies and a power controller; an integrated diskette drive and controller (separately priced but required); an operator's panel; and a maintenance panel. All of these components are contained in a single free-standing cabinet. The basic configuration also includes an external dual-drive diskette subsystem that provides a total of .5MB of storage (separately priced).

The contents of the basic cabinet can be expanded to include up to three additional 128K-byte storage modules, for a single-cabinet capacity of 512K bytes, plus up to three additional IOP's and three additional line module chassis, for a single-cabinet capacity of 64 line modules. (If more than two IOP's are contained in the basic cabinet, a storage port expander, which permits multiple IOP's and I/O devices to share storage access ports, is also required.)

If further expansion is required, up to three expansion cabinets can be configured with the system. (If more than two

## Sperry Univac Distributed Communications Processor/40 (DCP/40)

### Table 2. DCP/40 Compatible Mode: Line Adapter Options for Type II Scanner

Type of Line Interface*	Timing	Speed	Feature Number	Remarks
RS-232-C, V.24, V.28, local console	Asynchronous	Up to 2400 bps	F1828-00	
			F1828-01	Has reverse channel for Bell 202 type modem with speed up to 5 bps
			F1828-02	Has a supervisory channel with speed up to 150 bps; occupies 2 LA ports
RS-232-C, V.24, V.28, local console, or other terminal multiplexer	Synchronous	Up to 9600 bps	F1826-00	
			F1826-01	Has a supervisory channel with speed up to 150 bps; occupies 2 LA ports
MIL-STD-188C/188-100 low level	Asynchronous	45.45, 50, 75, 100, 110, 134.5, 150, 200, 300, 600, 1200, 1800, 2400 bps	F1829-00	Normal MIL-STD-188-100 or Inverse Data Polarity (RS-232-C) can be selected; control line polarity is RS-232-C
MIL-STD 188C/188-100 low level	Synchronous	Up to 9600 bps	F1827-00	Polarity options include normal MIL-STD-100, inverse data, normal data with inverse clock, inverse data with inverse clock. Control line polarity is RS-232-C
RS-422, X.27	Synchronous	Up to 100K bps	F3357-00	X.21-compatible; this feature provides hardware only—it is not software-supported; byte timing lead available for applications outside U.S.
Wide-Band, AT&T 300 Series data sets	Synchronous	19.2K, 40.8K, 50K, and 230.4K bps	F1830-00	
Wide-Band, V.35, Bell DDS	Synchronous	From 19.2K to 56K bps	F1834-00	
Relay; 20-75 Ma neutral or 10-40 Ma Polar telegraph lines	Asynchronous	Up to 15 char./sec.	F1832-00	
TWX; Bell 811B data sets	Asynchronous	Up to 150 bps	F1835-00	
U.S. Telex	Asynchronous	Up to 150 bps	F1836-00	
Bell 407A/B	Asynchronous	Up to 10 char./sec.	F2521-00	Input of parallel data from touch-tone phones
RS-232-C, V.24, V.28	Asynchronous	300, 600, 1200, 1800 bps	F2519-00	Provides internal clocking; for 1800 bps, must be attached to lower 63 port addresses of scanner
Automatic Dialing	Async/Sync	—	F1831-00	Provides interface for Bell 801 when attached to #F1828, F1826, or F1835 LA. Auto-Dial occupies the space of one LA

\*Cable selection required for specific type of interface where several interface standards are supported by the same line adapter.

► expansion cabinets are added to the basic system, a storage port expander is required in the basic cabinet.) Each expansion contains its own power supplies and power controller, and can accommodate one I/O controller, up to four IOPs, storage port expanders as needed, and associated line module chassis and line modules. In addition, one (but only one) expansion cabinet per system may also contain up to 12 128K-byte RAM storage modules, grouped into three 512K-byte storage banks; each bank has its own controller.

Thus, the total maximum RAM storage capacity per DCP/40 system is just over 2 megabytes, while the total maximum I/O capacity is 256 line modules.

Three additional dual-drive diskette subsystems may be daisy-chained to the first, providing a maximum storage capacity of 2 megabytes. A cartridge disk subsystem may be used in lieu of or in addition to the diskette subsystem. One or two magnetic tape drives can also be added to the system.

A Uniscope 200 or UTS 400 display station and a serial printer may optionally be attached for use as a local system console. The host system console can also function as a local DCP/40 console if it is configured as a terminal to the

network. An optional free-standing desk-type work surface, on which the console and diskette subsystem(s) can be placed, is also available.

The communications processor performs general-purpose processing tasks, as well as functions specific to network and local-site operations, under the control of microcoded programs loaded into local RAM storage. The processor includes a microcontroller that supports the internal bus structure, timing mechanism, control storage, dual arithmetic logic units (for comparing and checking computations), error checking and logging schemes, automatic instruction retry routines for microinstruction failure, and automatic restart and recovery procedures.

Local RAM storage is organized into one to four storage banks. Each bank contains 128K to 512K bytes of storage, for a system total of over 2 megabytes. Error checking logic provides for correction of all single-bit errors and flagging of all double-bit errors. All errors are automatically logged so that the processor can analyze the frequency of hardware failures and take any necessary recovery actions.

► The communications processor and each device connected to the system through an IOP has direct, independent access to

## Sperry Univac Distributed Communications Processor/40 (DCP/40)

► local storage. Storage is accessed via multiple storage ports. Four ports are provided in the basic cabinet, and four additional ports are provided in the expansion cabinet if any expansion storage is configured. If all available ports are occupied, cascaded storage port expanders are used to multiplex groups of requesters to each of the storage ports. Priority schemes in system logic handle simultaneous requests for storage access.

The system's I/O processors manage all input/output tasks. Each IOP provides programmed control for up to 16 line modules, and performs data exchanges, buffer allocation, message formatting, message recovery and retransmission, status reporting, statistics gathering, and polling.

Optional active line indicators can provide a visual display of line activity on data sets connected to an IOP. Each active line indicator displays activity for up to 16 lines on a single IOP, or, with an optional switching feature, for up to 64 lines on four IOP's. Each active line indicator is mounted on the top of the cabinet containing the IOP(s) to which it is connected.

The line modules are plug-in programmed interfaces that provide for connection of all external devices to the DCP/40 system. Various modules accommodate half- or full-duplex communications lines, host computer channel interfaces, or local peripheral interfaces. Each module is loaded with a microcoded program that supports the specific data format, transmission method, and other requirements of the line to be connected. The line modules also perform such functions as: data conversion (from parallel to serial and vice versa), data buffering, character parity and block check sequence generation and checking, character counting and control character recognition, and line timing and asynchronous clocking. Up to 256 line modules can be configured with a DCP/40 system, since in general, each line module occupies a single IOP port. The exception is that the byte-channel host interface line module, which provides for connection to a Series 90 or 1100/80 host computer, requires two IOP ports.

Local peripherals are attached to the system through the IOP's via one of two types of peripheral line modules: the 8-bit peripheral interface is used for the diskette subsystem; the 16-bit peripheral interface for all other local devices. The display console may also be attached locally via a communications line module, using a special "junction box."

Line modules for connection of host computer interface channels and communications lines are described under "Transmission Specifications."

Reliability features are built into each layer of the DCP/40's architecture. In addition to the error detection, logging, and correction schemes already mentioned, the system can support: configurational redundancy in both internal elements such as local storage, I/O processors, and line modules, as well as in the external network; virtual storage mapping that prevents software errors in any single system module from causing total system failure; and diagnostic programs in both macrocode and microcode that provide both online and offline tests of system and network components. DCP/40 dumps, as well as error logs and statistics reports, can be transmitted to the host upon demand by the host or DCP/40 console operator.

### DCP/40—Compatible Mode

Compatible mode operations represent specialized applications of the DCP/40 system that provide emulation of the predecessor 1100 Series DCP/Telcon system or the Series 90 Multi-Channel Communications Controller (MCC). Implementation of a DCP/40 in compatible mode requires little or no change in existing software.

In compatible mode, no expansion cabinets are supported and local RAM storage is limited to 128K bytes (non-expandable). A maximum of two IOP's are permitted in the basic cabinet if one or two Scanner II's are also configured; a maximum of one IOP is permitted if three Scanner II's are used.

Compatible mode operations require several DCP/40 components not utilized in native mode: compatible mode microprogram features; a Type II-E Scanner (Scanner II), a communications multiplexer that controls all communications lines interfaced with the system; and three interface modules (the scanner storage adapter, the scanner command/interrupt module, and the command interrupt line module).

The compatible mode microprogram features allow the DCP/40 communications processor to emulate the DCP processor and the IOP's to emulate the following DCP and MCC I/O channel devices: the host channel adapter, the remote I/O controller (not applicable to MCC systems), the parallel I/O controller, and the byte I/O controller.

The Scanner II supports up to 128 half-duplex or 64 full-duplex communications lines; up to three Scanner II's can be configured with the DCP/40 system. A wide variety of line adapters are provided for the Scanner II (see Table 2). Bit-oriented protocols such as UDLC, SDLC, ADCCP, and HDLC, can be interfaced with the synchronous or wideband adapters via the UDLC Procedure feature.

Active line indicators similar to those provided with the DCP/40 in native mode are available. In compatible mode, active line indicators can each handle 16 half-duplex or 8 full-duplex lines, and are mounted on top of the Scanner II cabinets.

The one scanner storage adapter per Scanner II is required to provide interfacing between each Scanner II and local DCP/40 storage (or a storage port expander). Each adapter occupies a storage port, or storage expander port, normally occupied by an IOP.

One scanner command/interrupt module per DCP/40 system is also required to interface the DCP/40 communications processor with I/O controllers handling combinations of IOP's and scanners.

One command interrupt line module per IOP is required and provides the IOP with a command interrupt capability that emulates the DCP input/output channels.

A Uniscope 100 display terminal may be used as a system console in place of a Uniscope 200 or UTS 400, which are also supported in compatible mode.

### TRANSMISSION SPECIFICATIONS

In native mode, line modules that connect remote devices, local peripherals, and host computers to the system are attached to the DCP/40 via the IOP ports. Each IOP provides 16 ports, and up to 16 IOP's may be configured with a DCP/40, so that a maximum of 256 line modules can be accommodated.

A choice of five serial line modules are offered to support connection of remote devices to the system over communications lines. RS-232-C and CCITT V.24/V.28 interfacing is supported in half- or full-duplex mode at asynchronous speeds of up to 2400 bps or at synchronous speeds of up to 19.2K bps. Wideband V.35 interfacing is supported at speeds up to 48K bps (European) or 64K bps (U.S.) Bell Digital Dataphone Service (DDS and DSDS) connections are supported at up to 56K bps. An automatic dialing line module provides interfacing to a Bell 801 or equivalent or CCITT V.24/V.25-compatible automatic calling unit, permitting placement of dialed calls under program control. ►

## Sperry Univac Distributed Communications Processor/40 (DCP/40)

► Protocols supported by the communications line modules include teletypewriter, asynchronous or synchronous UNISCOPE protocol, Universal Data Link Control (UDLC), 1100 full-duplex (FDX—used with Series 1100 equipment), REM1 (used with Sperry Univac 9200, 9300, or 90/30 Series processors and the 1004 card processor), and IBM Binary Synchronous Communications (BSC). Two of the line modules, the Medium Speed Line Module (F3163-00) and the High Speed Line Module (F3164-01), are able to be loaded with microprograms for specific line protocols.

In compatible mode, the DCP/40's local peripherals and channel-connected hosts are attached via IOP's but its communications lines are connected via one to three Scanner II communications multiplexers. Each Scanner II supports up to 128 half-duplex or 64 full-duplex communications lines. Lines are attached via line adapters, which connect to the Scanner II via scanner ports. Each line adapter supports a single half- or full-duplex line. Half-duplex line adapters occupy one scanner port; full-duplex line adapters occupy two scanner ports. Specific details on each of the Scanner II line adapters are described in Table 2.

**CONNECTION TO THE HOST:** A DCP/40 system may be connected to a host computer remotely via communications lines or directly via a host processor channel. Remote connections can be made to Sperry Univac 1100 Series and Series 90 mainframes and V77 minicomputers, IBM computers, and other systems compatible with the line protocols supported by the DCP/40 communications line modules.

In native mode, two parallel line modules are provided for direct-channel connection: the byte-channel line module provides an interface to a Sperry Univac Series 90 or 1100/80 processor via its byte multiplexer, block multiplexer, or selector channel; the word-channel line module provides an interface to an 1100 Series processor via its 32-bit internally specified index (ISI) word channel. Up to two channel interface modules (either type) can be accommodated per DCP/40 cabinet. The word-channel line module occupies one line module port; the byte-channel line module occupies two line module ports. The maximum data transfer rate is 1.2 megabytes per second. Maximum cable length is 200 feet.

In compatible mode, the same line modules are used as in native mode, but the DCP/40 microprocessor enables them to emulate the host channel adapters of the DCP and MCC systems. A maximum of two word-channel connections or one byte-channel connection are permitted. If two word-channel line modules are used, the maximum number of scanners is limited to two.

### SOFTWARE

Data Communications Architecture (DCA) is a set of rules and guidelines that permits users who comply to be able to tie their scattered electronic data processing elements into an interconnected network. In effect, Sperry Univac has identified the necessary tasks, separated the tasks into functions, and standardized the rules for interfaces. This permits the interconnection of network elements with dissimilar hardware and support software. One component of DCA is the TELCON system, a combination of hardware and software to interconnect remote terminals with Sperry Univac mainframe processors. The software portion of TELCON includes the software operative in the DCP/40, the related support software in the host, and the software to provide standardized DCA interfaces for certain intelligent terminals.

TELCON supports interactive, batch, and transaction-oriented data transfers. Under TELCON, all data is processed concurrently and is interleaved on UDLC circuits between nodes. In a multinode environment, any terminal has access

to any host in the network, and can be switched from one application or operational mode to another.

The DCP/40 with its resident TELCON software can serve as a front-end processor to one or more 1100 Series or Series 90 hosts, or as a nodal processor or a remote concentrator to one or more 1100 Series, Series 90, V77, IBM, or compatible systems or to another DCP/40 system.

TELCON provides the DCP/40 with comprehensive network management facilities for distributed or hierarchical networks, through which it can maintain, control, monitor, and protect the network. Through TELCON, the DCP/40 controls the establishment of sessions, access to various network systems, and allocation and use of network resources. As the network grows or changes, the DCP/40 can be dynamically reconfigured to support new network components.

The major tasks performed by TELCON operating system within the DCP/40 are:

- **Basic Executive**—Schedules processor time based on user priority. Equal priority users are handled on a first-in, first-out basis. Dispatches time-related functions, including suspension of a user for a specific time period. Also provides administrative functions, such as loading, deactivation, buffer management.
- **Hardware Interface Routines**—Provides the software support for the IOP's and line modules.
- **File management**—provides device-independent control of disk, diskette, and magnetic tape drives.
- **I/O Control**—Manages routing and queuing of all incoming and outgoing messages, including passing messages from one DCP/40 to another. When possible and necessary, the software can seek alternate routing and performs pacing of the number of messages to a given user.
- **Network Management Services**—Provides fundamental control and monitoring of the system, control of security, and the establishment of session links.
- **Loading and Initialization**—The integrated diskette contains the first load block, which calls in the bootstrap loader from local mass storage, the host computer, or another DCP/40 system. The bootstrap performs initialization functions and loads the system's operating software to complete the initialization process.

### COMPONENTS

**COMMUNICATIONS PROCESSOR:** In native mode, the communications processor utilizes a 32-bit microinstruction format and a 17-bit virtual byte address, which is translated to a 24-bit real address by the processor. The processor provides 128 general-purpose 16-bit registers, plus several specialized registers. The communications processor instruction set contains approximately 285 unique instructions for native mode operations. Microinstruction execution cycle time is 65 nanoseconds.

In compatible mode, the DCP/40 communications processor emulates a 16-bit computer with 32 general purpose registers. Full-word (16-bit) and double-word (32-bit) macroinstruction formats are used. Storage addressing is based on 16-bit or 17-bit addresses, which are translated to a 24-bit real address by the processor. The compatible mode instruction set contains approximately 211 unique instructions. The average execution time of one macroinstruction is 1 microsecond.

Local RAM storage capacity in native mode is 128K bytes to just over 2 megabytes, expandable in 128K increments. Data ►

## Sperry Univac Distributed Communications Processor/40 (DCP/40)

### Configuration

DCP/40 (Native Mode)

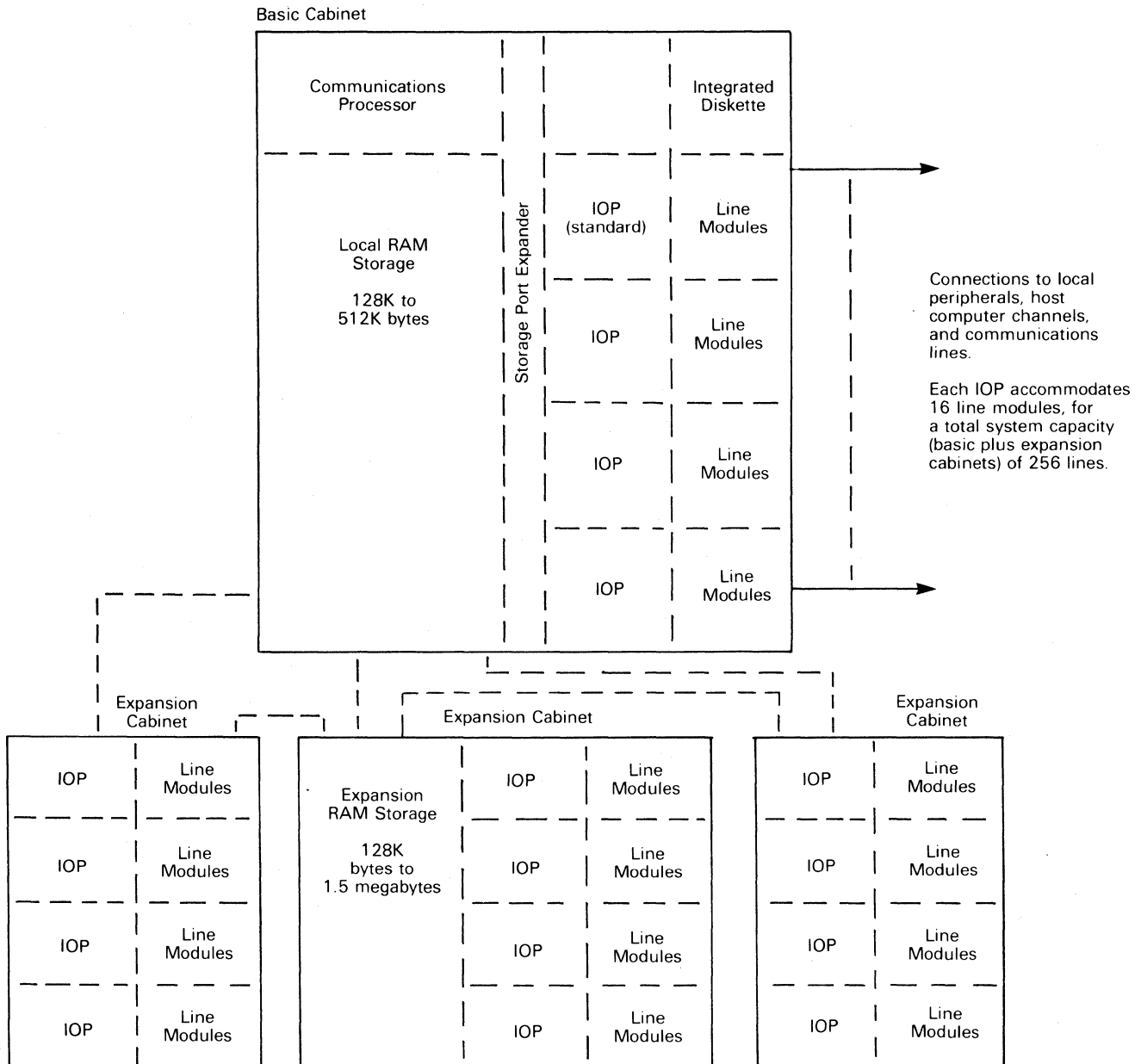

is formatted in storage as a 32-bit word, made up of 8-bit bytes. Read cycle time for a 32-bit word is 400 nanoseconds. Read access time is 300 nanoseconds. Single-bit, 4-bit, 8-bit, 16-bit, or 32-bit data quantities may be accessed from storage; the write cycle for partial or full words is 450 nanoseconds. In compatible mode, local RAM storage is limited to 128K bytes.

**I/O PROCESSORS:** The IOP's utilize a 16-bit microinstruction format and a 14-bit virtual byte address, which is translated to a 24-bit real address by the processor. An IOP can transfer data at up to 1.2 megabytes per second. The IOP instruction set contains approximately 83 unique instructions. Microinstruction execution cycle time is 80 nanoseconds.

**INTEGRATED DISKETTE:** A 256K-byte diskette subsystem containing a single drive and a diskette controller is required for initial system loading. It can also be used to store diagnostic programs, statistics, error logs, network control tables, and additional downloaded functions. The diskette controller interfaces with the system through an IOP and occupies the space of one line module.

**EXTERNAL DISKETTE:** A desk-top Model 8406 dual-drive diskette subsystem with controller is used as the basic system loading device as well as for mass storage. Each drive provides 256K bytes of storage. Read/write speed for a Model 8406 diskette drive is 250K bytes per second, rotational speed is 360 rpm, and average latency is 83.3 milliseconds. The diskette subsystem is connected to the DCP/40 through an IOP via an 8-bit peripheral interface. Up to eight devices (four

## Sperry Univac Distributed Communications Processor/40 (DCP/40)

subsystems) can be daisy-chained to a single 8-bit peripheral interface, up to a maximum combined cable length of 200 feet, to provide a total of 2 megabytes of diskette storage.

**CARTRIDGE DISK:** The Model 8408 cartridge disk subsystem can provide up to 20 megabytes of mass storage for the DCP/40 system; it can also be used as a system loading device in lieu of a diskette subsystem. The subsystem consists of a controller and one or two top-loading dual-spindle disk drives. Each drive provides 5MB of fixed and 5MB of removable disk storage. The data transfer rate for a Model 8408 drive is 2.5MB per second, and the average access time is 50 milliseconds. The cartridge disk subsystem is connected to the DCP/40 through an IOP via a 16-bit peripheral interface. A dual I/O interface option permits the subsystem to be shared by two different channels of one DCP/40 or by two separate DCP/40 systems.

**MAGNETIC TAPE SUBSYSTEM:** The Model 0871 Uniservo 10 magnetic tape subsystem contains a tape controller and a single 9-track 800/1600 bpi tape drive; a second, separately cabineted drive can be added. The data transfer rate is 40K bytes per second for PE formats or 20K bytes per second for NRZI formats; the tape speed is 25 ips. An automatic threading function is standard. The magnetic tape subsystem connects to the DCP/40 through an IOP via a 16-bit peripheral interface.

**CONSOLE:** A Uniscope 200 or UTS 400 display terminal may be used optionally as a local display console. The Uniscope 200 is a fully-featured editing/formatting terminal that provides a maximum screen capacity of 1920 characters, a typewriter keyboard, and a full upper/lower case ASCII character set. The UTS 400 is a user-programmable terminal that supports up to 32K bytes RAM memory for execution of user-written programs, and provides a maximum screen capacity of 1920 characters, and a choice of upper-case only, or upper/lower case, character sets, and a selection of keyboards in ASCII or various foreign languages. The Uniscope 200 can be locally connected to the DCP/40 system either via the parallel communications channel provided by a 16-bit peripheral interface, or, using a special "junction box," via a

synchronous communications line module (F1942-00). The UTS 400 can be locally connected only via the synchronous communications line module, using the junction box.

An optional auxiliary interface is available for both the Uniscope 200 and the UTS 400 for attachment of a slave printer. Two printer models are currently supported as console printers. The Model 800 is an 80-column non-impact matrix printer that operates at 300 cps. The Model 0786 is a 132-column impact matrix printer that comes in unidirectional or bidirectional models and prints at 200 cps.

**SCANNER II (for compatible mode only):** The Scanner II is a separately cabineted communications multiplexer that provides support for up to 128 half-duplex or 64 full-duplex communications lines. The basic Scanner II cabinet contains a control logic feature, a power supply, a maintenance panel, and one line adapter chassis. Expansion is accomplished by adding up to three additional line adapter chassis in the following order: the F2263-00 chassis for ports 33 to 64; the F2263-02 chassis for ports 65 to 96; and a second F2263-00 for ports 97 to 128.

Each line adapter chassis can contain one or two line bases, and each line base provides 16 line adapter ports. Thus, each chassis provides for 32 ports, for a total of 128 ports.

Each line adapter supports one half- or full-duplex line. Half-duplex line adapters occupy one line base port; full-duplex line adapters occupy two line base ports.

An automatic line speed detection capability, a UDLC procedure that interfaces bit-oriented protocols for up to 128 line adapters, and one or more active line indicators can be added to the Scanner II as options.

Up to two Scanner II's can be configured with the DCP/40 that also contains two IOP's; up to three Scanner II's can be configured if there is only one IOP. The Scanner II is connected directly either to a DCP/40 storage port or a storage port expander via a scanner storage adapter.

### Monthly Charges\*

		1-Year Lease	5-Year Lease	Purchase Price	Monthly Maint.
<b>DCP/40—Native Mode</b>					
8596-99	Basic DCP/40; includes free-standing cabinet, communications processor, first storage controller, 128K bytes of storage, first I/O controller module, first I/O processor, ROM memory, and microprograms; requires integrated flexible disk drive, (F1939-00), line modules, and either diskette subsystem (8406) or cartridge disk subsystem (8408 plus F2380)	1,763	1,463	57,535	263
1945-00	DCP/40 Expansion Cabinet; includes free-standing cabinet, power supply, and power controller; max. 3 per system, only one at which may contain storage; third expansion cabinet requires storage port expander (F1936-00)	828	688	27,060	123
F1930-00	Storage Expansion; provides additional 128K bytes of storage; up to 3 F1930-00 modules may be added to basic DCP/40; additional modules may be added to DCP/40 expansion cabinet via F2942-00 and F1929-99; max. 2M bytes total storage per system	172	142	5,570	27
F2942-00	Second Storage Controller; mounts in Expansion Cabinet; includes 128K bytes of storage plus support for three additional 128K Storage Expansion modules; max. 1 per system	822	682	26,880	122
F1929-99	Third/Fourth Storage Controller; mounts in Expansion Cabinet; includes 128K bytes of storage plus support for three additional 128K Storage Expansion modules; requires F2942-00; max. 2 per system	430	355	13,950	65

\*Includes maintenance.

### Sperry Univac Distributed Communications Processor/40 (DCP/40)

		Monthly Charges*			
		1-Year Lease	5-Year Lease	Purchase Price	Monthly Maint.
▶	F1933-00	446	371	14,680	66
	I/O Processor Controller Module; mounts in Expansion Cabinet; includes one I/O processor, one storage port expander, and space for mounting three additional I/O processors; max. 3 per system (1 in each expansion cabinet)				
	F2941-99	458	378	14,920	68
	Second I/O Processor; may be added to basic DCP/40, or to DCP/40 Expansion Cabinet already containing F1933-00; includes power supply for third and fourth I/O processors				
	F1932-99	434	359	14,185	64
	Third I/O Processor; may be added to basic DCP/40 or to DCP/40 Expansion Cabinet; requires F2941-99; includes storage port expander				
	F1932-98	328	268	10,635	48
	Fourth I/O Processor; may be added to basic DCP/40 or to DCP/40 Expansion Cabinet; requires F1932-99				
	F1825-05	29	24	960	4
	F1936-00	111	91	3,550	16
	Storage Port Expander; provides multiplexed interface to a single storage port for up to four requestors				
	F1939-00	60	50	1,920	10
	Integrated Flexible Disk; includes controller and one drive; required for basic DCP/40; may also be added to DCP/40 Expansion Cabinet in which at least one I/O Processor is installed				
	F1928-00	30	25	1,200	0
	Operator Station; free-standing work surface 60 inches wide by 30 inches deep by 38 inches high				
	F2944-00	75	60	2,400	10
	Isolation Transformer; permits 200, 208, 220, 230, or 240 volt AC 50/60 Hz operation				
	F1946-01	124	104	4,000	19
	Word Channel Interface; provides full-duplex interface to Series 1100 host processor word channel; max. 2 per basic or expansion cabinet; requires F2943-00				
	F1947-00	124	104	4,000	19
	Byte Channel Interface; for connection to Series 90 host processor byte multiplexer or block multiplexer channel; max. 2 per system, but each F2943-00 used precludes one F1947-00				
	F1949-00	34	29	1,045	4
	F1948-01	94	79	3,000	14
	8-Bit Peripheral Interface 16-Bit Peripheral Interface; operates in 8-bit or 16-bit mode; requires F2943-00				
	F2943-00	35	30	1,170	5
	Interface Expander; accommodates cables and connectors for multiple F1946-01's and F1948-01's; max. 4 per basic or expansion cabinet; each F2943-00 used precludes one F1947-00				
	F1941-00	23	18	740	3
	Asynchronous Interface; provides full-duplex RS-232-C/V.24/V.28 interface for data rates of 45.5 to 2400 bps				
	F1942-00	23	18	740	3
	Synchronous Interface; provides full-duplex RS-232-C/V.24/V.28 interface for data rates up to 9600 bps				
	F3163-00	41	36	1,275	6
	Medium Speed Loadable Interface; provides full-duplex synchronous RS-232-C/V.24/V.28 interface; also operates with Bell DDS; data rate depends on protocol used				
	F3164-01	29	24	1,005	4
	High Speed Loadable Interface; provides V.35 interfacing; data rate depends on protocol used				
	F1945-00	29	24	1,005	4
	Auto Dialing Line Module; provides interface to Bell 801 and V.24/V.25-compatible automatic calling units; requires F1941-00, F1942-00, or F3163-00				
<b>DCP/40—Compatible Mode</b>					
	8598-98	1,763	1,463	57,560	263
	Basic DCP/40 Compatible; includes free-standing cabinet, communications processor, storage controller, 128K bytes of storage, first I/O controller module, first I/O processor, ROM memory, and microprograms; requires integrated flexible disk (F1939-00) and one Scanner II (1928-03)				
	F1935-00	64	54	2,160	9
	Scanner Storage Adapter; provides interface between Type II Scanner and local storage				
	F1934-99	88	73	2,880	13
	Scanner Command Interrupt; provides interface for up to three Type II Scanners and/or one I/O processor command interrupt line module (combines maximum of 3); includes first command/interrupt module				
	F1950-00	23	18	720	3
	Second Command/Interrupt Module; provides control interface for second I/O processor; requires F1934-99				
	F1936-00	111	89	3,550	16
	Storage Port Expander; provides multiplexed interface to a single storage port for up to four requestors; required if F2941-99 or second Scanner II are configured				
	F2941-99	458	378	14,920	68
	F1939-00	60	50	1,920	10
	Integrated Flexible Disk; includes controller and one drive; required for basic DCP/40				

\*Includes maintenance.



**Sperry Univac Distributed Communications  
Processor/40 (DCP/40)**

		Monthly Charges*			
		1-Year Lease	5-Year Lease	Purchase Price	Monthly Maint.
▶ F1928-00	Operator Station; free-standing work surface 60 inches wide by 30 inches deep by 38 inches high	30	25	1,200	0
F2944-00	Isolation Transformer; permits 200, 208, 220, or 240 volt AC 50/60 Hz operation	75	60	2,400	10
F1946-00	Channel Interface; provides half-duplex 32-bit interface to Series 1100 host processor channel; maximum 4 per system; two F1946-00's required for each Series 1100 interface; requires F2943-00	124	104	4,000	19
F1947-00	Byte Channel Interface; for connection to Series 90 host processor byte multiplexer channel; max. 1 per system	124	104	4,000	19
F1949-00	8-Bit Peripheral Interface	34	29	1,045	4
F1948-00	16-Bit Peripheral Interface; operates in 8-bit or 16-bit mode; requires F2943-00	94	79	3,000	14
F2943-00	Interface Expander; accommodates cables and connectors for multiple F1946-00's and F1948-00's; max. 2 per system	35	30	1,170	5
F1931-02	Compatible Upgrade; upgrades DCP/40 compatible mode system to DCP/40 operating in native mode	6	6	95	1
<b>Peripherals</b>					
8406-00	Diskette Drive; 100/120 volt	112	89	3,360	19
8406-02	Diskette Drive; 200/240 volt	112	89	3,360	19
F2338-00	Diskette Expansion Drive; 100/120 volt	39	32	1,040	10
F2338-02	Diskette Expansion Drive; 100/120 volt	39	32	1,040	10
8408-02	Cartridge Disk Control; houses up to 2 F2380-04/06 drives	163	131	5,564	27
F2380-04	Cartridge Disk Drive; 10MB; 100/120 volt	523	419	17,750	105
F2380-06	Cartridge Disk Drive; 10MB; 220/240 volt	544	419	17,750	105
F2187-00	Dual I/O Interface for Cartridge Disk	46	36	1,568	7
0871-01	Uniservo 10 Magnetic Tape Unit; requires F2721-00; second 0871-01 requires F2879-00	372	299	13,425	78
F2721-00	Uniservo 10 Controller; provides control for up to two Uniservo 10 tape units; requires F1948-00	331	262	10,320	47
F2879-00	AC Power Switch	37	30	1,200	5
3542-93	Display Console; requires F1948-00	330	185	6,690	60
0786-56	Console Printer; 200 cps unidirectional matrix impact printer	173	150	5,250	33
0786-54	Console Printer; 200 cps bidirectional matrix impact printer	235	210	6,960	55
0774-90	Console Printer; Model 800 TP; 300 cps; non-impact	93	72	2,630	22
1928-03	Type II Scanner	641	497	23,000	66
F2263-00	Type II Scanner Expansion Chassis for 1st and 3rd expansion increments	69	54	2,360	10
F2263-02	Type II Scanner Expansion Chassis for 2nd expansion increment	32	25	1,120	4
F1801-01	Line Base, Type II	18	14	600	3
F1801-02	Line Base, Type II; F1801-01 plus speed scan option for data rates up to 230.4 bps	18	14	600	3
F2381-00	UDLC Procedures, Type II	50	39	1,720	7
F1869-01	Auto Line Speed Detection	14	12	452	3
F1825-02	Type II Line Indicator	13	11	440	2
F1828-00	Type II Line Adapter; RS-232-C, V.24, V.28, local; async up to 9600 bps	21	19	600	6
F1828-01	Type II Line Adapter; F1828-00 with reverse channel for Bell 202	26	23	760	7
F1828-02	Type II Line Adapter; F1828-00 with supervisory channel	32	29	920	9
F1829-00	Type II Line Adapter; MIL-188C/188-100; async. 45.5-2400 bps	21	19	600	6
F1826-00	Type II Line Adapter; RS-232-C, V.24, V.28, other terminal multiplexers; sync. up to 9600 bps	26	23	760	7
F1826-01	Type II Line Adapter; F1826-00 with supervisory channel	38	34	1,160	9
F1827-00	Type II Line Adapter; MIL-188C/188-100; sync. up to 9600 bps	26	23	760	7
F1830-00	Type II Line Adapter; wide-band, AT&T 300; sync. 19.2-50K bps	32	29	920	9
F1832-00	Type II Line Adapter; Telegraph; async. up to 150 bps	21	19	600	6
F1834-00	Type II Line Adapter; wide-band, Bell DDS; sync. 19.2K-56K bps	32	29	920	9
F1835-00	Type II Line Adapter; TWX; async. up to 150 bps	21	19	600	6
F1836-00	Type II Line Adapter; Telex; async. up to 150 bps	21	19	600	6
F2519-00	Type II Line Adapter; RS-232-C, V.24, V.28; clocking for 300, 600, 1200, 1800 bps. async.	26	21	760	7
F2521-00	Type II Line Adapter; Bell 407A/B; async. up to 10 cps	35	29	1,000	10
F3357-00	Type II Line Adapter; X.21; sync.	35	25	1,020	5
F1831-00	Type II Automatic dialing	21	19	600	6

\*Includes maintenance.

### Sperry Univac Distributed Communications Processor/40 (DCP/40)

Monthly  
License Fee



**Software**

6144-00	DCP/40 MCC Emulate O/S; provides for operation in MCC emulate mode	\$83
6136-00	DCP/40 DCP Emulate O/S; provides for operation in DCP emulate mode	99
6136-01	DCP/40 O/S; provides for operation in DCP/40 native mode	127
6136-99	DCP/40 MCC O/S; provides for operation in MCC emulate mode and DCP/40 native mode	165
6136-98	DCP/40 DCP O/S; provides for operation in DCP emulate mode and DCP/40 native mode	165

\*Includes maintenance. ■

# UNIVAC 3760 Communications Controller

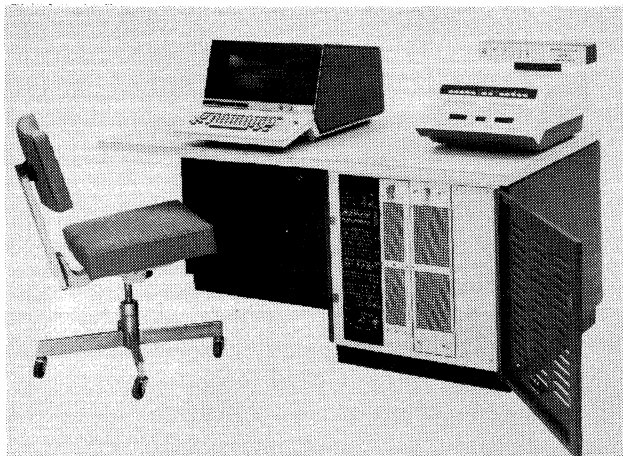

With the UNIVAC 3760, communications activity can be monitored and operations altered via the console, which consists of a Uniscopes 100 display and Tape Cassette System (TCS) and is an integral part of the basic 3760.

## MANAGEMENT SUMMARY

UNIVAC's 3760 Communications Controller is still the only programmable communications processor offered by a leading mainframe manufacturer as a direct replacement for IBM's 370X. Production deliveries began in April 1973.

The UNIVAC 3760 accommodates the more prominent IBM remote terminals (except for those that respond to SDLC line protocol) and Teletype's line of ASCII terminals via software emulation, as well as UNIVAC's own line of terminals. The 3760 is compatible with most IBM telecommunications programs, including BTAM, QTAM, and the more general TCAM under OS or DOS for both System/360 and 370 computers and under OS/VS and DOS/VS for System/370 computers. Compatibility with IBM's VTAM under DOS/VS, OS/VS1, and OS/VS2, however, is not currently provided.

Salient characteristics of the UNIVAC 3760 include:

- A maximum line capacity of 384 half-duplex lines or 192 full-duplex lines.
- A maximum throughput rate of 10K bytes per second for voice-grade lines and 37.5K bytes per second for wideband lines.
- Accommodations for up to 6 wideband lines.
- Synchronous transmission rates of up to 9600 bits/second.
- Asynchronous transmission rates of up to 2400 bits/second with program selectable data rates.
- Wideband rates from 19,200 to 50,000 bits/second.
- Automation transmission speed detection.

A front-end, programmable processor that is a direct replacement for the IBM 270X and 370X Communication Controller.

The system is available in five models starting with a 16K-byte, 8-line system with a modular build-up of memory and communication line handling capability to a maximum of 128K bytes and 384 lines.

Options include a variety of line interface bases and associated line sets with speeds ranging from 45 bps to 50K bps.

A basic 3760 Model 108 with 16K bytes of memory and 8 communications lines rents for \$1,520 per month, including maintenance.

A larger system, the Model 464, with 64K bytes of memory and 128 communications lines rents for \$4,110 per month, including maintenance.

## CHARACTERISTICS

VENDOR: UNIVAC Division, Sperry Rand Corporation, P.O. Box 500, Blue Bell, Pennsylvania 19422. Telephone (215) 542-4011.

DATE OF ANNOUNCEMENT: January 1973.

DATE OF FIRST DELIVERY: April 1973.

NUMBER DELIVERED TO DATE: 150.

SERVICED BY: UNIVAC.

## MODELS

The UNIVAC 3760 is available in five models. All models include a basic 3760 controller, but they differ in configuration and in capability. The parameters of the five 3760 models are defined in table 1.

## CONFIGURATION

The 3760 Communications Controller is composed of:

- The basic 3760, which includes the processor, 16K bytes of main memory, and the necessary interfaces between the processor and memory, processor and local I/O devices, processor and communications lines, and processor and host computer.
- Channel Adapter (ICA), which provides the data path between the 3760 and the selector, block multiplexer, or byte multiplexer channel of an IBM System/360 or System/370 host computer. The optional Dual Channel Switch permits manual switching of the ICA between two channels of a host computer or one channel on each of two host computers.
- Storage Interface, which includes one or two (optional) Storage Bank Chassis, each of which can contain up to

## UNIVAC 3760 Communications Controller

➤ UNIVAC also provides a variety of software to permit users to develop their own subroutines so that the 3760 communications network can be tailored to satisfy individual needs. The additional software includes:

- System/360 or System/370 Load/Dump—Permits the transfer of UNIVAC 3760 programs between the host processor and the 3760.
- System/360 or System/370 Cross Assembler—Permits users to generate their own 3760 subroutines on the host processor. The Cross Assembler interfaces the Load/Dump program to facilitate loading user-developed subroutines.
- UNIVAC 3760 Debug Routines—Permit users to debug application software on the 3760.
- BTAM On-line Test—Permits users to employ UNIVAC on-line test programs that run under BTAM to test network and terminal operation.

The 3760 operates under control of its own software, which is loaded from cassette tape via the standard Tape Cassette System (TCS) into 3760 main storage. Currently, 3760 software consists of emulation software only, which provides compatibility with existing IBM software as a 270X replacement; this software is not compatible with IBM's latest versions designed to run with the 370X Network Control Program (NCP). UNIVAC's plans for developing a front-end processing package similar to IBM's NCP or support for IBM's SDLC line protocol are indefinite at this time. However, UNIVAC's pending response to IBM's VTAM, NCP, and SDLC will determine the continued viability of the 3760 as a realistic alternative to the IBM 370X line for System/370 users.

Worldwide, UNIVAC has installed about 150 units to date. Typically, they are configurations handling about 16 lines. The largest configuration installed to date handles fewer than 100 lines.

### USER REACTION

Datapro interviewed seven users of the UNIVAC 3760, who reported on their experience with a total of eight systems. All of the systems had been installed for more than one year. Configurations ranged from 8 to 64 communications lines interfaced. The ratings assigned by these users are summarized below.

	Excellent	Good	Fair	Poor	WA*
Overall satisfaction	3	4	0	0	3.4
Ease of installation	4	2	1	0	3.4
Throughput	2	4	1	0	3.1
Hardware reliability	3	3	1	0	3.4
Manufacturer's maintenance:					
Promptness	2	3	2	0	3.0
Quality	3	3	1	0	3.3
Manufacturer's software	2	3	2	0	3.0
Technical support	4	1	2	0	3.3

\*Weighted Average on a scale of 4.0 for Excellent.

As can be seen by the results, users were well pleased with their 3760 systems. These ratings reflect a considerable improvement over a similar survey of the 3760 made last ➤

➤ 64K bytes of main memory in 16K-byte increments. A four-port memory multiplexer is part of each Storage Bank Chassis to provide a direct memory interface for the processor/ICA and for up to three Type II Scanners.

- Parallel I/O Controller, which interfaces the processor with a Uniscope 100 video display unit and Tape Cassette System (TCS) and provides three additional 16-bit-wide parallel channels for future attachment of disk or tape drives, card readers, and card punches.
- Scanners, which interface the line attachment hardware with the 3760 processor and Storage Multiplexer, a four-part, priority-controller multiplexer through which the processor and attached scanners access main memory. Two scanner types provide different levels of performance. The scanners are independently programmable via their own unique instruction set. Scanner programs are stored in 3760 memory, and programmed procedures are processor-initiated. At the completion of each operation, the scanner interrupts the processor and presents ending status indications.
- Line Bases, each of which interfaces a scanner and one or more line adapters and provides termination for the line adapters.
- Line Adapters, each of which interfaces a communications line (via a modem) and a line base and provides a standard modem interface (EIA Standard RS-232C, CCITT, or MIL-STD-188C). Eight different line adapters, divided between the two scanner types, provide clocking and control and control for particular types of lines and transmission techniques.

Physically, the 3760 consists of a free-standing desk which contains the processor, memory, and all basic interface modules. An operator's console consisting of a Uniscope 100 video display unit and a dual magnetic tape cassette recorder occupies the desk's top surface. Separate expansion cabinets are available for expanded communications capabilities.

Scanners are designated as Type I and Type II. The Type I Scanner, limited to one per 3760 Model 108 or 216, accommodates up to 16 half- or full-duplex communications lines. The Type II Scanner accommodates up to 32 half- or full-duplex lines. An Expansion Scanner doubles the line-accommodation capability of the Type II Scanner to 64 half- or full-duplex lines. Each Type II Scanner or Expansion Scanner can accommodate 64 half-duplex lines when the optional Half-Duplex Expansion feature is included. With this feature, a combined Type II Scanner and Expansion Scanner can accommodate 128 half-duplex lines.

The 3760 accommodates one, two or three Type II Scanners, each with an optional Expansion Scanner, to provide accommodate for a total of 384 half-duplex or 192 full-duplex communications lines. Each Type II Scanner, its Expansion Scanner, Half-Duplex Expansion feature, and related components including Line Bases and Line Adapters, is contained in an expansion cabinet located up to 25 cable-feet from the desk unit.

Line Bases, external to the Type II Scanner only, each accommodate 8 full- or half-duplex communications lines. One to four Line Bases interface each Type II Scanner or Expansion Scanner. The Type I Scanner contains an integral Line Base. The optional Half-Duplex Expansion feature doubles the half-duplex line capacity of a Type II Scanner or Expansion Scanner.

CONNECTION TO HOST COMPUTERS: The Channel Adapter (ICA) provides attachment to the selector, byte multiplexer, or block multiplexer channel of an IBM System/360 or 370 computer. A data transfer rate of 10,000 bytes/second can be maintained when the sum of the transfer rates of all attached lines permits. The transfer rate increases when wideband facilities are attached. The transfer rate is  $10,000 + 4,583n$  bytes/second ( $n$  equals 1 to 5) when 1 to 5 wideband lines are in use in addition to lower-speed lines, and 37,500 bytes/second for 6 wideband lines. ➤

## UNIVAC 3760 Communications Controller

## UNIVAC 3760 MODEL CHARACTERISTICS

3760 Model	Scanner Type and Quantity	Memory, Bytes	Line Adapter Type	Line Adapters and Maximum Quantity (3)	Total Lines (5)
108	1 Type I	16K to 32K	I	4 Dual Asynch; 4 Dual Synch; 2 Wideband; 2 Dual Dial (4)	8
216	1 Type I	32K	I	8 Dual Asynch; 8 Dual Synch; 2 Wideband; 4 Dual Dial (4)	16
232	1 Type II (1)	32K	II	32 Asynch; 32 Synch; 6 Wideband; 16 Dial (4)	32
264	1 Type II (2)	48K to 64K	II	64 Asynch; 64 Synch; 6 Wideband; 32 Dial (4)	64
464 (6)	1 Type II (2)	64K to 128K	II	384 Asynch; 384 Synch; 6 Wideband; 192 Dial (4)	64 full- or 128 half-duplex lines (6)

- (1) Includes 4 Line Bases.
- (2) Includes Expansion Scanner and 8 Line Bases.
- (3) Each 3760 model accommodates any combination of Line Adapters; however, Models 108 and 216 restrict the number of UNIVAC terminal types that each can support to one and two, respectively. Model 108 is limited to one type of communications facility; Models 216, 232, and 264 are limited to two types of communications facilities; Model 464 supports four types.
- (4) Displaces one Asynchronous or Synchronous Line Adapter for each attached Dial Adapter.
- (5) Total half- or full-duplex communications lines.
- (6) Model 464 can be expanded to include three Type II Scanners and Expansion Scanners, 128K bytes of memory, and up to 192 full-duplex or 384 half-duplex lines.

year by Datapro. At that time ratings were lower primarily due to hardware and software failures that were linked to initial installation. According to the current survey, these early problems have been for the most part solved by UNIVAC, and users are generally quite pleased with the system. Advantages most often cited by users include flexibility, reliability, stand-alone capability, modularity, and good diagnostic and control features.

There were some minor criticisms of the system voiced by a few users. These disadvantages included some excessive down time when connecting additional communications lines, limited software application programs and occasional lack of promptness of service. □

- ▶ A manual two-channel switch can be added to the Channel Adapter to provide a connection to two channels on the same computer or one channel on each of two host computers. Only one data path exists at any one time.

## TRANSMISSION SPECIFICATIONS

Line Adapters each accommodate a single half- or full-duplex communications line and are divided into three categories: synchronous, asynchronous (both are voice-grade), and wideband (synchronous only). Synchronous operation accommodates transmission rates up to 9600 bits/second; asynchronous, from 45.45 to 2400 bits/second; and wideband, from 19,200 to 50,000 bits/second. A total of eight Line Adapters are equally divided between Type I and Type II Scanners.

Type I Line Adapters accommodated by the Type I Scanner include:

- Type I Dual Synchronous Serial Line Adapter—contains two modem interfaces and can operate in the full- or half-duplex mode under program control. The integral line base of the Type I Scanner accommodates one to eight of these dual adapters.

- Type I Dual Asynchronous Serial Line Adapter—contains two modem interfaces and can operate in the full- or half-duplex mode under program control. The integral line base of the Type I Scanner accommodates one to eight of these adapters.
- Type I Wideband Line Adapter — accommodates two full- or half-duplex wideband communications lines. The Type I Scanner and combined Line Base can service two wideband lines concurrently or one wideband line and up to 14 voice-grade lines, depending on the system load.
- Type I Dual Dial Adapter — interfaces two Bell System 801 Automatic Calling Units (ACU). The Type I Scanner and integral Line Base can accommodate up to eight Dial Adapters; however, each Dial Adapter physically displaces a Type I Dual Synchronous or an Asynchronous Serial Line Adapter.

Type II Line Adapters accommodated by the Type II Scanner and Expansion Scanner include:

- Type II Synchronous Serial Line Adapter — accommodates one half- or full-duplex communications line via an attached modem. Each Type II Scanner or Expansion Scanner can accommodate up to 32 of these adapters.
- Type II Asynchronous Serial Line Adapter — accommodates one half- or full-duplex communications line via an attached modem. Each Type II Scanner or Expansion Scanner can accommodate up to 32 of these adapters.
- Type II Wideband Line Adapter — accommodates one half-duplex wideband communications line. Up to six can interface one or more Type II Scanners.
- Type II Dial Adapter — interfaces one Bell System 801 Automatic Calling Unit (ACU). Each Type II Dial Adapter physically displaces a Type II Synchronous or Asynchronous Serial Line Adapter.

Automatic Baud Rate Detection (ABRD) is available as a hardware option for Models 232, 264, and 464. This option ▶

# UNIVAC 3760 Communications Controller

## Configurations

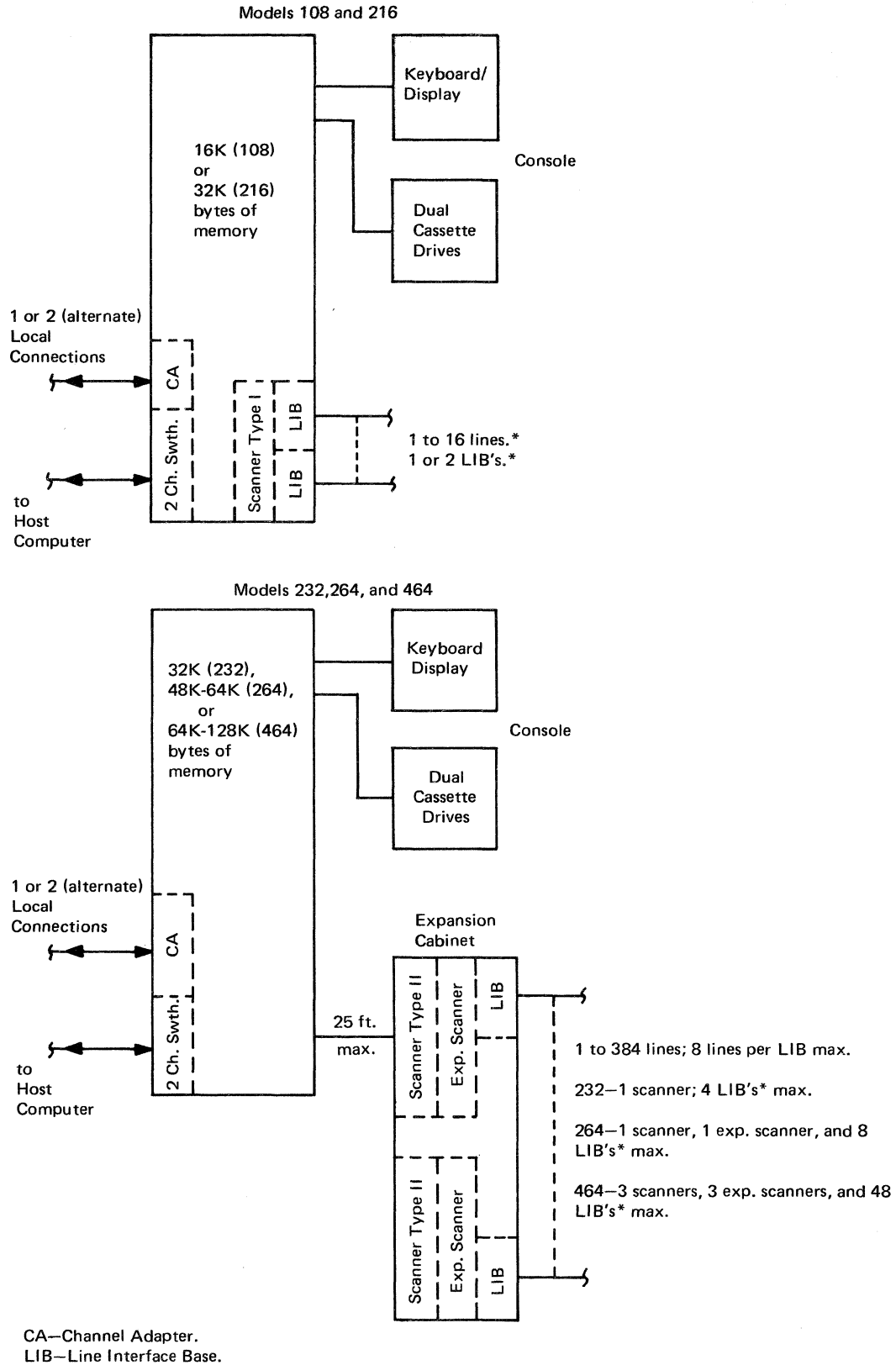

\*See table for available LIB's and line adapters and restrictions on combinations.

## UNIVAC 3760 Communications Controller

- ▶ permits detecting and setting asynchronous transmission rates of remote terminals via switched lines.

### SOFTWARE

The 3760 executes all operations under the direction of software contained within the unit's memory. UNIVAC 3760 software includes a Supervisor program, which provides overall system control, several Adapter Emulator programs designed to simulate the control and data-handling functions of the IBM 270X hardwired communication controllers and the associated Terminal Adapters, and Terminal Emulator programs that permit UNIVAC terminals to emulate counterpart IBM terminals.

The Supervisor includes several control functions or specialized routines that control system initialization, interval timing, interrupt dispatching, command processing, I/O scheduling, communications data transfer, and supervisory access via the 3760 console. The supervisor also interfaces individual emulator programs.

Adapter Emulation programs support most IBM and Teletype terminals that are currently supported by the IBM 270X communication controllers via their hard-wired terminal adapters. These programs provide software emulation for the following IBM Terminal Adapters:

- Terminal Adapter Type I – emulation supports communications between the UNIVAC 3760 and IBM 1050, IBM 2740 Model 1, and IBM 2741 terminals.
- Terminal Adapter Type III – emulation supports communications between the UNIVAC 3760 and IBM 2848/2260 and IBM 2845/2265 display terminals, each with or without an attached IBM 1053 printer.
- Synchronous Data Adapter Type II – emulation supports communications between the UNIVAC 3760 and IBM Binary Synchronous terminals, including the IBM 2780 and 3780 batch terminals, 3270 display terminal, other IBM terminals that use the BSC technique, and other System/360 or System/370 computers.

- Telegraph Adapter Type II – emulation supports communications between the UNIVAC 3760 and Teletype Model 33 or 35 teletypewriters.

Terminal Emulation programs support the following UNIVAC terminals as direct replacements for the corresponding IBM and Teletype terminals:

- UNIVAC Uniscope 100 – replaces the IBM 2848/2260 Display Station.
- UNIVAC Uniscope 100 and DCT 1000 – replaces the IBM 2248/2260 Display Station and 1053 Printer.
- UNIVAC DCT 1000 – replaces the IBM 1050 Terminal.
- UNIVAC DCT 500 – replaces the IBM 2740 Model 1 or IBM 2741 Communication Terminal.
- UNIVAC DCT 500 – replaces the Teletype Model 33 or 35.

**OPERATOR'S CONSOLE:** Consists of a UNIVAC Uniscope 100 video display unit and an associated dual magnetic tape cassette recorder. Via console software, the operator can send messages to any remote terminal in the network, display the contents of a control block associated with any line, display the contents of a location or block of memory, alter the contents of memory locations, load or dump program data (via the TCS), monitor the activity of a particular line, etc. Diagnostic routines can also be loaded via the console to aid in isolating network faults.

### PRICING

The UNIVAC 3760 Communications Controller is available for purchase or on a one-year or five-year lease. A separate maintenance contract is available for both arrangements. UNIVAC states that the following pricing is subject to change.

	Monthly Rental*	Purchase	Monthly Maint.
<b>3760 Model</b>			
108	\$1,215	\$ 54,600	\$171
216	1,476	66,675	203
232	2,156	96,100	249
264	2,604	114,600	292
464	2,865	124,900	324
<b>Additional Components</b>			
Channel Switch, 360/370	97	4,305	14
Auto. Baud Rate Detection	31	1,077	5
Storage Expansion (16K bytes)	261	10,300	32
Storage Chassis & Multiplexer	249	10,000	24
<b>Scanners:</b>			
Type I	51	2,100	10
Type II	610	28,500	35
Expansion Scanner	189	8,200	14
Line Base	20	675	5
Half-Duplex Expansion	66	2,475	11
<b>Type I Line Adapters:</b>			
Dual Asynchronous	20	630	4
Dual Synchronous	26	900	4
Dual Dial Adapter	26	872	5
Wide Band Adapter	52	1,743	11
<b>Type II Line Adapters:</b>			
Asynchronous	9	315	2
Synchronous	13	450	2
Dial Adapter	15	436	5
Wide Band Adapter	26	872	5
<b>Active Line Indicators:</b>			
First 16 lines	13	528	2
Additional 16 lines	13	528	2

\* For a one-year lease; includes maintenance. ■





# Sperry Univac Distributed Communications Processor/20 (DCP/20)

## PRODUCT DESCRIPTION

Sperry Univac has announced the DCP/20 Distributed Communications Processor, the second in a line of processors designed for network applications. The DCP/20 features a new processor model, up to 512K bytes of main memory, and communications line modules that support up to 48 lines. Utilizing the vendor's Distributed Communications Architecture, it may act as a front-end to an I100 Series and Series 90 mainframe, or a remote intelligent concentrator in a Sperry Univac or multi-vendor network.

The DCP/20 architecture provides for the distribution of processing operations between the general-purpose processor, one or two expansion processors, and microprogrammed line modules. The general-purpose processor handles general communications tasks, plus supporting the 16 line modules. The two expansion processors are physically identical to the general-purpose processor but perform only input/output operations. Like the general-purpose processor, each of the two expansion processors support up to 16 line modules. Serial lines to remote equipment, local peripheral interfaces and channel connections to on-site host processors can be accommodated by various line modules. Each communications line module provides interfacing for a specific type of channel or device. Connections to remote equipment via data communications lines, to local peripheral devices, and to on-site host computer channels can all be accommodated.

The DCP/20 can support the following devices as optional peripherals: a system console with or without an optional slave printer, one or two magnetic tape

**PRODUCT ANNOUNCEMENT:** Model DCP/20, a low cost, medium performance member of Sperry Univac's Distributed Communications Processor (DCP) family.

**ANNOUNCEMENT DATE:** June 16, 1981.

**DELIVERY SCHEDULE:** First customer shipments are scheduled for 1981.

## BASIC SPECIFICATIONS

**VENDOR:** Sperry Univac Division, Sperry Corporation, P.O. Box 500, Blue Bell, Pennsylvania 19422. Telephone (215) 542-4011.

**CONFIGURATION:** The DCP/20 is a multiprocessor-based system that supports a general-purpose processor with 256K bytes of main memory (expandable in two 128K-byte increments to 512K bytes), two optional expansion I/O processors, and a number of optional peripherals. The system, designed to operate with Sperry Univac's Telcon software, accommodates a wide range of communications processing requirements, including network management interface, internetwork control, communications, accounting, error control, on-line diagnostics, status monitoring, command processing, and system synchronization. The various elements of the DCP/20's operations are distributed among its processors and line modules.

Each processor and expansion processor provides programmed control for up to 16 data ports, for a maximum of 48 ports per system. Each port requires one communications line module to provide the specific functions that make that port operational. The line module both provides the physical connector needed to attach a peripheral device, computer channel, or communications line to the system and performs the programmed communications interfacing functions required for that particular device, channel, or line.



The DCP/20 Processor (center) is shown in configuration with (from left to right) the cartridge disk sub-system, one Uniservo 10 tape drive, and the optional operator's control console and impact console printer.

## Sperry Univac Distributed Communications Processor/20 (DCP/20)

► drives, up to two cartridge disk drives, and up to eight 250K-byte diskette drives.

The DCP/20 is designed to operate under Sperry Univac's Telcon software, which provides communications network control compliant with Sperry's Distributed Communications Architecture.

### RELATIONSHIP TO CURRENT PRODUCT LINE:

The DCP/20 is a scaled-down version of the DCP/40, offering most DCP/40 features to the smaller user at considerable cost savings. Like the DCP/40, the DCP/20 is based on a multiprocessor architecture that consists of one general-purpose processor plus multiple expansion processors dedicated to I/O handling tasks. The DCP/20 supports up to two expansion processors and up to 48 communications lines, whereas the DCP/40 supports up to 16 expansion I/O processors and up to 256 communications lines. Maximum main memory size is 512K bytes for the DCP/20 versus 2048K bytes for the DCP/40. All line modules and peripherals offered for the DCP/40 are also supported on the DCP/20. □

► Serial line modules are provided to connect the DCP/20 to serial data lines. They can also be used to attach the operator's control console to the system. The types of interfacing provided the various serial line modules include:

- General-purpose, asynchronous, full-duplex, RS-232/V.24/V.28 interfacing at data rates from 45.5 to 2400 bps.
- General-purpose, synchronous, full-duplex, RS-232/V.24/V.28 interfacing at data rates up to 9600 bps.
- Asynchronous or synchronous, full-duplex, RS-232/V.24/V.28 interfacing loadable with microsoftware support any of the following protocols or facilities: UDLC, REM 1, 1100 FDX, or Uniscope Sync at up to 19,200 bps; or BSC, Async (TTY), or Bell DDS at up to 9600 bps. Automatic data rate detection is provided in Async mode.
- Full-duplex, V.35 interfacing loadable with microsoftware supporting any of the following protocols or facilities: UDLC or 1100 FDX at up to 64K bps; European V.35 at 48K bps; or Bell DDS or DSDS at 56K bps.
- Interfacing to Bell 801, V.24/V.28-compatible, or NTT (Japan) automatic calling units.

Parallel line modules provide the hardware interface between the DCP/20 and peripheral subsystems or on-site host computers. These modules include: the Host Byte Channel Module; Host Word Channel Module; Sixteen-Bit Peripheral Line Module which provides an 8- or 16-bit interface to a cartridge tape or magnetic tape subsystem; and Byte I/O Line Module, which provides an 8-bit interface to a flexible disk subsystem.

Available peripherals to the DCP/20 include: 10MB or 20MB cartridge disk subsystem; up to four dual flexible disk subsystems, for a total of diskette storage capacity of 2MB; one or two Uniservo 10 magnetic tape drives; an operator's control console, which may be a Uniscope 200, UTS 400, or UTS 4000 CRT terminal; and an optional slave console printer, available in either 300-cps non-impact or 200-cps impact models.

### Monthly Charges\*

		Monthly Rental	5-Year Lease	Purchase Price	Monthly Maint.
<b>DCP/20</b>					
8597-99	Basic DCP/20; includes free-standing cabinet, communications processor, 256K bytes of storage, microprogram storage, and microprograms; requires integrated flexible disk and controller (F1939-00); requires cartridge disk (T8408)	\$1,347	\$1,122	\$43,880	\$202
8597-01	DCP/20 Expansion Cabinet; includes free-standing cabinet, power supply, and processor capable of I/O functions; provides mounting for 8 line modules (up to 16 line modules with F2894-00); requires F1936-00	734	609	24,000	109
F3539-00	Storage Expansion; provides additional 128K bytes of storage; max. of 2 can be added to DCP/20	137	117	4,500	22
F1939-00	Integrated Flexible Disk; provides control and 1 flexible disk drive for 256K byte diskettes; required for basic DCP/20	61	51	1,920	11
F1936-00	Storage Port Expander	112	92	3,550	17
F2943-00	Interface Expander; accommodates cables and connectors for 2 F1948-00s and 1 F1946-01; each F1947-00, when present, precludes 1 F2943-00	35	30	1,170	5
F2894-00	Line Module Expansion; provides expansion for additional 8 line modules in 8597-01	515	305	12,000	55
F2895-00	Active Line Indicators; provides the capability to monitor up to 16 half-/full-duplex lines in 8597-01 or 8597-99	29	24	890	4
F1946-00	1100 Series ISI Interface; provides full-duplex interface to a Series 1100 host processor word channel; requires F2943-00	126	106	4,000	21
F1947-00	Series 90 Byte Interface; provides byte interface to a Series 90 byte multiplexer or block multiplexer channel; space for 1 F1947-00 in each DCP/20 or DCP/20 expansion cabinet	126	106	4,000	21
F1948-00	16-Bit Peripheral Interface; for connection of a peripheral subsystem; allows operation in 8-bit or 16-bit mode; requires F2943-00	95	80	3,000	15
F1941-00	Asynchronous Interface; provides full-duplex RS-232-C/V.24/V.28 interface for data rates from 45.5 to 2400 bps	23	18	740	3
F1942-00	Synchronous Interface; provides full-duplex RS-232-C/V.24/V.28 interface for data rates to 9600 bps	23	18	740	3
F3163-00	Medium-Speed Loadable Interface; provides full-duplex synchronous or asynchronous RS-232-C/V.24/V.28 interface (data rate depends on protocol used); also operates with Bell DDS up to 9600 bps	42	37	1,275	7
F3164-01	High-Speed Loadable Interface; provides full-duplex V.35 interfacing; data rate depends on protocol used	119	99	3,745	19
F1945-00	Auto Dialing Line Module; provides interfacing to Bell 801 and V.24/V.25-compatible automatic calling units; requires F1941-00, F1942-00, or F3163-00	29	24	1,005	4
F1945-01	Auto Dialing Line Module; conforms to NTT (Japan) requirements	29	24	1,005	4

**Sperry Univac Distributed Communications  
Processor/20 (DCP/20)**

		Monthly Charges*			
		<u>Monthly Rental</u>	<u>5-Year Lease</u>	<u>Purchase Price</u>	<u>Monthly Maint.</u>
<b>Peripherals</b>					
8408-02	Cartridge Disk Control; provides control for and houses up to 2 F2380 drives; requires F1948-00	168	133	5,564	29
F2380-04	Cartridge Disk Drive; 10MB (5MB fixed, 5MB removable)	553	428	17,750	114
F2187-00	Dual I/O Interface for Cartridge Disk; permits cartridge disk subsystem to be shared by another computer	47	37	1,568	8
0871-00	Magnetic Tape Unit; requires F2721-00; second 0871-00 requires F2879-00	379	306	13,425	85
F2721-00	Uniservo 10 Magnetic Tape Controller; provides control for up to 2 0871 magnetic tape units; housed in cabinet of first tape unit; requires F1948-00	335	266	10,320	51
F2879-00	AC Power Switch	37	30	1,200	5
		<u>Monthly License Fee</u>	<u>Extended Service Support</u>		
6136-01	DCP/20/40 Operating System	\$146	\$46		

\*Includes maintenance.■

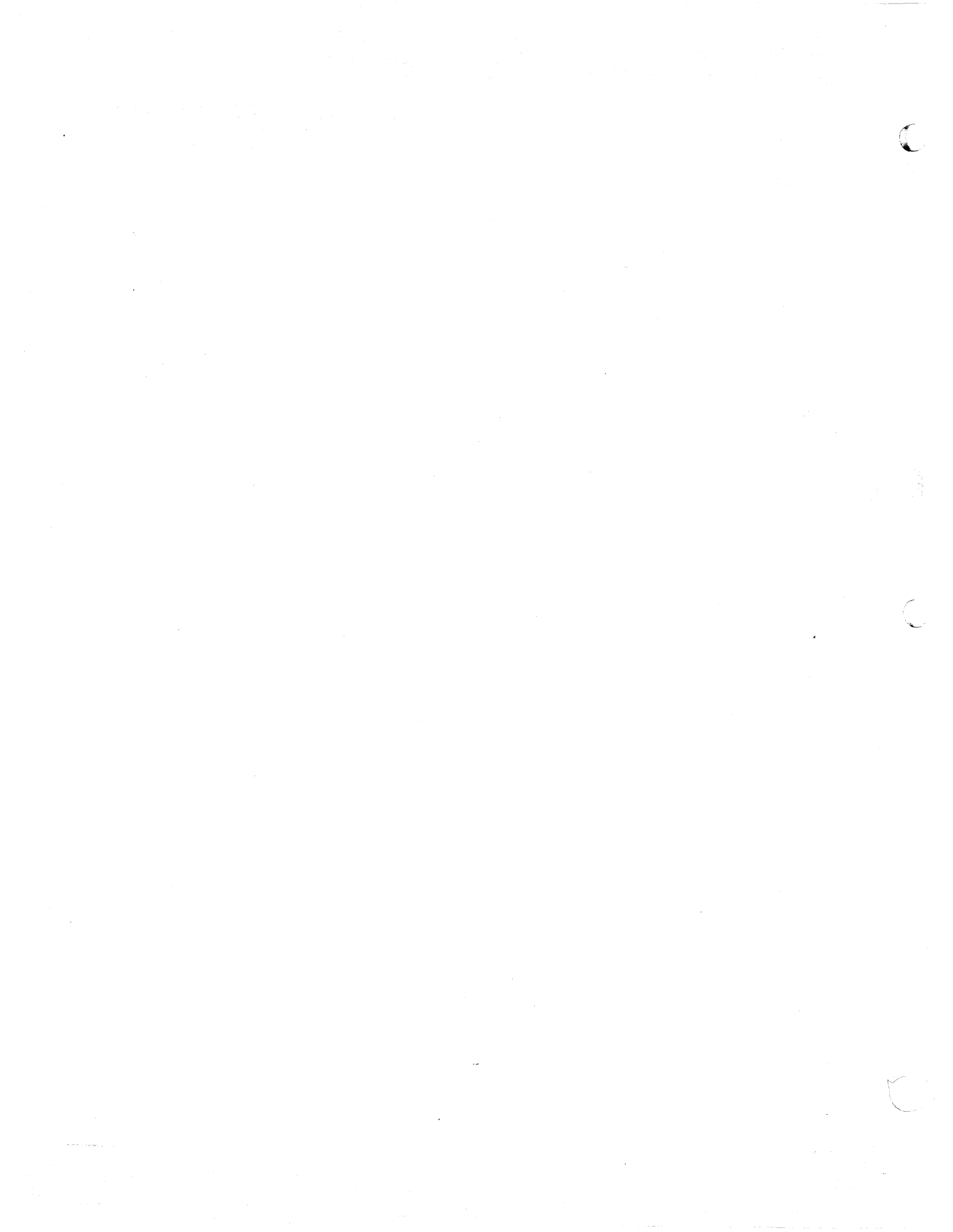

# Sperry Univac Distributed Communications Processor (DCP)



*In the foreground is a UNISCOPE 100 Console and a diskette unit atop the Distributed Communications Processor's desk-like cabinet. In the background is the Type II Scanner.*

## MANAGEMENT SUMMARY

The options and capabilities of the Distributed Communications Processor (DCP) can be better appreciated when the DCP's role in Sperry Univac's newly announced Distributed Communications Architecture (DCA) is kept in mind. Essentially, DCA is a set of ground rules that defines the functions that each element within a communications network should (and should not) perform. Furthermore, DCA defines the standards for interfacing between elements. The goal is to permit interconnection of dissimilar hardware/software into one communications network—provided there is compliance with the ground rules.

TELCON is a software and hardware system to implement DCA. The DCP hardware is employed within the TELCON system. Portions of the TELCON software reside in the DCP, portions in the host computers, and still other portions in any intelligent terminals in the network. Within TELCON the DCP performs the specific functions of front-end processing and line concentration, providing the user with no programmatic tools to alter the assigned function. However, within the assigned function, the hardware options and own-coding provisions provide significant flexibility. For example, the user is provided optional peripherals and software for recording transmission messages for audit and restart purposes.

The most important optional feature, from a network standpoint, is the Remote I/O Controller (RIOC). This feature is a microprocessor with 16, 16-bit parallel channels that permits a variety of hook-ups between DCP's, host 1100's, and local peripherals. For instance, seven 1100's, a console, and a magnetic tape subsystem

A front-end processor or remote concentrator for Sperry Univac 1100 Series host computers.

A total of 192 full-duplex or 384 half-duplex communication lines with any mix of protocols and with speeds up to 56K bytes per second is supported. Telex, TWX, EIA, CITT bit-oriented, and military standard line interfaces are provided.

The Remote I/O Controller feature provides attachment to a DCP multiple local/remote host computers and/or multiple DCP. Up to seven 1100 Series computers can be physically attached. An economical host attachment feature is provided for local attachment of one or two 1100/80's.

A typical DCP handling 10 lines for a host 1100/80 leases for \$2,140 per month, or can be purchased for \$71,800.

A typical DCP handling 128 lines for any 1100 Series host computer with cartridge disks for transmission message audit and restarts, leases for \$6,577 per month, or can be purchased for \$215,208.

The DCP operating with the TELCON software represents Sperry Univac's initial implementation of its newly announced Distributed Communication Architecture.

## CHARACTERISTICS

**VENDOR:** Sperry Univac Division, Sperry Rand Corporation, P.O. Box 500, Blue Bell, Pennsylvania 19422. Telephone (215) 542-4011.

**DATE OF ANNOUNCEMENT:** November 1976.

**DATE OF FIRST DELIVERY:** October 1977.

**NUMBER DELIVERED TO DATE:** —

**SERVICED BY:** Sperry Univac.

## CONFIGURATION

The basic Distributed Communications Processor (DCP) is a 16-bit word processor with byte (8-bit) addressability that is housed in a desk-like cabinet. Main storage is 32K bytes, expandable to 131, 072 bytes by the addition of integrated circuit storage modules; each module contains 16,384 bytes. The access time is 920 nanoseconds to read main storage and 860 nanoseconds to write to main storage.

External input/output access to main storage is either through the processor's general registers or through direct

## Sperry Univac Distributed Communications Processor

### COST OF TYPICAL DCP CONFIGURATIONS

Configuration	No. of half-duplex, asynchronous lines	Host Computer	Attachable to other DCP's	Scanner Type	Memory, bytes	Cartridge Disk	Purchase Price	Monthly Rental
A	10	1100/80	No	I	32K	No	\$ 71,800	\$2,140
B	10	1100 Series	Yes	I	32K	No	84,844	2,530
C	10	1100 Series	Yes	II	32K	No	110,908	3,304
D	128	1100 Series	Yes	II	64K	Yes	215,208	6,577

➤ could be physically interconnected. Or, four 1100's, five DCP's, a console, and two magnetic tape subsystems could be grouped. In effect, with the RIOC feature processor throughput, rather than physical attachment limitations, will most likely be the limiting factor for expansion.

I/O transfer between the RIOC and host computers are made four bytes at a time. The RIOC transfers data directly into memory without processor intervention. If the host is an 1100/80, a single byte I/O transfer feature, instead of the RIOC can be used. The difference, as shown in configurations A and B above, can amount to almost \$400 per month.

Selection of the type of scanner is another important consideration. When configuration requirements permit, the Type I Scanner should be selected in preference to the Type II Scanner. While they both operate at the same speed, the Type I offers cost and space savings (see Configuration B & C above). However, the Type I has limited interface capacity while the more costly Type II Scanner, housed in its own cabinet, offers sizable line interfacing capabilities. As with the RIOC, the physical line capacity limitations of the Type II Scanner probably exceeds the processor's processing capability.

The optimum memory size for the resident software, of course, is dependent on the line load and speeds, making generalizations meaningless.

The selection of line interfaces provided with the DCP is one of the most extensive offered by any manufacturer. Tables 1 and 2 later in this report list the interfaces and show the pay-off to Sperry Univac's approach to network architecture. The DCA ground rules permit the interconnection of a vast array of line disciplines supporting an even larger array of terminal types. The DCA approach produced hardware (DCP) that operates under software (TELCON) — not software operating under hardware. This new perspective may open the way to better communications. □

➤ access ports without processor intervention. The Single-Port Storage feature provides one direct access port, and the Multi-Port Storage feature provides four direct access ports.

The only front-end processor configuration that permits use of the Single-Port Storage feature is when the host computer is a local 1100/80 and when no more than 16

full-duplex or 16 half-duplex lines require support; this permits a Type I Scanner to be used. In this configuration, the necessary UNISCOPE 100 console requires the Parallel I/O Channel feature. This feature and the Type I Scanner are attached to an I/O Controller, which in turn is attached to the DCP's Multiplexer. The Multiplexer has access to memory either directly through the Single-Port Storage feature or through the processor's general registers. An Intercomputer Adapter, is required for attachment to the 1100/80. It is also attached to the Multiplexer through a Channel Controller. The presence of the Parallel I/O Channel feature permits up to three subsystems of tape and/or disks to be attached. A flexible Diskette subsystem attached to the standard, no-additional-cost Byte I/O Channel completes the Single-Port front-end processor configuration. All configurations require either a Flexible Diskette subsystem or a Cartridge Disk subsystem for bootstrapping. In the above configuration, a Cartridge subsystem could have been attached to one of the Parallel I/O Channel.

When the Single-Port Storage feature is replaced with a Multi-Port Storage feature, certain other attachments can have direct access to memory along with the Multiplexer. For instance, the line capacity of the above configuration can be increased to 32 full-duplex or 32 half-duplex lines with the attachment of a Type I Scanner Expansion feature to a port on the Multi-Port Storage feature. The original 16 lines on the Type I Scanner would still have access to memory via the Multiplexer.

The Intercomputer Adapter feature provides for single byte transfer between the DCP and the Byte Multiplexer Channel of an 1100/80. The other models in the 1100 Series do not have a Byte Multiplexer channel and therefore, require a word channel connection. The Remote I/O Controller (RIOC) feature can supply such an interface and has the added advantage of permitting the host to be local or remote. The RIOC is attached directly to a port on the Multi-Port Storage feature and has 16 parallel word I/O channels that can be attached to 1100 Series host, to the RIOC of other DCP's, to a UNISCOPE 100 as a local console, or to disk and tape subsystems. When an RIOC is used, the Parallel I/O Channel cannot be attached, which necessitates using the RIOC for connecting the console and any disks and tapes. The Type I Scanner Expansion cannot be attached when the RIOC is used. The RIOC is actually a microprogrammable processor which can transfer data directly to and from memory without processor intervention in either 8-bit, 16-bit, or 32-bit modes. The RIOC can be attached to transfer data in one direction at a time or to operate in full-duplex by using two of the I/O channels; as is the case when attached to an 1100 Series computer.

Expansion of the communication line capacity beyond 32 lines (or 16 lines when the RIOC is attached) requires the use of the Type II Scanner which, unlike the Type I Scanner, is not housed in the processor cabinet. The Type II Scanner has its own cabinet, but is wired directly to the Multi-Port Storage feature in the processor cabinet. The

## Sperry Univac Distributed Communications Processor

TABLE 1: LINE ADAPTER (LA) OPTIONS FOR TYPE I SCANNER

Type of Line Interface*	Timing	Speed	Feature Number	When LA is connected to LA Expansion Cabinet (Feature 8591-00) instead of directly to modem, then
RS-232C, V.24, local console	Asynchronous	Up to 9600 bps	F1798-00	Connects to U.S. Telex Interface, #F2373-00, for Telex lines.
	Synchronous	Up to 9600 bps	F1799-00	Connects to V.35 Interface, #F2370-00, to support V.35 standard
RS-232C, V.24, Mil Std-188C	Asynchronous	45.45, 50, 75, 100, 110, 134.5, 150, 200, 300, 600, 1200, 1800, 2400 bps	F1798-01	—
	Synchronous	Up to 9600 bps	F1799-01	—
IBM 2260	Asynchronous	Up to 2400 bps	F1798-04	—
Wide-Band, V.35	Synchronous	From 19.2 to 56K bps	F1814-00	—
TWX	Asynchronous	Up to 150 bps	F2371-00	—
RS-232C, V.24, V.35, X.21, bit-oriented (UDLC, SDLS, HDLC, ADCCP.)	Synchronous	Up to 9600 bps	F2372-99	Cannot be attached to modem directly. Up to three LA's can be attached to UDLC Module #F2645-99; up to two more LA's can be attached to UDLC Expansion Module, #F2643-01.
V.35, bit-oriented line protocol	Synchronous	Up to 56K bps	F2372-98	Same requirements as for LA #F2372-99.
Automatic Dialing (Up to 4 are supported for attachment to #F1798-00 or #F1799-00/01. Auto-Dial occupies the space of one LA).	Async/Sync	—	F1796-00	

\*Cable Selection required for specific type of interface where several interface standards are supported by the same line adapter.

► basic Type II Scanner accommodates 32 half-duplex or 16 full-duplex lines. It can be expanded in three additional increments to a total of 128 half-duplex or 64 full-duplex lines. A total of three type II Scanners, each wired directly to the Multi-Port Storage feature, results in a DCP supporting a total of 384 half-duplex or 192 full-duplex lines.

**CONNECTION TO HOST COMPUTER:** The Sperry Univac 1100 Series can be connected to the DCP either through a word channel (the RIOC), or through communications lines. When attached to the RIOC, or through connection is to an ISI Channel in the 1100 Computer and the transfer is in a 32-bit parallel mode. When using a communication line, it must be full-duplex and use Universal Data Link (UDLC) protocol.

The Sperry Univac 1100/80 can be attached to the DCP's Byte Channel Controller through one of two Intercomputer Adapter features. One feature permits one Byte Channel attachment to a local 1100/80. The other feature permits two Byte Channel Adapters to be attached to one local 1100/80 or a Byte Channel Adapter attached to each of two local 1100/80's. Only one channel can be active at a time; switching is controlled manually.

The Sperry Univac 9000 and 90 Series can be attached through communication lines. The DCP software, TEL—CON, treats such computers as terminals.

#### TRANSMISSION SPECIFICATIONS

**TYPE I SCANNER:** The Type I Scanner and the Type I Scanner Expansion each can accommodate eight Type I Line Adapters. Each Type I Line Adapter contains two full-duplex modem interfaces. Either or both modem interfaces in any Type I Line Adapter can also be operated as one half-duplex interface. Adapters are provided to support asynchronous speeds up to 9600 bps and synch-

ronous speeds up to 56,000 bps. RS-232C, V.24, V.35, wide-band, TWX, Telex, IBM 2260, military standards, local, and bit-oriented protocol line interfaces are provided. Automatic dialing for up to four lines is permitted. The characteristics of the nine line adapters feature are listed in Table 1.

The three cases when a line adapter can not be cabled directly to a modem or to a line are: when the lines have bit-oriented protocol (such as UDLC, SDLC, HDLC, ADCCP), when the line is a Telex line, or when the Synchronous RS-232C Line Adapter is used to support V.35 interface standards. In each case, the line adapters are cabled to an appropriate feature in the Line Adapter Expansion Cabinet, with the appropriate feature in that cabinet cabled to the modem or line.

An Active Line Indicator feature can be attached with a Type I Scanner. With this feature, the line activity of up to sixteen data sets can be displayed. The display indicators provided are: receive-data, transmit-data, and data-set-ready.

**TYPE II SCANNER:** The basic Type II Scanner can accommodate 16 line adapters for 16 full-duplex lines, or 32 line adapters for 32 half-duplex lines. The line adapters are attached to the scanner via Lines Bases. The Line Base feature has 16 ports, which support either 8 full-duplex or 16 half-duplex line adapters. Two Line Base features in the basic Type II Scanner are required to support the maximum compliment of line adapters.

The Type II Scanner can be expanded with three additional expansion increments, each equal in line handling capability to the basic scanner, i.e., 16 full-duplex lines or 32 half-duplex lines. A fully expanded Type II Scanner can accommodate 64 full-duplex or 128 half-duplex lines.

Type II Line Adapters are provided to support asynchronous speeds up to 9600 bps and synchronous speeds up to

## Sperry Univac Distributed Communications Processor

**TABLE 2: LINE ADAPTER (LA) OPTIONS FOR TYPE II SCANNER**

Type of Line Interface*	Timing	Speed	Feature Number	Remarks
RS-232C, V.24, V.28, local console	Asynchronous	Up to 9600 bps	F1828-00 F1828-01	Has reverse channel for Bell 202 type modem with speed up to 5 bps. The reverse channel occupies 1 LA port.
RS-232C, V.24, V.28, local console, or other terminal multiplexer	Synchronous	Up to 9600 bps	F1826-00 F1826-01	Has a supervisory channel with speed up to 150 bps; occupies 2 LA ports. Has a supervisory channel with speed up to 150 bps. occupies 2 LA ports.
MIL-STD-188C/188-100 low level	Asynchronous	45.45, 50, 75, 100, 110, 134.5, 150, 200, 300, 600, 1200, 1800, 2400 bps.	F1829-00	Normal MIL-STD-188-100 or Inverse Data Polarity (RS-232C) can be selected; control line polarity is RS-232C.
MIL-STD 188C/188-100 low level	Synchronous	Up to 9600 bps	F1827-00	Polarity options include normal MIL-STD-100, Inverse data, normal data with inverse clock, inverse data with inverse clock. Control line polarity is RS-232C.
Wide-Band, AT&T 300 Series data sets	Synchronous	19.2, 40.8, 50K bps	F1830-00	
Wide-Band, V.35, Bel LDS	Synchronous	From 19.2 to 56K bps	F1834-00	
Relay; 20-75 MA neutral 10-40 MA Polar telegraph lines	Asynchronous	Up to 10 char/sec	F1832-00	
TWX	Asynchronous	Up to 150 bps	F1835-00	
U.S. Telex	Asynchronous	Up to 150 bps	F1836-00	
Bell 407A/3	Asynchronous	Up to 10 char/sec	F2521-00	Input of paralleled data from touch-tone phones.
RS-232C, V.24, V.28	Asynchronous	300, 600, 1200, 1800 bps	F2519-00	For 1800 bps, must be attached to lower 64 port addresses of scanner.
Automatic Dialing	Async/Sync	—	F1831-00	Provides interface for Bell 801 when attached to #F1828, F1826, or F1835 LA. Auto-Dial occupies the space of one LA.

\*Cable selection required for specific type of interface where several interface standards are supported by the same line adapter.

➤ 56,000 bps. RS-232C, V.24, V.28, V.35, wide-band, military standard, TWX, Telex, telegraph, local, and bit-oriented protocol line interfaces are provided. The four-line restriction for Auto-Dialing for the Type I Scanner does not apply to the Type II Scanner. The 15 Line Adapters and Auto to the Type II Scanner. The characteristics of the 14 line Adapters and Auto-Dialing feature are listed in Table 2.

Up to eight Active Line Indicators can be attached to the Type II Scanner, to display the activity of 8 full-duplex or 16 half-duplex data sets. The indicators provided are receive-data, transmit-data, and data-set-ready. The characteristics of data presented to the Type II Scanner can be automatically captured by the Auto Line Speed Detection feature. The characteristics captured include data rate, character length, and parity convention of asynchronous terminals. When communication lines employ bit-oriented protocols, the UDLC Procedures feature must be included in the Type II Scanner. Such lines are restricted to the Scanner ports with the lowest 128 addresses.

### SOFTWARE

The Distributed Communications Processor was designed under Sperry Univac's new Distributed Communications Architecture (DCA). Essentially, DCA is a set of rules and guidelines that will permit users who comply to be able to tie their scattered electronic data processing elements into an interconnected network. In effect, Sperry Univac has

identified the necessary tasks, separated the tasks into functions; and standardized the rules for interfaces. This permits the interconnection of network elements with dissimilar hardware and support software. The first step towards this goal is the TELCON system, a combination of hardware and software to interconnect remote terminals with Sperry Univac 1100 Series data processors. The software portion includes the software operative in the DCP, the related support software in the 1100 Series, and the software to provide standardized DCA interfaces for certain intelligent terminals.

The DCP and its resident TELCON software can serve as a front-end processor to one or more 1100 Series systems, as a remote concentrator to one or more local DCP's, or as a remote concentrator to one or more host 1100 Series Systems. Such interconnection capability facilitates the design of fall-back arrangements.

The major tasks performed by TELCON within the DCP are:

- Basic Executive—Schedules processor time based on user priority. Equal priority users are handled on a first-in, first-out basis. Dispatches time-related functions, including suspension of a user for a specific time period. Also provides administrative functions, such as loading, deactivation, buffer management.



## Sperry Univac Distributed Communications Processor

- **Hardware Interface Routines**—Provides the software support between the processor's I/O interface with the various line protocols on both types of scanners, the RIOG, the Parallel I/O Channel Handler, the Byte I/O Controller Handler and the Intercomputer Channel Adapter Handler.
- **Common I/O Complex**—Provides a device independent interface between the processor.
- **Basic Executive**—Schedules processor time based on a user priority. Equal priority users are handled on a first-in, first-out basis. Dispatches time-related functions, including suspension of a user for a specific time period. Also provides administrative functions, such as loading, deactivation, buffer management.
- **Hardware Interface Routines**—Provides the software support between the processor's I/O interface with the various line protocols on both types of scanners, the RIOG, The Parallel I/O Channel Handler, the Byte I/O Controller Handler and the Intercomputer Channel Adapter Handler.
- **Common I/O Complex**—Provides a device independent interface between the processor and the disk, diskette, and magnetic tape handlers.
- **System Interface Routines**—Provides the software support for the following terminal and line handlers:

Uniscope 100/200, UTS 400/700, DCT 1000, and 1900 CADE terminals via the Uniscope handler. This handler operates independent of the host system and provides error recovery as well as polling.

DCT 500 teletypewriter and Teletype Model 33/35 via the DCT 500 Handler. This handler operates only in the non-addressed mode for support of single-station lines.

The UDLC line handler controls the interface between any terminal using UDLC protocol and the DCP.

The UDLC Trunk Line Handler Controls the message flow between the DCP and balanced UDLC, point-to-point trunks. When there are several physical links, the handler will manage them as logical links.

9200/9300, 90/30, and UTS 700 via the NTR Handler. Error recovery, as well as communications line control, is performed by this handler independently of the host computer.

9200/9300, UTS 700, and 1004 Card Processor via the REM 1 Handler. The handler is similar to the NTR except that NTR is full-duplex and REM 1 is for half-duplex.

Uniscope 100 via a Parallel Uniscope 100 Handler to support the device as a local console to the DCP.

BSC Line Handler provides an interface with Binary Synchronous protocol, half-duplex, terminals. The Handler operates independently of the host computer and performs polling and error recovery, but does not support data compression or expansion.

- **File Control-Maintenance**—Organization and protection of direct access and sequential access files is performed by this software function. In addition to user files, a System Configuration File is maintained. User own-coding "exist" in the software are provided. The user files are used for system failure recovery, checkpoint restart, and system audits.

- **Message Control Complex**—Routing and queuing of messages from the handlers including passing messages from one DCP to another. When possible, and necessary, the software can seek alternate routing and performs pacing of the number of messages to a given user.
- **New Activity Search**—Paces new activity by polling idle lines, based on main storage availability and other available system resources.
- **Network Management Services**—Provides fundamental control and monitoring of the system, control of security, and the establishment of session links.
- **Loading and Initialization**—The Read-only Memory contains the first load block, which calls in the bootstrap loader from the optionally selected device. The Bootstrap performs initialization functions and loads this portion of the software to complete the initialization process.
- **Debug Aids**—Provides various debugging aids including dumps, error logging, etc.

The major tasks that TELCON performs in the host 1100 Series computer include:

- **Interface Software**—The formatting of messages to the DCP in standard DCA format, adding information such as destination identification, status, sequence number, reformatting of input messages, control transmission flow through pacing commands from the DCP and the control of data acknowledgement.
- **Application Management Services**—Allows establishment of a session between the user and the system. A session request will be rejected if the user (terminal) does not possess the appropriate authority or if resources are not available.
- **Internal Interfaces**—Provides the interface between the communication system and the RSI Complex. This interface accommodates both demand processing and remote batch data.
- **TIP**—Provides the interface between the communication system and the TIP Complex. The TIP interface transfers messages to and from TIP queues formatted as required by COMPOOL.

Support software in the 1100 Series system is provided for the DCP.

Included is the Assembler whose output is processed by the Collector to produce DCP executable code. The system generator is SSG, whose output is processed by the Assembler and the Collector. SYMSTREAM is the SSG language. Network control tables and security tables are also generated by SSG, but it is not necessary to do full regeneration to alter the tables.

The ability to load the DCP via a communication line to the 1100 Series is possible because of a utility program in the 1100 called Down-line Loader. SSG supplies the utility with the necessary parameters. DCP dumps, error log, or statistical information can be transmitted to the host over a communication line when the host employs the Up-Line Dump utility.

### COMPONENTS

**PROCESSOR:** The base processor includes 32K bytes of main storage, a Read-Only Memory for bootstrapping, a

## Sperry Univac Distributed Communications Processor

► Multiplexer, a Byte I/O Controller, and a Channel Controller.

Main storage is expandable in 16,384 byte increments to 131,072 bytes.

To attach either the Type I Scanner or the Parallel I/O Channel to the Multiplexer, the I/O Controller feature is required.

For one or two (only one active at a time) byte channel attachments to 1100/80 host computers, an Intercomputer Adapter is employed. It is connected to the Multiplexer through the Channel Controller.

The Multiplexer obtains a direct memory interface by attachment to either the Single-Port Storage feature or the Multi-Port Storage feature. The Storage feature is linked to main memory.

The Remote I/O Controller can be attached only to Multi-Port Storage feature. The RIOC has 16 parallel word I/O channels.

The Read-only Memory comes in several no-cost versions, depending on which peripheral device will be used for bootstrapping.

The Type I Scanner Expansion is attached only to the Multi-Port Storage feature and excludes the use of RIOC.

Up to eight Type I Line Adapters can be attached to both the Type I Scanner and the Type I Scanner Expansion, for a total of 16 line adapters supporting 32 full- or half-duplex lines.

**TYPE II SCANNER:** The basic, unexpanded Type II Scanner can have two Line Base features attached. Each Line Base has 16 ports, and therefore will accommodate 8 line adapters to be used with full-duplex lines or 16 line adapters for half-duplex lines. The Scanner can be expanded with three expansion increments; each has the same capacity as the basic Scanner. Auto Line Speed Detection and UDLC Procedures are features that can be attached to the Type II Scanner.

**LINE ADAPTER EXPANSION CABINET:** When the DCP has the Type I Scanner, the line adapters may require this additional interface between the modem (or line) and the adapters themselves (see Table 1). The features that can be attached are; the UDLC Module, the UDLC Expansion Module, the V.35 Interface and the U.S. Telex Interface.

**DISKETTE DRIVE:** Provides 256K bytes of storage with a transfer rate of 31K bytes per second. The capacity can be doubled with the addition of an expansion drive.

**REMOTE CONTROL MODULE:** Permits remote start/stop and load initiation of the DCP. The Diskette Drive and Expansion features are required with this feature. ►

### Configuration

DCP with Type I Scanner

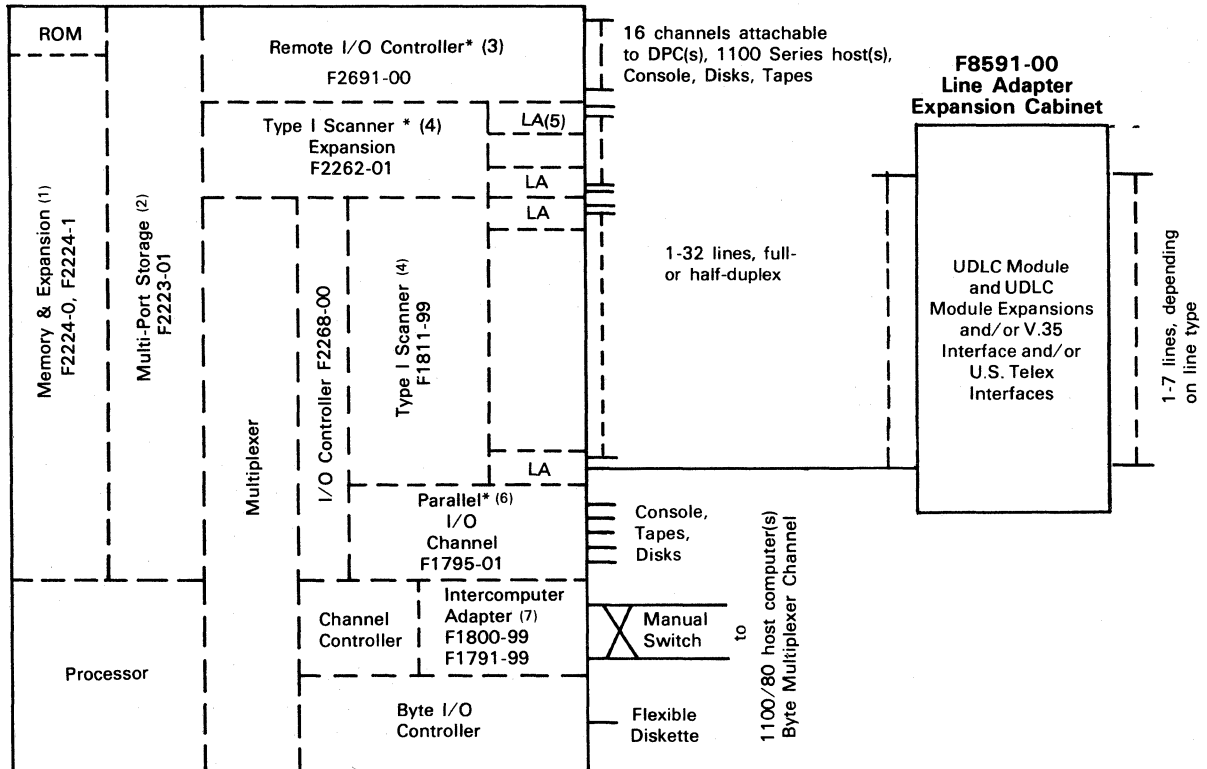

\*If Remote I/O Controller is attached, Parallel I/O Channel on the Type I Scanner Expansion features cannot be attached. Console, tapes, and disks are attached to the Remote Controller.

## Sperry Univac Distributed Communications Processor

➤ **CARTRIDGE DISK SYSTEM:** A two spindle drive is available. One spindle has a fixed disk; the other spindle can receive removable disks. Each spindle has a 5 mega-byte capacity. A Dual Interface feature permits the drives to have two channel attachments to one DCP or one attachment to each of two DCP's.

**UNISERVO 10:** The magnetic tape subsystem can have one or two drives of 9-track, dual density tape. Transfer

rate is 20K bytes per second at a recording density of 800 bits per inch (NRZI) or 40K bytes per second at a recording density of 1600 bits per inch (phase encoded). An automatic threading function is standard.

**DCP CONSOLE:** A Uniscope 100 Display Terminal is used as the DCP console. A 30 character-per-second, 132 print position printer can be attached as well as a 300 character-per-second Model 800 Terminal Printer. ➤

### Configuration

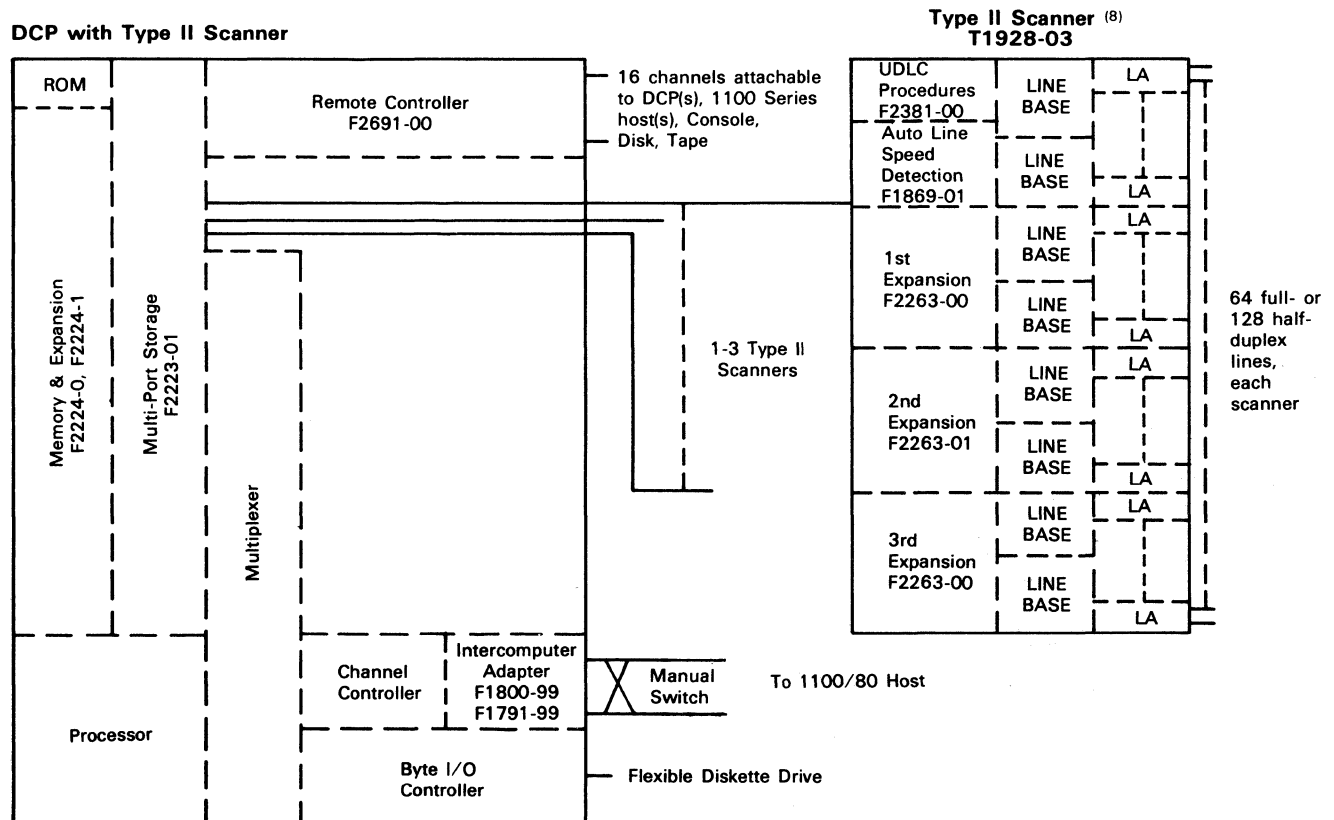

- (1) Main storage expandable to 131,072 bytes in 16,384 byte increments.
- (2) Single-port Storage can be used when the only direct port access requirement is for Multiplexer.
- (3) The RIOG has 16, 16-bit parallel channels. Two channels are required for attachment to an 1100 Series host.

- (4) Type I Scanner and Scanner Expansion can accommodate 16 Line Adapters; see Table 1 for LA characteristics.
- (5) Maximum of 32 Line Adapters.
- (6) A console and three tape and/or disk subsystems can be supported.
- (7) Single or dual attachment to one or two 1100/80 host computers; only one channel can

be active at a time.

- (8) Basic Type II Scanner and each Expansion can accommodate 16 full-duplex Line Adapters of 32 half-duplex Line Adapters. Maximum number of Line Adapters per fully expanded scanner is 64 full-duplex or 128 half-duplex; maximum number of Line Bases is 8. See Table 2 for LA characteristics.

## Sperry Univac Distributed Communications Processor

### ► PRICING

The DCP can be purchased or leased on either a 1-year or a 5-year basis. The 5-year basis provides for two payment schedules. The "level-payment" schedule is a monthly charge that is 85 percent of the 1-year schedule. The "reducing payment" schedule is 95 percent of the 1-year schedule for the first year, 90 percent the second year, 85 percent the third year, 80 percent the fourth year, and 75

percent for the fifth year. Maintenance is not discounted under these plans.

The standard UNIVAC agreement allow unlimited use of the equipment; exclusive of remedial and preventive maintenance of the equipment for nine consecutive hours a day, Monday through Friday. Extended periods of maintenance are available at extra cost. The monthly rental charge listed below include the maintenance charge.

		Monthly Rental* (1-yr lease)	Purchase Price	Monthly Maint.
T8579-83	Basic DCP (includes ROM)	\$1,204	\$40,668	\$187
F2224-00	16K bytes Main Storage (for increments: 32K-48K, 64K -80K, 96-112K bytes.)	113	3,600	23
F2224-01	16K bytes Main Storage (for increments: 48K-64K, 80-96K, 112K-128K bytes.)	68	1,800	23
F1791-99	Single Intercomputer Adapter	91	3,136	13
F1800-99	Dual Intercomputer Adapter	140	4,832	20
F2223-00	Single-Port Storage	100	3,460	14
F2223-01	Multi-Port Storage	126	4,040	25
F2268-00	I/O Controller	94	3,200	14
F1795-01	Parallel I/O Channel	70	2,400	10
F2691-00	Remote I/O Controller	525	18,000	75
<b>Peripherals</b>				
T8406-99	Diskette Drive; 100/120 volt	145	5,000	20
T8406-97	Diskette Drive; 200/240 volt	145	5,000	20
F2338-00	Diskette Expansion Drive; 100/120 volt	45	1,440	9
F2338-02	Diskette Expansion Drive; 100/120 volt	45	1,440	9
T8408-02	Cartridge Disk Control; Housing	162	5,564	23
F2380-04	Cartridge Disk Drive	562	20,296	90
F2187-00	Second I/O Interface for Cartridge Disk	46	1,568	7
T5042-95	Uniservo 10 Control and Tape Housing; for two tape units	446	15,280	64
T0870-27	Uniservo 10 Tape Unit	329	12,576	67
T8590-99	Remote Control of DCP Module	192	6,148	38
T3536-86	Console-UNISCOPE 100 Display Terminal	216	7,000	41
T8541-76	Printer for Console; 30 cps, 132 print positions	92	2,596	25
T0774-97	Terminal Printer for Console; 300 cps	79	2,320	18
<b>Scanners</b>				
F1811-99	Type I Scanner	20	636	4
F2262-01	Type I Scanner Expansion	230	9,456	33
F1798-00	Type I Line Adapter; RS-232C, V.24, local; Async. up to 9600 bps	20	630	4
F1799-00	Type I Line Adapter; RS-232C, V.24, local; sync, up to 9600 bps	26	900	4
F1798-01	Type I Line Adapter; RS-232C, V.24, Mil-188C; async. 45.45-2400 bps	20	630	4
F1799-01	Type I Line Adapter; RS-232C, V.24, Mil-188C; sync, up to 9600 bps	26	900	4
F1798-04	Type I Line Adapter; IBM 2260; async. up to 2400 bps	20	630	4
F1814-00	Type I Line Adapter; Wide-band, V.35; sync. 19.2K-56K bps	52	1,743	11
F2371-00	Type I Line Adapter TWX; async. up to 150 bps	39	1,320	6
F2372-99	Type I Line Adapter; bit-oriented; sync. up to 9600 bps	49	1,672	7
F2372-98	Type I Line Adapter; bit-oriented; Sync, up to 56K bps	49	1,672	7
F1796-00	Automatic Dialing, Type I	26	872	5
T8591-00	Line Adapter Expansion Cabinet	131	4,524	18
F2373-00	U.S. Telex Interface, Type I	44	1,520	6
F2370-00	V.35 Interface, Type I	47	1,600	7
F2645-99	UDLC Module, Type I	75	2,580	10
F2643-01	UDLC Module Expansion, Type I	6	184	1
T1928-03	Type II Scanner	632	23,000	57
F2263-00	Type II Scanner Expansion Chassis for 1st and 3rd expansion increments	68	2,360	9

### Sperry Univac Distributed Communications Processor

		<u>Monthly Lease*</u>	<u>Purchase Price</u>	<u>Monthly Maint.</u>
F2263-01	Type II Scanner Expansion Chassis for 2nd expansion increment	32	1,120	4
F1801-01	Line Base, Type II	18	600	3
F2381-00	UDLC Procedures, Type II	50	1,720	7
F1869-01	Auto Line Speed Detection	14	452	3
F1828-00	Type II Line Adapter; RS-232C, V.24, V.28, local; async up to 9600 bps	21	600	6
F1828-01	Type II Line Adapter; F1828-00 with reverse channel for Bell 202	26	760	7
F1828-02	Type II Line Adapter; F1828-00 with supervisor channel	31	920	8
F1829-00	Type II Line Adapter; MIL-188C/188-100; async. 45.45-2400 bps	21	600	6
F1826-00	Type II Line Adapter; RS-232C, V.24, V.28, other terminal multiplexers; sync. up to 9600 bps	26	760	7
F1826-01	Type II Line Adapter; F1826-00 with supervisory channel	37	1,160	8
F1827-00	Type II Line Adapter; Mil-188C/188-100; sync. up to 9600 bps	26	760	7
F1830-00	Type II Line Adapter; Wide-band, AT&T 300; sync. 19.2-50K bps	31	920	8
F1834-00	Type II Line Adapter; wide-band, Bell DDS; sync. 19.2K-56K bps	31	920	8
F1832-00	Type II Line Adapter; Telegraph; async. up to 150 bps	21	600	6
F1835-00	Type II Line Adapter; TWX; async. up to 150 bps	21	600	6
F1836-00	Type II Line Adapter; Telex; async. up to 150 bps	21	600	6
F2521-00	Type II Line Adapter; Bell 407A/3; async. up to 10 cps	34	1,000	9
F2519-00	Type II Line Adapter; RS-232C, V.24, V.28; clocking for 300, 600, 1200, 1800 bps. async.	26	760	7
F1831-00	Type II Automatic dialing	24	600	6
F1825-02	Type II Line Indicator	23	440	2
F1866-01	Type I Line Indicator	13	528	2

\*For 1-year lease; includes maintenance. □



# Unisys DCP Series Communications Processors

## **datapro** ANALYSIS

**UPDATE:** *Since our last report, Unisys has withdrawn the DCP/10A and DCP/20 from the DCP Series and added the top-of-the-line DCP/50 and the DCP/5 entry-level system. Unisys has also introduced the SNA/net program product that expands the networking capabilities of the DCP Series.*

Unisys introduced the Distributed Communications Processor (DCP) Series in 1979 with the DCP/40. Since that time, the company has added and withdrawn products until the series now includes the DCP/5, DCP/15, DCP/30, DCP/40, and DCP/50. These multiprocessor-based systems can serve as front-end processors, remote intelligent concentrators, or nodal processors in a Unisys or multivendor network.

The series supports the Unisys Distributed Communications Architecture (DCA), designed to implement operation without host or mainframe control. As a result, the role of a DCP does not depend on its size, location in the network, or the network topology. Essentially, DCA is a set of ground rules that define the functions to be performed by each element within a communications network and the standards for interfacing between elements. The goal is to permit interconnection of dissimilar hardware/software into one communications network in compliance with DCA ground rules.

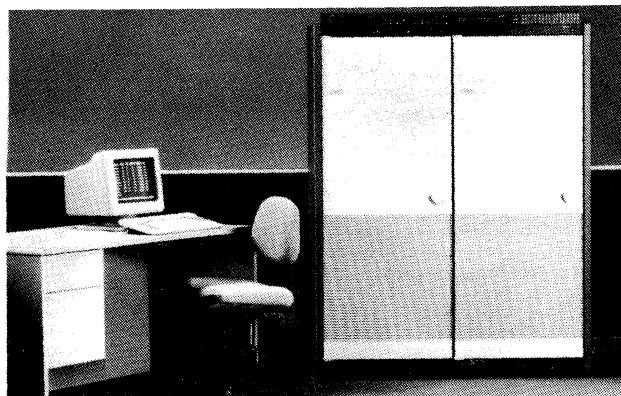

*Kurzweil's most powerful system is the \$17,950 K-5100. Besides the 400-dpi gray scale scanner especially designed by Fuji Xerox for scanning text, it includes software that enlarges uncertain characters on-screen so the user can correct them.*

**VENDOR:** Unisys Corp., P.O. Box 500, Blue Bell, Pennsylvania 19424. Telephone (215) 542-4011.  
**CANADIAN DISTRIBUTION:** Unisys Canada, 2001 Sheppard Avenue East, North York, Ontario M2J 4Z7. Telephone (416) 495-0515.  
**MODELS:** DCP/5, DCP/30, DCP/50, DCP/15, and DCP/40.  
**FUNCTION:** Front-end processor, nodal processor, remote concentrator.  
**HOST COMPUTERS SUPPORTED:** Unisys 1100 and 2200 Series, System 80.  
**ARCHITECTURE SUPPORTED:** Unisys Distributed Communications Architecture (DCA).  
**OPERATING SOFTWARE:** DCP/OS.  
**COMPETITION:** International Business Machines (IBM), NCR Comten.  
**PRICING:** From \$9,800 (DCP/5-5X2) to \$195,000 (DCP/50).

REPORT HIGHLIGHTS:	PAGE
<b>SPECIFICATIONS</b> .....	<b>102</b>
<b>Models</b> .....	<b>104</b>
<b>Configuration</b> .....	<b>105</b>
<b>Processing Components</b> .....	<b>105</b>
<b>Software</b> .....	<b>106</b>

Users manage the DCP processors and their networks through the DCP/OS operating system and Telcon communications and networking software. Since DCP/OS handles the hardware control functions, the Telcon software works directly with network applications such as SNA and PDN gateways. Programs supported by Telcon include IBM binary synchronous terminal products; IBM/Unisys terminal full-crossover in SNA environments; IBM remote batch and remote job entry terminals in binary synchronous or SNA environments; access to packet switched Public Data Networks (PDNs); access to circuit switched Public Data Networks; and access to other public and industry-standard networks.

## PRODUCT EVALUATION

In March 1989, Unisys announced the addition of the DCP/5 to the series for use in small sites. Housed within a Unisys Personal Workstation Model 500 personal computer, the DCP/5 reduces the cost of entering into the DCP family but provides users with the full functionality of the DCP Series in homogeneous and heterogeneous networks. The DCP/5 offers users the ease of installation of a personal

## Unisys DCP Series Communications Processors

computer combined with the capability of a communications processor. When acting as a remote concentrator, protocol converter, and network interface processor, the DCP/5 can support up to seven lines or up to five protocols.

Designed for both large and small users, the DCP/15 is a front-end processor for smaller Unisys 1100 and 2200 Series host computers. It can also act as an economical network processor and as a remote concentrator. The DCP/15 can simultaneously support transaction processing, time-sharing, remote job entry, and distributed processing applications. Its modular design will accommodate future needs.

The midrange model, DCP/30, features the same functionality as the other models and is compatible with them but delivers a transaction processing rate approximately three times faster than the DCP/15. Its microcode cycle time of 68 nanoseconds and its basic read cycle time of approximately 325 nanoseconds make it a logical choice for medium-sized networks. When configured as a front-end processor, a fully expanded DCP/30 can handle up to 40 communications line modules.

A multiprocessor, multitasking system, the DCP/40 operates with the Unisys 1100 Series, 2200 Series, and System 80 host computers. Users can configure up to 256 line modules with a DCP/40 because each line module generally occupies a single IOP port. The exception is the byte-channel host interface module, which supports connection to a Unisys Series 2200 or 1100/80 host and requires four ports.

The top-of-the-line DCP/50 supports intelligent communications for a wide variety of applications in larger networks. Its processor cycle time of approximately 26 nanoseconds and a storage cycle time of approximately 105 nanoseconds makes the DCP/50 more than 2.5 times more powerful than the DCP/40. It can process 135 transactions per second compared to 50 transactions per second for the DCP/40.

Telcon software enables users to connect a wide range of Unisys systems to a network—a span that extends from the largest 1100 or 2200 mainframe to the smallest personal computer. The Telcon software supports host services as well as terminal services. Through Telcon software, users can initiate file transfers and program-to-program communications, exchange documents and electronic mail, and work with host applications. Since the software operates independently of connected processors, the mainframe systems require no modifications.

### MARKET POSITION

The communications processor market numbers very few competitors. IBM dominates the scene, followed by NCR Comten and Amdahl. When IBM introduced its 3745 processor in 1988, competition intensified among the Big Three. NCR has not neglected its product line as evidenced by the introduction of the 5655, 5665, and 5675 processors in 1989. These machines are compatible with the earlier Comten 3695 and 5600 product lines.

NCR Comten emphasizes that its 5660 products address the need for coexistence of SNA and multivendor networks. Unisys has also geared its communications processors toward multivendor networks. This approach broadens the appeal of the machines and can attract more users. Amdahl can capitalize on its plug compatibility with IBM products.

Although Unisys does not rank among the leaders, the company has built steadily upon the capabilities of the DCP Series, investing in its development, refining its features, and expanding its communications options. The innovative design of the DCP/5, a cost-effective entry into the communications processor arena, should appeal to many users who will respond to the concept of acquiring a fully functioning communications processor that can be installed as easily as a PC.

## SPECIFICATIONS

**MODELS:** DCP/5, DCP/30, DCP/50, DCP/15, and DCP/40.

**DATE OF FIRST ANNOUNCEMENT:** DCP/5—1989; DCP/15—1986; DCP/40—1979.

**DATE OF FIRST DELIVERY:** DCP/5—April 1989; DCP/15—1987; DCP/40—1979.

**NUMBER INSTALLED TO DATE:** 3,500+.

**SERVICED BY:** Unisys Corporation.

### OVERVIEW

The Distributed Communications Processor (DCP) Series can serve as front ends to a Unisys 1100 Series, 2200, or System 80 mainframe; as nodal processors; or as remote concentrators in a Unisys or multivendor environment. Single or multiline communications modules of the DCP Series provide support for RS-232-C (V.24/V.28) synchronous and asynchronous lines. The 4x1 line module can ter-



## Unisys DCP Series Communications Processors

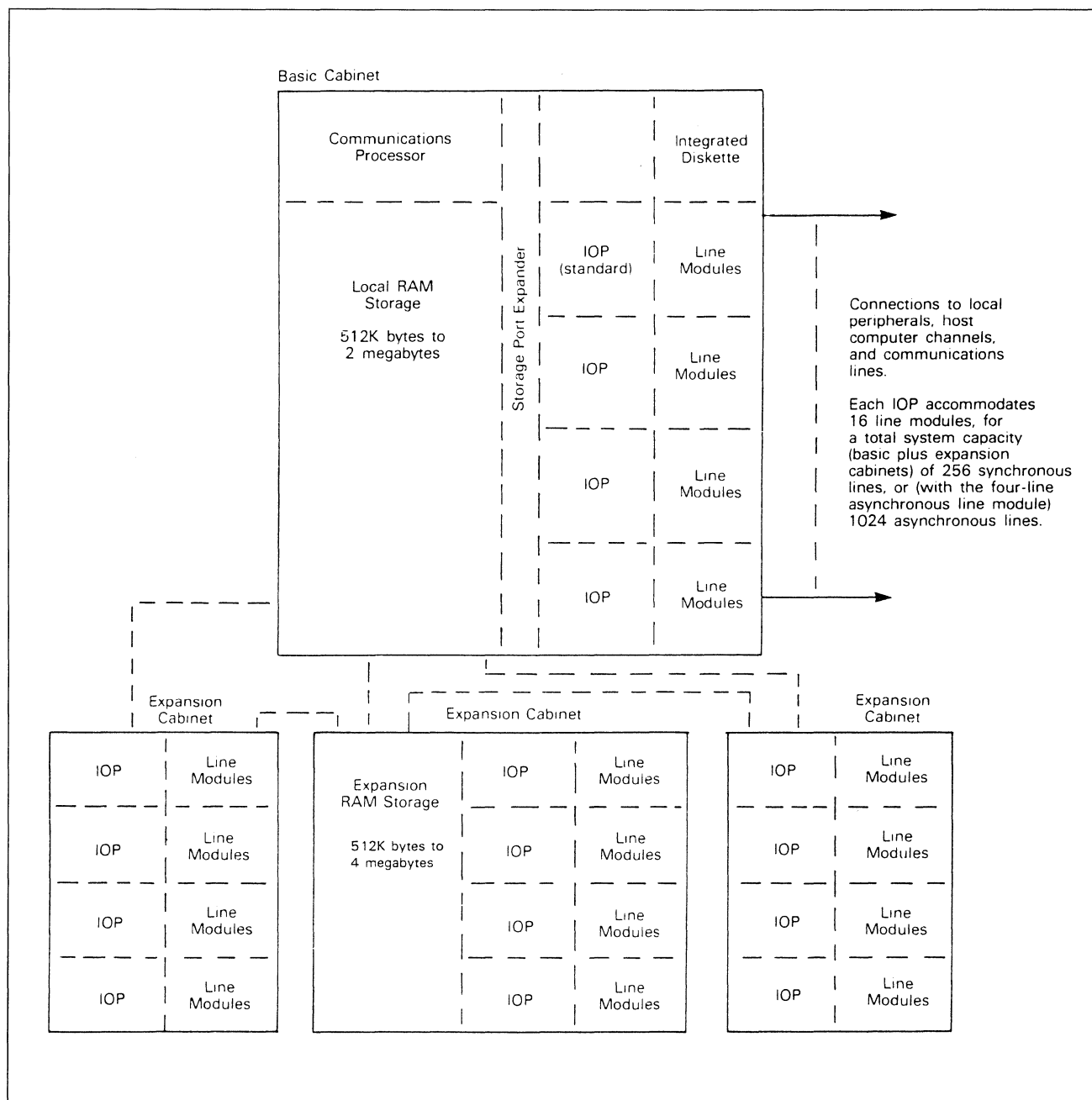

Figure 1. Basic DCP/40 configuration.

minate up to four lines. Unisys also offers a dual-line module, which can support two communicating protocols.

In addition to serving as a hardware interface, a line module can perform communications functions for each line in a system. Line module functions include character assembly/disassembly; character parity and block check sequence generation and checking; data buffering; control character recognition; line timing and asynchronous clocking; and automatic data rate detection.

The Parallel Line Modules for the series are Host Block Mux, a channel module that interfaces to a Unisys host computer through the byte channel; Host Word Channel, which provides connections to a Unisys host computer through the word channel; Multiple Device Line Module, which allows access to a freestanding 8441 mass storage subsystem; and SCSI Line Module, which provides an interface to integrated mass storage.

For data security, Unisys has equipped the DCP Series with the following protective mechanisms:

## Unisys DCP Series Communications Processors

### Maximum Communications Line Package (DCP5 - 7 X 4)

Unisys Personal Workstation<sup>2</sup>  
(PW<sup>2</sup>)  
Model 500  
(INTEL<sup>®</sup> 80286-based PC  
operating MS-DOS<sup>®</sup>)

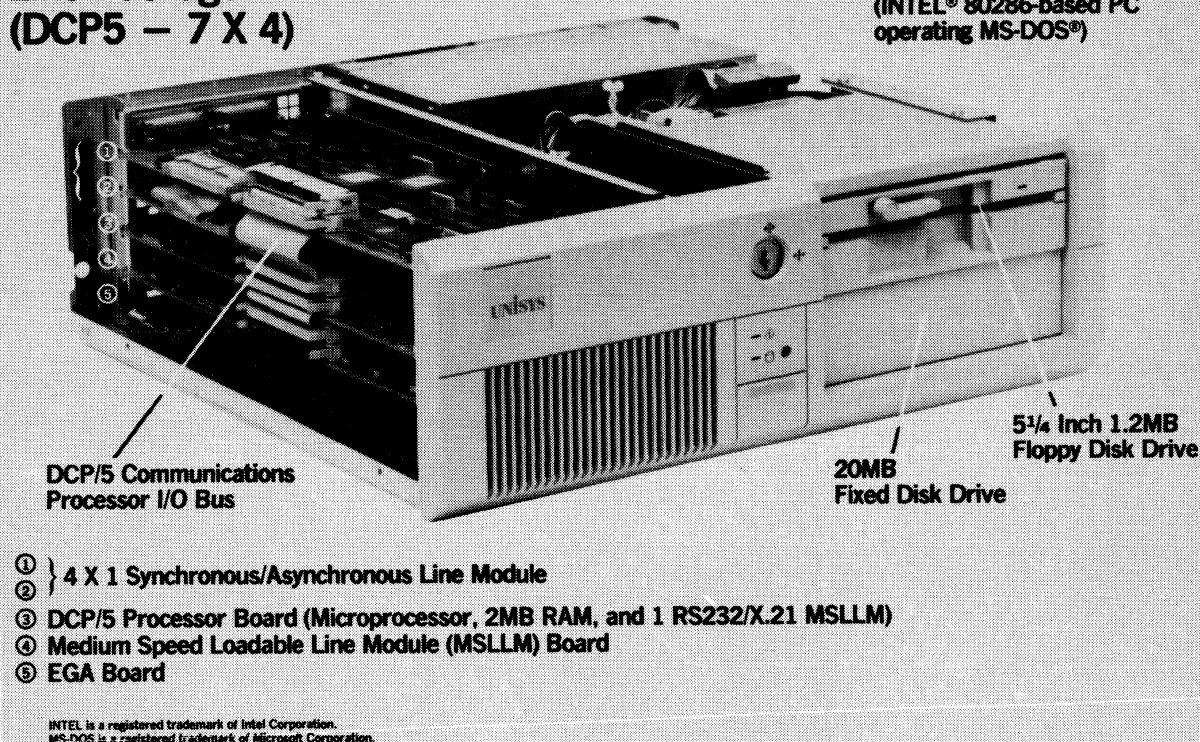

The DCP/50 is the top of the line. It has a processor cycle time of approximately 26 nanoseconds and a storage cycle time of approximately 105 nanoseconds.

- storage protection to control access rights to local storage;
- levels of privilege to reserve instructions in executive software;
- architectural designs that confine and isolate programs and data within protected environments; and
- error detection and recovery procedures to protect data from inadvertent alteration.

The Input/Output processors are microprogrammed with 16-bit microinstructions and an 8-bit data path. The storage interface is 32 bits plus 4 parity bits. The internal registers are 1,024-by-32 bit stack with byte parity.

The machines support RS-232-C (V.24/V.28), V.35, Auto Dial (US RS-366), Auto Dial (Japan NTT), RS-449, Bell 303, X.21, twisted pair, coaxial cable, 802.3 LAN, UNISCOPE, BSC, SDLC, HDLC, and UDLC.

## MODELS

**DCP/5.** The low-end model, the DCP/5 is housed in a Unisys Personal Workstation Series 500/12 (PW 500) and is suited for small sites that require full-function networking.

The DCP/5 can function as a remote concentrator, protocol converter, and network interface processor. It can support up to seven lines or up to five protocols. When the PW 500 acts as a DCP/5, it cannot perform any personal computing tasks. The PW 500 keyboard and monitor function as operator and maintenance input/output devices for the DCP/5, and its 20M-byte mass storage completely serves the operations and use of the DCP/5. It can support transaction processing rates as high as 14 per second.

**DCP/15.** The DCP/15 can serve as a front-end processor for smaller Unisys 1100 and Unisys 2200 Series host computers, as a low-cost network processor, and as a remote concentrator. The unit can simultaneously support transaction processing, timesharing, remote job entry, and distributed processing applications. The DCP/15 accommodates synchronous, asynchronous, and wideband transmissions at rates up to 64K bps.

**DCP/30.** The midrange model within the series, the DCP/30 can perform front-end and nodal processing, remote concentration communications, and networking functions. The machine can process 45 (UTS) transactions per second (50 characters in, 100 characters out). With its basic micro-code cycle time of approximately 68 nanoseconds and read cycle time of approximately 325 nanoseconds, the DCP/30

## Unisys DCP Series Communications Processors

functions well in a medium-sized network. When configured as a front-end processor, a fully expanded DCP/30 can service up to 40 communications line modules.

**DCP/40.** The former high-end model of the series, the DCP/40 is a multiprocessor, multitasking system used with the Unisys 1100 Series, 2200 Series, and System 80. The processor performs general-purpose tasks, as well as functions specific to network and local site operations, under the control of microcoded programs loaded into local RAM storage.

**DCP/50.** Unisys has optimized the top-of-the-line DCP/50 for larger networks that demand more power. The machine can handle front-end and nodal processing, remote concentration communications, and networking tasks. The DCP/50 can process 135 transactions per second (50 characters in, 100 characters out).

### CONFIGURATION

**DCP/5.** In addition to the PW 500, the DCP/5 has 2M bytes of error correcting local storage, a personal computer interface for mass storage access, and a medium-speed loadable line module, all of which reside on a single printed circuit board that plugs into a PW 500 extension slot. Line modules can occupy the other three expansion slots. Since it uses DCP/OS and Telcon networking software, the DCP/5 is software compatible with the other models of the DCP family.

**DCP/15.** The DCP/15 consists of three main components: processor, local storage, and communications line modules. The components come in a 19-inch rack that users can mount in an existing communications cabinet or the components can be delivered in a cabinet, designed for the DCP/15. The DCP/15 also features an integrated 20M-byte fixed disk subsystem and a 5½-inch flexible disk drive. Unisys offers host interface modules for the system.

**DCP/30.** The DCP/30 consists of a communications processor, storage, I/O processor, parallel line modules, and integrated mass storage. Storage capacity is 4M bytes, and one to three IOPs can be configured per system. Integrated mass storage consists of a 655K-byte formatted flexible disk and a 20M-byte formatted rigid disk.

**DCP/40.** The DCP/40 consists of a communications processor, microprograms stored on an integral diskette, storage controller, 512K-byte RAM storage module, input/output controller, input/output processor, line module chassis with space for up to 16 line modules, and external dual-drive 60M-byte disk subsystem. All of these components are housed in a freestanding cabinet, which can be expanded to include up to three additional 512K-byte storage modules, up to three additional IOPs, and three additional line module chassis. The DCP/40 can support up to 16 I/O processors.

**DCP/50.** The DCP/50 consists of the communications processor, 2M bytes storage expandable to 8M bytes in increments of 2M bytes, I/O processor, communications line modules, parallel line modules, and integrated mass storage with a 655K-byte formatted flexible disk and a 20M-byte formatted rigid disk. Users can configure 1 to 16 IOPs per system.

### PROCESSING COMPONENTS

**DCP/5.** The processor of the DCP/5 is a microprogrammable device with direct access to local storage. The processor performs general communications processing as well as input/output processing functions, which supply programmed control for up to five data paths. The medium-speed loadable line module on the DCP/5 system board uses one data path or port; optional line modules use the remaining four ports.

The DCP/5 processor offers the following features:

- Instruction repertoire—300 communications instructions;
- Input/output instructions—85;
- Microprogramming—16-bit microinstruction;
- Microcode cycle time—125 ns.;
- General registers—32; and
- Input/output ports—five for full-/half-duplex serial line modules.

**DCP/15.** The processor is a microprogrammable device with direct access to local storage. It performs general communications processing as well as input/output processing. The I/O processing functions provide programmed control for up to 14 data paths, which can be a combination of serial lines to remote equipment, channels to peripheral devices, or channel connections to on-site Unisys 1100 Series hosts.

The functional characteristics for the processor are the same as those for the DCP/5 except those for the input/output ports. Unisys has equipped the DCP/15 with 14 I/O ports for full-/half-duplex serial or parallel line modules.

**DCP/30.** Processor characteristics include:

- Instruction repertoire—300;
- Microprogramming—16-bit microinstruction plus ECC;
- Microcode cycle time—68 ns.;
- Data path—16/32 bit, checked by parity and duplication;

## Unisys DCP Series Communications Processors

- Storage interface—32 bit plus byte parity; 24-bit byte address; and
- General registers—32, 16-bit registers plus parity.

**DCP/40.** The processor includes a microcontroller that supports the internal bus structure, timing mechanism, control storage, dual arithmetic logic units, error checking and logging schemes, automatic instruction retry routines for microinstruction failure, and automatic restart and recovery procedures.

**DCP/50.** Processor characteristics include:

- Instruction repertoire—300;
- Microprogramming—32-bit microinstruction plus byte parity;
- Microcode cycle time—26 ns.;
- Data path—16 bit, checked by parity and duplication;
- Storage interface—32 bit plus byte parity, 24-bit byte address;
- General registers—128, 16-bit registers plus parity.

### SOFTWARE

**DCP/OS** is the operating system for the DCP processors. It controls and manages the hardware, program and data file management, and system management. The performance of these functions frees the separately loaded Telcon software to support the following: network application programs such as IBM binary synchronous terminal products; IBM/Unisys terminal crossover to DCA and SNA; IBM remote batch and job entry terminals for binary synchronous or SNA environments; and programs that access packet switched and other types of standard public and private networks. DCP/OS serves as a uniform interface to existing and future DCP hardware products.

**DCP/Telcon** performs the following functions: off-loading computer systems by managing online terminals; enabling Unisys systems to communicate with each other in distrib-

uted data networks; and implementing communications in industry-standard networks, including those from IBM.

Unisys has restructured Telcon software into layered, discrete modules that are loaded into the DCP after the initialization process has occurred through DCP/OS. Telcon's restructuring makes it easier to install and enables it to operate on shorter processing paths for more efficient execution and recovery in case of an error. The modularity of the DCP/Telcon system prevents a shutdown of the entire system if a problem occurs in one module. Under problem situations, DCP/OS does not have to be reloaded. **SNA/net** is a Unisys program that furnishes SNA networking capability, based on Unisys DCP systems. SNA/net features:

- SNA PU type 5 network resource control, compatible with ACF/VTAM;
- SNA subarea networking compatible in the network with ACF/NCP;
- network control distributed within the network and not in the mainframe host;
- concurrent operation of Unisys Distributed Communications Architecture (DCA) and SNA over a common physical network of communications processors and trunks;
- crossover connectivity between DCA and SNA network destinations; and
- resilient network nodes capable of switching to backup DCPs.

SNA/net consists of a base component, two optional standard features, and various optional custom features that are available as Reorderable Customer Engineering Requests (RCERs). These components are installed in each DCP node in the network according to the dictates of the node. Not all DCPs in a customer's network require the SNA/net component.

### PRICING

The following prices are for purchase, one-year lease, and on-site maintenance.

## Unisys DCP Series Communications Processors

### EQUIPMENT PRICES

		Purchase Price (\$)	One-Year Monthly Lease (\$)	Monthly Maintenance (\$)
<b>DCP/5</b>				
DCP 5-5X2	Communications processor, input/output processor, 2MB local storage, internal medium-speed line module in a PW 2500 workstation with one English KB and MS-DOS 3.3, and a 4x1 sync/async line module for a maximum of 5 lines and a maximum of 2 protocols supported	9,800	—	72.00
DCP 5-5X5	Communications processor, input/output processor, 2MB local storage, internal medium-speed line module in a PW 2500 workstation with one English KB and MS-DOS 3.3; also includes two 2x2 medium-speed loadable line modules; maximum 5 lines and 5 protocols	11,500	—	75.00
DCP 5-7X4	Communications processor, input/output processor, 2MB local storage, internal medium-speed line module in a PW 2500 workstation with one English KB and MS-DOS 3.3, one 2x2 medium-speed loadable line module; maximum of 7 lines and 4 protocols supported	14,300	—	75.00
<b>DCP/15</b>				
1986-57	DCP/15 cabinet, processor with 2MB storage expandable to 4MB; multiple device line module, 5¼-inch integrated flexible diskette drive with controller, 20MB formatted integrated hard disk drive; for freestanding operation within a Mapper 10, System 11, or Series 1100 host network	18,095	754	81.00
1986-59	Expanded DCP/15; same as 1986-57, but includes processor with 4MB main storage	26,290	1,095	86.00
1986-58	Expanded DCP/15; same as 1986-57, but includes processor with 4MB main storage	26,290	1,095	86.00
1986-56	Expanded DCP/15, 20MB disk; same as 1986-57, but includes a 20MB formatted integrated rigid disk drive	18,095	754	81.00
2053-91	DCP/15, 20MB disk; same as 1986-57, but excludes cabinet and includes air chamber; requires housing in a customer-provided, industry-standard cabinet that conforms to EIA RS-310 for 19-inch equipment	16,885	703	81.00
2053-90	DCP/15, 20MB disk; same as 2053-91, but also includes a 20MB formatted, integrated rigid disk drive	16,885	703	81.00
2053-89	Expanded DCP/15, 20MB disk; same as 2053-91, but includes processor with 4MB main storage	25,080	1,045	86.00
2053-88	Expanded DCP/15, 20MB disk; same as 2053-91, but includes processor with 4MB main storage and a 20MB formatted integrated rigid disk drive	25,080	1,045	86.00
<b>DCP/30</b>				
8619-97	DCP/30; includes DCP/30 cabinet, housing the processor/storage, I/O module, power control module; processor/storage feature adds a comm processor, 4MB of local storage on two PC boards; initial I/O module provides an IOP, 19-inch card rack and power supplies; power control module; integrated mass storage with 3½-inch flexible disk with 1MB unformatted capacity and 3½-inch rigid disk with a 20MB formatted capacity, and disk drive controller; SCSI	55,000	2,292	237.50
F 4997-00	Integrated mass storage; provides DCP/30 with additional flexible and rigid disk capacity, and disk drive controller up to a maximum of 2 features per I/O module	3,400	142	24.00
F 3893-03	Multiple Device LM; provides the DCP/30 with additional SCSI LMs for use with one or two F 4997-00 mass storage units per each I/O module	1,300	54	7.00
<b>DCP/40</b>				
8596-96	DCP/40; processor with storage controller and 512KB of storage housed in a freestanding cabinet; includes an I/O controller module, first I/O processor, microprogram storage; mounting for three additional storage expansions	84,245	2,305	488.50
F 1930-00	Storage expansion—128KB; provides a 128KB storage for 8596-97 or T1945	5,570	152	34.50
F 1929-98	Compatible upgrade; upgrades an 8596-98 with 128K to an 8596-96 with 1024K; provides for operation in DCP/40 primary mode	39,245	1,035	283.00
<b>DCP/50</b>				
8619-98	DCP/50; communications processor for freestanding operation; console; cabinet housing one processor/storage module; I/O module #1, maintenance control feature, power control module; processor/storage module provides communications processor, 2MB local storage, first storage port expander, 19-inch card rack, and power supplies; I/O module provides IOP, 19-inch card rack, and power supplies; integrated mass storage provides 3½-inch flexible disk with a 1MB unformatted capacity, 3½-inch rigid disk with a 20MB formatted capacity, disk drive controller, and SCSI line module	195,000	8,125	483.00
F 4993-00	Provides 2MB of local storage expansion for DCP/50; used to expand storage from 2MB to 4MB and from 6MB to 8MB	85,000	3,542	147.00
F 4993-01	Provides 2MB of local storage expansion for DCP/50 to expand storage from 4MB to 6MB; includes control logic for the second storage bank	85,000	3,542	147.00
F 4996-00	Provides the second or third storage port expander PC card for the DCP/50 basic cabinet	9,750	406	26.00
F 4996-01	Provides a storage port expander PC card for the DCP/50 basic cabinet	10,000	417	15.50
F 4995-01	I/O module; provides an I/O processor, 19-inch card rack, and power supplies	35,000	1,458	12.50



# Unisys Corporation DCP Series Communications Processors

## MANAGEMENT SUMMARY

**UPDATE:** *The former Sperry Corporation is now under the Unisys umbrella, which continues to offer the DCP Series of communications processors. A new model, the DCP/15, has joined the other members of the DCP line. DCP/OS is the new operating system for the DCP processors and the Telcon software has been restructured.*

The DCP communications processors made their first appearance in 1979 with the introduction of the DCP/40. Two years later the DCP/20 was introduced, and in 1983 the entry-level DCP/10 made its appearance. Since that time, the DCP/10 has been replaced by the DCP/10A and, in 1986, the DCP/15 joined the family. These communications processors are multiprocessor-based systems that can be used as front-end processors, remote intelligent concentrators, or nodal processors in a Unisys or multiple-vendor network. The processors can simultaneously support transaction, time-sharing, distributed processing, and remote job entry applications.

The system architecture used in the DCP Series communications processors distributes processing operations between one general-purpose processor, multiple I/O processors (except for the DCP/10A), and microprogrammed line modules. The general-purpose processor handles general communications tasks. The I/O processors are physically identical to the general-purpose processor in the smaller models and are dedicated to I/O handling tasks. Each I/O processor supports up to 16 line modules. Connections to remote devices, to local peripherals, and to on-site host computer channels are accommodated by various

The Unisys DCP Series of communications processors consists of the Distributed Communications Processor/40 (DCP/40), DCP/20, DCP/15, and the DCP/10A. These communications processors can be used as front ends to a Unisys 1100 Series, 2200, or System 80 mainframe, or as nodal processors or remote concentrators in a Unisys or multivendor environment. The DCP/40 is the largest member of the DCP family and can support up to 16 I/O processors; the DCP/20 is the middle member supporting three I/O processors, with the first handling both the communications processor and I/O processing functions. The DCP/10A is the entry-level processor and does not support independent IOPs (input/output processors), but does have a single processor that provides the functions of each.

**FUNCTION:** Front-end processor, nodal processor, remote concentrator.

**HOST COMPUTERS SUPPORTED:** Unisys 1100 and 2200 Series, System 80.

**ARCHITECTURE SUPPORTED:** Unisys Distributed Communications Architecture (DCA).

**OPERATING SOFTWARE:** Telcon Operating System software, DCP/OS.

**COMPETITION:** International Business Machines (IBM), NCR Comten.

**PRICE:** Prices vary depending on configuration.

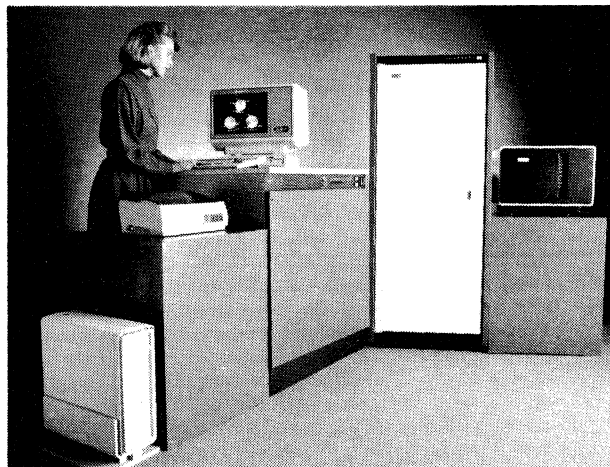

*The DCP/20 communications processor from Unisys is the mid-range model in the DCP product line. It is a modular systems that operates as a front-end processors for a Series 1100, 2200 or System 80 mainframe.*

## CHARACTERISTICS

**VENDOR:** Unisys Corporation, P.O. Box 500, Blue Bell, Pennsylvania 19424. Telephone (215) 542-4011.

**DATE OF ANNOUNCEMENT:** Distributed Communications Processor/40—1979; DCP/20—1981; DCP/10A—1983; DCP/15—1986.

**DATE OF FIRST DELIVERY:** DCP/40—1979; DCP/20—1982; DCP/10A—1983; DCP/15—1987.

**NUMBER DELIVERED TO DATE:** 3,500+.

**SERVICED BY:** Unisys Corporation.

## MODELS

The Distributed Communications Processors (DCP) Series of communications processors consists of four models that include the DCP/40, DCP/20, DCP/15, and DCP/10A. These processors can act as front-end processors, nodal processors, or remote intelligent concentrators in a Unisys or multiple vendor environment.

## Unisys Corporation DCP Series Communications Processors

**TABLE 1. SERIAL COMMUNICATIONS LINE MODULE OPTIONS  
FOR THE DCP SERIES COMMUNICATIONS PROCESSORS**

Feature No.	Line Module	Interfaces	Protocols	Data Rates
F1942-00	Synchronous (half- or full-duplex)	EIA RS-232-C, CCITT V.24 and V.28	Synchronous; Uniscope	Up to 9600 bps
F1941-00	Asynchronous (half- or full-duplex)	EIA RS-232-C, CCITT V.24 and V.28	Asynchronous; Uniscope or teletypewriter	Up to 2400 bps
F3165-00	Multiline asynchronous (half- or full-duplex)	EIA RS-232-C, CCITT V.24 and V.28	Teletypewriter**	Up to 2400 bps
F1945-00	Automatic dialing	EIA RS-366 (Bell 801) CCITT V.24 and V.25	Protocol independent	—
F1945-01 (DCP/20 only)	Automatic dialing	NTT (Japanese) compatible	Protocol independent	—
F3163-00	Medium-speed loadable* (half- or full-duplex)	EIA RS-232-C, CCITT V.24 and V.28	Basic asynchronous** Basic synchronous UDLC BSC REM 1 NTR	Up to 19,200 bps, except up to 9600 bps for BSC
F3163-04	Medium-speed loadable* (half- or full-duplex)	EIA RS-449	Basic synchronous UDLC BSC REM 1 NTR	Up to 9600 bps
F3163-01	Medium-speed loadable* (half- or full-duplex)	CCITT X.21	Basic synchronous UDLC BSC NTR	Up to 9600 bps
F3164-01	High-speed loadable* (half- or full-duplex)	CCITT V.35	Basic synchronous UDLC BSC REM 1 NTR	Up to 64,000 bps
F3164-00	High-speed loadable (half- or full-duplex)	Bell 303	Basic synchronous UDLC BSC REM 1 NTR	Up to 64,000 bps

\* Program-loadable protocols.

\*\*Includes auto baud rate detection.

➤ line modules. Each line module provides interfacing for a specific type of channel or device.

The DCP Series processors are incorporated with Telcon software to form the DCP/Telcon system. The Telcon system uses the Distributed Communications Architecture (DCA) and is made up of numerous, layered, discrete modules, which are loaded into the DCP processor after it has been initialized using DCP/OS. DCP/OS controls the hardware, handles data file management and programs, and simplifies system maintenance.

The DCP/Telcon system is used in redundant configurations; offers distributed network management services, security maintenance, monitoring, and control; can manage various configurations of synchronous, asynchronous, and wideband communications lines; supports devices for unattended operation, local initialization, and redundant applications; and utilizes a powerful instruction set that is designed for communications programming.

### ➤ CONFIGURATION

#### DCP/40

The (DCP/40) is a multiprocessor, multitasking system that is used with an 1100 Series, 2200 Series, or System 80 host computer. All functional characteristics are provided in microcode, which is loaded into system memory.

The basic DCP/40 includes a communications processor; the basic DCP/40 microprograms (stored on an integral diskette); a storage controller and one 512K-byte RAM storage module; an input/output (I/O) controller and one IOP; a line module chassis with space for up to 16 line modules for connection of host computers, local peripherals, and communications lines (line modules are priced separately); power supplies and a power controller; an integrated diskette drive and controller (separately priced but required); an operator's panel; and a maintenance panel. All of these components are contained in a single freestanding cabinet. The basic configuration also includes an external, dual-drive disk subsystem that provides a total of 60MB of storage (separately priced).

➤ The contents of the basic cabinet can be expanded to include up to three additional 512K-byte storage modules, for a ➤



## Unisys Corporation DCP Series Communications Processors

➤ The options and capabilities of the DCP Series communications processors can be better appreciated when their role in Unisys' DCA is kept in mind. Basically, DCA is a set of ground rules that defines the functions that each element within a communications network should perform. Furthermore, DCA defines the standards for interfacing between elements. The goal is to permit interconnection of dissimilar hardware/software into one communications network in compliance with DCA ground rules. Under DCA, the interconnection of a vast array of line disciplines, supporting an even larger array of terminal types, is permitted. Not unexpectedly, therefore, the range of line interfaces provided with the DCP Series communications processors is rather extensive. Table 1, in this report, lists the DCP interfaces supported.

Another DCA concept is to produce hardware (e.g., the DCP/40) that operates under software, not software operating under hardware. Portions of the DCA software reside in the DCP processors, portions in the host computers, and still other portions in a DCA intelligent terminal in the network. Within Telcon, the DCP performs the specific functions of communications processing and line concentration, providing the user with no programmatic tools to alter the assigned function. However, within the assigned function, the hardware options and own-coding provisions provide significant flexibility.

### COMPETITIVE POSITION

The DCP Series communications processors can perform functions similar to those handled by the IBM or NCR Comten processors. The DCP/10A and DCP/15 compete against IBM's 3720 and Comten's 5620, while the DCP/20 and DCP/40 go up against the IBM 3725 and Comten 3690 and 3695. The DCP systems utilize the X.25 gateway from DCA to other networks, as well as the BSC and SNA gateways to IBM systems. They also support various public data networks.

While the DCP communications processors offer comparable functions to other vendors' products, they are basically designed to work within the Unisys framework. These processors do go farther than other mainframe vendors' processors in offering host-independent networking.

### ADVANTAGES AND RESTRICTIONS

The DCP Series communications processors were designed to operate within the DCA architecture and perform network processing. They were not designed to operate as distributed processing systems or as independent stand-alone systems. As communications processors within a network, they offer a variety of functions including network control, multiple terminal support, line cost savings, a broad range of data transmission rates, modularity and growth capabilities, multiple terminal type support, and the ability to design communications networks to meet data processing and data transmission needs. The processors offer host-independent communications network operation and have the ability to accommodate non-Unisys communications protocols and network management ca-

➤ single cabinet capacity of 2M bytes, plus up to three additional IOPs and three additional line module chassis, for a single cabinet capacity of 64 line modules. (If more than two IOPs are contained in the basic cabinet, a storage port expander, which permits multiple IOPs and I/O devices to share storage access ports, is also required.)

If further expansion is required, up to three expansion cabinets can be configured with the system. (If more than two expansion cabinets are added to the basic system, a storage port expander is required in the basic cabinet.) Each expansion contains its own power supplies and power controller, and can accommodate one I/O controller, up to four IOPs, storage port expanders as needed, and associated line module chassis and line modules. In addition, one (but only one) expansion cabinet per system may also contain up to twelve 128K-byte RAM storage modules, grouped into three 512K-byte storage banks; each bank has its own controller.

Additional disk subsystems may be added to the first. One or two magnetic tape drives can also be added to the system.

A SVT-1120 display station must be attached for use as a local system console, with a serial printer as an option. The host system console can also function as a local DCP/40 console if it is configured as a terminal to the network. An optional freestanding desk-type work surface, on which the console can be placed, is also available.

The communications processor performs general-purpose processing tasks, as well as functions specific to network and local-site operations, under the control of microcoded programs loaded into local RAM storage. The processor includes a micro-controller that supports the internal bus structure, timing mechanism, control storage, dual arithmetic logic units (for comparing and checking computations), error checking and logging schemes, automatic instruction retry routines for microinstruction failure, and automatic restart and recovery procedures.

Local RAM storage consists of 512K bytes of integrated circuit, multibank, error correcting storage that can be expanded in 512K-byte increments up to 2M bytes. An expansion cabinet can be added that provides an additional 4M bytes in 512K-byte increments. Error checking logic provides for correction of all single-bit errors and flagging of double-bit errors. All errors are automatically logged so that the processor can analyze the frequency of hardware failures and take any necessary recovery actions.

The communications processor and each device connected to the system through an IOP has direct, independent access to local storage. Storage is accessed via multiple storage ports. Four ports are provided in the basic cabinet, and four additional ports are provided in the expansion cabinet if any expansion storage is configured. If all available ports are occupied, cascaded storage port expanders are used to multiplex groups of requesters to each of the storage ports. Priority schemes in system logic handle simultaneous requests for storage access.

The system's I/O processors manage all input/output tasks. Each IOP provides programmed control for up to 16 line modules, and performs data exchanges, buffer allocation, message formatting, message recovery and retransmission, status reporting, statistics gathering, and polling.

➤ Optional active line indicators can provide a visual display of line activity on data sets connected to an IOP. Each active line indicator displays activity for up to 16 lines on a single IOP, or, with an optional switching feature, for up to 64 lines on four IOPs. Each active line indicator is mounted on the top of the cabinet containing the IOP(s) to which it is connected.

## Unisys Corporation DCP Series Communications Processors

➤ capabilities. The DCP Series provides a range of communications processors that are capable of performing as either front-end processors, remote concentrators, or nodal processors.

These communications processors were designed to meet the needs of a small data comm center as well as larger communications centers. The modularity and compatibility of the systems allow growth from the entry-level DCP/10A to the largest member, the DCP/40.

The processors offer large storage capabilities, with the DCP/40 providing up to 6M bytes. Security measures built into the software and the hardware safeguard the system's data from unwarranted intrusion, error, and tampering.

### USER REACTION

Unisys provided Datapro with a list of DCP users to contact for a user reaction. We were able to talk with two users: one who had both the DCP/10 and DCP/20 and another who had the DCP/40. The length of time that the systems had been installed ranged from six months to six years.

#### USER #1

This user has had the DCP/10 installed for six months, and the DCP/20, installed for three and a half years. The DCP/10 is connected remotely to the DCP/20, and both processors are used as network processors and terminal controllers. The DCP/20 serves one mainframe and 120 terminals, in addition to the 50 terminals supported by the DCP/10.

This user rated his DCP communications processors Good in Overall Performance, Hardware Reliability, Quality of Manufacturer's Software & Firmware, and Quality of Manufacturer's Technical Support. He rated the Maintenance Service Excellent, Ease of Installation as Fair, and gave a rating of Poor to Ease of Operation, Ease of Expansion, and Ease of Programming. In qualifying his poor rating for Ease of Operation, the user felt that documentation was the main problem as it was not well done or nonexistent. If a problem arises, it is difficult to find since there is no menu to guide personnel through a problem determination procedure. Another related problem is that the Series 1100 mainframe uses words, while the DCP/10 and DCP/20 use bytes, and translation is time consuming and difficult. Documentation was also the main reason behind the poor rating given to Ease of Programming. With limited documentation, the user has to depend upon Unisys for any major changes.

The user qualified his poor rating for Ease of Expansion by saying that the problem he had encountered with swapping boards for increased MB size has been solved in the newer models. Originally, the boards could support only 0.5MB and then they would have to be swapped. Now, Unisys provides larger capacity, so today's users should not encounter this problem. ➤

➤ The line modules are plug-in, programmed interfaces that provide for connection of all external devices to the DCP/40 system. Various modules accommodate half- or full-duplex communications lines, host computer channel interfaces, or local peripheral interfaces. Each module is loaded with a microcoded program that supports the specific data format, transmission method, and other requirements of the line to be connected. The line modules also perform such functions as data conversion (from parallel to serial and vice versa), data buffering, character parity and block check sequence generation and checking, character counting and control character recognition, and line timing and asynchronous clocking. Up to 256 line modules can be configured with a DCP/40 system, since, in general, each line module occupies a single IOP port. The exception is the byte-channel host interface line module, which provides for connection to a Series 2200 or 1100/80 host computer and requires four IOP ports.

Local peripherals are attached to the system through the IOPs via the Sixteen-Bit Peripheral Line Module for the disk and magnetic tape drives.

Line modules for connection of host computer interface channels and communications lines are described under "Transmission Specifications."

Reliability features are built into each layer of the DCP/40's architecture. In addition to the error detection, logging, and correction schemes already mentioned, the system can support configurational redundancy in both internal elements such as local storage, I/O processors, and line modules, as well as in the external network; virtual storage mapping that prevents software errors in any single system module from causing total system failure; and diagnostic programs in both macrocode and microcode that provide both online and offline tests of system and network components. DCP/40 dumps, as well as error logs and statistics reports, can be transmitted to the host upon demand by the host or DCP/40 console operator.

#### DCP/20

The DCP/20 is a smaller version of the DCP/40. The basic configuration includes a general-purpose processor, I/O processor, 512K bytes of main memory, and support for up to 16 line modules. The main memory can be expanded in 512K-byte increments to a maximum of 2M bytes. Up to two optional I/O processors may be added to the basic system, each of which can support up to 16 line modules, for a system maximum of 48 line modules.

Available peripherals to the DCP/20 include a 10MB or 20MB cartridge disk subsystem; up to four dual-flexible disk subsystems, for a total diskette storage capacity of 8MB; one or two Uniservo 10 magnetic tape drives; an operator's control console or SVT-1120 terminal; and an optional slave console printer, available in a 200-cps bidirectional impact model. The Sixteen-Bit Peripheral Line Module is used to connect the cartridge tape and magnetic tape subsystems to the DCP/20; the Byte I/O Line Module is used to connect the flexible disk subsystems.

#### DCP/15

The DCP/15 is an entry-level member of the DCP family and can be used in the same network as other members of the DCP family. The DCP/15 can act as a front-end processor for Series 1100 host computer systems, as well as being a network processor or a remote concentrator. The basic configuration includes a processor, local storage, and communications line modules packaged together in a 19-inch rack. It also supports a 20MB fixed disk subsystem, host interface modules, a 5½-inch flexible disk drive, up to 4MB of main memory, and support for up to 12 line modules. ➤

## Unisys Corporation DCP Series Communications Processors

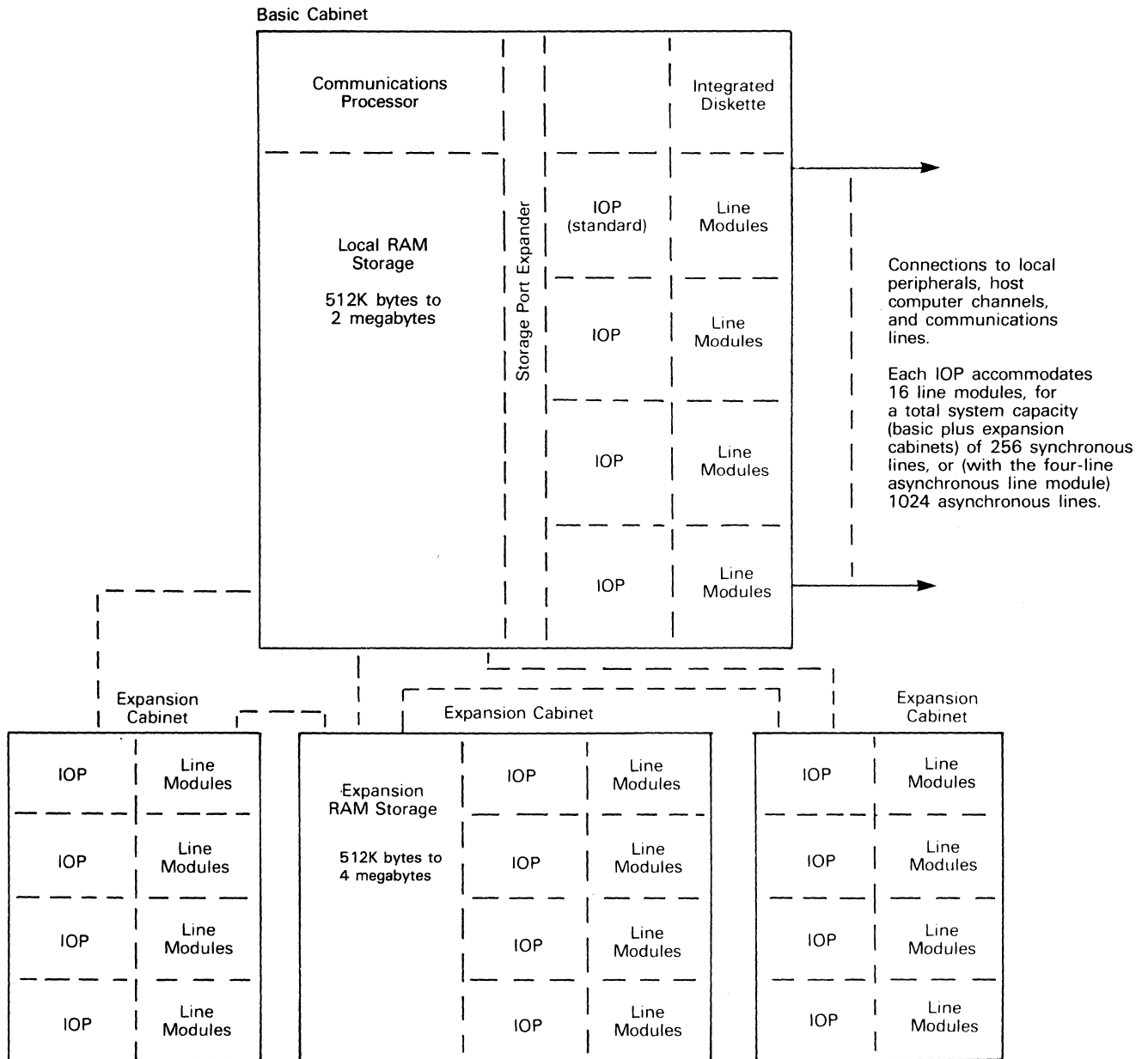

Figure 1. Basic DCP/40 configuration.

➤ User #1 made the decision to buy the DCP communications processors without looking at the competition, because he already had Unisys mainframes and was leery of mixing vendors. He sees this compatibility issue as one advantage that Unisys and other mainframe vendors that offer communications processors have over the competition. Other advantages of the DCP processors are the ability to off-load all communications functions from the mainframe onto the communications processors, thus freeing up the mainframe, and the ability to upload and download without interfering with the main processor.

When asked about problems with the DCP processors, the user mentioned again the poor or inadequate documentation. He also did not like the separate Winchester disk

➤ The DCP/15 also supports a freestanding disk subsystem that can store Telcon system files, diagnostic problems, and network database files. The subsystem has a Winchester Disk and can support up to two disk drive assemblies. Each disk supports up to 72MB of storage. An integrated disk drive that is used for mass storage is also supported by the DCP/15. It has a 20MB capacity and shares the same controller and peripheral adapter as the integrated flexible disk. This disk drive can store the operating system, logging network operation statistics, on-line diagnostic programs, and configuration files.

➤ A remote control module can be used to control the DCP/15 at an unattended, remote site. This module provides control of system program load, start/stop operations, and the system power for up to four processors. Control commands are sent to the module over serial communications circuits.

## Unisys Corporation DCP Series Communications Processors

▷ drive, which was difficult to reboot and was not always big enough to hold a dump. In spite of certain problems encountered with the DCP/10 and DCP/20, this user would definitely recommend the DCP communications processors to potential buyers. He feels that they are reliable systems and competitive in price.

### USER #2

Since 1981, user #2 has been using a DCP/40 as a front-end processor and a remote batch concentrator. The DCP/40 serves a Series 1100 mainframe, as well as 1400 terminals. This user explained that he had split the host to appear as two hosts, and that the DCP/40 supports either host. In asking the user to rate the DCP/40, he gave either Excellent or Good ratings in all categories except for Ease of Programming, which received a rating of Fair.

He had been involved in the decision to buy, and said that while he had looked at Chi Corporation's processors, he felt that it was better to stay with Unisys since he was using a Unisys mainframe. He also felt that any growth or changes Unisys made to the mainframe would be reflected in the DCP processors.

In discussing the advantages of the DCP/40, the user mentioned its capability to support a much larger network; its growth is not constrained. He also liked the fact that Unisys continues to support its communications protocols. In discussing problems or disadvantages of the DCP/40, the user mentioned that the off-loading from the host was limited and not as had been promised. He thought that the reason for this was the use of high-level languages. Another problem encountered was accountability. The host side support and Telcon software support side had difficulty deciding who was responsible for problems, and while the issue was slowly improving, it was still a bottleneck.

When asked if he would recommend this system to a potential user, there was a long pause before he gave a qualifying "yes." The qualifications were over the price, which is not inexpensive, and the needs of the user. He said that if the user was looking for a product that supports a terminal network with limited personnel at the sites and with limited software support, then yes, it was a good system to buy. □

▶ **The line switch module is used to support unattended operation of the communications subsystem. This module allows switching of communications lines and peripherals subsystems between DCP/15s. Switching control can be done manually, under remote program control, and under local program control.**

### DCP/10A

The DCP/10A, another entry-level member of the DCP family, can be used in the same network with other DCP communications processors. The basic configuration includes a general-purpose processor, local storage, 2MB of main memory, and support for up to six line modules.

Like the DCP/15, the DCP/10A supports the following peripherals: a cartridge disk subsystem, an integrated disk drive for mass storage, a remote control module, and a line switch module. The remote control module can be used to control the DCP/10A in an unattended, remote environment, while the line switch module is used to support unattended operation of the communications subsystem.

### TRANSMISSION SPECIFICATIONS

Line modules that connect remote devices, local peripherals, and host computers to the system are attached to the DCP via the IOP ports. Each IOP provides 16 ports. Up to 16 IOPs may be configured with a DCP/40, so that a maximum of 256 line modules can be accommodated. On the DCP/20, both the general-purpose processor and the IOPs provide line module ports. The DCP/20 supports up to three IOPs, with the first handling both communications processor and I/O processor functions. The DCP/20 can accommodate a maximum of 48 line modules. The DCP/10A uses a single processor which offers both communications processor and I/O processor functions. The DCP/10A supports six line modules, while the DCP/15 supports 12 line modules.

A number of serial line modules are offered to support connection of remote devices to the system over communications lines. Many line modules are offered in a 4 x 1 configuration, thus DCP's can support up to four times the number of lines, as compared to numbers of line modules. RS-232-C, CCITT V.24/V.28, RS-449, V.35, AT&T 303, RS-366, Japan NTT, and X.21 interfaces are supported in half- or full-duplex mode at speeds up to 64K bps. The processors can also interface to both X.21 (circuit) and X.25 (packet) public data networks.

A remote control module, using microprograms, allows remote control of the power on/off, IPL, and other functions of up to four DCP/40, DCP/20, DCP/15, or DCP/10A processors via communications lines.

With an optional line switch module operation under microprograms, the communications lines or peripherals can be switched from a local or remote source via a direct connection or communications line connection. The LSM consists of a cabinet, power supply and control, and control logic. One communication interface feature (F3163-00 or -04) is required to attach the LSM to a modem.

Various switches are available that provide the capability to switch eight RS-232-C communication links, eight V.35 lines, four RS-449 lines, four wideband lines, or four 16-bit peripheral interfaces from one communications controller to another.

Protocols supported by the communications line modules include teletypewriter, asynchronous or synchronous UNISCOPE protocol, Universal Data Link Control (UDLC), 1100 full-duplex (FDX—used with Series 1100 equipment), REM1 (used with Unisys 9200, 9300, or 90/30 Series processors and the 10004 card processor), Nine Thousand Remote (NTR—also used with 9000 Series Processors), 3270, 2780, SNA 3270, 3770, and IBM Binary Synchronous Communications (BSC). Two types of line modules, the Medium-Speed Line Module and the High-Speed Line Module, can be loaded with microprograms for specific line protocols.

**CONNECTION TO THE HOST:** A DCP/40, DCP/20, DCP/15, or DCP/10A system may be connected to a host computer remotely via communications lines or directly through a host processor channel. Connections to the System 80 are exclusively through communications lines, while the 2200 Series can be connected using either a communication line or a byte channel interface. ▶

## Unisys Corporation DCP Series Communications Processors

► Five parallel line modules are provided for direct-channel connection: the Host Byte Channel Module provides an interface to a 1100 Series or 2200 Series mainframe through its byte multiplexer, block multiplexer, or selector channel; the Host Word Channel Module provides an interface to an 1100 Series processor with its 32-bit internally specified index (ISI) word channel; the sixteen-bit peripheral line module provides an interface to a peripheral subsystem in either an 8- or 16-bit mode (DCP/40 and DCP/20); Byte I/F module provides an 8-bit interface to an 8409 disk and a flexible disk (DCP/10A and DCP/20); and the Front End Processor (FEP) interface module that connects a System 11/Mapper 10 system to a standalone DCP/10A. Up to four channel interface modules (either type) can be accommodated per DCP/40 or DCP/20, while the DCP/15 can support two and the DCP/10A one. The Word-Channel Line Module occupies three line module ports; the Byte-Channel Line Module occupies four line module ports.

### SOFTWARE

Data Communications Architecture (DCA) is a set of rules and guidelines that permits users who comply to be able to tie their scattered electronic data processing elements into an interconnected network. In effect, it identifies the necessary tasks, separates the tasks into functions, and standardizes the rules for interfaces. This permits the interconnection of network elements with dissimilar hardware and support software. One component of DCA is the Telcon system, a combination of hardware and software to interconnect remote terminals with mainframe processors and interconnect mainframes. The software portion of Telcon includes the software operative in the DCP/40, DCP/20, DCP/15, or DCP/10A, the related support software in the host, and the software to provide standardized DCA interfaces for certain intelligent terminals and Unisys micro products.

Telcon supports interactive-, batch-, and transaction-oriented data transfers. Under Telcon, all data is processed concurrently and is interleaved on UDLC circuits between nodes. In a multinode environment, any terminal has access to any host in the network and can be switched from one application or operational mode to another, while any mainframe application can access any other mainframe application.

The DCP/40, DCP/20, DCP/15, or DCP/10A, with its resident Telcon software, can serve as a front-end processor to one or more 1100 Series, or as a nodal processor or a remote concentrator to one or more 1100 Series, Series 80, IBM or compatible systems, or to another DCP/40, DCP/20, DCP/15, or DCP/10A system.

Telcon provides the DCP Series processors with comprehensive network management facilities for distributed or hierarchical networks, through which it can maintain, control, monitor, and protect the network. Through Telcon, the DCP controls the establishment of sessions, access to various network systems, and allocation and use of network resources. As the network grows or changes, the DCP can be dynamically reconfigured to support new network components.

The operating system for the DCP processors is DCP/OS, which controls and manages the hardware, program and data file management, and system maintenance. With these jobs delegated to DCP/OS, the Telcon software was arranged into layered, discrete modules that are loaded into the DCP after initialization by DCP/OS.

The major tasks performed by the DCP/OS and Telcon software within the DCP/40, DCP/20, DCP/15, or DCP/10A are:

- **Basic Executive**—Schedules processor time based on user priority. Equal priority users are handled on a first-in, first-out basis. Dispatches time-related functions, including suspension of a user for a specific time period. Also provides administrative functions, such as loading, deactivation, and buffer management.
- **Hardware Interface Routines**—Provides the software support for the IOPs and line modules.
- **File management**—Provides device-independent control of disk, diskette, and magnetic tape drives.
- **I/O Control**—Manages the queuing of all incoming and outgoing messages, including passing messages from one DCP to another. When possible and necessary, the software can seek alternate routing and performs pacing of the number of messages to a given user.
- **Network Management Services**—Provides fundamental control and monitoring of the system, dynamic addition and deletion of communications lines and terminals, gathering of network statistics, control of security, and the establishment of session links.
- **Loading and Initialization**—The integrated diskette contains the first load block, which calls in the bootstrap loader from local mass storage, the host computer, or another DCP system. The bootstrap performs initialization functions and loads the system's operating software to complete the initialization process.

Unisys also provides DCA support for access to several European and Canadian public data networks. The X.25 packet-switching and X.21 circuit switching support takes the form of line modules for DCP Series processors and software packages that run under the Telcon system. Such modules are available for the following packet-switching services: the Nordic PDN in Scandinavia; PSS in the United Kingdom; Datex-P in West Germany; Transpac in France; Datapac in Canada; GTE Telenet in the United States; DN-1 in The Netherlands; Austpac in Australia; Iberpac/Arpac in Spain and Argentina; and Datex-P in Austria.

### COMPONENTS

**COMMUNICATIONS PROCESSOR:** The communications processor utilizes a 32-bit microinstruction format plus byte parity. The processor provides 128 general-purpose 16-bit registers, plus several specialized registers. The communications processor instruction set contains approximately 300 instructions for native mode operations. Microinstruction execution cycle time is 65 nanoseconds (ns) for the DCP/40, 80 ns for the DCP/20, 125 ns for the DCP/15, and 250 ns for the DCP/10A.

Maximum local RAM storage capacity is up to 2M bytes in increments of 512K bytes for the DCP/20 and DCP/10A. The DCP/15 has a maximum capacity of 4M bytes. Maximum storage for the DCP/40 is up to 2M bytes in increments of 512K bytes, with an expansion cabinet offering an additional 4M bytes in 512K bytes for a total storage capacity of 6M bytes. In the DCP/40 and DCP/20, data is formatted in storage as a 32-bit word with 7 bits designated for error correction. The read-cycle time and full-word write-cycle time is 450 ns for the DCP/40. The read-cycle time for the DCP/20 is 400 ns and a full-word write-cycle time is 450 ns. The DCP/15 read-cycle time is 500 ns with a full-word write cycle time of 375 ns. The DCP/10A has a read-cycle time of 1,000 ns and a full-word write cycle of 750 ns.

**I/O PROCESSORS (IOP):** The IOP is designed to handle input/output for the DCP Series processors. The IOPs used with the DCP/40 and DCP/20 each provide control for up to 16 data paths. The DCP/15 supports up to 14 data paths, ►

## Unisys Corporation DCP Series Communications Processors

▶ while the DCP/10A supports 8 paths. Virtual addressing is used by the IOPs to access the full storage of the DCPs. The DCP/40 can use a total of 16 IOPs, the DCP/20 uses a total of 3 IOPs, while the DCP/15 and DCP/10A each supports a single processor providing both communications processor and I/O processor functions.

The IOP for the DCP/40 and DCP/20 uses a 16-bit micro-instruction, an 8-bit data path, a 32-bit storage address plus byte parity, a 24-bit byte addressing system and 1024 internal registers that use 32-bit stacks with byte parity. Up to 85 macroinstructions can be used to control the IOPs.

**INTEGRATED DISKETTE:** A 655K-byte diskette drive and a diskette controller are required for initial system loading. It can also be used to store diagnostic programs, statistics, error logs, network control tables, and additional downloaded functions. The diskette controller interfaces with the system through an IOP and occupies the space of one line module.

**DISK SUBSYSTEMS:** The Model 8408 cartridge disk subsystem can provide up to 10 megabytes of mass storage in a single cabinet for the DCP/40 or the DCP/20 system; it can also be used as a system loading device in lieu of a diskette subsystem. The subsystem consists of a controller and one or two top-loading, dual-spindle disk drives. Each drive provides 5MB of fixed and 5MB of removable disk storage. The data transfer rate for a Model 8408 drive is 2.5MB per second, and the average access time is 50 milliseconds. The cartridge disk subsystem is connected to the DCP through an IOP via a 16-bit peripheral interface. A dual I/O interface option permits the subsystem to be shared by two different channels of one DCP or by two separate DCP systems. Multiple drives can be attached through separate line modules.

The 8409 disk subsystem is a standalone mass storage device. The 8409 can be used as a storage device for the Telcon system, for network database files, and for distributed data processing applications. The disk subsystem can be ordered with one or two disk drive assemblies that initially

support either 4.75, 14.25, and 23.8 megabytes of storage each.

The 8441 Mass storage subsystem is also a free standing mass storage subsystem with the same functions as noted above for the 8409. The 8441's basic system contains one drive with a 30MB formatted capacity that can be expanded by one drive for a total capacity of 60MB.

**MAGNETIC TAPE SUBSYSTEM (DCP/40 and DCP/20):** The Model 0871 Uniservo 10 magnetic tape subsystem contains a tape controller and a single nine-track 800/1600 bpi tape drive; a second, separately cabineted drive can be added. The data transfer rate is 40K bytes per second for the PE formats or 20K bytes per second for NRZI formats; the tape speed is 25 ips. An automatic threading function is standard. The magnetic tape subsystem connects to the DCP using an IOP through a 16-bit peripheral interface.

**CONSOLE:** A SVT 1120 display terminal must be used optionally as a local display console. The SVT 1120 is a fully featured editing/formatting terminal that provides a maximum screen capacity of 1,920 characters, a typewriter keyboard, and a full upper-/lowercase ASCII character set. An optional auxiliary interface is available for the SVT 1120 for attachment of a slave printer.

### PRICING

The Unisys DCP/40, DCP/20, DCP/15, and DCP/10A communications processors are available for purchase or on a one-year or five-year lease. Unisys also offers a seven-year lease to state and local governments and to educational institutions. Educational institutions are eligible for an additional 10 percent discount. The discount does not apply to maintenance service charges. The basic maintenance charge covers maintenance of the equipment for nine consecutive hours a day between the hours of 7 a.m. and 6 p.m., Monday through Friday. Extended periods of maintenance are available at premium rates.

### EQUIPMENT PRICES

		1-Year Lease (\$)	5-Year Lease (\$)	Purchase Price (\$)	Monthly Maint. (\$)
<b>DCP/40</b>					
8596-96	Basic DCP/40; includes freestanding cabinet, communications processor, first storage controller, 512K bytes of storage, first I/O controller module, first I/O processor, ROM memory, and microprograms; requires integrated flexible disk drive, (F1939-00/01), line modules, and cartridge disk subsystem	2,305	1,843	84,245	452
1945-99	DCP/40 Expansion Cabinet; includes freestanding cabinet, power supply, and power controller; max. 3 per system, only one of which may contain storage; third expansion cabinet requires storage port expander (F1936-00)	740	593	27,060	146
F1930-00	Storage Expansion; provides additional 128K bytes of storage; for expansion memory through DCP/40 expansion cabinet (1945-00)	152	121	5,570	32
K1930-01	Storage Expansion; provides additional 512K bytes of storage; up to three K1930-01 modules may be added to basic DCP/40; additional 128K-byte (F1930-00) modules may be added to DCP/40 expansion cabinet through F2942-00 and F1929-99; max. 3.5M bytes total storage per system	410	325	15,600	126
F2942-00	Second Storage Controller; mounts in expansion cabinet; includes 128K bytes of storage plus support for three additional 128K storage expansion modules; max. 1 per system	735	588	26,880	145
F1929-99	Third/Fourth Storage Controller; mounts in expansion cabinet; includes 128K bytes of storage plus support for three additional 128K storage expansion modules; requires F2942-00; max. 2 per system	365	290	13,950	77
F1933-00	I/O Processor Controller Module; mounts in expansion cabinet; includes one I/O processor, one storage port expander and space for mounting three additional I/O processors; max. 3 per system (1 in each expansion cabinet)	399	320	14,680	78
F2941-99	Second I/O Processor; may be added to basic DCP/40, or to DCP/40 expansion cabinet already containing F1933-00; includes power supply for third and fourth I/O processors	410	326	14,920	81

\*Lease prices do not include maintenance.

## Unisys Corporation DCP Series Communications Processors

		Monthly Charges*			
		1-Year Lease (\$)	5-Year Lease (\$)	Purchase Price (\$)	Monthly Maint. (\$)
<b>DCP/40 (Continued)</b>					
F1932-99	Third I/O Processor; may be added to basic DCP/40 or to DCP/40 expansion cabinet; requires F2941-99; includes storage port expander	389	310	14,185	76
F1932-98	Fourth I/O Processor; may be added to basic DCP/40 or to DCP/40 expansion cabinet; requires F1932-99	294	231	10,635	57
F1825-05	Active Line Indicator; provides a visual display of line activity on up to 16 communication line modules in a single IOP. Mounts on top of cabinet containing the IOP	26	21	960	4
F1936-00	Storage Port Expander; provides multiplexed interface to a single storage port for up to four requestors	95	75	3,550	19
F1939-01	Integrated Flexible Disk; includes controller and one drive; required for basic DCP/40; may also be added to DCP/40 expansion cabinet in which at least one I/O processor is installed; requires microprogram diskette (1931-98)	53	42	1,920	12
F1931-98	Flexible Disk; contains DCP/40 Processor and I/O Processor microprograms for operation in primary mode	4	3	144	1
<b>DCP/20</b>					
8597-78	Basic DCP/20; includes freestanding cabinet, communications processor, 512K bytes of storage (can be expanded in 512K-byte increments to a max. of 2048K bytes), microprogram storage, microprograms, integrated flexible diskette. May require a Host Interface; does not include a mass storage subsystem	1,458	972	35,000	229
8597-76	Same as 8597-78 except includes 1024K bytes	1,755	1,170	42,110	355
8597-01	DCP/20 Expansion Cabinet; includes freestanding cabinet, power supply, and processor capable of I/O functions; provides mounting for 8 line modules (up to 16 line modules with F2894-00); requires 1936-00	656	525	24,000	119
F3539-00	Storage Expansion; provides additional 128K bytes storage, max. of 2 can be added to DCP/20	131	105	4,500	24
F3539-99	Storage Expansion; provides additional 256K bytes of storage; max. of 1 can be added to DCP/20	225	150	8,650	48
F1939-01	Integrated Flexible Disk; provides control and one flexible disk drive for 256K-byte diskettes; required for basic DCP/20	53	42	1,920	12
F1936-00	Storage Port Expander; provides a multiplexed interface to a single local storage access port for up to four requestors	95	75	3,550	19
F2894-00	Line Module Expansion; provides expansion for additional 8 line modules in 8597-01	460	250	12,000	60
F2895-00	Active line Indicators; provides the capability to monitor up to 16 half-/ full-duplex lines in 8597-01.	25	20	890	4
<b>DCP/15</b>					
1986-67	Basic DCP/15; includes cabinet, processor w/20MB of storage expandable to 40MB, power supply, power distribution, active line indicators, microprograms, multiple device line module, and integrated flexible diskette drive with controller.	630	420	15,125	50
1986-65	DCP/15; same as 1986-67 but includes processor with 4MB main storage.	972	648	23,320	55
1986-63	DCP/15; same as 1986-67 but includes a 20MB formatted Integrated Rigid Disk drive	714	476	17,125	70
1986-61	DCP/15; same as 1986-67 but includes processor with 4MB main storage and a 20MB integrated rigid disk drive.	1,055	703	25,320	75
2053-99	DCP/15; same as 1986-67 but excludes cabinet and includes air chamber; requires housing in a customer industry standard cabinet that conforms to EIA RS-310 for 19-inch equipment.	580	387	13,915	50
2053-97	Same as 2053-99 but includes processor with 4MB main storage.	921	614	22,110	50
2053-95	DCP/15—20MB disk; same as 2053-99 except has a 20MB integrated rigid disk drive.	663	442	15,915	70
2053-93	Expanded DCP/15—20MB disk; same as 2053-99 except includes processor with 4MB main storage and a 20MB integrated rigid disk drive.	1,005	670	24,110	75
F4158-01	Integrated disk—20MB; provides 20M bytes of formatted mass storage through a 5¼-inch rigid disk drive that mounts in the DCP/15 enclosure.	83	56	2,000	20
F4961-00	Storage expansion—2MB; expands a DCP/15 with 2MB of main storage to 4MB.	401	267	9,625	5
F3895-01	Power supply expansion; provides DCP/15 with additional +5 volt power.	40	27	970	5
<b>DCP/10A</b>					
1986-75	Basic DCP/10A; freestanding cabinet, communications processor, 512K bytes of storage expandable to 2048K bytes, power supply, active line indicators, microprogram storage, microprograms, multiple device line module, diskette drive with controller. Works with Mapper 10, System 11, or Series 1100 hosts	623	415	14,950	159
1986-73	DCP/10A; same as 1986-75 but includes processor with 1024K bytes	852	568	20,450	229
1986-71	DCP/10A; same as 1986-75 but also includes an integrated 10MB rigid disk drive	740	493	17,750	210

\*Lease prices do not include maintenance.

Unisys Corporation DCP Series  
Communications Processors

		Monthly Charges*			
		1-Year Lease (\$)	5-Year Lease (\$)	Purchase Price (\$)	Monthly Maint. (\$)
<b>DCP/10A (Continued)</b>					
1986-69	DCP/10A; same as 1986-75 but includes processor with 1024K bytes and a 10MB integrated rigid disk drive	939	646	23,250	280
2005-75	DCP/10A; same as 1986-75 but does not include cabinet; requires housing in a customer-provided, industry-standard cabinet	587	386	13,716	152
2005-73	Same as 2005-75 except includes processor with 1,024K bytes	816	539	19,216	222
2005-71	DCP/10A; same as 2205-75 except also includes a 10MB integrated rigid disk drive	704	464	16,516	203
2005-69	DCP/10A; same as 2005-75 except includes processor with 1024K bytes and a 10MB integrated rigid disk drive	903	617	22,016	273
F3891-03	Storage expansion; expands DCP/10A with 512K bytes from 512K bytes to 1024K bytes. Can be expanded up to a max. 2048K bytes by adding F4427-00	433	289	10,400	70
F4443-99	DCP/10A Storage Conversion; provides conversion of an installed DCP/10 to allow storage expansion above 512K bytes	433	289	10,400	70
F4427-00	Storage expansion; expands DCP/10A or DCP/10 with F4443-99 installed, from 1024K bytes to 1536K bytes, or from 1536K bytes to a max. of 2048K bytes	433	289	10,400	70
8409-99	8409 Disk subsystem; provides cabinet, control, and one 4.6M-byte disk drive; may be expanded to 14.0M bytes by the addition of F4085-00	376	280	9,650	82
F4085-00	Expands the capacity of one 4.6M-byte drive from 4.6MB to 14.0M bytes	100	74	1,096	12
<b>Options</b>					
8590-00	Remote Control Module (RCM); provides remote control of DCP/40s, DCP/20s, or DCP/15, or DCP/10As through communications line for power on/off, IPL, and other control functions	355	280	13,526	61
F1937-00	Remote Control Adapter; provides RCM with interface to DCP/40	48	38	1,824	11
F2893-00	Remote Control Adapter; provides RCM with interface to DCP/20	48	38	1,824	11
F3898-00	Remote Control Adapter; provides RCM with interface to DCP/10A	50	40	1,915	11
2523-00	Line Switch Module (LSM); provides capability to switch communications lines and/or peripherals from a local or remote source under program control through a direct or communications line DCP/40, DCP/20, or DCP/10A connection	748	597	28,750	112
F3556-00	RCM/LSM Local Control Interface for DCP/15	95	75	3,600	16
F3557-00	RCM/LSM Microprograms for DCP/15	9	7	350	1
1962-00	LSM Auxiliary Cabinet (for DCP/40 and DCP/20)	197	143	6,872	39
F3105-00	Modem Expander, RS-232-C	38	30	1,440	4
F3109-00	LSM Switch; RS-232-C; controls up to 8 lines	132	102	4,930	22
F3110-00	LSM Switch; CCITT V.35; controls up to 8 lines	245	195	9,325	43
F3112-00	LSM Switch, RS-449, controls up to 4 lines	156	125	6,000	27
F3113-00	LSM Switch, 16-bit I/O, controls up to 4 channels (DCP/40 and DCP/20)	188	150	7,200	33
F3559-00	LSM Switch, AT&T 303; controls up to 4 lines	440	350	16,800	82
F3835-00	Remote Partitioning Feature; for Series 1100 Multiprocessor partitioning	25	20	960	5
<b>Line Modules</b>					
F1946-02	Word Channel Interface; provides full-duplex interface to Series 1100 host processor word channel; max. 2 per basic or expansion cabinet	110	89	4,000	23
F1947-02	Byte Channel Interface; for connection to Series 90 host processor byte multiplexer or block multiplexer channel (DCP/40 and DCP/20)	105	85	4,000	23
F1947-03	8-bit Peripheral Interface to a Series 1100 host processor block multiplexer channel (DCP/10A)	105	85	4,000	23
F1948-01	16-bit Peripheral Interface; operates in 8-bit or 16-bit mode	84	68	3,000	16
F1949-00	Byte I/O Line Module; provides 8-bit interface for flexible diskette subsystem; for DCP/20 only	30	25	1,045	4
F1941-00	Asynchronous Interface; provides full-duplex RS-232-C/V.24/V.28 interface for data rates of 45.5 to 2400 bps	25	20	960	3
F1942-00	Synchronous Interface; provides full-duplex RS-232-C/V.24/V.28 interface for data rates up to 9600 bps	26	21	960	3
F3165-00	Multiline Asynchronous Interface; provides full-duplex support for four communications lines up to 2400 bps with RS-232-C/V.24/V.28 interface; Automatic Data Rate Detection (ADRD) is provided	79	63	2,880	14
F1945-00	Auto Dialing Line Module; provides interface to AT&T 801 and V.24/V.25 compatible automatic calling units; requires F1941-00, F1942-00, or F3163-00	25	20	1,005	4
F1945-01	Auto Dialing Line Module; conforms to NTT (Japan) requirements	25	20	1,005	4
F3163-00	Medium Speed Loadable Interface; provides full-duplex asynchronous and synchronous RS-232-C/V.24/V.28 interface; also operates with AT&T DDS; data rate depends on protocol used; up to 19.2K bps; async provides auto baud rate detect	35	30	1,275	8
F3163-01	Same as F3163-00 except with X.21 interface up to 9600 bps	63	50	2,500	14
F3163-04	Same as F3163-00 except with RS-449 interface up to 9600 bps	50	40	1,920	11
F3164-01	High-Speed Loadable Interface; provides V.35 interfacing; data rate depends on protocol used; up to 64K bps	100	80	3,745	21
F3164-00	Same as F3164-01 except with AT&T 303 interface	188	150	7,200	38

\*Lease prices do not include maintenance.



## Unisys Corporation DCP Series Communications Processors

### Monthly Charges\*

		1-Year Lease (\$)	5-Year Lease (\$)	Purchase Price (\$)	Monthly Maint. (\$)
<b>Peripherals</b>					
8408-02	Cartridge Disk Control; houses up to 2 F2380-04/06 drives	146	109	5,564	32
8409-99	8409 Disk Subsystem; provides cabinet, control, and one 4.6M-byte disk drive; may be expanded to 14.0M bytes by the addition of F4085-00	378	280	9,650	82
F4085-00	4.6MB to 14.0MB expansion	100	74	1,096	12
F2380-04	Cartridge Disk Drive; 10MB; 100/120 volt	461	330	17,750	124
F2380-06	Cartridge Disk Drive; 10MB; 220/240 volt	461	330	17,750	124
F2187-00	Dual I/O Interface for Cartridge Disk	39	29	1,568	9
0871-01	Uniservo 10 Magnetic Tape Unit; requires F2721-00; second 0871-01 requires F2879-00	318	239	13,962	93
F2721-00	Uniservo 10 Controller; provides control for up to two Uniservo 10 tape units; requires F1948-00	284	215	10,320	56
F2879-00	AC Power Switch	32	25	1,200	5
3560-93	VTS 1120 Console; 120 V, 60 Hz. Requires synchronous communications interface	128	97	3,225	33
3560-92	VTS 1120 Console; 100/120/220/240 V, 50/60 Hz. Requires synchronous communications interface	128	97	3,225	33
0797-99	Console Printers; 80 cps; 80-column matrix impact printer	67	50	750	29
0798-99	Console Printer; 200-cps, bidirectional 132-column matrix printer	188	156	4,000	70
F3145-00/	Also F3145-03; Diskette Expansion; provides expanded 1M bytes of storage for the flexible diskette; for DCP/20 only	67	44	1,500	11
01/02		67	44	1,500	11

\*Lease prices do not include maintenance.

## SOFTWARE PRICES

		Single Extended Term (\$)	Monthly Rent (\$)	Monthly LSS Charge (\$)
<b>Software</b>				
6136-02	DCP/40 O/S; provides for DCP/40 operation under Telcon	13,500	300	—
6136-95	DCP/20 O/S; provides for DCP/20 operation under Telcon	9,000	200	—
6136-92	DCP/10A O/S; provides for DCP/10A operation under Telcon	6,750	150	—
6136-86	DCP/15 Telcon OS	8,500	190	—
6257-00	X.25 packet switching software for DATEX-P (German) PDN	7,875	175	35
6257-01	X.25 packet switching software for PSS (United Kingdom) PDN	7,875	175	35
6258-00	X.21 circuit switching software for Nordic public circuit switched data network	7,875	175	26
6276-00	3270 BSC Terminal Handler	6,750	150	—
6276-01	3270 BSC Inverted Terminal Handler	4,500	100	—
6277-00	2780/3780 Inverted Terminal Handler	3,375	75	—
F6124-00	SNA/UTS Gateway; for use with Telcon O/S (Level 5 or higher) and Telcon/IBM SNA base (6843-00), both of which are a prerequisite; provides access to IBM SNA hosts by UTS terminals	4,500	100	15
F6124-01	SNA/3270 Gateway; for use with Telcon O/S (Level 5 or higher) and Telcon/IBM SNA base; provides access in either point-to-point or multipoint configurations	7,875	175	26

\*Does not include software support service, which must be ordered separately. ■



# Unisys DCP Series Communications Processors

## In this report:

Analysis .....	-102
Characteristics.....	-104
Pricing.....	-106

## Product Summary

### Editor's Note

Since our last report on the Distributed Communications Processor (DCP) Series, Unisys has withdrawn Models DCP/15 and DCP/40, retained Models DCP/5, DCP/30, and DCP/50, and added Models DCP/25, DCP/35, and DCP/55. Recent enhancements include support for power-on-pluggable line modules, redundant input/output module power supplies, a redesigned maintenance control feature (MCF), an improved power control feature, and a high-performance input/output module capability.

### Description

The DCP family now consists of the DCP/5, DCP/25, DCP/30, DCP/35, DCP/50, and DCP/55 systems. They range in size from the DCP/5, which serves as a remote concentrator for up to 11 communications lines, to the top-of-the-line DCP/55, which is a dual processor that can support over 1,500 communications lines.

The models can function as front-end processors (FEPs), nodal processors (NPs), remote concentrators (RCs), or as a mixture of these functions. The DCP/5, however, func-

tions primarily as a remote concentrator and/or as a nodal processor. Telcon and DCP/OS serve as the software for the DCP family. DCP/OS handles basic operations, including memory management, file control, and service utilities; Telcon provides networking intelligence.

### Strengths

The DCP family displays a high level of versatility. The products can perform front-end processing, nodal processing, remote concentration, communications functions, and networking functions.

### Limitations

When the DCP/5 is functioning in its networking capacity, the personal workstation supports only communications tasks and does not perform personal computing functions.

### Competition

Amdahl, IBM, NCR Comten.

### Vendor

Unisys Corp.  
P.O. Box 500  
Blue Bell, PA 19422  
(215) 542-4011

### Price

From \$9,800 (DCP/5) to \$396,000 (DCP/55).

—By Barbara Callahan  
Associate Editor

# Analysis

## Product Strategy

Unisys introduced the Distributed Communications Processor (DCP) Series in 1979. Since that time, the company has added and withdrawn products from this line. The series now consists of the DCP/5, DCP/25, DCP/30, DCP/35, DCP/50, and DCP/55. They range in size from the entry-level DCP/5, which supports up to 11 communications lines, to the top-of-the-line DCP/55, which supports over 1,500 communications lines. DCP systems can function as front-end processors (FEPs), nodal processors (NPs), or remote concentrators (RCs) in a Unisys or multivendor network. The DCP/5, however, operates mostly as a remote concentrator and/or a nodal processor.

Although varied in the applications they support, the models in the DCP series are based on a common machine architecture. All DCPs have a communications processor (CP), which is a microprogrammed controller that supplies the bus structure, timing, micromemory, arithmetic logic units, and error control required to execute the CP instruction repertoire. Local storage serves the CP and each input/output processor (IOP) and CP control. The IOPs function as the external interfaces from the DCPs to mass storage, host computer channels, and various line modules. A line module serves as the connection point for terminals, channels, and networks to the DCP system. The line module operating with the IOP forms a port processor (PP). Depending on system type and configuration, up to 16 PPs can function under the control of a single IOP.

Users manage the DCP processors and their networks through the DCP/OS operating system and Telcon communications and networking software. DCP/OS handles basic operations, including memory management, file control, and service utilities; Telcon supplies the networking intelligence. Telcon provides gateways to non-DCA networks,

such as IBM's SNA and many public data networks. Without interrupting the performance of the system, users can add or remove programs, reconfigure portions of the system, and activate memory dumps.

## Decision Points

Unisys designed the DCP series to satisfy a variety of needs. Users can select from six models. Unisys positions the DCP/5 as the low end of the DCP series and targets the machine to small sites. In remote environments, the DCP/5 can function in an unattended mode. The product can act as a remote concentrator and LAN-to-WAN gateway at small sites, supporting up to 11 lines. Although housed in a Unisys Personal Workstation, the DCP/5 is dedicated to communications tasks; the workstation will not perform any personal computing applications when the DCP/5 is activated. The keyboard and monitor serve as operator and maintenance console devices.

The DCP/25 concentrates a large number of lines at remote locations; it can also act as a front-end processor. The DCP/30 midrange model is compatible with all the other models of the DCP family. The DCP/30 can perform front-end processing, nodal processing, remote concentration, communications, and networking functions. The model is appropriate for medium-sized networks.

The DCP/35, compatible with the other members of the DCP family, incorporates two processors. DCP/35 performs front-end processing, nodal processing, remote concentration, communications, and networking functions.

Users with large networks can take advantage of the power of the DCP/50, which supports a wide variety of applications in larger sized networks. Based on Unisys Communications Processor Architecture (CPA) and Telcon communications software, the DCP/50 can function in the same networks as other DCP products.

The DCP/55 is the top-of-the-line product in the family. It also supports intelligent communications for a wide variety of applications in larger networks. The DCP/55 increases the power of the DCP products through its dual processors. It has a processor cycle time of approximately 26 nanoseconds and a storage cycle time of approximately 105 nanoseconds. It is 1.7 times more powerful than the DCP/50.

## Company Profile Unisys Corp.

### **Corporate Headquarters**

P.O. Box 500  
Blue Bell, PA 19422  
(215) 542-4011

### **In Canada**

Unisys Corp.  
2001 Sheppard Avenue E.  
North York, ON M2J 4Z7  
(416) 495-0515

### **Officers**

*CEO:* James A. Unruh  
*Executive Vice Presidents:*  
Cyril Yansouni, Reto  
Braun  
*Vice President Information  
Services:* Howard A.  
Downey

### **Company Background**

Unisys was formed in 1986 from the merger of Burroughs Corp. and Sperry Corp. The company is a manufacturer of commercial information systems, defense systems, and related services. It serves more than 60,000 customers in over 100 countries. Long a supplier of large-scale mainframe computers, Unisys has built a \$2 billion business based on workstations and UNIX-based departmental systems. In January 1990, Unisys formed the Systems Management Group to provide systems integration and professional services in government and commercial markets.

In July 1990, Unisys reported that earnings fell 78 percent for the second quarter, to \$11.8 million, for a loss of 9 cents per share after preferred dividend payments. Revenue fell 4 percent to \$2.47 billion from \$2.57 billion for the same quarter in 1989. In October 1990, Unisys reported a loss of approximately \$356.8 million for the third quarter, compared to a loss of about \$648.2 million a year earlier. Revenues increased 2.1 percent to approximately \$2.4 billion from about \$2.35 billion for the third quarter in 1989.

In October 1990, Unisys announced plans to reduce staff by 5,000 due to the nearly \$357 million loss incurred in the third quarter and the possibility of additional losses in the fourth quarter. The company attributes problems to a soft demand for computers internationally.

### **Alliances**

*January 1990—* Announced a joint development agreement with KPMG Peat Marwick for a systems integration program to support EDI applications. Unisys provides the software and hardware, and Peat Marwick provides consulting services to users.

### *January 1990—*

Announced an agreement with VISsystems, Inc. in which VISsystems became a Marketing Associate through the Unisys Value-Added Marketing Division.

*March 1990—* Signed an agreement with Sigma Imaging Systems for Sigma to develop a special version of its OMNIDISK imaging software to run on Unisys PW2 personal computers and integrate with FileNet's Image Access Facility.

*April 1990—* Announced an agreement with Oracle Corp. under which the Oracle relational database management system and associated tools are ported to the Unisys 2200 mainframe line.

*April 1990—* Announced a joint marketing agreement with Unidata, under which the Value-Added Marketing Division of Unisys makes Unidata's SQL-based RDBMS available on the Unisys U 6000 Series.

*April 1990—* Signed an agreement with Formula Consultants under which Formula Consultants modifies its System for Tape Administration and Reporting (STAR-1100) to operate on Unisys 1100/90 and 2200 Series mainframes.

*May 1990—* Entered into an agreement with Intercim under which Intercim's Factory Data Manager software is available to users of Unisys U Series UNIX OS-based computers.

*May 1990—* Announced a four-year OEM agreement with Solbourne Computer Inc. to resell Solbourne workstations and servers.

*June 1990—* Signed an agreement with Novell, which certified Unisys as an authorized NetWare Support Organization and as a Novell Authorized Education Center.

*June 1990—* Entered into an agreement with Misui & Co. to provide for the private placement to Mitsui of \$150 million of Unisys convertible preferred stock in two series and a \$50 million five-year subordinated loan.

*August 1990—* Renewed a purchase agreement with Sun Microsystems in which Unisys purchases for internal development and resells Sun's SPARC-based workstations and servers.

*November 1990—* Announced an agreement with AT&T USL, in which the two companies will jointly market ALLY, a 4GL tool from Unisys that will be fully integrated with TUXEDO, AT&T's transaction processing system for its UNIX System V.

## **Market Position**

The communications processor market includes very few players. IBM dominates the scene, followed by NCR Comten and Amdahl. When IBM

introduced its 3745 processor in 1988, competition intensified among the Big Three. NCR Comten recently added the 5645 to its family of 5600 SNA communications processors. NCR Comten emphasizes that its 5660 products address the need for

coexistence of SNA and multivendor networks. Unisys has also geared its communications processors toward multivendor networks. This approach broadens the appeal of the machines and can attract more users. Amdahl can capitalize on its plug compatibility with IBM products.

Although Unisys does not rank among the leaders, the company has built steadily upon the capabilities of the DCP series, investing in its development, refining its features, and expanding its communications options. The innovative design of the DCP/5, a cost-effective entry into the communications processor arena, should appeal to many users who will respond to the concept of acquiring a fully functioning communications processor that can be installed as easily as a PC.

## Characteristics

### Processor Features

Unisys has equipped the DCP family with the following features.

**Power-on-Pluggable Line Module.** This feature exploits the capability of the I/O modules and backplane to suppress power transients and bus interface interruptions that occur with power-on removal or insertion of line modules.

**Redundant Power Supply.** Two power supplies are incorporated into the I/O modules. After a failure in power supply is detected by the power control and maintenance control feature, restoral takes place without system interruption.

**Triple Input/Output Processor (DCP/50 and DCP/55 only).** The provision of three input/output processors within a single input/output module increases the potential throughput of the input/output module by a factor of 3. This high-performance input/output module serves configurations that require high-demand I/O processing, such as host interfaces, LAN line modules, high-speed line modules, and multiline line modules. The input/output module has three I/O processors and one SPE/IO in a segmented back panel and 19-inch card rack

with dual power supplies. Users can mount as many as 14 line modules in the remaining card slots.

**Maintenance Control Feature (MCF).** The new design of the MCF has increased the size of the read-only memory (ROM), incorporated random access memory (RAM), and incorporated a personal computer interface (PCI) with a 19.2K bps rate for remote control capabilities. The remote control interface has a dual-port capability. MCF collects the faults and abnormal condition information from the power control module.

**Power Control Feature.** Located in each cabinet, this feature provides a front-end access to assemblies within the module. Fault latch indicators indicate the status of the system power supplies and fans.

**DCP Line Modules.** Line modules interface with communications devices, peripherals, and host computers. Communications line modules link DCPs to modems, terminals, and other networks. Peripheral line modules support connections to integrated peripheral devices. Host interface line modules provide direct attachment to host computer channels.

**The High-Speed ILM20 Line Module (DCP/25/30/35/50/55 systems).** The ILM20 provides one to four HDLC line interfaces with a four-line aggregate data rate up to T1/C1 speeds of 1.544M/2.048M bps. It supports four V.35, EIA-530, or X.21 interfaces, operating at a 2.048M bps aggregate data rate, or an RS-232-C interface operating at speeds up to 19.2K bps on each line. An on-board coprocessor supports the X.25 LAPB protocol.

### Line Module Configurations

Type	Method
Block MUX	Line module to attach to host block MUX channel
Word Channel	Line module to attach to host word channel
High Speed	Intelligent line modules supporting up to a 4-line aggregate data rate of 2.048M bps; V.35, EIA 530, X.21 interfaces supported
Multiline (8 & 4)	Synchronous and asynchronous line modules for data rates up to 9.6K bps; RS-232-C and D, V.24/V.28 interfaces supported
High Speed	Synchronous line modules for data rates up to 64K bps; AT&T 303 and V.35 interfaces supported
Medium Speed	Synchronous line modules for data rates up to 19.2K bps; RS-232-C and D, RS-449, and X.21 interfaces supported

Type	Method
Direct Connect	Line modules to support up to 16 multidropped, direct coax-connected, single stations at data rates up to 250K bps
Twisted Pair	Line modules to support Unisys telephone twisted-pair-connected terminals at data rates up to 64K bps
IEEE 802.3 LAN	Line modules to support connections to IEEE 802.3 (Ethernet) LANs at data rates up to 10M bps
Auto Dial	Line modules to interface with automatic calling units

## Models

### DCP/5

The compatibility of the DCP/5 with the communications processor architecture of the DCP family is implemented through its system board, line modules, DCP/OS operating system, and Telcon software. The DCP/5 is currently housed in the Unisys PW2 500 or PW2 800 Series personal computer.

The system board is a microprogrammable device that performs network processing tasks, including input/output. A hardware microprocessor (the Unisys COM chip) implements the functions of the communications processor, input/output processor, and storage controller. Two megabytes of error-correcting local storage are included on the system board. A single, medium-speed, loadable line module (MSLLM) is also included on the system board, providing full-duplex RS-232-C or X.21 attachment to a synchronous or asynchronous line at speeds up to 19.2K bps. Four types of DCP/5 line modules use four processor ports. Since the DCP/5 resides in a personal computer, DCP/5 line modules are not interchangeable with line modules used by other DCP systems.

### DCP/25/30/35/50/55 Basic Systems

Users can configure these systems in various ways, but a Basic System (defined as an entry-level system plus a local storage selection) is required to provide DCP/Telcon operability. Users can augment the entry-level systems with additional components to attain the required functionality.

In a front-end processor configuration, a word channel or block mux (FIPS) line module is required. Unisys recommends a network console, which can be any supported protocol/terminal, to operate a DCP/Telcon network. The console can reside anywhere in the network and can operate in session with Network Management Services (NMS). The console can control network operation and gather performance statistics.

An integrated 655K-byte flexible and 20M-byte (optional 80M-byte) hard disk are part of every system. Users can add additional mass storage with more integrated units.

## Configuration

**DCP/5.** The DCP/5 is housed in the Unisys PW2 500 or PW2 800 Series personal computer.

**DCP/25.** A maximum DCP/25 system includes a DCP/25 processor, 8M bytes of memory, a cabinet, two standard I/O modules, up to 31 line module slots, and up to 184 communications lines. The DCP/25 cabinet includes a power control module and active line indicators for three I/O modules. The third I/O module position is used for conversion to a DCP/30/35/50/55 system.

**DCP/30.** A maximum DCP/30 system includes a DCP/30 processor, 8M bytes of memory, two cabinets, six standard I/O modules, up to 93 line module slots, and up to 680 communications lines. The DCP/30 basic and expansion cabinet each include a power control module and active line indicators for three input/output modules. The DCP/30 processor/storage boards mount in reserved line module slots.

**DCP/35.** A maximum DCP/35 system includes two DCP/30 processor boards, 8M bytes of memory, two cabinets, six standard I/O modules, up to 92 line module slots, and up to 672 communications lines. The DCP/35 processor/storage boards mount in reserved line module slots.

**DCP/50.** A maximum DCP/50 system includes a DCP/50 processor, six cabinets (five expansions), 8M bytes of memory, 16 I/O modules, up to 247 line module slots, and up to 1,912 communications lines. The first cabinet provides the CP/Storage Module and two high-performance I/O modules. The CP/Storage Module houses the processor, two Storage Port Expansions (SPE/CPs), one 4M-byte storage bank, and space for an additional 4M-byte bank. The second cabinet and each expansion cabinet contains a standard I/O module in the top cabinet position and mounting capacity for two more I/O modules. Each DCP/50 Enhanced System Cabinet includes one power control module and active line indicators for three I/O modules.

## Software

### DCP Operating System (DCP/OS)

A multiprogramming operating system, DCP/OS supports the DCP architecture and controls all DCP hardware operations. It allows multitasking programs to be executed in demand (interactive) or batch mode. DCP/OS creates the environment for the development and operation of communications hardware and related utility programs.

Features and functions provided by DCP/OP include a file manager, CPA (access to CPA structures), RUN, process control, a port processor, a line module, a dictionary, interprogram messaging, record handling, and instrumentation. DCP/OS also provides facilities

that support DCP operations, including software installation and booting, DCP memory management, and console and peripheral device management.

### **Telcon**

Telcon is the core communications software product for the DCPs, performing all communications processing on DCPs operating within a DCA network. Telcon enables multiple DCPs to be interconnected to form the backbone of a DCA network. DCPs within the network can perform communications processing independently of host processors, maintaining network communications paths and routing services, regardless of the operational status of individual hosts.

Users can define Telcon software to determine the characteristics and connections of all devices in the network that communicate through a particular DCP. Telcon executes as an application under DCP/OS, which manages all DCP internal processors, memory, and peripheral hardware. Telcon covers four categories: communications handlers and interface software, network management services, network software for establishing and maintaining communications between peer entities in a Telcon network, and support software for specialized capabilities.

Communications handlers and interface software include:

- Universal Data Link Control (UDLC) handler for intranetwork DCP-to-DCP trunk connections and connections between DCPs and remote DCA termination systems,
- Host Channel Handler (HCH) for word channel and byte channel connections between OS 1100 host processors and DCPs, and

- Communications Handlers supporting connection of a wide range of synchronous and asynchronous interactive and batch terminals to DCPs.

Network Management Services (NMS) software controls physical and logical facilities. NMS provides an administrative interface to a Telcon-based network for monitoring network activity and performance, collecting statistical data, performing online diagnostics, and controlling the operation of network facilities.

Network software for establishing and maintaining communications between peer entities in a Telcon network consists of a complex set of communications protocols, architecturally consistent with the seven-layer OSI model. Telcon includes protocol software that supports the information processing and data transport portions of a DCA network.

Support software handles specialized tasks, such as downloading software and configuration files to remote DCPs. Support software includes utilities that assist in configuring, generating, loading, and operating Telcon.

Telcon software also integrates software modules that support communications protocols required in other network environments. These additional software modules are called Telcon program products. Users install these program products as extensions to Telcon. The Telcon program products are LAN Platform, X.25 Packet Switched Communications Software (PSCS), TCP/IP Stack, and OSI Transport Services (OSITS).

### **Pricing**

Purchase prices for the DCP family are DCP/5—\$9,800; DCP/25—\$31,000; DCP/30—\$55,000; DCP/35—\$125,500; DCP/50—\$275,000; and DCP/55—\$396,000. ■