

# Friden

**DATA PROCESSING  
PRODUCTS  
IN ACTION**

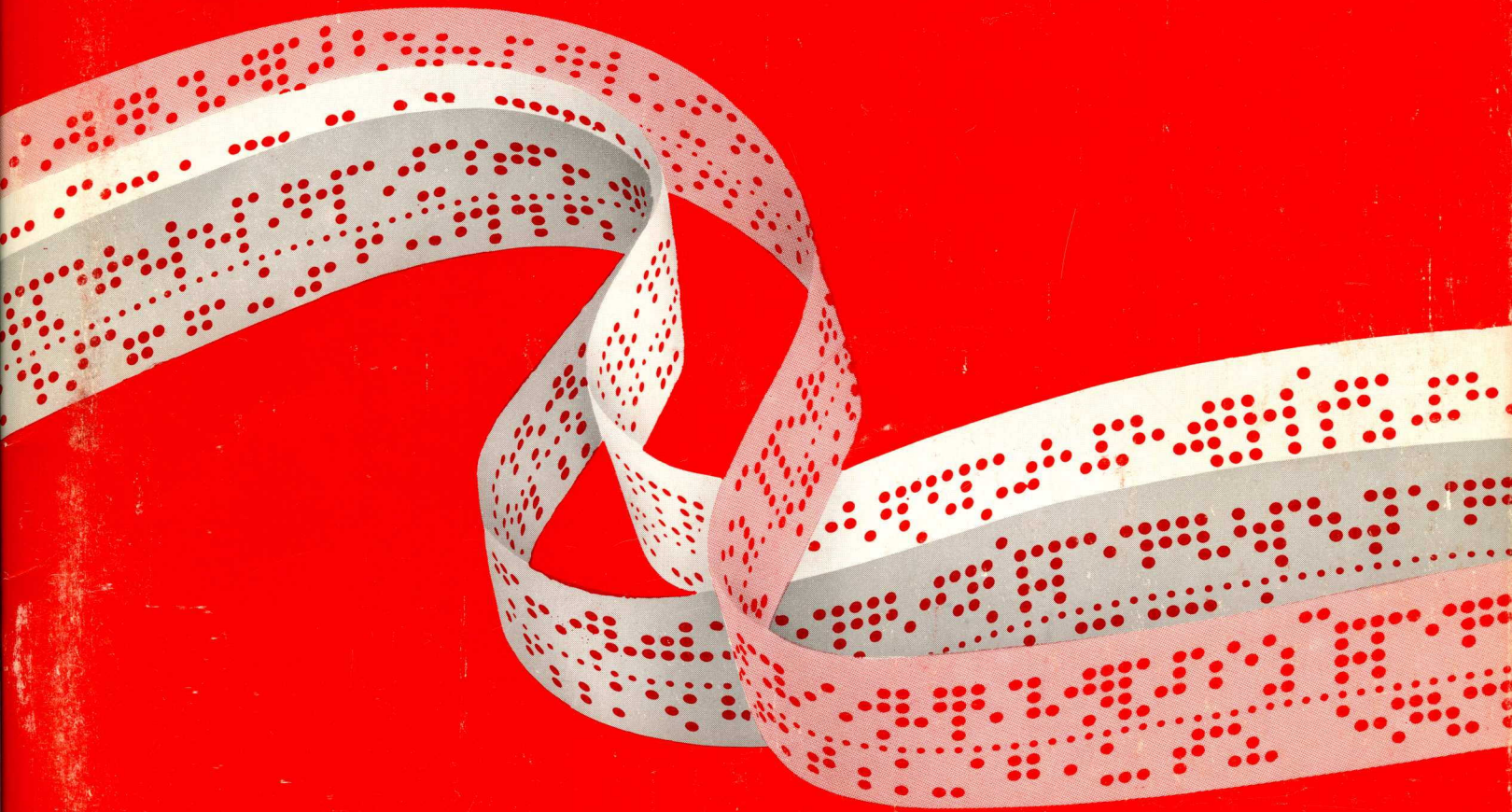

Published by



FRIDEN, INC.  
Educational Center  
31 Prince Street  
Rochester, New York, 14607

Friden\*

***DATA PROCESSING***  
***PRODUCTS***  
***IN ACTION***



Copyright 1964, by FRIDEN, INC.

\*A Trademark of FRIDEN, INC.

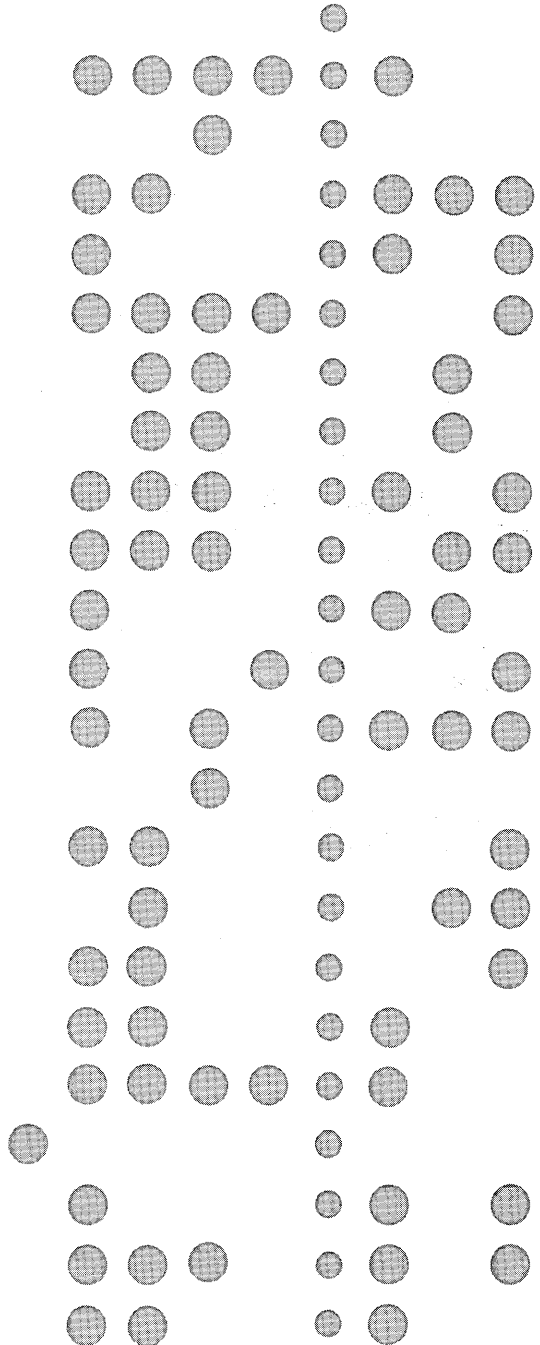
# Friden

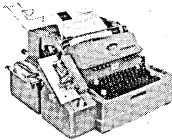

**DATA  
PROCESSING  
EQUIPMENT**

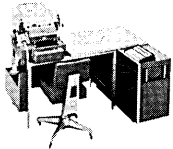
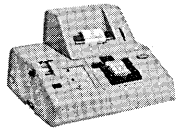
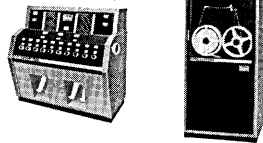
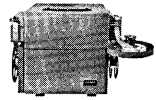
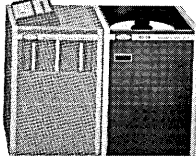
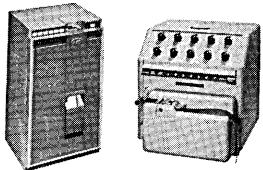
	<b>FLEXOWRITER*</b>
<b>COMPUTYPER*</b>	
	<b>COMPUTER</b>
<b>ADD-PUNCH*</b>	
	<b>COLLECTADATA*</b>
<b>TELEDATA*</b>	
	<b>MAGNETIC DISC FILE</b>
<b>AUXILIARY EQUIPMENT</b>	

\*A Trademark of FRIDEN, INC.

# Friden DATA PROCESSING EQUIPMENT IN ACTION

Data processing is the newest concept of machine control based on the ability of office machines to transfer data to the same or other machines automatically. FRIDEN data processing equipment that operates from, and produces punched paper tape, edge-punched cards, and tab cards (the "common language" between machines), is the point around which data processing systems are established.

Fundamentally, at the point of origin, data is stored in punched paper tape, edge-punched or tabulating cards, as a by-product of writing the source document. This punched tape, containing all or selected information, is subsequently used to control the FLEXO-WRITER automatic writing machine for other data processing machines to make data self-perpetuating.

The systems and methods described and illustrated in this publication depict but a few representative applications of FRIDEN data processing products "in action". This covers:

	Page	Computer Programs . . . . .	20
Letters . . . . .	2	Automated Bookkeeping . . . . .	22
Purchase Orders . . . . .	4	Insurance Policies . . . . .	24
Sales Orders . . . . .	6	Address Plates and Retail Credit . . .	26
Invoices . . . . .	8	Library Card Preparation . . . . .	28
Data Transmission . . . . .	10	Master Preparation For MICR Imprinting . . . . .	30
Production Scheduling . . . . .	12	Numerical Control . . . . .	32
Manufacturing Orders . . . . .	14	Automatic Documentation From Tabulating Cards . . . . .	34
Work In Process Accounting . . . . .	16	Magnetically Stored Information . . . .	36
Data Collection . . . . .	18		

# LETTERS

The acknowledgement of "new accounts" was always a problem for the County Trust Company, Westchester, New York. Particularly because it operated from 45 branches.

## FORMER METHOD

Prior to installing FRIDEN data processing equipment, new accounts were acknowledged by manually typing the letters at individual branch offices. The letters were one of the last operations in setting up a new account. This meant that they were prepared no sooner than the fourth day after the account was opened. In actual practice, they were prepared when it was convenient. This often meant a week or more after the account was opened by the customer.

Not only were these "thank you" letters manually typed, but the Addressograph plates used for subsequent identification of records, statements and other data also were manually created. Spelling errors, typing errors and misinterpretations were apparent in the Addressograph plates and had to be corrected.

Under the manual system, new account information was typed and proofread a total of three times. A new system was needed! The FLEXOWRITER automatic writing machine and SELECTADATA auxiliary reader with data selection, manufactured by FRIDEN, were installed. As a result, The County Trust Company was able to:

1. Produce "thank you" letters for new accounts within one day.
2. Provide, simultaneous to the letter writing, a by-product punched tape to operate an automatic Graphotype for Addressograph plate preparation.
3. Eliminate repetitive writings and proofreadings.
4. Create accurate, error-free records, swiftly and efficiently.
5. Process new account sheets for all 45 branches at a central location.

## NEW SYSTEM

After new account sheets are screened for accuracy, one copy is sent to the automatic writing machine operator. She prepares a new account ledger and manually types new account cards. Entered on the form are: customer name, address, type of account, branch number, account number and date that the account was opened.

Tape produced during this operation (manual preparation of new account cards) is subsequently placed in the SELECTADATA auxiliary reader with data selection to automatically print names, addresses and salutations on the new account letter.

The auxiliary reader with data selection is cable-connected to the automatic writing machine which contains a looped tape (the new account letter) in its reader.

Periodically during the day, the punched tape (which has been processed on the SELECTADATA auxiliary reader with data selection) is again processed on the reader to automatically type the customer's name and address on continuous envelopes in the automatic writing machine carriage.

Tapes, letters and new account cards are then sent to the bank's Addressograph department. Here the tape is processed in an automatic Graphotype machine to automatically produce plates. These plates are then used to prepare ledger cards for bookkeeping and also to print customer's name and account numbers on special account checks. The tapes and letters are then returned to the central file. Here the letters are inserted in envelopes and mailed, and the tapes are filed.

Now, the new system utilizes only one typing and one proofreading. The need for highly skilled Addressograph personnel is no longer necessary. And the end result is accomplished error-free, faster and in one central location.

Your local FRIDEN Representative has complete information regarding this application, and many others.

P. O. BOX 112  
THE COUNTY TRUST COMPANY  
WHITE PLAINS, N. Y.

P. O. BOX 112  
THE COUNTY TRUST COMPANY  
WHITE PLAINS, N. Y.

Mr. John Stuart  
35 Lakewood Street  
White Plains, New York

TELEPHONE  
AREA CODE 914  
946-4000

**THE COUNTY TRUST COMPANY**  
*Westchester's Bank*

JOHN A. KLEY  
PRESIDENT

WHITE PLAINS, N. Y.  
September 15, 1964

Mr. John Stuart  
53 Westchester  
White Plains

Dear Mr. Stuart:

Thank you for the account you opened with The County Trust Company. We are indeed pleased that you have favored our bank with this account.

Among the advantages of banking with us is the opportunity to make deposits or cash checks at any of our 45 offices throughout Westchester. All offices are open one evening a week in addition to regular business hours. You may also make deposits by mail if you so desire.

We enjoy banking at The County Trust Company and that you will enjoy the many other services we offer.

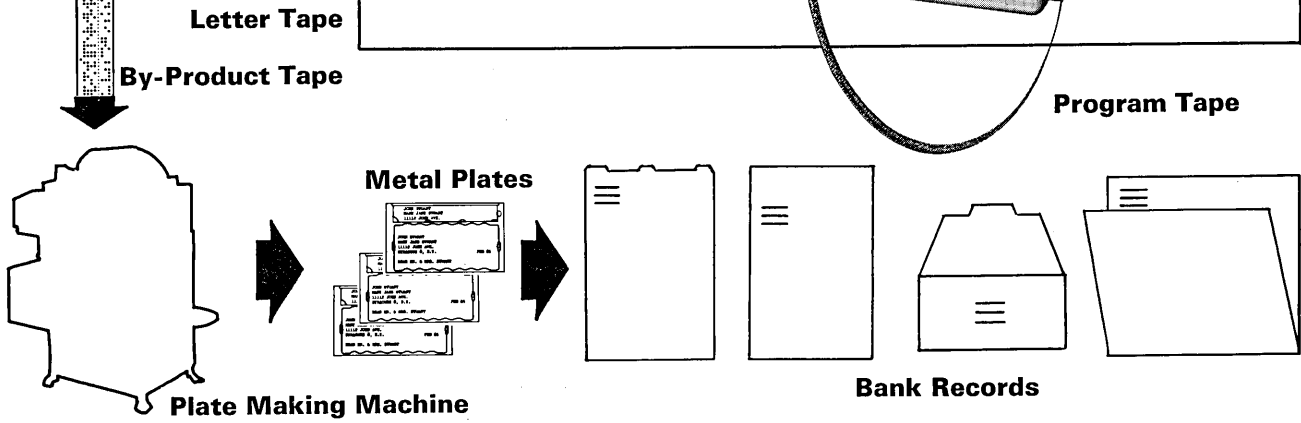
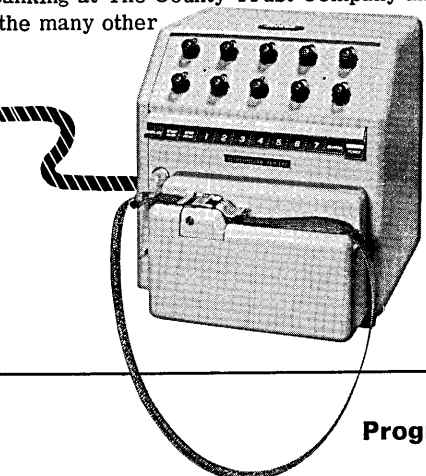
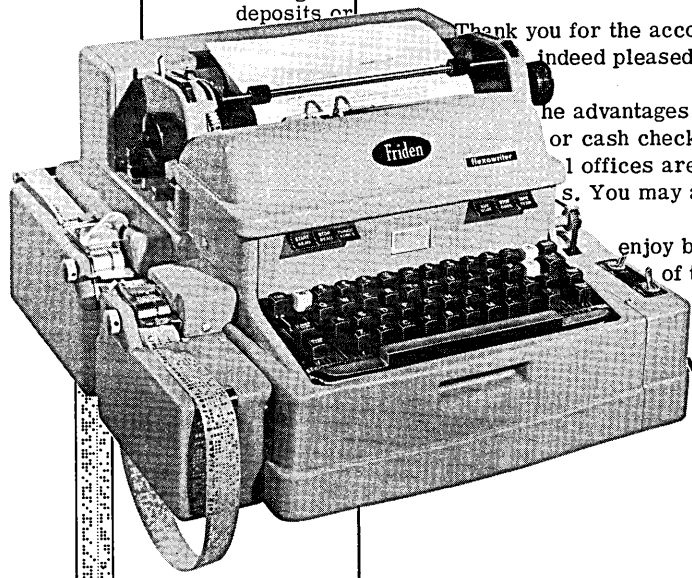

FRIDEN Equipment Used: FLEXOWRITER Automatic Writing Machine, SELECTADATA Auxiliary Reader with Data Selection.

# PURCHASE ORDERS

In early February, 1961, the U. S. launched its first successful solid propellant ICBM from Cape Kennedy. Much of the credit can be attributed to Thiokol Chemical Corporation's Wasatch Division, Brigham City, Utah.

An important aspect of the Wasatch Division's operation is the control and procurement of materials required for the development and production of solid propellant rocket motors. In 1960, a centralized materiel division was established.

## PAPER WORK PROBLEM

This department utilizes source documents such as: purchase orders, receiving reports, and other documents which affect the on hand, on order status of inventories controlled by the materiel division. The purchasing department is located in Brigham City while the shipping and receiving area is located at the main plant site 30 miles away. Having to distribute documents over a distance of 30 miles resulted in many problems.

Under the materiel division's former method of processing orders, all source documents were manually typed. This was too slow and error prone. To insure fast and accurate preparation of source documents and their swift distribution, the division developed an integrated data transmission (IDT) system, utilizing the FLEXOWRITER automatic writing machine and TELEDATA data transmission and reception system, manufactured by FRIDEN.

## THE SOLUTION

Under the new (IDT) system, these documents are prepared semi-automatically on the FLEXOWRITER automatic writing machine. Input to this unit is in the form of edge-punched cards which have been created for both vendors and items. These cards contain all constant data, and provide a source of error-free input to the automatic writing machine.

Edge cards are processed on the automatic writing machine to produce purchase orders, and in many cases requests for price quotations, at high speed. Simultaneously a punched tape record of all typing transactions is automatically created on the automatic writing machine. If the tape is created during the preparation of a request for price quotation, it is filed until the quotation is received from the vendor. Then it is used to automatically type the purchase order.

Punched tapes created at the time of purchase order writing are transmitted to the appropriate receiving location via TELEDATA data transmission and reception system. At the receiving location, a receiver punches a coded tape identical to the one being transmitted. This tape is processed on a FLEXOWRITER automatic writing machine to reproduce the purchase order. A punched tape is also produced during this operation. It is subsequently processed on the automatic writing machine to produce a receiving report and punched tape when goods are delivered. This tape is then transmitted via TELEDATA data transmission and reception system to the materiel division where the receiving report is reproduced in the same manner as described above.

## BENEFITS OF FRIDEN INSTALLATION

1. Fast preparation of source documents.
2. Increased accuracy through the reduction of "human error."
3. Improved communications through swift transmission of purchase order information and receiving reports.
4. Elimination of the keypunching and verification operations.
5. Improved management control through up-to-the minute records and reports.
6. Dollar savings through tighter inventory control, elimination of duplicate efforts, and paper savings.

Your local FRIDEN Representative has complete information regarding this application, and many others.



**Thiokol. CHEMICAL CORPORATION**  
 WAsATCH DIVISION • BRIGHAM CITY, UTAH

"C"

10000 PROGRESSIVE MFG. CO.  
 111 NEW ST.  
 PATERSON, N.J.

DATE	PAGE	OF	CONTRACT NUMBER
09-15-64	1		62-73110
ACCOUNT CHARGE			REQUISITION NUMBER
79343			TR 2-63411
PRIME CONTRACT NUMBER			

SHIP TO: **THIOKOL CHEMICAL CORPORATION**  
 Wasatch Division - Thiokol, Utah  
 MARK FOR: **Supply**

DEPARTMENT ORDERING	F.O.B.	SHIP VIA	BUYER
Supply	Destination	Your Way	M. E. Timothy
DO RATING	RESALE PERMIT	TAXABLE	TERMS
DX-D-9	# Q 319	X	2% 10 N-30

ITEM	QUANTITY	+ %	UNIT	DESCRIPTION OF SUPPLIES OR SERVICE TO BE FURNISHED	UNIT PRICE	AMOUNT
1.	200		Roll	TAPE- Sand blasting, 1" wide w/strong adhesive 16 Mil thick heavy fiber paper, rubber coated TCC Stock No. 30-734106	2.12	424.00
2.	252		Roll	TAPE- Sand blasting 2" W. w/strong adhesive 16 mill thick heavy fiber paper, rubber coated TCC Stock No. 30-734107	2.32	584.64

Clauses identified as numbers 3, 21 and 51 on the attached form TC No. 177 (Rev. 7-62) apply to this contract as though fully set forth herein.

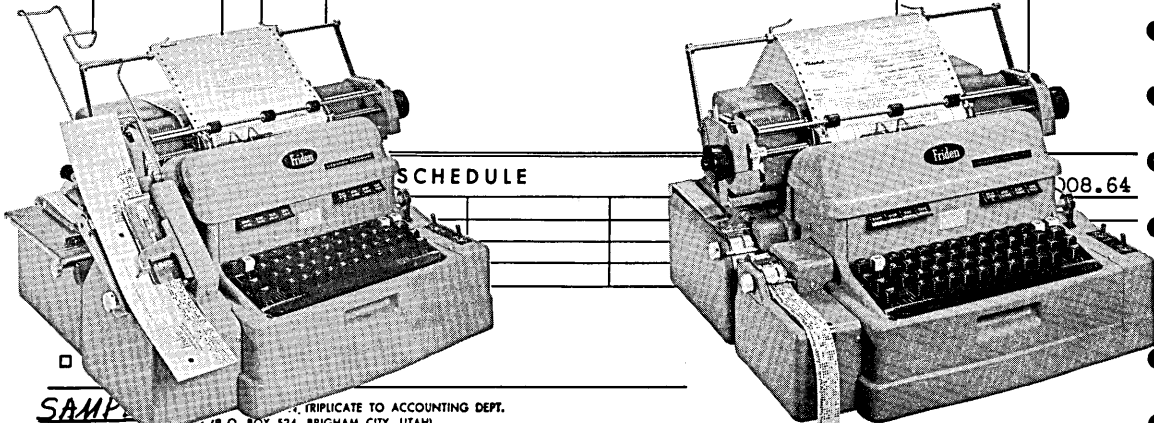

**PLEASE NOTE**  
 TRIPPLICATE TO ACCOUNTING DEPT.  
 (P.O. BOX 524, BRIGHAM CITY, UTAH)

EVERY CONTRACT NUMBER MUST APPEAR ON ALL INVOICES, B/L, LSES, BUNDLES, PACKING LISTS AND CORRESPONDENCE.

EXPEDITE AND RETURN ATTACHED ACKNOWLEDGEMENT COPY.

BY M. E. Timothy  
 TITLE Buyer  
Supply Purchasing

VENDOR

**By-Product Tape Transmitted**

**Duplicate Tape Received**

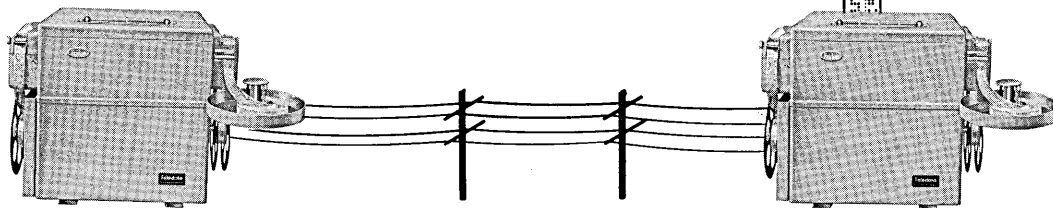

**Transmission**

**Reception**

FRIDEN Equipment Used: FLEXOWRITER Automatic Writing Machine, TELEDATA Data Transmission and Reception System.

# SALES ORDERS

All sales orders, invoices and statistical reports are now expedited quickly and economically at Mooney Brothers, fluid handling technologists, Little Falls, New Jersey. They did this by installing FRIDEN integrated data processing equipment.

## MOONEY'S PROBLEM

Prior to installation of the FRIDEN data processing equipment sales orders, invoices and statistical reports were manually computed and manually prepared on electric typewriters. These tasks were time consuming and required constant price checking, calculations and editing.

Since the primary responsibility of the company has always been complete customer satisfaction, fast processing and delivery of orders depended upon how quickly and efficiently paperwork was handled. To help Mooney do the job, the following FRIDEN equipment was selected: FLEXOWRITER automatic writing machine, COMPUTYPER automatic tape operated writing-computing machine, SELECTADATA auxiliary reader with data selection, and a Tape Punch.

## SALES ORDER PROCEDURE

The FLEXOWRITER automatic writing machine is the foundation of the order writing process at Mooney Brothers. Orders are received via mail and phone. After a credit check and edit, they are passed to the automatic writing machine operator. She then prepares a six-part sales-shipping order.

Edge-punched customer header cards and item cards, pertaining to each order, are pulled from separate tub files. The cards contain, in coded form, customer and item information. Costly errors can't occur once this information is coded in the edge-punched cards, no matter how many times the cards are used.

Next, the operator inserts the sales-shipping forms into the platen of the automatic writing machine. She then selects the proper programming for the sales-shipping order form and starts the SELECTADATA auxiliary reader with data selection.

The looped program tape in the reading mechanism of this unit automatically controls forms spacing and punching of select tapes for future invoicing.

When this is completed, the header card and item cards for the first order to be processed are inserted into the reading mechanism of the automatic writing machine. Customer header information and item data are automatically read and printed onto the document. And provisions are made for manual entry of variable information by the operator. This is accomplished by coding in the program tape which causes the automatic writing machine to stop at predetermined areas on the form, allowing manual entry of variable information.

During the order writing process, two selectively punched tapes are created. One select tape is punched by the automatic writing machine. It is filed with the order until final invoicing. Meanwhile, the other selectively punched tape is created by the Auxiliary Tape Punch unit. This punched tape is used in the COMPUTYPER automatic tape operated writing-computing machine, at an off time, to automatically produce a daily sales analysis report for management, reflecting order entries and numerical extensions.

## BENEFITS

1. Elimination of repetitive typing. Thus, increase in speed of handling order entries.
2. Improved accuracy because of storing error-free information on pre-punched cards.
3. Better paperwork flow.

# MOONEY BROTHERS CORP.

Clifford 6-6200  
N.Y.C. - LOngacre 4-7677  
TWX No. LTFS NJ 1495

195 PATERSON AVENUE

LITTLE FALLS, NEW JERSEY

CUSTOMER ORDER NO. 111	DATE OF ORDER 09-15-64	OUR ORDER NO.	ACCOUNT NO.	SALS'M.
---------------------------	---------------------------	---------------	-------------	---------

\*SOLD TO  
PROGRESSIVE MFG. CO.  
111 NEW ST.  
PATERSON, N. J.

SHIP TO  
\*SAME AS SOLD TO  
UNLESS INDICATED

DATE SHIPPED		SHIPPED VIA	TERMS 1% 10 DAYS NET 30 - LABOR NET	INVOICE DATE	INVOICE NO.
QUANTITY ORDERED	QUANTITY SHIPPED	B.O.	DESCRIPTION		
10			SPEC. GASKETS 12346		
10			SPEC. SPACER 54320		
10			SPEC. 1-1/2 HYCAR GASKETS 98764		

Customer and Item  
Edge-Punched Cards

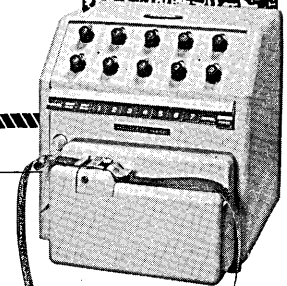
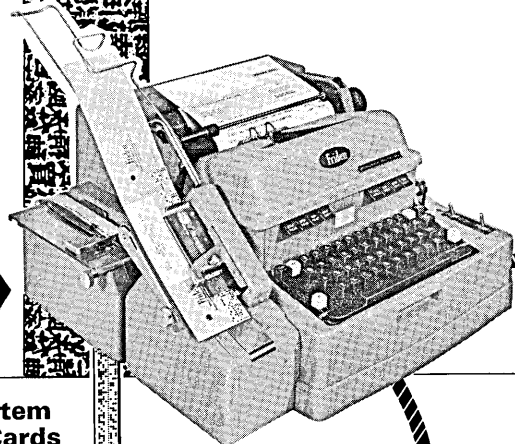

By-Product Tape

Program  
Tape

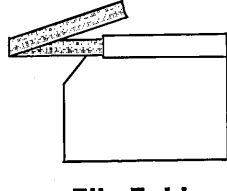

File Folder

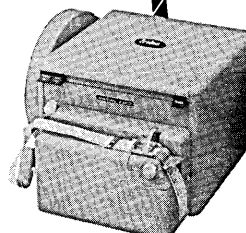

Statistical  
Tape

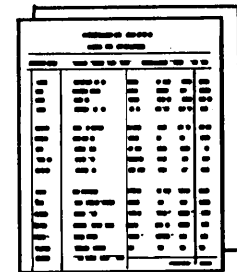

Management  
Reports

FRIDEN Equipment Used: FLEXOWRITER Automatic Writing Machine, SELECTADATA Auxiliary Reader with Data Selection, Auxiliary Tape Punch.

# INVOICES

At Mooney Brothers, after the shipping slip is returned, indicating the actual number of items shipped, the invoicing operator inserts a four-part invoice form into the platen of the automatic tape operated writing-computing machine.

This unit has the ability to read and type data coded in punched paper tape and edge-punched cards at high speed. By processing pre-punched tapes and cards (containing information which is normally repetitive) on the automatic tape operated writing-computing machine, documents are prepared with a minimum of manual entries.

The select tape created during original sales-shipping order writing is inserted into the reading mechanism on this unit. And the major portion of the invoice is prepared automatically. A row of program keys, located directly in front of the typing keyboard, allows the operator to easily initiate the mathematical computations that are required.

At the same time the invoice is prepared, a select tape is simultaneously punched in the punching mechanism of the automatic tape operated writing-computing machine. This select tape is later sent to the service bureau where statistical reports are prepared for management.

## OVER-THE-COUNTER SALES

Occasionally, business is transacted by over-the-counter sales. When this occurs, the order entry writing procedure is bypassed. Using the counter sales slip as source data, edge-punched cards are pulled from the file for the items purchased, and the header information is manually entered.

Header and item cards are used for repeat customer accounts. However, for new accounts only the item cards are initially used. These edge-punched cards are inserted into the reading mechanism of the automatic tape operated writing-computing machine to produce the invoice.

The theory of an integrated data processing system is to make all data self-perpetuating. This is accomplished in this system by simultaneously creating two punched paper tapes as the document is prepared. Each tape contains data from the original document that is pertinent for particular, subsequent data processing operations.

## MORE BENEFITS

Comments expressed by personnel and management at Mooney Brothers have verified the success of the new system. The system was designed to enhance greater overall paperwork efficiency. It has accomplished this aim. Benefits of the system are numerous, and the following is a list of the most eminent values attained:

1. Increased speed of preparing order entries and invoices through elimination of repetitive typing chores.
2. Increased accuracy through use of pre-punched edge cards.
3. Production increased greatly without any increase in personnel.
4. Better control over entire business operation.
5. Statistical reports for management prepared in one-third the time over previous method.

# MOONEY BROTHERS / CORP.

Clifford 6-6200  
 N.Y.C. - Longacre 4-7677  
 TWX No. LTFS NJ 1495

195 PATERSON AVENUE

LITTLE FALLS, NEW JERSEY

CUSTOMER ORDER NO. 111	DATE OF ORDER 09 15 64	OUR ORDER NO.	ACCOUNT NO.	SALS'M.
---------------------------	---------------------------	---------------	-------------	---------

\*SOLD TO  
 PROGRESSIVE MFG. CO.  
 111 NEW ST.  
 PATERSON, N. J.

SHIP TO  
 \*SAME AS SOLD TO UNLESS INDICATED

DATE SHIPPED	SHIPPED VIA	TERMS 1% 10 DAYS NET 30 - LABOR NET	INVOICE DATE 09/15/64	INVOICE NO. G-85111-1
--------------	-------------	-------------------------------------	--------------------------	--------------------------

ORDERED	QUANTITY SHIPPED	B.O.	UNIT PRICE	DESCRIPTION	AMOUNT
10	10		2.39	SPEC. GASKETS 12346	23.90
10	10		1.25	SPEC. SPACER 54320	12.50
10	10		4.35	SPEC. 1-1/2 HYCAR GASKETS 98764	43.50
				TOTAL	79.90

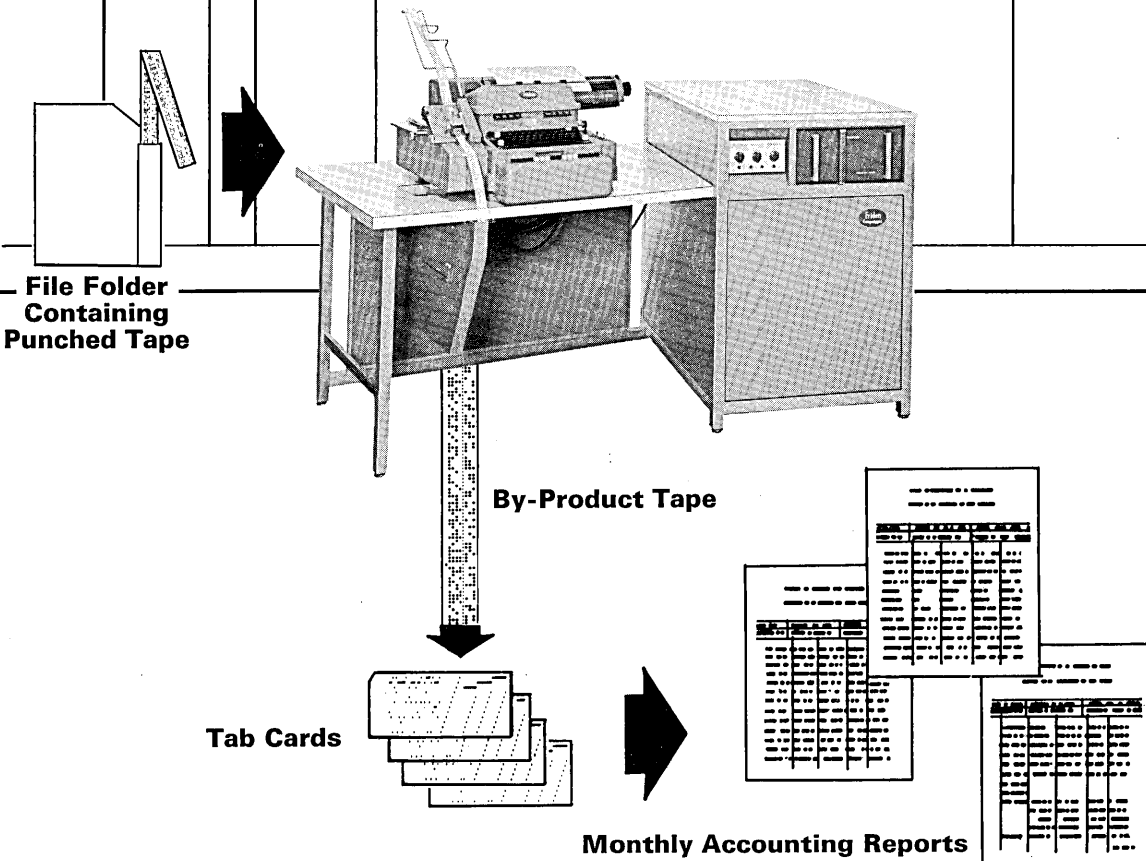

FRIDEN Equipment Used: COMPUTYPER Automatic Tape Operated Writing-Computing Machine.

# DATA TRANSMISSION

The Alpha Portland Cement Company is a large manufacturer and distributor located in Easton, Pennsylvania. Sales offices are located in Boston and New York City; plants are located in Catskill, New York, and Martins Creek, Pennsylvania.

For many years, orders received at the sales offices were mailed to the home office for processing. Sometimes, for rush orders, they were telephoned in. They were then typed and mailed (or telephoned) to the appropriate plant. Errors were common, and the system was quite slow. Increasing sales required a better solution.

Company management found the answer by installing TELEDATA data transmission and reception system.

## FROM SALES OFFICE

When an order from a customer is received by phone or mail, a pre-punched tape, corresponding to the customer, is drawn from the files and inserted in the FLEXOWRITER automatic writing machine. Using this tape, the automatic writing machine types the sales order-acknowledgement 86 percent automatically. As the typing takes place, a by-product tape is punched which flawlessly duplicates the sales order. The tape is then inserted in the TELEDATA data transmission and reception system which transmits it to the home office.

## TO HOME OFFICE

This sales order, transmitted from the sales office, is punched in tape on the receiver in the home office. The tape received is inserted in the automatic writing machine and types duplicate sales orders 100 percent automatically. As this typing occurs, a by-product tape is produced which will be used later to write the invoice. The order tape is then transmitted by TELEDATA data transmission and reception system to the plant. A home office switching station

permits routing of data transmission and reception system messages to any of the company's offices.

## TO PLANT

The order, received from the home office, is punched in tape by the plant's TELEDATA data transmission and reception system receiver. This tape types a work order 100 percent automatically. Tape is then filed until the order has been filled. At this time, the tape is used to write a bill of lading and a shipping memo (for the home office) 90 percent automatically. Weight and other variables are inserted at this time and transmitted to the home office.

## BACK TO HOME OFFICE

A by-product tape, punched when the order was first received, is removed from the file and inserted in the COMPUTYPER automatic tape operated writing-computing machine. Using the shipping memo from the plant as a source document, the invoice is prepared 85 percent automatically. During this operation, a by-product tape is produced by the automatic tape operated writing-computing machine. It is fed into an automatic tape-to-card converter that provides tabulating cards for input to tabulators for working up valuable statistical reports.

A word about the percentages quoted in the above paragraphs: Automatic typing is error-free typing. Information previously prepared manually, is now typed 90 percent automatically. Thus, the likelihood of error is correspondingly reduced!

## BENEFITS

Accuracy and speed of transmission are the major requirements in Alpha's servicing of orders. Delays and expensive mistakes have been eliminated by the TELEDATA data transmission and reception system.

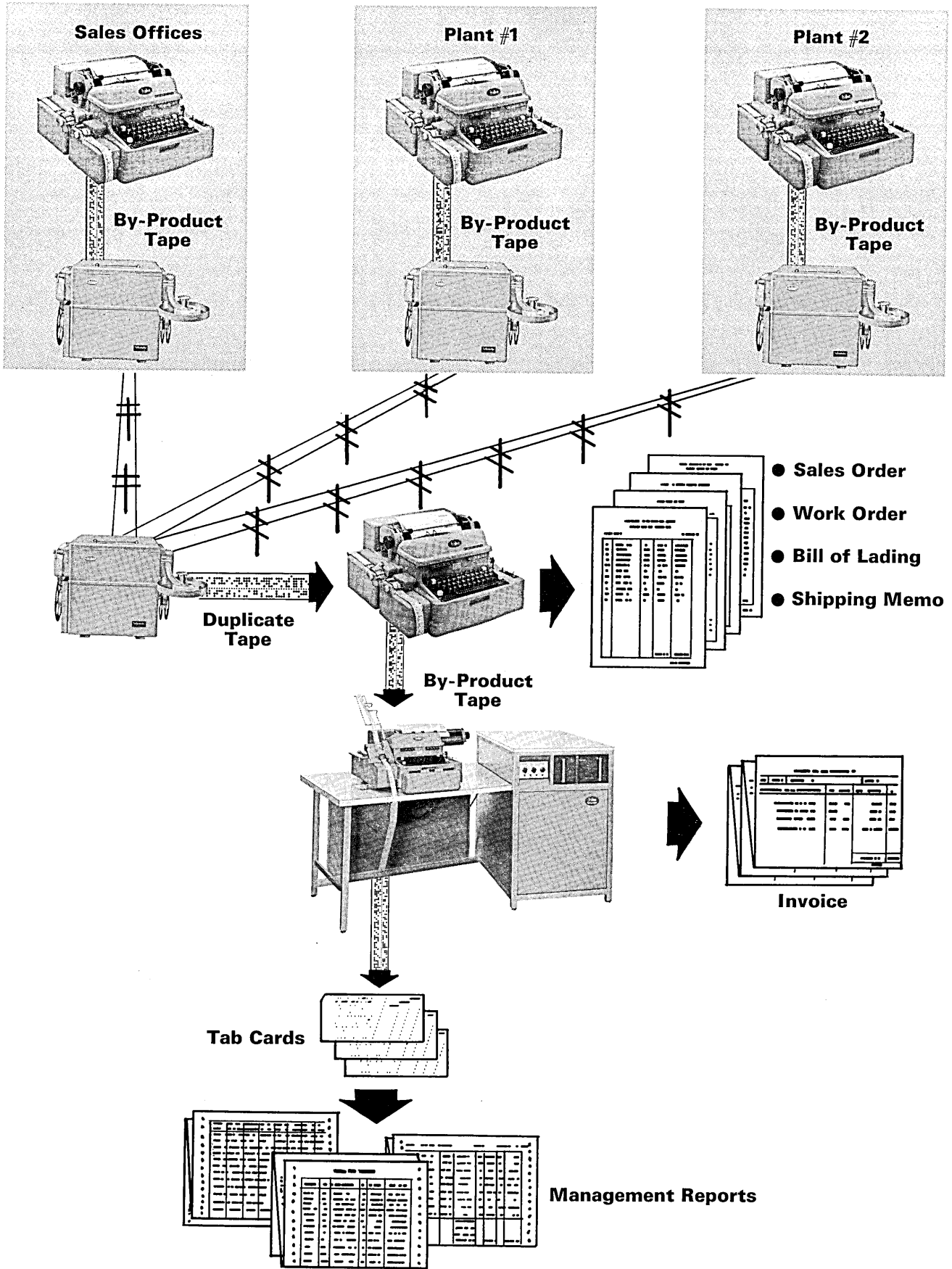

FRIDEN Equipment Used: FLEXOWRITER Automatic Writing Machine, TELEDATA Data Transmission and Reception System, COMPUTYPER Automatic Tape Operated Writing-Computing Machine.

# PRODUCTION SCHEDULING

Engineers from the Henry Vogt Machine Company, Louisville, Kentucky, work closely with their customers. As a result, they have attained the extraordinary ability to produce mechanical designs especially suited to the petroleum, chemical, power, and process industries.

Because of the business created as a result of this policy, a manufacturing, production order system was necessary to handle the increased volume.

A production order consists of written instructions to a factory foreman or other responsible personnel to produce goods specified according to the information indicated on the order. Also, production orders are issued to coordinate sales, materials, plant facilities and available personnel. Therefore, by its very nature, the production order must be a document that is completely accurate.

Often, production orders are manually typed on offset masters. These masters are then used to "run off" copies of the order for the various departments involved in the production operation. This is not always an easy task. Many times these orders involve page after page of complicated technical matter and numerical information.

## PRODUCTION ORDER SYSTEM

At Henry Vogt Machine Co., pre-printed forms are prepared for each customer order that is received. These forms contain information that is pertinent to a particular production item. Completed forms are routed to the operator of the automatic writing machine for preparation of a production order on an offset duplicating master.

Punched tapes have been created for various parts that are produced in the factory. These tapes contain coded information of a repetitive nature, plus codes to control positioning of the document as the production order is

prepared. The automatic writing machine operator selects the appropriate tape, places it in the reading mechanism of the machine and touches a single panel switch.

The automatic writing machine interprets each code in the punched tape errorlessly, at the rate of 100 words a minute. Special coding in the tape automatically stops the machine at pre-determined points so that variable information can be entered.

Production order information is typed directly onto offset duplicating master plates. A minimum amount of operator time and effort is required since the majority of information is contained in tape. Once this information is coded in tape, it need never be manually typed again.

## PROCESSING "STOCK" ORDERS

In each department within a plant, various parts for use in manufacturing are stored. At intervals, the supply of materials in these areas diminishes and additional parts must be manufactured. Standard "stock order" forms must be completed and routed to the floor. This document informs plant personnel that an additional number of pieces must be produced the next time this operation is run.

A file of pre-punched and pre-edited edge-punched cards for each part is maintained by the automatic writing machine operator. As a requisition is received from the floor, the appropriate edge card is pulled from the file.

Stock orders are prepared almost completely automatically on the FLEXOWRITER automatic writing machine. Data is typed at 100 words a minute from the edge cards.

Completed stock orders are forwarded to the appropriate manufacturing departments where the parts are produced and then returned to the "stock areas" for future use.



**Item Tapes**

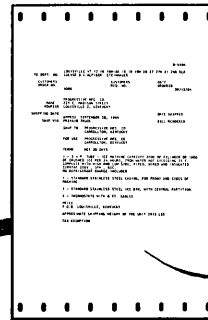
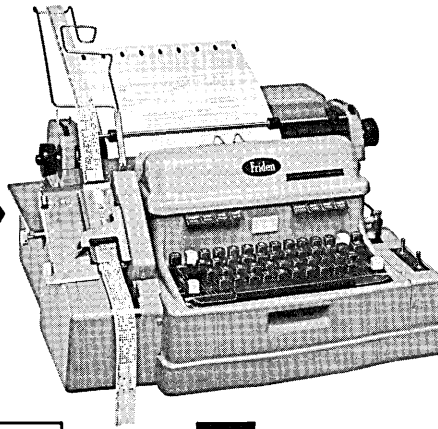
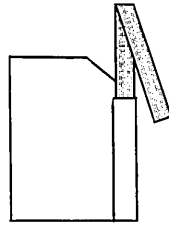

**Master Plate**

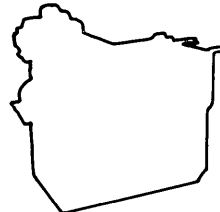

**Duplicator Machine**

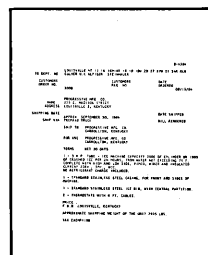

**Production Order**

D-4394

TO DEPT. NO. LOUISVILLE 4T 12 16 16H-AK 18 19 19W 20 27 27W 21 24R RLR  
 CULVER O.C. ALPIGER STEINHAUER

CUSTOMERS ORDER NO. 3000 CUSTOMERS REQ. NO. DATE ORDERED 09/15/64

NAME ADDRESS PROGRESSIVE MFG. CO.  
 225 E. MADISON STREET  
 LOUISVILLE 2, KENTUCKY

SHIPPING DATE APPROX. SEPTEMBER 30, 1964 DATE SHIPPED  
 SHIP VIA PREPAID TRUCK BILL RENDERED

SHIP TO PROGRESSIVE MFG. CO.  
 CARROLLTON, KENTUCKY

FOR USE PROGRESSIVE MFG. CO.  
 CARROLLTON, KENTUCKY

TERMS NET 30 DAYS

1 - 3 H.P. TUBE - ICE MACHINE CAPACITY 2000 OF CYLINDER OR 1900 OF CRUSHED ICE PER 24 HOURS, FROM WATER NOT EXCEEDING 75 F. COMPLETE WITH HIGH AND LOW SIDE, PIPED, WIRED AND INSULATED CURRENT 208V., 3PH., 60C. NO REFRIGERANT CHARGE INCLUDED.

1 - STANDARD STAINLESS STEEL CASING, FOR FRONT AND SIDES OF MACHINE.

1 - STANDARD STAINLESS STEEL ICE BIN, WITH CENTRAL PARTITION.

2 - THERMOSTATS WITH 6 FT. CABLES.

PRICE.....  
 F.O.B. LOUISVILLE, KENTUCKY

APPROXIMATE SHIPPING WEIGHT OF THE UNIT 2935 LBS.

TAX EXEMPTION

FRIDEN Equipment Used: FLEXOWRITER Automatic Writing Machine.

# MANUFACTURING ORDERS

Cleveland Cap Screw Company (CCSC) of Cleveland, Ohio, manufactures special headed and threaded bolts and screws.

Manufacturing of items whether for stock or customer orders requires the preparation of a mill order for production and inventory control purposes. This source document contains many numerical specifications which not only instruct milling personnel, but are important to management in the later reporting stage. Hence, clerical typing or transposition of data could, in the final stage, present an inaccurate picture of manufacturing/inventory requirements.

## PRESENT DATA PROCESSING SYSTEM

To meet the demands of accuracy required in all phases of the operation, CCSC installed the FLEXOWRITER automatic writing machine and its allied units. All work is in conjunction with a tab card system as illustrated on the facing page.

The automatic writing machine and Tab Card Punch Control unit (TCPC) are electrically connected to a card punch. This allows punched cards to be produced at the same time as the mill order is being written. The TCPC serves as a catalyst: interpreting both commands from the keyboard of the automatic writing machine and its input media (card A) and instantaneously converting this data into composite tab cards (card B). These composite cards contain most of the information on the mill order.

A machine scheduler works from a stock status report, entering handwritten data directly on tab card A for both stock and customer orders. This card is then encoded with such information as: raw material type, estimated weight, size code, shape, machine number, production start date, and cost center. The automatic writing machine operator then inserts the tab cards in the reader of the unit to automatically produce most of the mill order.

This five-part mill order is distributed to all departments concerned. The fifth copy remains in the bolt-making department and is used as a raw material requisition.

Simultaneously, tab card B is produced and is later used as input for automatically creating some of the entries on the daily production report. Or, if production is not completed by the end of the day, they are used to write the incompleting mill order reports for management.

Again, while utilizing the capabilities of the FLEXOWRITER automatic writing machine as a self-reporting station, two more composite tab cards are produced (C and D). These cards are processed on an accounting machine to produce additional reports for management.

Where production of a given job extends over more than one day, the cards in the mill order hold file will not be removed until production is completed. Each of these cards will have the number of pieces changed as well as the steel weight to reflect the production that has been completed.

## SYSTEMS BENEFITS

The ability of the automatic writing machine to errorlessly create its own source data has proven invaluable to the management of this company. Along with an average of 65 mill orders written daily, over 100 orders are reported per day on the daily production report. Thus, there is no time lag on day-by-day management decisions.

Through data collected from this and subsequent reports, management is able to accurately forecast future requirements. Machine and operator ability are accurately gauged. Raw material inventory is substantially reduced. By gearing manufacturing to this accurate forecasting, a satisfied list of customers is maintained.

Your local FRIDEN Representative has complete information regarding this application, and many others.

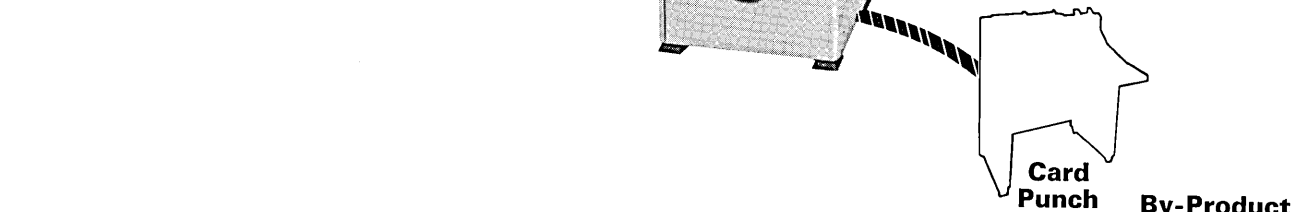
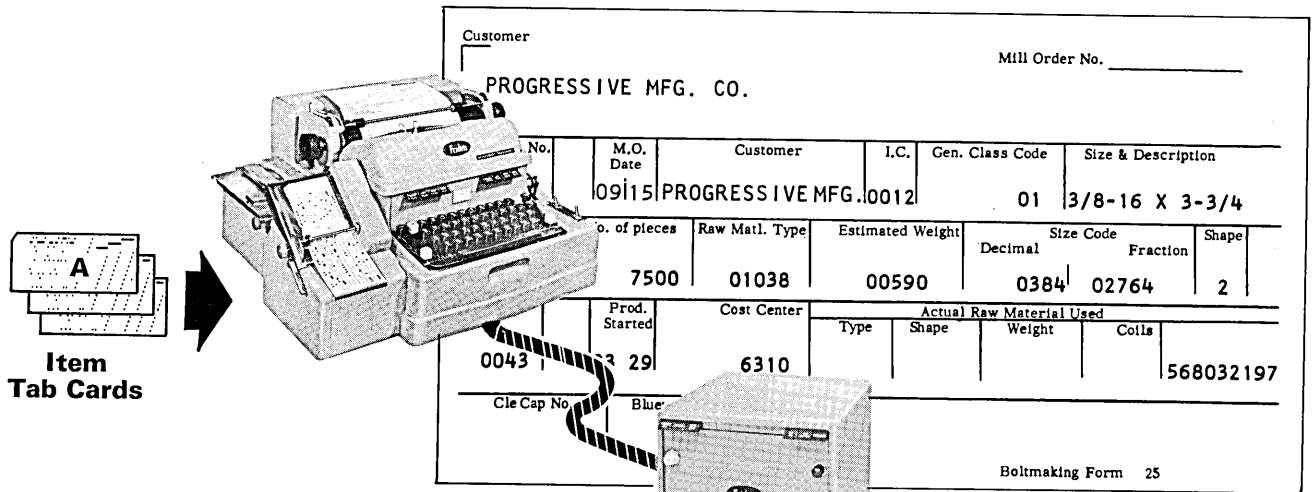

DEPT. BOLTMAKING DEPT. DAILY PRODUCTION REPORT DATE 09/15/64

M.O.	Cust. Name	Item Code	Gen. Cl.	Size Description	Comp Date	Pieces	Oper Code	Std. Hrs.	Oper. Hrs.	Setup Hrs.	Down Hrs.	Da Ret	Oper #	Mach #	Cost Ctr.	Raw Matl. Type	Heat #	# Colls	Weight	Operation Explanation
30620	STOCK	0022	01	3/8-24 X 3/4	0421	16000	0010	0010	008	001	001	01	123	000	051	6310	01038	CG120	001	00633
30622	FORD H	0012	01	1/4-20 X 1-7/8	0330	100500	0130	0010	009	001	000	00	080	000	049	6400	01018	CB301	003	00645
30621	FRIDEN	0012	01	3/8-16 X 3-3/4	0402	7500	0350	0010	010	000	000	00	091	097	056	6590	01038	CA408	000	00610
30623	GENERA	0012	01	3/8-16 X 4	0416	2500	0490	0010	007	025	005	03	090	000	047	6400	01020	CH306	002	00791

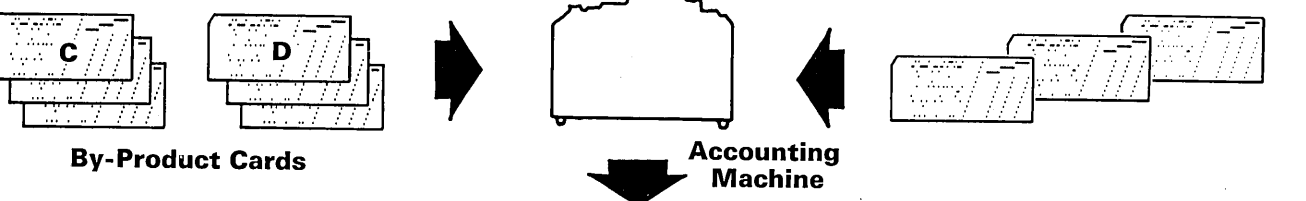
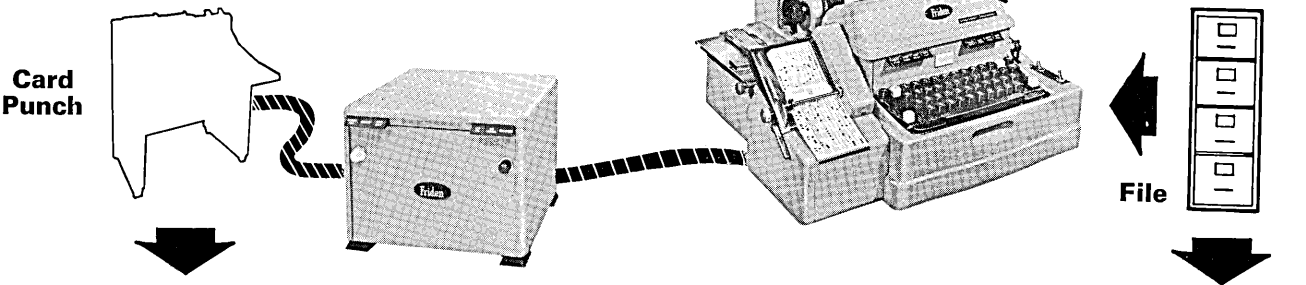

Management Reports

FRIDEN Equipment Used: FLEXOWRITER Automatic Writing Machine, Tab Card Punch Control Unit.

# WORK IN PROCESS ACCOUNTING

CELCO, Constantine Engineering Laboratories Company, of New Jersey, fabricates to order such electronic components as radar deflection yokes, transformers, magnetic amplifiers, centrifugally cast rotors and 400 cycle motors. Their engineers and technicians are immediately available for special applications and maintain their own air fleet for this purpose.

## PRIOR METHOD

Reports on cost analysis were done manually with the use of calculators, adding machines and typewriters. Often it was two or three weeks before it could be determined how much it cost to manufacture an item. What they needed was a daily report so immediate adjustments could be made.

## FRIDEN EQUIPMENT INSTALLED

CELCO obtained a COMPUTYPER automatic tape operated writing-computing machine and a FRIDEN Auxiliary Tape Punch, which is cable connected to this unit. This gives them an additional punching station for by-product information.

They also purchased a COLLECTADATA data collection system, consisting of three units for the collection of information . . . two Transmitters and one Receiver. The two Transmitters are strategically placed where data originates.

Information is transmitted over a closed circuit to the Receiver where it is collected in the form of punched paper tape. This tape

is then automatically processed by the automatic tape operated writing-computing machine, a "common-language" machine. The need for conversion to tab cards and the use of expensive computers is thus avoided.

## DATA COLLECTION SYSTEM

Information stored on two types of cards is transmitted over the COLLECTADATA data collection system -- a job card and a man card. The job card is created as a by-product of typing the production order. And the man card is that card which is permanently assigned to the employee.

Information stored in the two cards -- job manufacturing number, part number, employee number and rate; and the information in the dials -- quantity, time, operation number and reciprocal factor -- is transmitted to the Receiver where it is coded and stored in the form of punched paper tape. The tape is then processed in the COMPUTYPER automatic tape operated writing-computing machine, which has been previously programmed, to obtain the production report and job cost analysis.

## BENEFITS

The most important aspect of this whole system is the ability to obtain a daily cost analysis which is the heart of this business. CELCO is getting answers on estimated cost versus actual cost immediately and inexpensively.

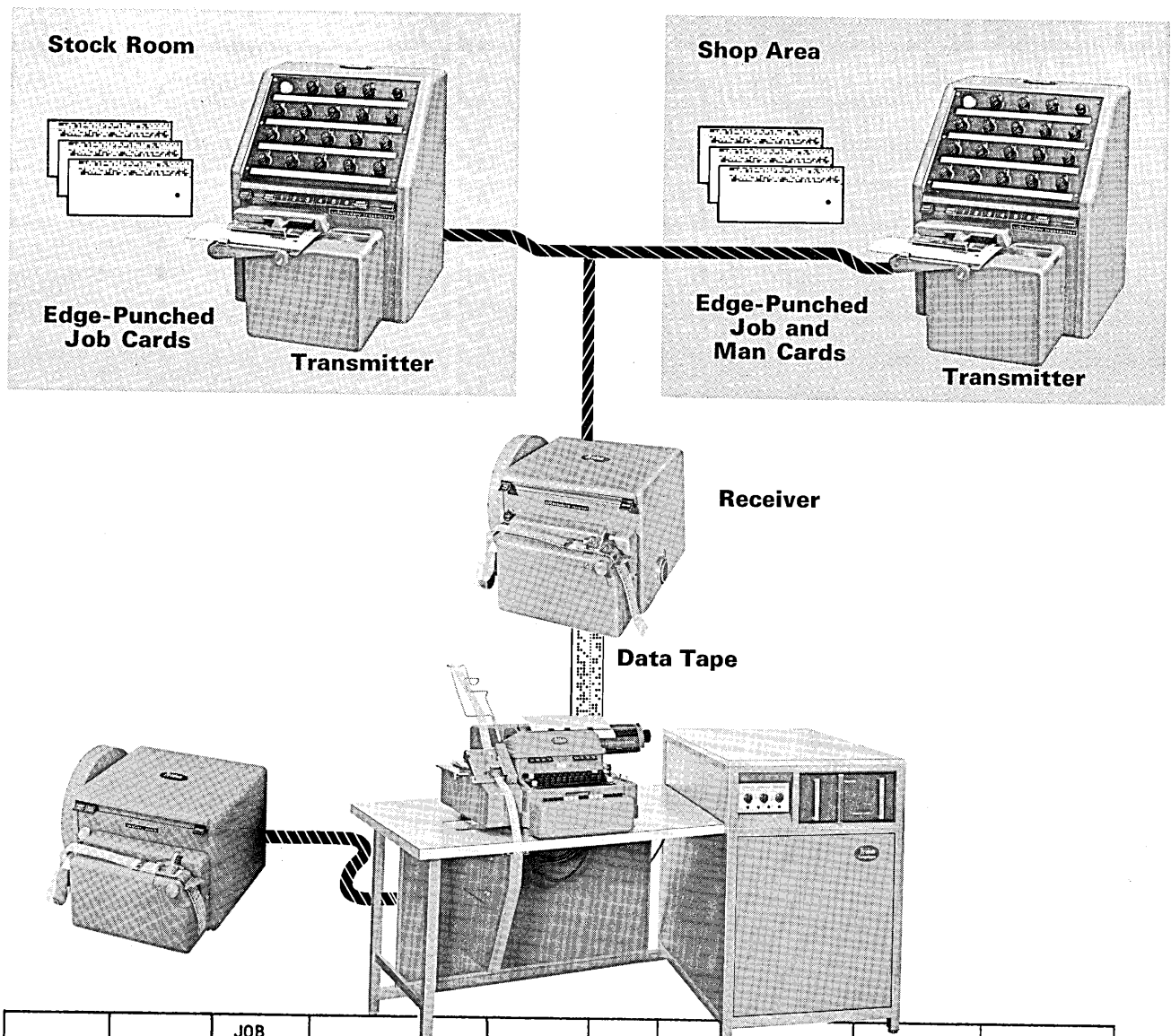

QUANTITY PRODUCED	ELAPSED TIME	JOB MFG. NO.	PART NO.	EMPLOYEE NUMBER	RATE	COST	OPERATION NUMBER	RECIPROCAL	UNIT COST		
									\$	¢	MILLS
0001	0.1	-4500A	28 D-1489	61	1.20	.12	271	99999.	12	00	
0003	0.4	-4449Y	3 08-243	24	1.70	.68	300	25000.	17	00	
0001	0.1	-5000A	1 AY521-P300	39	1.70	.17	350	99999.	17	00	
0001	0.4	-5000A	1 AY521-P300	39	1.70	.68	440	99999.	68	00	
0074	.5	-4271T	1680 1300150-1	14	1.40	.70	340	01351.		95	
0001	.4	-4500A	28 D-1489	61	1.20	.48	270	99999.	48	00	
0075	.3	-4271T	1680 1300150-1	14	1.40	.42	310	01333.		56	
0002											
0074											
0120											
0074											
0075											
0001											
0010											
0075											
0075	.5	-4271T	1680 1300150-1	14	1.40	.70	340	01351.		95	
0075	.3	-4271T	1680 1300150-1	14	1.40	.42	310	01333.		56	
0001	1.0	-4271T	1680 1300150-1	24	1.70	1.70	290	01351.		2	30
0075	0.2	-4271T	1680 1300150-1	47	1.50	.30	350	01351.		41	
0001	0.7	-4271T	1680 1300150-1	3	1.85	1.30	320	01333.		1	73
0075	.1	-4271T	1680 1300150-1	28	1.60	.16	330	01333.		21	
0075	.5	-4271T	1680 1300150-1	14	1.40	.70	340	01333.		93	
0075	.2	-4271T	1680 1300150-1	47	1.50	.30	350	01333.		40	
	3.5T						5.58T				

FRIDEN Equipment Used: COLLECTADATA 2 Data Collection System, COMPUTYPER Automatic Tape Operated Writing-Computing Machine, Auxiliary Tape Punch.

# DATA COLLECTION

The Taylor Instrument Companies, Rochester, New York, has installed a COLLECTADATA 30 data collection system, manufactured by FRIDEN. Three basic components make up the system: Transmitters, Receivers, and a Control Console. This system allows data to be transmitted from the source of activity to a central collection center. Here it is developed into meaningful, timely and accurate reports.

When new or customized products are to be built, specifications, drawings and parts lists are released to the industrial engineering department. This department prepares operation analysis sheets.

The analysis sheets are completed on a FLEXOWRITER automatic writing machine. Connected to the automatic writing machine is a FRIDEN Tab Card Punch Control (TCPC), which provides a direct link to the keypunch machine. As the sheets are typed, tab cards are being punched. They are used for input purposes when used with the data collection system. All tab cards are sent to data processing. Here the information contained in these cards is processed for industrial and managerial use.

## COLLECTION POINT

At this point, industrial engineering collects COLLECTADATA data collection system input cards, the planned operation list, blue prints, and perhaps a parts list. These materials, for each part to be manufactured, are combined into a plastic envelope and routed to production control. Here it is filed until ready to be released.

By reviewing the operation analysis sheet writing system, it can be seen that one typing operation has produced both a document and data in the form of punched tape and cards. This data is then perpetuated through a number of automatic processing methods to produce all necessary forms and cards needed to initiate a manufacturing

operation. In addition, the data is accurate, complete, and timely. It only requires a fraction of the time formerly needed by manual methods.

As the part moves from raw material issue through manufacturing operations, packing and stock, transmissions are made as various operations or portions thereof are completed. Included in this is variable information, such as work completed and rate charged. These entries are made by using the manual dials on the face of the Transmitter. All transmissions require a tab card and an employee badge.

## AN IMPORTANT ADVANTAGE

A major advantage of the COLLECTADATA data collection system is that it is also used for attendance recording. Four times a day, the Transmitters change to an attendance recording mode. At this time, the program selection and variable dials are inoperable; only the badge reader on the Transmitters is used. Employees then use their badges to register in and out of work.

All transmissions are received at the data processing department in the form of 8-channel punched tape. In addition, the Control Console automatically adds a 4-digit time code at the end of each transmission. This tape is then processed in a tape-to-card converter to produce tab cards.

These cards are then sorted into their respective groups and are further processed to provide accurate, timely reports for management. Reports can be classified into the following categories: payroll, production and inventory, cost accounting and sales analysis, purchasing and sales statistics.

Results are a daily costing of parts, weekly payroll, daily posting record to department supervisors, inventory control and cost comparison records. Also, notification of shortages will be given immediately.

Your local FRIDEN Representative has complete information regarding this application, and many others.

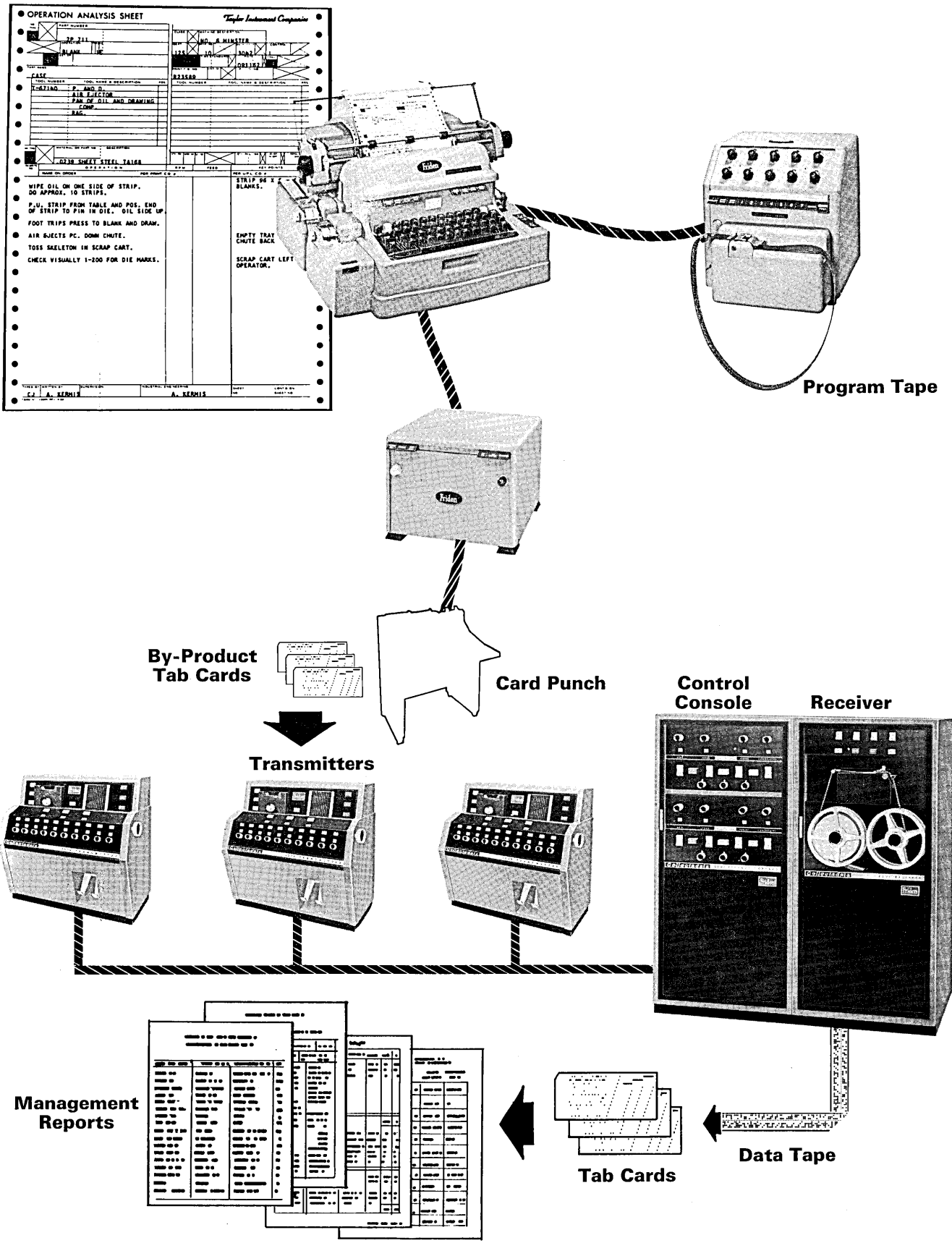

FRIDEN Equipment Used: FLEXOWRITER Automatic Writing Machine, SELECTADATA Auxiliary Reader with Data Selection, Tab Card Punch Control Unit, COLLECTA-DATA 30 Data Collection System.

# COMPUTER PROGRAMS

Shamrock-Neatway Products, Inc., Minneapolis, Minnesota, processes over 100 invoices daily, and valuable management reports, on the FRIDEN 6010 Electronic Computer. A large manufacturer of quality plastic products, this company concentrates mainly on plastic housewares and food and dairy containers. Over 900 items are manufactured and sold on a nation-wide basis.

The invoicing/reporting system at this company is a typical FRIDEN 6010 Computer application. This desk-size, solid-state computer is especially designed for business applications which require high-speed computations, plus descriptive alphabetic information. It accepts input in the form of punched tape, edge-punched cards, and from its typewriter-like keyboard. And it produces output in the form of a printed document, and punched tape or cards.

## PREVIOUS METHOD

Previously, a punched card accounting system was used for preparing sales orders, invoices, reports, and for inventory control. This system required the manual keypunching and verifying of input cards, a process which many times caused a substantial delay in the processing of orders. Usually, inventory records were not current, and reports were not detailed enough for management. These problems were eliminated by the new system.

## PRESENT SYSTEM

In this system, sales orders are prepared, inventory records are updated, and input media (punched tape) for the 6010 Computer is automatically created -- on the FLEXO-WRITER automatic writing machine. Customer and item cards provide a source of error-free input to this unit.

When an order is shipped, the punched tape, created as a by-product of sales order writing, is used as input to the 6010 Com-

puter for preparing invoices. All computations on the invoice are automatic, and performed at electronic speeds!

The 6010 calculates and types the gross sales amount per line, the discount amount, net sales and commission amount. Four totals are printed on the invoice: gross sales, total discount, net sales and total commission. During this operation, a punched tape is created on the 6010 Computer as an automatic by-product of preparing an invoice.

This tape is processed on the 6010 to automatically produce a daily invoice data report that contains pertinent data from each invoice. Totals which are accumulated during the preparation of this report are retained by the computer. They are subsequently typed on a daily sales distribution report by product line.

A second punched tape, containing monthly sales-to-date figures, is then processed on the 6010 Computer to produce an updated month-to-date sales report. During this operation, a punched tape is automatically created on the 6010. This tape is sent, weekly, to a service bureau for additional sales and cost reports.

## BENEFITS

Use of the FRIDEN 6010 Electronic Computer has benefited this company in many ways. More orders are processed than under the previous system, more efficiently and on time. Current inventory records and detailed sales, cost, and product reports enable management to exercise exacting control over the entire operation.

In addition, although the FRIDEN equipment meets the present requirements of this company, it's flexible enough to allow for changes in the future which will result from company growth and expansion.

Your local FRIDEN Representative has complete information regarding this application, and many others.





HOUSEWARES DIVISION  
PACKAGING DIVISION

PHONE: 336-9691  
AREA CODE 612

1010 LYNDALE AVENUE NORTH, MINNEAPOLIS, MINNESOTA 55411

**IMPORTANT**

Detach this strip at perforation before invoice is mailed to customer.

SOLD TO  
PROGRESSIVE MFG. CO.  
111 NEW ST.  
PATERSON, N. J.

INVOICE DATE  
09/15/64

ORDER ENTRY NUMBER PAGE  
SH 02-7859

SHIPPED TO  
PROGRESSIVE MFG. CO.  
111 NEW ST.  
PATERSON, N. J.

SHIPPED (PREPAID OR COLLECT)  
PREPAID

DETACH HERE

SHIPPED VIA  
BOX SHIPPED 09/15/64

LESS FREIGHT PLUS FREIGHT PLUS PARCEL POST

CUSTOMER ORDER NO. 8888888			TERMS NET 30			SALESMAN NAME & NUMBER HOUSE 999			INVOICE NUMBER SN 02-6578			COMMISSION	
QUANTITY SHIPPED	NUMBER CASES	STOCK NUMBER	COLOR	DESCRIPTION	PRICE UNIT	GROSS AMOUNT	DISCOUNT %	DISCOUNT AMT.	NET AMOUNT	%	\$		
5000	5	800SB	TURQ	IND 8OZ BASES	45.66M	228.30	5	11.42	216.88	00.0%	.00		
5000	5	800SL	WHITE	8 OZ. LIDS	12.00M	60.00	10/5	8.70	51.30	00.0%	.00		
45	2	S101	CLEAR	UTILITY BOX	4.56DZ	205.20			205.20	05.0%	10.26		
5000	2	3200SL	WHITE	HALFGAL LIDS	50.00M	250.00	10/5/5	46.94	203.06	10.0%	20.31		
				PLUS PREPAID FREIGHT		8.72			8.72				
						752.22T		67.06T	685.16T		30.57T		

No. 2

DAILY SUMMARY BY DEPARTMENTS - INVOICES  D/M  C/M

ITEM	Total Accts. Receivable	SHAMROCK		SPERZEL SEATS		NEATWAY PACKAGING		CUSTOM SALES		Tool Room	FREIGHT		Postage	Misc.
		Housewares Dept. #311	Containers Dept. #312	Domestic Dept. #321	Canadian Dept. #322	Containers Dept. #331	Printing Dept. #332	Injection Dept. #341	Extrusion Dept. #342	Dept. #349	Added Code #170	Deducted Code #413	Code #1129	Code #399
Monday														
Today's Totals	45350.15	18462.99	48891.20	6980.11	4789.00	88765.20	326.00	44987.00	100.00	100.00	6.85	34.00	2.65	876.00
Gross Mo. To Date	6987234.00	39662.30	104862.00	24556.11	4789.00	265432.25	1476.00	44987.00	6954.00	69854.00	98.97	278.65	12.94	1832.65
Gross Yr. To Date														
Tuesday														
Today's Totals	52460.75							44987.00	100.00	132.00	4.25	40.05	.95	563.00
Gross Mo. To Date	7039694.75													
Gross Yr. To Date														

5	EA	605003	700321	27.45	9.75	WC 04-1102
27	45T					
5	EA	605003	700321	78.00	43.86	WC 04-1103
78	.00T					
05	05260.01	310				SN 04-6171
15	OZ	10074	800311	55.80	41.40	
55	.80T					
23	22220.39	357				SN 04-6172
2	OZ	11175	800311	14.40	9.12	
1	OZ	26076	800311	9.60	7.45	
28	.00T					
15	13622.51	190				SN 04-6173
10000	M	21775	800331	2000.00	1281.50	
10000	M	21775	800331	700.00	550.90	
2700	.00T					
15	12868.07	190				SN 04-6174
20	EA	60078	800311	55.00	47.00	
55	.00T					
40	03178.52	450				SN 04-6175
		0311		3.84	2.88	
				3.84	2.88	
				3.84	2.88	
						SN 04-6176
				138.00	96.00	
						4-6177
						4-6178
6						
2	EA					
12	EA					
4	EA					
4	EA					
4	EA					
189	.96T					

No. 1 DAILY INVOICE REGISTER

ITEM	Accounts Receivable Total	Miscellaneous Sales		Freight Parcel Post & Express Invoice Charges	Merchandise Sales
		Code	\$		
Month To Date					
Year To Date					
Today's Invoices, D/M, or C/M #					
SN 04-6180					54.00
54.00T					
SN 04-6181	54.00				
68.40T					68.40
SN 04-6182	68.40				
7.68T					7.68
SN 04-6183	7.68			1.66	
5.26T					3.60
WC 04-1104	5.26			1.06	
11.98T					10.92
SN 04-6184	11.98				
22.00T					22.00
WC 04-1105	22.00			1.89	
23.42T					21.53
SN 04-6185	23.42				
7.68T					7.68
SN 04-6186	7.68				
77.00T					77.00
SN 04-6187	77.00				
13.92T					13.92
Today's Total					
New Month To Date					
New Year To Date					

FRIDEN Equipment Used: FLEXOWRITER Automatic Writing Machine, 6010 Electronic Computer.

# AUTOMATED BOOKKEEPING

The Accountants Service Bureau Corporation (ASBC) of Conneaut, Ohio, furnishes professional bookkeeping and accounting services for small and medium sized firms. A recently formed service bureau specializes in handling the data processing of other accounting firms.

Automating the general books of account is the key to turning drudgery to facility in any accounting system. Eliminating the repetitive handwritten entries in the journal, general ledger, balance sheet and the financial statement means better information is made available swiftly, accurately, and at less cost.

## ADD-PUNCH PROVIDES ANSWER

In order to accomplish this, there has to be a standard method of initially capturing records of the many daily business transactions. ASBC issues a standard daily voucher form to their clients. It is so designed to admit data in a logical sequence to their accounting system. Vouchers are returned on a sequential basis. Client activities are confidential as they are identified by code.

To translate the numeric information into a program understood by the tabulating machines, simultaneously giving a visual proof of correct work, ASBC utilizes the ADD-PUNCH 10 key "natural way" adding machine with tape punch. Some clients also use this 10 key "natural way" adding machine with tape punch to punch paper tape automatically. Instead of original documents, they merely send in the punched tape. Of prime importance is the fact that now only one entry is made and captured in punched tape and is errorlessly repeated throughout the system automatically!

On the facing page are shown the key ingredients in the system. The first line of digits on the visual proof tape represent: account number 14, client number 730, and the date 094, (September, 1964). Entries

followed by the symbol N are posting references only, and are not accumulated in the total amount.

Punched tape is automatically converted to tab cards which in turn produce a distribution of expenses for the past month. All distributions provide data which is collected in the general ledger and summarized in the financial statement.

## TWO-FOLD BENEFITS REALIZED

ASBC finds:

1. A minimum amount of time is spent creating management reports. A maximum amount of time is devoted to analysis and customer counseling.
2. Visual proofing of all entries made on the 10 key "natural way" adding machine with tape punch eliminates the need for repunching tab cards for verification.
3. Reduction in error correction time because punched tape must be proved prior to producing the final report.
4. No skilled operators or expensive retraining of replacements are required as anyone who can operate an adding machine can operate the ADD-PUNCH 10 key "natural way" adding machine with tape punch.

Their accounts find:

1. Office staffs can now concentrate on utilizing the information obtained from the final reports rather than routine data processing.
2. Reports produced faster -- no time lag.
3. Overall cost is relatively low.
4. Small companies now have the advantages of office automation formerly enjoyed only by larger organizations.

Your local FRIDEN Representative has complete information regarding this application, and many others.

DAILY VOUCHERS

Name CLIENT NO. 730 Date SEPTEMBER 15 1964

SALES	
Sales, Taxable	401 47.20
Sales, Non-Taxable	402 102.50
Sales, Tax Collected	191 1.50
Received on Account	110 10.00
<hr/>	
Total	161.20
<hr/>	
Less: Returns	440
Discounts Allowed	593 3.00
Charge Sales	110 14.00
Total	17.00
Total Cash	103 144.20

CASH DISBURSEMENTS	
Office Supplies	528 2.56
Utilities	520 4.20
Travel	522 1.70
Freight	456 2.90
Cash Discounts	593 1.98
Cash Refunds	441
Advertising	515
<hr/>	
Total Cash Paid	103
Total	

CASH RECONCILIATION

Cash-on-Hand, Beginning	-----	528 N
Add: Cash Receipts	-----	256 -
Total	-----	520 N
Less Cash Paid Out	-----	420 -
Bank Deposit	-----	522 N
Total Paid Out	-----	170 -
Cash-on-Hand, End of Day	-----	456 N

	.00 T
1 4 7 3 0 0 9 4 N C	4 0 1 N
	4 7 2 0
	4 0 2 N
1 0 2 5 0	1 9 1 N
	1 5 0
	1 1 0 N
	1 0 0 0
	1 6 1 2 0 S
	5 9 3 N
	3 0 0 -
	1 1 0 N
	1 4 0 0 -
	1 4 4 2 0 S
	5 2 8 N
	2 5 6 -
	5 2 0 N
	4 2 0 -
	5 2 2 N
	1 7 0 -
	4 5 6 N
	2 9 0 -
	5 9 3 N
	1 9 8 -
	1 3 0 8 6 -
	.00 T
	1 N C
	N
	N
	N
	N

Identifying Data  
Account Number  
Amount  
Account Number  
Amount

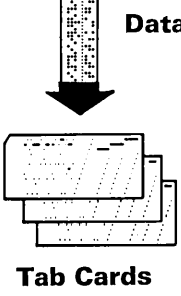
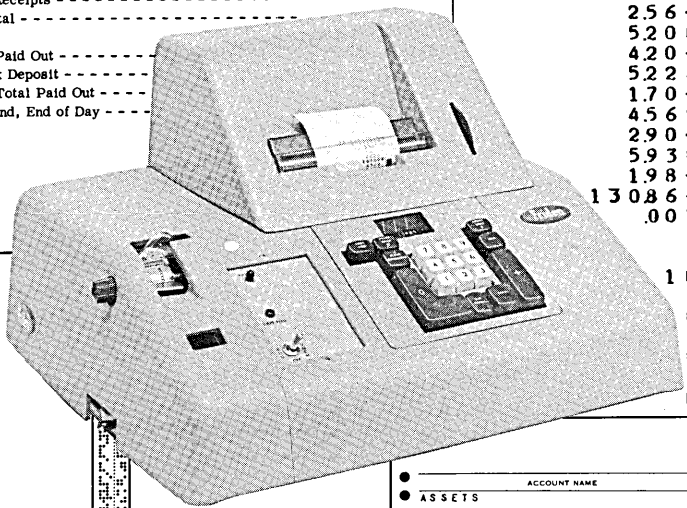

FINANCIAL STATEMENT		
ACCOUNT NAME	CURRENT PERIOD	YEAR TO DATE
<b>ASSETS</b>		
CURRENT ASSETS		
PETTY CASH		49776
CASH ON HAND	4089	110921
CASH IN BANK	14046	362429
ACCOUNTS RECEIVABLE TRADE	83691 CR	
ACCOUNTS RECEIVABLE OTHER		50000
NOTES RECEIVABLE		26581 CR
ALLOW FOR DOUBTFUL ACCT	3196 CR	1850747
INVENTORY	46205 CR	2200
ADVANCES		
TOTAL CURRENT ASSETS	114957 CR	2399492
PROPERTY PLANT AND EQUIP		
LAND		230000
BUILDINGS		2794415
ALLOWANCE FOR DEPRECIATION	7000 CR	824547 CR
MACHINERY AND EQUIPMENT	25600	1636783
ALLOWANCE FOR DEPRECIATION	12600 CR	613455 CR
FURNITURE AND FIXTURES		418663
ALLOWANCE FOR DEPRECIATION	3491 CR	183122 CR
TRUCKS AND AUTOS		286140
ALLOWANCE FOR DEPRECIATION	6275 CR	85422 CR
TOTAL PROPERTY PLANT EQUIP	3766 CR	3599655
DEFERRED CHARGES		
PREPAID SALES TAX	2504	5894
PREPAID INSURANCE	9871	35011
PREPAID TAXES	5911	40689
PREPAID INTEREST	3100 CR	15464
SALES TAX COLLECTED		
	3364	95058

FRIDEN Equipment Used: ADD-PUNCH 10 Key "Natural Way" Adding Machine with Tape Punch.

# INSURANCE POLICIES

Because the insurance business has been deluged with an increase in paperwork detail, attention to these functions has reduced effective utilization of sales time, as well as increasing clerical costs. And with competition at its highest peak, it became apparent that a solution to these problems must be found.

Therefore, to automate the writing of policy declarations, endorsements, renewals, claim checks and claim ledger cards, California Casualty Indemnity Exchange, San Francisco, California, installed FRIDEN data processing equipment in two departments . . . underwriting and claims.

## SYSTEM IN OPERATION

The first step in this system takes place within the underwriting department where all incoming policy applications are received and routed to the FLEXOWRITER automatic writing machine.

During the initial preparation of a policy declaration form, all data is manually entered through the keyboard of the automatic writing machine. Automatic positioning of the form is accomplished by a program tape. As this source document is being typed, two by-product tapes are created at the same time, each containing different data.

One tape, containing statistical data, is forwarded to the tabulating department for automatic conversion to tab cards. Later, these cards create monthly management reports. The second by-product tape is filed with a copy of the form in a policy jacket. It is used to automatically create subsequent endorsement or renewal declarations.

An additional data processing unit, the ACEO-P solenoid-operated input adding machine, is also used as input to the automatic writing machine within this system. The adding machine keyboard of this unit

is used to enter all premium amounts onto the policy declaration form. These numeric entries appear on a visible adding machine tape as well as cause printing of the appropriate digits on the document.

Totals also are automatically accumulated and printed on both the visible adding machine tape and policy declaration. Two other computations are made when applicable. These are: premium adjustments due to savings earned on a previous policy, and adjustments as a result of an installment charge added to the gross premium.

When an endorsement is initiated on the policy, the tape stored in the policy jacket is used to create the new document almost completely automatically. As the policy endorsement is written, two coded tapes are again simultaneously prepared.

## SAME STEPS USED

The same procedures are followed in the preparation of automobile policies, their endorsements and renewals. Automatic typing is accomplished in the same manner, and two by-product tapes are produced, one for management reports and one for subsequent processing.

When a claim is filed against a policy, the second punched tape is used to prepare a claims ledger card. FRIDEN data processing units facilitate the paperwork processing essential to: revising reserve funds, issuing claims checks, and preparing ledgers on all amounts paid on a claim.

## BENEFITS

California Casualty's utilization of the FRIDEN equipment has effected: a more productive utilization of clerical help; a smoother and more efficient policy preparation technique; and an overall reduction in operating expenditure.

Your local FRIDEN Representative has complete information regarding this application, and many others.

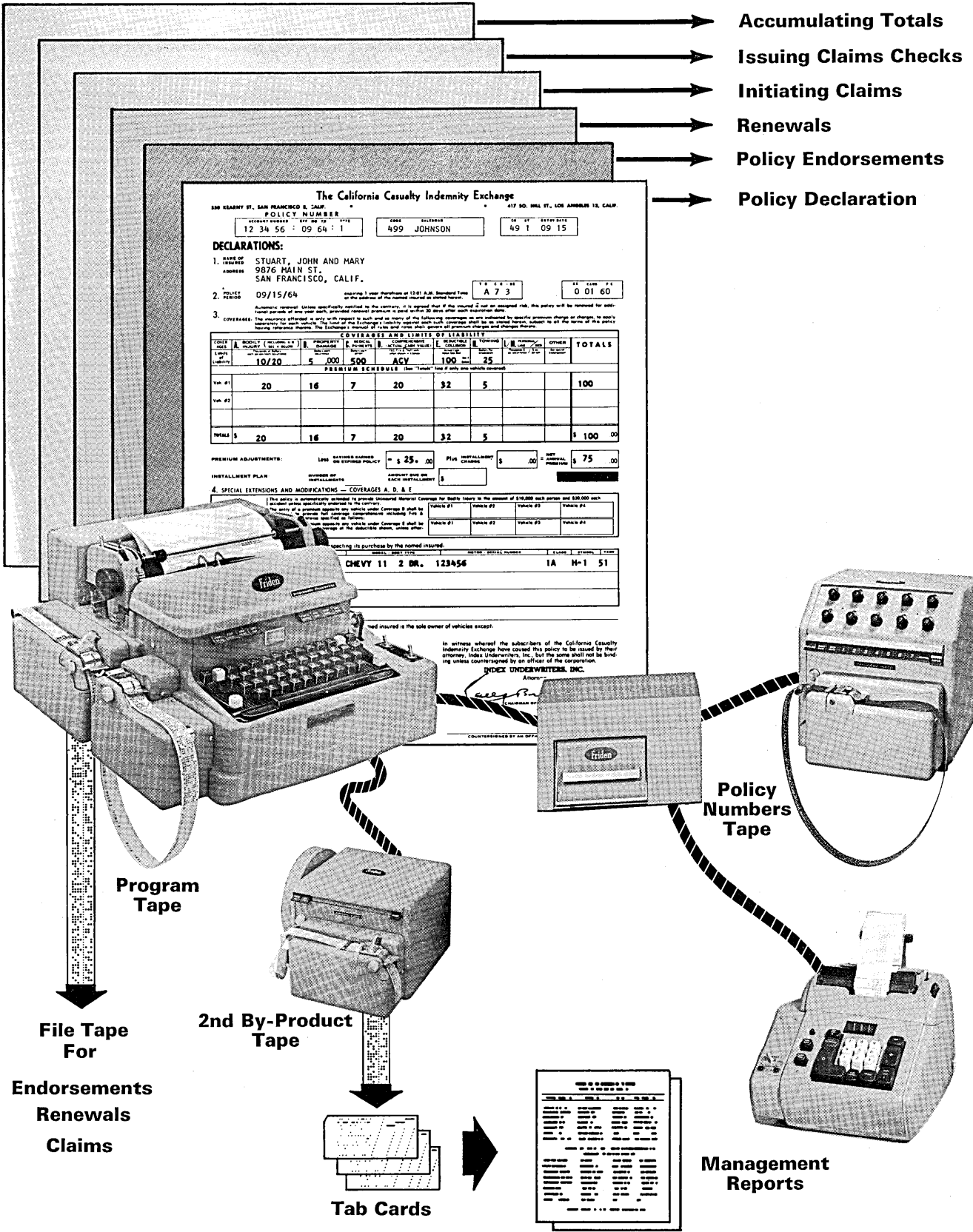

FRIDEN Equipment Used: FLEXOWRITER Automatic Writing Machine, SELECTADATA Auxiliary Reader with Data Selection, Auxiliary Accounting Keyboard Unit, Auxiliary Tape Punch.

# ADDRESS PLATES AND RETAIL CREDIT

The Marine Midland Bank, Syracuse, New York, is one of the many banks throughout the country offering the newest thing in charge account plans . . . the Shopper Credit Service.

Applications for charge accounts are made by shoppers through stores using the service. The stores funnel the applications into the credit service department of the bank. This department investigates, approves the account, makes embossed plates for internal and shopper use, and keeps the account serviced.

## FORMER METHOD

Previously, at Maring Midland Bank, embossed plates were made by manual methods. This involved many hours of manual keyboarding in order to keep the 50,000 user accounts updated. Much duplication of effort resulted because there were many errors in the preparation of the plates; and accuracy was a necessity.

Generally, three separate addressing plates are made for each shopper application. The first is a metal addressing plate that contains the name, address, account number, and a salutation. This is used for addressing monthly bills, promotional material, and other correspondence. The second and third plates, made of plastic, are "Mr." plates and "Mrs." plates, if it is a joint account. If not, only one other plastic plate is needed.

The plastic plates are given to the shoppers for identification, and for use in the stores to register sales slips. Copies of the sales slips are sent to the bank where a bill is prepared each month. All plates are updated every four months with a new expiration date.

## NEW SYSTEM

Marine Midland Bank now employs a FLEXOWRITER automatic writing machine

to give quicker, better, and more accurate service to its credit service customers.

The new system produces the three types of addressing plates in this manner: the SELECTADATA auxiliary reader with data selection (cable-connected to the automatic writing machine) contains a looped program tape. This tape controls the horizontal and vertical form spacing. It also turns the tape punches on and off, as needed, while the original application is being written. Proof copy is provided by the document on the automatic writing machine.

As the application is written, by-product tapes are produced on the automatic writing machine punch and the cable-connected Auxiliary Tape Punch. The by-product tape from the punch of the automatic writing machine is fed into the automatic plate making machine twice.

## ADDRESS PLATES

The first time through, it prepares the addressing plate. The second time through a "skipper" feature on the plate making machine is activated, allowing only information for the "Mr." plate to be embossed. By-product tapes from the Auxiliary Tape Punch prepare the "Mrs." plate, if it is needed.

A special program tape is used in the auxiliary reader with data selection, along with these by-product tapes, to update the tapes with a new expiration date every four months. This program tape also allows address changes, eliminations, and additions to be easily handled.

## MIDLAND'S BENEFITS

Besides giving quicker and more accurate service to their customers, the Marine Midland Bank of Syracuse has realized substantial cost savings in overhead and personnel through the use of the automatic writing machine in this system.

Your local FRIDEN Representative has complete information regarding this application, and many others.

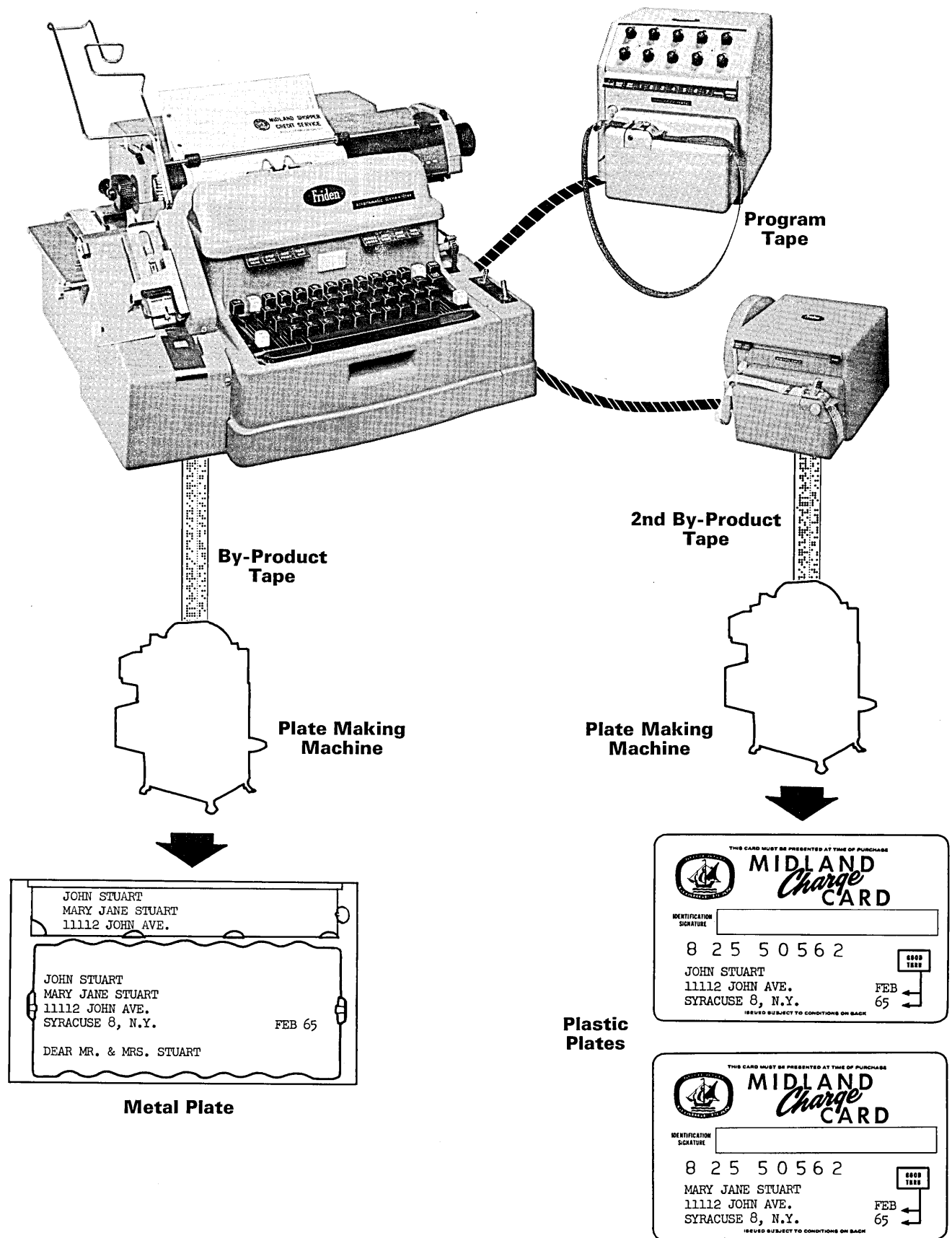

FRIDEN Equipment Used: FLEXOWRITER Automatic Writing Machine, SELECTADATA Auxiliary Reader with Data Selection, Auxiliary Tape Punch.

# LIBRARY CARD PREPARATION

Anne Arundel County, Maryland, boasts a public library which includes a main library in Annapolis, four branches in outlying areas, and three bookmobiles. Together they house approximately 165,000 volumes. And their present facilities are continually expanding to meet the demand for service from the growing population of the county. As a result, the main office must process some 2,300 new books monthly.

Previously all books were cataloged manually, using typewriters. All sets of cards required for each branch had to be typed over and over again. This meant each set had to be checked for possible transposition errors. Thus, books were delayed in getting to the branches even though all typing was done at the main office in Annapolis.

Now with a staff of 35 (admittedly understaffed for a library of their size), the library relies heavily on the FLEXOWRITER automatic writing machine for aid in this processing.

## NEW SYSTEM

Each of the four branches sends a representative to a weekly meeting with the Chief Librarian at the central library. This committee decides what books are to be purchased. A three-part purchase order (supplied by the jobber) is manually written on a typewriter. One copy remains at the central library. Two copies are sent to the jobber (one of these copies can be sent to the publisher if the book is not in stock).

When books arrive at the central library, a cataloger assigns the Dewey Decimal number on the requisition. She also indicates the "tracings" (i.e. subject headings and added entries). Then a copy of the book and the requisition form are given to the automatic writing machine operator who creates the master catalog cards.

As the operator is typing, the tape in the punch of the automatic writing machine captures all the information. Books that require the same number of cards are "batched" to be on a continuous tape.

After the master cards are proofed for accuracy, the tape is spliced to form a continuous loop and is inserted in the reader of the automatic writing machine. Continuous form library cards are placed in a tractor-feed platen on the FLEXOWRITER automatic writing machine. A special cable connected device is set to determine the required number of card sets by stopping the machine when the necessary number of carriage returns has been sensed. A panel switch is touched by the operator and she can now leave the machine and make up the "pocket cards" on her typewriter. The catalog card sets are typed automatically at 100 words a minute, providing error-free copy for each card.

Encountered several times a week are jobs requiring several hundred cards for one book. These are referred to as analytics. That is an anthology such as The Cavalcade of Comedy (with many authors) required 82 cards for each branch, or a total of 410 cards for five offices. The frequency of this type of work did not warrant using a printing method, so the cards formerly were manually typed. Transposition errors naturally cropped up more frequently. This voluminous repetitive typing job is now done automatically on the automatic writing machine.

## BENEFITS

Several typists working eight hours a day were needed to keep up with the increasing volume of work. Now the automatic writing machine is used an average of half a day. This frees personnel for more pressing duties. The new system is more accurate, faster, requires no rechecking and is less tiring. Finally, books are in the branches or on the shelves of the main library several days sooner than under the old method.



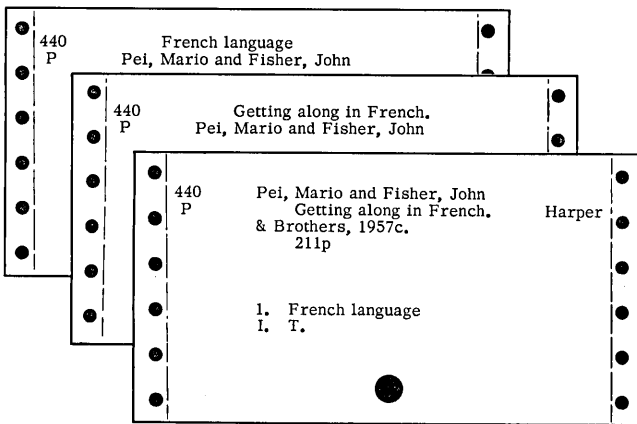

← **Master Cards  
Manually Typed**

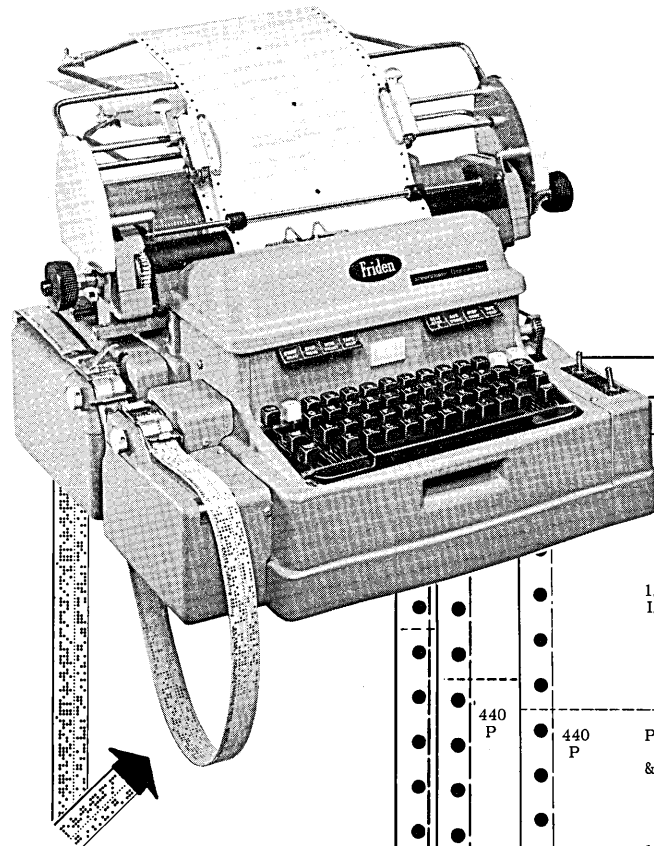

**By-Product  
Tape**

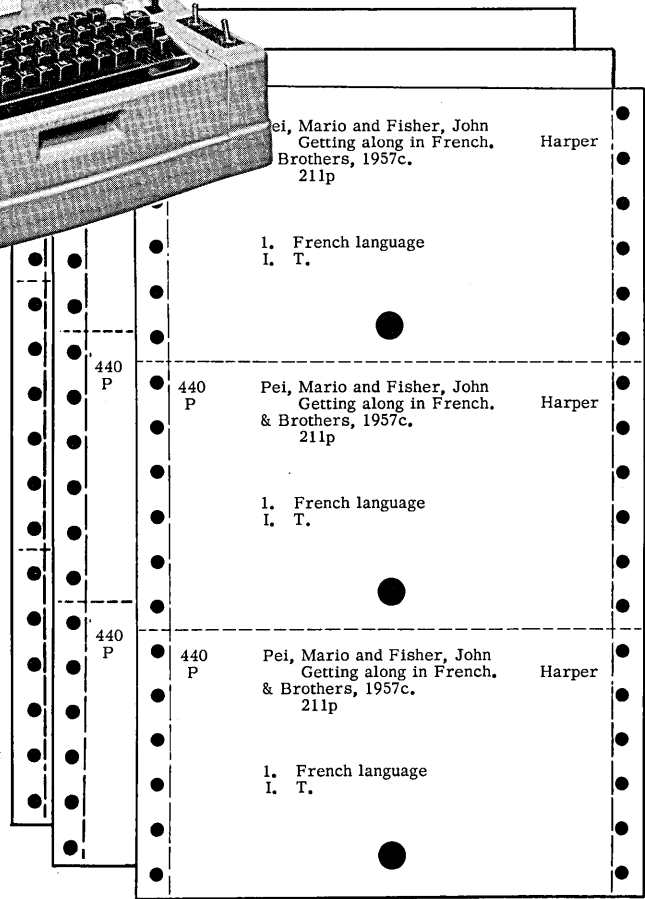

**Catalog Cards  
Automatically Typed** →

FRIDEN Equipment Used: FLEXOWRITER Automatic Writing Machine.

# MASTER PREPARATION FOR MICR IMPRINTING

Citizens Bank, Sheboygan, Wisconsin, undertook a study of automation methods in order to improve the efficiency of their check handling procedures and reduce costs. At that time, they were personalizing checks on an imprinting machine.

For each account, a lead slug was cast for printing use, and then stored for rerun purposes. This required storage chases for 12,000 accounts, which amounted to 5 file cabinets (about 75 cubic feet of space). Approved after study was a Magnetic Ink Character Recognition (MICR) system, to be used in conjunction with an offset duplicator and a FLEXOWRITER automatic writing machine Model MICR.

## FOR BANKING PURPOSES ONLY

The Model MICR is a proportional-spacing machine developed by FRIDEN for the banking industry. It was designed to comply with the American Bankers Association's (ABA) common machine language for automatic control of check handling.

Numerals and four control symbols used to produce the magnetic ink characters that make up the language are incorporated in the keyboard of the automatic writing machine. These characters are the key to full automation in banks. The Model MICR also was designed expressly to service this banking operation.

## PERSONALIZED CHECKS

Furthermore it's used to personalize checks and also encode them with the ABA devised characters automatically. An edge card containing the customer's name, address, account number and routing symbol-transit number is created on the Model MICR automatic writing machine and filed.

When a customer orders checks, his card is inserted in the automatic writing machine. By merely touching a panel switch, the information is typed on a direct image master in preparation for printing. Sheets of preprinted check forms are fed through the press set up with the prepared master and printed from it.

## ONE MILLION AT A TIME

Checks are ordered in sheets of five. One million checks are purchased from the printer at a time. The offset master is preprinted with a non-reproducing scale for positioning the reproducing image imprinted by the automatic writing machine.

As each batch of checks completes its run, the sheets, stacked by the press on a wooden drying shelf, are placed in a rack to stand overnight. No handling of individual sheets takes place until they are completely dry.

Next morning, the checks are cut and bound into checkbooks for the customers who ordered them. Also incorporated into the checkbooks is a reorder blank prepared just as the checks were. As soon as they are stapled, the books are mailed.

As each customer sends in his usual order for a new checkbook, an edge card is created. Thus the system of producing cards amounts to a "new business" procedure.

Customers of Citizens Bank have embossed plastic identification plates for use with deposit and withdrawal slips. New plates are mailed to customers with their first supply of MICR checks. Storage space has now been reduced to one file cabinet. Edge-punched cards for 15,000 accounts can be contained in only 15 cubic feet.

Edge-Punched  
Customer Cards

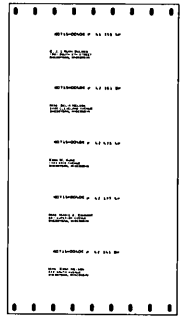
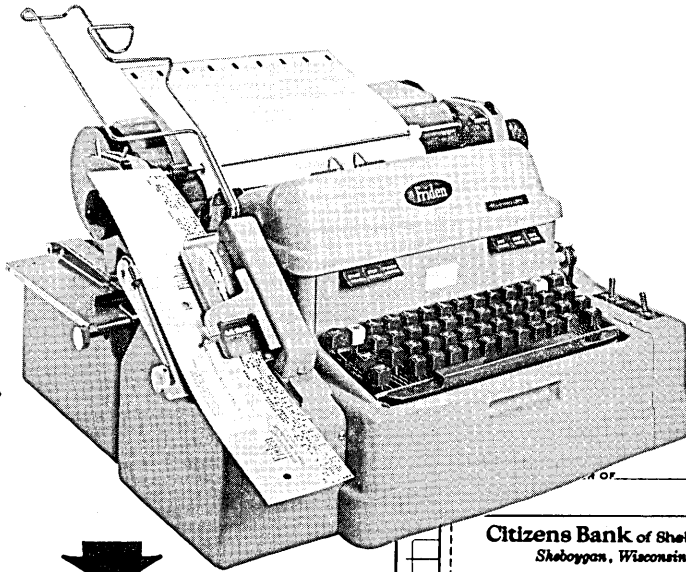

Master  
Plate

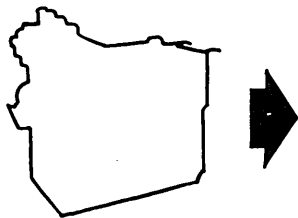

Printing  
Machine

	No. _____	19 <u>78-40</u>	\$ _____
		DOLLARS	
	Citizens Bank of Sheboygan Sheboygan, Wisconsin		<b>VOID</b>
	:0715=0040: # 4 1 255 4P		
CENTS			
	C. J. & RUTH DULMES 1901 SOUTH 8TH STREET SHEBOYGAN, WISCONSIN		No. _____ 19 <u>78-40</u> <u>715</u>
	PAY TO THE ORDER OF _____		\$ _____
		DOLLARS	
	Citizens Bank of Sheboygan Sheboygan, Wisconsin		<b>VOID</b>
	:0715=0040: # 4 2 361 0P		
CENTS			
	MRS. DELIA NELSON 2405 CLEVELAND AVENUE SHEBOYGAN, WISCONSIN		No. _____ 19 <u>78-40</u> <u>715</u>
	PAY TO THE ORDER OF _____		\$ _____
		DOLLARS	
	Citizens Bank of Sheboygan Sheboygan, Wisconsin		<b>VOID</b>
	:0715=0040: # 4 2 423 4P		
CENTS			
	EDNA M. KUNZ 1432 ERIE AVENUE SHEBOYGAN, WISCONSIN		No. _____ 19 <u>78-40</u> <u>715</u>
	PAY TO THE ORDER OF _____		\$ _____
		DOLLARS	
	Citizens Bank of Sheboygan Sheboygan, Wisconsin		<b>VOID</b>
	:0715=0040: # 4 2 177 4P		
CENTS			
	MRS. MARIE A. EBHARDT 631 SUPERIOR AVENUE SHEBOYGAN, WISCONSIN		No. _____ 19 <u>78-40</u> <u>715</u>
	PAY TO THE ORDER OF _____		\$ _____
		DOLLARS	
	Citizens Bank of Sheboygan Sheboygan, Wisconsin		<b>VOID</b>
	:0715=0040: # 4 2 664 4P		
CENTS			

FRIDEN Equipment Used: FLEXOWRITER Automatic Writing Machine.

# NUMERICAL CONTROL

Numerical control is rapidly becoming a popular and familiar facet of the metal-working industry. Often referred to as the "brains" of the production line, numerically controlled machines have proved to be reliable and relatively simple to operate.

They are engineered and conditioned to do what they are told -- nothing more, nothing less. How well a numerically controlled machine performs depends largely upon how well it is instructed. This is the basic concept on which a numerical control system rests.

## CONTROL TAPE IS KEY

The foundation of the numerically controlled milling machine utilized at Allis-Chalmers, West Allis, Wisconsin, is a control tape. It is produced on a FLEXOWRITER automatic writing machine, Model NC-1 and verified on a cable-connected Motorized Tape Reader. The tape is the cumulation of all design, engineering and process planning efforts used in the fabrication of castings for tractor drive housings.

Engineering drawings are prepared to illustrate the various tool positions of the numerically controlled machine. Then a step-by-step program sheet is manually written and double checked. This program sheet is given to the automatic writing machine operator. The program contains not only numeric instructions to the milling machine, but also alphabetic instructions to the machine operator.

The automatic writing machine operator types the information using the familiar keyboard of the unit. As the programming sheet is being prepared, a by-product tape is punched simultaneously. This original tape is then inserted in a cable-connected Motorized Tape Reader.

## CODE VERIFICATION

The original information is again typed on the NC-1 machine. As each character is

keyboarded, its assigned code is compared with the code in the original tape in the Motorized Tape Reader. If the two codes compare, the automatic writing machine punch will operate and punch the verified code in the new tape. If the codes do not compare, the FLEXOWRITER automatic writing machine punch will not operate and the keyboard will lock.

At this point, the operator must determine whether the error is contained in the original tape in the Motorized Reader or in the second typing. By simply pressing an ERROR RESET switch on the front panel of the automatic writing machine to unlock the keyboard, she types the correct character.

The correct code is punched in the second or verified tape. The Motorized Tape Reader keeps pace with the fastest typist and will lock the keyboard only when the two corresponding codes fail to compare.

After completing the verification, a "machine tape" is created by putting the verified tape in the reader of the automatic writing machine. Only the actual codes used to instruct the numerically controlled machine are retained in this tape.

Now, both machine and operator instructions are completely verified and checked. And the tape is ready to use in producing an output of 40 castings per 24 hour day.

## BENEFITS

Through the use of the numerical control FLEXOWRITER automatic writing machine, milling machine operator error has been reduced substantially. The job proceeds at a faster pace. Possible ruining of casting and boring tools has been eliminated. This reduces tooling and inventory costs. Tape is infallible. It can't get out of sequence and it's durable and unaffected by chance exposure to magnetic fields.

# PROGRAM SHEET FOR DEVLIEG SPIRAMATIC JIGMIL WITH Tapac III

Part No. 233712-10 Part Name FINAL DRIVE HSG. L.H. Sheet 1 of 3

Oper. No.	X Dimension	Y Dimension	Z Turret	Spindle Feed No.	Spindle Speed No.	Tool Change Auto Step
000	X±000000	Y±000000	Z00	F0	S00	T / P

INDEX STATION ONE						
000	X+000000	Y+000000				T
HORIZONTAL: PICK UP CENTERLINE OF INDEX TABLE. VERTICAL: USING 7.0434" DIM. ON TAPE CONSOLE & 1.0000" JO-BLOCK NDE SPINDLE BAR LOCATE OFF LOCATION PAD ON FIXTURE.  WHEN MACHINING RIGHT HAND HOUSING TURN KEY TO REVERSE POSITION ON "X" DIM. ONLY.						
010			Z01	F5	S11	T
ROUGH & FINISH /16"						
020						T
030					S10	T
040						T
050						T
070	X-040				S10	T
ROUGH 3 13/16" DIA. BORES. USE BAR #7						

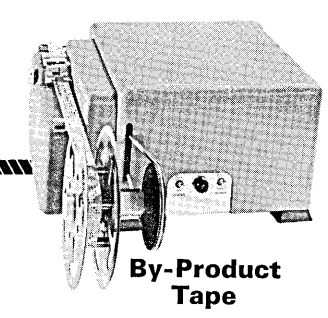
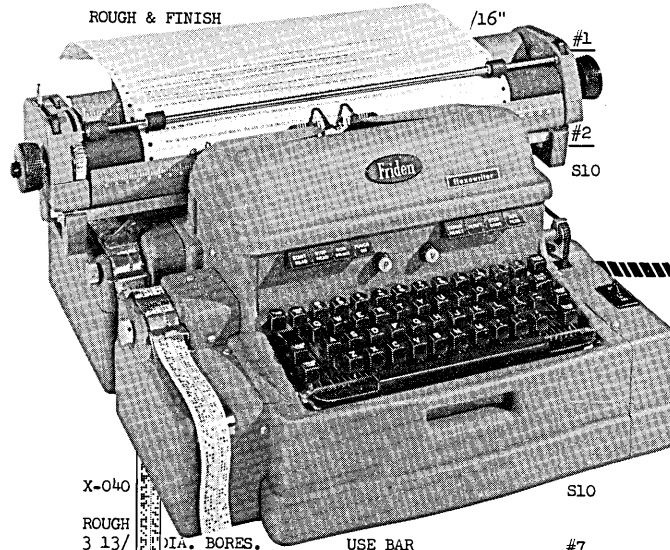

**By-Product Tape**

**Verified Tape**

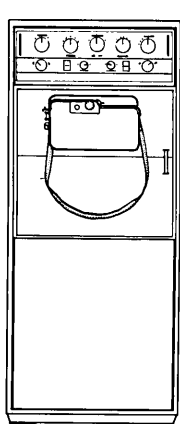

**Control Unit**

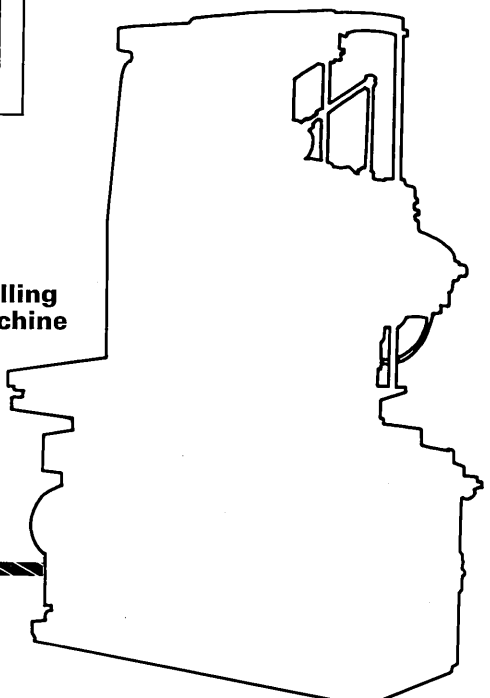

**Milling Machine**

FRIDEN Equipment Used: FLEXOWRITER Automatic Writing Machine, Motorized Tape Reader.

# AUTOMATIC DOCUMENTATION FROM TABULATING CARDS

Tabulating cards are widely used to store information. Both alphabetic and numeric data are recorded on special cards in the form of Hollerith codes. To recover the content of the tabulating cards, it is necessary to perform a function of decoding and, at the same time, place this data on a document.

The main purpose of the FRIDEN Automatic Card Reader (ACR-A) is to provide an accurate, fast translation of cards into a usable form. This form may be a document such as an invoice, or it may be punched paper tape which is used for further processing.

This versatile unit is designed and engineered for use with three FRIDEN business machines: FLEXOWRITER automatic writing machine, COMPUTYPER automatic tape operated writing-computing machine and the 6010 Electronic Computer.

## AUTOMATIC PROGRAM SELECTION

Automatic program selection is possible from randomly selected cards -- up to four different formats can be programmed for the unit. Programming of the ACR-A is highly flexible, and simply done through a removable control cylinder and terminal block. Both of these components are accessible in the ACR-A's housing and can be removed by the operator of the unit.

Cards are placed in a hopper which will accept up to 200 cards. When the ACR-A is started, either from the manually operated keyboard or a programmed code, the card feed mechanism moves the tab card to the read station--where the decoding takes place. The card is automatically ejected when the last card column is read and is released to the card stacker.

It's possible to cause skipping of cards (no translation) when this is required, and it

may be done automatically under program control of the system.

Since the Automatic Card Reader provides the ability to either document the information on the cards directly or convert it to usable form, it adds considerably to the flexibility required of some systems. Such applications as sales analysis by product, customer, territory and salesman are easily accomplished, as well as accounting functions like trial balance and age analysis.

The ACR-A is used in systems and listing applications. And the unit is a card-to-tape converter when connected to a FLEXOWRITER automatic writing machine.

## LISTING APPLICATIONS

Data punched in tabulating cards lends itself well to applications where frequent deletions and additions are required. Typical of this type of application is the writing of engineering bills of material and operation sheets.

In writing a bill of materials, the individual parts cards are sorted into numeric sequence and listed on the automatic writing machine, usually on a vellum master. Ease of up-dating is facilitated by removal of a parts card from the deck and insertion of another. If the ACR-A is connected to a COMPUTYPER automatic tape operated writing-computing machine or computer, the document could be a production parts explosion, showing the number of each individual component used in a particular number of assemblies.

Operation sheets are another straight listing application, but due to the rapidly changing technology of manufacturing and the new techniques offered by new tools, these sheets are constantly in need of up-dating. Changes are again accomplished by removal of obsolete operation cards and insertion of new operation cards.

Your local FRIDEN Representative has complete information regarding this application, and many others.

LIST OF MATERIAL

PC. NO.	QUANTITY			SIZE	TYPE	DESCRIPTION-MATERIAL & DIM SPEC	SERVICE	FSN OR REMARKS	LOCATION	INSUL REF	
	INST	EBPROC	OBRP							OD	THK
F1	1	1			FILTER	MIL-F-15919 TY 1 MODIFIED IN ACCORD WITH 73765-55X3, ASSY 7-C	P1				
F2	1	1		1/2	FUNNEL	COPPER-BRASS MESH EBB 2620-209 PC 103 EBCN 19-97-0351	P2				
F3	1	1		1/2	HANDPUMP	COML-PH FIG. 681 NO. 0 BORE ENDS FOR 1/2 IPS SILBRAZE CONN	P3	NOTE 16			
F4	6	6		1/4	TEE	MIL-F-1183 TY B EBCN 15-00-6207	P4, P12				
F5	1	1		2	ELL 45 ELGD/F-BRZG ELBOW, 90	150 LB BRZ EBB 2620-161 PC 306 EBCN 15-97-2466	P1				
F6	1	1		2	ELBOW, 90	MIL-F-1183 TY B EBCN 15-00-3114	P1				
F7	2	2		1/4	CONN, FLEX	EBB 2620-214, ASSY FB, L1-17 L2-17 WITH NICH NUTS	P4				
F8	3	3		3/4 X 3/8 X 3/4	TEE, RED.	MIL-F-1183 TY B EBCN 17-00-3825	P7, P10, P14	NOTE 15			
F9	3	3		3/8 X 1/4	BUSHING, RED.	MIL-F-1183 EBCN 17-00-0709	P7, P10, P14				
F10	3	3		3/4 IPS X 3/4 OD	CONNECTOR, MALE	MIL-F-1183 EBCN 17-00-0709	P7, P10, P14				
F11	1	1		1/2	COUPLING	PARKER CAT. NO. 12 FBTX	P15				
F12	3	3		1/2 X 1/2	ADAPTER FPT X M/BRZG	MIL-F-1183 TY B EBCN 15-00-2134	P7, P10, P14	NOTE 15			
F13	3	3		3/4 X 1/2	BUSHING, RED.	MIL-F-1183 EBCN 15-00-0232	P7, P10, P14	NOTE 15			
F14	3	3		3/4 X 3/4	ADAPTER FPT X M/BRZG	MIL-F-1183 EBCN 17-00-0714	P7, P10, P14				
F15	7	7		1/4	ELBOW, 90 UNION	MIL-F-1183 EBCN 15-00-0233	P3, P5, P7, P8, P10, P11, P14				
F16	4	4		1/4	UNION	MIL-F-1183	P4, P6, P9, P13				
F17	1	1		1/2	ELBOW, 90	MIL-F-1183 EBCN 15-00-7631	P2				
F18	1	1			HOSE FITTING	MIL-F-1183 TY B EBCN 15-00-3109	P15				
F19	1	1		1/2 X 1/4 X 1/4	TEE RED.	EBB 2620-002, ASSY KW 1500LB BRZ BHS1385766 EBCN 17-03-0290	P15				
F20	2	2		1/2 X 1/4	BUSHING, RED.	MIL-F-1183 EBCN 17-00-0712	P3, P4				
F21	3	3		1/2 X 1/4	BUSHING, RED. HPT X FPT	ASTM 81-40154 EBCN 17-00-0611	P8, P9, P13				
F22	6	6		.540 X .123 NOM	NIPPLE, PIPE	MIL-P-2780 GR A XR EBCN 45-00-0230	P5, P6, P8, P9, P11, P13				
F23	2	2		1/4	ELBOW, 90	MIL-F-1183 TY B EBCN 15-00-3107	P4, P8				
P1	72	72		2.375 X .065 MIN	TUBE COPPER	MIL-T-873 HD EBCN 45-00-0905	VENT-CELLULUBE LING TK	P1-1, 2, 3, 4			
P2	18	18		.840 X .065 MIN	TUBE COPPER	MIL-T-873 HD EBCN 45-00-1233	O-HP AIR COMPR				
P3	8-0	8-0		.540 X .072 MIN	TUBE COPPER	MIL-T-873 ANL EBCN 45-00-1423	CELLULUBE FROM HP				
P4	15 0	15-0		.540 X .072 MIN	TUBE COPPER	MIL-T-873 ANL EBCN 45-00-1423	COMBINED LUBE OIL				
P5	54	54		.540 X .072 MIN	TUBE COPPER	MIL-T-873 ANL EBCN 45-00-1423	O-COOLER HP AIR				
P6	18	18		.540 X .072 MIN	TUBE COPPER	MIL-T-873 ANL EBCN 45-00-1423	O FILTER-HP AIR				
P7	12	12		.540 X .072 MIN	TUBE COPPER	MIL-T-873 ANL EBCN 45-00-1423	DRAIN CASE-HP AIR				

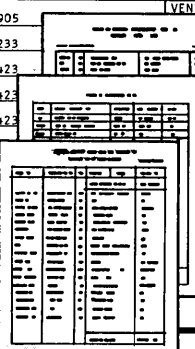

List of Materials  
 Operation Sheets  
 Bill of Materials

Tab Cards

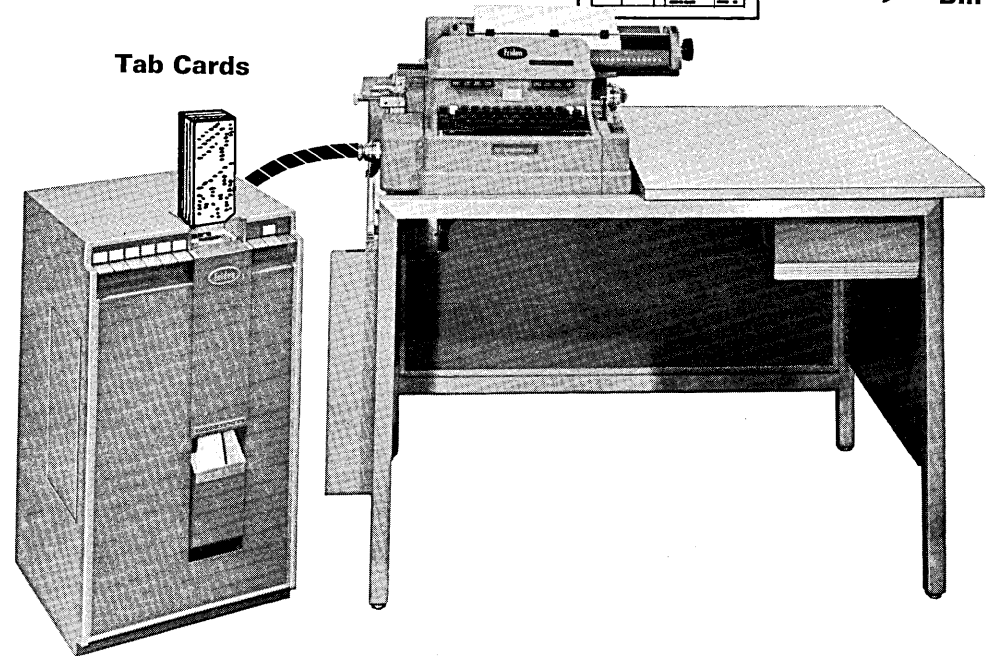

FRIDEN Equipment Used: FLEXOWRITER Automatic Writing Machine, Automatic Card Reader.

# MAGNETICALLY STORED INFORMATION

The FRIDEN 6018 Magnetic Disc File provides additional alphanumeric storage for the FRIDEN 6010 Electronic Computer. Each side of the easily removable magnetic disc provides for a total storage of 61,440 characters in 120 tracks of recording space. Random access speeds range from 6 to 360 ms, with an average of 180 ms. A single track is divided into eight sectors of 64 characters each, with a read/write speed of 50 ms per character. Search is initiated from instructions transmitted by the 6010 Computer.

## 960 ADDRESSABLE LOCATIONS

The disc contains 960 individual addressable locations on each side. With the read/write head in its home position, it's possible to find any one location at anytime, almost immediately. A single access to an individual track allows the reading or writing of a maximum of 512 characters.

## 6018 INCREASES 6010'S FLEXIBILITY

A wide range of business applications can be performed on the 6018 Disc File. Payroll, invoicing, inventory control, sales analysis, accounts receivable and payable up-dating are some examples. A brief explanation of payroll and invoicing applications follows.

### PAYROLL

In the payroll application, both the checks and the payroll register are prepared on the 6010 Computer. All constant employee information such as: employee number, name, social security number, hourly rate, number of dependents, savings deduction, insurance deduction and miscellaneous deductions are recorded on the disc.

Variable employee data such as: quarterly gross and year-to-date totals (gross, with-

holding tax, F.I.C.A., state tax, savings amount, insurance, and miscellaneous deduction) is also recorded on the disc.

The 6010 operator only enters the employee number, the regular hours and the overtime hours on the payroll register. All constant employee information is processed through the Computer. And the resultant computations are printed on the document. Variable employee information on the disc is automatically updated to reflect the employee's weekly earnings.

During the preparation of the payroll register, a by-product punched tape is automatically created on the input/output unit of the Computer. This tape is subsequently processed on the 6010 Computer to type the employee check and check stub, completely automatically.

### INVOICING

In the invoicing application, all constant item information such as the product code, price, item code number, description, item reorder level and the reorder quantity are recorded on the magnetic disc. This disc also contains variable item information such as: quantity on hand, quantity back ordered, and the unit sales to date figure. All constant customer information is contained in edge-punched cards. These cards are used to complete the header portion of the invoice.

To complete the body of the invoice, the 6010 operator merely types the correct product code and the quantity ordered. The 6010 Computer verifies the product code number, and then all item information is typed from the disc. Also, the various item balances on the disc are updated to reflect each transaction. And a by-product punched tape for a critical items purchase report is automatically prepared on the punching facilities of the 6010.



DEPT. 073

# PAYROLL REGISTER

DATE 7/10/64

EMPLOYEE NUMBER	NAME	SOCIAL SECURITY NUMBER	REGULAR		OVERTIME		CONSOLIDATED GROSS	WITHHOLDING TAX	F.I.C.A.	STATE TAX	SAVINGS	INSURANCE	MISC DEDUCTIONS	NET PAY
			HOURS	GROSS	HOURS	GROSS								
01007	ARTHUR T. ABBOTT	560-30-1500	40.0	114.20	.0	.00	114.20	15.99	4.14	1.14	1.50	2.50A	1.00	87.93
01503	MEREDITH J. ACKER	862-22-8647	40.0	118.00	8.0	35.40	2661.25	372.58	96.47	26.61	15.00	25.00	10.00	114.68
02003	LOWELL R. ADAMS	184-28-8765	40.0	158.20	2.0	11.87	3298.75	443.65	119.58	32.99	68.00	34.20	17.50	132.53
							3885.76	507.61	140.87	38.86	37.50	27.50	30.00	
							437.67	55.82	15.87	4.37	12.05	8.67	5.75	335.14

EMPLOYEE EARNINGS STATEMENT AND DEDUCTIONS

EMPLOYEE NO.	CHECK NO.	PERIOD ENDING	<b>Friden Inc.</b>									
01007	5712	70464	AUTOMATED CO., INC. No. 5712									
SOCIAL SECURITY NO. REG. HRS. REG. GROSS O/T HRS. O/T GROSS CONSOLIDATED GROSS			TO THE ORDER OF ARTHUR T. ABBOTT									
560-30-1500 40.0 114.20 .0 .00 114.20			DATE 7/10/64									
MISC TAX F.I.C.A. STATE TAX SAVINGS INSURANCE MISC			PAY 87 DOLLARS AND 93CENTS ***** \$ 87.93									
15.99 4.14 1.14 1.50 2.50A 1.00 87.93			SIGNATURE									
GROSS WITH TAX F.I.C.A. STATE TAX SAVINGS INSURANCE MISC			STATE BANK ANYWHERE, U.S.A. SPECIMEN									
2661.25 372.58 96.47 26.61 15.00 25.00 10.00			SIGNATURE									
YEAR TO DATE												

**PAYROLL DEMONSTRATION**

FRIDEN 6010 COMPUTER WITH 6018 MAGNETIC DISC FILE

EMPLOYEE EARNINGS STATEMENT AND DEDUCTIONS

EMPLOYEE NO.	CHECK NO.	PERIOD ENDING	<b>Friden Inc.</b>									
01503	5713	70464	AUTOMATED CO., INC. No. 5713									
SOCIAL SECURITY NO. REG. HRS. REG. GROSS O/T HRS. O/T GROSS CONSOLIDATED GROSS			TO THE ORDER OF MEREDITH J. ACKER									
862-22-8647 40.0 118.00 8.0 35.40 153.40			DATE 7/10/64									
MISC TAX F.I.C.A. STATE TAX SAVINGS INSURANCE MISC			PAY 114 DOLLARS AND 68CENTS ***** \$ 114.68									
19.66 5.56 1.53 6.80 3.42B 1.75 114.68			SIGNATURE									
GROSS WITH TAX F.I.C.A. STATE TAX SAVINGS INSURANCE MISC			STATE BANK ANYWHERE, U.S.A. SPECIMEN									
3298.75 443.65 119.58 32.99 68.00			SIGNATURE									
YEAR TO DATE												

**PAYROLL DEMONSTRATION**

FRIDEN 6010 COMPUTER WITH 6018 MAGNETIC DISC FILE

EMPLOYEE EARNINGS STATEMENT AND DEDUCTIONS

EMPLOYEE NO.	CHECK NO.	PERIOD ENDING	<b>Friden Inc.</b>									
02003	5714	70464	AUTOMATED CO., INC. No. 5714									
SOCIAL SECURITY NO. REG. HRS. REG. GROSS O/T HRS. O/T GROSS CONSOLIDATED GROSS			TO THE ORDER OF NORTH SIDE HARDWARE INC.									
184-28-8765 40.0 158.20 2.0 11.87 170.07			DATE 7/10/64									
MISC TAX F.I.C.A. STATE TAX SAVINGS INSURANCE MISC			PAY 114 DOLLARS AND 68CENTS ***** \$ 114.68									
20.17 6.17 1.70 3.75 2.75C 3.00 132.53			SIGNATURE									
GROSS WITH TAX F.I.C.A. STATE TAX SAVINGS INSURANCE MISC			STATE BANK ANYWHERE, U.S.A. SPECIMEN									
3885.76 507.61 140.87 38.86 37.50 27.50 30.00			SIGNATURE									
YEAR TO DATE												

**PAYROLL DEMONSTRATION**

FRIDEN 6010 COMPUTER WITH 6018 MAGNETIC DISC FILE

Fully automatic . . . Print Out from payroll register preparation

SOLD TO: NORTH SIDE HARDWARE INC. VALLEY VIEW HGTS. ROCHESTER, NEW YORK 14616		PRICE CODE 3	<b>Friden Inc.</b> SAN LEANDRO, CALIFORNIA		
SHIP TO: SUBURBAN ENTERPRISES 162 LITTLE CREEK DR. BUFFALO, NEW YORK 17203		DEMONSTRATION OF FRIDEN 6010 COMPUTER WITH 6018 MAGNETIC DISC FILE			
INVOICE NUMBER	INVOICE DATE	CUSTOMER NO.	CUST. ORDER NO.	SHIP VIA	
104732	12/08/64	1234321	XY4932A	BEST WAY	
PRODUCT CODE	QUANTITY ORDERED	QUANTITY SHIPPED	PRICE	DESCRIPTION	NET AMOUNT
1216	10	10	3.75	HANDYMANS REPAIR KIT	37.50
0472	13	13	2.50	10 OZ. CLAW HAMMER	32.50
3094	25	25	1.00	BRASS CABINET CATCH	25.00
6597	60	48	.50	MAPLE DRAWER PULL	24.00
1481	17	17	4.22	9 INCH BLOCK PLANE	
				10% SPECIAL DISCOUNT	11.90-
				3% STATE SALES TAX	3.21
				PAY THIS AMOUNT	110.31T

FRIDEN Equipment Used: 6010 Electronic Computer, 6018 Magnetic Disc File.

37

Remember:

Your local **Friden** representative has complete information regarding these applications, and many others . . . . .

Call him!

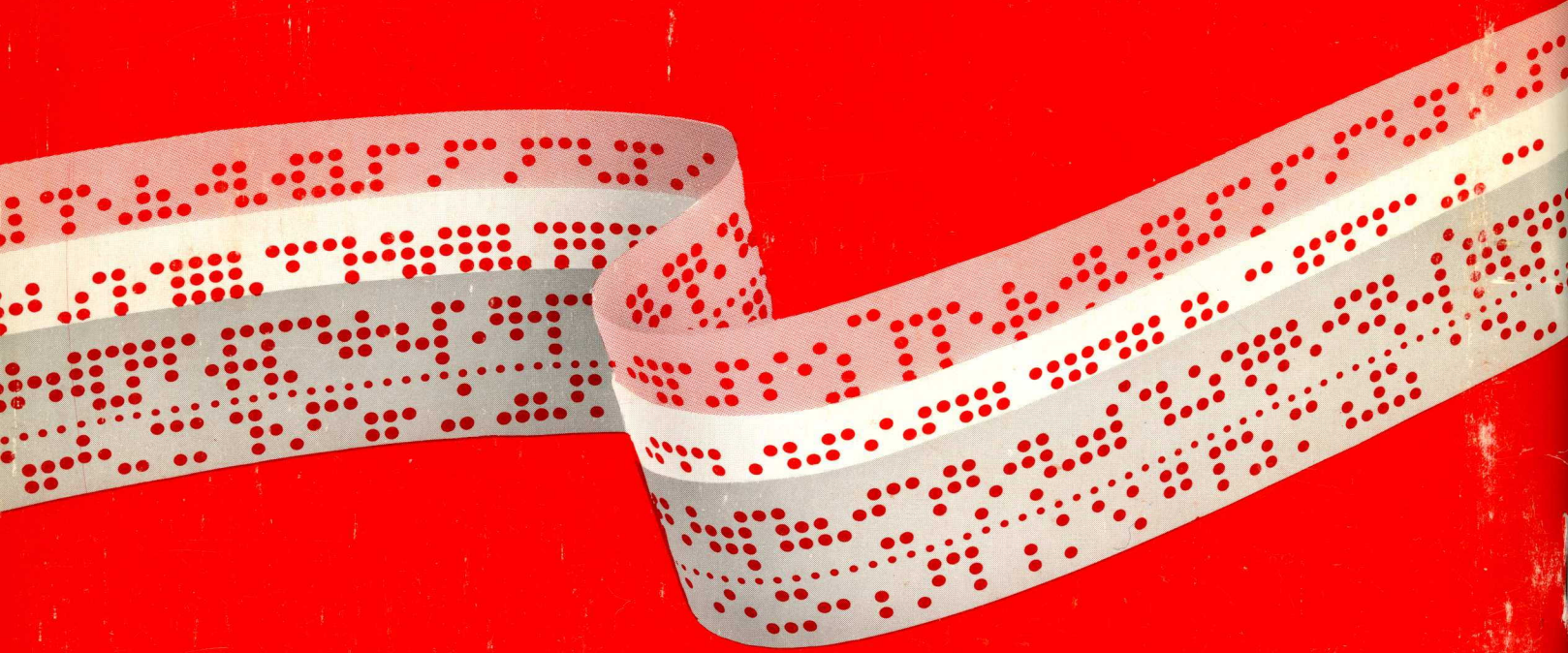

# Friden, Inc.

SAN LEANDRO · CALIFORNIA

SALES AND SERVICE THROUGHOUT THE WORLD

A SUBSIDIARY OF THE SINGER COMPANY