

Pascal 3.0 Procedure Library

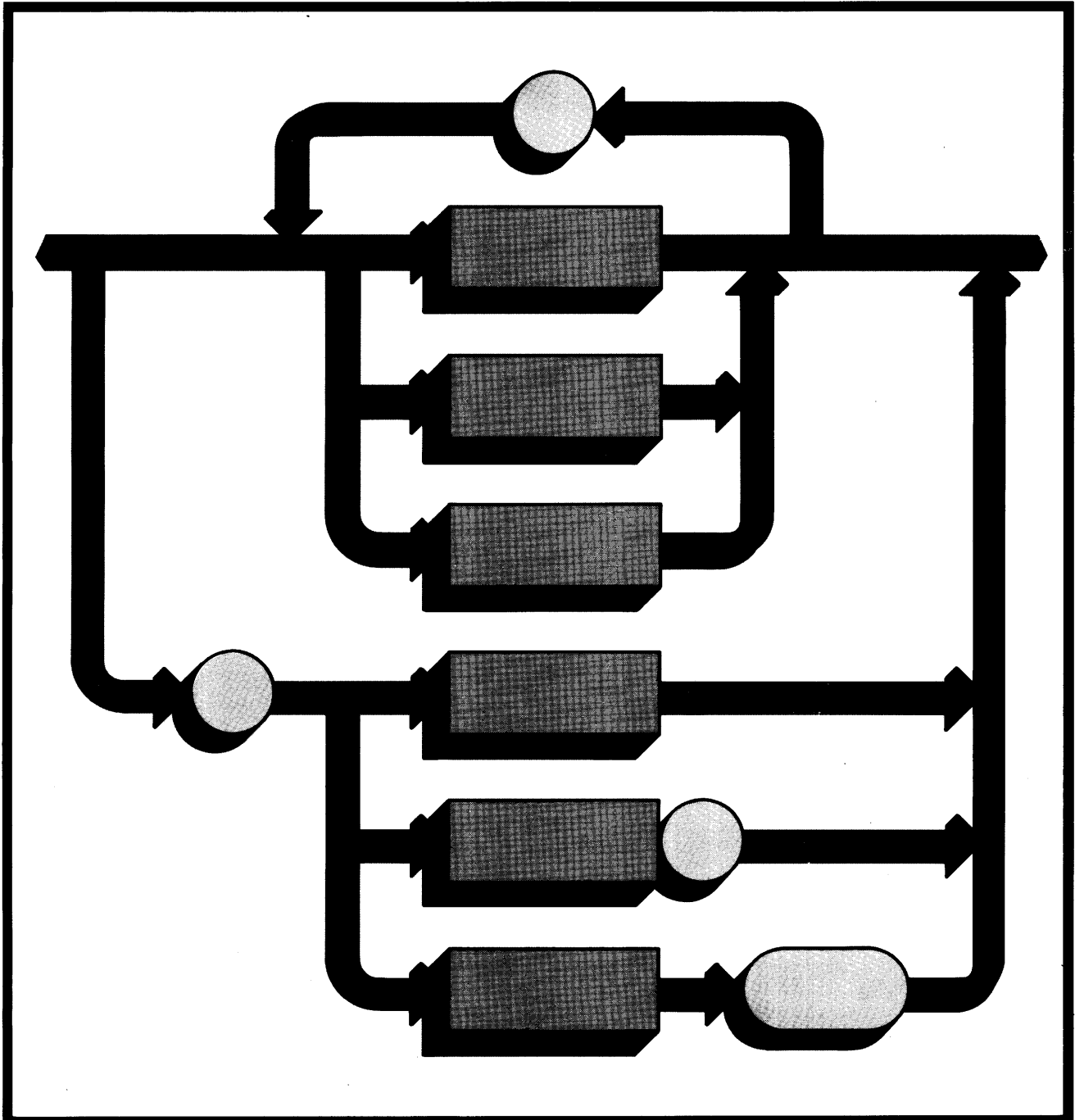

Pascal 3.0 Procedure Library

for the HP 9000 Series 200 Computers

Manual Part No. 98615-90030

© Copyright 1984, Hewlett-Packard Company.

This document contains proprietary information which is protected by copyright. All rights are reserved. No part of this document may be photocopied, reproduced or translated to another language without the prior written consent of Hewlett-Packard Company. The information contained in this document is subject to change without notice.

Use of this manual and flexible disc(s) or tape cartridge(s) supplied for this pack is restricted to this product only. Additional copies of the programs can be made for security and back-up purposes only. Resale of the programs in their present form or with alterations, is expressly prohibited.

Restricted Rights Legend

Use, duplication, or disclosure by the Government is subject to restrictions as set forth in paragraph (b)(3)(B) of the Rights in Technical Data and Software clause in DAR 7-104.9(a).

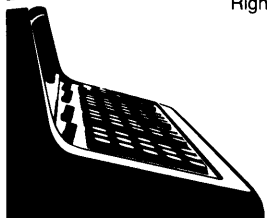

Hewlett-Packard Company
3404 East Harmony Road, Fort Collins, Colorado 80525

Printing History

New editions of this manual will incorporate all material updated since the previous edition. Update packages may be issued between editions and contain replacement and additional pages to be merged into the manual by the user. Each updated page will be indicated by a revision date at the bottom of the page. A vertical bar in the margin indicates the changes on each page. Note that pages which are rearranged due to changes on a previous page are not considered revised.

The manual printing date and part number indicate its current edition. The printing date changes when a new edition is printed. (Minor corrections and updates which are incorporated at reprint do not cause the date to change.) The manual part number changes when extensive technical changes are incorporated.

September 1984...First Edition with update.

Warranty Statement

Hewlett-Packard products are warranted against defects in materials and workmanship. For Hewlett-Packard Fort Collins Systems Division products sold in the U.S.A. and Canada, this warranty applies for ninety (90) days from the date of delivery.* Hewlett-Packard will, at its option, repair or replace equipment which proves to be defective during the warranty period. This warranty includes labor, parts, and surface travel costs, if any. Equipment returned to Hewlett-Packard for repair must be shipped freight prepaid. Repairs necessitated by misuse of the equipment, or by hardware, software, or interfacing not provided by Hewlett-Packard are not covered by this warranty.

HP warrants that its software and firmware designated by HP for use with a CPU will execute its programming instructions when properly installed on that CPU. HP does not warrant that the operation of the CPU, software, or firmware will be uninterrupted or error free.

HEWLETT-PACKARD MAKES NO WARRANTY OF ANY KIND WITH REGARD TO THIS MATERIAL, INCLUDING, BUT NOT LIMITED TO, THE IMPLIED WARRANTIES OF MERCHANTABILITY AND FITNESS FOR A PARTICULAR PURPOSE. Hewlett-Packard shall not be liable for errors contained herein or for incidental or consequential damages in connection with the furnishing, performance or use of this material.

* For other countries, contact your local Sales and Support Office to determine warranty terms.

Table of Contents

Chapter 1: Overview

Introduction	1
Prerequisites.	1
Chapter Overview	1
Chapter Previews.	2
Overview of Libraries and Modules	3
Modules and Libraries	3
The Librarian	3
Example Modules	3
Compiling and Running the Example Program	6
Setting Up Mass Storage	8
Using the Librarian	9
Overview of the Procedure Library	12
Standard LIBRARY Modules	12
The IO Modules.	14
The INTERFACE Modules.	14
The GRAPHICS Modules	15
The SEGMENTER Module	17
Building Your Own Library	18
General Recommendations	18
Specific Recommendations	18
Module Dependency Table	20

Chapter 2: Interfacing Concepts

Introduction	21
Terminology.	21
Why Do You Need an Interface?	23
Electrical and Mechanical Compatibility	24
Data Compatibility	24
Timing Compatibility.	24
Additional Interface Functions	24
Interface Overview.	25
HP-IB Interface	25
Serial Interface.	26
GPIO Interface.	26
Data Representations	27
Bits and Bytes	27
Representing Numbers.	28
Representing Characters	29
Representing Signed Integers	29
Representing Real Numbers	31

Chapter 3: The I/O Procedure Library

Introduction	33
Pascal I/O	33
I/O Library Organization	34
GENERAL	34
HP-IB	34
SERIAL	35
I/O Library Initialization	35
GENERAL Modules	36
HPIB Modules	37
SERIAL Modules	38
IODECLARATIONS Modules	38
Range of Interface Select Codes and Device Selectors	38
Information about Interface Cards	39
Other Types	42

Chapter 4: Directing Data Flow

Introduction	43
Specifying a Resource	43
Simple Device Selectors	43
Addressed Device Selectors	44

Chapter 5: Outputting Data

Introduction	45
Free-Field Output	46
Real Expressions	46
String Expressions	47
Characters	48
Words	48
Formatted Output	50
STRWRITE	50

Chapter 6: Inputting Data

Introduction	53
Free-Field Input	54
Real Variables	54
String Variables	55
Characters	56
Words	56
Skipping Data	57
Formatted Input	58
STRREAD	58

Chapter 7: Registers

Introduction	59
I/O System Registers	59
IOSTATUS Function	59
Examples	59
IOCONTROL Procedure	60
Examples	60
Common Register Definitions	60
Hardware Registers	60

Chapter 8: Errors and Timeouts

Introduction	61
Pascal Event Processing	62
TRY	62
RECOVER	63
ESCAPECODE	63
ESCAPE	63
I/O Error Handling	63
IOESCAPECODE	63
IOE_RESULT	63
IOE_ISC	64
IOERROR_MESSAGE	64
I/O Timeouts	65
Setting Up Timeout Events	65
I/O Errors	67

Chapter 9: Advanced Transfer Techniques

Introduction	69
Buffers	69
Buffer Control	70
Reading Buffer Data	70
Writing Buffer Data	71
Serial Transfers	72
Overlap Transfers	74
When Is the Transfer Finished?	74
Special Transfers	76
Word Transfer	76
Match Character Transfer	76
END Condition Transfer	76

Chapter 10: HP-IB Interface

Introduction	77
Initial Installation	78
Communicating with Devices	79
HP-IB Device Selectors	79
Moving Data Through the HP-IB	79
General Structure of the HP-IB	79
Examples of Bus Sequences	81
Addressing Multiple Listeners	82
Addressing a Non-Active Controller	82
Pascal Control of HP-IB	83
HP-IB Status	83
HP-IB Control	83
General Bus Management	84
Remote Control of Devices	84
Locking Out Local Control	85
Enabling Local Control	85
Triggering HP-IB Devices	86
Clearing HP-IB Devices	86
Aborting Bus Activity	86
Passing Control	87
Polling HP-IB Devices	87
HP-IB Interface Conditions	89
HP-IB Control Lines	90
Handshake Lines	90
Attention Line	91
The Interface Clear Line	91
The Remote Enable Line	91
The End or Identify Line	91
The Service Request Line	92
Determining Bus Line States	92
Advanced Bus Management	94
The Message Concept	94
Types of Bus Messages	94
Explicit Bus Messages	98
Summary of HP-IB IOSTATUS and IOCONTROL Registers	99
Summary of HP-IB IOREAD_BYTE and IOWRITE_BYTE Registers	103
Summary of Bus Sequences	113

Chapter 11: Datacomm Interface

Introduction	117
Prerequisites	117
Protocol	118
Data Transfers Between Computer and Interface	120
Overview of Datacomm Programming	123
Set Baud Rate	123
Set Stop Bits	123
Set Character Length	123
Set Parity	123
Example Terminal Emulator	124
Establishing the Connection	126
Determining Protocol and Link Operating Parameters	126
Using Defaults to Simplify Programming	127
Resetting the Datacomm Interface	128
Protocol Selection	128
Datacomm Options for Async Communication	129
Datacomm Options for Data Link Communication	133
Connecting to the Line	135
Connection Procedure	136
Initiating the Connection	136
Datacomm Errors and Recovery Procedures	138
Error Recovery	139
Datacomm Programming Helps	140
Terminal Prompt Messages	140
Secondary Channel, Half-duplex Communication	142
Communication Between Desktop Computers	142
Cable and Adapter Options and Functions	143
DCE and DTE Cable Options	143
Optional Circuit Driver/Receiver Functions	144
HP 98628 Datacomm Interface IOSTATUS and IOCONTROL Register Summary	145
HP 98628 Datacomm Interface IOSTATUS and IOCONTROL Registers	147

Chapter 12: RS-232 Serial Interface

Introduction	155
Details of Serial I/O	156
Baud Rate	157
Signal and Control Lines	157
Software Handshake, Parity and Character Format	158
Programming Techniques	159
Overview of Serial Interface Programming	159
Initializing the Connection	160
Transferring Data	162
Data Output	162
Data Input	163
Error Detection and Handling	163

Special Applications	165
Sending BREAK Messages	165
Redefining Handshake and Special characters	165
Using the Modem Line Control Registers	166
IOREAD_BYTE and IOWRITE_BYTE Register Operations	168
Status and Control Registers	169
Serial Interface Hardware Registers	173
Interface Card Registers	173
UART Registers	174
Cable Options and Signal Functions	177
The DTE Cable	177
The DCE Cable	178
HP 98644 Interface Differences	181
Hardware Differences	181
Pascal Differences	183
Model 216 and 217 Built-In Interface Differences	184
Hardware Differences	184
Pascal Differences	184

Chapter 13: GPIO Interface

Introduction	185
Interface Description	186
Interface Configuration	187
Interface Select Code	187
Hardware Interrupt Priority	187
Data Logic Sense	187
Data Handshake Methods	187
Interface Reset	198
Outputs and Inputs through the GPIO	199
ASCII and Internal Representations	199
Using the Special-Purpose Lines	202
Driving the Control Output Lines	202
Interrogating the Status Input Lines	202
GPIO Status and Control Registers	204
Summary of GPIO IOREAD_BYTE and IOWRITE_BYTE Registers	205
GPIO IOREAD_BYTE Registers	205
GPIO IOWRITE_BYTE Registers	207

Chapter 14: System Devices

Introduction	209
Supported Features	210
The SYSDEVS Module	211
The Example Programs	211
Interrupt Processing Overview	213
Hooking into Your System	213
Enabling Interrupts	215
System Features	216
The Beeper	217
Beeper Timing	217
The Clock	219
Direct Clock Access	222
The Timers	224
Timer Types	225
Timer Operations	225
Using a Timer	226
A Typical Timer ISR	227
Multi-Timer Example	228
Using the Periodic Timer	230
System Timer Example	232
The Display	234
Determining Display Type	234
Display States	235
Display Parameters	236
Changing Display Parameters	237
Controlling the Cursor	238
Dumping the Display	238
The Last Line	240
The Menus	242
The Status Area	243
The Runlight	244
The Debugger Window	245
The Keyboard	250
The Keyboard Hooks	251
Keyboard Request Hook	251
Keyboard ISR Hook	253
Keyboard Poll Hook	254
The Keybuffer	256
Keybuffer Control	257
Keybuffer I/O Hooks	257
Key Translation Services	259
The Translation Hook	259
Modifying the Language Table	262
The Knob	264
Keyboard Hardware	266
Key-Actions	270
Typing Aids Program	273

Powerfail	282
Battery Features	282
Powerfail Behavior	283
Powerfail Real-Time Clock	283
Non-Volatile RAM	284
Interface to the Host CPU	284
Commands to the Battery	285
SYSDEVS Listing	288
Chapter 15: Segmentation Procedures	
Introduction	295
A Word to the Wise	295
Using SEGMENTER Procedures	296
SEGMENTER Procedure Descriptions	297
SEGMENTER Initialization	297
Segmentation Free Space	297
Segmentation Using the Stack	297
Searching for a Procedure Name	300
Checking a Procedure Variable	300
Loading into the Explicit Code Area	301
Loading a Segment onto the Heap	302
Unloading a Segment	303
Unloading All Segments	303
SEGMENTER Errors	304
Procedure Library Summary	
I/O Procedures	305
Graphics Procedures	306
Procedure Library Reference	307
Introduction	307
Glossary	527

<h1>Overview</h1>	Chapter
	1

Introduction

This manual describes the procedures, functions, constants, and types provided by the Pascal Procedure Library. It also presents several examples of how to use them in Pascal programs.

The manual is divided into two major parts.

- The first part (Chapters 1 thru 15) is organized by topics. It explains particular programming concepts rather than individual procedures and functions.
- The second part (the Library Reference) is an alphabetical listing of the individual procedures and functions, showing syntax and semantic information for each.

Prerequisites

In order to successfully use this manual, you must understand the concept of *modules*. This chapter provides an overview of modules. (It is essentially a duplication of the first seven pages of the Librarian chapter in the *Pascal Workstation System* manual.) For a more complete description of modules, read the Modules section of the Compiler chapter in the *Pascal Workstation System* manual (about 10 pages of text).

Chapter Overview

The remainder of this chapter contains these sections:

- A preview of each remaining chapter in this manual.
- A general overview of using library modules.
- A description of the modules provided by the Procedure Library.
- Recommendations for building your library.

Chapter Previews

Here are brief descriptions of the rest of the chapters in this manual. There are also recommendations as to which you may need to read.

Chapter 2: Interfacing Concepts This chapter presents a brief explanation of relevant interfacing concepts and terminology. This discussion is especially useful for beginning I/O programmers, as it covers much of the why and how of interfacing. Experienced programmers may also want to skim this material to better understand the terminology used in this manual.

Chapter 3: I/O Procedure Library This chapter presents an introduction to the I/O Procedure Library. It describes the organization of the I/O library, its major capabilities, and examples of its use. All I/O programmers should read this chapter.

Chapter 4: Directing Data Flow This chapter describes how to specify which computer resource is to receive data from or send data to the computer by using select codes and device selectors.

Chapter 5: Data Input This chapter describes methods of sending data to devices. Examples of free-field and formatted output are given. You may be able to skip sections of this chapter, depending on your application.

Chapter 6: Data Output This chapter describes methods of receiving data from devices. Examples of free-field and formatted input are given. As with the preceding chapter, you may be able to skip sections of this chapter, depending on your application.

Chapter 7: Registers This chapter describes the purposes of interface registers and how to use them. Both the hardware and firmware registers are described in general. Specific interface register definitions are given in the corresponding chapter.

Chapter 8: Errors and Timeouts This chapter describes what you need to do in order to handle and recover from error and timeout conditions.

Chapter 9: Advanced Transfer Techniques This chapter discusses the high-performance transfer methods provided in the I/O library. These methods use “buffered” transfer mechanisms; they include interrupt, fast-handshake, and direct-memory access (DMA) transfer methods.

Chapter 10: HP-IB Interface This chapter describes programming techniques specific to HP-IB interfaces. Details of HP-IB communications processes are also included to promote better overall understanding of how this interface may be used. This discussion is valid for the built-in HP-IB interface, as well as for the optional HP 98624 HP-IB and 98625 High-Speed Disc interfaces.

Chapter 11: Data Communications Interface This chapter describes programming techniques specific to the HP 98628 Data Communications (or “Datacomm”) interface.

Chapter 12: RS-232C Serial Interface This chapter is a programming techniques discussion of the HP 98626 and 98644 RS-232C Serial interfaces.

Chapter 13: GPIO Interface This chapter describes techniques specific to programming the HP 98622 General-Purpose Input/Output (GPIO) interface.

Chapter 14: System Devices This chapter describes using the operating system module named SYSDEVS to access the built-in “system devices” such as the keyboard, display, clock, and beeper; it also describes how to access optional devices such as powerfail protection.

Chapter 15: Segmentation Procedures This chapter describes the procedures that provide the capability of segmenting programs at run-time.

Overview of Libraries and Modules

This section presents some important terms and concepts you will need to know in order to understand and use modules, and discusses how to use some general example modules. The subsequent section describes the modules provided in the Pascal Procedure Library.

Modules and Libraries

Modules declare procedures, functions, constants, and types. Once these objects have been declared, you can use them in your programs by importing them. (You will see examples momentarily.)

Libraries are *object files*. They contain zero or more *object modules*. Object modules are the product of the Compiler or Assembler¹. For instance, compiling a Pascal source module generates an object module which is placed in an object file. This file is actually a library, because it contains an object module. An object file (library) is composed of a *directory* of names of the module(s) that it contains, followed by the object modules themselves.

The Librarian

The purpose of the Librarian subsystem is to manage object modules. The Librarian can also produce object files; however, these files consist of object modules produced by the Compiler or Assembler. It can create library files and add modules to them or remove modules from them. Library files are intended to provide a convenient location to store object modules.

Example Modules

For this example, we will be using three example library modules provided on the DOC: disc shipped with your system. One contains a compiled program (PROG_1.CODE), and the other two contain compiled modules (MOD_2.CODE and MOD_3.CODE).

The DOC: disc also contains the source versions of these modules. Although this chapter will only be dealing specifically with the object versions, it is a good learning experience to compile the source versions to see how the Compiler deals with imported modules. One method is briefly outlined in the next section.

¹ Complete descriptions of how to produce and use Pascal and Assembler modules are provided in the Compiler and Assembler chapters of the *Pascal Workstation System* manual.

4 Overview

Here are source listings and brief explanations of each of the example modules.

Source Listing of PROG_1.CODE

```
PROGRAM ProgramOne(OUTPUT);

IMPORT ModuleTwo;

BEGIN
    WRITELN;
    WRITELN;
    WRITELN('***** ProgramOne *****');
    TwoLines;
    WRITELN('***** ProgramOne *****');

END.
```

The example program imports ModuleTwo, which declared the procedure named TwoLines. Here is the source of ModuleTwo, which was compiled and stored in the library (object-code) file named MOD_2.CODE.

Source Listing of MOD_2.CODE

```
MODULE ModuleTwo;

IMPORT ModuleThree;

EXPORT
    PROCEDURE TwoLines;

IMPLEMENT

    PROCEDURE TwoLines;
        BEGIN
            WRITELN('I came from ModuleTwo and brought this:');
            ThirdLine;
        END;

END.
```

ModuleTwo exports procedure TwoLines, which is used by ProgramOne. It also imports ModuleThree, which declares procedure ThirdLine and is in the library (object-code) file named MOD_3.CODE.

Source Listing of MOD_3.CODE

```

MODULE ModuleThree;

EXPORT
  PROCEDURE ThirdLine;

IMPLEMENT

  PROCEDURE ThirdLine;
  BEGIN
    WRITELN('I came from ModuleThree');
  END;

END.
```

This module exports procedure ThirdLine, which is imported by ModuleTwo. Notice that it does not import any modules.

Here are the results of running the program.

```

***** ProgramOne *****
I came from ModuleTwo and brought this:
I came from ModuleThree
***** ProgramOne *****
```

Here is what happens when you run ProgramOne. First, ProgramOne prints two blank lines and then the line of asterisks that contains its name. The procedure TwoLines, imported from ModuleTwo, is then called; it prints the message: I came from ModuleTwo and brought this:. Procedure ThirdLine, imported from ModuleThree, is then called; it prints the message: I came from ModuleThree. Control is then returned to TwoLines and then to the program, which again prints out its name in asterisks.

Let's take a look at what is needed in order for you to compile and run the program.

Compiling and Running the Example Program

When a program (or module) imports modules, the imported modules must be accessible at two times:

- When the program is compiled.
- When the program is loaded and run.

Let's take a look at what happens at these two times.

How the Compiler Finds Imported Modules

At compile time, the Compiler searches for each module imported by the source program (or module); more specifically, it searches to find each module's "interface text." Here is the order of the places where the Compiler looks in search of interface text:

1. In the source text being compiled. (The source text of modules and programs can be combined into one source file, as long as the modules precede the program and are in proper sequence.)
2. In an object file specified in a SEARCH Compiler option.
3. In the object file currently designated as the System Library.

A module's interface text consists of the following: the MODULE name; the IMPORT section, if present; and EXPORT section. These sections are part of the object module produced when the module was compiled or assembled. See the Compiler or Assembler chapters of the *Pascal Workstation System* manual for a more complete description of interface text.

The System Library is a special library file that is automatically used by the system. The default System Library is the file named "LIBRARY" found on the system volume at power-up. You can also change it with the What command and the Main Command Level.

How these Modules and Program Were Compiled

Here is a strategy (and the method actually used) for compiling these source modules and program. (Note that you will be learning these Librarian operations later in this section, so you will probably not want to perform this compilation exercise until *after* working through the examples using the object modules and program.)

1. Compile ModuleThree first (MOD_3.TEXT); call it MOD_3.CODE for simplicity. Since this module does not import any others, it will be compiled with no need to search for any imported module's interface text.
2. Use the Librarian to add the resultant object module (MOD_3.CODE) to the library file currently designated as the System Library. (Actually, you will be creating a new library into which you will place ModuleThree and the modules currently in the System Library; this type of operation is subsequently explained in this chapter.)
3. After merging these two libraries (into a third new library), you will need to do one of two things: use the What command to make the resultant library the System Library; or use the Filer to change the resultant library's name back to the name of the current System Library.
4. Next, compile ModuleTwo (MOD_2.TEXT); call it MOD_2.CODE. The external references to ModuleThree will be resolved when the Compiler finds the object ModuleThree in the System Library.

5. Then place this compiled module in the System Library as in steps 2 and 3.
6. Compile the program (PROG_1.TEXT). Since both object modules upon which this program depends are in the System Library, they will be accessed automatically by the Compiler when the program is compiled.
7. Run the program. The loader automatically looks in the System Library in order to resolve the external references; it loads the modules required to complete the program (in this case, ModuleTwo and ModuleThree).

Since the program and modules have already been compiled and the object files placed on the DOC: disc, we will not discuss other alternatives of making the source files accessible to the Compiler. (However, you are again encouraged to do this after learning how to use the Librarian. See the Compiler chapter of the *Pascal Workstation System* manual for details.)

Let's look now at how the loader finds imported object modules when the program is to be loaded for execution.

How the Loader Finds Imported Modules

Since a compiled program contains no record of where the Compiler found the imported modules, the loader must (by itself) find the imported object modules at load time. Here is the order of the places where the loader looks:

1. Modules that are part of the object file being loaded.
2. In modules already P-loaded in memory, which includes all INITLIB and Operating System modules. (The loader searches for these modules in reverse order to which they were P-loaded; in other words, the most-recently loaded modules are searched first.)
3. In the current System Library file.

In order to make all imported modules part of the object file that uses them (alternative 1 shown above), you have two choices:

- Combine the source modules into one *source* file (and compile it). You can use the Editor to add each imported module's source file to the source program. You can also use an INCLUDE Compiler option in the source program to include each imported module's source file in the compilation of the program.
- Combine the object modules into one *object* file. Use the Librarian to combine the program and imported modules into one object file; you can optionally Link the modules to save space.

With both of these methods, only the file containing the program need be loaded; and when the program is finished, the memory used by the modules can be reclaimed for other purposes. With P-loaded modules, this is not possible (without re-booting).

If you want to P-load modules to make them accessible to the loader (alternative 2 shown above), you will only need to P-load all modules which are not in one of the three places stated above. In the example modules already given, ProgramOne imports ModuleTwo, and ModuleTwo imports ModuleThree. In the second example that follows, you will be creating a library that contains these two modules and then P-loading the library. (You can alternatively P-load MOD_3.CODE and MOD_2.CODE, in that order, which does not require use of the Librarian.) The loader will then be able to link the modules contained in the library to any program that imports them at execution time.

In general, the most convenient way to use modules is to place them in the file that is currently designated as the “System Library” (alternative 3 shown above). This is probably the most common reason for using the Librarian. In the example that follows, you will add modules ModuleTwo and ModuleThree to the LIBRARY file and then run the program.

Setting Up Mass Storage

With some larger applications, you will need two on-line mass storage volumes when using the Librarian. If you only have one volume in your system, you may need to set up a memory volume. This discussion tells why two volumes may be needed and then outlines how to estimate the size of the volumes required.

When you combine the object modules in two libraries using the Librarian, you actually create a third (new) library and then copy into it the desired modules from the other two libraries. For instance, suppose that you want to add all of the CONFIG:GRAPHICS modules to the SYSVOL:LIBRARY file. You will first create a new library file, and then add the existing LIBRARY modules and the GRAPHICS modules to this new library. The volume on which this new library exists must *not* be taken off-line during the entire process.

Thus, two separate volumes are often necessary for these two reasons:

- The sum of *all* source libraries plus the new destination library often exceeds the capacity of one volume.
- The destination volume must *not* be taken off-line during this entire operation.

Continuing with our example, here is the total amount of space of on-line mass storage required for the operation (assuming you have only *one* disc drive).

- All modules in the standard LIBRARY file: approximately 64 sectors
- All modules in the standard GRAPHICS file: approximately 808 sectors
- The new library file: *roughly* the sum of 64 and 808 sectors

The grand total is over 1740 sectors (over 446 Kbytes). If you only have one mini disc drive with capacity of about 1050 sectors (about 270 Kbytes), then you will need two volumes for the process; the second volume will be a memory volume.

In this case, you could create a memory volume with a specified size of 500 blocks, or 250 Kbytes. (Note that memory volume blocks are 512 bytes each, while mini-disc sectors are 256 bytes each. See the Memvol command in the Overview chapter for more specific details on creating memory volumes.)

It is usually more convenient to use the memory volume as the destination volume, since that volume cannot be taken off-line.

The following examples assume that either you have two disc volumes on-line or that you have created a memory volume of sufficient size. For these examples, a memory volume of 500 blocks is sufficient.

Using the Librarian

The Librarian is provided on the ACCESS: disc shipped with the system. To use the Librarian, you will first need to put it on-line: either place the disc labeled ACCESS: in a drive, or copy the LIBRARIAN file to another location (such as a hard disc) and use the What command (at the Main Command Level) to specify this copy as the system Librarian. After doing either of these, pressing **L** directs the system to load and execute the LIBRARIAN file.

Here is the Librarian's main prompt:

```

Librarian [Rev. 3.0 15-APR-84]          1-May-84  8:11:58

Q Quit
P Printout OFF PRINTER:LINK.ASC
O      Output file: (none)
B write to Boot disk
H file Header maximum size:           38

I      Input file: (none)

Copyright 1984 Hewlett-Packard Company,
command?

```

The commands shown on the left-hand side of the screen are invoked by pressing the corresponding key.

Adding Modules to the System Library

A common way to use library modules is to add them to the current System Library file. Let's assume that it is the file named LIBRARY for present purposes, although you can change it to any file by using the What command at the Main Command Level. The general steps in the procedure used to add modules to LIBRARY are the same as those used to add modules to almost any library.

Here is a brief summary of the steps required:

1. Make a new library file, and copy into it all of the modules currently in LIBRARY.
2. Add ModuleThree and ModuleTwo to the new file (in this case the order of modules is arbitrary, since the loader will load them in the right order).
3. Replace the LIBRARY file with this new file.
4. Execute the program, and the modules are loaded automatically for you.

A more detailed procedure is given below.

1. Invoke the Librarian. This is done by pressing from the Main Command Level. (If the Librarian is not on-line, insert the ACCESS: disc and try again. Remove the ACCESS: disc once the Librarian has loaded.) Now use the Librarian to create the new library.
2. Put the SYSVOL: disc (or the one containing the LIBRARY file) in the #3 drive. Press and then type #3:LIBRARY, and press or to enter the Input file. You must include a trailing period to prevent the Librarian from appending the .CODE suffix.

When the Librarian finds the Input file, the display will show the name of the first module in the file. (You should see the module named RND if you have not yet modified the LIBRARY file.) If you have a printer, you can press to list all of the modules in the Input library.

3. (For this example, we will assume that you are using unit #4 as the second volume; however, if the LIBRARY file is small enough, you can also put the new library file on drive #3. We will also assume that the destination volume has enough room for the new library file.)

Press and enter #4:NEWLIB, as the Output file. Again, a trailing period prevents the .CODE suffix from being appended to the file name. If you are using a memory volume, use the unit number of the memory volume.

(If you are using a disc, this disc must *not* be removed until you have finished creating the new NEWLIB file.)

4. Press to enter the Edit mode. You should now see this prompt (in the middle of the screen):

```
F First module: RND
U Until module: (end of file)
```

5. You can now transfer all modules in the Input file to the Output file, including the last module, by pressing (for Copy).
6. When the preceding transfer is complete, press to append a module to the NEWLIB Output file. The Librarian prompts with Input file:. Put the DOC: disc, or whichever disc now contains ModuleThree, in Unit #3 (*not* #4, which must **not** be removed). Enter #3:MOD_3 as the Input file.

7. The Librarian now prompts with Enter list of modules or = for all. Enter = for all. After ModuleThree has been transferred to the NEWLIB library, the Librarian prompts with Append done, <space> to continue. Press the spacebar to clear the prompt.

Now use steps 6 and 7 again to copy ModuleTwo (in file MOD_2.CODE) into the NEWLIB file.

8. Now that all modules have been added to the NEWLIB file, press to stop editing and to keep the file.
9. You should now verify that the modules were indeed copied to the Output file. Press and enter #4:NEWLIB, as the Input file. Press the spacebar repeatedly to scan through the modules in the new library file. If you have a printer, press to get a File Directory listing.
10. If all modules are present, then press to Quit the Librarian.

11. Now you have one of two options to make this library the System Library: you can use the What command at the Main Level to specify the file named NEWLIB (on the destination volume) to be the System Library; or you can replace the LIBRARY file on the SYSVOL: disc with this file. If you choose the second option, it is probably better to keep the current copy of LIBRARY on the disc; you should first Change its name to something like OLDLIB and then Filecopy the NEWLIB file onto the SYSVOL: disc, changing its name to LIBRARY.
12. Make sure that the System Library file is on-line, and then eXecute or Run the program.

As the program is loaded, the imported modules will also be loaded automatically. Here are the results of running the program.

```
***** ProgramOne *****
I came from ModuleTwo and brought this:
I came from ModuleThree
***** ProgramOne *****
```

After the program has completed execution, the memory used by both program and modules can be used for other purposes.

As you can see, the System Library is a special library of object modules that is automatically accessed by the linking loader at program execution time (and by the Compiler at compile time). Because of this automatic access, you do not need to use the Permanent-load command to make this library's contents accessible to the loader. And also because of this automatic access, the System Library is generally used to store those modules often used in your programs.

Using modules in the Procedure Library is similar to using these example modules. Now that you know how to use modules, let's look at the specific library files and modules provided with your system.

Overview of the Procedure Library

The modules supplied with the Pascal system provide the following general categories of procedures:

- Standard procedures
- I/O procedures
- Graphics procedures
- Segmentation procedures

Standard LIBRARY Modules

The SYSVOL:LIBRARY file contains the “standard” library modules. It is a small collection of modules which contain general support procedures and functions for your programs. It has been made small in order to conserve disc space; however, you can easily add modules to it.

The following modules are contained in the standard LIBRARY file; using each module is described momentarily. (The listing was generated by using the Librarian’s ‘File directory’ command).

```
Librarian [Rev. 3.0 15-APR-84]      30-APR-84 12: 0:48      Page 1

FILE DIRECTORY OF: 'LIBRARY'

   1 RND                6 15-APR-84      3
   2 HPM                8 15-APR-84      9
   3 UIO                7 15-APR-84     17
   4 LOCKMODULE        7 15-APR-84     24
```

The first column indicates the ordinal number of the module; for instance, UIO is the third module in this library file. (The second column shows the module’s name.)

The third column indicates the size of the module (in 256-byte sectors).

The fourth column indicates the date the module was produced.

The fifth column shows the sector offset. RND has an offset of 3; since it has a size of 6 sectors, HPM has an offset of 9 sectors.

Using RND

Module RND must be imported when you use the random number generator. The random number generator is described in the Library Reference section of this manual under the entries RAND (a function) and RANDOM (a procedure).

As with most other modules, RND must be accessible at two times: when compiling and when running programs that import it. If it is in the System Library file at compile time and at run time, then it will be accessed automatically; see the preceding discussions of how the Compiler and loader find modules for the other alternatives.

In addition, RND imports the SYSGLOBALS module. This module was effectively P-loaded at boot time (it is part of the standard INITLIB file), so you will not need to do anything to make it accessible to the *loader*. However, the *Compiler* still needs to search the module's interface text, so you will need to make the interface text accessible to the Compiler. The interface text is in the CONFIG:INTERFACE file, and you can make it accessible in either of two ways: use a SEARCH Compiler option in your program, or add the SYSGLOBALS module to the current System Library file.

Using HPM

Module HPM provides the DISPOSE, NEW, MARK, and RELEASE procedures for managing dynamic variables in the heap. Techniques for using these procedures are described in the Heap Management section of the Compiler chapter of the *Pascal Workstation System* manual. Precise descriptions of syntax and semantics for the procedures is in the *HP Pascal Language Reference for Series 200 Computers*.

The HPM module needs never be imported, because its procedures are “Compiler intrinsics;” thus, it does not need to be accessible to the Compiler while compiling programs that use its procedures. However, it needs to be accessible to the loader at run time if you are using the \$HEAP_DISPOSE ON\$ Compiler option. In order to make it accessible to the loader, you can do one of three things: combine the object module with the object program (or module) that imports it; P-load the module; or add it to the current System Library.

For further details regarding the use of the HEAP_DISPOSE Compiler option, see the Compiler chapter of the *Pascal Workstation System* manual.

Using UIO

Module UIO provides the low-level “unit I/O” capabilities: UNITBUSY, UNITCLEAR, UNITREAD, UNITWAIT, and UNITWRITE. With these utility procedures and functions, you can read and write data on sectors of blocked devices which have been assigned unit numbers in the File System. For further details on these Unit I/O operations, see the Workstation Implementation section of the *HP Pascal Language Reference for Series 200 Computers*.

The UIO module need never be imported, because it is a “Compiler intrinsic;” thus, it does not need to be accessible to the Compiler while compiling programs that use its procedures and functions. However, it does need to be accessible to the loader at run time. You can do one of three things: combine the object module with the object program (or module) that imports it; P-load the module; or add it to the current System Library.

Using LOCKMODULE

LOCKMODULE provides locking capabilities for 'lockable' files. File locking operations are described in the SRM Concurrent File Access section of the File System chapter in the *Pascal Workstation System* manual.

LOCKMODULE must be imported if you use the file locking operations on LOCKABLE files. As with most other modules, it must be accessible at two times: when compiling and when running programs that import it. If it is in the System Library file at compile time and at run time, then it will be accessed automatically; see the preceding discussions of how the Compiler and loader find modules for the other alternatives.

The IO Modules

The file named IO on the LIB: disc contains modules that provide I/O procedures and functions. The bulk of this manual describes using the IO library. The Library Reference section of this manual lists the module(s) you must IMPORT for each procedure and function.

If you are using I/O procedures and functions in your programs, then the modules which declare those procedures and functions must be accessible to the Compiler and loader. If the modules are in the System Library, then they will automatically be accessed; for alternative methods of making them accessible, see the beginning of this chapter.

The modules contained in IO are shown in the following 'File directory' listing generated by the Librarian.

```
Librarian [Rev. 3.0 15-APR-84]      30-APR-84  11:52:17      Page 1
```

```
FILE DIRECTORY OF: 'IO'
```

1	IODECLARATIONS	17	15-APR-84	1
2	GENERAL_0	3	15-APR-84	18
3	IOLIBRARY_KERNE	1	15-APR-84	21
4	IOCOMASM	3	15-APR-84	22
5	GENERAL_1	8	15-APR-84	25
6	HPIB_1	10	15-APR-84	33
7	GENERAL_2	10	15-APR-84	43
8	GENERAL_3	9	15-APR-84	53
9	GENERAL_4	14	15-APR-84	62
10	HPIB_0	6	15-APR-84	76
11	HPIB_2	9	15-APR-84	82
12	HPIB_3	8	15-APR-84	91
13	SERIAL_0	9	15-APR-84	99
14	SERIAL_3	11	15-APR-84	108

The INTERFACE Modules

The INTERFACE file on the CONFIG: disc contains modules comprised of *only* the interface text of several operating system modules. (The interface text of a module consists of the MODULE name; the IMPORT section, if present; and the EXPORT section. It is used by the Compiler when compiling programs that depend on the module.) The INTERFACE file is provided so that your programs can import modules which in turn import these operating system modules (since the interface text of operating system modules is not otherwise accessible).

For instance, the SYSGLOBALS module is imported by most of the IO modules; so when compiling programs that import an IO module, the SYSGLOBALS module's interface text must be accessible to the Compiler. To make it accessible to the Compiler, either add the module to the System Library or specify the INTERFACE library file in a SEARCH Compiler option.

The modules contained in INTERFACE are as follows:

Librarian [Rev. 3.0 15-APR-84] 30-APR-84 11:53:49 Page 1

FILE DIRECTORY OF: 'INTERFACE'

1	ASM	5	15-APR-84	2
2	SYSGLOBALS	16	15-APR-84	7
3	MINI	2	15-APR-84	23
4	BOOTDAMMODULE	2	15-APR-84	25
5	LOADER	14	15-APR-84	27
6	INITLOAD	1	15-APR-84	41
7	ISR	2	15-APR-84	42
8	MISC	4	15-APR-84	44
9	FS	10	15-APR-84	48
10	INITUNITS	2	15-APR-84	58
11	LDR	2	15-APR-84	60
12	SETUPSYS	1	15-APR-84	62
13	SYSDEVS	15	15-APR-84	63
14	SYSDEVICES	1	15-APR-84	78
15	AB04XDVR	2	15-APR-84	79
16	AB04XINIT	1	15-APR-84	81
17	CI	4	15-APR-84	82
18	CMD	1	15-APR-84	86

Note

From a technical standpoint, the availability of this interface text gives you the ability to import these modules in your own programs. However, from a practical standpoint, the only module described enough to allow you to import it is the SYSDEVS module, which is discussed in the System Devices chapter.

The GRAPHICS Modules

The GRAPHICS file on the LIB: disc contains modules that provide graphics procedures and functions. The FGRAPHICS file on the FLTLIB: disc provides the same set of procedures and functions, but they have been optimized for use with the HP 98635 Floating-Point Math card. (The FGRAPHICS modules have been compiled with the \$FLOAT_HDW TEST\$ Compiler option, which increases the performance of graphics routines by using the HP 98635 Floating-Point Hardware card, if present. The GRAPHICS modules also use the card, if present, but the overhead of calling the normal math library routines, which then test for the card, does not provide the maximum performance.)

Graphics concepts and programming are explained in the *Pascal Graphics Techniques* manual.

The modules contained in GRAPHICS are as follows:

Librarian [Rev. 3.0 15-APR-84] 30-APR-84 11:55:57 Page 1

FILE DIRECTORY OF: 'GRAPHICS'

1	GLE_AUTL	6	15-APR-84	3
2	GLE_UTLS	8	15-APR-84	9
3	GLE_TYPES	22	15-APR-84	17
4	GLE_STROKE	7	15-APR-84	39
5	GLE_STEXT	7	15-APR-84	46
6	GLE_ASTEXT	6	15-APR-84	53
7	GLE_SMARK	7	15-APR-84	59
8	GLE_SCLIP	5	15-APR-84	66
9	GLE_ASCLIP	7	15-APR-84	71
10	GLE_FILE_IO	7	15-APR-84	78
11	GLE_HPIB_IO	13	15-APR-84	85
12	GLE_HPGL_OUT	20	15-APR-84	98
13	GLE_HPGL_IN	12	15-APR-84	118
14	GLE_RAS_OUT	16	15-APR-84	130
15	GLE_ARAS_OUT	21	15-APR-84	146
16	GLE_KNOB_IN	9	15-APR-84	167
17	GLE_GEN	13	15-APR-84	176
18	GLE_GENI	6	15-APR-84	189
19	DGL_TYPES	5	15-APR-84	195
20	DGL_VARS	17	15-APR-84	200
21	DGL_IBODY	7	15-APR-84	217
22	DGL_AUTL	7	15-APR-84	224
23	DGL_TOOLS	6	15-APR-84	231
24	DGL_GEN	21	15-APR-84	237
25	DGL_RASTER	18	15-APR-84	258
26	DGL_HPGL	11	15-APR-84	276
27	DGL_CONFIG_OUT	13	15-APR-84	287
28	DGL_KNOB	8	15-APR-84	300
29	DGL_HPGLI	7	15-APR-84	308
30	DGL_CONFIG_IN	8	15-APR-84	315
31	DGL_LIB	40	15-APR-84	323
32	DGL_POLY	26	15-APR-84	363
33	DGL_INQ	14	15-APR-84	389

If you are using *any* of the graphics procedures and functions in your programs, then *all* GRAPHICS modules through DGL_LIB (i.e., the first 31 of the preceding modules) must be accessible at compile time and at load time. Module DGL_POLY is only needed if you use procedures that work with polygons. Module DGL_INQ is only needed if you use the INQ_WS procedure.

If the modules are in the System Library, they will be accessed automatically; for alternative methods of making these modules accessible, see the beginning of this chapter.

The SEGMENTER Module

The SEGMENTER file on the CONFIG: disc contains the SEGMENTER module that provides procedures which allow you to dynamically (programmatically) load, execute, and unload program segments. For instance, you can use these procedures to segment and run programs in a minimum amount of memory; however, note that it sometimes requires some very clever programming to accomplish this type of feat. Examples of these procedures are given in the Segmentation Procedures chapter of this manual.

Here is a 'File directory' listing of the SEGMENTER library file, produced by the Librarian.

```
Librarian [Rev. 3.0 15-APR-84]    30-APR-84 11:58: 2    Page 1
```

```
FILE DIRECTORY OF: 'SEGMENTER'
```

```
  1 ALLOCATE           5 15-APR-84    1
  2 SEGMENTER         11 15-APR-84    6
```

Module SEGMENTER must be imported in order to use the segmentation procedures. Module ALLOCATE is only the initialization program for module SEGMENTER, so you will not be importing it.

As with importing most other modules, SEGMENTER must be accessible at two times: when compiling and when running programs that import it. If it is in the System Library file at compile time and at run time, then it will be accessed automatically; see the beginning of this chapter for alternative methods of making it accessible.

Building Your Own Library

In general, placing modules in the System Library is the simplest way of making modules accessible to the Compiler and loader. This section gives both general and specific recommendations about adding modules to this file. This is the primary method of using modules that is described in this section. Other methods (such as adding object modules to an object program's file) were described in the beginning of this chapter and in the Compiler chapter of the *Pascal Workstation System* manual.

General Recommendations

Only a few modules have been placed in the standard LIBRARY file in order to conserve disc space. You will probably want to add to it the modules you will be using.

If You Have Large Mass Storage Volumes

If you have a mass storage volume with sufficient capacity (such as a hard disc, an SRM system, or a dual-sided micro floppy), then you should add to the LIBRARY *all* the modules in IO, GRAPHICS, and INTERFACE. That way you will never have to worry about whether or not any module is accessible.

If You Have Smaller Volumes

If you are using a 5.25-inch disc (with 270-Kbyte capacity) as the system volume, then all of the modules in the LIBRARY, IO, GRAPHICS, and INTERFACE files will *not* fit on your disc. However, this should only be a problem if you are using *both* GRAPHICS and IO modules. (The LIBRARY, IO, and INTERFACE files will easily fit on one disc). More specific recommendations follow.

Specific Recommendations

If you really want to conserve space, you should add to the System Library file *only* the modules you need to import in order to use procedures in programs and modules. Here are the steps you will be taking:

1. Make a list of the procedures you will be using.
2. Make a list of the modules that need to be imported in order to use these procedures. You will find this information in the Procedure Library Reference description of each procedure (at the back of this manual).
3. Make a list of the modules upon which the imported modules depend. You will find this information in the following Module Dependency Table. For instance, most Procedure Library modules depend on the SYSGLOBALS (Operating System) module.

If possible, you should use an alternate method of accessing the modules upon which the imported modules depend; for example, use a SEARCH Compiler option to make the interface text of the SYSGLOBALS module accessible to the Compiler.

4. Create a new System Library file, and add to it only the necessary modules.

Here are specific recommendations for how to make modules from each of the files in the Procedure Library accessible to the Compiler or loader.

Making INTERFACE Modules Accessible

You can save quite a bit of disc space by not adding the INTERFACE modules to your System Library. Since INTERFACE modules are only used by the Compiler, you can make them accessible by merely specifying the INTERFACE file in a SEARCH Compiler option.

Making LIBRARY Modules Accessible

You can remove the module(s) that you are not using from the standard LIBRARY file.

If you will be using the standard LIBRARY modules named RND or LOCKMODULE, then module SYSGLOBALS must also be accessible; again, you can use a SEARCH Compiler option to tell the Compiler where to look for the module's interface text.

Making IO Modules Accessible

If you are using any IO modules, then you should have in your System Library only the following modules: IODECLARATIONS; the modules that must be imported in order to use procedures you have chosen; and any IO modules upon which the imported modules depend.

For instance, if you will be using the READSTRING procedure, then you will need to import the GENERAL_2 module (see the Library Reference entry for this procedure). You will also need IODECLARATIONS, and modules GENERAL_1 and HPIB_1 in the System Library (see the Module Dependency Table). Module SYSGLOBALS can be found by specifying the INTERFACE file in a SEARCH Compiler option.

Making GRAPHICS Modules Accessible

If you are using any graphics procedures, then you must have *all* GRAPHICS modules through DGL_LIB (i.e., the first 31 modules in the GRAPHICS file) in the System Library. The only modules that you can remove are DGL_POLY and DGL_INQ; the former is only required if you will be using polygon graphics procedures, and the latter if using the INQ_WS procedure. The INTERFACE modules, such as SYSGLOBALS and SYSDEVS, are *not* required at compile time.

Making SEGMENTER Modules Accessible

If you are using segmentation procedures, then you must have *both* the ALLOCATE and the SEGMENTER modules in the System Library.

Module Dependency Table

The Module Dependency Table shows which modules are imported by the standard LIBRARY, IO, GRAPHICS, and SEGMENTER modules.

Module to Be Imported	Module(s) Upon Which It Depends
LIBRARY Modules:	
RND	SYSGLOBALS
HPM	—
UIO	—
LOCKMODULE	SYSGLOBALS
IO Modules:	
IODECLARATIONS	SYSGLOBALS
IOCOMASM	SYSGLOBALS, IODECLARATIONS
GENERAL_0	SYSGLOBALS, IODECLARATIONS
GENERAL_1	SYSGLOBALS, IODECLARATIONS
GENERAL_2	SYSGLOBALS, IODECLARATIONS, GENERAL_1, HPIB_1
GENERAL_3	SYSGLOBALS, IODECLARATIONS
GENERAL_4	SYSGLOBALS, IODECLARATIONS, HPIB_1
HPIB_0	SYSGLOBALS, IODECLARATIONS
HPIB_1	SYSGLOBALS, IODECLARATIONS
HPIB_2	SYSGLOBALS, IODECLARATIONS, HPIB_0, HPIB_1
HPIB_3	SYSGLOBALS, IODECLARATIONS, GENERAL_1, HPIB_0, HPIB_1
SERIAL_0	SYSGLOBALS, IODECLARATIONS
SERIAL_3	SYSGLOBALS, IODECLARATIONS
GRAPHICS (and FGRAPHICS) Modules:	
DGL_LIB	ASM, IODECLARATIONS, SYSGLOBALS, MINI, ISR, MISC, FS, SYSDEVS, and all GRAPHICS modules <i>except</i> DGL_INQ and DGL_POLY
DGL_POLY	SYSGLOBALS, SYSDEVS, and all GRAPHICS modules <i>except</i> DGL_INQ
DGL_INQ	ASM, SYSGLOBALS, A804XDVR, DGL_TYPES, DGL_VARS, DGL_GEN, GLE_TYPES, GLE_GEN
SEGMENTER Modules:	
SEGMENTER	LOADER, LDR, SYSGLOBALS, MISC

Some Are Needed at Compile Time, Some Aren't

From the table, you can see that several Procedure Library modules depend upon various Operating System modules (such as SYSGLOBALS, IODECLARATIONS, SYSDEVS, and A804XDVR). However, the table does not show that *some* of the Procedure Library modules need these Operating System module(s) **only** at *load* time and **not** at *compile* time (some also need them at both times).

Modules such as SYSGLOBALS, SYSDEVS, and A804XDVR are part of the Operating System that is automatically loaded during the booting process (because they are in the standard INITLIB file.) Thus, you don't *ever* need to be concerned about making them accessible to the loader (unless you somehow remove them from the INITLIB file).

- The GRAPHICS and FGRAPHICS modules require the specified Operating System modules *only* at load time (not at compile time).
- The LIBRARY, IO, and SEGMENTER modules require the specified modules at *both* compile time and at load time. You can make these Operating System modules accessible to the Compiler by specifying the INTERFACE file in a SEARCH Compiler option or by adding them to the System Library.

Interfacing Concepts

Chapter

2

Introduction

This chapter describes the functions and requirements of interfaces between the computer and its resources. Most of the concepts in this chapter are presented in an informal manner. Hopefully, **all** levels of programmers can gain useful background information that will increase their understanding of the **why** and **how** of interfacing.

Terminology

These terms are important to your understanding of the text of this manual. They are not highly technical, so don't worry about not having a PhD. in computer science to be able to understand all of them. The purpose of this section is to make sure that our terms have the same meanings.

The term **computer** is herein defined to be the processor, its support hardware, and the Pascal-language operating system; together these system elements **manage** all computer resources. The term **computer resource** is herein used to describe all of the "data-handling" elements of the system. Computer resources include: internal memory, CRT display, keyboard, and disc drive, and any external devices that are under computer control.

The term **hardware** describes both the electrical connections and electronic devices that make up the circuits within the computer; any piece of hardware is an actual physical device. The term **software** describes the user-written, Pascal-language programs.

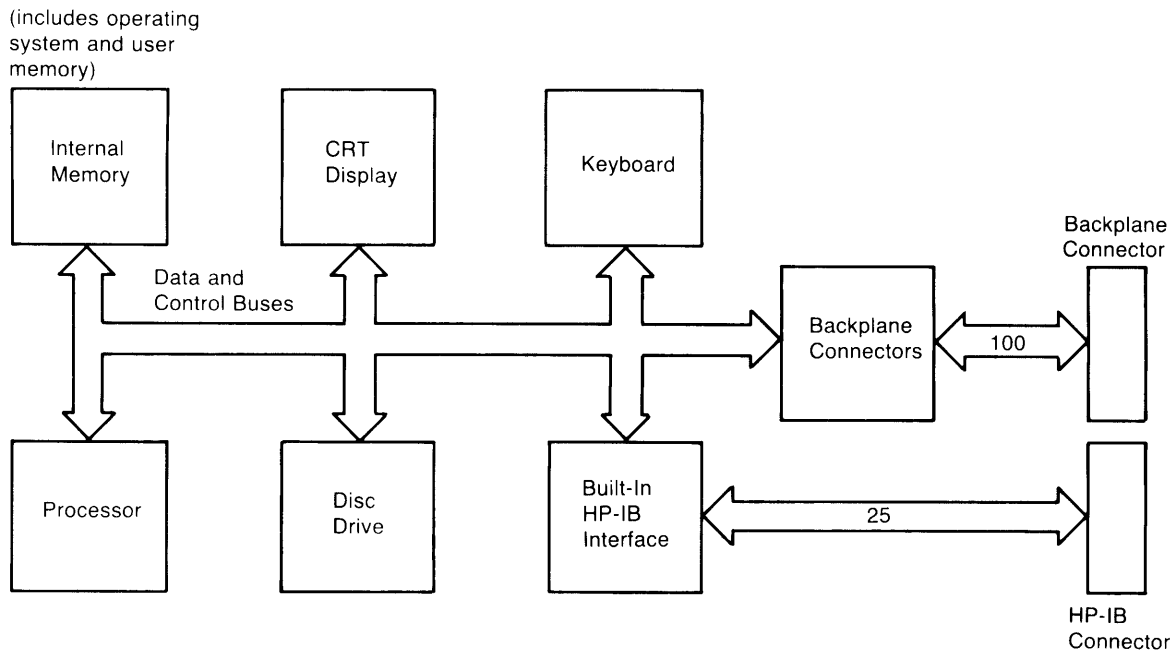

Block Diagram of the Computer

The term **I/O** is an acronym that comes from “Input and Output”; it refers to the process of copying data to or from computer memory. Moving data from computer memory to another resource is called **output**. During output, the **source** of data is computer memory and the **destination** is any resource, including memory. Moving data from a resource to computer memory is **input**; the source is any resource and the destination is a variable in computer memory.

The term **bus** refers to a common group of hardware lines that are used to transmit information between computer resources. The computer communicates directly with the internal resources through the data and control buses. The **computer backplane** is an extension of these internal data and control buses. The computer communicates indirectly with the external resources through interfaces connected to the backplane hardware.

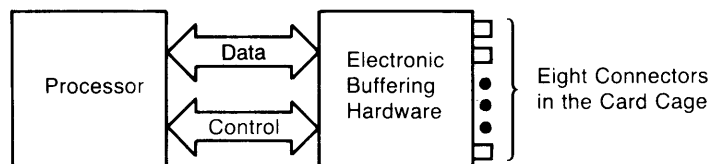

Backplane Hardware

Why Do You Need an Interface?

The primary function of an interface is, obviously, to provide a communication path for data and commands between the computer and its resources. Interfaces act as intermediaries between resources by handling part of the “bookkeeping” work, ensuring that this communication process flows smoothly. The following paragraphs explain the need for interfaces.

First, even though the computer backplane is driven by electronic hardware that generates and receives electrical signals, this hardware was not designed to be connected directly to external devices. The electronic backplane hardware has been designed with specific electrical logic levels and drive capability in mind. Exceeding its ratings will damage this electronic hardware.

Second, you cannot be assured that the connectors of the computer and peripheral are compatible. In fact, there is a good probability that the connectors may not even mate properly, let alone that there is a one-to-one correspondence between each signal wire’s function.

Third, assuming that the connectors and signals are compatible, you have no guarantee that the data sent will be interpreted properly by the receiving device. Some peripherals expect single-bit serial data while others expect data to be in 8-bit parallel form.

Fourth, there is no reason to believe that the computer and peripheral will be in agreement as to when the data transfer will occur; and when the transfer does begin the transfer rates will probably not match. As you can see, interfaces have a great responsibility to oversee the communication between computer and its resources. The functions of an interface are shown in the following block diagram.

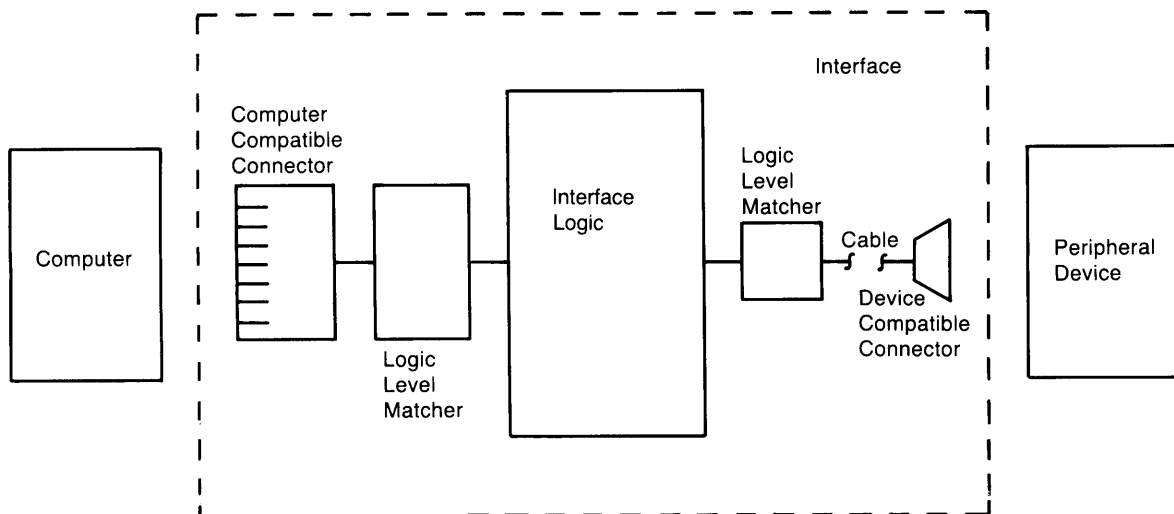

Functional Diagram of an Interface

Electrical and Mechanical Compatibility

Electrical compatibility must be ensured before any thought of connecting two devices occurs. Often the two devices have input and output signals that do not match; if so, the interface serves to match the electrical levels of these signals before the physical connections are made.

Mechanical compatibility simply means that the connector plugs must fit together properly. All Series 200 interfaces have 100-pin connectors that mate with the computer backplane. The peripheral end of the interfaces may have unique configurations due to the fact that several types of peripherals are available. Most of the interfaces have cables available that can be connected directly to the device so you don't have to wire the connector yourself.

Data Compatibility

Just as two people must speak a common language, the computer and peripheral must agree upon the form and meaning of data before communicating it. As a programmer, one of the most difficult compatibility requirements to fulfill before exchanging data is that the format and meaning of the data being sent is identical to that anticipated by the receiving device. Even though some interfaces format data, most interfaces have little responsibility for matching data formats; most interfaces merely move agreed-upon quantities of data to or from computer memory. The computer must generally make the necessary changes, if any, so that the receiving device gets meaningful information.

Timing Compatibility

Since all devices do not have standard data-transfer rates, nor do they always agree as to when the transfer will take place, a consensus between sending and receiving device must be made. If the sender and receiver can agree on both the transfer rate and beginning point (in time), the process can be made readily.

If the data transfer is not begun at an agreed-upon point in time and at a known rate, the transfer must proceed one data item at a time with acknowledgement from the receiving device that it has the data and that the sender can transfer the next data item; this process is known as a "handshake". Both types of transfers are utilized with different interfaces and both will be fully described as necessary.

Additional Interface Functions

Another powerful feature of some interface cards is to relieve the computer of low-level tasks, such as performing data-transfer handshakes. This distribution of tasks eases some of the computer's burden and also decreases the otherwise-stringent response-time requirements of external devices. The actual tasks performed by each type of interface card vary widely and are described in the next section of this chapter.

Interface Overview

Now that you see the need for interfaces, you should see what kinds of interfaces are available for the Series 200 computers using the Pascal Workstation System. Each of these interfaces is specifically designed for specific methods of data transfer; each interface's hardware configuration reflects its function.

This section briefly describes only these interfaces:

- HP-IB
- RS 232 Serial
- GPIO

Note that this Pascal System also supports the following types of interfaces:

- Data Communications
- EPROM Programmer
- Video output

The HP-IB Interface

This interface is Hewlett-Packard's implementation of the IEEE-488 1978 Standard Digital Interface for Programmable Instrumentation. The acronym "HP-IB" comes from Hewlett-Packard Interface Bus, often called the "bus".

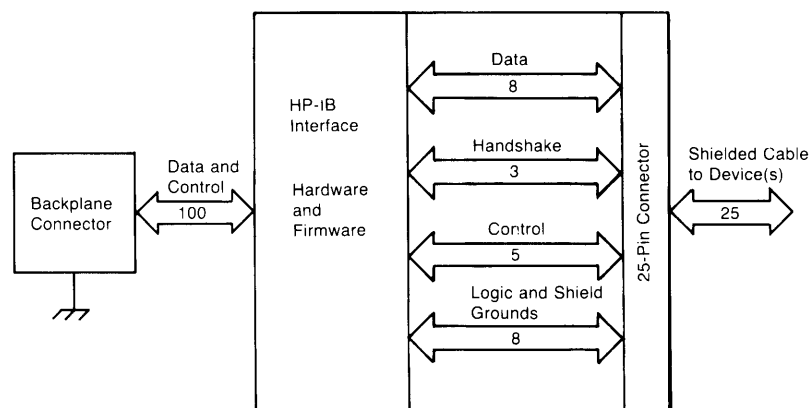

Block Diagram of the HP-IB Interface

The HP-IB interface fulfills all four compatibility requirements (hardware, electrical, data, and timing) with no additional modification. Just about all you need to do is connect the interface cable to the desired HP-IB device and begin programming. All resources connected to the computer through the HP-IB interface must adhere to this IEEE standard.

The "bus" is somewhat of an independent entity; it is a communication arbitrator that provides an organized protocol for communications between several devices. The bus can be configured in several ways. The devices on the bus can be configured to act as senders or receivers of data and control messages, depending on their capabilities.

The Serial Interface

The serial interface changes 8-bit parallel data into bit-serial information and transmits the data through a two-wire (usually shielded) cable; data is received in this serial format and is converted back to parallel data. This use of two wires makes it more economical to transmit data over long distances than to use 8 individual lines.

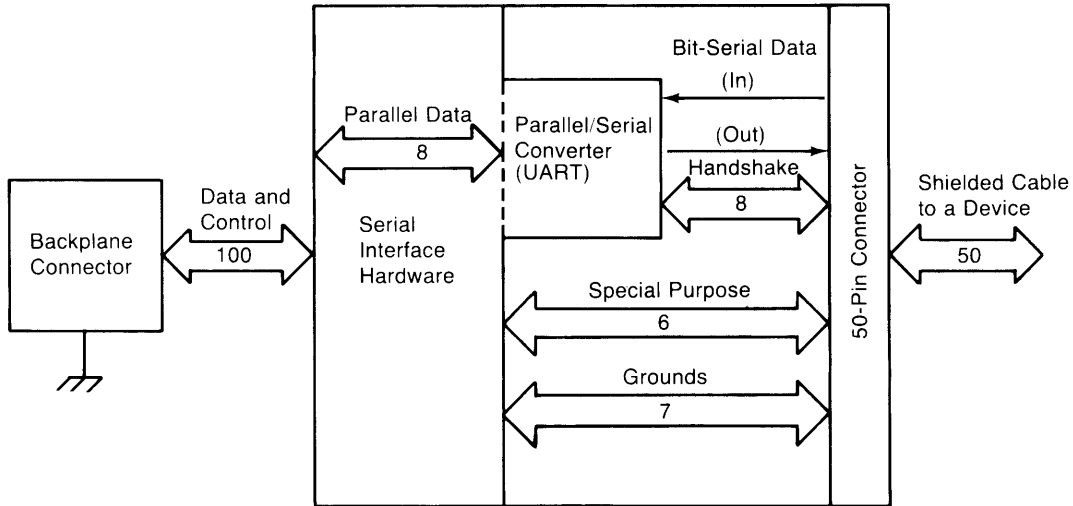

Block Diagram of the Serial Interface

Data is transmitted at several programmable rates using either a simple data handshake or no handshake at all.

The GPIO Interface

This interface provides the most flexibility of the three interfaces. It consists of 16 output-data lines, 16 input-data lines, two handshake lines, and other assorted control lines. Data is transmitted using several types of programmable handshake conventions and logic sense.

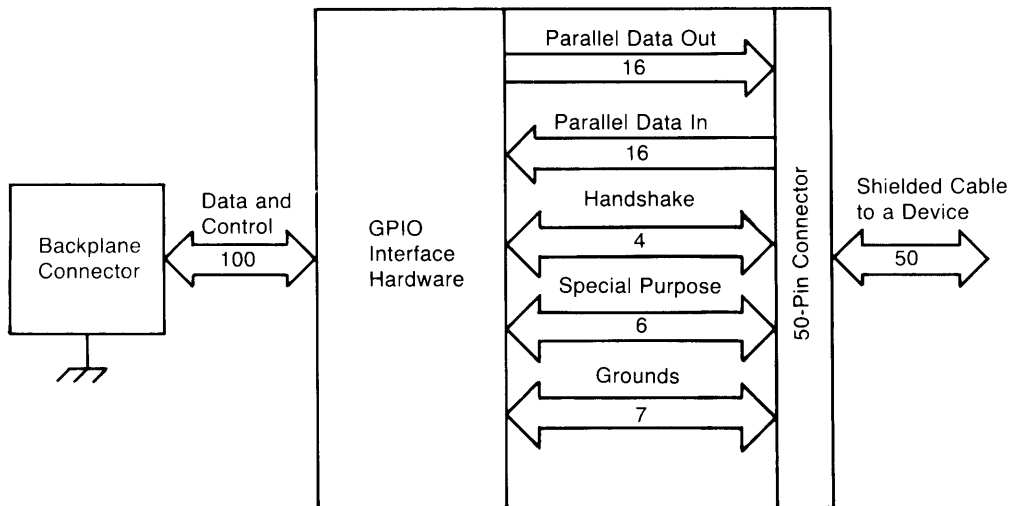

Block Diagram of the GPIO Interface

Much of the flexibility of this interface lies in the fact that you have almost direct access to the internal data bus for outputting and entering data.

Data Representations

As long as data is only being used internally, it really makes little difference how it is represented; the computer always understands its own representations. However, when data is to be moved to or from an external resource, the data representation is of paramount importance.

Bits and Bytes

Computer memory is no more than a large collection of individual bits (**binary digits**), each of which can take on one of two logic levels (high or low). Depending on how the computer interprets these bits, they may mean on or not on (off), true or not true (false), one or zero, busy or not busy, or any other bi-state condition. These logic levels are actually voltage levels of hardware locations within the computer. The following diagram shows the voltage of a signal line versus time and relates the logic levels to voltage levels.

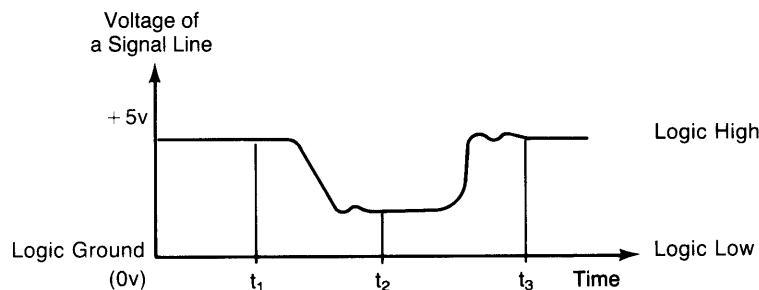

Voltage Levels and Positive-True Logic

In some cases, you want to determine the state of an individual bit (of a variable in computer memory, for instance). The logical binary functions (BIT_SET, BINCOMP, BINIOR, BINEOR, and BINAND) provide access to the individual bits of data.

In most cases, these individual bits are not very useful by themselves, so the computer groups them into multiple-bit entities for the purpose of representing more complex data. Thus, all data in computer memory are somehow represented with binary numbers.

The computer's hardware can access groups of 16 bits at one time through the internal data bus; this size group is known as a **word**. With this size of bit group, 65536 ($= 2 \uparrow 16$) different bit patterns can be produced. The computer can also use groups of eight bits at a time; this size group is known as a **byte**. With this smaller size of bit group, 256 ($= 2 \uparrow 8$) different patterns can be produced. How the computer and its resources interpret these combinations of ones and zeros is very important and gives the computer all of its utility.

The computer is also capable of logically handling 32 bits; this size group is known as a long word and is the Pascal INTEGER type.

Representing Numbers

The following binary weighting scheme is often used to represent numbers with a single data byte. Only the non-negative integers 0 through 255 can be represented with this particular scheme.

Most Significant Bit				Least Significant Bit			
Bit 7	Bit 6	Bit 5	Bit 4	Bit 3	Bit 2	Bit 1	Bit 0
1	0	0	1	0	1	1	0
Value = 128	Value = 64	Value = 32	Value = 16	Value = 8	Value = 4	Value = 2	Value = 1

Notice that the value of a 1 in each bit position is equal to the power of two of that position. For example, a 1 in the 0th bit position has a value of 1 ($= 2 \uparrow 0$), a 1 in the 1st position has a value of 2 ($= 2 \uparrow 1$), and so forth. The number that the byte represents is then the total of all the individual bit's values.

Determining the Number Represented

$$\begin{array}{rcl}
 0 * 2 \uparrow 0 & = & 0 \\
 1 * 2 \uparrow 1 & = & 2 \\
 1 * 2 \uparrow 2 & = & 4 \\
 0 * 2 \uparrow 3 & = & 0 \\
 1 * 2 \uparrow 4 & = & 16 \\
 0 * 2 \uparrow 5 & = & 0 \\
 0 * 2 \uparrow 6 & = & 0 \\
 1 * 2 \uparrow 7 & = & 128
 \end{array}
 \quad \begin{array}{l}
 \text{Number represented} = \\
 2 + 4 + 16 + 128 = 150
 \end{array}$$

The preceding representation is used by the “ORD” function when it interprets a byte of data. The next section explains why the character “A” can be represented by a single byte.

```

PROGRAM example(input,output);
VAR number : INTEGER;
BEGIN
  number := ORD('A');
  WRITELN(' Number = ',number);
END.

```

Printed Result

```

Number = 65

```

Representing Characters

Data stored for humans is often alphanumeric-type data. Since less than 256 characters are commonly used for general communication, a single data byte can be used to represent a character. The most widely used character set is defined by the ASCII standard¹. This standard defines the correspondence between characters and bit patterns of individual bytes. Since this standard only defines 128 patterns (bit 7 = 0), 128 additional characters are defined by the 9826 (bit 7 = 1). The entire set of the 256 characters on the Series 200 computers is hereafter called the ‘‘extended ASCII’’ character set.

When the CHR function is used to interpret a byte of data, its argument must be specified by its binary-weighted value. The single (extended ASCII) character returned corresponds to the bit pattern of the function’s argument.

```
PROGRAM example(input,output);
VAR number : INTEGER;
BEGIN
  number := 65;
  WRITELN(' Character is ',chr(number));
END.
```

Printed Result

```
Character is A
```

Representing Signed Integers

There are two ways that the computer represents signed integers. The first uses a binary weighting scheme similar to that used by the ORD function. The second uses ASCII characters to represent the integer in its decimal form.

Internal Representation of Integers

Bits of computer memory are also used to represent signed (positive and negative) integers. Since the range allowed by eight bits is only 256 integers, a double word (four bytes) is used to represent integers. With this size of bit group, $4\,294\,967\,296 (= 2 \uparrow 32)$ unique integers can be represented.

The range of integers that can be represented by 32 bits can arbitrarily begin at any point on the number line. With Series 200 Workstation Pascal, this range of integers has been chosen for maximum utility; it has been divided as symmetrically as possible about zero, with one of the bits used to indicate the sign of the integer.

¹ ASCII stands for ‘‘American Standard Code for Information Interchange’’. See the Appendix for the complete table.

With this “2’s complement” notation, the most significant bit (bit 31) is used as a sign bit. A sign bit of 0 indicates positive numbers and a sign bit of 1 indicates negatives. You still have the full range of numbers to work with, but the range of absolute magnitudes is divided in half (−2 147 483 648 through 2 147 483 647). The following 32-bit integers are represented using this 2’s-complement format.

	Binary representation	Decimal equivalent
	1111 1111 1111 1111 1111 1111 1111 1111	− 1
	0000 0000 0000 0000 0000 0000 0000 0001	1
	1111 1111 1111 1111 1111 1111 0000 0001	−255
	0000 0000 0000 0000 0000 0000 1111 1111	255

sign bit	↑	↑	↑	↑	↑	↑	↑
2 ↑ 30			2 ↑ 8	2 ↑ 7			2 ↑ 0

The representation of a positive integer is generated according to place value, just as when bytes are interpreted as numbers. To generate a negative number’s representation, first derive the positive number’s representation. Complement (change the ones to zeros and the zeros to ones) all bits, and then to this result add 1. The final result is the two’s-complement representation of the negative integer. This notation is very convenient to use when performing math operations. Let’s look at a simple addition of 2 two’s-complement integers.

Example: 3 + (−3) = ?

First, +3 is represented as:	0000 0000 0000 0000 0000 0000 0000 0011
Now generate −3’s representation:	
first complement +3,	1111 1111 1111 1111 1111 1111 1111 1100
then add 1	+ 0000 0000 0000 0000 0000 0000 0000 0001

−3’s representation:	1111 1111 1111 1111 1111 1111 1111 1101
 Now add the two numbers:	
	1111 1111 1111 1111 1111 1111 1111 1101
	+ 0000 0000 0000 0000 0000 0000 0000 0011

	1←
final carry not used	0000 0000 0000 0000 0000 0000 0000 0000
	1← carry on all places

ASCII Representation of Integers

ASCII digits are often used to represent integers. In this representation scheme, the decimal (rather than binary) value of the integer is formed by using the ASCII digits 0 through 9 {CHR(48) through CHR(57), respectively}. An example is shown below.

Example

The decimal representation of the binary value “1000 0000” is 128. The ASCII-decimal representation consists of the following three characters.

Character	1	2	8
Decimal value of character	49	50	56
Binary value of character	00110001	00110010	00111000

Representing Real Numbers

Real numbers, like signed integers, can be represented in one of two ways with the computers. They are represented in a special binary mantissa-exponent notation within the computers for numerical calculations. During output and enter operations, they can also be represented with ASCII-decimal digits.

Internal Representation of Real Numbers

Real numbers are represented internally by using a special binary notation¹. With this method, all numbers of the REAL data type are represented by eight bytes: 52 bits of mantissa magnitude, 1 bit for mantissa sign, and 11 bits of exponent. The following equation and diagram illustrate the notation; the number represented is 1/3.

Byte	1	2	3	4	...	8
Decimal value of character	63	213	85	85	...	85
Binary value of characters	00111111	11010101	01010101	01010101	...	01010101
	↑ mantissa sign	└───┬───┘ exponent		└──────────────────┘ mantissa		

¹ The internal representation used for real numbers is the IEEE standard 64-bit floating-point notation.

The I/O Procedure Library

Chapter

3

Introduction

This chapter presents an introduction to the I/O Procedure Library. This discussion includes the organization of the library, major capabilities, and an introduction into the use of the library. The last sections of this chapter contain a list of module capabilities. It is recommended that you scan these sections to familiarize yourself with what features are available in the I/O Library.

Pascal I/O

The Pascal language has been well known for some time as a good high-level language with modularity and transportability features. It has not had good I/O capabilities, particularly device I/O. The Pascal language on the HP Series 200 computers still does not have I/O as a fundamental part of the language.

Rather than adding specific built-in language features to support I/O, graphics, and other useful extensions, HP Standard Pascal has a general extension mechanism called modules. A module is very similar to a Pascal PROGRAM in that it can contain CONSTANTS, TYPES, VARIABLES, PROCEDURES, and FUNCTIONS.

Various portions of a module can be EXPORTed for anyone to use. The Pascal I/O Procedure Library is a collection of several modules. When you want to use the capabilities of the I/O library, you must tell the Compiler which module(s) you want from the I/O library. This is done with the IMPORT statement.

Here is an example of using the I/O library. Suppose you want to write a program that reads a string from a device and then writes a string to the same device. The read and write string procedures are both in the I/O module called GENERAL_2. So the program might look like this:

```
PROGRAM test ( INPUT , OUTPUT );
IMPORT GENERAL_2;           { tell the compiler which module }
VAR   str : STRING[255];
BEGIN
  READSTRING(724,str);      { read str with CR/LF termination }
  WRITESTRINGLN(724,str);  { write str with CR/LF termination }
END.
```

I/O Library Organization

Each of the I/O Library modules contains related features and capabilities. The I/O library contains modules that provide general capabilities that are valid for all interfaces and devices and of specific capabilities that are valid only for a specific interface or type of interface. Reading a character is an example of a general capability. Checking for ACTIVE CONTROL is an HP-IB specific operation.

The I/O Library is divided into groups: general and interface specific. The interfaces currently supported in the I/O Library consist of HP-IB, Serial, and Parallel (GPIO) interfaces. In the implementation of the I/O Library, all the necessary Parallel capabilities are handled in the general capabilities group. So, the I/O Library consists of three groups:

- GENERAL
- HPIB
- SERIAL

Each of these groups consists of several modules. The last section in this chapter contains a list of the procedures and functions in each of the modules in the I/O Library.

GENERAL

The GENERAL group contains the common operations used by all interfaces. This group consists of the following modules:

Module	Capability	Example
IODECLARATIONS	common constants, types, variables	what type of card is at interface select code 7
IOCOMASM	binary operations	binary AND of two integers
GENERAL_0	machine and hardware dependent status and control	hardware register access
GENERAL_1	character I/O	input a character
GENERAL_2	string and numeric I/O	input a real number
GENERAL_3	error messages	
GENERAL_4	transfers and buffers	output data via DMA

HPIB

The HPIB group contains routines that are useful for the built-in and optional HP-IB interfaces.

Module	Capability	Example
HPIB_0	access to HP-IB interface bus lines	clear the ATN line
HPIB_1	low level bus control	send an ATN bus command
HPIB_2	HP-IB messages	send selective device clear
HPIB_3	high level bus status and control	request bus service

SERIAL

The SERIAL group contains the capabilities specific to serial interfaces. Currently, the HP 98626 and 98628 are supported.

Module	Capability	Example
SERIAL_0	access to serial interface lines	set Clear To Send
SERIAL_3	high level serial control	set baud rate to 2400

Each module is a separate entity in the Pascal system. Being separate, only those modules imported from the system library are used in the running of an application program. This partitioning of the library minimizes the size of the program. The Pascal system, in normal programming, will load and link all the modules that you have imported. You only need to explicitly import the appropriate modules and use their procedures and functions.

I/O Library Initialization

The I/O Library provides a setup procedure, IOINITIALIZE, and a clean up procedure, IOUNINITIALIZE. Both procedures operate in a very similar manner. They perform the following operations:

- Reset all interfaces.
- Stop all transfers.
- Release all I/O resources (such as DMA channels).

A well written Pascal program that uses the I/O Library will include these procedures. These procedures are in the GENERAL_1 module. The example program from the previous section rewritten would look like:

```
PROGRAM test ( INPUT , OUTPUT );
IMPORT GENERAL_1,
        GENERAL_2;           { tell the compiler which modules }
VAR    str : STRING[255];
BEGIN
  IOINITIALIZE;              { set up the I/O system }
  READSTRING(724,str);      { read str with CR/LF termination }
  WRITESTRINGLN(724,str);   { write str with CR/LF termination }
  IOUNINITIALIZE;          { clean up the I/O system }
END;
```

The I/O system is used by the rest of the Pascal system for I/O operations. Because of this use, IOINITIALIZE is called by the system when power is first applied to the computer. Also, because I/O errors can occur during normal operation, the STOP and CLR I/O keys call IOUNINITIALIZE to clean up the I/O system state. This information leads to the fact that it is, in many instances, unnecessary to call IOINITIALIZE and IOUNINITIALIZE. It is, however, strongly recommended that you use these procedures. The use of the set-up and clean-up procedures will make your programs more resistant to hardware and firmware problems and to programming errors in software.

GENERAL Modules

GENERAL modules contain the capabilities that are useful for all interfaces. For syntax and semantics information refer to the reference section in the back of this manual.

MODULE iocomasm

FUNCTION bit_set	Is a bit set in a 32-bit integer?
FUNCTION binand	Logical AND of two 32-bit integers.
FUNCTION binior	Logical OR of two 32-bit integers.
FUNCTION bineor	Exclusive OR of two 32-bit integers.
FUNCTION bincmp	Logical complement of a 32-bit integer.

MODULE general_0

FUNCTION ioread_word	Read a 16-bit interface register.
PROCEDURE iowrite_word	Write a 16-bit interface register.
FUNCTION ioread_byte	Read an 8-bit interface register.
PROCEDURE iowrite_byte	Write an 8-bit interface register.
FUNCTION iostatus	Read the firmware interface register.
PROCEDURE iocontrol	Write the firmware interface register.

MODULE general_1

PROCEDURE ioinitialize	Reset the entire I/O system.
PROCEDURE iouninitialize	Reset the entire I/O system.
PROCEDURE ioreset	Reset a single interface card.
PROCEDURE readchar	Read a character from an interface.
PROCEDURE writechar	Write a character to an interface.
PROCEDURE readword	Read a 16-bit word from an interface.
PROCEDURE writeword	Write a 16-bit word to an interface.
PROCEDURE set_timeout	Set up an interface timeout value.

MODULE general_2

PROCEDURE readnumber	Read a real number.
PROCEDURE writenumber	Write a real number.
PROCEDURE readstring	Read a string.
PROCEDURE readstring_until	Read a string until a character match.
PROCEDURE writestring	Write a string.
PROCEDURE readnumberln	Read a real number until a LF occurs.
PROCEDURE writenumberln	Write a real number with a CR/LF.
PROCEDURE writestringln	Write a string with a CR/LF.
PROCEDURE readuntil	Read until a character match.
PROCEDURE skipfor	Skip over a number of characters.

MODULE general_3

FUNCTION ioerror_message	What is the error message for a specific I/O error?
--------------------------	---

MODULE general_4

PROCEDURE abort_transfer	Stop a transfer.
PROCEDURE transfer	Transfer a block of data as bytes.
PROCEDURE transfer_word	Transfer a block of data as words.
PROCEDURE transfer_until	Transfer in until a match character.
PROCEDURE transfer_end	Transfer using a card condition.
PROCEDURE jobuffer	Create a transfer buffer.
PROCEDURE buffer_reset	Reset the buffer space.
FUNCTION buffer_space	How much space is left in the buffer.
FUNCTION buffer_data	How much data is left in the buffer.
PROCEDURE readbuffer	Read a character from a buffer.
PROCEDURE writebuffer	Write a character to a buffer.
PROCEDURE readbuffer_string	Read a string from a buffer.
PROCEDURE writebuffer_string	Write a string to a buffer.
FUNCTION buffer_active	Is there a transfer active on the buffer?
FUNCTION isc_active	Is there a transfer active on the interface?

HPIB Modules

HPIB modules contain routines that are useful for the built-in and optional HP-IB interfaces. For syntax and semantics information refer to the reference section in the back of this manual.

MODULE hpib_0

PROCEDURE set_hpib	Set an HP-IB hardware line.
PROCEDURE clear_hpib	Clear an HP-IB hardware line.
FUNCTION hpib_line	Is an HP-IB hardware line set?

MODULE hpib_1

PROCEDURE send_command	Send an ATN command.
FUNCTION my_address	What is my bus address?
FUNCTION active_controller	Am I active controller?
FUNCTION system_controller	Am I system controller?
FUNCTION end_set	Was EOI received with the last byte?

MODULE hpib_2

PROCEDURE abort_hpib	Stop all bus activity.
PROCEDURE clear	Send clear command to a device.
PROCEDURE listen	Send listen command to a device.
PROCEDURE local	Send local command to a device.
PROCEDURE local_lockout	Send lockout command to all devices.
PROCEDURE pass_control	Pass active control to a device.
PROCEDURE ppoll_configure	Configure PPOLL response of a device.
PROCEDURE ppoll_unconfigure	Remove PPOLL response of a device.
PROCEDURE remote	Send remote command to a device.
PROCEDURE secondary	Send a secondary command.
PROCEDURE talk	Send talk command to a device.
PROCEDURE trigger	Send trigger command to a device.
PROCEDURE unlisten	Send unlisten command to all devices.
PROCEDURE untalk	Send untalk command to all devices.

MODULE hpib_3

FUNCTION requested	Is SRQ asserted?
FUNCTION ppoll	What is the bus parallel poll byte?
FUNCTION spoll	What is the device serial poll byte?
PROCEDURE request_service	Request bus service (via SRQ).
FUNCTION listener	Am I a listener?
FUNCTION talker	Am I a talker?
FUNCTION remotod	Is REN being asserted?
FUNCTION locked_out	Am I in the local lockout state?

SERIAL Modules

SERIAL modules contain the capabilities specific to serial interfaces. Currently, the HP 98626 and 98644 Serial and HP 98628 Datacomm cards are supported. For syntax and semantics information, refer to the reference section in the back of this manual.

MODULE serial_0

PROCEDURE set_serial	Set a serial line.
PROCEDURE clear_serial	Clear a serial line.
FUNCTION serial_line	Is a serial line set?

MODULE serial_3

PROCEDURE set_baud_rate	Set the interface baud rate.
PROCEDURE set_stop_bits	Set the interface number of stop bits.
PROCEDURE set_char_length	Set the interface character length.
PROCEDURE set_parity	Set the interface parity.
PROCEDURE send_break	Send a serial BREAK.
PROCEDURE abort_serial	Stop all serial activity.

IODECLARATIONS Module

Most of the I/O Library consists of modules that contain procedures and functions. However, the IODECLARATIONS module is a module of constants, types, and variables. This module is used by the rest of the I/O Library for range checking, common variables, and I/O system tables. IODECLARATIONS is also of use to you, the programmer, for various reasons. This section will not fully discuss the IODECLARATIONS module. It will only discuss few points of general interest.

The useful information in IODECLARATIONS relates to interface information. Typical questions about interfaces include:

- What is the range of interfaces?
- Is there an interface on interface select code 12?
- Is the interface on interface select code 15 a serial interface?
- Is the interface on interface select code 15 a 98626 serial interface or a 98628 serial interface?

The descriptions that follow will show the actual Pascal code used to define the various constants, types and variables.

Range of Interface Select Codes and Device Selectors

This range is supported by several constants and types. The I/O Library supports various select codes, as described in the next chapter. The interface select code range is from 0 through 31. There are two constants that define this range:

```
CONST  IOMINISC  = 0 ;
        IOMAXISC = 31 ;
```

In addition to defining the upper and lower limits of select codes there are type definitions that support interface select code and device variables. These type definitions are:

```
TYPE    TYPE_ISC      = IOMINISC..IOMAXISC ;
        TYPE_DEVICE   = IOMINISC..IOMAXISC*100+99;
```

These type definitions are used in the I/O Library for interface select code and device parameters. With the compiler option \$RANGE ON\$, which is the default, the compiler will emit a range check for your parameters. So, if you tried to use an interface select code of 45, the program would generate an error. You can use the type definitions for interface select code and device variables, if you desire. It is also possible to use integer variables and other integer subranges for interface select code and device variables.

Information about Interface Cards

There is a table defined in the IODECLARATIONS module that contains common information about all interface cards in the computer. This table is called ISC_TABLE and is an array of structured elements, a compound data type. The definition of this table is:

```
VAR    ISC_TABLE      : PACKED ARRAY [TYPE_ISC]
                          OF isc_table_type;
```

The compound data type ISC_TABLE_TYPE contains several pieces of information. The definition of this type is:

```
TYPE    isc_table_type = RECORD
        io_drv_ptr: ^driver;      { ptr to drivers }
        io_tmp_ptr: ^memory;     { ptr to R/W   }
        CARD_TYPE : -32768..32767;
        user_time : INTEGER;     { for timeout }
        CARD_ID   : -32768..32767;
        card_ptr  : ^card;       { card addr  }
    END;
```

The table contains pointers to the actual drivers, driver read/write memory space, user specified timeout value and a pointer to the physical address of the interface card in the computer's memory. The table also contains the type of card and card id information. You should only need to examine the card type and card id.

Note

All of this information is for system use. Do not modify any table entries.

The following program lists the type of card and card id for all interface select codes.

```
PROGRAM list_cards ( INPUT , OUTPUT );
IMPORT IODECLARATIONS;
VAR isc : TYPE_ISC;
BEGIN
  FOR isc := IOMINISC TO IOMAXISC DO
    WRITELN('card ',          isc:2,
           ' is of type ',   ISC_TABLE[isc].CARD_TYPE:4,
           ' with an id of ',ISC_TABLE[isc].CARD_ID:4);
  END;
```

This program is not useful because the values for card type and id are integers and you do not know what each value means. The IODECLARATIONS module has a series of pre-defined constants for the card type and id.

The CARD_TYPE field contains information about the generic card type—whether the card is Serial, HP-IB, etc. The constants are as follows:

```
CONST

no_card      = 0 ;
other_card   = 1 ;

system_card  = 2 ;
hpiib_card   = 3 ;
gpio_card    = 4 ;
serial_card  = 5 ;
graphics_card = 6 ;
srm_card     = 7 ;
bubble_card  = 8 ;
eprom_prgrm  = 9 ;
```

The CARD_ID field contains hardware specific information. For example, the id will inform you whether an HPIB_CARD is the internal interface or an optional 98624 plug-in card. This should only be necessary if you are doing low-level operations to the interfaces.

Note

The appearance of a card id in the following list **does not** imply Pascal support for the specified interface. The cards are mentioned because they may be supported by other languages which run on this machine.

The constants are defined as follows:

```
CONST

    hp98628_dsnd1  = -7;
    hp98629        = -6;
    hp_datacomm    = -5;
    hp98620        = -4;
    internal_kbd   = -3;
    internal_crt   = -2;
    internal_hpib  = -1;

    no_id          = 0;

    hp98624        = 1;  { HP-IB }
    hp98626        = 2;  { Serial }
    hp98622        = 3;  { GPIO }
    hp98623        = 4;  { BCD }
    hp98625        = 8;  { Fast Disc }
    hp98628_async  = 20; { Serial }
    hpGATOR        = 25; { bit-mapped alpha/graphics }
    hp98253        = 27; { EPROM programmer }
    hp98627        = 28; { Color output }
    hp98259        = 30; { Bubble }
    hp98644        = 66; { Serial }
```

A program to determine card type and id is shown below.

```
PROGRAM List_cards (INPUT,OUTPUT);

IMPORT
    IODECLARATIONS;

VAR
    Isc : Type_Isc;

BEGIN
    FOR Isc := IOMinIsc TO IOMaxIsc DO
        BEGIN
            IF Isc_Table[Isc].Card_Type > System_Card THEN
                BEGIN
                    WRITE('Card at ',Isc:2,' is of type: ');
                    CASE Isc_Table[Isc].Card_Type OF
                        HPIB_Card:    WRITE(' HP-IB ');
                        GPIO_Card:    WRITE(' GPIO ');
                        Serial_Card:  WRITE(' Serial ');
                        Graphics_Card: WRITE(' Graphics ');
                        SRM_Card:     WRITE(' SRM ');
                        Bubble_Card:  WRITE(' Bubble ');
                        EPROM_Prgmr:  WRITE(' EPROM ');
                        OTHERWISE    WRITE(' Other ');
                    END; { CASE Card_Type }
                END
            END
        END
    END
```



```

WRITE(' Card_ID: ');
CASE Isc_Table[Isc].Card_ID OF
  HP98253:      WRITE(' HP 98253      ');
  HP98259:      WRITE(' HP 98259      ');
  HP98622:      WRITE(' HP 98622      ');
  HP98623:      WRITE(' HP 98623      ');
  HP98624:      WRITE(' HP 98624      ');
  Internal_HPIB: WRITE(' built-in      ');
  HP98625:      WRITE(' HP 98625      ');
  HP98626:      WRITE(' HP 98626      ');
  HP98627:      WRITE(' HP 98627      ');
  HP98628_Async: WRITE(' HP 98628 - Async ');
  HP98629:      WRITE(' HP 98629      ');
  HP98644:      WRITE(' HP 98644      ');
  OTHERWISE    WRITE(' Other      ');
END; { CASE Card_ID }

WRITELN;

END; { IF .. BEGIN }

END; { FOR .. BEGIN }

END.

```

Other Types

In addition to the previously specified information there are some pre-defined types used throughout the I/O Library. These type definitions are:

```

IO_BIT      = 0..15 ;
IO_BYTE     = 0..255 ;
IO_WORD     = -32768..32767 ;
IO_STRING   = STRING[255];

```

Directing Data Flow

Chapter

4

Introduction

This chapter describes how to specify which computer resource is to send data to the computer or receive data from the computer. There are three main resources for the source and destination of data:

- Internal devices
- External devices
- Mass storage files

The I/O Library is used for accessing internal and external devices and is discussed here. The Pascal system has other methods for accessing mass storage files and these commands are covered in the *Pascal Workstation System* manual.

Specifying a Resource

The procedures and functions that perform I/O have a device selector parameter as a part of the parameter list. This parameter has two forms: a simple device selector and an addressed device selector.

Simple Device Selectors

Devices include the built-in CRT and keyboard, external printers and instruments, and all other physical entities that can be connected to the computer through an interface. Thus, each device connected to the computer can be accessed through its interface. Each interface has a unique number by which it is identified, known as its interface select code. The internal devices are accessed with the following, permanently assigned interface select codes.

<u>Device</u>	<u>Select Code</u>
CRT Display	1
Keyboard	2
Built-in HP-IB	7
Built-in Serial	9

Optional interfaces all have switch-settable select codes. These interfaces cannot use select codes 0 through 7; the valid range is 8 through 31. The following settings on optional interfaces have been made at the factory but can be changed to any other unique select code. See the interface's installation manual for further instructions.

<u>Device</u>	<u>Select Code</u>
98624A HP-IB	8
98626 Serial	9
98644 Serial	9
98622A GPIO	12
98625A Disc	14
98625A Datacomm	20

An example program using interface select codes is shown below:

```
PROGRAM selectcode ( INPUT , OUTPUT );
IMPORT GENERAL_2;
VAR   str : STRING[255];
BEGIN
  WRITESTRING(1,'type something - terminated by the ENTER key');
  READSTRING_UNTIL(CHR(13),2,str);
  WRITESTRING(12,'message from keyboard - ');
  WRITESTRINGLN(12,str);
END.
```

Addressed Device Selectors

Each device on an HP-IB interface has an address by which it is uniquely identified. The addressed device selector is a combination of the interface select code and the device's bus address. This combination is:

$$\text{interface select code} * 100 + \text{device bus address} = \text{addressed device selector}$$

A printer with a bus address of 1 on the internal HP-IB interface (which is an interface select code of 7) would be accessed with a device selector of 701.

An example program using an addressed device selector is shown below:

```
PROGRAM device ( INPUT , OUTPUT );
IMPORT GENERAL_2;
VAR   num : REAL;
BEGIN
  READNUMBERLN(724,num);
  WRITESTRING(701,'reading from voltmeter - ');
  WRITENUMBERLN(701,num);
END.
```

Outputting Data

Chapter**5**

Introduction

The preceding chapter described how to identify a specific device as the destination of data in a `WRITESTRING` procedure. Even though a few examples were shown, the details of how the data is sent was not discussed. This chapter describes the topic of outputting data to devices.

There are two general classes of output operations. The first type, known as “free field” output, uses the computer’s default data representation. The second class provides precise control over each character to be sent and is called “formatted” output.

The I/O Library is a separate set of procedures and functions. As such, it does not have variable length or variable type parameter lists. In Pascal there are normal “print” facilities called `WRITE` and `WRITELN` (for write line) that can have a variable list. Some examples are:

```
WRITELN('hello there');  
WRITELN('the value received was ',i);  
WRITE(i,' times ',j,' is equal to ',i*j);  
WRITE(client.name,' has ',client.eyecolor,' eyes');
```

Note that there are no requirements for what types of constants, variables, or expressions are allowed in a list, nor are there any requirements for their order in a list.

Because of this restriction on the variability of lists, the I/O Library only normally supports a small set of types. These types are:

- Real expressions
- Strings (up to 255 characters)
- Characters (8 bits)
- Words (16 bits)

The procedures that handle these types will only handle one of the type. These operations can be used in a series to get the effect of a list.

Free Field Output

As mentioned in the previous section, there are four main types supported directly by the I/O Library output facility. These are:

- Real Expressions
- String Expressions
- Characters
- Words

Real Expressions

There are two output procedures for real expressions: `WRITENUMBER` and `WRITENUMBERLN`. Both operate in an identical fashion except that `WRITENUMBERLN` appends a carriage return and line feed to the characters sent to the device. The form of these procedures is:

```
WRITENUMBER ( device_selector, numeric_expression );
WRITENUMBERLN ( device_selector, numeric_expression );
```

Both procedures are in the I/O Library module `GENERAL_2`. The device selector can be a simple interface select code or it can contain addressing information. The numeric expression can be any valid expression including simple real, integer, or integer subrange variables, numeric constants, and numeric expressions. An example program follows:

```
PROGRAM realexpression (INPUT,OUTPUT);
IMPORT      IODECLARATIONS,
           GENERAL_2;
VAR a      : REAL;
    i      : INTEGER;
    device : TYPE_DEVICE;
BEGIN
  device:=701;
  i:=12;
  a:=12.34;
  WRITENUMBERLN(device,i);
  WRITENUMBERLN(device,a);
  WRITENUMBERLN(device,1234);
  WRITENUMBERLN(device,a+1234);
  WRITENUMBERLN(device,i+12);
END.
```

This program will produce the following output:

```
1.20000E+001
1.23400E+001
1.23400E+003
1.24634E+003
2.40000E+001
```

The example program did not use WRITENUMBER. This is because there are no additional characters sent with the ASCII character sequence. Two numbers sent with two consecutive WRITENUMBERs might look like:

```
1.23456E+1239.87654E-321
```

Notice that there is no separator. The examples toward the end of this section will show examples of WRITENUMBER. Be sure that you remember that the real number can be preceded by a minus sign.

String Expressions

There are two output procedures for string expressions: WRITESTRING and WRITESTRINGLN. Both operate in an identical fashion except that WRITESTRINGLN appends a carriage return and line feed to the characters sent to the device. The form of these procedures is:

```
WRITESTRING ( device_specifier , string_expression ) ;
WRITESTRINGLN ( device_specifier , string_expression ) ;
```

Both procedures are in the I/O Library module GENERAL_2. The device selector can be a simple interface select code or it can contain addressing information. The string expression can be any valid expression including simple string variables, string constants, and string expressions. An example program follows:

```
PROGRAM strings (INPUT,OUTPUT);
IMPORT          IODECLARATIONS,
               GENERAL_2;
VAR s          : STRING[255];
    t          : STRING[32];
    device     : TYPE_DEVICE;
BEGIN
  device:=701;
  s:='first string';
  t:='second string';
  WRITESTRING (device,s);
  WRITESTRINGLN(device,t);
  WRITESTRING (device,'this is a string constant and ');
  WRITESTRINGLN(device,'this is the '+s);
  WRITESTRINGLN(device,'both '+s+' and the '+t);
END.
```

This program will produce the following output:

```
first stringsecond string
this is a string constant and this is the first string
both first string and the second string
```

Characters

There is a single output procedure for single characters: `WRITECHAR`. The form of this procedure is:

```
WRITECHAR (interface_select_code, character_expression);
```

The procedure is in the I/O Library module `GENERAL_1`. The interface select code cannot be a device specifier (like 701). Refer to the HP-IB section regarding bus addressing. The character expression can be a character variable, character constant, or character expression. An example program follows:

```
PROGRAM characters (INPUT,OUTPUT);
IMPORT          IODECLARATIONS,
               GENERAL_1,
               GENERAL_2;
VAR c          : CHAR;
    i,j        : INTEGER;
    device     : TYPE_DEVICE;
    isc        : TYPE_ISC;
BEGIN
  isc:=7;
  device:=701;
  WRITESTRING(device,'some characters <');
  WRITECHAR(isc,'x');
  c:='y';
  WRITECHAR(isc,c);
  j:=ORD('z');
  WRITECHAR(isc,chr(j));
  FOR i:=65 TO 90 DO WRITECHAR(isc,chr(i));
  WRITESTRINGLN(isc,'>');
END;
```

This program will produce the following output:

```
some characters <xyzABCDEFGHJKLMNOPQRSTUVWXYZ>
```

Words

There is a single output procedure for 16 bit words. It is `WRITEWORD`. The form of this procedure is:

```
WRITEWORD (interface_select_code, word_expression);
```

The procedure is in the I/O Library module `GENERAL_1`. The first parameter must be an interface select code; it cannot be a device selector (like 701). Refer to the HP-IB section regarding bus addressing. The word expression can be a word, integer, or integer subrange variable, integer constant, or integer expression. The evaluated value must be in the range of -32768 to 32767 .

The procedure has two different behaviors, depending on what type of interface it is used with. When used with a GPIO interface (HP 98622), this procedure will send a single 16 bit quantity over the 16 data lines on the interface. This procedure will send two consecutive bytes for all other interface types — most significant byte first, least significant byte last. An example program for an HP-IB interface follows:

```
PROGRAM words (INPUT,OUTPUT);
IMPORT      IODECLARATIONS,
            GENERAL_1,
            GENERAL_2;
TYPE short = -32768..32767;
VAR c      : CHAR;
    i,j    : INTEGER;
    x      : IO_WORD;
    y      : short;
    device : TYPE_DEVICE;
    isc    : TYPE_ISC;
BEGIN
  isc:=7;
  device:=701;
  WRITESTRING(device,'some characters <');
  x:=65*256+66;
  WRITEWORD(isc,x);
  WRITEWORD(isc,67*256+68);
  j:=69*256+70;
  WRITEWORD(isc,j);
  j:=ORD('z');
  FOR i:=65 TO 75 DO WRITEWORD(isc,j*256+i);
  WRITESTRINGLN(isc,'>');
END.
```

This program will produce the following output:

```
some characters <ABCDEFzAzBzCzDzEzFzGzHzIzJzK>
```

The following program is an example of how to use the “free field” procedures together to get effect of a full parameter list:

```
PROGRAM strings (INPUT,OUTPUT);
IMPORT      IODECLARATIONS,
            GENERAL_1,
            GENERAL_2;
VAR s,t     : STRING[255];
    x       : REAL;
    device  : TYPE_DEVICE;
    isc     : TYPE_ISC;
BEGIN
  device:=701;
  isc :=7;
  s:='Range1;Trigger1;Number';
  x:=100;
  t:='Store';
  WRITESTRING (device,s);
  WRITENUMBER (isc ,x);
  WRITESTRING (isc ,t);
  WRITECHAR  (isc ,chr(10));
END.
```

This program will produce the following output sequence:

```
Range1;Trigger1;Number1.00000E+002Store
```

Formatted Output

The previous “free field” procedures are adequate for a large number of applications. There are, however, a large number of applications that need the “formatted” output capability. The I/O Library does not directly provide this capability. Formatted output is achieved with the use of the built in procedure STRWRITE.

STRWRITE

The STRWRITE procedure is a version of the standard Pascal procedure WRITE. The difference is that STRWRITE sends the character stream to a string variable, as opposed to an output file. The form of STRWRITE is as follows:

```
STRWRITE (string_variable, starting_char, next_char_var, ...output list...);
```

The string variable is the destination for the output operation. The starting character position is an integer expression that indicates which character in the string is the start of the output area. The next character variable will contain, after the execution of STRWRITE, the next available character in the string for a successive STRWRITE or other string operation. For additional information, refer to *The HP Pascal Language Reference for Series 200 Computers*.

The following program is an example of how to use STRWRITE to produce formatted output:

```
PROGRAM formatted (INPUT,OUTPUT);
IMPORT      IODECLARATIONS,
           GENERAL_2;
TYPE color = ( blue , brown , green , red );
VAR s,name : STRING[255];
    pos,n   : INTEGER;
    eyes    : color;
    device  : TYPE_DEVICE;
BEGIN
    device:=701;

    name  :='John Smith';
    n     :=12;
    eyes  :=blue;

    STRWRITE(s,1,pos, name,' is employee number ',n:4);
    SETSTRLEN(s,pos-1);
    WRITESTRINGLN(device,s);

    STRWRITE(s,1,pos, 'and has ',eyes,' eyes ');
    SETSTRLEN(s,pos-1);
    WRITESTRINGLN(device,s);
END.
```

This program will produce the following output:

```
John Smith is employee number 12  
and has BLUE eyes
```

Inputting Data

Chapter

6

Introduction

There are two general classes of input operations. The first type, known as “free-field” input, uses a default interpretation of the data to be input. The second class provides precise control over each character to be received and is called “formatted” input.

The I/O Library is a separate set of procedures and functions. As such, it does not have variable length or variable type parameter lists. However, in Pascal there are normal “input” facilities, called READ and READLN (for read line), that can have a variable length list. Some examples are as follows:

```
READ(name); FOR i:= 1 TO 100 DO READ(mychar[i]);  
READ(voltage,frequency); READLN(prompt);
```

Note that there are no requirements for what types of variables are allowed in the list, nor are there any requirements on the order of variables on the list. Because of this restriction on the variability of lists, the I/O Library only normally supports a small set of input data types. These types are as follows:

- Real variables
- Strings (up to 255 characters)
- Characters (8 bits)
- Words (16 bits)

In addition to these data types, the I/O Library supports some field skipping facilities. The procedures that handle these types and facilities will only handle one operation at a time. However these operations can be used in a series to get the effect of a list.

Free-Field Input

As mentioned in the previous section, there are four main data types supported directly by the I/O Library input facility:

- Real Variables
- String Variables
- Characters
- Words

Real Variables

There are two input procedures for real variables: READNUMBER and READNUMBERLN. Both operate in an identical fashion except that READNUMBERLN searches for a line feed termination from the device. The form of these procedures is:

```
READNUMBER ( device_selector, numeric_expression );
READNUMBERLN ( device_selector, numeric_expression );
```

Fundamental to understanding how these procedures work is the concept of termination. The READNUMBER procedures will skip over any number of non-numeric characters until a numeric character is found. Then, up to 255 numeric characters will be read in as an ASCII representation of a real number. Numeric characters are defined to be the following characters:

0	5	E
1	6	e
2	7	+
3	8	-
4	9	period
		space

When reading numbers, the terminating conditions are:

- Any non-numeric character after numeric characters have been read, or
- 255 numeric characters read.

Note

Note that spaces are not considered to be “non-numeric” characters, and therefore will not terminate numbers. Erroneous results may occur if you try to use them to terminate or delimit numbers, because these procedures do not report receiving erroneously formatted numbers.

Both procedures are in the I/O Library module `GENERAL_2`. The first parameter can be either a simple interface select code or a device selector that contains addressing information. The variable must be a real variable (including a real array element). An example program follows:

```
PROGRAM realvariable ( INPUT, OUTPUT );
IMPORT IODECLARATIONS,
      GENERAL_2;
VAR
  a   : REAL;
BEGIN
  { input comes from keyboard }
  WRITELN('Type in a real number, terminated by a non-numeric character');
  READNUMBER(1,a);
  WRITELN;
  WRITELN('Here is the value you entered: ',a);

  WRITELN('Type in a real number, terminated by CTRL-J');
  READNUMBERLN(1,a);
  WRITELN;
  WRITELN('Here is the value you entered: ',a);

END.
```

String Variables

There are two input procedures for string variables: `READSTRING` and `READSTRING_UNTIL`. Both operate in a similar manner except that `READSTRING_UNTIL` searches for a specified termination character where the `READSTRING` uses some default terminations.

The form of the `READSTRING` procedure is:

```
READSTRING (device_selector, string_variable);
```

The `READSTRING` procedure will read characters into a string until one of the following termination conditions are encountered:

- A line feed is received.
- A carriage return and a line feed are received.
- The string variable is filled.

The line feed or carriage return and line feed are NOT placed in the string variable. The form of the `READSTRING_UNTIL` procedure is:

```
READSTRING_UNTIL (termination_character,
                  device_selector, string_variable);
```

The `READSTRING_UNTIL` procedure will read in characters into a string until one of the following termination conditions are encountered:

- The match character is received.
- The string variable is filled.

The termination character is placed into the string variable.

Both procedures are in the I/O Library module GENERAL_2. An example program follows:

```
PROGRAM stringvariable (INPUT,OUTPUT);
IMPORT      IODECLARATIONS,
           GENERAL_2;
VAR s      : STRING[255];
    t      : STRING[ 8];
BEGIN
  { the keyboard is the input device }

  WRITELN('enter a string terminated with a control-J');
  READSTRING(1,s);
  WRITELN('you entered <',s,'> as your string');

  WRITELN('enter a string of 8 characters');
  READSTRING(1,t);
  WRITELN('you entered <',t,'> as your string');

  WRITELN('enter a string terminated with an ENTER ( carriage return )');
  READSTRING_UNTIL(chr(13),1,s);
  WRITELN('you entered <',s,'> as your string');

END.
```

Characters

There is a single input procedure for single characters—READCHAR. The form of this procedure is:

```
READCHAR (interface_select_code, character_variable);
```

The procedure is in the I/O Library module GENERAL_1. The interface select code cannot be a device specifier (like 701). Refer to the HP-IB section regarding bus addressing. The variable must be a character variable. An example program follows:

```
PROGRAM characters (INPUT,OUTPUT);
IMPORT      IODECLARATIONS,
           GENERAL_1;
VAR c      : CHAR;
BEGIN
  REPEAT
    READCHAR(1,c);
    WRITELN;
    WRITELN('you typed ',c,' which is character ',ORD(c):3);
  UNTIL c=CHR(13);
  WRITELN('done');
END.
```

Words

READWORD is the input procedure for 16-bit words. The form of this procedure is:

```
READWORD (interface_select_code, integer_variable);
```

The procedure is in the I/O Library module GENERAL_1. The first parameter must be an interface select code; it cannot be a device selector that contains addressing information (like 701). Refer to the HP-IB section regarding bus addressing. The variable must be an integer variable. The returned value will be in the range of $-32\,768$ to $32\,767$.

The procedure has two different behaviors, depending on what type of interface it is used with. When used with an HP 98622 GPIO interface, this procedure will read a single 16-bit quantity from the 16 data lines on the interface. This procedure will read two consecutive bytes for all other interface types – most significant byte first, least significant byte last. An example program for an HP-IB interface follows:

```
PROGRAM words (INPUT,OUTPUT);
IMPORT      IDECLARATIONS,
           GENERAL_1;
VAR x      : INTEGER;
BEGIN
  READWORD(12,x);
  WRITELN('the word received was : ',x:7);
END.
```

Skipping Data

There are applications where you want to skip over a block of data and do not wish to store the information. The I/O Library has two procedures to support skipping over data: READUNTIL and SKIPFOR.

The READUNTIL procedure skips over data until a match character is received. It is of the form:

```
READUNTIL (termination_character, device_selector);
```

The SKIPFOR procedure skips over a specified number of characters. It is of the form:

```
SKIPFOR (skip_count, device_selector);
```

The skip count is an integer expression. Both procedures are in I/O Library module GENERAL_2.

Formatted Input

The previous “free field” procedures are adequate for a large number of applications. There are, however, a large number of applications that need the “formatted” input capability. The I/O Library does not directly provide this capability. Formatted input is achieved with the use of the built in procedure STRREAD.

STRREAD

The STRREAD procedure is a version of the standard Pascal procedure READ. The difference is that STRREAD reads the character stream from a string variable, as opposed to an input file. The form of STRREAD is as follows:

```
STRREAD (string_variable, starting_char, next_char_var, ...input list...);
```

The string variable is the source for the input operation. The starting character position is an integer expression that indicates which character in the string is the start of the data to be read. The next character variable will contain, after the execution of STRREAD, the next available character in the string for a successive STRREAD or other string operation. For additional information, refer to the *HP Pascal Language Reference for Series 200 Computers*.

The following program is an example of how to use STRREAD to produce formatted input.

```
PROGRAM formatted (INPUT,OUTPUT);
IMPORT      IODECLARATIONS,
           GENERAL_2;
TYPE color = ( blue , brown , green , red );
VAR s      : STRING[12];
    t      : STRING[ 8];
    pos    : INTEGER;
    eyes   : color;
BEGIN

    WRITELN('enter 8 alphabetic characters');
    WRITELN('and then type the characters BLUE');

    READSTRING(1,s);

    STRREAD(s,1,pos, t,eyes);

    WRITELN('the string is ',t,' and the eyes are ',eyes);

END.
```

Registers

Chapter

7

Introduction

There are two classes of registers available to the Pascal I/O Library: hardware registers and I/O system registers. Hardware registers are actual registers located on the I/O cards, while I/O system registers are maintained by the Pascal I/O system. I/O system registers are often concatenations of bits in hardware registers, maintained and accessed by I/O system routines.

The hardware registers are accessed with the low-level `IOREAD_BYTE` and `IOREAD_WORD` functions and `IOWRITE_BYTE` and `IOWRITE_WORD` procedures. The I/O system registers are accessed with the higher-level `IOSTATUS` function and `IOCONTROL` procedure.

In most instances, it is unnecessary for the programmer to access the I/O system registers. Some of the more common register operations are supported in high level procedures and functions. It is best to use the high level procedures and functions when possible because these are more easily understood and are more transportable. Refer to the chapters that deal with the specific interface for the high level procedures and functions.

I/O System Registers

The I/O System registers are called the status and control registers. In previous desktop computers and in the current Series 200 HP BASIC language, these registers are accessed with the BASIC `STATUS` and `CONTROL` statements. In the Pascal system most of the I/O system registers have the same definitions as the BASIC system. This is only mentioned in case you already have an understanding of the BASIC registers.

The IOSTATUS Function

A status register is read with the `IOSTATUS` function. To read a register, specify the interface and the register number of interest in the parameter list. Only a single register may be examined with each invocation of `IOSTATUS`.

Examples

```
interface := 12;
register := 0;
i := IOSTATUS(interface,register);

WRITELN('bus state is ',IOSTATUS(7,7));
```

{ reg 0 is card id }
{ set interface id }
{ set HP-IB bus state }

The IOCONTROL Procedure

A control register is written with the IOCONTROL procedure. It is necessary to specify the interface and the register number, and the value to be written in the parameter list. Only a single register may be modified with each invocation of IOCONTROL.

Examples

```
interface := 7;           { Built-in HP-IB, }
register   := 3;         { Register 3 sets address. }
IOCONTROL(interface,register,5); { Set address to 5, }

IOCONTROL(7,0,1);       { Reset HP-IB interface. }
```

Common Register Definitions

The status and control registers are very interface dependent both in number and definition of the registers. There are two registers that are defined for all except two interfaces:

- status register 0 (for card identification)
- control register 0 (to reset the interface card)

The keyboard and CRT (interface select codes 1 and 2) do not have status and control registers implemented.

Hardware Registers

The hardware registers are accessed by the system. It is, therefore, dangerous for you to access these registers unless you have a complete understanding of both the register definition and of the consequences of accessing the hardware registers. Their locations and definitions are given in subsequent chapters that describe each interface's registers. The IOREAD_BYTE and IOWRITE_BYTE perform an eight-bit (byte) operation on the computer backplane. The IOREAD_WORD and IOWRITE_WORD perform a 16-bit (word) operation on the computer backplane.

Errors and Timeouts

Chapter
8

Introduction

There are two types of events supported in the Pascal I/O Library:

- I/O Errors
- I/O Timeouts

These I/O events are handled via the TRY/RECOVER event handling mechanism. Refer to the Compiler chapter of the *Pascal Workstation System* manual for additional information on TRY/RECOVER.

Note that timeouts are only available on handshake operations. There is no timeout facility on the advanced transfers. Also note that the Datacomm interface control blocks use the TRY/RECOVER mechanism.

Pascal Event Processing

Pascal's event-handling mechanism is very much different from that found in BASIC or HPL on the Series 200 computers. BASIC and HPL are interpreted languages. At the end of each program line, there is a call to a system routine that checks for the occurrence of events. If one has occurred (and is enabled to initiate a program branch), then the appropriate branch is taken. The Pascal Compiler does not generate code at the end of each line to check for events. Pascal takes advantage of a hardware feature that allows an event to escape from whatever code is currently being executed to a previously defined event handler. An example program that uses this event handling is as follows:

```

$SYSPROG ON$                { enable optional compiler features }
PROGRAM errors (INPUT,OUTPUT);
  VAR a : REAL;
  BEGIN
    TRY
      a := 1;
      a := a/0;                { this should generate an error }
      WRITELN('This should not get executed');
    RECOVER                    { this is the event handler      }
    BEGIN
      WRITELN('I have gotten an error');
      WRITELN('The escape code is ',ESCAPECODE);
      ESCAPE(ESCAPECODE);     { Pass error on                  }
    END;

    WRITELN('Program finished normally');
  END.

```

When run, this program will generate a CRT screen similar to the following:

```

I have gotten an error
The escape code is      -5

-----
error -5: divide by zero
PC value:      -444090

```

The error handling in Pascal depends on four language features:

- TRY
- RECOVER
- ESCAPECODE
- ESCAPE

These features are not in the normal Pascal language. To access these features it is necessary to turn on a Compiler option called SYSPROG. This Compiler option enables error handling and several other system features. Refer to the Compiler chapter of the *Pascal Workstation System* manual for additional information about \$SYSPROG ON\$.

TRY

TRY defines the start of a block of code that is to be handled by a following RECOVER block. This block of code may contain anything including procedure and function calls. If any error occurs, it will be handled by the RECOVER block, unless there is a nested TRY/RECOVER block. TRY/RECOVER blocks may be nested to any level. The inner-most RECOVER block will receive control.

If no error occurs in a TRY/RECOVER block then the next statement following the RECOVER block is executed.

RECOVER

RECOVER defines the start of the error handling code. The RECOVER code must be a simple statement or a BEGIN/END block.

ESCAPECODE

ESCAPECODE is an INTEGER variable that contains the error code from the last error. System errors have negative values. User errors should have positive values.

ESCAPE

ESCAPE is a procedure that generates an error escape. It has a single INTEGER parameter. When ESCAPE is executed it places the parameter into the ESCAPECODE variable and generates an error. This error will be trapped by a RECOVER block, if any.

I/O Error Handling

I/O errors are just one of several error conditions that can occur in the Pascal system. Because of the multitude of errors that can happen within device I/O, only one ESCAPECODE has been allocated for use by the I/O Library. When ESCAPECODE has the value -26 , the error was an I/O error.

The I/O Library uses some additional variables and functions for the various errors that it can generate:

- IOESCAPECODE
- IOE_RESULT
- IOE_ISC
- IOERROR_MESSAGE

IOESCAPECODE

IOESCAPECODE is an integer constant with the value -26 . This constant is compared with the ESCAPECODE to determine if the ESCAPE was due to an I/O error. The constant IOESCAPECODE is defined in the I/O Library Module IODECLARATIONS.

IOE_RESULT

IOE_RESULT is an integer variable. This variable contains the specific I/O error code, if any. The variable IOE_RESULT is defined in the I/O Library Module IODECLARATIONS. A listing of current error codes and their messages is in the last section in this chapter. For each error code, the I/O Library has defined a constant for that error. For example, when IOE_RESULT has the value 11, the error is that there is no firmware to support the interface card in the system. This error has a constant defined in IODECLARATIONS called `ioe_no_driver` that is defined to have the decimal value 11.

IOE_ISC

IOE_ISC is an integer variable. This variable contains the interface select code of the last interface to generate an I/O error. If the error was not due to an interface problem, then IOE_ISC will contain the value 255 (which is NO_ISC). The variable IOE_ISC is defined in the I/O Library Module IODECLARATIONS.

IOERROR_MESSAGE

IOERROR_MESSAGE is a string function. This function has one INTEGER parameter that should contain the I/O error code IOE_RESULT. The function returns a string that is the English error message associated with the specific error code. The string function IOERROR_MESSAGE is in the I/O Library Module GENERAL_3. A listing of current error codes and their messages is in the last section in this chapter.

The following program is an example of handling an I/O error using the TRY/RECOVER mechanism used with the features of the I/O Library. This program attempts to write a string out to an HP-IB interface without first addressing the interface card as a talker.

```

$SYSPROG ON$                { enable optional compiler features }
PROGRAM io_errors (INPUT,OUTPUT);
  IMPORT  IODECLARATIONS,
          GENERAL_1,
          GENERAL_2,
          GENERAL_3;

BEGIN
  TRY
    IOINITIALIZE;           { put I/O system into known state }
    WRITESTRINGLN(7,'I am not sending address information');
    WRITELN('This should not get executed');
  RECOVER                   { this is the event handler      }
  BEGIN
    WRITELN('I have gotten an error');
    WRITELN('The escape code is ',ESCAPECODE);
    IF ESCAPECODE=IOESCAPECODE
    THEN BEGIN
      WRITELN('The error was an I/O error');
      WRITELN(IOERROR_MESSAGE(IOE_RESULT),' on isc ',IOE_ISC);
    END
    ELSE BEGIN
      ESCAPE(ESCAPECODE);  { pass error on                  }
    END;
  END;
  WRITELN('Program finished normally');
END.

```

When run, this program will generate a CRT screen similar to the following:

```

I have gotten an error
The escape code is          -26
The error was an I/O error
not addressed as talker on isc      7
Program finished normally

```

Note that the program finished normally. The path that was executed inside the RECOVER block did not perform an ESCAPE. Therefore, the statement immediately following the RECOVER block is executed next.

It is important to structure your TRY/RECOVER blocks in a manner similar to the one just shown. This is necessary because **all** errors go through the TRY/RECOVER mechanism. If you do not check the cause of the error with ESCAPECODE, you might trap an error meant for some other TRY/RECOVER or an error you did not expect.

I/O Timeouts

A timeout occurs when the handshake response from any external device takes longer than a specified amount of time to complete. The time specified for the timeout is usually the maximum time that a device can be expected to take to respond to a handshake during an I/O statement.

Setting Up Timeout Events

The SET_TIMEOUT procedure in Module GENERAL_1 has two parameters, the interface select code and a single REAL parameter that is the time that the I/O Library will wait for an operation to complete. This parameter is the time in seconds. The parameter can range from 0 thru 8191 seconds with a resolution of .001 seconds. The default timeout value is 0, which is interpreted by the I/O Library as a timeout period of infinity—the system will wait forever for the operation to complete.

The timeout event is just another I/O error. The timeout error has the I/O error code (IOE_RESULT) of 17 (I/O error constant ioe_timeout).

A sample program trapping timeouts follows. This program will try to send some data to a device ten times and will then stop.

```

$SYSPROG ON$                                { enable optional compiler features }
PROGRAM timeouts (INPUT,OUTPUT);
  IMPORT IODECLARATIONS,
         GENERAL_1,
         GENERAL_2,
         GENERAL_3;
  VAR attempt : INTEGER;
      success : BOOLEAN;
BEGIN
  IOINITIALIZE;
  SET_TIMEOUT(7,1,0);                        { timeout of 1 second on isc 7  }
  attempt := 1;
  success := FALSE;
  REPEAT
    TRY
      WRITESTRINGLN(724,'This device does not exist on the bus');
      success := TRUE;
    RECOVER                                  { this is the event handler  }
    BEGIN
      IF ESCAPECODE=IOESCAPECODE
      THEN BEGIN
        IF ( IOE_RESULT = IOE_TIMEOUT ) AND ( IOE_ISC = 7 )
        THEN BEGIN
          IORESET(7);                        { because interface is in a bad state }
          WRITELN('timeout #',attempt:2);
          attempt := attempt+1;
        END
        ELSE BEGIN
          WRITELN(IDERROR_MESSAGE(IOE_RESULT),' on isc ',IOE_ISC);
          ESCAPE(ESCAPECODE);
        END;
      END
      ELSE BEGIN
        ESCAPE(ESCAPECODE);                  { pass error on  }
      END;
    END;
  UNTIL ( attempt>10 ) OR success;
  WRITELN('Program finished');
  IOUNINITIALIZE;                            { clean up interface state  }
END.

```

When run, this program will generate a CRT screen similar to the following:

```

timeout # 1
timeout # 2
timeout # 3
timeout # 4
timeout # 5
timeout # 6
timeout # 7
timeout # 8
timeout # 9
timeout #10
Program finished

```

I/O Errors

The following list contains the error codes in the I/O Library. The error code value is stored in the system variable IOE_RESULT. This list also contains the text of the error message produced by the GENERAL_3 string function IOERROR_MESSAGE. The name of the error is a constant that is declared in the IODECLARATIONS Module. The errors from 306 through 327 are HP 98628A Datacomm interface errors.

Name	Value	Error Message
ioe_no_error	0	no error
ioe_no_card	1	no card at select code
ioe_not_hpib	2	interface should be hpib
ioe_not_act	3	not active controller
ioe_not_dvc	4	should be device not sc
ioe_no_space	5	no space left in buffer
ioe_no_data	6	no data left in buffer
ioe_bad_tfr	7	improper transfer attempted
ioe_isc_busy	8	the select code is busy
ioe_buf_busy	9	the buffer is busy
ioe_bad_cnt	10	improper transfer count
ioe_bad_tmo	11	bad timeout value
ioe_no_driver	12	no driver for this card
ioe_no_dma	13	no dma
ioe_no_word	14	word operations not allowed
ioe_not_talk	15	not addressed as talker
ioe_not_lstn	16	not addressed as listener
ioe_timeout	17	a timeout has occurred
ioe_not_sctl	18	not system controller
ioe_rds_wtc	19	bad status or control
ioe_bad_sct	20	bad set/clear/test operation
ioe_crd_dwn	21	interface card is dead
ioe_eod_seen	22	end/eod has occurred
ioe_misc	23	miscellaneous - value of param error
ioe_dc_fail	306	dc interface failure
ioe_dc_usart	313	USART receive buffer overflow
ioe_dc_ovfl	314	receive buffer overflow
ioe_dc_clk	315	missing clock
ioe_dc_cts	316	CTS false too long
ioe_dc_car	317	lost carrier disconnect
ioe_dc_act	318	no activity disconnect
ioe_dc_conn	319	connection not established
ioe_dc_conf	325	bad data bits/par combination
ioe_dc_reg	326	bad status /control register
ioe_dc_rval	327	control value out of range

Notes

Advanced Transfer Techniques

Chapter

9

Introduction

This chapter discusses advanced transfer techniques. These transfers are intended primarily for two main applications:

- Where the computer is much faster than the device being communicated with
- Where the computer is slower than the device being communicated with

This chapter includes discussions on buffers, serial transfers, overlap transfers and special forms of transfers.

Buffers

Buffers are the data area where the transfer procedures read and write the data that is being transferred. This area is actually in two pieces. One piece is the control block for the buffer. The other is the memory where data is actually stored.

The control block is a user variable. This variable must be of the type `BUF_INFO_TYPE` which is defined in the I/O Library module `IODECLARATIONS`. This block of information contains various fields including a pointer to the actual data area.

The data area is not allocated when the `BUF_INFO_TYPE` variable is declared. The data area is allocated at program execution time with the execution of a procedure called `IOBUFFER`. This procedure is of the form:

```
IOBUFFER (buffer_control_block, size_in_bytes);
```

The size in bytes is an integer value and can be of any size that the memory in your computer can create. The `IOBUFFER` procedure, at program execution time, will allocate the data area and initialize the various pointers in the buffer control block (a variable of `BUF_INFO_TYPE`). `IOBUFFER` and all other I/O Library transfer procedures are in the `GENERAL_4` module.

The data area that is allocated is allocated with the `NEW` facility. Refer to the *HP Pascal Language Reference for Series 200 Computers* for more information on `NEW` and its related capabilities. In particular, be careful of the `MARK` and `RELEASE` facilities since these can affect the buffer space.

Once a buffer has been declared and allocated, it is necessary to be able to read and write the buffer. The I/O Library, as with normal input and output, has a small number of procedures and functions to access the buffer space. These procedures and functions are:

- BUFFER_RESET
- BUFFER_SPACE
- BUFFER_DATA
- READBUFFER
- WRITEBUFFER
- READBUFFER_STRING
- WRITEBUFFER_STRING

Buffer Control

Necessary aspects of buffer control are empty and fill pointers. When data is written into the buffer, the fill pointer is incremented. When data is read from the buffer the empty pointer is incremented. When these two pointers meet, there is no data in the buffer.

The procedure `BUFFER_RESET` puts the empty and fill pointers back to the start of the buffer—effectively clearing it of data. The form of this procedure is:

```
BUFFER_RESET (buffer_control_block);
```

The integer function `BUFFER_SPACE` returns the number of bytes that are available at the end of the buffer from the fill pointer to the end of the buffer. This function is of the form:

```
BUFFER_SPACE (buffer_control_block);
```

The integer function `BUFFER_DATA` returns the number of bytes of data that are available in the buffer from the empty pointer to the fill pointer. This function is of the form:

```
BUFFER_DATA (buffer_control_block);
```

Reading Buffer Data

There are two procedures that read buffer data: `READBUFFER` and `READBUFFER_STRING`. `READBUFFER` reads a single character. `READBUFFER_STRING` reads a string. The form of these procedures is:

```
READBUFFER (buffer_control_block, character_var);
READBUFFER_STRING (buffer_control_block, string_var,
                  character_count );
```

The `READBUFFER_STRING` will read the specified number of characters from the buffer into the string variable.

Writing Buffer Data

There are two procedures that write buffer data: `WRITEBUFFER` and `WRITEBUFFER_STRING`. `WRITEBUFFER` writes a single character. `WRITEBUFFER_STRING` writes a string. The form of these procedures is:

```
WRITEBUFFER (buffer_control_block, character);
WRITEBUFFER_STRING (buffer_control_block, string);
```

The `WRITEBUFFER_STRING` will write the entire number of characters from the string expression into the buffer.

The following is an example program showing the creation and use of a buffer:

```
PROGRAM buffers (INPUT,OUTPUT);
IMPORT          IODECLARATIONS,
               GENERAL_4;
VAR buffer : BUF_INFO_TYPE;
    i      : INTEGER;
    c      : CHAR;
BEGIN

    IOBUFFER(buffer,100);           { create a 100 character buffer }
    BUFFER_RESET(buffer);          { make sure it is empty      }

    FOR i:=65 TO 90 DO
        WRITEBUFFER(buffer,chr(i)); { put character data in the buf }
        WRITEBUFFER_STRING(buffer,'hello'); { put a string in the buffer }
    END;

    WHILE BUFFER_DATA(buffer)>0 DO BEGIN
        READBUFFER(buffer,c);       { dump out the buffer by char }
        WRITE(c);
    END; { of WHILE DO BEGIN }
    WRITELN;

END.
```

This program will produce the following screen on the CRT:

```
ABCDEFGHIJKLMNPOQRSTUVWXYZhello
```

Serial Transfers

Serial transfers are those that complete before the next Pascal line is executed. This is the normal approach that Pascal uses in program execution. This type of transfer is useful in the application where you have a high speed data transfer where the computer is slower than or the same speed as the device.

The procedure that performs a data transfer to and from a buffer is the TRANSFER procedure. It has the following form:

```
TRANSFER (device, transfer_mode, direction,
          buffer_control_block, count);
```

The “device” parameter is the device selector (like 12 or 701) described in previous chapters. The “count” parameter is the number of bytes to be transferred by the procedure. The “buffer control block” parameter is the buffer variable of type BUF_INFO_TYPE.

The “direction” parameter is of a special type and can have two values: FROM_MEMORY and TO_MEMORY. So a direction of FROM_MEMORY is an output transfer and TO_MEMORY is an input transfer.

The “transfer mode” parameter is also of a special type. For serial transfers it can have the values:

- SERIAL_DMA
- SERIAL_FHS
- SERIAL_FASTEST

The DMA mode specifies a direct memory access transfer. The FHS mode specifies a fast handshake transfer. The FASTEST mode specifies that if DMA is installed and available for the transfer, then it should be used, otherwise a FHS transfer will occur. Some interfaces do not support DMA transfers (like the Datacomm interface). Those interfaces, when a FASTEST transfer is requested, will give a FHS transfer since they cannot do DMA.

The DMA mode transfer can only transfer 1 through 65 536 bytes of data. The fast handshake transfer can be of arbitrary size.

An example program using a serial transfer to a printer is:

```

PROGRAM transfers (INPUT,OUTPUT);
IMPORT      IODECLARATIONS,
            GENERAL_4;
VAR buffer : BUF_INFO_TYPE;
    i,j    : INTEGER;
    c      : CHAR;
BEGIN

    IOBUFFER(buffer,100);           { create a 100 character buffer }

    FOR j:=1 TO 5 DO BEGIN

        BUFFER_RESET(buffer);      { make sure it is empty      }
        FOR i:=65 TO 90 DO
            WRITEBUFFER(buffer,chr(i)); { put character data in the buf }
            WRITEBUFFER(buffer,chr(13)); { put in a carriage return }
            WRITEBUFFER(buffer,chr(10)); { put in a line feed      }
            TRANSFER(701,SERIAL_FASTEST,
                FROM_MEMORY,buffer,
                buffer_data(buffer)); { send all of the data in buf }
            WRITELN('this line will not be printed until the transfer is done');

        END; { of FOR DO BEGIN }

    END.

```

This program will produce the following on the CRT:

```

this line will not be printed until the transfer is done
this line will not be printed until the transfer is done
this line will not be printed until the transfer is done
this line will not be printed until the transfer is done
this line will not be printed until the transfer is done

```

and this on the PRINTER:

```

ABCDEFGHIJKLMNPOQRSTUVWXYZ
ABCDEFGHIJKLMNPOQRSTUVWXYZ
ABCDEFGHIJKLMNPOQRSTUVWXYZ
ABCDEFGHIJKLMNPOQRSTUVWXYZ
ABCDEFGHIJKLMNPOQRSTUVWXYZ

```

Overlap Transfers

Serial transfers are useful for high-speed applications. The computer will not continue execution of the program until the transfer is complete. For lower speed applications, this is not adequate. The Pascal I/O Library provides an overlap transfer mechanism. This mechanism allows for the program to continue execution while the transfer is continuing. The overlap transfer mechanism is identical to the serial transfer. Its form is:

```
TRANSFER (device, transfer_mode, direction,
          buffer_control_block, count);
```

All of the parameters are the same as for other types of transfers, with the exception of the “transfer_mode” parameter. For overlap transfers, the parameter can have the following values:

Transfer Mode Value	Meaning
OVERLAP_INTR	Interrupt transfer
OVERLAP_DMA	dma transfer
OVERLAP_FHS	Interrupt on first byte fast handshake on rest
OVERLAP_FASTEST	dma if available, else use overlap_fhs
OVERLAP	dma if available, else use overlap_intr

The overlap fast handshake mode has also been called burst mode, because it does not consume any CPU time until the first byte is transferred. The overlap mode is provided so that if your application requires a data transfer to execute concurrently with the program execution, then you will get the most efficient method available.

The DMA mode transfer can only transfer 1 through 65 536 bytes of data. The other transfer modes can be of arbitrary size.

When is the Transfer Finished?

There are two BOOLEAN functions which can tell you if a transfer is still occurring between a buffer and an interface. These are:

```
BUFFER_BUSY (buffer_control_block);
```

and

```
ISC_BUSY (interface_select_code);
```

Either function returns TRUE if the transfer is still active.

The following program is an example of an overlap transfer. This program does not do anything useful with the spare time available to it.

```

PROGRAM overlaped (INPUT,OUTPUT);
IMPORT      IODECLARATIONS,
            GENERAL_4;
VAR buffer : BUF_INFO_TYPE;
    i,j    : INTEGER;
    c      : CHAR;
BEGIN

    IOBUFFER(buffer,100);           { create a 100 character buffer }

    FOR j:=1 TO 5 DO BEGIN

        WHILE BUFFER_ACTIVE( buffer ) DO
        BEGIN
            WRITELN('waiting for transfer to finish');
            END;

        BUFFER_RESET(buffer);       { make sure it is empty           }
        FOR i:=65 TO 90 DO
            WRITEBUFFER(buffer,chr(i)); { put character data in the buf }
            WRITEBUFFER(buffer,chr(13)); { put in a carriage return    }
            WRITEBUFFER(buffer,chr(10)); { put in a line feed         }
            TRANSFER(701,OVERLAP_INTR,
                FROM_MEMORY,buffer,
                buffer_data(buffer)); { send all of the data in buf }

        END; { of FOR DO BEGIN }

    END.

```

This program will produce the following on the PRINTER:

```

ABCDEFGHIJKLMNPOQRSTUVWXYZ
ABCDEFGHIJKLMNPOQRSTUVWXYZ
ABCDEFGHIJKLMNPOQRSTUVWXYZ
ABCDEFGHIJKLMNPOQRSTUVWXYZ
ABCDEFGHIJKLMNPOQRSTUVWXYZ

```

Special Transfers

In addition to the block transfers that were described above, there are three additional versions of transfer. They are:

- word transfers
- match character transfers
- END condition transfers

Word Transfer

The GPIO interface can support 16 bit data transfers. The TRANSFER_WORD procedure simultaneously transfers 2 bytes over the GPIO interface. The form of this procedure is:

```
TRANSFER_WORD (device, transfer_mode, direction,
               buffer_control_block, count);
```

All of the parameters are the same with the exception of the count which now contains the 16-bit word count to be transferred. All the transfer types, overlap and serial, are the same as a regular transfer.

Match Character Transfer

This transfer procedure will transfer data into the computer until a match character is found. Note that this transfer, called TRANSFER_UNTIL, is an input only transfer. The form of the procedure is:

```
TRANSFER_UNTIL (termination_char, device, transfer_mode,
                direction, buffer_control_block);
```

The termination character is the match character that will stop the transfer. The transfer will also stop when there is no more room in the buffer. All of the other parameters are the same. Most of the transfer types, overlap and serial, are the same as a regular transfer - except that DMA transfers are not allowed. Note that there is NO count parameter. The direction must be TO_MEMORY.

END Condition Transfer

This transfer procedure will transfer data into the computer until an interface condition occurs or it will transfer data out with the last data byte being sent with an interface condition. This transfer is TRANSFER_END and has the form:

```
TRANSFER_END (device, transfer_mode, direction,
              buffer_control_block);
```

All of the parameters are the same. Note that there is NO count. The transfer will send all the available data followed by the condition or will receive data until the end condition occurs or the buffer fills up. All the transfer types, overlap and serial, are the same as a regular transfer. An example of an end condition is the EOI condition on HP-IB.

The HP-IB Interface

Chapter

10

Introduction

This chapter describes the techniques necessary for programming the HP-IB interface. Many of the elementary concepts have been discussed in previous chapters. This chapter describes the specific details of how this interface works and how it is used to communicate with and control systems consisting of various HP-IB devices.

The HP-IB (Hewlett-Packard Interface Bus), commonly called the “bus”, provides compatibility between the computer and external devices conforming to the IEEE 488-1978 standard. Electrical, mechanical, and timing compatibility requirements are all satisfied by this interface.

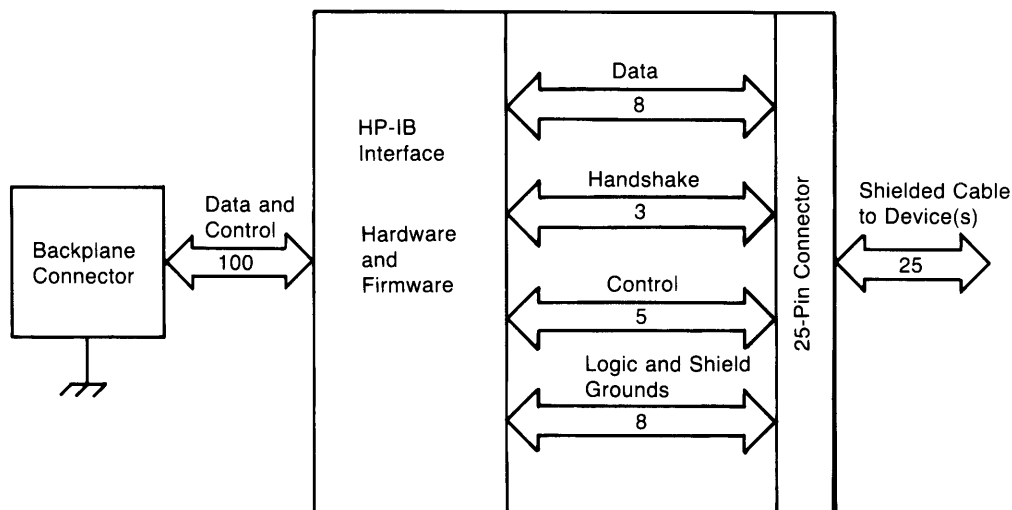

The HP-IB interface is both easy to use and allows great flexibility in communicating data and control information between the computer and external devices. It is one of the easiest methods to connect more than one device to the same interface.

Initial Installation

Refer to the HP-IB Installation Note for information about setting the switches and installing an external HP-IB interface. Once the interface has been properly installed, you can verify that the switch settings are what you intended by running the following program. The defaults of the internal HP-IB interface can also be checked with the program. The results are displayed on the CRT.

```
PROGRAM check_hPib ( INPUT , OUTPUT );
  IMPORT IODECLARATIONS,
         HPIB_1;
  VAR isc : TYPE_ISC;
  BEGIN
    WRITELN('Enter HP-IB interface select code');
    READLN(isc);

    IF ISC_TABLE[isc].CARD_TYPE <> HPIB_CARD
    THEN BEGIN
      WRITELN('The interface at isc ',isc:2,' is not an HP-IB interface');
    END
    ELSE BEGIN
      WRITELN('The interface at isc ',isc:2,' is an HP-IB interface');

      IF ISC_TABLE[isc].CARD_ID = HP98624
      THEN WRITELN(' and is an optional, external interface')
      ELSE WRITELN(' and is the standard, built in interface');

      WRITE('The interface is ');
      IF NOT SYSTEM_CONTROLLER(isc) THEN WRITE('NOT ');
      WRITELN('the system controller');

      WRITE('The interface has a bus address of ',my_address(isc):2);

    END; { of IF THEN/ELSE }
  END.
```

The terms system controller and bus address are described in the following sections. The internal HP-IB has a jumper that is set at the factory to make it a system controller. This jumper is located below the lowest interface slot at the computer backplane. The lowest interface (or memory board) in the backplane must be removed to access this jumper. If the jumper in the center of the clear plastic cover is placed on the middle and right most pins, as seen from the rear of the computer, the computer is set to be a system controller. If the jumper is on the middle and leftmost pins, then the computer is not system controller and will have a bus address of 20.

Communicating with Devices

This section describes programming techniques used to output data to and enter data from HP-IB devices. General bus operation is also briefly described.

HP-IB Device Selectors

Since the HP-IB allows the interconnection of several devices, each device must have a means of being uniquely accessed. Specifying just the interface select code of the HP-IB interface through which a device is connected is not sufficient to identify that device on the bus.

Each device connected to the bus has an address by which it can be identified. This address must be unique to allow individual access of each device. Most HP-IB devices have a set of switches that are used to set its address. Those that do not have switches, like the built in HP-IB interface in the computer, have a pre-set bus address. So, when a particular HP-IB device is to be accessed, it must be identified with both its interface and its bus address.

The interface select code is the first part of an HP-IB device selector. The interface select code of the internal HP-IB is 7. The second part of an HP-IB device selector is the device's bus address. This address is the range of 0 through 30. As described in the Directing Data Flow chapter, interface 7, device address 17 would have a device selector of 717. Interface 10, device address 2 would have a device selector of 1002.

Moving Data Through the HP-IB

Data is output from and entered into the computer through the output and input procedures described in earlier chapters. All the information in these chapters applies directly to the HP-IB interface. The advanced transfer techniques described in the preceding chapter also apply to the HP-IB interface.

Example

```
PROGRAM hpib_io (INPUT,OUTPUT);
  IMPORT          GENERAL_2;
  VAR a          : REAL;
      i          : INTEGER;
  BEGIN
    WRITESTRINGLN(701,'message to a printer');
    WRITESTRINGLN(724,'RIT1N1S');
    FOR i:= 1 TO 100 DO BEGIN
      READNUMBER (724,a);
      WRITELN('the reading from the voltmeter is ',a:6:2);
    END; { of FOR DO BEGIN }
  END.
```

General Structure of the HP-IB

Communications through the HP-IB are made according to a precisely defined set of rules. These rules help to ensure that only orderly communication may take place on the bus. For conceptual purposes, the organization of the HP-IB can be compared to that of a committee. A committee has certain "rules of order" that govern the manner in which business is to be conducted. For the HP-IB, these rules of order are the IEEE 488-1978 standard.

One member, designated the “committee chairman,” is set apart for the purpose of conducting communications between members during the meetings. This chairman is responsible for overseeing the actions of the committee and generally enforces the rules of order to ensure the proper conduct of business. If the committee chairman cannot attend a meeting, he designates some other member to be “acting chairman.”

On the HP-IB, the **system controller** corresponds to the committee chairman. The system controller is generally designated by setting a switch on the interface and cannot be changed under program control. However, it is possible to designate an “acting chairman” on the HP-IB. On the HP-IB, this device is called the **active controller**, and may be any device capable of directing HP-IB activities, such as a desktop computer.

When the system controller is first turned on or reset, it assumes the role of active controller. Thus, only one device can be designated system controller. These responsibilities may be subsequently passed to another device while the system controller tends to other business. This ability to pass control allows more than one computer to be connected to the HP-IB at the same time.

In a committee, only one person at a time may speak. It is the chairman’s responsibility to “recognize” which one member is to speak. Usually, all committee members present always listen; however, this is not always the case on the HP-IB. One of the most powerful features of the bus is the ability to selectively send data to individual (or groups of) devices.

Imagine slow note takers and fast note takers on the committee. Suppose that the speaker is allowed to talk no faster than the slowest note taker can write. This would guarantee that everybody gets the full set of notes and that no one misses any information. However, requiring all presentations to go at that slow pace certainly imposes a restriction on our committee, especially if the slow note takers do not need the information. Now, if the chairman knows which presentations are not important to the slow note takers, he can direct them to put away their notes for those presentations. That way, the speaker and the fast note taker(s) can cover more items in less time.

A similar situation may exist on the HP-IB. Suppose that a printer and a flexible disc are connected to the bus. Both devices do not need to listen to all data messages sent through the bus. Also, if all the data transfers must be slow enough for the printer to keep up, saving a program on the disc would take as long as listing the program on the printer. That would certainly not be a very effective use of the speed of the disc drive if it was the only device to receive the data. Instead, by “unlistening” the printer whenever it does not need to receive a data message, the computer can save a program as fast as the disc can accept it.

During a committee meeting, the current chairman is responsible for telling the committee which member is to be the talker and which is (are) to be the listener(s). Before these assignments are given, he must get the **attention** of all members. The talker and listener(s) are then designated, and the next data message is presented to the listener(s) by the talker. When the talker has finished the message, the designation process may be repeated.

On the HP-IB, the active controller takes similar action. When talker and listener(s) are to be designated, the **attention signal line** (ATN) is asserted while the talker and listener(s) are being addressed. ATN is then cleared, signaling that those devices not addressed to listen may ignore all subsequent data messages. Thus, **the ATN line separates data from commands**; commands are accompanied by the ATN line being true, while data messages are sent with the ATN line false.

On the HP-IB, devices are **addressed to talk** and **addressed to listen** in the following orderly manner. The active controller first sends a single command which causes all devices to **unlisten**. The talker's address is then sent, followed by the address(s) of the listener(s). After all listeners have been addressed, the data can be sent from the talker to the listener(s). Only device(s) addressed to listen accept any data that is sent through the bus (until the bus is reconfigured by subsequent addressing commands).

The data transfer, or **data message**, allows for the exchange of information between devices on the HP-IB. Our committee conducts business by exchanging ideas and information between the speaker and those listening to his presentation. On the HP-IB, **data is transferred from the active talker to the active listener(s) at a rate determined by the slowest active listener on the bus**. This restriction on the transfer rate is necessary to ensure that no data is lost by any device addressed to listen. The **handshake** used to transfer each data byte ensures that all data output by the talker is received by all active listeners.

Examples of Bus Sequences

Most data transfers through the HP-IB involve a talker and only one listener. For instance, when an input or output procedure is used to send data to or from a device, the following sequence of commands is sent through the bus.

```
WRITESTRINGLN(701,'Data');
```

1. The unlisten command is sent.
2. The talker's address is sent (the computer's talk address).
3. The listener's address is sent (address 01).
4. The data bytes "D", "a", "t", "a", carriage return and line feed are sent.

```
READSTRING(724,Message);
```

1. The unlisten command is sent.
2. The talker's address is sent (talk address for device 24).
3. The listener's address is sent (the computer listen address).
4. The data bytes are transferred.

Addressing Multiple Listeners

HP-IB allows more than one device to listen as data is sent through the bus. The Pascal I/O Library supports this capability in the following way. It is necessary for you to address the bus yourself. The procedures to do this addressing exist in the module HPIB_2. The following example shows how to address the computer as a talker and several devices as listeners.

```
UNLISTEN(isc);
TALK    (isc,MY_ADDRESS(isc));
LISTEN  (isc,address_1);
LISTEN  (isc,address_2);
LISTEN  (isc,address_3);
WRITESTRINGLN(isc,'This message sent to three listeners.');
```

An example where the computer is one of several devices listening to some incoming data is :

```
UNLISTEN(isc);
TALK    (isc,address_1);
LISTEN  (isc,MY_ADDRESS(isc));
LISTEN  (isc,address_2);
LISTEN  (isc,address_3);
READSTRING(isc,str);
```

The UNLISTEN, TALK and LISTEN procedures are in the I/O Library module HPIB_2.

Addressing a Non-Active Controller

The bus standard states that a non-active controller cannot perform any bus addressing. When only the interface select code is specified in an input or output procedure, no bus addressing occurs.

If the computer currently is not the active controller, it can still act as a talker or listener, provided it has been previously addressed. So, if an input or output procedure is executed while the computer is not an active controller, the computer first determines whether or not it is an active talker or listener. If not addressed to talk or listen, the computer waits until it is properly addressed and then performs the operation. Examples of non-controller I/O are:

```
READCHAR(7,c); { If not a listener, then wait until addressed to listen. }
WRITESTRINGLN(7,'This message sent after I'm addressed to talk.');
```

```
READSTRING_UNTIL(CHR(13),7,str);
```

If the computer is the active controller, it proceeds with the data transfer without addressing which devices are talker and listener(s). If the bus has not been configured properly (the controller not being addressed as a talker or listener), an error is reported. The escapecode is -26 (I/O) and the io error is 15 or 16 (not addressed as a talker or listener). The following program shows a typical use of this non-addressing approach.

```
WRITESTRINGLN(705,'This goes to device 5 on isc 7.');
```

```
LISTEN(7,1);
```

```
WRITESTRINGLN(7,'This goes to devices 1 and 5.');
```

```
LISTEN(7,20);
```

```
FOR i := 1 TO 10 DO
```

```
    WRITESTRINGLN (7,'These ten lines go to devices 1, 5, and 20.');
```

Pascal Control of HP-IB

The Pascal I/O Library has a number of procedures and functions for controlling the HP-IB. You have already seen a number of them in the preceding examples. These capabilities are broken down into two major groups – status and control.

HP-IB Status

Normal use of HP-IB requires three main status facilities:

- What is my address?
- Am I system controller?
- Am I active controller?

The function MY_ADDRESS returns the current device address of the specified interface. This integer function is in module HPIB_1. It has the form:

```
MY_ADDRESS ( interface_select_code );
```

The function SYSTEM_CONTROLLER returns a TRUE or FALSE depending on whether or not the interface is set to be the system controller. This boolean function is in module HPIB_1, and has the form:

```
SYSTEM_CONTROLLER ( interface_select_code );
```

The function ACTIVE_CONTROLLER returns a TRUE or FALSE depending on whether or not the interface is currently the active controller. This boolean function is in module HPIB_1, and has the form:

```
ACTIVE_CONTROLLER ( interface_select_code );
```

HP-IB Control

Normal use of HP-IB requires five main control facilities:

- Send untalk
- Send unlisten
- Send a talk command
- Send a listen command
- Send a secondary command

The UNTALK and UNLISTEN procedures send the appropriate command on the bus. These procedures are in the HPIB_2 module. The interface must be active controller for them to complete. They have the form:

```
UNTALK      ( interface_select_code );
```

```
UNLISTEN   ( interface_select_code );
```

The TALK, LISTEN and SECONDARY commands send a talk, listen or secondary command. These procedures are in the HPIB_2 module. The interface must be an active controller form for them to complete. They have the form:

```
TALK      ( interface_select_code , address );

LISTEN    ( interface_select_code , address );

SECONDARY ( interface_select_code , address );
```

General Bus Management

The HP-IB standard provides several mechanisms that allow managing the bus and the devices on the bus. Here is a summary of the procedures that invoke these control mechanisms.

ABORT_HPIB is used to abruptly terminate all bus activity and reset all devices to power-on states.

CLEAR is used to set all (or only selected) devices to a pre-defined, device-dependent state.

LOCAL is used to return all (or selected) devices to local (front-panel) control.

LOCAL_LOCKOUT is used to disable all devices' front-panel controls.

PASS_CONTROL is used to pass active control to another device on the bus.

PPOLL is used to perform a parallel poll on all devices (which are configured and capable of responding).

PPOLL_CONFIGURE is used to setup the parallel poll response of a particular device.

PPOLL_UNCONFIGURE is used to disable the parallel poll response of a device (or all devices on an interface).

REMOTE is used to put all (or selected) devices into their device-dependent, remote modes.

SEND_COMMAND is used to manage the bus by sending explicit command messages.

SPOLL is used to perform a serial poll of the specified device (which must be capable of responding).

TRIGGER is used to send the trigger message to a device (or selected group of devices).

These procedures (and functions) are described in the following discussion. However, the actions that a device takes upon receiving each of the above commands are, in general, different for each device. Refer to a particular device's manuals to determine how it will respond. Detailed descriptions of the actual sequence of bus messages invoked by these statements are contained in "Advanced Bus Management" near the end of this chapter.

Remote Control of Devices

Most HP-IB devices can be controlled either from the front panel or from the bus. If the device's front-panel controls are currently functional, it is in the Local state. If it is being controlled through the HP-IB, it is in the Remote state. Pressing the front-panel "Local" key will return the device to Local (front-panel) control, unless the device is in the Local Lockout state (described in a subsequent discussion).

The Remote message is automatically sent to all devices whenever the system controller is powered on, reset, or sends the Abort message. A device also enters the Remote state automatically whenever it is addressed. The REMOTE procedure also outputs the Remote message, which causes all (or specified) devices on the bus to change from local control to remote control. The interface must be configured as the system controller to execute the REMOTE procedure. The REMOTE procedure is in module HPIB_2.

Examples

```
REMOTE (7) ;
```

```
REMOTE (700) ;
```

Locking Out Local Control

The Local Lockout message effectively locks out the “local” switch present on most HP-IB device front panels, preventing a device’s user from interfering with system operations by pressing buttons and thereby maintaining system integrity. As long as Local Lockout is in effect, no bus device can be returned to local control from its front panel.

The Local Lockout message is sent by executing the LOCAL_LOCKOUT procedure. This message is sent to all devices on the specified bus, and it can only be sent by the interface when it is the active controller. This procedure is in module HPIB_2.

Examples

```
LOCAL_LOCKOUT (7) ;
```

The Local Lockout message is sent by executing the LOCAL_LOCKOUT procedure. This message is sent to all devices on the specified HP-IB interface, and it can only be sent by the interface when it is the active controller. This procedure is in module HPIB_2.

Enabling Local Control

During system operation, it may be necessary for an operator to interact with one or more devices. For instance, an operator might need to work from the front panel to make special tests or to troubleshoot. And, in general, it is good systems practice to return all devices to local control upon conclusion of remote-control operations. Executing the LOCAL procedure returns the specified devices to local (front-panel) control. The interface must be the active controller to send the LOCAL message. This procedure is in module HPIB_2.

Examples

```
LOCAL (7) ;
```

```
LOCAL (801) ;
```

If primary addressing is specified, the Go-to-Local message is sent only to the specified device(s). However, if only the interface select code is specified, the Local message is sent to all devices on the specified HP-IB interface and any previous Local Lockout message (which is still in effect) is automatically cleared. The interface must be the system controller to send the Local message (by specifying only the interface select code).

Triggering HP-IB Devices

The TRIGGER procedure sends a Trigger message from the controller to a selected device or group of devices. The purpose of the Trigger message is to initiate some device-dependent action; for example, it can be used to trigger a digital voltmeter to perform its measurement cycle. Because the response of a device to a Trigger Message is strictly device-dependent, neither the Trigger message nor the interface indicates what action is initiated by the device. This procedure is in module HPIB_2.

Examples

```
TRIGGER (7) ;
```

```
TRIGGER (707) ;
```

Specifying only the interface select code outputs a Trigger message to all devices currently addressed to listen on the bus. Including device addresses in the statement triggers only those devices addressed by the statement.

Clearing HP-IB Devices

The CLEAR procedure provides a means of “initializing” a device to its predefined, device-dependent state. When the CLEAR procedure is executed, the Clear message is sent either to all devices or to the specified device, depending on the information contained within the device selector. If only the interface select code is specified, all devices on the specified HP-IB interface are cleared. If primary-address information is specified, the Clear message is sent only to the specified device. Only the active controller can send the Clear message. This procedure is in module HPIB_2.

Examples

```
CLEAR (7) ;
```

```
CLEAR (700) ;
```

Aborting Bus Activity

The ABORT_HPIB procedure may be used to terminate all activity on the bus and return all the HP-IB interfaces of all devices to a reset (or power-on) condition. Whether this affects other modes of the device depends on the device itself. The interface must be either the active or the system controller to perform this function. If the system controller (which is not the current active controller) executes this statement, it regains active control of the bus. This procedure is in module HPIB_2. **Only the interface select code may be specified;** device selectors which contain primary-addressing information (such as 724) may not be used. This procedure is in module HPIB_2.

Examples

```
ABORT_HPIB (7) ;
```

Passing Control

The `PASS_CONTROL` procedure will pass current active control to another device on the bus. The interface must be active controller. This procedure is in module `HPIB_2`.

Examples

```
PASS_CONTROL (720) ;
```

Polling HP-IB Devices

The parallel poll is the fastest means of gathering device status when several devices are connected to the bus. Each device (with this capability) can be programmed to respond with one bit of status when parallel polled, making it possible to obtain the status of several devices in one operation. If a device responds affirmatively to a parallel poll, more information as to its specific status can be obtained by conducting a serial poll of the device.

Configuring Parallel Poll Responses

Certain devices can be remotely programmed by the active controller to respond to a parallel poll. A device which is currently configured for a parallel poll responds to the poll by placing its current status on one of the bus data lines. The logic sense of the response and the data-bit number can be programmed by the `PPOLL_CONFIGURE` procedure. If more than one device is to respond on a single bit, each device must be configured with a separate `PPOLL_CONFIGURE` procedure. This procedure is in module `HPIB_2`.

Note

Use of `PPOLL_CONFIGURE` may interfere with the Pascal Operating System, especially if an external disk is being used. **Be very careful.**

Example

```
PPOLL_CONFIGURE (705,mask) ;
```

The value of the mask (any numeric expression can be specified) is first rounded and then used to configure the device's parallel response. The least significant 3 bits (bits 0 through 2) of the expression are used to determine which data line the device is to respond on (place its status on). Bit 3 specifies the "true" state of the parallel poll response bit of the device. A value of 0 implies that the device's response is 0 when its status-bit message is true.

Example

The following statement configures device at address 01 on interface select code 7 to respond by placing a 0 on bit 4 when its status response is "true".

```
PPOLL_CONFIGURE (701,4) ;
```

Conducting a Parallel Poll

The PPOLL function returns a single byte containing up to 8 status bit messages of all devices on the bus capable of responding to the poll. Each bit returned by the function corresponds to the status bit of the device(s) configured to respond to the parallel poll. (Recall that one or more devices can respond on a single line.) The PPOLL function can only be executed on an interface that is currently the active controller. This function is in module HPIB_3.

Example

```
Response := PPOLL ( 7 ) ;
```

Disabling Parallel Poll Responses

The PPOLL_UNCONFIGURE procedure gives the interface (as active controller) the capability of disabling the parallel poll responses of one or more devices on the bus.

Note

Use of PPOLL_UNCONFIGURE may interfere with the Pascal Operating System, especially if an external disk is being used. **Be very careful.**

Examples

The following statement disables device 5 only.

```
PPOLL_UNCONFIGURE ( 705 ) ;
```

This statement disables all devices on interface select code 8 from responding to a parallel poll.

```
PPOLL_UNCONFIGURE ( 8 ) ;
```

If no primary addressing is specified, all bus devices are disabled from responding to a parallel poll. If primary addressing is specified, only the specified devices (which have the parallel poll configure capability) are disabled.

Conducting a Serial Poll

A sequential poll of individual devices on the bus is known as a serial poll. One entire byte of status is returned by the specified device in response to a serial poll. This byte is called the Status Byte message and, depending on the device, may indicate an overload, a request for service, or a printer being out of paper. The particular response of each device depends on the device.

The SPOLL function performs a serial poll of the specified device; the interface must be the active controller. This function is in module HPIB_3.

Examples

```
Response := SPOLL ( 724 ) ;
```

HP-IB Interface Conditions

The HP-IB interface can be in various states at various times. It is desirable for the programmer to know about this state information. The major conditions of interest are:

- Is a device requesting service?
- Am I a talker?
- Am I a listener?
- What remote/local state am I in?

These conditions are supported by the following I/O Library functions in the HPIB_3 module. All of these functions are boolean functions and will return an appropriate TRUE or FALSE indication depending of the condition state.

function	meaning
REQUESTED (interface_select_code)	Is SRQ asserted?
TALKER (interface_select_code)	Am I a talker?
LISTENER (interface_select_code)	Am I a listener?
REMOVED (interface_select_code)	Is REN asserted?
LOCKED_OUT (interface_select_code)	Am I in a locked out state?

The REQUESTED function requires that the interface be active controller. The REMOVED function requires that the interface not be system controller. The LOCKED_OUT function requires that the interface not be active controller. An example program segment follows.

```

WHILE REQUESTED(isc) DO
  FOR i:=0 TO 7 DO BEGIN
    IF BIT_SET(SPOLL(isc*100+i),6)
      THEN WRITELN('device ',i:2,' requesting service ');
    END; { of FOR DO BEGIN }
  END;

```

HP-IB Control Lines

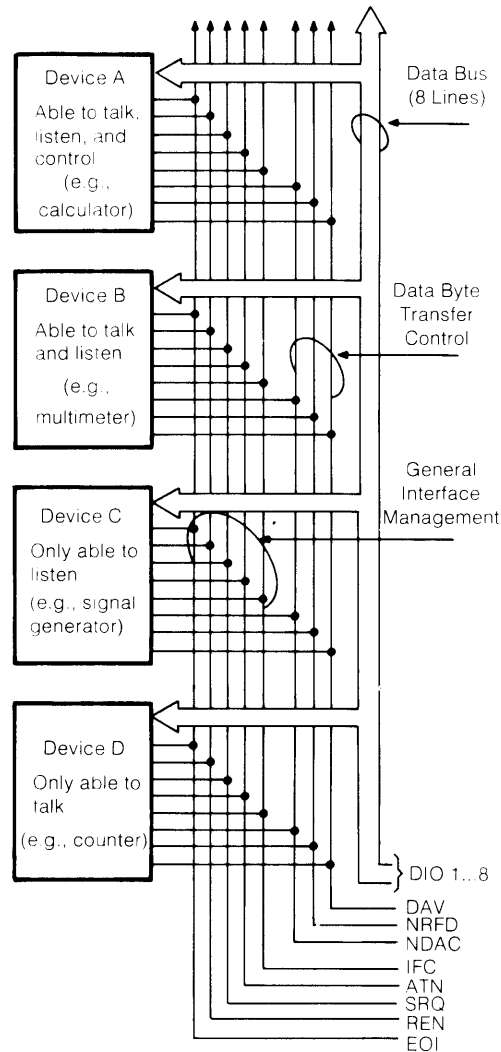

Handshake Lines

The preceding figure shows the names given to the eight control lines that make up the HP-IB. Three of these lines are designated as the “handshake” lines and are used to control the timing of data byte exchanges so that the talker does not get ahead of the listener(s). The three handshake lines are as follows.

DAV	Data Valid
NRFD	Not Ready for Data
NDAC	Not Data Accepted

The **HP-IB interlocking handshake** uses the lines as follows. All devices currently designated as active listeners would indicate when they are ready for data by using the NRFD line. A device not ready would pull this line low (true) to signal that it is not ready for data, while any device that is ready would let the line float high. Since an active low overrides a passive high, this line will stay low until all active listeners are ready for data.

When the talker senses that all devices are ready, it places the next data byte on the data lines and then pulls DAV low (true). This tells the listeners that the information on the data lines is valid and that they may read it. Each listener then accepts the data and lets the NDAC line float high (false). As with NRFD, only when all listeners have let NDAC go high will the talker sense that all listeners have read the data. It can then float DAV (let it go high) and start the entire sequence over again for the next byte of data.

The Attention Line (ATN)

Command messages are encoded on the data lines as 7-bit ASCII characters, and are distinguished from normal data characters by the logic state of the attention line (ATN). That is, when ATN is **false**, the states of the data lines are interpreted as **data**. When ATN is **true**, the data lines are interpreted as **commands**. The set of 128 ASCII characters that can be placed on the data lines during this ATN-true mode are divided into four classes by the states of data lines DIO6 and DIO7. These classes of commands are shown in a table in the section called “Advanced Bus Management”.

The Interface Clear Line (IFC)

Only the system controller can set the IFC line true. By asserting IFC, all bus activity is unconditionally terminated, the system controller regains the capability of active controller (if it has been passed to another device), and any current talker and listeners become unaddressed. Normally, this line is only used to terminate all current operations, or to allow the system controller to regain control of the bus. It overrides any other activity that is currently taking place on the bus.

The Remote Enable Line (REN)

This line is used to allow instruments on the bus to be programmed remotely by the active controller. Any device that is addressed to listen while REN is true is placed in the Remote mode of operation.

The End or Identify Line (EOI)

Normally, data messages sent over the HP-IB are sent using the standard ASCII code and are terminated by the ASCII line-feed character, CHR(10). However, certain devices may wish to send blocks of information that contain data bytes which have the bit pattern of the line-feed character but which are actually part of the data message. Thus, no bit pattern can be designated as a terminating character, since it could occur anywhere in the data stream. For this reason, the EOI line is used to mark the end of the data message.

The EOI line is not directly supported by the input and output procedures. It is supported in advanced transfers by the TRANSFER_END procedure.

The I/O Library does provide access to the EOI line at a lower level. The state of the EOI line after the last byte read is stored in the system and can be viewed with the END_SET boolean function which is module HPIB_1. An example of this function is:

```
UNLISTEN(7);
TALK(7,20);
LISTEN(7,MY_ADDRESS(7));
REPEAT
  READCHAR(7,c[i]);
UNTIL END_SET(7);
```

The I/O Library also provides a facility for setting the EOI line with a byte to be sent. This is provided with the procedure SET_HPIB which is in module HPIB_0. An example use of this procedure is:

```
UNLISTEN(7);
TALK(7,MY_ADDRESS(7));
LISTEN(7,11);
FOR i:=1 TO STRLEN(str)-1 DO WRITECHAR(7,str[i]);
SET_HPIB(7,EOI_LINE);
WRITECHAR(7,str[STRLEN]);
```

After the character output occurs, the EOI line will be set false automatically.

The Service Request Line (SRQ)

The active controller is always in charge of the order of events that occur on the HP-IB. If a device on the bus needs the controller's help, it can set the service request line true. This line sends a request, not a demand, and it is up to the controller to choose when and how it will service that device. The REQUESTED function tells the controller whether it is being requested. The procedure to request the service is the REQUEST_SERVICE procedure in the module HPIB_3. This module is of the form:

```
REQUEST_SERVICE ( interface_select_code , response_byte );
```

The response byte is an integer value in the range of 0 through 255. If bit 6 of this byte is set, the SRQ line will be asserted by this interface. If bit 6 is not set, then this device will not assert the SRQ line. The interface must not be active controller to request service.

Determining Bus-Line States

IOSTATUS register 7 contains the current states of all bus hardware lines. Reading this register returns the states of these lines.

```
bus_lines := IOSTATUS(7,7);
```

Status Register 7**Bus Control and Data Lines**

Most significant Bit

Least Significant Bit

Bit 15	Bit 14	Bit 13	Bit 12	Bit 11	Bit 10	Bit 9	Bit 8
ATN True	DAV True	NDAC* True	NRFD* True	EOI True	SRQ** True	IFC True	REN True
Value = -32 768	Value = 16 384	Value = 8 192	Value = 4 096	Value = 2 048	Value = 1 024	Value = 512	Value = 256

Bit 7	Bit 6	Bit 5	Bit 4	Bit 3	Bit 2	Bit 1	Bit 0
DIO8	DIO7	DIO6	DIO5	DIO4	DIO3	DIO2	DIO1
Value = 128	Value = 64	Value = 32	Value = 16	Value = 8	Value = 4	Value = 2	Value = 1

* Only if addressed to TALK, else not valid.

** Only if Active Controller, else not valid.

Note

Due to the way the bi-directional buffers work, NDAC and NRFD are not accurately read by this IOSTATUS function unless the interface is currently addressed to talk. Also, SRQ is not accurately shown unless the interface is currently the active controller.

Advanced Bus Management

Bus communication involves both sending data to devices and sending commands to devices and the interface itself. “General Structure of the HP-IB” stated that this communication must be made in an orderly fashion and presented a brief sketch of the differences between data and commands. However, most of the bus operations described so far in this chapter involve sequences of commands and/or data which are sent automatically by the computer when HP-IB statements are executed. This section describes both the commands and data sent by HP-IB statements and how to construct your own, custom bus sequences.

The Message Concept

The main purpose of the bus is to send information between two (or more) devices. These quantities of information sent from talker to listener(s) can be thought of as messages. However, before data can be sent through the bus, it must be properly configured. A sequence of commands is generally sent before the data to inform bus devices which is to send and which is (or are) to listen to the subsequent message(s). These commands can also be thought of as messages.

Most bus messages are transmitted by sending a byte (or sequence of bytes) with numeric values of 0 through 255 through the bus data lines. When the Attention line (ATN) is true, these bytes are considered commands; when ATN is false, they are interpreted as data. Bus command groups and their ASCII characters and codes are shown in “Bus Commands and Codes”.

Types of Bus Messages

The messages can be classified into twelve types. This computer is capable of implementing all twelve types of interface messages. The following list describes each type of message.

1. A Data message consists of information which is sent from the talker to the listener(s) through the bus data lines.
2. The Trigger message causes the listening device(s) to initiate device-dependent action(s).
3. The Clear message causes either the listening device(s) or all of the devices on the bus to return to their device-dependent “clear” states.
4. The Remote message causes listening devices to change to remote program control when addressed to listen.
5. The Local message clears the Remote message from the listening device(s) and returns the device(s) to local front-panel control.
6. The Local Lockout message disables a device’s front-panel controls, preventing a device’s operator from manually interfering with remote program control.
7. The Clear Lockout/Local message causes all devices on the bus to be removed from Local Lockout and to revert to the Local state. This message also clears the Remote message from all devices on the bus.
8. The Service Request message can be sent by a device at any time to signify that the device needs to interact with the the active controller. This message is cleared by sending the device’s Status Byte message, if the device no longer requires service.

9. A Status Byte message is a byte that represents the status of a single device on the bus. This byte is sent in response to a serial poll performed by the active controller. Bit 6 indicates whether the device is sending the Service Request message, and the remaining bits indicate other operational conditions of the device.
10. A Status Bit message is a single bit of device-dependent status. Since more than one device can respond on the same line, this Status Bit may be logically combined and/or concatenated with Status Bit messages from many devices. Status Bit messages are returned in response to a parallel poll conducted by the active controller.
11. The Pass Control message transfers the bus management responsibilities from the active controller to another controller.
12. The Abort message is sent by the system controller to assume control of the bus unconditionally from the active controller. This message terminates all bus communications, but is not the same as the Clear message.

These messages represent the full implementation of all HP-IB system capabilities; all of these messages can be sent by this computer. However, each device in a system may be designed to use only the messages that are applicable to its purpose in the system. It is important for you to be aware of the HP-IB functions implemented on each device in your HP-IB system to ensure its operational compatibility with your system.

Bus Commands and Codes

The table below shows the decimal values of IEEE-488 command messages. Remember that **ATN is true** during all of these commands. Notice also that these commands are separated into four general categories: Primary Command Group, Listen Address Group, Talk Address Group, and Secondary Command Group. Subsequent discussions further describe these commands.

Decimal Value	ASCII Character	Interface Message	Description
		PCG	Primary Command Group
1	SOH	GTL	Go to Local
4	EOT	SDC	Selected Device Clear
5	ENQ	PPC	Parallel Poll Configure
8	BS	GET	Group Execute Trigger
9	HT	TCT	Take Control
17	DC1	LLO	Local Lockout
20	DC4	DCL	Device Clear
21	NAK	PPU	Parallel Poll Unconfigure
24	CAN	SPE	Serial Poll Enable
25	EM	SPD	Serial Poll Disable
		LAG	Listen Address Group
32-62	Space through > (Numbers & Special Chars.)		Listen Addresses 0 through 30
63	?	UNL	Unlisten
		TAG	Talk Address Group
64-94	@ through ↑ (Uppercase ASCII)		Talk Addresses 0 through 30
95	_ (underscore)	UNT	Untalk
		SCG	Secondary Command Group
96-126	` through ~ (Lowercase ASCII)		Secondary Commands 0 through 30
127	DEL		Ignored

Address Commands and Codes

The following table shows the ASCII characters and corresponding codes of the Listen Address Group and Talk Address Group commands. The next section describes how to send these commands.

Address Characters		Address Code	Address Switch Settings				
Listen	Talk	Decimal	(5)	(4)	(3)	(2)	(1)
Space	@	0	0	0	0	0	0
!	A	1	0	0	0	0	1
"	B	2	0	0	0	1	0
#	C	3	0	0	0	1	1
\$	D	4	0	0	1	0	0
%	E	5	0	0	1	0	1
&	F	6	0	0	1	1	0
'	G	7	0	0	1	1	1
(H	8	0	1	0	0	0
)	I	9	0	1	0	0	1
*	J	10	0	1	0	1	0
+	K	11	0	1	0	1	1
,	L	12	0	1	1	0	0
-	M	13	0	1	1	0	1
.	N	14	0	1	1	1	0
/	O	15	0	1	1	1	1
0	P	16	1	0	0	0	0
1	Q	17	1	0	0	0	1
2	R	18	1	0	0	1	0
3	S	19	1	0	0	1	1
4	T	20	1	0	1	0	0
5	U	21	1	0	1	0	1
6	V	22	1	0	1	1	0
7	W	23	1	0	1	1	1
8	X	24	1	1	0	0	0
9	Y	25	1	1	0	0	1
:	Z	26	1	1	0	1	0
;	[27	1	1	0	1	1
<	/	28	1	1	1	0	0
=]	29	1	1	1	0	1
>	↑	30	1	1	1	1	0

Explicit Bus Messages

Any "ATN" command can be sent in any order with a procedure called SEND_COMMAND. This procedure will send the specified command on the bus. The interface must be active controller. The form of the procedure is:

```
SEND_COMMAND ( interface_select_code , command_character );
```

The command character is a normal character expression in the range of CHR(0) through CHR(255). You should be very careful when using this procedure because you can put devices into bad or unknown states. The procedure is in module HPIB_1.

Example

```
SEND_COMMAND(7,'?');      { send unlisten }
SEND_COMMAND(7,'_');      { send untalk   }
SEND_COMMAND(7,'!');      { send dvc 01 listen }
SEND_COMMAND(7,'U');      { send dvc 21 talk   }
```

Summary of HP-IB IOSTATUS and IOCONTROL Registers

Status Register 0

Card Identification

Most Significant Bit

Least Significant Bit

Bit 7	Bit 6	Bit 5	Bit 4	Bit 3	Bit 2	Bit 1	Bit 0
0	0	0	0	0	0	0	1
Value = 128	Value = 64	Value = 32	Value = 16	Value = 8	Value = 4	Value = 2	Value = 1

Control Register 0

Interface Reset

Most Significant Bit

Least Significant Bit

Bit 7	Bit 6	Bit 5	Bit 4	Bit 3	Bit 2	Bit 1	Bit 0
Any Bit Will Reset Interface							
Value = 128	Value = 64	Value = 32	Value = 16	Value = 8	Value = 4	Value = 2	Value = 1

Status Register 1

Interrupt and DMA Status

Most Significant Bit

Least Significant Bit

Bit 7	Bit 6	Bit 5	Bit 4	Bit 3	Bit 2	Bit 1	Bit 0
Interrupts Enabled	Interrupt Requested	Interrupt Level		0	0	DMA Channel 1 Enabled	DMA Channel 0 Enabled
Value = 128	Value = 64	Value = 32	Value = 16	Value = 8	Value = 4	Value = 2	Value = 1

Control Register 1

Serial Poll Response Byte

Most Significant Bit

Least Significant Bit

Bit 7	Bit 6	Bit 5	Bit 4	Bit 3	Bit 2	Bit 1	Bit 0
Device Dependent Status	SRQ 1 = I did it 0 = I didn't	Device Dependent Status					
Value = 128	Value = 64	Value = 32	Value = 16	Value = 8	Value = 4	Value = 2	Value = 1

Control Register 2

Most Significant Bit

Bit 7	Bit 6	Bit 5	Bit 4	Bit 3	Bit 2	Bit 1	Bit 0
DIO8 1 = True	DIO7 1 = True	DIO6 1 = True	DIO5 1 = True	DIO4 1 = True	DIO3 1 = True	DIO2 1 = True	DIO1 1 = True
Value = 128	Value = 64	Value = 32	Value = 16	Value = 8	Value = 4	Value = 2	Value = 1

Parallel Poll Response Byte

Least Significant Bit

Status Register 3

Most Significant Bit

Bit 7	Bit 6	Bit 5	Bit 4	Bit 3	Bit 2	Bit 1	Bit 0
System Controller	Active Controller	0	Primary Address of Interface				
Value = 128	Value = 64	Value = 32	Value = 16	Value = 8	Value = 4	Value = 2	Value = 1

Controller Status and Address

Least Significant Bit

Control Register 3

Most Significant Bit

Bit 7	Bit 6	Bit 5	Bit 4	Bit 3	Bit 2	Bit 1	Bit 0
Not Used			Primary Address				
Value = 128	Value = 64	Value = 32	Value = 16	Value = 8	Value = 4	Value = 2	Value = 1

Set My Address

Least Significant Bit

Status Register 4**Interrupt Status**

Most Significant Bit

Bit 15	Bit 14	Bit 13	Bit 12	Bit 11	Bit 10	Bit 9	Bit 8
Active Controller	Parallel Poll Configuration Change	My Talk Address Received	My Listen Address Received	EOI Received	SPAS	Remote/Local Change	Talker/Listener Address Change
Value = 32 768	Value = 16 384	Value = 8 192	Value = 4 096	Value = 2 048	Value = 1 024	Value = 512	Value = 256

Least Significant Bit

Bit 7	Bit 6	Bit 5	Bit 4	Bit 3	Bit 2	Bit 1	Bit 0
Trigger Received	Handshake Error	Unrecognized Universal Command	Secondary Command While Addressed	Clear Received	Unrecognized Addressed Command	SRQ Received	IFC Received
Value = 128	Value = 64	Value = 32	Value = 16	Value = 8	Value = 4	Value = 2	Value = 1

Status Register 5**Interrupt Enable Mask**

Most Significant Bit

Bit 15	Bit 14	Bit 13	Bit 12	Bit 11	Bit 10	Bit 9	Bit 8
Active Controller	Parallel Poll Configuration Change	My Talk Address Received	My Listen Address Received	EOI Received	SPAS	Remote/Local Change	Talker/Listener Address Change
Value = 32 768	Value = 16 384	Value = 8 192	Value = 4 096	Value = 2 048	Value = 1 024	Value = 512	Value = 256

Least Significant Bit

Bit 7	Bit 6	Bit 5	Bit 4	Bit 3	Bit 2	Bit 1	Bit 0
Trigger Received	Handshake Error	Unrecognized Universal Command	Secondary Command While Addressed	Clear Received	Unrecognized Addressed Command	SRQ Received	IFC Received
Value = 128	Value = 64	Value = 32	Value = 16	Value = 8	Value = 4	Value = 2	Value = 1

Status Register 6

Interface Status

Most Significant Bit

Bit 15	Bit 14	Bit 13	Bit 12	Bit 11	Bit 10	Bit 9	Bit 8
REM	LLO	ATN True	LPAS	TPAS	LADS	TADS	*
Value = - 32 768	Value = 16 384	Value = 8 192	Value = 4 096	Value = 2 048	Value = 1 024	Value = 512	Value = 256

Least Significant Bit

Bit 7	Bit 6	Bit 5	Bit 4	Bit 3	Bit 2	Bit 1	Bit 0
System Controller	Active Controller	0	Primary Address of Interface				
Value = 128	Value = 64	Value = 32	Value = 16	Value = 8	Value = 4	Value = 2	Value = 1

* Least-significant bit of last address recognized

Status Register 7

Bus Control and Data Lines

Most Significant Bit

Bit 15	Bit 14	Bit 13	Bit 12	Bit 11	Bit 10	Bit 9	Bit 8
ATN True	DAV True	NDAC* True	NRFD* True	EOI True	SRQ** True	IFC True	REN True
Value = - 32 768	Value = 16 384	Value = 8 192	Value = 4 096	Value = 2 048	Value = 1 024	Value = 512	Value = 256

Least Significant Bit

Bit 7	Bit 6	Bit 5	Bit 4	Bit 3	Bit 2	Bit 1	Bit 0
DIO8	DIO7	DIO6	DIO5	DIO4	DIO3	DIO2	DIO1
Value = 128	Value = 64	Value = 32	Value = 16	Value = 8	Value = 4	Value = 2	Value = 1

* Only if addressed to TALK, else not valid.

** Only if Active Controller, else not valid.

Status Register 8

Unrecognized Command

Most Significant Bit

Least Significant Bit

Bit 7	Bit 6	Bit 5	Bit 4	Bit 3	Bit 2	Bit 1	Bit 0
Value = 128	Value = 64	Value = 32	Value = 16	Value = 8	Value = 4	Value = 2	Value = 1

Summary of HP-IB IOREAD_BYTE and IOWRITE_BYTE Registers

IOREAD Registers

- Register 1 — Card Identification
- Register 3 — Interrupt and DMA Status
- Register 5 — Controller Status and Address
- Register 17 — Interrupt Status 0¹
- Register 19 — Interrupt Status 1¹
- Register 21 — Interface Status
- Register 23 — Control-Line Status
- Register 29 — Command Pass-Through
- Register 31 — Data-Line Status¹

HP IOREAD_BYTE Register 1

Card Identification

Bit 7	Bit 6	Bit 5	Bit 4	Bit 3	Bit 2	Bit 1	Bit 0
Future Use Jumper Installed	0	0	0	0	0	0	1
Value = 128	Value = 64	Value = 32	Value = 16	Value = 8	Value = 4	Value = 2	Value = 1

Bit 7 is set (1) if the “future use” jumper is installed and clear (0) if not.

Bits 6 through 0 constitute a card identification code (= 1 for all HP-IB cards).

Note

This register is only implemented on external HP-IB cards. The internal HP-IB, at interface select code 7, “floats” this register (i.e., the states of all bits are indeterminate).

HP-IB IOREAD_BYTE Register 3

Interrupt and DMA Status

Bit 7	Bit 6	Bit 5	Bit 4	Bit 3	Bit 2	Bit 1	Bit 0
Interrupt Enabled	Interrupt Request	Interrupt Level		X	X	DMA1	DMA0
Value = 128	Value = 64	Value = 32	Value = 16	Value = 8	Value = 4	Value = 2	Value = 1

¹ Indicates that an IOREAD_BYTE operation will change the state of the interface.

Bit 7 is set (1) if interrupts are currently enabled.

Bit 6 is set (1) when the card is currently requesting service.

Bits 5 and 4 constitute the card's hardware interrupt level (a switch setting on all external cards, but fixed at level 3 on the internal HP-IB).

Bit 5	Bit 4	Hardware Interrupt Level
0	0	3
0	1	4
1	0	5
1	1	6

Bits 3 and 2 are not used (indeterminate).

Bit 1 is set (1) if DMA channel one is currently enabled.

Bit 0 is set (1) if DMA channel zero is currently enabled.

Note

Bits 7, 5, 4, 3, 2, and 1 are not implemented on the internal HP-IB (interface select code 7).

HP-IB IOREAD_BYTE Register 5

Controller Status and Address

Most Significant Bit			Least Significant Bit				
Bit 7	Bit 6	Bit 5	Bit 4	Bit 3	Bit 2	Bit 1	Bit 0
System Controller	Not Active Controller	X	← HP-IB Primary Address of Interface → (MSB) (LSB)				
Value = 128	Value = 64	Value = 32	Value = 16	Value = 8	Value = 4	Value = 2	Value = 1

Bit 7 is set (1) if the interface is the System Controller.

Bit 6 is set (1) if the interface is **not** the current Active Controller and clear (0) if it **is** the Active Controller.

Bit 5 is not used.

Bits 4 through 0 contain the card's Primary Address switch setting. The following bit patterns indicate the specified addresses.

Bit					Primary Address
4	3	2	1	0	
0	0	0	0	0	0
0	0	0	0	1	1
				⋮	⋮
1	1	1	0	1	29
1	1	1	1	0	30
1	1	1	1	1	(not allowed)

Note

Bits 5 through 0 are not implemented on the internal HP-IB.

HP-IB IOREAD_BYTE Register 17**MSB of Interrupt Status**

Most Significant Bit

Least Significant Bit

Bit 7	Bit 6	Bit 5	Bit 4	Bit 3	Bit 2	Bit 1	Bit 0
MSB Interrupt	LSB Interrupt	Byte Received	Ready for Next Byte	End Detected	SPAS	Remote/ Local Change	My Address Change
Value = 128	Value = 64	Value = 32	Value = 16	Value = 8	Value = 4	Value = 2	Value = 1

Bit 7 set (1) indicates that an interrupt has occurred whose cause can be determined by reading the contents of this register.

Bit 6 set (1) indicates that an interrupt has occurred whose cause can be determined by reading Interrupt Status Register 1 (IOREAD_BYTE Register 19).

Bit 5 set (1) indicates that a data byte has been received.

Bit 4 set (1) indicates that this interface is ready to accept the next data byte.

Bit 3 set (1) indicates that an End (EOI with ATN=0) has been detected.

Bit 2 set (1) indicates that the Serial-Poll-Active State has been entered.

Bit 1 set (1) indicates that a Remote/Local State change has occurred.

Bit 0 set (1) indicates that a change in My Address has occurred.

HP-IB IOREAD_BYTE Register 19

LSB of Interrupt Status

Most Significant Bit				Least Significant Bit			
Bit 7	Bit 6	Bit 5	Bit 4	Bit 3	Bit 2	Bit 1	Bit 0
Trigger Received	Handshake Error	Unrecognized Command Group	Secondary Command While Addressed	Clear Received	My Address Received (MLA or MTA)	SRQ Received	IFC Received
Value = 128	Value = 64	Value = 32	Value = 16	Value = 8	Value = 4	Value = 2	Value = 1

- Bit 7** set (1) indicates that a Group Execute Trigger command has been received.
- Bit 6** set (1) indicates that an Incomplete-Source-Handshake error has occurred.
- Bit 5** set (1) indicates that an unidentified command has been received.
- Bit 4** set (1) indicates that a Secondary Address has been sent in while in the extended-addressing mode.
- Bit 3** set (1) indicates that the interface has entered the Device-Clear-Active State.
- Bit 2** set (1) indicates that My Address has been received.
- Bit 1** set (1) indicates that a Service Request has been received.
- Bit 0** set (1) indicates that the Interface Clear message has been received.

HP-IB IOREAD_BYTE Register 21

Interface Status

Most Significant Bit				Least Significant Bit			
Bit 7	Bit 6	Bit 5	Bit 4	Bit 3	Bit 2	Bit 1	Bit 0
REM	LLO	ATN True	LPAS	TPAS	LADS	TADS	LSB of Last Address
Value = 128	Value = 64	Value = 32	Value = 16	Value = 8	Value = 4	Value = 2	Value = 1

- Bit 7** set (1) indicates that this Interface is in the Remote State.
- Bit 6** set (1) indicates that this interface is in the Local Lockout State.
- Bit 5** set (1) indicates that the ATN signal line is true.
- Bit 4** set (1) indicates that this interface is in the Listener-Primary-Addressed State.
- Bit 3** set (1) indicates that this interface is in the Talker-Primary-Addressed State.
- Bit 2** set (1) indicates that this interface is in the Listener-Addressed State.
- Bit 1** set (1) indicates that this interface is in the Talker-Addressed State.
- Bit 0** set (1) indicates that this is the least-significant bit of the last address recognized by this interface.

HP-IB IOREAD_BYTE Register 23**Control-Line Status**

Most Significant Bit

Least Significant Bit

Bit 7	Bit 6	Bit 5	Bit 4	Bit 3	Bit 2	Bit 1	Bit 0
ATN True	DAV True	NDAC* True	NRFD* True	EOI True	SRQ** True	IFC True	REN True
Value = 128	Value = 64	Value = 32	Value = 16	Value = 8	Value = 4	Value = 2	Value = 1

*Only if addressed to TALK, else not valid.

**Only if Active Controller, else not valid.

A set bit (1) indicates that the corresponding line is currently true; a 0 indicates that the line is currently false.

HP-IB IOREAD_BYTE Register 29**Command Pass-Through**

Most Significant Bit

Least Significant Bit

Bit 7	Bit 6	Bit 5	Bit 4	Bit 3	Bit 2	Bit 1	Bit 0
DIO8	DIO7	DIO6	DIO5	DIO4	DIO3	DIO2	DIO1
Value = 128	Value = 64	Value = 32	Value = 16	Value = 8	Value = 4	Value = 2	Value = 1

This register can be read during a bus holdoff to determine which Secondary Command has been detected.

HP-IB IOREAD_BYTE Register 31**Bus Data Lines**

Most Significant Bit

Least Significant Bit

Bit 7	Bit 6	Bit 5	Bit 4	Bit 3	Bit 2	Bit 1	Bit 0
DIO8	DIO7	DIO6	DIO5	DIO4	DIO3	DIO2	DIO1
Value = 128	Value = 64	Value = 32	Value = 16	Value = 8	Value = 4	Value = 2	Value = 1

A set bit (1) indicates that the corresponding HP-IB data line is currently true; a 0 indicates the line is currently false.

HP-IB IOWRITE_BYTE Registers

- Register 3 — Interrupt Enable
- Register 17 — MSB of Interrupt Mask
- Register 19 — LSB of Interrupt Mask
- Register 23 — Auxiliary Command Register
- Register 25 — Address Register
- Register 27 — Serial Poll Response
- Register 29 — Parallel Poll Response
- Register 31 — Data Out Register

HP-IB IOWRITE_BYTE Register 3

Interrupt Enable

Most Significant Bit

Least Significant Bit

Bit 7	Bit 6	Bit 5	Bit 4	Bit 3	Bit 2	Bit 1	Bit 0
Enable Interrupt	X	X	X	X	X	Enable Channel 1	Enable Channel 0
Value = 128	Value = 64	Value = 32	Value = 16	Value = 8	Value = 4	Value = 2	Value = 1

Bit 7 enables interrupts from this interface if set (1) and disables interrupts if clear (0).

Bits 6 through 2 are “don’t cares” (i.e., their values have no effect on the interface’s operation).

Bit 1 enables DMA channel 1 if set (1) and disables if clear (0).

Bit 0 enables DMA channel 0 if set (1) and disables if clear (0).

Note

Bits 7 through 1 are not implemented on the internal HP-IB interface and thus have no effect on the interface’s operation.

IOWRITE_BYTE Register 17

MSB of Interrupt Mask

Setting a bit of this register enables an interrupt for the specified condition. The bit assignments are the same as for the MSB of Interrupt Status Register (IOREAD Register 17), except that bits 7 and 6 are not used.

IOWRITE_BYTE Register 19

LSB of Interrupt Mask

Setting a bit of this register enables an interrupt for the specified condition. The bit assignments are the same as for the LSB of Interrupt Status Register (IOREAD Register 19).

HP-IB IOWRITE_BYTE Register 23**Auxiliary Command Register**

Most Significant Bit				Least Significant Bit			
Bit 7	Bit 6	Bit 5	Bit 4	Bit 3	Bit 2	Bit 1	Bit 0
Set	X	X	Auxiliary Command Function				
Value = 128	Value = 64	Value = 32	Value = 16	Value = 8	Value = 4	Value = 2	Value = 1

Bit 7 is set (1) for a Set operation and clear (0) for a Clear operation.

Bits 6 and 5 are “don’t cares”.

Bits 4 through 0 are Auxiliary-Command-Function-Select bits. The following commands can be sent to the interface by sending the specified numeric values.

Decimal Value	Description of Auxiliary Command
0	— Clear Chip Reset.
128	— Set Chip Reset.
1	— Release ACDS holdoff. If Address Pass Through is set, it indicates an invalid secondary has been received.
129	— Release ACDS holdoff; If Address Pass Through is set, indicates a valid secondary has been received.
2	— Release RFD holdoff.
130	— Same command as decimal 2 (above).
3	— Clear holdoff on all data.
131	— Set holdoff on all data.
4	— Clear holdoff on EOI only.
132	— Set holdoff on EOI only.
5	— Set New Byte Available (nba) false.
133	— Same command as decimal 5 (above).
6	— Pulse the Group Execute Trigger line, or clear the line if it was set by decimal command 134.
134	— Set Group Execute Trigger line.
7	— Clear Return To Local (rtl).
135	— Set Return To Local (must be cleared before the device is able to enter the Remote state).
8	— Causes EOI to be sent with the next data byte.
136	— Same command as decimal 8 (above).
9	— Clear Listener State (also cleared by decimal 138).
137	— Set Listener State.
10	— Clear Talker State (also cleared by decimal 137).
138	— Set Talker State.

(Continued)

Decimal Value	Description of Auxiliary Command
11	— Go To Standby (gts; controller sets ATN false).
139	— Same command as decimal 11 (above).
12	— Take Control Asynchronously (tca; ATN true).
140	— Same command as decimal 12 (above).
13	— Take Control Synchronously (tcs; ATN true).
141	— Same command as decimal 13 (above).
14	— Clear Parallel Poll.
142	— Set Parallel Poll (read Command-Pass-Through register before clearing).
15	— Clear the Interface Clear line (IFC).
143	— Set Interface Clear (IFC maintained >100 μ s).
16	— Clear the Remote Enable (REN) line.
144	— Set Remote Enable.
17	— Request control (after TCT is decoded, issue this to wait for ATN to drop and receive control).
145	— Same command as decimal 17 (above).
18	— Release control (issued after sending TCT to complete a Pass Control and set ATN false)
146	— Same command as decimal 18 (above).
19	— Enable all interrupts.
147	— Disable all interrupts.
20	— Pass Through next Secondary Command.
148	— Same command as decimal 20 (above).
21	— Set T1 delay to 10 clock cycles (2 μ s at 5 MHz).
149	— Set T1 delay to 6 clock cycles (1.2 μ s at 5 MHz).
22	— Clear Shadow Handshake.
150	— Set Shadow Handshake.

HP-IB IOWRITE_BYTE Register 25

Address Register

Most Significant Bit			Least Significant Bit				
Bit 7	Bit 6	Bit 5	Bit 4	Bit 3	Bit 2	Bit 1	Bit 0
Enable Dual Addressing	Disable Listen	Disable Talker	Primary Address				
Value = 128	Value = 64	Value = 32	Value = 16	Value = 8	Value = 4	Value = 2	Value = 1

Bit 7 set (1) enables the Dual-Primary-Addressing Mode.

Bit 6 set (1) invokes the Disable-Listen function.

Bit 5 set (1) invokes the Disable-Talker function

Bits 4 through 0 set the device's Primary Address (same address bit definitions as READIO Register 5).

HP-IB IOWRITE_BYTE Register 27

Serial Poll Response Byte

Most Significant Bit			Least Significant Bit				
Bit 7	Bit 6	Bit 5	Bit 4	Bit 3	Bit 2	Bit 1	Bit 0
Device Dependent Status	Request Service	Device-Dependent Status					
Value = 128	Value = 64	Value = 32	Value = 16	Value = 8	Value = 4	Value = 2	Value = 1

Bits 7 and 5—0 specify the Device-Dependent Status.

Bit 6 sends an SRQ if set (1).

Note

Given an unknown state of the Serial Poll Response Byte, it is necessary to write the byte with bit 6 set to zero followed by a write of the byte with bit 6 set to the desired final value. This will insure that a SRQ will be generated if one was desired.

HP-IB IOWRITE_BYTE Register 29

Parallel Poll Response

Most Significant Bit				Least Significant Bit			
Bit 7	Bit 6	Bit 5	Bit 4	Bit 3	Bit 2	Bit 1	Bit 0
DIO8	DIO7	DIO6	DIO5	DIO4	DIO3	DIO2	DIO1
Value = 128	Value = 64	Value = 32	Value = 16	Value = 8	Value = 4	Value = 2	Value = 1

A 1 sets the appropriate bit true during a Parallel Poll; a 0 sets the corresponding bit false. Initially, and when Parallel Poll is not configured, this register must be set to all zeros.

HP-IB IOWRITE_BYTE Register 31

Data-Out Register

Most Significant Bit				Least Significant Bit			
Bit 7	Bit 6	Bit 5	Bit 4	Bit 3	Bit 2	Bit 1	Bit 0
DIO8	DIO7	DIO6	DIO5	DIO4	DIO3	DIO2	DIO1
Value = 128	Value = 64	Value = 32	Value = 16	Value = 8	Value = 4	Value = 2	Value = 1

Summary of Bus Sequences

The following tables show the bus activity invoked by executing HP-IB statements and functions. The mnemonics used in these tables were defined in the previous section of this chapter.

Note that the bus messages are sent by using single lines (such as the ATN line) and multi-line commands (such as DCL). The information shows the state of and changes in the state of the ATN line during these bus sequences. The tables implicitly show that these **changes in the state of ATN remain in effect unless another change is explicitly shown in the table**. For example, if a statement sets ATN (true) with a particular command, it remains true unless the table explicitly shows that it is set false (ATN). The ATN line is implemented in this manner to avoid unnecessary transitions in this signal whenever possible. It should not cause any dilemmas in most cases.

ABORT_HPIB

	System Controller		Not System Controller	
	Interface Select Code Only	Primary Addressing Specified	Interface Select Code Only	Primary Addressing Specified
Active Controller	IFC (duration $\geq 100\mu\text{sec}$) REN ATN	Error	ATN MTA UNL ATN	Error
Not Active Controller	IFC (duration $\geq 100\mu\text{sec}$)* REN ATN		No Action	

* The IFC message allows a non-active controller (which is the system controller) to become the active controller.

CLEAR

	System Controller		Not System Controller	
	Interface Select Code Only	Primary Addressing Specified	Interface Select Code Only	Primary Addressing Specified
Active Controller	ATN DCL	ATN MTA UNL LAG SDC	ATN DCL	ATN MTA UNL LAG SDC
Not Active Controller	Error			

LOCAL

	System Controller		Not System Controller	
	Interface Select Code Only	Primary Addressing Specified	Interface Select Code Only	Primary Addressing Specified
Active Controller	$\overline{\text{REN}}$ ATN	ATN MTA UNL LAG GTL	ATN GTL	ATN MTA UNL LAG GTL
Not Active Controller	$\overline{\text{REN}}$	Error	Error	

LOCAL_LOCKOUT

	System Controller		Not System Controller	
	Interface Select Code Only	Primary Addressing Specified	Interface Select Code Only	Primary Addressing Specified
Active Controller	ATN LLO	Error	ATN LLO	Error
Not Active Controller	Error			

PASS_CONTROL

	System Controller		Net System Controller	
	Interface Select Code Only	Primary Addressing Specified	Interface Select Code Only	Primary Addressing Specified
Active Controller	ATN TCT ATN	ATN UNL TAG TCT ATN	ATN TCT ATN	ATN UNL TAG TCT ATN
Not Active Controller	Error			

PPOLL

	System Controller		Not System Controller	
	Interface Select Code Only	Primary Addressing Specified	Interface Select Code Only	Primary Addressing Specified
Active Controller	ATN & EOI (duration ≥ 25μs) Read byte EOI Restore ATN to previous state	Error	ATN & EOI (duration ≥ 25μs) Read byte EOI Restore ATN to previous state	Error
Not Active Controller	Error			

PPOLL_CONFIGURE

	System Controller		Not System Controller	
	Interface Select Code Only	Primary Addressing Specified	Interface Select Code Only	Primary Addressing Specified
Active Controller	Error	ATN MTA UNL LAG PPC PPE	Error	ATN MTA UNL LAG PPC PPE
Not Active Controller	Error			

PPOLL_UNCONFIGURE

	System Controller		Not System Controller	
	Interface Select Code Only	Primary Addressing Specified	Interface Select Code Only	Primary Addressing Specified
Active Controller	ATN PPU	ATN MTA UNL LAG PPC PPD	ATN PPU	ATN MTA UNL LAG PPC PPD
Not Active Controller	Error			

REMOTE

	System Controller		Not System Controller	
	Interface Select Code Only	Primary Addressing Specified	Interface Select Code Only	Primary Addressing Specified
Active Controller	REN <u>ATN</u>	REN ATN MTA UNL LAG	Error	
Not Active Controller	REN	Error	Error	

SPOLL

	System Controller		Not System Controller	
	Interface Select Code Only	Primary Addressing Specified	Interface Select Code Only	Primary Addressing Specified
Active Controller	Error	ATN UNL MLA TAD <u>SPE</u> ATN Read data ATN SPD UNT	Error	ATN UNL MLA TAD <u>SPE</u> ATN Read data ATN SPD UNT
Not Active Controller	Error			

TRIGGER

	System Controller		Not System Controller	
	Interface Select Code Only	Primary Addressing Specified	Interface Select Code Only	Primary Addressing Specified
Active Controller	ATN GET	ATN UNL LAG GET	ATN GET	ATN MTA UNL LAG GET
Not Active Controller	Error			

The Datacomm Interface

Chapter**11**

Introduction

The HP 98628 Data Communications Interface enables your desktop computer to communicate with any device that is compatible with standard asynchronous or HP Data Link data communication protocols. Devices can include various modems or link adapters, as well as equipment with standard RS-232C or current loop links.

This chapter discusses both asynchronous and Data Link protocols, and programming techniques. Subject areas that are similar for both protocols are combined, while information that is unique to one protocol or the other is separated according to application.

Prerequisites

It is assumed that you are familiar with the information presented in Data Communication Basics (98046-90005), and that you understand data communication hardware well enough to determine your needs when configuring the datacomm link. Configuration parameters include such items as half/full duplex, handshake, and timeout requirements. If you have any questions concerning equipment installation or interconnection, consult the appropriate interface or adapter installation manuals.

The datacomm interface supports several cable and adapter options. They include:

- RS-232C Interface cable and connector wired for operation with data communication equipment (male cable connector) or with data terminal equipment (female cable connector).
- HP 13264A Data Link Adapter for use in HP 1000- or HP 3000-based Data Link network applications
- HP 13265A Modem for asynchronous connections up to 300 baud, including built-in autodial capability¹.
- HP 13266A Current Loop Adapter for use with current loop links or devices.

Some of the information contained in this chapter pertains directly to certain of these devices in specific applications.

¹ The HP 13265A modem is compatible with Bell 103 and Bell 113 Modems, and is approved for use in the USA and Canada. Most other countries do not allow use of user-owned modems. Contact your local HP Sales and Service office for information about local regulations.

Before you begin datacomm operation, be sure all interfaces, cables, connectors, and equipment have been properly plugged in. Power must be on for all devices that are to be used. Consult applicable installation manuals if necessary.

Protocol

Two protocols are switch selectable on the datacomm interface. They are also software selectable during normal program operation. The switch setting on the interface determines the default protocol when the computer is first powered up. Protocol is changed between Async and Data Link during program operation by selecting the new protocol, waiting for the message to reach the card, then resetting the card. The exact procedure is explained in the IOCONTROL register operations section of this chapter.

Asynchronous Communication Protocol

Asynchronous data communication is the most widely used protocol, especially in applications where high data integrity is not mandatory. Data is transmitted, one character at a time, with each character being treated as an individual message. Start and stop bits are used to maintain timing coordination between the receiver and transmitter. A parity bit is sometimes included to detect character transmission errors. Asynchronous character format is as follows: Each character consists of a start bit, 5 to 8 data bits, an optional parity bit, and 1, 1.5, or 2 stop bits, with an optional time gap before the beginning of the next character. The total time from the beginning of one start bit to the beginning of the next is called a character frame.

Parity options include:

- NONE No parity bit is included.
- ODD Parity set if EVEN number of "1"s in character bits.
- EVEN Parity set if ODD number of "1"s in character bits.
- ONE Parity bit is set for all characters.
- ZERO Parity bit is zero for all characters.

Here is a simple diagram showing the structure of an asynchronous character and its relationship to previous and succeeding characters:

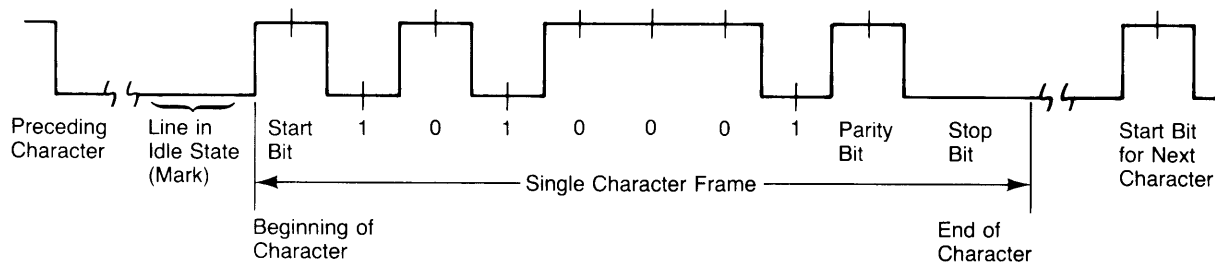

Data Link Communication Protocol

Data Link protocol overcomes the data integrity limitations of Async by handling data in blocks. Each block is transmitted as a stream of individual asynchronous characters, but protocol control characters and block check characters are also transmitted with the data. The receiver uses the protocol control characters to determine block boundaries and data format. Block check characters are used to detect transmission errors. If an error occurs, the block is retransmitted until it is successfully received. Block protocol and format is similar to Binary Synchronous Communication (BSC or Bisync, for short).

Data Link protocol provides for two transmission modes: Transparent, and Normal. In transparent mode, any data format can be transferred because datacomm control characters are preceded by a DLE character. If a control character is sent without an accompanying DLE, it is treated as data. When normal mode is used, only ASCII data can be sent, and datacomm control characters are not allowed in the data stream. The HP 1000 and HP 3000 computers usually transmit in transparent mode. All transmissions from your desktop computer are sent as transparent data. If your application involves non-ASCII data transfers (discussed later in this chapter), be sure the HP 1000 or HP 3000 network host is using transparent mode for all transmissions to your computer.

Each data block sent to the network host by the datacomm interface is structured as follows:

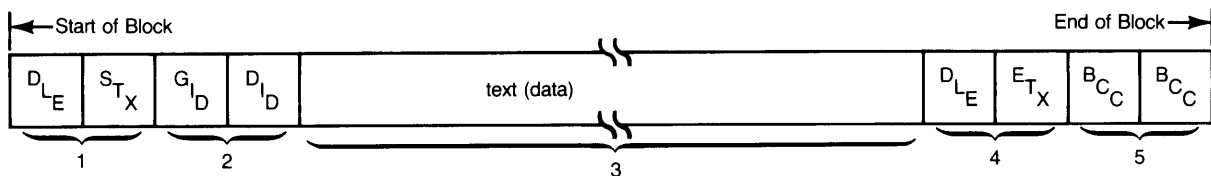

1. The "start transmission" control characters identify the beginning of valid data. If a DLE is present, the data is transparent; if absent, data is normal. All data from your desktop computer is transparent.
2. The terminal identification characters are included in blocks sent to the network host. Blocks received from the network host do not contain these two characters.
3. Data characters are transmitted in succession with no time lapse between characters.
4. The "end transmission" control characters identify the end of data. DLE ETX or DLE ETB indicate transparent data. ETX or ETB indicates normal data.
5. Block check characters (usually two characters) are used to verify data integrity. If the value received does not match the value calculated by the receiver, the entire block is rejected by the receiver. Block check includes GID and DID characters in transmissions to the network host.

Protocol control characters are stripped from the data transfer, and are not passed from the interface to the computer. For information about network polling, terminal selection and other Data Link operations, consult the Data Link network manuals supplied with the HP 1000 or HP 3000 network host computer.

Data Transfers Between Computer and Interface

Data transfers between your desktop computer and its datacomm interface involve two message types: control blocks, and data. Both types are encountered in both output and input operations as follows:

- Outbound control blocks are created by IOCONTROL procedures.
- Outbound data messages are created by the output procedures.
- Inbound control blocks are created by certain protocol operations such as Data Link block boundaries, or Async prompt, end-of-line, parity/framing error, or break detection.
- Inbound data messages are created by the interface as messages are received from the remote. They are transferred to the Pascal programs via the input procedures.

Outbound Control Blocks

Outbound control blocks are messages from your computer to the datacomm interface that contain interface control information. They are usually generated by IOCONTROL procedures, although TRANSFER_END creates a control block that terminates a given Async transmission or forces a block to be sent on the Data Link. Outbound control blocks are serially queued with data. An exception to the queued control block rule is output to Control Register 0 (card reset) which is executed immediately.

Note

When an interface card reset is executed by use of a IOCONTROL procedure, the control block that results is transmitted directly to the interface. It is not queued up, so any previously queued data and control blocks are destroyed. To prevent loss of data, be sure that all queued messages have been sent before resetting the datacomm interface. IOStatus Register 38 returns a value of 1 when the outbound queue is empty. Otherwise, its value is 0. To prevent loss of inbound data, IOStatus Register 5 must return a value of zero prior to reset.

Inbound Control Blocks

Inbound control blocks are messages from the interface to the computer that identify protocol control information. Which item(s) are allowed to create a control block is determined by the contents of IOControl Register 14. IOStatus Registers 9 and 10 identify the contents of the block, and IOControl Register 24 defines what protocol characters are also included with inbound Async data messages. Refer to the IOControl and IOStatus Register section at the end of this chapter for details about register contents for various control block types.

Two types of information are contained in each control block: Type and Mode. The TYPE is contained in IOSTATUS register 9; the MODE in IOSTATUS register 10. Type and Mode values can be used to interpret datacomm operation as follows:

Async Protocol Control Blocks

Type	Mode	Interpretation
250	1	Break received (channel A).
251	1 ¹	Framing error in the following character.
251	2 ¹	Parity error in the following character.
251	3 ¹	Both Framing and Parity error in the following character.
252	1	End-of-line terminator detected.
253	1	Prompt received from remote.

Data Link Protocol Control Blocks

Type	Mode	Interpretation
254	1	Preceding block terminated by ETB character.
254	2	Preceding block terminated by ETX character.
253 ²		(See following table for Mode interpretation.)

Mode Bit(s)	Interpretation
0	1 = Transparent data in following block. 0 = Normal data in following block.
2,1	00 = Device Select (most common). 01 = Group Select 10 = Line Select
3	1 = Command Channel 0 = Data Channel

For Data Link applications, control blocks are normally set up for end-of-block (ETB or ETX). Control blocks are then used to terminate TRANSFER_END operation, or are trapped via an I/O escape. Control block contents are not important for most applications unless you are doing sophisticated protocol-control programming.

For Async applications, terminal emulator programs usually use prompt and end-of-line control blocks. Use of other functions such as break or error detection depend on the requirements of the individual application.

¹ Parity/framing error control blocks are not generated when characters with parity and/or framing errors are replaced by an underscore (_) character.

² This type is used mainly in specialized applications. In most cases, you can expect a Mode value of zero or one for Type 253 Data Link control blocks. For most Data Link applications, control blocks are not used by programmers.

Outbound Data Messages

Outbound data messages are created when an output procedure is executed. Here is a short summary of how output parameters can affect datacomm operation.

- Async protocol: Data is transmitted directly from the outbound queue. When operating in half-duplex, TRANSFER_END causes the interface to turn the line around and allow the remote device to send information back (line turn-around is initiated when the interface sets the Request-to-send line low). TRANSFER_END has no effect when operating in full duplex.
- Data Link protocol: Data messages are concatenated until at least 512 characters are available, then a block of 512 characters is sent. Block boundaries may or may not coincide with the end of a given output message.
You can force transmission of shorter blocks by using the TRANSFER_END procedure. The interface then transmits the last pending block regardless of its length. This technique is useful for ensuring that block boundaries coincide with message boundaries, or for sending one message string per block when you are transmitting short records.

Inbound Data Messages

Inbound data messages are created by the datacomm interface as information is received from the remote. Input procedures are terminated when a control block is encountered or the input variable is filled. Whether control characters are included in the data stream depends on the configuration of Control Register 24 (Async operation only). Control information is never included in inbound data messages when using Data Link protocol.

With this brief introduction to the data communications capabilities of the HP 98628 Datacomm Interface, you are ready to begin programming your desktop computer for datacomm operation. The next section of this chapter introduces Pascal datacomm programming techniques.

Overview of Datacomm Programming

Your desktop computer uses several I/O Library facilities for data communication with various computers, terminals, and other peripheral devices. Datacomm programs will include part or all of the following elements:

- Input procedures (including transfers)
- Output procedures (including transfers)
- IOSTATUS functions
- IOCONTROL procedures
- High level control procedures.

The input and output procedures are described in the previous chapters. Later sections of this chapter discuss the IOSTATUS and IOCONTROL operations. The I/O Library provides several high level control procedures to set up the serial interface card and its parameters. These procedures are in the module SERIAL_3 and consist of the following procedures. Note that these procedures are for ASYNC operations ONLY.

Set Baud Rate

This procedure will set the interface baud rate. It is of the form:

```
SET_BAUD_RATE ( isc , rate );
```

The rate is a real expression with the range of 0 through 19 200.

Set Stop Bits

This procedure will set the number of stop bits on the interface. The procedure is of the form:

```
SET_STOP_BITS ( isc , number_of_bits );
```

The number of bits is a real expression with valid values of 1, 1.5 and 2.

Set Character Length

This procedure will set the number of bits in a character on the specified interface. The procedure is of the form:

```
SET_CHAR_LENGTH ( isc , number_of_bits );
```

The number of bits is an integer expression with valid values of 5, 6, 7, and 8 bits per character.

Set Parity

This procedure sets the parity mode of the specified interface. The procedure is of the form:

```
SET_PARITY ( isc , parity );
```

The parity parameter is an enumerated type with the following values:

```

no_parity
odd_parity
even_parity
zero_parity
one_parity

```

Example Terminal Emulator

The following program is a very simple terminal emulator. It uses overlap transfers to bring data into the computer and uses handshake I/O to send data from the computer. This is not a supported product — merely an example program.

```

$SYSPROG ON$
$UCSD ON$
$DEBUG ON$

PROGRAM TERMINAL (INPUT,OUTPUT,KEYBOARD);

  IMPORT iodeclarations,
         general_0,
         general_1,
         general_2,
         general_3,
         general_4,
         serial_0,
         serial_3;

  CONST mysc      = 20;
        bufsize  = 1000;
        kbdunit  = 2;
  VAR   i        : INTEGER;
        mybuf    : buf_info_type;
        bufchar  : CHAR;
        oldbufchar : CHAR;
        kbdchar  : CHAR;
        half_duplex : BOOLEAN;
        auto_lf  : BOOLEAN;

  BEGIN
    TRY

      ioinitialize;

      iocontrol      (mysc,22,0); { no protocol }
      iocontrol      (mysc,23,0); { no handshake }
      iocontrol      (mysc,24,127);{ pass all chars }
      iocontrol      (mysc,28,0); { card EOL = none }

      set_baud_rate  (mysc,2400);
      set_parity     (mysc,odd_parity);
      set_char_length(mysc,7);
      set_stop_bits  (mysc,1);

      iocontrol      (mysc,8,63); { set all modem lines }

      iocontrol      (mysc,12,1); { connect the card }

      half_duplex := TRUE ;
      auto_lf     := TRUE ;
    
```

```

iobuffer(mybuf,bufsize);
transfer(mysc,overlap,to_memory,mybuf,bufsize);
WRITELN('TERMINAL EMULATOR READY');
REPEAT
  IF NOT ( UNITBUSY(kbdunit) )
  THEN BEGIN
    IF EOLN(keyboard)
    THEN BEGIN
      READ(keyboard,kbdchar);
      kbdchar := io_carriage_rtn;
    END
    ELSE BEGIN
      READ(keyboard,kbdchar);
    END; { of IF EOLN }

    IF half_duplex
    THEN BEGIN
      WRITE(kbdchar);
    END;
    IF auto_lf AND ( kbdchar = io_carriage_rtn )
    THEN BEGIN
      writechar(mysc,kbdchar);
      kbdchar := io_line_feed;
    END;
    writechar(mysc,kbdchar);
  END;

  IF buffer_data(mybuf) <> 0
  THEN BEGIN
    oldbufchar := bufchar;
    readbuffer(mybuf,bufchar);
    IF bufchar = io_line_feed
    THEN BEGIN
      IF oldbufchar = io_carriage_rtn
      THEN BEGIN
        { nothing }
      END
      ELSE BEGIN
        WRITE(io_carriage_rtn);
      END;
    END
    ELSE BEGIN
      WRITE(bufchar);
    END;
  END;

  IF (NOT isc_busy(mybuf)) AND (buffer_data(mybuf) = 0)
  THEN BEGIN
    transfer(mysc,overlap,to_memory,mybuf,bufsize);
  END;
UNTIL FALSE;
RECOVER BEGIN

PAGE(output);
WRITELN;
WRITELN('escape code : ',escapecode);
IF ESCAPECODE=ioescapecode
THEN BEGIN
  WRITELN('some I/O problem has occurred');
  WRITELN(ioerror_message(ioe_result));
  WRITELN('on select code ',ioe_isc:4);
END
ELSE BEGIN
  IF ESCAPECODE<>-20
  THEN BEGIN
    WRITELN('some non-I/O problem has occurred');
  END
  ELSE BEGIN

```

continued

```

        WRITELN('stop Key pressed');
    END;

    ESCAPE(ESCAPECODE);

    END;

END.
```

Establishing the Connection

Determining Protocol and Link Operating Parameters

Before information can be successfully transferred between two devices, a communication link must be established. You must include the necessary protocol parameters to ensure compatibility between the communicating machines. To determine the proper parameters for your application, select Async or Data Link protocol, then answer the following questions:

For BOTH Async and Data Link Operation:

- Is a modem connection being used? What handshake provisions are required? (Data Link does not use modems, but multi-point Async modem connections use a protocol compatible with Data Link.)
- Is half-duplex or full-duplex line protocol being used?

For Async Operation ONLY:

- What line speed (baud rate) is being used for transmitting?
- What line speed is being used for receiving?
- How many bits (excluding start, stop, and parity bits) are included in each character?
- What parity is being used: none, odd, even, always zero, or always one?
- How many stop bits are required on each character you transmit?
- What line terminator should you use on each outgoing line?
- How much time gap is required between characters (usually 0)?
- What prompt, if any, is received from the remote device when it is ready for more data?
- What line terminator, if any, is sent at the end of each incoming line?

For Data Link Operation ONLY:

- What line speed (baud rate) is being used? (Data Link uses the same speed in both directions.)
- What parity is being used: none (HP 1000 network host), or odd (HP 3000 network host)?
- What is the device Group Identifier (GID) and Device Identifier (DID) for your terminal?
- What is the maximum block length (in bytes) the network host can accept from your terminal?

All these parameters are configured under program control by use of IOCONTROL procedures. Alternately, default values for line speed, modem handshake, parity, and Async or Data Link protocol selection can be set using the datacomm interface configuration switches. Other default parameters are preset by the datacomm interface to accommodate common configurations. You can use the defaults, or you can override them with IOCONTROL procedures for program clarity and immunity to card settings. Default IOControl Register values are shown in

the IOCONTROL and IOSTATUS register tables in the back of this chapter. The HP 98628 Datacomm Interface Installation manual (98628-90000) explains how to set the default switches on the interface.

The next section of this chapter shows a summary of the available default options and switch settings for both Async and Data Link.

Using Defaults to Simplify Programming

The datacomm interface includes two switch clusters. One cluster is used to program the select code and interrupt level. The other cluster sets defaults for protocol, line speed (baud rate), modem handshake, and parity. Setting the defaults on the card eliminates the need to program the corresponding interface IOCONTROL registers. These defaults are useful in applications where the configuration of the link is rarely altered, and the program is not used on other machines with dissimilar configurations. They also enable a beginning programmer to use output and input procedures to perform simple datacomm operations without using IOCONTROL or IOSTATUS statements. On the other hand, where link configuration may vary, or where programs are used on several different machines with dissimilar configurations, it is usually worthwhile to override the defaults with IOCONTROL procedures. This assures known datacomm behavior, independent of interface defaults.

Here, for your convenience is a brief summary of the default switch options:

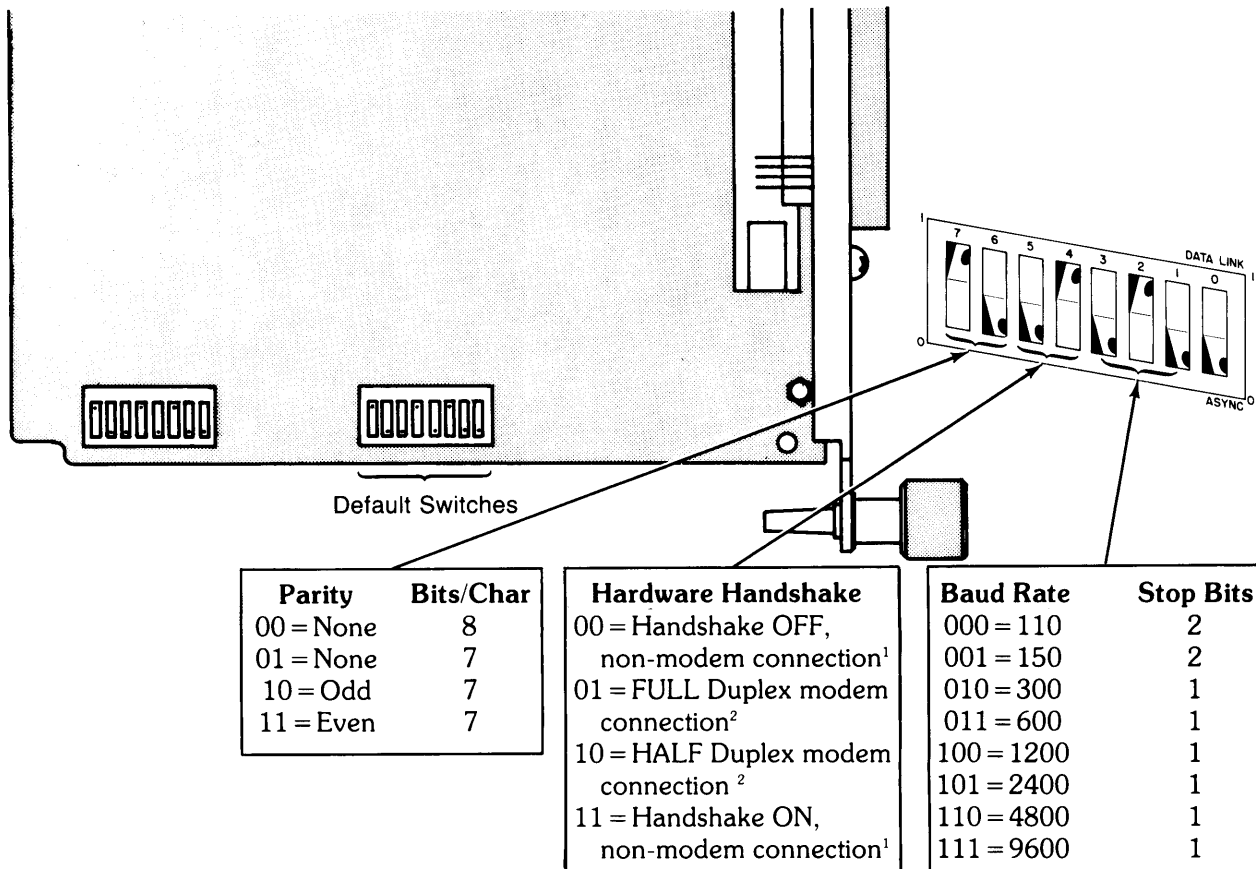

Async Default Configuration Switches

¹ Default No Activity timeout: Disabled

² Default No Activity timeout: 10 minutes

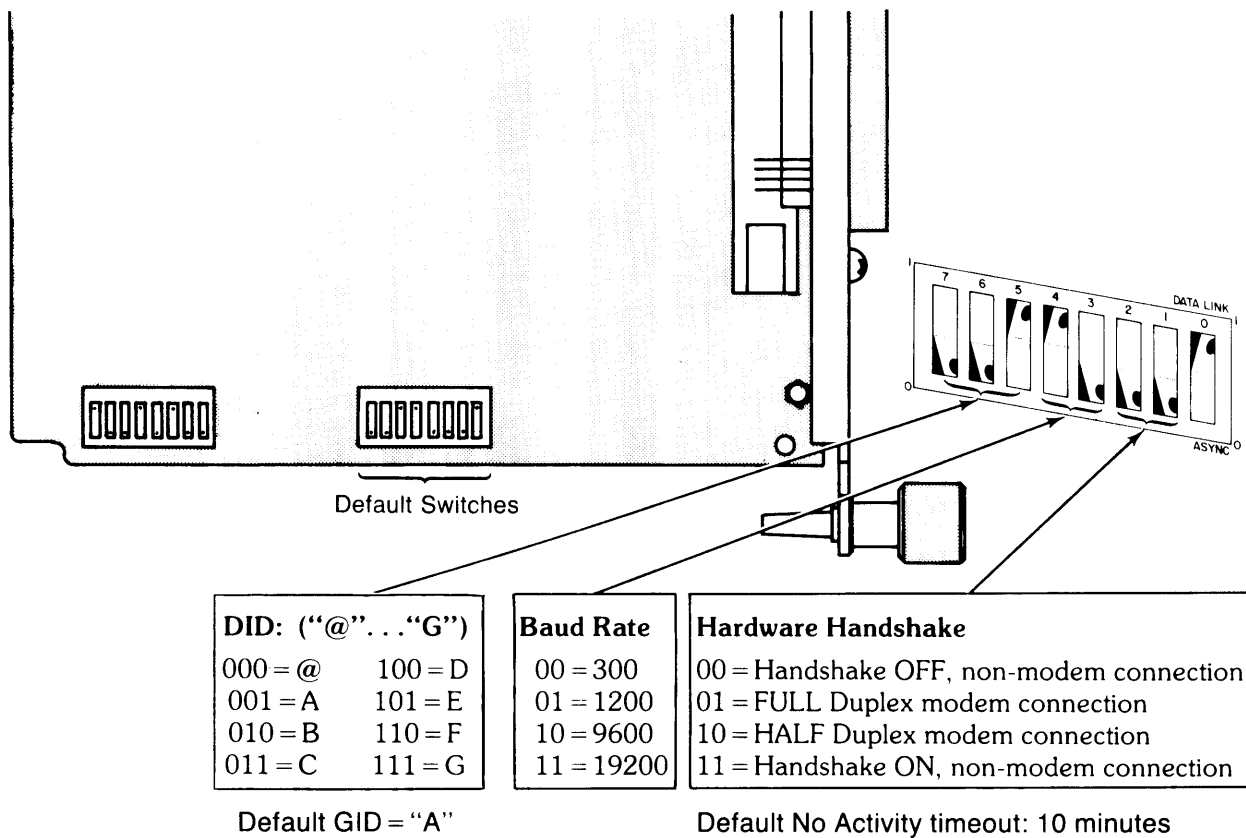

Data Link Default Configuration Switches

Resetting the Datacomm Interface

Before you establish a connection, the datacomm interface must be in a known state. **The datacomm interface does not automatically disconnect from the datacomm link when the computer reaches the end of a program.** To prevent potential problems caused by unknown link conditions left over from a previous session, it is a good practice to *reset* the interface card at the beginning of your program before you start configuring the datacomm connection. Resetting the card causes it to disconnect from the line and return to a known set of initial conditions.

Example

```
IORESET (20) ;
```

Protocol Selection

During power-up and reset, the card uses the default switches to preset the card to a known state. The protocol select switch defines which protocol the card uses at power-up only. If the default protocol is the same as you are using, you can skip the protocol selection statements. However, if the switch might be set to the wrong protocol, or if you want to change protocol in the middle of a program, you can use a IOCONTROL procedure to select the protocol. After the protocol is selected, reset the card again to make the change. Here is how to do it:

Select the protocol to be used:

```
IOCONTROL (Sc,3,1); {Select Async Protocol}
```

or

```
IOCONTROL (Sc,3,2); {Select Data Link Protocol}
```

Wait until the protocol select message has been sent to the card, then reset the card. The Reset command restarts the interface microcomputer using the selected protocol.

```
REPEAT
UNTIL IOSTATUS(Sc,38) =1 ;
IORESET (Sc) ;
```

Note

Be careful when resetting the interface card during normal program operation. Data and Control information are sent to the card in the same sequence as the statements originating the information are executed. When a card reset is initiated by a IOCONTROL procedure, the reset is not placed in the queue with outbound data, but is executed immediately. Therefore, if there is other information in the output queue waiting to be sent, a reset can cause the data to be lost. To prevent loss of data, use IOSTATUS function (register 38) to verify that all data transfers have run to completion before you reset the interface.

You are now ready to program datacomm options that are related to the selected protocol. In applications where defaults are used, the options are very simple. The following pair of examples shows how to set up datacomm options for each protocol.

Datacomm Options for Async Communication

This section explains how to configure the datacomm interface for asynchronous data communication. The example used shows how to set up all configurable options without considering default values. Some statements in the example are redundant because they override interface defaults having the same value. Others may or may not be redundant because they override configuration switch options. The remaining statements are necessary because they override the default values, replacing them with non-default values required for proper operation of the example program. If you are not familiar with Asynchronous protocol, consult the section on protocol for the needed background information.

Control Block Contents

Configuration of the link begins with register 14 which determines what information is placed in the control blocks that appear in the input (receive) queue. In this example, only the end-of-line position and prompts are identified. Parity or framing errors in received data, and received breaks are not identified in the queue. This register interacts with Control registers 28 thru 33.

Datacomm Line Timeouts

Registers 16-19 set timeout values to force an automatic disconnect from the datacomm link when certain time limits are exceeded. For most applications, the default values are adequate. A value of zero disables the timeout for any register where it is used. Each register accepts values of 0 thru 255; units vary with the register function.

- Register 16 (Connection timeout) sets the time limit (in seconds) allowed for connecting to the remote device. It is useful for aborting unsuccessful attempts to dial up a remote computer using public telephone networks.
- Register 17 (No Activity timeout) sets an automatic disconnect caused by no datacomm activity for the specified number of minutes. Default value is determined by default handshake switch setting. Default is not affected by IOCONTROL procedures to IOControl Register 23 (hardware handshake).
- Register 18 (Lost Carrier timeout) disconnects when:

Full Duplex: Data Set Ready (Data Mode) or Data Carrier Detect go false, or

Half Duplex: Data Set Ready goes false,

indicating that the carrier from the remote modem has disappeared from the line. Value is in multiples of 10 milliseconds.

- Register 19 (Transmit timeout) disconnects when a loss-of-clock occurs or a clear-to-send (CTS) is not returned by the modem within the specified number of seconds.

Line Speed (Baud Rate)

The transmit and receive line speed(s) are set by IOControl Registers 20 and 21, respectively. Each is independent of the other, and they are not required to have identical values. The following baud rates are available for Async communication:

Register Value	Baud Rate	Register Value	Baud Rate	Register Value	Baud Rate	Register Value	Baud Rate
0	0 ¹	4	134.5	8	600 ²	12	3600
1	50	5	150 ²	9	1200 ²	13	4800 ²
2	75	6	200	10	1800	14	9600 ²
3	110 ²	7	300 ²	11	2400 ²	15	19 200

All configurable line speeds are available to IOCONTROL Registers 20 and 21. Only the eight speeds indicated can be selected using the default switches (see the switch configuration diagram earlier in this chapter). When the configuration switch defaults are used, transmit and receive speeds are identical. The selected line speed must not exceed the capabilities of the modem or link.

¹ An external clock must be provided for this option.

² These speeds can be programmed using the default switches on the interface card. Other speeds are accessed by CONTROL statements. (The HP 13265A Modem can be operated up to 300 baud.)

Handshake

Registers 22 and 23 configure handshake parameters. There are two types of handshake:

- Software or protocol handshake specifies which of the participants is allowed to transmit while the other agrees to receive until the exchange is reversed. Options include:
 1. No handshake, commonly used with connections to non-interactive devices such as printers.
 2. Enq/Ack (EQ/AK) or DC1/DC3 handshake, with the desktop computer configured either as a host or a terminal. Handshake characters are defined by registers 26 and 27.
 3. DC1/DC3 handshake with the desktop computer as both a host AND a terminal. Handshake characters are defined by registers 26 and 27. This option simplifies communication between two desktop computers.
- Hardware or modem handshake that establishes the communicating relationship between the interface and the associated datacomm hardware such as a modem or other link device. The four available options are:
 1. Handshake Off, non-modem connection – most commonly used for 3-wire direct connections to a remote device.
 2. Full Duplex modem connection – used with full-duplex modems or equivalent connections.
 3. Half Duplex modem connection – used with half-duplex modems or equivalent connections.
 4. Handshake On, non-modem connection – used with printers and other similar devices that use the Data Carrier Detect (DCD) and Clear-to-send (CTS) lines to signal the interface card. When DCD is held down by the peripheral, the interface ignores incoming data. When CTS is held down, the interface does not transmit data to the device until CTS is raised.

Options 2 and 3 are usually associated with modems or similar devices, but may be used occasionally with direct connections when the remote device provides the proper signals. Refer to the table at the end of this chapter for a list of handshake signals and how they are handled for each cable or adapter option.

Handling of Non-data Characters

Register 24 specifies what non-data characters are to be included in the input queue. For each bit that is set, the corresponding information is passed along with the incoming data. If the bit is not set, the information is discarded, and is not included in the inbound data stream that is passed to the desktop computer by the interface.

- Bit 0: Include handshake characters in data stream. They are defined by Control Registers 26 and 27.
- Bit 1: Include incoming end-of-line character(s). EOL characters are defined by Control Registers 28-30.
- Bit 2: Include incoming prompt character(s). Prompt is defined by Control Registers 31-33.
- Bit 3: Include any null characters encountered.
- Bit 4: Include any DEL (rubout) characters in data.
- Bit 5: Include any CHR\$(255) encountered. This character is encountered ONLY when 8-bit characters are received.
- Bit 6: Change any characters received with parity or framing errors to an underscore. If this bit is not set, all inbound characters are transferred exactly as received, with or without errors.

Register 25 is not used.

Protocol Handshake Character Assignment

Registers 26 and 27 establish what characters are to be used for handshaking between communicating machines. You can select the values of 6 (AK) or 17 (DC1) for register 26, and 5 (EQ) or 19 (DC3) for register 27. Any ASCII value from 0 thru 255 can be used, but non-standard values should be reserved for exceptional situations.

End-of-line Recognition

Registers 28, 29, and 30 operate in conjunction with registers 14 (control block mask) and 24 (non-data character stripping) and defines the end-of-line sequence used to identify boundaries between incoming records. Register 28 (value of 0, 1 or 2) defines the number of characters in the sequence, while registers 29 and 30 contain the decimal equivalent of the ASCII characters. If register 28 is set for one character, register 30 is not used. Register 29 contains the first EOL character, and register 30, if used, contains the second. If register 28 is zero, registers 29 and 30 are ignored and the interface cannot recognize line separators.

Prompt Recognition

Registers 31, 32, and 33 operate in conjunction with registers 14 and 24 and define the prompt sequence that identifies a request for data by the remote device. As with end-of-line recognition, the first register defines the number of characters (0, 1, or 2), while the second and third registers contain the decimal equivalents of the prompt character(s). Register 33 is not used with single-character prompts. If register 31 is zero, registers 32 and 33 are ignored and the interface is unable to recognize any incoming prompts.

Character Format Definition

Registers 34 through 37 are used to define the character format for transmitted and incoming data.

- Register 34 sets the character length to 5, 6, 7, or 8 bits. The value used is the number of bits per character minus five (0 = 5 bits, 3 = 8 bits). When 8-bit format is specified, parity must be Odd, Even, or None (parity “1” or “0” cannot be used).
- Register 35 specifies the number of stop bits sent with each character. Values of 0, 1, or 2 are used to select 1, 1.5, or 2 stop bits, respectively.
- Register 36 specifies the parity to be used. Options include:

Register Value	Parity	Result
0	None	Characters are sent with no parity bit. No parity checks are made on incoming data.
1	Odd ¹	Parity bit is set if there is an EVEN number of ones in the character code. Incoming characters are also checked for odd parity.
2	Even ¹	Parity bit is set if there is an ODD number of ones in the character code.
3	0	Parity bit is present, but always zero. No parity checks are made on incoming data.
4	1	Parity bit is present, but always one. No parity checks are made on incoming data.

Parity must be odd, even, or none when 8-bit characters are being transferred.

- Register 37 sets the time gap (in character times, including start, stop, and parity bits) between one character and the next in a transmission. It is usually included to allow a peripheral, such as a teleprinter, to recover at the end of each character and get ready for the next one. A value of zero causes the start bit of a new character to immediately follow the last stop bit of the preceding character.

Control Register 38 is not used.

Break Timing

Register 39 sets the break time (2-255 character times). A Break is a time gap sent to the remote device to signify a change in operating conditions. It is commonly used for various interrupt functions. The interface does not accept values less than 2. Register 6 is used to transmit a break to the remote computer or device.

Datacomm Options for Data Link Communication

This section explains how to configure the datacomm interface for Data Link operation. If you are not familiar with Data Link protocol and terminology, consult the section on protocol for the needed background information.

¹ Parity sense is based on the number of ones in the character including the parity bit. An EVEN number of ones in the character, plus the parity bit set produces an ODD parity. An ODD number of ones in the character plus the parity bit set produces an EVEN parity.

Control Block Contents

Data Link configuration begins with IOControl Register 14. This register determines what information is to be placed in control blocks and included with inbound data transferred from the interface to the desktop computer.

- ETX (Bit 1) identifies the end of a transmission block that contains one or more complete records.
- ETB (Bit 2) identifies the end of a transmission block where the last record is continued in the next block of data.
- Bit 0 causes a control block to be inserted that identifies the beginning of a new block of data.

Datacomm Line Timeouts, and Line Speed

Registers 15 through 19 are functionally identical for both Async and Data Link. Refer to the preceding Async section for more information. Register 20 sets the line speed for both transmitting and receiving (Data Link does not accommodate split-speed operation). The following line speed options are available:

Register Value	Baud Rate	Register Value	Baud Rate	Register Value	Baud Rate	Register Value	Baud Rate
0	0 ¹	9	1200 ²	12	3600	15	19 200 ²
7	300 ²	10	1800	13	4800		
8	600	11	2400	14	9600 ²		

Terminal Identification

Registers 21 and 22 specify the terminal identifier characters for the datacomm interface. Register 21 contains the GID (Group IDentifier), and register 22 contains the DID (Device IDentifier). Values of 0-26 correspond to the characters @, A, B, . . . , Z. These registers must be configured to match the terminal identification pair assigned to your device by the Data Link Network Manager. In the example, Line 1320 is redundant because it duplicates the default GID value. Line 1330 overrides the DID default switch on the interface card, and may or may not be necessary. Alternate methods for assigning different GID/DIDs are shown following the group of configuration IOCONTROL procedures.

Handshake

Register 23 establishes the hardware handshake type. There is no formal software handshake with Data Link because the network host controls all data transfers. Hardware or modem handshake options are identical to Asynchronous operation. Handshake should be OFF (register set to 0) when using the HP 13264A Data Link Adapter. When you are using non-standard interconnections such as direct or modem links to the network host, select the handshake option that fits your application. Refer to the table at the end of this chapter for a list of handshake signals and how they are handled for each cable or adapter option.

¹ An external clock must be provided for this option.

² These speeds can be programmed using the default switches on the interface card. Other speeds are accessed by CONTROL statements.

Transmitted Block Size

Register 24 defines the maximum transmitted block length. When transmitting blocks of data to the network host, the block length must not exceed the available buffer space on the receiving device. Block size can be specified for increments of two from 2 to 512 characters per block. A value of zero forces the block length to a maximum of 512 bytes. For other values, the block length limit is twice the value sent to the register. For example, a register value of 130 produces a transmitted block length not exceeding 260 characters (bytes).

Parity

Register 36 defines the parity to be used. Unlike Async, Data Link has only two parity options: None, or Odd. Odd parity is:

Register Value	Parity	Application
0	NONE	Required for operation with HP 1000 network host
1	ODD	Required for operation with HP 3000 network host

Registers 25 through 35, and 37 and above are not used.

Connecting to the Line

Interface configuration is now complete. You are ready to begin connecting to the datacomm line. The exact procedure used to connect to the line varies slightly, depending on the type of link being used. Before you connect, you must know what the link requirements are, including dialing procedures, if any.

Switched (Public) Telephone Links

When you are using a public or switched telecommunications link, the modem connection between computers must be established. The HP 13265A Modem can be used in any Async application that requires a Bell 103- or Bell 113-compatible modem operating at up to 300 baud line speed. However, the HP 13265A Modem is not suitable for data rates exceeding 300 baud. For higher baud rates, use a modem that is compatible with the one at the remote computer site. Modems cannot be used for remote connections from a terminal to the data link.

Private Telecommunications Links

Private (leased) links require modems unless the link is short enough for direct connection (up to 50 feet, depending on line speed). The HP 13265A Modem can be used at data rates up to 300 baud. For higher speeds, a different modem must be used.

Direct Connection Links

For short distances, a direct connection may be used without modems or adapters, provided both machines use compatible interfaces. Async connections normally use RS-232C interfaces. You can also operate as a Data Link terminal directly connected to an HP 1000 or HP 3000 host computer through a dedicated Multipoint Async interface on the network host, although such connections are unusual.

Data Link Connections

Most Data Link connections use an HP 13264A Data Link Adapter to connect directly to the Data Link. In special situations, a modem may be used to communicate with a Multipoint Async interface on the HP 1000 or HP 3000 network host. When the Data Link Adapter is used, no special procedures are required. If you are using a leased or switched telecommunications link, the procedures are the same as when using point-to-point Async with modems.

Connection Procedure

This section describes procedures for modem connections using telephone telecommunications circuits. If you are NOT using a switched, modem link, skip to the next section: Initiating the Connection.

Dialing Procedure for Switched (Public) Modem Links

Except for dialing, connection procedures do not usually vary between switched and dedicated links. Dialing procedures depend on whether the modem is designed for manual or automatic dialing. Automatic dialing can be used with the HP 13265A Modem, but other modems must be operated with manual dialing unless you design your own interface to an Automatic Calling Unit. For manual dialing procedures, consult the operating manual for the modem you are using.

Automatic Dialing with the HP 13265A Modem:

The automatic dialer in the HP 13265A Modem is accessed by Control Register 12. The IOCONTROL procedure is followed by an output procedure that contains the telephone number string, including dial rate and timing characters. The two statements set up the automatic dialer, but dialing is not started until a “start connection” command is sent to IOControl Register 12. Here is an example sequence:

```
IOCONTROL (Sc,12,2) ;
WRITESTRING (Sc,'> 9 @@@ (303)-555-1234') ;
```

The output procedure contains several essential elements.

- The first character (“>”), if included, specifies a fast dialing rate. If it is omitted, the default slow dialing rate is used.
- A time delay character “@” may be inserted anywhere in the string. A one-second time delay is executed in the dialing sequence each time a delay character is encountered.
- Numeric character sequences define the telephone number. Multiple dial-tone sequences, such as when calling out from a PBX (Private Branch Exchange), can be used by inserting a suitable delay to wait for the next dial tone.
- Unrecognized characters such as parentheses, hyphens, and spaces can be included for clarity. They are ignored by the automatic dialer.
- Up to 500 characters can be included in the telephone number string.

Here is how an autodial connection is executed:

- The `IOCONTROL (Sc,12,2)` places a “start dialing” control block in the outbound queue to the interface. The `OUTPUT` statement places the telephone number string (including spaces and other characters) in the queue after the control block. When the interface encounters the control block, it transfers the string to the HP 13265A Modem’s autodial circuit. No other action is taken at this time.
- When `IOCONTROL (Sc,12,1)` is executed, another control block is queued up. When the interface encounters the block, it sends a “start connection” command to the modem. The modem then disconnects from the line, waits two seconds, then reconnects. The autodialer waits 500 milliseconds, then starts executing the telephone number string. The string is executed character-by-character in the same sequence as sent by the output procedure.
- If your application requires more than 500 milliseconds to guarantee a dial tone is present, you can increase the delay by adding delay characters (“@”) where needed, one second per character. Be sure to provide adequate delays in multiple dial tone sequences, such as when calling through a private branch exchange (PBX) to a public telephone network.
- When dialing is complete, the modem is connected to the line, and you are ready to start communication. The next section explains how to determine when connection is complete.

Two dialing rates are available: slow (default) and fast. To select the fast rate, you must include the fast rate character (“>”) as the `FIRST` character in the telephone number string. Here is a summary of differences between the two options:

Parameter	Slow Dialing	Fast Dialing
Click Length	60 milliseconds	32.5 milliseconds
Click Gap	40 milliseconds	17.5 milliseconds
Number Gap	700 milliseconds	300 milliseconds

One to ten dial pulses (clicks) are sent for each digit 1 through 0, respectively. The number gap is the time lag between the end of the last click of one number and the beginning of the first click of the next number.

Most Bell System facilities can handle both fast and slow dialing rates, but private or independent telephone systems or companies may require slow dialing.

Initiating the Connection

After you have executed the necessary dialing procedures, if any, you are ready to initiate the connection. The following statement is used to start the connection:

```
IOCONTROL (Sc,12,1) ;{Start Connection.}
```

This statement sends a control block to the interface telling it to connect to the datacomm line. If the HP 13265A Modem is being used, and the autodialer is enabled, it starts dialing the number. Otherwise, the interface executes a direct connection to the line, or tells the modem or data link adapter to connect.

The status of the connection process can be monitored by using the IOSTATUS function. The following lines hold the computer in a continuous loop until the connection is complete:

```
REPEAT
  State := IOSTATUS(Sc,12);
  IF State=2 THEN WRITELN ('Dialing');
  IF State=1 THEN WRITELN ('Trying to Connect');
UNTIL State=3;
WRITELN ('Connected') ;
```

Refer to the IOStatus and IOControl Register section for interpretation of the values in IOStatus Register 12. Only values of 1, 2, or 3 are usually encountered at this stage of the program.

As soon as IOStatus Register 12 indicates that connection is complete, you are ready to continue into the main body of the terminal emulator or other program you are writing. This completes the datacomm initialization and connection phase of the program.

Datacomm Errors and Recovery Procedures

Several errors can be encountered during datacomm operation. They are listed here with probable causes and suggested corrective action.

Error	Description and Probable Cause
306	Interface card failure. This error occurs during interface self-test, and indicates an interface card hardware malfunction. You can repeat the power-up self-test by pressing the Reset key. If the error persists, replace the defective card. Using a defective card may result in improper datacomm operation, and should be considered only as a last resort.
313	USART receive buffer overflow. The SIO buffer is not being cleared fast enough to keep up with incoming data. This error is uncommon, and is usually caused by excessive processing demands on the interface microprocessor. To correct the problem, examine Pascal program flow to reduce interference with normal interface operation. This error causes the interface to disconnect from the datacomm line and go into a SUSPENDED state. Clear or reset the interface card to recover.
314	Receive Buffer overflow. Data is not being consumed fast enough by the desktop computer. Consequently, the buffer has filled up causing data loss. This is usually caused by excessive program demands on the desktop computer CPU, or by poor program structure that does not allow the desktop computer to properly service incoming data when it arrives. Modify the Pascal program(s) to allow more frequent interrupt processing by the desktop computer, or change to a lower baud rate and/or use protocol handshaking to hold off incoming data until you are ready to receive it. This error causes the interface to disconnect from the datacomm line and go into a SUSPENDED state. Clear or reset the interface to recover.
315	Missing Clock. A transmit timeout has occurred because the transmit clock has not allowed the card to transmit for a specified time limit (Control Register 19). This error can occur when the transmit speed is 0 (external clock), and no external clock is provided, or be caused by a malfunction. The interface is disconnected from the datacomm line and is SUSPENDED. To recover, correct the cause, then reset the card.

Error	Description and Probable Cause
316	CTS false too long. Due to clear-to-send being false on a half-duplex line, the interface card was unable to transmit for a specified time limit (Control Register 19). The card has disconnected from the datacomm line, and is in a SUSPENDED state. To recover, determine what has caused the problem, correct it, then reset or clear the interface card.
317	Lost Carrier disconnect. Data Set Ready (DSR) (and/or Data Carrier Detect, if full-duplex) went inactive for the specified time limit (Control Register 18). This condition is usually caused by the telecommunications link or associated equipment. The card has disconnected from the datacomm line and is in a SUSPENDED state. To recover, clear or reset the interface card.
318	No Activity Disconnect. The interface card disconnected from the datacomm line automatically because no information was transmitted or received within the time limit specified by Control Register 17. The card is in a SUSPENDED state. Clear or reset the interface to recover.
319	Connection not established. The card attempted to establish connection, but Data Set Ready (DSR) (and Data Carrier Detect, if full duplex) was not active within the time limit specified by Control Register 16. The card has disconnected from the datacomm line and is in a SUSPENDED state. Clear or reset the interface to recover.
325	Illegal DATABITS/PARITY combination. IOCONTROL procedures have attempted to program 8 bits per character and parity "1" or "0". The IOCONTROL procedure causing the error is ignored, and the previous setting remains unchanged. To correct the problem, change the IOCONTROL procedure(s) and/or interface default switch settings.
326	Register address out of range. An IOCONTROL or STATUS function has attempted to address a non-existing register. The command is ignored, and the interface card state remains unchanged.
327	Register value out of range. An IOCONTROL procedure attempted to place an illegal value in a defined register. The command is ignored, and the interface card state remains unchanged.

Error Recovery

When any error from Error 313 through Error 319 occurs, it forces the interface card to disconnect from the datacomm line. When a forced disconnect terminates the connection, the interface is placed in a SUSPENDED state, indicated by Status Register 12 returning a value of 4. The interface cannot be reconnected to the datacomm line when it is SUSPENDED. ABORT_SERIAL and IORESET are used to recover from the suspended state and resume normal card operation.

To recover from a SUSPENDED interface, two programmable options are available, all of which destroy any existing data in the transmit and receive queues. They are:

- The ABORT_SERIAL procedure clears the receive and transmit queues.
- RESET interface (IOControl Register 0 or IORESET) clears all buffers and queues, and resets all IOCONTROL options to their power-up state EXCEPT the protocol which is determined by the most recent IOCONTROL statement (if any) addressed to register 3 since power-up.

Another option is available. Pressing **Stop** (**CLR I/O**) causes a hardware reset to be sent to all interfaces. This completely resets the datacomm interface to its power-up state with protocol and other options determined by the default switch settings.

Datacomm Programming Helps

This section is designed to assist you in writing datacomm programs for special applications by discussing selected techniques and characteristics that can present obstacles to the beginning programmer.

Terminal Prompt Messages

Care must be exercised to ensure that messages are never transmitted to the network host if the host is not prepared to properly handle the message. Receipt of a poll from the host does not necessarily mean that the host can handle the message properly when it is received. Therefore, prompts or interpretation of messages from the host are used to determine the status of the host operating system.

Prompts are message strings sent to the terminal by a cooperating program. They are well-defined and predictable, and are usually tailored to specific applications. When the terminal interacts directly with RTE or one or more subsystems, the process becomes less straightforward. Each subsystem usually has its own prompt which is not identical to other subsystem prompts. To maintain orderly communication with subsystems, you must interpret each message string from the host to determine whether it is to be treated as a prompt.

Prevention of Data Loss on the HP 1000

On the HP 1000, the RTE Operating System manages information transfer between programs or subsystems and system I/O devices, including DSN/DL. Terminals are continually polled by the host's data link interface (unless auto-poll has been disabled by use of an HP 1000 File Manager CN command). Since there is no relationship between automatic polling and HP 1000 program and subsystems execution, it is possible to poll a terminal when there is no need for information from that terminal. If the terminal sends a message in response to a poll when no data is being requested, the HP 1000 discards the message, causing the data to be lost, and treats it as an asynchronous interrupt. A break-mode prompt is then sent to the terminal by the host.

The terminal must determine that the host is ready to receive a message in order to ensure that messages are properly handled by the host. This is done by checking all messages from the host (CREAD until queue is empty) and not transmitting (CWRITE) until a prompt message or its equivalent has been received (unless you want to enter break-mode operation). Since the HP 1000 does not generate a consistent prompt message for all programs and subsystems, it is easiest to use cooperating programs to generate a predictable prompt. If your application requires interaction with other subsystems, prompts can usually be most easily identified by the ABSENCE of the sequence: `CR^LF^E_C_` at the end of a message. When a proper sequence has been identified, you are reasonably certain that the host is ready for your next message block.

Here is an example of host messages where a prompt is sent by the File Manager (FMGR) and answered by a RUN,EDITR command. Note that the prompt from the interactive editor fits the description of a prompt because a line-feed is not included after the carriage-return in the sequence.

:E_C_	Prompt is sent by FMGR to terminal.
RU,EDITR	EDITR Run command is sent to host.
SOURCE FILE NAME?C_R^L^F^E_C_	File name message is sent by the host, followed by a
C_R/^B^L^E_C_	prompt sequence which has no line-feed. Sequence is
	different from FMGR prompt.

Whenever an unexpected message from a terminal is received by RTE, it is treated as an asynchronous interrupt which terminates normal communication with that terminal. A break-mode prompt is sent to the terminal by RTE, and the next message is expected to be a valid break-mode command. If the the message is not a valid command (such as data in a file being transferred), the data is discarded, and an error message is sent to the terminal. If, in the meantime, the cooperating program or subsystem generates an input request, the next data block is sent to the proper destination, but is out of sequence because at least one block has been lost. You can prevent such data losses and the mass confusion that usually ensues (especially during high-speed file transfers to the host), by disabling auto-poll on the HP 1000 data link interface. With auto-poll OFF, no polls are sent to your terminal unless the host is prepared to receive data.

Disabling Auto-poll on the HP 1000

To operate with auto-poll OFF, log on to the network host, disable auto-poll, perform all datacomm activities and file transfers, enable auto-poll, then log off. **If you don't enable auto-poll at the end of a session, polling is suspended to your terminal after log-off, and you cannot reestablish communication with the host unless polling is restored from another terminal or the network host System Console.**

The auto-poll ON/OFF commands are:

CN,LU#,23B,101401B	Auto-poll OFF ¹
CN,LU#,23B,001401B	Auto-poll ON ¹

where LU# us the logical unit number assigned to your terminal.

When auto-poll is disabled, no polls are sent to your terminal unless an input request is initiated by the cooperating program or subsystem on the network host. When the request is made, a poll is scheduled, and polling continues until a reply is received from the terminal. When the reply is received, and acknowledged, polling is suspended until the next input is scheduled. Operating with auto-poll OFF is especially useful when transferring files TO the HP 1000. Otherwise, in most applications, it is practical to leave auto-poll ON.

¹ The File Manager CN (Control) command parameters for the multipoint interface are described in more detail in the 91730A Multipoint Terminal Interface Subsystem User's Guide (91730-90002).

Prevention of Data Loss on the HP 3000

Neither the HP 1000 nor the HP 3000 provide a DC1 poll character when they are ready for data inputs from DSN/DL. The HP 3000, like the HP 1000, also discards data if it has not requested the transfer. Since the HP 3000 does not provide an auto-poll disable command, you must interpret messages from the HP 3000 to determine that it is ready for the next data block before you transmit the block.

Secondary Channel, Half-duplex Communication

Half-duplex telecommunications links frequently use secondary channel communication to control data transmission and provide for proper line turn-around. This is done by using Secondary Request-to-send (SRTS) and Secondary Data Carrier Detect (SDCD) modem signals.

Consider two devices communicating with each other: Each connects to the datacomm link, then waits for SDCD to become active (true). As each device connects to the line, Secondary Request-to-send is enabled, causing each modem to activate its secondary carrier output. The Secondary Data Carrier Detect is, in turn, activated by each modem as it receives the secondary data carrier from the other end.

When communication begins, the first device to transmit (assumed to be your computer, in this case) clears its Secondary Request-to-send modem line. This removes the secondary data carrier from the line, causing the other modem to clear SDCD to its terminal or computer, telling it that you have the line. (The modems also maintain proper line switching and prevent timing conflicts so both ends don't try to get the line simultaneously.) The other device receives data, and must not attempt to transmit until you relinquish control of the line as indicated by SDCD true. After you finish transmitting, you must again activate SRTS so that SDCD can be activated to the other device, allowing it to use the line if it has a message.

Communication Between Desktop Computers

Two desktop computers can be connected, directly, or by use of modems. DC1/DC3 handshake protocol can be used conveniently to enable each computer to transmit at will without risk of buffer or queue overruns. To ensure proper operation, the following guidelines apply:

- Set up IOControl Register 22 with a value of 5. This allows both computers to act either as host or terminal in any given situation, depending on which one initiates the action.
- Set up IOControl Registers 26 and 27 for DC1 and DC3 respectively, or use two other characters if necessary.
- Data to be transmitted must NOT contain any characters matching the contents of IOControl Register 26 or 27. This prevents the receiving interface from confusing data with control characters.
- If both computers attempt to transmit large amounts of data at the same time, a lock-up condition may result where each side is waiting for the other to empty its buffers.

Cable and Adapter Options and Functions

The HP 98628A Datacomm Interface is available with RS-232C DTE and DCE cable configurations, or it can be connected to various modems or adapters for other applications.

DTE and DCE Cable Options

DTE and DCE cable options are designed to simplify connecting two desktop computers without the use of modems. The DTE cable (male RS-232 connector) is configured to make the datacomm interface look like standard data terminal equipment when it is connected to an RS-232C modem. The DCE cable (female RS-232 connector) is configured so that it eliminates the need for modems in a direct connection. When you connect two computers to each other in a direct non-modem connection, both datacomm interfaces are functionally identical. The DCE cable acts as an adapter so that both interfaces behave exactly as they would if they were connected to a pair of modems by means of DTE cables.

Several signal lines are rerouted in the DCE cable so that, in direct connections, outputs from one interface are connected to the corresponding inputs on the other interface. Certain outputs on each interface are also connected to inputs on the same card by "loop-back" connections in the DCE cable.

The schematic diagram in this section shows two datacomm interfaces directly connected through a DTE-DCE cable pair. Note that the DCE cable wiring complements the DTE cable so that output signals are properly routed to their respective destinations. Signal names at the RS-232C connector interface are the same as the signal names for the DTE interface. However, because the DCE cable adapts signal paths, the signal name at the RS-232C connector does not necessarily match the signal name at the DCE interface. Connector pin numbers are included in the diagram for your convenience.

RS-232C DTE (male) Cable Signal Identification Tables

Signal		Interface Pin #	RS-232C Pin #	Mnemonic	I/O	Function
RS-232C	V.24					
AA	101	24	1	—	—	Safety Ground
BA	103	12	2		Out	Transmitted Data
BB	104	42	3		In	Received Data
CA	105	13	4	RTS	Out	Request to Send
CB	108	44	5	CTS	In	Clear to Send
CC	107	45	6	DSR	In	Data Set Ready
AB	102	48	7	—	—	Signal Ground
CF	109	46	8	DCD	In	Data Carrier Detect
SCF (OCR2)	122	47	12	SDCD	In	Secondary DCD
DB	114	41	15		In	DCE Transmit Timing
DD	115	43	17		In	DCE Receive Timing
SCA (OCD2)	120	15	19	SRTS	Out	Secondary RTS
CD	108.1	14	20	DTR	Out	Data Terminal Ready
CE (OCR1)	125	9	22	RI	In	Ring Indicator
CH (OCD1)	111	40	23	DRS	Out	Data Rate Select
DA	113	7	24		Out	Terminal Transmit Timing

Optional Circuit Driver/Receiver Functions

Two optional drivers and receivers are used with the RS-232C cable options. Their functions are as follows:

Drivers		Receivers	
Name	Function	Name	Function
OCD1	Data Rate Select	OCR1	Ring Indicator
OCD2	Secondary Request-to-send	OCR2	Secondary Data Carrier Detect
OCD3	Not used		
OCD4	Not used		

OCD2 is used for autodial pulsing in the HP 13265A Modem. None of the optional drivers and receivers are used for Data Link and Current Loop Adapters.

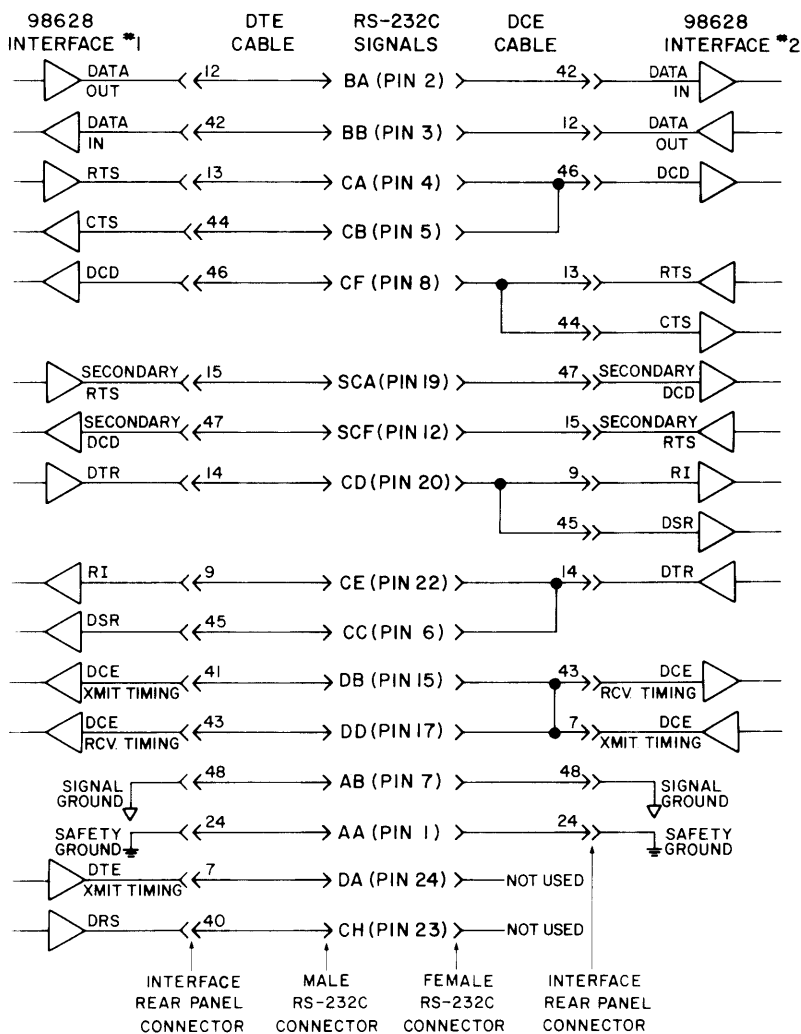

DTE/DCE Interface Cable Wiring

HP 98628 Datacomm Interface IOSTATUS and IOCONTROL Register Summary

Pascal Register Map - Control Registers

Register =	Use
000 .. 127	Buffered Control - Queued up with data
257 .. 383	Direct Control - Occurs immediately (meaning is the same as buffered ctl register + 256)
512	Immediate transfer in Abort
513	Immediate transfer out Abort

Unless indicated otherwise, the Status Register returns the current value for a given parameter; the Control Register sets a new value.

Register	Function
0	Control: Interface Reset; Status: Interface Card ID
1 (Status only)	Hardware Interrupt Status: 1 = Enabled, 0 = Disabled
2 (Status only)	Datacomm activity: 0 = inactive, 1 = ENTER in process, 2 = OUTPUT in process
3	Select Protocol: 1 = Async, 2 = Data Link
4 (Status only)	Interrupt Status. Interrupt operations are not currently supported at a user level in Pascal.
5	Control: Terminate transmission; Status: Inbound queue status
6	Control: Send BREAK to remote; Status: 1 = BREAK pending
7 (Status only)	Current modem receiver line states
8	Modem driver line states
9 (Status only)	Control block TYPE
10 (Status only)	Control block MODE
11 (Status only)	Available outbound queue space
12	Control: Connect/Disconnect line; Status: Line connection status
13	Interrupt mask. Interrupt operations are not currently supported at a user level in Pascal.
14	Control Block mask
15	Modem line interrupt mask. Interrupt operations are not currently supported at a user level in Pascal.
16	Connection timeout limit
17	No Activity timeout limit
18	Lost Carrier timeout limit
19	Transmit timeout limit
20	Async: Transmit baud rate (line speed) Data Link: Set Transmit/Receive baud rate (line speed)
21	Async: Incoming (receiver) baud rate (line speed) Data Link: GID address (0 thru 26 corresponds to "@" thru "Z")
22	Async: Protocol handshake type Data Link: DID address (0 thru 26 corresponds to "@" thru "Z")
23	Hardware handshake type: ON/OFF, HALF/FULL duplex, Modem/Non-modem

Register	Function
24	Async: Control Character mask Data Link: Block Size limit
25 (Status only)	Number of received errors since last interface reset
26	Async: First protocol character (ACK/DC1) Data Link: NAKs received since last interface reset

Registers 27-35, 37, and 39 are used with Async protocol only. They are not accessible during Data Link operation.

27	Second protocol handshake character (ENQ/DC3)
28	Number of characters in End-of-line sequence
29	First character in EOL sequence
30	Second character in EOL sequence
31	Number of characters in PROMPT sequence
32	First character in PROMPT sequence
33	Second character in PROMPT sequence
34	Data bits per character excluding start, stop and parity
35	Stop bits per character (0 = 1, 1 = 1.5, and 2 = 2 stop bits)
36	Parity sense: 0 = NONE, 1 = ODD, 2 = EVEN, 3 = ZERO, 4 = ONE Data Link: 0 = NONE (HP 1000 host), 1 = ODD (HP 3000 host)
37	Inter-character time gap in character times (Async only)
38 (Status only)	Transmit queue status (1 = empty)
39	BREAK time in character times (Async only)
125 (Control only)	Abort both input and output transfers.
512 (Control only)	Immediate transfer in Abort.
513 (Control only)	Immediate transfer out Abort.

HP 98628 Datacomm Interface IOSTATUS and IOCONTROL Registers

General Notes: Control registers accept values in the range of zero through 255. Some registers require specified values, as indicated. Illegal values or values less than zero or greater than 255, cause ERROR 327. Accessing a non-existent register generates ERROR 326.

Reset value, shown for various Control Registers, is the default value used by the interface after a reset or power-up until the value is overridden by an IOCONTROL procedure.

Status 0 Card Identification
Value returned: 52 (if 180 is returned, check select code switch cluster and make sure switch R is ON).

Control 0 Card Reset
Any value, 1 thru 255, resets the card. Immediate execution. Data in queues is destroyed.

Status 1 Hardware Interrupt Status (not used in most applications)
1 = Enabled 0 = Disabled

Status 2 Datacomm Activity
0 = No activity pending on this select code.
Bit 0 set: input in process.
Bit 1 set: output in process.
(Non-zero ONLY during multi-line function calls.)

Status 3 Current Protocol Identification:
1 = Async, 2 = Data Link Protocol

Control 3 Protocol to be used after next card reset (CONTROL 5,0;1)
1 = Async Protocol 2 = Data Link Protocol
This register overrides default switch configuration.

Status 4 Interrupt status. Interrupt operations are not currently supported at a user level in Pascal.

Status 5 Inbound queue status

Value	Interpretation
0	Queue is empty
1	Queue contains data but no control blocks
2	Queue contains one or more control blocks but no data
3	Queue contains both data and one or more control blocks

Control 5 Terminate Transmission
Data Link: Sends previous data as a single block with an ETX terminator, then idles the line with an EOT.
Async: Tells card to turn half-duplex line around. Does nothing when line is full-duplex. The next data output automatically regains control of the line by raising the RTS (request-to-send) modem line.

- Status 6** Break status: 1 = BREAK transmission pending, 0 = no BREAK pending.
- Control 6** Send Break; causes a Break to be sent as follows:
 Data Link Protocol: Send Reverse Interrupt (RVI) reply to inbound block, or CN character instead of data in next outbound block.
 Async Protocol: Transmit Break. Length is defined by Control Register 39.
 Note that the value sent to the register is arbitrary.
- Status 7** Modem receiver line states (values shown are for male cable connector option for connection to modems).
 Bit 0: Data Mode (Data Set Ready) line
 Bit 1: Receive ready (Data Carrier Detect line)
 Bit 2: Clear-to-send (CTS) line
 Bit 3: Incoming call (Ring Indicator line)
 Bit 4: Depends on cable option or adapter used
- Status 8** Returns modem driver line states.
- Control 8** Sets modem driver line states (values shown are for male cable connector option for connection to modems).
 Bit 0: Request-to-send (RS or RTS) line 1 = line set (active)
 Bit 1: Data Terminal Ready (DTR) line 0 = line clear (inactive)
 Bit 2: Driver 1: Data Rate Select
 Bit 3: Driver 2: Depends on cable option or adapter used
 Bit 4: Driver 3: Depends on cable option or adapter used
 Bit 5: Driver 4: Depends on cable option or adapter used
 Bits 6,7: Not used
- Reset value = 0** prior to connect. Post-connect value is handshake dependent.
 Note that RTS line cannot be altered (except by OUTPUT or OUTPUT...END) for half-duplex modem connections.
- Status 9** Returns control block TYPE if last input terminated on a control block. See Status Register 10 for values.
- Status 10** Returns control block MODE if last input terminated on a control block.

Async Protocol Control Blocks

Type	Mode	Interpretation
250	1	Break received (Channel A)
251	1 ¹	Framing error in the following character
251	2 ¹	Parity error in the following character
251	3 ¹	Parity and framing errors in the following character
252	1	End-of-line terminator detected
253	1	Prompt received from remote
0	0	No Control Block encountered

¹ Parity/framing error control blocks are not generated when characters with parity and/or framing errors are replaced by an underscore (_) character.

Data Link Protocol Control Blocks

Type	Mode	Interpretation
254	1	Preceding block terminated by ETB character
254	2	Preceding block terminated by ETX character
253 ²	—	(see following table for Mode interpretation)
0	0	No Control Block encountered.

Mode Bit(s)	Interpretation
0	1 = Transparent data in following block 0 = Normal data in following block
2,1	00 = Device select 01 = Group select 10 = Line select
3	1 = Command channel 0 = Data channel

Status 11 Returns available outbound queue space (in bytes), provided there is sufficient space for at least three control blocks. If not, value is zero.

Status 12 Datacomm Line connection status

Value	Interpretation
0	Disconnected
1	Attempting Connection
2	Dialing
3	Connected ¹
4	Suspended
5	Currently receiving data (Data Link only)
6	Currently transmitting data (Data Link only)

Note

When the datacomm line is suspended, ABORT_SERIAL, or IORESET must be executed before the line can be reconnected.

Reset value = 0 if R on interface select code switch cluster is ON (1).

Control 12 Connects, disconnects, initiates auto-dialing as follows:

Value	Interpretation
0	Disconnects
1	Connects
2	Initiates

Status 13 Interrupt mask. Interrupt operations are not currently supported at a user level in Pascal.

Control 13 Interrupt mask. Interrupt operations are not currently supported at a user level in Pascal.

² This type is used primarily in specialized applications.

¹ When using Data Link: Connected - datacomm idle

Status 14 Returns current Control Block mask.

Control 14 Sets Control Block mask. Control block information is queued sequentially with incoming data as follows:

Bit	Value	Async Control Block Passed	Data Link Control Block Passed
0	1	Prompt position	Transparent/Normal Mode ¹
1	2	End-of-line position	ETX Block Terminator ²
2	4	Framing and/or Parity error ³	ETB Block Terminator ²
3	8	Break received	

Reset Value: 0 (Control Blocks disabled) 6 (ETX/ETB Enabled)

Bits 4, 5, 6, and 7 are not used.

Status 15 Modem line interrupt mask. Interrupt operations are not currently supported at a user level in Pascal.

Control 15 Modem line interrupt mask. Interrupt operations are not currently supported at a user level in Pascal.

Status 16 Returns current connection timeout limit.

Control 16 Sets Attempted Connection timeout limit.
Acceptable values: 1 thru 255 seconds. 0 = timeout disabled.
Reset Value = 25 seconds

Status 17 Returns current No Activity timeout limit.

Control 17 Sets No Activity timeout limit.
Acceptable values: 1 thru 255 minutes. 0 = timeout disabled.
Reset Value = 10 minutes (disabled if Async, non-modem handshake).

Status 18 Returns current Lost Carrier timeout limit.

Control 18 Sets Lost Carrier timeout limit in units of 10 ms.
Acceptable values: 1 thru 255. 0 = timeout disabled.
Reset Value = 40 (400 milliseconds)

Status 19 Returns current Transmit timeout limit.

Control 19 Sets Transmit timeout limit (loss of clock or CTS not returned by modem when transmission is attempted).
Acceptable values: 1 thru 255.0 = timeout disabled.
Reset Value = 10 seconds

¹ Transparent/Normal format identification control block occurs at the BEGINNING of a given block of data in the receive queue.

² ETX and ETB Block Termination identification control blocks occur at the END of a given block of data in the receive queue.

³ This control block precedes each character containing a parity or framing error.

Status 20 Returns current transmission speed (baud rate). See table for values.
Control 20 Sets transmission speed (baud rate) as follows:

Register Value	Baud Rate	Register Value	Baud Rate
0	External Clock	8	600
*1	50	9	1200
*2	75	10	1800
*3	110	11	2400
*4	134.5	12	3600
*5	150	13	4800
*6	200	14	9600
7	300	15	19200

* Async only. These values cannot be used with Data Link. These values set transmit speed ONLY for Async; transmit AND receive speed for Data Link. Default value is defined by the interface card configuration switches.

Status 21 Protocol dependent. Returns receive speed (Async) or GID address (Data Link) as specified by Control Register 21.

Control 21 Protocol dependent. Functions are as follows:

Data Link: Sets Group IDentifier (GID) for terminal. Values 0 thru 26 correspond to identifiers @, A, B,... Y, Z, respectively. Other values cause an error. Default value is 1 ("A").

Async: Sets datacomm receiver speed (baud rate). Values and defaults are the same as for Control Register 20.

Status 22 Protocol dependent. Returns DID (Data Link) or protocol handshake type (Async) as specified by Control Register 22.

Control 22 Protocol dependent. Functions are as follows:

Data Link: Sets Device IDentifier (DID) for terminal. Values are the same as for Control Register 21. Default is determined by interface card configuration switches.

Async: Defines protocol handshake type that is to be used.

Value	Handshake type
0	Protocol handshake disabled
1	ENQ/ACK with desktop computer as the host
2	ENQ/ACK, desktop computer as a terminal
3	DC1/DC3, desktop computer as host
4	DC1/DC3, desktop computer as a terminal
5	DC1/DC3, desktop computer as both host and terminal

Status 23 Returns current hardware handshake type.

Control 23 Sets hardware handshake type as follows:

0 = Handshake OFF, non-modem connection.

1 = FULL-DUPLEX modem connection.

2 = HALF-DUPLEX modem connection.

3 = Handshake ON, non-modem connection.

Reset Value is determined by interface configuration switches.

Status 24 Protocol dependent. Returns value set by preceding IOCONTROL procedure to Control Register 24.

Control 24 Protocol dependent. Functions as follows:
Data Link protocol: Set outbound block size limit.

Value	Block size	Value	Block size
0	512 bytes	4	8 bytes
1	2 bytes	:	:
2	4 bytes	:	:
3	6 bytes	255	510 bytes

Reset outbound block size limit = 512 bytes

Async Protocol: Set mask for control characters included in receive data message queue.

Bit set: transfer character(s).

Bit cleared: delete character(s).

Bit set	Value	Character(s) passed to receive queue
0	1	Handshake characters (ENQ, ACK, DC1, DC3)
1	2	Inbound End-of-line character(s)
2	4	Inbound Prompt character(s)
3	8	NUL (CHR(0))
4	16	DEL (CHR(127))
5	32	CHR(255)
6	64	Change parity/framing errors to underscores (_) if bit is set.
7	128	Not used

Reset value = 127 (bits 0 thru 6 set)

Status 25 Returns number of received errors since power up or reset.

Note

Control Registers 26 through 35, Status Registers 27 through 35, and Control and Status Registers 37 and 39 are used for ASYNC protocol ONLY. They are not available during Data Link operation.

Status 26 Protocol dependent
Data Link protocol: Returns number of transmit errors (NAKs received) since last interface reset.

Async protocol: Returns first protocol handshake character (ACK or DC1).

Control 26 (Async only) Sets first protocol handshake character as follows:
6 = ACK, 17 = DC1. Other values used for special applications only. **Reset value = 17** (DC1). Use ACK when Control Register 22 is set to 1 or 2. Use DC1 when Control Register 22 is set to 3, 4, or 5.

Status 27 (Async only) Returns second protocol handshake character.

Control 27 (Async only) Sets second protocol handshake character as follows:
5 = ENQ, 19 = DC3. Other values used for special applications only. **Reset value = 19** (DC3). Use ENQ when Control Register 22 is set to 1 or 2. Use DC3 when Control Register 22 is set to 3, 4, or 5.

- Status 28** Returns number of characters in inbound
(Async only) End-of-line delimiter sequence.
- Control 28** Sets number of characters in End-of-line delimiter sequence
(Async only) Acceptable values are 0 (no EOL delimiter), 1, or 2. **Reset Value = 2**
- Status 29** Returns first End-of-line character.
(Async only)
- Control 29** Sets first End-of-line character. **Reset Value = 13** (carriage return)
(Async only)
- Status 30** Returns second End-of-line character.
(Async only)
- Control 30** Sets second End-of-line character. **Reset Value = 10** (line feed)
(Async only)
- Status 31** Returns number of characters in Prompt sequence.
(Async only)
- Control 31** Sets number of characters in Prompt sequence.
(Async only) Acceptable values are 0 (Prompt disabled), 1 or 2.
Reset Value = 1
- Status 32** Returns first character in Prompt sequence.
(Async only)
- Control 32** Sets first character in Prompt sequence.
(Async only) **Reset Value = 17** (DC1)
- Status 33** Returns second character in Prompt sequence.
(Async only)
- Control 33** Sets second character in Prompt sequence.
(Async only) **Reset Value = 0** (null)
- Status 34** Returns the number of bits per character.
(Async only)
- Control 34** Sets the number of bits per character as follows:
(Async only) 0 = 5 bits/character 2 = 7 bits/character
1 = 6 bits/character 3 = 8 bits/character
When 8 bits/char, parity must be NONE, ODD, or EVEN.
Reset Value is determined by interface card default switches.
- Status 35** Returns the number of stop bits per character.
(Async only)
- Control 35** Sets the number of stop bits per character as follows:
(Async only) 0 = 1 stop bit 1 = 1.5 stop bits 2 = 2 stop bits
Reset Value: 2 stop bits if 150 baud or less, otherwise 1 stop bit.
Reset Value is determined by interface configuration switch settings.

- Status 36** Returns current Parity setting.
- Control 36** Sets Parity for transmitting and receiving as follows:
- Data Link Protocol: 0 = NO Parity; Network host is HP 1000 Computer.
1 = ODD Parity; Network host is HP 3000 Computer.
Reset Value = 0
- Async Protocol : 0 = NONE; no parity bit is included with any characters.
1 = ODD; Parity bit SET if there is an EVEN number of "1"s in the character body.
2 = EVEN; Parity bit OFF if there is an ODD number of "1"s in the character body.
3 = "0"; Parity bit is always ZERO, but parity is not checked.
4 = "1"; Parity bit is always SET, but parity is not checked.
- Default is determined by interface configuration switches.** If 8 bits per character, parity must be NONE, ODD, or EVEN.
- Status 37** Returns inter-character time gap in character times.
(Async only)
- Control 37** Sets inter-character time gap in character times.
(Async only) Acceptable values: 1 thru 255 character times.
0 = No gap between characters. **Reset Value = 0**
- Status 38** Returns Transmit queue status.
If returned value = 1, queue is empty, and there are no pending transmissions.
- Status 39** Returns current Break time (in character times).
(Async only)
- Control 39** Sets Break time in character times.
(Async only) Acceptable values are: 2 thru 255. **Reset Value = 4.**
- Control 125** Abort both input and output transfers.
- Control 512** Immediate transfer in Abort.
- Control 513** Immediate transfer out Abort.

RS-232 Serial Interface

Chapter

12

Introduction

The HP 98626¹ Serial Interface is an RS-232C² compatible interface used for simple asynchronous (“async” for short) I/O applications such as driving line printers, terminals, or other peripherals. If your applications require more advanced capabilities, use the HP 98628 Datacomm Interface instead.

The Serial Interface uses a UART (Universal Asynchronous Receiver and Transmitter) integrated circuit to generate the required signals. Because the Serial Interface does not have a processor onboard, the computer must provide most control functions. Consequently, there is more interaction between the card and computer than when you use a more intelligent interface.

The RS-232C interface standard establishes electrical and mechanical interface requirements, but does not define the exact function of all the signals that are used by various manufacturers of data communications equipment and serial I/O devices. Consequently, when you plug your Serial Interface into an RS-232 connector, there is no guarantee the devices can communicate unless you have configured optional parameters to match the requirements of the other device.

The terms “asynchronous data communication” and “serial I/O” refer to a technique for transferring data between two devices one bit at a time where characters are not synchronized with preceding or subsequent characters. Each character is sent as a complete entity without relationship to other events. Characters may be sent in close succession, or they may be sent sporadically as data becomes available. Start and stop bits are used to identify the beginning and end of each character, with the character data placed between them.

¹ The HP 98644 interface and the built-in serial interface of the Model 216 and 217 computers are similar to the 98626 interface. Differences are described at the end of this chapter.

² RS-232C is a data communication standard established and published by the Electronic Industries Association (EIA). Copies of the standard are available from the association at 2001 Eye Street N. W., Washington D. C. 20006. Its equivalent for European applications is CCITT V.24.

Details of Serial I/O

The transfer of data over a serial line is a trivial operation when the host and terminal devices are designed to work together. However, some applications require some configuration before the communication can be performed smoothly. You must determine the operating parameters of the terminal device and then set up the host device for compatible operation.

The Serial Interface¹ includes three default configuration switch clusters in addition to the select code and interrupt level switches. These three switch clusters include Modem Line, Baud Rate, and Line Control switches. The operating parameters can be set using these switches or by program control which overrides most switches.

To determine operating parameters, you need to know the answer for each of the following questions about the peripheral device.

- What baud rate (line speed) is expected by the peripheral?
- Which of the following signal and control lines are actively used during communication with the peripheral?

—Data Set Ready (DSR) —Data Carrier Detect (DCD)
—Clear to Send (CTS) —Ring Indicator (RI)

In addition, you must know the expected format for an individual frame of character data. Each character frame consists of the following elements:

- **Start Bit**—The start bit signals the receiver that a new character is being sent. All other bits in a given frame are synchronized to the start bit.
- **Character Data Bits**—The next bits are the binary code of the character being transmitted, consisting of 5, 6, 7, or 8 bits; depending on the application.
- **Parity Bit**—The parity bit is optional, included only when parity is enabled.
- **Stop Bit(s)**—One or more stop bits identify the end of each character. The serial interface has no provision for inserting time gaps between characters.

Here is a simple diagram showing the structure of an asynchronous character and its relationship to other characters in the data stream:

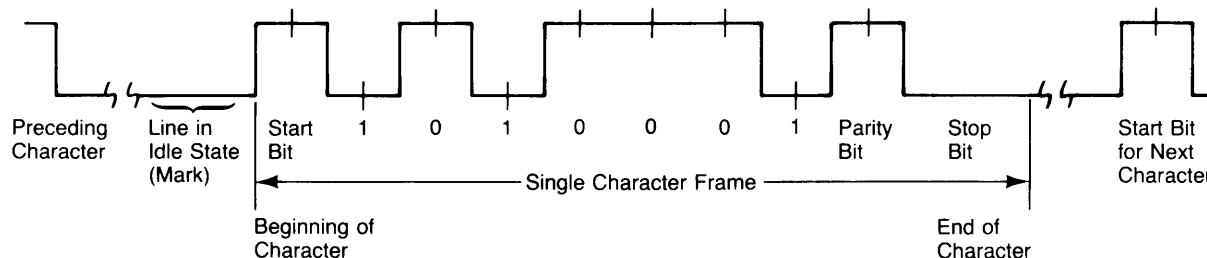

¹ There are no Modem Status Line, Baud Rate, or Line Control switches on the 98644 interface.

Baud Rate

The rate at which data bits are transferred between the interface and the peripheral is called the baud rate. The interface card must be set to transmit and receive at the same rate as the peripheral, or data cannot be successfully transferred. The Baud Rate Select switches can be set to any one of the following values.

Baud Rate Switch Settings

Switch Settings					Switch Settings				
Baud Rate	3	2	1	0	Baud Rate	3	2	1	0
50	0	0	0	0	1200	1	0	0	0
75	0	0	0	1	1800	1	0	0	1
110	0	0	1	0	2400 *	1	0	1	0
134.5	0	0	1	1	3600	1	0	1	1
150	0	1	0	0	4800	1	1	0	0
200	0	1	0	1	7200	1	1	0	1
300	0	1	1	0	9600	1	1	1	0
600	0	1	1	1	19200	1	1	1	1

* factory switch settings

Modem Status and Control Lines

A modem is used for serial communications between the computer and a remote device. The interface uses the following lines to indicate its status to the modem.

- Data-Terminal-Ready (DTR)—Indicates that the interface is ready for communications.
- Request-To-Send (RTS)—Indicates that the interface wants to send data.

The modem indicates its status to the interface through the following lines:

- Data-Set-Ready (DSR)—Indicates that the modem (data set) is ready.
- Clear-To-Send (CTS)—Indicates that the interface can transmit data over the communications link.
- Data-Carrier-Detect (DCD)—Indicates that the remote device has requested data.
- Ring-Indicator (RI)—Indicates that the modem is receiving an incoming call.

The Status Line Disconnect switches are used to connect or disconnect the modem status lines from the interface cable. When a given switch is in the “CONNECT” position, the corresponding status line (from the peripheral) is connected to the interface circuitry. When it is in the “ALWAYS ON” position, the status line is disconnected (from the peripheral) and the interface receiver input for that line is held high (logic true). Although these status lines are **only** monitored by the interface if Control register 13 is set (and the default for Control register 13 is 0, or clear), any status lines that are not actively used while communicating with the peripheral should be *disconnected* to minimize errors due to electrical noise in the cable.

Note that Status Line Disconnect switches **cannot** be altered under program control. To reconfigure the switches, the interface must be removed from the computer (with power **off**) and the settings changed by hand. Note also that these switches are not implemented on the built-in serial interfaces of the Model 216 and 217 computers.

Software Handshake, Parity and Character Format

The Line Control switches are used to preset the software handshake, character format, and parity options. Functions are as follows:

Line Control Switch Settings

Software Handshake (Bits 6,7)	Parity (Bits 5,4,3)	Stop Bits (Bit 2)	Character Length (Bits 1,0)
00 ENQ/ACK	xx0 no parity	0 1 stop bit	00 5 bits/char
01 Xon/Xoff	001 odd parity	1 2 stop bits	01 6 bits/char
10 Reserved	011 even parity	(1.5 stop bits	10 7 bits/char
11 None	101 always One	if 5 bits/char)	11 8 bits/char
	111 always Zero		

* factory switch settings

Software Handshake

Software handshakes are used by two communicating devices in order to prevent overflowing buffers. Special characters are used to implement the handshake. Two types of software handshakes are implemented.

- Enquire/Acknowledge—the host of this handshake sends an Enquire character after sending a specified number of characters (usually 80 characters), and then waits until it receives an Acknowledge character from the terminal. The terminal sends the Acknowledge character when it is ready to receive the specified number of characters.
- Xon/Xoff—the terminal sends an Xoff character when its receiving buffer is close to overflowing and then sends an Xon character when the buffer can again receive characters.

The Enquire/Acknowledge handshake implemented on the Serial Interface is the terminal-only version. The interface responds with an Acknowledge character (ASCII character 6) after it has received an Enquire character (ASCII character 5).

The Xon/Xoff handshake is the “host and terminal” version. The interface responds to an Xoff character by stopping all transmission. It resumes transmission when it receives a Xon character. It also sends a Xoff character (ASCII character 19) when it is running out of receiver buffer space, and sends an Xon character (ASCII character 17) after the buffer data has been processed.

Parity

The parity bit is used to detect errors as incoming characters are received. If the parity bit does not match the expected sense, the character is assumed to be incorrectly received. The action taken when an error is detected depends upon the interface and/or the application program.

Parity sense is determined by system requirements. The parity bit may be included or omitted from each character by enabling or disabling the parity function. When the parity bit is enabled, four options are available.

- ODD—Parity bit is set if there is an even number of bits set in the data character. The receiver performs parity checks on incoming characters.
- EVEN—Parity bit is set if there is an odd number of bits set in the data character. The receiver performs parity checks on incoming characters.
- ONE—Parity bit is set for all characters. Parity is checked by the receiver on all incoming characters.
- ZERO—Parity bit is cleared, but present for all characters. Parity is checked by the receiver on all characters.

Programming Techniques

Overview of Serial Interface Programming

Your computer uses several I/O Library facilities for data communication with various computers, terminals and peripheral devices. Serial Interface programs will include part or all of the following elements:

- Input procedures (including buffer-transfers)
- Output procedures (including buffer-transfers)
- IOSTATUS functions
- IOCONTROL procedures
- High level control procedures

The following steps represent a normal sequence of operations in a Serial I/O program.

1. Initialize the particular interface with an IORESET or initialize the whole I/O system by doing an IOINITIALIZE.
2. Set the operating parameters, this includes hardware characteristics, hardware handshake, and software handshake. This step can be skipped if the interface defaults are adequate.
3. Activate the Serial Interface by an IOCONTROL to Control Register 12. This activates the receiving buffer.
4. Do input and output using the I/O library procedures and functions. This is where all the data is transferred between the computer and the peripheral.
5. Deactivate the interface with an IOCONTROL to Control Register 12.
6. Cleanup the card by a IORESET or cleanup the whole I/O system by doing an IOUNINITIALIZE. This step disables the receiving buffer on the interface.

Initializing the Connection

Before you can successfully transfer information to a device, you must match the operating characteristics of the interface to the corresponding characteristics of the peripheral device. This includes matching signal lines and their functions as well as matching the character format for both devices. You can override some of the interface configuration switch settings by using the IOCONTROL procedure. This not only enables you to guarantee certain parameters, but also provides a means for changing selected parameters in the course of a running program. Control Register definitions for the Serial Interface are listed at the end of this chapter.

Interface Reset

Whenever an interface is connected to a modem that may still be connected to a telecommunications link from a previous session, it is good programming practice to reset the interface to force the modem to disconnect, unless the status of the link and remote connection are known. When the interface is connected to a line printer or similar peripheral, resetting the interface is usually unnecessary unless an error condition requires it.

The Serial Interface can be reset by an IORESET, IOINITIALIZE, IOUNINITIALIZE or by use of an IOCONTROL operation to register 0. The interface is restored to its power-up condition by all of these operations, except that the timeout is not altered with the IORESET and IOCONTROL procedures.

Resetting the Serial Interface puts it in a non-active state. To activate the card use:

```
IOCONTROL( isc, 12, 1 )
```

But before the interface is activated, the operating parameters should be set.

Selecting the Baud Rate

In order to successfully transfer information between the interface card and a peripheral, the interface and peripheral must be set to the same baud rate. In addition to the procedure SET_BAUD_RATE, Control Register 3 will allow the user to change the baud rate. The following baud rates are recommended:

50	150	1200	4800
75	200	1800	7200
110	300	2400	9600
134	600	3600	19200

For example, to select a baud rate of 3600, either of these statements can be used:

```
IOCONTROL ( isc,3,3600 )
```

or

```
SET_BAUD_RATE ( isc, 3600 )
```

Use of values other than those shown may result in incorrect operation.

To verify the current baud rate setting, use the IOSTATUS function addressed to Status Register 3. All rates are in baud (bits/second).

Setting Character Format, Parity and Software Handshake

Control Register 4 overrides the Line Control switches that control software handshake, parity, and character format. To determine the value sent to the register, add the appropriate values selected from the following table:

Line Control IOCONTROL Register

Software Handshake (Bits 6,7)	Parity (Bits 5,4,3)	Stop Bits (Bit 2)	Character Length (Bits 1,0)
00 ENQ/ACK	xx0 no parity	0 1 stop bit	00 5 bits/char
00 Xon/Xoff	001 odd parity	1 2 stop bits	01 6 bits/char
01 Reserved	011 even parity	(1.5 stop bits	10 7 bits/char
11 None	101 always One	if 5 bits/char)	11 8 bits/char
	111 always Zero		

For example, use IOCONTROL to configure a character format of 8 bits per character, two stop bits, EVEN parity, and no software handshake:

```
IOCONTROL( isc, 4, BINARY('11011111'))
```

or

```
IOCONTROL( isc, 4, 223 )
```

To configure a 5-bit character length with 1 stop bit, no parity bit, and Enquire/Acknowledge software handshake use:

```
IOCONTROL( isc, 4, 0 )
```

The Serial_3 procedures SET_PARITY, SET_STOP_BITS, and SET_CHAR_LENGTH can be used to individually set these parameters. But to change the software handshake, you must do an IOCONTROL to register 4.

Modem Handshake

Two types of connections can be selected for the serial interface: direct connection and modem connection. The difference between the two types of connection is that with the modem connection, the modem lines DSR and DCD have to be high when a character is received and the lines DSR and CTS have to be high when a character is transmitted. To change modem checking, you must do an IOCONTROL to Control Register 13. For example:

```
IOCONTROL( isc, 13, 1 ) { turns on modem handshake }
```

```
IOCONTROL( isc, 13, 0 ) { direct connection }
```

Transferring Data

When the interface is properly configured, either by use of default switches or IOCONTROL statements, you are ready to begin data transfers.

Data Output

When a non-“buffer-transfer” output operation is done (example WRITECHAR), the interface waits until the previous character is sent and then puts the next character in the buffer. If your application requires that the character is sent before continuing with the program, bits 5 and 6 of Status Register 10 can be checked. The following procedure waits until all characters are transmitted:

```

procedure wait_sent( isc : type_isc );
{
  This procedure waits until the transmit buffer is empty.
  It works for the 98626 and 98628 cards.
  The modules IODECLARATIONS, GENERAL_0, and IOCOMASM needs
  to be imported.
}
var busy : boolean;
begin
  repeat
    if isc_table[isc].card_id = hp98626 then
      busy := binand( iostatus(isc,10),HEX('60')) <> HEX('60'))
    else { assume the card is hp98628 }
      busy := iostatus(isc,38) = 0;
    until not busy;
  end;
end;

```

In the program the output sequence should be:

```

writechar( isc, 'a' );
wait_sent( isc );

```

Data Input

When a non-“buffer-transfer” input operation is done (example READSTRING), the interface waits for each character until the number of characters required is satisfied. For some applications, knowing if there is a character in the buffer is important. Bit 0 of Status Register 10 gives this information. The following function returns TRUE if there is at least one character in the receive buffer:

```
function have_char( isc : type_isc ) : boolean;
{
  This function returns true if there is a character in the
  receive buffer. If not it returns false.
  It works for the 98626 and 98628 cards.
  The modules IODECLARATIONS, GENERAL_0, and IOCOMASM need
  to be imported.
}
begin
  if isc_table[isc].card_id = hp98626 then
    have_char := odd( iostatus( isc, 10 ))
  else { assume it is hp98628 card }
    have_char := odd( iostatus( isc, 5 ));
  end;
```

The program input sequence would be:

```
if have_char( isc ) then readchar( isc, character );
```

Error Detection and Handling

The Serial Interface can detect and report several different classes of errors. The handling of errors by the interface differs depending on the severity of the error. For an unrecoverable error, an ESCAPE error is given. In case of an ESCAPE error, you can evaluate the error in the RECOVER section of your program. An I/O procedure ESCAPE error gives an ESCAPECODE of -26. To identify the error more closely, you can use the IOERROR_MESSAGE procedure with the IOE_RESULT variable as the parameter. For example:

```
if ESCAPECODE = -26 then
  begin
    writeln ( IOERROR_MESSAGE( IOE_RESULT ));
    ESCAPE( ESCAPECODE );
  end;
```

The TRY/RECOVER mechanism, the ESCAPECODE variable and the ESCAPE procedure are available by using \$SYSPROG ON\$. The IOERROR_MESSAGE procedure and the IOE_RESULT variable are available when you IMPORT the IODECLARATIONS module.

The errors which can happen are listed below.

- **Parity Error**—The parity bit on an incoming character does not match the parity expected by the receiver. This condition is most commonly caused by line noise. The interface handles this error by changing the character into a special character. This special character is defined by Control Register 19 and the default character is an underscore (“_”). The interface also sets bit 2 of Status Register 10.
- **Framing Error**—Start and stop bit(s) do not match the timing expectations of the receiver. This can occur when line noise causes the receiver to miss the start bit or obscures the stop bits. This error is handled similar to a parity error: the received character is translated into the special character defined by Register 19. The interface also sets bit 3 of Status Register 10.
- **Break received**—A BREAK was sent to the interface by the peripheral device. The Serial Interface does not interpret this condition as an error. The interface sets bit 4 of Status Register 10. Since BREAK is detected as a special type of framing error, bit 3 of Status Register 10 is also set. However, no special character is inserted into the receive buffer.
- **Overrun error**—Incoming data was not consumed fast enough so that one or more data characters were lost. This error can occur in two different ways: the software receive buffer overflowed, and the hardware receive buffer overflowed. In the first case, the program running cannot keep up with the receiver buffer at the current baud rate. Either reduce the baud rate, use software handshake, or change the program so that characters are read consistently. In the second case the error implies that interrupts were disabled so that the characters could not be processed. In both cases, an ESCAPE is generated and an IOE_RESULT of 314 results. In the second case, bit 1 of Status Register 10 is also set.
- **Timeout error**—Timeout errors occur when a character is not read or written within the timeout period specified. An ESCAPE is generated and an IOE_RESULT of 17 results. A timeout can occur when writing a character if DSR or CTS is low for the duration of the timeout. A timeout can occur when reading a character if no valid character was received during the timeout period.
- **CTS False Too Long**—This error occurs when a software handshake character cannot be sent because either DSR or CTS is low. The interface gives an ESCAPE error with an IOE_RESULT of 316.
- **Range Errors**—These errors occur when parameters passed to I/O library procedures and functions are out of range. For example, the Serial Interface does not support DMA; a call to TRANSFER with the transfer type being OVERLAP_DMA will result in an ESCAPE error with an IOE_RESULT of 7. These errors do not indicate a communications problem, rather they indicate a programming problem.

The ESCAPE errors “Overrun” and “CTS False Too Long” can happen even when there is no direct read or write to the interface. These errors will be saved by the interface and will be given at the next read or write operation to the interface. To avoid these ESCAPE errors, you can check Status Register 14. This register will return the IOE_RESULT of any pending errors. It will also clear the pending error so that the error can be handled without going into a RECOVER block.

As mentioned above, Status Register 10 has four bits which indicate if certain error conditions have occurred on the card. The four bits (1 through 4) are read-destructive bits. That is, if the register is read, the error bits are reset to zero.

When an ESCAPE error occurs (other than range type errors), it means there is a fairly serious problem. You should reset the interface if you decide to continue with the program. However an IORESET is sometimes undesirable since it resets all hardware parameters and modem connections are broken. To alleviate this problem, a soft reset is provided. A call to IOCONTROL with Register 14 and a non-zero value as parameters resets the interface without changing the hardware parameters or modem connections. It also clears the receive buffer.

Special Applications

This section provides advanced programming information for applications requiring special techniques.

Sending BREAK Messages

A BREAK is a special character transmission that usually indicates a change in operating conditions. Interpretation of break messages varies with the application. To send a break message, send a non-zero value to control Register 1.

```
IOCONTROL( isc,1,1 )    {Send a BREAK to peripheral}
```

Redefining Handshake and Special characters

Control registers 15 through 18 can be used to redefine the software handshake characters. The values passed to these registers should be the ordinal value of the character. The following example changes the Xon handshake character to DC2.

```
IOCONTROL( isc, 15, 20 )
```

Status registers 15 through 19 gives the ordinal value of the current handshake character. The following assigns to a character the current Acknowledge character.

```
ch := CHR(IOSTATUS(isc, 18))
```

As mentioned previously, Control Register 19 redefines the character into which parity error and framing error are converted. The following example sets this character to be the ASCII character DEL.

```
IOCONTROL( isc, 19, 127 )
```

Status Register 19 returns the current special character.

Using the Modem Line Control Registers

Modem line handshaking is performed automatically by the Serial Interface. The lines set by the interface are DTR and RTS. The lines checked by the interface are DSR, DCD, and CTS. Lines are set by the Serial Interface regardless of the modem handshake selection. Modem lines are checked only if the modem handshake is turned on. You can change the values of the modem lines by writing to Control Register 5 or 7. The operations which involve modem lines are described below.

- Reset—both DTR and DSR are set to low.
- Activate—DTR is set to high.
- Deactivate—both DTR and DSR are set to low.
- Output—RTS is set to high. If the modem handshake is on, the interface will wait until DSR and CTS to become high before putting the characters in the transmit buffer.
- Input—If the modem handshake is on, all characters received when DSR or DCD is low are discarded (not put into the buffer).
- TRANSFER_END—When this procedure is called with direction “from_memory”, at the end of the transfer RTS will be set low.

The following table summarizes the modem lines affected.

How Operations Affect Modem Lines

	DTR	RTS	DSR	CTS	DCD
reset	0	0	—	—	—
activate	1	—	—	—	—
deactivate	0	0	—	—	—
input	—	—	X	—	X
output	—	1	X	X	—
transfer_end	—	0	—	—	—

—	the modem line was not used.
0	the modem line was set to low.
1	the modem line was set to high.
X	the modem line was checked.

Control Register 5 controls various functions related to modem operation. Bits 0 thru 3 control modem lines, and bit 4 enables a self-test loopback configuration.

Modem Handshake Lines (RTS and DTR)

As explained earlier in this chapter, Request-To-Send and Data-Terminal-Ready lines are set or cleared by certain Serial Interface operations. For example, RTS is set high by the first write operation. Your application might require RTS to be high before the first write operation. The following example sets both RTS and DTR high at the same time.

```
IOCONTROL( isc, 5, 3 ); { set both RTS and DTR high }
IOCONTROL( isc,12, 1 ); { activate the receive buffer }
```

The above example also clears the loopback bit, and it clears the modem lines DRS and SRTS. To change only those two bits would require:

```
IOCONTROL(isc, 5, BINIOR(IOSTATUS(isc, 5), BINARY('00000011'))
{Sets RTS and DTR without disturbing other bits of register 5}
```

Programming the DRS and SRTS Modem Lines

Bits 3 and 2 of Control Register 5 control the present state of the Data Rate Select (DRS) and Secondary-Request-To-Send (SRTS) lines, respectively. When either bit is set, the corresponding modem line is activated. When the bit is cleared, so is the modem line.

Configuring the Interface for Self-test Operations

Self-test programs can be written for the Serial Interface. Prior to testing the interface, it must be properly configured. Using bit 4 of Control Register 5, you can rearrange the interconnections between input and output lines on the interface, enabling the interface to feed outbound data to the inbound circuitry.

When LOOPBACK is enabled (bit 4 is set), the UART output is set to its MARK state and sent to the Transmitted Data (TxD) line. The output of the transmitter shift register is then connected to the input of the receiver shift register, causing outbound data to be looped back to the receiver. In addition, the following modem control lines are connected to the indicated modem status lines.

Loopback Connections

<u>Modem Control Line</u>		to	<u>Modem Status Line</u>	
DTR	Data Terminal Ready		CTS	Clear-to-send
RTS	Request-to-send		DSR	Data Set Ready
DRS	Data Rate Select		DCD	Data Carrier Detect
SRTS	Secondary RTS		RI	Ring Indicator

When loopback is active, receiver and transmitter interrupts are fully operational. Modem control interrupts are then generated by the modem control outputs instead of the modem status inputs. Refer to Serial Interface hardware documentation for information about card hardware operation.

IOREAD_BYTE and IOWRITE_BYTE Register Operations

For those cases where you need to write special interface driver routines, the interface card hardware registers can be accessed by use of `IOREAD_BYTE` and `IOWRITE_BYTE` procedures. These capabilities are intended for use by experienced programmers who understand the inherent programming complexities that accompany this versatility. Warning: operations through hardware registers might interfere with the Serial Interface drivers.

Some registers are read/write: that is, both `IOREAD_BYTE` and `IOWRITE_BYTE` operations can be performed on a given register. Writing places a new value in the register; a read operation returns the current value. All registers have 8 bits available, and accept values from 0 thru 255 unless noted otherwise. When the value of a given bit is 1, the bit is set. Otherwise it is zero (cleared or inactive).

Some hardware registers are similar in structure and function to Status and Control Registers. However, their interaction with the Pascal operating system is considerably different. To prevent incorrect program operation, do not intermix the use of Status/Control registers and hardware registers in a given program.

Status and Control Registers

Most Control Registers accept values in the range from 0 thru 255. Some registers accept only specified values as indicated, or higher values for baud rate settings. Values less than zero are not accepted. Higher-order bits not needed by the interface are discarded if the specified value exceeds the valid range.

Reset value is the default value used by the interface after a reset or power-up until the value is overridden by a IOCONTROL procedure.

Status 0—Card Identification

Value returned: 2 (if 130 is returned, the Remote jumper wire has been removed from the interface card). The value returned for a 98644 card is 66 (or 194 if the Remote jumper has been removed).

Control 0—Card Reset

Any value, 1 thru 255, resets the card. Immediate execution. Data transfers in process are aborted and any buffered data is destroyed.

Status 1—Interrupt Status

Bit 7 set: Interface hardware interrupt to CPU enabled.

Bit 6 set: Card is requesting interrupt service.

Bits 5&4: 00 Interrupt Level 3

01 Interrupt Level 4

10 Interrupt Level 5

11 Interrupt Level 6

Bits 3 thru 0 not used.

Control 1—Transmit BREAK

Any non-zero value sends a 400 millisecond BREAK on the serial line.

Status 2—Interface Activity Status

Bit 5 set: Software handshake character pending. The peripheral is the host and it should not be sending more characters since it is waiting for either an ENQUIRE character (ENQ/ACK handshake) or a Xon character (Xon/Xoff handshake).

Bit 4 set: Waiting for handshake character. The desktop is acting as a host and it is not transmitting because it has received an Xoff character and it is waiting for an Xon character.

Bit 1 set: Interrupts are enabled for this interface.

Bit 0 set: Transfer in progress. Either an input or an output transfer is in progress.

Bits 2, 3, 6, and 7 are not used.

Status 3—Current Baud Rate

Returns current baud rate.

Control 3 -- Set New Baud Rate

The recommended baud rates are:

50	150	1200	4800
75	200	1800	7200
110	300	2400	9600
134	600	3600	19200

Status 4—Current Character Format

See Control Register 4 for function of individual bits.

Control 4—Set New Character Format

Software Handshake (Bits 6,7)	Parity (Bits 5,4,3)	Stop Bits (Bit 2)	Character Length (Bits 1,0)
00 ENQ/ACK	xx0 no parity	0 1 stop bit	00 5 bits/char
01 Xon/Xoff	001 odd parity	1 2 stop bits	01 6 bits/char
10 Reserved	011 even parity	1 1.5 if	10 7 bits/char
11 None	101 always One	5 bits/char	11 8 bits/char
	111 always Zero		

Status 5—Current Status of Modem Control Lines

Returns CURRENT line state values. See Control Register 5 for function of each bit.

Control 5—Set Modem Control Line States

Bit 4 set: Enables loopback mode for diagnostic tests.

Bit 3 set: Set Secondary Request-to-Send line to active state.

Bit 2 set: Set Data Rate Select line to active state.

Bit 1 set: Set Request-To-Send line to active state.

Bit 0 set: Set Data-Terminal-Ready line to active state.

Status 6—Data In

Reads character from receive buffer. Results are undefined if no character is present in the receive buffer.

Control 6—Data Out

Sends character to the transmitter holding register. This transmits a character **without** affecting modem lines. (Be sure that the transmitter holding register is *empty* before this operation.)

Status 7¹—Optional Receiver/Driver Status

Returns current value of optional circuit drivers or receivers as follows:

Bit 3: Optional Circuit Driver 3 (OCD3).

Bit 2: Optional Circuit Driver 4 (OCD4).

Bit 1: Optional Circuit Receiver 2 (OCR2).

Bit 0: Optional Circuit Receiver 3 (OCR3).

Other bits are not used (always 0).

¹ With the 98644 interface, this register always contains 0.

Control 7¹—Set New Optional Driver States

Sets (bit = 1) or clears (bit = 0) optional circuit drivers as follows:

- Bit 3: Optional Circuit Driver 3 (OCD3),
 - Bit 2: Optional Circuit Driver 2 (OCD2).
- Other bits are not used.

Status 10—UART Status

Bit set indicates UART status or detected error as follows:

- Bit 7: Not used.
- Bit 6: Transmit Shift Register empty.
- Bit 5: Transmit Holding Register empty.
- Bit 4: Break received.
- Bit 3: Framing error detected.
- Bit 2: Parity error detected.
- Bit 1: Receive Buffer Overrun error.
- Bit 0: Receiver Buffer full.

Note: bits 1 through 4 are read destructive, they will be cleared each time this register is read with an IOSTATUS.

Status 11—Modem Status

Bit set indicates that the specified modem line or condition is active.

- Bit 7: Data Carrier Detect (DCD) modem line active.
- Bit 6: Ring Indicator (RI) modem line active.
- Bit 5: Data Set Ready (DSR) modem line active.
- Bit 4: Clear-to-Send (CTS) modem line active.
- Bit 3: Change in DCD line state detected.
- Bit 2: RI modem line changed from true to false.
- Bit 1: Change in DSR line state detected.
- Bit 0: Change in CTS line state detected.

Note: Bits 0 through 3 are read destructive; they will be cleared each time this register is read with an IOSTATUS.

Status 12—Interface activity

Returned value:

- 0—The interface is deactivated.
- 1—The interface is active.

Control 12—Set interface active

Value:

- 0—Deactivate the interface.
- 1—Activate the interface, sets DTR and does a soft reset.

Status 13—Modem handshake status

Returned value:

- 0—modem line handshaking is disabled.
- 1—modem line handshaking is enabled.

¹ With the 98644 interface, writing this register performs no operation.

Control 13—Set modem handshake

Value

- 0—disable checking of modem lines.
- 1—enable checking of modem lines.

Status 14—Error pending

Returns the IOE_RESULT of any escape errors pending on the interface. A value of 0 is returned if no errors are pending.

Control 14—Soft reset

Any value, 1 through 255 resets the interface without affecting the modem lines or the hardware parameters. Receive buffer is reset with this command.

Status 15—Current Xon handshake character

Returns the ordinal value of the current Xon handshake character.

Control 15—Redefine Xon handshake character

Sets the Xon handshake character to have ordinal value equal to the input value. Default is DC1 (ASCII character 17).

Status 16—Current Xoff handshake character

Returns the ordinal value of the current Xoff handshake character.

Control 16—Redefine Xoff handshake character

Sets the Xoff handshake character to have ordinal value equal to the input value. Default is DC3 (ASCII character 19).

Status 17—Current Enquire handshake character

Returns the ordinal value of the current Enquire handshake character.

Control 17—Redefine Enquire handshake character

Sets the ENQUIRE handshake character to have ordinal value equal to the input value. Default is ENQ (ASCII character 5).

Status 18—Current Acknowledge handshake character

Returns the ordinal value of the current Acknowledge handshake character.

Control 18—Redefine Acknowledge handshake character

Sets the Acknowledge handshake character to have ordinal value equal to the input value. Default is ACK (ASCII character 6).

Status 19—Current framing parity error character

Returns the ordinal value of the special character into which framing errors and parity errors would be converted.

Control 19—Redefine framing/parity error handshake character

Sets the special character used to represent framing errors and parity errors to have an ordinal value equal to the input value. Default is an underscore (``_``) (ASCII character 95).

Serial Interface Hardware Registers

Interface Card Registers

IOREAD_BYTE and IOWRITE_BYTE registers 1, 3, 5, and 7 access interface registers. Their functions are as follows:

Register 1—Interface Reset and ID

IOREAD_BYTE to Register 1 returns the interface ID value—2 for the HP 98626 Serial Interface (or 66 for the 98644 interface) IOWRITE_BYTE to Register 1 with any value resets the interface as when using an IOCONTROL statement to Control Register 0.

Register 3—Interrupt Control

Only the upper four bits of Register 3 are used. Bits 5 and 4 return the setting of the Interrupt Level switches on the interface. Their values are as follows:

00	Interrupt Level 3	10	Interrupt Level 5
01	Interrupt Level 4	11	Interrupt Level 6

Bit 6 is set when an interrupt request is originated by the UART. No machine interrupt can occur unless bit 7, Interrupt Enable is set by an IOWRITE_BYTE statement. Only bit 7 is affected by IOWRITE_BYTE statements. During IOREAD_BYTE, bit 7 returns the current enable value; bits 6 thru 4 return interrupt request and level information.

Register 5¹—Optional Circuit and Baud Rate Control

IOWRITE_BYTE to bits 7 and 6 control the state of optional circuit drivers 3 and 4, respectively. IOREAD_BYTE returns current values of the respective drivers, plus the following:

Bit 5—Optional Circuit Receiver 2 state.

Bit 4—Optional Circuit Receiver 3 state.

Bits 3-0—Current Baud Rate switch setting (not necessarily the current UART baud rate).

These switches can be interpreted in any way you choose. The current interpretation given to them by the serial interface drivers are as follows:

Setting	Baud Rate	Setting	Baud Rate
0000	50	1000	1200
0001	75	1001	1800
0010	110	1010	2400
0011	134.5	1011	3600
0100	150	1100	4800
0101	200	1101	7200
0110	300	1110	9600
0111	600	1111	19200

Note that IOWRITE_BYTE to this register can NOT be used to set the baud rate. Use Register 23, bit 7 and Registers 17 and 19 instead.

Register 7¹—Line Control Switch Monitor

IOREAD_BYTE of this register returns the current settings of the Line Control switches that set the default character format and parity. Bits 7 thru 0 correspond to switches 7 thru 0, respectively. IOWRITE_BYTE operations to this register are meaningless.

¹ Registers 5 and 7 are not defined with the 98644 interface.

UART Registers

Addresses 17 through 29 access UART registers. They are used to directly control certain UART functions. The function of Registers 17 and 19 are determined by the state of bit 7 of Register 23.

Register 17—Receive Buffer/Transmitter Holding Register

When bit 7 of Register 23 is clear (0), this register accesses the single-character receiver buffer by use of `IOREAD_BYTE`. The `IOWRITE_BYTE` procedure places a character in the transmitter holding register.

The receiver and transmitter are doubly buffered. When the transmitter shift register becomes empty, a character is transferred from the holding register to the shift register. You can then place a new character in the holding register while the preceding character is being transmitted. Incoming characters are transferred to the receiver buffer when the receiver shift register becomes full. You can then input the character (`IOREAD_BYTE`) while the next character is being constructed in the shift register.

Registers 17 and 19—Baud Rate Divisor Latch

When bit 7 of Register 23 is set, Registers 17 and 19 access the 16-bit divisor latch used by the UART to set the baud rate. Register 17 forms the lower byte; Register 19 the upper. The baud rate is determined by the following relationship:

$$\text{Baud Rate} = 153\,600 / \text{Baud Rate Divisor}$$

To access the Baud Rate Divisor latch, set bit 7 of Register 23. This disables access to the normal functions of Registers 17 and 19, but preserves access to the other registers. When the proper value has been placed in the latch, be sure to clear bit 7 of Register 23 to return to normal operation.

Register 19—Interrupt Enable Register

When bit 7 of Register 23 is clear (0), this register enables the UART to interrupt when specified conditions occur. Only bits 0 thru 3 are used. `IOWRITE_BYTE` establishes a new value for each bit; `IOREAD_BYTE` returns the current register value. Interrupt enable conditions are as follows:

- Bit 3—Enable Modem Status Change Interrupts. When set, enables an interrupt whenever a modem status line changes state as indicated by Register 29, bits 0 thru 3.
- Bit 2—Enable Receiver Line Status Interrupts. When set, enables interrupts by errors, or received BREAKs as indicated by Register 27, bits 1 thru 4.
- Bit 1—Enable Transmitter Holding Register Empty Interrupt. When set, allows interrupts when bit 5 of Register 27 is also set.
- Bit 0—Enable Receiver Buffer Full Interrupts. When set, enables interrupts when bit 0 of Register 27 is also set.

Register 21—Interrupt Identification Register

This register identifies the cause of the highest-priority, currently-pending interrupt. Only bits 2, 1, and 0 are used. Bit 0, if set, indicates no interrupt pending. Otherwise an interrupt is pending as defined by bits 2 and 1. Causes of pending interrupts in order of priority are as follows:

- 11—Receiver Line Status interrupt (highest priority) is caused when bit 2 of Register 19 is set and a framing, parity, or overrun error, or a BREAK is detected by the receiver (indicated by bits 1 thru 4 of Register 27). The interrupt is cleared by reading Register 27.
- 10—Receive Buffer Register Full interrupt is generated when bit 0 of Register 19 is set and the Data Ready bit (bit 0) of Register 27 is active. To clear the interrupt, read the receiver buffer, or write a zero to bit 0 of Register 27.
- 01—Transmitter Holding Register Empty interrupt occurs when bit 1 of Register 19 is set and bit 5 of Register 27 is set. The interrupt is cleared by writing data into the transmitter holding register (Register 17 with bit 7 of Register 23 clear) with a IOWRITE_BYTE statement, or by reading this register (Interrupt Identification).
- 00—Modem Line Status Change interrupt occurs when bit 3 of Register 19 is set and a modem line change is indicated by one or more of bits 0 thru 3 of Register 29. To clear the interrupt, read Register 29 which clears the status change bits.

Register 23—Character Format Control Register

This register is functionally equivalent to Control and Status Register 4 except for bits 6 and 7. IOWRITE_BYTE sets a new character format; IOREAD_BYTE returns the current character format setting.

- Bit 7—Divisor Latch Access Bit. When set, enables you to access the divisor latches of the Baud Rate generator during read/write operations to registers 17 and 19.
- Bit 6—Set BREAK. When set, holds the serial line in a BREAK state (always zero), independent of other transmitter activity. This bit must be cleared to disable the break and resume normal activity.
- Bits 5,4—Parity Sense. Determined by both bits 5 and 4. When bit 5 is set, parity is always ONE or ZERO. If bit 5 is not set, parity is ODD or EVEN as defined by bit 4. The combinations of bits 5 and 4 are as follows:

00	ODD parity	10	Always ONE
01	EVEN parity	11	Always ZERO

Bit 3—Parity Enable. When set, sends a parity bit with each outbound character, and checks all incoming characters for parity errors. Parity is defined by bits 4 and 5.

Bit 2—Stop Bit(s). Defined by a combination of bit 2 and bits 1 & 0.

Bit 2	Character Length	Stop Bits
0	5, 6, 7, or 8	1
1	5	1.5
1	6, 7, or 8	2

Bits 1,0—Character Length. Defined as follows:

Bits 1&0	Character Length
00	5 bits
01	6 bits
10	7 bits
11	8 bits

Register 25—Modem Control Register

This is a READ/WRITE register. IOREAD_BYTE returns current control register value. IOWRITE_BYTE sets a new value in the register. This register is equivalent to interface Control Register 5.

Bit 4—Loopback. When set, enables a loopback feature for diagnostic testing. Serial line is set to MARK state, UART receiver is disconnected, and transmitter output shift register is connected to receiver input shift register. Modem line outputs and inputs are connected as follows: DTR to CTS, RTS to DSR, DRS to DCD, and SRTS to RI. Interrupts are enabled, with interrupts caused by modem control outputs instead of inputs from modem.

Bit 3—Secondary Request-to-Send. Controls the OCD2 driver output. 1 = Active, 0 = Disabled.

Bit 2—Data Rate Select. Controls the OCD1 driver output. 1 = Active, 0 = Disabled.

Bit 1—Request-to-Send. Controls the RTS modem control line state. When bit 1 = 1, RTS is always active. When bit 1 = 0, RTS is toggled by the output operations, as described earlier in this chapter.

Bit 0—Data Terminal Ready. Holds the DTR modem control line active when the bit is set. If not set, DTR is controlled by output or input operations, as described earlier.

Bits 7, 6, and 5 are not used.

Register 27—Line Status Register

Bit 7—Not used.

Bit 6—Transmitter Shift Register Empty. Indicates no data present in transmitter shift register.

Bit 5—Transmitter Holding Register Empty. Indicates no data present in transmitter holding register. The bit is cleared whenever a new character is placed in the register.

Bit 4—Break Indicator. Indicates that the received data input remained in the spacing (line idle) state for longer than the transmission time of a full character frame. This bit is cleared when the line Status register is read.

Bit 3—Framing Error. Indicates that a character was received with improper framing; that is, the start and stop bits did not conform with expected timing boundaries.

Bit 2—Parity Error. Indicates that the received character did not have the expected parity sense. This bit is cleared when the register is read.

Bit 1—Overrun Error. Indicates that a character was destroyed because it was not read from the receiver buffer before the next character arrived. This bit is cleared by reading the line Status register.

Bit 0—Data Ready. Indicates that a character has been placed in the receiver buffer register. This bit is cleared by reading the receiver buffer register, or by writing a zero to this bit of the line Status register.

Register 29—Modem Status Register

- Bit 7—Data Carrier Detect. When set, indicates DCD modem line is active.
- Bit 6—Ring Indicator. If set, indicates that the RI modem line is active.
- Bit 5—Data Set Ready. If set, indicates that the DSR modem line is active.
- Bit 4—Clear-to-send. If set, indicates that CTS is active.
- Bit 3—Change in Carrier Detect. When set, indicates that the DCD modem line has changed state since the last time the modem status register was read.
- Bit 2—Trailing Edge of Ring Indicator. Set when the RI modem line changes from active to inactive state.
- Bit 1—Delayed Data Set Ready. Set when the DSR line has changed state since the last time the modem status register was read.
- Bit 0—Change in Clear-to-send. If set, indicates that the CTS modem line has changed state since the last time the register was read.

HP 98626 Cable Options and Signal Functions

The HP 98626A Serial Interface is available with RS-232C DTE and DCE cable configurations. The DTE cable option consists of a male RS-232C connector and cable designed to function as Data Terminal Equipment (DTE) when used with the serial interface. The cable and connector are wired so that signal paths are correctly routed when the cable is connected to a peripheral device wired as Data Communication Equipment (DCE), such as a modem. The cables are designed so that you can write programs that work for both DCE and DTE connections without requiring modifications to accommodate equipment changes.

The DCE cable option includes a female connector and cable wired so that the interface and cable behave like normal DCE. This means that signals are routed correctly when the female cable connector is connected to a male DTE connector.

Line printers and other peripheral devices that use RS-232C interfacing are frequently wired as DTE with a female RS-232C chassis connector. This means that if you use a male (DTE) cable option to connect to the female DTE device connector, no communication can take place because the signal paths are incompatible. To eliminate the problem, use an adapter cable to convert the female RS-232C chassis connector to a cable connector that is compatible with the male or female interface cable connector. The HP 13242 adapter cable is available in various configurations to fit most common applications. Consult cable documentation to determine which adapter cable to use.

The DTE Cable

The signals and functions supported by the DTE cable are shown in the signal identification table which follows. The table includes RS-232C signal identification codes, CCITT V.24 equivalents, the pin number on the interface card rear panel connector, the RS-232C connector pin number, the signal mnemonic used in this manual, whether the signal is an input or output signal, and its function.

RS-232C DTE (male) Cable Signal Identification Tables

Signal RS-232C	V.24	Interface Pin #	RS-232C Pin #	Mnemonic	I/O	Function
AA	101	24	1	–	–	Safety Ground
BA	103	12	2		Out	Transmitted Data
BB	104	42	3		In	Received Data
CA	105	13	4	RTS	Out	Request to Send
CB	108	44	5	CTS	In	Clear to Send
CC	107	45	6	DSR	In	Data Set Ready
AB	102	48	7	–	–	Signal Ground
CF	109	46	8	DCD	In	Data Carrier Detect
SCF (OCR2)	122	47	12	SDCD	In	Secondary DCD
DB	114	41	15		In	DCE Transmit Timing
DD	115	43	17		In	DCE Receive Timing
SCA (OCD2)	120	15	19	SRTS	Out	Secondary RTS
CD	108.1	14	20	DTR	Out	Data Terminal Ready
CE (OCR1)	125	9	22	RI	In	Ring Indicator
CH (OCD1)	111	40	23	DRS	Out	Data Rate Select
DA	113	7	24		Out	Terminal Transmit Timing

Optional Circuit Driver/Receiver Functions

Not all signals from the interface card are included in the cable wiring. RS-232C provides for four optional circuit drivers and two receivers. Only two drivers and two receivers are supported by the DCE and DTE cable options. They are as follows:

Drivers		Receivers	
Name	Function	Name	Function
OCD1	Data Rate Select	OCR1	Ring Indicator
OCD2	Secondary Request-to-send	OCR2	Secondary Data Carrier Detect
OCD3	Not used		
OCD4	Not used		

If your application requires use of OCD3 or OCD4, you must provide your own interface cable to fit the situation.

The DCE Cable

The DCE cable option is designed to adapt a DTE cable and serial or data communications interface to an identical interface on another desktop computer. It is also used with the serial interface to simulate DCE operation when driving a peripheral wired for DTE operation. The DCE cable is equipped with a female connector. Since most DTE peripherals are also equipped with female connectors (pin numbering is the same as the standard male DTE connector), an adapter (such as the HP 13242M) is used to connect the two female connectors as explained earlier.

Note

Not all RS-232C devices are wired the same. To ensure proper operation, you must know whether the peripheral device is wired as DTE or DCE. The interface cable option and associated adapter cable, if needed, must be configured to properly mate with the female DTE chassis connector.

The following schematic diagram shows the input and output signals for the Serial Interface and how they are connected to a DCE peripheral.

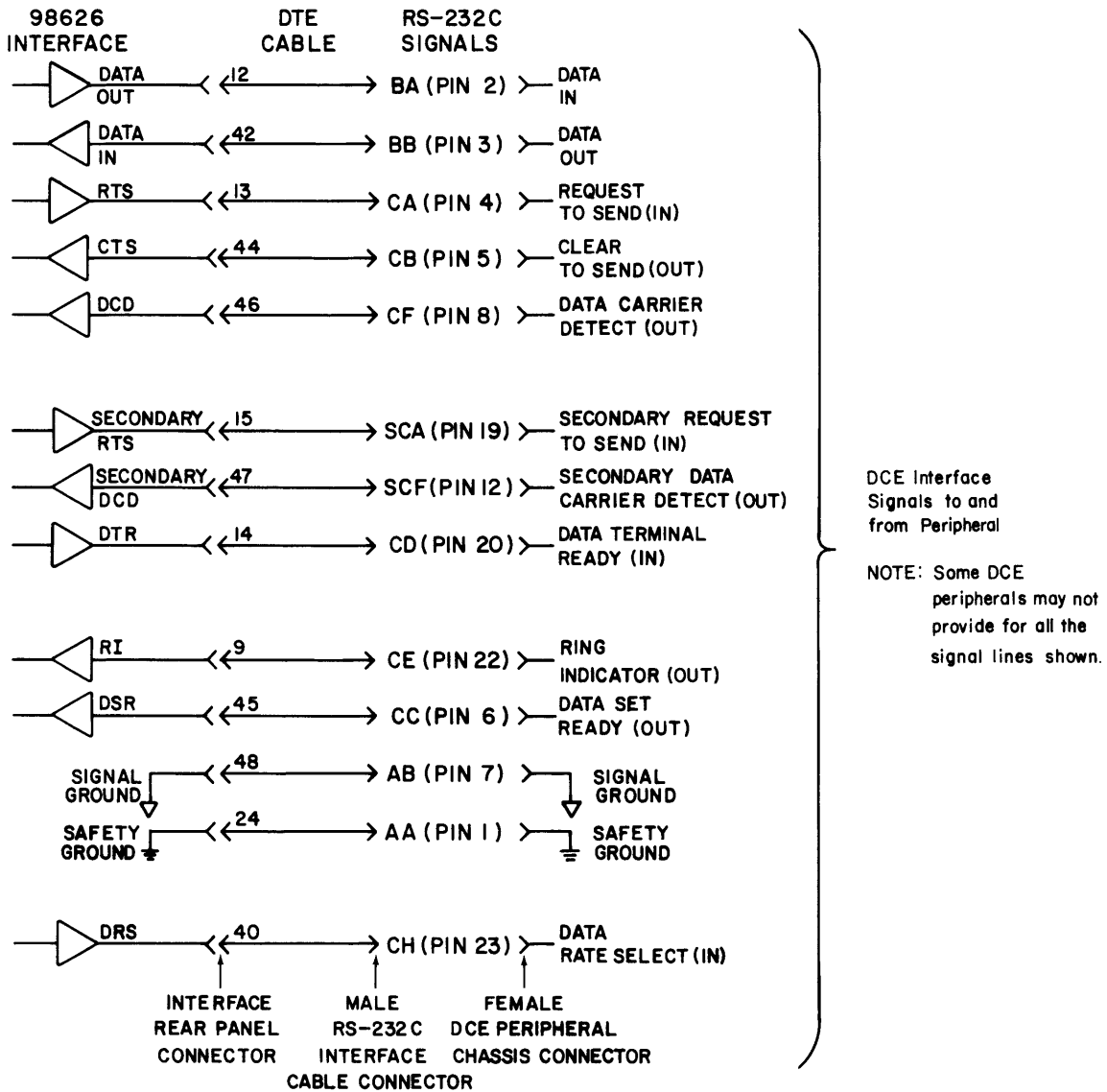

DTE Cable Diagram

This diagram shows an HP 13242M adapter cable connected to a DCE interface cable and a DTE peripheral. Note that RTS is connected to CTS in the DCE cable. If your peripheral uses RTS/CTS handshaking, a different adapter cable must be used with the appropriate DTE or DCE interface cable option.

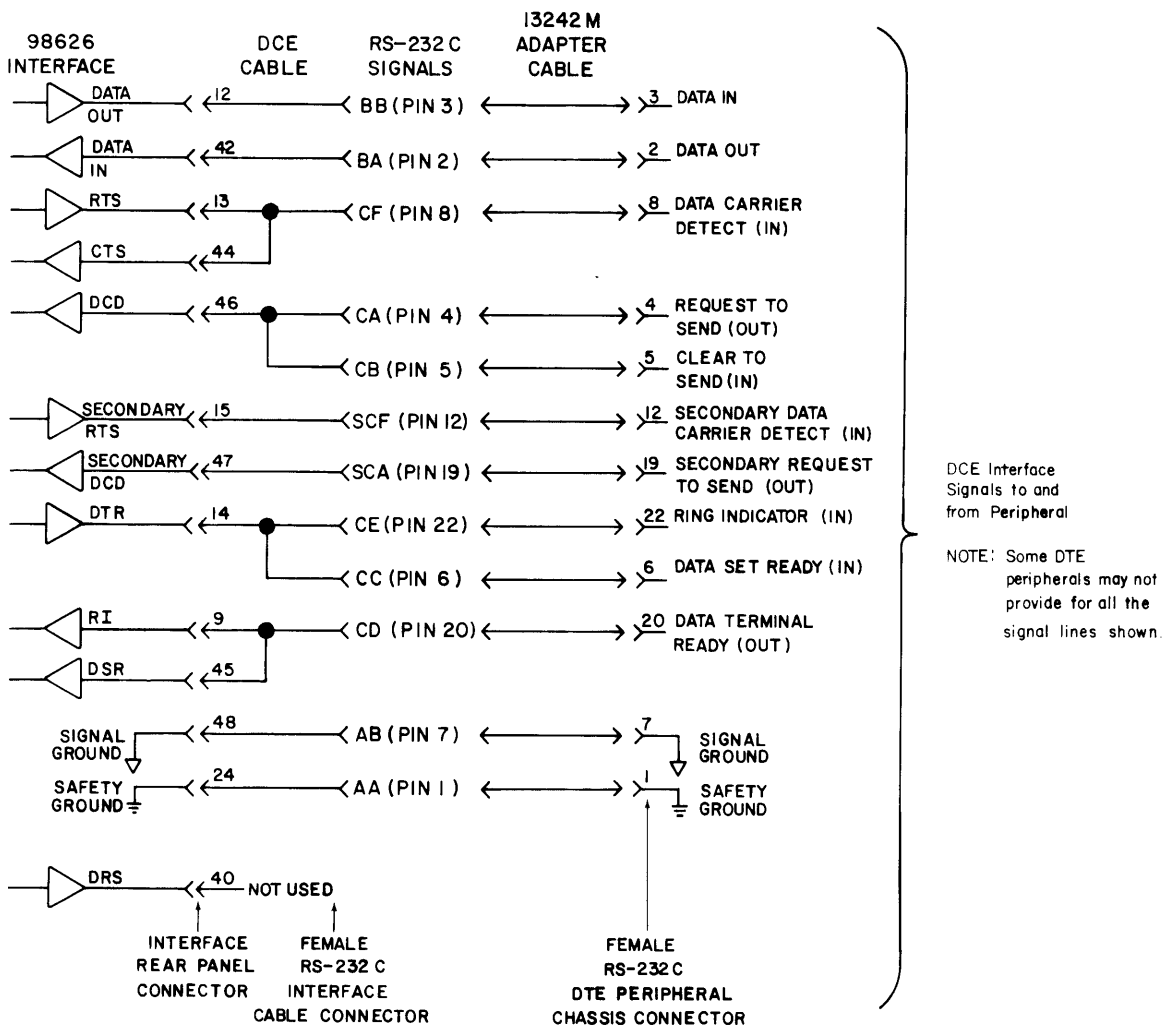

DCE Cable Diagram

HP 98644 Interface Differences

The HP 98644 RS-232 Serial Interface is nearly identical to the HP 98626 RS-232 Serial Interface. This section describes the few differences between them.

Hardware Differences

The differences in the hardware of the two cards occur in the following areas:

- Card ID register contains 66 (rather than 2).
- There are no optional driver and receiver lines.
- There are fewer configuration switches (there are no Baud Rate or Line Control switches).
- There is a 25-pin coverplate connector (instead of 50).
- There are different cables available.

Card ID Register

The default card ID for the HP 98644 interface is 66. (The card ID of the 98626 is 2.)

Note

HP 98644 cards are logged as HP 98626 interfaces while booting machines with Boot ROM 3.0 (and earlier versions). This is not a problem, because the Pascal 3.0 I/O system recognizes the 98644 card properly.

You can also change the card ID to 2 (to make it look like a 98626) by cutting a jumper on the card. See the 98644's installation manual for details.

See the following Pascal Differences section for details of how to read this register with software.

Optional Driver Receiver Circuits

On the 98626 interface, there are two optional driver lines (OCD3 and OCD4) and two optional receiver lines (OCR2 and OCR3). These lines are **not** implemented on the 98644 interface.

Configuration Switches

The 98644 card does not implement the following configuration switches on the card:

- Baud Rate
- Line Control (character length, parity, etc.)

These operating parameters are set to defaults that match the 98626 card by the Pascal system. See the subsequent Pascal differences section for default values.

Coverplate Connector

The connector on the 98644 interface's coverplate is set up for DTE (Data Terminal Equipment) applications; it has a 25-pin, female, D-series connector (the connector on the 98626 is a 50-pin connector). Here are the pin designators for the connector.

Pin	Signal Description
1	Safety Ground
2	Transmitted Data
3	Received Data
4	Request to Send
5	Clear to Send
6	Data Set Ready
7	Signal Ground
8	Carrier Detect
9	not used
10	not used
11	not used
12	not used
13	not used
14	not used
15	not used
16	not used
17	not used
18	not used
19	not used
20	Data Terminal Ready
21	not used
22	Ring Indicator
23	Data Rate Select
24	not used
25	not used

Cables

You can use standard RS-232C compatible cables, as long as the signal lines are connected properly. Here are cables available from HP Computer Supplies Operation.

HP Product Number	Description
13242N	Modem cable (male to male)
13242G	DTE cable (male to male, with pins 2 and 3 reversed)
13242H	DCE cable (male to <i>female</i> , with pins 2 and 3 reversed)

Pascal Differences

The only differences between programming these two interfaces with the Workstation Pascal System are in the register definitions given in this section. See the Status and Control Registers section and the Serial Interface Hardware Registers section for further details.

Card ID Register

The card ID register is IOSTATUS register 0. It will contain a value of 66 if the interface is a 98644. (It will contain 2 if the card ID jumper has been cut.) If the REMOTE jumper has been removed, then the value returned will be 194 (= 128 + 66) or 130 (= 128 + 2).

The card ID can also be determined by reading IOREAD_BYTE register 1.

Optional Driver/Receiver Registers

Since there are no optional driver or receiver lines on the 98644 interface, IOSTATUS and IOCONTROL register 7 are not implemented for this card. (IOSTATUS register 7 always contains 0, and IOCONTROL register 7 is a no-op.)

The hardware register bits that are **not** defined because of this difference are as follows: bits 7 and 6 of IOWRITE_BYTE and register 5 (for writing OCD3 and OCD4, respectively); bits 7 and 6 of IOREAD_BYTE and register 5 (for reading OCD3 and OCD4, respectively); bits 5 and 4 of IOREAD_BYTE register 5 (for reading OCR2 and OCR3, respectively).

Baud Rate and Line Control Registers

Since there are no switches to set the default baud rate and line control parameters, the Pascal system sets them to its own default values, which are as follows:

Parameter	Default value
Baud rate	2400 baud
Character length	8 bits/character
Stop bits	1 stop bit
Parity	Parity disabled
Parity type	Odd parity

IOSTATUS registers 3 (baud rate) and 4 (line control) are still implemented for the 98644 interface and retain their original definitions. However, the hardware registers no longer contain any baud rate and line control information (since there are no switches to read). The hardware registers affected are IOREAD_BYTE register 5 (bits 3 thru 0) and register 7 (bits 7 thru 0), respectively.

You can still program the baud rate and line control parameters by writing to IOCONTROL register 3 (baud rate) and IOCONTROL register 4 (character format). These registers correspond to IOWRITE_BYTE register 5 (bits 3 thru 0) and register 23 (bits 5 thru 0), respectively.

Model 216 and 217 Built-In Interface Differences

This section describes the differences between the HP 98626 Serial interface and the built-in Serial interface in the Model 216 (HP 9816) and 217 (HP 9817) Computers.

Hardware Differences

The hardware differences between the built-in serial interfaces and the 98626 interface occur in the following areas:

- There are no Select Code switches (the Select Code is hard-wired to 9).
- There are no Interrupt Level switches (the Interrupt Level is hard-wired to 3).
- There are no Status Line Disconnect switches (the modem status lines are always monitored; you **cannot** throw switches to make them “ALWAYS ON” like you can with with the 98626 interface).

Pascal Differences

There are no differences between programming these two interfaces with the Workstation Pascal System.

The GPIO Interface

Chapter

13

Introduction

This chapter should be used in conjunction with the *HP 98622A GPIO Interface Installation* manual. **The best way to use these two documents is to read this chapter before attempting to configure and connect the interface** according to the directions given in the installation manual. The reason for this order of use is that knowing how the interface works and how it is driven by Pascal programs will help you to decide how to connect it to your peripheral device.

The HP 98622 Interface is a very flexible parallel interface that allows you to communicate with a variety of devices. The interface sends and receives up to 16 bits of data with a choice of several handshake methods. The interface is known as the General-Purpose Input/Output (GPIO) Interface. This chapter describes the use of the interface's features from Pascal programs.

Interface Description

The main function of any interface is to transfer data between the computer and a peripheral device. This section briefly describes the interface lines and how they function. Using the lines from Pascal programs is more fully described in subsequent sections.

The GPIO Interface provides **32 lines for data input and output**: 16 for input (DI0 — DI15), and 16 for output (DO0 — DO15).

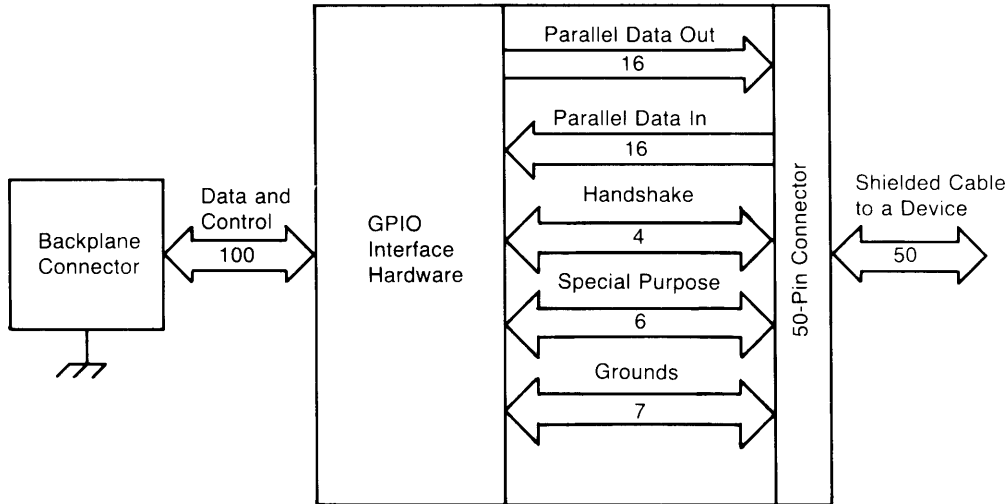

Block Diagram of the GPIO Interface

Three lines are dedicated to **handshaking** the data from source to destination device. The Peripheral Control line (PCTL) is controlled by the interface and is used to initiate data transfers. The Peripheral Flag line (PFLG) is controlled by the peripheral device and is used to signal the peripheral's readiness to continue the transfer process.

Four general-purpose lines are available for any purpose that you may desire; two are controlled by the computer and sensed by the peripheral (CTL0 and CTL1), and two are controlled by the peripheral device and sensed by the computer (STI0 and STI1).

Both Logic Ground and Safety Ground are provided by the interface. Logic Ground provides the reference point for signals, and Safety Ground provides earth ground for cable shields.

Interface Configuration

This section presents a brief summary of selecting the interface's configuration-switch settings. It is intended to be used as a checklist and to begin to acquaint you with programming the interface. **Refer to the installation manual for the exact location and setting of each switch.**

Interface Select Code

In Pascal, allowable interface select codes range from 8 through 31; codes 1 through 7 are already used for built-in interfaces. The GPIO interface has a factory default setting of 12, which can be changed by re-configuring the "SEL CODE" switches on the interface.

Hardware Interrupt Priority

Two switches are provided on the interface to allow selection of hardware interrupt priority. The switches allow hardware priority levels 3 through 6 to be selected. **Hardware priority** determines the order in which simultaneously occurring interrupt events are processed.

Data Logic Sense

The data lines of the interface are **normally low-true**; in other words, when the voltage of a data line is low, the corresponding data bit is interpreted to be a 1. This logic sense may be changed to high-true with the Option Select Switch. Setting the switch labeled "DIN" to the "0" position selects high-true logic sense of Data In lines. Conversely, setting the switch labeled "DOUT" to the "1" position inverts the logic sense of the Data Out lines. The default setting is "1" for both.

Data Handshake Methods

This section describes the data handshake methods available with the GPIO Interface. A general description of the handshake modes and clock sources is given first. A more detailed discussion of each handshake is then given to allow you to choose the handshake mode, clock source, and handshake-line logic sense that is compatible with your peripheral device.

As a brief review, a data handshake is a method of synchronizing the transfer of data from the sending to the receiving device. In order to use any handshake method, **the computer and peripheral device must be in agreement as to how and when several events will occur.** With the GPIO Interface, the following events must take place to synchronize data transfers; the first two are optional.

- The computer may optionally be directed to perform a one-time "OK check" of the peripheral before beginning to transfer any data.
- The computer may also optionally check the peripheral to determine whether or not the peripheral is "ready" to transfer data.
- The computer must indicate the direction of transfer and then initiate the transfer.
- During output operations, the peripheral must read the data sent from the computer while valid; similarly, the computer must clock the peripheral's data into the interface's Data In registers while valid during input operations.
- The peripheral must acknowledge that it has received the data.

Handshake Lines

The GPIO handshakes data with three signal lines. The Input/Output line, **I/O**, is driven by the computer and is used to signal the direction of data transfer. The Peripheral Control line, **PCTL**, is also driven by the computer and is used to initiate all data transfers. The Peripheral Flag line, **PFLG**, is driven by the peripheral and is used to acknowledge the computer's requests to transfer data.

Handshake Logic Sense

Logic senses of the PCTL and PFLG lines are selected with switches of the same name. The logic sense of the I/O line is High for input operations and Low for output operations; this logic sense cannot be changed. The available choices of handshake logic sense and handshake modes allow nearly all types of peripheral handshakes to be accommodated by the GPIO Interface.

Handshake Modes

There are two general handshake modes in which the PCTL and PFLG lines may be used to synchronize data transfers: Full-Mode and Pulse-Mode Handshakes. If the peripheral uses pulses to handshake data transfers **and** meets certain hardware timing requirements, the Pulse-Mode Handshake may be used. The Full-Mode Handshake should be used if the peripheral does not meet the Pulse-Mode timing requirements.

The handshake mode is selected by the position of the "HSHK" switch on the interface, as described in the installation manual. Both modes are more fully described in subsequent sections.

Data-In Clock Source

Ensuring that the data are valid when read by the receiving device is slightly different for output and input operations. During outputs, the interface generally holds data valid while PCTL is in the Set state, so the peripheral must read the data during this period. During inputs, the data must be held valid by the peripheral until the peripheral signals that the data are valid (which clocks the data into interface Data In registers) or until the data is read by the computer. The point at which the data are valid is signalled by a transition of PFLG. The PFLG transition that is used to signal valid data is selected by the "CLK" switches on the interface. Subsequent diagrams and text further explain the choices.

Peripheral Status Check

Many peripheral devices are equipped with a line which is used to indicate the device's current "OK-or-Not-OK" status. If this line is connected to the Peripheral Status line (PSTS) of the GPIO Interface, and the computer determines the status of the peripheral device by checking the state of PSTS. The logic sense of this line may be selected by setting the "PSTS" switch.

The computer performs a check of the Peripheral Status line (PSTS) **before initiating any transfers** as part of the data-transfer handshake. If PSTS indicates "Not OK," an error is reported with `ioe_result` set to 21; otherwise, the transfer proceeds normally. This feature is available with both Full-Mode and Pulse-Mode Handshakes. See "Using the PSTS Line" for further details.

Full-Mode Handshakes

The Full-Mode Handshake mode is described first for two reasons. The first reason is that the PCTL and PFLG transitions must always occur in the order shown, so only one sequence of peripheral handshake responses needs to be shown. Secondly, this mode will generally work when the Pulse-Mode Handshake may not be compatible with the peripheral's handshake signals. The Pulse-Mode Handshake is described in the next section.

The following diagrams show the order of events of the Full-Mode output and input Handshakes. These drawings are not drawn to any time scale; only the order of events is important. The I/O line has been omitted to simplify the diagrams; in all cases, it is driven Low before any output is initiated by the computer and High before any input is initiated.

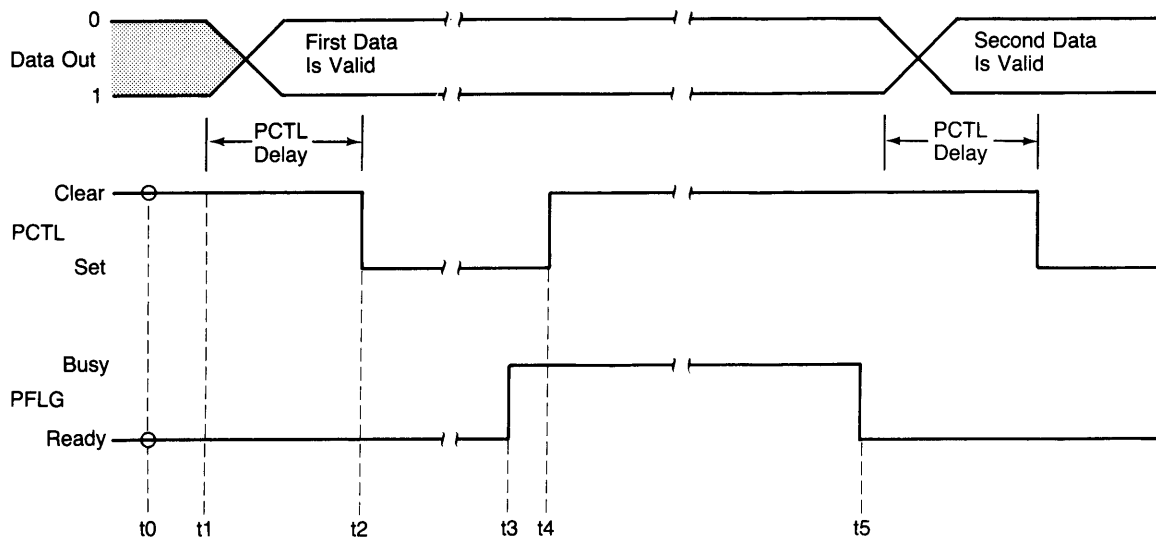

Diagram of Full-Mode OUTPUT Handshakes

With Full-Mode Handshakes, the computer first checks to see that the peripheral device is Ready before initiating the transfer of each byte/word (t_0); with this handshake mode, the peripheral indicates **Ready when both PCTL is Clear and PFLG is Ready**. If the peripheral does not indicate Ready, the computer waits until a Ready is indicated.

When a Ready is sensed, the computer places data on the Data Out lines (t_1) and drives the I/O line Low (not shown). The interface then waits the PCTL Delay time before initiating the transfer by placing PCTL in the Set state (t_2).

The peripheral acknowledges the computer's request by placing the PFLG line Busy (t_3); this PFLG transition automatically Clears the PCTL line (t_4). However, the computer cannot initiate further transfers until the peripheral is Ready with Full-Mode Handshake; the peripheral is not Ready until both PCTL is Clear and PFLG is Ready (t_5).

The data on the Data Out lines is held valid from the time PCTL is Set until after the peripheral indicates Ready. The peripheral may read the data any time within this time period.

The PCTL and PFLG lines are used in the same manner in Full-Mode input Handshakes as in Full-Mode output Handshakes. However, there are three options available as to when the peripheral's data may be valid: at the Ready-to-Busy transition of PFLG (BSY clock source), at the Busy-to-Ready transition of PFLG (RDY clock source), and when the Data In lines are read with an IOSTATUS function (READ clock source). The first two of these options are shown in the following two diagrams.

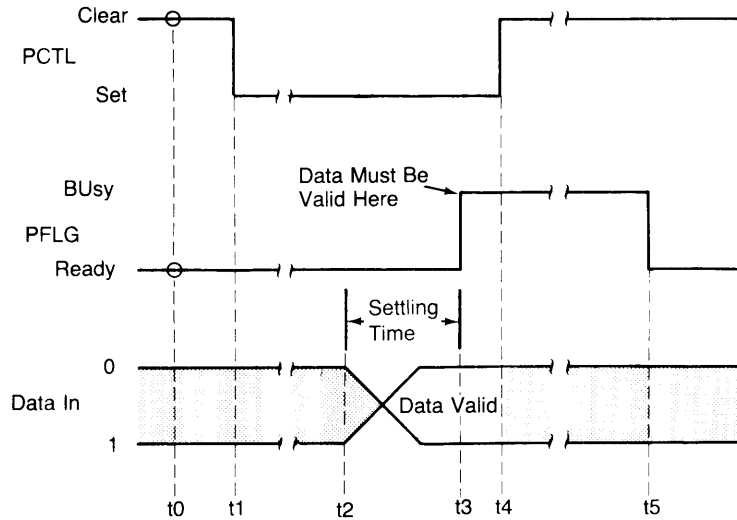

Full-Mode Input Handshake with BSY Clock Source

As with Full-Mode output Handshakes, the computer first checks to see if the peripheral is Ready (t0); since PCTL is Clear and PFLG is Ready, the handshake may proceed. The computer places the I/O line in the High state (not shown) and then initiates the handshake by placing PCTL in the Set state (t1).

With the “BSY” clock source, the PFLG transition to the Busy state clocks the peripheral’s data into the interface’s Data-In registers; consequently, the peripheral must place data on the Data-In lines (t2), allowing enough time for the data to settle before placing PFLG in the Busy state (t3). This PFLG transition to the Busy state automatically Clears PCTL (t4). The next handshake may be initiated when PFLG is placed in the Ready state by the peripheral (t5).

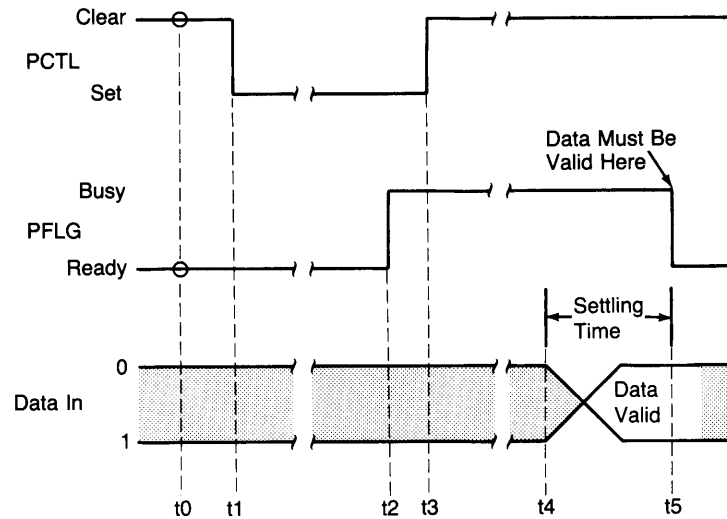

Full-Mode Input Handshake with RDY Clock Source

As with other Full-Mode Handshakes, the computer first checks to see if the peripheral is ready (t_0). Since PCTL is Clear and PFLG is Ready, the computer may drive the I/O line High (not shown) and initiate the handshake by placing PCTL in the Set state (t_1).

The peripheral may acknowledge by placing PFLG Busy (t_2), which automatically Clears PCTL (t_3). Unlike the previous example, this transition does not clock data into the interface Data-In registers. With the “RDY” clock source, the peripheral must place the data on the Data-In lines (t_4), allowing enough time for the data to settle before placing PFLG in the Ready state (t_5). The computer may then initiate a subsequent transfer.

Pulse-Mode Handshakes

The following drawings show the order of handshake-line events during Pulse-Mode Handshakes. Notice that the **main difference** between Full-Mode and Pulse-Mode Handshakes is that the **PFLG is not checked for Ready before the computer initiates Pulse-Mode Handshakes**; the computer may initiate a subsequent data transfer as soon as the PCTL line is Cleared by the Ready-to-Busy transition of PFLG.

Two cycles of data transfers are shown in these diagrams to illustrate that the computer need not wait for the PFLG = Ready indication with the Pulse-Mode Handshake. The first cycle shown in each diagram is a typical example of the first transfer of an I/O statement. The dashed PFLG line at the beginning of the second cycle shows that computer disregards whether or not PFLG is in the Ready state before the next transfer is initiated.

This absence of the PFLG check allows a **potentially higher data-transfer rate** than possible with the Full-Mode Handshake; however, in some cases, it also places additional timing restrictions on the peripheral’s response time, as described in the text.

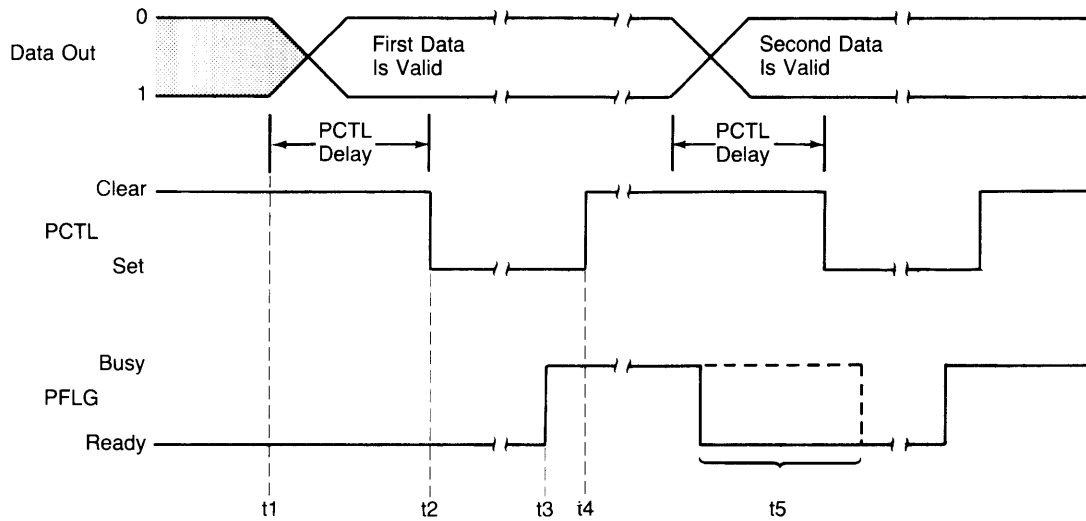

Busy Pulses With Pulse-Mode Output Handshake

The PFLG line is not checked for Ready before the computer drives the I/O line Low (not shown) and places data on the Data-Out lines (t1). A PCTL Delay time later, the interface initiates the transfer by placing PCTL in the Set state (t2).

The peripheral acknowledges by placing PFLG Busy (t3); this transition automatically Clears PCTL (t4). The dashed PFLG line shows that the computer may initiate another transfer any time after PCTL is Clear, possibly before the peripheral places PFLG in the Ready state (t5).

The Busy Pulse shown in the diagram is identical to the PFLG’s response during the previous Full-Mode handshake; however, the Pulse-Mode Handshake works properly with this type of pulse **only** if the peripheral reads the data by the time PCTL is Clear (data should be read between t2 and t3). If the peripheral has not read the data by the time that PCTL is Clear, it might erroneously read the data for the second transfer, since the computer might have already changed the data and initiated the second transfer.

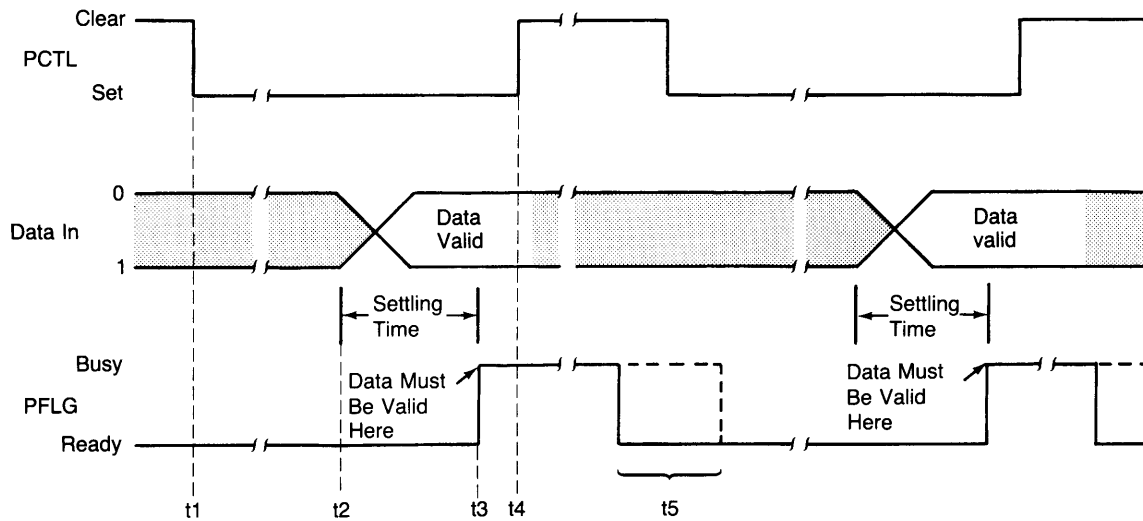

Busy Pulses With Pulse-Mode Input Handshakes (BSY Clock Source)

The computer does not have to check for PFLG to be Ready before placing I/O in the High state (not shown) and initiating the transfer by placing PCTL in the Set state (t1).

The peripheral must place data on the Data In lines (t2), allowing enough time for the data to settle before placing PFLG in the Busy state (t3). This Ready-to-Busy transition of PFLG automatically Clears PCTL. The dashed PFLG signal shows that the next transfer may be initiated before PFLG indicates Ready.

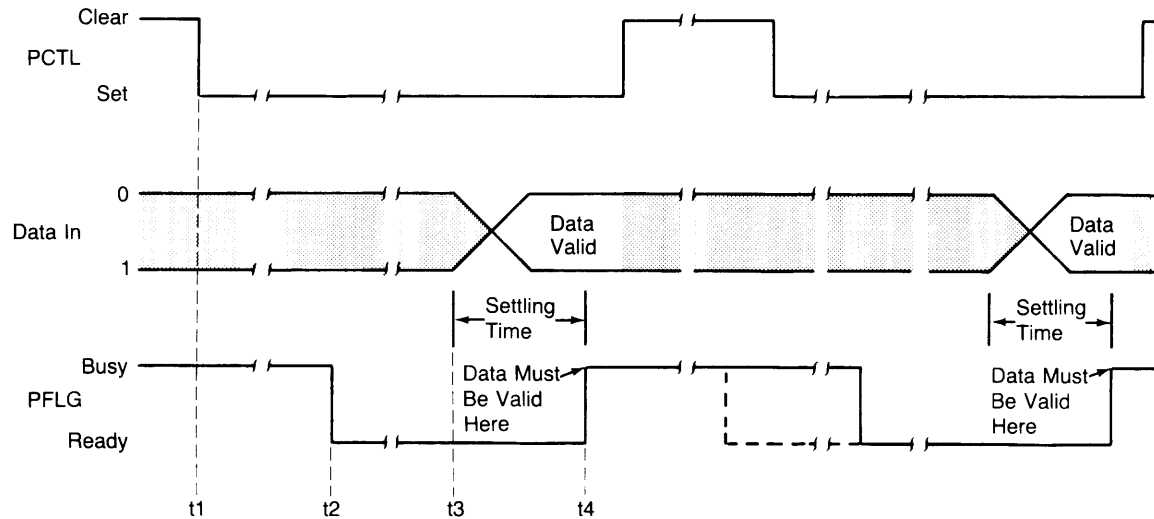

Busy Pulses With Pulse-Mode Input Handshakes (RDY Clock Source)

The computer does not have to check for PFLG to be Ready before placing I/O in the High state (not shown) and initiating the transfer by placing PCTL in the Set state (t1).

The peripheral must place data on the Data In lines (t2), allowing enough time for the data to settle before placing PFLG Busy (t3). This requirement **may seem contradictory**, since the clock source is the Busy-to-Ready transition of PFLG. However, with Pulse-Mode handshakes, the peripheral is assumed to be Ready whenever PCTL is Clear; consequently, the computer may read the data any time after PCTL is cleared by the Ready-to-Busy transition of PFLG. The PFLG transition to Busy Clears PCTL (t4), after which the peripheral may place PFLG Ready (t5).

Note

In order to use this type of pulse with the Pulse-Mode Handshake and RDY clock source, the peripheral must adhere to the stated timing restrictions.

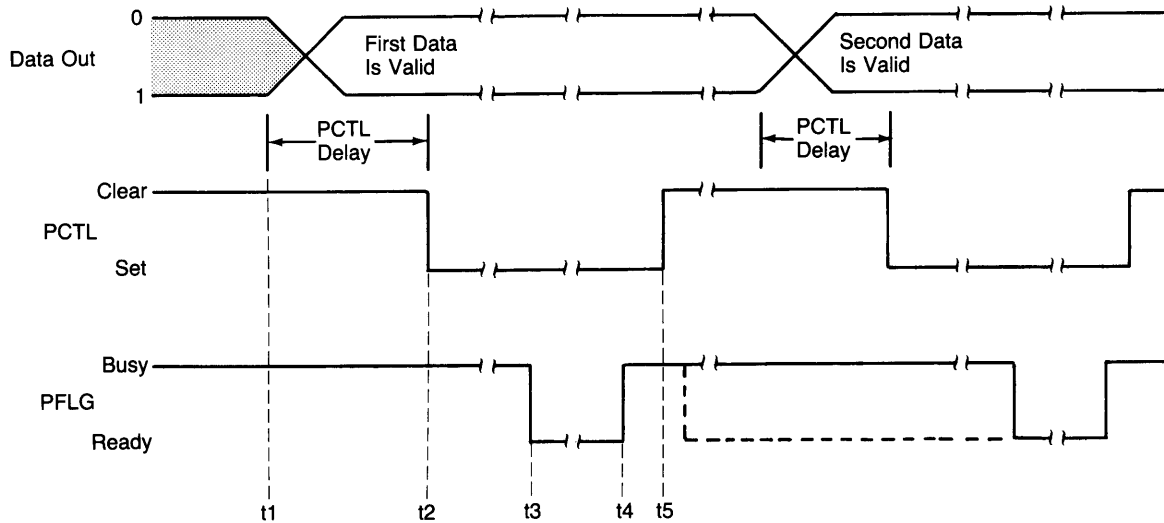

Ready Pulses With Pulse-Mode Output Handshakes

The PFLG line is not checked for Ready before the computer drives the I/O line Low (not shown) and places data on the Data Out lines (t_1). A PCTL Delay time later the interface initiates the transfer by placing PCTL in the Set state (t_2).

The peripheral later acknowledges by placing PFLG in the Ready state (t_3). The handshake is completed by the peripheral placing PFLG in the Busy state (t_4), which automatically Clears PCTL (t_5).

If the peripheral uses the type of Ready pulses shown, either the Pulse-Mode handshake with default PFLG logic sense or Full-Mode handshake with inverted PFLG logic sense may be used. With this type of pulse, the data being output may be read by the peripheral as long as PCTL is Set.

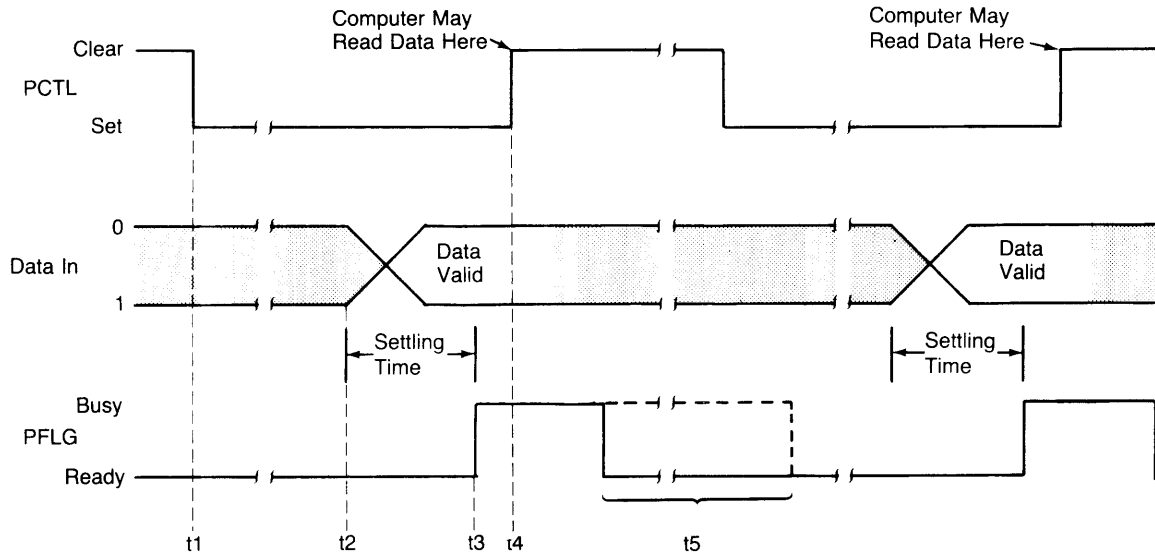

Ready Pulses With Pulse-Mode Input Handshakes (BSY Clock Source)

The computer does not have to check for PFLG to be Ready before placing I/O in the High state (not shown) and initiating the transfer by placing PCTL in the Set state (t1).

The peripheral acknowledges by placing PFLG in the Ready state (t2). The peripheral must place data on the Data In lines (t3), allowing enough time for the data to settle before placing PFLG in the Busy state (t4). With this type of pulse, events t2 and t3 may also occur in the reverse order.

The Ready-to-Busy transition of PFLG automatically Clears PCTL (t4). The dashed PFLG signal shows that the state of PFLG is not checked before the computer initiates a subsequent transfer.

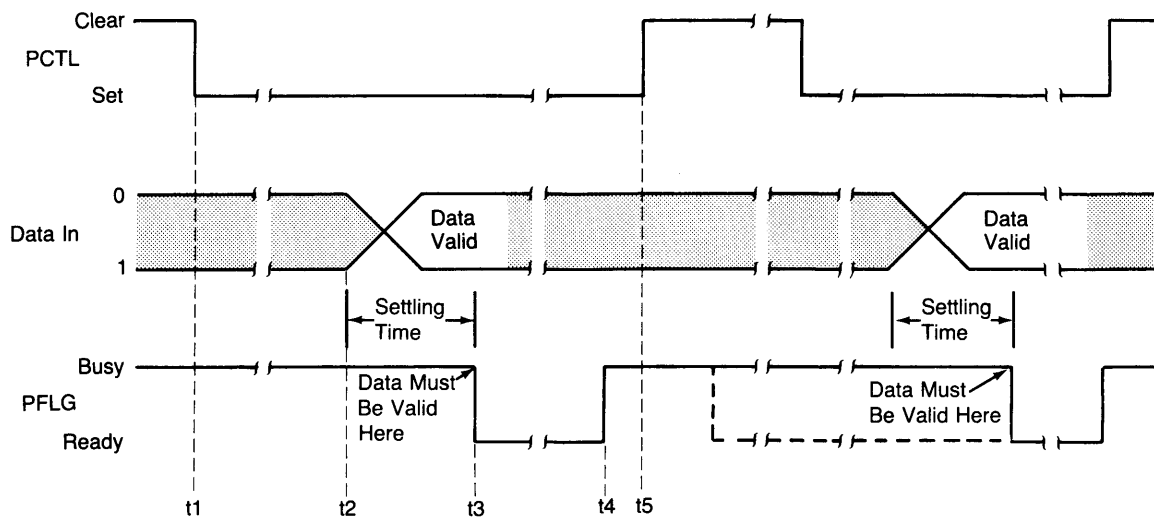

Ready Pulses With Pulse-Mode Input Handshakes (RDY Clock Source)

The computer does not have to check for PFLG to be Ready before placing I/O in the High state (not shown) and initiating the transfer by placing PCTL in the Set state (t1).

The peripheral must place data on the Data In lines (t2), allowing enough time for the data to settle before placing PFLG Ready (t3). The peripheral places PFLG in the Busy state (t4), which automatically Clears PCTL (t5).

Interface Reset

The interface should always be reset before use to ensure that it is in a known state. All interfaces are automatically reset by the computer at certain times: when the computer is powered on, when the **RESET** key is pressed, and at other times including when the **STOP** or **CLR I/O** keys are pressed and when IOINITIALIZE and IOUNINITIALIZE are executed. The interface may be optionally reset at other times under control of Pascal programs. Two examples are as follows:

```
IORESET(12);
```

```
SC:=12;
IOCONTROL(SC,1);
```

The following action is invoked whenever the GPIO Interface is reset:

- The Peripheral Reset line (PRESET) is pulsed Low for at least 15 microseconds.
- The PCTL line is placed in the Clear state.
- If the DOUT CLEAR jumper is installed, the Data Out lines are all cleared (set to logic 0).

The following lines are **unchanged** by a reset of the GPIO Interface:

- The CTL0 and CTL1 output lines.
- The I/O line.
- The Data Out lines, if the DOUT CLEAR jumper is not installed.

Outputs and Inputs through the GPIO

This section describes techniques for outputting and inputting data through the GPIO Interface. The mechanism by which data are communicated are the electrical signals on the data lines. The actual signals that appear on the data lines depend on three things: the data currently being transferred, how this data is being represented, and the logic sense of the data lines.

Brief explanations of ASCII and internal data representation are given in Chapter 4. This section gives simple examples of how several representations are implemented during outputs and inputs through the GPIO Interface.

ASCII and Internal Representations

When data are moved through the GPIO Interface, the **data are generally sent one byte at a time, with the most significant byte first**. However, there are **three exceptions**; data are represented by words when READWORD and WRITEWORD are used, and when TRANSFERWORD is used and when numeric data are moved with reads of IOSTATUS register 3 and writes to IOCONTROL register 3. The following diagrams illustrate which data lines are used during byte and word transfers.

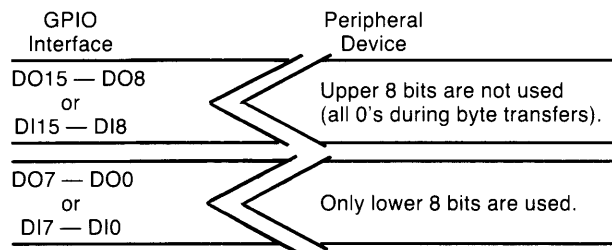

Diagram of Byte Transfers

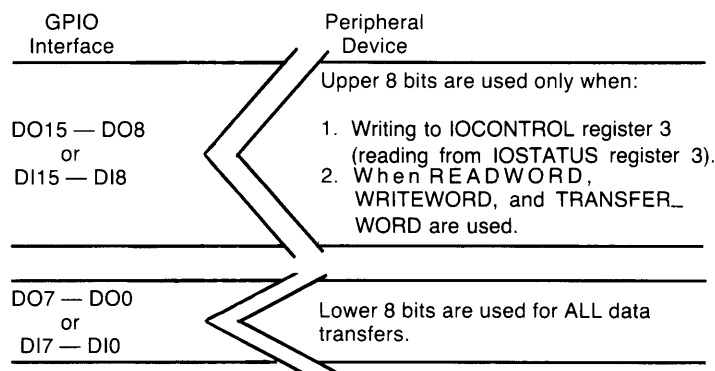

Diagram of Word Transfers

Example - Output Data Bytes

The following diagram shows the actual logic signals that appear on the least significant data byte (DO7 thru DO0) as the result of the corresponding output procedure; the most significant byte is always zeros with byte transfers. The actual logic levels depend on how the data lines are configured (i.e., as Low-true or High-true).

```
WRITESTRINGLN(12, 'ASCII' );
```

Signal Line		ASCII
DO7 DO0	Char.
0 1 0 0	0 0 0 1	A
0 1 0 1	0 0 1 1	S
0 1 0 0	0 0 1 1	C
0 1 0 0	1 0 0 1	I
0 1 0 0	1 0 0 1	I
0 0 0 0	1 1 0 1	C _R
0 0 0 0	1 0 1 0	L _F

```
WRITECHAR(12, 'B' );
```

Signal Line		ASCII
DO7 DO0	Char.
0 1 0 0	0 0 1 0	B

Example - Input Data Bytes

The following diagrams show the variable values that result from the logic signals being present during the corresponding input procedures on the least significant data byte (DI7 thru DI0); the most significant byte is always ignored with byte transfers. The actual logic levels required depend on how the data lines are configured (i.e., as Low-true or High-true).

```
READCHAR(12, c),
WRITELN('Value entered=', ORD(c));
```

Value entered= 65

Signal Line		ASCII
DI7 DI0	Char.
0 1 0 0	0 0 0 1	A

```
READSTRING(12, Str);
WRITELN ('String entered=', Str);
```

String entered= ruok?

Signal Line		ASCII
DI7 DI0	Char.
0 1 1 1	0 0 1 0	r
0 1 1 1	0 1 0 1	u
0 1 1 0	1 1 1 1	o
0 1 1 0	1 0 1 1	k
0 0 1 1	1 1 1 1	?
0 0 0 0	1 0 1 0	L _F

Example - Output Data Words

The following diagrams show the actual signals that appear on the Data Out lines as a result of the corresponding Pascal procedures and numeric values. All numeric values are first rounded to an INTEGER value before being placed on the Data Out lines. The actual logic level that appears on each line depends on how the lines have been configured (i.e., as High-true or Low-true).

```
Word:=3*256+3;
WRITEWORD(12,word);
```

Signal Lines			
DO15	DO8	DO7 DO0
0	0	0	0 0 0 0 0 0 1 1

```
Output_16_bits:=-1;
IOCONTROL(12,3,Output_16_bits);
```

Signal Lines			
DO15	DO8	DO7 DO0
1	1	1	1 1 1 1 1 1 1 1

It is important to note that no output handshake is executed when the IOCONTROL procedure is executed; only the states of the Data Out lines and the I/O line are affected. Handshake sequence, if desired, must be performed by Pascal procedures in the program.

Example - Input Data Words

The following diagrams show the variable values that result from entering the logic signals on the Data In lines. Note that all sixteen-bit values entered are interpreted as INTEGER values.

```
READWORD(12,Input_16_bits);
WRITELN('INTEGER entered=',Input_16_Bits);
```

```
INTEGER entered= 511
```

Signal Lines			
DI15	DI8	DI7 DI0
0	0	0	0 0 0 0 1 1 1 1 1 1 1 1

```
X:=IOSTATUS(12,3);
WRITELN('INTEGER entered=',X);
```

```
INTEGER entered= -512
```

Signal Lines			
DI15	DI8	DI7 DI0
1	1	1	1 1 1 0 0 0 0 0 0 0 0 0

It is important to note that no enter handshake is performed when the IOSTATUS function is executed. The only actions taken are the I/O line being placed in the High state and the Data In registers being read. If an input handshake is required, it must be performed by the Pascal program.

Using the Special-Purpose Lines

Four special-purpose signal lines are available for a variety of uses. Two of these lines are available for output (CTL0 and CTL1), and the other two are used as inputs (STI0 and STI1).

Driving the Control Output Lines

Setting bits 0 and 1 of GPIO IOCONTROL register 2 places a logic low on CTL0 and CTL1, respectively. The definition of this IOCONTROL register is shown in the following diagram.

Control Register 2						Peripheral Control	
Most Significant Bit						Least Significant Bit	
Bit 7	Bit 6	Bit 5	Bit 4	Bit 3	Bit 2	Bit 1	Bit 0
Not Used						Set CTL1 (1 = Low; 0 = High)	Set CTL0 (1 = Low; 0 = High)
Value = 128	Value = 64	Value = 32	Value = 16	Value = 8	Value = 4	Value = 2	Value = 1

```

CH0 := 0 ;
CH1 := 1 ;
IOCONTROL ( 12 , 2 , CH1 * 2 + CH0 ) ;

```

As indicated in the diagram, setting a bit in the register places the corresponding line Low, while clearing the bit places a logic High on the line. The logic polarity of these signals cannot be changed. The signal remains on these lines until another value is written into the IOCONTROL register, and Reset has no effect on the state of either line.

Interrogating the Status Input Lines

The state of both status input lines STI0 and STI1 are determined by reading bits 0 and 1 of IOSTATUS register 5, respectively. A logic “1” in a bit position indicates that the corresponding line is at logic Low, and a “0” indicates the opposite logic state. This logic polarity cannot be changed. The definition of GPIO IOSTATUS register 5 is shown below.

Status Register 5					Peripheral Status		
Most Significant Bit					Least Significant Bit		
Bit 7	Bit 6	Bit 5	Bit 4	Bit 3	Bit 2	Bit 1	Bit 0
0	0	0	0	PSTS Ok	EIR Line Low	STI1 Line Low	STI0 Line Low
Value = 128	Value = 64	Value = 32	Value = 16	Value = 8	Value = 4	Value = 2	Value = 1

```
P_status:=IOSTATUS(12,5);  
Sti0:=BIT_SET(P_status,0);  
Sti1:=BIT_SET(P_status,1);
```

Reading this register returns a numeric value that reflects the logic states of these lines **at the instant the computer reads the interface lines**; the state of these lines are not latched by any internal or external event.

GPIO Status and Control Registers

Status Register 0 Card identification = 3

Control Register 0 Writing any numeric value into this register resets the interface.

Status Register 1

Interrupt and DMA Status

Most Significant Bit

Least Significant Bit

Bit 7	Bit 6	Bit 5	Bit 4	Bit 3	Bit 2	Bit 1	Bit 0
Interrupts Are Enabled	An Interrupt Is Currently Requested	Interrupt Level Switches (Hardware Priority)		Burst-Mode DMA	Word-Mode DMA	DMA Channel 1 Enabled	DMA Channel 0
Value = 128	Value = 64	Value = 32	Value = 16	Value = 8	Value = 4	Value = 2	Value = 1

Control Register 1 Writing any numeric value into this register sets the PCTL line true.

Status Register 2 Not implemented

Control Register 2

Peripheral Control

Most Significant Bit

Least Significant Bit

Bit 7	Bit 6	Bit 5	Bit 4	Bit 3	Bit 2	Bit 1	Bit 0
Not Used						Set CTL1 (1 = Low; 0 = High)	Set CTL0 (1 = Low; 0 = High)
Value = 128	Value = 64	Value = 32	Value = 16	Value = 8	Value = 4	Value = 2	Value = 1

Status Register 3 Data In (16 bits)

Control Register 3 Data Out (16 bits)

Status Register 4 1 = Ready; 0 = Busy

Status Register 5

Peripheral Status

Most Significant Bit

Least Significant Bit

Bit 7	Bit 6	Bit 5	Bit 4	Bit 3	Bit 2	Bit 1	Bit 0
0	0	0	0	PSTS Ok	EIR Line Low	STI1 Line Low	STI0 Line Low
Value = 128	Value = 64	Value = 32	Value = 16	Value = 8	Value = 4	Value = 2	Value = 1

Summary of GPIO IOREAD_BYTE and IOWRITE_BYTE Registers

This section describes the GPIO Interface’s IOREAD_BYTE and IOWRITE_BYTE registers. Keep in mind that these registers should be used **only** when you know the exact consequences of their use, as using some of the registers improperly may result in improper interface behavior. If the desired operation can be performed with IOSTATUS or IOCONTROL, you should not use IOREAD_BYTE or IOWRITE_BYTE.

GPIO IOREAD_BYTE Registers

- Register 0—Interface Ready
- Register 1—Card Identification
- Register 2—Undefined
- Register 3—Interrupt Status
- Register 4—MSB of Data In
- Register 5—LSB of Data In
- Register 6—Undefined
- Register 7—Peripheral Status

IOREAD_Byte Register 0 **Interface Ready**
 A 1 indicates that the interface is Ready for subsequent data transfers, and 0 indicates Not Ready.

IOREAD_BYTE Register 1 **Card Identification**
 This register always contains 3, the identification for GPIO interfaces.

IOREAD_BYTE Register 3 **Interrupt Status**

Most Significant Bit				Least Significant Bit			
Bit 7	Bit 6	Bit 5	Bit 4	Bit 3	Bit 2	Bit 1	Bit 0
Interrupts Are Enabled	An Interrupt Is Currently Requested	Interrupt Level Switches (Hardware Priority)		Burst-Mode DMA	Word-Mode DMA	DMA Channel 1 Enabled	DMA Channel 0 Enabled
Value = 128	Value = 64	Value = 32	Value = 16	Value = 8	Value = 4	Value = 2	Value = 1

IOREAD_BYTE Register 4 **MSB of Data In**

Most Significant Bit				Least Significant Bit			
Bit 7	Bit 6	Bit 5	Bit 4	Bit 3	Bit 2	Bit 1	Bit 0
DI15	DI14	DI13	DI12	DI11	DI0	DI9	DI8
Value = 128	Value = 64	Value = 32	Value = 16	Value = 8	Value = 4	Value = 2	Value = 1

IOREAD_BYTE Register 5

LSB of Data In

Most Significant Bit

Least Significant Bit

Bit 7	Bit 6	Bit 5	Bit 4	Bit 3	Bit 2	Bit 1	Bit 0
DI7	DI6	DI5	DI4	DI3	DI2	DI1	DI0
Value = 128	Value = 64	Value = 32	Value = 16	Value = 8	Value = 4	Value = 2	Value = 1

IOREAD_Byte Register 7

Peripheral Status

Most Significant Bit

Least Significant Bit

Bit 7	Bit 6	Bit 5	Bit 4	Bit 3	Bit 2	Bit 1	Bit 0
0	0	0	0	PSTS Ok	EIR Line Low	STI1 Line Low	STI0 Line Low
Value = 128	Value = 64	Value = 32	Value = 16	Value = 8	Value = 4	Value = 2	Value = 1

GPIO IOWRITE_BYTE Registers

- Register 0 — Set PCTL
- Register 1 — Reset Interface
- Register 2 — Interrupt Mask
- Register 3 — Interrupt and DMA Enable
- Register 4 — MSB of Data Out
- Register 5 — LSB of Data Out
- Register 6 — Undefined
- Register 7 — Set Control Output Lines

IOWRITE_BYTE Register 0

Set PCTL

Writing any numeric value to this register places PCTL in the Set state.

IOWRITE_BYTE Register 1

Reset Interface

Writing any numeric value to this register resets the interface.

IOWRITE_BYTE Register 2

Interrupt Mask

Most Significant Bit

Least Significant Bit

Bit 7	Bit 6	Bit 5	Bit 4	Bit 3	Bit 2	Bit 1	Bit 0
Not Used						Enable Interface Ready Interrupts	Enable EIR Interrupts
Value = 128	Value = 64	Value = 32	Value = 16	Value = 8	Value = 4	Value = 2	Value = 1

IOWRITE_BYTE Register 3

Interrupt and DMA Enable

Most Significant Bit

Least Significant Bit

Bit 7	Bit 6	Bit 5	Bit 4	Bit 3	Bit 2	Bit 1	Bit 0
Enable Interrupts	Not Used			Enable Burst-Mode DMA	Enable Word-Mode DMA	Enable DMA Channel 1	Enable DMA Channel 0
Value = 128	Value = 64	Value = 32	Value = 16	Value = 8	Value = 4	Value = 2	Value = 1

IOWRITE_BYTE Register 4

MSB of Data Out

Most Significant Bit

Least Significant Bit

Bit 7	Bit 6	Bit 5	Bit 4	Bit 3	Bit 2	Bit 1	Bit 0
DO15	DO14	DO13	DO12	DO11	DO10	DO9	DO8
Value = 128	Value = 64	Value = 32	Value = 16	Value = 8	Value = 4	Value = 2	Value = 1

IOWRITE_BYTE Register 5

LSB of Data Out

Most Significant Bit

Least Significant Bit

Bit 7	Bit 6	Bit 5	Bit 4	Bit 3	Bit 2	Bit 1	Bit 0
DO7	DO6	DO5	DO4	DO3	DO2	DO1	DO0
Value = 128	Value = 64	Value = 32	Value = 16	Value = 8	Value = 4	Value = 2	Value = 1

IOWRITE_BYTE Register 7

Set Control Output Lines

Most Significant Bit

Least Significant Bit

Bit 7	Bit 6	Bit 5	Bit 4	Bit 3	Bit 2	Bit 1	Bit 0
Not Used						Set CTL1 (1 = Low; 0 = High)	Set CTL0 (1 = Low; 0 = High)
Value = 128	Value = 64	Value = 32	Value = 16	Value = 8	Value = 4	Value = 2	Value = 1

System Devices

Chapter

14

Introduction

This chapter introduces the SYSDEVS module and the special features available inside most Series 200 Computers. This information will allow you to access almost every feature available inside *your* computer including: the beeper, clock, crt, keyboard, type-ahead buffer, key translator, timers, and powerfail. Earlier releases of the Workstation Pascal System required importing several different modules to access these devices. Now you only need SYSDEVS.

A Bit of Advice

The following list explains some of the problems you will encounter if you decide to use the devices and routines described in this chapter. Be forewarned, these devices were originally intended to be used only by the operating system and not by application programs. If you write a program which uses these devices, it may not be transportable to all other Series 200 Computers. It will definitely *not* be compatible with previous releases of Pascal.

- Correct use of the system devices requires a familiarity of both the Pascal language and the Workstation Pascal System. If you have not programmed in Pascal, do yourself a favor and avoid this chapter until you have gained some programming experience. It is very easy to “crash” or “hang” your system with the information provided in this chapter.
- Programs which access the internal devices must be very carefully written. Most of the system features use interrupt service routines (ISR) and variables which are procedures. If your program doesn't run correctly the first time, the operating system may become so confused that you won't get a second chance. You will have to re-boot the system and start over.
- If you customize your system, and something goes wrong, **do not expect the standard support services to be able to help you.** It is virtually impossible to support something that is unique to every customer. **Special system internals consulting may be available in your area.**
- All system devices are **not** available on all of the Series 200 computers. For example, the powerfail option is not available on most models. Extensive use of every available feature on your computer almost guarantees non-transportability to other Series 200 Computers (unless your programs are extremely well written).
- The programs presented in this chapter will **not** work with any other operating system, including the HP-UX Operating System. Similar capabilities are provided in HP-UX but are accessed differently.

After reading these warnings, you may wonder why these features are presented at all. The answer is quite simple. If your computer has these features, you should be able to use them without a tremendous effort. As a side benefit, some of the information presented in this chapter can be used to determine the hardware configuration of any Series 200 Computer.

Supported Features

The following Series 200 Computer features are accessed through the SYSDEVS module. While SYSDEVS provides access to all of these features, not all of them may be present inside *your* computer. Tests for the presence of these features are included when possible.

Tone Generator

- Beep with fixed frequency and duration (bell).
- Beep with specified frequency and duration.

Clock

- Elapsed time in hundredths of a second.
- Set and read the date.
- Set and read the time of day.

Timers

- Enquire timer status.
- Set or cancel periodic system interrupt.
- Set or cancel real-time match timer interrupt.
- Set or cancel cyclic timer interrupt.
- Set or cancel delayed timer interrupt.
- Set or cancel non-maskable delayed interrupt (timeout).

CRT

- Toggle alpha screen on and off.
- Toggle graphics screen on and off.
- Interrogate screen parameters.
- Check or set status indicator (run-light)
- Control of the last line of the CRT.
- Control of the debugger window.
- Dump alpha procedure variable.
- Dump graphics procedure variable.

The Keyboard

- Examine keycodes and qualifiers (shift, control, extend).
- Set keystroke auto-repeat rate.
- Set delay before keystroke auto-repeat.
- Keystroke interrupt processing.

Type-ahead Keybuffer

- Control the display of the type-ahead buffer.
- Modify the contents of the keybuffer.
- Control the file system access to the buffer.

Key Translation Services

- Translate keycodes to ASCII characters.
- Modify semantic action.
- Specify lookup table.

Rotary pulse generator (The RPG or “knob”)

- Knob interrupt processing.
- Mask knob interrupts.

Powerfail

- Test for presence of battery.
- Send command to powerfail.
- Interrogate powerfail status.

You may have noticed that some of the listed features correspond to actual hardware devices while others are really pseudo-devices (such as the type-ahead buffer). From SYSDEVS point of view, it does not matter if a “device” corresponds to an actual hardware device. Real devices and pseudo-devices are treated similarly.

Note

Programs which access these features must be carefully written and debugged. Any error may “crash” the operating system.

The SYSDEVS Module

The SYSDEVS module contains the necessary interface text to access most internal devices and features available on current Series 200 Computers. The primary reasons for creating SYSDEVS were to unify low-level access to the hardware in the Series 200 Computers and to allow the Pascal Language System (Workstation) to operate without one or more of these devices present.

By using SYSDEVS and avoiding other modules for accessing your computer's internal hardware, your programs will be safer from future changes to the operating system and underlying hardware. However, no guarantee is made that your program will not require modifications in the future.

SYSDEVS is a standard part of INITLIB and its interface (export) text can be found in the INTERFACE file.

The SYSGLOBALS Module

Some of the features provided by the SYSDEVS module use constructs exported by the SYSGLOBALS module. Like SYSDEVS, the actual SYSGLOBALS "code" always resides in memory (it is part of INITLIB) while the interface text can be found in the library named INTERFACE. The examples in this chapter often import SYSGLOBALS to access useful features and constructs. For example, the clock uses a packed record that is exported by SYSGLOBALS for the time and date. If you are not familiar with the SYSGLOBALS module, you can ask the Librarian to list the interface text.

Previous Module Names

In general, previous versions of the Pascal Language System had individual modules for each device or feature. Although some of the previous module names still exist in Pascal 3.0, their interface text has probably changed or no longer exists in the 3.0 version.

If you wrote programs in previous versions of Pascal which imported the BAT, CLOCK, CRT, or KBD modules, you will find similar functionality in the SYSDEVS module. Not necessarily *identical* functionality, but similar functionality. For example, if you imported KBD for the BEEP procedure, you can just change KBD to SYSDEVS in your program's import statement. However, if you imported KBD for manipulating the type-ahead buffer, not only were you very brave, but you will now have to "re-think" your strategy since there is a new interface to the keybuffer. This may not be as bad as you think. It is now quite easy to manipulate the type-ahead buffer.

For the most part, operations that use the file system are not affected by SYSDEVS (i.e. operations that use the standard input, output, keyboard, and listing files that appear in the program header).

The Example Programs

All of the example programs found in this chapter are included on the DDC: disc supplied with your system. To save space, the files were stored as type ASCII (".ASC" suffix). Your Editor can read these files but remember to specify the suffix. It is still recommended that you read through the listings to better understand how the examples work.

Some examples will interact with each other. Example programs whose name ends with the letter "P" become a permanent part of the system and can only be removed by re-booting the computer (or modifying the example).

Not all examples given in this chapter will work on all Series 200 Computers. If you find an example that will not work on your computer, study it to see what it is trying to do. You may have to make slight modifications for your particular display or keyboard. For example, if your display has only 50 columns, a long prompt may wrap to the next line. Simply shorten the prompt to fit your display. Of course, if your computer does not have the necessary hardware, the example program will probably fail.

The fact that all examples may not work is not an oversight, it is simply an attempt to keep the examples as short as possible. Be sure to study all of the examples and text since some examples use features described in other sections.

As a last resort, if you need assistance contact your Sales and Service office and ask about possible consulting or training for Pascal "internals".

Note

The example programs in this chapter were compiled using a LIBRARY that contained the source text from the INTERFACE module. If you have not added INTERFACE to your standard LIBRARY, you must include the compiler option, `SEARCH 'CONFIG:INTERFACE,'` at the start of each example program.

Please do not execute an example program before you read the section where it is listed. Some examples will change your operating system. If you are having trouble typing the examples into your computer, you should stop typing and start reading.

Interrupt Processing Overview

Many of the features made accessible by SYSDEVS produce hardware interrupts. When a device interrupts, the operating system must react to the interrupt in an intelligent manner.

To handle interrupts effectively, the internal architecture of your computer allows seven different levels (priorities) of interrupts. Most of the devices described in this chapter produce interrupts at the lowest level (level 1). Other levels are used by other devices and interfaces. For example, if your system has internal disc drives, they interrupt on level 2. The highest priority (level 7) is usually reserved for very important purposes (such as the RESET key) since a level 7 interrupt can “override” all other levels of interrupts.

When the computer is operating, any interrupt will cause it to stop what it is doing and branch to the appropriate routine to service the interrupt. After the interrupt has been processed, the computer resumes the task it was performing before it was interrupted.

If a higher priority interrupt should occur during the processing of an interrupt, the computer stops what it was doing and starts processing the higher priority interrupt. Only after handling the higher priority interrupt will the computer resume processing the lower priority interrupt. Thus, a low level interrupt may go unnoticed during the processing of a high level interrupt.

Installing an additional service routine for levels 2 through 7 requires procedures exported by the module named ISR. Adding a service routine for most system devices is easier since the SYSDEVS module exports procedure variables that let you “hook into” the operating system.

One of the restrictions of interrupt service routines is not being able to detect interrupts at the same or lower level. For instance, while servicing a timer interrupt, you cannot use a `readln` statement since the keyboard also interrupts at the same level. The keyboard interrupt will go unnoticed until you finish processing the timer interrupt (an exception to this is shown in the Keyboard section).

Unlike normal programs which use the “user” stack, interrupt processing uses the “supervisor” stack. Since only about 5K bytes are reserved for the supervisor stack, avoid recursive procedures, excessive procedure calls, large local variables, and passing variables by value within your ISR. Large global variables and passing large objects by reference do not cause problems. If you “overflow” the supervisor stack, unexpected behavior or errors will result (the system will “crash”).

Hooking into Your System

Before trying to access a system feature, it is important to understand the methods used by the operating system to communicate with these features. Accidentally or intentionally disconnecting a feature from the operating system may result in unexpected errors or behavior.

There are two major classes of devices accessed by SYSDEVS; those which perform an action when requested (such as the beeper or the display) and those which actually interrupt the system (such as the keyboard or a timer). The first class of devices generally has a simple interface and is invoked by calling the proper procedure. The second class of devices usually has a more complex interface and is accessed by taking control of the proper “hook”.

In general, each device that generates a hardware interrupt has a “hook” (procedure variable) that contains the “name” (actually the address) of the procedure in the operating system which can process the interrupt. The interrupt processing procedure is also called an interrupt handler or interrupt service routine (ISR). Typical identifiers for these hooks include: `KBDISRHOOK`, `TIMERISRHOOK`, and `RPGISRHOOK` (their type is `PROCEDURE` and they may have parameters).

When an interrupt occurs, the operating system detects it, determines which device produced the interrupt, and invokes the proper “hook”. Normally, this hook points to a procedure inside the operating system which can handle the interrupt. The computer then continues whatever task it was performing before the interrupt.

If you have been following closely, you may have noticed the best feature of a procedure variable; it is a variable. You can write your own procedure and replace the operating system’s procedure with your own. Inside your procedure, you can determine what action to take or you may decide to pass the interrupt back to the standard operating system procedure.

There are some important things to remember when you are writing interrupt service routines.

- An ISR must be very carefully written (a bad hook can hang your system). Errors occurring inside an ISR will **not** get reported by the operating system.
- In general, your routine should only attempt to process the interrupts you are looking for; other interrupts should be passed on to the operating system. You may think of your ISR as just a link in a chain.
- If you take control of a system hook and your ISR does not remain in memory, unexpected behavior or errors will result. You can either make your routine a permanent part of the operating system or restore the hook to its original value before terminating your program.
- Keep your ISRs as short as possible. A slow ISR will affect the overall performance of the system. An overly large ISR can crash the operating system. Also, don’t forget, your routine may be interrupted at any time. The value of a system global may suddenly change while you are processing an interrupt.
- When processing an interrupt, no other interrupts at the same (or lower) level will be detected. (There is a special “hook” that lets you receive keystrokes while inside an ISR.)

When writing a hook, you must include the `#SYSPRG#` compiler option, however, due to the nature of most interrupt service routines, they **cannot** be compiled with the `#DEBUG#` compiler option. These restrictions require careful coding and patience on your part. A good idea is to save your files before executing any ISR program. That way, if something goes wrong, you only have to reboot your system to try again.

One last point. Your keyboard generates an interrupt every time you press a key. If you “take over” the keyboard hook, be very careful. A bad keyboard hook stops you from communicating with the computer. Your last resort may be the power switch.

Enabling Interrupts

Your Series 200 Computer allows the masking (suppression) of timer, keyboard, and special interrupts. Once a device has been masked, it cannot generate interrupts. Thus, no service routines will be called.

The `MASKOPSHOOK` procedure variable is used to control the enabling and disabling of interrupts. The procedure has two parameters, the first is the name of a mask for the device to be enabled while the second is the name of the mask for the device to be disabled.

The five masks are described below.

<code>KBDMASK</code>	This mask prevents the operating system from reacting to keystrokes. While disabled, only the RESET key will have any effect. This mask also disables knob (RPG) interrupts and all HP-HIL devices.
<code>RESETMASK</code>	This mask disables the RESET key.
<code>TIMERMASK</code>	This mask stops interrupts caused by the Cyclic, Delay, and Match timers. To use these interrupts you must also provide an ISR of your own.
<code>PSIMASK</code>	This mask prevents the Periodic System Interrupt (PSI). When enabled, the PSI produces an interrupt every 10 milliseconds. To use these interrupts you must also provide an ISR of your own.
<code>FHIMASK</code>	This mask enables and disables the level 7 “Non-Maskable Interrupt” (NMI) delay timer interrupts. Using this level of interrupt requires that an ISR to be linked into the operating system using the procedures exported by the module named <code>ISR</code> .

Since each mask has been assigned a positive numeric constant by `SYSDEVS`, multiple masks can be specified by adding the constants (as shown below). A zero (0) is specified when no action is to be taken. For instance, this call will enable the timer interrupts.

```
call(MASKOPSHOOK, TIMERMASK, 0);
```

To disable the timers, reverse the order of the parameters.

```
call(MASKOPSHOOK, 0, TIMERMASK);
```

The following call will simultaneously enable the keyboard and timers while disabling the reset key.

```
call(MASKOPSHOOK, KBDMASK+TIMERMASK, RESETMASK);
```

In general, at power-up, the keyboard and reset key are enabled, while the timers, periodic system interrupt, and “fast-handshake” interrupt are disabled.

The following example program will disable the keyboard momentarily.

```

$sysprog$
Program MASK1(input,output);

import sysdevs;

var
  i : integer;
begin
  call(maskopshook,0,KBDMASK+RESETMASK);           {disable all keys}
  writeln('All keys ignored');
  for i := 1 to 500000 do;                          {wait a few seconds}
    call(maskopshook,KBDMASK+RESETMASK,0);         {enable all keys}
    writeln('All keys restored');
  end,

```

Once disabled, the keyboard is “disconnected” from the system. If something goes wrong while the keyboard is masked or if you forget to re-enable the keyboard, the power-switch may be your only chance for recovery. Even if you are writing a program that will mask the reset key, you might consider leaving the reset key active until the development work is done.

A better solution is to use the `TRY..RECOVER` programming extension to ensure that any disabled device is re-enabled before the program terminates. This technique is used by several of the examples presented in this chapter.

System Features

The rest of this chapter describes the various features which can be accessed by the `SYSDEVS` module. Most features can be accessed in more than one way. That is to say, there are many levels of access for a given device. Not all possible levels of access will be described in this chapter. In general, only the “higher” levels are described. By using the highest-level methods of accessing a feature, your programs are less likely to require changes due to new releases of software or revisions to the hardware.

Here is a list of the features described in this chapter.

- Beeper
- Clock
- Timers
- Display
- Keyboard
- Type-ahead buffer
- Key translator
- Powerfail

The supporting interface text for all of these features appears at the end of this chapter.

Note

All example programs in this chapter will **not** work on all Series 200 Computers. Slight modifications may be necessary.

If you have not already done so, please go back and read the section entitled *The Example Programs*.

The Beeper

If your computer has an internal tone generator, it can be accessed by two procedures exported from the SYSDEVS module. These procedures did not change from earlier releases, except they are now found in SYSDEVS.

- The BEEP procedure activates the tone generator at a fixed frequency and duration.
- The BEEPER(*frequency*, *duration*) procedure allows you to specify the frequency and duration of the generated tone.

The actual code that causes the hardware to make a noise is not in SYSDEVS, it is located elsewhere (currently in the A804XDVR module). However, by using SYSDEVS to access the procedures you are less likely to have to change your program in the future.

There are 63 audible tones that can be produced by the BEEPER procedure. The useful frequency values are 1 through 63. The actual frequency is 81.38 times the passed value. This gives a range of frequencies from about 81 Hz. to 5200 Hz. Passing a 0 as the frequency produces silence.

Note that if you have the newer style HP-HIL keyboard, its interface has different sound generator hardware. The actual frequency may be slightly different.

The value of the duration parameter can range from 0 through 255 and is measured in hundredths of a second (centiseconds). Passing a value of 0 produces a duration of 256 centiseconds.

Although both parameters to the BEEPER function are declared to be of type `byte`, integer expressions may be used.

SYSDEVS exports two constants (`BFREQUENCY` and `BDURATION`) which can be used with the BEEPER procedure to produce the same sound as the BEEP procedure.

Beeper Timing

Once started, there is no way to determine if a sound is still being produced. Thus, sending two commands in a row may only produce one sound. A small wait loop will prevent the commands from “stepping” on each other. For example,

```

Program BEEP1;

import SYSDEVS;

var i: integer;

begin
  beep;                {ring the bell}
  for i := 0 to 9999 do; {delay tactic}
    beep;              {another bell}
  end;

```

This same method can be used with the BEEPER procedure.

```

Program BEEPER1(output);

import SYSDEVS;

var f, z : integer;

begin
  for f := 63 downto 0 do      {all frequencies}
    begin
      beeper(f, 5);           {short duration}
      writeln(round(f*81.4));  {show frequency}
      for z := 1 to 9999 do;  {wait a bit}
      end;
    end;
end.

```

If you wanted to ensure completion of a previous command, you could use the internal clock or a timer to count the centiseconds. However, it is probably not a good idea to wait inside an ISR until a beep is finished; you might miss a keystroke or a timer interrupt.

Intentionally sending commands to the tone generator before it finishes a previous command can produce interesting sounds as the following program demonstrates.

```

Program BEEPER2;

import SYSDEVS;

var i : 0..255;
    j : integer;

begin
  for i := 128 downto 1 do
    begin
      beeper( i mod 64, 10);      {all frequencies}
      for j := 1 to (128-i)*10 do; {strange delays}
      end;
    end;
end.

```

The Clock

Several procedures and a function are exported by SYSDEVS for accessing the internal clock. The clock interface has not changed from earlier releases of Pascal.

- The `SYSCLOCK` function returns an integer representing the number of centiseconds since midnight.

Of course, if the clock has not been set to the correct time, this function returns the time since power-up.

The procedures exported for the clock require packed records representing the date and time. These records are defined in SYSGLOBALS and are also listed later.

- The `SYSDATE(thedate)` procedure returns the packed month, day, and year.
- The `SYSTIME(thetime)` procedure returns the packed hour, minute, and centisecond.

Similar procedures are exported for setting the time and date.

- The `SETSYSDATE(thedate)` procedure sets the date.
- The `SETSYSTIME(thetime)` procedure sets the time of day.

The `SYSCLOCK` function can be used in timing or “stopwatch” applications. (Another timer is described in the Timers section.) The following program prints the value of `SYSCLOCK` for five seconds and then quits.

```

Program CLOCK1(output);

import sysdevs;

var quittime : integer;

begin
  quittime := sysclock + 500;      {quit five seconds from now}
  while sysclock < quittime do
    write(#1, 'Centiseconds: ', sysclock);
  end.

```

In this program the “quittime” is computed by adding 500 centiseconds to the current `sysclock`. Using this method to set a future time would not work for times greater than 24 hours; nor would it work at midnight when the clock is reset to zero. (At midnight you would need to use the date as well as the time.) A later example uses such a method.

The SYSDATE and SYSTIME procedures are used in the following program to read the current date and time. The program also demonstrates two methods of displaying the formatted date and time.

```

Program CLOCK2(outPut);

import sysglobals, sysdevs;

const century = 1900;

type monthtype = (nul,Jan,Feb,Mar,Apr,May,Jun,Jul,Aug,Sep,Oct,Nov,Dec);

var  date      : daterec;
     time      : timerec;
     mtag      : monthtype;
     timestr   : string[8];
     i, days, months, years,
     hours, minutes, seconds : integer;

begin
  sysdate(date);    {get the date from the clock}
  systime(time);    {get the time from the clock}

  {plain} writeln('plain');
  writeln(date.day:2,'-', date.month:2,'-', date.year:2);
  writeln(time.hour:2,':',time.minute:2,':',round(time.centisecond/100):2);

  {fancy} writeln('fancy');
  days := date.day;
  months := date.month;
  years := century + date.year;
  mtag := nul; for i := 1 to months do mtag := succ(mtag);
  writeln(days:2,' ',mtag,' ',years:4);
  hours := time.hour;
  minutes := time.minute;
  seconds := round(time.centisecond/100);
  strwrite(timestr,1,i,hours:2,':',minutes:2,':',seconds:2);
  for i := 1 to strlen(timestr) do
    if timestr[i] = ' ' then timestr[i] := '0';
  writeln(timestr);
end.

```

The program prints the date and time as follows.

```

Plain
 2- 4-84
15:34: 4
fancy
 2 APR 1984
15:34:04

```

Setting the time can be accomplished by the SETSYTIME procedure as demonstrated in the following program. A similar program with the proper range checking could set the date.

```

$sysprog$
Program CLOCK3(input,output);

import sysglobals, sysdevs;

var   time       : timerec;
      tstr       : string[255];
      delimit    : char;
      i, hours, minutes, seconds : integer;

begin
  systime(time);           {get the time from the clock}
  write('The current time is:      ');
  writeln(time.hour:2,':',time.minute:2,':',round(time.centisecond/100):2);
  writeln;
  write('Enter the new time in the form: hh:mm:ss '); readln(tstr);
  if strlen(tstr) > 0 then
    begin
      try
        stread(tstr,1,i,hours,delimit,minutes,delimit,seconds);
      recover
        begin
          writeln('Unrecognized time format. Try again,');
          writeln('For example, try typing: 12:34:56 ');
          escape(0);           {bail out}
        end;

      if (hours >= 0) and (minutes >= 0) and (seconds >= 0) then
        if (hours < 24) and (minutes < 60) and (seconds < 60) then
          begin
            time.hour := hours;
            time.minute := minutes;
            time.centisecond := seconds * 100;
            setsystime(time);           {set the clock}
          end
        else
          writeln('Value too large. Try again,');
        else
          writeln('Value too small. Try again,');
        end;
    end;
end.

```

The program prints the following prompt.

```

The current time is:      15:34:48
Enter the new time in the form: hh:mm:ss

```

An error message is printed if the time value is too large, too small, or not formatted correctly.

The `DATEREC` and `TIMEREC` types used in the previous examples are defined in the `SYSGLOBALS` module as follows.

```

daterec      = packed record
year         : 0..100;
day         : 0..31;
month       : 0..12;
end;

timerec      = packed record
hour        : 0..23;
minute     : 0..59;
centisecond : 0..5999;
end;

datetimerec  = packed record
date       : daterec;
time      : timerec;
end;

```

If you use these types, do not forget to perform the necessary range checking before assigning values.

Direct Clock Access

In addition to the standard clock procedures, the clock may also be accessed by these procedure variables.

- `CLOCKREQHOOK` is the interface to the `CLOCK` module, and will also set the battery-backup clock.
- `CLOCKIOHOOK` is an interface to the routine which actually communicates with the clock hardware.

Both hooks let you read or set the time and date, but each uses its own method. There is nothing to stop you from using these hooks, instead of the standard procedures for reading the clock, however your program will probably require more changes in the future.

For the first hook, `SYSDEVS` exports the following enumerated type.

```
CLOCKFUNC = (CGETDATE, CGETTIME, CSETDATE, CSETTIME);
```

An example call to read the date is shown below.

```
call(clockreqhook, CGETDATE, data);
```

Where `data` is a variable of type `CLOCKDATA` viewed as either `TIMETYPE` or `DATETYPE` as described by this record.

```

CLOCKDATA = RECORD
CASE BOOLEAN OF
TRUE : (TIMETYPE:TIMEREC);
FALSE: (DATETYPE:DATEREC);
END;

```

Of course, if you just read the date, you would want to access the data as `data.datetype`, rather than try to decode the date as a time of day. The types, `TIMEREC` and `DATEREC` were described earlier.

The second hook uses the following enumerated type to control the clock.

```
CLOCKOP = (CGET, CSET);
```

Thus, a call to read the date would appear as follows.

```
call(clockiohook, CGET, rtcdata)
```

Where the `rtcdata` is a variable of the following type.

```
RTCTIME = PACKED RECORD
    PACKEDTIME, PACKEDDATE : INTEGER;
END;
```

When possible, do not use this last hook since it operates directly on the clock hardware and not through the operating system. (The lower the level of access, the more likely it will have to be changed in the future.)

Note

Although perfectly suited for most application programs, the example programs presented here will not work inside an interrupt service routine because the clock already uses the level 1 ISR.

The Timers

There are three independent hardware timers inside your Series 200 Computer. Since these timers are not used by the operating system, they are available for any purpose you choose.

The three programmable timers are:

- Cyclic – This timer repeatedly interrupts the system at a specified interval.
- Delay – This timer interrupts the system after a specified delay.
- Match – This timer interrupts the system at a specified time of day.

While each timer can be set or read independently, the timers are enabled and disabled (masked) collectively. All examples in this section include the necessary statements to enable the timers.

The `TIMERISRHOOK` is a procedure variable called by the operating system's timer ISR when an interrupt is generated by the timer hardware. Thus, if you change `TIMERISRHOOK` to use your ISR, you will be able to process the interrupts as you choose.

The timers are programmed by the `TIMERIOHOOK`. The timer hook is a procedure variable that takes three parameters. The first parameter is the name of the timer to be used. `SYSDEVS` exports an enumerated type that lists the timers.

```
TIMERTYPES = (CYCLICT, PERIODICT, DELAYT, DELAY7T, MATCHT);
```

The second parameter is the operation code.

```
TIMEROPTYPE = (SETT, READT, GETTINFO);
```

The third parameter is the timer data. This is a data variable that can be viewed as a number of centiseconds (for the cyclic and delay timers), a time of day (for the match timer), and as a return value for the `GETTINFO` request.

```
TIMERDATA = RECORD
    CASE INTEGER OF
        0: (COUNT: INTEGER);
        1: (MATCH: TIMERECD);
        2: (RESOLUTION, RANGE: INTEGER);
    END;
```

Thus a typical call to the `TIMERIOHOOK` would appear as follows.

```
call(timeriohook, CYCLICT, SETT, mydata);
```

Where `mydata` is a variable of type `TIMERDATA` and would contain the count to set the cycle timer. How `TIMERDATA` is interpreted depends on its usage.

Timer Types

A short explanation of each timer is given below.

CYCLICT	This timer interrupts on a specified interval; the interval is given in centiseconds, in the COUNT field of the TIMERDATA variable.
PERIODICT	This timer interrupts every centisecond. See the later section entitled <i>Using the Periodic Timer</i> for details on using this timer.
DELAYT	Interrupts once after a specified amount of time. The time is given in centiseconds in the COUNT field of the TIMERDATA variable and is measured from the time the SETT operation reaches the hardware.
MATCHT	This timer interrupts whenever a specified time of day is reached. The time is given in TIMERECD form (hour, minute, and centisecond) in the MATCH field of the TIMERDATA record.
DELAY7T	This “timer” is the same as DELAYT except that the interrupt will occur as a level 7 (non-maskable interrupt). Use of this timer requires you install a level 7 ISR with the procedures given in module ISR. There is no system default code for a DELAY7T interrupt.

Timer Operations

Here are the permissible timer operations.

SETT	Sets the timer using the data specified by the TIMERDATA.
READT	Returns the current setting of the timer in a variable of TIMERDATA type.
GETTINFO	This command returns information in the RESOLUTION and RANGE fields of TIMERDATA. If the RESOLUTION is zero then the timer is physically missing, otherwise RESOLUTION is the smallest possible timer interval given in microseconds. For current Series 200 Computers this is 10000 microseconds or 1 centisecond.

The RESOLUTION and RANGE values of a timer cannot be changed.

The following program checks the status of each timer to see if it is being used.

```

$SYSPROG$
Program TIMER1(output);

import sysglobals, sysdevs;

var
    tdata : timerdata;
    time  : timerec;           {type from SYSGLOBALS}

begin {TIMER1 program}
    writeln('*** Cyclic timer ***');
    call(timeriohook, CYCLICT, GETTINFO, tdata);
    write('Resolution: ', tdata.resolution:0, ' usec. ');
    write(' Range: ', tdata.range:0, ' usec. ');
    call(timeriohook, CYCLICT, READT, tdata);
    writeln(' Count: ', tdata.count:0, ' centisec. ');

```



```

writeln('*** Delay timer ***');
call(timeriohook, DELAYT, GETTINFO, tdata);
write('Resolution: ', tdata.resolution:0, ' usec. ');
write(' Range: ', tdata.range:0, ' usec. ');
call(timeriohook, DELAYT, READT, tdata);
writeln(' Count: ', tdata.count:0, ' centisec. ');

writeln('*** Match timer ***');
call(timeriohook, MATCHT, GETTINFO, tdata);      {set CYCLIC timer}
write('Resolution: ', tdata.resolution:0, ' usec. ');
write(' Range: ', tdata.range:0, ' usec. ');
call(timeriohook, MATCHT, READT, tdata);      {set CYCLIC timer}
write(' "HH:MM:SS" ', tdata.match.hour:0, ': ');
write(tdata.match.minute:0, ': ', tdata.match.centisecond:0);
end,

```

A sample output is given below.

```

*** Cyclic timer ***
Resolution: 10000 usec. Range: 16777215 usec. Count: 16777216 centisec.
*** Delay timer ***
Resolution: 10000 usec. Range: 16777215 usec. Count: 16777216 centisec.
*** Match timer ***
Resolution: 10000 usec. Range: 16777215 usec. "HH:MM:SS" 0:0:0

```

Note that the count value is greater than the range! This is not an error, it just indicates that the timers have not been used. If you “clear” the timers after using them, as shown in the following programs, you will restore the timers to the values printed above. This allows a program to test if a timer is already in use.

When you check a timer, if the count values are not as above, the timer may be in use.

Using a Timer

The CYCLICT, DELAYT, and MATCHT timers are set up and used similarly. The choice of timer depends on the application. A timer’s general mode of operation is to provide an interrupt whenever a specific time condition is met. Timers therefore involve the use of interrupt service routines. As always, misuse of an ISR can cause the system to “hang”.

The typical sequence of using one of these timers is described below. (Using the periodic timer is described later.)

1. Save the value of `TIMERISRHOOK` by copying it into a variable of type `KBDHOOKTYPE`. The copy will be needed for the last step and may be used to “pass on” interrupts you do not wish to handle.
2. Set `TIMERISRHOOK` to the procedure which will process the interrupt.
3. Set the time condition in a variable of type `TIMERDATA`.
4. Make a system call to set the timer.

```
CALL(timeriohook, timer_type, SETT, time_condition_variable);
```

Where `timer_type` is the name of the timer you wish to use.

- Now enable the timers and wait for interrupts.

```
CALL(maskopshook,TIMERMASK,0);
```

When an interrupt occurs, your procedure will be executed rather than the standard processing procedure. (A typical ISR procedure is shown later.) If more than one timer ISR is in use, be sure to “pass on” any interrupt you do not wish to process. You may leave your ISR installed as long as you wish (provided the program stays in memory).

- When you no longer desire to process interrupts, call the MASKOPSHOOK to disable further interrupts.

```
CALL(maskopshook,0,TIMERMASK);
```

- Set the time condition to zero (0) in the TIMERDATA variable.
- Call the TIMERIOHOOK (with zero as the data) to clear the timer.

```
CALL(timeriohook,timer_type,SETT,time_condition_variable);
```

Although the timer does not require this call, it will set the timer’s control values to a known state that can be tested by some other program that may wish to use the timer.

- Set the value of TIMERISRHOOK back to the copy made in the first step. You have now returned the system to its normal state. Your program can now terminate.

If you think the timer may already be in use, you might want to perform the test mentioned previously before executing these steps.

A Typical Timer ISR

Here is the generic form of a timer interrupt service routine. Your ISR will need to use the same procedure parameters given below but not necessarily the same procedure name. The boolean variables shown below are assumed to be defined as globals.

```
procedure timehook(var statbyte, databyte: byte; var doit: boolean);
begin
  if doit then
    begin
      periodic := odd(statbyte div 16);           {statbyte bit 4}
      timer := odd(statbyte div 32);             {statbyte bit 5}
      cyclic := odd(databyte div 32);           {databyte bit 5 = cyclic}
      delay := odd(databyte div 64);            {databyte bit 6 = delay}
      match := odd(databyte div 128);          {databyte bit 7 = match}
    end;
  end;
end; {proc}
```

The procedure has three variables, the `statusbyte` indicates the which “class” of timer interrupt occurred, the `databyte` indicates which timer interrupted, and `doit` indicates whether any action should be taken. If `doit` is false, then no action should be taken (the interrupt was processed elsewhere).

A call through `TIMERISRHOOK` will only occur if `statusbyte` bit-4 or bit-5 is true. (See the keyboard hook for the meaning of the other status bits.) Bit-4 indicates if the interrupt was generated by the periodic system interrupt (which interrupts every centisecond when enabled). If bit-5 is true, then a cycle, delay, or match timer interrupt has occurred. To determine which timer has interrupted, the top three bits of the data byte can be tested. Databyte Bit-7 indicates a match-time, bit-6 indicates a delay, and bit 5 indicates a cycle interrupt.

Note that both a periodic interrupt and a timer interrupt can occur at the same time (Status byte bit-4 and bit-5 both true). Also, two or three regular timers can interrupt at the same time (Data byte bit-5, bit-6, and bit-7 all true). It is possible for a timer or periodic interrupt to be completely missed if the operating system is processing a higher level interrupt.

A provision has been made for counting missed cyclic interrupts. If bit-5 of the data byte is true (cyclic interrupt) the lower 5 bits (bit-4 through bit-0) contain the count of missed cyclic interrupts. Thus, up to 31 missed cycle interrupts can be logged. Actually, the count “saturates” at 31 so there is no way of knowing if more than 31 missed interrupts have occurred. The count will be reset to zero when the timer is read.

Multi-Timer Example

The following program sets each timer then waits for 15 interrupts. When an interrupt occurs, the program prints the name of the timer. This program assumes that the timers are not already in use and clears the timers when it is finished.

```

$sysProg$
Program TIMER2(output);

import sysglobals, a804xdvr, sysdevs;

const
  readintrmask = 4;
var
  intcount      : integer;
  tdata         : timerdata;           {type is from sysglobals}
  saveisrhook   : kbdhooktype;        {type is from sysdevs}
  saveoldmask   : byte;

procedure set_timers;
var
  overflow : integer;
begin
  tdata.count := 100;                  {1.00 seconds}
  call(timeriohook, CYCLICT, SETT, tdata); {set CYCLIC timer}

  tdata.count := 550;                  {5.50 seconds}
  call(timeriohook, DELAYT, SETT, tdata); {set DELAY timer}

  {push-ups to set the match timer to a future time}
  systime(tdata.match);                {set the current time}
  with tdata.match do
  begin
    overflow := centisecond + 950;      {add 9.50 seconds}
    centisecond := overflow mod 6000;   {may carry to minutes}
    if overflow > 5999 then            {too many seconds}
    begin
      overflow := minute + 1;          {carry to next minute}
      minute := overflow mod 60;       {may carry to hours}
      if overflow > 59 then            {too many minutes}
      begin
        overflow := hour + 1;          {carry to next hour}
        hour := overflow mod 24;       {may carry to next day}
      end;
    end;
  end;
  call(timeriohook, MATCHT, SETT, tdata); {set the MATCH timer}

```

```

{Next procedure is from AB04XDVR and will save the interrupt mask}
cmd_read_1(readintrmask,saveoldmask);

{Next line enables timer interrupts if they are currently disabled}
if odd(saveoldmask div 4) then call(MASKOPSHOOK, TIMERMASK,0);
end; {Proc}

Procedure clear_timers;
begin
  {Next line disables timer interrupts if they were originally disabled}
  if odd(saveoldmask div 4) then call(MASKOPSHOOK,0,TIMERMASK);

  tdata.count := 0;           {set data to zero}
  call(timeriohook, CYCLICT, SETT, tdata);   {clear CYCLE timer}
  call(timeriohook, DELAYT, SETT, tdata);    {clear DELAY timer}
  call(timeriohook, MATCHT, SETT, tdata);    {clear MATCH timer}
end; {Proc}

Procedure timehook(var statbyte, databyte: byte; var doit: boolean);
var
  periodic,
  timer,
  cyclic,
  delay,
  match      : boolean;
begin
  {Interrupt Service Routine}
  periodic := odd(statbyte div 16);           {statbyte bit 4}
  timer := odd(statbyte div 32);             {statbyte bit 5}
  if periodic then
    call(saveisrhook,statbyte,databyte,doit); {Pass it back to system}
  cyclic := odd(databyte div 32);           {bit 5 = cyclic}
  delay := odd(databyte div 64);           {bit 6 = delay}
  match := odd(databyte div 128);          {bit 7 = match}
  intcount := intcount + 1;                {count interrupts}
  write(intcount:3,' ':3);                  {print the count}
  if timer and cyclic then write('Cyclic ');
  if timer and delay then write('Delay ');
  if timer and match then write('Match ');
  writeln('interrupt. ');
end; {Proc}

begin {TIMER2 Program}
try
  intcount := 0;           {initialize count}
  saveisrhook := timerisrhook; {save old timer hook}
  timerisrhook := timehook;  {use new timer hook}
  set_timers;              {set and enable timers}
  writeln('Running');
  repeat {nothings} until intcount > 14; {wait for 15 interrupts}
  escape(0);               {invoke recover-block}
recover
begin
  clear_timers;           {clear and disable timers}
  timerisrhook := saveisrhook; {restore old hook}
  writeln('Stopped');
end;
end.

```

Here are the results of running the multi-timer program.

```
Running
 1  Cyclic interrupt.
 2  Cyclic interrupt.
 3  Cyclic interrupt.
 4  Cyclic interrupt.
 5  Cyclic interrupt.
 6  Delay interrupt.
 7  Cyclic interrupt.
 8  Cyclic interrupt.
 9  Cyclic interrupt.
10  Cyclic interrupt.
11  Match interrupt.
12  Cyclic interrupt.
13  Cyclic interrupt.
14  Cyclic interrupt.
15  Cyclic interrupt.
Stopped
```

Note that there is nothing to stop two timers from interrupting at the same time. If this happens, only one call will be made to the ISR, but both “flag” bits will be set. (You might want to modify the program to see what happens.)

Also note that the previous program does **not** pass on timer interrupts. This means that if another timer ISR is already active, it will not “see” the timer interrupts during the execution of the above program. If you wanted to give the other program a change to also process the interrupts, you would need to add the following line at the end of the ISR procedure in the above program.

```
call(saveisrhook, statbyte, databyte, doit);
```

Of course, since the previous program changes the settings of all of the timers, any prior timer settings would be lost.

Not Enough Timers

Just as there is an old “law” about software expanding to fill all available memory, you may soon find that you need an extra timer. You might consider using the periodic timer (described next) or the clock; however, both have certain restrictions. Another possibility would be to “multiplex” a timer. For example, if you wanted a cyclic interrupt at 30 times a second and another at 10 times a second, it would be easy to count the interrupts in the “slower” ISR and take an action only on every third interrupt.

Using the Periodic Timer

When enabled, the periodic timer interrupts the operating system every centisecond (every 10 milliseconds). Beware, misuse of this timer will impact the performance of your system. If your routine took 1 millisecond to execute, the operating system would spend 10 per cent of its time in your routine. Use this timer only when absolutely necessary and keep your ISR as short (fast) as possible.

To set up and use the periodic timer, follow these steps.

1. Save the value of `TIMERISRHOOK` by copying it into a variable of type `KBDHOOKTYPE`. The copy will be needed for the last step.
2. Set `TIMERISRHOOK` to the procedure which will process the interrupt.
3. Enable timer interrupts and wait for interrupts.

```
CALL(maskopshook,PSIMASK,0);
```

When an interrupt occurs, your procedure will be executed rather than the standard interrupt service routine. You may leave your ISR installed as long as you wish (provided the program stays in memory).

4. When you are no longer desire to process interrupts, call the `MASKOPSHOOK` to disable further interrupts.

```
CALL(maskopshook,0,PSIMASK);
```

5. Set the value of `TIMERISRHOOK` back to the copy made in the first step. You have returned the system to its normal state.

When you use the `PERIODIC` timer, remember to keep your service routines as short as possible since they will be executed every centisecond. A slow ISR for this timer will seriously degrade overall system performance. Also remember that interrupts run in “supervisor” mode. Heavy use of the stack may cause the operating system to “crash”.

Periodic Timer Example

The following program enables the periodic timer for about a second.

```
$sysprog$
Program TIMER3(output);

import sysglobals, sysdevs;

var
  i : integer;
  saveisrhook : Kbdhooktype;           {type is from sysdevs}

procedure ptimehook(var statbyte, databyte: byte; var doit: boolean);
begin
  {Interrupt Service Routine}
  if odd(statbyte div 16) then write(',');   {periodic timer}
  if odd(statbyte div 32) then
    call(saveisrhook, statbyte, databyte, doit); {some other timer}
end; {proc}

begin {TIMER3 program}
  try
    saveisrhook := timerisrhook;           {save old timer hook}
    timerisrhook := ptimehook;            {use new timer hook}
    call(maskopshook, PSIMASK, 0);        {enable interrupts}
    for i := 1 to 100000 do {nothing};    {wait for a few intr,}
    escape(0);                             {invoke recover-block}
  recover
    call(maskopshook, 0, PSIMASK);        {disable interrupts}
    timerisrhook := saveisrhook;         {restore old hook}
end,
```

The program prints a period (.) for every interrupt.

System Timer Example

The final timer example program sets the cyclic timer to continually display the cursor position on the screen. Note that this example must become part of the operating system since it does not release the timer hook.

```

$sysprog$
Program TIMER4P(output);

import sysglobals, sysdevs, loader, fs;

var fposx, fposy : integer;
    fconsole      : file of char;
    tdata         : timerdata;           {type is from sysglobals}
    saveisrhook   : kbdhooktype;       {type is from sysdevs}

Procedure set_timer;
begin
    tdata.count := 10;                  {0.10 = 10 per second}
    call(timeriohook, CYCLICT, SETT, tdata); {set CYCLIC timer}
    call(MASKOPSHOOK, TIMERMASK, 0)       {enable timer interrupts}
end; {Proc}

Procedure clear_timer;
begin
    tdata.count := 0;                  {set data to zero}
    call(timeriohook, CYCLICT, SETT, tdata); {clear CYCLE timer}
    call (MASKOPSHOOK, 0, TIMERMASK)      {disable timer interrupts}
end; {Proc}

Procedure cyclehook(var statbyte, databyte: byte; var doit: boolean);
var i, rval : integer;
    tempstr : string[8];
begin
    {Interrupt Service Routine}
    if odd(statbyte div 32) {timer} and odd(databyte div 32) {cyclic} then
        begin
            if doit then                {process interrupt only if doit is true}
                begin
                    doit := false;      {processed here}
                    fsetxy(OUTPUT, fposx, fposy); {set cursor pos.}
                    fposx := fposx + 1;   {origin at 1}
                    fposy := fposy + 1;
                    tempstr := 'xx,xx';   {desired format}
                    if fposx < 100 then
                        strwrite(tempstr, 1, rval, fposy:2, ',', fposx:2) {copy into string}
                    else
                        strwrite(tempstr, 1, rval, fposy:2, fposx:3); {copy into string}
                    for i := 1 to 5 do
                        setstatus(i-1, tempstr[i]);           {print it on screen}
                    end;
                end;
            end;
            {If doit is still true then pass the interrupt on to the next hook}
            if doit then call(saveisrhook, statbyte, databyte, doit); {pass it on}
        end;
    end; {Proc}

```

```

begin {TIMER4P program}
  try
    saveisrhook := timerisrhook;           {save old timer hook}
    timerisrhook := cyclehook;           {use new timer hook}
    set_timer;                             {set and enable timers}
    writeln('Cursor-display enabled.');
```

	{keep this around}
--	--------------------

```

    MARKUSER;
  recover
    begin
      clear_timer;                         {clear and disable timers}
      timerisrhook := saveisrhook;        {restore old hook}
      writeln('Crashed.');
```

	{keep this around}
--	--------------------

```

    end;
end.
```

Running this program causes the current cursor position to be displayed in the lower right-hand corner of the display. The program checks the cursor position and updates the display ten times every second. Other system information could be displayed in a similar fashion.

The `setstatus` statement is used in this program to print the cursor information in the status area of the display (see the next section for details).

The `markuser` statement is imported from the `LOADER` module and instructs the loader to move the current “top-of-heap” pointer to the end of the most recently loaded program. This prevents the program from being unloaded (scratched) when it finishes executing. (Without this statement, the timer ISR would be removed from memory and the next interrupt would call a non-existent routine resulting in very unusual behavior.)

The Display

The SYSDEVS module provides access to several features of the display (CRT) including most of the features previously imported from the modules KBD and CRT. In Pascal 3.0, there are now two display modules, a module for alpha-type displays (CRT) and a module for bit-mapped displays (CRTB). Neither module has any interface text. Their features are accessed through SYSDEVS.

As mentioned previously, there are usually several levels of access to a device. Before introducing the access to the display provided by SYSDEVS, it is worth mentioning what can be accomplished by the file system. By using the file system to access the display, you are practically guaranteed that your program will operate correctly on all Series 200 Computers that have the necessary hardware.

The following table lists the effects of control characters written to the display.

Character	Effect
chr(1)	Homes cursor to upper-left corner.
chr(7)	Produces a beep.
chr(8)	Moves the cursor left one position (if possible).
chr(9)	Clears from the cursor to end of line.
chr(10)	Moves the cursor down one position (if possible).
chr(11)	Clears from the cursor to the end of the screen.
chr(12)	Homes the cursor and clears the screen.
chr(13)	Moves the cursor to the left end of the line.
chr(28)	Moves the cursor right one position (if possible).
chr(31)	Moves the cursor up one position (if possible).

All of these control characters produce an action rather than display a character. A “shorthand” notation exists in HP Pascal for including these control characters in output statements. For example, to clear the display before printing, try the following statement.

```
writeln(#12, 'Home Sweet Home');
```

Many of the examples in this chapter use this notation.

Determining Display Type

Inside most Series 200 Computers there are two independent screens (also called rasters). There is an “alpha” screen and a “graphics” screen. The alpha screen can display only characters (text) while the graphics screen is capable of displaying individual dots or lines (of course, a character can be formed out of dots and lines on a graphics screen). Both screens may be displayed independently or at the same time.

Your computer may have only one of these screens. The graphics screen is a deletable option on some computers while the newest computers only have a “bit-mapped” (graphics-type) character display. On the bit-mapped displays, clearing alpha or graphics clears both alpha and graphics since they use the same hardware.

SYSDEVS exports an enumerated type and a system variable of that type which let you determine what kind of display is in use. Currently, only the first three “kinds” of displays are supported by the operating system.

```
crtkinds = (NOCRT, ALPHATYPE, BITMAPTYPE, SPECIALCRT1, SPECIALCRT2);
```

The following short program will print the current console display type.

```
Program CRT1(input, output);

import sysdevs;

begin
  writeln(currentcrt);
end.
```

Unless you have modified the system, either ALPHATYPE or BITMAPTYPE will be displayed. NOCRT is returned if the display hardware is missing or if a remote console is being used.

Display States

This section on display states only applies to non-bit-mapped (non-BITMAPTYPE) displays. The bit-mapped displays have only one screen for both alpha and graphics and that screen cannot be turned off.

SYSDEVS exports a boolean for each screen which indicates whether the screen is being displayed. For the majority of Series 200 Computers, both of these booleans will be true after power-up. The booleans are:

- ALPHASTATE – This boolean is true when the alpha screen is being displayed.
- GRAPHICSTATE – This boolean is true when the graphics screen is being displayed.

The booleans are for testing only. Changing one to false will not turn off the display. You can toggle a screen (turn it on or off) from the keyboard by pressing the proper key. To control the screens from inside a program, SYSDEVS exports the following procedures.

- TOGGLEALPHAHOOK – This procedure toggles the alpha screen on or off.
- TOGGLEGRAPHICSHOOK – This procedure toggles the graphics screen on or off.

By combining the booleans and the procedures, you can control what will be displayed; as the following program demonstrates.

```

$SYSPROG$
Program CRT2;

import sysdevs;

begin
  {If graphics is on, turn it off}
  if graphicstate then call(togglegraphicshook);
  {If alpha is not on, turn it on}
  if not alphastate then call(togglealphahook);
end.
```

Executing this program will turn off the graphics screen (if it was on), and turn on the alpha screen (if it was off). When the Pascal System first “wakes-up”, both displays are on if the hardware is present (the graphics screen is also cleared so even though it is on, nothing is shown).

Display Parameters

The safest way to interrogate screen parameters is to use the `SYSCOM` variable. `SYSCOM` is of type `ENVIRONPTR` (a pointer to an `ENVIRONMENT`). The `ENVIRONMENT` is a record containing three records: `MISCINFO`, `CRTCTRL`, `CRTINFO` and an integer `CRTTYPE`. The records contain information used by the operating system to determine what actions to take when communicating with the display. If you decide to change any of the following parameters, you will need to reinitialize the CRT (explained later in this section).

The `MISCINFO` record contains booleans that can be tested to determine the operating characteristics of the display. `MISCINFO` is a record of type `crtfrec`. The second record in `SYSCOM` is the `CRTTYPE` (type `crtorec`) which contains the control characters to which the screen will respond. The last record in the `ENVIRONMENT` is `CRTINFO` (type `crtirec`). The `CRTINFO` record contains a considerable amount of information concerning the display. The following program prints the values of a `CRTINFO` record.

```

Program CRT3(input, output);

import sysdevs;

begin
  with syscom^.crtinfo do
  begin
    write('      Width   Height   Memaddr   Control');
    writeln('      Buffer Progstate   Buflen');
    write(width:10, height:10, crtmemaddr:10, crtcontroladdr:10);
    write(keybufferaddr:10, progstateinfoaddr:10, keybuffersize:10);
    writeln;
    write('right left down   up badc cdel stop');
    writeln('brek flsh eof altm ldel bksp etx');
    write(ord(right):5, ord(left):5, ord(down):5, ord(up):5);
    write(ord(badc):5, ord(chardel):5, ord(stop):5, ord(break):5);
    write(ord(flush):5, ord(eof):5, ord(altmode):5, ord(linedel):5);
    writeln(ord(backspace):5, ord(etx):5);
    writeln;
    writeln('      Prefix  Cursormask      Spare');
    write(ord(prefix), cursormask, spare);
  end;
end.

```

Typical values are printed below.

Width	Height	Memaddr	Control	Buffer	Progstate	Buflen
80	24	5316608	5341185	5320448	5320592	72

right	left	down	up	badc	cdel	stop	brek	flsh	eof	altm	ldel	bksp	etx
28	8	10	31	63	8	19	16	6	3	27	127	8	3

Prefix	Cursormask	Spare
0	0	0

If you write values into the `crtmemaddr` space, characters may appear on the display.

Do **not** write values into the `crtcontroladdr` space since this **can damage the display**.

While `SYSCOM` contains all of the information concerning alpha-type displays, if you have a bit-mapped display (`CURRENTCRT = BITMAPPEDTYPE`), there are some other variables of interest.

- `BITMAPADDR` – This integer contains the address of the bitmap control space. Do not read from or write anything in the control space since this **can damage the display**.
- `FRAMEADDR` – This integer contains the address of the first byte of memory used for the frame buffer (bit-mapped display area). The first byte corresponds to the upper-left corner of the display. Consecutive bytes above this address are screen locations.
- `REPLREGCOPY` – This shortint contains a copy of the replacement rule register.
- `WINDOWREGCOPY` – This shortint contains a copy of the bitmap window width register.
- `WRITEREGCOPY` – This shortint contains a copy of more bit-map control register information since the actual registers are write-only and cannot be read.

Changing Display Parameters

If you decide to change any of the display parameters described previously, you will need to reinitialize the display. Simply changing the display parameters will **not** change the set up.

The following program will change the height of your display to 12 lines. The program first prints the current screen height so you can restore the display height to its value after running the program.

```

$sysprog$
program CRT4(output);

import sysdevs;

var z : integer;

begin
  with syscom^.crtinfo do
    begin
      writeln('      Width  Height');
      writeln(width:10, height:10);
      for z := 1 to 150000 do;
        height := 12;           {set new value}
        call(crtinithook);     {change display}
        writeln;
        writeln('      Width  Height');
        writeln(width:10, height:10);
      end;
    end;
end.
```

After running the program, try using the Editor, or Filer. You will see than only the top lines of the display are used. To return your display to normal, change the `height` parameter and re-run it. Errors will result if you exceed the maximum values for your display size.

Controlling the Cursor

SYSDEVS exports two variables, `xPos` and `yPos`, which contain the column (x) and row (y) location of the cursor. If you want to move the cursor by changing these values, you will also need to call `updatecursorhook` to actually change the location of the cursor. The following program demonstrates moving the cursor.

```

$sysProg$
program CRT5(input,output);

import sysglobals, sysdevs, uio;

var
  i,j : shortint;
  z : integer;
  c : char;

begin
  writeln('This program moves the cursor around the screen. ');
  writeln('Press any key to stop. ');
  i := 1; j := 1;                                {initial increments}
  while unitbusy(2) do                            {unitbusy is from UIO}  {run until keypress}
  begin
    if (xPos < 0) or (xPos >= syscom^.crtinfo.width)  {too wide}
    then i := -i;                                     {change direction}
    if (yPos < 0) or (yPos >= syscom^.crtinfo.height-1) {too high}
    then j := -j;                                     {change direction}
    xPos := xPos + i;                                {change x cursor position}
    yPos := yPos + j;                                {change y cursor position}
    call(updatecursorhook);                          {update cursor location}
    for z := 1 to 5000 do                            {wait a bit}
    end;
    read(c);                                          {clear the keystroke}
  end;
end,

```

Running this program bounces the cursor around the screen. Pressing any key will cause it to stop.

Remember, if you use the file system rather than this method to position the cursor, your program is less likely to require changes in the future.

Dumping the Display

Dumping the display refers to creating a hardcopy (by printer) or a softcopy (by file) of the contents of the display. It does not refer to a frustrated user knocking the display off the computer.

Two hooks are exported by SYSDEVS for producing a printout of whatever is currently shown on the display. If you call the `DUMPALPHAHOOK` or `DUMPGRAPHICSHOOK` inside a program, the contents of the respective screen will be dumped to your local printer. If no printer is connected to the system, a printer timeout will occur. You then may then either abort the dump or correct the problem (i.e. put a printer on-line).

If you have a bit-mapped display, your printer must have graphics capability for either the `dump-alpha` or `dump-graphics` routines to work properly. As you might suspect, for a bit-mapped display `dump-alpha` and `dump-graphics` are equivalent.

If you have a printer that is not supported by the system or wish to send the dump to a file, you can take control of the hook by substituting your own procedure for the system's dump procedure.

The following program will send the contents of the alpha screen to a file. If you have only a bit-mapped display, see the comments at the end of the example program. Note that this program installs itself in the operating system and can only be removed by re-booting the computer.

```

$sysprog$
Program CRTGP(input,output);

module dump2file;

import sysglobals, sysdevs;

export

var
  savedumphook : procedure;           {a place to save the old dumpalpha hook}

procedure initdump;                  {initialization routine}
procedure dumpit;                     {new dumpalpha hook}

implement

type
  screen = packed array[0..maxint] of crtword;   {alpha-screen is crtwords}
  tricky = record case boolean of                {'magic' record that}
    true : (i : integer);                       {can be an integer}
    false: (a : anyptr);                        {or a pointer}
  end;

var
  dcount : integer;                       {number of dumps counter}
  w, h   : integer;                       {display width & height}
  scrptr : ^screen;                       {a pointer to a screen type}
  trickrec : tricky;                      {used for type coercion}
  fn : string[16];                        {string for the filename}
  df : text;                              {dump-file variable}

procedure dumpit;
var
  i, j : integer;
  s : string[255];
begin
  dcount := dcount + 1;                   {count times called}
  strwrite(fn,1,i,'DUMP',DCOUNT:1,'.ASC'); {make filename}
  try
    rewrite(df,fn);                        {open file}
    setstrlen(s,w);
    for j := 0 to h-1 do                   {make a string for each CRT line}
      begin
        for i := 0 to w-1 do
          begin
            s[i+1] := scrptr^[i+j*w].character;
          end;
        writeln(df,s);                     {write string to the dumpfile}
      end;
    close(df,'LOCK');
  recover
    writeln('*** DUMP-Alpha failed. ***');
end;

```

```

Procedure initdump;
begin
  with syscom^.crtinfo do
  begin
    w := width;
    h := height;
    trickrec.i := syscom^.crtinfo.crtmemaddr;      {set screen address}
    scrptr := trickrec.a;                          {point to screen}
  end;
  savedumphook := dumpalphahook;                  {save old hook}
  dumpalphahook := dumpit;                         {install new hook}
end;

end; {module}

import loader, sysdevs, dump2file;

begin
  initdump;
  markuser;
  writeln;
  writeln('The dump-alpha-to-a-file utility has been installed.');
```

```

  writeln;
  writeln('When you press the dump-alpha key, the contents of the');
  writeln('display will be sent to an ASCII file in the default');
  writeln('directory. The files are numbered (e.g. ''DUMP2.ASC'').');
```

```

end.
```

A program to dump the graphics screen to a printer would be similarly constructed, but would use a pointer to the start of the graphics screen. Also, since the graphics memory is just a contiguous series of bytes, it would not require using the CRTWORD type.

The exact method used to dump the graphics raster to a printer depends upon the how the printer handles graphics and the way the graphics raster is constructed. Most monochrome displays use one bit-per-pixel while color displays may use one byte-per-pixel. You will also need to consult your printer manual (does it support graphics and what escape sequences do you need to send to set graphics mode). You may then have to transform the bit patterns since most displays map the pixels horizontally while many dot-matrix printers print the bit patterns vertically.

The Last Line

There is a special hook for the last line of the display. The last line usually displays the contents of the type-ahead buffer or a menu prompt.

If you have a keyboard that has a **MENU** key, pressing it will cause the system to stop echoing the type-ahead buffer and start displaying a menu. If your keyboard does not have a **MENU** key, then the type-ahead buffer is always displayed. An example program in the Keyboard section of this chapter will allow you to display a menu regardless of your keyboard type.

Without getting too involved with the information presented in the Keyboard section, it is worth mentioning that there is a control record for the type-ahead keybuffer. One of the fields of this record is a boolean which controls whether the contents of the type-ahead buffer should be echoed on the display. This boolean is used in the example program shown later in this section.

Several operations can be performed on the last line of the display. SYSDEVS exports the following type which lists the last-line operations.

```
CRTLLOPS=(CLLPUT,CLLSHIFTL,CLLSHIFTR,CLLCLEAR,CLLDISPLAY,PUTSTATUS);
```

These operations are used with the CRTLLHOOK to control the last line. The following example program demonstrates the various operations.

```
$sysprog$
Program CRT7(output);

import sysdevs;

type
  dispstr = string[80];
  dispstrptr = ^dispstr;
var
  i, z : integer;
  llchar : char;
  llpos : integer;
  llstr : dispstr;
  save_echo : boolean;

begin
  save_echo := keybuffer^.echo;           {save echo state for later}
  keybuffer^.echo := false;              {don't echo type-ahead}
  call(crtllhook, CLLCLEAR, llpos, llchar); {clear the last line}

  writeln('Display a string in the last line');
  llstr := 'Flashing messages get attention.';
  for i := 1 to 16 do
    begin
      call(crtllhook, CLLDISPLAY, llstr, ' '); {display the string}
      for z := 1 to 15000 do;
        call(crtllhook, CLLCLEAR, llpos, llchar); {clear the last line}
        for z := 1 to 15000 do;
        end;
      for z := 1 to 150000 do;

  writeln('Writing into the last line');
  llstr := 'This is the last line of the display.';
  for i := 1 to strlen(llstr) do
    begin
      call(crtllhook, CLLPUT, i, llstr[i]);     {print each character}
      for z := 1 to 15000 do;
    end;
    for z := 1 to 150000 do;

  writeln('Moving text to the right. ');
  for i := 1 to 10 do
    begin
      call(crtllhook, CLLSHIFTR, llpos, ' '); {dance to the right}
      for z := 1 to 15000 do;
    end;
    for z := 1 to 150000 do;
```



```

writeln('Moving text to the left,');
for i := 1 to 10 do
  begin
    call(crtllhook, CLLSHIFTL, llpos, ' ');      {dance to the left}
    for z := 1 to 15000 do;
    end;
  for z := 1 to 150000 do;

  call(crtllhook, CLLCLEAR, llpos, llchar);      {clear the last line}
  writeln('Set some status bytes,');
  for i := 1 to 5 do
    begin
      llpos := i;
      llchar := chr(i+ord('0'));
      call(crtllhook, PUTSTATUS, llpos, llchar);  {do the status bytes}
      for z := 1 to 95000 do;
    end;
  for z := 1 to 150000 do;

  writeln('Finished, Return to normal,');
  call(crtllhook, CLLCLEAR, llpos, llchar);      {clear the last line}
  for i := 1 to 5 do call(crtllhook, PUTSTATUS, i, ' ');
  keybuffer^.echo := save_echo;                  {restore echo state}
end.

```

So that you can watch what happens, the example program was written to perform all the operations very slowly. If you ran a previous example that uses the status area, it may be difficult to see the effects of the `PUTSTATUS` statement.

The Menus

In addition to displaying the contents of the type-ahead keybuffer, the last line of the display is capable of displaying a menu. If your keyboard has a **MENU** key, pressing the key will result in a menu being displayed instead of the keybuffer. If you do not have a **MENU** key on your keyboard, you may still use the menu feature although the system menu definitions will not apply.

A menu is simply a prompt; a reminder of how the softkeys ("f" keys) are defined. The operating system uses two menus, one for unshifted softkeys and one for shifted softkeys. The prompts do *not* indicate which definition is in effect. For example, if the shifted menu is displayed, pressing the unshifted softkey does not perform the shifted function (it performs the unshifted function).

`SYSDEVS` exports the following type.

```
MENUTYPE = (M_NONE, M_SYSNORM, M_SYSSHIFT, M_U1, M_U2, M_U3, M_U4);
```

The `MENUSTATE` variable indicates which menu is currently displayed. Only the first three menu types are used by the operating system. The user menus are provided for your own use.

Two system menus are also exported by `SYSDEVS`.

- `SYSTEMMENU` A string pointer to the unshifted system softkey menu.
- `SYSTEMMENU SHIFT` A string pointer to the shifted system softkey menu.

To simplify using the menus, SYSDEVS also exports a pointer type (STRING80PTR) that can be used to point to menu strings. If you want to change a menu, change the pointer, not the string.

The following example program sets a user menu.

```

$sysprog$
Program CRT8(input,output);

import sysglobals, sysdevs;

const
    sPmenu = string80
    ['! f1 | f2 | f3 | f4 | ||| ||| f5 | f6 | f7 | f8 |'];
var
    z,
    dummyi : integer;
    dummyc : char;
    savemode, saveecho : boolean;
    savemenustate : menustate;
    sSpecialmenu : string80ptr;

begin
    savemode := kbdsysmode;
    kbdsysmode := false;
    savemenustate := menustate;
    menustate := m_none;
    saveecho := keybuffer^.echo;
    keybuffer^.echo := false;
    call(crtllhook,cllclear,dummyi,dummyc);    {clear last line}
    sSpecialmenu := addr(sPmenu);             {point at the menu}
    call(crtllhook,clldisplay,sSpecialmenu^.dummys);
    writeln('Wow. A menu. ');
    for z := 1 to 250000 do;
        write(#12);
        call(crtllhook,cllclear,dummyi,dummyc);    {clear last line}
        kbdsysmode := savemode;
        {menustate := savemenustate;}
        keybuffer^.echo := saveecho;
    end.

```

A more complete menu example is given in a later program.

The Status Area

The last eight character positions on the display are used for status indicators and the runlight. The operating system uses the last position as the runlight and the next to the last character as the menu mode ("U" for user or "S" for system). The debugger uses the entire status area to display its information. If you are not using the debugger, you may use any of the first five positions of the status area without disturbing other functions.

SYSDEVS exports a procedure that lets you change the contents of the status area. Although this includes the runlight position, there is special procedure for changing the runlight (described next). The status area can also be controlled by the last line hook mentioned previously.

- `SETSTATUS(n,c)` – This procedure lets you position (*n*) a character (*c*) in the status area.

An error will occur if the position (*n*) is outside the range 0 through 7.

While characters can be written to the status area by the `SETSTATUS` procedure or by the `ctrlhook`, to read the current values you will need to use the `STATUSLINE` variable.

- `STATUSLINE` – This variable contains a readable copy of the status display area of the system CRT (e.g. `STATUSLINE[7]` is the runlight).

The following program manipulates the contents of the status area.

```

program CRT9(input, output);

import sysdevs;

var   i, j, z : integer;
      c : char;

begin
  for i := 1 to 100 do
    begin
      for j := 0 to 7 do
        begin
          setstatus(j, '*');
          for z := 1 to 1999 do;
            setstatus(j, ' ');
          end;
        end;
      end;
    end;
  end.

```

The Runlight

The last character position on the display is reserved for the runlight. The runlight indicates which subsystem is in use or which operation is in progress. When the system is waiting for input, the runlight usually indicates an I/O condition.

SYSDEVS exports a function and a procedure for accessing the runlight.

- `RUNLIGHT` – This function returns the current character being displayed in the runlight position.
- `SETRUNLIGHT(c)` – This procedure sets the runlight to the specified character.

The following program plays with the runlight.

```

program CRT10(input, output);

import sysdevs;

var   i, z : integer;
      c : char;

begin
  c := runlight;           {save value for later}
  for i := 32 to 127 do
    begin
      setrunlight(chr(i));
      for z := 1 to 1999 do;
      end;
      setrunlight(c);     {restore runlight value}
    end;
end;

```

Unless you have changed it, the `RUNLIGHT` function returns an R, X, or D during the running, execution, or debugging of a program.

By now you may have noticed that there are at least three different ways to change the runlight. (You can use the last line hook, the status area procedure, or the runlight procedure.)

The Debugger Window

`SYSDEVS` supports an independent window into the display screen. Although originally designed for the debugger's use, the window can be used by your programs.

`SYSDEVS` exports the following type which lists the operations for controlling the debugger window.

```

DBCRTOPS = (DBINFO, DBEXCG, DBGOTOXY, DBPUT, DBINIT, DBCLEAR, DBCLINE,
            DBSCROLLUP, DBSCROLLDN, DBSCROLLL, DBSCROLLR, DBHIGHL);

```

These operations are used with the debugger display hook (`DBCRTHOOK`) and a debugger window record (type `DBINFO`) to create and maintain a separate display window. An example call to set the highlight byte (i.e. inverse, blinking, etc.) would appear as follows.

```

call(dbcrthook, DBHIGHL, dbinfo);

```

Where the data parameter `dbinfo` is a variable of type `DBCINFO`. The various operations are listed below.

Command	Action
<code>DBINFO</code>	Requests information about the window parameters. The values are returned in the data parameter.
<code>DBEXCG</code>	Exchanges the contents of the display area with the save area. (See below.)
<code>DBGOTOXY</code>	Positions the cursor at the specified coordinates.
<code>DBPUT</code>	Prints the specified character at the given coordinate.
<code>DBINIT</code>	Initializes the window.
<code>DBCLEAR</code>	Clears the window.
<code>DBCLINE</code>	Clears the current line.
<code>DBSCROLLUP</code>	Scrolls the contents of the window up one line. (The contents of the top line are lost.)
<code>DBSCROLLDN</code>	Scrolls the contents of the window down one line. (The contents of the bottom line are lost.)
<code>DBSCROLLL</code>	Scrolls the contents of the window left one column. (The contents of the first column are lost.)
<code>DBSCROLLR</code>	Scrolls the contents of the window right one column. (The contents of the last column are lost.)
<code>DBHIGHL</code>	Sets the default highlight byte. (e.g. blinking, inverse, etc.)

One nice feature of the debugger window is its ability to save the current display contents. This allows you to use the window then restore the original contents.

The steps to set up and use this feature are outlined below.

1. Choose and set the window margins.
2. Call `DBINFO` to compute the number of bytes needed to save the display area.
3. Call the system procedure `newbytes` (found in module `ASM`) to reserve space for the display contents.
4. Call `DBINIT` to initialize the window.
5. Call `DBEXCG` to exchange the contents of the display with the contents of the save area.
6. Call `DBCLEAR` to clear the window for use.
7. After using the window, call `DBEXCG` to restore the original contents to the display.

The following program demonstrates the various debugger window operations and then restores the original window contents.

```

$sysprog$
Program CRT11(input,output);

import sysglobals, asm, sysdevs;

type
  dbstring = string[255];
  tricky = record case boolean of
    true : (i : integer);
    false : (a : anyPtr);
  end;
var
  i, w, h, z : integer;
  dbcX, dbcY : integer;
  dbs : dbstring;
  dbCrtInfo : dbcinfo;
  trickrec : tricky;

Procedure debug_info;
begin
  call(dbcrtHook,DBINFO,dbCrtInfo);           {request info}
  with dbCrtInfo do
    begin
      trickrec.a := savearea;                 {trick to print pointer value}
      write(' xmin xmax ymin ymax curx cury');
      if w < 80 then writeln;                 {small screen}
      writeln(' savearea savesize dcuraddr', ' areaisdbCrt');
      write(xmin:5,xmax:5,ymin:5,ymax:5,cursx:5,cursy:5);
      if w < 80 then writeln;
      writeln(trickrec.i:9,savesize:9,dcursoraddr:9,areaisdbCrt:13);
    end;
  end; {proc}

Procedure open_dbwindow;
var
  I : integer;
begin
  with dbCrtInfo do
    begin
      xmin := 0;    xmax := w-1;             {set desired window size}
      ymin := h-5;  ymax := h-1;
      cursx := xmin; cursy := ymin;         {set cursor inside window}
      call(dbcrtHook,DBINFO,dbCrtInfo);    {compute savearea size}
      newbytes(savearea,savesize);         {create space for image}
      call(dbcrtHook,DBINIT,dbCrtInfo);    {initialize window}
      call(dbcrtHook,DBEXCG,dbCrtInfo);    {save display contents}
    end; {with}
  end; {proc}

```

```

Procedure dbwrite(var dbcx, dbcy : integer; dbs : dbstring);
var
  i : integer;
begin
  with dbcrtinfo do
    begin
      call(dberthook,DBINFO,dbcrtinfo);           {check values}
      if dbcx > xmax then dbcx := xmax;          {check boundrys}
      if dbcx < xmin then dbcx := xmin;
      if dbcy > ymax then dbcy := ymax;
      if dbcy < ymin then dbcy := ymin;
      cursx := dbcx; cursy := dbcy;
      call(dberthook,DBGOTOXY,dbcrtinfo);        {set cursor}
      for i := 1 to strlen(dbs) do
        begin
          c := dbs[i];
          call(dberthook,DBPUT,dbcrtinfo);        {Print each character}
          cursx := cursx + 1;                     {compute new cursor position}
          if cursx > xmax then
            begin
              cursx := xmin;
              cursy := cursy + 1;
              if cursy > ymax then
                begin
                  call(dberthook,DBSCROLLUP,dbcrtinfo);   {need new line}
                  cursy := ymax;
                end;
            end;
          call(dberthook,DBGOTOXY,dbcrtinfo);      {update cursor position}
        end;
      dbcx := cursx; dbcy := cursy;               {return the new position}
    end; {with}
  end; {Proc}

begin
  with syscom^.crtinfo do
    begin
      w := width;                               {display-screen width}
      h := height;                              {display-screen height}
    end;
    for i := 1 to h-1 do writeln(' ':w-3,i:0);   {print line numbers}
    write(' ':w-3,h:0);                          {print last line number}
    writeln(#1,#10,'Initial Conditions'); debug_info;
    open_dbwindow;
    writeln(#10,'Debugger window parameters'); debug_info;
    writeln(#10,'Writing into debug window. ');
    dbcx := 0; dbcy := 0;                        {cursor position}
    for i := 1 to 200 do dbwrite(dbcx, dbcy, 'This is the Debugger window. ');
    for z := 1 to 10000 do
      dbs := ''; dbcx := 0; dbcy := 22; dbwrite(dbcx,dbcy,dbs);
    for z := 1 to 100000 do
      beep; call(dberthook,dbscrollup,dbcrtinfo);   {go up}
    for z := 1 to 100000 do
      beep; call(dberthook,dbscrollldn,dbcrtinfo);  {go down}
    for z := 1 to 100000 do
      beep; call(dberthook,dbscrollll,dbcrtinfo);   {go left}
    for z := 1 to 100000 do
      beep; call(dberthook,dbscrollr,dbcrtinfo);    {go right}

```

```

for z := 1 to 100000 do;
  beep; call(dbcrtHook,DBEXCG,dbcrinfo);           {restore image}
  writeln(#10,'Display restored. '); debug_info;
end,

```

No checking is performed by the debugger window hook to ensure that you stay within the window boundaries. Of course, if you change something outside the window area, the original contents will not be restored by the `DBEXCG` command.

Note that during the scrolling operations, characters on the edge of the window are lost and not restored by later operations.

A Simplified Window

If you do not care what happens to the original contents of the display window, several of the steps previously explained can be eliminated.

The following steps create a window but do not save the original contents of the display.

1. Choose and set the window margins.
2. Call `DBINIT` to initialize the window.
3. When you are finished with the window, call `DBCLEAR` to clear the window.

This simpler method may improve performance when using multiple windows.

The Keyboard

Currently, there are three different styles of keyboards used with Series 200 Computers and supported by SYSDEVS.

- The HP 98203A Keyboard. A small detachable keyboard with a rotary pulse generator (knob).
- The HP 98203B Keyboard. A large keyboard with a rotary pulse generator (knob).
- The HP 46020A Keyboard. A thin keyboard that is electronically compatible with the HP-HIL (Hewlett-Packard Human Interface Link).

All of these keyboards are supported by SYSDEVS, however, only one of these keyboards is used by a particular Series 200 Computer. This is no problem if you are writing programs for *your* computer. If you plan to write programs that will work on *all* Series 200 Computers, your program should only use those keys that are available on all keyboards. (See the section on Keyboards and Keycodes.)

To determine the type of keyboard, SYSDEVS exports the following enumerated type.

```
KEYBOARDTYPE (NOKBD, LARGEKBD, SMALLKBD, ITFKBD, SPECIALKBD1, SPECIALKBD2);
```

At this time only the first four types are supported by the system. (The HP-HIL keyboard is the ITFKBD in the preceding type declaration.) If you create some special hardware configuration that acts like a keyboard, you might wish to stop the system from trying to interpret your signals by setting the keyboard type to one of the unused values.

SYSDEVS also exports the following type that lists the languages which can be supported by Pascal.

```
LANGTYPE = (NO_KBD, FINISH_KBD, BELGIAN_KBD, CDN_ENG_KBD, CDN_FR_KBD,
            NORWEGIAN_KBD, DANISH_KBD, DUTCH_KBD, SWISS_GR_KBD, SWISS_FR_KBD,
            SPANISH_EUR_KBD, SPANISH_LATIN_KBD, UK_KBD, ITALIAN_KBD,
            FRENCH_KBD, GERMAN_KBD, SWEDISH_KBD, SPANISH_KBD,
            KATAKANA_KBD, US_KBD, ROMANB_KBD, NS1_KBD, NS2_KBD, NS3_KBD);
```

These two types are used with the keyboard request hook in the following program to print your keyboard type and language.

```
$sysprog$
Program KBD1(input,output);

import sysglobals, sysdevs;

var i, rv : integer;
    s : string[255];
    kbdata : byte;

begin
  call(kbdreqhook, SET_KBDLANG, kbdata);           {sets kbdlang}
  call(kbdreqhook, SET_KBDTYPE, kbdata);          {sets kbdconfig and kbdtype}
  writeln('Configuration byte = ', kbdconfig:3);
  writeln(' Keyboard language = ', kbdlang);
  writeln(' Keyboard type = ', kbdtype);
end.
```

The Keyboard Hooks

SYSDEVS exports several hooks (procedure variables) for accessing the features of the keyboard.

KBDREQHOOK	This hook is used to pass information to and from the keyboard controller hardware.
KBDIOHOOK	This is the procedure variable called by the file system to read from the typeahead buffer.
KBDISRHOOK	This hook is invoked when a key is pressed, to handle key codes. (This is an extension of the keyboard interrupt service routine found in earlier releases of Pascal.)
KBDPOLLHOOK	This procedure variable is used to allow keyboard operations when the processor priority is too high for normal operations.

Most of these hooks are explained below.

Keyboard Request Hook

This procedure has two parameters. The first is the command or request code and the second is the data value to be sent or returned. Thus, a typical system call would appear as follows.

```
CALL(kbdreqhook, request, kdata);
```

Where `kdata` is a variable of type `byte`. The supported requests are given below.

Request	Description
KBD_ENABLE	Allows the keyboard controller to interrupt. The data parameter is not used or changed. Note that for non-HP-HIL keyboards this operation is identical to <code>RPG_ENABLE</code> . (See the later section about the Knob.)
KBD_DISABLE	Stops the keyboard controller from interrupting. The data parameter is not used or changed. Note that for non-HP-HIL keyboards this operation is identical to <code>RPG_DISABLE</code> . (See the later section about the Knob.)
SET_AUTO_DELAY	Sets the time delay from keypress to first auto repeat of the key. The data parameter is the time in centiseconds.
GET_AUTO_DELAY	Returns the value set by the last <code>SET_AUTO_DELAY</code> . The value is returned in the data parameter.
SET_AUTO_REPEAT	Sets the time interval between auto repeated keys. The data parameter is the time in centiseconds.
GET_AUTO_REPEAT	Returns the value set by the last <code>SET_AUTO_REPEAT</code> . The value is returned in the data parameter.
SET_KBDTYPE	Reads the configuration byte from the keyboard controller and sets <code>KBDCONFIG</code> and <code>KBDTYPE</code> . The data parameter will be the same value as <code>KBDCONFIG</code> .
SET_KBDLANG	Reads the language byte from the keyboard controller and decodes the byte to set <code>KBDLANG</code> . The data parameter will be the same value as the language byte.

The following program lets you change the keyboard repeat and delay settings.

```

$sysprog$
Program KBD2(input,output);

import sysglobals, sysdevs;

var i, rv : integer;
    s : string[255];
    auto_repeat,
    auto_delay : byte;

begin
  call(kbdreqhook, GET_AUTO_REPEAT, auto_repeat);
  writeln('Current auto-repeat-rate = ', auto_repeat);
  call(kbdreqhook, GET_AUTO_DELAY, auto_delay);
  writeln('Current delay-before-repeat time = ', auto_delay);
  writeln;
  write('Enter new auto-repeat-rate (0..255): ');
  readln(s);
  if strlen(s) > 0 then
    begin
      try
        stread(s,1,rv,i);
        if i in [0..255] then
          begin
            auto_repeat := i;
            call(kbdreqhook, SET_AUTO_REPEAT, auto_repeat);
          end
        else
          writeln('Out-of-range');
          recover writeln('*** not-numeric input ***');
        end;
      writeln;
      write('Enter new delay-before-auto-repeat (0..255): ');
      readln(s);
      if strlen(s) > 0 then
        begin
          try
            stread(s,1,rv,i);
            if i in [0..255] then
              begin
                auto_delay := i;
                call(kbdreqhook, SET_AUTO_DELAY, auto_delay);
              end
            else
              writeln('Out-of-range');
              recover writeln('*** not-numeric input ***');
            end;
          end;
        end.

```

Keyboard ISR Hook

The `KBDISRHOOK` procedure variable is called by the keyboard controller to handle keycodes. You must exercise caution if you take control of this hook. If an error should occur, you may not be able to regain control of the keyboard. You may have to cycle power to restore the system.

This is the second hook to be invoked whenever a key is pressed. The first hook is the `KBDTRANSHOOK`. See the later section on Translation Services for the details of that hook.

The following program prints the keycode and modifiers for each keystroke.

```

$sysprog$
Program KBD3(input,output);

import sysglobals, sysdevs;

var Keycount : integer;
    savehook : kbdhookType;

procedure Kbdhook(var statbyte, databyte : byte; var doit : boolean);
begin
    {Interrupt Service Routine}
    Keycount := Keycount + 1;
    write(Keycount:3,' ');
    if not odd(statbyte div 32) then write('Control-') else write(' ');
    if not odd(statbyte div 16) then write('Shift-') else write(' ');
    if not odd(statbyte div 8) then write('Extend-') else write(' ');
    writeln(' Databyte: ',databyte:3,' ');
end;

begin
    try
        Keycount := 0;                               {initialize count}
        savehook := KbdISRhook;                       {save old key hook}
        KbdISRhook := Kbdhook;                        {use new hook}
        writeln('Waiting for Keystrokes');
        repeat
            until Keycount > 24;
            escape(0);
        recover
            begin
                KbdISRhook := savehook;                {restore old hook}
                writeln('Stopped');
            end;
    end.

```

Running this program will suspend normal processing of keystrokes and print the keycode for each key. After a few keystrokes, the system will be returned to normal.

Keyboard Poll Hook

The `KBDPOLLHOOK` procedure variable is used to detect keystrokes when the processor priority is too high for normal operations.

The following program demonstrates its use.

```

$sysProg$
Program KBD4(input,output);

import sysglobals, asm, sysdevs;

var
  savehook, saveisrhook : KbdhookType;
  tdata : timerdata;           {type is from sysglobals}
  busy : boolean;
  z : integer;
  c : char;

procedure Kbdhook(var statbyte, databyte : byte; var done : boolean);
var busy, shift : boolean;
begin
  {Keyboard Interrupt Service Routine}
  writeln('Keyboard Hook Called. ');
end;

procedure timehook(var statbyte, databyte: byte; var doit: boolean);
var z : integer;
begin
  {Timer Interrupt Service Routine}
  if odd(statbyte div 32) {timer} and odd(databyte div 64) {delay} then
    begin
      writeln('Now executing a very slow timer hook without polling');
      writeln('Try typing a few keys. ');
      writeln;
      for z := 1 to 1000000 do;
        writeln;
      writeln('Now executing a very slow timer hook with polling');
      writeln('Try typing something. ');
      for z := 1 to 50000 do call(KBDPOLLHOOK, busy);
      writeln('Now leaving timer ISR');
    end
  else
    call(saveisrhook, statbyte, databyte, doit); {pass it on}
end; {proc}

```

```

begin
  try
    savehook := kbdisrhook;           {save old key hook}
    kbdisrhook := kbhook;           {use new key hook}
    saveisrhook := timerisrhook;    {save old timer hook}
    timerisrhook := timehook;       {use new timer hook}
    tdata.count := 375;              {3.75 seconds}
    call(timeriohook, DELAY, SETT, tdata); {set DELAY timer}
    writeln('In a moment, a timer will interrupt ');
    writeln('and a very slow ISR will be executed. ');
    writeln('At first, no keystrokes will be detected. ');
    writeln;
    writeln;
    call(MASKOPSHOOK, TIMERMASK, 0);  {enable timer interrupts}
    for z := 1 to 1000000 do;         {wait for interrupt}
      escape(0);
    recover
    begin
      call (MASKOPSHOOK, 0, TIMERMASK); {disable timer interrupts}
      kbdisrhook := savehook;          {restore old hook}
      timerisrhook := saveisrhook;    {restore old hook}
      writeln('Program stopped. ');
    end;
  end.

```

When this program is run, it sets the delay timer to interrupt a few seconds in the future, prints a message, and waits for the interrupt. Once the timer ISR has been invoked by the interrupt, further keystrokes are “masked” by the fact that the interrupt priority is now at level 1 (the same level that the keyboard uses). After a few seconds, keyboard polling is enabled and the keystrokes are acknowledged.

It is recommended that this feature be used only when absolutely necessary.

The Keybuffer

The main purpose of the type-ahead keybuffer is to provide a place for the keyboard interrupt service routine to store keydata until the system or current program is ready to read it. Access to this buffer is provided through a procedure named `KEYBUFOPS`.

Control of the keybuffer has changed from earlier releases of Pascal. The buffer is now managed through a procedure residing in `SYSDEVS` which allows the keyboard system to operate even if no display hardware exists inside the computer. For speed of operations, the buffer is now maintained as a circular queue. The array containing the keydata is available for direct access but it is not recommended that this be done. Instead, `SYSDEVS` exports several procedures for maintaining the keybuffer.

The variable `KEYBUFFER` is a pointer to a `KBUFREC` which is shown below.

```
KBUFREC = RECORD
    ECHO: BOOLEAN;
    NON_CHAR: CHAR;
    MAXSIZE,SIZE,INP,OUTP: INTEGER;
    BUFFER: KBUFPTR;
END;
```

The fields are described below.

ECHO	Returns <code>TRUE</code> if operations on the <code>BUFFER</code> and <code>NON_CHAR</code> are to be reflected on the system display. You may set this variable true or false depending on whether you want the operations to be reflected on the system display.
NON_CHAR	Used to store a readable copy of the current non_advanced character (if any) used by keyboard semantic procedures.
MAXSIZE	The current maximum size of the buffer (in practice this is set by the CRT driver depending on the amount of display area devoted to the typeahead).
SIZE	The number of characters currently in the buffer.
INP	Internal buffer input index. This variable points to the next location where keydata will be placed. This is not the pointer to the displayed type-ahead keybuffer.
OUTP	Internal buffer output index. This variable points to the next location where keydata will be removed. This is not the pointer to the displayed type-ahead keybuffer.

The following program prints the current values of the keybuffer record.

```
Program KBD5(output);

import sysdevs;

begin
  with Keybuffer^ do
    begin
      writeln('Echo: ',echo);
      writeln('Non-char: "',non_char,'"   Ord(non_char): ',ord(non_char):3);
      writeln('Maxsize: ',maxsize:3,'   Size: ',size:3,
              '   Inp: ',inp:3,'   Outp: ',outp:3);
    end;
end.
```

Try running this program several times (use the User-restart command). Each time the program is run, the input and output pointers will change. If you hold down the key, the buffer will fill and the `size` parameter will increase.

Keybuffer Control

To manipulate the contents of the keybuffer, `SYSDEVS` exports the `KEYBUFOPS` procedure. This procedure has two parameters, the first is the keybuffer operation and the second is a character. The operations are listed in the following type and explained below.

```
KOCTYPE = (KGETCHAR, KAPPEND, KNONADVANCE, KCLEAR, KDISPLAY,
           KGETLAST, KPUTFIRST);
```

Each operation is explained below.

<code>KGETCHAR</code>	The first character in the buffer is moved to <code>C</code> , then deleted from the buffer. Do not do this if the buffer is empty (i.e. <code>KEYBUFFER^.SIZE = 0</code>).
<code>KAPPEND</code>	Move the character <code>c</code> to the end of the buffer. <code>NON_CHAR</code> is set to an ASCII space. Do not make this call if the buffer is full (i.e. <code>KEYBUFFER^.SIZE = KEYBUFFER^.MAXSIZE</code>).
<code>KNONADVANCE</code>	The character <code>c</code> is moved to <code>NON_CHAR</code> .
<code>KCLEAR</code>	The buffer is set empty.
<code>KDISPLAY</code>	If <code>ECHO = TRUE</code> then display line is cleared, the current buffer contents sent to the display, otherwise do nothing.
<code>KGETLAST</code>	Move the last character in the buffer to <code>c</code> then delete it from the buffer. Do not make this call if the buffer is empty (i.e. <code>KEYBUFFER^.SIZE = 0</code>).
<code>KPUTFIRST</code>	Move the character <code>c</code> to the front of the buffer. Do not make this call if the buffer is full (<code>KEYBUFFER^.SIZE = KEYBUFFER^.MAXSIZE</code>).

An typical call to append a character to contents of the type-ahead buffer, would appear as follows.

```
KEYBUFOPS(KAPPEND, c);
```

Where `c` is of type `char`. An example of this feature is shown in the next section.

Keybuffer I/O Hooks

A pair of hooks exists for the file system interface to the keybuffer. These procedure variables allow you to control the access to the keybuffer.

- `KBDWAITHOOK` – This procedure variable is called when there is a read request from the file system and the typeahead buffer is empty.
- `KBDRELEASEHOOK` – This procedure is called from the keyboard ISR when data is placed in the buffer.

The following example demonstrates these hooks.

```

$sysprog$
Program KBDB(input,output);

import sysdevs;

var
  c,d : char;
  z : integer;
  i : integer;
  s : string[255];
  done : boolean;
  savewaithook : Procedure;
  savereleasehook : Procedure;

Procedure release_here;
begin
  done := false;
  writeln('Release hook activated,');
  if Keybuffer^.inp = 0 then
    c := Keybuffer^.buffer^[Keybuffer^.maxsize]      {get the last character}
  else
    c := Keybuffer^.buffer^[Keybuffer^.inp-1];      {get the last character}
  if c = chr(13) then done := true;                {was it a C/R?}
end;

Procedure wait_here;
begin
  writeln('Wait hook activated,');
  repeat {nothing} until done;                    {wait until a C/R?}
end;

begin
  try
    writeln('If you have a menu displayed, please turn it off,');
    for z := 1 to 300000 do;
      writeln;
      writeln('In a few seconds, ',
              'the file system will attempt to read from the keybuffer');
      for z := 1 to 300000 do;
        writeln;
        writeln('When you see that the wait hook has been activated,');
        writeln('Press a few keys and then press <enter> or <return>,');
        writeln;
        savewaithook := Kbdwaithook;                {save wait hook}
        Kbdwaithook := wait_here;
        savereleasehook := Kbdreleasehook;          {save release hook}
        Kbdreleasehook := release_here;
        for z := 1 to 200000 do;
          readln(s);                                {file system request}
          writeln;
          write('The string returned by the readln statement is: ');
          writeln(s);
          writeln;
          escape(0);
        recover

```

```

begin
  if escapecode <> 0 then writeln('Error:',escapecode:3);
  kbdwaithook := savewaithook;
  kbdreleasehook := savereleasehook;
  writeln('Done.');
```

```

end;
end.
```

Key Translation Services

A new set of procedures has been created as part of the translation services facility. These procedures provide mappings of keycodes to “universal keycodes” and keycode to character (see the Keycode section for details on keycode mapping). The main purpose of this package is to centralize system translation requirements. If you take control of the keyboard hook, you can use these services to decode keystrokes.

Keystrokes are processed on two levels. When a key is pressed, the system first invokes the key translation hook (`KBDTRANSHOOK`). This hook will provide whatever semantics are necessary to perform the requested operation regardless of the keyboard type. When the translation hook is finished, a call is made to the keyboard ISR hook (`KBDISRHOOK`) where normal key processing can occur.

The Translation Hook

All keystrokes are first interpreted by the translation hook (`KBDTRANSHOOK`). `SYSDEVS` exports a type (`KEYTRANSTYPE`) and a variable of that type (`TRANSMODE`) which control the actions performed by the translation hook. The possible modes are:

```
KEYTRANSTYPE = (KPASSTHRU, KSHIFT_EXTC, KPASS_EXTC);
```

These types are explained below.

<code>KPASSTHRU</code>	This mode causes no keycode interpretation. All first level keycode interpretation is by-passed (including <code>SYSTEM/USER</code> mode conversions of softkeys).
<code>KSHIFT_EXTC</code>	This mode treats the “Extend char” keys as shift keys. (This is the “normal” setting.)
<code>KPASS_EXTC</code>	In this mode, only the down-stroke of the “Extend char” keys is passed. (This is the “normal” setting for <code>KATAKANA</code> keyboards.)

The common language record variable, `LANGCOM`, is a record (type `LANGCOMREC`) which contains the original keystroke information and the results of the semantic action of the translation hook. The fields for a `LANGCOMREC` are listed below.

<code>STATUS</code>	Contains the original keyboard status register value.
<code>DATA</code>	Contains the original keyboard data register value.
<code>KEY</code>	Interpreted key (usually an ascii character code).
<code>RESULT</code>	The return code from the semantic routine.
<code>SHIFT</code>	This boolean returns true if the shift key was held down.
<code>CONTROL</code>	This boolean returns true if the control key was held down.
<code>EXTENSION</code>	This boolean returns true if the extension key was in the “down” mode.

Another important keycode translation variable is `LANGTABLE` (an array [0..1] of type `LANGPTR` where `LANGPTR` is a pointer to a `LANGRECORD`). This variable is the “look-up” table for the translation of keycodes into characters and is the control record for the current keyboard “language”. The fields are shown below.

<code>CAN_NONADV</code>	When true this variable indicates non-advancing keys are allowed.
<code>LANGCODE</code>	Contains the language code for this record (type <code>LANGTYPE</code>).
<code>SEMANTICS</code>	This procedure does translations for the given language.
<code>KEYTABLE</code>	An array used to translate keycodes.

The last field (`KEYTABLE`) is an array of `LANGKEYREC`. Each `LANGKEYREC` record contains the translation controls for a single key. The fields for a `LANGKEYREC` are described as follows.

<code>NO_CAPSLOCK</code>	If true, ignore the capslock state (<code>KBDCAPSLOCK</code>).
<code>NO_SHIFT</code>	If true, ignore the shift key state.
<code>NO_EXTENSION</code>	If true, ignore the extension key state (may use shift interpretation).
<code>KEYCLASS</code>	The general key class (shown below). <code>KEYTYPE = (ALPHA_KEY, NONADV_KEY, SPECIAL_KEY, IGNORED_KEY, NONA_ALPHA_KEY);</code>
<code>KEYS</code>	These two codes (usually ASCII) are for the unshifted and shifted interpretation of the key.

The following program takes control of the key translation hook and prints selected fields of the preceding records.

```

$sysProg$
Program KBD7(input,output);

import sysglobals, sysdevs;

var Keycount : integer;
    savehook : kbdhooktype;

Procedure kbdhook(var statbyte, databyte : byte; var doit : boolean);
begin
  {Translation Interrupt Service Routine}
  Keycount := Keycount + 1;
  write(Keycount:3,' ');
  with langstable[langindex]^, Keytable[databyte] do
  begin
    writeln(' no-caps no-shift no-ctrl no-ext   Keyclass Key sh-key');
    writeln(' ':4,no_capslock:9,no_shift:9,no_control:9,no_extension:9,
            Keyclass:12,Keys[false]:5,Keys[true]:6);
  end;
  doit := false;           {tell ISR hook to ignore key}
end; {proc}

begin
  try
    Keycount := 0;           {initialize count}
    savehook := kbdtranshook; {save old trans hook}
    kbdtranshook := kbdhook; {use new hook}
    writeln('Waiting for keystrokes');
    repeat
      until Keycount > 24;
    escape(0);
  recover
  begin
    kbdtranshook := savehook; {restore old hook}
    writeln('Stopped');
  end;
end.

```

One other noteworthy variable (KBDSYSMODE) controls the semantic actions of the translation services. When this variable is true, the softkeys will be specially mapped for the HP-HIL keyboards (see the Keyboard Hardware section for an explanation of this mapping).

Modifying the Language Table

As mentioned previously, the LANGTABLE variable is a two element array. This allows two independent key lookup tables. For HP-HIL keyboards, the default language uses the first table while the ROMAN8 characters occupy the second table. For non-HP-HIL keyboards, the second table is used only if the default language is KATAKANA.

If you want to make slight modifications to the lookup table, the following short program generates a long program that can be edited and then executed to change the lookup table.

```

Program KBDB(input,output);

import sysdevs;

const
  test = false;

var
  s   : string[1];
  f   : text;
  i, c : integer;

begin
  writeln('This program will create a program named KBDBALT');
  writeln('on the default (prefixed) volume. ');
  writeln;
  write('Do you wish to proceed? (Y/N) ');
  read(s);
  if not (s[1] = 'y') and not (s[1] = 'Y') then halt(0);
  writeln;
  {Set the "test" constant true to display program, false to create program}
  if test then rewrite(f, 'CONSOLE:') else rewrite(f, ':KBDBALT.TEXT');
  writeln(f, 'PROGRAM KBDBALT(INPUT,OUTPUT);');
  writeln(f);
  writeln(f, 'IMPORT SYSDEVS;');
  writeln(f);
  writeln(f, '{This program installs and enables an alternate language.}');
  writeln(f, '{Change the variables for each keycode as you desire.}');
  writeln(f);
  writeln(f, 'BEGIN');
  with langstable[0]^ do
    begin
      writeln(f, '  LANGTABLE[0]^,CAN_NONADV := ',can_nonadv,';');
      writeln(f, '  LANGTABLE[0]^,LANGCODE := ',langcode,';');
      writeln(f);
      for i := 0 to 127 do
        begin
          if not (i in [0,4,126,127]) then
            begin

```

```

write(i:0,',');
writeln(f,' WITH LANGTABLE[0]^,KEYTABLE['i:0,'] DO');
writeln(f,' BEGIN');
write(f,' NO_CAPSLOCK := ',keytable[i].no_capslock:5,'; ');
writeln(f,'NO_SHIFT := ',keytable[i].no_shift:5,'; ');
write(f,' NO_CONTROL := ',keytable[i].no_control:5,'; ');
writeln(f,'NO_EXTENSION := ',keytable[i].no_extension:5,'; ');
writeln(f,' KEYCLASS := ',keytable[i].keyclass,';');
c := ord(keytable[i].keys[false]);
write(f,' KEYS[FALSE] := CHR('c:0,')');
if not (c in [0..32,125]) then write(f,'{'chr(c),'}');
else write(f,'{');
c := ord(keytable[i].keys[true]);
write(f,'KEYS[TRUE] := CHR('c:0,')');
if not (c in [0..32,125]) then writeln(f,'{'chr(c),'}');
else writeln(f,'{');
writeln(f,' END;');
end;
end;
writeln(f,' WRITELN(''The language table has been modified,'')');
writeln(f,'END.');
```

```

end;
if test = false then close(f,'lock');
```

```

writeln;
writeln('Done.');
```

```

end.
```

Running this program creates another program which, when executed, modifies the language lookup table. Once created, the new program can be easily modified to suit your needs.

The Knob

The knob or RPG (Rotary Pulse Generator) is available with some keyboards and provides a way to quickly move the cursor around the display. By taking control of its hook, you can have the knob perform other functions. Of course, if you do not have this hardware, this hook is of little interest (skip ahead to the next section).

Earlier release of Pascal used the keyboard hook to handle knob interrupts. SYSDEVS now supports a separate hook (RPGISRHOOK) for the knob.

Interrupts from the knob can be enabled or disabled by sending a command through another knob hook (RPGREQHOOK). This procedure has two parameters. The first is the operation while the second is the data value.

The knob request hook allows the following operations.

RPG_ENABLE	Allow the controller to interrupt. The data parameter is not used or changed. Note that this is the same as KBD_ENABLE for non-HP-HIL keyboards.
RPG_DISABLE	Stop the controller from interrupting. The data parameter is not used or changed. Note that this is the same as KBD_DISABLE for non-HP-HIL keyboards.
SET_RPG_RATE	Sets the knob sampling rate to the value specified by the data parameter. The data represents the sample period in centiseconds.
GET_RPG_RATE	Returns the knob sampling rate in the data parameter. The data represents the sample period in centiseconds.

The knob accumulation period can be modified by the following program.

```

$sysprog$
Program KNOB1(input,output);

import sysglobals, sysdevs;

var i, rv : integer;
    s : string[255];
    rate : byte;

begin
  call(rpgreqhook, GET_RPG_RATE, rate);
  writeln('Current Knob-rate = ', rate);
  writeln;
  write('Enter new rate (0..255): ');
  readln(s);
  if strlen(s) > 0 then
    begin
      try
        strread(s,1,rv,i);
        if i in [0..255] then
          begin
            rate := i;
            call(rpgreqhook, SET_RPG_RATE, rate);
          end
        else
          writeln('Out-of-range');
          recover writeln('*** not-numeric input ***');
        end;
      end;
    end;
end.

```

The next program takes over the RPGISRHOOK momentarily.

```

$sysprog$

Program KNOB2(output);

import sysglobals, sysdevs;

var
  z : integer;
  shift, control : boolean;
  saverpshook : kbdhooktype;

procedure knobhook(var statbyte, databyte : byte; var doit : boolean);
begin
  {RPG Interrupt Service Routine}
  shift := not odd(statbyte div 16);
  control := not odd(statbyte div 32);
  if shift then
    if databyte >= 128 then writeln('down') else writeln('up')
  else
    if databyte >= 128 then writeln('right') else writeln('left');
  end;
end;

begin
  saverpshook := rpgrhook;
  rpgrhook := knobhook;
  writeln('Try turning the knob. ');
  for z := 1 to 500000 do {nothing};
  beep;
  rpgrhook := saverpshook;
end.









```

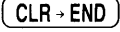

Running this program will cause the knob to print “up”, “down”, “left”, or “right” depending on the direction of the rotation and the status of the shift key. After a few seconds the system will return to normal.

Keyboard Hardware











In general, application programs written and compiled prior to this release of Pascal can execute with the new HP-HIL keyboard without change. However, since some keys no longer exist, the new keyboard supports two softkey interpretation modes: User mode and System mode. The current mode is signified by the letter "s" or "u" appearing in the lower-right corner next to the runlight.

In system mode, the following softkeys ("f" keys) are defined as follows.

Softkey	Definition
f1	
f2	
f3	
f4	
f5	
f6	
f7	
f8	

At powerup the keyboard is in System mode. In User mode the "f" keys (f1 through f8) are mapped to the "k" keys (k1 through k8) found on the older type keyboards. Only the  key and the  key found on the older keyboards have no equivalent keys on the new keyboard.

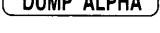
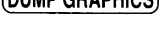
Other keys are mapped as follows.

Old Key	New key
	 (Appears in a different location)
	RETURN
	SELECT
	BREAK
	
	
	PRINT
	 -PRINT

The following illustrations show the keycodes generated by the keys found on each of the three classes of keyboards supported by SYSDEVS. A key-action table follows that can be used to determine the system's response to a particular keystroke.

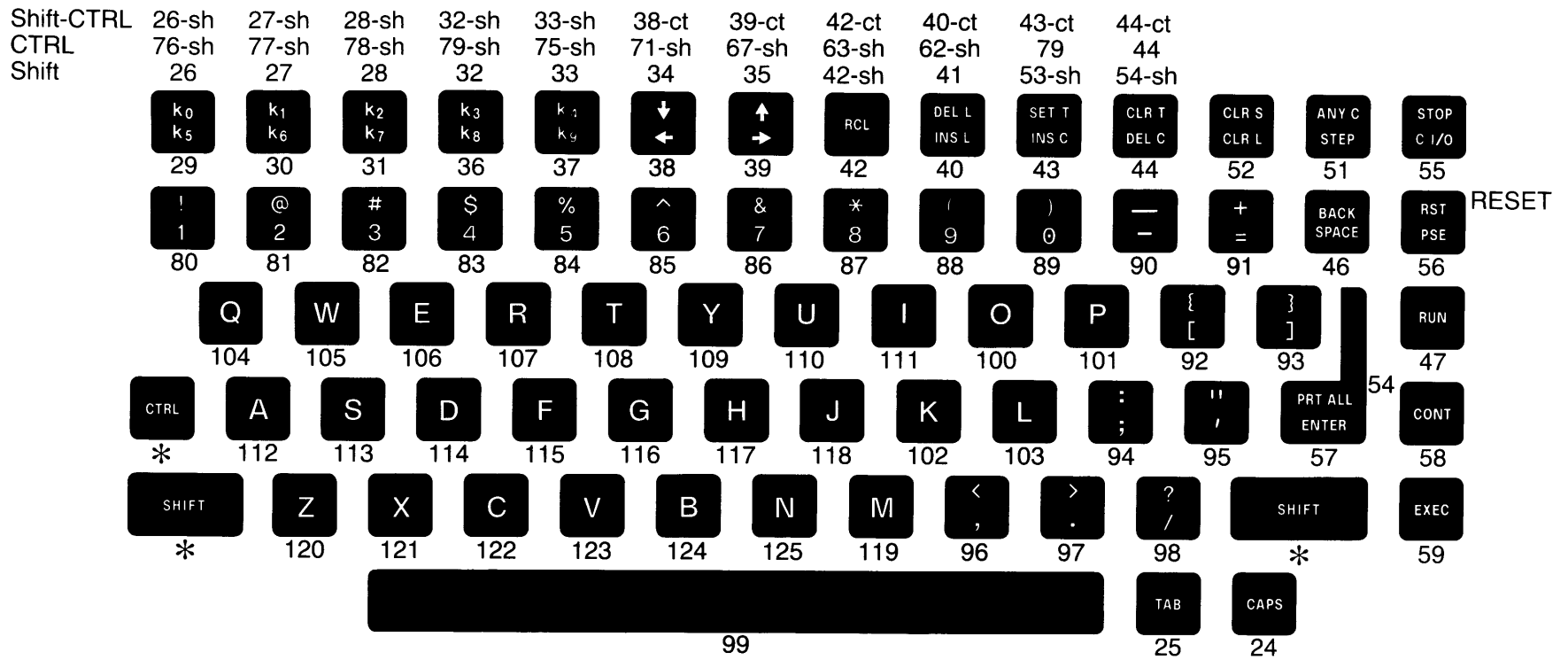

HP 98203A Keyboard

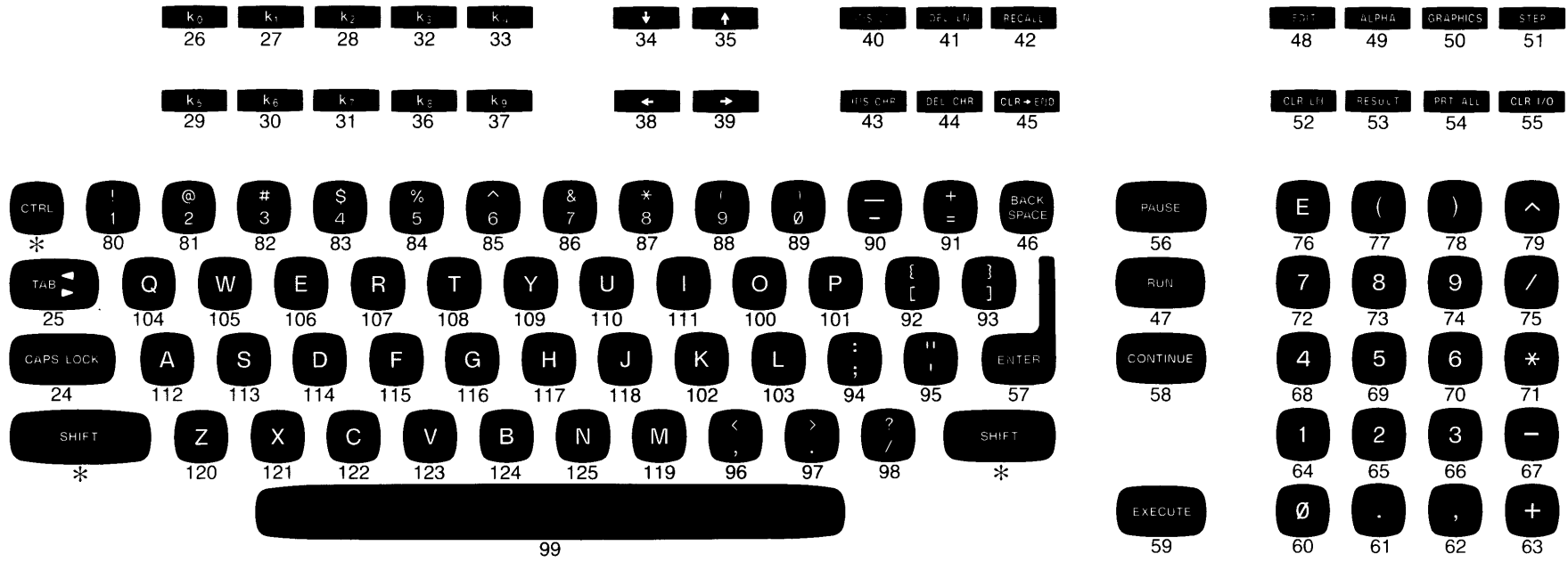

HP 98203B Keyboard

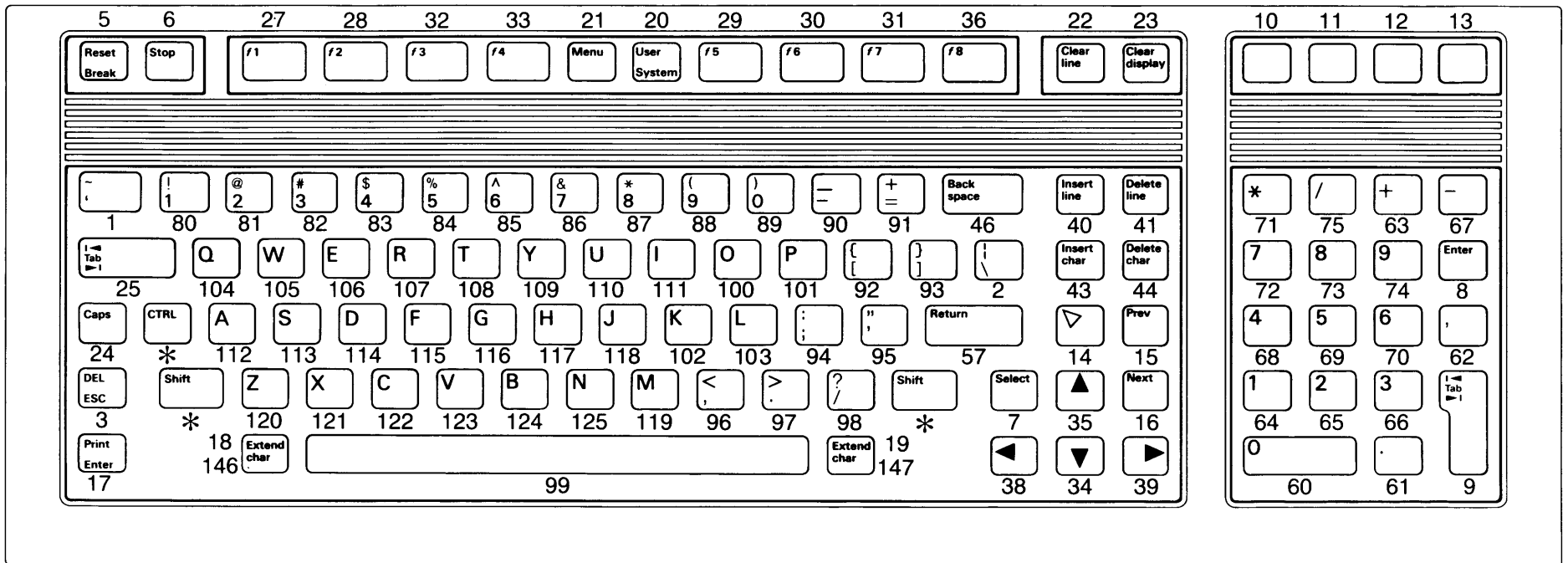

HP 46020A Keyboard

Key-Actions

The following table lists all possible keycodes and the operating system's response to each keycode.

Note

Not all keycodes can be generated by your keyboard. Please refer to the previous illustrations to determine which keycodes can be generated by your keyboard.

0	Undefined. All keycodes labeled "Undefined" are either ignored or cause a beep depending on the language semantics routine installed. The only way to generate an undefined keycode is to call the keyboard or translation hook with the proper data byte and status byte.
1	HP-HIL only – A language dependant character is placed in the typeahead buffer.
2	HP-HIL only – A language dependant character is placed in the typeahead buffer.
3	HP-HIL only – ESC Places CHR(27) in the typeahead buffer. Shifted-key (DEL) places CHR(127) in the typeahead buffer.
4	Undefined.
5	HP-HIL only – With debugger, pauses the system. Otherwise ignored. Shift or Shift-Control – With debugger, enters debugger's command interpreter. Without debugger, performs powerup (level 7 interrupt) Control – With debugger, enters debugger's command interpreter. Otherwise ignored.
6	HP-HIL only – Generates escape -20 and calls cleariohook.
7	HP-HIL only – Send chr(3) to the typeahead keybuffer. If shifted, send chr(27).
8	HP-HIL only, keypad – Send chr(13) to the typeahead keybuffer.
9	HP-HIL only, keypad – Send chr(9) to the typeahead keybuffer.
10	HP-HIL only, keypad – Beeps.
11	HP-HIL only, keypad – Beeps.
12	HP-HIL only, keypad – Beeps.
13	HP-HIL only, keypad – Beeps.
14	HP-HIL only – Beeps.
15	HP-HIL only – Beeps.
16	HP-HIL only – Beeps.
17	HP-HIL only – Send chr(13) to the typeahead buffer. Shift – Dump alpha. Sends the current contents of the alpha display to the system printer. Shift-Control – Dump Graphics. Sends the current contents of the graphics display to the system printer. Control – Beeps.

- 18 HP-HIL only – For non-KATAKANA keyboards, this key acts as a shift key to invoke the ROMAN8 translation of the keycodes (while this key is held down). For KATAKANA keyboards this sets ASCII mode (switches to ASCII translation until key code 19). Keycode 146 is sent when this key is released.
- 19 HP-HIL only – For non-KATAKANA keyboards, this key functions the same as keycode 18. For KATAKANA keyboards this sets KATAKANA mode (switches to KATAKANA translation until key code 18). Keycode 147 is sent when this key is released.
- 20 HP-HIL only – Sets system mode.
Shift – Sets user mode.
Control – Ignored.
- 21 HP-HIL only – Beeps if in user mode.
If in system mode, the key will change the menu display as follows:
Toggles the display between no menu and the unshifted menu unless the shifted menu is displayed in which case the unshifted menu is displayed.
Shift – Toggles the display between no menu and the shifted menu unless the unshifted menu is displayed in which case the no menu is displayed.
- 22 HP-HIL only – Send chr(127) to the typeahead keybuffer.
Control – clears the typeahead buffer.
- 23 HP-HIL only – Send chr(12) to the typeahead keybuffer.
Control – clears the typeahead buffer.
- 24 Toggles capslock state variable.
- 25 Send chr(9) to the typeahead keybuffer.
- 26 Non-HP-HIL only – Beeps.
- 27 Beeps.
- 28 Beeps.
- 29 Beeps.
- 30 Beeps.
- 31 Beeps.
- 32 Beeps.
- 33 Beeps.
- 34 Send chr(10) to the typeahead keybuffer.
- 35 Send chr(31) to the typeahead keybuffer.
- 36 Beeps.
- 37 Non-HP-HIL only – Beeps.
- 38 Send chr(8) to the typeahead keybuffer.
Control – Clears last character in typeahead buffer.

- 39 Send chr(28) to the typeahead keybuffer.
- 40 Send the letter "I" to the typeahead keybuffer.
- 41 Send the letter "D" to the typeahead keybuffer.
Shift – If the keyboard type is "small" then this key is interpreted to be the ALPHA key. (See keycode 49.)
- 42 Non-HP-HIL only – Beeps.
Shift – If the keyboard type is "small" then this key is interpreted to be the GRAPHICS key. (See keycode 50.)
- 43 Send the letter "I" to the typeahead keybuffer.
Shift – If the keyboard type is "small" then this key is interpreted to be the DUMP ALPHA key. (See keycode 49.)
- 44 Send the letter "D" to the typeahead keybuffer.
Shift – If the keyboard type is "small" then this key is interpreted to be the DUMP GRAPHICS key. (See keycode 50.)
- 45 Non-HP-HIL only – Beeps.
- 46 Send chr(8) to the typeahead keybuffer.
Control – Removes the last character in the typeahead buffer.
- 47 Non-HP-HIL only – Send the letter "R" to the typeahead keybuffer.
- 48 Non-HP-HIL only – Send the letter "E" to the typeahead keybuffer.
- 49 Non-HP-HIL only – If the alpha screen is displayed, turn off the graphics screen. Otherwise turn on the alpha screen.
Shift – Dump alpha. Sends the current contents of the alpha display to the system printer.
- 50 Non-HP-HIL only – If the graphics screen is displayed, turn off the alpha screen. Otherwise turn on the graphics screen.
Shift – Dump graphics. Sends the current contents of the graphics display to the system printer.
- 51 Non HP-HIL only – Ignored without debugger. See the Debugger.
Shift – The next 3 digit keys are combined to produce a character (e.g. 065 is the character A).
- 52 Non-HP-HIL only – Send chr(127) to the typeahead keybuffer.
Shift – Send chr(12) to the typeahead keybuffer.
Control – Clears the typeahead buffer.
- 53 Non-HP-HIL only – Beeps.
- 54 Non-HP-HIL only – Beeps.
- 55 Non-HP-HIL only – Generates escape -20 and calls cleariohook.

- 56 Non-HP-HIL only – With debugger, pauses the system. Otherwise ignored.
 Shift or Shift-Control – With debugger, enters debugger’s command interpreter. Without debugger, performs powerup (level 7 interrupt)
 Control – With debugger, enters debugger’s command interpreter. Otherwise ignored.
- 57 Non-HP-HIL only – Send chr(13) to the typeahead keybuffer.
- 58 Non-HP-HIL only – Resumes from paused state. Ignored if no DEBUGGER installed.
- 59 Non-HP-HIL only – Send chr(3) to the typeahead keybuffer.
 Shift – Send chr(27) to the typeahead keybuffer.
- 60 thru 125 All keycodes in this range are alpha keys and the exact character placed in the typeahead buffer depends on the language conversion table active when the key is pressed.
- 125 thru 255 All keycodes above 125 are undefined except 146 and 147.
- 146 Keycode generated when key 18 is released.
- 147 Keycode generated when key 19 is released.

Typing Aids Program

What follows is a listing of a program which lets you redefine the action of all non-alpha keys. It makes use of several features described in this chapter.

This program allows all non-alpha keys (including the “softkeys”) to be used as typing aids. The keys may be defined and used at any time (e.g. you can define a key while using the Editor, Filer, or other subsystem).

To define a key, press and hold both **CTRL** and **SHIFT** keys as you press the (non-alpha) key to be defined. A window will appear on the display and you will then be able to create or edit the keystrokes which will be placed in the typeahead keybuffer when that key is pressed. Each key allows two strings, one for the key and one for the shifted key.

The first seven characters of the edit-string are reserved for the label portion of the string. (The softkey labels appear in the menus.) The remaining characters are what’s placed in the type-ahead buffer.

To enter a control-character in the string, press and hold the **CTRL** key down while pressing the key you want (e.g. **RETURN**, **ENTER**, **BACK SPACE**, etc.) The insert character and delete character keys may also be used to help in the editing process.

When you are finished editing the string, press **EXECUTE** or **SELECT** (depending on your keyboard) to return to normal operation. The next time you press the key you defined, its string will be placed in the type-ahead keybuffer. If the key is undefined, its normal action will occur.

Note that this program will not work if an application program takes control of the keyboard hook. Erratic behavior may occur if you try to define a key during I/O operations.

The program installs itself in the operating system and can be “unhooked” if you need to use the keyboard hooks for some other purpose. If some other program changes the “hooks” you may be able to recover by executing the program and pressing “R” (Remove) and then “I” (Install).

Once you have defined some keys, you can save them in a file called “SOFTKEYS” on the default volume by executing the program and giving the “S” (Save) command. You can then load those definitions by the “G” (Get) command. Remember, the Get command expects to load the key definitions from the default (prefixed) volume.

```

$sysprog on$
$partial_eval on$
$heap_dispose on$
Program KBDSP(input,output);

{ This program is part of the documentation you received and not part
  of the supported system software. With this program you can define
  all non-alphanumeric keys as typing-aids. This program may not work
  correctly on all Series 200 Computers or with all system software. }

module PassKey;

import sysglobals, asm, sysdevs;

export

var
  initialized : boolean;
  using_hooks : boolean;
  edit_mode   : boolean;

  procedure build_menus;
  procedure do_hooks;
  procedure undo_hooks;
  procedure get_keys;
  procedure save_keys;
  procedure PassKey_init;

implement

type
  dbstring = string[80];
  keytable = packed array[0..59,false..true] of dbstring;
  keyfile = file of keytable;
var
  local, sline,
  shift, control,
  knob, ecaps : boolean;           {ecaps = edit mode caps}
  kchar : char;                   {current key char}
  kcode : byte;                   {current key code}
  ecode : byte;                   {edit-key code}
  ktype : keytype;
  edptr : shortint;              {edit-string pointer}
  schar : string[1];             {string character}
  keyfileptr : ^keyfile;
  keytableptr : ^keytable;
  usernorm, usershift : string80ptr; {menus}
  saveisrhook : kbdhooktype;
  savereghook : kbdhooktype;
  savetranshook : kbdhooktype;
  dbcrtinfo : dbcinfo;           {debug window record}
  dbcx, dby : shortint;          {cursor location}
  dbs : dbstring;               {editing strings}

procedure init_dbwindow;
var
  i : integer;

```

```

begin
  call(dbc_rhook,DBINFO,dbcrinfo);
  with dbcrinfo, syscom^.crinfo do
    begin
      xmin := 0;
      xmax := width-1;
      ymin := height-4;
      ymax := height-1;
      cursx := xmin; cursy := ymin;
      call(dbc_rhook,DBINFO,dbcrinfo);
      newbytes(savearea,savesize);
    end; {with}
  end; {Proc}

Procedure dbwrite(var dbcx, dbcy : shortint; dbs : dbstring);
var
  i : integer;
begin
  with dbcrinfo do
    begin
      call(dbc_rhook,DBINFO,dbcrinfo);
      if dbcx > xmax then dbcx := xmax;
      if dbcx < xmin then dbcx := xmin;
      if dbcy > ymax then dbcy := ymax;
      if dbcy < ymin then dbcy := ymin;
      cursx := dbcx; cursy := dbcy;
      call(dbc_rhook,DBGOTOXY,dbcrinfo);
      for i := 1 to strlen(dbs) do
        begin
          c := dbs[i];
          call(dbc_rhook,DBPUT,dbcrinfo);
          if cursx < xmax then cursx := cursx + 1;
          call(dbc_rhook,DBGOTOXY,dbcrinfo);
        end;
        dbcx := cursx; dbcy := cursy;
      end; {with}
    end; {Proc}

Procedure build_menus;
var
  rv : integer;
  dummyc : char;
  dummyi : integer;
begin
  setstrlen(usernorm^,71);
  strwrite(usernorm^,1,rv,'|',str(Keytabptr^[27,false],1,7),'|',
    str(Keytabptr^[28,false],1,7),'|',
    str(Keytabptr^[32,false],1,7),'|',
    str(Keytabptr^[33,false],1,7),'|',
    '###',
    str(Keytabptr^[29,false],1,7),'|',
    str(Keytabptr^[30,false],1,7),'|',
    str(Keytabptr^[31,false],1,7),'|',
    str(Keytabptr^[36,false],1,7),'|');
  setstrlen(usershift^,71);
  strwrite(usershift^,1,rv,'|',str(Keytabptr^[27,true],1,7),'|',
    str(Keytabptr^[28,true],1,7),'|',
    str(Keytabptr^[32,true],1,7),'|',
    str(Keytabptr^[33,true],1,7),'|',
    '###2###',
    str(Keytabptr^[29,true],1,7),'|',
    str(Keytabptr^[30,true],1,7),'|',
    str(Keytabptr^[31,true],1,7),'|',
    str(Keytabptr^[36,true],1,7),'|');
  case menustate of
    m_u1 : call(crtllhook,cldisplay,usernorm^,dummyc);
    m_u2 : call(crtllhook,cldisplay,usershift^,dummyc);
    m_none : begin
      menustate := m_u1;
      kbdsysmode := false;
      setstatus(6,'U');
      keybuffer^.echo := false;
      call(crtllhook,cllclear,dummyi,dummyc);
      call(crtllhook,cldisplay,usernorm^,dummyc);
    end;
  otherwise
  end; {case}
end;
end;

```

```

Procedure translate_key;
type
  clp = packed array[0..59] of char;
const
  {assign add-characters to 'controlled' keycodes for editor}
  ctrlookUP = clp [#000#000#000#027#000#000#000#000#003#013#009,
                  #010#011#012#013#014#015#016#000#000#000,
                  #010#011#127#012#000#009#010#011#012#015,
                  #016#017#013#014#010#031#018#019#008#028,
                  #000#000#000#000#000#000#008#000#000#000,
                  #000#000#127#000#000#000#000#013#027#003]; {0 thru 59}
begin
  Ktype := langstable[langindex]^,keytable[kcode],keyclass;
  if kcode < 3 then
    kchar := langstable[langindex]^,keytable[kcode],keys[ecaps<>shift]
  else
    if kcode < 60 then
      kchar := ctrlookUP[kcode]
    else
      if kcode < 100 then
        kchar := langstable[langindex]^,keytable[kcode],keys[shift]
      else
        if kcode < 126 then
          kchar := langstable[langindex]^,keytable[kcode],keys[ecaps<>shift]
        else
          kchar := langstable[langindex]^,keytable[kcode],keys[shift];
end;

Procedure finish_edit;
begin
  while strlen(dbs) < 7 do strappend(dbs,' ');
  if strlen(dbs) > 80 then setstrlen(dbs,80);
  if NOT shift then keytabetr^[ecode,sline] := dbs; {save the edited line}
  call(dberthook,DBINFO,dbortinfo);
  call(dberthook,DBEXCG,dbortinfo); {restore image}
  if (ecode in [27,..33]) or (ecode = 36) then build_menus;
  edit_mode := false;
  local := true;
end;

Procedure edit_entry;
var
  i, rv : integer;
begin
  if not control and ((kcode=7) or (kcode=59)) then finish_edit
  else
    begin
      translate_key;
      strwrite(schar,1,i,kchar); {copy into str-type if we need it}
      if control or (ktype = alpha_key) then
        begin
          if edptr <= strlen(dbs) then
            begin
              dbs[edptr] := kchar;
              if edptr < 78 then edptr := edptr+1;
              dbwrite(dbcx,dbcy,schar);
            end
          else
            begin
              if strlen(dbs) < 78 then
                begin
                  setstrlen(dbs,strlen(dbs)+1);
                  strwrite(dbs,strlen(dbs),i,kchar);
                  edptr := edptr+1;
                  dbwrite(dbcx,dbcy,schar);
                end;
            end;
          end;
        end
      else {NOT control}
        case kcode of
          24: {caps lock}
            begin
              ecaps := not ecaps; {toggle local capslock}
            end;
        end;
    end;
end;

```

```

34,35: {down-arrow, up-arrow}
begin
  while strlen(dbs) < 7 do strappend(dbs, ' ');
  KeytabPtr^[ecode,sline] := dbs; {save edited line}
  sline := not sline;
  dbcX := 0; i := 2; if sline then i := 3;
  dbcY:=dbcrinfo.ymin + i;
  dbs := KeytabPtr^[ecode,sline];
  dbwrite(dbcX, dbcY, dbs);
  dbcX := 0; if strlen(dbs)=7 then dbcX := 7;
  dbcY:=dbcrinfo.ymin + i;
  edPtr := dbcX + 1;
  dbwrite(dbcX, dbcY, '');
end;

38,46: {left-arrow, back-space}
begin
  if edPtr > 1 then
    begin
      edPtr := edPtr-1;
      dbcX := dbcX - 1; dbwrite(dbcX,dbcY,'');
    end;
  end;

39: {right-arrow}
begin
  if edPtr <= strlen(dbs) then
    begin
      edPtr := edPtr+1;
      dbcX := dbcX + 1; dbwrite(dbcX,dbcY,'');
    end;
  end;

43: {insert-char}
begin
  if strlen(dbs) < 78 then
    begin
      i := strlen(dbs) - edPtr + 1;
      if i > 0 then
        begin
          setstrlen(dbs,strlen(dbs)+1);
          strwrite(dbs,edPtr+1,rV,str(dbs,edPtr,i));
          strwrite(dbs,edPtr,i,' ');
          dbcX := 0; i := 2; if sline then i := 3;
          dbcY:=dbcrinfo.ymin + i;
          dbwrite(dbcX, dbcY, dbs);
          dbcX := edPtr-1; dbwrite(dbcX, dbcY, '');
        end;
      end;
    end;

44: {delete-char}
begin
  if strlen(dbs) > 0 then
    begin
      i := strlen(dbs) - edPtr + 1;
      if i > 0 then
        begin
          strwrite(dbs,edPtr,rV,str(dbs,edPtr+1,i-1));
          setstrlen(dbs,strlen(dbs)-1);
          dbcX := 0; i := 2; if sline then i := 3;
          dbcY:=dbcrinfo.ymin + i;
          dbwrite(dbcX, dbcY, dbs);
          dbwrite(dbcX, dbcY, ' '); {blank-out last char}
          dbcX := edPtr-1; dbwrite(dbcX, dbcY, '');
        end;
      end;
    end;
  otherwise beep;
end; {case}
end; {if-then-else}
end; {Proc}

```

```

Procedure start_edit;
var
  i : integer;
begin
  call(dbcrtHook,DBINIT,dbcrinfo);           {init window}
  call(dbcrtHook,DBEXCG,dbcrinfo);         {save image}
  dbcx:=0; dbcy:=dbcrinfo.ymin + 0;
  dbs := '***** DEFINE KEY xx *****';
  strwrite(dbcx,30,i,kcode:2);             {fix number}
  dbwrite(dbcx, dbcy, dbs);
  dbcx:=0; dbcy:=dbcrinfo.ymin + 1;
  dbwrite(dbcx, dbcy, 'Label..Definition.....');
  dbcx:=0; dbcy:=dbcrinfo.ymin + 2;
  dbwrite(dbcx, dbcy, Keytabetr^[kcode,false]);
  dbcx:=0; dbcy:=dbcrinfo.ymin + 3;
  dbwrite(dbcx, dbcy, Keytabetr^[kcode,true]);
  ecode := kcode;                          {save Keycode for finish_edit}
  if menustate = m_u2 then begin
    sline := true;                          {edit-shift}
    dbcy:=dbcrinfo.ymin + 3;
  end
  else
    begin
      sline := false;                       {edit-normal}
      dbcy:=dbcrinfo.ymin + 2;
    end;
  dbs := Keytabetr^[ecode,sline];          {copy string to edit}
  edptr := 1; if strlen(dbs) >= 7 then edptr := 8; dbcx:=edptr-1;
  dbwrite(dbcx, dbcy, '');                 {Position cursor}
  edit_mode := true;
  local := true;
end;

Procedure newrpsHook(var statbyte, databyte : byte; var doit : boolean);
begin
  {RPG Interrupt Service Routine}
  if not edit_mode then
    call(saverpsHook,statbyte,databyte,doit)
  else
    begin
      local := true;
      kcode := databyte;
      shift := not odd(statbyte div 16);
      control := not odd(statbyte div 32);
      if shift then
        if databyte >= 128 then kcode := 34 else kcode := 35
      else
        if databyte >= 128 then kcode := 39 else kcode := 38;
      edit_entry;
    end;
end;

Procedure newtransHook(var statbyte, databyte : byte; var doit : boolean);
var
  dummyc : char;
  dummyi : integer;
begin
  {First Keyboard ISR, Keycode translation and semantics hook}
  local := false;
  kcode := databyte;
  shift := not odd(statbyte div 16);
  control := not odd(statbyte div 32);
  if edit_mode then edit_entry;
  if not edit_mode and shift and control and
    (kcode < 60) and (kcode > 2) then start_edit
  else
    begin
      if (databyte = 21) or (databyte=26) and (kbdtype <> itfKbd) then
        begin
          databyte := 21;                    {Convert K0 (26) key to be MENU key}
          if NOT Kbdssystemmode then
            begin {usermode}
              doit := not doit;
              if shift then
                if menustate = m_u2 then menustate := m_none
                else menustate := m_u2
            end
          end
        end
      end
    end
  end;
end;

```

```

        else
            if menustate = m_u1 then menustate := m_none
            else menustate := m_u1;
            keybuffer^.echo := (menustate=m_none); {don't echo typeahead}
            call(crtllhook,cllclear,dummyi,dummyc); {clear last line}
        case menustate of
            m_none : begin
                keybufops(Kdisplay,dummyc);
                keybuffer^.echo := true;
            end;
            m_u1   : call(crtllhook,clldisplay,usnorm^,dummyc);
            m_u2   : call(crtllhook,clldisplay,usershift^,dummyc);
            otherwise
            end; {case}
        end; {if}
    end;
end;

if (databyte = 20) or (databyte=37) and (kbdtype <> itfkbd) then
begin
    databyte := 20; {Convert K9 (37) to be USER/SYSTEM key}
    kbdsysmode := not shift;
    if (menustate = m_u1) or (menustate = m_u2) then
        begin
            menustate := m_none;
            keybuffer^.echo := true;
            keybufops(Kdisplay,dummyc);
        end;
    end;

    if doit then call(savetranshook,statbyte,databyte,doit);
end;
end; {proc}

procedure addtobuffer;
var
    c : char;
    i : integer;
    tas : dbstrings;
begin
    i := strlen(keytabptr^[kcode,shift]);
    tas := str(keytabptr^[kcode,shift],8,i-7);
    if (strlen(tas) <= (keybuffer^.maxsize-keybuffer^.size)) then
        for i := 1 to strlen(tas) do
            begin
                c := tas[i]; keybufops(KAPPEND, c);
            end
        else
            beep;
    end;
end;

procedure newisrhook(var statbyte, databyte : byte; var doit : boolean);
begin
    {Keyboard Interrupt Service Routine}
    if not edit_mode and not local then
        begin
            if (kcode < 3) or (kcode > 59) then
                call(saveisrhook,statbyte,databyte,doit)
            else
                if (strlen(keytabptr^[kcode,shift]) < 8) then
                    call(saveisrhook,statbyte,databyte,doit)
                else
                    addtobuffer; {typeahead}
            end;
        end;
end;

procedure do_hooks;
var
    hook1, hook2 : boolean;
begin
    if initialized then writeln;
    hook1 := false;
    hook2 := false;
    if kbdisrhook <> newisrhook then
        begin
            hook1 := true;
            saveisrhook := kbdisrhook;
            kbdisrhook := newisrhook;
            saverpsrhook := rpsrhook;
            rpsrhook := newrpsrhook;
            writeln('ISR Hooks Installed.',#9);
        end
    end;
end;

```

```

else writeln('*** ISR already hooked. ***');
if Kbdtranshook <> newtranshook then
begin
hook2 := true;
savetranshook := Kbdtranshook;
Kbdtranshook := newtranshook;
writeln('Translation Hook Installed.',#9);
end
else writeln('*** Translation already hooked. ***');
if hook1 and hook2 then using_hooks := true;
end;
end;

Procedure undo_hooks;
var
hook1, hook2 : boolean;
begin
if initialized then writeln;
hook1 := false;
hook2 := false;
if Kbdisrhook <> saveisrhook then
begin
hook1 := true;
Kbdisrhook := saveisrhook;
regisrhook := saveresghook;
writeln('ISR Hooks Removed.',#9);
end
else writeln('*** ISR already unhooked. ***');

if Kbdtranshook <> savetranshook then
begin
hook2 := true;
Kbdtranshook := savetranshook;
writeln('Translation Hook Removed.',#9);
end
else writeln('*** Translation already unhooked. ***');
if hook1 and hook2 then using_hooks := false;
end;
end;

Procedure set_keys;
begin
new(Keyfileptr);
try
writeln(#12,'Trying to load "KEYFILE".');
reset(Keyfileptr^,':KEYFILE');
read(Keyfileptr^,Keytabptr^);
close(Keyfileptr^);
build_menus;
escape(0);
recover
begin
if (escapecode = 0) then writeln('Keys loaded,');
else writeln('FAILED to load, escapecode = ',escapecode:3);
end;
dispose(Keyfileptr);
end;
end;

Procedure save_keys;
begin
new(Keyfileptr);
try
writeln(#12,'Trying to save "KEYFILE".');
rewrite(Keyfileptr^,':KEYFILE');
write(Keyfileptr^,Keytabptr^);
close(Keyfileptr^,'LOCK');
escape(0);
recover
begin
if (escapecode = 0) then writeln('Keys saved,');
else writeln('FAILED to save, escapecode = ',escapecode:3);
end;
dispose(Keyfileptr);
end;
end;

```

```

Procedure PasKey_init;
var
  i : integer;
begin
  if not initialized then
    begin
      if KeytabPtr = nil then new(KeytabPtr);
      if usernorm = nil then new(usernorm);
      if usershift = nil then new(usershift);
      for i := 0 to 59 do
        begin
          KeytabPtr^[i,false] := '-plain-';
          KeytabPtr^[i,true] := '-shift-';
        end;
      {Default Key labels}
      strwrite(KeytabPtr^[27,false],1,i,' f1 ');
      strwrite(KeytabPtr^[27,true],1,i,' F1 ');
      strwrite(KeytabPtr^[28,false],1,i,' f2 ');
      strwrite(KeytabPtr^[28,true],1,i,' F2 ');
      strwrite(KeytabPtr^[32,false],1,i,' f3 ');
      strwrite(KeytabPtr^[32,true],1,i,' F3 ');
      strwrite(KeytabPtr^[33,false],1,i,' f4 ');
      strwrite(KeytabPtr^[33,true],1,i,' F4 ');
      strwrite(KeytabPtr^[29,false],1,i,' f5 ');
      strwrite(KeytabPtr^[29,true],1,i,' F5 ');
      strwrite(KeytabPtr^[30,false],1,i,' f6 ');
      strwrite(KeytabPtr^[30,true],1,i,' F6 ');
      strwrite(KeytabPtr^[31,false],1,i,' f7 ');
      strwrite(KeytabPtr^[31,true],1,i,' F7 ');
      strwrite(KeytabPtr^[36,false],1,i,' f8 ');
      strwrite(KeytabPtr^[36,true],1,i,' F8 ');
      dbcx := 0; dbcxy := 0;
      init_dbwindow;
      ecaps := false;
      local := false;
      edit_mode := false;
      build_menus;
      writeln(#10,'PassKey is initialized. ');
      writeln(#10,#10,'To define any non-alpha Key, ');
      writeln('Press <CTRL> and <SHIFT> and [KEY] ');
      writeln('at the same time. ');
      if kbdtype <> itfKbd then
        writeln(#10,#13,'Press K0 to toggle menu. ',
          #10,#13,'Key K9 sets SYSTEM mode, ',
          #10,#13,'<shift>K9 sets USER mode. ');
      end
    end
  else
    writeln('Already initialized. ');
  end;
end; {module}

{Program KBD9P(input,output);}

import sysglobals, sysdevs, loader, PassKey;

var
  i : integer;
  cmdchar : char;
  quittime : boolean;

begin
  try
    if not initialized then
      try
        begin
          do_hooks;
          pasKey_init;
          initialized := true;
          markuser;
        end;
      recover
        begin
          BEEP;
          if using_hooks then undo_hooks;
          initialized := false;
          escape(escapecode);
        end;
    end;
  end;
end;

```



```

quittime := false;
repeat
  write(#1,'PasKey:  Install hooks,  Remove hooks,  ',
        'Get Keys,  Save Keys,  Quit [1,0]? ',#8);
  read(cmdchar);
  case cmdchar of
    'I','i' : do_hooks;
    'R','r' : undo_hooks;
    'G','g' : get_keys;
    'S','s' : save_keys;
    'Q','q',#27 : quittime := true;
              : write(#12);
    otherwise
      write(#12,#7);
  end;
until quittime;      {Program done, return to command interpreter}
recover
begin
  if not initialized then writeln('Initialization FAILED,')
  else writeln('Program crashed,');
  writeln('Escape: ',escapecode);
  escape(escapecode);
end;
end.

```

Powerfail

Some Series 200 Computers may be equipped with an optional battery powered back-up supply, which also contains an uninterruptible real-time clock and some non-volatile CMOS RAM. This section describes the features of this option and how they are accessed. The interface is the same as earlier releases of Pascal.

SYSDEVS exports a boolean (`BATTERYPRESENT`) which returns `TRUE` if the hardware is present. To determine if your computer has the optional powerfail circuit, test this boolean.

When power fails, the battery and its controller are capable of giving a warning and supplying power for a programmable amount of time. The Pascal Language System only uses the battery to provide 60 second protection (the maximum) and to store the system date and time between powerdown and powerup.

The boolean variable `BATTERYPRESENT` is set by the Boot ROM at powerup. If its value is true, then a battery is present.

The `BATCOMMAND` procedure is used to communicate with the powerfail hardware. `BATCOMMAND` takes a command byte, followed by a number telling how many bytes of data to send to the battery, followed by five bytes of data. To send, for instance, a command followed by three bytes, use the call:

```
batcommand (commandbyte,3,data1,data2,data3,0,0)
```

with dummy bytes for the unused data arguments.

Function `BATBYTE RECEIVED` waits until a data byte is available from the battery and then returns it to the caller.

The powerfail hardware may also be accessed by two hooks exported by `SYSDEVS`.

- `BATCMDHOOK` is a procedure variable used to pass information to the controller.
- `BATREADHOOK` is a procedure variable used to read information from the controller.

Battery Features

The Powerfail option contains an 18 volt, 2 amp-hour nickel-cadmium (NICAD) battery with its associated charging and transfer circuitry, a real-time clock, and CMOS RAM which is battery powered when the AC power is off.

The Powerfail option is controlled by an 8041A microcomputer which provides some user-programmable features. Two 5-volt power supplies are included on the Powerfail circuit board. One insures that the Powerfail microcomputer and voltage comparators are operating before the rest of the computer comes up, and the other keeps the CMOS circuitry operating when AC power is off.

Note

The word "battery" is generally used in the following discussion to denote the entire Powerfail "smart peripheral", under the control of its 8041 microcomputer.

Powerfail Behavior

Once the battery turns on and passes its self-test, it may be thought of as having four states: Power Valid, Power Failed, Last Second, and Switched Off. The 8041 may be programmed to interrupt the host CPU via level 7 (non-maskable interrupt) at each transition among these states, or host CPU interrupts may be suppressed. (Obviously, there is no interrupt on the transition to Switched Off.)

Note that the computer's power switch has been specially wired to prevent the battery from thinking power has failed when the computer is turned off. Pulling the power cord from the socket will invoke the powerfail option.

1. **Power Valid:** This is the normal state, when things are running properly. When power fails, the battery will immediately go to Power Failed state.
2. **Power Failed:** In this state, the battery provides protective power to the mainframe for a limited time (default 60 seconds). After a delay which is programmable (default zero seconds) the battery will try to interrupt the mainframe with a power-failed interrupt. If power does not return during the protection period or the NICAD battery is about to die, the battery will go to Last Second state. If power returns and stays up for a specified time (default 1 second) the battery returns to Power Valid state.
3. **Last Second:** One second after this state is entered, the battery will go to Switched Off state and shut down the computer. After Last Second is entered, the computer **will** be shut down even if power comes back.
4. **Switched Off:** Once this happens, if the power is restored the computer will go through its normal power-up sequence as if someone had turned on the main power switch.

Note that in Power Failed state, if power is restored but protection time runs out before the power-back delay is elapsed, the battery will go to Last Second anyway.

There is a fourth timer in the battery which is not programmable. Its purpose is to prevent the power supply from heating up too much while the fan is off. It counts up to 60 seconds when there is a power failure, and if it reaches 60 seconds the computer is shut off. This timer is not cleared when power comes back, but counts back down toward zero at half speed. For instance if power was down for 40 seconds, it would have to be on for 80 seconds before a full minute of protection is again available.

Powerfail Real-Time Clock

The non-interruptible real-time clock is kept as a combination of three pieces of data: a 32-bit timer which counts in 10 millisecond increments, a record of the timer value when the clock was set, and the time and date when the clock was set (the date and time use the same format as the system clock).

To figure out the real time, the battery subtracts the current timer count from the timer value when the clock was set, and adds the difference to the time and date when the clock was set. This is a time-consuming operation which is normally only done when the machine is turned on. For moment-to-moment timing while the computer is on, use the keyboard microcomputer which has a number of timing features.

Non-Volatile RAM

The battery contains 128 bytes of battery-powered CMOS RAM. 16 bytes are used by the battery for its own purposes; 112 are available for user-programmed purposes.

This RAM is accessed by moving it into 8041 memory in 16-byte blocks. Commands are available which enable the host CPU to read or modify a block while it is in the 8041's memory.

No standards have been established for how users may allocate space in this RAM, except that the first 16 byte block is reserved for the real-time clock.

Here is the layout of bytes in the first 16 byte block:

Byte	Usage / Meaning
0-2	Will be \$0F, \$A5, \$C2 if the battery has been commanded to set the real time since the CMOS RAM woke up; else garbage. You can use these values to verify that the real time is probably meaningful.
3	Least significant byte of time when clock was set.
4	2nd byte of time when clock was set.
5	Most significant byte of time when clock was set.
6	Least significant byte of day number when clock was set.
7	Most significant byte of day when clock was set.
8-11	Value of 32-bit CMOS counter at time when clock was set.
12-15	Used as temporary cell during computation of real time to honor \$41 command.

Interface to the Host CPU

The host CPU can send commands to the battery by writing to the byte at address \$458021. Reading a byte from this address yields battery status information.

The host CPU can write data bytes to the battery through address \$458001, or read data from the battery via the same byte address.

The battery status register bits are interpreted as follows:

Bit	Meaning
0	If = 1, there is data ready to read at \$458001.
1	If = 1, command buffer full; If = 0, battery is ready for a command to be written to \$458021. MUST be zero before a command is sent.
2	If = 1, battery is interrupting the host CPU on level 7.
5	If = 1 and bit 2 = 1, this is Last Second interrupt.
6	If = 1 and bit 2 = 1, this is power returning interrupt.
7	If = 1 and bit 2 = 1, this is power fail interrupt.

In general the host CPU communicates with the battery by sending a command to the command register, then sending one or more bytes of data to the data register. If the battery is enabled to interrupt the host CPU, level 7 (non-maskable) interrupts will signal the mainframe of changes in battery state. Otherwise the host CPU may ask the battery what's up. See commands \$0x and \$C3 below.

Commands to the Battery

The following commands can be sent to the battery.

\$01	Tells the battery to turn off backup power. This command is used to discontinue battery protection in order to conserve the charge. It will turn power off even if there is not a power failure; if there is no power failure, the machine will come back up in about one second.
\$10	Tells the battery to stop interrupting on level 7. It takes the battery about 200 microseconds to stop interrupting after this command is received. (The command has been received when bit 1 of the status register goes to zero).
\$2x	Set the interrupt mask. This command disables the three types of interrupt. The lower four bits of the command are: bit 0 must be zero. bit 1 – If one, power fail interrupt disabled. If zero, enable condition stays unchanged. bit 2 – If one, power back interrupt disabled. If zero, enable condition stays unchanged. bit 3 – If one, last second interrupt disabled. If zero, enable condition stays unchanged.
\$0x	Clear the interrupt mask. Used to enable the three types of interrupt. The lower four bits of the command are: bit 0 – must be zero. bit 1 – If one, power fail interrupt enabled. If zero, enable condition stays unchanged. bit 2 – If one, power back interrupt enabled. If zero, enable condition stays unchanged. bit 3 – If one, last second interrupt enabled. If zero, enable condition stays unchanged. Note that command \$0E will be ignored. Only one or two of these bits should be cleared at a time.

Data is written to and read from the CMOS memory through a 16 byte buffer in the 8041's address space. The following four commands have to do with using the CMOS memory and the buffer.

- \$F_x Tells the battery to send a byte from the CMOS buffer to the host CPU. The lower four bits of the command act as a pointer to the byte to be sent. Bit zero of the status register will be 1 when the data is ready.
- \$B_x Used to write to the CMOS buffer. The four lower bits of the command act as a pointer to the byte to be written in the buffer. The command is followed by sending the data. The buffer pointer is retained and decremented when a data byte is received, so if all 16 bytes of the buffer are to be sent, issue command \$BF followed by 16 data bytes.
- \$7_x This command tells the battery to load the CMOS buffer with a 16 byte block of CMOS memory. Bit zero must be a zero. Bits one through three tell what block to load, and must indicate 1 through 7; block zero is used by the Real Time Clock.
- \$6_x Tells the battery to write the CMOS buffer into one of the 16-byte blocks of CMOS RAM. Bit zero must be zero. Bits one through three tell what block to write. If block zero is written to, the real time will be lost.

The real time is read and written through the same buffer that is used to read and write CMOS memory. The following three commands are used to read and write the real time.

- \$B7 Sets up the real time in the CMOS buffer. Tells the battery that the next five bytes of data sent will be the real time. The five data bytes must be sent in this order:
 MSB (most significant byte) of days.
 LSB (least significant byte) of days.
 MSB of time of day.
 Second byte of time of day.
 LSB of time of day.
 "Days" is an arbitrary integer. "Time of day" is the number of 10 msec ticks since midnight.
- \$40 Tells the battery to set the time to what is in the buffer.
- \$41 Tells the battery to load the buffer with the real time. Then particular bytes of the real time can be requested by the host CPU using these commands:
 \$F7 MSB of day
 \$F6 LSB of day
 \$F5 MSB of time of day
 \$F4 Second byte of time of day
 \$F3 LSB of time of day

There are three ongoing timers that may be read. These are maintained by the 8041 and are all two bytes long; they are “volatile” in that they are cleared when the machine shuts down. A single timer buffer in 8041 memory is used by the host CPU to access these timers.

- #82 Tells the battery to load the timer buffer with the value of the non-programmable 60-second power-supply cooling timer.
- #90 Load timer buffer with the amount of time that power has been back without leaving Power Fail state.
- #94 Load timer buffer with the length of the most recent power failure since power-up. This timer is set to zero whenever the power fail state is first entered.
- #EB Send the MSB of the timer buffer to the host CPU.
- #EA Send the LSB of the timer buffer to the host CPU.
- #A7 Set the amount of protection time. Command is followed by two bytes of data (MSB first) indicating the protection time in 10-msec tics. Anything greater than 60 seconds will be treated as 60 seconds.
- #A5 Set the amount of time power must be gone before giving a level 7 interrupt. Command is followed by two data bytes (MSB first). Time is in 10-msec tics.
- #A3 Set the amount of time power must be back before leaving the power fail state. Command is followed by two data bytes (MSB first). Time is in 10-msec tics.
- #DB Tells battery to send power status to the host CPU. The data bits returned are:
 bit 0 – If one, power is down.
 bit 1 – If one, power fail interrupt delay is up.
 bit 5 – If one, the AC is gone.
- #C3 Tells battery to send a status word to the host CPU.
 bit 1 – If one, power fail interrupt is masked.
 bit 2 – If one, power back interrupt is masked.
 bit 3 – If one, last second interrupt is masked.
 bit 4 – If one, battery is in Last Second state and power is about to go away.
 bit 6 – If one, the battery is in power fail state.
- #C6 Tells battery to send host CPU the self-test status. A value of zero means 8041 thinks battery passed self-test. A value of 2 means it failed.
- #C7 This command tells the battery to send the amount of the last second that has been used up. It is only valid in Last Second state, and returns time in 10-msec tics.

SYSDEVS Listing

What follows is the commented export text of the SYSDEVS module.

```

IMPORT SYSGLOBALS;
EXPORT
  { * DUMMY DECLARATIONS *****}
  TYPE
    KBDHOOKTYPE = PROCEDURE(VAR STATBYTE,DATABYTE: BYTE;
      VAR DOIT: BOOLEAN);
    OUTZTYPE     = PROCEDURE(VALUE1,VALUE2: BYTE);
    REQUESTTYPE = PROCEDURE(CMD: BYTE; VAR VALUE: BYTE);
    BOOLPROC    = PROCEDURE(B:BOOLEAN);

  { * CRT *****}
  { ***** THIS SECTION HAS HARD OFFSET REFERENCES *****}

  TYPE
    CRTWORD = RECORD CASE INTEGER OF
      1:(HIGHLIGHTBYTE,CHARACTER: CHAR);
      2:(WHOLEWORD: SHORTINT);
    END;
    CRTLLOPS =(CLLPUT,CLLSHIFTL,CLLSHIFTR,CLLCLEAR,CLLDISPLAY,PUTSTATUS);
    CRTLLTYPE=PROCEDURE(OP:CRTLLOPS; ANYVAR POSITION:INTEGER; C:CHAR);
    DBCRTOPS =(DBINFO,DBEXCG,DBGOTOXY,DBPUT,DBINIT,DBCLEAR,DBCLINE,DBSCROLLUP,
      DBSCROLLDN,DBSCROLLL,DBSCROLLR,DBHIGHL);
    DBCINFO  = RECORD
      SAVEAREA : WINDOWP;
      SAVESIZE : INTEGER;
      DCURSORADDR : INTEGER;
      XMIN,XMAX,YMIN,YMAX : SHORTINT;
      CURSX,CURSY      : SHORTINT;
      C : CHAR;
      AREAISDBCRT : BOOLEAN;
    END;
    DBCRTTYPE=PROCEDURE(OP:DBCRTOPS; VAR DBCRT:DBCINFO);

    crtconsttype = packed array [0..11] of byte;

    crtfrac = packed record
      nobreak,stupid,slowterm,hasxcrt,
      haslcrt{built in crt},hasclock,
      canupscroll,candownscroll      :   boolean;
    end;

    b9 = packed array[0..8] of boolean;
    b14= packed array[0..13] of boolean;
    crtcrec = packed record                                     (* CRT CONTROL CHARS *)
      rlf,ndfs,eraseeol,
      eraseeos,home,
      escape           : char;
      backspace       : char;
      fillcount       : 0..255;
      clearscreen,
      clearline       : char;
      prefixed        : b9
    end;

```

```

crtirec = packed record                                (* CRT INFO & INPUT CHARS *)
    width,height      : shortint;
    crtmemaddr,crtcontroladdr,
    keybufferaddr,progstateinfoaddr: integer;
    keybuffersize: shortint;
    crtcon            : crtconsttype;
    right,left,down,up: char;
    badch,chardel,stop,
    break,flush,eof  : char;
    altmode,linedel  : char;
    backspace,
    etx,prefix       : char;
    prefixed         : bit4;
    cursormask       : integer;
    spare            : integer;
end;

environ = record
    miscinfo: crtirec;
    crttype: integer;
    crtctrl: crtirec;
    crtinfo: crtirec;
end;

environptr = ^environ;

crtkinds = (NOCRT, ALPHATYPE, BITMAPTYPE, SPECIALCRT1, SPECIALCRT2);

VAR
    SYSCOM: ENVIRONPTR;
    ALPHASTATE[ 'ALPHAFLAG' ] : BOOLEAN;
    GRAPHICSTATE[ 'GRAPHICSFLAG' ] : BOOLEAN;
    CRTIOHOOK : AMTYPE;
    TOGGLEALPHAHOOK : PROCEDURE;
    TOGGLEGRAPHICSHOOK : PROCEDURE;
    DUMPALPHAHOOK : PROCEDURE;
    DUMPGRAPHICSHOOK : PROCEDURE;
    UPDATECURSORHOOK : PROCEDURE;
    CRTINITHOOK : PROCEDURE;
    CRTLLHOOK : CRTLLTYPE;
    DBCRTHOOK : DBCRTTYPE;
    XPOS : SHORTINT; { CURSOR X POSITION }
    YPOS : SHORTINT; { CURSOR Y POSITION }
    CURRENTCRT : CRTKINDS; { ACTIVE ALPHA DRIVER TYPE }
    BITMAPADDR : INTEGER; { ADDRESS OF BITMAP CONTROL SPACE }
    FRAMEADDR : INTEGER; { ADDRESS OF BITMAP FRAME BUFFER }
    REPLREGCOPY : SHORTINT; { REGISTER COPIES FOR BITMAP DISPLAY }
    WINDOWREGCOPY : SHORTINT; { MUST BE IN GLOBALS BECAUSE REGISTERS }
    WRITEREGCOPY : SHORTINT; { ARE NOT READABLE -- MAY BE UNDEFINED }

{ * KEYBOARD ***** }
CONST
    KBD_ENABLE = 0; KBD_DISABLE = 1;
    SET_AUTO_DELAY = 2; SET_AUTO_REPEAT = 3;
    GET_AUTO_DELAY = 4; GET_AUTO_REPEAT = 5;
    SET_KBDTYPE = 6; SET_KBDLANG = 7;

```



```

{ * CLOCK ***** }
TYPE
  RTCTIME = PACKED RECORD
    PACKEDTIME,PACKEDDATE:INTEGER;
  END;
  CLOCKFUNC = (CGETDATE,CGETTIME,CSETDATE,CSETTIME);
  CLOCKOP = (CGET,CSET);
  CLOCKDATA = RECORD
    CASE BOOLEAN OF
      TRUE : (TIMETYPE:TIMEREC);
      FALSE:(DATETYPE:DATEREC);
    END;
  CLOCKREQTYPE = PROCEDURE(CMD:CLOCKFUNC; ANYVAR DATA:CLOCKDATA);
  CLOCKIOTYPE = PROCEDURE(CMD:CLOCKOP ; VAR DATA:RTCTIME);
VAR
  CLOCKREQHOOK : CLOCKREQTYPE; { CLOCK MODULE INTERFACE }
  CLOCKIOHOOK : CLOCKIOTYPE; { CARD DRIVER INTERFACE }

{ * TIMER ***** }
TYPE
  TIMERTYPES = (CYCLICT,PERIODICT,DELAYT,DELAY7T,MATCHT);
  TIMEROPTYPE = (SETT,READT,GETTINFO);
  TIMERDATA = RECORD
    CASE INTEGER OF
      0: (COUNT: INTEGER);
      1: (MATCH: TIMEREC);
      2: (RESOLUTION,RANGE:INTEGER);
    END;
  TIMERIOTYPE = PROCEDURE(TIMER: TIMERTYPES;OP: TIMEROPTYPE;VAR TD: TIMERDATA);
VAR
  TIMERIOHOOK : TIMERIOTYPE;
  TIMERISRHOOK : KBDHOOKTYPE;

{ * KEYBUFFER ***** }
CONST
  KMAXBUFSIZE = 255;
TYPE
  KOPTYPE = (KGETCHAR,KAPPEND,KNONADVANCE,KCLEAR,KDISPLAY,
    KGETLAST,KPUTFIRST);
  KBUFTYPE= PACKED ARRAY[0..KMAXBUFSIZE] OF CHAR;
  KBUFPTR = ^KBUFTYPE;
  KBUFRECPtr = ^KBUFREC;
  KBUFREC = RECORD
    ECHO: BOOLEAN;
    NON_CHAR: CHAR;
    MAXSIZE,SIZE,INP,OUTP: INTEGER;
    BUFFER: KBUFPTR;
  END;

```

```

TYPE
  STRING8OPTR = ^STRING80;
  KEYBOARDTYPE = (NOKBD,LARGEKBD,SMALLKBD,ITFKBD,SPECIALKBD1,SPECIALKBD2);
  LANGTYPE = (NO_KBD,FINISH_KBD,BELGIAN_KBD,CDN_ENG_KBD,CDN_FR_KBD,
              NORWEGIAN_KBD,DANISH_KBD,DUTCH_KBD,SWISS_GR_KBD,SWISS_FR_KBD,
              SPANISH_EUR_KBD,SPANISH_LATIN_KBD,UK_KBD,ITALIAN_KBD,
              FRENCH_KBD,GERMAN_KBD,SWEDISH_KBD,SPANISH_KBD,
              KATAKANA_KBD,US_KBD,ROMAN8_KBD,NS1_KBD,NS2_KBD,NS3_KBD);
  MENUTYPE = (M_NONE,M_SYSNORM,M_SYSSHIFT,M_U1,M_U2,M_U3,M_U4);
VAR
  KBDREQHOOK      : REQUEST1TYPE;
  KBDIOHOOK       : AMTYPE;
  KBDISRHOOK      : KBDHOOKTYPE;
  KBDPOLLHOOK     : BOOLPROC;
  KBDTYPE         : KEYBOARDTYPE;
  KBDCONFIG       : BYTE;           { KEYBOARD CONFIGURATION JUMPER }
  KBDLANG         : LANGTYPE;
  SYSMENU         : STRING8OPTR;
  SYSMENUSHIFT    : STRING8OPTR;
  MENUSTATE       : MENUTYPE;

{ * ENABLE / DISABLE ***** }
CONST
  KBDMASK=1;RESETMASK=2;TIMERMASK=4;PSIMASK=8;FHIMASK=16;
VAR
  MASKOPSHOOK : OUT2TYPE; { ENABLE, DISABLE }

{ * BEEPER ***** }
VAR
  BEEPERHOOK: OUT2TYPE;
  BFREQUENCY, BDURATION: BYTE;

{ * RPG ***** }
CONST
  RPG_ENABLE = 0; RPG_DISABLE = 1;
  SET_RPG_RATE = 2; GET_RPG_RATE = 3;
VAR
  RPGREQHOOK: REQUEST1TYPE;
  RPGISRHOOK: KBDHOOKTYPE;

{ * BATTERY ***** }
TYPE
  BATCMDTYPE = PROCEDURE(CMD: BYTE; NUMDATA: INTEGER;
                        B1, B2, B3, B4, B5: BYTE);
  BATREADTYPE= PROCEDURE(VAR DATA: BYTE);
VAR
  BATTERYPRESENT[-563]: BOOLEAN;
  BATCMDHOOK : BATCMDTYPE;
  BATREADHOOK: BATREADTYPE;

```

```

VAR
  KEYBUFFER : KBUFRECPT;
  KBDWAITHOOK: PROCEDURE;
  KBDRELEASEHOOK: PROCEDURE;
  STATUSLINE: PACKED ARRAY[0..7] OF CHAR;
  {0 s or f = STEP/FLASH IN PROGRESS (WAITING FOR TRAP #0)}
  {1..5 last executed/current line number }
  {6 S=SYSTEM U=USER DEFINITION FOR ITF SOFT KEYS}
  { BLANK FOR NON ITF KEYBOARDS }
  {7 RUNLIGHT }

{ * KEY TRANSLATION SERVICES *****}
TYPE
  KEYTRANSTYPE = (KPASSTHRU,KSHIFT_EXTC,KPASS_EXTC);
  KEYTYPE = (ALPHA_KEY,NONADV_KEY,SPECIAL_KEY,IGNORED_KEY,NONA_ALPHA_KEY);

  LANGCOMREC = RECORD
    STATUS : BYTE;
    DATA : BYTE;
    KEY : CHAR;
    RESULT : KEYTYPE;
    SHIFT,CONTROL,EXTENSION: BOOLEAN;
  END;
  LANGKEYREC = RECORD
    NO_CAPSLOCK: BOOLEAN;
    NO_SHIFT : BOOLEAN;
    NO_CONTROL : BOOLEAN;
    NO_EXTENSION : BOOLEAN;
    KEYCLASS : KEYTYPE;
    KEYS : ARRAY[BOOLEAN] OF CHAR;
  END;
  LANGRECORD= RECORD
    CAN_NONADV: BOOLEAN;
    LANGCODE : LANGTYPE;
    SEMANTICS : PROCEDURE;
    KEYS : ARRAY[0..127] OF LANGKEYREC;
  END;
  LANGPTR = ^LANGRECORD;
VAR
  LANGCOM : LANGCOMREC;
  LANGTABLE : ARRAY[0..1] OF LANGPTR;
  LANGINDEX : 0..1;
  KBDTRANSHOOK : KBDHOOKTYPE;
  TRANSMODE : KEYTRANSTYPE;
  KBDSYSMODE, KBDALTLCK, KBDCAPSLOCK : BOOLEAN;

{ * HPHIL *****}
const
  le_configured = hex('B0');
  le_error = hex('B1');
  le_timeout = hex('B2');
  le_loopedown = hex('B4');

  lmaxdevices = 7;

```

```

type
  loopdrvop = (datastarting,dataended,resetdevice);
  loopdrvproc = procedure(op:loopdrvop);

  HPHILOP      = (RAWSHIFTOP,NORMSHIFTOP,CHECKLOOPOP,CONFIGUREOP,LCOMMANDOP);

  HPHILCMDPROC = PROCEDURE(OP : HPHILOP);

  descripRec = packed record { DEVICE DESCRIBE RECORD }
    case boolean of
      true : (id      : byte;
              twosets : boolean;
              abscoords: boolean;
              size16  : boolean;
              hasPrompts:boolean;
              reserved : 0..3;
              numaxes  : 0..3;
              counts   : shortint;
              maxcountx: shortint;
              maxcounty: shortint;
              maxcountz: shortint;
              nPrompts : 0..7;
              nbuttons  : 0..7);
      false:(darray : array[1..11] of char);
    end;

  devicerec = record
    devstate : integer;
    descrip  : descripRec;
    opsProc  : loopdrvProc;
    dataProc : kbdhookType;
  end;

  loopdrvPtr = ^loopdriverrec;
  loopdriverrec = record
    lowid,highid,daddr : byte;
    opsProc  : loopdrvProc;
    dataProc : kbdhookType;
    next     : loopdrvPtr;
  end;

  LOOPCONTROLREC = RECORD
    rawmode : boolean;
    loopdevices : array[1..lmaxdevices] of devicerec;
    loopdevice  : 1..lmaxdevices;
    loopcmd     : byte; { last loop command sent }
    loopdata    : byte; { data bye in / out }
    looperror   : boolean; { error occured on last operation }
    loopinconfi: boolean; { now doing reconfigure }
    loopcmddone: boolean; { last sent command is done }
    loopisok    : boolean; { loop is configured }
    loopdevreadings: boolean; { readings poll data }
  END;

```

```

var

    loopdriverlist : loopdrvPtr;
    LOOPCONTROL    : ^LOOPCONTROLREC;
    HPHILCMDHOOK   : HPHILCMDPROC;

{-----}
PROCEDURE SYSDEV_INIT;
{* BEEPER *****}
PROCEDURE BEEPER;
PROCEDURE BEEPER(FREQUENCY,DURATION:BYTE);
{* RPG *****}
PROCEDURE SETRPGRATE(RATE : BYTE);
{* KEYBOARD *****}
PROCEDURE KBDSETUP(CMD,VALUE:BYTE);
PROCEDURE KBDIO(FP: FIBP; REQUEST: AMREQUESTTYPE;
                ANYVAR BUFFER: WINDOW; BUFSIZE,POSITION: INTEGER);
procedure lockedaction(a: action);
{* CRT *****}
PROCEDURE CRTIO(FP: FIBP; REQUEST: AMREQUESTTYPE;
                ANYVAR BUFFER: WINDOW; BUFSIZE,POSITION: INTEGER);
PROCEDURE DUMMYCRTLL(OP:CRTLLOPS; ANYVAR POSITION:INTEGER; C:CHAR);
{* BATTERY *****}
PROCEDURE BATCOMMAND(CMD:BYTE; NUMDATA:INTEGER; B1, B2, B3, B4, B5: BYTE);
FUNCTION  BATBYTERECEIVED:BYTE;
{* CLOCK *****}
function  sysclock: integer; {centiseconds from midnight}
procedure sysdate (var thedate: daterec);
procedure systime (var thetime: timerec);
procedure setsysdate ( thedate: daterec);
procedure setsystime ( thetime: timerec);
{* KEYBUFFER *****}
PROCEDURE KEYBUFOPS(OP:KOPTYPE; VAR C: CHAR);
{* STATUSLINE *****}
PROCEDURE SETSTATUS(N:INTEGER; C:CHAR);
FUNCTION  RUNLIGHT:CHAR;
PROCEDURE SETRUNLIGHT(C:CHAR);

```

Segmentation Procedures

Chapter**15**

Introduction

The SEGMENTER library file (provided on the CONFIG: disc) provides a set of procedures to permit programmers to dynamically (programmatically) load, execute, and unload program segments. These dynamically loaded program segments may import modules already loaded to gain access to their procedures and variables. Entire program files may be loaded and executed, or the file may be loaded and individual procedures may be called as needed. Dynamically loaded programs may in turn load other program segments.

Programmers may use these procedures to write applications which require much more code space than may be available in the computer, or run applications on a computer with only a minimum amount of memory, thus reducing costs for other users.

A Word to the Wise

The SEGMENTER library provides a powerful set of capabilities to the programmer. With this power comes some danger. These procedures make use of internal system variables and procedures. Improper use of the SEGMENTER procedures can produce drastic side effects (such as the computer hanging up, or data being destroyed).

Before using these procedures in your code, study the procedure descriptions and examples carefully. Be familiar with the \$SYSPROG\$ extensions, especially the use of procedure variables. You should also be aware that these procedures are provided as an optional library – they are not a part of HP Standard Pascal, and they are implemented only on the HP Series 200 Computers. Similar capabilities may be available from other manufacturers, but the details of implementation are probably quite different.

Using the SEGMENTER Procedures

Using the SEGMENTER library procedures is similar to using other Pascal libraries. A program that uses the procedures must `IMPORT` module `SEGMENTER`. In order to be imported successfully, this module must be accessible at two times: at load time, and at compile time. The easiest way to ensure accessibility at these two times is to put the module into the current System Library file. (See the Overview chapter for other methods.) The `SEGMENTER` code file actually contains two modules, so make sure you copy *both* modules into the library file.

Since the `SEGMENTER` module imports other system modules (`LOADER`, `LDR`, `SYSGLOBALS`, and `MISC`), the interface text of these modules (provided in the standard `CONFIG:INTERFACE` file) must also be accessible to the Compiler.

You will also need the `$SYSPROG$` Compiler option, since the procedures make use of the `ANYVAR` construct and procedure variables.

Note

A program using the `SEGMENTER` library procedures should not be compiled with the `$HEAP_DISPOSE ON$` Compiler option. If you do, unpredictable results may occur.

SEGMENTER Procedure Descriptions

The following section provides a detailed description of the procedures provided by the SEGMENTER library. Note that the programmer has a choice of three places into which to load code: into a user-specified area, onto the stack, or into the heap. Each of these choices has its own advantages and disadvantages, and it is up to the programmer to choose the best fit for a particular application.

SEGMENTER Initialization

This procedure allocates two explicit areas to be used by the loader to load code files.

```
procedure init_segmenter(anyvar lowcode, highcode,
                        lowglobal, highglobal: byte);
```

The code area, bounded by `lowcode` to `highcode`, is used by procedure `load_segment` as the area where code is loaded. The code area may be allocated anywhere. The global area, bounded by `lowglobal` to `highglobal`, is used by procedures `load_segment`, `load_heap_segment`, `call_segment`, and `call_segment_proc`; the area is used to allocate all global variables declared by modules in the code file which is loaded. The global area must be allocated from global data space.

Note that since the parameters are of type ANYVAR, the program may pass variables of any type as the boundaries of the code and global areas. The variables are typically elements of arrays. If the `load_segment` procedure will not be used, any variables may be passed as `lowcode` and `highcode`.

`init_segmenter` should be called only once during a program, and it must be called before the first call to `load_segment`, `load_heap_segment`, `call_segment`, `call_segment_proc`, `unload_segment`, or `unload_all`.

Segmentation Free Space

This procedure returns the number of bytes still remaining in the explicit code and global areas which were set up by `init_segmenter`.

```
procedure segment_space(var code, global: integer);
```

Segmentation Using the Stack

The following two procedures are used to load program segments onto the stack, then execute the programs or procedures in the segments.

Calling a Program

This procedure is used to call a program.

```
procedure call_segment(filename: fid);
```

The parameter `filename` is a string (TYPE `fid=string[120]`) which contains the name of a code file. The code file is expected to contain one or more programs. (Programs have main bodies and start execution addresses, whereas other modules do not.) `Call_segment` loads the code file onto the stack. The global data for the modules is allocated from the explicit global area set up by `init_segmenter`. After loading the code file, all of the programs in it are called as if they were procedures.

When the program or programs finish (or if there is an error exit), then code file is automatically unloaded. Note that since the code is loaded on the stack, the heap is not involved in this operation. Therefore, the program which is called is at liberty to add or subtract from the heap during its execution.

The following example shows how `call_segment` may be used. Note that the “HI” program imports a global variable defined in the program which loaded it.

Compile the following program into “MAIN.CODE”:

```

$SYSPROG$
$SEARCH 'SEGMENTER,' 'INTERFACE,' $

PROGRAM MAIN(INPUT, OUTPUT);

    MODULE STUFF;
    EXPORT VAR S: STRING[80];
    IMPLEMENT
    END;

IMPORT SEGMENTER, STUFF;

VAR G: PACKED ARRAY [0..4000] OF 0..255;

BEGIN
    INIT_SEGMENTER(G, G, G, G[4000]);
    CALL_SEGMENT('HI.CODE');
    WRITELN;
    WRITELN('S = ', S);
END.

```

The following program is compiled into the file “HI.CODE”:

```

$SEARCH 'MAIN'$

PROGRAM HI(OUTPUT);
IMPORT STUFF;

BEGIN
    S := 'HOWDY';
END.

```

Calling a Procedure

```
procedure call_segment_proc(filename: fid; symbol: proc_name);
```

This procedure is identical to `call_segment`, except that the parameter `symbol` is the name of the entry point which is to be called instead of the start execution address (TYPE `proc_name=string[120]`). If the entry point already exists in the system from a previously loaded file, then no file is loaded. The code file does not need to contain a program. The entry point consists of the module name followed by an underscore followed by the procedure name as used in the module. For example, procedure `PROC1` contained in module `MODX` is referred to as `MODX.PROC1`. The following example shows how this procedure may be used:

This is the main program:

```
#SEARCH 'SEGMENTER.', 'INTERFACE.',$
PROGRAM MAIN(INPUT, OUTPUT);
IMPORT SEGMENTER;
VAR G: PACKED ARRAY [0..4000] OF 0..255;
BEGIN
  INIT_SEGMENTER(G, G, G, G[4000]);
  CALL_SEGMENT_PROC('OVERLAY.CODE', 'MODX.PROC1');
  WRITELN;
  WRITELN('END OF MAIN PROGRAM');
END.
```

The following module should be compiled into file "OVERLAY.CODE":

```
MODULE MODX;
EXPORT PROCEDURE PROC1;
IMPLEMENT
  PROCEDURE PROC1;
  BEGIN
    WRITELN('HELLO FROM PROC1');
  END;
END.
```

Be very careful. If the symbol being called is a procedure which uses files which are local to the module in which it exists, the initialization body of the module containing the procedure will not have been called, so the file variables will be in an uninitialized state. In such cases, it is better to use `load_segment` or `load_heap_segment` and then call the initialization body of the module before calling the procedure. Alternatively, you could write the segment so that the main body of the segment is a call to the desired procedure and use `call_segment`.

Searching For a Procedure Name

```
function find_proc(symbol: proc_name): segment_proc;
```

This function returns a procedure variable whose name is passed in the parameter `symbol`. If no such symbol can be found among those already loaded, then a dummy procedure is returned in the procedure variable. If the dummy procedure is called, it will do an `ESCAPE(120)`.

This function can be used to search for any procedure in the system, not just those loaded by the `SEGMENTER` procedures. The following example shows how this may be done by locating a system procedure which performs cursor addressing.

```
$SYSPROG$
$search 'SEGMENTER,','INTERFACE, '$

PROGRAM MAIN(INPUT, OUTPUT);

IMPORT SEGMENTER;

VAR P: RECORD CASE INTEGER OF
    0: (PR: SEGMENT_PROC);
    1: (P2: PROCEDURE(VAR T: TEXT; X, Y: INTEGER));
END;

BEGIN

    P.PR := FIND_PROC('FS_FGOTOXY');

    CALL(P,P2, OUTPUT, 10,10);

    WRITE('HI');

END,
```

Checking a Procedure Variable

```
function exists_proc(p: segment_proc): boolean;
```

This function is a predicate which indicates whether the procedure `P` is not the dummy procedure mentioned in `find_proc`. It can be used to determine whether `find_proc` was successful. An example of its usage is shown below:

```
$SYSPROG$
$search 'SEGMENTER,','*INTERFACE, '$

PROGRAM MAIN(INPUT, OUTPUT);

IMPORT SEGMENTER;

VAR S: PROC_NAME;
    P: SEGMENT_PROC;

BEGIN
    WRITE('EXECUTE WHAT PROCEDURE? '); READLN(S);

    P := FIND_PROC(S);
    IF EXISTS_PROC(P) THEN CALL(P)
        ELSE WRITELN('NO SUCH PROCEDURE');

END,
```

Loading Into the Explicit Code Area

```
procedure load_segment(filename: fid);
```

The `filename` parameter is a string (TYPE `fid=string[120]`) which contains the name of a code file. The `load_segment` parameter will load the code file and associated global variables into the two areas explicitly defined by `init_segmenter`. Global variables defined by the modules in this file will be zeroed. No code is actually executed. Especially note that the initialization bodies of modules are not executed at this time.

In order to call procedures or module initialization bodies contained within the code segment, the `find_proc` function must be used to search for the entry point. In addition, `unload_segment` or `unload_all` must be called before the program terminates.

The following program gives an example of the use of `load_segment` and `find_proc`:

```
$SYSPROG$
$search 'SEGMENTER,' , 'INTERFACE,' $

PROGRAM MAIN(INPUT, OUTPUT);

IMPORT SEGMENTER;

TYPE SPACE = PACKED ARRAY [0,,4000] OF 0,,255;
   SPACEPTR = ^SPACE;

VAR G: SPACE;
    C: SPACEPTR;

BEGIN
  NEW(C);
  INIT_SEGMENTER(C^[0], C^[4000], G, G[4000]);
  TRY
    LOAD_SEGMENT('OVERLAY.CODE');
    CALL(FIND_PROC('MODX_PROC1'));
    UNLOAD_SEGMENT;
    WRITELN;
    WRITELN('END OF MAIN PROGRAM');
  RECOVER BEGIN
    UNLOAD_ALL;
    ESCAPE(ESCAPECODE);
  END;
END,
```

The following module should be compiled into file "OVERLAY.CODE":

```
MODULE MODX;

EXPORT PROCEDURE PROC1;

IMPLEMENT

  PROCEDURE PROC1;
  BEGIN
    WRITELN('HELLO FROM PROC1');
  END;

END,
```

Loading a Segment Onto the Heap

```
procedure load_heap_segment(filename: fid);
```

This procedure is the same as `load_segment`, except that the code file is loaded onto the heap instead of the explicit code area. The global variables for the modules in the file are still allocated from the explicit global area.

The following program is an example of the use of `load_heap_segment`. Note that no space is allocated in the explicit code area.

```
$SYSPROG$
$search 'SEGMENTER.', 'INTERFACE,' $

PROGRAM MAIN(INPUT, OUTPUT);

IMPORT SEGMENTER;

TYPE SPACE = PACKED ARRAY [0..4000] OF 0..255;

VAR G: SPACE;

BEGIN
  INIT_SEGMENTER(G, G, G, G[4000]);
  TRY
    LOAD_HEAP_SEGMENT('OVERLAY.CODE');
    CALL(FIND_PROC('MODX_PROC1'));
    UNLOAD_SEGMENT;
    WRITELN;
    WRITELN('END OF MAIN PROGRAM');
  RECOVER BEGIN
    UNLOAD_ALL;
    ESCAPE(ESCAPECODE);
  END;
END.
```

The following module should be compiled into file "OVERLAY.CODE":

```
MODULE MODX;

EXPORT PROCEDURE PROC1;

IMPLEMENT

  PROCEDURE PROC1;
  BEGIN
    WRITELN('HELLO FROM PROC1');
  END;

END.
```

Unloading a Segment

```
procedure unload_segment;
```

This procedure will unload the most recent code file which was loaded by `load_segment` or `load_heap_segment`. Memory space in the explicit code and global space will be deallocated and made available for subsequent loading. If the file unloaded had been loaded by procedure `load_heap_segment`, then the heap is released to the size it was when `load_heap_segment` was called. Note that this will deallocate any heap variables that may have been allocated (with `NEW`) since the file was loaded.

Note

If all segments have already been unloaded, an `ESCAPE(121)` is executed.

Unloading All Segments

```
procedure unload_all;
```

This procedure unloads all code files which have been loaded by either `load_segment` or `load_heap_segment`.

Note

All code files loaded by `load_segment` or `load_heap_segment` must be unloaded before the program terminates. It is the programmer's responsibility to see that this is done. If not done, the system may not be able to recover, and the machine may go "out to lunch". A good practice is to use a "TRY..RECOVER" around the body of the program to do an `unload_all` if there is any error escape.

SEGMENTER Errors

Here is a list of errors that can be generated when using the SEGMENTER module (in addition to the usually defined system run-time errors):

ESCAPECODE Value	Meaning
-2	stack overflow (not enough memory to execute loader)
100..105	field overflow trying to link or relocate something
110	circular or too deeply nested symbol definitions
111	improper link info format
112	not enough memory
116	file was not a code file
117	not enough space in the explicit global area
118	incorrect version number
119	unresolved external references
120	generated by the dummy procedure returned by find_proc
121	unload_segment called when there are no more segments to unload
122	not enough space in the explicit code area

Procedure Library Summary

I/O Procedures

HP-IB Status/Control

ABORT_HP-IB	Ceases all HP-IB activity and attempts to place the HP-IB in a known state.
ACTIVE_CONTROLLER	TRUE if the specified interface is currently active controller.
CLEAR	Attempts to send a form of the clear message to the specified device(s).
CLEAR_HP-IB	Clears the specified HP-IB line.
END_SET	Indicates whether or not EOI was set on the last byte read.
HP-IB_LINE	Returns the current state of the specified line. Not all lines are accessible at all times.
LISTEN	Sends the specified listen address on the bus.
LISTENER	TRUE if the specified interface is currently addressed as a listener.
LOCAL	Places the device(s) in local mode.
LOCAL_LOCKOUT	Sends LLO (the local lockout message) on the bus.
LOCKED_OUT	TRUE if the specified interface is currently in the local lockout state.
MY_ADDRESS	Returns the HP-IB address of the specified HP-IB interface.
PASS_CONTROL	Passes control from the specified interface to another device on the bus.
PPOLL	Sets the ATN and EOI bus lines on the specified interface and then reads the data bus lines.
PPOLL_CONFIGURE	Programs the logical sense and data bus line on which the selected device responds to a parallel poll.
PPOLL_UNCONFIGURE	Causes the specified device(s) to disable the parallel poll response.
REMOTE	Sends the messages to place the bus device(s) into the remote state.
REMOVED	Indicates if the REM line is being asserted.
REQUESTED	TRUE if any device is currently asserting the SRQ line.
REQUEST_SERVICE	Sets up the SPOLL response byte in the specified interface.
SECONDARY	Sends a secondary command byte over the bus.
SEND_COMMAND	Sends a single byte over the HP-IB interface with ATN true.
SET_HP-IB	Sets the specified HP-IB control line.
SPOLL	Performs a serial poll to the selected device.
SYSTEM_CONTROLLER	TRUE if the specified interface is the system controller.
TALK	Sends a talk address over the bus.

TALKER	TRUE if the specified interface is currently addressed as a talker.
TRIGGER	Sends a trigger command to the specified device(s).
UNLISTEN	Sends an unlisten command on the bus.
UNTALK	Sends an untalk command on the bus.

Serial Control

ABORT_SERIAL	Attempts to return a serial interface to a known state.
CLEAR_SERIAL	Clears the specified line on a serial interface card.
SEND_BREAK	Sends a break to the selected serial interface.
SERIAL_LINE	TRUE if the specified line on the serial interface is asserted.
SET_BAUD_RATE	Sets the serial interface to the specified baud rate.
SET_CHAR_LENGTH	Specifies the character length, in bits, for serial communications.
SET_PARITY	Determines what parity mode the serial interface will use.
SET_SERIAL	Sets the specified modem line on the connector.
SET_STOP_BITS	Sets the number of stop bits on the serial interface.

General Status/Control

IOCONTROL	Sends control information to the selected interface.
IOERROR_MESSAGE	Returns a string containing an English textual description of an error produced by the I/O procedure library.
IOINITIALIZE	Initializes all interfaces.
IOREAD_BYTE	Reads the byte contained in specified register (physical address) on the selected interface.
IOREAD_WORD	Reads the word contained in the specified register (physical address) on the selected interface.
IORESET	Resets the specified interface to its initial (power on) state.
IOSTATUS	Returns the contents of an interface status register.
IOUNINITIALIZE	Uninitializes all interfaces.
IOWRITE_BYTE	Writes the supplied value (representing one byte) to the specified register (physical address) on the selected interface.
IOWRITE_WORD	Writes the supplied value (representing 16 bits) to the specified register on the selected interface.
SET_TIMEOUT	Sets up a timeout for all read and write operations except transfer.

General Input

READCHAR	Reads a single byte from the specified interface.
READWORD	Reads 2 bytes from byte oriented interfaces or a single 16 bit quantity from word-oriented interfaces.
READNUMBER	Performs a free field numeric entry from the specified device.
READNUMBERLN	Reads in a free field number and then searches for a line feed.
READSTRING	Reads characters into the specified string.
READSTRING_UNTIL	Reads characters from the selected device into the specified string until the prescribed terminator is encountered.
READUNTIL	Reads characters until the match character occurs.
SKIPFOR	Reads the specified number of characters from the selected device.

General Output

WRITECHAR	Sends a single byte as data over the interface path.
WRITENUMBER	Outputs a free field number to the specified device.
WRITENUMBERLN	Outputs the number, a carriage return and a linefeed.
WRITESTRING	Sends the specified string to the specified device.
WRITESTRINGLN	Outputs the string, a carriage return and a line feed.
WRITEWORD	Writes 2 bytes to a byte-oriented interface or a 16-bit quantity to a word-oriented interface.

Buffer Control

BUFFER_DATA	Returns the number of characters available in the buffer.
BUFFER_RESET	Sets the empty and fill pointers to the empty state.
BUFFER_SPACE	Returns the available space left in the buffer.
BUFFER	Create a buffer area of the specified number of bytes.

Buffer I/O

READBUFFER	Reads a single byte from the buffer space and updates the empty pointer in the buf_info record.
READBUFFER_STRING	Reads the specified number of characters from the buffer and puts them into the string variable.
WRITEBUFFER	Writes a single byte into the buffer space and update the fill pointer in the buf_info record.

WRITEBUFFER_STRING	Takes the specified string and places it in the buffer and updates the fill pointer.
--------------------	--

Transfer Control

ABORT_TRANSFER	Stop any transfer that is currently active in the buffer.
BUFFER_BUSY	Returns a TRUE if there is a transfer occurring on the buffer.
ISC_BUSY	Returns a TRUE if there is a transfer occurring on the interface.
TRANSFER	Transfers the specified number of bytes to or from the buffer space using the specified transfer type.
TRANSFER_END	Transfers data to or from the buffer.
TRANSFER_UNTIL	Transfers bytes into the buffer until the buffer is full or the termination character was received.
TRANSFER_WORD	Transfers the specified number of words into the buffer.

Binary Logic Operations

BINAND	Returns the bit-by-bit logical AND of its arguments.
BINCMP	Returns the bit-by-bit logical complement of the argument.
BINEOR	Returns the bit-by-bit logical exclusive-OR of the argument.
BINIOR	Returns the bit-by-bit logical inclusive-OR of its arguments.
BIT_SET	TRUE if the specified bit position of the argument is equal to 1.

Graphics Procedures

Graphics Control

CLEAR_DISPLAY	Clears the graphics display.
CONVERT_WTODMM	Converts from world coordinates to millimetres on the graphics display.
CONVERT_WTOLMM	Converts from world coordinates to millimetres on the locator surface.
DISPLAY_FINIT	Enables the output of the graphics library to be sent to a file.
DISPLAY_INIT	Enables a device as the logical graphics display.
DISPLAY_TERM	Disables the enabled graphics display device.
GRAPHICSError	Returns an integer error code and can be used to determine the cause of a graphics escape.
GRAPHICS_INIT	Initializes the graphics system.
GRAPHICS_TERM	Terminates the graphics system.
INPUT_ESC	Allows the user to obtain device dependent information from the graphics system.
INQ_COLOR_TABLE	Inquires the color modeling parameters for an index into the device-dependent color capability table.
INQ_PGN_TABLE	Inquires the polygon style attributes for an entry in the polygon style table.
INQ_WS	Allows the user to determine characteristics of the graphics system.
MAKE_PIC_CURRENT	Makes the picture current.
OUTPUT_ESC	Performs a device dependent escape function on the graphics display device.
SET_TIMING	Selects the timing mode for graphics output.

Graphics Output Primitives

GTEXT	Draws characters on the graphics display.
INT_LINE	Draws a line from the starting position to the world coordinate specified.
INT_MOVE	Sets the starting position to the world coordinate position specified.
INT_POLYGON	Displays a polygon-set starting and ending at the specified point adhering to the specified polygon style exactly as specified (i.e., device-independent results).
INT_POLYGON_DD	Displays a polygon-set starting and ending at the specified point adhering to the specified polygon style in a device-dependent fashion.
INT_POLYLINE	Draws a connected line sequence starting at the specified point.
LINE	Draws a line from the starting position to the world coordinate specified.

MARKER	Outputs a marker symbol at the starting position.
MOVE	Sets the starting position to the world coordinate specified.
POLYGON	Displays a polygon-set starting and ending at the specified point adhering to the specified polygon style exactly as specified (i.e., device-independent results).
POLYGON_DEV_DEP	Displays a polygon-set starting and ending at the specified point adhering to the specified polygon style in a device-dependent fashion.
POLYLINE	Draws a connected line sequence starting at the specified point.

Primitive Attributes

SET_CHAR_SIZE	Sets the character size attribute for graphical text.
SET_COLOR	Sets the color attribute for output primitives except for polygon interior fill.
SET_COLOR_MODEL	Chooses the color model for interpreting parameters in the color table.
SET_COLOR_TABLE	Redefines the color description of the specified entry in the color table. This color definition is used when the color index is selected via SET_COLOR.
SET_LINE_STYLE	Sets the line style attribute.
SET_LINE_WIDTH	Sets the line-width attribute. The number of line-widths possible is device dependent.
SET_PGN_COLOR	Selects the polygon interior color attribute for subsequently generated polygons by providing a selector for the color table.
SET_PGN_LS	Selects the polygon interior line-style attribute for subsequently generated polygons by providing a selector for the device dependent line-style table.
SET_PGN_STYLE	Selects an entry in the polygon style table, thus selecting the attributes for subsequently generated polygons.
SET_PGN_TABLE	Defines the attributes of an entry in the polygon style table.
SET_TEXT_ROT	Specifies the text direction.

Viewing Transformations

SET_ASPECT	Redefines the aspect ratio of the virtual coordinate system.
SET_DISPLAY_LIM	Redefines the logical display limits of the graphics display.
SET_VIEWPORT	Sets the boundaries of the viewport in the virtual coordinate system.
SET_WINDOW	Defines the boundaries of the window.

Graphics Input

AWAIT_LOCATOR	Waits until activation of the locator button and then reads from the enabled locator device.
LOCATOR_INIT	Enables the locator device for input.
LOCATOR_TERM	Disables the enabled locator device.
SAMPLE_LOCATOR	Samples the current locator device.
SET_ECHO_POS	Defines the locator echo position on the graphics display.
SET_LOCATOR_LIM	Redefines the logical locator limits of the graphics locator.

Procedure Library Reference

Introduction

The Pascal programming language was designed as a teaching language, and as such was intended to be machine independent. This attribute has good and bad points. Being machine independent makes the language more easily transportable, but also ensures that it is difficult, if not impossible, to access any innovative hardware features provided by a specific computer system.

To allow easy access to the graphics and I/O features of your computer, a set of procedures and functions are provided with your system. This reference describes the syntax and semantics for the procedures and functions provided to access I/O and graphics.

The small block of text labeled `IMPORT`, immediately below the title of each entry, lists the module which must be declared in an `IMPORT` statement in order to access the feature. Modules which are needed by these imported modules, if any, are shown in the Module Dependency Table at the end of the reference.

ABORT_HPIB

IMPORT: hpib_2
iodeclarations

This **procedure** ceases all HP-IB activity and attempts to place the HP-IB in a known state. If the controlling interface is System Controller, but not Active Controller, it is made Active Controller.

Syntax

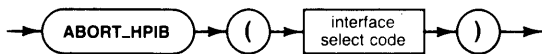

Item	Description/Default	Range Restrictions	Recommended Range
interface select code	Expression of TYPE <i>type_isc</i> . This is an INTEGER subrange.	0 thru 31	7 thru 31

Semantics

The actual action taken depends upon whether the computer is currently active or system controller. The various actions taken are listed in the table below:

	System Controller		Not System Controller	
	Interface Select Code Only	Primary Addressing Specified	Interface Select Code Only	Primary Addressing Specified
Active Controller	IFC (duration $\geq 100\mu\text{sec}$) REN ATN	Error	ATN MTA UNL ATN	Error
Not Active Controller	IFC (duration $\geq 100\mu\text{sec}$)* REN ATN		No Action	

* The IFC message allows a non-active controller (which is the system controller) to become the active controller.

ABORT_SERIAL

```
IMPORT: serial_3
       iodeclarations
```

This **procedure** attempts to return a serial interface to a known state. Any current active transfers are halted.

Syntax

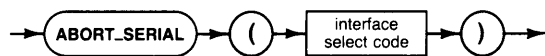

Item	Description/Default	Range Restrictions	Recommended Range
interface select code	Expression of TYPE <i>type_isc</i> . This is an INTEGER subrange.	0 thru 31	7 thru 31

ABORT_TRANSFER

IMPORT: general_4
iodeclarations

This **procedure** will stop any transfer that is currently active in the buffer.

Syntax

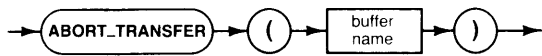

Item	Description/Default	Range Restrictions
buffer name	Variable of TYPE <i>buf_info_type</i> .	See the Advanced Transfer Techniques chapter

Semantics

The termination of the transfer is accomplished by resetting the interface currently associated with the specified buffer name. **This returns the interface to power on default configuration, and all configuration information is lost.**

ACTIVE_CONTROLLER

IMPORT: hpib_1
 iodeclarations

This **BOOLEAN function** returns TRUE if the specified interface is currently active controller.

Syntax

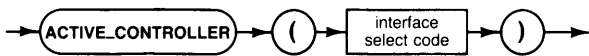

Item	Description/Default	Range Restrictions	Recommended Range
interface select code	Expression of TYPE <i>type_isc</i> . This is an INTEGER subrange.	0 thru 31	7 thru 31

ADDR_TO_LISTEN

IMPORT: hpib_1
iodeclarations

Note

This function is provided for use by the internal I/O Procedure Library drivers, only. Unexpected and possible undesirable results may occur if it is used.

The following sequence of statements will address a device to listen:

```
.  
.  TALK (7,24);  
  UNLISTEN (7);  
  LISTEN( 7, MY_ADDRESS(7));  
.
```

ADDR_TO_TALK

```
IMPORT: hpib_1
       iodeclarations
```

Note

This function is provided for use by the internal I/O Procedure Library drivers, only. Unexpected and possible undesirable results may occur if it is used.

The following sequence of statements will address a device to talk:

```
.
.
UNLISTEN (7);
LISTEN (7,24);
TALK (7, MY_ADDRESS(7));
.
.
```

AWAIT_LOCATOR

IMPORT: dgl_lib

This **procedure** waits until activation of the locator button and then reads from the enabled locator device. Various echo methods can be selected.

Syntax

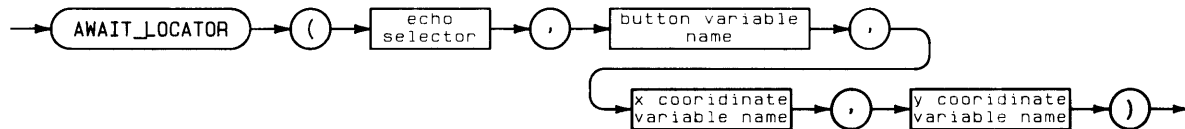

Item	Description/Default	Range Restrictions
echo selector	Expression of TYPE INTEGER	MININT to MAXINT
button variable name	Variable of TYPE INTEGER	—
x coordinate variable name	Variable of TYPE REAL	—
y coordinate variable name	Variable of TYPE REAL	—

Procedure Heading

```
PROCEDURE AWAIT_LOCATOR (      Echo      : INTEGER;
                             VAR Button  : INTEGER;
                             VAR WX, WY : REAL    );
```

Semantics

AWAIT_LOCATOR waits until the locator button is activated and then returns the value of the selected button and the world coordinates of the locator. While the button press is awaited, the locator position can be tracked on the graphic display device. If an invalid button is pressed, the button value will be returned as 0; otherwise it will contain the value of the button pressed. On locators that use a keyboard for the button device (e.g. HP 9826 / HP 9836), the ordinal value of the key pressed is returned.

The **echo selector** selects the type of echo used. Possible values are:

- 0 - No echo.
- 1 - Echo on the locator device.
- 2 - Small cursor
- 3 - Full cross hair cursor
- 4 - Rubber band line
- 5 - Horizontal rubber band line
- 6 - Vertical rubber band line
- 7 - Snap horizontal / vertical rubber band line
- 8 - Rubber band box
- 9 and above - Device dependent echo on the locator device.

Locator input can be echoed on either a graphics display device or a locator device. The meaning of the various echoes on various devices used as locators and displays is discussed below.

The **button value** is the INTEGER value of the button used to terminate the locator input.

The **x** and **y position** represent the world coordinate point returned from the enabled locator.

AWAIT_LOCATOR implicitly makes the picture current before sending any commands to the locator device. The locator should be enabled (LOCATOR_INIT) before calling AWAIT_LOCATOR. The locator is terminated by the procedure LOCATOR_TERM.

Range and Limit Considerations

If the echo selector is out of range, the call to AWAIT_LOCATOR is completed using an echo selector of 1 and no error is reported. Echoes 2 through 8 require a graphics display to be enabled. If a display is not enabled, the call will be completed with echo 1 and GRAPHICSERROR will return 4.

If the point entered is outside of the current logical locator limits, the transformed point will still be returned in world coordinates.

Starting Position Effects

The location of the starting position is device dependent after this procedure with echo 0 or echo 1. For soft-copy devices it is typically unchanged; however, for plotters the pen position (starting position) will remain at the last position it was moved to by the operator. This is done to reduce pen movement back to the current position after each AWAIT_LOCATOR invocation.

Echo Types

Several different types of echoing can be performed. Some echoes are performed on the locator device while others use the graphics display device. When the echo selector is in the range 2 thru 8, the graphics display device will be used in echoing. All of the echoes on the graphics display start at a point on the graphics display called the locator echo position (see SET_ECHO_POS). For some of these echoes the locator echo position is also used as a fixed reference point. For example, the fixed end of the rubber band line will be at the locator echo position. The echoes available are:

2. Small cursor
Track the position of the locator on the graphics display device. The initial position of the cursor is at the locator echo position. The point returned is the locator position.
3. Full cross hair cursor
Designate the position of the locator on the graphics display device with two intersecting lines. One line is horizontal with a length equal to the width of the logical display surface. The other line is vertical with a length equal to the height of the logical display surface. The initial point of intersection is at the current locator echo position. The point returned is the locator position.
4. Rubber band line
Designate the endpoints of a line. One end is fixed at the locator echo position; the other is designated by the current locator position. The locator position can be told from the locator echo position by the presence of a small cursor (echo 2) at end representing the locator echo position. The point returned is the locator position.

5. Horizontal rubber band line
Designate a horizontal line. One endpoint of the line is fixed at the locator echo position; the other endpoint has the world Y-coordinate of the locator echo position and the world X-coordinate of the current locator position. The locator position can be told from the locator echo position by the presence of a small cursor (echo 2) at end representing the locator echo position. The point returned will have the X-coordinate of the locator position and the Y-coordinate of the locator echo position.
6. Vertical rubber band line
Designate a vertical line. One endpoint of the line is fixed at the locator echo position; the other endpoint will have the world X-coordinate of the locator echo position and the world Y-coordinate of the current locator position. The locator position can be told from the locator echo position by the presence of a small cursor (echo 2) at end representing the locator echo position. The point returned will have the X-coordinate of the locator echo position and the Y-coordinate of the locator position.
7. Snap horizontal / vertical rubber band line
Designate a horizontal / vertical line. One endpoint of the line is fixed at the locator echo position. The other endpoint will be either a horizontal (see echo 5) or vertical (see echo 6) rubber band line, depending on which one produces the longer line. If both lines are of equal length, a horizontal line will be used. The locator position can be told from the locator echo position by the presence of a small cursor (echo 2) at end representing the locator echo position. The point returned is the endpoint of the echoed line.
8. Rubber band box
Designate a rectangle. The diagonal of the rectangle is the line from the locator echo position to the current locator position. The locator position can be told from the locator echo position by the presence of a small cursor (echo 2) at end representing the locator echo position. The point returned will be the locator position.

Echo selectors of 1 and greater than or equal to 9 produce a device dependent echo on the locator device. Most locator devices support at least one form of echoing. Possible ones include beeping, displaying the value entered, or blinking a light each time a point is entered. If the specified echo is not supported on the enabled locator device, echo 1 will be used.

Echoes on Raster Displays

Raster displays support all the echoes described under "Echo Types."

Echoes on HPGL Plotters

Hard copy plotting devices (such as the 9872 or the 7580) cannot perform all the echoes listed above. The closest approximation possible is used for simulating them. The actual echo performed may also depend on whether the plotter is also being used as the locator. The echoes available on plotters are:

2. Small cursor
Initially the plotter's pen will be moved to the locator echo position. The pen will then reflect the current locator position (i.e., track) until the locator operation is terminated.
3. Full cross hair cursor
Simulated by ECHO #2.
4. Rubber band line
Simulated by ECHO #2.

5. Horizontal rubber band line
If the plotter is **not** the current locator device, the plotter's pen will initially be moved to the current locator echo position. The pen will then reflect the X coordinate of the current locator position and the Y coordinate of the current locator echo position.
If the plotter is used as the locator, this echo is simulated by echo 2 except the current locator X coordinate and the locator echo position Y coordinate are returned.
6. Vertical rubber band line
If the plotter is **not** the current locator device, the plotter's pen position will initially be moved to the current locator echo position. The pen will then reflect the X coordinate of the current locator echo position and the Y coordinate of the current locator position.
If the plotter is used as the locator, this echo is simulated by echo 2 except the locator echo position X coordinate and the current locator Y coordinate are returned.
7. Snap horizontal / vertical rubber band line
Designate a horizontal / vertical line. One endpoint of the line is fixed at the locator echo position. The other endpoint will be either a horizontal (see echo 5) or vertical (see echo 6) rubber band line, depending on which one produces the longer line. If both lines are of equal length, a horizontal line will be used. The locator position can be told from the locator echo position by the presence of a small cursor (echo 2) at end representing the locator echo position. The point returned is the endpoint of the echoed line.
8. Rubber band box
Simulated by echo 2. The point returned will be the locator position.

Tablet Locators

For HPGL graphics tablets the operator positions the stylus to the desired position and depresses it. The button value returned is always one. For an echo selector of 1 the tablet beeper is sounded when the stylus is depressed. An echo selector greater than or equal to 9 uses the same echo as an echo selector of 1.

The Knob as Locator

When the knob is specified as the locator (LOCATOR_INIT with device selector of 2) the keyboard keys have the following meanings:

Arrow keys	Move the cursor in the direction indicated.
Knob	Move the cursor right and left.
Knob with shift key pressed	Move the cursor up and down.
Number keys 1 → 9	Change the amount the cursor is moved per arrow keypress or knob rotation. 1 provides the least movement and 9 provides the most.

All other keys act as the locator buttons. The ordinal value of the locator button (key) struck is returned in BUTTON.

For an echo selector of 1 the position of the locator is indicated by a small crosshair cursor on the graphics display.

The initial position of the cursor is located at the current starting position of the graphics display. This is the point obtained by the last invocation of `await_locator`, or the lower left hand corner of the locator limits if no point has been received since `LOCATOR_INIT` was executed. For back to back `AWAIT_LOCATOR` calls this would mean the second `AWAIT_LOCATOR` would begin where the first `AWAIT_LOCATOR` left the cursor. Echo selectors greater than or equal to 9 have the same effect as an echo selector of 1.

Locator input can be echoed on either a graphics display device or a locator device. Echoes 2 thru 8 are explained above under "Echoes on Raster Displays" and "Echoes on HPGL Plotters". For an echo selector of 0 or 1 the pen tracks the locator position. Echo selectors greater than or equal to 9 have the same effect as an echo selector of 1.

HPGL Plotters as Locators

The `AWAIT_LOCATOR` function enables a digitizing mode in the device. For HPGL plotters the operator then positions the pen to the desired position with the cursor buttons or joy stick and then presses the enter key. The pen state (0 for 'up', and 1 for 'down') is returned in the button parameter.

Following locator input (echo on the locator device), the pen position will remain at the last position it was moved to by the operator. This means that the starting position for the next graphics primitive will be wherever the pen was left.

Locator input can be echoed on either a graphics display device or a locator device. Echoes 2 thru 8 are explained above under "Echoes on Raster Displays" and "Echoes on HPGL Plotters". For an echo selector of 0 or 1 the pen tracks the locator position. Echo selectors greater than or equal to 9 have the same effect as an echo selector of 1.

Error Conditions

The graphics system must be initialized and the locator device must be enabled or the call will be ignored. If the echo selector is between 1 and 9 and the graphics display is not enabled, the call will be completed with an echo selector of 1. If any of the preceding errors are encountered, an `ESCAPE (-27)` is generated, and `GRAPHICSError` will return a non-zero value.

BINAND

IMPORT: iocomasm

This INTEGER **function** returns the bit-by-bit logical-and of its arguments.

Syntax

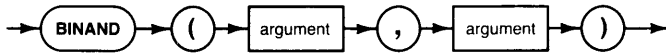

Item	Description/Default	Range Restrictions
argument	Expression of TYPE INTEGER.	MININT thru MAXINT

Semantics

The arguments for this function are represented as 32-bit two's complement integers. Each bit in an argument is logically anded with the corresponding bit in the other argument. The results of all the ands are used to construct the integer which is returned.

BINCMP

IMPORT: iocomasm

This **INTEGER function** returns the bit-by-bit logical complement of the argument.

Syntax

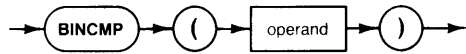

Item	Description/Default	Range Restrictions
argument	Expression of TYPE INTEGER.	MININT thru MAXINT

Semantics

The argument for this function is represented as a 32-bit two's complement integer. Each bit in the argument is logically complemented, and the resulting integer is returned.

BINEOR

IMPORT: iocomasm

This INTEGER **function** returns the bit-by-bit logical exclusive-or of the two arguments.

Syntax

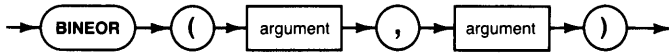

Item	Description/Default	Range Restrictions
argument	Expression of TYPE INTEGER.	MININT thru MAXINT

Semantics

The arguments for this function are represented as 32-bit two's complement integers. Each bit in an argument is exclusively-ored with the corresponding bit in the other argument. The results of all the exclusive-ors are used to construct the integer which is returned.

BINIOR

IMPORT: iocomasm

This INTEGER **function** returns the bit-by-bit logical inclusive-or of its arguments.

Syntax

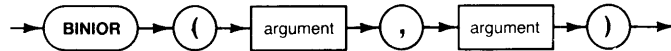

Item	Description/Default	Range Restrictions
argument	Expression of TYPE INTEGER.	MININT thru MAXINT

Semantics

The arguments for this function are represented as 32-bit two's complement integers. Each bit in an argument is inclusively-ored with the corresponding bit in the other argument. The results of all the inclusive-ors are used to construct the integer which is returned.

BIT_SET

IMPORT: iocomasm

This **BOOLEAN function** is TRUE if the specified bit position of the argument is equal to 1.

Syntax

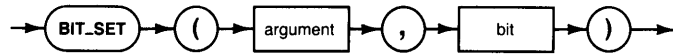

Item	Description/Default	Range Restrictions	Recommended Range
argument	Expression of TYPE INTEGER.	MININT thru MAXINT	
bit position	Expression of TYPE INTEGER.	MININT thru MAXINT	0 thru 31

Semantics

The argument for this function is represented as a 32-bit two's complement integer. Bit 0 is the least-significant bit and bit 31 is the most-significant bit.

BUFFER_BUSY

IMPORT: general_4
iodeclarations

This BOOLEAN function is TRUE if there is a transfer active on the specified buffer.

Syntax

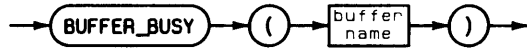

Item	Description/Default	Range Restrictions
buffer name	variable of TYPE buf_info_type	See the Advanced Transfer Techniques chapter

BUFFER_DATA

IMPORT: general_4
 iodeclarations

This INTEGER **function** returns the number of characters available in the buffer.

Syntax

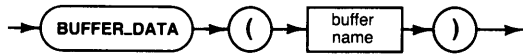

Item	Description/Default	Range Restrictions
buffer name	Variable of TYPE <i>buf_info_type</i> .	See the Advanced Transfer Techniques chapter

BUFFER_RESET

IMPORT: general_4
iodeclarations

This **procedure** will set the empty and fill pointers to the empty state.

Syntax

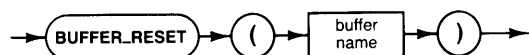

Item	Description/Default	Range Restrictions
buffer name	Variable of TYPE <i>buf_info_type</i> .	See the Advanced Transfer Techniques chapter

Semantics

The actual buffer data will not be modified - only the pointers to it. A buffer will only be reset if there are no transfers currently active on the specified buffer.

BUFFER_SPACE

IMPORT: general_4
iodeclarations

This INTEGER **function** returns the available space left in the buffer.

Syntax

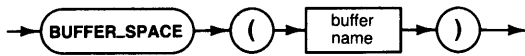

Item	Description/Default	Range Restrictions
buffer name	Variable of TYPE <i>buf_info_type</i> .	See the Advanced Transfer Techniques chapter

Semantics

This function not only returns the current available space in the buffer, it also attempts to keep data at the front of the buffer. The buffer is reset if there is no data remaining in the buffer.

CLEAR

IMPORT: hplib_2
iodeclarations

This **procedure** attempts to send a form of the clear message to the specified HP-IB device(s).

Syntax

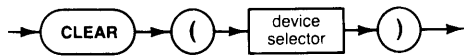

Item	Description/Default	Range Restrictions	Recommended Range
device selector	Expression of TYPE <i>type_device</i> . This is an INTEGER subrange.	0 thru 3199	See glossary

Semantics

	System Controller		Not System Controller	
	Interface Select Code Only	Primary Addressing Specified	Interface Select Code Only	Primary Addressing Specified
Active Controller	ATN DCL	ATN MTA UNL LAG SDC	ATN DCL	ATN MTA UNL LAG SDC
Not Active Controller	Error			

CLEAR_DISPLAY

IMPORT: dgl_lib

This **procedure** clears the graphics display.

Syntax

→ CLEAR_DISPLAY →

Procedure Heading

```
PROCEDURE CLEAR_DISPLAY;
```

Semantics

The graphics system provides the capability to clear the graphics display of all output primitives at any time in an application program. This procedure has different meaning for different graphics display devices. CLEAR_DISPLAY makes the picture current. The starting position is not effected by this procedure.

HPGL Plotters

Plotters with page advance will be sent a command to advance the paper. On devices such as fixed page plotters, a call to CLEAR_DISPLAY simply makes the picture current.

Raster Displays

On CRT displays, this procedure clears the display to the background color. This means slightly different things on different displays:

Monochrome	If color table location 0 is 0 then the display is cleared to black. Otherwise, the display is cleared to white.
HP 98627A	The display is cleared to the non-dithered color closest to the color represented specified by color table location 0. (e.g., If color table location 0 was Red = .5, Green = .2, Blue = 0, the display would be cleared to red.)
HP Model 36C	The display is cleared to the color represented by color table location 0.

Error conditions:

The graphics system must be initialized and a display must be enabled or the call will be ignored, an ESCAPE (- 27) will be generated, and the GRAPHICSERROR function will return a non-zero value.

CLEAR_HPIB

IMPORT: hpib_0
iodeclarations

This **procedure** will clear the specified HP-IB line. Not all lines are accessible at all times.

Syntax

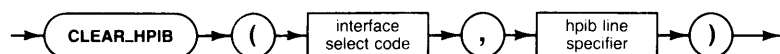

Item	Description/Default	Range Restrictions	Recommended Range
interface select code	Expression of TYPE <i>type_isc</i> . This is an INTEGER subrange.	0 thru 31	7 thru 31
hpib line specifier	Expression of enumerated TYPE <i>hpib_line</i> .	atn_line dav_line ndac_line nrfd_line eoi_line srq_line ifc_line ren_line	

Semantics

All possible *hpib_line* types are not legal when using this procedure.

Handshake lines (DAV, NDAC, NRFD) are never accessible, and an error is generated if an attempt is made to clear them.

The interface clear line (IFC) is automatically cleared after being set, and no action occurs if an attempt is made to clear it through CLEAR_HPIB.

The Service Request line (SRQ) is not accessible through CLEAR_HPIB, and should be accessed through REQUEST_SERVICE. Attempting to clear the service line directly through CLEAR_HPIB generates an error.

The remote enable line (REN) can be cleared only if the selected interface is currently System Controller. Otherwise, an error is generated.

The attention line (ATN) can be cleared only if the selected interface is currently Active Controller. Otherwise, an error is generated.

CLEAR_SERIAL

IMPORT: serial_0
 iodeclarations

This **procedure** will clear the specified line on a serial interface card.

Syntax

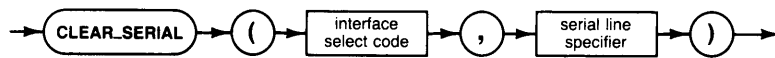

Item	Description/Default	Range Restrictions	Recommended Range
interface select code	Expression of TYPE <i>type_isc</i> . This is an INTEGER subrange.	0 thru 31	7 thru 31
serial line specifier	Expression of enumerated TYPE <i>type_serial_line</i> .	rts_line cts_line dcd_line dsr_line drs_line ri_line dtr_line	

Semantics

The values of the enumerated TYPE *type_serial_line* have the following definitions :

name	RS-232 line
rts	ready to send
cts	clear to send
dcd	data carrier detect
dsr	data set ready
drs	data rate select
dtr	data terminal ready
ri	ring indicator

The access to the various lines is determined by the use of an Option 1 or Option 2 connector on the selected interface.

CONVERT_WTODMM

IMPORT: dgl_lib

This **procedure** converts from world coordinates to millimetres on the graphics display.

Syntax

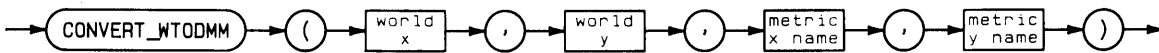

Item	Description/Default	Range Restrictions
world x	Expression of TYPE REAL	—
world y	Expression of TYPE REAL	—
metric x name	Variable of TYPE REAL	—
metric y name	Variable of TYPE REAL	—

Procedure Heading

```

PROCEDURE CONVERT_WTODMM (      WX, WY      : REAL;
                               VAR MmX, MmY : REAL );
  
```

Semantics

This procedure returns a coordinate pair (**metric X, metric Y**) representing the **world X** and **Y** coordinates. The metric X and Y values are the number of millimetres along the X and Y axis from the supplied world coordinate point to the origin of the metric coordinate system on the device. The location of this origin is device dependent.

For raster devices, the metric origin is the lower-left dot. For HPGL plotters, it is the lower-left corner of pen movement.

Since the origin of the world coordinate system need not correspond to the origin of the physical graphics display, converting the point (0.0,0.0) in the world coordinate system may not result in the value (0.0,0.0) offset from the physical display device's origin.

CONVERT_WTODMM will take any world coordinate point, inside or outside the current window, and convert it to a point offset from the physical display device's origin.

Error conditions:

The graphics system must be initialized and the graphics display must be enabled or the call will be ignored, an ESCAPE (- 27) will be generated, and GRAPHICSError will return a non-zero value.

CONVERT_WTOLMM

IMPORT: dgl_lib

This **procedure** converts from world coordinates to millimetres on the locator surface.

Syntax

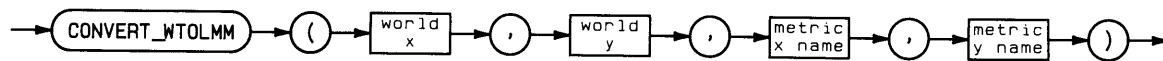

Item	Description/Default	Range Restrictions
world x	expression of TYPE REAL	—
world y	expression of TYPE REAL	—
metric x name	variable of TYPE REAL	—
metric y name	variable of TYPE REAL	—

Procedure Heading

```

PROCEDURE CONVERT_WTOLMM (      WX, WY      : REAL;
                               VAR MmX, MmY : REAL );
  
```

Semantics

This procedure returns a coordinate pair (**metric x,metric y**) representing the **world X** and **Y** coordinates. The metric x and y values are the number of millimetres along the X and Y axis from the supplied world coordinate point to the origin of the metric coordinate system on the device. The location of this origin is device dependent.

For raster devices, the metric origin is the lower-left dot. For HPGL plotters, it is the lower-left corner of pen movement.

Since the origin of the world coordinate system need not correspond to the origin of the physical locator device, converting the point (0.0,0.0) in the world coordinate system does not necessarily result in the value (0.0,0.0) offset from the physical locator device's origin.

CONVERT_WTOLMM will take any world coordinate point, inside or outside the current window, and convert it to a point offset from the physical locator origin.

Error Conditions

The graphics system must be initialized, the graphics device must be enabled, and the locator must be initialized or the call will be ignored, an ESCAPE (-27) will be generated, and GRAPHICSERROR will return a non-zero value.

DISPLAY_FINISH

IMPORT: dgl_lib

This **procedure** enables the output of the graphics library to be sent to a file.

Syntax

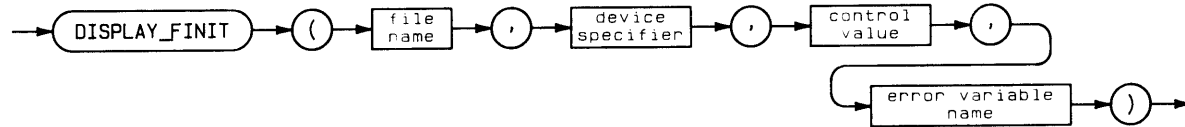

Item	Description/Default	Range Restrictions	Recommended Range
file name	Expression of TYPE <i>Gstring255</i> ; can be a STRING of any length up to 255 characters.	Must be a valid file name (see "The File System")	—
device specifier	Expression of TYPE <i>Gstring255</i> ; can be a STRING of any length up to 255 characters. First six characters are significant.	9872A, 9872B, 9872C, 9872S, 9872T, 7470A, 7475A, 7550A and 7586B	—
control value	Expression of TYPE INTEGER	MININT thru MAXINT	see below
error variable name	Variable of TYPE INTEGER	—	—

Procedure Heading

```

PROCEDURE DISPLAY_FINISH (      File_Name   : Gstring255,
                               Device_Name : Gstring255,
                               Control     : INTEGER,
                               var Ierr    : INTEGER );
  
```

Semantics

DISPLAY_FINISH allows output from the graphics library to be sent to a file. This file can then be sent a graphics display device by use of the operating system's file system (e.g. FILER, or SRM spooler). The contents of the file are device dependent, and **MUST** be sent only to devices of the type indicated in device name when the file was created.

The **file name** specifies the name of the file to send device dependent commands to.

The **device specifier** tells the graphics system the type of device that the file will be sent to. Only some types of devices may use this command. For example raster devices (i.e. the internal display) may not use this command. For the currently supported devices, see the range restrictions under Syntax, above.

The **control value** is used to control characteristics of the graphics display device and should be set according to the display device the file is intended for. See “Control Values,” below, for the meaning of the control value.

The **error variable name** will contain a value indicating whether the graphics display device was successfully initialized.

Value	Meaning
0	The graphics display device was successfully initialized.
1	The graphics display device (indicated by <i>device name</i>) is not supported by the graphics library.
2	Unable to open the file specified. File error is returned in Escapecode, and Ioresult (see the Pascal Language System User’s manual).

DISPLAY_FINISH enables a file as the logical graphics display. The file can be of any type, although the current spooling mechanisms can only handle TEXT and ASCII files. The file need not exist before this procedure is called. If this procedure is successful the file will be closed with 'LOCK' when DISPLAY_TERM is executed.

This procedure initializes and enables the graphics display for graphics output. Before the device is initialized the device status is 0, the device address is 0, and the device name is the default name. The default name is ' ' (six ASCII blanks).

When the device is enabled the device status is set to 1 (enabled) and the internal device specifier used by the graphics library is set to the file name provided by the user. The device name is set to the supplied device name. This information is available by calling INQ_WS with operation selectors of 11050 and 12050.

Initialization includes the following operations:

- The graphics display surface is cleared (e.g., CRT erased, plotter page advanced) if Bit 7 of CONTROL is not set.
- The starting position is set to a device dependent location.
- The logical display limits are set to the default limits for the device.
- The aspect ratio of the virtual coordinate system is applied to the logical display limits to define the limits of the virtual coordinate system.
- All primitive attributes are set to the default values.
- The locator echo position is set to its default value.

Only one graphics output device can be initialized at a time. If a graphics display device is currently enabled, the enabled device will be terminated (via DISPLAY_TERM) and the call will continue.

A call to MOVE or INT_MOVE should be made after this call to update the starting position and in so doing, place the physical pen or beam at a known location on the graphics display device.

The Control Value

The control value is used to control characteristics of the graphics display device. Bits should be set according to the following bit map. All unused bits should be set to 0.

0	0	0	0	0	0	0	0	0	0	0	0	0	0	0	0
15	14	13	12	11	10	9	8	7	6	5	4	3	2	1	0

Bits	Meaning
0 thru 6	Currently unused. Should be set to 0.
7	If this bit is set (BIT 7 = 1), it will inhibit clearing of the graphics display as part of the DISPLAY_FINISH procedure. Some devices have the ability to not clear the graphics display, or not to perform a page advance during device initialization. This bit is ignored on devices that do not support the feature.
8 thru 15	Not used by DISPLAY_FINISH.

HPGL Plotter Initialization

When an HPGL device is initialized the following device dependent actions are performed, in addition to the general initialization process:

- Pen velocity, force, and acceleration are set to the default for that device.
- ASCII character set is set to 'ANSI ASCII'.
- Paper cutter is enabled (HP 9872S / HP 9872T).
- Advance page option is enabled (HP 9872S / HP 9872T / HP 7550A).
- Paper is advanced one full page (HP 9872S / HP 9872T / HP 7550A) (unless DISPLAY_INIT CONTROL bit 7 is set).
- The automatic pen options are set (HP 7580 / HP 7585 / HP 7586B / HP 7550A).

The default initial dimensions for the HPGL plotters supported by the graphics library are:

Plotter	Wide mm	High mm	Wide points	High points	Aspect	Resolution points/mm
9872	400	285	16000	11400	.7125	40.0
7580	809.5	524.25	32380	20970	.6476	40.0
7585	1100	891.75	44000	35670	.8107	40.0
7586	1182.8	898.1	47312	35924	.7593	40.0
7470	257.5	191.25	10300	7650	.7427	40.0
7550	411.25	254.25	16450	10170	.6182	40.0
7475	416	259.125	16640	10365	.6229	40.0

Any device not in this list is **not** supported.

The default logical display surface is set equal to the maximum physical limits of the device. The view-surface is always justified in the lower left corner of the current logical display surface (corner nearest the turret for the HP 7580 and HP 7585 plotters). The physical origin of the graphics display is at the lower left boundary of pen movement.

Error Conditions

If the graphics system is not initialized, the call is ignored, an ESCAPE (–27) is generated, and GRAPHICSError returns a non-zero value.

DISPLAY_INIT

IMPORT: dglLib

This **procedure** enables a device as the logical graphics display.

Syntax

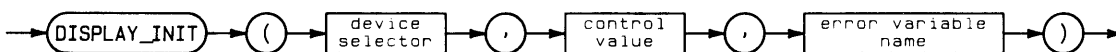

Item	Description/Default	Range Restrictions	Recommended Range
device selector	Expression of TYPE INTEGER	MININT to MAXINT	
control value	Expression of TYPE INTEGER	MININT to MAXINT	-
error variable name	Variable of TYPE INTEGER	-	-

Procedure Heading

```

PROCEDURE DISPLAY_INIT (      Dev_Adr : INTEGER ,
                             Control  : INTEGER ,
                             VAR IErr  : INTEGER );
  
```

Semantics

DISPLAY_INIT enables a device as the logical graphics display. It initializes and enables the graphics display device for graphics output.

Before the device is initialized the device status is 0, the device address is 0, and the device name is the default name. The default name is ' ' (six ASCII blanks).

When the device is enabled the device status is set to 1 (enabled) and the internal device specifier used by the graphics library is set equal to the device selector provided by the user. The device name is set to the device being used. This information is available by calling INQ_WS with operation selectors 11050 and 12050.

The **device selector** specifies the physical address of the graphics output device.

- device selector = 3: Primary internal graphics CRT (i.e., the display designated as the console where the command line is displayed)
- device selector = 6: Secondary internal graphics CRT, if present (i.e., any display other than the console that does not require a select code and/or bus address to access it)
- $8 \leq \text{device selector} \leq 31$: Interface Card Select Code (HP 98627A default = 28)
- $100 \leq \text{device selector} \leq 3199$: composite HPIB/device address

The **control value** is used to control device dependent characteristics of the graphics display device. (See the subsequent section called "The Control Value").

The **error variable name** will contain a value indicating whether the graphics display device was successfully initialized.

Value	Meaning
0	The graphics display device was successfully initialized.
2	Unrecognized device specified. Unable to communicate with a device at the specified address, non-existent interface card or non-graphics system supported interface card.

If an error is encountered, the call will be ignored.

The graphics library attempts to directly identify the type of device by using its device selector in some way. The meanings for device address are listed above.

At the time that the graphics library is initialized, all devices which are to be used must be connected, powered on, ready, and accessible via the supplied device selector. Invalid device selectors or unresponsive devices result in that device not being initialized and an error being returned.

Only one graphics output device maybe initialized at a time. If a graphics display device is currently enabled, the enabled device will be terminated (via DISPLAY_TERM) and the call will continue.

A call to MOVE or INT_MOVE should be made after this call to update the starting position and in so doing, place the physical pen or beam at a known location on the graphics display device.

The Control Value

Used to control characteristics of the graphics display device. Bits should be set according to the following bit map. All unused bits should be set to 0.

0	0	0	0	0	0	0	0	0	0	0	0	0	0	0	0
15	14	13	12	11	10	9	8	7	6	5	4	3	2	1	0

Bits	Meaning
0 thru 6	Currently unused. Should be set to 0.
7	If this bit is set (BIT 7 = 1), it will inhibit clearing of the graphics display as part of the DISPLAY_FINISH procedure. Some devices have the ability to not clear the graphics display, or not to perform a page advance during device initialization. This bit is ignored on devices that do not support the feature.
8 thru 15	Bits 8 though 15 are used by some devices to control device dependent features of those devices.

Bits 8,9, and 10 of DISPLAY_INIT's CONTROL parameter determine the type of display for the HP 98627A card and the default dimensions assumed by the graphics system.

CONTROL	Bits		Description
	10	9 8	
256	001		US STD (512 x 390, 60 hz refresh)
512	010		EURO STD (512 x 390, 50 hz refresh)
768	011		US TV (512 x 474, 15.75 Khz horizontal refresh, interlaced)
1024	100		EURO TV (512 x 512, 50 hz vertical refresh, interlaced)
1280	101		HI RES (512 x 512, 60 hz)
1536	110		Internal (HP) use only

Out of range values are treated as if CONTROL = 256.

When using a Model 237 display that is designated the console, bit 8 of DISPLAY_INIT's CONTROL parameter determines if the entire screen will be used for graphics. A value of 256 (i.e., bit 8 = 1) turns off the echo of the type-ahead buffer, and allocates the entire screen for graphics. The type-ahead buffer echo is re-enabled by the DISPLAY_TERM procedure call.

General Initialization Operations

Initialization includes the following operations:

- The graphics display surface is cleared (e.g., CRT erased, plotter page advanced) unless Bit 7 of the control value is set.
- The starting position is set to a device dependent location. (This is undefined for HPGL plotters.)
- The logical display limits are set to the default limits for the device.
- The aspect ratio of the virtual coordinate system is applied to the logical display limits to define the limits of the virtual coordinate system.
- All primitive attributes are set to the default values.
- The locator echo position is set to its default value.
- If the display and locator are the same physical device, the logical locator limits are set to the limits of the view surface.

Raster Display Initialization

When a raster display is initialized the following device dependent actions are performed, in addition to the general initialization process:

- The starting position is in the lower left corner of the display.
- Graphics memory is cleared if bit 7 of the control word is 0.
- Initialize the color table to default values. If the device has retroactive color definition (Model 36C) and the color table has been changed from the default colors, the colors of an image will change even if bit 7 is set to 1.
- The graphics display is turned on.
- The view surface is centered within the logical display limits.

- The drawing mode (see OUTPUT_ESC) is set to dominate.
- The DISPLAY_INIT CONTROL parameter is used as specified above.

The following table describes the internal raster displays for Series 200 computers:

Computer	Wide mm	High mm	Wide points	High points	Memory Planes	Color Map
Model 216	160	120	400	300	1	no
Model 217	230	175	512	390	1	no
Model 220 (HP82913A)	210	158	400	300	1	no
Model 220 (HP82912A)	152	114	400	300	1	no
Model 226	120	88	400	300	1	no
Model 236	210	160	512	390	1	no
Model 236 Color	217	163	512	390	4	yes
Model 237	312	234	1024	768	1	no

The HP 98627A is a 3 plane non-color mapped color interface card which connects to an external RGB monitor. Bits 8,9, and 10 of DISPLAY_INIT's CONTROL parameter determine the type of display for the HP 98627A card and the default dimensions assumed by the graphics system.

CONTROL	Bits		Description
	10	9 8	
256	001		US STD (512 x 390, 60 hz refresh)
512	010		EURO STD (512 x 390, 50 hz refresh)
768	011		US TV (512 x 474, 15.75 Khz horizontal refresh, interlaced)
1024	100		EURO TV (512 x 512, 50 hz vertical refresh, interlaced)
1280	101		HI RES (512 x 512, 60 hz)
1536	110		Internal (HP) use only

Out of range values are treated as if CONTROL = 256.

The physical size of the HP 98627A display (needed by the SET_DISPLAY_LIM procedure) may be given to the graphics system by an escape function (OPCODE = 250). The physical limits assumed until the escape function is given are:

CONTROL = 256	153.3mm wide and 116.7mm high.
512	153.3mm wide and 116.7mm high.
768	153.3mm wide and 142.2mm high.
1280	153.3mm wide and 153.3mm high.

The default logical display surface of the graphics display device is the maximum physical limits of the screen. The physical origin is the lower left corner of the display.

The view surface is always centered within the current logical display surface.

HPGL Plotter Initialization

When an HPGL device is initialized the following device dependent actions are performed, in addition to the general initialization process:

- Pen velocity, force, and acceleration are set to the default for that device.
- ASCII character set is set to 'ANSI ASCII'.
- Paper cutter is enabled (HP 9872S / HP 9872T).
- Advance page option is enabled (HP 9872S / HP 9872T / HP 7550A / HP 7586B).
- Paper is advanced one full page (HP 9872S / HP 9872T / HP 7550A / HP 7586B) (unless DISPLAY_INIT CONTROL bit 7 is set).
- The automatic pen options are set (HP 7580 / HP 7585).

The default initial dimensions for the HPGL plotters supported by the graphics library are:

Plotter	Wide mm	High mm	Wide points	High points	Aspect	Resolution points/mm
9872	400	285	16000	11400	.7125	40.0
7580	809.5	524.25	32380	20970	.6476	40.0
7585	1100	891.75	44000	35670	.8107	40.0
7586	1182.8	898.1	47312	35924	.7593	40.0
7470	257.5	191.25	10300	7650	.7427	40.0
7550	411.25	254.25	16450	10170	.6182	40.0
7475	416	259.125	16640	10365	.6229	40.0

The maximum physical limits of the graphics display for an HPGL device not listed above are determined by the default settings of P1 and P2. The default settings of P1 and P2 are the values they have after an HPGL 'IN' command. Refer to the specific device manual for additional details.

The default logical display surface is set equal to the area defined by P1 and P2 at the time DISPLAY_INIT is invoked. The view surface is always justified in the lower-left corner of the current logical display surface (corner nearest the turret for the HP 7580, HP 7585 and HP 7586 plotters). The physical origin of the graphics display is at the lower-left boundary of pen movement.

Note

If the paper is changed in an HP 7580, HP 7585 or HP 7586 plotter while the graphics display is initialized, it should be the same size of paper that was in the plotter when DISPLAY_INIT was called. If a different size of paper is required, the device should be terminated (DISPLAY_TERM) and re-initialized after the new paper has been placed in the plotter.

Error Conditions

The graphics system must be initialized or the call will be ignored, an ESCAPE (-27) will be generated, and GRAPHICSError will return a non-zero value.

DISPLAY_TERM

IMPORT: dgl_lib

This **procedure** disables the enabled graphics display device.

Syntax

→ **DISPLAY_TERM** →

Procedure Heading

```
PROCEDURE DISPLAY_TERM;
```

Semantics

DISPLAY_TERM terminates the device enabled as the graphics display. DISPLAY_TERM completes all remaining display operations and disables the logical graphics display. It makes the picture current and releases all resources being used by the device. The device name is set to the default name ' ' (six ASCII blanks), the device status is set to 0 (not enabled) and the device address is set to 0. DISPLAY_TERM does not clear the graphics display.

The graphics display device should be disabled before the termination of the application program. DISPLAY_TERM is the complementary routine to DISPLAY_INIT.

Error Conditions

The graphics system should be initialized and the display should be enabled or the call will be ignored, an ESCAPE (−27) will be generated, and GRAPHICSError will return a non-zero value.

DMA_RELEASE

IMPORT: iocomasm
iodeclarations

Note

This function is provided for use by the internal I/O Procedure Library drivers, only. Unexpected and possible undesirable results may occur if it is used.

DMA channel allocation and deallocation occur automatically in the I/O library.

DMA_REQUEST

IMPORT: iocomasm
iodeclarations

Note

This function is provided for use by the internal I/O Procedure Library drivers, only. Unexpected and possible undesirable results may occur if it is used.

DMA channel allocation and deallocation occur automatically in the I/O library.

END_SET

IMPORT: hpib_1
iodeclarations

This BOOLEAN **function** indicates whether or not EOI was set on the last byte read – this is **not** a current indication of the EOI line.

Syntax

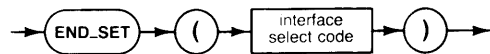

Item	Description/Default	Range Restrictions	Recommended Range
interface select code	Expression of TYPE <i>type_isc</i> . This is an INTEGER subrange.	0 thru 31	7 thru 31

GRAPHICSEERROR

IMPORT: dgl_lib

This **function** returns an integer error code and can be used to determine the cause of a graphics escape.

Syntax

→ GRAPHICSEERROR →

Function Heading

```
FUNCTION GRAPHICSEERROR: INTEGER;
```

Semantics

When an error occurs that uses the escape function, escape-code `-27` is used. After the escape is trapped and it has been determined that the graphics library is the source of the error (the escape code equal to `-27`), GRAPHICSEERROR can be used to determine the cause of the error. The function returns the value of the last error generated and then clears the value of the return error. A user who is trapping errors and wishes to keep the value of the error must save it in some variable.

The following list of returned values and the error they represent can be used to interpret the value returned by GRAPHICSEERROR.

Value	Meaning
0	No errors since the last call to GRAPHICSEERROR or since the last call to GRAPHICS_INIT.
1	The graphics system is not initialized. ACTION: Call ignored.
2	The graphics display is not enabled. ACTION: Call ignored.
3	The locator device is not enabled. ACTION: Call ignored.
4	Echo value requires a graphics display to be enabled. ACTION: Call completes with echo value = 1.
5	The graphics system is already initialized. ACTION: Call ignored.
6	Illegal aspect ratio specified. X-SIZE and Y-SIZE must be greater than 0. ACTION: Call ignored.
7	Illegal parameters specified. ACTION: Call ignored.
8	The parameters specified are outside the physical display limits. ACTION: Call ignored.
9	The parameters specified are outside the limits of the window. ACTION: Call ignored.
10	The logical locator and the logical display are the same physical device. The logical locator limits cannot be defined explicitly, they must correspond to the logical view surface limits. ACTION: Call ignored.

- 11 | The parameters specified are outside the current virtual coordinate system boundary. ACTION: Call ignored.
- 13 | The parameters specified are outside the physical locator limits. ACTION: Call ignored.
- 14 | Color table contents cannot be inquired or changed. ACTION: Call ignored.
- 18 | The number of points specified for a polygon or polyline operation is less than or equal to zero. ACTION: Call ignored.

GRAPHICS_INIT

IMPORT: dgl_lib

This **procedure** initializes the graphics system.

Syntax



Procedure Heading

```
PROCEDURE GRAPHICS_INIT;
```

Semantics

GRAPHICS_INIT initializes the graphics system. It must be the first graphics system call made by the application program. Any procedure call other than GRAPHICS_INIT will be ignored. GRAPHICS_INIT performs the following operations:

- Get dynamic storage space for the graphics library.
- Sets the aspect ratio to 1.
- Sets the virtual coordinate and viewport limits to range from 0 to 1.0 in the X and Y directions.
- Sets the world coordinate limits to range from -1.0 to 1.0 in the X and Y directions.
- Sets the starting position to $(0.0, 0.0)$ in world coordinate system units.
- Sets all attributes equal to their default values.

GRAPHICS_INIT does not enable any logical devices. The graphics system is terminated with a call to GRAPHICS_TERM. Calling GRAPHICS_INIT while the graphics system is initialized will result in an implicit call to GRAPHICS_TERM, before the system is reinitialized.

Note

Space is allocated for the graphics system using the standard Pascal procedure, NEW. The application program should call this procedure before any space is allocated for the application program. If memory allocated at graphics_init is to be returned at graphics_term, the compiler option \$HEAP_DISPOSE ON\$ must be used.

GRAPHICS_TERM

IMPORT: dgl_lib

This **procedure** terminates the graphics system.

Syntax

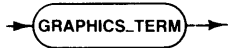

→ GRAPHICS_TERM →

Procedure Heading

```
PROCEDURE GRAPHICS_TERM;
```

Semantics

GRAPHICS_TERM terminates the graphics system. Termination includes terminating both the graphics display and the locator devices. GRAPHICS_TERM does not clear the graphics display.

GRAPHICS_TERM should be called as the last graphics system call in the application program.

GRAPHICS_TERM releases dynamic memory allocated during GRAPHICS_INIT. In order that this memory actually be returned the compiler option \$HEAP_DISPOSE ON\$ must be used.

Error Conditions

If the graphics system is not initialized, the call will be ignored, an ESCAPE (–27) will be generated, and GRAPHICS_ERROR will return a non-zero value.

GTEXT

IMPORT: dgl_types
 dgl_lib

This **procedure** draws characters on the graphics display.

Syntax

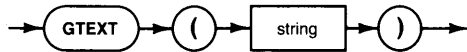

Item	Description/Default	Range Restrictions
string	Expression of TYPE <i>Gstring255</i> . Can be a string of any length up to 255 characters	length ≤ 255 characters

Procedure Heading

```
PROCEDURE GTEXT ( String : Gstring255 );
```

Semantics

The **string** contains the characters to be output.

GTEXT produces characters on the graphics display. A series of vectors representing the characters in the string is produced by the graphics system.

When the text string is output, the starting position will represent the lower left-hand corner of the first character in STRING. Text is normally output from left to right and is printed vertically with no slant.

After completion of this call, the starting position is left in a device dependent location such that successive calls to GTEXT will produce a continuous line of text (i.e., GTEXT('H'); GTEXT('I'); is equivalent to GTEXT('HI'))).

The attributes of color, line-style, line-width, text rotation, and character size apply to text primitives. However, the text will appear with these attributes only if the graphics device is capable of applying them to text.

Characters

The character sets provided by the graphics system are the same ones used by the CRT in alpha mode, namely the standard character set plus either the Roman extension character set (for all non-Katakana machines) or the Katakana character set (for Katakana machines).

Characters are defined within a cell that has an aspect ratio of 9/15. The character cells are adjacent, both horizontally and vertically, as shown here.

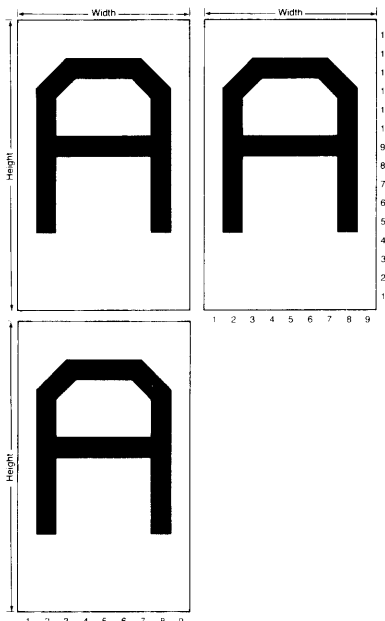

Control Codes

The following control codes are supported by GTEXT:

Control Character	Program Access	Keyboard Access	Action
backspace	CHR(8)	CTRL-H	Move one character cell to the left along the text direction vector (defined by SET_CHAR_SIZE).
linefeed	CHR(10)	CTRL-J	Move down the height of one character cell.
carriage return	CHR(13)	CTRL-M	Move back the length of the text just completed.

Any other control characters are ignored.

The current position is maintained to the resolution of the display device. A text size less-than-or-equal-to the resolution of the display device will result in all the characters in a GTEXT call, or a series of GTEXT calls, being written to the same point on the device.

The current position returned by an INQ_WS is **not** updated by calls to GTEXT. If you want to know the current position after a GTEXT, you must do a MOVE, or some other call which updates the current position.

Error Conditions

If the graphics system is not initialized or a display is not enabled, the call will be ignored, an ESCAPE (-27) will be generated, and GRAPHICSError will return a non-zero value.

HPIB_LINE

IMPORT: hpib_0
 iodeclarations

This **BOOLEAN function** will return the current state of the specified line. Not all lines are accessible at all times.

Syntax

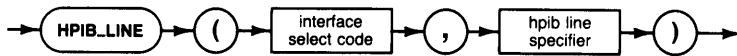

Item	Description/Default	Range Restrictions	Recommended Range
interface select code	Expression of TYPE <i>type_isc</i> . This is an INTEGER subrange.	0 thru 31	7 thru 31
hpib line specifier	Expression of enumerated TYPE <i>hpib_line</i> .	atn_line dav_line ndac_line nrfd_line eoi_line srq_line ifc_line ren_line	

Semantics

The lines are only accessible when the hardware buffer is pointing into the interface. For example, REN can only be examined when the selected interface is **not** system controller. No error is generated when an in-accessible line is examined.

Semantics

The **operation selector** determines the device dependent inquiry escape function being invoked.

The **INTEGER array size** is the number of INTEGER parameters to be returned in the INTEGER array by the escape function. The correct value for this can be found in the hundred's place of the operation selector (see the table below).

The **REAL array size** is the number of REAL parameters to be returned in the REAL array by the escape function. The correct value for this can be found in the thousand's place of the operation selector (see the table below).

The **INTEGER array** is the array in which zero or more INTEGER parameters are returned by the escape function.

The **REAL array** is the array in which zero or more REAL parameters are returned by the escape function.

The **error variable** will contain a code indicating whether the input escape function was performed.

Value	Meaning
0	Inquiry escape function successfully completed.
1	Inquiry operation (operation selector) not supported by the graphics display device.
2	INTEGER array size is not equal to the number of INTEGER parameters to be returned.
3	REAL array size is not equal to the number of REAL parameters to be returned.

If the error variable contains a non-zero value, the call has been ignored.

INPUT_ESC allows application programs to access special device features on a graphics display device. The type of information returned from the graphics display device is determined by the value of operation selector. Possible inquiry escape functions may return the status or the options supported by a particular graphics display device.

Inquiry escape functions only apply to the graphics display device. INPUT_ESC implicitly makes the picture current before the escape function is performed.

HPGL Plotter Operation Selectors

The following inquiry is supported:

Operation Selector	Meaning
2050	Inquire about current turret. INTEGER array [1] = -1 >> Turret mounted, but its type is unknown INTEGER array [1] = 0 >> No turret mounted INTEGER array [1] = 1 >> Fiber tip pens INTEGER array [1] = 2 >> Roller ball pens INTEGER array [1] = 3 >> Capillary pens INTEGER array [2] = 0 >> No turret mounted or turret has no pens INTEGER array [2] = n >> Sum of these values: 1: Pen in stall #1 2: Pen in stall #2 4: Pen in stall #3 8: Pen in stall #4 16: Pen in stall #5 32: Pen in stall #6 64: Pen in stall #7 128: Pen in stall #8

For example, if INTEGER array[2] = 3, pens would only be contained in stalls 1 and 2.

Operation selector 2050 is supported on the HP 7475, HP 7550, HP 7580, HP 7585 and HP 7586 plotters.

Error Conditions

If the graphics system is not initialized or a display is not enabled, the call will be ignored, an ESCAPE (-27) will be generated, and GRAPHICSError will return a non-zero value.

INQ_COLOR_TABLE

IMPORT: dgl_lib
 dgl_inq

This **procedure** inquires the color modeling parameters for an index into the device-dependent color capability table.

Syntax

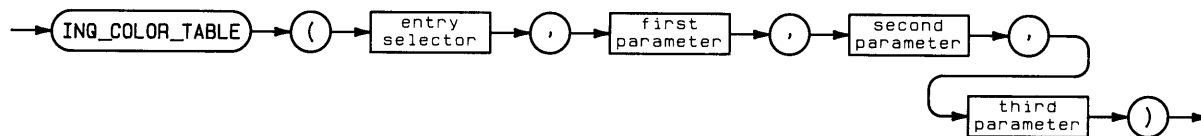

Item	Description/Default	Range Restrictions
entry selector	Expression of TYPE INTEGER	>0
first parameter name	Variable of TYPE REAL	-
second parameter name	Variable of TYPE REAL	-
third parameter name	Variable of TYPE REAL	-

Procedure Heading

```

PROCEDURE INQ_COLOR_TABLE (      Index : INTEGER;
                                VAR ColP1 : REAL;
                                VAR ColP2 : REAL;
                                VAR ColP3 : REAL      );
    
```

Semantics

This routine inquires the color modelling parameters for the specified location in a device-dependent color capability table.

The **entry selector** specifies the location in the color capability table. The parameters returned are for the specified location. The size of the color capability table is device dependent. For raster displays in Series 200 computers, 32 entries are available.

The **first parameter** represents red intensity if the RGB model has been selected with the SET COLOR statement, or hue if the HSL model has been selected.

The **second parameter** represents green intensity if the RGB model has been selected with the SET COLOR statement, or saturation if the HSL model has been selected.

The **third parameter** represents blue intensity if the RGB model has been selected, or luminosity if the HSL model has been selected.

A more detailed description of the color models and the meaning of their parameters can be found under the procedure definition of SET_COLOR_MODEL.

Note

The color table stores color specifications as RGB values. The conversion from RGB to HSL is a one-to-many transformation, and the following arbitrary assignments may be made during the conversion:

```
IF Luminosity = 0
  THEN Hue = 0
      Saturation = 0

IF Saturation = 0
  THEN Hue = 0
```

Error Conditions

If the graphics system is not initialized, a display device is not enabled, the color table contents cannot be inquired, or the color table entry selector is out of range, the call is ignored, an ESCAPE (−27) will be generated, and GRAPHICSError will return a non-zero value.

INQ_PGN_TABLE

IMPORT: dgl_lib
 dgl_inq

This **procedure** inquires the polygon style attributes for an entry in the polygon style table.

Syntax

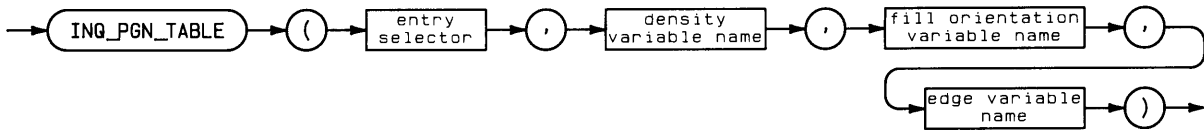

Item	Description/Default	Range Restrictions	Recommended Range
entry selector	Expression of TYPE INTEGER	MININT thru MAXINT	Device dependent
density variable name	Variable of TYPE REAL	—	—
fill orientation variable name	Variable of TYPE REAL	—	—
edge variable name	Variable of TYPE INTEGER	—	—

Procedure Heading

```

PROCEDURE INQ_PGN_TABLE (      Index   : INTEGER;
                             VAR Densty : REAL;
                             VAR Orient  : REAL;
                             VAR Edge   : INTEGER );
    
```

Semantics

The **entry selector** specifies the entry in the polygon style table the inquiry is directed at.

The **density variable** will contain a value between -1 and 1. This magnitude of this value is the ratio of filled area to non-filled area. Zero means the polygon interior is not filled. One represents a fully filled polygon interior. All non-zero values specify the density of continuous lines used to fill the interior. Negative values are used to specify crosshatching. Calculations for fill density are based on the thinnest line possible on the device and on continuous line-style. If the interior line-style is not continuous, the actual fill density may not match that found in the polygon style table.

The **fill orientation variable** will contain a value from -90 through 90. This value represents the angle (in degrees) between the lines used for filling the polygon and the horizontal axis of the display device. The interpretation of fill orientation is device-dependent. On devices that require software emulation of polygon styles, the angle specified will be adhered to as closely as possible, within the line-drawing capabilities of the device. For hardware generated polygon styles, the angle specified will be adhered to as closely as is possible given the hardware simulation of the requested density. If crosshatching is specified, the fill orientation specifies the angle of orientation of the first set of lines in the crosshatching, and the second set of lines is always perpendicular to this.

The **edge variable** will contain a 0 if the polygon edge is not to be displayed and a 1 if the polygon edge is to be displayed. If polygon edges are displayed, they adhere to the current line attributes of color, line-style, and line-width, in effect at the time of polygon display.

All current devices support 16 entries in the polygon table. The polygon styles defined in the default tables are defined to exploit the hardware capabilities of the devices they are defined for.

Error Conditions

The graphics system must be initialized, a display must be enabled, and the entry selector must be in range or the call will be ignored, an ESCAPE (-27) will be generated, and GRAPHICSEERROR will return a non-zero value.

INQ_WS

IMPORT: dgl_lib
 dgl_inq

This **procedure** allows the user to determine characteristics of the graphics system.

Syntax

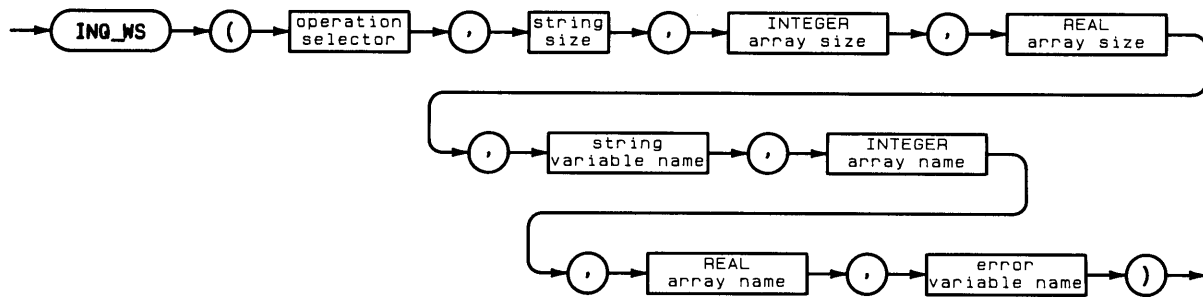

Item	Description/Default	Range Restrictions
operation selector	Expression of TYPE INTEGER	see below
string size	Expression of TYPE INTEGER	see below
integer array size	Expression of TYPE INTEGER	see below
REAL array size	Expression of TYPE INTEGER	see below
string variable name	Variable of TYPE PACKED ARRAY OF CHAR	—
INTEGER array name	Variable of TYPE ARRAY OF INTEGER	—
REAL array name	Variable of TYPE ARRAY OF REAL	—
error variable name	Variable of TYPE INTEGER	—

Procedure Heading

```
PROCEDURE INQ_WS (
    Opcode : INTEGER;
    Ssize  : INTEGER;
    Isize  : INTEGER;
    Rsize  : INTEGER;
    ANYVAR Slist : Gchar_list;
    ANYVAR Ilist : Gint_list;
    ANYVAR Rlist : Greal_list;
    VAR Ierr  : INTEGER);
```

Semantics

The **operation selector** is an integer from the list of operation selectors given below. It is used to specify the topic of the inquiry to the system.

The **string size** is used to specify the maximum number of characters that are to be returned in the string array by the function specified by the operation selector. If there is a 1 in the ten-thousand's place a string value will be returned. The number of characters in the string is returned in the first entry in the INTEGER array.

The **INTEGER array size** is the number of integer parameters that are returned in the integer array by the function specified by OPCODE. The thousand's digit of the operation selector is the number of elements the INTEGER array must contain.

The **REAL array size** is the number of REAL parameters that are returned in the REAL array by the function specified by OPCODE. The hundred's digit of the operation selector is the number of elements the REAL array must contain.

The **string array** is a PACKED ARRAY OF CHAR which will contain a string or strings that represents characteristics of the work station specified by the value of operation selector. The application program must ensure that string array is dimensioned to contain all of the values returned by the selected function.

The **INTEGER array** will contain integer values that represent characteristics of the work station specified by the value of OPCODE. The application program must ensure that the integer array is dimensioned to contain all of the values returned by the selected function.

The **REAL array** will contain REAL values that represent characteristics of the work station specified by the value of OPCODE. The application program must ensure that the REAL array is dimensioned to contain all of the values returned by the selected function.

The **error variable** will return an integer indicating whether the inquiry was successfully performed.

Value	Meaning
0	The inquiry was successfully performed.
1	The operation selector was invalid.
2	The INTEGER array size was not equal to the number INTEGER parameters requested by the operation selector.
3	The REAL array size was not equal to the number of REAL parameters requested by the operation selector.
4	The string array was not large enough to hold the string requested by the operation selector.

The procedure `INQ_WS` returns current information about the graphics system to the application program. The type of information desired is specified by a unique value of `OPCODE`. The thousands digit of the operation selector specifies the number of integer values returned in the integer array and the hundreds digit specifies the number of `REAL` values returned in the `REAL` array. A 1 in the ten-thousand's place indicates that a value will be returned in the string.

One use of `INQ_WS` is device optimization: the use of inquiry to enhance the application's utilization of the output device. An example of this is using color to distinguish between lines when a device supports colors, and using line-styles when color is not available. Another example is maximizing the aspect ratio used, based on the maximum aspect ratio of the display device.

Device dependent information returned by the procedure is undefined if the device being inquired from is not enabled (e.g., inquire number of colors supported, operation selector 1053, only returns valid information when the display is enabled).

If the graphics system is not initialized, the call will be ignored and `GRAPHICSError` will return a non-zero value.

Supported Operation Selectors

The operation selectors supported by the system and their meaning is listed below:

Operation Selector	Meaning
250	Current cell size used for text. REAL Array[1] = Character cell width in world coordinates REAL Array[2] = Character cell height in world coordinates
251	Marker size. REAL Array[1] = Marker width in world coordinates REAL Array[2] = Marker height in world coordinates
252	Resolution of graphics display REAL Array[1] = Resolution in X direction (points/mm) REAL Array[2] = Resolution in Y direction (points/mm)
253	Maximum dimensions of the graphics display. REAL Array[1] = Maximum size in X direction (MM) REAL Array[2] = Maximum size in Y direction (MM)
254	Aspect ratios REAL Array[1] = Current aspect ratio of the virtual coordinate system. REAL Array[2] = Aspect ratio of logical limits.
255	Resolution of locator device REAL Array[1] = Resolution in X direction (points/mm) REAL Array[2] = Resolution in Y direction (points/mm)
256	Maximum dimensions of the locator display. REAL Array[1] = Maximum size in X direction (MM) REAL Array[2] = Maximum size in Y direction (MM)
257	Current locator echo position REAL array[1] = X world coordinate position REAL array[2] = Y world coordinate position
258	Current virtual coordinate limits REAL array[1] = Maximum X virtual coordinate REAL array[2] = Maximum Y virtual coordinate
259	Starting position. The information returned may not be valid (not updated) following a text call, an escape function call, changes to the viewing transformation or after initialization of the graphics display device. REAL array[1] = X world coordinate position REAL array[2] = Y world coordinate position
450	Current window limits REAL array[1] = Minimum X world coordinate position REAL array[2] = Maximum X world coordinate position REAL array[3] = Minimum Y world coordinate position REAL array[4] = Maximum Y world coordinate position
451	Current viewport limits REAL array[1] = Minimum X virtual coordinate REAL array[2] = Maximum X virtual coordinate REAL array[3] = Minimum Y virtual coordinate REAL array[4] = Maximum Y virtual coordinate

Operation Selector	Meaning
1050	Does graphics display device support clipping at physical limits? INTEGER Array[1] = 0 - No INTEGER Array[1] = 1 - Yes, to the view-surface boundaries INTEGER Array[1] = 2 - Yes, but only to the physical limits of the display surface.
1051	Justification of the view surface within the logical display limits. INTEGER Array[1] = 0 - View-surface is centered within the logical display limits INTEGER Array[1] = 1 - View surface is positioned in the lower left corner of the logical display limits.
1052	Can the graphics display draw in the background color? Drawing in the background color can be used to 'erase' previously drawn primitives. INTEGER Array[1] = 0 - No INTEGER Array[1] = 1 - Yes
1053	The total number of non-dithered colors supported on the graphics display. The number returned does not include the background color. (Compare operation selectors 1053, 1054, and 1075.) INTEGER Array[1] = number of distinct colors supported.
1054	Number of distinct non-dithered colors which can appear on the graphics display at one time. The number returned does not include the background color. INTEGER Array[1] = number of distinct colors which can appear on the display device at one time.
1056	Number of line-styles supported on the graphics display. INTEGER Array[1] = number of hardware line-styles supported.
1057	Number of line-widths supported on the graphics display. INTEGER Array[1] = number of line-widths supported.
1059	Number of markers supported on the graphics display. INTEGER Array[1] = # of distinct markers supported.
1060	Current value of color attribute. INTEGER Array[1] = Current value of color attribute.
1062	Current value of line-style attribute INTEGER Array[1] = Current value of line-style attribute.
1063	Current value of line-width attribute. INTEGER Array[1] = Current value.
1064	Current timing mode. INTEGER Array[1] = 0 - Immediate visibility INTEGER Array[1] = 1 - System buffering
1065	Number of entries in the polygon style table. INTEGER Array[1] = # styles.
1066	Current polygon interior color index. INTEGER Array[1] = Index

Operation Selector	Meaning
1067	Current polygon style index. INTEGER Array[1] = Index
1068	Maximum number of polygon vertices that a display device can process. INTEGER Array[1] = 0 No hardware support. = N (0<n<32767) Number of vertices supported. = 32767 The graphics display device uses all available memory to process polygons (the maximum number of vertices is determined by current free memory).
1069	Does the graphics device support immediate, retroactive change of polygon style for polygons already displayed? INTEGER Array[1] = 0 - No. INTEGER Array[1] = 1 - Yes.
1070	Does the graphics device support hardware (or low-level device handler) generation of polygons using INT_POLYGON_DD? INTEGER Array[1] = 0 - No INTEGER Array[1] = 1 - Yes
1071	Does the graphics device support immediate, retroactive change for primitives already displayed? INTEGER Array[1] = 0 - No INTEGER Array[1] = 1 - Yes
1072	Can the background color of the display be changed? INTEGER Array[1] = 0 - No INTEGER Array[1] = 1 - Yes
1073	Can entries in the color table be redefined using SET_COLOR_TABLE? INTEGER Array[1] = 0 - No INTEGER Array[1] = 1 - Yes
1074	Current color model in use. INTEGER Array[1] = 1 - RGB INTEGER Array[1] = 2 - HSL
1075	Number of entries in the color capability table. The number returned does not include the background color. INTEGER Array[1] = # entries
1076	Current polygon interior line-style. INTEGER Array[1] = Current interior line-style
11050	Graphics display device association. String = Name of device path. (Internal device specifier.) INTEGER Array[1] = Number of characters in the device path.
11052	Locator device association. String = Name of device path. (Internal device specifier.) INTEGER Array[1] = Number of characters in the device path.

Operation Selector	Meaning
12050	Graphics display device information. String = Name of graphics display device. INTEGER Array[1] = Number of characters in the device name. INTEGER Array[2] = Status = 0 Graphics display is not enabled. = 1 Graphics display is enabled.
13052	Graphics locator device information. String = Name of the locator device. INTEGER Array[1] = Number of characters in the device name. INTEGER Array[2] = Status = 0 Locator device is not enabled. = 1 Locator device is enabled. INTEGER Array[3] = Number of buttons on the locator device.

Error Conditions

If the graphics system is not initialized, the call will be ignored, an ESCAPE (-27) will be generated, and GRAPHICSError will return a non-zero value.

INT_LINE

IMPORT: dgl_types
dgl_lib

This **procedure** draws a line from the starting position to the world coordinate specified.

Syntax

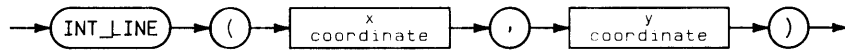

Item	Description/Default	Range Restrictions
x coordinate	Expression of TYPE <i>Gshortint</i> ; This is subrange of INTEGER	– 32 768 to 32 767
y coordinate	Expression of TYPE <i>Gshortint</i> ; This is subrange of INTEGER	– 32 768 to 32 767

Procedure Heading

```
PROCEDURE INT_LINE ( Iwx, Iwy : Gshortint );
```

Semantics

The **x** and **y coordinate** pair is the ending of the line to be drawn in the world coordinate system.

A line is drawn from the starting position to the world coordinate specified by the x and y coordinates. The starting position is updated to this point at the completion of this call.

The primitive attributes of line style (see SET_LINE_STYLE), line width (see SET_LINE_WIDTH), and color (see SET_COLOR) apply to lines drawn using INT_LINE.

This procedure is the same as the LINE procedure, with the exception that the parameters are of type *Gshortint* (– 32 768..32 767). When used with some displays this procedure may perform about 3 times faster than the LINE procedure. For all other displays this procedure has about the same performance as the LINE procedure.

The INT_LINE procedure only has increased performance when the following conditions exist:

- The display must be a raster device.
- The window bounds within the range – 32 768 to 32 767.
- The window must be less than 32 767 units wide and high.

INT operations are provided for efficient vector generation. Although their use can be mixed with other, non-integer operations, one dot roundoff errors may result with mixed use since different algorithms are used to implement each.

Drawing to the starting position generates the shortest line possible. Depending on the nature of the current line-style, nothing may appear on the graphics display surface. See SET_LINE_STYLE for a complete description of how line-style affects a particular point or vector.

INT_MOVE

IMPORT: dgl_types
dgl_lib

This **procedure** sets the starting position to the world coordinate position specified.

Syntax



Item	Description/Default	Range Restrictions
x coordinate	Expression of TYPE <i>Gshortint</i> , This is subrange of INTEGER	- 32 768 to 32 767
y coordinate	Expression of TYPE <i>Gshortint</i> , This is subrange of INTEGER	- 32 768 to 32 767

Procedure Heading

```
PROCEDURE INT_MOVE ( Iwx, Iwy : INTEGER );
```

Semantics

The **x** and **y coordinate** pair define the new starting position in world coordinates.

INT_MOVE specifies where the next graphical primitive will be output. It does this by setting the value of the starting position to the world coordinate system point specified by the x and y coordinate values and then moving the pen (or its logical equivalent) to that point.

The starting position corresponds to the location of the physical pen or beam in all but four instances: after a change in the viewing transformation, after initialization of a graphical display device, after the output of a text string, or after the output of an escape function. A call to MOVE or INT_MOVE should therefore be made after any one of the following calls to update the value of the starting position and in so doing, place the physical pen or beam at a known location: SET_ASPECT, DISPLAY_INIT, SET_DISPLAY_LIM, OUTPUT_ESC, TEXT, SET_VIEWPORT, and SET_WINDOW.

This procedure is the same as the MOVE procedure, with the exception that the parameters are of type *Gshortint* (- 32 768..32 767). When used with the same display, this procedure can perform about 3 times faster than the MOVE procedure. For all other displays this procedure has about the same performance as the MOVE procedure.

The INT_MOVE procedure only has increased performance when the following conditions exist:

- The display must be a raster device.
- The window bounds within the range $-32\,768$ to $32\,767$.
- The window must be less than 32767 units wide and high.

INT operations are provided for efficient vector generation. Although their use can be mixed with non-integer operations, one dot roundoff errors may result with mixed use since different algorithms are used to implement each.

Error Conditions

The graphics system must be initialized and a graphics display must be enabled or the call will be ignored, an ESCAPE (-27) will be generated, and GRAPHICSError will return a non-zero value.

INT_POLYGON

IMPORT: dgl_types
 dgl_lib
 dgl_poly

This **procedure** displays a polygon-set starting and ending at the specified point adhering to the specified polygon style exactly as specified (i.e., device-independent results).

Syntax

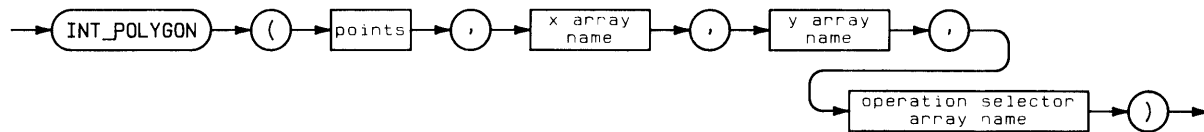

Item	Description/Default	Range Restrictions
points	Expression of TYPE INTEGER	MININT thru MAXINT
x array name	Array of TYPE <i>Gshortint</i> . <i>Gshortint</i> is a sub-range of INTEGER.	- 32 768 to 32 767
y array name	Array of TYPE <i>Gshortint</i> . <i>Gshortint</i> is a sub-range of INTEGER.	- 32 768 to 32 767
operation selector array name	Array of TYPE <i>Gshortint</i> . <i>Gshortint</i> is a sub-range of INTEGER.	- 32 768 to 32 767

Procedure Heading

```

PROCEDURE INT_POLYGON ( NPoint      : INTEGER;
                        ANYVAR   Xvec  : Gshortint_list;
                        ANYVAR   Yvec  : Gshortint_list;
                        ANYVAR   Opcodes : Gshortint_list);

```

Semantics

Points is the number of vertices in the polygon set.

The **x** and **y coordinate arrays** contain the world coordinate values for each vertex of the polygon-set. The vertices must be in order. The vertices for the first sub-polygon must be at the beginning of these arrays, followed by the vertices for the second sub-polygon, etc. So, the coordinate arrays must contain a total number of vertices that equals points.

The **operation selector array** contains a series of integer operation selectors defining which vertices start new polygons, and defining which edges should be displayed.

Value	Meaning
0	Don't display the line for the edge extending to this vertex from the previous vertex.
1	Display the line for the edge extending to this vertex from the previous vertex.
2	This vertex is the first vertex of a sub-polygon. Succeeding vertices are part of a sub-polygon until a new start-of-polygon operation selector (2) is encountered. (Or the end of the arrays is encountered.)

Note

The first entry in the operation selector array **must** be 2, since it is the first vertex of a sub-polygon.

INT_POLYGON is used to output a polygon-set, specified in world coordinates, adhering exactly to the polygon style attributes that are currently specified. A polygon-set is a set of polygons (called “sub-polygons”) that are treated graphically as one polygon. This is accomplished by “stacking” the sub-polygons. The subpolygons in a polygon-set may intersect or overlap each other.

The edge of a sub-polygon is defined as the line sequence that connects its vertices in the order specified. If the last vertex specified for a sub-polygon is not the same as the first, they are automatically connected.

When a polygon-set is displayed, the primitive attributes for polygons and lines define its appearance. In particular, the interior of the polygon-set will be filled according to the attributes of polygon style, polygon interior color and polygon interior line-style. If the edges are to be displayed as specified in the polygon style, the edges will adhere to the current line attributes of color, line-style and line-width. A dot will disappear on an edged polygon if the edge is done with a complementing line.

The filling of polygons also depends on how the sub-polygons “nest” within each other. An “even-odd” rule is used for determining which areas will be filled. Moving across the screen, count the edges of the polygon. Odd-numbered edges will turn the fill on and even-numbered edges will turn the fill off. The picture below will help clear up how the fills work.

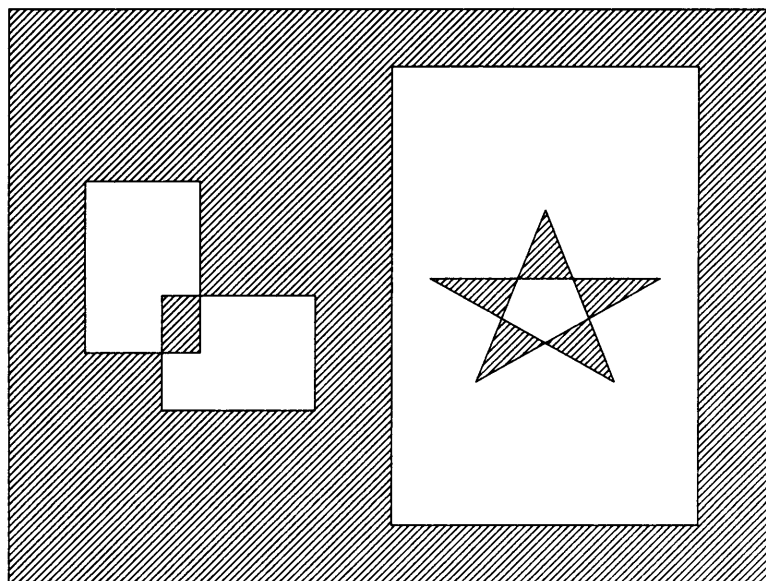

Polygon Filling

Refer to SET_PGN_TABLE, SET_PGN_STYLE, SET_PGN_COLOR, SET_PGN_LS for a more detailed description of how attributes affect polygons.

As stated above, the values in the operation selector array define how the edges of the sub-polygons are displayed. The edge from the (I-1)th vertex to the Ith vertex will only be displayed if the Ith entry in the operation selector array equals 1. To display the edge from the last vertex to the first vertex of a sub-polygon, the first vertex must be explicitly respecified after all the other vertices of the sub-polygon, with an operation selector equal to 1. Otherwise the edge from the last vertex to the first will not be drawn. It will, however, automatically be connected for polygon filling.

If it is within the capabilities of the device, filling of the sub-polygon will be done to the sub-polygon edges regardless of whether the edges are displayed. If an entry in the operation selector array does not equal 0, 1, or 2, it will be treated as if it were equal to 0 and the edge will not be drawn.

When INT_POLYGON is used, the current position is updated to the end of the last sub-polygon specified in the polygon-set. The end of the last sub-polygon is defined to be the first (implicit last) vertex of the subpolygon. So, if there is only one vertex in a polygon-set this call degenerates to an update of the current position to the first coordinate set in the x and y point arrays (x coordinate array[1], y coordinate array[1]).

It is the application program's responsibility to ensure that the arrays are all dimensioned to at least the number of elements specified by points and that at least that many values are contained in each array.

Polygons are defined to be closed surfaces. When a sub-polygon extends beyond a clipping edge the closed nature of the sub-polygon is destroyed. As with other primitives, unpredictable results may occur if the sub-polygon extends beyond the clipping window.

This procedure is the same as the POLYGON procedure, with the exception that the parameters are of type *Gshortint* (–32 768..32 767). When used with some displays this procedure may perform about 3 times faster than the POLYGON procedure. For all other displays this procedure has about the same performance as the POLYGON procedure.

The INT_POLYGON procedure only has increased performance when the following conditions exist:

- The display must be a raster device.
- The window bounds are within the range –32 768 through 32 767.
- The window must be less than 32 767 units wide and high.

INT_POLYGON is provided for efficient vector generation. Although its use can be mixed with MOVE, LINE, POLYLINE, and POLYGON, one dot roundoff errors may result with mixed use since different algorithms are used to implement each.

Error Conditions

The graphics system must be initialized, a graphics display must be enabled, all parameters must be within specified limits and the number of points specified must be greater than 0 or the call will be ignored, an ESCAPE (–27) will be generated, and GRAPHICSEERROR will return a non-zero value.

INT_POLYGON_DD

IMPORT: dgl_types
 dgl_lib
 dgl_poly

This **procedure** displays a polygon-set starting and ending at the specified point adhering to the specified polygon style in a device-dependent fashion.

Syntax

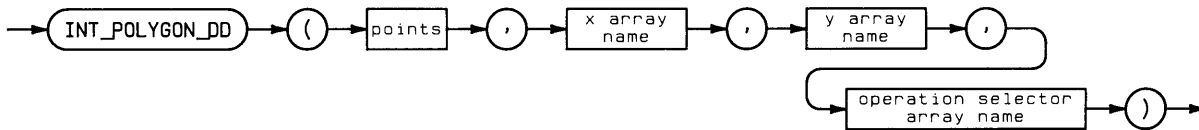

Item	Description/Default	Range Restrictions
points	Expression of TYPE INTEGER	MININT thru MAXINT
x array name	Array of TYPE <i>Gshortint</i> . <i>Gshortint</i> is a sub-range of INTEGER.	- 32 768 to 32 767
y array name	Array of TYPE <i>Gshortint</i> . <i>Gshortint</i> is a sub-range of INTEGER.	- 32 768 to 32 767
operation selector array name	Array of TYPE <i>Gshortint</i> . <i>Gshortint</i> is a sub-range of INTEGER.	- 32 768 to 32 767

Procedure Heading

```

PROCEDURE INT_POLYGON_ DD (
    Npoint      : INTEGER;
    ANYVAR Xvec : Gshortint_list;
    ANYVAR Yvec : Gshortint_list;
    ANYVAR Opcodes : Gint_list );
    
```

Semantics

Points is the number of vertices in the polygon set.

The **x** and **y coordinate arrays** contain the world coordinate values for each vertex of the polygon-set. The vertices must be in order. The vertices for the first sub-polygon must be at the beginning of these arrays, followed by the vertices for the second sub-polygon, etc. So, the coordinate arrays must contain a total number of vertices that equals points.

The **operation selector array** contains a series of integer operation selectors defining which vertices start new polygons, and defining which edges should be displayed.

Value	Meaning
0	Don't display the line for the edge extending to this vertex from the previous vertex.
1	Display the line for the edge extending to this vertex from the previous vertex.
2	This vertex is the first vertex of a sub-polygon. Succeeding vertices are part of a sub-polygon until a new start-of-polygon operation selector (2) is encountered. (Or the end of the arrays is encountered.)

Note

The first entry in the operation selector array **must** be 2, since it is the first vertex of a sub-polygon.

INT_POLYGON_DD is used to output a polygon-set, specified in world coordinates, adhering within the capabilities of the device to the polygon style attributes that are currently specified. A polygon-set is a set of polygons (called "sub-polygons") that are treated graphically as one polygon. The subpolygons in a polygon-set may intersect or overlap each other.

The edge of a sub-polygon is defined as the line sequence that connects its vertices in the order specified. If the last vertex specified for a sub-polygon is not the same as the first, they are automatically connected.

When a polygon-set is displayed, the primitive attributes for polygons and lines define its appearance. In particular, the interior of the polygon-set will be filled according to the attributes of polygon style, polygon interior color and polygon interior line-style. If the edges are to be displayed as specified in the polygon style, the edges will adhere to the current line attributes of color, line-style and line-width.

The filling of polygons also depends on how the sub-polygons "nest" within each other. An "even-odd" rule is used for determining which areas will be filled. Moving across the screen, count the edges of the polygon. Odd-numbered edges will turn the fill on and even-numbered edges will turn the fill off. The picture below will help clear up how the fills work.

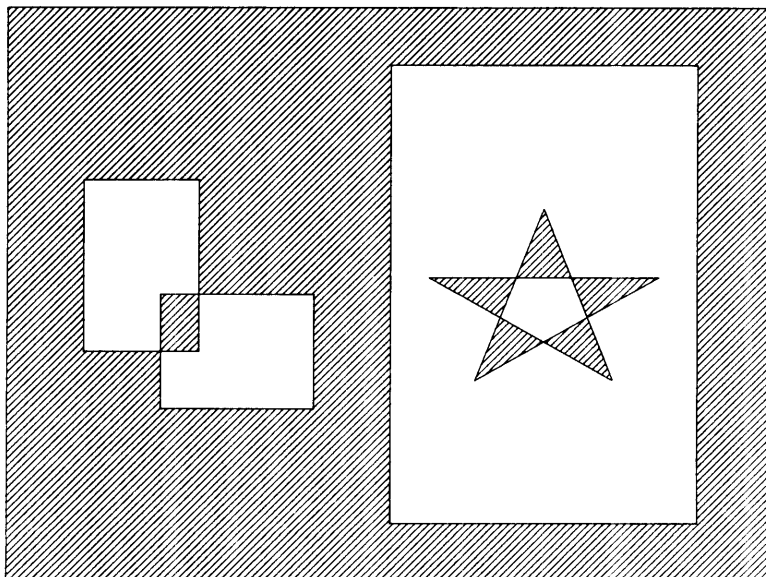

Polygon Filling

Refer to SET_PGN_TABLE, SET_PGN_STYLE, SET_PGN_COLOR, SET_PGN_LS for a more detailed description of how attributes affect polygons.

As stated above, the values in the operation selector array define how the edges of the sub-polygons are displayed. The edge from the (I-1)th vertex to the Ith vertex will only be displayed if the Ith entry in the operation selector array equals 1. To display the edge from the last vertex to the first vertex of a sub-polygon, the first vertex must be explicitly respecified after all the other vertices of the sub-polygon, with an operation selector equal to 1. Otherwise the edge from the last vertex to the first will not be drawn. It will, however, automatically be connected for polygon filling.

If it is within the capabilities of the device, filling of the sub-polygon will be done to the sub-polygon edges regardless of whether the edges are displayed. If an entry in the operation selector array does not equal 0, 1, or 2, it will be treated as if it were equal to 0, i.e., the edge will not be drawn.

When INT_POLYGON_DD is used, the current position is updated to the end of the last sub-polygon specified in the polygon-set. The end of the last sub-polygon is defined to be the first (implicit last) vertex of the subpolygon. So, if there is only one vertex in a polygon-set this call degenerates to an update of the current position to the first coordinate set in the x and y point arrays (x coordinate array[1], y coordinate array[1]).

It is the application program's responsibility to ensure that the arrays are all dimensioned to at least the number of elements specified by points and that at least that many values are contained in each array.

Device capabilities vary widely. Not all devices are able to draw polygon edges as requested. If a device is not able to draw polygon edges as requested, they will be simulated in software. The simulation will always adhere to the edge value in SET_PGN_STYLE and the operation selector in INT_POLYGON_DD, but the line-style and color of the edge will depend on the capability of the device to produce lines with those attributes.

Polygon fill capabilities can vary widely between devices. A device may have no filling capabilities at all, may be able to perform only solid fill, or may be able to fill polygons with different fill densities and at different fill line orientations. INT_POLYGON_DD tries to match the device capabilities to the request. If the device cannot fill the request at all, then no simulation is done and the polygon will not be filled. For HPGL plotters, the fill is simulated. For raster devices, if the density is greater than 0.5, a solid fill is used, otherwise, the fill is simulated.

In the case where the polygon style specifies non-display of edged, this would result in no visible output although visible output had been specified. To provide some visible output in this case, INT_POLYGON_DD will outline the polygon using the color and line-style specified for the fill lines. However, only those edge segments specified as displayable by the operation selector array will be drawn. Therefore, if all edge segments are specified as non-displayed, there will still be no visible output.

Regardless of the capabilities of the device, INT_POLYGON_DD sets the starting position to the first vertex of the last member polygon specified in the call. If there is only one polygon specified, the starting position will therefore be set to the first vertex specified.

Polygons are defined to be closed surfaces. When a sub-polygon extends beyond a clipping edge the closed nature of the sub-polygon is destroyed. As with other primitives, unpredictable results may occur if the sub-polygon extends beyond the clipping window.

This procedure is the same as the procedure `POLYGON_DEV_DEP`, with the exception that the parameters are of type *Gshortint* (–32 768..32 767). When used with some displays this procedure may perform about 3 times faster than the `POLYGON_DEV_DEP` procedure. For all other displays this procedure has about the same performance as the `POLYGON_DEV_DEP` procedure.

The `INT_POLYGON_DD` procedure only has increased performance when the following conditions exist:

- The display is a raster device.
- The window bounds are within the range –32 768 through 32 767.
- The window is less than 32 767 units wide and high.

`INT_POLYGON_DD` is provided for efficient vector generation. Although its use can be mixed with `MOVE`, `LINE`, `POLYLINE`, and `POLYGON_DEV_DEP`, one dot roundoff errors may result with mixed use since different algorithms are used to implement each.

Error Conditions

The graphics system must be initialized, a graphics display must be enabled, all parameters must be within specified limits and the number of points (Points) must be greater than 0 or the call will be ignored, an `ESCAPE` (–27) will be generated, and `GRAPHICSEERROR` will return a non-zero value.

INT_POLYLINE

```
IMPORT: dgl_types
       dgl_lib
```

This procedure draws a connected line sequence starting at the specified point.

Syntax

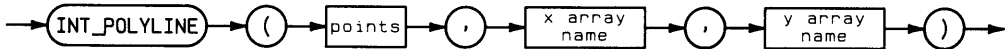

Item	Description/Default	Range Restrictions
points	Expression of TYPE INTEGER	MININT thru MAXINT
x array name	Array of TYPE <i>Gshortint</i> . <i>Gshortint</i> is a sub-range of INTEGER.	- 32 768 to 32 767
y array name	Array of TYPE <i>Gshortint</i> . <i>Gshortint</i> is a sub-range of INTEGER.	- 32 768 to 32 767

Procedure Heading

```
PROCEDURE INT_POLYLINE (
                        Npts          : INTEGER;
                        ANYVAR Xvec, Yvec : Gshortint_list )
```

Semantics

Points is the number of vertices in the polygon set.

The **x** and **y coordinate arrays** contain the world coordinate values for each vertex of the polyline-set. The vertices must be in order. The vertices for the first sub-polyline must be at the beginning of these arrays, followed by the vertices for the second sub-polyline, etc. So, the coordinate arrays must contain a total number of vertices that equals points.

The procedure INT_POLYLINE provides the capability to draw a series of connected lines starting at the specified point. A complete object can be drawn by making one call to this procedure. This call first sets the starting position to be the first elements in the x and y coordinate arrays. The line sequence begins at this point and is drawn to the second element in each array, then to the third and continues until points-1 lines are drawn.

This procedure is equivalent to the following sequence of calls:

```
INT_MOVE (X_coordinate_array[1],Y_coordinate_array[1]);
INT_LINE (X_coordinate_array[2],Y_coordinate_array[2]);
INT_LINE (X_coordinate_array[3],Y_coordinate_array[3]);
      :
      :
INT_LINE (X_coordinate_array[Points],Y_coordinate_array[Points]);
```

The starting position is set to (X_coordinate_array[Points], Y_coordinate_array[Points]) at the completion of this call.

Specifying only one element, or Points equal to 1, causes a move to be made to the world coordinate point specified by the first entries in the two coordinate arrays.

It is the application program's responsibility to ensure that the arrays are all dimensioned to at least the number of elements specified by points and that at least that many values are contained in each array.

Depending on the nature of the current line-style nothing may appear on the graphics display. See SET_LINE_STYLE for a complete description of how line-style affects a particular point or vector.

The primitive attributes of color, line-style, and line-width apply to polylines.

This procedure is the same as the POLYLINE procedure, with the exception that the parameters are of type *Gshortint* (–32 768..32 767). When used with some displays this procedure may perform about 3 times faster than the POLYLINE procedure. For all other displays this procedure has about the same performance as the POLYLINE procedure.

The INT_POLYLINE procedure only has increased performance when the following conditions exist:

- The display must be a raster device.
- The window bounds within the range –32 768 to 32 767.
- The window must be less than 32 767 units wide and high.

INT_POLYLINE is provided for efficient vector generation. Although its use can be mixed with MOVE, LINE, and POLYLINE, one dot roundoff errors may result with mixed use since different algorithms are used to implement each.

Error Conditions

The graphics system must be initialized, a graphics display must be enabled, all parameters must be within specified limits and the number of points (points) must be greater than 0 or the call will be ignored, an ESCAPE (–27) will be generated, and GRAPHICSError will return a non-zero value.

IOBUFFER

IMPORT: general_4
 iodeclarations

This **procedure** will create a buffer area of the specified number of bytes. The buffer name variable contains the various empty and fill pointers necessary to use the buffer space.

Syntax

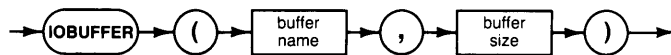

Item	Description/Default	Range Restrictions
buffer name	Variable of TYPE <i>buf_info_type</i> .	See the Advanced Transfer Techniques chapter
buffer size	Expression of TYPE INTEGER, specifies bytes.	MININT thru MAXINT

Semantics

Re-executing IOBUFFER on a buffer name will allocate new space in the system, not reclaim the old space, or put a transfer in the old space into a known state.

MARK and RELEASE interact with IOBUFFER, and it is possible to lose an io buffer by releasing it.

The buffer name should be in a VAR declaration at the outermost level of the program or module containing it.

IOCONTROL

IMPORT: general_0
iodeclarations

This **procedure** sends control information to the selected interface. Refer to the specific interface in the Status and Control Register Appendix in the Pascal System User's Manual.

Syntax



Item	Description/Default	Range Restrictions	Recommended Range
interface select code	Expression of TYPE <i>type_isc</i> . This is an INTEGER subrange.	0 thru 31	7 thru 31
register number	Expression of TYPE <i>io_word</i> . This is an INTEGER subrange.	- 32 768 thru 32 767	Interface dependent
control value	Expression of TYPE INTEGER.	MININT thru MAXINT	0 thru 65 535 (interface dependent)

Note

Unexpected and possibly undesirable side effects may result from attempting to use this procedure in combination with other parts of the I/O procedure library. Make sure you understand the full implications of using it before including it in a program.

IOERROR_MESSAGE

IMPORT: general_3
 iodeclarations

This **function** returns a value of TYPE *iostring* (a string dimensioned to 255 characters) containing an English textual description of an error produced by the I/O procedure library.

Syntax



Item	Description/Default	Range Restrictions	Recommended Range
error number	Expression of TYPE INTEGER.	MININT thru MAXINT	0 thru 327

Semantics

Example:

```
PROGRAM Sample(Input, Output);
.
.
.
BEGIN
  TRY
  .
  .
  .
  RECOVER BEGIN
    IF Escapecode = Ioescapecode THEN
      WRITELN (IOERROR_MESSAGE(Ioe_result), ' on ', Ioe_isc);
      ESCAPE (Escapecode);
    END {Recover}
  END. {Main Program}
```

See the Errors and Timeouts chapter for further details on the IOE_RESULT and IOE_ISC variables.

IO_FIND_ISC

IMPORT: iodeclarations

Note

This function is provided for use by the internal I/O Procedure Library drivers, only. Unexpected and possible undesirable results may occur if it is used.

IO_ESCAPE

IMPORT: iodeclarations

Note

This function is provided for use by the internal I/O Procedure Library drivers, only. Unexpected and possible undesirable results may occur if it is used.

IOINITIALIZE

IMPORT: general_1

This **procedure** resets all interfaces.

Syntax

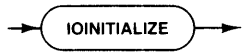

Semantics

A program should be bracketed by IOINITIALIZE and IOUNINITIALIZE.

```
PROGRAM userProg ( ..... ) ;  
  .  
  .  
BEGIN  
  ioinitialize;  
  .  
  .  
  .  
  iouninitialize;  
END.
```

IOREAD_BYTE

IMPORT: general_0
 iodeclarations

This **function** reads the byte contained in specified register (physical address) on the selected interface. The function returns a value of TYPE *io_byte*. This is an INTEGER subrange, 0..255.

Syntax

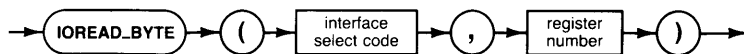

Item	Description/Default	Range Restrictions	Recommended Range
interface select code	Expression of TYPE <i>type_isc</i> . This is an INTEGER subrange.	0 thru 31	7 thru 31
register number	Expression of TYPE <i>io_word</i> . This is an INTEGER subrange.	- 32 768 thru 32 767	Interface dependent

Semantics

Note

These are physical address registers, **not** the Status registers used by the IOSTATUS statement. See the Memory Map Appendix in the *Pascal Workstation System* manual.

IOREAD_WORD

IMPORT: general_0
iodeclarations

This **function** reads the word contained in the specified register (physical address) on the selected interface. The function returns a value of TYPE *io_word*. This is an INTEGER sub-range, -32 768..32 767.

Syntax

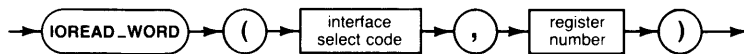

Item	Description/Default	Range Restrictions	Recommended Range
interface select code	Expression of TYPE <i>type_isc</i> . This is an INTEGER subrange.	0 thru 31	7 thru 31
register number	Expression of TYPE <i>io_word</i> . This is an INTEGER subrange.	- 32 768 thru 32 767	Interface dependent

Semantics

Note

These are physical address registers, **not** the Status registers used by the IOSTATUS statement. See the Memory Map Appendix in the *Pascal Workstation System* manual.

IORESET

IMPORT: general_1
 iodeclarations

This **procedure** will reset the specified interface to its initial (power on) state. Any currently active transfers will be terminated.

Syntax

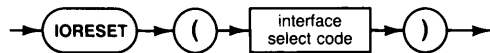

Item	Description/Default	Range Restrictions	Recommended Range
interface select code	Expression of TYPE <i>type_isc</i> . This is an INTEGER subrange.	0 thru 31	7 thru 31

IOSTATUS

IMPORT: general_0
iodeclarations

This **function** returns the contents of an interface status register. The value returned is of TYPE *io_word*, an integer subrange (– 32 768 thru 32 767).

Syntax

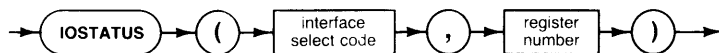

Item	Description/Default	Range Restrictions	Recommended Range
interface select code	Expression of TYPE <i>type_isc</i> . This is an INTEGER subrange.	0 thru 31	7 thru 31
register number	Expression of TYPE <i>io_word</i> . This is an INTEGER subrange.	– 32 768 thru 32 767	Interface dependent

Semantics

The register meaning depends on the interface. Refer to the specific interface in the Status and Control Registers.

IO_SYSTEM_RESET

IMPORT: general_0
iodeclarations

Note

This function is provided for use by the internal I/O Procedure Library drivers, only. Unexpected and possible undesirable results may occur if it is used.

IOUNINITIALIZE

IMPORT: general_1
iodeclarations

This **procedure** resets all interfaces.

Syntax



Semantics

A program should be bracketed by IOINITIALIZE and IOUNINITIALIZE.

```
PROGRAM userprog ( ..... ) ;  
.  
.  
BEGIN  
  ioinitialize;  
  .  
  .  
  iouninitialize;  
END.
```

IOWRITE_BYTE

IMPORT: general_0
 iodeclarations

This **procedure** writes the supplied value (representing one byte) to the specified register (physical address) on the selected interface. The actual action resulting from the operation depends on the interface and register selected.

Syntax

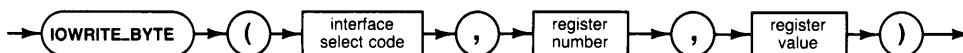

Item	Description/Default	Range Restrictions	Recommended Range
interface select code	Expression of TYPE <i>type_isc</i> . This is an INTEGER subrange.	0 thru 31	7 thru 31
register number	Expression of TYPE <i>io_word</i> . This is an INTEGER subrange.	- 32 768 thru 32 767	Interface dependent
register value	Expression of TYPE <i>io_byte</i> . This is an INTEGER subrange.	0 thru 255	Interface dependent

Semantics

Notes

These are physical address registers, **not** the Status registers used by the IOSTATUS statement. See the Memory Map Appendix in the *Pascal Workstation System* manual.

Unexpected and possibly undesirable side effects may result from attempting to use this procedure in combination with other parts of the I/O procedure library. Make sure you understand the full implications of using it before including it in a program.

IOWRITE_WORD

IMPORT: general_L0
iodeclarations

This **procedure** writes the supplied value (representing 16 bits) to the specified register on the selected interface. The actual action resulting from the operation depends on the interface and register selected.

Syntax

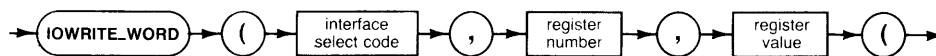

Item	Description/Default	Range Restrictions	Recommended Range
interface select code	Expression of TYPE <i>type_isc</i> . This is an INTEGER subrange.	0 thru 31	7 thru 31
register number	Expression of TYPE <i>io_word</i> . This is an INTEGER subrange.	- 32 768 thru 32 767	Interface dependent
register value	Expression of TYPE <i>io_word</i> . This is an INTEGER subrange.	- 32 768 thru 32 767	Interface dependent

Semantics

Notes

These are physical address registers, **not** the Status registers used by the IOSTATUS statement. See the Memory Map Appendix in the *Pascal Workstation System* manual.

Unexpected and possibly undesirable side effects may result from attempting to use this procedure in combination with other parts of the I/O procedure library. Make sure you understand the full implications of using it before including it in a program.

ISC_BUSY

IMPORT: general_4
 iodeclarations

This BOOLEAN function is TRUE if there is a transfer active on the specified interface.

Syntax

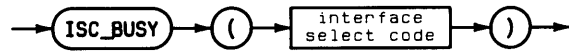

Item	Description/Default	Range Restrictions
interface select code	Expression of TYPE <code>type_isc</code> . This is an INTEGER subrange	7 thru 31

KERNEL_INITIALIZE

IMPORT: general_0

Note

This function is provided for use by the internal I/O Procedure Library drivers, only. Unexpected and possible undesirable results may occur if it is used. It will probably blow up your program, and will definitely destroy any operation you are currently performing in the I/O Procedure Library.

LINE

IMPORT: dgl_lib

This **procedure** draws a line from the starting position to the world coordinate specified.

Syntax

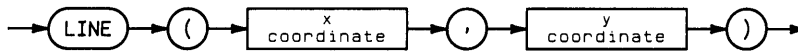

Item	Description/Default	Range Restrictions
x coordinate	Expression of TYPE REAL	—
y coordinate	Expression of TYPE REAL	—

Procedure Heading

```
PROCEDURE LINE ( Wx , Wy : REAL );
```

Semantics

A line is drawn from the starting position to the world coordinate specified by the X and Y coordinates. The starting position is updated to this point at the completion of this call.

The **x** and **y coordinate** pair is the ending of the line to be drawn in the world coordinate system.

The primitive attributes of line style, line width, and color apply to lines drawn using LINE. Drawing to the starting position generates the shortest line possible. Depending on the nature of the current line-style, nothing may appear on the graphics display surface. See SET_LINE_STYLE for a complete description of how line-style affects a particular point or vector.

Error Conditions

The graphics system must be initialized and a display must be enabled or this call will be ignored, an ESCAPE (- 27) will be generated, and GRAPHICSError will return a non-zero value.

LISTEN

IMPORT: hpib_2
iodeclarations

This **procedure** will send the specified listen address on the bus. The ATN line will be set true. The interface must be active controller.

Syntax

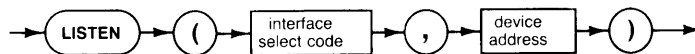

Item	Description/Default	Range Restrictions	Recommended Range
interface select code	Expression of TYPE <i>type_isc</i> . This is an INTEGER subrange.	0 thru 31	7 thru 31
device address	Expression of TYPE <i>type_hpib_address</i> . This is an INTEGER subrange.	0 thru 31	0 thru 30

LISTENER

IMPORT: hpib_3
 iodeclarations

This **BOOLEAN function** will return TRUE if the specified interface is currently addressed as a listener.

Syntax

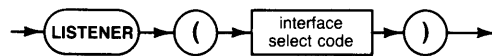

Item	Description/Default	Range Restrictions	Recommended Range
interface select code	Expression of TYPE <i>type_isc</i> . This is an INTEGER subrange.	0 thru 31	7 thru 31

LOCAL

IMPORT: hpib_2
iodeclarations

This **procedure** places the device(s) in local mode.

Syntax

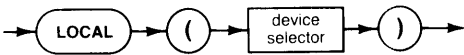

Item	Description/Default	Range Restrictions	Recommended Range
device selector	Expression of TYPE <i>type_device</i> . This is an INTEGER subrange.	() thru 3199	See glossary

Semantics

LOCAL (701) places the device at address 1 on interface 7 in the Local mode. LOCAL(7) places all devices on interface 7 in Local mode.

	System Controller		Not System Controller	
	Interface Select Code Only	Primary Addressing Specified	Interface Select Code Only	Primary Addressing Specified
Active Controller	$\overline{\text{REN}}$ ATN	ATN MTA UNL LAG GTL	ATN GTL	ATN MTA UNL LAG GTL
Not Active Controller	$\overline{\text{REN}}$	Error	Error	

LOCAL_LOCKOUT

IMPORT: hpib_2
 iodeclarations

This procedure sends LLO (the local lockout message) on the bus. The interface must be active controller.

Syntax

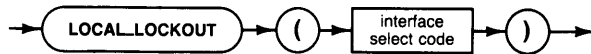

Item	Description/Default	Range Restrictions	Recommended Range
interface select code	Expression of TYPE <i>type_isc</i> . This is an INTEGER subrange.	0 thru 31	7 thru 31

Semantics

	System Controller		Not System Controller	
	Interface Select Code Only	Primary Addressing Specified	Interface Select Code Only	Primary Addressing Specified
Active Controller	ATN LLO	Error	ATN LLO	Error
Not Active Controller	Error			

LOCATOR_INIT

IMPORT: dgl_lib

This **procedure** enables the locator device for input.

Syntax

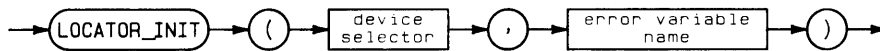

Item	Description/Default	Range Restrictions
device selector	Expression of TYPE INTEGER	MININT TO MAXINT
error variable name	Variable of TYPE INTEGER	-

Procedure Heading

```

PROCEDURE LOCATOR_INIT (      Dev_Adr : INTEGER ,
                             VAR Ierr  : INTEGER );
    
```

Semantics

The **device selector** specifies the physical addresses of the graphics locator device.

- device selector = 2 The Knob on Series 200 Computers
- 100 <= device selector <= 3199 composite HPIB/device address

The **error variable** will contain a value indicating whether the locator device was successfully enabled.

Value	Meaning
0	The locator device was successfully initialized.
2	Unrecognized device specified. Unable to communicate with a device at the specified address, non-existent interface card or non-graphics system supported interface card.

If the error variable contains a non-zero value, the call has been ignored.

LOCATOR_INIT enables the logical locator device for input. Enabling the locator includes associating the logical locator device with a physical device and initializing the device. The device name is set to the name of the physical device, the device status is set to 1 (enabled) and the internal device selector used by the graphics library is set equal to the device selector provided by the user. This information is available by calling INQ_WS with operation selectors 11052 and 13052.

LOCATOR_INIT implicitly makes the picture current before attempting to initialize the device.

LOCATOR_INIT enables the logical locator device for input. Enabling the locator includes associating the logical locator device with a physical device and initializing the device.

The graphics library attempts to directly identify the type of device by using its device address in some way. The meanings of the device address are defined above.

At the time that the graphics library is initialized, all devices which are to be used must be connected, powered on, ready, and accessible via the specified physical address. Invalid addressed or unresponsive devices result in that device not being initialized and an error being returned.

The locator device must be enabled before it is used for input. The locator device is disabled by calling LOCATOR_TERM.

If the graphics display and the locator are not the same physical device (e.g. HP 9826 display and HP 9111 locator), then the logical locator limits will be set to the default values for the particular locator used. If the graphics display and locator are the same physical device (e.g., HP 9826 display and HP 9826 knob locator), then the logical locator limits are set to the current view surface limits.

The locator echo position is set to the default value (see SET_ECHO_POS).

Only one locator device may be enabled at a time. If a locator is currently enabled, then the enabled device will be terminated (via LOCATOR_TERM) and the call will continue. The locator device should be disabled before the termination of the application program. LOCATOR_INIT is the complementary routine to LOCATOR_TERM.

HPGL Locator Devices

When the locator device is initialized on an HPGL device, the graphics display is left unaltered. HPGL devices are initialized to the following defaults when LOCATOR_INIT is executed:

Plotter	Wide mm	High mm	Wide points	High points	Aspect	Resolution points/mm
9872	400	285	16000	11400	.7125	40.0
7580	809.5	524.25	32380	20970	.6476	40.0
7585	1100	891.75	44000	35670	.8107	40.0
7586	1182.8	898.1	47312	35924	.7593	40.0
7470	257.5	191.25	10300	7650	.7427	40.0
7550	411.25	254.25	16450	10170	.6182	40.0
7475	416	259.125	16640	10365	.6229	40.0

The maximum physical limits of the locator for a HPGL device not listed above are determined by the default settings of P1 and P2. The default settings of P1 and P2 are the values they have after an HPGL 'IN' command. Refer to the specific device manual for additional details.

The default logical display surface is set equal to the area defined by P1 and P2 at the time LOCATOR_INIT is invoked.

Note

If the paper is changed in an HP 7580 or HP 7585 plotter while the graphics locator is initialized, it should be the same size of paper that was in the plotter when LOCATOR_INIT was called. If a different size of paper is required, the device should be terminated (LOCATOR_TERM) and re-initialized after the new paper has been placed in the plotter.

No locator points are returned while the pen control buttons are depressed on HPGL plotters.

The Knob as Locator

When the locator device is initialized, the graphics display is left unaltered. The default initialization characteristics for the knob on various Series 200 computers is listed below:

Computer	Wide mm	High mm	Wide points	High points	Aspect	Resolution points/mm
Model 216	160	120	400	300	.75	2.5
Model 217	230	175	512	390	.7617	2.226
Model 220 (HP82913A)	210	158	400	300	.75	1.905
Model 220 (HP82912A)	152	114	400	300	.75	2.632
Model 226	120	88	400	300	.75	3.333
Model 236	210	160	512	390	.7617	2.438
Model 236 Color	217	163	512	390	.7617	2.39
Model 237	312	234	1024	768	.75	3.282

The knob uses the current display limits as its locator limits for locator echoes 2 through 8. For all other echoes the above limits are used. An example of when the two limits may differ follows:

The knob locator is initialized on a Model 226. The graphics display is an HP 98627A color output card. The resolution of the locator is 0 through 399 in the X dimension, and 0 through 299 in the Y dimension. The resolution of the display is 0 through 511 in the X dimension, and 0 through 389 in the Y dimension. When AWAIT_LOCATOR is used with echo 4, the locator will effectively have the HP 98627A resolution for the duration of the AWAIT_LOCATOR call. However, if echo 1 is used with AWAIT_LOCATOR, the cursor will appear on the Model 226 and the locator has a resolution of 0 through 399 and 0 through 299. Note that all conversion routines and inquiries will use the Model 226 limits.

The physical origin of the locator device is the lower left corner of the display.

Error Conditions

The graphics system must be initialized or this call will be ignored, an ESCAPE (-27) will be generated, and GRAPHICSError will return a non-zero value.

LOCATOR_TERM

IMPORT: dgl_lib

This **procedure** disables the enabled locator device.

Syntax

→ LOCATOR_TERM →

Procedure Heading

```
PROCEDURE LOCATOR_TERM;
```

Semantics

LOCATOR_TERM terminates and disables the enabled locator device. It transmits any termination sequence required by the device and releases all resources being used by the device. The device name is set to the default device name (' '), the device status is set to 0 (not enabled) and the device address is set to 0.

LOCATOR_TERM is the complementary routine to LOCATOR_INIT.

If a locator device is used, LOCATOR_TERM should be called before the application program is terminated.

Error Conditions

The graphics system must be initialized and a locator device enabled or this call will be ignored, an ESCAPE (- 27) will be generated, and GRAPHICSError will return a non-zero value.

LOCKED_OUT

IMPORT: hpib_3
iodeclarations

This **BOOLEAN function** will return TRUE if the specified interface is currently in the local lockout state. If the interface is currently active controller a FALSE value will be returned regardless of the local lockout state.

Syntax

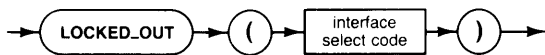

Item	Description/Default	Range Restrictions	Recommended Range
interface select code	Expression of TYPE <i>type_isc</i> . This is an INTEGER subrange.	0 thru 31	7 thru 31

MAKE_PIC_CURRENT

IMPORT: dgl_lib

This **procedure** makes the picture current.

Syntax

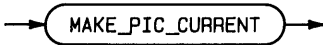

Procedure Heading

```
PROCEDURE MAKE_PIC_CURRENT;
```

Semantics

The graphics display surface can be made current at any time with a call to MAKE_PIC_CURRENT. This insures that all previously generated primitives have been sent to the graphics display device. Due to operating system delays, all picture changes may not have been displayed on the graphics display upon return to the calling program. MAKE_PIC_CURRENT is most often used in system buffering mode (see SET_TIMING) to make sure that all output has been sent to the graphics display device when required.

Before performing any non-graphics library input or output to an active graphics device, (e.g., a Pascal read or write), it is essential that all of the previously generated output primitives be sent to the device. If immediate visibility is the current timing mode, all primitives will be sent to the device before completion of the call to generate them, but if system buffering is used, MAKE_PIC_CURRENT should be called before performing any non-graphics system I/O.

The following routines implicitly make the picture current:

AWAIT_LOCATOR	DISPLAY_TERM	INPUT_ESC
LOCATOR_INIT	SAMPLE_LOCATOR	

A call to MAKE_PIC_CURRENT can be made at any time within an application program to insure that the image is fully displayed. MAKE_PIC_CURRENT does not modify the current timing mode.

Error Conditions

The graphics system must be initialized and a display must be enabled or this call will be ignored, an ESCAPE (− 27) will be generated, and GRAPHICSERROR will return a non-zero value.

MARKER

IMPORT: dgl_lib

This **procedure** outputs a marker symbol at the starting position.

Syntax

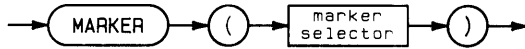

Item	Description/Default	Range Restrictions	Recommended Range
marker selector	Expression of TYPE INTEGER	MININT TO MAXINT	1 thru 19

Procedure Heading

```
PROCEDURE MARKER ( Marker_num : INTEGER );
```

Semantics

The **marker selector** determines which marker will be output. There are 19 defined invariant marker symbols (1-19). They are defined as follows:

1 - '.'	7 - rectangle	13 - '3'
2 - '+'	8 - diamond	14 - '4'
3 - '*'	9 - rectangle with cross	15 - '5'
4 - 'O'	10 - '0'	16 - '6'
5 - 'X'	11 - '1'	17 - '7'
6 - triangle	12 - '2'	18 - '8'
		19 - '9'

Marker numbers 20 and larger are device dependent.

MARKER outputs the marker designated by the marker selector, centered about the starting position. The starting position is left unchanged at the completion of this call.

If the marker selector specified is greater than the number of distinct marker symbols that are supported by a device, then marker number 1 ('.') will be used. INQ_WS can be used to inquire the number of distinct marker symbols that are available on a particular graphics display device. Depending on a particular display device's capabilities, the graphics library uses either hardware or software to generate the marker symbols.

The size and orientation of markers is fixed and not affected by the viewing transformation. The size of markers is device dependent and cannot be changed.

Only the primitive attributes of color and highlighting apply to markers. However, the marker will appear with these attributes only if the device is capable of applying them to markers.

Error Conditions

The graphics system must be initialized and a display device enabled or the call will be ignored, an ESCAPE (-27) will be generated, and GRAPHICSError will return a non-zero value.

MOVE

IMPORT: dgl_lib

This **procedure** sets the starting position to the world coordinate specified.

Syntax

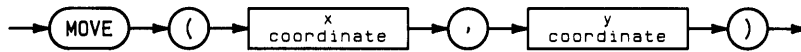

Item	Description/Default	Range Restrictions
x coordinate	Expression of TYPE REAL	—
y coordinate	Expression of TYPE REAL	—

Procedure Heading

```
PROCEDURE MOVE ( Wx, Wy : REAL );
```

Semantics

MOVE specifies where the next graphical primitive will be output. It does this by setting the value of the starting position to the world coordinate system point specified by the X,Y coordinate values and then moving the physical beam or pen to that point.

The **x** and **y coordinate** pair is the new starting position in world coordinates.

The starting position corresponds to the location of the physical pen or beam in all but four instances: after a change in the viewing transformation, after initialization of a graphical display device, after the output of a text string, or after the output of a graphical escape function. A call to MOVE or INT_MOVE should therefore be made after any one of the following calls to update the value of the starting position and in so doing, place the physical pen or beam at a known location: SET_ASPECT, DISPLAY_INIT, SET_DISPLAY_LIM, OUTPUT_ESC, TEXT, SET_VIEWPORT, and SET_WINDOW.

Error Conditions

The graphics system must be enabled and a display device enabled or this call will be ignored, an ESCAPE (- 27) will be generated, and GRAPHICSError will return a non-zero value.

MY_ADDRESS

IMPORT: hpib_1
 iodeclarations

This **function** returns an INTEGER subrange (TYPE type_hpib_addr) representing the HP-IB address of the specified HP-IB interface.

Syntax

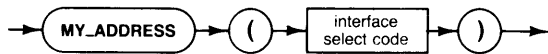

Item	Description/Default	Range Restrictions	Recommended Range
interface select code	Expression of TYPE <i>type_isc</i> . This is an INTEGER subrange.	0 thru 31	7 thru 31

OUTPUT_ESC

IMPORT: dgl_lib

This **procedure** performs a device dependent escape function to inquire from the graphics display device.

Syntax

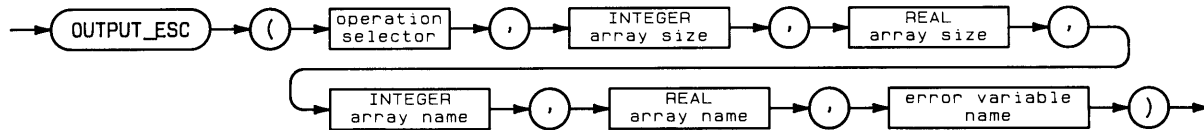

Item	Description/Default	Range Restrictions	Recommended Range
operation selector	Expression of TYPE INTEGER	MININT to MAXINT	–
INTEGER array size	Expression of TYPE INTEGER	MININT to MAXINT	>0
REAL array size	Expression of TYPE INTEGER	MININT to MAXINT	>0
INTEGER array name	Any valid variable. Should be INTEGER array	–	–
REAL array name	Any valid variable. Should be REAL array	–	–
error variable name	Variable of TYPE INTEGER	–	–

Procedure Heading

```

PROCEDURE OUTPUT_ESC (
    Opcode : INTEGER;
    Isize  : INTEGER;
    Rsize  : INTEGER;
    ANYVAR Ilist : Gint_list;
    ANYVAR Rlist : Greal_list;
    VAR Ierr  : INTEGER );
    
```

Semantics

The **operation selector** determines the device dependent output escape function to be performed. The codes supported for a given device are described in the device handlers section of this document.

The **INTEGER array size** is the number of INTEGER parameters contained in the INTEGER array. The thousand's digit of the operation selector is the number of INTEGER parameters that the graphics system expects.

The **REAL array size** is the number of REAL parameters contained in the REAL array by the escape function. The ten-thousand's digit of the operation selector is the number of REAL parameters that the graphics system expects.

The **INTEGER array** is the array in which zero or more INTEGER parameters are contained.

The **REAL array** is the array in which zero or more REAL parameters are contained.

The **error variable** will contain a value indicating whether the escape function was performed.

Value	Meaning
0	Output escape function successfully sent to the device.
1	Operation not supported by the graphics display device.
2	The INTEGER array size is not equal to the number of required INTEGER parameters.
3	The REAL array size is not equal to the number of required REAL parameters.
4	Illegal parameters specified.

If the error variable contains a non-zero value, the call has been ignored.

OUTPUT_ESC allows application programs to access special device features on a graphics display device. The desired escape function is specified by a unique value for opcode.

The type of information passed to the graphics display device is determined by the value of opcode. The graphics library does not check OUTPUT_ESC parameters which will be sent directly to the display device. This can lead to device dependent results if out of range values are sent.

Output escape functions only apply to the graphics display device.

The starting position may be altered by a call to OUTPUT_ESC.

Error Conditions

The graphics system must be initialized and a display device must be enabled or this call will be ignored, an ESCAPE (-27) will be generated, and GRAPHICSError will return a non-zero value.

Raster Device Escape Operations

Operation Selector	Function
52	Dump graphics of the currently active display device if it is the console or a bit-mapped display. Graphics will be dumped to the graphics printer (PRINTER:); if color, all planes are ORed.
53	Await vertical blanking. This escape function will not exit until the CRT is performing vertical blanking. The following example shows how to use this function when changing the color table to reduce flicker. <pre>OUTPUT_ESC (53, 0, 0, dummy, dummy, error); SET_COLOR_TABLE (0, r, g, b);</pre> <p>The color table is not changed until the crt is blank (during a refresh cycle). Otherwise changing the color map in the middle of a scan would create a screen that was half the old color, and half the new color for one frame (1/60 sec). To the eye this would look like a flicker.</p>
250	Specify device limits. REAL Array [1] = Points (dots) per mm in X direction REAL Array [2] = Points (dots) per mm in Y direction
1050 ¹	Turn on or off the graphics display. INTEGER array [1] = 0 → turn display off. INTEGER array [1] <> 0 → turn display on.
1051 ¹	Turn on or off the alpha display. INTEGER array [1] = 0 → turn display off. INTEGER array [1] <> 0 → turn display on.
1052	Set special drawing modes. Using this escape function will redefine the meaning of the set color attribute. For details on how a given drawing mode affects a color see "Drawing Modes" in SET_COLOR. This drawing mode does not apply to device dependent polygons. Out of range values default to dominate drawing mode. INTEGER array[1] = 0 → Dominate drawing mode. = 1 → Non-dominate drawing mode. = 2 → Erase drawing mode. = 3 → Complement drawing mode.
1053	Dump graphics (from the specified color planes) to the graphics printer (PRINTER:). Also dumps graphics on a Model 237 if it is the currently active display. INTEGER array [1] = Color plane selection code. BIT 1 = 1 → Select plane 1. (Blue on HP 98627A) BIT 2 = 1 → Select plane 2. (Green on HP 98627A) BIT 3 = 1 → Select plane 3. (Red on HP 98627A) BIT 4 = 1 → Select plane 4.
1054	Clear selected graphics planes. INTEGER Array [1] = 0 - Clear all planes INTEGER Array [1] <> 0 - Color plane selection code. BIT 1 = 1 Clear plane 1 (Blue on HP 98627A) BIT 2 = 1 Clear plane 2 (Green on HP 98627A) BIT 3 = 1 Clear plane 3 (Red on HP 98627A) BIT 4 = 1 Clear plane 4

¹ This operation is not available for the Model 237 computer.

Operation Selector	Function
10050	<p>Set all HP 9836C color table locations. This escape function allows the user to change all locations in the hardware color map with one procedure. The software maintained color table will be updated by this call. This escape function is the same as calling SET_COLOR_TABLE with indexes 0 - 15.</p> <p>REAL Array [1] = Parm1 REAL Array [2] = Parm2 Index 0 REAL Array [3] = Parm3</p> <p>REAL Array [4] = Parm1 REAL Array [5] = Parm2 Index 1 REAL Array [6] = Parm3</p> <p> : :</p> <p>REAL Array [46] = Parm1 REAL Array [47] = Parm2 Index 15 REAL Array [48] = Parm3</p> <p>Parm1, Parm2, and Parm3 are defined to be the same as used with SET_COLOR_TABLE.</p> <p>The size of the INTEGER array must equal 0 and the size of the REAL array 48.</p>

The following table shows which escape codes are supported on which Series 200 raster displays:

Operation Selector	216	217	220	226	236	236 Color	237	98627A
52	yes	yes	yes	yes	yes	yes	yes	yes
53	no	no	no	no	no	yes	no	no
250	no	no	no	no	no	no	no	yes
1050	yes	yes	yes	yes	yes	yes	no	yes
1051	yes	yes	yes	yes	yes	yes	no	no
1052	yes	yes	yes	yes	yes	yes	yes	yes
1053	no	no	no	no	no	yes	yes	yes
1054	yes	no	no	yes	yes	yes	no	yes
10050	no	no	no	no	no	yes	no	no

HPGL Plotter Escape Operations

Operation Selector	Function
1052*	Enable cutter. Provides means to control the Plotter paper cutters. Paper is cut after it is advanced. INTEGER array [1] = 0 Cutter is disabled. INTEGER array [1] <> 0 Cutter is enabled.
1052	Set automatic pen. This instruction provides a means for utilizing the smart pen options of the plotter. Initially, all automatic pen options are enabled. INTEGER array [1]: BIT 1 = 1 Lift pen if it has been down for 60 seconds. BIT 2 = 1 Put pen away if it has been motionless for 20 seconds. BIT 3 = 1 Do not select a pen until a command which makes a mark. This causes the pen to remain in the turret for the longest possible time.
1053	Advance the paper either one half or a full page. INTEGER array [1] = 0 >> Advance page half INTEGER array [1] <> 0 >> Advance page full
2050	Select pen velocity. This instruction allows the user to modify the plotter's pen speed. Pen speed may be set from 1 to the maximum for the given device. INTEGER array [1] = Pen speed (INTEGER from 1 to device max). INTEGER array [2] = Pen number (INTEGER from 1 to 8; other integers select all pens)
2051	Select pen force. The force may be set from 10 to 66 gram-weights. INTEGER array [1] = Pen force (INTEGER from 1 to 8). 1: 10 gram-weights 2: 18 gram-weights 3: 26 gram-weights 4: 34 gram-weights 5: 42 gram-weights 6: 50 gram-weights 7: 58 gram-weights 8: 66 gram-weights INTEGER array [2] = Pen number (INTEGER 1 to 8; other integers select all pens)
2052	Select pen acceleration. The acceleration may be set from 1 to 4 G's. INTEGER array [1] = Pen acceleration (INTEGER from 1 to 4). INTEGER array [2] = Pen number (INTEGER 1 to 8; other integers select all pens)

Operation Selector	9872	7470	7475	7550	7580	7585	7586
1052*	S/T	no	no	no	no	no	no
1052	no	no	yes	yes	yes	yes	yes
1053	S/T	no	no	yes	no	no	yes
2050	yes	yes	yes	yes	yes	yes	yes
2051	no	no	yes	yes	yes	yes	yes
2052	no	no	yes	yes	yes	yes	yes

PASS_CONTROL

IMPORT: hpib_2
iodeclarations

This **procedure** passes active control from the specified interface to another device on the bus.

Syntax

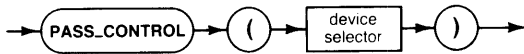

Item	Description/Default	Range Restrictions	Recommended Range
device selector	Expression of TYPE <i>type_device</i> . This is an INTEGER subrange.	0 thru 3199	See glossary

Semantics

	System Controller		Net System Controller	
	Interface Select Code Only	Primary Addressing Specified	Interface Select Code Only	Primary Addressing Specified
Active Controller	ATN TCT ATN	ATN UNL TAG TCT ATN	ATN TCT ATN	ATN UNL TAG TCT ATN
Not Active Controller	Error			

POLYGON

```
IMPORT: dgl_types
       dgl_lib
       dgl_poly
```

This **procedure** displays a polygon-set starting and ending at the specified point adhering to the specified polygon style exactly as specified (i.e., device-independent results).

Syntax

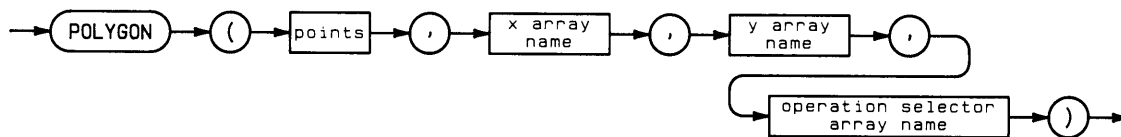

Item	Description/Default	Range Restrictions
points	Expression of TYPE INTEGER	MININT thru MAXINT
x array name	Array of TYPE REAL.	—
y array name	Array of TYPE REAL.	—
operation selector array name	Array of TYPE <i>Gshortint</i> . <i>Gshortint</i> is a sub-range of INTEGER.	– 32 768 to 32 767

Procedure Heading

```
PROCEDURE POLYGON ( Npoint      : INTEGER;
                   ANYVAR Xvec  : Greal_list;
                   ANYVAR Yvec  : Greal_list;
                   ANYVAR Opcodes : Gshortint_list);
```

Semantics

Points is the number of vertices in the polygon set.

The **x** and **y coordinate arrays** contain the world coordinate values for each vertex of the polygon-set. The vertices must be in order. The vertices for the first sub-polygon must be at the beginning of these arrays, followed by the vertices for the second sub-polygon, etc. So, the coordinate arrays must contain a total number of vertices that equals **points**.

The **operation selector array** contains a series of integer operation selectors defining which vertices start new polygons, and defining which edges should be displayed.

Value	Meaning
0	Don't display the line for the edge extending to this vertex from the previous vertex.
1	Display the line for the edge extending to this vertex from the previous vertex.
2	This vertex is the first vertex of a sub-polygon. Succeeding vertices are part of a sub-polygon until a new start-of-polygon operation selector (2) is encountered. (Or the end of the arrays is encountered.)

Note

The first entry in the operation selector array **must** be 2, since it is the first vertex of a sub-polygon.

POLYGON is used to output a polygon-set, specified in world coordinates, adhering exactly to the polygon style attributes that are currently specified. A polygon-set is a set of polygons (called "sub-polygons") that are treated graphically as one polygon. This is accomplished by "stacking" the sub-polygons. The subpolygons in a polygon-set may intersect or overlap each other.

The edge of a sub-polygon is defined as the line sequence that connects its vertices in the order specified. If the last vertex specified for a sub-polygon is not the same as the first, they are automatically connected.

When a polygon-set is displayed, the primitive attributes for polygons and lines define its appearance. In particular, the interior of the polygon-set will be filled according to the attributes of polygon style, polygon interior color and polygon interior line-style. If the edges are to be displayed as specified in the polygon style, the edges will adhere to the current line attributes of color, line-style and line-width. A dot will disappear on an edged polygon if the edge is done with a complementing line.

The filling of polygons also depends on how the sub-polygons "nest" within each other. An "even-odd" rule is used for determining which areas will be filled. Moving across the screen, count the edges of the polygon. Odd-numbered edges will turn the fill on and even-numbered edges will turn the fill off. The picture below will help clear up how the fills work.

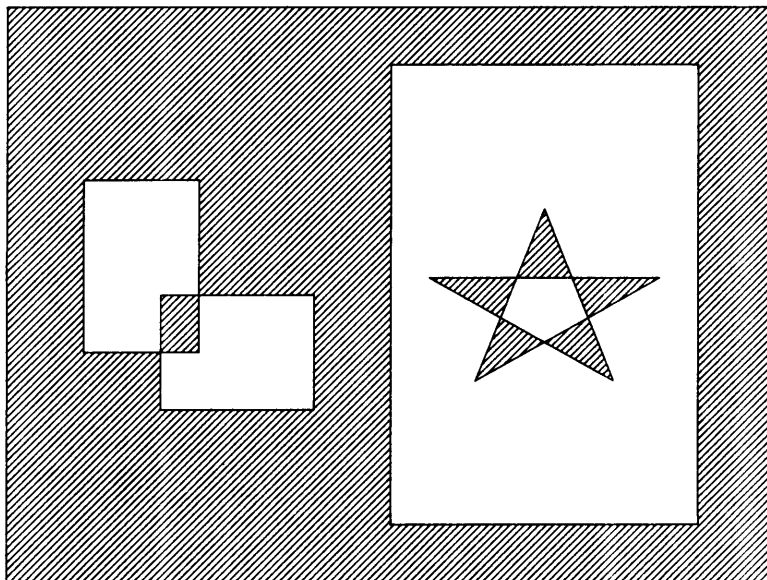

Polygon Filling

Refer to SET_PGN_TABLE, SET_PGN_STYLE, SET_PGN_COLOR, SET_PGN_LS for a more detailed description of how attributes affect polygons.

As stated above, the values in the operation selector array define how the edges of the sub-polygons are displayed. The edge from the (I-1)th vertex to the Ith vertex will only be displayed if the Ith entry in the operation selector array equals 1. To display the edge from the last vertex to the first vertex of a sub-polygon, the first vertex must be explicitly respecified after all the other vertices of the sub-polygon, with an operation selector equal to 1. Otherwise the edge from the last vertex to the first will not be drawn. It will, however, automatically be connected for polygon filling.

If it is within the capabilities of the device, filling of the sub-polygon will be done to the sub-polygon edges regardless of whether the edges are displayed. If an entry in the operation selector array does not equal 0, 1, or 2, it will be treated as if it were equal to 0 and the edge will not be drawn.

When POLYGON is used, the current position is updated to the end of the last sub-polygon specified in the polygon-set. The end of the last sub-polygon is defined to be the first (implicit last) vertex of the subpolygon. So, if there is only one vertex in a polygon-set this call degenerates to an update of the current position to the first coordinate set in the x and y point arrays (x coordinate array[1], y coordinate array[1]).

It is the application program's responsibility to ensure that the arrays are all dimensioned to at least the number of elements specified by points and that at least that many values are contained in each array.

Polygons are defined to be closed surfaces. When a sub-polygon extends beyond a clipping edge the closed nature of the sub-polygon is destroyed. As with other primitives, unpredictable results may occur if the sub-polygon extends beyond the clipping window.

Error Conditions

The graphics system must be initialized, a graphics display must be enabled, all parameters must be within specified limits and the number of points specified must be greater than 0 or the call will be ignored, an ESCAPE (- 27) will be generated, and GRAPHICSEERROR will return a non-zero value.

POLYGON_DEV_DEP

IMPORT: dgl_types
 dgl_lib
 dgl_poly

This **procedure** displays a polygon-set starting and ending at the specified point adhering to the specified polygon style in a device- dependent fashion.

Syntax

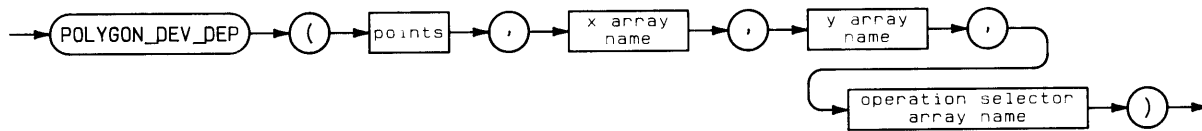

Item	Description/Default	Range Restrictions
points	Expression of TYPE INTEGER	MININT thru MAXINT
x array name	Array of TYPE REAL.	-
y array name	Array of TYPE REAL.	-
operation selector array name	Array of TYPE <i>Gshortint</i> . <i>Gshortint</i> is a sub-range of INTEGER.	- 32 768 to 32 767

Procedure Heading

```
PROCEDURE POLYGON_DEV_DEP ( Npoint : INTEGER;
    ANYVAR Xvec : Greal_list;
    ANYVAR Yvec : Greal_list;
    ANYVAR Opcodes : Gshortint_list);
```

Semantics

Points is the number of vertices in the polygon set.

The **x** and **y coordinate arrays** contain the world coordinate values for each vertex of the polygon-set. The vertices must be in order. The vertices for the first sub-polygon must be at the beginning of these arrays, followed by the vertices for the second sub-polygon, etc. So, the coordinate arrays must contain a total number of vertices that equals points.

The **operation selector array** contains a series of integer operation selectors defining which vertices start new polygons, and defining which edges should be displayed.

Value	Meaning
0	Don't display the line for the edge extending to this vertex from the previous vertex.
1	Display the line for the edge extending to this vertex from the previous vertex.
2	This vertex is the first vertex of a sub-polygon. Succeeding vertices are part of a sub-polygon until a new start-of-polygon operation selector (2) is encountered. (Or the end of the arrays is encountered.)

Note

The first entry in the operation selector array **must** be 2, since it is the first vertex of a sub-polygon.

POLYGON-DEV-DEP is used to output a polygon-set, specified in world coordinates, adhering (within the capabilities of the device) to the polygon style attributes that are currently specified. A polygon-set is a set of polygons (called "sub-polygons") that are treated graphically as one polygon. The subpolygons in a polygon-set may intersect or overlap each other.

The edge of a sub-polygon is defined as the line sequence that connects its vertices in the order specified. If the last vertex specified for a sub-polygon is not the same as the first, they are automatically connected.

When a polygon-set is displayed, the primitive attributes for polygons and lines define its appearance. In particular, the interior of the polygon-set will be filled according to the attributes of polygon style, polygon interior color and polygon interior line-style. If the edges are to be displayed as specified in the polygon style, the edges will adhere to the current line attributes of color, line-style and line-width.

The filling of polygons also depends on how the sub-polygons "nest" within each other. An "even-odd" rule is used for determining which areas will be filled. Moving across the screen, count the edges of the polygon. Odd-numbered edges will turn the fill on and even-numbered edges will turn the fill off. The picture below will help clear up how the fills work.

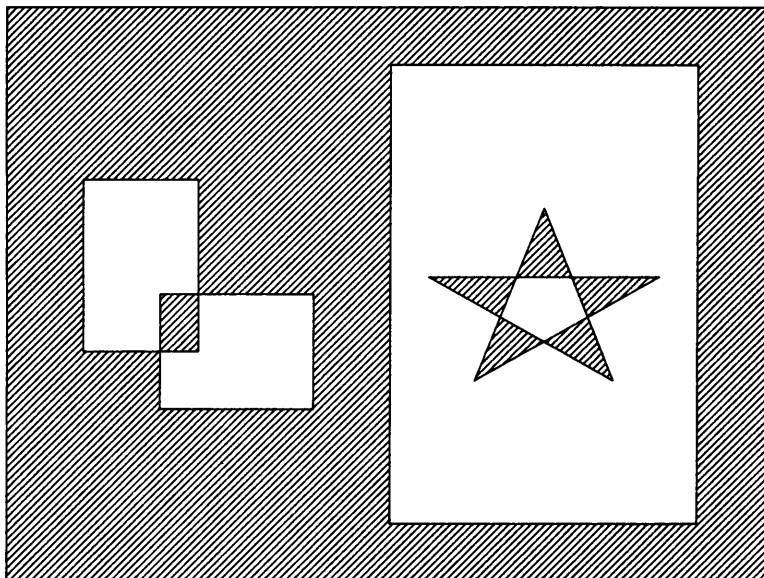

Polygon Filling

Refer to SET_PGN_TABLE, SET_PGN_STYLE, SET_PGN_COLOR, SET_PGN_LS for a more detailed description of how attributes affect polygons.

As stated above, the values in the operation selector array define how the edges of the sub-polygons are displayed. The edge from the (I-1)th vertex to the Ith vertex will only be displayed if the Ith entry in the operation selector array equals 1. To display the edge from the last vertex to the first vertex of a sub-polygon, the first vertex must be explicitly respecified after all the other vertices of the sub-polygon, with an operation selector equal to 1. Otherwise the edge from the last vertex to the first will not be drawn. It will, however, automatically be connected for polygon filling.

If it is within the capabilities of the device, filling of the sub-polygon will be done to the sub-polygon edges regardless of whether the edges are displayed. If an entry in the operation selector array does not equal 0, 1, or 2, it will be treated as if it were equal to 0. i.e., the edge will not be drawn.

When POLYGON_DEV_DEP is used, the current position is updated to the end of the last sub-polygon specified in the polygon-set. The end of the last sub-polygon is defined to be the first (implicit last) vertex of the subpolygon. So, if there is only one vertex in a polygon-set this call degenerates to an update of the current position to the first coordinate set in the x and y point arrays (x coordinate array[1], y coordinate array[1]).

It is the application program's responsibility to ensure that the arrays are all dimensioned to at least the number of elements specified by points and that at least that many values are contained in each array.

Device capabilities vary widely. Not all devices are able to draw polygon edges as requested. If a device is not able to draw polygon edges as requested, they will be simulated in software. The simulation will always adhere to the edge value in SET_PGN_STYLE and the operation selector in POLYGON_DEV_DEP, but the line-style and color of the edge will depend on the capability of the device to produce lines with those attributes.

Polygon fill capabilities can vary widely between devices. A device may have no filling capabilities at all, may be able to perform only solid fill, or may be able to fill polygons with different fill densities and at different fill line orientations. POLYGON_DEV_DEP tries to match the device capabilities to the request. If the device cannot fill the request at all, then no simulation is done and the polygon will not be filled. For HPGL plotters, the fill is simulated. For raster devices, if the density is greater than 0.5, a solid fill is used, otherwise, the fill is simulated.

In the case where the polygon style specifies non-display of edged, this would result in no visible output although visible output had been specified. To provide some visible output in this case, POLYGON_DEV_DEP will outline the polygon using the color and line-style specified for the fill lines. However, only those edge segments specified as displayable by the operation selector array will be drawn. Therefore, if all edge segments are specified as non-displayed, there will still be no visible output.

Regardless of the capabilities of the device, POLYGON_DEV_DEP sets the starting position to the first vertex of the last member polygon specified in the call. If there is only one polygon specified, the starting position will therefore be set to the first vertex specified.

Polygons are defined to be closed surfaces. When a sub-polygon extends beyond a clipping edge the closed nature of the sub-polygon is destroyed. As with other primitives, unpredictable results may occur if the sub-polygon extends beyond the clipping window.

Error Conditions

The graphics system must be initialized, a graphics display must be enabled, all parameters must be within specified limits and the number of points (Points) must be greater than 0 or the call will be ignored, an ESCAPE (- 27) will be generated, and GRAPHICSEERROR will return a non-zero value.

POLYLINE

IMPORT: dgl_lib

This **procedure** draws a connected line sequence starting at the specified point.

Syntax

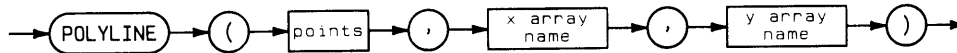

Item	Description/Default	Range Restrictions
points	Expression of TYPE INTEGER	MININT thru MAXINT
x array name	Array of TYPE REAL.	—
y array name	Array of TYPE REAL.	—

Procedure Heading

```

PROCEDURE POLYLINE (          Npts          : INTEGER;
                      ANYVAR Xvec, Yvec : Greal_list )
  
```

Semantics

Points is the number of vertices in the polygon set.

The **x** and **y coordinate arrays** contain the world coordinate values for each vertex of the polyline-set. The vertices must be in order. The vertices for the first sub-polyline must be at the beginning of these arrays, followed by the vertices for the second sub-polyline, etc. So, the coordinate arrays must contain a total number of vertices that equals points.

The procedure POLYLINE provides the capability to draw a series of connected lines starting at the specified point. A complete object can be drawn by making one call to this procedure. This call first sets the starting position to be the first elements in the x and y coordinate arrays. The line sequence begins at this point and is drawn to the second element in each array, then to the third and continues until points-1 lines are drawn.

This procedure is equivalent to the following sequence of calls:

```

MOVE (X_coordinate_array[1],Y_coordinate_array[1]);
LINE (X_coordinate_array[2],Y_coordinate_array[2]);
LINE (X_coordinate_array[3],Y_coordinate_array[3]);
      :
      :
LINE (X_coordinate_array[Points],Y_coordinate_array[Points]);
  
```

The starting position is set to (X_coordinate_array[Points], Y_coordinate_array[Points]) at the completion of this call.

Specifying only one element, or Points equal to 1, causes a move to be made to the world coordinate point specified by the first entries in the two coordinate arrays.

It is the application program's responsibility to ensure that the arrays are all dimensioned to at least the number of elements specified by points and that at least that many values are contained in each array.

Depending on the nature of the current line-style nothing may appear on the graphics display. See SET_LINE_STYLE for a complete description of how line-style effects a particular point or vector.

The primitive attributes of color, line-style, and line-width apply to polylines.

Error Conditions

The graphics system must be initialized, a graphics display must be enabled, all parameters must be within specified limits and the number of points (points) must be greater than 0 or the call will be ignored, an ESCAPE (- 27) will be generated, and GRAPHICSEERROR will return a non-zero value.

PPOLL

IMPORT: hpib_3
iodeclarations

This **function** will perform an HP-IB parallel poll. This involves setting the ATN and EOI bus lines on the specified interface and then read the data bus lines after waiting 25usec. The ATN and EOI lines are then returned to the clear state.

Syntax



Item	Description/Default	Range Restrictions	Recommended Range
interface select code	Expression of TYPE <i>type_isc</i> . This is an INTEGER subrange.	0 thru 31	7 thru 31

Semantics

	System Controller		Not System Controller	
	Interface Select Code Only	Primary Addressing Specified	Interface Select Code Only	Primary Addressing Specified
Active Controller	ATN & EOI (duration $\geq 25\mu\text{s}$) Read byte EOI Restore ATN to previous state	Error	ATN & EOI (duration $\geq 25\mu\text{s}$) Read byte EOI Restore ATN to previous state	Error
Not Active Controller	Error			

PPOLL_CONFIGURE

IMPORT: hpib_2
 iodeclarations

This **procedure** programs the logical sense and data bus lines, a devices parallel poll response.

Syntax

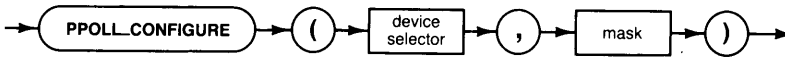

Item	Description/Default	Range Restrictions	Recommended Range
device selector	Expression of TYPE <i>type_device</i> . This is an INTEGER subrange.	0 thru 3199	See glossary
mask	Expression of TYPE INTEGER.	MININT thru MAXINT	0 thru 15

Semantics

This procedure assumes that the device's response is bus-programmable. The computer must be active controller to execute this statement.

	System Controller		Not System Controller	
	Interface Select Code Only	Primary Addressing Specified	Interface Select Code Only	Primary Addressing Specified
Active Controller	Error	ATN MTA UNL LAG PPC PPE	Error	ATN MTA UNL LAG PPC PPE
Not Active Controller	Error			

The mask is coded. The three least significant bits determine the data bus line for the response. The fourth bit determines the logical sense of the response.

Note

Use of PPOLL_CONFIGURE may interfere with the Pascal Operating System, especially if an external disk is being used. **Be very careful.**

PPOLL_UNCONFIGURE

IMPORT: hplib_2
iodeclarations

This **procedure** will cause the specified device(s) to disable the parallel poll response.

Syntax

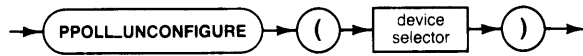

Item	Description/Default	Range Restrictions	Recommended Range
device selector	Expression of TYPE <i>type_device</i> . This is an INTEGER subrange.	0 thru 3199	See glossary

Semantics

	System Controller		Not System Controller	
	Interface Select Code Only	Primary Addressing Specified	Interface Select Code Only	Primary Addressing Specified
Active Controller	ATN PPU	ATN MTA UNL LAG PPC PPD	ATN PPU	ATN MTA UNL LAG PPC PPD
Not Active Controller	Error			

Note

Use of PPOLL_UNCONFIGURE may interfere with the Pascal Operating System, especially if an external disk is being used. **Be very careful.**

RAND

IMPORT: rnd
sysglobals

This SHORTINT function returns a random number greater than or equal to zero and less than the specified SHORTINT range.

Syntax

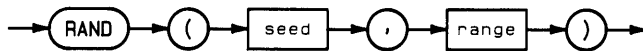

Item	Description/Default	Range Restrictions
seed	INTEGER	1 thru MAXINT - 1
range	SHORTINT	1 thru $2^{31} - 1$

Semantics

Given a **seed** and a **range**, the random number generator function returns a random number greater than or equal to zero and less than the range. It also randomizes the **seed** INTEGER.

RANDOM

IMPORT: rnd

This procedure takes a seed INTEGER, randomizes it and returns the new random number in the seed variable.

Syntax

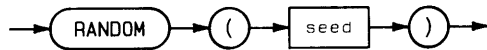

Item	Description/Default	Range Restrictions
seed	INTEGER	1 thru MAXINT - 1

Semantics

When the following program is run, the RANDOM procedure returns all $2^{31} - 1$ INTEGERS before repeating a value.

```

Program test(output);

import RND;

var seed : INTEGER;
    doomsday : BOOLEAN;

begin
    seed := 1234;
    doomsday := false;

    repeat
        RANDOM(seed);
        write(seed);
    until doomsday;

end.
```

READBUFFER

IMPORT: general_4
 iodeclarations

This **procedure** will read a single byte from the buffer space and update the empty pointer in the *buf_info* record. An error will occur when a read is attempted beyond the end of valid data.

Syntax

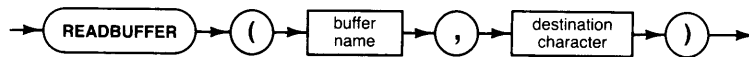

Item	Description/Default	Range Restrictions
buffer name	Variable of TYPE <i>buf_info_type</i> .	See the Advanced Transfer Techniques chapter
destination character	Variable of TYPE CHAR.	—

READBUFFER_STRING

IMPORT: general_4
iodeclarations

This **procedure** will read the specified number of characters from the buffer and put them into the string variable. The empty pointer is updated. If the string is not big enough or if there is insufficient data in the buffer there will be an error.

Syntax

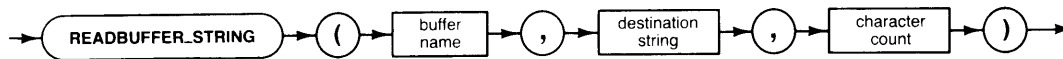

Item	Description/Default	Range Restrictions	Recommended Range
buffer name	Variable of TYPE <i>buf_info_type</i> .	See Chapter 11	
destination string	Variable of TYPE STRING.	—	
character count	Expression of TYPE INTEGER.	MININT thru MAXINT	0 thru 255

READCHAR

IMPORT: general_1
 iodeclarations

This **procedure** will read a single byte from the specified interface.

Syntax

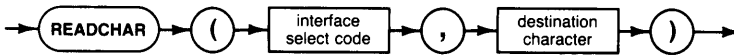

Item	Description/Default	Range Restrictions	Recommended Range
interface select code	Expression of TYPE <i>type_isc</i> . This is an INTEGER subrange.	0 thru 31	7 thru 31
destination character	Variable of TYPE CHAR.		

Semantics

If no character is ready the routine will wait until the character comes in or until a timeout occurs (if any was set up).

An HPIB interface must be addressed as a listener before performing a READCHAR, or an error will be generated. To avoid this, use the following sequence:

```

    .
    .
    TALK (7,24);
    UNLISTEN(7)
    LISTEN( 7, MY_ADDRESS(7));
    READCHAR (7, Character);
    .
    .
    
```

READWORD

IMPORT: general_1
iodeclarations

This **procedure** will read 2 bytes from interfaces that are byte-oriented. The GPIO card and any other word-oriented interface will read a single 16 bit quantity.

Syntax

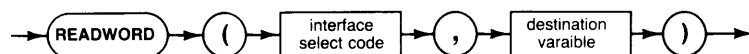

Item	Description/Default	Range Restrictions	Recommended Range
interface select code	Expression of TYPE <i>type_isc</i> . This is an INTEGER subrange.	0 thru 31	7 thru 31
destination variable	Variable of TYPE INTEGER.		

Semantics

An interface less than 16-bits wide will be read into the most-significant-byte first, then into the lease-significant-byte.

An HP-IB interface must be addressed as a listener before performing a READWORD, or an error will be generated. To avoid this, use the following sequence:

```

.
.
TALK (7,24);
LISTEN( 7, MY_ADDRESS(7) );
READWORD (7, Character);
.
.

```

READNUMBER

IMPORT: general_2
 iodeclarations

This **procedure** will read a free-field number from the specified device.

Syntax



Item	Description/Default	Range Restrictions	Recommended Range
device selector	Expression of TYPE <i>type_device</i> . This is an INTEGER subrange.	0 thru 3199	See glossary
destination variable	Variable of TYPE REAL.		

Semantics

The routine will skip over non-numeric characters until a valid number is entered. Numeric characters will be entered until a non-numeric character is read from the interface, or until 256 characters have been read. No further characters are read.

Note

Note that spaces are not considered to be “non-numeric” characters, and therefore will not terminate numbers. Erroneous results may occur if you try to use them to terminate or delimit numbers, because these procedures do not report receiving erroneously formatted numbers.

READNUMBERLN

IMPORT: general_2
iodeclarations

This **procedure** will read in a free-field number from the specified device, and then terminate upon receiving a line feed.

Syntax

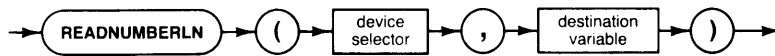

Item	Description/Default	Range Restrictions	Recommended Range
device selector	Expression of TYPE <i>type_device</i> . This is an INTEGER subrange.	0 thru 3199	See glossary
destination variable	Variable of TYPE REAL.		

Semantics

The routine will skip over non-numeric characters until a valid number is entered. Characters will be entered until a non-numeric character is read from the interface. If a line feed is the next character, no more characters are read; otherwise, characters are read until a line feed is encountered.

READSTRING

IMPORT: general_2
 iodeclarations

This **procedure** will read in characters to the specified string.

Syntax



Item	Description/Default	Range Restrictions	Recommended Range
device selector	Expression of TYPE <i>type_device</i> . This is an INTEGER subrange.	0 thru 3199	See glossary
destination string	Variable of TYPE STRING.		

Semantics

This procedure will read characters into the specified string until one of the following conditions occur :

- a carriage return & line feed are read
- a line feed is read
- the string is filled up

The line feed or carriage return/line feed are not put into the string.

READSTRING_UNTIL

IMPORT: general_2
iodeclarations

This **procedure** will read characters from the selected device into the specified string until the prescribed terminator is encountered.

Syntax

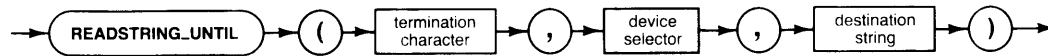

Item	Description/Default	Range Restrictions	Recommended Range
termination character	Expression of TYPE CHAR.	—	
device selector	Expression of TYPE <i>type_device</i> . This is an INTEGER subrange.	0 thru 3199	See glossary
destination string	Variable of TYPE STRING.		

Semantics

This procedure will read characters into the string until one of the following conditions occurs :

- termination character is received
- the string is filled

The termination character is placed into the string.

READUNTIL

IMPORT: general_2
 iodeclarations

This **procedure** will read characters until the match character occurs. All characters read in will be thrown away.

Syntax

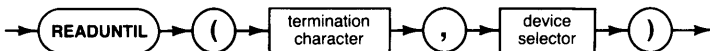

Item	Description/Default	Range Restrictions	Recommended Range
termination character	Expression of TYPE CHAR.	–	
device selector	Expression of TYPE <i>type_device</i> . This is an INTEGER subrange.	0 thru 3199	See glossary

REMOTE

IMPORT: hplib_2
iodeclarations

This **procedure** sends the messages to place the bus device(s) into the remote state.

Syntax



Item	Description/Default	Range Restrictions	Recommended Range
device selector	Expression of TYPE <i>type_device</i> . This is an INTEGER subrange.	0 thru 3199	See glossary

Semantics

	System Controller		Not System Controller	
	Interface Select Code Only	Primary Addressing Specified	Interface Select Code Only	Primary Addressing Specified
Active Controller	REN ATN	REN ATN MTA UNL LAG	Error	
Not Active Controller	REN	Error	Error	

REMOTED

IMPORT: hpib_3
 iodeclarations

This **BOOLEAN function** indicates if the REN line is being asserted. The interface should be non-system controller.

Syntax

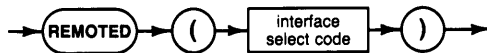

Item	Description/Default	Range Restrictions	Recommended Range
device selector	Expression of TYPE <i>type_device</i> . This is an INTEGER subrange.	0 thru 3199	See glossary

REQUESTED

IMPORT: hpib_3
iodeclarations

This BOOLEAN **function** returns TRUE if any device is currently asserting the SRQ line. The interface must be active controller.

Syntax

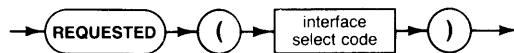

Item	Description/Default	Range Restrictions	Recommended Range
interface select code	Expression of TYPE <i>type_isc</i> . This is an INTEGER subrange.	0 thru 31	7 thru 31

REQUEST_SERVICE

```
IMPORT: hplib_3
       iodeclarations
```

This **procedure** will set up the spill response byte in the specified interface. If bit 6 is set, SRQ will be set. The interface must not be active controller.

Syntax

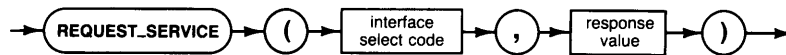

Item	Description/Default	Range Restrictions	Recommended Range
interface select code	Expression of TYPE <i>type_isc</i> . This is an INTEGER subrange.	0 thru 31	7 thru 31
response value	Expression of TYPE INTEGER.	MININT thru MAXINT	0 thru 255

SAMPLE_LOCATOR

IMPORT: dgl_lib

This **procedure** samples the current locator device

Syntax

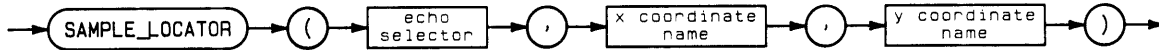

Item	Description/Default	Range Restrictions
echo selector	Expression of TYPE INTEGER	MININT to MAXINT
x coordinate name	Variable of TYPE REAL	—
y coordinate name	Variable of TYPE REAL	—

Procedure Heading

```

PROCEDURE SAMPLE_LOCATOR (      Echo   : INTEGER;
                               VAR Wx, Wy : REAL   );
  
```

Semantics

The **echo selector** determines the level of input echoing. Possible values are:

- 0 - No echo.
- ≥1 - Echo on the locator device.

The **x** and **y coordinates** are the values of the coordinates, expressed in world coordinate units, returned from the enabled locator device.

SAMPLE_LOCATOR returns the current world coordinate value of the locator without waiting for any user intervention. Typically, the locator is sampled in applications involving the continuous input of data points that are very close together.

If the point sampled is outside of the current logical locator limits, the transformed point will still be returned.

The number of echoes supported by a locator device and the correlation between the echo value and the type of echoing performed is device dependent. Most locator devices support at least one form of echoing. Possible echoes are beeping, displaying the point sampled, etc. See the locator descriptions below to find the locators supported by the various devices. If the echo value is larger than the number of echoes supported by the enabled locator device, then echo 1 will be used.

Locator echoing can only be performed on the locator device. The locator echo position is not used in conjunction with any echoes performed while sampling a locator.

SAMPLE_LOCATOR implicitly makes the picture current before sampling the locator.

The Knob as Locator

The keyboard beeper is sounded when the locator is sampled if an echo is selected (echo selector ≥ 1). The sample locator function returns the last AWAIT_LOCATOR result or 0.0, 0.0 if AWAIT_LOCATOR has not been invoked since LOCATOR_INIT.

HPGL Locators

The sample locator function returns the current locator position without waiting for an operator response (pen position on plotters). On a 9111A graphics Tablet, the beeper is sounded when the stylus is depressed. For echo selectors greater than or equal to 9, the same echo as echo selector 1 is used.

Error Conditions

The graphics system must be initialized and a locator device enabled or this call will be ignored, an ESCAPE (- 27) will be generated, and GRAPHICSError will return a non-zero value.

SECONDARY

IMPORT: hpib_2
iodeclarations

This **procedure** will send a secondary command byte over the bus. The interface must be active controller.

Syntax

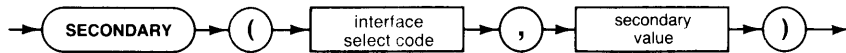

Item	Description/Default	Range Restrictions	Recommended Range
interface select code	Expression of TYPE <i>type_isc</i> . This is an INTEGER subrange.	0 thru 31	7 thru 31
secondary value	Expression of TYPE <i>type_hpib_addr</i> . This is an INTEGER subrange.	0 thru 31	

SEND_BREAK

```
IMPORT serial_3
    iodeclarations
```

This **procedure** will send a break to the selected serial interface. (A break is an extended mark period followed by an extended space period.)

Syntax

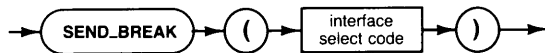

Item	Description/Default	Range Restrictions	Recommended Range
interface select code	Expression of TYPE <i>type_isc</i> . This is an INTEGER subrange.	0 thru 31	7 thru 31

SEND_COMMAND

IMPORT: hplib_1
iodeclarations

This **procedure** sends a single byte over the HP-IB interface with attention true. The computer needs to be active controller when this happens.

Syntax

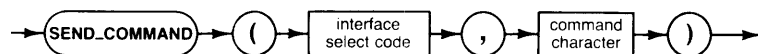

Item	Description/Default	Range Restrictions	Recommended Range
interface select code	Expression of TYPE <i>type_isc</i> . This is an INTEGER subrange.	0 thru 31	7 thru 31
command character	Expression of TYPE CHAR.		

Semantics

Note

Use of PPOLL_CONFIGURE may interfere with the Pascal Operating System, especially if an external disk is being used. **Be very careful.**

SERIAL_LINE

IMPORT: serial_0
 iodeclarations

This BOOLEAN function returns TRUE if the specified line on the serial interface is asserted.

Syntax

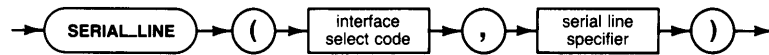

Item	Description/Default	Range Restrictions	Recommended Range
interface select code	Expression of TYPE <i>type_isc</i> . This is an INTEGER subrange.	0 thru 31	7 thru 31
serial line specifier	Expression of enumerated TYPE <i>type_serial_line</i> .	rts_line cts_line dcd_line dsr_line drs_line ri_line dtr_line	

Semantics

The values of the enumerated TYPE *type_serial_line* have the following definitions:

name	RS-232 line
rts	ready to send
cts	clear to send
dcd	data carrier detect
dsr	data set ready
drs	data rate select
dtr	data terminal ready
ri	ring indicator

The access to the various lines is determined by the connector used on the selected interface.

SET_ASPECT

IMPORT: dgl_lib

This **procedure** redefines the aspect ratio of the virtual coordinate system.

Syntax

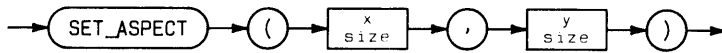

Item	Description/Default	Range Restrictions
x size	Expression of TYPE REAL	–
y size	Expression of TYPE REAL	–

Procedure Heading

```
PROCEDURE SET_ASPECT ( X_size, Y_size : REAL );
```

Semantics

The **x size** is the width of the virtual coordinate system in dimensionless units. The size must be greater than zero.

The **y size** is the height of the virtual coordinate system in dimensionless units. The size must be greater than zero.

SET_ASPECT sets the aspect ratio of the virtual coordinate system, and hence the view surface, to be y size divided by x size. A ratio of 1 defines a square virtual coordinate system, a ratio greater than 1 specifies it to be higher than it is wide; and a ratio less than 1 specifies it to be wider than it is high. Since x size and y size are used to form a ratio, they may be expressed in any units as long as they are the same units.

The range of coordinates for the virtual coordinate system is calculated based on the value of the aspect ratio. The coordinates of the longer axis are always set to range from 0.0 to 1.0 and those of the shorter axis from 0 to a value that achieves the specified aspect ratio. SET_ASPECT defines the limits of the virtual coordinate system.

ASPECT RATIO (AR)	X LIMITS	Y LIMITS
AR < 1	0.0, 1.0	0.0, 1.0 * AR
AR = 1	0.0, 1.0	0.0, 1.0
AR > 1	0.0, 1.0 / AR	0.0, 1.0

When a call to SET_ASPECT is made, the graphics system sets the viewport equal to the limits of the virtual coordinate system. This routine can therefore be used to access the entire logical display surface. A program could display an image on the entire HP 9826 graphics display, which has an aspect ratio of 399/299, in the following manner:

```
SET_ASPECT ( 399, 299 );
```

To set the aspect ratio to the entire display in a device independent manor, INQ_WS may be used as follows:

```
PROCEDURE Set_max_aspect;

    CONST    Get_aspect=254;

VAR        Dummy      : INTEGER;
           Error       : INTEGER;
           Ratio_list : ARRAY[1..2] OF REAL;

BEGIN {PROCEDURE Set_max_aspect}
    INQ_WS (Get_aspect,0,0,2,Dummy,Dummy, Ratio_list, Error);
    IF Error=0 THEN
        SET_ASPECT(1,0,Ratio_list[2]);
    END; {PROCEDURE Set_max_aspect}
```

The initial value of the aspect ratio is 1, setting the virtual coordinate system to be a square. This square is mapped to the largest inscribed square on any display surface, so that the viewable area is maximized. As a result, the initial virtual coordinate system limits range from 0.0 to 1.0 in both the X and Y directions. A program can access the largest inscribed rectangle on any display surface by modifying the value of the aspect ratio. The exact placement of the rectangle on the display surface is device dependent, but it is centered on CRT's and justified in the lower left hand corner of plotters.

The starting position is not altered by this call. Since this call redefines the viewing transformation, the starting position may no longer represent the last world coordinate position. A call to MOVE or INT_MOVE should therefore be made after this call to update the starting position.

If the logical locator is associated with the same physical device as the graphics display, then a call to SET_ASPECT will set the logical locator limits equal to the new limits of the virtual coordinate system.

Since the window is not affected by the SET_ASPECT procedure, distortion may result in the window to viewport mapping if the window does not have the same aspect ratio as the virtual coordinate system (see SET_WINDOW).

The locator echo position is set to the default value by this procedure.

Error Conditions

The graphics system must be initialized and both X and Y size must be greater than zero or this call will be ignored, an ESCAPE (-27) will be generated, and GRAPHICSEERROR will return a non-zero value.

SET_BAUD_RATE

IMPORT: serial_3
iodeclarations

This **procedure** will set the serial interface to the specified baud rate.

Syntax

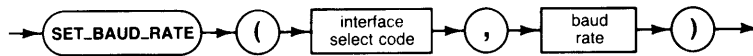

Item	Description/Default	Range Restrictions	Recommended Range
interface select code	Expression of TYPE <i>type_isc</i> . This is an INTEGER subrange.	0 thru 31	7 thru 31
baud rate	Expression of TYPE REAL.	–	50 thru 19200 (for 98628)

SET_CHAR_LENGTH

IMPORT: serial_3
 iodeclarations

This **procedure** specifies the character length for serial communications, in bits. The valid range of values is 5..8.

Syntax

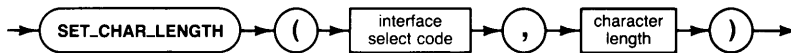

Item	Description/Default	Range Restrictions	Recommended Range
interface select code	Expression of TYPE <i>type_isc</i> . This is an INTEGER subrange.	0 thru 31	7 thru 31
character length	Expression of TYPE INTEGER.	MININT thru MAXINT	5 thru 8

SET_CHAR_SIZE

IMPORT: dgl_lib

This **procedure** sets the character size attribute for graphical text.

Syntax

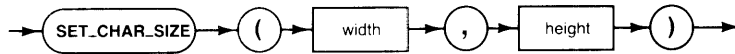

Item	Description/Default	Range Restrictions
width	Expression of TYPE REAL	–
height	Expression of TYPE REAL	–

Procedure Heading

```
PROCEDURE SET_CHAR_SIZE ( Width, Height : REAL );
```

Semantics

The **width** is the requested graphics character cell width in world coordinate units. (width <> 0.0)

The **height** is the requested graphics character cell height in world coordinate units. (height <> 0.0)

SET_CHAR_SIZE sets the character size for subsequently output graphics text. The absolute value of width and height are used to specify the world coordinate size of a character cell. Therefore, the actual physical size of a character output is determined by applying the current viewing transformations to the world coordinate units specification.

The default character size (set by GRAPHICS_INIT and DISPLAY_INIT) is dependent upon the physical device associated with the graphical display device. The size is determined as follows:

- Height := .05 x (height of the world coordinate system)
- Width := .035 x (width of the world coordinate system)

If a change is made to the viewing transformation (by SET_WINDOW, SET_VIEWPORT, SET_DISPLAY_LIM, or SET_ASPECT), the value of the character size attribute will not be changed, but the actual size of the characters generated may be modified.

Error Conditions

The graphics system must be initialized, a display must be enabled, and width and height must both be non-zero or this call will be ignored, an ESCAPE (-27) will be generated, and GRAPHICSError will return a non-zero value.

SET_COLOR

IMPORT: dgl_lib

This **procedure** sets the color attribute for output primitives except for polygon interior fill.

Syntax

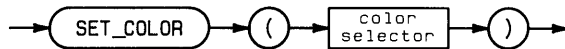

Item	Description/Default	Range Restrictions
color selector	Expression of TYPE INTEGER	–

Procedure Heading

```
PROCEDURE SET_COLOR ( Color : INTEGER );
```

Semantics

SET_COLOR sets the color attribute for the following primitives:

- Lines
- Markers
- Polylines
- Polygon Edges
- Text

At device initialization a default color table is created by the graphics system. The size and contents of the table are device dependent. At least one entry exists for all devices. A call to INQ_WS with OPCODE equal to 1053 will return the number of colors available on a given graphics device. Some devices allow the color table to be modified with SET_TABLE.

The **color selector** is an index into the color table. The contents of the color table are then used to specify the color when primitives are drawn. On some devices (HPGL plotters), the color selector maps directly to a pen number for the device. On the HP 9836C, the entries in the color table can be modified with SET_COLOR_TABLE.

The default value of the color attribute is 1. If the value of the color selector is not supported on the graphics display, the color attribute will be set to 1.

A color selector of 0 has special effects depending on the graphics display used. For raster devices, a color selector of 0 means to draw in the background color. For most plotters, it puts the pen away.

If the device is not capable of reproducing a color in the color table, the closest color which the device is capable of reproducing is used instead. On some devices, this may depend on the primitive being displayed. For example, the HP98627A color output interface card is capable of a large selection of polygon fill colors, but only 8 line colors. Thus, the fill color could match the selected color much more closely than the line color used to outline the polygon.

Default Raster Color Map

The following table shows the default (initial) color table for the black and white displays (HP 9816 / HP 9920 / HP 9826 / HP 9836):

Index #	Hue	Saturation	Luminosity
0	0	0	0
1	0	0	1.0000
2	0	0	0.9375
3	0	0	0.8750
4	0	0	0.8125
5	0	0	0.7500
6	0	0	0.6875
7	0	0	0.6250
8	0	0	0.5625
9	0	0	0.5000
10	0	0	0.4375
11	0	0	0.3750
12	0	0	0.3125
13	0	0	0.2500
14	0	0	0.1875
15	0	0	0.1250
16	0	0	0.0625

Colors 17 through 31 are set to white.

The following table shows the default (initial) color table for the color displays (HP 9836C and HP 98627A):

Index #	Color name	Red	Green	Blue
0	Black	0.000000	0.000000	0.000000
1	White	1.000000	1.000000	1.000000
2	Red	1.000000	0.000000	0.000000
3	Yellow	1.000000	1.000000	0.000000
4	Green	0.000000	1.000000	0.000000
5	Cyan	0.000000	1.000000	1.000000
6	Blue	0.000000	0.000000	1.000000
7	Magenta	1.000000	0.000000	1.000000
8	Black	0.000000	0.000000	0.000000
9	Olive green	0.800000	0.733333	0.200000
10	Aqua	0.200000	0.400000	0.466667
11	Royal blue	0.533333	0.400000	0.666667
12	Violet	0.800000	0.266667	0.400000
13	Brick red	1.000000	0.400000	0.200000
14	Burnt orange	1.000000	0.466667	0.000000
15	Grey brown	0.866667	0.533333	0.266667

Colors 9 through 15 are a graphic designers idea of colors for business graphics. Color table entries not shown above are set to white.

Raster Drawing Modes

For raster devices (e.g., HP 9836 display) the effect of the color selectors depends on the current drawing mode (drawing mode is set using the OUTPUT_ESC function). The color selectors and their effects are listed below:

Mode	Color Selector = 0	Color Selector >= 1
DOMINATE (Default mode)	Background (erase, set bits to 0)	Draw (set bits to 1, overwrite current pattern)
NON-DOMINATE	Background (erase, set bits to 0)	Draw (set bits to 1 Inclusive OR with current pattern)
ERASE	Background (erase, set bits to 0)	Background (erase, set bits to 0)
COMPLEMENT	Background (erase, set bits to 0)	Complement (Invert bits in selected planes)

Plotters

A Color Selector of 0 selects no pens (the current pen is put away). The supported range of Color Selectors for each supported plotter is:

- 9872A - 0 thru 4
- 9872B - 0 thru 4
- 9872C/S/T - 0 thru 8
- 7580A/7585A - 0 thru 8
- 7470A - 0 thru 2

Error Conditions

The graphics system must be initialized and a display must be enabled or this call will be ignored, an ESCAPE (-27) will be generated, and GRAPHICSError will return a non-zero value.

SET_COLOR_MODEL

IMPORT: dgl_lib

This **procedure** chooses the color model for interpreting parameters in the color table.

Syntax

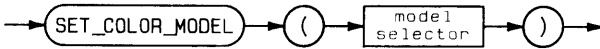

Item	Description/Default	Range Restrictions	Recommended Range
model selector	Expression of TYPE INTEGER	MININT thru MAXINT	1 or 2

Procedure Heading

PROCEDURE SET_COLOR_MODEL (MODEL : integer);

Semantics

The **model selector** determines the color model which will be used to interpret the values passed to the color table with SET_COLOR_TABLE or read from it with INQ_COLOR_TABLE.

Value	Meaning
1	RGB (Red-Green-Blue) color cube.
2	HSL (Hue-Saturation-Luminosity) color cylinder.

The RGB physical model is a color cube with the primary additive colors (red, green, and blue) as its axes. With this model, a call to SET_COLOR_TABLE specifies a point within the color cube that has a red intensity value (X-coordinate), a green intensity value (Y-coordinate) and a blue intensity value (Z-coordinate). Each value ranges from zero (no intensity) to one.

Effects of RGB color parameters

Parm 1 (RED)	Parm 2 (GREEN)	Parm 3 (BLUE)	Resultant color
1.0	1.0	1.0	White
1.0	0.0	0.0	Red
1.0	1.0	0.0	Yellow
0.0	1.0	0.0	Green
0.0	1.0	1.0	Cyan
0.0	0.0	1.0	Blue
1.0	0.0	1.0	Magenta
0.0	0.0	0.0	Black

The HSL perceptual model is a color cylinder in which:

- The angle about the axis of the cylinder, in fractions of a circle is the hue (red is at 0, green is at 1/3 and blue is at 2/3).
- The radius is the saturation. Along the center axis of the cylinder, (saturation equal zero) the colors range from white through grey to black. Along the outside of the cylinder (saturation equal one) the colors are saturated with no apparent whiteness.
- The height along the center axis is the luminosity (the intensity or brightness per unit area). Black is at the bottom of the cylinder (luminosity equal zero) and the brightest colors are at the top of the cylinder (luminosity equal one) with white at the center top.

Hue (angle), saturation (radius), and luminosity (height) all range from zero to one. Using this model, a call to SET_COLOR_TABLE specifies a point within the color cylinder that has a hue value, a saturation value, and a luminosity value.

Effects of HSL color parameters

Parm 1 (Hue)	Parm 2 (Sat)	Parm 3 (Lum)	Resultant color
Don't Care	0.0	1.0	White
0.0	1.0	1.0	Red
1/6	1.0	1.0	Yellow
2/6	1.0	1.0	Green
3/6	1.0	1.0	Cyan
4/6	1.0	1.0	Blue
5/6	1.0	1.0	Magenta
Don't Care	Don't Care	0.0	Black

When a call to SET_COLOR_MODEL switches color models, parameter values in subsequent calls to SET_COLOR_TABLE then refer to the new model. Switching models does not affect color definitions that were previously made using another model. Note that when the value of a color table entry is inquired (INQ_COLOR_TABLE), it is returned in the current model, which may not be the model in which it was originally specified.

Not all color specifications can be displayed on every graphics device, since the devices which the graphics library supports differ in their capabilities. If color specification is not available on a device, the graphics system will request the closest available color.

Error Conditions

The graphics system must be initialized and the color selector must evaluate to 0 or 1 or this call will be ignored, an ESCAPE (-27) will be generated, and GRAPHICSEERROR will return a non-zero value.

SET_COLOR_TABLE

IMPORT: dgl_lib

This **procedure** redefines the color description of the specified entry in the color table. This color definition is used when the color index is selected via SET_COLOR.

Syntax

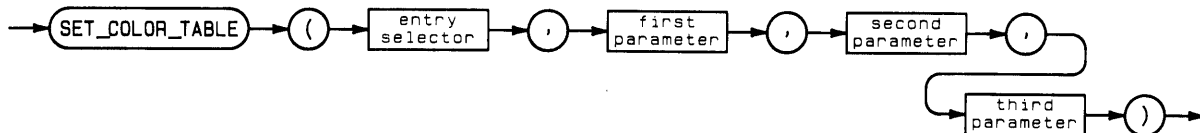

Item	Description/Default	Range Restrictions	Recommended Range
entry selector	Expression of TYPE INTEGER	MININT to MAXINT	device dependent (see below)
first parameter	Expression of TYPE REAL	0 thru 1	–
second parameter	Expression of TYPE REAL	0 thru 1	–
third parameter	Expression of TYPE REAL	0 thru 1	–

Procedure Heading

```

PROCEDURE SET_COLOR_TABLE ( Index : INTEGER;
                           ColP1 : REAL;
                           ColP2 : REAL;
                           ColP3 : REAL    );
  
```

Semantics

SET_COLOR_TABLE is ignored by some devices (such as pen plotters) which do not allow their color table to be changed. The procedure INQ_WS (opcode 1073) tells whether the color table can be changed.

The **entry selector** specifies the location in the color capability table that is to be redefined. For raster displays in Series 200 computers, 32 entries are available.

The **first parameter** represents red intensity if the RGB model has been selected with the SET COLOR statement, or hue if the HSL model has been selected.

The **second parameter** represents green intensity if the RGB model has been selected with the SET COLOR statement, or saturation if the HSL model has been selected.

The **third parameter** represents blue intensity if the RGB model has been selected, or luminosity if the HSL model has been selected.

A more detailed description of the color models and the meaning of their parameters can be found under the procedure definition of SET_COLOR_MODEL.

The effect of a redefinition of the color table on previously output primitives is device dependent. On most devices changing the color table will only affect future primitives; however, on the Model 236C (HP 9836C) changing a color table entry with a color selector from 0 through 15 will immediately change the color of primitives previously drawn with that entry. The procedure INQ_WS (opcode 1071) tells whether retroactive color change is supported.

Monochromatic Displays

All Series 200 computers except the Model 236C have a monochromatic internal CRT. Changing an entry in the table will not affect the current display; however, future changes to the display will use the new contents of the table. Device dependent polygons use the color table entry when performing dithering.

The color that lines are drawn with (black or white) is determined from the perceived intensity of the color table entry. This is calculated as follows:

```

if (red * 0.3 + green * 0.59 + blue * 0.11) > 0.1
  then
    color := white
  else
    color := black;

```

The HP 98627A Display

Changing an entry in the table will not affect the current display; however, future changes to the display will use the new contents of the table. Device dependent polygons use the color table entry when performing dithering.

The color that lines are drawn with (one of the 8 non-dithered colors) is determined from the closest HSL value to the requested value.

The Model 236C

The first 16 locations (0..15) of the color table map directly to the hardware color map. Changing one of these color table locations will immediately change the display (assuming the color has been used).

The next 16 locations (16..31) will not affect the current display; however, future changes to the display will use the new contents of the color table.

Device dependent polygons drawn with color table locations 0..15 will be drawn in a solid color without using dithering. When drawn with color table location above 15 dithering will be used.

Note

Since dithering on the HP 9836C uses the current color map values (i.e., color table locations 0..15) changing the first 16 color table locations will affect the dither pattern used. This leads to two major effects. First, changing the first 16 locations after a polygon was generated using dithering will change the dither pattern such that its averaged color no longer matches the color that it was generated with. Second, since the dither pattern is based on the first 16 colors, the first 16 colors can be set to produce a dither pattern with minimum color changes between pixels within the pattern. The following example produces a continuous shaded polygon across the crt:

```

$RANGE OFF$
PROGRAM T;

IMPORT dsl_types, dsl_lib, dsl_poly;

VAR I          : INTEGER;
    Xvec,Yvec  : ARRAY [1..2] OF REAL;
    Ovec       : ARRAY [1..2] OF Gshortint;
    C          : REAL;

BEGIN
    GRAPHICS_INIT;
    DISPLAY_INIT(3,0,i);
    SET_ASPECT(511,389);
    SET_WINDOW(0,511,0,389);

    FOR I := 0 to 15 DO
        SET_COLOR_TABLE(I,I/15,I/15,I/15); { set up color map }

    SET_PGN_COLOR ( 16 );
    SET_PGN_STYLE ( 16 );

    Yvec[1] := 100; Yvec[2] := 150; Ovec[1] := 2; Ovec[2] := 0;
    FOR I := 0 to 511 DO
        BEGIN
            Xvec[1] := I; Xvec[2] := I;
            C : 1-I/511;
            SET_COLOR_TABLE(16,C,C,C); { set polygon color }
            POLYGON_DEV_DEP(2,Xvec,Yvec,Ovec);
        END;
    END,

```

The color that lines are drawn with (one of the first 16 non-dithered colors) is determined from the closest HSL value to the requested value.

Dithered Polygon Fills

All the raster displays use a technique called dithering for filling device dependent polygons. The polygon is divided into 4 pixel by 4 pixel 'dither cells'. The colors that are placed in each pixel location inside the dither cells average to the current polygon color. The eye will average the pixels, and see the intended color.

The 98627A has 3 memory planes thus, providing 8 non-dithered colors (white, red, green, blue, cyan, magenta, and black). Using dithering 4913 polygon colors may be generated. To obtain a polygon color of half-tone yellow ($R = 0.5$ $G = 0.5$ $B = 0.0$) the dither cell would contain 8 black pixels and 8 yellow pixels.

On black and white displays, the largest r,g,b value of the current_polygon color is used to determine the dither pattern.

On the HP 9836C the current values of the color map are used to determine the dither cell pixel colors. This leads to a very very large number of colors that the HP 9836C can produce when performing device dependent polygon fill.

The Background Color

Color index 0 represents the background color. The ability to redefine this index is device-dependent. Many devices do not allow the redefinition of their background color. Whether a display device has the ability to redefine the background color can be inquired via a call to INQ_WS with opcode = 1072. All raster displays in the 200 Series are capable of redefining the background color.

Error Conditions

The graphics system must be initialized and a display device must be enabled or this call will be ignored, an ESCAPE (-27) will be generated, and GRAPHICSError will return a non-zero value.

SET_DISPLAY_LIM

IMPORT: dgl_lib

This **procedure** redefines the logical display limits of the graphics display.

Syntax

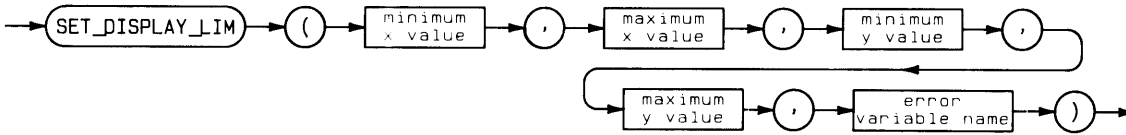

Item	Description/Default	Range Restrictions
minimum x value	Expression of TYPE REAL	-
maximum x value	Expression of TYPE REAL	-
minimum y value	Expression of TYPE REAL	-
maximum y value	Expression of TYPE REAL	-
error variable name	Variable of TYPE INTEGER	-

Procedure Heading

```
PROCEDURE SET_DISPLAY_LIM (      Xmin, Xmax,
                               Ymin, Ymax : REAL,
                               VAR      Ierr : INTEGER );
```

Semantics

The **minimum x value** is the distance in millimetres that the left side of the logical display limits is offset from the left side of the physical display limits.

The **maximum x value** is the distance in millimetres that the right side of the logical display limits is offset from the left side of the physical display limits.

The **minimum y value** is the distance in millimetres that the bottom of the logical display limits is offset from the bottom of the physical display limits.

The **maximum y value** is the distance in millimetres that the top of the logical display limits is offset from the bottom of the physical display limits.

The **error variable** will contain an integer indicating whether the limits were successfully set.

Value	Meaning
0	The display limits were successfully set.
1	The minimum x value was greater than or equal to the maximum x value and/or the minimum y value was greater than the maximum y value.
2	The parameters specified were outside the physical display limits.

If the error variable is non-zero, the call was ignored.

SET_DISPLAY_LIM allows an application program to specify the region of the display surface where the image will be displayed. The limits of this region are defined as the logical display limits. Upon initialization, the graphics system sets these limits equal to some portion of the specified physical device. This routine allows a programmer to set the plotting surface of a very large plotter equal to the size of an 8 1/2 x 11 inch paper, for example.

The pairs (minimum x value, minimum y value) and (maximum x value, maximum y value) define the corner points of the new logical display limits in terms of millimetres offset from the origin of the physical display. The exact position of the physical display origin is device dependent. The specifics of various devices are covered later in this entry.

This procedure causes a new virtual coordinate system to be defined. SET_DISPLAY_LIM calculates the new limits of the virtual coordinate system as a function of the current aspect ratio and the new limits of the logical display. This does not affect the limits of the viewport. Since it changes the size of the area onto which the viewport is mapped, it may scale the size of the image displayed. It will not distort the image; it can only make it smaller or larger.

SET_DISPLAY_LIM should only be called while the graphics display is enabled.

Neither the value of the starting position nor the location of the physical pen or beam is altered by this routine. Since this routine may redefine the viewing transformation, the starting position may be mapped to a different coordinate on the display surface. A call to MOVE or INT_MOVE should therefore be made after this call to update the value of the starting position and in so doing, place the physical pen or beam at a known location.

If the logical display and logical locator are associated with the same physical device, a call to SET_DISPLAY_LIM will set the logical locator limits equal to the new limits of the virtual coordinate system. A call to SET_DISPLAY_LIM also sets the locator echo position to its default value, the center of the world coordinate system.

Display Limits of Raster Devices

The internal CRT's for Series 200 computers have the following limits:

Computer	Wide mm	High mm	Wide points	High points	Aspect	Resolution points/mm
Model 216	160	120	400	300	.75	2.5
Model 217	230	175	512	390	.7617	2.226
Model 220 (HP82913A)	210	158	400	300	.75	1.905
Model 220 (HP82912A)	152	114	400	300	.75	2.632
Model 226	120	88	400	300	.75	3.333
Model 236	210	160	512	390	.7617	2.438
Model 236 Color	217	163	512	390	.7617	2.39
Model 237	312	234	1024	768	.75	3.282

The physical size of the HP 98627A display (needed by the SET_DISPLAY_LIM procedure) may be given to the graphics system by an escape function (OPCODE = 250). The physical limits assumed until the escape function is given are:

CONTROL	=	256	153.3mm wide and 116.7mm high.
		512	153.3mm wide and 116.7mm high.
		768	153.3mm wide and 142.2mm high.
		1024	153.3mm wide and 153.3mm high.
		1280	153.3mm wide and 153.3mm high.

The default logical display surface of the graphics display device is the maximum physical limits of the screen. The physical origin is the lower left corner of the display.

The view surface is always centered within the current logical display surface. The origin of a raster display is the lower-left dot.

HPGL Plotter Display Limits

Plotter	Wide mm	High mm	Wide points	High points	Aspect	Resolution points/mm
9872	400	285	16000	11400	.7125	40.0
7580	809.5	524.25	32380	20970	.6476	40.0
7585	1100	891.75	44000	35670	.8107	40.0
7586	1182.8	898.1	47312	35924	.7593	40.0
7470	257.5	191.25	10300	7650	.7427	40.0
7550	411.25	254.25	16450	10170	.6182	40.0
7475	416	259.125	16640	10365	.6229	40.0

The maximum physical limits of the graphics display for a HPGL device not listed above are determined by the default settings of P1 and P2. The default settings of P1 and P2 are the values they have after an HPGL 'IN' command. Refer to the specific device manual for additional details.

The default logical display surface is set equal to the area defined by P1 and P2 at the time DISPLAY_INIT is invoked. The view-surface is always justified in the lower left corner of the current logical display surface (corner nearest the turret for the HP 7580 and HP 7585 plotters). The physical origin of the graphics display is at the lower left boundary of pen movement.

Note

If the paper is changed in an HP 7580, HP 7585 or HP 7586 plotter while the graphics display is initialized, it should be the same size of paper that was in the plotter when DISPLAY_INIT was called. If a different size of paper is required, the device should be terminated (DISPLAY_TERM) and re-initialized after the new paper has been placed in the plotter.

Error Conditions

The graphics system must be initialized and a display device enabled or this call will be ignored, an ESCAPE (-27) will be generated, and GRAPHICSError will return a non-zero value.

SET_ECHO_POS

IMPORT: dgl_lib

This **procedure** defines the locator echo position on the graphics display.

Syntax

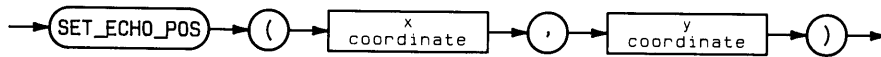

Item	Description/Default	Range Restrictions
x coordinate	Expression of TYPE REAL	—
y coordinate	Expression of TYPE REAL	—

Procedure Heading

```
PROCEDURE SET_ECHO_POS ( Wx , Wy : REAL );
```

Semantics

The **x** and **y coordinate** pair is the new echo position in world coordinates.

When echoing on the display device, SET_ECHO_POS allows a programmer to define the position of the locator echo position. This is a point in the world coordinate system that represents the initial position of the locator. It is used with certain locator echoes on the graphics display. For example, it is used as the anchor point when a rubber band echo is performed. With this echo, the graphics cursor is initially turned on at the locator echo position. From that time on, the cursor reflects the position of the locator and a line extends from the locator echo position to the locator as it moves around the graphics display. To be used in echoing, the point must be displayable. Therefore, if the point specified is outside of the limits of the window the call is ignored.

The locator echo position will only be used when AWAIT_LOCATOR is called with echo types 2 through 8, e.g., type 4 is a rubber band line echo. The locator echo position is only used when the locator echo is being sent to the graphics display device, and is not used when sampling the locator.

SET_ECHO_POS should only be called while the graphics display and locator are initialized. If the point passed to SET_ECHO_POS is outside the current window limits, then the call to SET_ECHO_POS is ignored and no error is given.

The default locator echo position is the center of the limits of the window. When the locator is initialized, the locator echo position is set to the default value. When a call is made which affects the viewing transformations for the graphics display surface or the logical locator limits, the locator echo position is set to the default value. The calls which cause this are SET_ASPECT, DISPLAY_INIT, SET_DISPLAY_LIM, LOCATOR_INIT, SET_LOCATOR_LIM, SET_WINDOW, and SET_VIEWPORT.

Once the locator echo position is set, it retains this value until the next call to SET_ECHO_POS or until a call is made which resets it to the default value.

Error Conditions

The graphics system must be initialized, and a display device and a locator device must be enabled, or this call will be ignored, an ESCAPE (- 27) will be generated, and GRAPHICSER-ROR will return a non-zero value.

SET_HPIB

IMPORT: hpib_0
 iodeclarations

This **procedure** will set the specified HP-IB control line. Not all HP-IB lines are accessible at all times.

Syntax

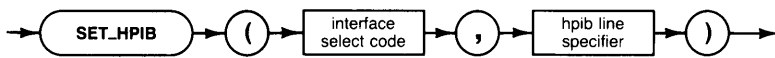

Item	Description/Default	Range Restrictions	Recommended Range
interface select code	Expression of TYPE <i>type_isc</i> . This is an INTEGER subrange.	0 thru 31	7 thru 31
hpib line specifier	Expression of enumerated TYPE <i>hpib_line</i> .	atn_line dav_line ndac_line nrfd_line eoi_line srq_line ifc_line ren_line	

Semantics

All possible *hpib_line* types are not legal when using this procedure. Handshake lines (DAV, NDAC, NRFD) are never accessible, and an error is generated if an attempt is made to set them.

The Service Request line (SRQ) is not accessible and should be set with REQUEST_SERVICE.

Setting the Interface Clear line (IFC) and the Remote Enable line (REN) requires the system to be system controller.

Setting the Attention line (ATN) requires the interface to be active controller.

SET_LINE_STYLE

IMPORT: dgl_lib

This **procedure** sets the line style attribute.

Syntax

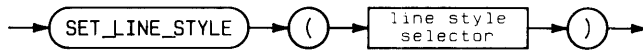

Item	Description/Default	Range Restrictions	Recommended Range
line style selector	Expression of TYPE INTEGER	MININT thru MAXINT	Device Dependent

Procedure Heading

```
PROCEDURE SET_LINE_STYLE (Line_Style : INTEGER);
```

Semantics

The **line style selector** is the line style to be used for lines, polylines, polygon edges, and text.

Markers are not affected by line-style. Polygon interior line-style is selected with SET_PGN_LS.

SET_LINE_STYLE sets the line style attribute for lines and text. The mapping between the value of the line style attribute and the line style selected is device dependent. If a line style attribute is requested that the device cannot perform exactly as requested, line style 1 will be performed.

There are three types of line-styles: start adjusted, continuous, and vector adjusted:

Start adjusted line-styles always start the cycle at the beginning of the vector. Thus if the current line-style starts with a pattern, each vector drawn will start with that pattern. Likewise, if the current line-style starts with a space and then a dot, each vector will be drawn starting with a space and then a dot. In this case if the vectors are short, they might not appear at all.

Continuous line styles are generated such that the pattern will be started with the first vector drawn. Subsequent vectors will be continuations of the pattern. Thus, it may take several vectors to complete one cycle of the pattern. This type of line-style is useful for drawing smooth curves, but does not necessarily designate either endpoint of a vector. A side effect of this type of line-style is if a vector is small enough it might be composed only of the space between points or dashes in the line-style. In that case, the vector may not appear on the graphics display at all.

Vector adjusted line-styles treat each vector individually. Individual treatment guarantees that a solid component of the dash pattern will be generated at both ends of the vector. Thus, the endpoints of each vector will be clearly identifiable. This type of line-style is good for drawing rectangles. The integrity of the line-style will degenerate with very small vectors. Since some component of the dash pattern must appear at both ends of the vector, the entire vector for a short vector will often be drawn as solid.

The following figure illustrates how one pattern would be displayed using each one of the different line-style types:

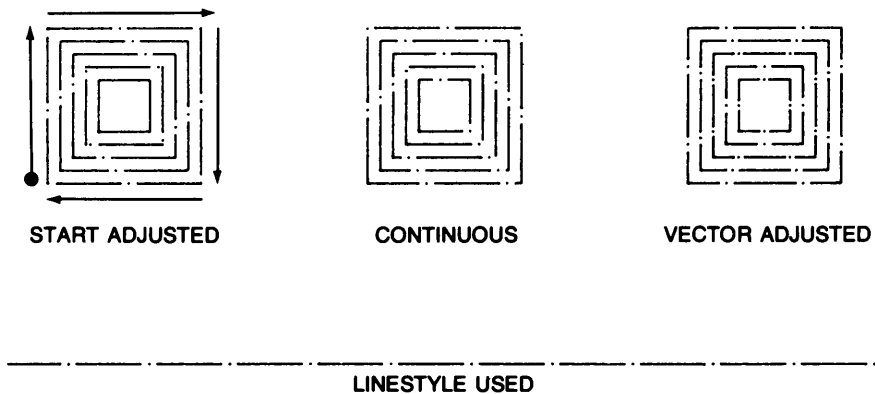

It should be apparent from the above discussion that drawing to the starting position will generate a point (the shortest possible line) only if the line-style is such that the pen is down (or the beam is on) at the start of that vector. Likewise, whole vectors may not appear on the graphics display surface if the line-style is such that the vector is smaller than the blank space in the line-style. The device handlers section of this document details the line-styles available for each device.

Note

When using continuous line styles, complement and erase drawing modes (available on some raster displays e.g., HP 9826) may not completely remove lines previously drawn. This happens since the line style pattern may not be in sync with the first line when the second line is drawn. By setting the line-style to solid when using complement and erase drawing modes the application program can insure that the line is completely removed.

Raster Line Styles

Eight pre-defined line-styles are supported on the graphics display. All of the line-styles may be classified as being “continuous”:

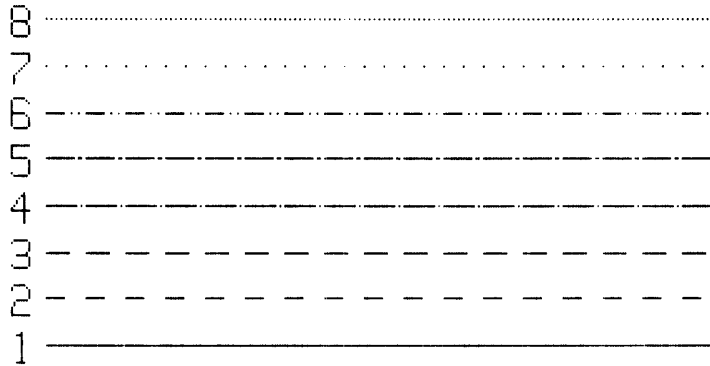

Raster Line Styles

Plotter Line Styles

The following table describes the line styles available on the supported plotters.

Device	Number of continuous line-styles	Number of vector adjusted line-styles
9872	7	0
7580	7	6
7585	7	6
7470	7	0
Other	7	0

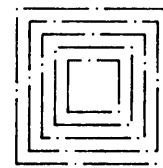
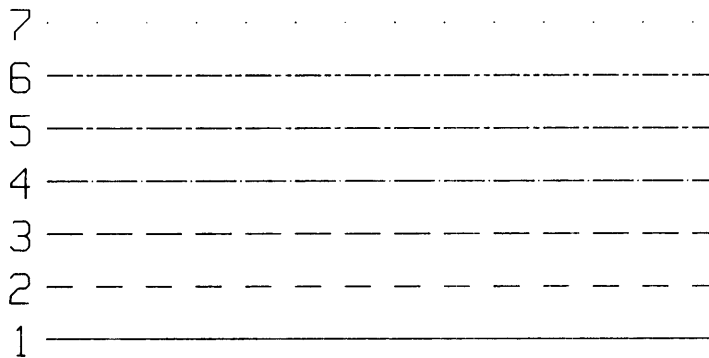

CONTINUOUS

**HP 9872 and 7470 Line Styles
(all are continuous)**

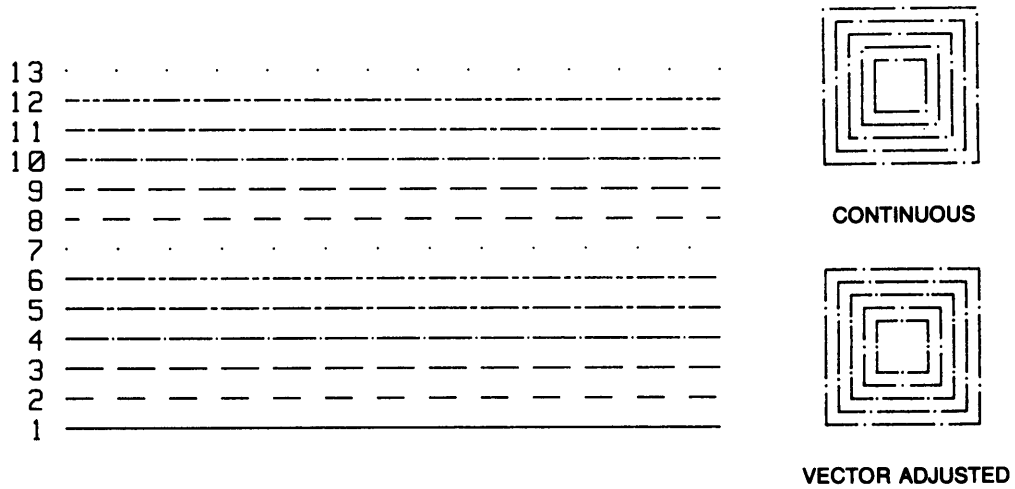

HP 7580, 7585 and 7586 Line Styles

If the line style specified is not supported by the graphics display, the call is completed with `LINE_STYLE = 1` and no error is reported.

Error Conditions

The graphics system must be enabled and a display device must be enabled or this call will be ignored and `GRAPHICSError` will return a non-zero value.

SET_LOCATOR_LIM

IMPORT: dgl_lib

This **procedure** redefines the logical locator limits of the graphics locator.

Syntax

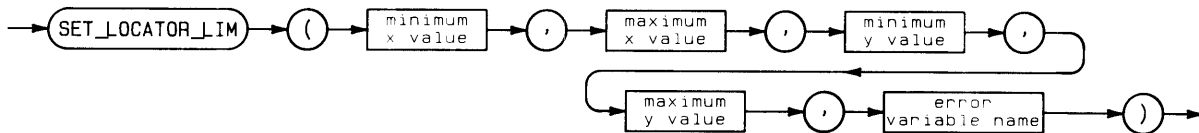

Item	Description/Default	Range Restrictions
minimum x value	Expression of TYPE REAL	—
maximum x value	Expression of TYPE REAL	—
maximum y value	Expression of TYPE REAL	—
minimum y value	Expression of TYPE REAL	—
error variable name	Variable of TYPE INTEGER	—

Procedure Heading

```

PROCEDURE SET_LOCATOR_LIM (      Xmin, Xmax,
                                Ymin, Ymax : REAL,
                                VAR Ierr   : INTEGER );
  
```

Semantics

The **minimum x value** is the distance in millimetres that the left side of the logical locator limits is offset from the left side of the physical locator limits.

The **maximum x value** is the distance in millimetres that the right side of the logical locator limits is offset from the left side of the physical locator limits.

The **minimum y value** is the distance in millimetres that the bottom of the logical locator limits is offset from the bottom of the physical locator limits.

The **maximum y value** is the distance in millimetres that the top of the logical locator limits is offset from the bottom of the physical locator limits.

The **error variable** will contain an integer indicating whether the limits were successfully set.

Value	Meaning
0	The display limits were successfully set.
1	The minimum x value was greater than or equal to the maximum x value and/or the minimum y value was greater than the maximum y value.
2	The parameters specified were outside the physical display limits.
3	Attempt to explicitly define locator limits on a device which is both the logical locator and the logical display. The logical display limits are used when a device is shared for both purposes, and they cannot be redefined with this call.

If the error variable is non-zero, the call was ignored.

SET_LOCATOR_LIM allows an application program to specify the portion of the physical locator device that should be used to perform locator functions. When the logical locator device is enabled (via LOCATOR_INIT) the logical device limits are set to a device dependent portion of the physical locator device. With a call to this routine the user can set the logical locator limits by specifying a new area within the physical locator limits.

The pairs (minimum x value, minimum y value) and (maximum x value, maximum y value) define the corner points of the new logical locator limits in terms of millimetres offset from the origin of the physical locator. The exact position of the physical locator origin is device dependent. Specific origins are covered later in this entry.

If a logical locator and a logical display are associated with the same physical device, then the logical locator limits must be the same as the logical view surface limits. Specifically, the effects of the association with the same physical device are as follows:

- The logical locator limits are initialized to the same values as the virtual coordinate system.
- Any call which redefines the virtual coordinate system limits will also redefine the logical locator limits.
- The logical locator limits can not be defined by a call to SET_LOCATOR_LIM.

By changing the logical locator limits any portion of the graphics locator can be addressed, with the restrictions stated above.

The logical locator limits always map directly to the view surface, therefore, distortion may result in the mapping between the logical locator and the display when the logical locator limits and the view surface have different aspect ratios. If the distortion is not desired it can be avoided by assuring that the logical locator limits maintain the same aspect ratio as that of the view surface.

SET_LOCATOR_LIM should only be called while the graphics locator is enabled. SET_LOCATOR_LIM sets the locator echo position to the default value (see SET_ECHO_POS).

Locator Limits: The Knob

The knob may be used as a locator on Series 200 computers. The default characteristics of the knob on various Series 200 computers is listed in the table below.

Computer	Wide mm	High mm	Wide points	High points	Aspect	Resolution points/mm
Model 216	160	120	400	300	.75	2.5
Model 217	230	175	512	390	.7617	2.226
Model 220 (HP82913A)	210	158	400	300	.75	1.905
Model 220 (HP82912A)	152	114	400	300	.75	2.632
Model 226	120	88	400	300	.75	3.333
Model 236	210	160	512	390	.7617	2.438
Model 236 Color	217	163	512	390	.7617	2.39
Model 237	312	234	1024	768	.75	3.282

The knob uses the current display limits as its locator limits for locator echoes 2 through 8. For all other echoes the above limits are used. An example of when the two limits may differ follows:

The knob locator is initialized on an HP 9826. The graphics display is an HP 98627A color output card. The resolution of the locator is 0 through 399 in x dimension, and 0 through 299 in y dimension. The resolution of the display is 0 through 511 in x dimension, and 0 through 389 in y dimension. When `await_locator` is used with echo 4, the locator will effectively have the HP 98627A resolution for the duration of the `await_locator` call. However if echo 1 is used with `await_locator`, the cursor will appear on the HP 9826 and the locator has a resolution of 0×399 and 0×299 . Note that all conversion routines, and inquiries will use the HP 9826 limits.

The physical origin of the locator device is the lower left corner of the display.

Locator Limits: HPGL Devices

HPGL devices can be used as locators. The default characteristics of some HPGL devices are listed below.

Plotter	Wide mm	High mm	Wide points	High points	Aspect	Resolution points/mm
9872	400	285	16000	11400	.7125	40.0
7580	809.5	524.25	32380	20970	.6476	40.0
7585	1100	891.75	44000	35670	.8107	40.0
7586	1182.8	898.1	47312	35924	.7593	40.0
7470	257.5	191.25	10300	7650	.7427	40.0
7550	411.25	254.25	16450	10170	.6182	40.0
7475	416	259.125	16640	10365	.6229	40.0
9111	300.8	217.6	12032	8704	.7234	40.0

The maximum physical limits of the locator for a HPGL device not listed above are determined by the default settings of P1 and P2. The default settings of P1 and P2 are the values they have after an HPGL 'IN' command. Refer to the specific device manual for additional details.

The default logical display surface is set equal to the area defined by P1 and P2 at the time `LOCATOR_INIT` is invoked.

Note

If the paper is changed in an HP 7580, HP 7585 or HP 7586 plotter while the graphics display is initialized, it should be the same size of paper that was in the plotter when DISPLAY_INIT was called. If a different size of paper is required, the device should be terminated (DISPLAY_TERM) and re-initialized after the new paper has been placed in the plotter.

Error Conditions

The graphics system must be initialized and a display device enabled or this call will be ignored, an ESCAPE (–27) will be generated, and GRAPHICSError will return a non-zero value.

SET_LINE_WIDTH

IMPORT: dgl_lib

This **procedure** sets the line-width attribute. The number of line-widths possible is device dependent.

Syntax

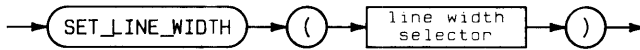

Item	Description/Default	Range Restrictions
line-width selector	Expression of TYPE INTEGER	MININT thru MAXINT

Procedure Headings

```
PROCEDURE SET_LINE_WIDTH ( Linewidth : INTEGER );
```

Semantics

SET_LINE_WIDTH sets the line-width attribute for lines, polylines and text. The line-width attribute does not affect markers which are defined to be always output with the thinnest line-width supported on the device. All devices support at least one line-width. The range of line-widths is device dependent but line-width 1 is always the thinnest line-width supported. For devices that support multiple line-widths, the line-width increases as line-width does until the device supported maximum is reached. For example, line-width = 1 specifies the thinnest, line-width = 2 specifies the next wider line-width, etc.

If line-width is greater than the number of line-widths supported by the graphics display or line-width is less than 1, then the line-width will be set to the thinnest available width (line-width = 1). All subsequent lines and text will then be drawn with the thinnest available line-width. A call to INQ_WS with OPCODE equal to 1063 to inquire the value of the line-width will then return a 1.

The initial line-width is the thinnest width supported by the device (line-width = 1).

Note

All current devices support a single line-width.

Error Conditions

The graphics system must be initialized and a display device must be enabled or this call is ignored, an ESCAPE (-27) will be generated, and GRAPHICSError will return a non-zero value.

SET_PARITY

IMPORT: serial_3
 iodeclarations

This **procedure** determines what parity mode the serial interface will use.

Syntax

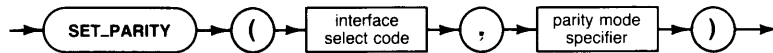

Item	Description/Default	Range Restrictions	Recommended Range
interface select code	Expression of TYPE <i>type_isc</i> . This is an INTEGER subrange.	0 thru 31	7 thru 31
parity mode specifier	Expression of enumerated TYPE <i>type_parity</i> .	no_parity odd_parity even_parity one_parity zero_parity	

SET_PGN_COLOR

IMPORT: dgl_lib
dgl_poly

This **procedure** selects the polygon interior color attribute for subsequently generated polygons by providing a selector for the color table.

Syntax



Item	Description/Default	Range Restrictions	Recommended Range
color selector	Expression of TYPE INTEGER	MININT thru MAXINT	Device dependent.

Procedure Heading

```
PROCEDURE SET_PGN_COLOR ( Cindex : INTEGER );
```

Semantics

The **color selector** is an index into the color table. The contents of the color table are then used to specify the color when primitives are drawn. On some devices (HPGL plotters), the color selector maps directly to a pen number for the device. On the HP 9836C, the entries in the color table can be modified with SET_COLOR_TABLE. The color actually used depends on the value in a device dependent color table.

At device initialization a default color table is created by the graphics system. The size and contents of the table are device dependent. At least one entry exists for all devices. A call to INQ_WS with OPCODE equal to 1053 will return the number of colors available on a given graphics device. Some devices allow the color table to be modified with SET_TABLE.

The default value of the color attribute is 1. If the value of the color selector is not supported on the graphics display, the color attribute will be set to 1.

A color selector of 0 has special effects depending on the graphics display used. For raster devices, a color selector of 0 means to draw in the background color. For most plotters, it puts the pen away.

Dithering

If the device is not capable of reproducing a color in the color table, the closest color which the device is capable of reproducing is used instead. For polygon fill (in a device dependent mode) this may involve dithering. For example, the HP 98627A color output interface card is capable of a large selection of polygon fill colors, but only 8 line colors. Thus, the fill color could match the selected color much more closely than the line color used to outline the polygon. See SET_COLOR_TABLE for details on how colors are matched to the devices.

Default Raster Color Map

The following table shows the default (initial) color table for the black and white displays (HP 9816 / HP 9920 / HP 9826 / HP 9836):

Index #	Hue	Saturation	Luminosity
0	0	0	0
1	0	0	1.0000
2	0	0	0.9375
3	0	0	0.8750
4	0	0	0.8125
5	0	0	0.7500
6	0	0	0.6875
7	0	0	0.6250
8	0	0	0.5625
9	0	0	0.5000
10	0	0	0.4375
11	0	0	0.3750
12	0	0	0.3125
13	0	0	0.2500
14	0	0	0.1875
15	0	0	0.1250
16	0	0	0.0625

Colors 17 though 31 are set to white.

The following table shows the default (initial) color table for the color displays (HP 9836C and HP 98627A):

Index #	Color name	Red	Green	Blue
0	Black	0.000000	0.000000	0.000000
1	White	1.000000	1.000000	1.000000
2	Red	1.000000	0.000000	0.000000
3	Yellow	1.000000	1.000000	0.000000
4	Green	0.000000	1.000000	0.000000
5	Cyan	0.000000	1.000000	1.000000
6	Blue	0.000000	0.000000	1.000000
7	Magenta	1.000000	0.000000	1.000000
8	Black	0.000000	0.000000	0.000000
9	Olive green	0.800000	0.733333	0.200000
10	Aqua	0.200000	0.400000	0.466667
11	Royal blue	0.533333	0.400000	0.666667
12	Violet	0.800000	0.266667	0.400000
13	Brick red	1.000000	0.400000	0.200000
14	Burnt orange	1.000000	0.466667	0.000000
15	Grey brown	0.866667	0.533333	0.266667

Colors 9 though 15 are a graphic designers idea of colors for business graphics. Color table entries not shown above are set to white.

Raster Drawing Modes

Raster drawing modes have no effect on polygon fill color.

Plotters

A Color Selector of 0 selects no pens (the current pen is put away). The supported range of Color Selectors for each supported plotter is:

- 9872A - 0 thru 4
- 9872B - 0 thru 4
- 9872C/S/T - 0 thru 8
- 7550A/7580A/7585A/7586B - 0 thru 8
- 7470A - 0 thru 2
- 7475 - 0 thru 6

Error Conditions

The graphics system must be initialized and a display must be enabled or this call will be ignored, an ESCAPE (- 27) will be generated, and GRAPHICSEERROR returns a non-zero value.

SET_PGN_LS

IMPORT: dgl_lib
 dgl_poly

This **procedure** selects the polygon interior line-style attribute for subsequently generated polygons by providing a selector for the device dependent line-style table.

Syntax

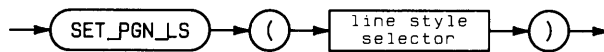

Item	Description/Default	Range Restrictions	Recommended Range
line-style selector	Expression of TYPE INTEGER	MININT thru MAXINT	Device dependent

Procedure Heading

```
PROCEDURE SET_PGN_LS ( Lindex : INTEGER );
```

Semantics

The **line style selector** is the line style to be used for polygon interiors.

Line-styles for other primitives are selected using SET_LINE_STYLE.

The mapping between the value of the line style attribute and the line style selected is device dependent. If a line style attribute is requested that the device cannot perform exactly as requested, line style 1 will be performed.

There are three types of line-styles - start adjusted, continuous, and vector adjusted:

Start adjusted line-styles always start the cycle at the beginning of the vector. Thus if the current line-style starts with a pattern, each vector drawn will start with that pattern. Likewise, if the current line-style starts with a space and then a dot, each vector will be drawn starting with a space and then a dot. In this case if the vectors are short, they might not appear at all.

Continuous line styles are generated such that the pattern will be started with the first vector drawn. Subsequent vectors will be continuations of the pattern. Thus, it may take several vectors to complete one cycle of the pattern. This type of line-style is useful for drawing smooth curves, but does not necessarily designate either endpoint of a vector. A side effect of this type of line-style is if a vector is small enough it might be composed only of the space between points or dashes in the line-style. In that case, the vector may not appear on the graphics display at all.

Vector adjusted line-styles treat each vector individually. Individual treatment guarantees that a solid component of the dash pattern will be generated at both ends of the vector. Thus, the endpoints of each vector will be clearly identifiable. This type of line-style is good for drawing rectangles. The integrity of the line-style will degenerate with very small vectors. Since some component of the dash pattern must appear at both ends of the vector, the entire vector for a short vector will often be drawn as solid.

The following figure illustrates how one pattern would be displayed using each one of the different line-style types:

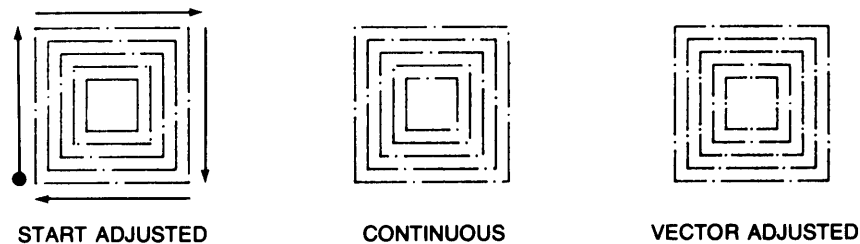

It should be apparent from the above discussion that drawing to the starting position will generate a point (the shortest possible line) only if the line-style is such that the pen is down (or the beam is on) at the start of that vector. Likewise, whole vectors may not appear on the graphics display surface if the line-style is such that the vector is smaller than the blank space in the line-style. The device handlers section of this document details the line-styles available for each device.

Note

When using continuous line styles, complement and erase drawing modes (available on some raster displays e.g., HP 9826) may not completely remove lines previously drawn. This happens since the line style pattern may not be in sync with the first line when the second line is drawn. By setting the line style to solid when using complement and erase drawing modes the application program can insure that the line is completely removed.

Raster Line Styles

Eight pre-defined line-styles are supported on the graphics display. All of the line-styles may be classified as being "continuous":

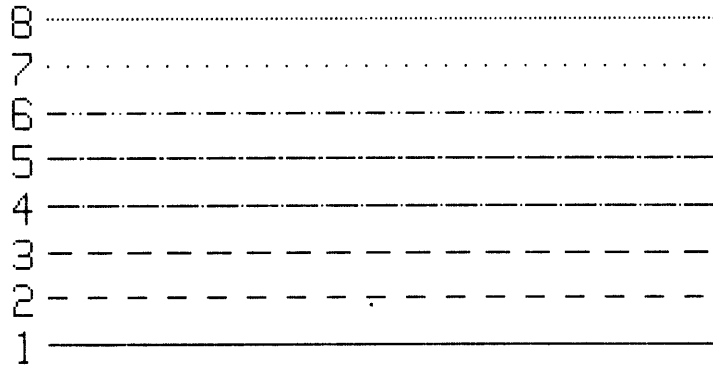

Raster Line Styles

Plotter Line Styles

The following table describes the line styles available on the supported plotters.

Device	Number of continuous line-styles	Number of vector adjusted line-styles
9872	7	0
7470	7	0
7475	7	0
7550	7	6
7580	7	6
7585	7	6
7586	7	6
Other	7	0

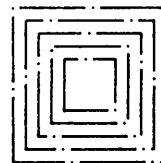
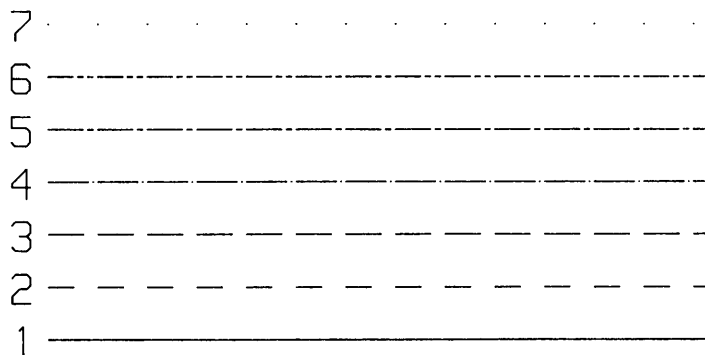

CONTINUOUS

**HP 9872, 7470 and 7475 Line Styles
(all are continuous)**

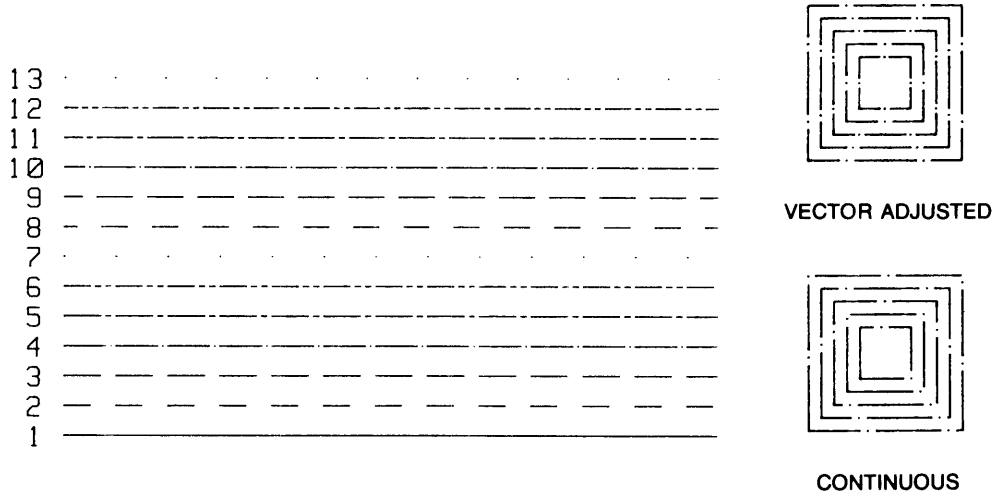

HP 7550, 7580, 7585 and 7586 Line Styles

If the line style specified is not supported by the graphics display, the call is completed with `LINE_STYLE = 1` and no error is reported.

The graphics system must be enabled and a display device must be enabled or this call will be ignored and `GRAPHICSError` will return a non-zero value.

Error conditions:

The graphics system must be initialized and a display device must be enabled or this call will be ignored, an `ESCAPE (-27)` will be generated, and `GRAPHICSError` will return a non-zero value.

SET_PGN_STYLE

IMPORT: dgl_lib
 dgl_poly

This **procedure** selects the polygon style attribute for subsequently generated polygons by providing a selector for the polygon style table.

Syntax

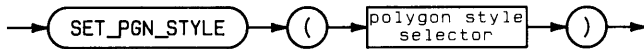

Item	Description/Default	Range Restrictions	Recommended Range
polygon style selector	Expression of TYPE INTEGER	MININT thru MAXINT	Device dependent

Procedure Heading

```
PROCEDURE SET_PGN_STYLE ( Pindex : INTEGER );
```

Semantics

Polygon styles can vary in polygon interior density, polygon interior orientation and polygon edge display. See SET_PGN_TABLE for details on default styles, and how the polygon style table may be changed.

Error Conditions

The graphics system must be initialized and a display device must be enabled or this call will be ignored and GRAPHICSError will return a non-zero value.

SET_PGN_TABLE

IMPORT: dgl_lib
dgl_poly

This **procedure** defines a polygon style attribute, i.e. an entry in a polygon style table.

Syntax

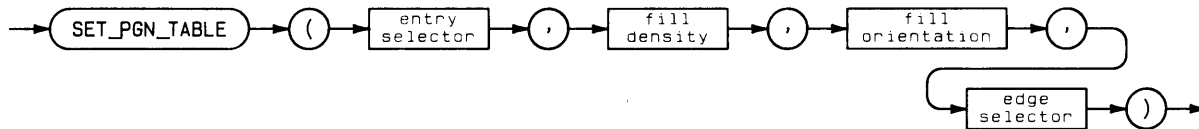

Item	Description/Default	Range Restrictions	Recommended Range
entry selector	Expression of TYPE INTEGER	MININT thru MAXINT	Device dependent
fill density	Expression of TYPE REAL	MININT thru MAXINT	-1 thru 1
fill orientation	Expression of TYPE REAL	MININT thru MAXINT	-90 thru 90
edge selector	Expression of TYPE INTEGER	MININT thru MAXINT	—

Procedure Heading

```
PROCEDURE SET_PGN_TABLE ( Index : INTEGER;  
                          Densy  : REAL;  
                          Orient  : REAL;  
                          Edge   : INTEGER );
```

Semantics

This routine defines the attribute of polygon style, i.e. it specifies an entry in a polygon style table. This entry contains information that specifies polygon interior density, polygon interior orientation, polygon edge display, and device-independence of polygon display.

The **entry selector** specifies the entry in the polygon style table that is to be redefined.

The **fill density** determines the density of the polygon interior fill. The magnitude of this value is the ratio of filled area to non-filled area. Zero means the polygon interior is not filled. One represents a fully filled polygon interior. All non-zero values specify the density of continuous lines used to fill the interior.

Positive density values request parallel fill lines in one direction only. Negative values are used to specify crosshatching. For a given density, the distance between two adjacent parallel lines is greater with cross hatching than in the case of pure parallel filling. Calculations for fill density are based on the thinnest line possible on the device and on continuous line-style.

The distance between fill lines – hence density – does not change with a change of scale caused by a viewing transformation. If the interior line-style is not continuous, the actual fill density may not match that found in the polygon style table.

The **fill orientation** represents the angle (in degrees) between the lines used for filling the polygon and the horizontal axis of the display device. The interpretation of fill orientation is device-dependent. On devices that require software emulation of polygon styles, the angle specified will be adhered to as closely as possible, within the line-drawing capabilities of the device. For hardware generated polygon styles, the angle specified will be adhered to as closely as is possible given the hardware simulation of the requested density. If crosshatching is specified, the fill orientation specifies the angle of orientation of the first set of lines in the crosshatching, and the second set of lines is always perpendicular to this.

The value of the **edge selector** determines whether the edge of the polygon is displayed. If the edge selector is 0, the edges will not be displayed. If the edge selector is 1, display of individual edge segments depends on the operation selector in the call that draws the polygon set, POLYGON, INT_POLYGON, POLYGON_DEV_DEP, or INT_POLYGON_DD.

If polygon edges are displayed, they adhere to the current line attributes of color, line-style, and line-width, in effect at the time of polygon display.

A device-dependent number of polygon styles are available. All devices support at least 16 entries in the polygon table. The polygon styles defined in the default tables are defined to exploit the hardware capabilities of the devices they are defined for.

Polygon interiors can be generated in either a device-dependent or device-independent fashion, by calling POLYGON_DEV_DEP or POLYGON respectively.

Polygons generated in a device-dependent fashion will utilize the available hardware polygon generation capabilities of the device to increase the speed and efficiency of polygon generation. The output may vary depending on the device. Devices that have no hardware polygon generation capabilities will only do a minimal representation of the polygon if a device-dependent representation of the polygon is requested. If an edge is not requested, an outline of the non-clipped boundaries of the polygon interior will be drawn in the current polygon interior color and polygon interior line-style if the density of the polygon interior was not zero.

Polygons generated in a device-independent fashion will adhere strictly to the polygon style specification. The polygon interior generated would look similar when generated on different devices for a given polygon style specification. However, on raster devices rasterization of the fill lines may leave empty pixels when solid fill is requested with an orientation that is not 0 or 90 degrees. Available hardware would only be used where the polygon style could be generated exactly as specified.

The number of entries in the polygon style table and the default contents of the table are device dependent. However, all devices support the following polygon style table:

Entry	Density	Angle	Edge
1	0.0	0.0	1
2	0.125	90.0	1
3	0.125	0.0	1
4	-0.125	0.0	1
5	0.125	45.0	1
6	0.125	-45.0	1
7	-0.125	45.0	1
8	0.25	90.0	1
9	0.25	0.0	1
10	-0.25	0.0	1
11	0.25	45.0	1
12	0.25	-45.0	1
13	-0.25	45.0	1
14	-0.5	0.0	1
15	1.0	0.0	0
16	1.0	0.0	1

Error Conditions

The graphics system must be initialized, a display must be enabled, and the parameters must be within the specified limits or this call will be ignored, an ESCAPE (-27) will be generated, and GRAPHICSError will return a non-zero value.

SET_SERIAL

IMPORT: serial_
iodeclarations

This **procedure** will set the specified modem line on the connector. Not all lines are available at all times. The use of an Option 1 or Option 2 connector determines which lines are accessible.

Syntax

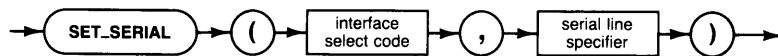

Item	Description/Default	Range Restrictions	Recommended Range
interface select code	Expression of TYPE <i>type_isc</i> . This is an INTEGER subrange.	0 thru 31	7 thru 31
serial line specifier	Expression of enumerated TYPE <i>type_serial_line</i> .	rts_line cts_line dcd_line dsr_line drs_line ri_line dtr_line	

TABLE HERE

Semantics

The values of the enumerated TYPE *type_serial_line* have the following definitions:

Name	RS-232 line
rts	ready to send
cts	clear to send
dcd	data carrier detect
dsr	data set ready
drs	data rate select
dtr	data terminal ready
ri	ring indicator

SET_STOP_BITS

IMPORT: serial_3
iodeclarations

This **procedure** will set the number of stop bits on the serial interface. The valid range of values includes 1, 1.5, and 2.

Syntax

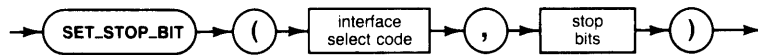

Item	Description/Default	Range Restrictions	Recommended Range
interface select code	Expression of TYPE <i>type_isc</i> . This is an INTEGER subrange.	0 thru 31	7 thru 31
stop bits	Expression of TYPE REAL.	–	1, 1.5, 2

SET_TEXT_ROT

IMPORT: dgl_lib

This procedure specifies the text direction.

Syntax

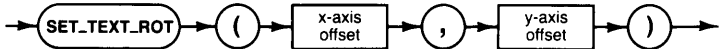

Item	Description/Default	Range Restrictions
x-axis offset	Expression of TYPE REAL	-
y-axis offset	Expression of TYPE REAL	-

Procedure Heading

```
PROCEDURE SET_TEXT_ROT ( Dx, Dy : REAL );
```

Semantics

The **x axis offset** and the **y axis offset** specify the world coordinate components of the text direction vector relative to the world coordinate origin. These components cannot both be zero.

This procedure specifies the direction in which graphics text characters are output. The default value (X-axis offset = 1.0; Y-axis offset = 0.0) for the text direction vector is such that characters are drawn in a horizontal direction left to right. The default value is set during GRAPHICS_INIT and DISPLAY_INIT. With X-axis offset = - 1.0 and Y-axis offset = 1.0 a 135 degree rotation from the horizontal (in a counter clockwise direction) may be obtained.

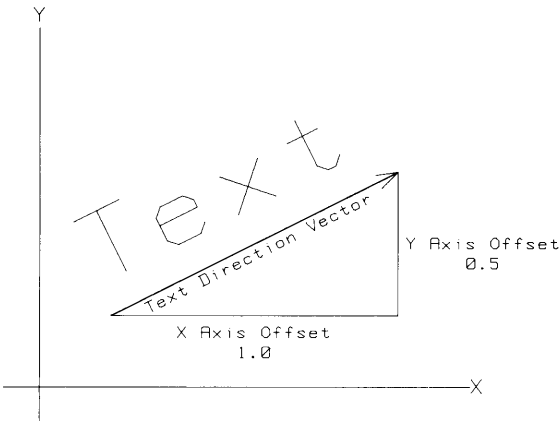

Text Rotation Angle

Error Conditions

The graphics system must be initialized, a display must be enabled, and the parameters must be within the specified limits or this call will be ignored, an ESCAPE (- 27) will be generated, and GRAPHICSEERROR will return a non-zero value.

SET_TIMEOUT

IMPORT: general_1
iodeclarations

This **procedure** will set up a timeout for all I/O Library input and output operations except transfer.

Syntax

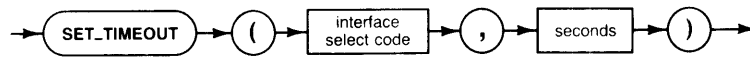

Item	Description/Default	Range Restrictions	Recommended Range
interface select code	Expression of TYPE <i>type_isc</i> . This is an INTEGER subrange.	0 thru 31	7 thru 31
seconds	Expression of TYPE REAL.	—	0, .001 thru 8192.000, inc. by .001

Semantics

Zero (0) is no timeout (infinite).

The resolution is to 1 millisecond.

If the select codes do not respond within the specified time an ESCAPE will be performed. Refer to the chapter on Errors and Timeouts.

Example:

```

.
.
.
TRY
  SETTIMEOUT(12,1000);
  READCHAR(12,character);
RECOVER BEGIN
  IF Escapecode = Ioescapecode AND
     Ioe_result = Ioe_timeout AND
     Ioe_isc = 12
  THEN WRITELN ('TIMEOUT on Interface 12')
END; {end of RECOVER}
.
.
.

```

SET_TIMING

IMPORT: dgl_lib

This **procedure** selects the timing mode for graphics output.

Syntax

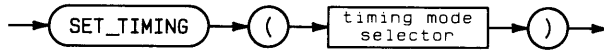

Item	Description/Default	Range Restrictions
timing mode selector	Expression of TYPE INTEGER	0 or 1

Procedure Heading

```
PROCEDURE SET_TIMING ( Opcode : INTEGER );
```

Semantics

The **timing mode selector** determines the timing mode used.

Value	Meaning
0	Immediate visibility mode
1	System buffering mode

Graphics library timing modes are provided to control graphics throughput and picture update timing. Picture update timing refers to the immediacy of visual changes to the graphics display surface. Regardless of the timing mode used, the same final picture is sent to the graphics display. SET_TIMING only controls when a picture appears on the graphics display, not what appears.

The graphics system supports two timing modes:

- *Immediate visibility* Requested picture changes will be sent to the graphics display device before control is returned to the calling program. Due to operating system delays there may be a delay before the picture changes are visible on the graphics display device.
- *System buffering* Requested picture changes will be buffered by the graphics system. This means that the graphics output will not be immediately sent to the display device. This allows the graphics library to send several graphics commands to the graphics display device in one data transfer, therefore, reducing the number of transfers. System buffering is the initial timing mode.

The following routines implicitly make the picture current:

```

    AWAIT_LOCATOR    DISPLAY_TERM    INPUT_ESC
    LOCATOR_INIT     SAMPLE_LOCATOR
  
```

The immediate visibility mode is less efficient than the system buffering mode. It should only be used in those applications that require picture changes to take place as soon as they are defined, even if the finished picture takes longer to create. When changing the timing mode to immediate visibility the picture is made current.

An alternative to immediate visibility that will solve many application needs is the use of system buffering together with the `MAKE_PIC_CURRENT` procedure. With this method, an application program places graphics commands into the output buffer and flushes the buffer (see `MAKE_PIC_CURRENT`) only at times when the picture must be fully displayed.

A call to `MAKE_PIC_CURRENT` can be made at any time within an application program to insure that the image is fully defined. `MAKE_PIC_CURRENT` flushes the output buffer but does not modify the timing mode.

Before performing any non-graphics system input or output (to a graphics system device) such as a PASCAL read or write, the output buffer must be empty. If the buffer is not flushed (via immediate visibility of `MAKE_PIC_CURRENT`) prior to non-graphics system I/O, the resulting image may contain some 'garbage' such as escape functions or invalid graphics data.

Note

Although `SET_TIMING` can be used with all display devices, only HPGL plotters buffer commands.

Error Conditions

The graphics system must be initialized and all parameters must be in range or this call will be ignored, an ESCAPE (- 27) will be generated, and `GRAPHICSError` will return a non-zero value.

SET_TO_LISTEN

IMPORT: hpib_1
iodeclarations

Note

This function is provided for use by the internal I/O Procedure Library drivers, only. Unexpected and possible undesirable results may occur if it is used.

SET_TO_TALK

IMPORT: hpib_1
iodeclarations

Note

This function is provided for use by the internal I/O Procedure Library drivers, only. Unexpected and possible undesirable results may occur if it is used.

SET_VIEWPORT

IMPORT: dgl_lib

This **procedure** sets the boundaries of the viewport in the virtual coordinate system.

Syntax

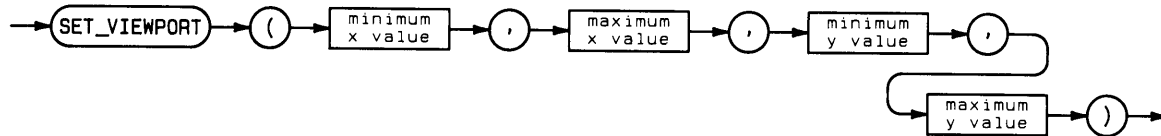

Item	Description/Default	Range Restrictions
minimum x value	Expression of TYPE REAL	0.0-1.0
maximum x value	Expression of TYPE REAL	0.0-1.0
minimum y value	Expression of TYPE REAL	0.0-1.0
maximum y value	Expression of TYPE REAL	0.0-1.0

Procedure Heading

```
PROCEDURE SET_VIEWPORT ( Vxmin, Vxmax,
                        Vymin, Vymax : REAL );
```

Semantics

The **minimum x value** is the minimum boundary in the X-direction expressed in virtual coordinates.

The **maximum x value** is the maximum boundary in the X-direction expressed in virtual coordinates.

The **minimum y value** is the minimum boundary in the Y-direction expressed in virtual coordinates.

The **maximum y value** is the maximum boundary in the Y-direction expressed in virtual coordinates.

SET_VIEWPORT sets the limits of the viewport in the virtual coordinate system. The viewport must be within the limits of the virtual coordinate system; otherwise the call will be ignored.

The initial viewport is set up with the minimum x and y values set to 0.0 and the maximum X and Y values set to 1.0.

The initial viewport is set by `GRAPHICS_INIT` and `SET_ASPECT`. This initial viewport is mapped onto the maximum visible square within the logical display limits. This area is called the view surface. The placement of the view surface within the logical display limits is dependent upon the device being used. It is generally centered on CRT displays and is placed in the lower left-hand corner of plotters.

By changing the limits of the viewport, an application program can display an image in several different positions on the same graphics display device. A program can make a call to `SET_VIEWPORT` anytime while the graphics system is initialized.

The starting position is not altered by this call. Since this call redefines the viewing transformation, the starting position may no longer represent a known world coordinate position. A call to `MOVE` or `INT_MOVE` should be made after this call to update the starting position.

Error Conditions

The graphics system must be initialized, all parameters must be within the specified range, the minimum X value must be less than the maximum X value and the minimum Y value must be less than the maximum Y value and all parameters must be within the current virtual coordinate system boundary, or this call will be ignored, an `ESCAPE (-27)` will be generated, and `GRAPHICSERROR` will return a non-zero value..

SET_WINDOW

IMPORT: dgl_lib

This **procedure** defines the boundaries of the window.

Syntax

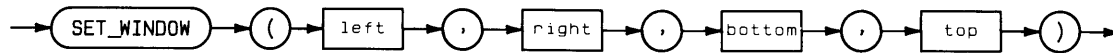

Item	Description/Default	Range Restrictions
left	Expression of TYPE REAL	See below
right	Expression of TYPE REAL	See below
bottom	Expression of TYPE REAL	See below
top	Expression of TYPE REAL	See below

Procedure Heading

```
PROCEDURE SET_WINDOW ( Wxmin, Wxmax,
                      Wymmin, Wymax : REAL );
```

Semantics

The **left** is the minimum boundary in the X-direction expressed in world coordinates. (i.e., the left window border). Must not equal maximum x value.

The **right** is the maximum boundary in the X-direction expressed in world coordinates. (i.e. the right window border). Must not equal minimum x value.

The **bottom** is the minimum boundary in the Y-direction expressed in world coordinates. (i.e. the bottom window border). Must not equal maximum y value.

The **top** is the maximum boundary in the Y-direction expressed in world coordinates. (i.e. the top window border). Must not equal minimum y value.

SET_WINDOW defines the limits of the window. All positional information sent to and received from the graphics system is specified in world coordinate units. This allows the application program to specify coordinates in units related to the application.

If the top value is less than the bottom value, the Y-axis will be inverted. If the right value is less than the left boundary, the X-axis will be inverted.

The window is linearly mapped onto the viewport specified by SET_VIEWPORT. This is done by mapping the left boundary to the minimum X-viewport boundary, the right boundary to the maximum X-viewport boundary, the bottom boundary to the minimum Y-viewport boundary, and the top boundary to the maximum Y-viewport boundary. If distortion of the graphics image is not desired, the aspect ratio of the window boundaries should be equal to the aspect ratio of the viewport.

The default window limits range from -1.0 to 1.0 on both the X and Y axis. GRAPHICS_INIT is the only procedure which sets the window to its default limits.

The starting position is not altered by this call. Since this call redefines the viewing transformation, the starting position may no longer represent a known world coordinate position. A call to MOVE or INT_MOVE should therefore be made after this call to update the starting position.

SET_WINDOW can be called at anytime while the graphics system is initialized.

Error Conditions

The graphics system must be initialized, the minimum value for either axis must not equal the maximum value for that axis or this call will be ignored, an ESCAPE (-27) will be generated, and GRAPHICSERROR will return a non-zero value.

SKIPFOR

IMPORT: general_2
 iodeclarations

This **procedure** will read the specified number of characters from the selected device. The characters will be thrown away.

Syntax

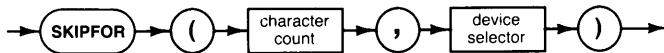

Item	Description/Default	Range Restrictions	Recommended Range
character count	Expression of TYPE INTEGER.	MININT thru MAXINT	–
device selector	Expression of TYPE <i>type_device</i> . This is an INTEGER subrange.	0 thru 3199	See glossary.

SPOLL

IMPORT: hpib_3
iodeclarations

This INTEGER function will perform a serial poll to the selected device. The serial poll byte is returned by the function.

Syntax

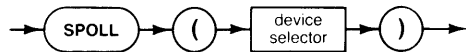

Item	Description/Default	Range Restrictions	Recommended Range
device selector	Expression of TYPE <i>type_device</i> . This is an INTEGER subrange.	0 thru 3199	See glossary.

Semantics

The interface must be active controller and the device must be a device address (i.e. 701, not 7). The bus sequence will look like:

	System Controller		Not System Controller	
	Interface Select Code Only	Primary Addressing Specified	Interface Select Code Only	Primary Addressing Specified
Active Controller	Error	ATN UNL MLA TAD SPE ATN Read data ATN SPD UNT	Error	ATN UNL MLA TAD SPE ATN Read data ATN SPD UNT
Not Active Controller	Error			

SYSTEM_CONTROLLER

```
IMPORT: hpib_1
       iodeclarations
```

This BOOLEAN **function** returns TRUE if the specified interface is the system controller.

Syntax



Item	Description/Default	Range Restrictions	Recommended Range
interface select code	Expression of TYPE <i>type_isc</i> . This is an INTEGER subrange.	0 thru 31	7 thru 31

TALK

IMPORT: hpib_2
iodeclarations

This **procedure** will send a talk address over the bus. The interface must be active controller.

Syntax

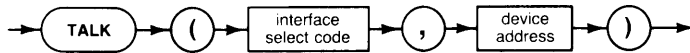

Item	Description/Default	Range Restrictions	Recommended Range
interface select code	Expression of TYPE <i>type_isc</i> . This is an INTEGER subrange.	0 thru 31	7 thru 31
device address	Expression of TYPE <i>type_hpib_address</i> . This is an INTEGER subrange.	0 thru 3	Interface dependent

TALKER

IMPORT: hpib_3
 iodeclarations

This **BOOLEAN function** will return TRUE if the specified interface is currently addressed as a talker.

Syntax

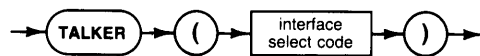

Item	Description/Default	Range Restrictions	Recommended Range
interface select code	Expression of TYPE <i>type_isc</i> . This is an INTEGER subrange.	0 thru 31	7 thru 31

TRANSFER

IMPORT: general_4
iodeclarations

This **procedure** will transfer the specified number of bytes to or from the buffer space using the specified transfer type.

Syntax

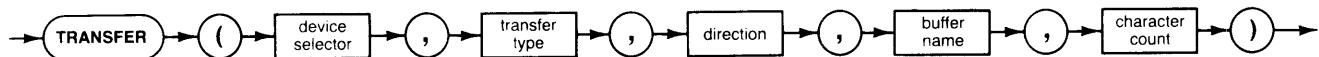

Item	Description/Default	Range Restrictions	Recommended Range
device selector	Expression of TYPE <i>type_device</i> . This is an INTEGER subrange.	0 thru 3199	See glossary
transfer type	Expression of the enumerated TYPE <i>user_tfr_type</i> .	serial_dma serial_fhs serial_fastest overlap_intr overlap_dma overlap_fhs overlap_fastest overlap	
direction	Expression of the enumerated TYPE <i>dir_of_tfr</i> .	to_memory from_memory	
buffer name	Variable of TYPE <i>buf_info_type</i> .	See glossary	
character count	Expression of TYPE INTEGER.	MININT thru MAXINT	

TRANSFER_END

IMPORT: general_4
 iodeclarations

This **procedure** will transfer data to or from the buffer.

Syntax

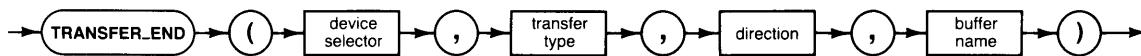

Item	Description/Default	Range Restrictions	Recommended Range
device selector	Expression of TYPE <i>type_device</i> . This is an INTEGER subrange.	0 thru 3199	See glossary
transfer type	Expression of the enumerated TYPE <i>user_tfr_type</i> .	serial_dma serial_fhs serial_fastest overlap_intr overlap_dma overlap_fhs overlap_fastest overlap	
direction	Expression of the enumerated TYPE <i>dir_of_tfr</i> .	to_memory from_memory	
buffer name	Variable of TYPE <i>buf_info_type</i> .	See glossary	

Semantics

If the transfer is into the computer then the transfer will terminate when an END condition (like EOI) comes true or the buffer is filled. If The transfer is out of the computer then the transfer will send all of the available data with the END condition sent with the last byte.

TRANSFER_SETUP

IMPORT: general_4
iodeclarations

Note

This function is provided for use by the internal I/O Procedure Library drivers, only. Unexpected and possible undesirable results may occur if it is used.

TRANSFER_UNTIL

IMPORT: general_4
 iodeclarations

This **procedure** will transfer bytes into the buffer until the buffer is full or the termination character was received. (The DMA transfer type is not allowed).

Syntax

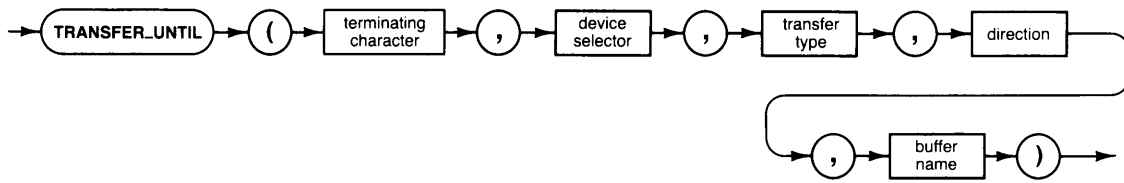

Item	Description/Default	Range Restrictions	Recommended Range
terminating character	Expression of TYPE CHAR.	—	
device selector	Expression of TYPE <i>type_device</i> . This is an INTEGER subrange.	0 thru 3199	See glossary
transfer type	Expression of the enumerated TYPE <i>user_tfr_type</i> .	serial_dma serial_fhs serial_fastest overlap_intr overlap_dma overlap_fhs overlap_fastest overlap	
direction	Expression of the enumerated TYPE <i>dir_of_tfr</i> .	to_memory from_memory	
buffer name	Variable of TYPE <i>buf_info_type</i> .	See glossary	

TRANSFER_WORD

IMPORT: general_4
iodeclarations

This **procedure** will transfer the specified number of words into the buffer. This transfer will only work with 16-bit interfaces.

Syntax

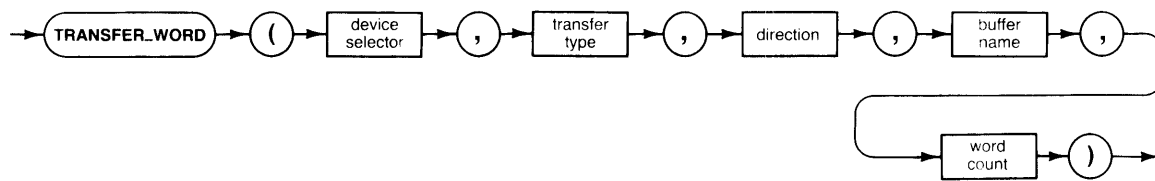

Item	Description/Default	Range Restrictions	Recommended Range
device selector	Expression of TYPE <i>type_device</i> . This is an INTEGER subrange.	0 thru 3199	See glossary
transfer type	Expression of the enumerated TYPE <i>user_tfr_type</i> .	serial_dma serial_fhs serial_fastest overlap_intr overlap_dma overlap_fhs overlap_fastest overlap	
direction	Expression of the enumerated TYPE <i>dir_of_tfr</i> .	to_memory from_memory	
buffer name	Variable of TYPE <i>buf_info_type</i> .	See glossary	
word count	Expression of TYPE INTEGER.	MININT thru MAXINT	

TRIGGER

IMPORT: hplib_2
 iodeclarations

This procedure sends a trigger command to the specified device(s).

Syntax

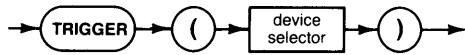

Item	Description/Default	Range Restrictions	Recommended Range
device selector	Expression of TYPE <i>type_device</i> . This is an INTEGER subrange.	0 thru 3199	See glossary

Semantics

	System Controller		Not System Controller	
	Interface Select Code Only	Primary Addressing Specified	Interface Select Code Only	Primary Addressing Specified
Active Controller	ATN GET	ATN UNL LAG GET	ATN GET	ATN MTA UNL LAG GET
Not Active Controller	Error			

UNLISTEN

IMPORT: hpib_2
iodeclarations

This **procedure** will send an unlisten command on the bus. The interface must be active controller.

Syntax

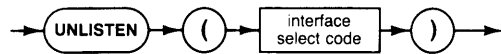

Item	Description/Default	Range Restrictions	Recommended Range
interface select code	Expression of TYPE <i>type_isc</i> . This is an INTEGER subrange.	0 thru 31	7 thru 31

UNTALK

```
IMPORT: hpib_2
       iodeclarations
```

This **procedure** will send an untalk command on the bus. The interface must be active controller.

Syntax

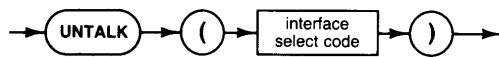

Item	Description/Default	Range Restrictions	Recommended Range
interface select code	Expression of TYPE <i>type_isc</i> . This is an INTEGER subrange.	0 thru 31	7 thru 31

WRITEBUFFER

IMPORT: general_4
iodeclarations

This **procedure** will write a single byte into the buffer space and update the fill pointer in the *buf_info* record.

Syntax

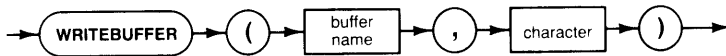

Item	Description/Default	Range Restrictions
buffer name	Variable of TYPE <i>buf_info_type</i> .	See the Advanced Transfer Techniques chapter
character	Expression of TYPE CHAR.	—

WRITEBUFFER_STRING

IMPORT: general_4
 iodeclarations

This **procedure** will take the specified string and place it in the buffer and update the fill pointer. An error will occur if there is insufficient space.

Syntax

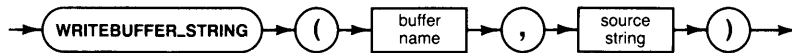

Item	Description/Default	Range Restrictions
buffer name	Variable of TYPE <i>buf_info_type</i> .	See the Advanced Transfer Techniques chapter
source string	Expression of TYPE <i>io_string</i> . This is STRING[255].	—

WRITECHAR

IMPORT: general_1
iodeclarations

This **procedure** will send a single byte as data over the interface path (writechar will drop the "ATN" line on an HP-IB interface).

Syntax

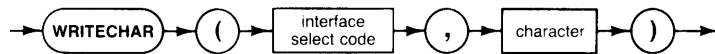

Item	Description/Default	Range Restrictions	Recommended Range
interface select code	Expression of TYPE <i>type_isc</i> . This is an INTEGER subrange.	0 thru 31	7 thru 31
source character	Expression of TYPE CHAR.	-	

Semantics

An HPIB interface must be addressed as a talker before performing a WRITECHAR, or an error will be generated. To avoid this, use the following sequence:

```

:
:
LISTEN (7,24);
TALK (7, MY_ADDRESS(7));
WRITECHAR (7, Character);
:
:
    
```

WRITENUMBER

IMPORT: general_2
 iodeclarations

This **procedure** outputs a free field number to the specified device. The format rules follow the HP Pascal standard for WRITE. No additional characters are sent after the number.

Syntax

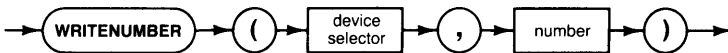

Item	Description/Default	Range Restrictions	Recommended Range
device selector	Expression of TYPE <i>type_device</i> . This is an INTEGER subrange.	0 thru 3199	See glossary
number	Expression of TYPE REAL	-	

WRITENUMBERLN

IMPORT: general_2
iodeclarations

This procedure will output the number and a carriage return/ linefeed.

Syntax

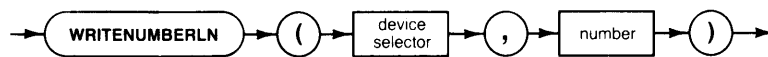

Item	Description/Default	Range Restrictions	Recommended Range
device selector	Expression of TYPE <i>type_device</i> . This is an INTEGER subrange.	0 thru 3199	See glossary
number	Expression of TYPE REAL	—	

WRITESTRING

IMPORT: general_2
 iodeclarations

This **procedure** will send the specified string to the specified device. No additional characters are sent.

Syntax

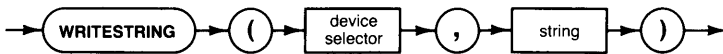

Item	Description/Default	Range Restrictions	Recommended Range
device selector	Expression of TYPE <i>type_device</i> . This is an INTEGER subrange.	0 thru 3199	See glossary
string	Expression of TYPE STRING	–	

WRITESTRINGLN

IMPORT: general_2
iodeclarations

This **procedure** will write out the string followed by a carriage return/line feed.

Syntax

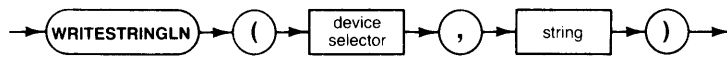

Item	Description/Default	Range Restrictions	Recommended Range
device selector	Expression of TYPE <i>type_device</i> . This is an INTEGER subrange.	0 thru 3199	See glossary
string	Expression of TYPE STRING	–	

WRITEWORD

IMPORT: general_1
 iodeclarations

This **procedure** will write 2 consecutive bytes to a byte-oriented interface. A word oriented interface will write a single 16-bit quantity.

Syntax

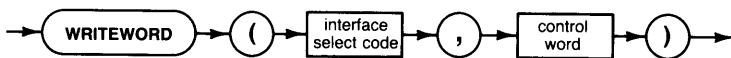

Item	Description/Default	Range Restrictions	Recommended Range
interface select code	Expression of TYPE <i>type_isc</i> . This is an INTEGER subrange.	0 thru 31	7 thru 31
control word	Expression of TYPE INTEGER.	MININT thru MAXINT	

Module Dependency Table

The Module Dependency Table shows which modules are imported by the standard LIBRARY, IO, GRAPHICS, and SEGMENTER modules.

Module to Be Imported	Module(s) Upon Which It Depends
LIBRARY Modules:	
RND	SYSGLOBALS
HPM	—
UIO	—
LOCKMODULE	SYSGLOBALS
IO Modules:	
IODECLARATIONS	SYSGLOBALS
IOCOMASM	SYSGLOBALS, IODECLARATIONS
GENERAL_0	SYSGLOBALS, IODECLARATIONS
GENERAL_1	SYSGLOBALS, IODECLARATIONS
GENERAL_2	SYSGLOBALS, IODECLARATIONS, GENERAL_1, HPIB_1
GENERAL_3	SYSGLOBALS, IODECLARATIONS
GENERAL_4	SYSGLOBALS, IODECLARATIONS, HPIB_1
HPIB_0	SYSGLOBALS, IODECLARATIONS
HPIB_1	SYSGLOBALS, IODECLARATIONS
HPIB_2	SYSGLOBALS, IODECLARATIONS, HPIB_0, HPIB_1
HPIB_3	SYSGLOBALS, IODECLARATIONS, GENERAL_1, HPIB_0, HPIB_1
SERIAL_0	SYSGLOBALS, IODECLARATIONS
SERIAL_3	SYSGLOBALS, IODECLARATIONS
GRAPHICS (and FGRAPHICS) Modules:	
DGL_LIB	ASM, IODECLARATIONS, SYSGLOBALS, MINI, ISR, MISC, FS, SYSDEVS, and all GRAPHICS modules <i>except</i> DGL_INQ and DGL_POLY
DGL_POLY	SYSGLOBALS, SYSDEVS, and all GRAPHICS modules <i>except</i> DGL_INQ
DGL_INQ	ASM, SYSGLOBALS, A804XDVR, DGL_TYPES, DGL_VARS, DGL_GEN, GLE_TYPES, GLE_GEN
SEGMENTER Modules:	
SEGMENTER	LOADER, LDR, SYSGLOBALS, MISC

Some Are Needed at Compile Time, Some Aren't

From the table, you can see that several Procedure Library modules depend upon various Operating System modules (such as SYSGLOBALS, IODECLARATIONS, SYSDEVS, and A804XDVR). However, the table does not show that *some* of the Procedure Library modules need these Operating System module(s) **only** at load time and **not** at *compile* time (some also need them at both times).

Modules such as SYSGLOBALS, SYSDEVS, and A804XDVR are part of the Operating System that is automatically loaded during the booting process (because they are in the standard INITLIB file.) Thus, you don't *ever* need to be concerned about making them accessible to the loader (unless you somehow remove them from the INITLIB file).

- The GRAPHICS and FGRAPHICS modules require the specified Operating System modules *only* at load time (not at compile time).
- The LIBRARY, IO, and SEGMENTER modules require the specified modules at *both* compile time and at load time. You can make these Operating System modules accessible to the Compiler by specifying the INTERFACE file in a SEARCH Compiler option or by adding them to the System Library.

Glossary

aspect ratio - The ratio of the height to width of an area (e.g. the area of a display surface).

attribute - See primitive attribute.

buffer name - A structured variable of TYPE *buf_info_type*.

complement drawing mode - A device dependent drawing mode for raster graphic displays in which a line is drawn by inverting bits in the display memory.

character cell - An imaginary rectangle placed around a character which defines its dimensions. The character size attribute determines the size of the character cell.

clipping - The elimination from view of all visible primitives or parts of primitives which lie outside the clipping limits (see window clipping).

default - See initial value.

device selector - An INTEGER expression used to specify the source or destination of an I/O transfer. A device selector can use either an interface select code or a combination of an interface select code and a primary address. To construct a device selector with a primary address, multiply the interface select code by 100 and add the primary address.

echoing - A mechanism for reflecting the status of an input function. Echoing is manifested in several ways as a function of the different input functions and the different physical devices being used.

erase drawing mode - A device dependent drawing mode for raster graphic displays in which a line is drawn by setting bits in the display memory to zero (off).

escape function - A facility within the graphics system which allows access to device dependent functions of a graphics display device.

file designator - A variable which points to the file informaton block for a lif file. It is a structured variable of the form:

```
LIFFILE = RECORD
        FPOINTER: INTEGER;
        END;
```

graphics display device - A device which displays graphics output.

initial value - The value of an attribute, viewing component, or characteristic of a work station which is in effect when the graphics system is initialized.

inquiry - User request for the current status, value, or characteristics of the graphics environment.

lif file name - The name of a lif file in the lif directory. A variable of TYPE *lifname*, which is a packed array of characters, of the form:

```
LIFNAME=PACKED ARRAY[1..10] OF CHAR;
```

line - A vector drawn from the current position to a specified point.

linestyle - An output primitive attribute which controls the pattern with which lines and text primitives are drawn.

locator device - An input device which returns a world coordinate point.

locator input function - An input function which returns a world coordinate point corresponding to a location on a locator device.

logical device - An abstraction of a typical graphics device, defined in terms of the type of data input or output. The logical devices supported by the graphics system are locator and graphics display.

logical display limits - The bounds of the logical display surface.

logical display surface - The portion of a graphics display device within which all output will appear.

mapping - The transformation of data from one coordinate system to another.

move - Moving the starting position to a specified point without generating a line.

object - The conceptual graphics entity in the application program. Objects are defined in terms of output primitives and primitive attributes. Their units are the units of the world coordinate system.

output primitive - The basic element of an object. The output primitives which the graphics system supports are: move, draw and text. Values of the primitive attributes determine aspects of the appearance of output primitives.

picture - A collective reference to all the images on a display device.

primary address - An INTEGER in the range 0 thru 31 that specifies an individual device on an interface which is capable of supporting more than one device. The HP-IB interface can support more than one device. (Also see "device selector.")

primitive - See output primitive.

primitive attribute - A characteristic of an output primitive, such as color, linestyle, character size, etc.

raster display - A type of graphics display in which all vectors are defined by turning on dots across a screen. TV is an example of a raster display.

sampled input - An input operation which does not require operator intervention; the routine returns with the current value as soon as the input device can respond.

viewing operation - See viewing transformation.

viewing transformation - An operation which maps positions in the world coordinate system to positions in device coordinates, thereby transforming objects into images.

viewport - The rectangular region of the view surface onto which the window will be mapped.

view surface - The largest rectangle within the logical display limits having the same aspect ratio as the virtual coordinate system.

virtual coordinate system - A two-dimensional coordinate system representing an idealized display device. Virtual coordinates are always in the range 0.0 to 1.0.

window - A rectangular region in the viewplane which may delimit the portion of the projected image which will be output.

world coordinate system - The two dimensional left handed cartesian coordinate system in which objects are described by the user program (user units).

Subject Index

a

Abort (HP-IB)	86
Active controller (HP-IB)	78, 83
Address (HP-IB)	83
Addressed to listen state (HP-IB)	89
Addressed to talk state (HP-IB)	89
Addresses (HP-IB)	78
Advanced bus management (HP-IB)	94
ALLOCATE module	17
Asynchronous protocol (Datacomm)	118, 129
Attention line (HP-IB)	91
Attention message (HP-IB)	80
Auto-dialing (Datacomm)	136
Auto-poll (Datacomm)	141
Auxiliary command register (HP-IB)	109

b

Backplane	22
Battery features (System devices)	282
Baud rate (Datacomm)	123, 130
Baud rate (Serial)	157, 160
Beeper (System devices)	217
Bit	27
Block size (Datacomm)	135
Break messages (Serial)	165
Break timing (Datacomm)	133
Buffers:	
BUF_INFO_TYPE	69
Control of	70
END condition transfers	76
Feeding of	71
General	69
Match character transfers	76
Overlap transfers	74
Reading data from	70
Serial transfers	72
Special transfers	76
Terminating transfers	74
Word transfers	76
Writing data to	71

BUF_INFO_TYPE	69
Bus	22
Bus address	44
Bus line states (HP-IB)	92
Bus sequences (HP-IB)	81
Byte	27

c

Cable options (Datacomm)	143
Cable options (Serial)	177
CARD_ID	39-41
CARD_TYPE	39-41
Chapter previews	2
Character format (Datacomm)	133
Character format (Serial)	156, 158, 161
Character length (Datacomm)	123
Characters (internal representation of)	29
Clear (HP-IB)	86
Clock (System devices)	219
Commands table (HP-IB)	96
Compatibility (of interfaces)	24
Compile strategy (for modules)	6
Compiler intrinsics	13
Compiler options:	
FLOAT_HDW	15
HEAP_DISPOSE	13
RANGE ON	39
SEARCH	6
SYSPROG	62
Computer (block diagram)	22
Computer resource	21
Control blocks (Datacomm)	120, 129, 134
Control characters (System devices)	234
CRT information	236
CRT interface (select code 1)	43
Cursor control (System devices)	238

d

Data compatibility	24
Data flow, directing	43
Data input:	
Datacomm	120
General	53
GPIO	199
HP-IB	79
Serial	163
Data link connections (Datacomm)	136
Data link options (Datacomm)	133
Data link protocol (Datacomm)	119
Data messages (Datacomm)	122
Data messages (HP-IB)	81
Data output:	
Datacomm	120
General	45
GPIO	199
HP-IB	79
Serial	162
Data representations:	
Bits and bytes	27
Characters	29
GPIO	199
Numbers	28
Real numbers	31
Signed integers	29
Data types:	
I/O	38-42
Supported for input	53
Supported for output	45
Datacomm:	
Asynchronous	129
Asynchronous protocol	118
Auto-dialing	136
Auto-poll	141
Baud rate	123, 130
Block size	135
Break timing	133
Cable adapter options	143
Character format	133
Character length	123
Connecting to the line	135
Connection procedures	136
Control blocks	120, 129, 134
Data Communication Basics (98046-90005)	117
Data link connections	136
Data link options	133
Data link protocol	119
Data messages	122
DCE and DTE cable options	143

Defaults	127
Dialing procedures	136
Direct connection links	135
Driver/receiver circuits	144
End-of-line recognition	132
Errors and recovery	138
Establishing the connection	126
Example terminal emulator	124
Half-duplex	142
Handshake	131, 134
Handshake characters	132
Initiating connection	137
Introduction	117
IOSTATUS and IOCONTROL registers	145
Line timeouts	130
Non-data characters	132
Operating parameters	126
Overview of programming	123
Parity	118, 123, 135
Preventing data loss	140
Private links	135
Programming helps	140
Prompt recognition	132
Protocol	118, 128
Reset	128
RS-232C cable signals	143
Secondary channel	142
Start bit	118
Stop bits	118, 123
Telephone links	135
Terminal identification	134
Terminal prompt messages	140
Date and time (System devices)	219
DCE and DTE cables (Datacomm)	143
DCE cable (Serial)	178
Debugger window (System devices)	245
Defaults:	
Datacomm	127
GPIO	187-8
HP-IB	78
Serial	157-8
Dependency of modules (table)	20
Destination (of I/O operations)	22
Device selectors:	
General	38, 43, 44
HP-IB	79
Device-independent Graphics (DGL)	16
Dialing procedures (Datacomm)	136
Direct connection links (Datacomm)	135
Directing data flow	43
Display control characters (System devices)	234
DISPOSE (procedure)	13
Driver/receiver circuits (Datacomm)	144
DTE cable (Serial)	177

e

Electrical compatibility	24
END condition transfers	76
End or Identify (HP-IB)	91
End-of-line recognition (Datacomm).....	132
Errors:	
Datacomm	138
General	61
I/O	63
I/O (table)	67
Segmentation	304
Serial (Serial)	163
ESCAPE	63
ESCAPECODE	63
Establishing the connection (Datacomm) ..	126
Events (errors and timeouts)	61
Example modules	3
Example terminal emulator (Datacomm) ..	124
Explicit commands (HP-IB)	98

f

FGRAPHICS modules	15
Floating-point math card (HP 98635)	15
FLOAT_HDW (Compiler option)	15
Formatted input	58
Formatted output	50-1
Free-field input	54-7
Free-field output	45-50
Full-mode handshakes (GPIO)	189

g

General bus management (HP-IB)	84
GENERAL modules	34, 37
Go to local (HP-IB)	85
GPIO interface (select code 12)	26, 44
GPIO:	
Configuration	187
Data input	199
Data output	199
Data representations	199
Description	186
Examples of I/O	200, 201
Full-mode handshakes	189
Handshake lines	188
Handshakes	187
Interface reset	198
Interrupt priority	187
Introduction	185
IOREAD_BYTE and IOWRITE_BYTE registers	205
IOSTATUS and IOCONTROL registers	204
Logic sense	187
Peripheral status line	188
Pulse-mode handshakes	191
Select code	187
Special purpose lines	202
GRAPHICS modules	15
Graphics programming	15

h

Half-duplex (Datacomm)	142
Handshake characters (Datacomm)	132
Handshake:	
Datacomm	131, 134
General	24
GPIO	187
HP-IB	81, 90
Serial	158, 166
Hardware	21
HEAP_DISPOSE (Compiler option)	13
HP 98635 Floating-point math card	15
HP 98644 differences (Serial)	181
HP-IB address	44
HP-IB interface description	25
HP-IB interface, built-in (select code 7)	43
HP-IB interface, optional (select code 8)	44
HP-IB:	
Abort	86
Active controller	80, 83
Address of interface	78, 83
Addressed to listen state	89
Addressed to talk state	89
Addressing to listen	81, 82
Addressing to talk	81
Advanced bus management	94
Attention line	91
Attention message	80
Auxiliary command register	109
Bus line states	92
Clear	86
Commands (table)	96
Control thru Pascal	83
Data messages	81
Device selectors	79
End or Identify	91
Example bus sequences	81
Explicit commands	98
General bus management	84
General I/O operations	79
General rules	79
Go to local	85
Handshake	81
Handshake lines	90
Installation	78
Interface clear	91
Interface conditions	89
Introduction	77
IOCONTROL and IOSTATUS registers	99
IOREAD_BYTE and IOWRITE_BYTE registers	103
Listen and talk messages	81
Local lockout	85
Local lockout state	89
Messages	94
Multiple listeners	82
Non-active controller	82
Pass control	87
Polling	87
Remote enable	91
Remote message	84
Remote state	89
Secondary addresses	84
Send command	98
Service request	92
Service requested state	89
Status	83
Summary of bus sequences	113
System controller	80, 83
System controller jumper/switch	78
Triggering	86
Unlisten and untalk messages	83
HPIB modules	34, 37
HPM module	13

i

I/O (definition of)	22	Interface text	14, 6
I/O error handling	63	Interfaces:	
I/O errors	61	Additional functions	24
I/O events (errors and timeouts)	61	Datacomm	117
I/O Procedure Library:		Functional diagram	23
GENERAL modules	34, 36	GPIO	26
HPIB modules	34, 37	HP-IB	25, 77
Initialization	35	Overview	25
Introduction	33	Registers	59
IODECLARATIONS module	38	Select codes	38, 43
Organization	34	Serial	26
SERIAL modules	35, 38	Why needed?	23
I/O terminology	21	Interfacing concepts	21
I/O timeouts	61, 65	Interrupt priority (GPIO)	187
Initialization (I/O)	35	Interrupt processing overview (System	
Initiating connection:		devices)	213
Datacomm	137	IO data types	38-42
Serial	160	IO modules	14
INITLIB modules	7	IODECLARATIONS modules	38
Input (defined)	22	IOERROR_MESSAGE	64
Input:		IOESCAPECODE	63
Characters	56	IOE_ISC	64
Formatted	58	IOE_RESULT	63
Free-field	54-57	IOREAD_BYTE and IOWRITE_BYTE registers:	
Real numbers	54	General	59
Skipping data	57	GPIO	205
Strings	55	HP-IB	103
Termination	54	Serial	168, 173
Words	56	IOSTATUS and IOCONTROL registers:	
Integers (internal representation of)	29	Datacomm	145
Interface clear (HP-IB)	91	General	59
Interface conditions (HP-IB)	89	GPIO	204
INTERFACE modules	14	HP-IB	99
Interface reset:		Serial	169
Datacomm	128	ISC_TABLE	39
GPIO	198		
HP-IB	99		
Serial	160		

k

Key buffer (System devices).....	256
Key codes (System devices).....	267
Keyboard (System devices).....	250
Keyboard interface (select code 2).....	43
Knob (System devices).....	264

l

Librarian:	
Main prompt.....	9
Purpose of.....	3
Using.....	9
Libraries:	
Creating.....	8
Overview.....	3
LIBRARY.....	6, 9
LIBRARY modules.....	12
Library overview.....	3
Line timeouts (Datacomm).....	130
Listen addresses (HP-IB).....	81, 82
Local lockout (HP-IB).....	85
Local lockout state (HP-IB).....	89
LOCKMODULE.....	13
Logic sense (GPIO).....	187
Loopback (Serial).....	167

m

Manual organization.....	1
MARK (procedure).....	13
Mass storage.....	8
Match character transfers.....	76
Menus (System devices).....	242
Messages (HP-IB).....	94
Models 216 and 217 differences (Serial).....	184
Modem handshake (Serial).....	161
Modem line control (Serial).....	166
Modem status and control (Serial).....	157
Modem-line handshakes (Serial).....	166
Modules:	
Adding to the System Library.....	9
ALLOCATE.....	17
Compiling.....	6
Dependency table.....	20
Directory.....	3
Examples (on DOC disc).....	3

FGRAPHICS.....	15
File sizes.....	8
GENERAL.....	34, 36
GRAPHICS.....	15
How the Compiler finds them.....	6
How the loader finds them.....	7
HPIB.....	34, 37
HPM.....	13
Importing.....	4
INTERFACE.....	14
IO.....	14, 34
IODECLARATIONS.....	38
LIBRARY.....	12
LOCKMODULE.....	13
Making them accessible.....	18, 19, 6, 7
Overview.....	3
RND.....	12
SEGMENTER.....	17
SERIAL.....	35, 38
Standard.....	12
SYSDEVS.....	211
SYSGLOBALS.....	211
UIO.....	13
Multiple listeners (HP-IB).....	82

n

NEW (procedure).....	13
Non-active controller (HP-IB).....	82
Non-data characters (Datacomm).....	132
Numbers (internal representation of).....	28

o

Object file.....	3, 7
Operating parameters (Datacomm).....	126
Output:	
Characters.....	48
Data types supported.....	45
Definition of.....	22
Formatted.....	50-1
Free-field.....	45-50
General.....	45
Real numbers.....	46
Strings.....	47
Words.....	48
Overlap transfers.....	74
Overview of manual.....	1

p

P-load (modules)	7
Parity (Datacomm)	118, 123, 135
Parity (Serial)	156, 158, 161
Pascal Graphics Techniques manual	15
Pass control (HP-IB)	87
Peripheral status line (GPIO)	188
Polling (HP-IB)	87
Powerfail (System devices)	282
Preventing data loss (Datacomm)	140
Private links (Datacomm)	135
Procedure Library	12
Programming helps (Datacomm)	140
Programming techniques	159
Prompt recognition (Datacomm)	132
Protocol (Datacomm)	118, 128
Protocol (Serial)	158
Pulse-mode handshakes (GPIO)	191

r

RAND (function)	12
RANDOM (procedure)	12
Range of device selectors	39
Range of select codes	38
Reading buffers	70
Real numbers (internal representation of)	29
RECOVER	62
Registers:	
Common definitions	60
Datacomm	145
General	59
GPIO	204
Hardware vs. I/O System	59
HP-IB	99
Serial	169
RELEASE (procedure)	13
Remote enable (HP-IB)	91
Remote message (HP-IB)	84
Remote state (HP-IB)	89
Reset:	
Datacomm	128
GPIO	198
HP-IB	99
Serial	160
Resource	43
RND module	12

RS-232 Serial:	
98626 interface	155
98644 interface	155, 181
Built-in (Models 216 and 217)	184
Introduction	155
UART	155
RS-232C cable signals (Datacomm)	143
Run light (System devices)	244

s

SEARCH Compiler option	6
Secondary addresses (HP-IB)	84
Secondary channel (Datacomm)	142
Segmentation:	
Calling a procedure	299
Calling a program	297
Checking a procedure variable	300
Errors	304
Free space	297
Initialization	297
Introduction	295
Searching for a procedure name	300
Unloading segments	303
Using the explicit code area	301
Using the heap	302
Using the stack	297
WARNING - You're on your own	297
SEGMENTER module	17
Select codes	38, 43
Self-test (Serial)	167
Send command (HP-IB)	98
Serial interfaces	26, 44
SERIAL modules	35, 38
Serial transfers	72
Serial:	
98626 interface	155
98644 interface	155, 181
Baud rate	157, 160
Break messages	165
Built-in (Models 216 and 217)	184
Cable options	177
Character format	156, 158, 161
Data input	163
Data output	162
DCE cable	178
DTE cable	177
Error handling	163

Handshake	158, 166	SYSGLOBALS	211
HP 98644 differences	181	SYSPROG (Compiler option)	62
Initializing the connection	160	System controller (HP-IB)	78, 83
Interface reset	160	System devices:	
Introduction	155	Battery commands	285
IOREAD_BYTE and IOWRITE_BYTE registers	168, 173	Battery features	282
IOSTATUS and IOCONTROL registers	169	Beeper	217
Loopback	167	Bit-mapped display parameters	237
Models 216 and 217 differences	184	Changing display parameters	237
Modem handshake	161	Clock	219
Modem line control	166	Cursor control	238
Modem status and control	157	Date and time	219
Modem-line handshakes	166	Debugger window	245
Parity	158, 161	Direct clock access	222
Parity bit	156	Display	234
Programming techniques	159	Display control characters	234
Self-test	167	Display parameters	236
Signal functions	177	Display status area	243
Software handshake	158, 161, 165	Display types	234
Special applications	165	Dumping the display	238
Special characters	165	Example programs	211
Start bit	156	Hooks	213
Status-Line Disconnect switches	157	Interrupt masks	215
Stop bits	156	Interrupt processing overview	213
Transferring data	162	Interrupts (enabling)	215
Service request (HP-IB)	92	Introduction	209
Service requested state (HP-IB)	89	ISR	214
Signal functions:		Key actions	270
Datacomm	143	Key buffer	256
Serial	177	Key buffer I/O hooks	257
Skipping data (during input)	57	Key codes	267
Software	21	Key translation hook	259
Software handshake:		Keyboard	250
Datacomm	131	Keyboard ISR hook	253
Serial	158, 161, 165	Keyboard poll hook	254
Source (of I/O operations)	22	Keyboard request hook	251
Source file	3	Keyboard types	250
Source text	6	Keyboards	266
Special purpose lines (GPIO)	202	Knob	264
Special transfers	76	Language table	262
Standard modules	12	Language types	250
Start bit:		Last line of display	240
Datacomm	118	Menus	242
Serial	156	Missed timer interrupts	228
Status (HP-IB)	83	Module	211
Status-Line Disconnect switches (Serial)	157	Periodic timer	230
Stop bits:		Powerfail	282
Datacomm	123	Run light	244
Serial	156	Simplified debugger window	249
Summary of bus sequences (HP-IB)	113	Supported features	210
Supported features (System devices)	210	SYSDEVS source listing	288
		System timer example	232
		Timer ISR	227

Timer operations	225
Timers	224
Toggle alpha/graphics	235
Tone generator	217
Typing aids program	273
WARNING-You're on your own	209
System Library:	
Adding modules to it	9
Building your own	18
Defined	6
Volume size considerations	18, 8
When used by Compiler	6
When used by loader	7

t

Talk addresses (HP-IB)	81
Telephone links (Datacomm)	135
Terminal identification (Datacomm)	134
Terminal prompt messages (Datacomm)	140
Terminating transfers	74
Terminology	21
Timeouts	61, 65
Timeouts (Datacomm)	130
Timers (System devices)	224
Timing compatibility	24
Tone generator (System devices)	217
Transfers:	
END condition	76
Introduction	69
Match character	76
Overlap	74
Serial	72
Special	76
Termination of	74
Word	76
Triggering (HP-IB)	86
TRY	62
TRY/RECOVER blocks	61-63
Typing aids program (System devices)	273

u

UART (RS-232 interface)	155
UCSD Unit I/O operations	13
UIO module	13
Unit I/O operations	13
UNITBUSY (function)	13
UNITCLEAR (procedure)	13
UNITREAD (procedure)	13
UNITWAIT (procedure)	13
UNITWRITE (procedure)	13
Unlisten and untalk messages (HP-IB)	83

v

Volumes	8
-------------------	---

w

What command	6, 9
Where the buffers live	69
Word	27
Word transfers	76
Words	48, 56
Writing data	45
Writing to buffers	71

Manual Comment Sheet Instruction

If you have any comments or questions regarding this manual, write them on the enclosed comment sheets and place them in the mail. Include page numbers with your comments wherever possible.

If there is a revision number, (found on the Printing History page), include it on the comment sheet. Also include a return address so that we can respond as soon as possible.

The sheets are designed to be folded into thirds along the dotted lines and taped closed. Do not use staples.

Thank you for your time and interest.

MANUAL COMMENT SHEET

Pascal 3.0 Procedure Library
for the HP 9000 Series 200 Computers

98615-90030

September 1984

Update No. _____

(See the Printing History in the front of the manual)

Name: _____

Company: _____

Address: _____

Phone No: _____

fold

fold

fold

fold

BUSINESS REPLY MAIL
FIRST CLASS PERMIT NO. 37 LOVELAND, COLORADO

POSTAGE WILL BE PAID BY ADDRESSEE

Hewlett-Packard Company
Fort Collins Systems Division
Attn: Customer Documentation
3404 East Harmony Road
Fort Collins, Colorado 80525



NO POSTAGE
NECESSARY
IF MAILED
IN THE
UNITED STATES

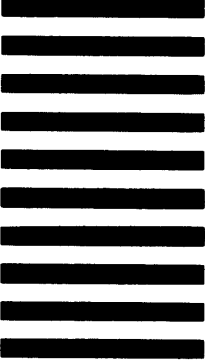



Part No. 98615-90030
E0984
Microfiche No. 98615-99030

Printed in U.S.A.
First Edition with update
September 1984