

GA22-7001-6
File No. S/370-00

Systems

**IBM System/370
System Summary**

IBM

GA22-7001-6
File No. S/370-00

Systems

**IBM System/370
System Summary**

IBM

Preface

This publication is intended to provide basic information about IBM System/370, the data processing system based on IBM System/360 but extending beyond the capabilities of that system. The objective of this publication is to help readers achieve a general understanding of this data processing system and the interrelationships of its components. Included in the overview are the system concepts, features, individual models, and attachable input/output devices and terminals. Discussed in greater depth are the System/370 programming systems.

This publication is divided into eight sections. Sections 1 through 3 discuss the system structure and features; Section 4 describes the programming systems; Section 5 gives an introductory explanation of teleprocessing; Section 6 presents summary information about individual system models; Sections 7 and 8 describe the system input/output devices and terminals.

In general, the sections should be read in sequence, since information presented in one section often depends on an understanding of information in previous sections. Section 4, however, can be read independently of the other sections.

A basic knowledge of data processing systems, such as that given in the *Introduction to IBM Data Processing Systems*, GC20-1684, is assumed. However, for the programming systems information (Section 4), the reader is assumed to have basic knowledge of IBM programming systems, such as that found in *IBM System/360 Operating System Introduction*, GC22-6534.

A list of abbreviations and a glossary of terms which do not appear in the *IBM Data Processing Glossary*, GC20-1699, follow the Contents.

More detailed information about System/370 is available in *IBM System/370 Principles of Operation*, GA22-7000.

Seventh Edition (December 1976)

This is a reprint of GA22-7001-5 incorporating changes released in the following Technical Newsletters:

GN22-0517 (dated June 22, 1976)

GN22-0509 (dated July 15, 1976)

GN22-0519 (dated September 30, 1976)

GN22-0521 (dated October 15, 1976)

Changes are periodically made to the specifications herein; before using this publication in connection with the operation of IBM systems, refer to the latest *IBM System/370 Bibliography*, GC20-0001, for the editions that are applicable and current.

Requests for copies of IBM publications should be made to your IBM representative or to the IBM branch office serving your locality.

This manual was prepared by the IBM System Products Division, Product Publications, Dept. B98, PO Box 390, Poughkeepsie, N.Y. 12602. A form for readers' comments is provided at the back of this publication. If the form has been removed, comments may be sent to the above address. Comments become the property of IBM.

Section 1. Introduction to IBM System/370	1-1	Data Management	4-6
Section 2. System/370 Basic Structure	2-1	Recovery Management	4-8
Data Formats	2-1	Service Aids	4-8
Data Representation	2-2	Methods of Storing and Retrieving Data	4-10
Main Storage	2-2	Teleprocessing	4-11
Addressing	2-2	VS1 Standard and Optional Features	4-13
Data Positioning	2-2	APF (Authorized Program Facility)	4-13
Performance Factors	2-4	AVR (Automatic Volume Recognition)	4-15
Central Processing Unit	2-4	Automated System Initialization	4-15
Arithmetic and Logical Operations	2-4	BLDL Table	4-15
Instruction Formats	2-5	Checkpoint/Restart	4-15
System Control Panel	2-6	Consoles—MCS (Multiple Console Support)	4-15
Input/Output	2-7	Distributed Intelligence System	4-15
Channels	2-7	DIDOCs (Device Independent Display Operator Console Support) and SDS (Status Display Support)	4-16
I/O Devices	2-8	Dynamic Dispatching	4-16
Control Unit Function	2-8	DSS (Dynamic Support System)	4-16
I/O Interface	2-8	Extended Timer Option	4-16
Interruption System	2-8	Fetch Protection	4-16
Virtual Storage Capability	2-9	IBM 3600 Finance Communication System Support	4-16
Multiprocessing	2-9	I/O Load Balancing	4-17
Section 3. System/370 Features	3-1	Job Log Facility	4-17
Main Storage Features	3-1	OLTEP (Online Test Executive Program)	4-17
Main Storage Capacities	3-1	PAGETUNE Command	4-17
Storage Protection	3-1	Partition Deactivation/Reactivation	4-17
High-Speed Buffer Storage	3-1	PWF (Power Warning Feature) Support	4-17
Central Processing Unit Features	3-2	SWA (Scheduler Work Area)	4-18
Instruction Sets	3-2	Shared DASD (Direct Access Storage Device)	4-18
Decimal	3-2	Storage Protection Option	4-18
Floating Point	3-2	System Log	4-18
Extended Precision Floating Point	3-2	SMF (System Management Facilities)	4-18
Direct Control	3-2	Time-Slicing Facility	4-19
Interval Timer	3-2	TOLTEP (Teleprocessing Online Test Executive Program)	4-19
Time-of-Day Clock	3-2	Support Programming	4-19
Byte-Oriented Operand	3-2	System Assembler	4-19
Translation	3-2	Linkage Editor	4-19
Clock Comparator and CPU Timer	3-3	Loader	4-19
Channel Features	3-3	Utility Programs	4-19
Channel Indirect Data Addressing	3-3	Emulator Programs	4-20
Channel-to-Channel Adapter	3-3	VS1 Starter System	4-20
Two-Channel Switch	3-3	IVP (Installation Verification Procedure)	4-20
Command Retry	3-3	Type I and Type II Programs	4-21
System Features	3-3	IBM Program Products	4-21
Compatibility Features for Other IBM Systems	3-3	OS/VS2 (Operating System/Virtual Storage 2)	4-21
OS/DOS Compatibility	3-4	Features and Facilities	4-21
Handling the Job Stream	4-21	Handling Data Sets	4-21
Handling the System	4-22	Managing the System	4-22
Managing the System	4-22	Reliability, Availability, and Serviceability	4-22
Reliability, Availability, and Serviceability	4-22	IBM Program Products	4-23
Section 4. System/370 Programming Systems	4-1	Bibliography	4-23
OS/VS1 (Operating System/Virtual Storage 1)	4-1	Virtual Machine Facility/370 (VM/370)	4-23
Introduction to OS/VS1	4-1	Elements of VM/370: CP, CMS, and RSCS	4-23
Virtual Storage	4-1	Virtual Machine Operating Systems	4-24
Advantages of VS1 Virtual Storage	4-2	Virtual Machine Assist Feature	4-24
JES (Job Entry Subsystem)	4-3	VM/370 Applications	4-25
OS/MFT—OS/VS1 Differences	4-3	Programming	4-25
Compatibility	4-3	Operations	4-25
Minimum System Requirements	4-4	Interactive Use	4-26
Devices Supported by VS1	4-4	Bibliography	4-27
System Control Program Components	4-4		
Job Management	4-4		
Task Management	4-6		

Section 5. Teleprocessing	5-1	3340 Direct Access Storage Facility	
Elements of a Teleprocessing Network	5-2	(3340 Disk Storage Drive and Control Model A2,	
Host Processor	5-2	3340 Disk Storage Drive Models B1 and B2)	
Communications Control Devices	5-2	3344 Direct Access Storage Models B2 and B2F	7-12
Modulation/Demodulation Devices	5-2	3350 Direct Access Storage Models A2, A2F,	
Communications Lines	5-2	B2, B2F, C2, and C2F	7-13
Line Disciplines	5-4	3851 Mass Storage Facility Models A1-A4 and B1-B4	7-14
Terminals	5-4	Diskette Input/Output Devices	7-14
Programming Systems	5-5	3540 Diskette Input/Output Unit Models B1 and B2	7-14
Teleprocessing Applications	5-6	Display Devices	7-16
Systems Network Architecture (SNA)	5-6	2250 Display Unit Models 1 and 3	
Advanced Function for Communications	5-7	2840 Display Control Model 2	7-16
		2260 Display Station Models 1 and 2	
Section 6. System/370 Models	6-1	2848 Display Control Models 1, 2, 3, 21, and 22	7-20
System/370 Model 115	6-1	3277 Display Station Models 1 and 2	
System Components	6-2	3272 Control Unit Models 1 and 2	7-21
Programming Support	6-2.1	Magnetic Character Readers	7-22
System/370 Model 125	6-3	1255 Magnetic Character Reader Models 1, 2, and 3	7-22
System Components	6-3	1419 Magnetic Character Reader	7-23
Programming Support	6-4.1	3890 Document Processor Models A1-A6, B1-B6	7-23
System/370 Model 135	6-5	Magnetic Tape Devices	7-25
System Components	6-6	2401 Magnetic Tape Unit Models 1-6 and 8	7-25
Programming Support	6-6.1	2415 Magnetic Tape Unit and Control Models 1-6	7-26
System/370 Model 138	6-6.2	2420 Magnetic Tape Unit Models 5 and 7	7-27
System Components	6-6.2	2803 Tape Control Models 1, 2, and 3	
Programming Support	6-6.3	2804 Tape Control Models 1, 2, and 3	7-29
System/370 Model 145	6-7	2816 Switching Unit Model 1	7-29
System Components	6-7	3410 Magnetic Tape Unit Models 1, 2, and 3	
Programming Support	6-8.1	3411 Magnetic Tape Unit and Tape Control	
System/370 Model 148	6-8.2	Models 1, 2, and 3	7-30
System Components	6-8.2	3420 Magnetic Tape Unit Models 3 through 8	
Programming Support	6-8.3	3803 Tape Control Models 1, 2, and 3	7-31
System/370 Model 155	6-9	Optical Readers	7-35
System Components	6-9	1287 Optical Reader Models 1, 2, 3, 4, and 5	7-35
Programming Support	6-10	1288 Optical Page Reader	7-36
System/370 Model 158	6-11	3881 Optical Mark Reader Model 1	7-37
System Components	6-12	3886 Optical Character Reader Model 1	7-38
Programming Support	6-12.1	Printer-Keyboards	7-39
System/370 Model 165	6-13	1052 Printer-Keyboard Model 7	7-39
System Components	6-13	3210 Console Printer-Keyboard Models 1 and 2	7-39
Programming Support	6-14	3215 Console Printer-Keyboard	7-40
System/370 Model 168	6-15	Printers	7-41
System Components	6-15	1053 Printer Model 4	7-41
Programming Support	6-16.1	1403 Printer Model 2, 7, and N1	7-41
System/370 Model 195	6-17	2821 Control Unit Models 1-3, 5, and 6	7-42
System Components	6-18	1443 Printer Model N1	7-42
Programming Support	6-18	3203 Printer Models 1, 2, 3, and 4	7-43
		3211 Printer	
Section 7. Input/Output Devices	7-1	3811 Control Unit	7-43
Auxiliary Processors	7-6.1	3800 Printing Subsystem	7-44
3838 Array Processor Models 1, 2, and 3	7-6.1	5203 Printer Model 3	7-45
Direct Access Storage Devices	7-7	5213 Printer Model 1	7-45
2305 Fixed Head Storage Models 1 and 2		Punched Card Devices	7-46
2835 Storage Control Models 1 and 2	7-7	1442 Card Read Punch Model N1	7-46
2311 Disk Storage Drive Model 1	7-8	1442 Card Punch Model N2	7-46
2314 A-Series Direct Access Storage Facility		2501 Card Reader Models B1 and B2	7-46
(2314 Storage Control Model A1 and 2312, 2313, and		2520 Card Read Punch Model B1	7-47
2318 Disk Storage Model A1)		2520 Card Punch Models B2 and B3	7-47
2314 B-Series Direct Access Storage Facility		2540 Card Read Punch	7-48
(2314 Storage Control Model B1 and 2319 Disk Storage		2560 Multi-Function Card Machine Models A1 and A2	7-48
Models B1 and B2)	7-9	2596 Card Read Punch Model 1	7-49
2319 Disk Storage Models A1, A2, and A3	7-9	3504 Card Reader Models A1 and A2	
2841 Storage Control	7-10	3505 Card Reader Models B1 and B2	
3330 Disk Storage Models 1, 2, and 11		3525 Card Punch Models P1, P2, and P3	7-50
3333 Disk Storage and Control Models 1 and 11			
3830 Storage Control Models 2 and 3	7-10		

5425 Multi-Function Card Unit Models A1 and A2	7-51	3780 Communications Terminal	
Punched Tape Devices	7-53	3781 Card Punch	8-16
1017 Paper Tape Reader Models 1 and 2		Display Devices	8-19
1018 Paper Tape Punch		2260 Display Station Models 1 and 2	
2826 Paper Tape Control Unit Model 1	7-53	2848 Display Control Models 1, 2, and 3	8-19
2671 Paper Tape Reader		2265 Display Station	
2822 Paper Tape Reader Control	7-53	2845 Display Control	8-19
Systems	7-55	3275 Display Station Models 1, 2, 11, and 12	8-20
2790 Data Communication System	7-55	Systems	8-22
3270 Information Display System	7-55	1030 Data Collection System	8-22
3850 Mass Storage System	7-55	1050 Data Communication System	8-23
Section 8. Teleprocessing Equipment	8-1	1060 Data Communication System	8-24
Data Transmission Multiplexers	8-4	1130 Computing System	8-25
2701 Data Adapter Unit	8-4	2770 Data Communication System	8-25
3704 Communications Controller Models A1, A2, A3, and A4	8-5	2790 Data Communication System	8-26
3705 Communications Controller Models A1, A2, B1-B4, C1-C6, D1-D8, E1-E8, F1-F8, G1-G8, and H1-H8	8-6	3270 Information Display System	8-28
Modulator/Demodulator Units	8-8	3600 Finance Communication System	8-31
2711 Line Adapter Unit	8-8	3650 Retail Store System	8-35
3872 Modem		3660 Supermarket System	8-35
3874 Modem		3740 Data Entry System	8-38
3875 Modem	8-8	3770 Data Communication System	8-40
Audio Communications Devices	8-10	3790 Communication System	8-41
7770 Audio Response Unit Model 3	8-10	5230 Data Collection System	8-42.1
Data Terminal Devices	8-11	System/3	8-42.2
1001 Data Transmission Terminal	8-11	System/32	8-43
2740 Communication Terminal Models 1 and 2	8-11	Data Acquisition and Process Control Systems	8-44
2741 Communication Terminal	8-12	System/7	8-44
2780 Data Transmission Terminal	8-12	1070 Process Communication System	8-45
3735 Programmable Buffered Terminal	8-13	1800 Data Acquisition and Control System	8-46
3767 Communication Terminal	8-15	Index	X-1

Abbreviations

APF	authorized program facility
APG	automatic priority group
ASB	automatic SYSIN batching
bpi	bytes per inch
DADSM	direct-access device space management
DASF	direct-access storage facility
DIDOCs	device-independent operator console support
DSO	direct system output
EOD	end of data
GMT	Greenwich Mean Time
ICA	integrated communications adapter
IDR	identification record
ISC	integrated storage controls
IVP	installation verification procedure
lpm	lines per minute
MIC	missing interruption checker
MSF	mass storage facility
MSS	mass storage system
MT/ST	Magnetic Tape/SELECTRIC® Typewriter
MVS	multiple virtual storage
op code	operation code
PSQA	pageable system queue area
RAS	reliability, availability, serviceability
RBA	relative byte address
RDE	reliability data extractor
RES	remote entry services
SDLC	synchronous data link control
SDS	status display support
SNA	systems network architecture
SSI	system status index

Instruction Formats

RR	register to register
RS	register and storage
RX	register and indexed storage
S	implied operand and storage
SI	immediate operand and storage
SS	storage to storage

Programming Systems, Subsystems, and Languages

CP	Control Program
DOS/VS	Disk Operating System/Virtual Storage
GAM	Graphic Access Method
NCP/VS	Network Control Program/Virtual Storage
OS/MVT	Operating System/Multiprogramming Varied Task
OS/VS1	Operating System/Virtual Storage 1
OS/VS2	Operating System/Virtual Storage 2
PEP	Partitioned Emulation Programming
RAM	Resident Access Methods
RSCS	Remote Spooling Communication System
RTAM	Remote Terminal Access Method
VSAM	Virtual Storage Access Method
VTAM	Virtual Telecommunications Access Method

Glossary

(Refer to the *IBM Data Processing Glossary*, GC20-1699, for definition of those terms not included in this listing.)

alter/display: A feature whereby main storage data may be displayed and altered at the display/keyboard console.

average access time: The average time interval between the instant of request and the instant of delivery from a storage device.

block multiplex mode: The transmission of data to multiple I/O devices by the realtime interleaving of records in block form.

buffer storage: An area of storage set aside for temporary use to compensate for differences in the rate or time of data transmission.

byte multiplex mode: The transmission of data to multiple I/O devices by the realtime interleaving of bytes.

byte-oriented operand: A feature that allows operands to reside on any byte boundary.

character generator: A feature that translates the byte necessary to trace an alphanumeric character on the face of a display tube.

code-dependent device: A device whose operation depends on the code used in representing data.

command retry: A channel and control-unit procedure that causes a command to be retried without requiring an I/O interruption.

commercial instruction set: A combination of instructions of the standard instruction set and the decimal feature.

communications—start-stop: One of three classifications of adapter used for connecting remote and local devices to the 2701 Data Adapter Unit.

compatibility feature: A feature, also called an emulator, that allows an IBM system to execute programs written for another system.

console file: A disk file, one of the major operational components of the Model 158 System Console.

correction code check: A noncomparative data validity check performed by the 2835 Storage Control to provide the 2305 Fixed Head Storage with correction capabilities.

data acquisition and control: The process of identifying, isolating, and gathering source data and providing the correct facility for its transmission.

data density: On magnetic tape, the number of bytes per inch.

data link: The communications lines, modems, and other communications equipment arranged for data, used in the transmission of information between two or more locations.

data transfer rate: The number of bytes (or packed decimal digits and signs) per second transferred to or from the processing unit by a storage unit.

decimal arithmetic: Arithmetic operations performed on decimal numbers.

decimal feature: A feature that permits storage-to-storage decimal arithmetic operation.

dual density: A feature that allows a program to use a tape unit in either 800 or 1600 bytes per inch (bpi) recording.

duplex circuit: A circuit that can carry data in two directions at the same time.

Dynexcel: A type of tape material (IBM Series/500, DYNEXCEL®) used on the 2401 for 800 or 1600 bytes per inch (bpi) recording.

editing: The process of modifying data such as inserting or deleting special characters.

EOR character: An end-of-record character used to separate input records.

error checking and correction (ECC): The detection, in the processing unit, and correction of all single-bit errors, plus the detection of double-bit and some multiple-bit errors.

extended floating-point number: A floating-point number with a 112-bit fraction. This is approximately 34-decimal-place precision.

extended-precision floating point: A feature that provides operations on extended floating-point numbers.

field length: The length of a specified area in a record used for a particular category of data.

fixed length data format: A format in which data is present in units of equal and unvarying length.

floating-point feature: A processing unit feature that has at its disposal four 64-bit floating-point registers and the instructions to perform floating-point arithmetic calculations.

high-order bit: The leftmost bit in the bit representation of a unit of information.

in-flight: During the process of moving.

instruction set: A set of instructions grouped for convenience in marketing.

internal performance: A factor in the total productivity of a system determined by a combination of throughput, response time, and availability.

interruption, classes of: The six classes of program interruption are: program, supervisor call, external, restart, machine check, and I/O.

interruptions, disallowing of: The delaying of or prevention of an interruption.

interval timer: A timer that resides at location 80 in main storage. The interval timer causes a request for an external interruption when it steps from positive to negative.

I/O interface. The physical and the logical connection between the channel and the I/O control unit.

journal roll: An adding-machine or cash-register tape.

light pen: A pen-like device used in system operation to identify a point or path (continuous combination of points) on the face of a display tube.

local mode: A mode of operation that allows a communication terminal to be used as a typewriter.

logical operations: The comparing, testing, translating, editing, and relocating of logical data.

long floating-point number: A floating-point number with a 56-bit fraction. This is approximately 17-decimal-place precision.

low-order bit: The rightmost bit in the bit representation of a unit of information.

machine-dependent: Relates to a program or procedure that requires the use of specific hardware.

magnetic tape cartridge: An encased reel of magnetic tape.

micro-instruction retry: The process of recovering from intermittent failures through the use of microprogram routines that, when an error is detected, return the processing unit to a point in the operation that was correctly executed. The operation continues from there.

multipath: A type of control unit that permits several I/O devices to transfer data at the same time.

native attachment: An attachment that is an integral part of the basic hardware.

nine-track compatibility: A feature that allows the reading and writing of nine-track magnetic tape at 800 bytes per inch (bpi) as well as 1600 bytes per inch.

nondestructive cursor: A cursor that, at any given location on a display face, has no effect on data in residence.

nonprivileged instruction: An instruction that is valid in both the problem and the supervisor states, as contrasted to a privileged instruction that is valid only in the supervisor state.

nonshared subchannel: A division of a channel data path that can control only one I/O device.

OS/DOS compatibility: A feature that provides a System/370 model with the ability to execute DOS programs under OS control.

packed format: A data format in which a byte may contain either two decimal digits or one decimal digit and a sign.

parallel data adapter: A classification of transmission adapter used with the 2701 in data acquisition and control. A circuit is provided for each bit in the code structure.

pen path: The continuous series of positions or configurations of an activated light pen as it moves across the face of a display tube.

pen tracking: The movement of an activated light pen across the face of a display tube.

phase encoding: A method of recording on magnetic tape in which both 0-bits and 1-bits are recorded.

program card: A card punched to control automatic operations and field sizes during card punching and verifying.

program switching: The switching from one program to another in the performance of a transaction.

read/write head: A device used to sense (read) or record (write) magnetic spots on a magnetic surface.

realtime application: An application that processes input as it is generated, as opposed to batch-type processing.

realtime process: A process in which response to input is fast enough to affect subsequent input.

reloadable control storage (RCS): Storage used to execute a set of microprograms that is used to control the processor, plus channel functions and features. These microprograms are loaded into the RCS from the console as an initial microprogram load procedure.

remote (vs local): Physically separated but acting on or controlling, as a terminal operates in teleprocessing. May have facility for operating in local mode completely independent of the main unit.

rotational delay: In a rotating storage device the time period between the request and positioning of the desired record under the read head.

rotational position sensing: A feature of the 2835 Storage Control that increases channel availability by releasing the channel during most of record search time.

rotational speed: In a direct access storage device, the revolutions per minute (RPMs) of the rotating drum or disk.

rubber banding: A tracking technique in the use of a light pen on a display tube face whereby a single vector can be displayed from each starting point of tracking to the position of the pen.

selectable unit (SU): A collection of macro instructions and modules that provides new function and device support. Selectable units are shipped independently of OS/VS2 releases.

selector mode: One or two modes in which a block multiplexer channel can operate, the other being block multiplex mode.

selector subchannel: A subchannel of the shared type that operates in burst mode and can operate one I/O device concurrently with byte multiplexer subchannels.

Series/500: A type of magnetic tape (Dynexcel) used by IBM that will handle data densities of 800 or 1600 bytes per inch (bpi).

seven-track compatibility: A feature that enables a tape unit to write or read seven-track tape at 200, 556, or 800 characters per inch (cpi).

shared path: The single data path of a byte multiplexer channel shared concurrently, in byte mode, by more than one low-speed I/O device.

shared subchannel: A division of a channel data path; one that can control several I/O devices through one unit.

short floating-point number: A floating-point number with a 24-bit fraction. This is approximately seven-decimal-place precision.

simultaneous home-loop operation: Local operation between units of the same configuration.

single-path: A type of control unit, usually integrated with an I/O unit, that controls only that device.

standard instruction set: A set of instructions that includes all System/370 instructions that are not part of any separately defined feature.

storage access width: The number of bytes fetched in each main-storage access.

storage cycle time: The time required by main storage to process a reference to it.

storage interleaving: A performance factor that allows 2, 4, 8, or 16 storage accesses to be started during a storage cycle.

subchannel: A division of a channel data path.

supervisor-call interruption: An interruption caused by the supervisor-call instruction in passing control to the supervisor.

switch, two-channel: A feature that allows each of the two data paths of the integrated storage controls (ISC) feature to be connected to two channels on the same or separate systems.

synchronous communications adapter: A classification of transmission adapter used in connecting remote and local devices to the 2701 Data Adapter Unit.

synchronous data link control (SDLC): A line discipline in teleprocessing that includes comprehensive detection and recovery procedures, at the data link level, for transmission errors that may be introduced by the communications lines.

system control panel: A panel, usually mounted on the processing unit, that provides the operator with manual control of the system.

Systems Network Architecture (SNA): A flexible teleprocessing network design that utilizes a single access method, a single network control program, and a single communications line control.

tape cartridges: See magnetic tape cartridge.

time-of-day clock: A feature that provides a precise measure of time suitable for accurate elapsed time measurements and time-of-day indication.

train cartridge: A cartridge, used on the 3211 Printer, containing a train of characters that are not linked together.

transparency: A feature in teleprocessing that allows the sending and receiving of control characters as data, negating their control function.

two-byte interface: A feature of the 3165 Processing Unit that permits a 2880 Block Multiplexer Channel to transfer data at rates as high as 3 million bytes per second.

universal instruction set: A combination of instructions of the commercial instruction set and the floating-point feature.

utility: Pertaining to a problem program designed to perform a common task.

wait time: Time the processing unit spends in the wait state.

zoned decimal format: A data format in which a zone character accompanies each decimal digit, except in the low-order byte position, which is occupied by a sign and decimal digit.

Section 1. Introduction to IBM System/370

IBM System/370 (Figures 1-1 through 1-4) is a general-purpose system readily adaptable to a large number of applications. System/370 provides a variety of upward-compatible models which offer the user a system of impressive performance.

System/370 offers the advantages of System/360 plus

- Faster internal performance
- Greater channel capabilities
- Increased processor storage
- Virtual storage capability
- Greater teleprocessing flexibility
- Integrated emulation of other IBM systems
- Added reliability, availability, and supportability

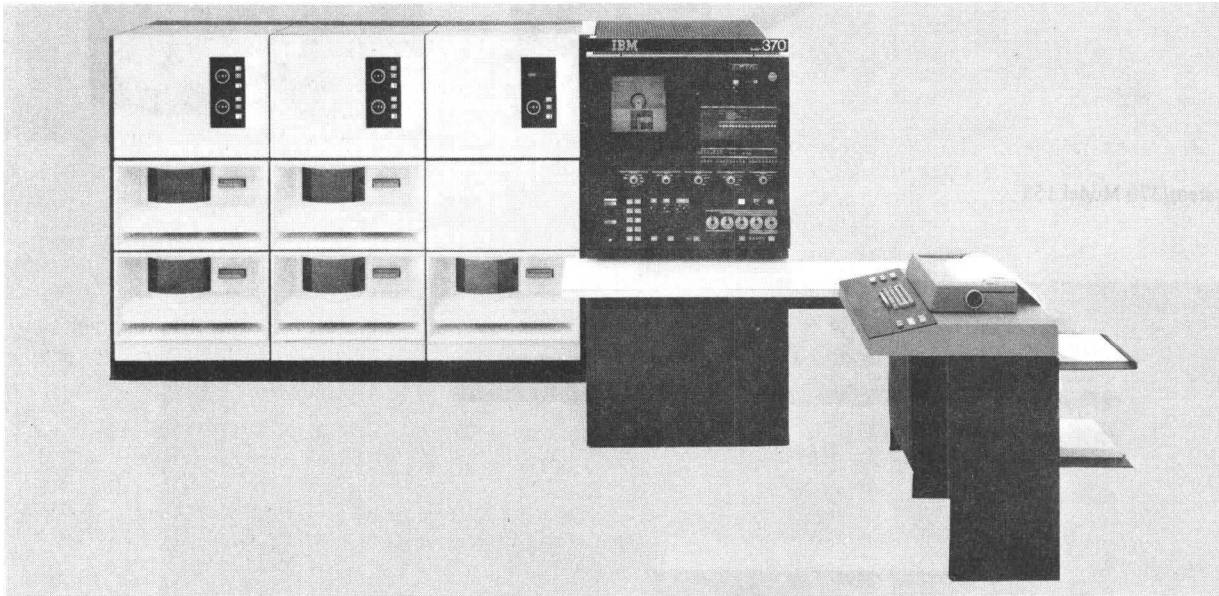

Figure 1-1. System/370 Model 135

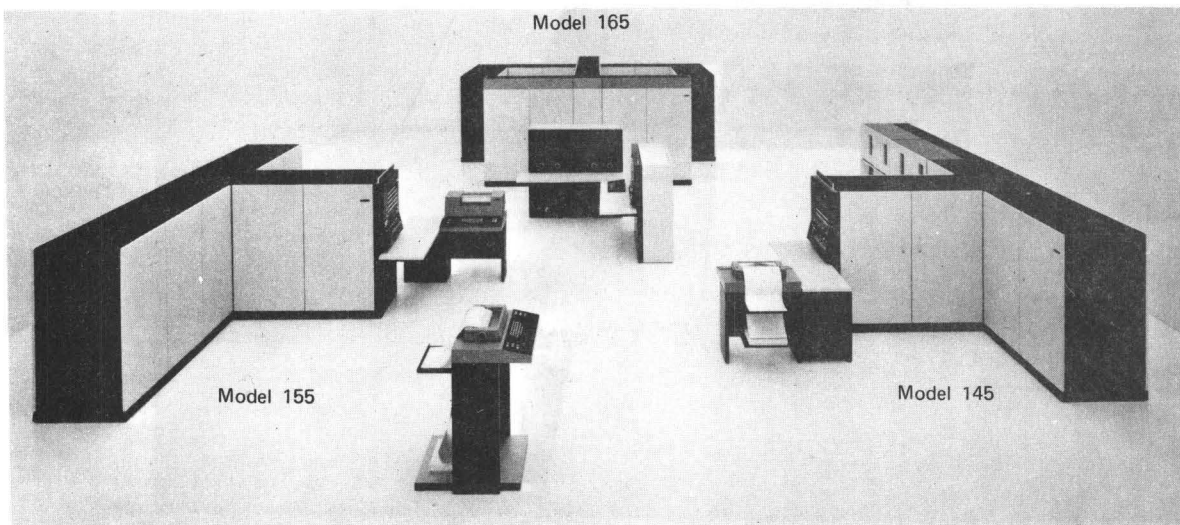

Figure 1-2. System/370 Models 145, 155, and 165

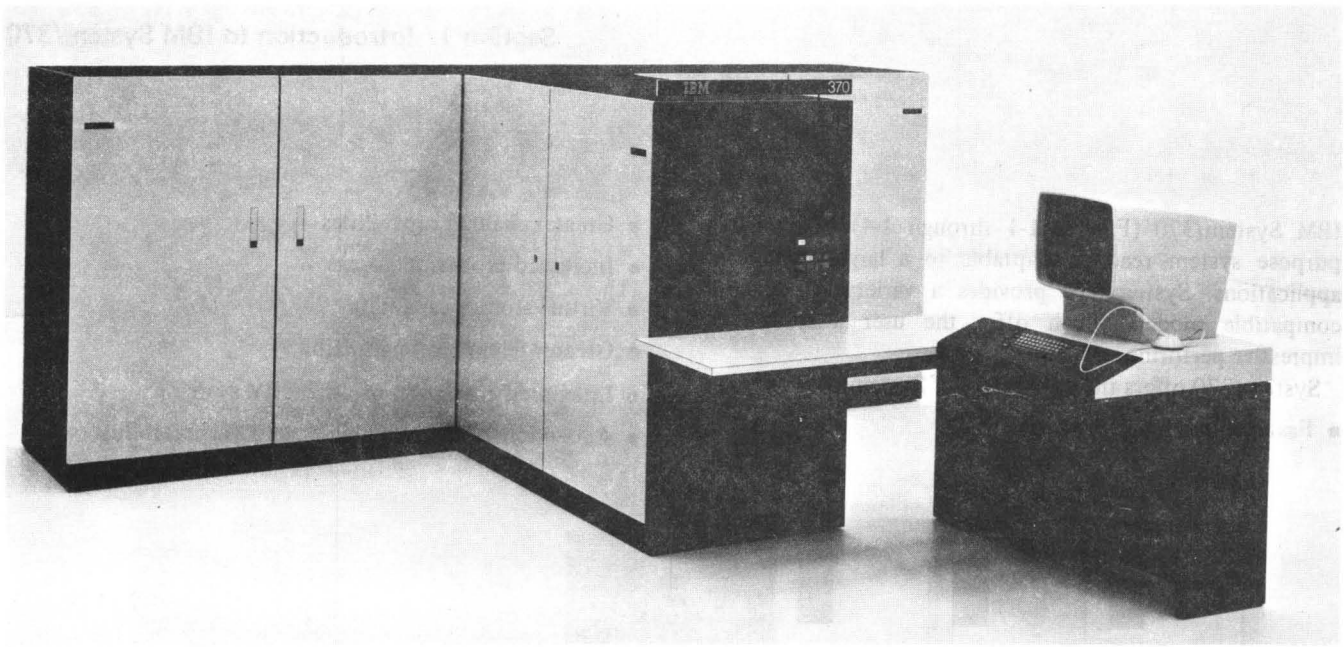

Figure 1-3. System/370 Model 158

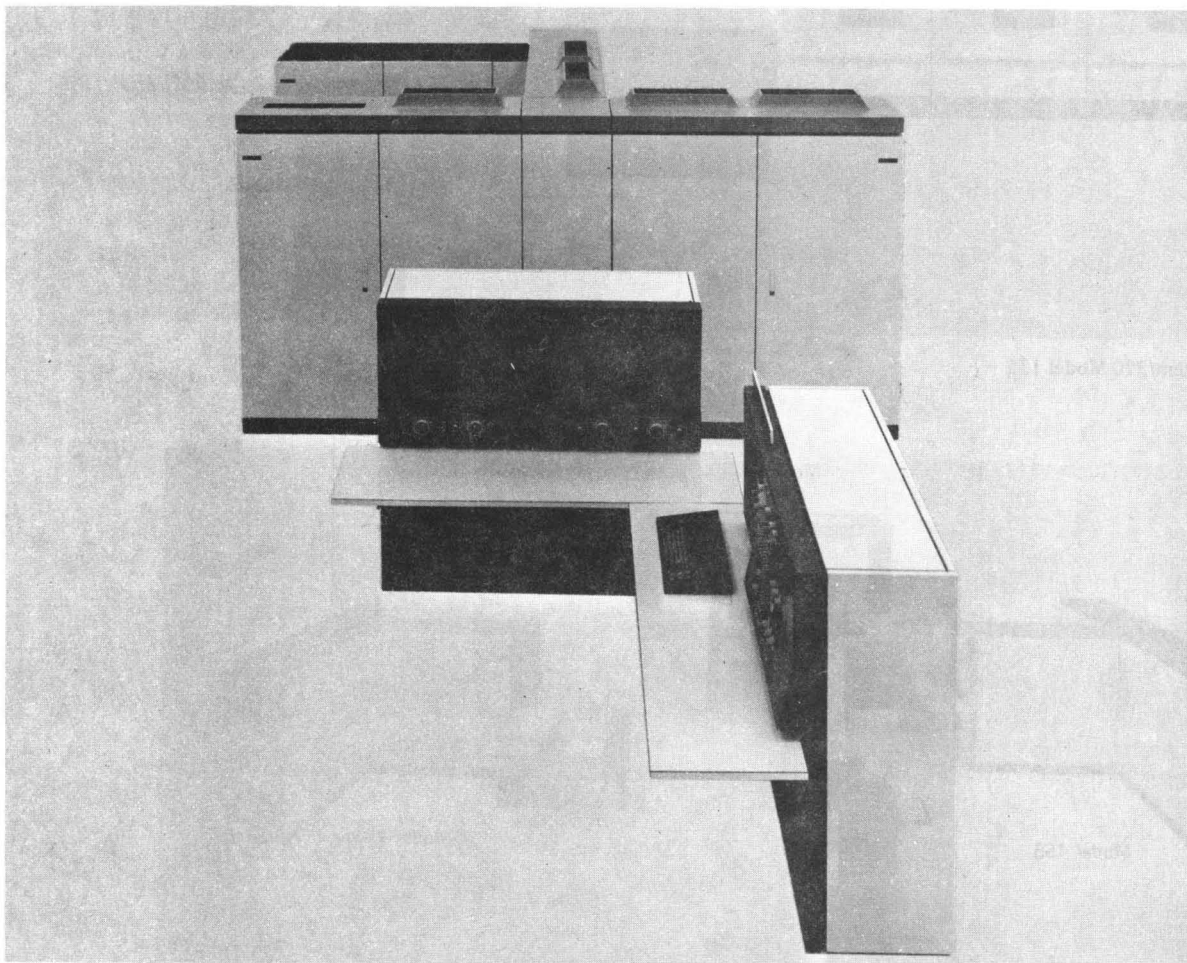

Figure 1-4. System/370 Model 168

Section 2. System/370 Basic Structure

The basic structure of a System/370 model (Figure 2-1) includes main storage, a central processing unit (CPU), one or more channels, and online input/output (I/O) devices. Online means that the I/O equipment, whether local or remote, operates under program control. Main storage may physically be a part of the CPU (processor storage), or it may be a standalone unit. A channel may be an integral part of the CPU, or it may be an independent unit. I/O devices are generally attached to channels through control units and the I/O interface. A control unit can be an integrated adapter or attachment, or it can physically be a separate unit. Figures 7-1 and 8-1 in Sections 7 and 8, respectively, show specific attachments by I/O device type.

Data Formats

The system transmits data in multiples of eight bits. Each eight-bit unit of data is called a *byte*, the basic building

block of all formats in System/370. In CPU's and buffers, a ninth bit, the *parity* or *check* bit, is transmitted with each byte and carries odd parity in the byte. The parity bit cannot be affected by the program; its only purpose is to cause an interruption when a parity error is detected. In this manual, references to data exclude the mention of the associated parity bits.

A *field* is composed of one or more bytes. The *halfword*, *word*, and *doubleword* are fields of consecutive bytes; a halfword has two bytes, a word has four bytes, and a doubleword has eight bytes. These fields make up the basic fixed-length data formats (Figure 2-2).

Data formats are either fixed-length or variable-length. During processing, the field length is either implied by the operation to be performed, or it is stated explicitly as part of the instruction.

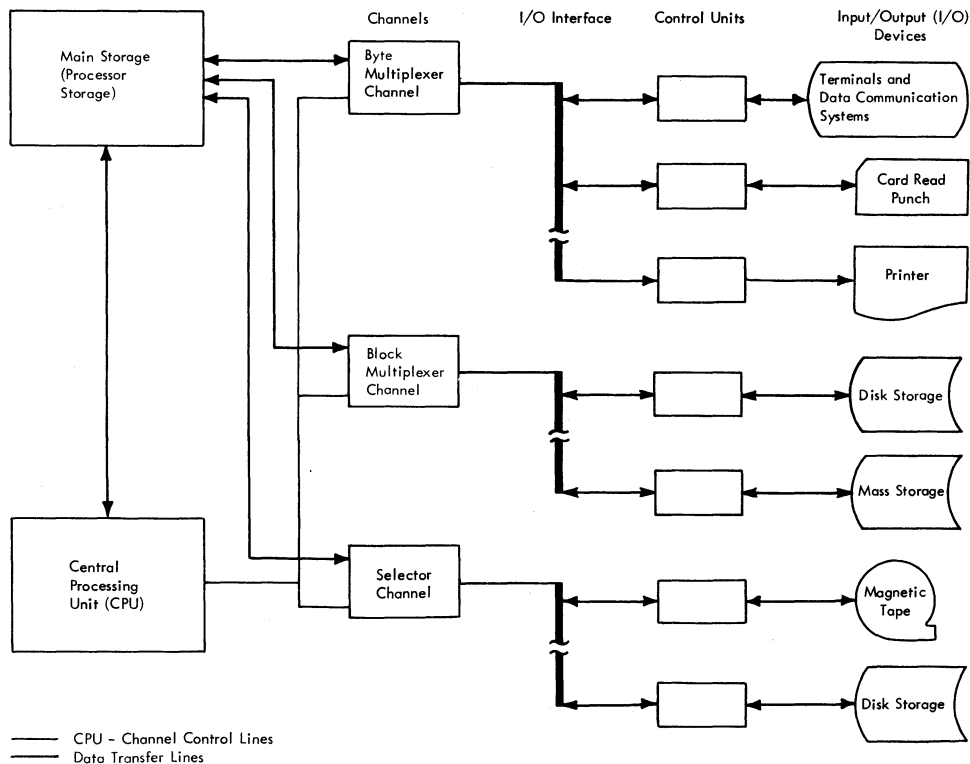

Figure 2-1. Organization of a Representative System/370 Model

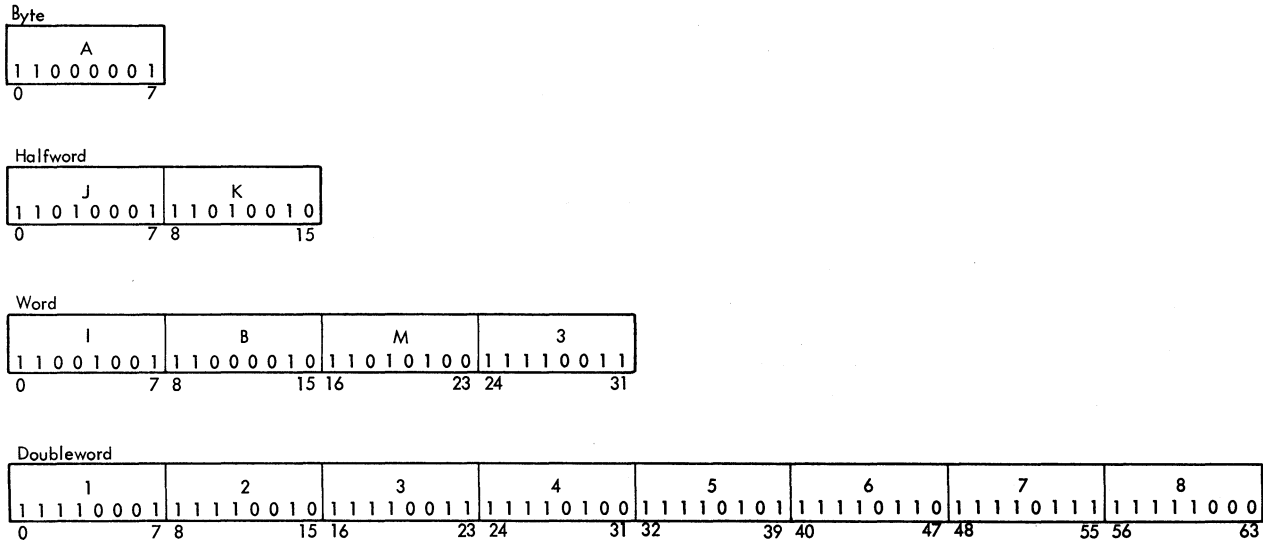

Figure 2-2. Basic Fixed-Length Data Formats (with EBCDIC-Coded Data)

Data Representation

In System/370, data (whether numeric, alphabetic, or alphameric) is processed in multiples of an eight-bit byte. The data may be in binary form (as numeric data for most scientific computations) or it may be in a binary *code*. Coding permits data to be represented by characters (for example, 1, 2, A, B, and *) on devices such as card readers, visual display units, and printers. These devices are code-dependent; that is, their operation depends on the code used to represent the characters.

The eight-bit byte provides for as many as 256 characters, which allows for future code expansion and permits System/370 to accept most present and future codes. The character code used internally in System/370 processing is the extended binary-coded-decimal interchange code (EBCDIC). The bit positions in EBCDIC (Figure 2-3) are numbered the same as those of bytes (left to right, 0-7).

MAIN STORAGE

Main storage provides the system with directly addressable fast-access storage of data. Both data and programs must be loaded into main storage (from input devices) before they can be processed. Some low-address locations are reserved for special purposes.

Addressing

Byte locations in main storage are consecutively numbered starting with 0; each number is the address of a different byte location. A group of bytes in storage is addressed by

the lowest-numbered byte location of the group. The number of bytes in the group is either implied by the instruction format or explicitly defined by the instruction itself. The addressing arrangement uses a 24-bit binary address, which gives System/370 the capability of addressing as many as 16,777,216 bytes of storage.

Data Positioning

Restrictions on data positioning in main storage depend on several factors, such as whether the data field is variable or fixed length. A variable-length field may be positioned on any byte boundary in usable main storage, but a fixed-length field (such as a halfword, word, or doubleword) may or may not, depending on what type of reference is made to the data field.

The *byte-oriented operand* feature, which is described in Section 3, allows some fixed-length fields to be positioned on byte boundaries rather than only on *integral boundaries*. A boundary is integral for a unit of data when its main storage address is a multiple of that unit's length in bytes. For example, halfwords (two bytes) should have main storage addresses that are multiples of 2. Figure 2-4 shows integral boundaries for the common units of data, with main storage addresses as four-digit decimal numbers (0000, 0001, 0002, etc.) rather than as the 24-digit binary numbers that are actually used. Sequential halfword addresses are shown in Figure 2-4 as 0000, 0002, 0004, etc. Words (four bytes) must have addresses that are multiples of 4 (shown in Figure 2-4 as 0000, 0004, 0008, etc.), and doublewords (eight bytes) must have addresses that are multiples of 8 (shown in Figure 2-4 as 0000, 0008, etc.).

EBCDIC Bit Order
0 1 2 3 4 5 6 7

Bit Positions	0123	Bit Positions								4567							
	0000	0001	0010	0011	0100	0101	0110	0111	1000	1001	1010	1011	1100	1101	1110	1111	
0000																	
0001																	
0010																	
0011																	
0100	Blank											¢	.	<	(+	
0101	&											!	\$	*)	;	¬
0110	-	/										,	%	-	>	?	
0111												:	#	@	'	=	"
1000		a	b	c	d	e	f	g	h	i							
1001		j	k	l	m	n	o	p	q	r							
1010			s	t	u	v	w	x	y	z							
1011																	
1100		A	B	C	D	E	F	G	H	I							
1101		J	K	L	M	N	O	P	Q	R							
1110			S	T	U	V	W	X	Y	Z							
1111		0	1	2	3	4	5	6	7	8	9						

Figure 2-3. EBCDIC Character Codes (Excluding Control Characters)

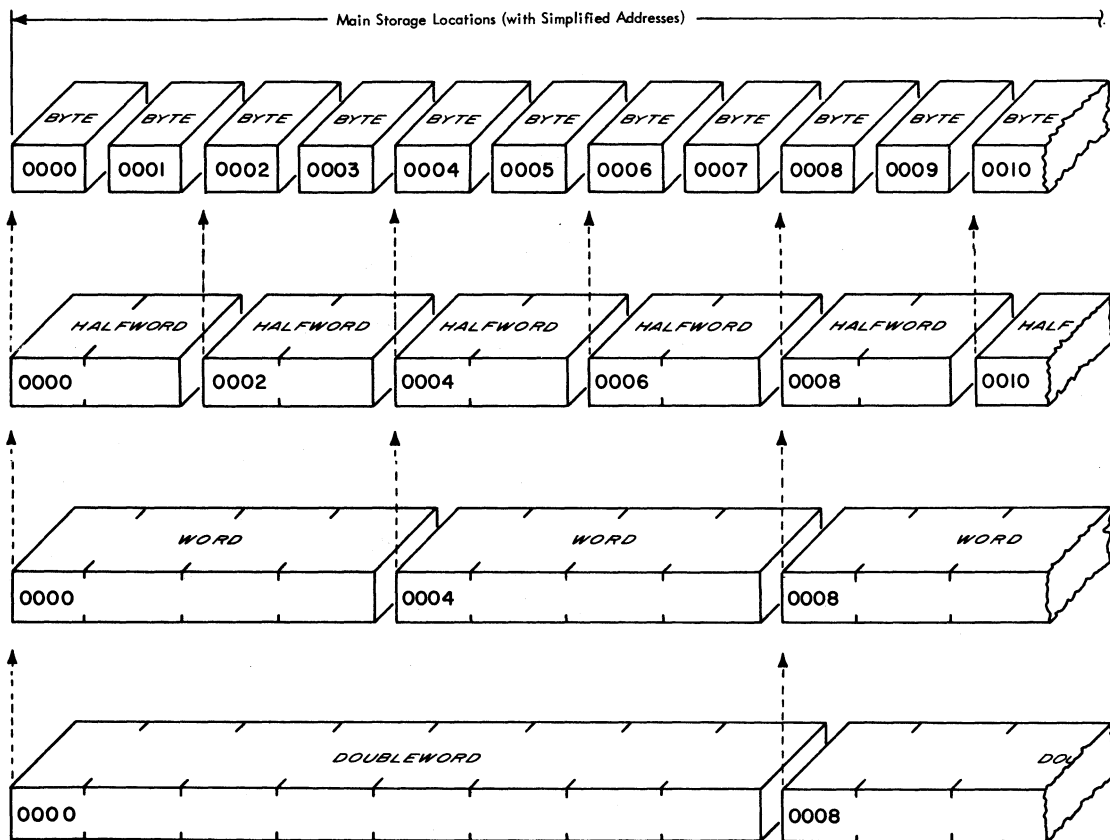

Figure 2-4. Representative Integral Boundaries for Halfwords, Words, and Doublewords in Main Storage

Performance Factors

The variety of main-storage units available for the System/370 models permits the system to be tailored to suit the individual needs of the user. The units differ in capacities, access widths, cycle times, and degrees of interleaving.

Depending on the model, storage capacities range from 64K (65,536 bytes) to 8,192K (8,388,608 bytes). (In this manual, 1K = 1,024.)

Storage Access Width is the number of bytes transferred to or from main storage in each access. As access width increases, the quantity of data that may be transferred per unit time increases. The width, which is model-dependent, ranges from 2 to 16 bytes.

Storage Cycle Time is a measure of storage speed and is defined as the length of time that main storage is busy whenever a reference is made to it. Generally, the shorter the cycle time, the greater the number of operations that can be performed in any time interval. The storage cycle time is 2.07 microseconds or less, the exact value depending on the system model.

Storage Interleaving, a model-dependent capability, increases the number of main-storage accesses started in a storage cycle, thereby significantly increasing the amount of data accessed per unit time.

CENTRAL PROCESSING UNIT

The central processing unit (CPU) is the controlling center of System/370. It provides facilities for:

- Addressing main storage.
- Fetching and storing data.
- Arithmetic and logical processing of data.
- Executing instructions in a desired sequence.
- Initiating communication between main storage and input/output (I/O) devices.

Three types of programmable registers are provided by the processing unit: general, floating-point, and control. The 16 *general registers* and 4 *floating-point registers* are accessible to the problem programmer and are capable of receiving data, holding it, and permitting it to be operated on. The general registers are used primarily for fixed-point, logical, and addressing operations. The floating-point registers are used only for floating-point arithmetic. The control registers provide for the handling of information used to control some system operations. These registers are accessible to the control program by way of specific instructions.

The number of registers and register positions available with any system model depends on which installed functions require control registers.

Arithmetic and Logical Operations

The arithmetic and logical operations fall into four classes:

- Decimal arithmetic
- Fixed-point arithmetic
- Floating-point arithmetic
- Logical operations

These classes differ in the data formats and field lengths used, the registers involved, and the operations provided.

Decimal Arithmetic

Decimal arithmetic, used principally for commercial applications, is performed on signed decimal data. Generally, decimal data entering and leaving the system via devices such as card reader-punches and printers is in *zoned* format (Figure 2-5). But for processing and for storage in direct-access and magnetic-tape devices, decimal data is in *packed* format (Figure 2-6). Packing fits two decimal digits (or one digit and sign) per byte. Because only four binary digits are needed to express one decimal digit, packing permits more efficient handling of decimal data.

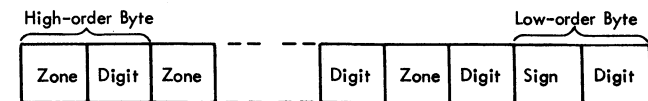

Figure 2-5. Zoned Decimal Number Format

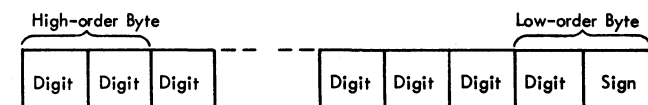

Figure 2-6. Packed Decimal Number Format

Packed data is taken from main storage, processed, and returned to storage without the data passing through any general registers; this is called *storage-to-storage* processing. The decimal field length, specified by the instruction, can be expanded to as many as 31 digits plus sign, all packed in up to 16 bytes.

Fixed-Point Arithmetic

Fixed-point arithmetic is used to perform arithmetic operations on both data and storage addresses.

The fixed-point binary word (Figure 2-7), the basic arithmetic operand in System/370, is a 32-bit signed integer (a 31-bit integer with a high-order sign bit). Halfword operands can be specified in many operations where a fullword is not needed, thus improving both performance and use of storage.

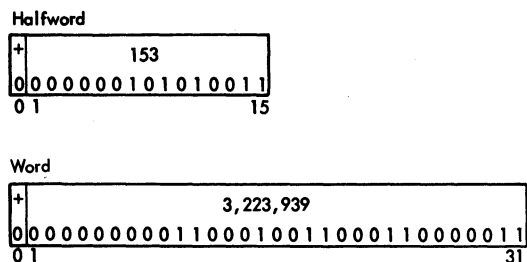

Figure 2-7. Fixed-Point Number Formats (with Signed Binary Data)

The 16 general registers, each four bytes (32 bits) wide, are used for fixed-point operations. For fixed-point product and dividend precision, two adjacent registers can be coupled, effectively doubling the register width.

Floating-Point Arithmetic

Floating-point arithmetic, used primarily in scientific applications, greatly increases the speed, precision, and efficiency of computations. In System/370, this form of numeric representation can express positive or negative decimal values from about 10^{-78} to about 10^{76} .

Floating-point numbers may be short (24-bit fractions, with about seven-decimal-place precision), long (56-bit fractions, with about 17-decimal-place precision), or extended (112-bit fractions, with about 34-decimal-place precision). Floating-point fractions are made up of hexadecimal (base 16) digits, each consisting of four binary digits and having equivalent decimal (base 10) values of 0-15. The short format (Figure 2-8) usually reduces execution times and increases the number of operands that can be stored, the long format (Figure 2-9) provides greater precision, and the extended format (Figure 2-10) provides about twice the precision of the long format. (See "Extended-Precision Floating-Point Feature," Section 3.)

Four floating-point registers, each eight bytes wide, are provided. The availability of these registers eliminates much fetching and storing of intermediate results. The 16 general registers are also used, primarily for indexing and address arithmetic.

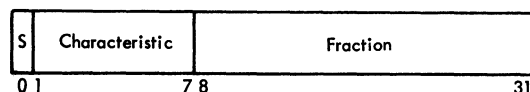

Figure 2-8. Short Floating-Point Number Format

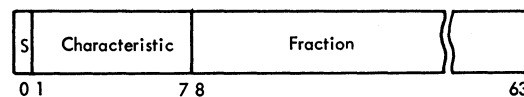

Figure 2-9. Long Floating-Point Number Format

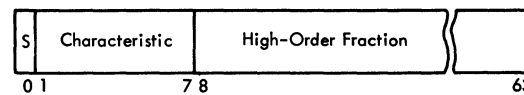

Figure 2-10. Extended Floating-Point Number Format

Logical Operations

The logical operations provide System/370 with the ability to manipulate logical quantities. The manipulations include: comparing, testing, translating (character for character), editing (sign and punctuation control), and moving logical data. The data may have either a fixed- or variable-length format (Figures 2-11 and 2-12). Fixed-length data, processed through the general registers, may be one, four, or eight bytes long; variable-length data, processed storage to storage, can extend to 256 bytes.

Fixed-Length Logical Operand (One, Four, or Eight Bytes)

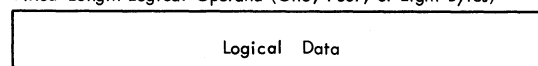

Figure 2-11. Fixed-Length Logical Format

Variable-Length Logical Operand (Up to 256 Bytes)

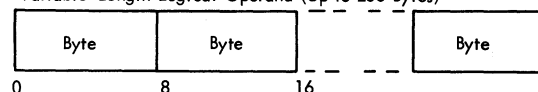

Figure 2-12. Variable-Length Logical Format

Instruction Formats

Main storage addressing and the execution of processing programs are directed by the CPU. The instructions that make up these programs may be of several different formats, identified by the format codes RR, RX, RS, S, SI, and SS (Figure 2-13).

RR denotes a register-to-register operation. The operands are in general registers, and the result replaces the first operand.

RX denotes a register-and-indexed-storage operation. The first operand is in a general register, and the second operand is in a main storage location. This format includes a

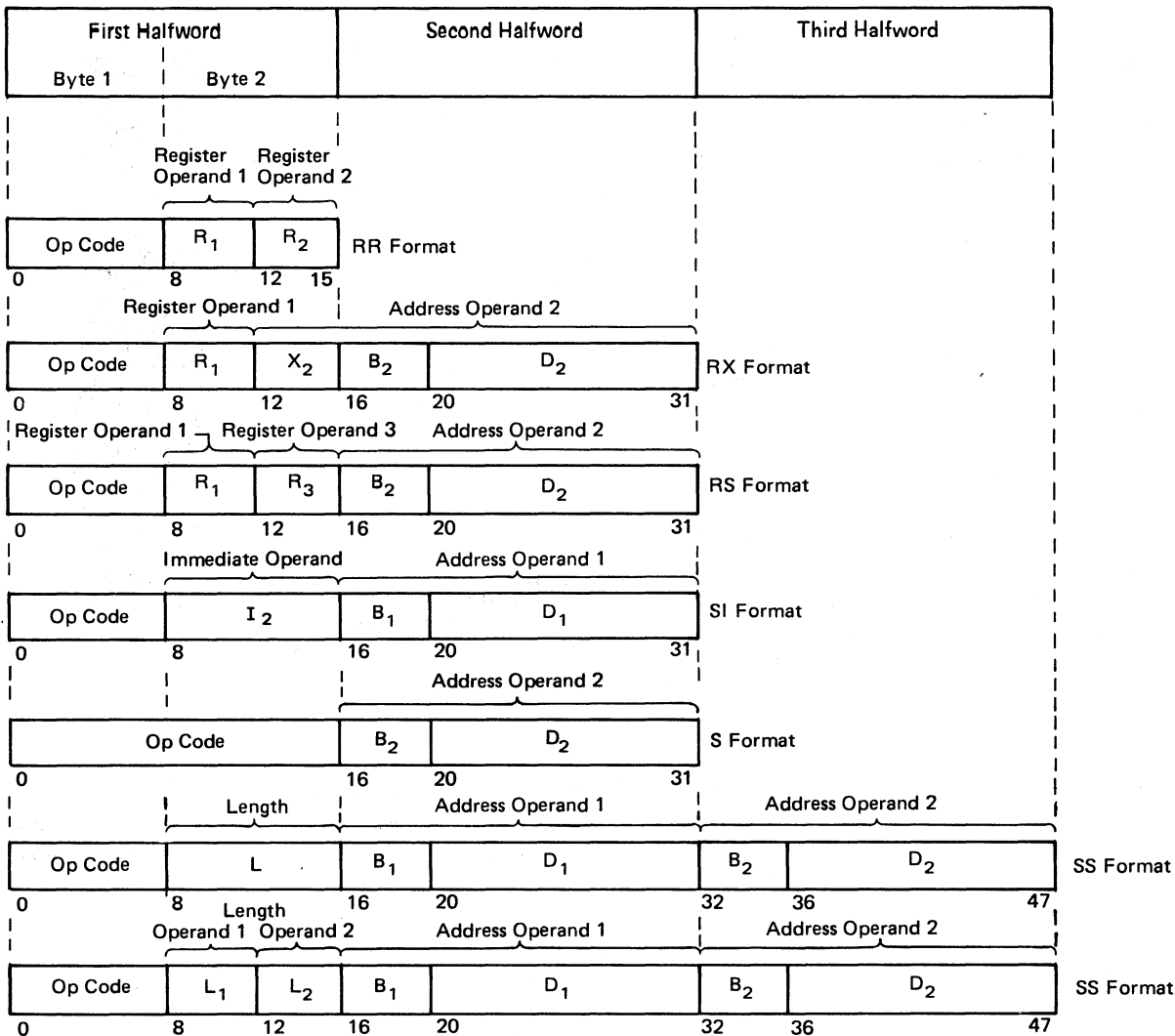

Figure 2-13. Basic Instruction Formats

quantity for indexing the main storage address; the quantity is contained within a general register, which is used as an index register and specified by the instruction. The result of an RX operation may replace the first operand depending on the instruction.

RS denotes a register-and-storage operation. The first operand is in a general register, the second operand is in main storage, and a third may be specified by another general register.

S denotes an operation using an implied operand and storage.

SI denotes an immediate-operand-and-storage operation. The first operand is one byte of data carried in the instruction itself (the immediate operand), and the second operand is in main storage.

SS denotes a storage-to-storage operation. Both operands are in main storage.

Generally, the first byte of each of these formats gives the operation code (the "op code"), which identifies the operation to be performed; for S-format instructions, however, the first two bytes are used for the op code.

System Control Panel

The control panel, usually mounted on the CPU, provides the operator with manual control of the system. It gives the operator the ability to reset a system, to store and display information, and to load initial program information.

The need for operator manipulation of manual controls is minimized by the system design and by the governing control program, reducing the number and seriousness of operator errors.

A large-system capability permits the operator controls to also be mounted on a standalone console, such as the IBM 2150 Console.

INPUT/OUTPUT

An input/output operation transfers data between main storage and an I/O device. An I/O operation is initiated by a program instruction that generates a command to a *channel*. A *control unit* receives the command via the I/O interface, decodes it, and starts the I/O device.

Channels

Channels are the direct controllers of I/O devices and control units. They provide System/370 with the ability to read, write, and compute, all at the same time, by relieving the CPU of the task of communicating directly with the I/O devices.

Channels may be standalone units, complete with the necessary logical and storage capabilities, or they may time-share CPU facilities and be physically integrated with the CPU. The type available to any system model depends on the system model itself. In either case, the channel functions are identical. Channels may be implemented, however, to have different data transfer rates.

Functionally, the channel data path is divided into *subchannels*. To a programmer, each subchannel is a separate channel, and can be programmed as such.

Some subchannels can control several I/O devices, whereas others can control only one; these are called *shared* and *nonshared* subchannels, respectively.

System/370 has three types of channels: byte multiplexer, selector, and block multiplexer.

Byte Multiplexer Channels

Byte multiplexer channels separate the operations of high-speed devices from those of lower-speed devices. Channel operations are in either of two modes: *byte* mode for lower data rates, and *burst* mode for higher data rates.

In byte mode, the single data path of the channel can be shared by a large number of lower-speed I/O devices (such as card readers, printers, and terminals) operating concurrently; the channel receives and sends data to the I/O devices on demand.

Burst mode is forced by devices such as magnetic tape units, disks, or data cell storage, and is not under the control of the programmer. Such high-speed devices, having established a logical connection with a channel, usually stay connected to it for the duration of data transfer and thereby force the channel into burst-mode state.

The IBM 2870 Multiplexer Channel (Figure 2-14), the standalone unit used with Models 165, 168, and 195, houses one byte multiplexer channel. Like the in-CPU byte multiplexer channels, 2870's have *byte multiplexer subchannels*; additionally, 2870's can have *selector subchannels*.

Byte multiplexer subchannels may operate in either byte or burst mode, and may be of either the shared or nonshared type. In byte mode, each can operate one

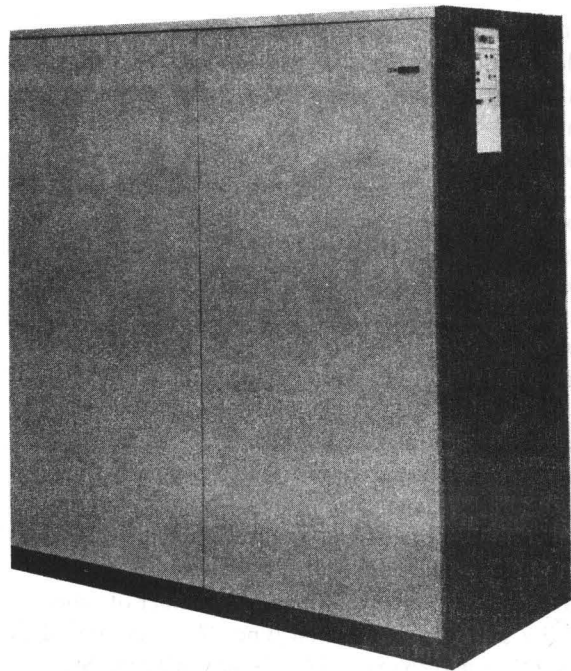

Figure 2-14. IBM 2870 Multiplexer Channel

low- or medium-speed I/O device concurrently, if the total load on the channel does not exceed the channel capacity. In burst mode, one byte multiplexer subchannel monopolizes the byte multiplexer channel and operates one higher-speed I/O device.

Selector subchannels, which are of the shared type only, operate only in burst mode; each can operate one I/O device concurrently with the byte multiplexer subchannels but can control as many as 16 I/O devices.

Selector Channels

Selector channels transmit data to or from a single I/O device at a time. They can handle both high- and lower-speed I/O devices, but their burst-mode operation makes them especially suitable for high-speed devices. Each selector channel attaches up to eight I/O control units and can address as many as 256 I/O devices. One I/O device per selector channel can be transmitting data at any given time; no other I/O device on the channel can transmit data until all data is handled for the selected device.

In general, I/O operations on a selector channel are overlapped with processing, and all channels can operate simultaneously, provided that the processing unit's data rate capabilities are not exceeded. The maximum data rates for the selector channels vary with the System/370 models and the channel options available, and range from 1.3 to 1.85 million bytes per second.

The IBM 2860 Selector Channel, the standalone unit used with Models 165, 168, and 195, is similar in appearance to the 2870 Multiplexer Channel (Figure 2-14), and can house one, two, or three selector channels.

Block Multiplexer Channels

Block multiplexer channels have advantages of both byte multiplexer and selector channels in that they can concurrently operate many high-speed I/O devices on a single data path.

Block multiplexer channels operate in either of two modes: selector or block multiplex. *Selector mode* is functionally equivalent to selector channel operation, permitting attachment of all the I/O devices which can attach to selector channels. In *block multiplex mode*, these channels permit interleaving (multiplexing) of channel programs for high-speed devices in such a way that channel programs can be initiated sooner and channels can be freed earlier than would be possible with selector channels. The byte and block multiplexer channels differ primarily in that the block multiplexer channels can operate with much faster I/O devices, and they transfer larger quantities of data per transmission. These quantities are referred to as *blocks*, and may include a number of records.

Block multiplexer channels provide a number of subchannels of the shared or nonshared type. The maximum data rates for block multiplexer channels vary with the System/370 models and channel options available, and range from 1.2 to 3.0 million bytes per second.

The IBM 2880 Block Multiplexer Channel, the standalone unit used with Models 165, 168, and 195, is similar in appearance to the 2870 (Figure 2-14), and houses either one or two block multiplexer channels.

I/O Devices

I/O devices fall into a number of categories, some of which overlap. They are used in and for:

- Auxiliary storage
- Machine and manual (keyed) input, both local and remote
- Teleprocessing
- Reading (or output) of external documents and displays
- Process control
- Data acquisition

Many I/O devices function with an external document, such as a punched card or a reel of magnetic tape. Others handle only electrical signals, such as those in process-control and data acquisition systems.

Control Unit Function

The control unit function provides the logic circuitry and the storage areas (buffers) needed to operate the attached I/O devices. Yet, to the user, most control unit functions cannot be distinguished from I/O device functions.

The control unit function may be part of the I/O device or the CPU (integrated attachments), or it can physically be a separate unit.

I/O Interface

The I/O interface provides a uniform method of attaching various I/O devices (through control units) to a channel.

The information format and the control signal sequences provided by the interface are independent of the type of control unit and channel. Certain I/O devices that do not use the I/O interface do use the same programming information format and sequences.

INTERRUPTION SYSTEM

The interruption system permits System/370 to dynamically respond to equipment and programming errors, and greatly aids the efficient use of I/O equipment. To make the interruption procedure as short and simple as possible, switching between the interrupted program and the control program (the program that services interruptions) must be efficient.

The interruption system uses *program status words* (PSW's) to hold status and control information. Additionally, System/370 uses control registers to regulate the interruption system.

As soon as an interruption occurs, all current status information, together with an identification of the cause of the interruption, is put into a PSW. This "old" PSW is stored at a fixed location. The system then automatically fetches a "new" PSW from a different fixed location. Each class of interruption uses two fixed locations in main storage: one to receive the old PSW when the interruption occurs, and the other to supply the new PSW that governs the servicing of that class of interruption.

After the interruption has been serviced, the CPU is restored by the control program to the status it had before the interruption.

Classes of Interruptions

The interruption system separates interruptions into six classes:

Program interruptions are caused by various kinds of programming errors; the exact type of condition is identified in the program old PSW.

Supervisor Call interruptions are caused when the program issues an instruction to pass control to the part of the control program, called the *supervisor*, which performs the supervisory functions associated with a task.

External interruptions are caused by an external device that requires attention, by the interval timer (an internal clocking device) going past zero, or by the operator pressing the interrupt key.

I/O interruptions are caused by an I/O unit ending an operation or otherwise needing attention. Identification of the device and channel causing the interruption is stored in the I/O old PSW; in addition, the status of the device and channel is stored in a fixed location.

Machine Check interruptions are caused by the machine-checking circuits detecting an error.

Restart interruptions are caused by the operator activating the restart key or by another processing unit specifying restart.

Disallowing of Interruptions

Most interruptions may be either allowed or temporarily disallowed. When an interruption is disallowed, it is either delayed or does not take place, the outcome depending mainly on the class of interruption. The following interruptions can be disallowed:

- All I/O interruptions
- All external interruptions
- Some program interruptions
- The machine-check interruption

Priority of Interruptions

During the execution of an instruction, several interruptive events may occur simultaneously. When this occurs, the competing interruption requests are serviced in a fixed order of priority.

VIRTUAL STORAGE CAPABILITY

System/370 virtual storage extends and enhances system capabilities by permitting users to program as though the system had use of as much as 16,384K (16,777,216 bytes) of storage. This storage capability is provided by way of several features (such as dynamic address translation and channel indirect data addressing) and associated programming support. The contents of virtual storage are usually maintained on an external storage medium called *external page storage*.

Virtual storage is divided into *segments* of either 64K (65,536 bytes) or 1,024K (1,048,576 bytes). Each segment is divided into *pages* of 2K or 4K bytes. A segment is a block of sequential logical addresses spanning 64K or 1,024K bytes in virtual storage. A page is a block of sequential logical addresses spanning 2K or 4K bytes in

virtual storage. A page may contain instructions, data, or both. A page is transferable between real storage and external page storage. When a program is executed, the addresses specified by the program are translated, via dynamic address translation, into real addresses in main storage.

As pages of virtual storage are addressed, if they are not already in main storage they are brought in from external page storage to replace pages in real main storage that are not needed. The swapping of pages of storage is performed by the operating system.

MULTIPROCESSING

Two multiprocessing (MP) models of System/370 Model 158 or 168 operating under a single system control program form a large-scale System/370 multiprocessing system.

The CPU's of both systems share a configuration control panel located between the CPU's. This panel contains the operator controls for MP operations such as the allocation of main storage.

The MP system offers several advantages:

1. It improves workload balance between the CPU's by sharing main storage and I/O devices for more efficient use of these units. The combined system thereby can adjust its resources in response to the varying workload.
2. It increases critical system availability, especially desirable in realtime applications. By use of the configuration control panel, various units can be removed from operation and the system reconfigured without them.
3. It increases system flexibility. Each of the two systems can operate independently, each with its own system control program and its assigned main storage and I/O devices.

Non-MP Model 158 or 168 CPU's can be converted to the respective MP versions, and the features and I/O devices available to the non-MP Model 158's and 168's are also available to the respective MP versions.

This section describes the more prominent standard and optional features of System/370. The features discussed are listed under the name of that part of the basic system structure with which they are usually associated.

Some features are standard for some System/370 models and optional for others; and some features are available to only certain models. (See Section 6 for the features available with any specific model.)

MAIN STORAGE FEATURES

Main (or processor) storage includes all storage that is directly addressable.

Main Storage Capacities

Main storage capacities offer a wide latitude in choosing the amount of storage required. The capacities vary from 64K (65,536 bytes) to 8,192K (8,388,608 bytes), depending on the system model. Available models have a choice of several storage capacities, with each model's maximum capacity several times its minimum.

Storage Protection

Storage protection, made up of the store and fetch protection features, prevents the unauthorized changing or use of the contents of main storage. *Store protection* prevents the contents of main storage from being altered by storage addressing errors in programs or input from I/O devices. *Fetch protection* prevents the unauthorized fetching of data and instructions from main storage. As many as 15 programs (with associated main storage areas) can be protected at one time. The storage protection feature, including store protection and fetch protection, is standard on all System/370 models.

Protection is achieved by dividing main storage into 2,048-byte blocks and by associating a five-bit *key in storage* (Figure 3-1) with each block. Each key in storage may be thought of as a lock. Each block of storage, then, has its own "lock." Two instructions are provided for assigning and inspecting the key, which contains a four-bit *code*. The same code may be used by many blocks, using binary codes 0001-1111.

A user's right of access to storage is identified by a four-bit *protection key* (Figure 3-1), located in the program status word (PSW) or in a special word used in channel

operations. The protection key may be thought of as the key for the "lock." During a main-storage reference (storing or fetching), the key in storage is compared with the protection key associated with the reference. Access to the location is granted only when the four leftmost (high-order) bits of the key in storage match the protection key, or when the protection key is zero (0000). The rightmost (low-order) bit of the key in storage determines whether fetch protection is operative for the storage block associated with that key. If the bit is 1, fetch protection is operative; if it is 0, it is inoperative.

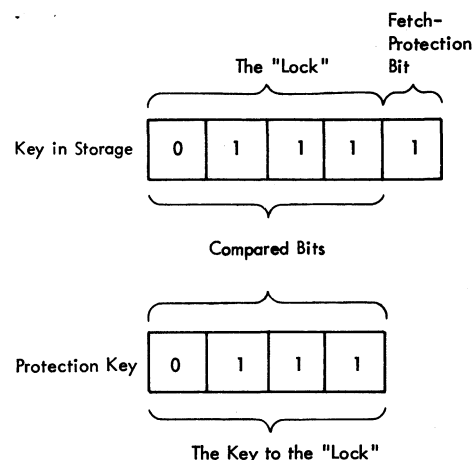

Figure 3-1. Key in Storage and Protection Key, Showing Matching Keys

High-Speed Buffer Storage

Buffer storage can sharply reduce the time required for fetching currently used sections of main storage. On the Model 168, for example, the CPU can obtain eight bytes from the buffer in two cycles (160 nanoseconds), and a request can be initiated every cycle. This compares with five cycles (400 nanoseconds) required to obtain eight bytes directly from main storage.

Buffer operation is handled entirely by hardware and is transparent to the programmer, who does not need to adhere to any particular program structure to achieve close-to-optimum use of the buffer.

CENTRAL PROCESSING UNIT FEATURES

Instruction Sets

System/370 has three instruction sets: the standard, commercial, and universal (Figure 3-2).

The *System/370 standard instruction set* includes all instructions that are not part of any separately defined feature. These instructions provide the basic processing capability of the system.

The *System/370 commercial instruction set* includes the System/370 standard instruction set and the System/370 decimal feature instructions.

The *System/370 universal instruction set* includes the System/370 commercial instruction set and the System/370 floating-point feature instructions.

The System/370 instruction sets are fully described in the *IBM System/370 Principles of Operation, GA22-7000*.

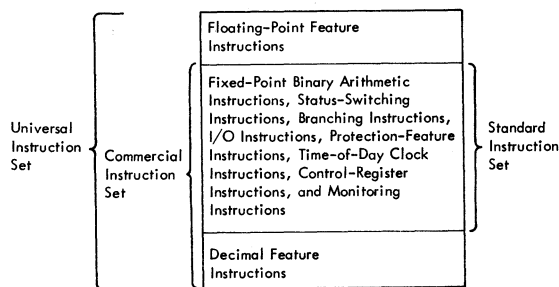

Figure 3-2. System/370 Instruction Sets

Decimal

This feature, especially useful in commercial operations, permits storage-to-storage decimal arithmetic operations and includes two instructions to assist in editing output.

Floating Point

This feature, used primarily in scientific operations, permits calculations on data with a wide range of magnitude. Included with this feature are four 64-bit floating-point registers, which are used to perform these calculations. Operands can be selected for either 24-bit fractions (short precision) or 56-bit fractions (long precision).

Extended Precision Floating Point

This feature permits floating-point operands to have 112-bit fractions (extended precision) compared to the 56-bit fractions available with long-precision floating-point arithmetic. It also permits results to be rounded from extended to long precision or from long to short precision.

Direct Control

Direct control provides for exchanging control signals between two System/370 CPU's, between a System/370 CPU and a System/360 CPU, or between a System/370 and some specialized device, such as an analog-to-digital converter.

Direct control bypasses the channel by using the direct control instructions and an external-signal facility, consisting of six external interruption lines, each of which, when pulsed, sets up the conditions for an external interruption.

Some System/370 models provide the external-signal facility as a separate feature (that is, minus the instructions).

Interval Timer

This timer provides program interruptions on a program-controlled basis. The timer, which is updated by timing circuits, has a time resolution of 3.333 milliseconds (0.104 millisecond for the Model 195), and a total clock cycle of 15.5 hours.

Time-of-Day Clock

This feature provides a precise measure of time suitable for accurate elapsed time measurements and time-of-day indication. The clock's binary value, updated each microsecond (each quarter-microsecond in the Model 195), can be interrogated or set by provided instructions. The total clock cycle is approximately 142 years.

Byte-Oriented Operand

Before describing the function of this feature, a distinction needs to be made between privileged and nonprivileged instructions, some of which make reference to fixed-length data fields. Essentially, *privileged* instructions are those used solely with control programs, whereas *nonprivileged* instructions are used in processing or problem programs, as well as in control programs.

The byte-oriented operand feature removes the integral-boundary restriction from fixed-length fields referenced by most *nonprivileged* instructions, permitting the fields to be located in main storage on byte boundaries. For optimum performance, however, these fixed-length fields should be located on integral boundaries, since significant performance degradation may result from the use of this feature.

Translation

The System/370 translation feature includes the translation feature instructions, dynamic address translation, extended control mode, program event recording, and store status and program reset.

Dynamic Address Translation

This feature translates program-specified addresses into real addresses in main storage. With appropriate programming support, it can be used to move data and programs to an external storage device, and later return them to main storage for completion of execution.

Address translation uses a lookup procedure employing tables in main storage. A special buffer is used to store as many as 128 address translations, the number depending on the system model. All storage references are first compared with the buffer to determine if a current translation exists. If one does exist, it is used; if not, translation proceeds and the result is put into the buffer.

Extended Control Mode

This feature provides for an expanded PSW format and for a CPU mode in which certain System/370 features (such as dynamic address translation) can operate. When the system is not in extended control mode, it is in basic control mode.

Program Event Recording

Program event recording provides a means for debugging programs, and permits a programmer to be alerted to the following events:

- A successful branch
- Alteration of a selected general register
- Instruction fetching from a selected main storage area
- Alteration of a selected main storage area.

Store Status and Program Reset

The store status and program reset facilities include a reset function that does not destroy the contents of the programmable registers and a store status function that places the contents of the programmable registers into main storage.

Clock Comparator and CPU Timer

Expanded CPU timing functions are provided by this feature. The clock comparator causes an external interruption when the time-of-day clock reaches a value specified by the user. The CPU timer measures elapsed time and causes an external interruption when a prespecified interval of time has elapsed. The CPU timer can also be used as a high-resolution timer.

CHANNEL FEATURES

Channel Indirect Data Addressing

This feature provides the means for applying address translation to I/O operations.

Channel-to-Channel Adapter

This adapter provides a path for data transfers between two channels and synchronizes such transfers, providing systems with interchannel communication.

The channels are usually on separate systems. Connecting a channel of one system to a channel of another has the effect of interconnecting two CPU's.

The adapter uses one or two control-unit positions on each of the two connected channels, but only one channel need have the adapter.

Two-Channel Switch

This feature attaches a path to a second channel. The two channels may be on the same CPU or different CPU's. Switching is under program control.

Command Retry

Command retry, a control-unit-dependent feature, can cause a failing channel command to be retried without requiring an I/O interruption. The number of retries is device-dependent.

SYSTEM FEATURES

Compatibility Features for Other IBM Systems

A number of features are available that permit operation of certain models of System/370 by the use of programs written for other IBM systems. These compatibility features are combinations of circuitry and programming that make the System/370 able to read programs written for the other system and to function like that system. In many cases, the program runs much faster on System/370 than on the system for which it was written.

Compatibility features are also called *emulators*, but not *simulators*. The latter, although they may perform the same function, do so with programming alone and thus run slower.

A compatibility feature is particularly useful when the user needs time to convert his present programs to System/370 code but, at the same time, wants the advantages offered by System/370. In addition, using such a feature may eliminate the need for converting programs that are seldom used.

Sufficient storage and appropriate or equivalent I/O devices must be available for the use of a compatibility feature. Furthermore, the use of one compatibility feature may preclude the use of another. Under unusual conditions, a feature may not be able to maintain exact compatibility; for example, programs that are time-dependent may not yield identical results, and the handling of error conditions may differ.

In general, the lower end models of System/370 offer 1401/1440/1460 and System/360 Model 20 compatibility. The upper end models offer 7070/7074, 7080, and 7090/7094 compatibility.

OS/DOS Compatibility

This feature provides a System/370 model with the ability to execute DOS programs under OS control.

Section 4. System/370 Programming Systems

The programming systems information as presented in this section assumes that the reader has a basic knowledge of IBM programming systems, such as that found in *IBM System/360 Operating System Introduction*, GC28-6534.

The IBM-supplied programming systems that support the System/370 include:

- DOS/VS (Disk Operating System/Virtual Storage)
- OS/VS1 (Operating System/Virtual Storage 1)
- OS/VS2 (Operating System/Virtual Storage 2)
- VM/370 (Virtual Machine Facility/370)

This section describes OS/VS1, OS/VS2, and VM/370. For information about DOS/VS, see *Introduction to DOS/VS*, GC33-5370. Also, more detailed descriptions of OS/VS2 and VM/370 can be found in *Introduction to OS/VS2 Release 2*, GC28-0661, and *IBM Virtual Machine Facility/370: Introduction*, GC20-1800, respectively.

OS/VS1 (Operating System/Virtual Storage 1)

OS/VS1 is one of the IBM-supplied programming systems that support the System/370. This support is comparable to that provided by OS/MFT (System/360 Operating System Multiprogramming with a Fixed Number of Tasks). Many enhancements as well as significant new features, however, are provided in VS1. Because OS/VS1 is a growth version of OS/MFT, this section assumes a basic knowledge of operating systems. For further information about OS/VS1 and OS/VS1 publications, see these publications:

- *Introduction to Virtual Storage in System/370*, GR20-4260
- *OS/VS1 Planning and Use Guide*, GC24-5090
- *IBM System/370 Bibliography*, GC20-0001
- *IBM System/370 Bibliography of Industry Systems and Application Programs*, GC20-0370

INTRODUCTION TO OS/VS1

OS/VS1 is a system control program (SCP) that makes possible the concurrent execution of as many as 15 separate jobs within a single computing system having only one central processor, while continuing to provide all other applicable services of the IBM System/370 Operating System.

Externally, OS/VS1 has the same functional characteristics as the current release of OS/MFT; internally, it includes several enhancements that make it a more effective

and versatile operating system. The most significant enhancements are:

- VS (Virtual Storage)
- JES (Job Entry Subsystem)
- VSAM (Virtual Storage Access Method)
- VTAM (Virtual Telecommunications Access Method)

VSAM and VTAM are described under "Methods of Storing and Retrieving Data" and "Teleprocessing," respectively.

Virtual Storage

OS/VS1 uses the System/370 hardware feature called *Dynamic Address Translation (DAT)* that provides an expanded address space of up to 16,777,216 bytes. This enlarged storage is called *virtual storage*, which the user shares with the system control program.

Virtual storage is the address space that appears to the user as real (main) storage and from which instructions and data are mapped into real storage locations. In MFT, processor storage is referred to as main storage. VS1 uses the term *real storage* to designate the main storage of System/370, whereas *virtual storage* refers to its complete addressing range.

Figure 4-1 illustrates how VS1 implements virtual storage through a combination of the DAT hardware feature and the *paging* function of the system control program.

Programs are actually stored on auxiliary storage, called *external page storage*, which is divided into 2K blocks called *slots*; similarly, programs themselves are divided into 2K blocks called *pages* and real storage is divided into 2K blocks called *page frames*. The system transfers pages of programs from external page storage to real storage as they are required for execution, automatically translating the program's virtual storage addresses to actual addresses in real storage. The pages are not necessarily contiguous in real storage. This process is called *paging* and is transparent to the user. Page-in obtains a page from auxiliary storage and page-out returns a page to auxiliary storage. To accomplish the paging function, the page supervisor must:

- Recognize the need for page transfer to real storage.
- Select an appropriate real storage block for the page.
- Maintain an available supply of real storage blocks.
- Save the contents of pages by moving them to auxiliary storage, if necessary.
- Recognize the need to fix (or lock) a page in real storage.

Although VS1 is primarily a paging-environment system, the system control program enables the execution of

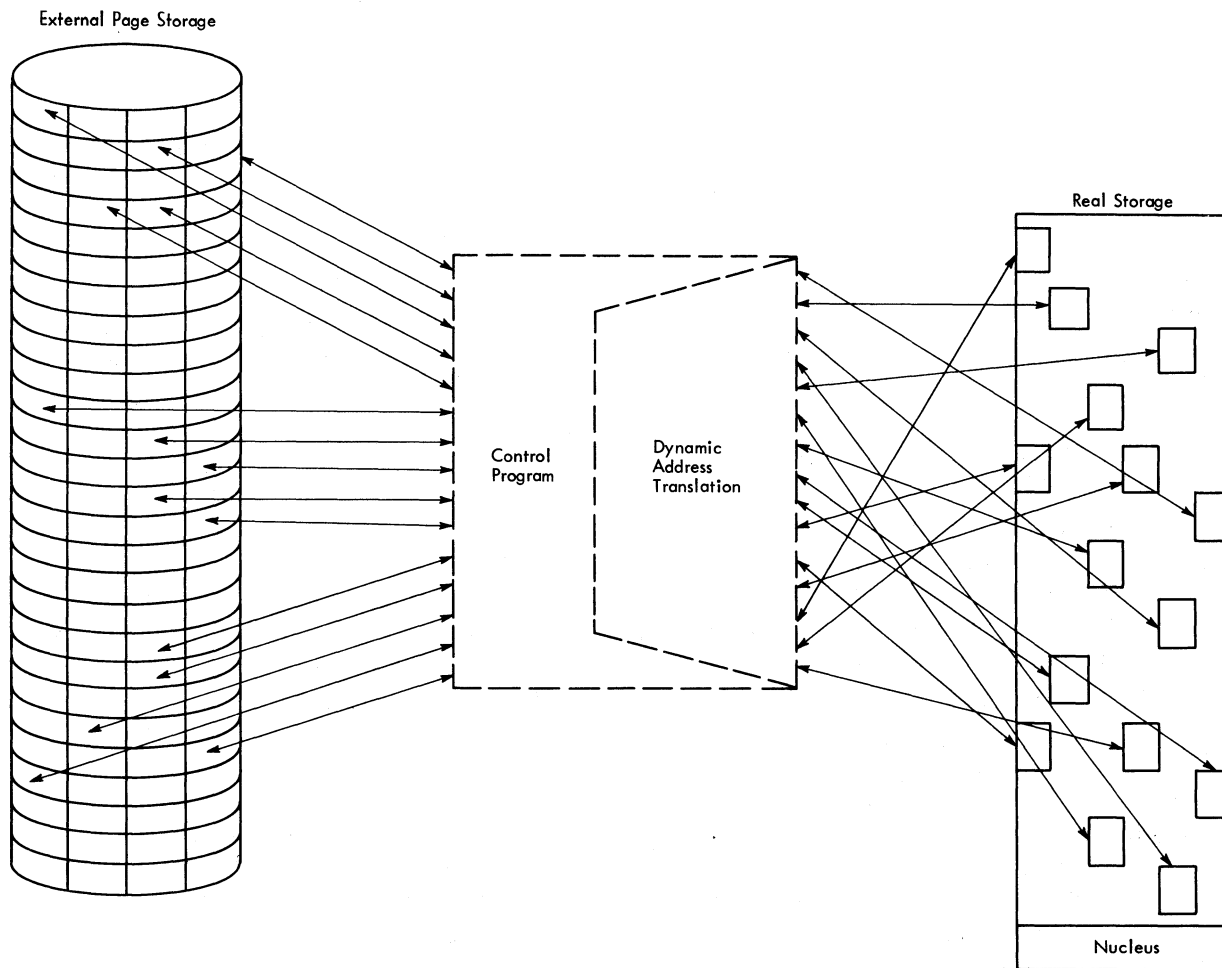

Figure 4-1. Virtual Storage Implementation

programs that cannot be paged between auxiliary storage and real storage. These programs, therefore, must run via the 'virtual = real' facility. This facility gives you real storage for any of your programs that do not run in the normally paged environment of VS1. It allocates real storage if it is available, at job execution time, with real storage addresses equivalent to virtual storage addresses on a byte basis, for the amount of storage you have specified for the job involved. Multiple virtual = real jobs execute concurrently if the system has enough real storage to accommodate the jobs. The classes of programs that do not run in a paged environment are:

1. Programs that modify the channel program while it is active.
2. Programs that are highly time dependent, such as some magnetic ink character recognition (MICR) programs.
3. Programs that use the execute channel program (EXCP) with user-written appendages.

Advantages of VS1 Virtual Storage

- Most jobs requiring more address space than the available real storage can execute in a VS1 environment.

- VS1 dynamically allocates real storage on an as-used or as-required basis.
- Real storage that was unused, by partitions, in an OS/MFT system can be recovered with VS1 and used by other partitions, because virtual address space in a partition does not require real storage until it is addressed.
- The small partition scheduling requirements of OS/MFT do not exist in VS1 because virtual address space sufficient for scheduler requirements is provided for all partitions. Thus, no partition forces another to wait for scheduling.
- You can test most programs with large design points on machines with smaller real storage. The performance of these programs is directly related to their storage requirements versus real storage availability.
- You can write future processors for VS1 with few storage restrictions.
- Infrequently executed system tasks do not require real storage to be permanently reserved for their use. You can page-in these programs on demand.

- You can reserve virtual storage for unscheduled top-priority jobs.
- Partition redefinition requirement is reduced.

JES (Job Entry Subsystem)

JES is a control-program facility that provides streamlined job processing in VS1. It spools and schedules primary input and output streams.

JES performs two spooling functions:

1. It reads all primary input streams, including JCL and data, from the input device, and stores them on a direct access storage device in a format convenient for later processing by the system and by the user's programs.
2. It similarly stores system (and selected user) print and punch output on a direct access storage device until a convenient time for printing or punching.

Spooling provides the following advantages:

- Nonsharable devices, generally unit record devices, are used at full rated speed if enough buffers are available.
- Nonsharable devices are used only for the time required to read, print, or punch the data.

Without spooling, the device is occupied for the entire time that a job is reading input or writing output. Thus, the device runs only as fast as the job can accept or generate data.

If system resources are the objects of contention (for example, buffer assignment), JES schedules the contending activities to assure the highest degree of system availability. Because data is stored on a direct access storage device, jobs or their output can be processed in a different order from that in which they were submitted. This ability to control system work is called *job queuing*. Jobs can be scheduled by class, and by priority within class.

OS/MFT—OS/VS1 Differences

In general, all major OS/MFT features are available in VS1. Listed below, however, are some of the more significant differences, which VS1 does not support. For a more complete list of differences between OS/MFT and OS/VS1, refer to the *OS/VS1 Planning and Use Guide*, GC24-5090.

- Main storage hierarchies: Large core storage (LCS) is not attachable to the System/370. (In programs where hierarchy values are specified, these values are added together.)
- TESTRAN: A low-usage component of MFT.
- Graphic Job Processor (GJP): A low-usage component of MFT.
- Satellite Graphic Job Processor (SGJP): A low-usage component of MFT.
- Queued Telecommunications Access Method (QTAM): Superseded by Telecommunications Access Method (TCAM).

- HASP: Superseded by JES.
- Remote Job Entry (RJE): Superseded by Remote Entry Services (RES).
- Rollout/Rollin: Not required because paging gives real storage to tasks as they need it. In programs that specify rollout/rollin, it is ignored.
- IEBUPDAT utility program: Superseded in VS1 by the IEBUPDTE utility program.
- IBCRCVRP (independent) utility program: Superseded in VS1 by the IEHATLAS (system) utility program.
- IHGUAP utility program: A low-usage component of MFT.
- IMAPTFLE service aid: Replaced by HMAPTFLE in VS1.
- IMASMP service aid: Replaced by HMASMP in VS1.
- IMDMDMAP service aid: Replaced by HMBLIST in VS1.
- SER0 and SER1: Their functions are provided in VS1 by the machine check handler (MCH) and the channel check handler (CCH).

Compatibility

In general, most object programs written for MFT execute in VS1. Existing programs that do not operate under VS1 without modification include:

1. Time-dependent programs (such as MICR).
2. Programs written to deliberately cause program exceptions.
3. Programs using machine-dependent data.
4. Programs using the program status word (PSW) bit 12 (the ASCII bit).
5. Programs reserving low-address storage for special purposes.
6. Programs dependent on devices or facilities not supported or available in System/370 or VS1.
7. Programs that require model-dependent System/360 functions.
8. Programs attempting to read or write SYSIN or SYSOUT data by other than SAM (sequential access method) (that is, EXCP will not work on these data sets).
9. Programs that depend on a valid UCB pointer in the TIOT for SYSIN/SYSOUT data sets.
10. Programs that include TCAM object decks. TCAM message control programs and TCAM message processing programs using the ICOPY, TCOPY, QCOPY, and TCHNG macro instructions must be reassembled and link-edited. TCAM message processing programs not using any of these macro instructions need only to be relink-edited.
11. Programs using TCAM II.

In addition, some MFT programs that do execute in VS1 may require virtual = real execution and do not use demand

paging. Current OS data sets process in the VS1 system without modification or conversion.

For compatibility, the JCL (job control language) statements of VS1 remain basically unchanged from MFT. The differences between the MFT JCL and the VS1 JCL are an additional parameter that permits the execution of programs in the virtual = real mode, a parameter that permits the printing of multiple copies of a data set, and two profile-type parameters that enable an installation to establish an automated scheduling algorithm. Additionally, VS1 processes VSAM (virtual storage access method) JCL parameters and ignores the HIERARCHY and ROLLOUT/ROLLIN parameters.

VS1 is upward compatible to VS2. This compatibility includes source program code, object program code, job control language, and conventions and standards.

Minimum System Requirements

The minimum system required for VS1 includes:

- A System/370 with at least 144K of real storage.
- DAT (dynamic address translation) feature.
- Standard multiplexer channel with associated input/output devices (one read/punch and one printer).
- One selector and/or block multiplexer channel with at least one of the system's direct access storage devices.
- These direct access storage devices are: at least three 2314/2319 devices, or two 3330/3333 devices, or two 3340 devices.
- Storage protection feature.
- Program event recording feature.
- Monitor call.
- One console device.

Note: System generation requires the addition of one tape unit and one 2314, 2319, 3330, 3333, or 3340 direct access storage device.

Devices Supported by VS1

OS/VS1 supports a variety of devices and control units, including:

- Direct access storage devices and control units
- Magnetic tape devices and control units
- MICR/OCR (magnetic ink character recognition/optical character recognition) devices
- Consoles and displays
- Communication terminals and control units
- Printers and printer control units
- Card readers and card punches
- Industry-oriented processing devices

For a complete list of OS/VS1 supported devices and control units, see *OS/VS1 Planning and Use Guide*, GC24-5090.

SYSTEM CONTROL PROGRAM COMPONENTS

The purpose of a data processing installation is to do work. VS1, as in MFT, enables the user to concentrate on this goal by performing many routine, and in some cases complicated, data processing operations. The programs that perform these operations are grouped and classified as a *system control program*. The system control program of VS1 has four major functions. They are:

1. *Job management*—To accept and schedule jobs in a continuous flow.
2. *Task management*—To supervise, on a sequential or priority basis, each unit of work to be done.
3. *Data management*—To simplify storage, retrieval, and maintenance of all data, regardless of the way it is organized and stored.
4. *Recovery management*—To reduce the damaging effects that a computer, channel, or I/O device malfunction might otherwise have on a program in process.

In addition to these management functions, certain programs are included to complete the family of functions performed by the system control program. These programs include utilities, a language processor, service programs (linkage editor and loader), and service aid programs.

Job Management

Job management, or job scheduling services, performs the same basic functions in VS1 as in MFT. These include:

1. Analysis of the input stream: scanning the input data to identify control statements; interpreting and analyzing the control statements; preparing the necessary control tables that describe each job to the system.
2. Allocation of I/O devices: ensuring that all necessary I/O devices are allocated; ensuring that direct access storage space is allocated as required; ensuring that the operator has mounted any required tape and direct access volumes.
3. Overall scheduling: selecting jobs for execution, by class and priority within a class.
4. Transcription of input data units, and user output from a direct access device.
5. Communication between the operator and the system.
6. System restart capabilities.

The changes made to job management in VS1 increase reliability, performance, and function. Improvements for VS1 include:

- Balancing the channel and device load.
- New time-of-day clock support.
- Preallocated external storage for system (spooled) data sets.

- Transparent buffering and spooling facilities.
- Scheduler work area data sets (SWADS) or the optional scheduler work area (SWA) in each partition separate the work areas and reduce contention for scheduler resources.
- Readers and writers are reenterable, and all programs use a single copy of each.
- Job control statements are interpreted by the initiators instead of the readers so that the unit-record input devices can run at near rated speeds.
- If system resources are in contention for a system data set, the job entry subsystem (JES) schedules the activities to assure the highest degree of system availability.

Job Flow

Before a job can execute, you must tell VS1 about the job and job steps through the job control language. The job control language supplies the system with job and program information, data characteristics, and device requirements before the program executes.

A job flows through the VS1 system by passing through two functional areas:

1. JES (job entry subsystem) where it is under VS1 control when it is read into the system until it is written out.
2. The partition where the program instructions are executed.

The JES reader reads jobs and data into the system. The reader is a part of the JES component called JEPS (job entry peripheral services). The job next enters JECS (job entry central services) which spools it on a data set and places records relative to its processing requirements on a job queue to await execution.

The initiator selects each job for execution. JECS transfers the data between the spooled data sets and virtual storage.

Before a job enters a partition, the interpreter subroutine of the initiator converts job control statements into system control tables based on job control information. At the same time, the allocation routines fill the device requirements. Once the initiator has completed its preparation activities, the program begins execution by calling for the necessary access method and supervisor services for data and program management.

When a VS1 program completes the execution phase, it performs the necessary termination and device deallocation and notifies the initiator that execution of the next job or job step (program) can begin. After each job is completed, the writer assumes control to perform the necessary output operations.

Job Initiation

The initiator for VS1 is pageable. When a command is entered from the console specifying an initiator procedure,

the initiating task is established in the partition to schedule job execution. The initiator job selection routine attempts to dequeue the highest-priority job within a class from the first job input queue associated with its partition.

When the final step of the job is terminated or bypassed, any reserved data sets are returned to the system, and the initiator is ready to select another job.

Interpreter: The interpreter analyzes the contents of job control statements and builds tables that are used during the initiation and execution of job steps. The VS1 interpreter operates as a subroutine of the initiator.

Allocation: Allocation is a subroutine of the initiator. It analyzes the I/O device requirements of job steps, allocates devices to them, issues volume mounting instructions, and verifies that the volumes are mounted on the correct device. In VS1, the selection of a device is based on an I/O load-balancing algorithm.

Job Termination

When a problem program completes execution, the VS1 termination routines free (deallocate) all resources used by the program and perform the necessary cleanup to enable the system to continue functioning for other problem programs.

Command Processing

Some commands enter the system via the console or the input job stream. Others can enter only through the console. Most MFT commands are compatible with VS1. One enhancement is the ability for the operator to manipulate printer output.

You can enter this new VS1 command facility from the console only, enabling you to:

- Obtain multiple copies of job output on a data set or job basis.
- Immediately stop the job output stream and start writing again from the beginning.
- Forward space or backward space the output data.
- Single-, double-, or triple-space the output.
- Go to the next data set, or restart the output writing of the current data set.
- Suspend the writing of a job's output data, and replace it on the output hold queue to be written out later.
- Checkpoint SYSOUT data sets at specified intervals.
- Display outstanding requests of users running under remote entry services (RES).
- Dump selected areas of virtual storage to the SYS1.DUMP data set.

VS1 command facilities that are compatible with MFT include:

- Flexibility to manipulate jobs by displaying the class, priority, and the number of jobs to be processed; suspending the execution of certain jobs or classes of jobs; releasing jobs that have been suspended; direct canceling of a particular job; and changing the priority or class of a particular job.
- Redefining the size of a partition. In a virtual storage environment, the partitions actually are allocated in virtual storage so that the change in partition size is made in virtual storage and not in real storage as in MFT.
- Preparing for shutting down the system at the end of the day by enabling the user to save important statistics and data records.
- Modifying certain processing characteristics such as: changing output writer classes and conditions under which the output writer pauses for servicing; changing job classes associated with each system initiator; changing the job classes and output classes associated with direct system output processing (DSO); changing programmer-specified values providing the programmer has set the proper indicators in his program to allow such revisions.
- Starting a job called (via the console) from a procedure library to override the normal selection of jobs entered via the input job stream.
- Establishing the device to be used as the input work queue and whether this queue is to be formatted, as well as specifying the location of the library containing certain program procedures (procedure library), and specifying which automatic commands the user wishes to override.
- Allocating an I/O device to all job steps that require a particular volume, without intervening demountings and remountings of that volume. (The volume must be removable.)
- Placing I/O devices (other than a communications line) into online or offline status.

When commands within a VS1 job are entered in an input stream, they are executed when that job is selected for execution. When commands are entered via the console, or between jobs in an input stream, they are executed immediately.

Task Management

Task management controls the allocation and use of the CPU, virtual storage, real storage, and programming resources. The major change between task management for MFT and task management for VS1 is the addition of the page supervisor facility to manage virtual storage (see

“Virtual Storage” in this section). Task management has seven major functions or routines. The routines are collectively referred to as the supervisor:

- Interruption supervisor analyzes interruptions to determine what supervisor processing is required.
- Task supervisor records which tasks are currently in the system, their status, priorities, the programs they require, and the order in which these tasks are to be performed.
- Virtual storage supervisor allocates and frees virtual storage, and records what use is being made of any portion of virtual storage. All requests made to main storage in MFT are made to virtual storage in VS1 (for example, FREEMAIN and GETMAIN).
- Contents supervisor loads programs into virtual storage, and records what programs are currently in virtual storage and what characteristics these programs possess.
- Timer supervisor sets and maintains the timers from information provided in timer macro instructions.
- Input/output supervisor controls the reading of data from, and the writing of data to, physical devices. The I/O supervisor also provides the necessary translation for channel programs requiring a change from their virtual to real storage addresses for execution. During this translation, the I/O supervisor takes into account non-contiguous pages in real storage and fixes all required pages in real storage for the duration of the I/O operation.
- Page supervisor allocates and releases real storage space for pages, and transfers pages between real storage and external page storage.

Data Management

Data management’s objective is to achieve maximum efficiency in managing the mass of data associated with the many programs that are processed at an installation. Data management routines control all operations associated with input/output devices: allocating space on volumes, channel scheduling, storing, naming, and cataloging data sets, moving data between real and auxiliary storage, and handling errors that occur during input/output operations.

The data management routines include access methods, catalog management, DADSM (direct access device space management), and open/close/end-of-volume support. Figure 4-2 illustrates the relationship between a job and the services necessary for the management of data as well as the management of the job in execution.

Access Methods

The access methods, which communicate with the I/O supervisor, are primarily responsible for moving information between virtual storage and external storage and maintaining it in external storage. The data management

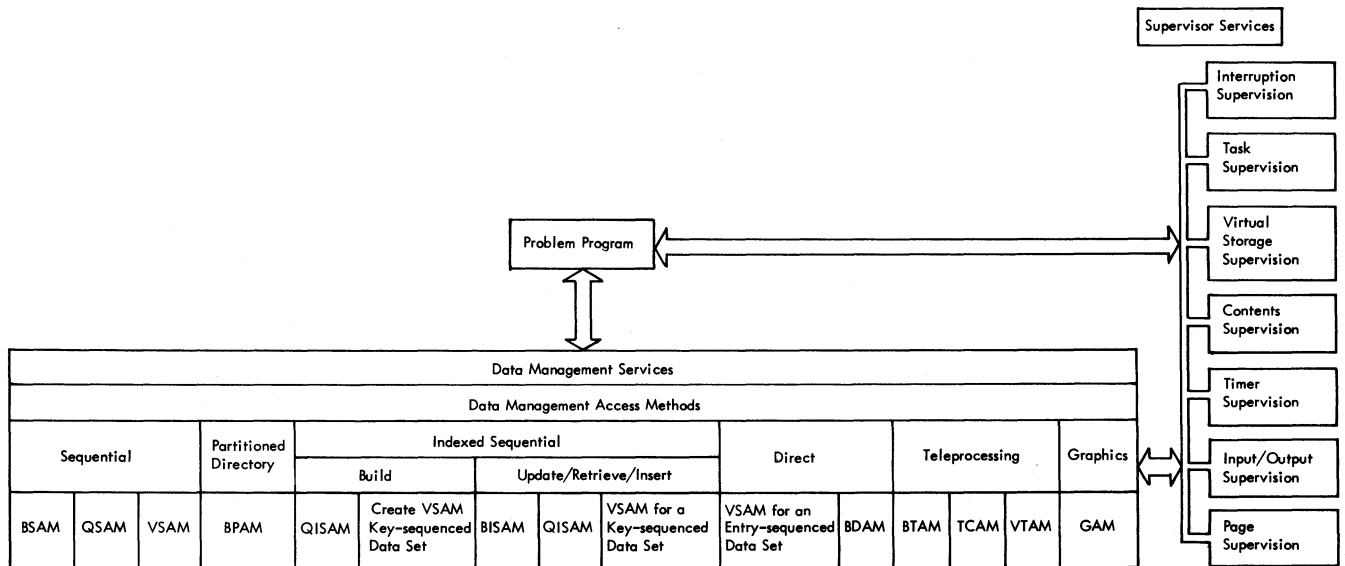

Figure 4-2. Data Management and Supervisor Services

routines that service problem programs require information about the data. This information is supplied when data is first recorded, some through the job control statements, and some at execution time. For a complete description of access methods, see "Methods of Storing and Retrieving Data" in this section.

Catalog Management

Catalog management routines maintain the collection of data set indexes (the catalog) that is used by the control program to locate volumes. The catalog management routines also locate the cataloged data sets. The catalog, itself a data set (SYSCTLG), resides on one or more direct access volumes. It contains indexes that relate data set names to the serial numbers and device types of the volumes containing the data sets. In maintaining the catalog, the catalog management routines create and delete indexes, and add or remove entries. To locate a data set, catalog management routines search through the indexes for the index entry containing the last part of the qualified name of the data set. (Note: VSAM (virtual storage access method) creates and maintains separate catalogs. See "VSAM" under "Methods of Storing and Retrieving Data" in this section.)

DADSM (Direct Access Device Space Management)

DADSM consists of routines that allocate space on direct access volumes to data sets. The routines are used primarily by job management routines during the initiation of job steps when space is obtained for output data sets. They also are used by other data management routines for increasing the space already assigned to a data set, and for releasing space no longer needed.

When space is needed on a volume, the DADSM routines check the volume table of contents (VTOC) for enough available contiguous tracks to satisfy the request. If there are not enough contiguous tracks, the request is filled using as many as five noncontiguous groups of free tracks.

O/C/EOV (Open/Close/End-of-Volume)

O/C/EOV support routines:

- Open a data control block before a data set is read or written.
- Close a data control block after a data set has been read or written.
- Process end-of-volume (EOV) conditions when an end-of-volume or end-of-data (EOD) set condition occurs during an I/O operation.

Open Processing: Before accessing a data set, an OPEN macro instruction must open the DCB (data control block) for that data set. When a processing program issues an OPEN macro instruction, the open routine of the control program:

- Verifies the mounting of volumes.
- Merges data set attributes from the data definition (DD) statement into the control blocks.
- Determines access method routines.

Close Processing: After processing has been completed for a data set, a CLOSE macro instruction must close the DCB for that data set. When a processing program issues a CLOSE macro instruction, the close routine of the control program:

- Processes input and output labels.

- Disposes of volumes.
- Restores the DCB to its original condition by removing the information that was merged from the DD statement.

End-of-Volume Processing: EOV (end-of-volume) processing is performed when end-of-data set or end-of-volume conditions occur during I/O operations on sequentially organized data sets. When a routine of a sequential access method encounters a tape or file mark (end-of-data set) or an end-of-volume condition, the routine issues a supervisor call instruction to pass control to the EOV routine.

Recovery Management

A failure of the system, whether during the development of new programs or while processing jobs, can result in a loss of productivity. To protect against, or at least to diminish the effects of, a failure, RAS (reliability, availability, and serviceability) facilities interact with the control program. RAS facilities attempt to retry or bypass machine malfunctions that result in system failure.

Recovery management is a RAS service in VS1 that reduces the damaging effects that a computer, channel, or I/O device malfunction might otherwise have on a program in process.

These programs provide recovery management services:

MCH (Machine-Check Handler) processes machine-check interruptions. Depending on the severity of the malfunction, MCH:

1. Restores the system to normal operation, or
2. Terminates tasks associated with the malfunction so the system can resume processing, or
3. Places the system in the wait state.

In all cases, MCH writes diagnostic messages and error records. These records are placed in the SYS1.LOGREC data set.

CCH (Channel-Check Handler) receives control after the detection of a channel data check, channel control check, or interface control check. For channel control checks and interface control checks, CCH:

1. Indicates the results of the analysis of the error for later use by the error recovery procedures when they set up for a retry of the I/O operation.
2. Constructs a record of the error environment. When this record is later recorded, a message is issued to inform the operator that a channel-detected error has been recorded on SYS1.LOGREC.

For channel data checks, CCH constructs a record of the error. The error recovery procedures do not require information from CCH to retry I/O operations on which channel data checks occurred.

APR (Alternate Path Retry) permits an I/O operation that has developed an error on one channel path to be retried on

another channel path (if another channel path is assigned to the device performing the I/O operation). APR also provides the capability to vary a path to a device online or offline.

DDR (Dynamic Device Reconfiguration), upon receiving a request from the operating system or from the operator, permits a demountable volume to be moved from one device to another and repositioned, if necessary. This method is used to bypass various I/O errors, and is done without abnormally terminating the affected job or reperforming an IPL (initial program load).

MIC (Missing Interruption Checker) polls active I/O operations to determine if a channel end and/or device end interruption has been pending for more than an installation-specified period of time. Also, it provides a reminder message for mount requests.

Other RAS components available with VS1 to enhance the continuous operation of a system include OLTEP (online test executive program), DSS (dynamic support system), PWF (power warning feature), checkpoint/restart, and TOLTEP (teleprocessing online test executive program). For a description of these components, see "VS1 Standard and Optional Features" in this section.

Service Aids

A variety of programs that diagnose system or application program failures is available with VS1. The service aids described below are standard features.

GTF (Generalized Trace Facility)

GTF is a debugging tool that can be used to trace software behavior (system or problem program). GTF uses a hardware instruction (monitor call) to detect system events and to create trace records. Problem programs may also use a GTF macro instruction (GTRACE) to record problem program data in the trace data set.

GTF lets the user single out those programming activities he wishes traced within the system, including such things as I/O interrupts for all or specific devices, all program interrupts or only specific program interrupts, and all or only specific supervisor call interrupts.

The output from GTF is a trace data set that can be used with a data reduction program to edit the data set. The data reduction program enables the system to format specific trace activities. It operates as a problem program that can be called via the job control language.

HMBLIST Program

This service aid is a problem program that assists in problem determination by printing:

- A formatted listing of linkage editor/loader input and output (that is, object and load modules).

- A cross-reference listing of symbolic references within a load module without reprocessing that module through the linkage editor.
- A formatted listing of information in a module's CSECT (control section) IDR (identification record).
- A formatted listing of all program modifications for a load module or library.
- A map of a system's nucleus.

HMASPZAP Program

This service aid is a problem program that allows the user to inspect and modify data at the time a problem is diagnosed. Various combinations of the control statements for this service aid enable the user to:

- Inspect and modify instructions and data in any load module that exists as a member of a partitioned data set.
- Inspect and modify data in a specific data record that exists in a data set residing on a DASD (direct access storage device).
- Dump an entire data set, a specific member of a partitioned data set, or any portion of a data set residing on a DASD (direct access storage device).
- Update the system status index (SSI) in the directory entry for a load module.

HMSADAMP Program

The standalone dump service aid provides the user with a flexible, installation-tailored dump facility. It generates one of the following types of dump programs:

- The low-speed dump program dumps the contents of real storage to a printer or tape. The dump output is translated and unblocked. Output that is directed to tape can be printed by the print dump service aid or the IEBPTPCH utility program.
- The high-speed dump program dumps the contents of real storage to tape. Optionally, it can also produce dumps of page data sets. The dump output is in large, untranslated hexadecimal blocks. The HMDPRDMP service aid must be used to format, translate, and print the output.

HMDPRDMP Program

The print dump service aid is a problem program that formats and prints the contents of the standalone dump output data set, the SYS1.DUMP data set, and the GTF output data set. The user can supply control statements that control print dump output. Some of the areas and traces that can be printed are:

- Queue control block (QCB) trace
- System control blocks for all active tasks

- Allocated virtual storage
- Virtual storage ranges
- Real storage ranges
- Page data set records
- System nucleus

HMAPTFLE Program

This service aid is a problem program used to apply program temporary fixes (PTF). It generates control statements and applies PTFs in one operation. It produces the JCL and control statements needed to apply PTFs. The JCL must be executed in a later, separate step.

IMCJOBQD and IMCOSJQD Programs

The job queue dump service aid programs produce a formatted copy of the resident job list, system job queue data set, system scheduler work area data set, and scheduler work area data sets. The user can dump each of these control areas in its entirety or can specify certain sections to be dumped.

The two job queue dump programs are a standalone program and a system-assisted program. IMCJOBQD, the standalone program, provides a dump facility after system failure, and it also preserves the status of system queues at the time of system failure. IMCOSJQD, the system-assisted program, can run concurrently with other jobs, and it enables you to re-IPL using different volumes for SYS1.SYSJOBQE and SYS1.SYSWADS, while dumping the previous queues.

HMASMP Program

The SMP (system modification program) service aid enables you to either apply to or remove from a VS1 system IBM-issued modifications or your own modifications. You can apply or remove the modifications either selectively or in a group.

SMP performs these major functions:

- Checking the modification input for accuracy and determining whether a particular modification applies to your system.
- Putting IBM or user modifications into the operating system, distribution, or user library.
- Removing IBM or user modifications from the system.
- Maintaining records of the content and status of your system by creating a record of all the modules and macros in your system. As you make modifications, SMP adds records of these changes.
- Maintaining an audit trail of system modifications by means of time-stamped and date-stamped records kept in a history log.

Additionally, SMP can print the contents of the input data (modifications) or any of the SMP primary data sets.

Methods of Storing and Retrieving Data

The variety of techniques for gaining access to a data set is derived from two variables: data access technique and data set organization.

Access Techniques

The data management programs provide two general techniques for moving data: the queued technique and the basic technique. The queued technique offers you the maximum amount of automatic I/O facilities. The basic technique places some of the responsibility for data handling on the programmer, but gives him more direct control of I/O operations.

Queued Access Technique: When using the queued access technique, you can concentrate on data processing alone; the data management routines handle most I/O considerations. For example, I/O is automatically synchronized with processing. When you issue a GET macro instruction, the desired record is already in an input buffer, so processing can continue without delay. When a buffer is empty, the data management routines automatically refill it. The same principle applies for output records (PUT macro). They are collected in an output buffer and written when the buffer is full. When operating under a priority scheduling system, and if output is directed to a system output class (a class of system output units shared by all jobs), data is first written on a direct access device. When scheduling permits, the writer transfers the data to the proper device.

Because the queued access technique brings records into virtual storage before they are actually needed, the data management programs need a method of anticipating the user's demands. Therefore, the queued access technique can be used to retrieve only records in a sequential order, for example, records on magnetic tape.

Basic Access Technique provides the READ and WRITE macro instructions for input and output. These instructions move blocks, not records. As with the queued access technique, actual transmission to a specified device may be deferred and done by the writer when working under a priority system and output is going to a system output class.

Unlike the queued technique, the basic technique does not provide automatic synchronization of program processing and I/O. When issuing a READ, you cannot assume that the record is in virtual storage as you can assume with GET. You must determine that the I/O operation has been completed before attempting to use the desired record. Data management provides macro instruction facilities to

check for successful completion of I/O operations and, if necessary, to wait for their completion.

Access Methods

The basic access methods are used for all data organizations while the queued access methods apply only to sequential and indexed sequential data sets as shown in Figure 4-3. The new access method, VSAM, employs a modified basic and queued access technique and applies to direct and sequential data sets.

Data Set Organization	Access Technique	
	Basic	Queued
Sequential	BSAM	QSAM
VSAM	VSAM	VSAM
Partitioned	BPAM	----
Indexed Sequential	BISAM	QISAM
VSAM Key - Sequenced	VSAM	VSAM
Direct	BDAM	----
VSAM Entry - Sequenced	VSAM	VSAM
Graphics	GAM	----

Figure 4-3. Data Management Access Methods

VSAM (Virtual Storage Access Method) is used with direct access storage devices on the IBM System/370 with VS1. It creates and maintains two types of data sets. One is sequenced by a key field within each record and is called a key-sequenced data set. Data records are located by using the key field and an index that records key fields and the address of the associated data, similar to ISAM (indexed sequential access method). The other is sequenced by the time of arrival of each record into the data set and is called an entry-sequenced data set. Data records are located by using the record's displacement from the beginning of the data set. The displacement is called the RBA (relative byte address). The RBA is similar to the relative block address used with BDAM (basic direct access method).

VSAM stores, retrieves, and updates user data records in these types of device independent data sets. VSAM stores data records in a new data format designed for long-term data stability and for data base applications. Data in both types of data sets can be accessed either sequentially or directly.

VSAM enhances many ISAM capabilities, including device independence, concurrent processing, data portability, and kinds of accessing supported. VSAM provides multiple

levels of password security protection. It creates and maintains separate VSAM catalogs that contain specialized information about each VSAM data set and link data sets with their indexes.

VSAM provides a multifunction service program that defines, deletes, prints, copies, and provides backup and portability of VSAM data sets and maintains separate catalogs. An interface routine, ISAM interface, which allows most existing ISAM programs access to VSAM data sets, is also provided.

Note: To use ISAM interface, you must convert both the ISAM JCL to VSAM JCL and the ISAM data set to VSAM.

For further information about VSAM, see the publication *OS/VS Virtual Storage Access Method (VSAM) Planning Guide*, GC26-3799.

Basic Access Methods: The basic access methods and their functions are:

- **BSAM** (basic sequential access method) sequentially organizes data and stores or retrieves physical blocks of data. The READ/WRITE macro instructions cause the initiation of an I/O operation. The completion of these operations is tested by using synchronization macro instructions. Automatic translation between EBCDIC and ASCII codes is provided for magnetic tape labels and record formats.
- **BDAM** (basic direct access method) organizes records within a data set on direct access volumes in any manner the programmer selects. Storage or retrieval of a record is by actual or relative address within the data set. This address can be that of the desired record, or a starting point within the data set, where a search for the record based on a key furnished by a programmer begins. BDAM also uses addresses as starting points for searching for available space for new records.
- **BISAM** (basic indexed sequential access method) stores and retrieves records randomly from an indexed sequential data set. It reads selectively by using the READ macro instruction and specifying the key of the logical record to be retrieved. You can replace individual records or add new records randomly.
- **BPAM** (basic partitioned access method), when used in conjunction with BSAM, can efficiently store and retrieve discrete sequences of data (members) belonging to the same data set on a direct access device. Each member has a simple name. The data set includes a directory that relates the member name with the address where the sequence begins. You can add members to a partitioned data set as long as space is available. (BPAM is usually used to store or retrieve programs.)

Queued Access Methods: The queued access methods and their functions are:

- **QSAM** (queued sequential access method) organizes data sequentially. It retrieves and stores logical records as requested. QSAM anticipates the need for records based on their sequential order, and normally has the desired record in virtual storage, ready for use, before the request for retrieval. When writing data, the program normally continues as if the record had been written immediately, although QSAM's routines may block it with other logical records, and defer the actual writing until the output buffer has been filled. Automatic translation between EBCDIC and ASCII codes is provided for magnetic tape labels and record formats.
- **QISAM** (queued indexed sequential access method) creates an indexed sequential data set and retrieves and updates records sequentially from such a data set. Synchronization of the program with the completion of I/O transfer and record blocking/deblocking are automatic. With QISAM you can also reorganize an existing data set.

Teleprocessing Access Methods: The teleprocessing access methods are:

- **BTAM** (basic telecommunications access method)
- **TCAM** (telecommunications access method)
- **VTAM** (virtual telecommunications access method)

These access methods are described in this section under "Teleprocessing."

Teleprocessing

Teleprocessing refers to a large variety of data processing applications in which data is received from or sent to a central data processing system over communication lines, including ordinary telephone lines. Usually the source or destination of the data is remote from the central processing system, although it can be in the same building. In any event, the source or destination points of the data are often called terminals or (for some applications) workstations.

A terminal, or workstation, can have one I/O device or a combination of I/O devices. A large variety of such devices is available for use at remote terminals. These include special keyboards, graphic display devices, printers, and card read-punch units. In addition, a remote terminal may be represented by another data processing system.

A teleprocessing program for most applications is normally divided along functional lines into two parts: a message control program and a message processing program. Message is the traditional name for a unit of information that is transferred to or from a remote terminal via telecommunication lines.

Users of TCAM (telecommunications access method) message control programs and message processing programs under MFT must reassemble/recompile their programs before they can run under VS1.

Message Control Programs

The main function of a message control program is to control the transmission of information between a message processing program in the central computing system and I/O devices at remote terminals. In this respect it performs much the same function as access method routines that control the transmission of information between an ordinary processing program and local I/O devices. For this reason, routines that IBM provides for use in creating a message control program are also called access method routines.

The three sets of such routines are:

- VTAM (virtual telecommunications access method)
- TCAM (telecommunications access method)
- BTAM (basic telecommunications access method)

VTAM (Virtual Telecommunications Access Method) is a direct-control access method that enables application programs to control VTAM terminals without concern for intermediate connections, such as control units and telecommunication lines. It is designed to use advanced hardware and software including System/370 virtual storage, the IBM 3704 and 3705 Communications Controllers, the OS/VS1 operating system, and the teleprocessing subsystems that use the SDLC (synchronous data link control) line discipline.

With VSAM (virtual storage access method), VTAM can be used to provide a complementary data base/data communication facility. In addition to its primary role of data transmission, VTAM has features that establish it as a base for building small to large telecommunication systems. These features are:

- Sharing of network resources, which reduces line costs and makes more efficient use of the network.
- Concurrent execution of TCAM and VTAM application programs using the same telecommunication network.
- Services required for interactive applications such as online inquiries and updates.
- Operation with the IBM 3704 and 3705 Communications Controllers to reduce the number of functions performed in the central computer for remote devices.
- Generation options for tailoring the telecommunication system to the user's needs.
- Support for industry-oriented teleprocessing subsystems such as the IBM 3600 Finance Communication System.
- RAS (reliability, availability, and serviceability) aids to assist in reducing both the incidence of errors in the

telecommunication system and the impact of errors that do occur, and in maintaining the telecommunication system.

TCAM (Telecommunications Access Method) is a generalized IOCS (input/output control system) that extends the techniques of logical IOCS to the telecommunication environment. Data sets accessed by the problem program are queues of messages coming in from, or going out to, remote terminals via communication lines.

TCAM furnishes far more than the control for I/O operations. In addition to supporting the transfer of messages between the terminal and user-written application programs, TCAM provides a high-level, flexible, message control language. (Data enters a telecommunication system in the form of messages.) You can use TCAM macro instructions to construct an installation-oriented message control program that controls the flow of message traffic from one remote terminal to another (message switching application), and between remote terminals and any application programs (message processing applications).

A telecommunication control system created through the use of the TCAM message control language:

- Establishes contact and controls message traffic between the computer and terminals.
- Deletes and inserts line-control characters automatically, thereby removing line-control from the user's domain.
- Dynamically assigns and uses buffers as required.
- Edits incoming and outgoing messages (for example, code translation and insertion of new fields in message headers).
- Forwards messages to destination terminals and application programs.
- Takes corrective action and provides special handling for messages containing errors.
- Maintains statistical information about message traffic and system components.

BTAM (Basic Telecommunications Access Method) is for limited applications that do not require the extensive TCAM message control facilities, and for applications that require special user facilities.

The BTAM facilities provide the means to design and construct almost any teleprocessing application. These include facilities for creating terminal lists and performing the following operations:

- Polling terminals
- Answering and initiating calls
- Receiving and transmitting messages
- Translating line codes
- Addressing terminals

- Online testing
- Changing the status of terminal lists
- Error recording and handling

Message Processing Programs

A program that processes or otherwise responds to messages received from remote terminals must be designed for a specific application. In designing the program, all of the facilities of VS1 are available. The program processes messages sequentially by a single task, or it processes more than one message concurrently by separate tasks. In many applications, a message processing program requires access to data or routines stored in local direct access storage. In such applications it is possible for separate tasks to process several messages concurrently. As the processing of one message is delayed while access is being gained to direct access storage, another message can be processed.

Specific Teleprocessing Applications Provided by IBM

A number of specific teleprocessing applications have been designed by IBM and are available as optional VS1 features. These include:

- RES (remote entry services)
- CRJE (conversational remote job entry)
- Graphic programming services
- Industry-oriented teleprocessing systems

RES (Remote Entry Services) extends the functions of JES (job entry subsystem) so that the batch computing facilities of VS1 can be made available to users at remote terminal (workstation) devices. RES allows jobs to be submitted from these remote workstations and the output from these jobs to be routed back to the originating location and/or to other workstations. Transmissions are made via communication lines. More users, therefore, would have direct access to a central computing system for job processing.

In a RES environment, you can submit jobs (one or more at a time) from a remote workstation directly into the central computer, thus bypassing the usual procedure of submitting jobs through the computing center to the computer via the system operator.

The only teleprocessing access method used by RES is RTAM (remote terminal access method). RTAM must be specifically included by a separate RTAM generation.

CRJE (Conversational Remote Job Entry) is an optional VS1 facility that enables remote users to enter jobs for batch processing using keyboard terminals. You can enter jobs conversationally by carrying on a dialogue with the central computing system.

Remote job input consists of programs and data that you create at the terminal. Typed lines of program source

statements, data, and job control statements are collected within the system; there is thus no need for keypunching, and there is no wait for operator handling or card reading. Simple error-correction procedures enable you to enter data correctly and easily.

Job turnaround time is greatly reduced because data is transmitted directly between the central processor and the terminal. To submit a job for execution, you select the program, data, and job control statements that are to be entered in the job stream. When the job is completed, you can examine the output at your terminal or have it directed to a system output device.

Graphic Programming Services handle graphic input and output and include macro instructions and problem-oriented routines to be used as building blocks in the construction of graphic processing programs. It also includes the graphic access method (GAM) that supports the IBM 2250 and 2260 Display Units.

You can create a display on one or more 2250 Display Units (Models 1 and 3) through the services of the graphic subroutine package (GSP). The displays produced consist of any figure that can be constructed with points, lines, arcs, and characters.

Industry-Oriented Teleprocessing Systems have been developed to perform the data processing requirements for specific industries, such as banking and food distribution. These systems, when attached to a central computing system, have teleprocessing capabilities. Among these specialized systems are:

- 3600 Finance Communication System
- 3650 Retail Store System
- 3660 Supermarket System

VS1 STANDARD AND OPTIONAL FEATURES

Some of the standard and optional features available with VS1 are listed alphabetically in Figure 4-4.

A feature is standard if it is automatically resident in the system after system generation. That is, no special user-system interaction is required to make the feature operational. An optional feature, on the other hand, is a feature that requires a user-supplied triggering device (such as specifying a certain parameter in a macro instruction) to make it available or operational in the system.

A brief functional description of some of the more significant features available with VS1 follows Figure 4-4.

APF (Authorized Program Facility)

The authorized program facility (APF) allows your installation to control access to restricted system functions and (optionally) user functions by maintaining an authorization list that identifies the modules that are permitted to use

VSI Features	Status	
	Standard	Optional
Alternate Path Retry (APR)	X	
Attach Function	X	
Attach Function Made Resident	X	
Authorized Program Facility (APF)	X	
Automated System Initialization (ASI)	X	
Automatic Partition Redefinition	X	
Automatic Volume Recognition (AVR)		X
Basic Direct Access Method (BDAM)	X	
Basic Indexed Sequential Access Method (BISAM)		X
Basic Partitioned Access Method (BPAM)	X	
Basic Sequential Access Method (BSAM)	X	
BLDL Table		X
Channel Check Handler (CCH)	X	
Checkpoint/Restart Facility		X
Consoles - Alternate and Composite Consoles Options		X
Consoles - Multiple Consoles Support (MCS)		X
Conversational Remote Job Entry (CRJE) Facility		X
DEB Validity Checking	X	
Device Independent Display Operator Console Support (DIDOCs)		X
Direct Access Volume Serial Number Verification	X	
Distributed Intelligence System		X
Dynamic Device Reconfiguration (DDR)	X	
Dynamic Dispatching		X
Dynamic Support System (DSS)	X	
Extended Fixed List	X	
Extended Timer Option		X
Extract Function Made Resident	X	
Fetch Protection		X
Graphic Programming Services		X
Greenwich Mean Time (GMT)	X	
IBM 3600 Finance Communication System Support		X
Identify Function Made Resident	X	
Indexed Sequential Access Method (ISAM)		X
I/O Load Balancing		X
Job Log Facility		X
Job Step Timing	X	
Machine Check Handler (MCH)	X	
Missing Interruption Checker	X	
Multiple Wait Option	X	
Online Test Executive Program (OLTEP)	X	
PAGETUNE Command	X	
Partition Deactivation/Reactivation		X
Power Warning Feature (PWF)		X
Program Controlled Interrupt (PCI) Fetch		X
Queued Indexed Sequential Access Method (QISAM)		X
Queued Sequential Access Method (QSAM)	X	
Reenterable Load Modules Made Resident	X	
Resident Access Method Routines	X	
Resident Job List	X	
Remote Entry Services (RES)	X	
Remote Terminal Access Method (RTAM)		X
Scheduler Work Area (SWA)	X	
Selective Posting	X	
Shared DASD		X
SPIE Routines Made Resident	X	
Storage Protection Option	X	
System Log		X
System Management Facilities (SMF)		X
System Modification Program (SMP)	X	
Telecommunications Option (BTAM, TCAM, VTAM)		X
Teleprocessing Online Test Executive Program (TOLTEP)		X
Time-Slicing Facility		X
Trace Option		X
Transient SVC Table		X
Types 3 and 4 SVC Routines Made Resident		X
User Modify Logical Cylinder Facility		X
User-Added SVC Routines		X
Validity Check Option	X	
Virtual Storage Access Method (VSAM)		X
Volume Statistics Facility		X

Figure 4-4. VSI Standard and Optional Features

restricted functions. This feature improves system integrity by ensuring the preservation of programs for their intended use.

AVR (Automatic Volume Recognition)

The automatic volume recognition (AVR) feature issues volume-mounting instructions to the operator to minimize the time lost in performing job setups. The operator can premount labeled volumes on any available tape or disk device. AVR automatically records in a table the identification of the volume and the device used.

When a particular volume is needed for job setup, AVR searches the table containing the volume information. If the required volume is already mounted, the usual procedure of issuing a volume-mounting message is bypassed. This feature is advantageous in installations where work schedules are normally set in advance and follow a repeated pattern.

Automated System Initialization

The automated system initialization standard feature makes the system initialization process faster and more flexible and rapid. It significantly reduces the operator's role in the initialization process. Flexibility comes from the use of a data set (SYS1.PARMLIB), or card reader, to hold control statements that contain the system initialization parameters. By defining the proper set of parameters, each initialization tailors the system to better meet the needs of the anticipated job mixture.

System initialization is faster when this automated feature is used because the operator simply enters a reference (via the console) to the appropriate list in SYS1.PARMLIB or the card reader. Automated system initialization can also be invoked automatically by specifying the AUTO parameter at SYSGEN time. Formerly, the operator manually entered all of the needed parameters via the console.

BLDL Table

The BLDL Table is a list of the track addresses of user-specified module names in SYS1.LINKLIB and/or SYS1.SVCLIB. The table reduces the time required to find the listed modules on these libraries. The user has the option of making the BLDL Table fixed in real storage.

Checkpoint/Restart

The checkpoint/restart facility provides an opportunity to restart a job that terminates abnormally due to a hardware, programming, or system error. The restart is permitted either at the beginning of a job step or at a checkpoint within a job step. In either case the restart can be automatic or you can defer it until the job is resubmitted.

Consoles—MCS (Multiple Console Support)

MCS enables an installation to use one primary (or master) console and multiple secondary consoles. These secondary consoles can be dedicated to one or more system functions such as a tape library, disk library, or teleprocessing control. MCS services all consoles concurrently, creating an environment for operator-system interaction that gives each console the appearance of being the only console on the system. Each console operator receives only those messages from the system that are related to the commands that he enters and to his assigned functions. MCS:

- Routes messages to selected functional areas.
- Allows a user-written exit routine to modify the message's routing and description codes before the message is issued.
- Switches to an alternate console if a primary console should fail.
- Allows automatic message deletion on devices such as display tubes (graphics).
- Supports a hard-copy log for the recording of routed messages, operator commands, and system responses.

Distributed Intelligence System

Distributed Intelligence System is a separately ordered feature that permits several System/7 processors to be combined into a network with a System/370 operating system. The network offers the computing power and bulk storage of a System/370 linked with the rapid response and the sensor attachments of one or more System/7 processors. Up to 64 System/7 processors can be connected to the System/370 through one IBM 5098-N5 sensor-based control unit. The number of 5098-N5's that can be attached to a System/370 depends on the storage, processing, and physical attachment capabilities of the System/370.

All the processors within the Distributed Intelligence System network function together as one single processor. An event at either a System/7 or at the System/370 can trigger one or more of these actions at any computer in the network:

- Loading and executing programs in any computer attached to the network.
- Moving data from one computer to another or from one location to another within a computer.
- Reading data from a System/370 storage device to any computer within the network.
- Writing data to a System/370 storage device from any computer within the network.
- Communicating with a console printer from any computer within the network.

DIDOCS (Device Independent Display Operator Console Support) and SDS (Status Display Support)

DIDOCS provides uniform operator console support for a range of display devices. DIDOCS may be included in a system only when a display console and multiple console support (MCS) are specified.

DIDOCS enables you to:

- Display messages from the VS1 control program and problem program on the display console device.
- Enter commands from the display console to the control program via the alphanumeric keyboard and/or light pen, when available.
- Display out-of-line status displays as requested by the status display support.

SDS (status display support) provides for the presentation of information to a system operator clearly and understandably. It also provides the ability for messages sent to a display device to be displayed out of line in a special area of the screen. This allows related messages to be grouped together and easily read by the operator.

Dynamic Dispatching

Dynamic dispatching helps provide optimum use of CPU and I/O resources by altering the dispatching priorities of selected tasks while they are executing, so they can more efficiently use the system's resources.

The dispatching priorities for selected tasks indicates the task's requirements for I/O and CPU time. These dispatching priorities are calculated by an algorithm that distinguishes between I/O bound tasks (higher priority) so that the CPU is available to perform other tasks. Not all tasks must execute under dynamic dispatching. Thus you can specify dynamic dispatching for only some of your partitions.

DSS (Dynamic Support System)

DSS (dynamic support system) is a debugging program that assists the IBM program support representative and user-authorized maintenance personnel to identify and correct causes of programming failures. DSS requires the program event recording (PER) hardware feature of the System/370.

DSS has its own I/O capability and has access to both real and virtual storage. When executing, DSS has control of the system. It can gain control from, and return control to, VS1 via its own monitoring functions.

Because DSS takes control of the system on each activation, time dependencies cannot be maintained. Therefore, DSS should not be used while a time-dependent program, such as teleprocessing, is running.

Although DSS can make changes, the changes are not permanent. Any modifications made to the system are not

carried over to the next IPL. Also, DSS cannot modify itself, IPL, or NIP.

Extended Timer Option

The extended timer option offers more extensive interval timing services than are available with the standard interval timer. It can be used to establish multiple time intervals that can be active at the same time.

The feature is restricted to System/370 models having the CPU timer and clock comparator.

Fetch Protection

Fetch protection provides security for user data by preventing unauthorized or unintentional access to a user's area of storage by other than the intended user. This protection includes the entire dynamic storage area (virtual storage partitions assigned to job steps and system tasks) and all nonkey-0 subpools.

IBM 3600 Finance Communication System Support

The 3600 is a teleprocessing system developed specifically for the finance industry to help perform the varied data processing transactions in a financial institution. The 3600 system is made up of financial products and general-purpose data processing products, which together form a data processing system with three parts:

1. Controller and terminals.
2. Communication link.
3. Central computing system.

The controller in the 3600 system is the IBM 3601 Finance Communication Controller. The 3600 system terminals are the IBM 3604 Keyboard Display, the IBM 3610 Document Printer, the IBM 3612 Passbook and Document Printer, the IBM 3618 Administrative Line Printer, and the IBM 3614 Consumer Transaction Facility.

The communication link in the 3600 system allows data transmission between the 3601 Finance Communication Controller or the 3614 Consumer Transaction Facility and the central computing system. The communication link is made up of a telecommunication line, a pair of modems, and an IBM 3704 or 3705 Communications Controller. The 3704 (or 3705) is a programmable transmission control unit that directs telecommunications between the 3601 controller or the 3614 terminal and the central computing system.

The central computing system processes financial transactions in coordination with the 3601 Finance Communication Controller, with which it exchanges data over the communication link, or in conjunction with the 3614 Consumer Transaction Facility attached directly to the communication link. The CPU of the central processing

system can be any one of the following System/370 models with the relocate feature: 135, 138, 145, 148, 155 II, 158, 165 II, or 168. The CPU must have at least 256K bytes of real storage.

I/O Load Balancing

I/O load balancing allocates data sets to devices in such a way as to attempt to equalize the amount of I/O contention on each device. The devices are selected for allocation of data sets by considering many variables. By monitoring the speed of the device, counting the number of I/O events to each device, and comparing the different characteristics of different devices, I/O load balancing selects the best device available. If space is not available on that volume, load balancing selects the next best choice.

I/O load balancing can be used only for nonspecific requests (that is, where no volume serial number or device address is specified).

Job Log Facility

Operating systems that have the job log feature specified collect WTO's (write-to-operator), WTOR's (write-to-operator-with-reply), replies to WTOR's, and WTL's (write-to-log) (if SYSLOG is inactive) for each job and include them in the job's printed output. When a multiple-line WTO is issued, only the first line is included in the job log.

OLTEP (Online Test Executive Program)

You can use OLTEP to:

- Diagnose I/O errors.
- Verify I/O device repairs.
- Verify engineering changes.
- Check the operation of devices periodically.
- Verify the integrity of customer data.

You can use OLTEP without relinquishing control of the system and with minimum interference to other jobs that are running.

PAGETUNE Command

The PAGETUNE command allows a knowledgeable system programmer to tune the paging algorithm to meet the changing demands of a multipartition system. A system programmer who understands the operation of the page supervisor should determine if, when, and how to use the PAGETUNE command. For example, if an installation is teleprocessing oriented during one shift but batch oriented during another, the installation may decide to alter the VS1 paging algorithm to smooth the online transition from one state to another.

The system programmer should select the PAGETUNE options necessary to meet the installation needs and give direction to the operator entering the command. The

PAGETUNE command can also be automatically executed when the automated system initialization process is used. Briefly, the PAGETUNE command enables you to:

- Alter the page supervisor task deactivation mechanism.
- Alter the page supervisor page replacement algorithm.
- Suspend the task deactivation mechanism.
- Alter realtime intervals associated with the task reactivation function.
- Reset a modified paging algorithm being used by the VS1 paging algorithm.
- Display certain values or parameters being used by the VS1 paging algorithm.

Partition Deactivation/Reactivation

With this VS1 feature, the operator can control the deactivation and reactivation activity of the page supervisor. Task deactivation is necessary to prevent the phenomenon known as thrashing. The term thrashing can be defined as excessive overhead and severe performance degradation caused by nonproductive paging activity. Thrashing is induced when the amount of real storage available is insufficient to contain the space requirements of active tasks. To prevent thrashing, the page supervisor must be able to deactivate active tasks. Therefore, the operator must never define all active partitions ineligible for deactivation.

Declaring a partition ineligible for deactivation is useful whenever a partition is to run a critical job or online teleprocessing application. Operator-initiated task reactivation can be beneficial, for example, should a currently deactivated job have to meet a certain deadline. The operator can exercise one of a number of options available for deactivating or reactivating tasks.

The operator, at IPL time, can vary the time function of task reactivation from 0 to 9 seconds. This specified value is used by the page supervisor at system wait time in an attempt to reactivate the highest-priority partition currently deactivated. Task reactivation is executed whenever the specified time interval has elapsed, the paging rate has diminished to zero, and sufficient storage has become available to reinstate the deactivated task.

PWF (Power Warning Feature) Support

Power warning feature (PWF) support, with its associated hardware, prevents the loss of information that is in real storage when a utility power disturbance occurs. The hardware includes an uninterruptible power supply (UPS), which provides alternate power, and equipment to signal the PWF routines when a disturbance occurs.

PWF support, after receiving the signal of a power disturbance and determining the significance of the disturbance, can transfer the contents of real storage to disk storage. After utility power is restored, you can use the

power warning feature support restore routine to refresh the contents of real storage from disk.

PWF support requires that a system have the following features:

- The uninterruptible power supply (UPS), which supplies power to a critical subset of a system for a minimum of 1 second per 100K bytes of real storage.
- A power line disturbance detector, which, after detecting a disturbance, sends a signal to PWF.
- A power warning feature, a separately ordered IBM feature that causes a machine check (power warning interrupt) when signaled that a disturbance has occurred.
- Two data sets, called *warn data sets*, which are allocated, cataloged, and mounted on two disk drives of the same model.

SWA (Scheduler Work Area)

Scheduler work area (SWA) is an area in virtual storage that contains the scheduler tables (formerly written to SWADS) from DASD. The choice between the tables being on SWADS or in SWA is on an initiator basis and is controlled by the system programmer (via the initiator procedure EXEC statement PARM field) or by the operator (via overriding the PARM= field in the START command). There is one SWA for each initiator.

Shared DASD (Direct Access Storage Device)

The shared DASD option allows one or more direct access storage devices to be shared between two or more CPU's when the drives are connected to a control unit that has a path to each CPU. This feature allows access to the devices through separate channels connected to separate CPU's.

Systems can share common data and consolidate data when necessary; no change to existing records, data sets, or volumes is necessary.

Sharing is accomplished by a two-channel or four-channel switch that allows a shared control unit to be switched between two channels from different systems. The VS1 control program controls the use of a shared device so that data being used in one CPU is protected from modification by a program in another CPU, and so that access-arm contention between CPU's is minimized.

The shared DASD facility can be included in a system only at system generation time.

Storage Protection Option

Storage protection keys are assigned to 2K areas of storage that are designated for use by either the system (storage protection key of 0) or problem programs (storage protection keys of 1-15). This feature prohibits the modification, by a problem program, of areas of storage other than those identified with the problem program's storage

protection key. The system has access to all allocated storage protection keys and may, on occasion, use non-key-0 areas.

System Log

The system log consists of two SYSOUT data sets on which the communications between the programmer and/or operator and the system are recorded.

Several kinds of information can be recorded in the system log:

1. Job time, step time, and data from the job and execute statements of a job that has ended can be written in the log. This information is entered in the log by the user's own accounting routine.
2. Operating data entered by problem programs using a write-to-log (WTL) macro instruction can be written in the log.
3. Operators can record in the log descriptions of unusual events that occur during processing.
4. Write-to-operator (WTO) and write-to-operator-with-reply (WTOR) may be recorded in the log on systems with the multiple console support option when the system log (SYSLOG) is specified as the hard-copy device. This includes the routing codes used to route the messages and the time the message was executed.
5. Commands issued through the operator's consoles and the input stream, and commands issued by VS1 and responses can be entered in the log in systems with multiple console support when the system log is specified as the hard-copy device.

When one of the system data sets is filled, VS1 writes it out. The operator, at any time, may also write out the system log.

SMF (System Management Facilities)

System management facilities (SMF) collects and, optionally, records system, job management, and data management information on a DASD file. It also provides control program exits to installation-supplied routines that can periodically monitor the operation of a job or job step.

SMF collects information such as:

- System configuration
- Job and job step identification
- CPU wait time
- CPU time used by each job and job step
- Virtual or real storage requested by each job step
- Virtual or real storage used for each job step
- Paging statistics on a job step and system basis
- I/O device use by each job step
- Temporary and nontemporary data set use by each job and job step

- Temporary and nontemporary data set status
- VSAM data space status
- Status of removable direct access volumes
- Input count by each job and job step
- Output count by each job
- Output writer records by each job
- Allocation recovery records by each job
- Vary online and offline records

It is possible to suppress the writing of all or selected SMF records at IPL time.

The SMF exits to installation-written routines allow certain parameters to be passed to them to identify the job and job step being processed and to provide accounting and operating information. These exit routines can cancel jobs, write records to the SMF data set, open and use their own data sets, and suppress the writing of certain SMF records.

Time-Slicing Facility

The time-slicing facility permits each task of a specified priority to have control of the CPU for a given time. Normally, a task maintains control either until it is complete, until a higher-priority task becomes ready, or until it must wait for some event (such as an I/O operation). With time-slicing, a group of tasks share the CPU, each for the same fixed time. As soon as one task has used its allotted time, control is passed to the next-ready task in the time-slice group. (This, of course, is contingent on no other task outside of the time-slice group having a higher priority and being ready for execution.)

When a time-sliced task loses control before the expiration of its time (either because it must wait or because a higher-priority task acquires the CPU), the remainder of the time is not saved. When control is returned to the time-slice group, the next task is dispatched, not the task that lost control.

TOLTEP (Teleprocessing Online Test Executive Program)

TOLTEP for VTAM is the interface between online test programs (OLT), the operating system, and devices allocated to VTAM. You can use TOLTEP to:

- Perform preventive maintenance.
- Perform problem determination.
- Diagnose I/O errors.
- Verify device repairs and engineering changes.

TOLTEP is included in the system when VTAM is generated. It runs as a task of VTAM and resides in the VTAM region. TOLTEP can run concurrently with OLTEP (online test executive program) and can be invoked by more than one user at the same time.

SUPPORT PROGRAMMING

A wide selection of support programs is available with VS1. The processing programs are designed to reduce the time, training, expense, and manpower required to design and code efficient problem-state programs.

System Assembler

The OS/VS1 System Assembler is the only language translator that is a standard SCP component of VS1. It is a macro assembler that enlarges the language now available under OS for System/360 Assembler F and provides improved messages to diagnose user errors. The language supported by the System Assembler is compatible with that supported by Assemblers E and F. In addition, it is a subset of, and compatible with, the language supported by the program product Assembler H.

You can use the OS/VS1 System Assembler to program any type of application. All services provided by the VS1 system control program are available when using the System Assembler.

Linkage Editor

The VS1 linkage editor provides new control statements to take advantage of virtual storage and the authorized program facility in addition to those functions provided by the MFT linkage editor. The linkage editor forms a single program that is ready to be loaded and executed. It enables changes to be made in a program without recompiling (or reassembling) the complete program; only those sections that are changed need to be recompiled.

Loader

The loader combines the basic editing functions of the linkage editor and the loading function of program fetch in one job step. It loads object modules produced by language translators and load modules produced by the linkage editor for execution. It is designed for high-performance loading of modules that do not require the specific facilities of the linkage editor and program fetch. The loader does not produce load modules for program libraries.

Utility Programs

The utility programs provided with VS are divided into three categories:

- Data set utility programs
- System utility programs
- Independent utility programs

Data Set Utility Programs are used chiefly by the programmer and operator. The list that follows describes the general function of each utility:

- IEBCOMPR compares two identically organized sequential or partitioned data sets at the logical record level.
- IEBCOPY copies, compresses, merges, loads, and unloads partitioned data sets.
- IEBDG provides a *pattern* of test data used as a programming debugging aid.
- IEBEDIT creates an edited input job stream data set from a master job stream data set.
- IEBGENER copies a sequential data set or a partitioned member, or produces a partitioned data set from sequential input.
- IEBISAM copies, reorganizes, and prints indexed sequential data sets.
- IEBPTPCH prints or punches all, or selected portions, of a sequential or partitioned data set.
- IEBUPDTE creates and updates symbolic libraries, incorporates changes to partitioned members or sequential data sets, and changes data set organization from sequential to partitioned or vice versa.

System Utility Programs are used chiefly by the system programmer to maintain collections of data and system control information. This list describes the general function of each program:

- IEHATLAS locates and assigns an alternate track to replace a defective track. It retrieves usable data records from the defective track and transfers them to the alternate track.
- IEHDASDR prepares direct access volumes for use and dumps data from, or restores data to, these volumes.
- IEHINITT writes IBM volume label sets in EBCDIC, BCD, or in ASCII on magnetic tapes.
- IEHIOSUP updates TTR entries in the transfer control tables of the SVC (supervisor call) library.
- IEHLIST lists entries in a catalog, entries in the directory of one or more partitioned data sets, or entries in a volume table of contents.
- IEHMOVE moves or copies logical collections of operating system data.
- IEHPROGM modifies system control data and maintains data sets at an organizational level.
- IFHSTATR formats and writes information from type 21 ESV (error statistics by volume) records.

Independent Utility Programs are used chiefly by the operator. These utility programs operate outside, and in

support of, OS/VS1. The general function performed by each program is described in the following list:

- IBCDASDI initializes direct access volumes for use with OS/VS1 and assigns alternate tracks on direct access storage volumes.
- IBCDMPRS dumps or restores data between a direct access storage device and a transportable volume.
- ICAPRTBL loads the UCS (Universal Character Set) buffer and the FCB (forms control buffer) for an IBM 3211 Printer.

Emulator Programs

Integrated emulator programs, used with a compatibility feature, allow object programs written for one system to be executed on another system with little or no reprogramming. The compatibility feature consists of hardware and microprogrammed routines that aid emulation. The emulator programs are executed as problem programs under the VS1 system control program. Although the emulator programs are components of the system control program, the user must order them separately from IBM. The VS1-supported emulators are shown in Figure 4-5.

Emulators	System/370 Models					
	135	145	155 II	158	165 II	168
1401/1440/1460, 1410/7010		X	X	X		
1401/1440/1460	X	X				
7070/7074			X	X	X	X
7080					X	X
709/7090/7094 II					X	X
OS/DOS	X	X	X	X		

Figure 4-5. Emulators

VS1 STARTER SYSTEM

The IBM-supplied starter system is required to generate your first OS/VS1 system. Thereafter, you can use the generated system to create an alternate configuration.

IVP (INSTALLATION VERIFICATION PROCEDURE)

When OS/VS1 is installed at a customer location, an IBM representative performs installation verification procedure (IVP) to assure that the system is operational and supports the hardware configuration. This procedure is performed as part of IBM's system control program installation procedure for the initial installation of VS1 and for updates.

The jobs included in the IVP job stream are limited to the VS1 system control program. These jobs exercise the functions within the newly configured VS1 system, but no attempt is made to exercise any specific function. The job

stream consists of existing VS1 facilities (programs, commands, etc.) which, when executed, exercise the VS1 functions and provide identification and information about the devices in the system.

TYPE I AND TYPE II PROGRAMS

For specific information about the Type I functional programs and the Type II application programs that run under VS1, see your local IBM representative.

IBM PROGRAM PRODUCTS

VS1 is designed so that program products can operate in this new environment as part of the system's upward compatibility. Program products, available from IBM for a license fee, can be categorized as those that are system oriented and those that are industry oriented. For further information about these program products, see your local IBM representative.

OS/VS2 (Operating System/Virtual Storage 2)

OS/VS2 Release 2 (MVS—Multiple Virtual Storage) is a virtual storage operating system with multiprogramming, multiprocessing, time-sharing (TSO), and a job entry subsystem (JES2). MVS supports System/370 Models 145, 155 II, 158, 165 II, and 168; and the 158 MP and 168 MP (tightly-coupled multiprocessors).

The three most important features of MVS are:

1. Virtual storage
2. Multiprocessing
3. Time-sharing

Virtual Storage: MVS extends the concept of virtual storage to provide multiple address spaces; that is, each system user has his own private address space. (For additional information on virtual storage, see *Introduction to Virtual Storage in System/370*, GR20-4260.)

Multiprocessing: MVS directs the combined resources of both processors (in a tightly-coupled environment) and schedules execution of simultaneous tasks to provide higher utilization of shared I/O and storage.

Time-Sharing: In MVS, time-sharing (TSO) is a standard feature. The user has access to the system through a command language from remote terminals.

FEATURES AND FACILITIES

Many features and facilities that were available in previous operating systems (OS/MVT and OS/VS2 Release 1) are

also available (essentially unchanged) in MVS. A complete description of all MVS functions is contained in *Introduction to OS/VS2 Release 2*, GC28-0661. The following paragraphs summarize the major new and redesigned features of MVS such as:

- JES2, a new job entry subsystem
- SRM, a system resources manager
- MF/1, a system activity measurement facility
- VIO (Virtual I/O), a virtual I/O paging mechanism for temporary data set
- New data set handling facilities
- New recovery termination management functions
- New allocation design

Handling the Job Stream

Multiple virtual storage (MVS) offers new facilities to improve the management of jobs with the resources available in the system.

JES2 operates as the primary job entry subsystem in MVS and provides:

- An input/output spooling function
- A simplified job class scheduling structure
- A remote job entry capability

SWA (scheduler work area), a pageable portion of an address space, contains control blocks and tables created during JCL interpretation. The inclusion of SWA in MVS eliminates the need for the system job queue and reduces the requirements for preallocated auxiliary storage.

Allocation: The new allocation design allows an installation to assign names to subsets of devices and to define a precedence list for allocating device types. The intent is to reduce contention for devices (serialization) and to reduce allocation time by tailoring the allocation process.

Dynamic allocation of auxiliary storage is now available to both background and foreground jobs, and provides support for

- Multivolume or multiunit data sets
- Generation data groups
- Concatenation of data sets (except VSAM and ISAM data sets)
- Optional freeing of data sets (at CLOSE)
- Allocation of devices other than direct access devices

Handling Data Sets

Data management facilities in MVS are intended to provide systematic and effective means of organizing, identifying, storing, cataloging, and retrieving all data.

VSAM (virtual storage access method) operates with direct access devices and supports both sequential and

direct processing. VSAM creates and maintains two types of data sets:

- Key-sequenced: Organized by a key-field in each record
- Entry-sequenced: Organized chronologically

The VSAM Catalog: The master catalog in Multiple Virtual Storage (MVS) must be a VSAM master catalog. You can convert an existing catalog (OS or OS/VS2 Release 1) to the VSAM format by using a facility of Access Method Services. Also, you can use a utility program, IEHUCAT, to update an existing master catalog with changes made to the VSAM master catalog. (*Note:* MVS provides support for non-VSAM private catalogs through the CVOL processor.)

Access Method Services is a set of service routines intended for use with VSAM data sets. Some functions provided are:

- Defining, copying, and printing data sets
- Deleting VSAM entries from a catalog
- Providing data set portability between DOS/VS and OS/VS.

VIO (virtual I/O) handles temporary data sets in MVS and provides the following advantages:

- Elimination of some of the usual I/O device allocation and data management overhead for temporary data sets
- Generally, more efficient use of direct access storage space
- Use of the I/O balancing capability of the paging mechanism

Operating the System

Operator Commands: The operator command language now supports:

- JES2 (job entry subsystem)
- SRM (system resources manager)
- Multiple private address spaces
- Multiprocessing

System Initialization: Multiple Virtual Storage (MVS) includes facilities that are aimed at increasing the speed and flexibility of system initialization. The increased flexibility in specifying parameters is an attempt to increase the speed of the process by decreasing the amount of required operator intervention.

Managing the System

As computer systems become more complex, the ability to control the use of the system and its resources becomes more important. MVS includes facilities to help an installation manage its system.

SRM (System Resources Manager) monitors a wide range of data about the condition of the system. It analyzes system-wide CPU and I/O load, monitors storage utilization, and requests that address spaces be swapped into or out of real storage in an attempt to keep the utilization of each of the resources within an acceptable range. In addition, SRM monitors the rate of usage of system resources by individual users, compares this rate to a target usage specified by the installation, and attempts to maintain this target resource usage rate by making the appropriate swapping decisions.

MF/1 (System Activity Measurement Facility) collects information about system activities and produces trace records and reports. MF/1 can monitor the following classes of system activity: CPU, paging, work load, channel and I/O device.

System Integrity is the ability of the system to protect itself against unauthorized user access; that is, an unauthorized program using any system interface should be unable to:

- Bypass store or fetch protection (read from or write into another user's area)
- Bypass password checking (access password protected data for which a password has not been supplied)
- Obtain control in an authorized state.

In MVS, all known integrity exposures have been removed. IBM will accept as valid any APAR that describes an unauthorized program's use of any system interface (defined or undefined) to bypass store or fetch protection, to bypass password checking, or to obtain control in an authorized state.

Note: An authorized program in MVS is one that executes in a system key (Key 0-7), in supervisor state, or is authorized via the authorized program facility (APF).

Reliability, Availability, and Serviceability

Multiple Virtual Storage (MVS) provides improved reliability, and advanced availability and serviceability (RAS) facilities that can be used to promote continuous system operation.

RTM (Recovery Termination Management) cleans up system resources when a task or address space terminates. Specifically, RTM:

- Performs normal and abnormal task termination
- Performs normal and abnormal address space termination
- Writes dumps and records errors
- Provides for recovery for supervisory routines by routing control to functional recovery routines (FRRs)

- Provides for recovery in a tightly coupled MP environment by routing control to alternate CPU recovery (ACR) when one CPU fails.

Software Error Recording: In MVS, records of software failure and recovery activity are written in the SYS1.LOGREC data set. The recorded data can be retrieved, formatted, and printed to provide assistance in isolating system failures and evaluating the effectiveness of program changes.

Power Warning Feature (Power Warning Feature) support, along with the hardware that supports it, prevents the loss of information in real storage when a utility power disturbance occurs. PWF support, after receiving the signal of a power disturbance and determining the significance of the disturbance, can transfer the contents of real storage to disk storage. After utility power is restored, you can use PWF support to refresh the contents of real storage from disk storage.

System Modification Program (SMP) is a service aid that enables you to put IBM modifications or your own modifications into an MVS system. In addition, SMP maintains records of the contents and status of your operating system.

IBM PROGRAM PRODUCTS

Program products are available from IBM for a license fee. For further information about program products, see your local IBM representative.

BIBLIOGRAPHY

For additional information about multiple virtual storage (MVS), including the total scope of the system, and compatibilities and incompatibilities with MVT and OS/VS2 Release 1, see the following publications:

- *Introduction to OS/VS2 Release 2*, GC28-0661
- *OS/VS2 Planning Guide for Release 2*, GC28-0667
- *OS/VS2 Release 2 Guide*, GC28-0671
- *IBM System/370 Bibliography*, GC20-0001
- *IBM System/370 Bibliography of Industry Systems and Application Programs*, GC20-0370

Virtual Machine Facility/370 (VM/370)

VM/370 is a system control program (SCP) that manages a real computing system so that all of its resources—CPU, storage, and input/output devices—are available to many

users at the same time. Each user has at his disposal the functional equivalent of a real, dedicated computing system. Because this functional equivalent is simulated for the user by VM/370 and does not really exist, it is called a virtual machine.

VM/370 is designed for IBM System/370 Models 135, 138, 145, 148, 155 II, 158, 165 II, and 168. The System/370 must have the dynamic address translation (DAT) feature, a hardware facility that translates virtual storage addresses to real storage addresses, and the system timing facility. Also, it must operate in extended control mode, a mode in which all the features of a System/370, including dynamic address translation, are operational.

VM/370 is the System/370 version of a control program called CP-67/CMS, which performs similar functions on a System/360 Model 67. Like its predecessor, VM/370 provides:

- Virtual machines and virtual storage
- The ability to run multiple operating systems concurrently
- A conversational, time-sharing system

A major difference between CP-67/CMS and VM/370 is that VM/370 provides a remote spooling communications subsystem (SCS). In addition, VM/370 supports such devices as the IBM 3330 Disk Storage, the IBM 3340 Direct Access Storage Facility, and the IBM 2305 Fixed Head Storage, and offers several performance options to optimize performance in the virtual machine environment.

ELEMENTS OF VM/370: CP, CMS, AND RSCS

VM/370 has three major elements:

1. The control program (CP), which controls the resources of the real computer to provide multiple virtual machines. Executing a program on a virtual machine produces exactly the same output as executing that program on a real machine.

When a user logs onto VM/370, CP creates a virtual machine for him based on information stored in the VM/370 directory. The VM/370 directory contains one entry for each user identification. Each entry includes: the password associated with the userid; a description of the virtual input/output devices associated with this virtual machine; its normal and maximum virtual storage sizes; the user's CP command privilege class(es); and optional virtual machine characteristics, such as extended control mode.

CP controls the resources of the real computer to provide multiple virtual machines. CP intercepts, translates, and schedules all real input/output operations of the virtual machine. All virtual machines execute in problem state, and the control program traps and processes all interrupts and privileged instructions. Only CP executes in supervisor state.

- The conversational monitor system (CMS) is the major subsystem of VM/370. Together with the control program of VM/370, it provides a time-sharing system suitable for direct problem solving and program development. CMS is an operating system that runs only in a VM/370 virtual machine. (CMS uses the Diagnose interface for all of its disk and tape input/output operations and includes no error recovery routines.)

CMS is a conversational, single-user system. The user's interface to CMS is the virtual operator's console, that is, the terminal used to gain access to VM/370.

CMS has no multiprogramming capabilities, as it is designed to run in a VM/370 virtual machine. CP provides the time-sharing environment; CMS provides the conversational user interface. Using CMS, the user can write programs to run under CMS or under another virtual machine operating system.

CMS is used to incorporate all VM/370 program releases and program fixes.

- The VM/370 remote spooling communications subsystem (RSCS) provides the spooling of files between remote stations and virtual machines at the VM/370 installation. (Remote stations are configurations of I/O devices attached to the VM/370 computer by binary synchronous communications (BSC) switched or non-switched lines.)

The VM/370 computer is the functional center of communications in the RSCS teleprocessing network. The operator of the RSCS virtual machine controls the network by issuing RSCS commands at the RSCS virtual machine console.

The facilities of RSCS are selected and controlled by means of commands and control cards. Connections between geographically remote locations are made by the operator of the RSCS virtual machine.

Each location in the RSCS network is assigned a location identifier, which RSCS uses to find a link, or path, to the remote location.

VIRTUAL MACHINE OPERATING SYSTEMS

While the control program of VM/370 manages the concurrent execution of the virtual machines, it is also necessary to have an operating system managing the work flow within each virtual machine. Because each virtual machine executes independently of other virtual machines, each one can use a different operating system, or different releases of the same operating system.

The operating systems that can run in virtual machines are shown in Figure 4-6. CP provides each of these with virtual device support and virtual storage. The operating systems themselves execute as though they were controlling real devices and real storage, but they must not violate any of the VM/370 restrictions.

Figure 4-7 shows six virtual machines running concurrently under control of CP on an IBM System/370

Batch or Single-User Interactive	Multiple-Access
DOS	APL, DOS-360
DOS/VS	(with CP option)
OS/PCP	VM/370
OS/MFT	Time Sharing
OS/MVT	Option of OS
OS/VS1	
OS/VS2	Conversational
OS-ASP	CMS
PS44	
RSCS	

Figure 4-6. Virtual Machine Operating Systems

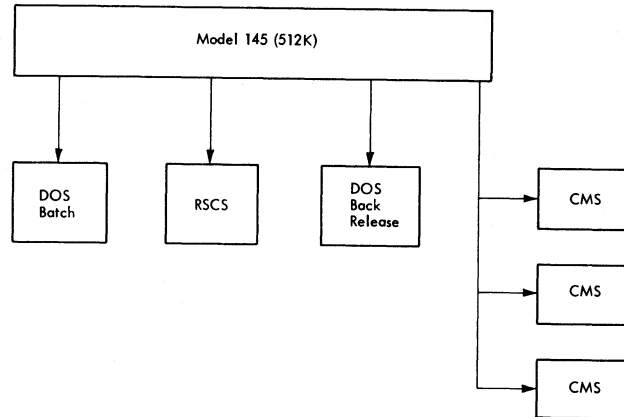

Figure 4-7. Multiple Virtual Machines

Model 145, with 512K bytes of real storage. One machine is doing batch production work under the present release of DOS; a second is executing programs that require a back release of DOS; and a third is controlling the RSCS network. The other three virtual machines are running CMS for three separate conversational users.

VIRTUAL MACHINE ASSIST FEATURE

The Virtual Machine Assist feature, which improves the performance of VM/370, is a combination of a CPU feature and VM/370 programming. Virtual storage operating systems (such as OS/VS1 and DOS/VS) that run in problem state under control of VM/370, use many privileged instructions and SVCs that cause interrupts that VM/370 must handle. When the Virtual Machine Assist feature is used, many of these interrupts are intercepted and handled by the CPU; consequently, VM/370 performance is improved.

The Virtual Machine Assist feature is available with System/370 Models 135, 138, 145, 148, 158, and 168.

Whenever VM/370 is loaded (via IPL) on a CPU that has the Virtual Machine Assist feature, the feature is enabled for all virtual machines on the system. The system operator can disable and enable the feature for the system.

When a user logs on, the assist feature is enabled for his virtual machine if it is enabled for the system. The general user can set the feature off for his virtual machine, and later

set it on again. He can also control whether SVC interrupts are handled by the Assist feature or by VM/370.

Under some conditions, the Virtual Machine Assist feature cannot be used. CP automatically turns the feature off if the user invokes certain trace functions, attaches a dedicated channel, or attempts to load a system containing a shared segment. CP automatically turns the feature on again when the user ends tracing, detaches the dedicated channel, or loads a system that does not contain a shared segment.

VM/370 APPLICATIONS

VM/370 assists an installation to perform its work more efficiently and easily. Virtual machine applications aid programmers, operations personnel, and interactive users.

Programming

Programming is facilitated in the following ways:

1. Programs being developed need not conform to the real storage size of the real computer.
2. Virtual machines make program testing more flexible. Subject to available resources, a virtual machine can be made active whenever needed, thus relaxing normally tight or inflexible testing schedules and allowing programmers more compilations and tests per day.
3. JCL (job control language) usually is not needed when compiling, assembling, and/or testing under CMS.
4. Users can test privileged code in their own virtual machines.
5. Programmers can use debugging aids at their terminal that parallel those of an operator at a system console: displaying and storing into the general or floating-point registers or into virtual storage, instruction address stopping, and altering the normal flow of execution. Which of these functions each user is allowed to perform are defined by the privilege class(es) assigned to him.
6. CMS simplifies the creation and manipulation of source programs on disk, and allows the user to examine selected portions of program listings and storage dumps at his terminal.
7. RSCS allows users to transmit files to, and receive files from, users at other remote locations.
8. The VM/370 data privacy, security, and user-isolation features protect each user's data, programs, and disk files from access or destruction by other users.
9. Many System/360 and System/370 programs can be compiled under control of CMS; within certain restrictions these programs can also be tested under CMS. DOS assembler language programs can be compiled under CMS if the installation adds the appropriate DOS macros to the CMS system. Problem programs using DOS macros can be conversationally developed under control of CMS; then control of the virtual machine is passed to DOS, and the programs are compiled and tested. The

user specifies which operating system is to control his virtual machine by means of the IPL command of CP.

Operations

The virtual machine environment relieves certain problems of scheduling, updating programs and backup, and expedites production in the following ways:

1. System generation, updating, and system testing, as well as operating system conversion and testing, can be done without a dedicated real machine, concurrently with normal production work. This reduces errors that might otherwise be caused by using a system that has not been fully tested, and it also reduces the possibility of abnormal terminations of the system. For example, a program temporary fix (PTF) applied to a copy of an IBM operating system volume can be tested concurrently with the production execution of that same operating system in another virtual machine, provided sufficient direct-access storage resources are available. The virtual machine test will be analogous to one made on a real machine provided:

- There are no timing dependencies.
- The test is not measuring time.
- Dynamically modified channel programs are not used except as allowed by VM/370.

A possible combination of virtual machines in a VM/370 configuration is shown in Figure 4-8. Operating system testing is shown running concurrently with batch work and a variety of conversational applications.

2. VM/370 allows DOS and OS, including virtual storage (VS) versions, to run concurrently on the same System/370. Multiple copies of the same operating system can also run concurrently in separate virtual machines.
3. Many types of batch applications can be run, either in an individual user's virtual machine or in a virtual machine dedicated to running batch, with no change to the batch program.
4. New computer operators can get hands-on experience using a virtual machine terminal as a system console.
5. An installation using VM/370 has more flexibility in using another System/370 computing system for backup. The backup system need not be the same System/370 model nor have the same amount of real storage. Backup can be done in two ways:
 - The VM/370 system residence volume and the user and CMS volumes can run on another System/370 if the device addresses on both machines are the same. This is not unique to VM/370; the same procedure would be used to back up OS or DOS systems.
 - The second method is unique to VM/370. The user volumes alone can be carried over to another computing system that is using VM/370. The backup

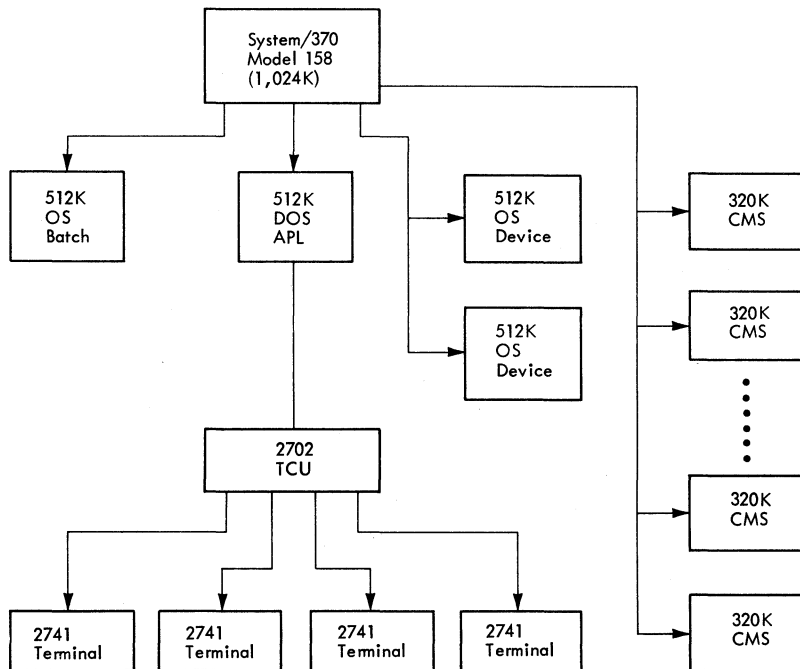

Figure 4-8. Virtual Machines for Concurrent Program Maintenance

system must include, but is not limited to, the same type and number of real devices as these user volumes require. Because the virtual devices defined in the user volumes are not assigned to specific real devices until execution time, the installations need not concern themselves with device addresses; VM/370 on the backup system assigns real devices just as it does for its own virtual machines. Thus, the production work of the system being backed up can run in virtual machines concurrently with the execution of the virtual machines of the backup system.

Interactive Use

Two kinds of interactive systems run under VM/370: multiple-access and single-user.

1. Multiple-access systems like APL/DOS-360 run in one virtual machine and directly service many interactive terminals. A user of a multiple-access system dials the system instead of logging on to connect his terminal with the virtual machine running the multiple-access system he wishes to use. Once his terminal is connected, the user issues statements in the command language associated with the multiple-access system only.

For example, dialing APL could connect the user's terminal with an APL/DOS-360 system running in a virtual machine under VM/370. Once connected, the user communicates only with APL commands and cannot use any CP commands.

2. Systems that a single user can run interactively include the conversational monitor system (CMS) and any operating system that can run on a virtual machine. A time-sharing environment is created when VM/370 creates multiple virtual machines, each controlled by a copy of CMS. These systems operate concurrently with each other as well as with other conversational or batch systems. CMS is useful for program development and problem solving.

The CMS command language provides each user with a wide range of capabilities at his remote terminal, such as:

- Creating source programs, data, and text files directly on disk.
- Adding, deleting, modifying, rearranging, extracting, or merging files and/or portions of files.
- Compiling, testing, and debugging some types of OS problem programs under CMS.
- Creating complete job streams to be passed to batch processing systems such as DOS or OS for compilation and/or execution. The resultant output can be printed on a high-speed printer or directed back to CMS for analysis and correction by the user.
- Submitting jobs to a background CMS batch facility.
- Extending CMS facilities to suit the user's requirements, such as creating additional commands or developing command procedures.

BIBLIOGRAPHY

For additional information about VM/370 and VM/370 publications, see these publications:

- *IBM Virtual Machine Facility/370: Introduction*, GC20-1800
- *IBM System/370 Bibliography*, GC20-0001
- *IBM System/370 Bibliography of Industry Systems and Application Programs*, GC20-0370

Section 5. Teleprocessing

Teleprocessing is the processing of data that is received from or sent to remote locations by way of communications facilities.

A teleprocessing network consists of a number of communications lines (communications facilities) connecting a central data processing system with remote teleprocessing devices (Figure 5-1). Such devices can be terminals, control units, or other data processing systems. In this overview, any machine or group of machines capable of generating and/or receiving signals transmitted over communications lines will be referred to as a terminal or terminals. Thus, terminals may be data processing systems, communications systems such as the IBM 3270 Information Display System, or a single unit such as the IBM 2740 Communication Terminal.

As an example of how a teleprocessing network functions, a clerk in an insurance company's branch office receives a telephone call asking for information about an insured's account. Asking the caller to hold the line, the clerk enters the information request into a terminal, and the request is sent over a communications line to the System/370 at the insurance company's main office. When

the request reaches the computer, several things happen. The computer interrupts processing whatever job it is working on and saves all necessary data and instructions so that it can resume processing the job at the exact point of interruption. As the information is received over the communications lines, the communications module in the control program converts the data into machine language, stores it in a buffer area, and checks to see that it was transmitted correctly.

The nature of the request may dictate that a number of operations be performed. To process the request, the teleprocessing program directs the System/370 to examine the appropriate policy file and bring the insured's record from storage. The program then searches the record for the information requested and sends it over the communications lines to the clerk who originated the request. The clerk reads the information as it is displayed or typed out at his terminal and relays the information to the policyholder or adjuster waiting on the telephone.

At the main office, the control program has returned the System/370 to its status prior to the interruption, and the computer has resumed processing. As a result of the

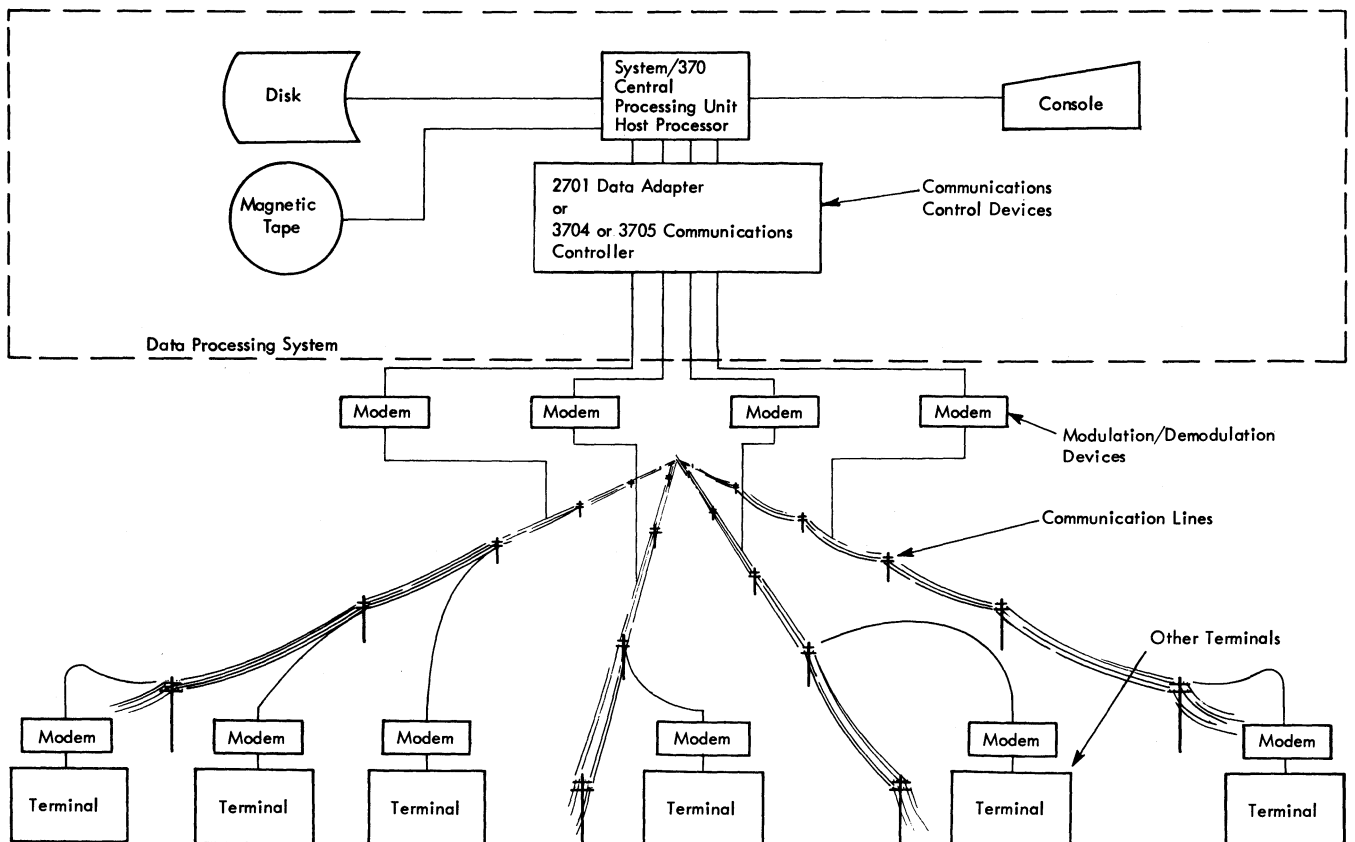

Figure 5-1. A Teleprocessing Network

telephone inquiry, the clerk in the branch office may update the insured's record and transmit this information to the System/370 at the main office at a later time.

ELEMENTS OF A TELEPROCESSING NETWORK

The elements of a teleprocessing network (Figure 5-1) consist of a host processor (central data processing system), communications control devices, modulation/demodulation devices (modems), communications lines, other terminals, and programming systems. Three of these elements, the communications control devices, modems, and communications lines, constitute a *data link* (Figure 5-2).

Host Processor

System/370 is designed so that it can serve as the host processor in a teleprocessing network. Requirements for the host processor include multiprogramming capability, adequate storage capacity, storage protection, adequate speed for the applications required, and, for planning purposes, the potential for expanding storage capacity and speed.

The host processor for a teleprocessing network must be able to handle random and unscheduled input, as well as serialized and scheduled input.

- System/370 can handle multiple inputs, random and batch, at the same time.
- System/370 offers upward compatible models which provide a wide range of storage capacities and speeds (Section 6).
- System/370 provides storage protection which prevents one program from changing another program's instructions and data.
- System/370 also provides great flexibility for multiple channel attachments which can increase teleprocessing capability.

Communications Control Devices

Communications control devices are hardware components that link the communications lines to the host processor. These devices can be external to the processor, such as the IBM 3704 or 3705 Communications Controller, or they can be a part of the processor of a System/370, such as the integrated communications adapter feature. When control devices are external units, they can be classified as data transmission multiplexers.

The transfer of data requires noninformation transmissions for setting up, controlling, checking, and terminating information exchange. These noninformation exchanges constitute *data link control*. Communications control devices handle data link control; thus, functions of these devices include:

- Synchronization (getting the receiver in step with the transmitter)
- Identifying the sender and receiver

- Delimiting the beginning and ending of information (code translation)
- Error detection and recovery

In order for a host processor to send data over communications lines, the data must be converted (serialized) to a serial stream of binary digits. Likewise, when the host processor receives data from a remote terminal, this data must be reconverted (deserialized) into machine language for processing (Figure 5-2). Control devices perform this function.

Modulation/Demodulation Devices

After data which is to be transmitted is serialized by the control device, the binary signals must be converted to audio-frequency signals (modulated) for transmission over communications lines and reconverted (demodulated) at the other end. A modulation/demodulation device or modem performs this function. One modem is required at each end of a data link (Figure 5-2). Data sets and line adapters have the same function as a modem.

Depending upon the type of communications lines and modem equipment, transmission of data can be voice grade (permits transmission of both data and human voice) or subvoice-grade (transmission of data only). A modem can be an integral part of a control device or terminal, or it can be an external unit.

Communications Lines

Communications lines are classified according to:

- Configuration
- Transmission direction
- Type
- Transmission mode

Configuration

Two basic communications line configurations are:

- Point-to-point (connects two terminals).
- Multipoint (connects multiple terminals). In a multipoint configuration, one terminal must always be designated as the primary (control) terminal, and all others are secondary (tributary) terminals.

Transmission Direction

A communications line that transmits data in either direction, but not simultaneously, is called *half-duplex*. A line that transmits in both directions at the same time is called *duplex* or *full duplex* (Figure 5-3).

Type

Basically, two types of communications lines are available: *switched* and *nonswitched*.

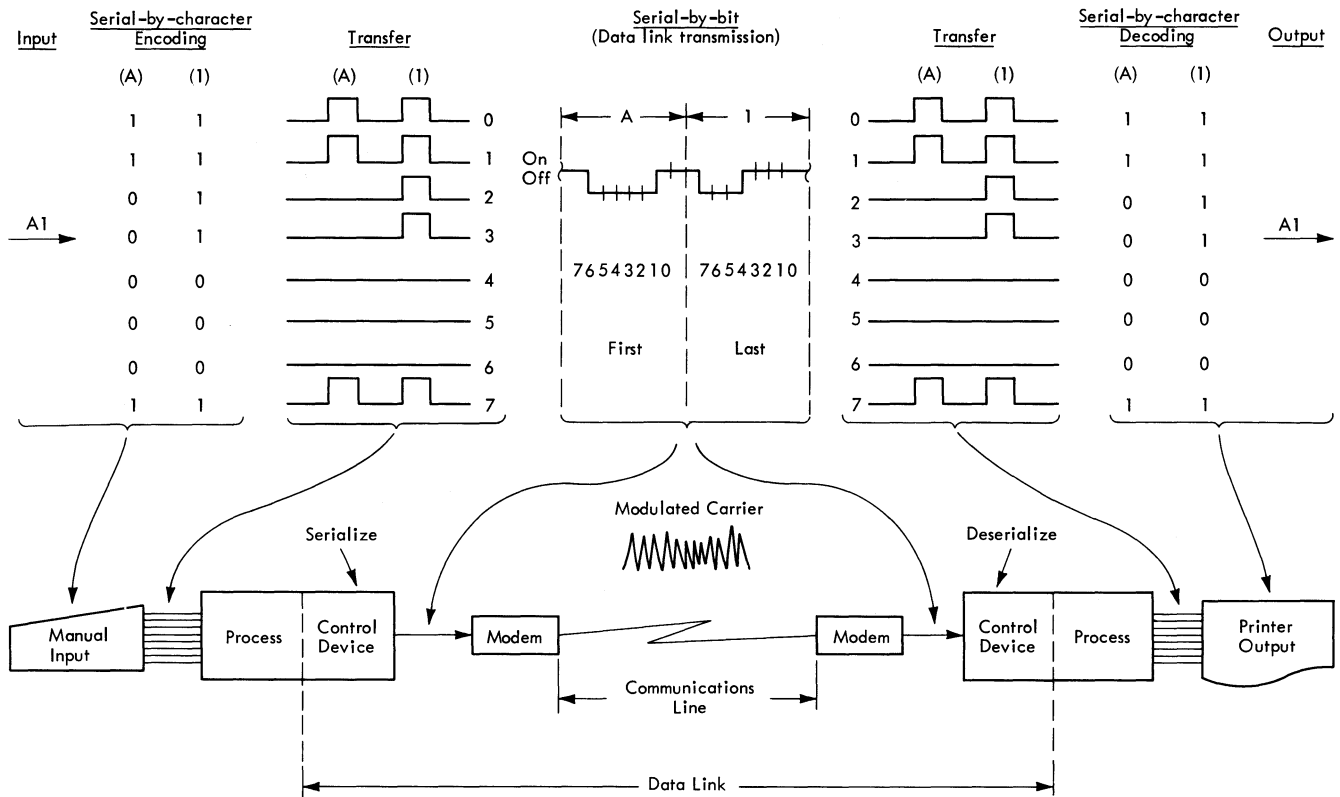

Figure 5-2. Data Conversion for Data Transmission

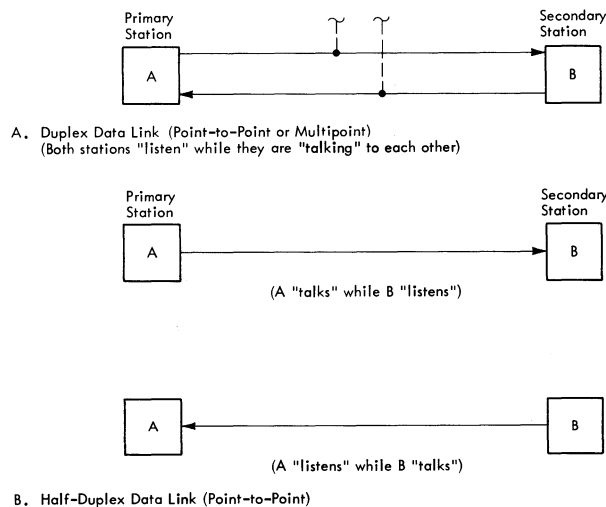

Figure 5-3. Communications Lines Configurations

Switched lines (also called dial) connect terminals by means of common carrier exchange equipment. Dialing establishes a connection, which is maintained only while data is being transmitted. Switched lines are half-duplex only.

Nonswitched lines are available for use at any time, and dialing is not required to make a connection. Nonswitched lines may be either leased or private lines. Leased lines are leased from a communications common carrier and are

usually telephone or telegraph lines. Private lines are privately owned and may be supplied by the teleprocessing network owner or by a communications equipment company.

Duplex transmission requires leased or private lines (nonswitched).

Transmission Mode

Communications lines can transmit in asynchronous mode (also called serial start-stop mode) or synchronous mode.

Asynchronous transmission requires the use of start and stop bits to designate the beginning and ending of transmission.

Synchronous transmission is transmission in which the sending and receiving terminals are operating continuously at substantially the same frequency: the receiving terminal on a communications line operates in step with the transmitting terminal through the recognition of a specific bit pattern (sync pattern) at the beginning of each transmission. Synchronous mode, therefore, eliminates the need for start and stop bits and permits continuous uninterrupted transmission, increasing transmission speed and reducing turnaround time.

Codes

A variety of codes can be used to represent data characters when transmitting over communications lines. Two of the

most commonly used are ASCII (American National Standard Code for Information Interchange) and EBCDIC (Extended Binary Coded Decimal Interchange Code). ASCII offers 128 possible characters. EBCDIC has 256 possible code combinations, of which 17 are used for control purposes, 96 are used for text characters, and the remaining are unassigned.

Line Disciplines

A line discipline provides a set of rules for the orderly transfer of data from one location to another using communications facilities. Two line disciplines currently used are binary synchronous communications (BSC) and synchronous data link control (SDLC).

Binary Synchronous Communications

Binary synchronous communications (BSC) procedure provides for synchronous transmission of binary-coded data. BSC expands transmission capability in a teleprocessing network through its ability to accommodate three different transmission codes and a broad range of medium- and high-speed equipment. BSC offers intermix capabilities which allow different types of BSC terminals to communicate with the host processor (functioning as the control terminal) on a nonswitched multipoint network, or with the host processor (functioning as the central terminal) over a switched point-to-point network. Also available with BSC is a transparency feature which permits greater versatility in the range of coded data that can be transmitted. This versatility is achieved because all data, including the normally restricted data link line control characters, is treated as specific "bit patterns" (data only) when transmitted in transparent mode. Thus, unrestricted coding of data is permitted for transparent mode operation. This is particularly useful for transmitting binary data, floating-point numbers, packed decimal data, and so on.

Synchronous Data Link Control

Synchronous data link control (SDLC), a more sophisticated line discipline than BSC, provides for the efficient management of synchronous data transmission between buffered terminals using centralized control over communications lines.

SDLC can transmit over duplex or half-duplex, switched or nonswitched lines. Whereas SDLC configurations may be point-to-point, multipoint, or multi-multipoint (Figure 5-4), BSC uses point-to-point or multipoint configurations. Also, SDLC will accommodate *any* code while BSC accommodates three codes.

SDLC offers a fixed format for transmission which eliminates many of the control characters required for BSC transmission. When using SDLC:

- Message delimiting is not required.
- Error checking is automatic.

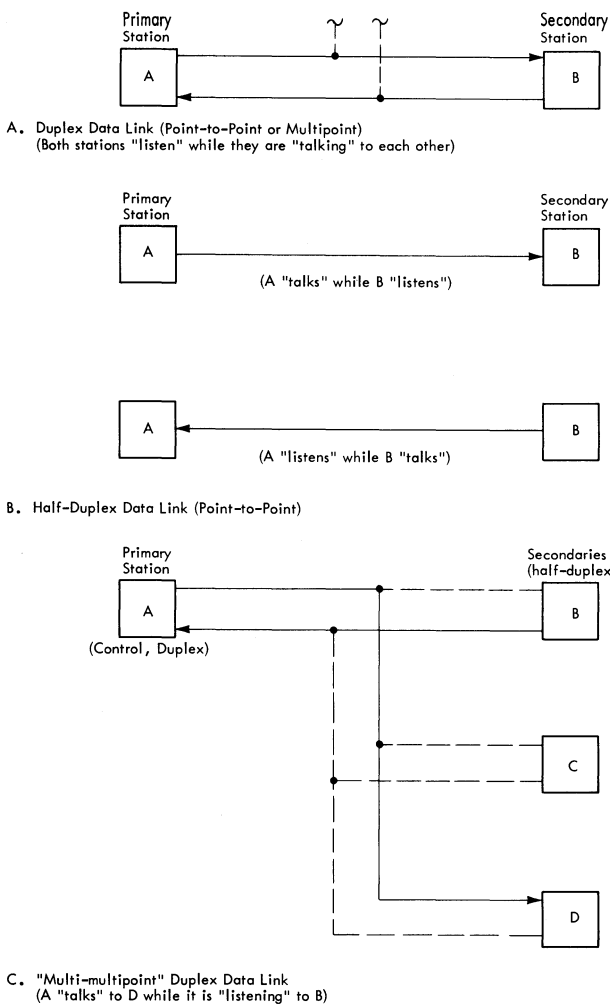

Figure 5-4. Data Link Configurations

- Previous transmissions can be confirmed at the same time that additional data is being transmitted.
- Any type of data, coded or noncoded, can be transmitted.

SDLC allows terminals with different characteristics to share a single communications line. Thus hard-copy (printer) terminals and video-display terminals can share the same communications lines.

Terminals

The type of terminal used for handling data flow in a teleprocessing network depends upon the complexity and capability (applications) required for a specific network. The terminals are the workhorses of the network. All useful data is received from or sent to the terminal.

Terminals can be keyboard displays, keyboard printers, a communications system such as the IBM 3270 Information Display System, or a System/370. Terminals can prerecord data on diskettes or tape for batch transmission or mailing. Terminals can accommodate asynchronous (start-stop) and synchronous (BSC and SDLC) modes of transmission. Many

combinations of these features and other features are possible. Section 6 discusses various models of System/370. Section 8 discusses various types of data transmission multiplexers, single terminals, and communications systems.

Programming Systems

A programming system is a developed, tested, and documented group of support programs which include:

- Controlling and scheduling of I/O devices
- Job, task, and data management
- Application programs
- Utilities

Included in data management is teleprocessing device support which provides a link between the application program and remotely connected teleprocessing terminals via the communications control device. This support is divided into three access methods which aid the host processor application programs in obtaining data from remote terminals.

Basic or Virtual Telecommunications Access Method (BTAM/VTAM) directs the transmission of data between the host processor application programs and terminals. BTAM/VTAM provides basic capabilities to:

- Receive messages
- Send messages
- Chain input buffers
- Dial and answer (switched lines)
- Detect and correct errors
- Perform code translation

Stated simply, BTAM/VTAM controls terminal input/output operations.

If queued control is required in an asynchronous transmission mode network, *Queued Telecommunications Access Method* (QTAM) is available. QTAM includes BTAM capabilities as well as message queuing, routing, and logging.

If queued control is required in a synchronous transmission mode network, *Telecommunications Access Method* (TCAM) is available. For example, data can be directed to an inactive terminal and held in queue until that terminal is activated and connected.

SDLC line discipline utilizes VTAM which connects, disconnects, and controls access between the application programs and all the terminals in the network whether they are locally or remotely attached. Although a terminal may be allocated at one time to a specific application, the communications control devices and communications lines are shared among concurrently active application programs. Different terminals, multidropped on one line, may concurrently communicate with different application programs. When an IBM 3704 or 3705 Communications Controller is installed as the control device, VTAM allocates some of the network management responsibilities to this unit.

The *Network Control Program-Virtual Storage* (NCP/VS) operates with the IBM 3704 or 3705 to route data through the network. Through commands sent from VTAM, the NCP/VS assumes much of the responsibility for controlling communications lines (Figure 5-5). Thus, valuable host processor space is freed for higher, application-related functions. Also, because some control is exercised locally (in the 3704 and 3705), line traffic is reduced and line costs are lowered.

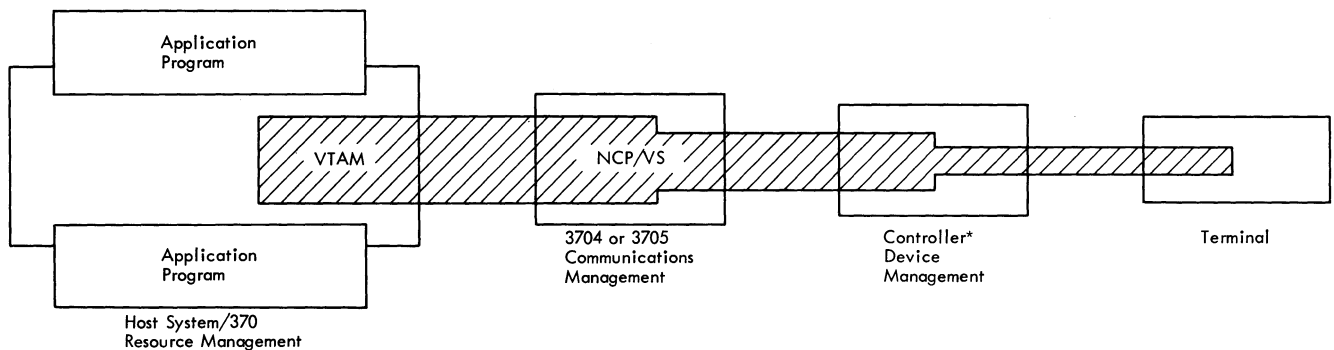

 = Function
 * 3601, 3651, and 3791 are examples

Figure 5-5. Concept of Function Distribution under Programming Control

TELEPROCESSING APPLICATIONS

The types of applications which are provided by a teleprocessing network are many and varied. Some of the most widely used applications include:

- *Data Entry.* Entry of data from a remote terminal into a host processor via a communications link by a remote terminal.
- *Record Update.* Alteration, deletion, or addition of data contained on existing data files stored at the host processor site via a communications link from a remote terminal.
- *Remote Job Entry.* Entry of logic functions from a remote terminal to be executed at the host processor location via a communications link.
- *Message Switching.* The ability to relay a message from one remote terminal to one or more remote terminals via a host processor and a series of communications links.
- *Time Sharing.* The allocation of host processor resources so that many remote terminals may execute programs concurrently and may interact with the programs during execution.
- *Data Acquisition And Process Control.* A high-speed data acquisition system is designed to maintain constant communication with a process for such purposes as:
 1. Determining whether the process is operating within acceptable limits.
 2. Providing records for accounting or management decisions.
 3. Providing a record of data obtained during a research experiment.

A process control system usually incorporates data acquisition facilities and has the additional capability of using the acquired data as a basis for supervising and controlling the process.

SYSTEMS NETWORK ARCHITECTURE (SNA)

Systems Network Architecture reorganizes the best of what is already known about teleprocessing networks and produces greater equipment utilization and economy in operation. By combining a single access method, a single network control program, and a single communications line control, SNA offers an orderly approach to supplying current communication needs and a sound foundation for advanced applications (future needs). See Figure 5-6.

SNA introduces standardization into communications systems:

- A single, standardized line discipline—SDLC
- A single, standardized access method—VTAM
- A network control program—NCP/VS
- A family of standardized, mutually compatible terminals:
 - IBM 3270 Information Display System (models 11 and 12)
 - IBM 3600 Finance Communication System
 - IBM 3650 Retail Store System
 - IBM 3660 Supermarket System
 - IBM 3767 Communication Terminal
 - IBM 3770 Data Communication System
 - IBM 3790 Communication System

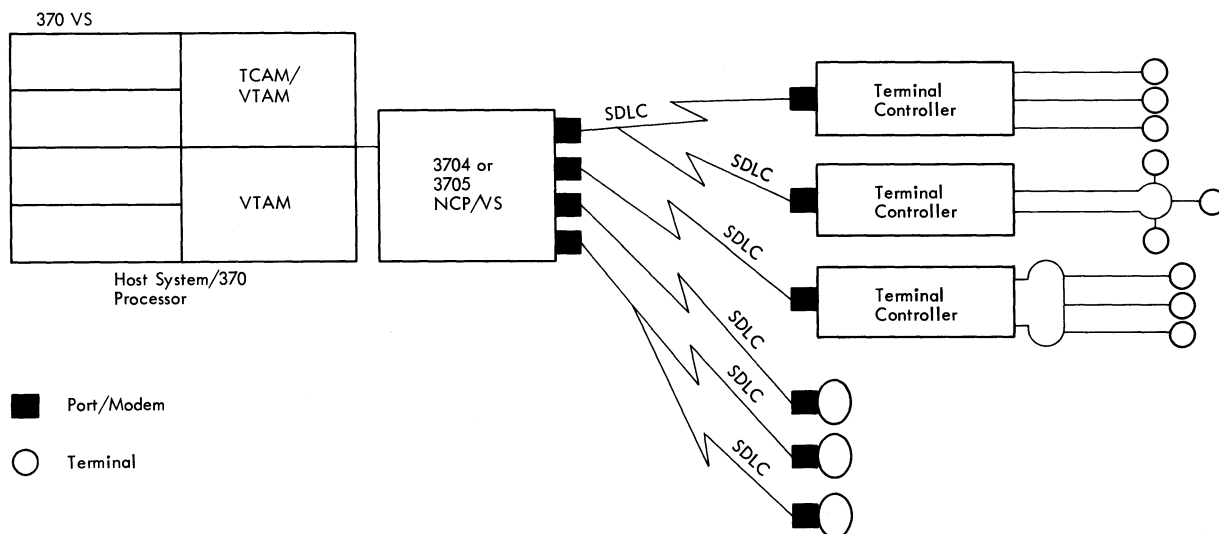

Figure 5-6. Systems Network Architecture

ADVANCED FUNCTION FOR COMMUNICATIONS

An extension of SNA, Advanced Function for Communications ties this mutually compatible family of terminals and virtual system operations into a unified communications structure. This structure, through partitioned

emulation programming (PEP), allows the IBM 3704 and 3705 Communications Controllers to operate as an IBM 2701 Data Adapter Unit, thus permitting attachment of terminals that use BSC or start-stop line control within the same network (Figure 5-7).

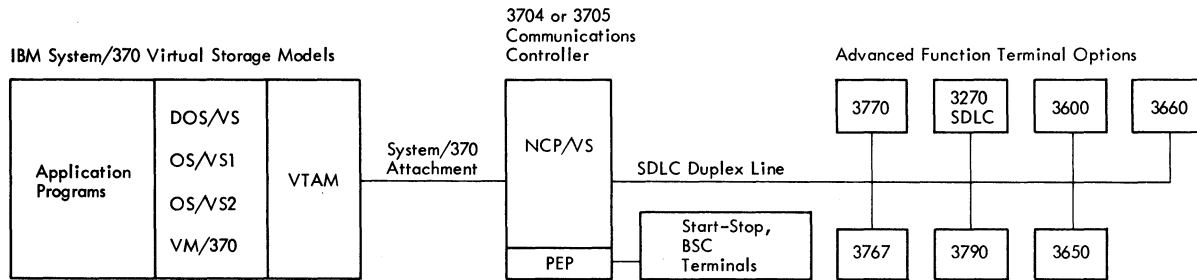

Figure 5-7. Advanced Function for Communications

The individual models of System/370 are briefly described in this section. Figures 6-1 through 6-9 show the different System/370 models. Figure 6-10 at the end of the section compares the prominent features and characteristics of each model with those of the other models. Information about directly attachable (local) I/O devices, control units, and systems is included in Section 7. Section 8 contains brief summaries of the various types of teleprocessing equipment attachable to System/370 on a remote basis.

System/370 Model 115

System/370 Model 115 (Figure 6-1), the smallest of the System/370 models, is a compact, versatile system with 64K (65,536 bytes) to 384K (393,216 bytes) of monolithic main (processor) storage. The Model 115, with either the IBM 3115-0 Processing Unit or the IBM 3115-2 Processing Unit that has extended performance, provides users with virtual storage capability. The Model 115 offers native (integrated) attachment of punched-card, tape, and disk devices; printers; and teleprocessing terminals. The Model 115 also offers channel attachment of a variety of I/O devices, including the IBM 3540 Diskette Input/Output Unit for cardless system operation.

Other prominent features contributing to performance are:

1. An integrated display/keyboard console, which provides the system control function and uses the display for better system-operator communication.
2. A console file, which provides the facility for loading control storage with microprograms or a system check-out program.
3. The alter/display function, which provides a means of displaying and altering main storage data at a printer-keyboard.

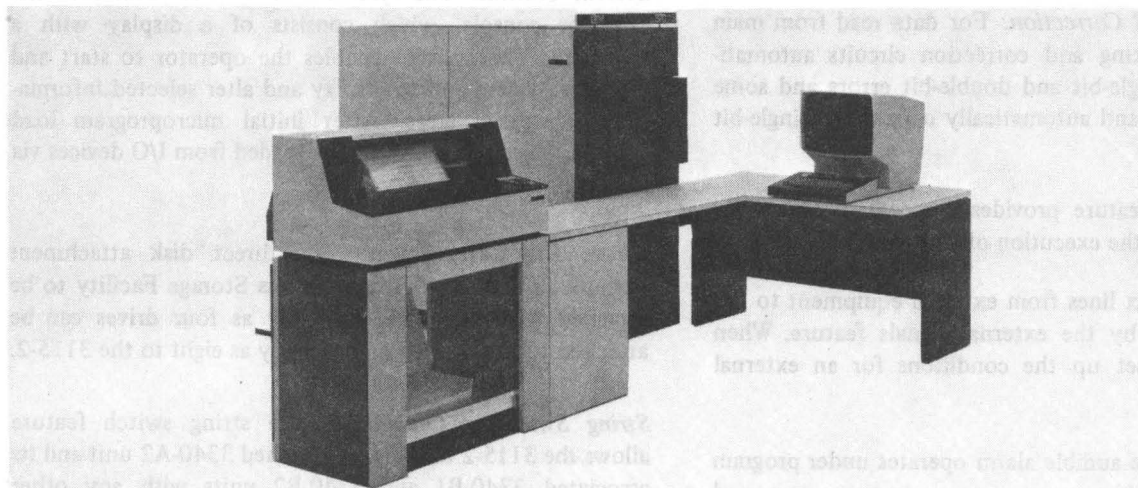

Figure 6-1. IBM System/370 Model 115 with IBM 3203 Printer

Standard Features

System/370 commercial instruction set
 Byte-oriented operand
 Storage protection (store and fetch)
 Interval timer
 Time-of-day clock
 Clock comparator and CPU timer
 Dynamic address translation
 Program event recording
 Basic or extended control mode
 Error checking and correction (in main storage)
 Monitoring
 Channel indirect data addressing
 Direct disk attachment (3340)
 Service processor (SVP)
 Audible alarm

Optional Features

Floating point (3115-0)
 Floating point, including extended precision
 External signals
 System/360 Model 20 compatibility
 1052 compatibility
 1401/1440/1460 compatibility
 1403/3203 carriage control
 2311-1/3340-series compatibility
 2314/3340-series compatibility
 Basic byte multiplexer channel (3115-0 and 3115-2)
 Extended byte multiplexer channel (3115-2)
 Integrated card I/O attachment
 Magnetic tape adapter (for 3410/3411 or 3803-3/3420)
 Integrated printer attachment
 Integrated console printer attachment
 Integrated communications adapter
 3340 fixed head attachment capability
 3340 string switching capability (3115-2)

System Components

Central Processing Unit: IBM 3115-0 or 3115-2 Processing Unit

The 3115-0 or 3115-2 Processing Unit contains main storage, and also contains several subprocessors, which increase operating efficiency. These subprocessors include:

The *main storage controller*, which controls access to main storage, and also keeps and updates the address registers for the other subprocessors.

The *service processor*, which loads microprograms from a console file, handles maintenance support and the manual control of the system, and logs and evaluates errors.

The *machine instruction processor (MIP)* of the 3115-0, which fetches and executes program instructions, carries out arithmetic/logical instructions, analyzes I/O instructions, calculates addresses, sets condition codes, updates the PSW, and controls the direct disk attachment.

The *instruction processing unit (IPU)* of the 3115-2, which performs the same functions as the MIP of the 3115-0 except for control of the direct disk attachment. This function is handled by a separate I/O processor. Because it does not have to control the direct disk attachment, the IPU has a higher instruction execution rate than the MIP.

The *input/output processors*, which execute I/O commands, and supervise data transfer between the I/O devices and the main storage controller.

Basic Machine Cycle Time: 480 nanoseconds (0.48 microsecond) for one byte on the machine instruction processor of the 3115-0; 480 nanoseconds for two bytes on the instruction processing unit of the 3115-2.

Instruction Sets: The System/370 commercial instruction set is standard with the Model 115. Adding the floating-point feature provides the Model 115 with the System/370 universal instruction set.

Error Checking and Correction: For data read from main storage, error-checking and correction circuits automatically detect all single-bit and double-bit errors and some multiple-bit errors, and automatically correct the single-bit errors.

Monitoring: This feature provides a means of selectively recording events in the execution of a program.

External Signals: Six lines from external equipment to the CPU are provided by the external signals feature. When pulsed, the lines set up the conditions for an external interruption.

Audible Alarm: The audible alarm operates under program control to alert the operator to operator errors and messages.

Processor Storage: Part of IBM 3115-0 or 3115-2 Processing Unit

Processor Storage Capacities:

Capacity (Bytes)	115 Model Designation	
	If 3115-0 Used	If 3115-2 Used
65,536	F	F2
98,304	FE	FE2
131,072	G	G2
163,840	GE	GE2
196,608	GF	GF2
262,144	—	H2
393,216	—	HG2

Storage Cycle Time: 480 nanoseconds (0.48 microsecond).

Storage Access Width: Two bytes (one halfword).

Channels: Part of IBM 3115-0 or 3115-2 Processing Unit

Model 115 can have one byte multiplexer channel with 32 subchannels, up to eight of which can be shared.

The basic 3115-0 or 3115-2 channel data rate is 19 kilobytes per second in byte mode. The 3115-2 channel equipped with the extended byte multiplexer feature has a data rate of 25 kilobytes per second in byte mode. The burst-mode data rate for either channel is 29 kilobytes per second.

System

Basic System: The minimum configuration for a Model 115 includes one 3115-0 or 3115-2 Processing Unit, one IBM 3340 Direct Access Storage Facility Model A2, one line printer, and either the 3540 Diskette Input/Output Unit or a card reader.

System Control: The system controls are located at the operator console, which consists of a display with a keyboard. The console enables the operator to start and stop the system and to display and alter selected information in storage areas. After initial microprogram load (IMPL), object programs can be loaded from I/O devices via the keyboard and display.

Direct Disk Attachment: The direct disk attachment permits an IBM 3340 Direct Access Storage Facility to be attached to Model 115. As many as four drives can be attached to the 3115-0 and as many as eight to the 3115-2.

String Switching Capability: The string switch feature allows the 3115-2 to share an attached 3340-A2 unit and its associated 3340-B1 and 3340-B2 units with any other System/370 processing unit except the 3115-0 or the 3125-0.

Integrated Card I/O Attachment: The IBM 2560 Multi-function Card Machine Model A1 or A2 can be attached to the Model 115 with an integrated 2560 attachment; the IBM 5425 Multi-function Card Unit can be attached to the Model 115 with an integrated 5425 attachment.

Magnetic Tape Adapter: A magnetic tape subsystem can be attached to a Model 115 via the magnetic tape adapter. This subsystem can consist of an IBM 3411 Magnetic Tape Unit and Control, with up to five IBM 3410 Magnetic Tape Units (the 3411 and 3410 model numbers must correspond); or an IBM 3803 Tape Control Model 3, with up to eight IBM 3420 Magnetic Tape Units Model 3 or 5. The magnetic tape adapter allows attachment of the 3410/3411 subsystem to any 3115-0 model or a 3115-2 Model F2 through H2, or attachment of the 3803/3420 subsystem to any 3115-0 or 3115-2 model.

Integrated Printer Attachment: This attachment allows an IBM 3203 Printer Model 1 or 2 or an IBM 5203 Printer Model 3 to be attached to a Model 115 without requiring a separate control unit.

Integrated Console Printer Attachment: This attachment allows an IBM 5213 Printer Model 1 to be attached to a Model 115 to provide hard-copy output of messages displayed on the operator's console.

Integrated Communications Adapter: This adapter allows as many as four synchronous and eight asynchronous communications lines, or as many as five synchronous communications lines, to attach to a Model 115 without requiring a separate transmission control unit. Data rates range from 45.5 to 1200 bps for asynchronous lines and from 1200 to 50,000 bps for synchronous lines.

Compatibility Features: The compatibility features available for the Model 115 include:

- System/360 Model 20
- 1052
- 1401/1440/1460
- 1403/3203 carriage control
- 2311-1/3340-series
- 2314/3340-series

Programming Support

Model 115 is supported by DOS and DOS/VS. With the CPU in basic control mode, operation with System/360 programs is possible if the 1052 and 2311 (or 2314) compatibility features are installed and both the IBM 5213 Printer and IBM 3340 Direct Access Storage Facility Model A2 are attached.

System/370 Model 125

The System/370 Model 125 (Figure 6-2), with either the IBM 3125-0 Processing Unit or the IBM 3125-2 Processing Unit, which has improved performance, provides users with a compatible low-end System/370 having a storage capacity of from 96K (98,304 bytes) to 512K (524,288 bytes). Monolithic circuitry, used in both main (processor) storage and control storage, and virtual storage capability contribute to the high performance level of the Model 125.

Other prominent features contributing to performance are:

1. An integrated display/keyboard console, which provides the system control functions, replaces the conventional indicators and switches, and uses the display for better system/operator communication.
2. Native (integrated) attachment of a variety of I/O devices, which eliminates the need for external control units; or channel attachment of other I/O devices such as the IBM 3540 Diskette Input/Output Unit for cardless system operation.
3. A console file, which provides the facility for loading control storage with microprograms or a system check-out program.
4. The alter/display function, which provides a means of displaying and altering main storage data at the display/keyboard console.

Standard Features

System/370 commercial instruction set
Byte-oriented operand
Storage protection (store and fetch)
Interval timer
Time-of-day clock
Clock comparator and CPU timer
Dynamic address translation
Program event recording
Basic or extended control mode
Error checking and correction (in main storage)
Monitoring

Channel indirect data addressing
Direct disk attachment (3330/3333 or 3340)
Microinstruction retry
Service processor (SVP)
Audible alarm

Optional Features

Floating point, including extended precision
External signals
System/360 Model 20 compatibility
1052 compatibility
1401/1440/1460 compatibility
1403/3203 carriage control compatibility
2311-1/3330-series compatibility
2311-1/3340-series compatibility
2314/3340-series compatibility
Byte multiplexer channel
Integrated card I/O attachments
Magnetic tape adapter (for 3410/3411 or 3803-3/3420)
Integrated printer attachment
Integrated console printer attachment
Integrated communications adapter
3340 fixed head attachment capability
3340 string switching capability (3125-2)

System Components

Central Processing Unit: IBM 3125-0 or 3125-2 Processing Unit

The IBM 3125-0 or 3125-2 Processing Unit contains main storage and several subprocessors for independent handling of programs, diagnostics, and input/output processing. These subprocessors include: a main storage controller (MSC), a service processor (SVP), an instruction processing unit (IPU), and input/output processors.

The *main storage controller* (MSC) can directly access main storage and control accessing of main storage by the other processors on a fixed-priority basis. The MSC has a logical storage area containing address registers assigned to each processor. The registers are maintained and updated by the MSC as it handles each request for access to main storage.

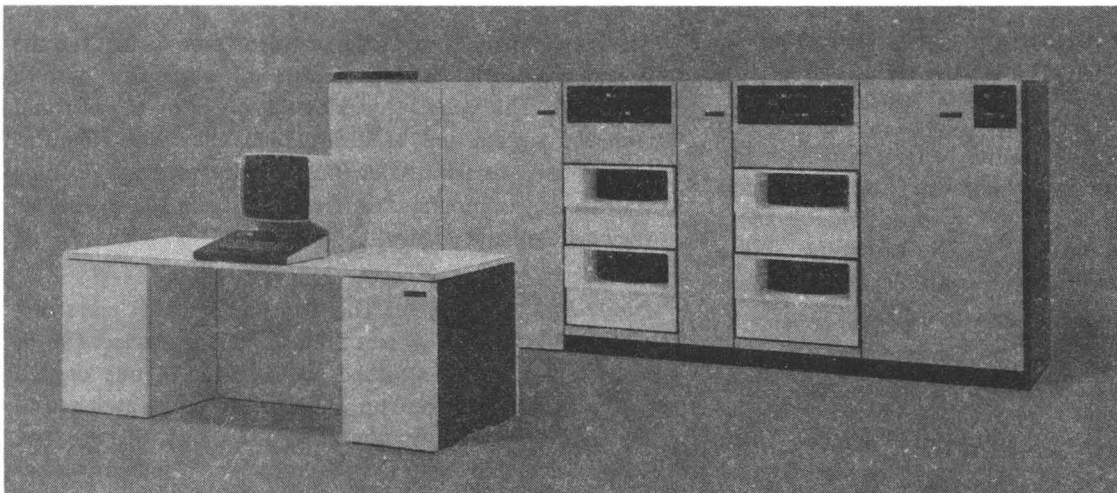

Figure 6-2. IBM System/370 Model 125 with IBM 3330 and 3333 Disk Storage

String Switching Capability: The string switch feature allows the 3125-2 to share one or two strings consisting of a 3340-A2 unit and its associated 3340-B1 and 3340-B2 units with any other System/370 processing unit except the 3115-0 or the 3125-0.

Integrated Card I/O Attachment: This feature permits the direct attachment of an appropriate model of one of the following to the Model 125:

2560 Multi-function Card Machine
3504 Card Reader
3525 Card Punch
5425 Multi-function Card Unit

Magnetic Tape Adapter: A magnetic tape subsystem can be attached directly to the Model 125 via the magnetic tape adapter. This subsystem can consist of an IBM 3411 Magnetic Tape Unit and Control, with up to five IBM 3410 Magnetic Tape Units (the 3411 and 3410 model numbers must correspond); or an IBM 3803 Tape Control Model 3, with up to eight 3420 Magnetic Tape Units Model 3 or 5.

Integrated Printer Attachment: The IBM 1403 Printer Model 2, 7, or N1, or the IBM 3203 Printer Model 1 or 2, can be attached directly to the Model 125 via the integrated 3203 printer attachment.

Integrated Console Printer Attachment: This feature allows the IBM 5213 Printer Model 1 to be attached as an integral

part of the Model 125 operator console. The 5213 provides hard-copy output of operator messages that are displayed.

Integrated Communications Adapter and Extension: This feature allows as many as 16 asynchronous or 6 synchronous communications lines to be attached to the Model 125 without requiring a separate transmission control unit. Data rates range from 45.5 to 600 bps for asynchronous lines and from 600 to 50,000 bps for synchronous lines.

Compatibility Features: The compatibility features available for the Model 125 include:

System/360 Model 20
1052
1401/1440/1460
1403/3203 carriage control
2311-1/3330-series
2311-1/3340-series
2314/3340-series

Programming Support

Model 125 is supported by DOS and DOS/VS. With the CPU in basic control mode, operation with System/360 programs is possible if the 1052 and 2311 (or 2314) compatibility features are installed and both the IBM 5213 Printer and IBM 3340 Direct Access Storage Facility Model A2 are attached. If the IBM 3330 Disk Storage is attached, the 2311 (or 2314) compatibility feature is not required for operation with DOS Release 27.

System/370 Model 135

The System/370 Model 135 (Figure 6-3), with either the IBM 3135 Processing Unit or the IBM 3135-3 Processing Unit (with improved performance), offers processor storage capacities of up to 512K (524,288 bytes) and virtual storage capability with System/370 reliability and performance at relatively low cost. Features such as error checking and correction (ECC) circuits and instruction retry increase Model 135 reliability, and monolithic storage circuits contribute significantly to performance.

Further enhancing the Model 135 are:

1. The console file, which provides the facility for loading control storage with the System/370 microprogram, diagnostic microprograms, or a system checkout program.
2. The alter/display function, which provides a means of displaying and altering main storage data at a printer-keyboard.
3. The CPU-integrated I/O adapters, which eliminate the need for external control units for some commonly used I/O devices.

Standard Features

System/370 commercial instruction set (3135)
 System/370 universal instruction set (3135-3)
 Byte-oriented operand
 Storage protection (both store and fetch)
 Interval timer
 Time-of-day clock
 Clock comparator and CPU timer (3135-3)
 Console file
 Dynamic address translation
 Channel indirect data addressing
 Program event recording
 Basic or extended control mode
 Error checking and correction (in main storage and control storage)

Conditional swapping (3135-3)
 PSW key handling (3135-3)
 Instruction retry
 Monitoring
 APL assist (3135-3)
 Extended control-program support (3135-3)
 Byte multiplexer channel (one: channel 0)
 Channel retry information
 Command retry
 OS/DOS compatibility
 Audible alarm

Optional Features

System/370 universal instruction set (3135)
 Floating point (3135)
 Extended-precision floating point (3135-3 prerequisite)
 Direct control (with external interrupt)
 Clock comparator and CPU timer (3135)
 System/360 Model 20 compatibility
 1401/1440/1460 compatibility
 2314/3340 compatibility
 Selector channels (first and second) (3135)
 Block multiplexer channel (3135)
 Block multiplexer channels (first and second) (3135-3)
 Block multiplexer shared subchannel
 Multiplexer subchannels, additional
 2319 integrated file adapter (IFA)
 3330/3340-series integrated file adapter (IFA)
 IFA conversion
 Universal character set adapter
 Integrated printer adapter (IPA)
 Integrated communications adapter (ICA)
 Adapter for 3210-1 or 3215-1 Console Printer-Keyboard
 Expanded control storage (3135)
 Virtual machine assist (3135)
 Emergency power-off control
 APL assist (3135)

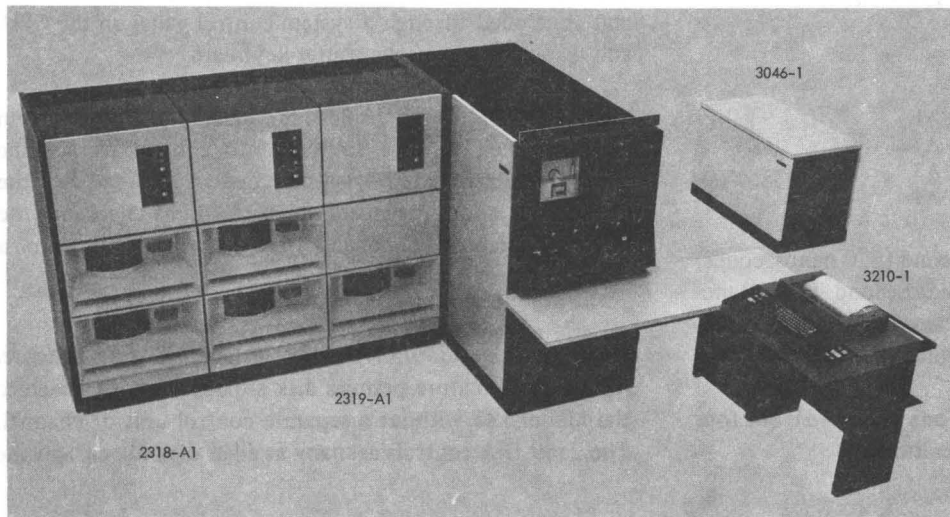

Figure 6-3. IBM System/370 Model 135 with IBM 2318 and 2319 Disk Storage, IBM 3210 Console Printer-Keyboard, and IBM 3046 Power Unit

System Components

Central Processing Unit: IBM 3135 or 3135-3 Processing Unit

The 3135 has seven models: FE, GD, GF, H, HF, HG, and I. The 3135-3 Models A1, A2, A3, and A4 are available as a miscellaneous-equipment specification (MES) to current 3135 Models H, HF, HG, and I.

Basic Machine Cycle Time: 275 to 1,485 nanoseconds (0.275 to 1.485 microseconds), depending on the type of instruction performed.

Instruction Sets: The System/370 commercial instruction set is standard with the 3135 Processing Unit. The System/370 universal instruction set is standard with the 3135-3 Processing Unit.

Instruction Retry: Instruction retry automatically examines any instruction during whose execution an error is detected, and in most cases reattempts its execution.

Error Checking and Correction: For data read from main storage and control storage, error checking and correction circuits automatically detect all single- and double-bit errors and some multiple-bit errors, and automatically correct the single-bit errors.

Monitoring: This feature provides a means of selectively recording events in the execution of a program.

Processor Storage: Part of 3135 or 3135-3 Processing Unit

Processor Storage Capacities:

Capacity (Bytes)	135 Model Designation	
	If 3135 Used	If 3135-3 Used
98,304	FE	—
147,456	GD	—
196,608	GF	—
262,144	H	A1
327,680	HF	A2
393,216	HG	A3
524,288	I	A4

Storage Cycle Time: 0.770 microsecond (770 nanoseconds) for main storage read, 0.935 microsecond (935 nanoseconds) for main storage write. These storage cycle times include the fetch time for the next microinstruction.

Storage Access Width: Two bytes (one halfword), but four bytes (one word) in certain read operations.

Control Storage: Part of 3135 or 3135-3 Processing Unit

Control Storage Capacity: The control storage capacity of the 3135 Processing Unit is 24K (24,576 bytes), expandable to 36K (36,864 bytes) or 48K (49,152 bytes). The control storage capacity of the 3135-3 Processing Unit is 128K (131,072 bytes).

Channels: Part of 3135 or 3135-3 Processing Unit

The Model 135 can have as many as four channels, including the IFA, which is addressed as channel 1. One byte multiplexer channel is standard on both the 3135 and the 3135-3. The byte multiplexer channel for the 3135 has 16 subchannels as standard, which can be extended to 64, 128, or 256 subchannels by option. The byte multiplexer channel for the 3135-3 has 64 subchannels as standard, which can be extended to 128 or 256 subchannels by option.

The 3135 can have one or two additional selector channels that can have the optional block multiplexer channel feature to operate as block multiplexer channels.

The 3135-3 can have one or two additional block multiplexer channels.

Each block multiplexer channel for the Model 135 can have one of three subchannel combinations. Subchannels can be combined as 16 nonshared and 1 shared, 8 nonshared and 9 shared, or 8 nonshared and 5 shared.

System

The Model 135 system consists of the following:

IBM 3135 or 3135-3 Processing Unit
IBM 3210 or 3215 Console Printer-KeyBoard Model 1
IBM 3046 Power Unit Model 1
Appropriate input/output devices for a minimum or larger system configuration

System Control: The Model 135 is operated, monitored, and controlled through a system control panel on the CPU, and through the console printer-keyboard.

Console File: The console file, located on the system control panel, is used to load into control storage the microprogram required for system operation. As part of the loading operation, diagnostic microprograms check out the CPU and adapters. Other disks for the console file carry a diagnostic program for system checkout.

2319 and/or 3330/3340-series Integrated File Adapter (IFA): Each feature permits disk storage units to attach to the Model 135 without a separate control unit or channel. The 2319 IFA controls as many as eight disk drives, and the

3330/3340-series IFA allows one or two 3333 units or 3340-A2 units to be attached directly to the Model 135. Each 3333 can attach up to three 3330 units. Each 3340-A2 can attach 3340-B1 or -B2 units, and one 3340-A2 can also attach 3344-B2 or -B2F units. The maximum number of drives per string is eight. A 3333/3330 string and a 3340 string (without 3344's) can be attached to the IFA if the optional intermix feature is installed. Both the 2319 IFA and the 3330/3340-series IFA can be attached to the same system if the system has the IFA conversion feature installed.

Integrated Printer Adapter (IPA): This feature allows an IBM 1403 Printer Model 2, 7, or N1 to be attached to the Model 135 without a separate control unit. The universal character set is available as a subfeature.

Integrated Communications Adapter (ICA): This feature allows direct attachment of eight communication lines.

Compatibility Features: The compatibility features available for the Model 135 are:

System/360 Model 20
1401/1440/1460
2314/3340
OS/DOS

Programming Support

The Model 135 is supported by DOS, DOS/VS, OS/MFT, OS/VS1, and VM/370.

System/370 Model 138

The IBM System/370 Model 138 (Figure 6-3.1) provides either 512K (524,288 bytes) or 1,024K (1,048,576 bytes) of processor storage and virtual storage capability at a level of performance between that of the Models 135 and 145.

Other characteristics that contribute significantly to the performance of the Model 138 include:

1. Control storage capacity that covers control storage requirements for the full line of Model 138 standard and optional features.
2. A display console with a keyboard that provides a visual communication link with the system.
3. Instruction retry facilities, and error checking and correction (ECC) circuits.
4. The CPU-integrated I/O adapters, which eliminate the need for external control units for several commonly used I/O devices.
5. Extended control-program support.

Standard Features

System/370 universal instruction set
Extended-precision floating point
Byte-oriented operand
Control registers
Storage protection (for store and fetch)
Interval timer
Time-of-day clock
Clock comparator and CPU timer
Console file
Dynamic address translation
Channel indirect data addressing
Program event recording
Basic or extended control mode
Store status
Conditional swapping
PSW key handling

Error checking and correction (in main storage and control storage)
Instruction retry
Monitoring
APL assist
Extended control-program support
Byte multiplexer channel (with 64 byte multiplexer subchannels)
Block multiplexer channels (two, each with 1 shared and 16 non-shared block multiplexer subchannels)
Channel retry information
Command retry
OS/DOS compatibility
Audible alarm

Optional Features

Direct control
Channel priority
System/360 Model 20 compatibility
1401/1440/1460 compatibility
2314/3340 compatibility
Block multiplexer shared subchannels (8 nonshared and 9 shared or 8 nonshared and 5 shared)
Multiplexer subchannels (128 or 256 subchannels)
Integrated communications adapter (ICA)
Integrated printer adapter (IPA) for 1403
3330/3340-series integrated file adapter (IFA)
3333 or 3340 string switching capability
3333/3340 intermix capability
3340 fixed-head attachment capability
3344 fixed-head attachment capability
Integrated 3203-4 Printer attachment

System Components

Central Processing Unit: IBM 3138 Processing Unit

Basic Machine Cycle Time: 275 to 1,485 nanoseconds (0.275 to 1.485 microseconds), depending on the type of instruction performed.



Figure 6-3.1. IBM System/370 Model 138 with Display Console and Keyboard

Instruction Set: The System/370 universal instruction set is standard with the Model 138.

Instruction Retry: Instruction retry automatically examines any instruction during whose execution an error is detected, and in most cases reattempts its execution.

Error Checking and Correction: For data read from main storage and control storage, error checking and correction circuits automatically detect all single- and double-bit errors and some multiple-bit errors, and automatically correct the single-bit errors.

Extended Control-Program Support: This is a hardware assist that reduces the CPU time needed to execute certain supervisor functions in both VS1 and VM/370.

Monitoring: This feature provides a means of selectively recording events in the execution of a program.

Processor Storage: Part of 3138 Processing Unit

Processor Storage Capacities:

Capacity (Bytes)	Model
524,288	I
1,048,576	J

Storage Cycle Time:

Operation	Time (Nanoseconds)
Read byte or halfword	715
Read fullword	880
Write	935

Storage Access Width: Two bytes or four bytes, depending on the operation.

Control Storage: Part of 3138 Processing Unit

Control Storage Capacity: 128K (131,072 bytes).

Channels: Part of 3138 Processing Unit

The Model 138 can have as many as four channels, including the IFA, which is addressed as channel 1. One byte multiplexer and two block multiplexer channels are standard.

The byte multiplexer channel has 64 subchannels as standard, which can be extended to 128 or 256 subchannels by option.

Each block multiplexer channel can have one of three subchannel combinations. Subchannels can be combined as

16 nonshared and 1 shared, 8 nonshared and 9 shared, or 8 nonshared and 5 shared.

System

The Model 138 system consists of:

IBM 3138 Processing Unit with attached display console and keyboard

IBM 3046 Power Unit Model 1

Appropriate input/output devices for a minimum or larger system configuration

System Control: The Model 138 is operated, monitored, and controlled through the system control panel on the CPU, and through the display console.

Console File: The console file, located under the operator's console table, is used to load into control storage the microprogram required for system operation. As part of the loading operation, diagnostic microprograms check out the CPU and adapters. Other disks for the console file carry a diagnostic program for system checkout.

3330/3340-series Integrated File Adapter (IFA): This feature allows one or two 3333 units or 3340-A2 units to be attached directly to the Model 138. Each 3333 can attach up to three 3330 units. Each 3340-A2 can attach 3340-B1 or -B2 units, and one 3340-A2 can also attach 3344-B2 or -B2F units. The maximum number of drives per string is eight. A 3333/3330 string and a 3340 string (without 3344's) can be attached to the IFA if the optional intermix feature is installed.

Integrated Printer Adapter (IPA) for the 1403: This feature allows an IBM 1403 Printer Model 2, 7, or N1 to be attached to the Model 138 without a separate control unit. The universal character set is available as a subfeature.

Integrated 3203-4 Printer Attachment: This feature allows an IBM 3203 Printer Model 4 to be attached to the Model 138.

Integrated Communications Adapter (ICA): This feature allows direct attachment of eight communication lines.

Compatibility Features: The compatibility features available for the Model 138 are:

System/360 Model 20
1401/1440/1460
2314/3340
OS/DOS

Programming Support

The Model 138 is supported by DOS/VS, OS/VS1, and VM/370.

System/370 Model 145

The System/370 Model 145 (Figure 6-4), with either the IBM 3145 Processing Unit or the IBM 3145-3 Processing Unit (with improved performance), is a versatile data processing system for both commercial and scientific applications. It has virtual storage capability, provides efficient performance while preserving upward compatibility, and offers processor storage capacities as large as 2,048K (2,097,152 bytes).

The performance of the Model 145 is further enhanced by:

1. System/370's notable reliability and serviceability features, such as its retry capabilities, error-logging facilities, extensive internal checking circuits, and error checking and correction (ECC) circuits for main storage and control storage.
2. A console file, which provides a facility for loading control storage with either the System/370 microprogram, extensive microdiagnostics, or system tests.
3. An alter/display function, which provides a means of displaying and altering main storage without interfering with any concurrent I/O operations.
4. A control storage capacity of 128K (131,072 bytes) in the 3145-3 Processing Unit.

Standard Features

System/370 commercial instruction set (3145)
System/370 universal instruction set (3145-3)
Extended-precision floating point (3145-3)
Byte-oriented operand
Storage protection (for store and fetch)
Interval timer
Time-of-day clock
Console file
Dynamic address translation
Channel indirect data addressing
Program event recording
Basic or extended control mode
Error checking and correction (in main storage and control storage)
Micro-instruction retry
Monitoring
APL assist (3145-3)
Extended control-program support (3145-3)

Advanced control program support (3145-3)
Byte multiplexer channel
Block multiplexer channel (3145-3)
Selector channel (3145)
Channel retry information
Command retry
OS/DOS compatibility
Audible alarm

Optional Features

System/370 universal instruction set (3145)
Floating point (includes extended precision) (3145)
Clock comparator and CPU timer (required for 3145-3)
Word buffer (required for 3145-3)
Direct control
1401/1440/1460 compatibility
1401/1440/1460, 1410/7010 compatibility
3345 Storage and Control Frame Model 1, 2, 3, 4, or 5 (3145)
Byte multiplexer subchannels, additional
Selector channels (second, third, and fourth) (3145)
Block multiplexer channel (3145)
Block multiplexer channels (second, third, and fourth) (3145-3)
Channel-to-channel adapter
Integrated file adapter (IFA) (3145)
Integrated storage control (ISC)
Virtual machine assist (3145)
APL assist (3145)
Adapter for a 3210-1 or 3215-1 Console Printer-Keyboard
Adapter for a 3210-2 Console Printer-Keyboard

System Components

Central Processing Unit: IBM 3145 or 3145-3 Processing Unit

The 3145 has 12 models: GE, GFD, H, HG, and I; and H2, HG2, I2, IH2, J2, JI2, and K2. The 3145-3 has seven improved-performance models (A1 through A7) available as a miscellaneous-equipment specification (MES) to current 3145 Models H2 through K2.

Basic Machine Cycle Time: 202.5 to 315.0 nanoseconds (0.2025 to 0.315 microsecond) for the 3145 and 180.0 to 270.0 nanoseconds (0.180 to 0.270 microsecond) for the 3145-3. The exact time for each CPU depends on internal CPU operations.

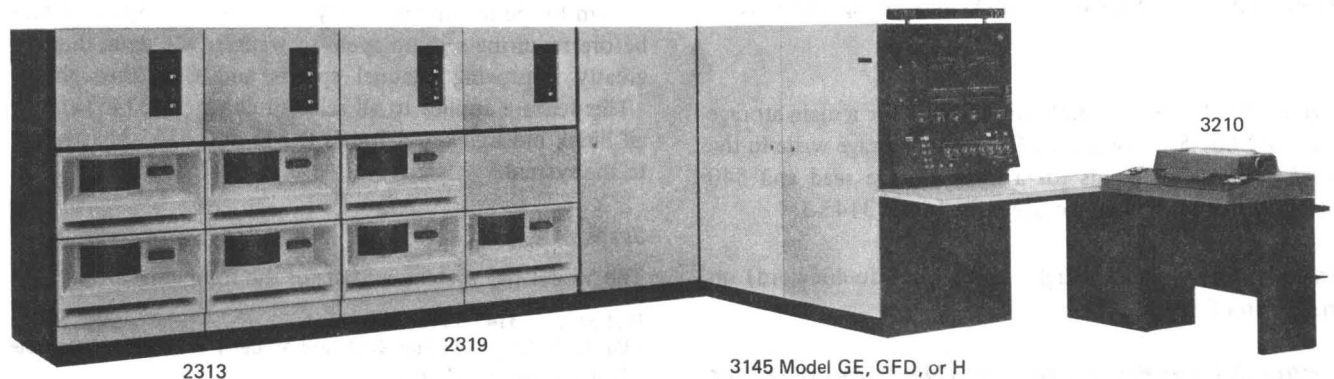

Figure 6-4. IBM System/370 Model 145 with IBM 2313 and 2319 Disk Storage and IBM 3210 Console Printer-Keyboard

Instruction Sets: The System/370 commercial instruction set is standard with the 3145 Processing Unit and becomes the System/370 universal instruction set by the addition of the floating-point feature. The System/370 universal instruction set is standard with the 3145-3 Processing Unit.

Micro-instruction Retry: The ability to recover from many intermittent failures is provided through retry techniques performed by microprogram routines that save the source data before it is altered during an operation. When an error is detected, a microprogram returns the CPU to the beginning of the operation or to a point in the operation that was correctly executed, and the operation is continued.

Error Checking and Correction: For data read from main storage and control storage, error checking and correction circuits automatically detect all single- and double-bit errors and some multiple-bit errors, and automatically correct the single-bit errors.

Processor Storage: Part of 3145 or 3145-3 Processing Unit: and on Certain Models of the 3145 Includes the IBM 3345 Storage and Control Frame Model 1, 2, 3, 4, or 5

Processor Storage Capacities:

Capacity (Bytes)	145 Model Designation	
	If 3145 Used	If 3145-3 Used
163,840	GE	-
196,608*	-	A1
212,992	GFD	-
262,144	H, H2	-
327,680*	-	A2
393,216	HG, HG2	-
458,752*	-	A3
524,288	I, I2	-
720,896*	-	A4
786,432	IH2	-
983,040*	-	A5
1,048,576	J2	-
1,507,328*	-	A6
1,572,864	J12	-
2,031,616*	-	A7
2,097,152	K2	-

*Reflects the removal of 64K from 3145 model being converted.

Storage Cycle Time: 540.0 nanoseconds for a main storage read and 607.5 nanoseconds for a main storage write in the 3145; 405 nanoseconds for a main storage read and 540 nanoseconds for a main storage write in the 3145-3.

Storage Access Width: Eight bytes (one doubleword) on instruction fetches.

Control Storage: Part of 3145 or 3145-3 Processing Unit

Control Storage Access Time: 109 nanoseconds for the 3145 and 75 nanoseconds for the 3145-3.

Control Storage Capacity: The 3145 has a control storage capacity of 32K (32,768 bytes) that is expandable to 64K to cover control storage requirements for installed features. The additional control storage capacity is at the expense of main storage. The storage boundary is determined at the time that the microprogram is compiled by IBM.

The 3145-3 has a control storage capacity of 128K (131,072 bytes) that covers control storage requirements for the full line of 3145-3 features including extended control-program support. In converting from a 3145 to a 3145-3, all of the currently used control storage and up to 64K of main storage is removed and replaced with the new 128K control storage.

Channels: Part of 3145 or 3145-3 Processing Unit

The 3145 Processing Unit can have as many as five channels. One byte multiplexer channel and one selector channel are standard. Three additional selector channels are available as optional features. If the IFA feature is installed, only one additional selector channel can be attached. The block multiplexer channel feature provides block multiplexer capabilities for all system selector channels.

The 3145-3 Processing Unit can have as many as five channels. One byte multiplexer channel and one block multiplexer channel are standard. Three additional block multiplexer channels are available as special features.

The byte multiplexer channel for the 3145 has 16 subchannels as standard. Subchannels can be added for a total of 32, 64, 128, or 256. The byte multiplexer channel for the 3145-3 has 64 subchannels as standard. Subchannels can be added for a total of 128 or 256.

The block multiplexer channels for the 3145 have 16 nonshared subchannels as standard. Subchannels can be added, in increments of 16, for a system total of 512. Block multiplexer channels for the 3145-3 have 64 nonshared subchannels as standard. Subchannels can be added for a system total of 128, 256, or 512.

Word Buffer: This feature increases the efficiency of the system by permitting assembly of up to four bytes of data before requiring a share cycle to transfer the data, thereby greatly improving channel speeds and CPU throughput.

This feature applies to all selector channels (3145) and to all block multiplexer channels (3145 and 3145-3) attached to the system.

System

The Model 145 system consists of the following:

- IBM 3145 or 3145-3 Processing Unit
- IBM 3210 Console Printer-Keybaord Model 1 or IBM 3215 Console Printer-Keybaord Model 1

IBM 3345 Storage and Control Frame (3145 Models H, HG, and I)
IBM 3046 Power Unit Model 1 (3145 Models HG and I)
IBM 3047 Power Unit Model 1 (3145 Models H2, HG2, I2, IH2, J2,
JI2, K2, and 3145-3 Models A1 through A7)
Appropriate input/output devices for a minimum or larger system
configuration

Compatibility Features: The compatibility features available for the Model 145 are:

1401/1440/1460
1401/1440/1460, 1410/7010
OS/DOS

System Control: The Model 145 is operated, monitored, and controlled through the system control panel on the 3145 or 3145-3 Processing Unit, and through a 3210 or 3215 Console Printer-Keyboard Model 1.

Console File: The console file, located under the operator's console table, is the initial microprogram loading (IMPL) device for the system. The file provides all microcode, on removable diskettes, for the system. Diskettes supplied with the system provide the required microcode for system operation, emulators, diagnostics, and any other required microprogram material to be loaded into control storage.

Integrated File Adapter (for 3145 Models GE, GFD, H, HG, and I): This feature, assigned exclusive use of selector channels 1 and 4, incorporates a file control unit for

controlling three to eight drives of natively attached disk storage. This control unit attaches the three-drive 2319 Disk Storage Model A1. Additionally attachable, to a maximum of five drives, are the single-drive 2312-A1, two-drive 2318-A1, three-drive 2319-A2, and four-drive 2313-A1.

Integrated Storage Control (for 3145 Models H, HG, and I through the 3345 Storage and Control Frame Models 3, 4, and 5, respectively; and for 3145 Models H2, HG2, I2, IH2, J2, JI2, K2, and All 3145-3 Models): This feature permits the attachment of one or two 3333 units with associated 3330's, one or two 3340-A2 units with associated 3340-B1 or -B2 units, or one or two 3350-A2 or -A2F units with associated 3350-B2, -B2F, -C2, or -C2F units, for a maximum of eight drives per string. Up to two additional 3333/3330, 3340, or 3350 strings can be attached. Attachment of one or two 3340-A2's with 3344's is mutually exclusive with attachment of either 3333's or 3350-A2's or -A2F's. A two-channel switch attaches the integrated storage control to a second channel, providing channel sharing ability.

Programming Support

The Model 145 is supported by DOS, DOS/VS, OS/MFT, OS/MVT, OS/VS1, OS/VS2, and VM/370.

System/370 Model 148

The IBM System/370 Model 148 (Figure 6-4.1) is a versatile data processing system for both commercial and scientific applications. It has virtual storage capability, provides efficient performance while preserving upward compatibility, and offers processor storage capacities of 1 megabyte (1,048,576 bytes) or 2 megabytes (2,097,152 bytes).

The performance of the Model 148 is further enhanced by:

1. System/370 reliability and serviceability features, such as retry capabilities, error-logging facilities, extensive internal checking circuits, and error checking and correction (ECC) circuits for main storage and control storage.
2. A console file, which provides a facility for loading control storage with either the System/370 microprogram, extensive microdiagnostics, or system tests.
3. An input/output display console and keyboard for operator communication with the system. The display console provides a fast means of displaying system status information and also provides the capability to select some aspects of the system environment at initial microprogram loading (IMPL) time.
4. Extended control-program support.
5. Control storage capacity that covers control storage requirements for the full line of Model 148 standard and optional features.

Standard Features

System/370 universal instruction set
Extended-precision floating point
Byte-oriented operand
Control registers
Storage protection (for store and fetch)
Interval timer
Time-of-day clock
Clock comparator and CPU timer

Console file
Dynamic address translation
Channel indirect data addressing
Program event recording
Basic or extended control mode
Error checking and correction (in main storage and control storage)
Micro-instruction retry
Monitoring
APL assist
Extended control-program support
Advanced control program support
Byte multiplexer channel (64 byte multiplexer subchannels)
Block multiplexer channels (64 block multiplexer subchannels)
Channel retry information
Command retry
Word buffer
OS/DOS compatibility
Audible alarm

Optional Features

Direct control
1401/1440/1460 compatibility
1401/1440/1460, 1410/7010 compatibility
Byte multiplexer subchannels (additional, for a total of 128 or 256)
Block multiplexer subchannels (additional, for a total of 128, 256, or 512)
Channel-to-channel adapter
Emergency power-off control
Integrated storage control with options
Integrated 3203-4 Printer attachment

System Components

Central Processing Unit: IBM 3148 Processing Unit

Basic Machine Cycle Time: 180 to 270 nanoseconds (0.180 to 0.270 microsecond), depending on internal CPU operations.

Instruction Set: The System/370 universal instruction set and extended-precision floating-point feature are standard with the Model 148.

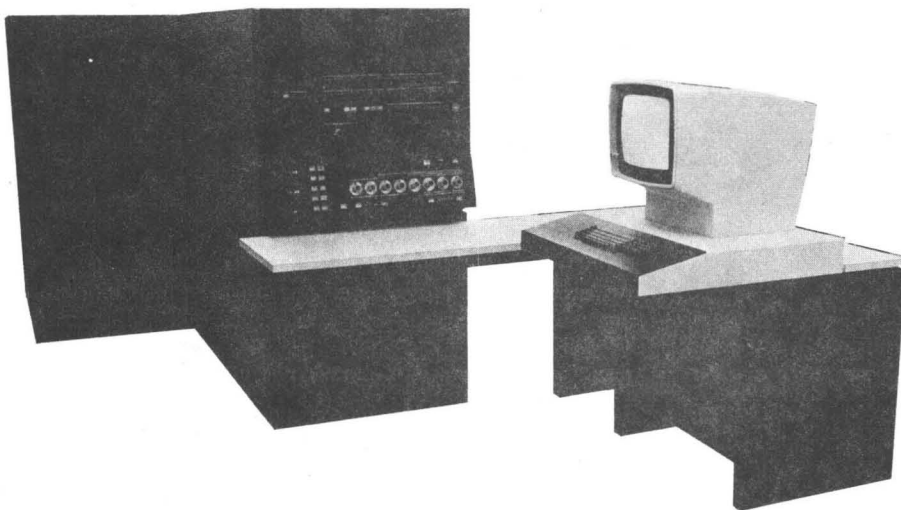

Figure 6-4.1. IBM System/370 Model 148 with Display Console and Keyboard

Micro-instruction Retry: The ability to recover from many intermittent failures is provided through retry techniques performed by microprogram routines that save the source data before it is altered during an operation. When an error is detected, a microprogram returns the CPU to the beginning of the operation or to a point in the operation that was correctly executed, and the operation is continued.

Error Checking and Correction: For data read from main storage and control storage, error checking and correction circuits automatically detect all single- and double-bit errors and some multiple-bit errors, and automatically correct the single-bit errors.

Advanced Control Program Support: This feature provides the following:

- Compare and swap instructions
- PSW key handling instructions
- Clear I/O function

Extended Control-Program Support: This is a hardware assist that reduces the CPU time needed to execute certain supervisor functions in both VS1 and VM/370.

Monitoring: This feature provides a means of selectively recording events in the execution of a program.

Processor Storage: Part of 3148 Processing Unit

Processor Storage Capacities:

Capacity (Bytes)	Model
1,048,576	J
2,097,152	K

Storage Cycle Time: 405 nanoseconds for a main storage read and 540 nanoseconds for a main storage write.

Storage Access Width: Eight bytes (one doubleword) on instruction fetches.

Control Storage: Part of 3148 Processing Unit

Control Storage Access Time: 75 nanoseconds.

Control Storage Capacity: 128K (131,072 bytes).

Channels: Part of 3148 Processing Unit

One byte multiplexer channel and four block multiplexer channels are standard on the Model 148.

The byte multiplexer channel has 64 byte multiplexer subchannels, and additional subchannels can be added for a total of 128 or 256 subchannels.

The four block multiplexer channels have 64 nonshared subchannels as standard. Subchannels can be added for a system total of 128, 256, or 512. Each channel has the word buffer that increases channel data rate by allowing up to four bytes at a time to be transferred between the channel and processor storage.

System

The Model 148 system consists of:

- IBM 3148 Processing Unit with attached display console and keyboard
- IBM 3047 Power Unit Model 1
- Appropriate input/output devices for a minimum or larger system configuration

System Control: The Model 148 is operated, monitored, and controlled through the system control panel on the CPU, and through the display console.

Console File: The console file, located under the operator's console table, is the initial microprogram loading (IMPL) device for the system. The file provides all microcode, on removable diskettes, for the system. Each diskette contains a full control storage load of system microcode. Diskettes supplied with the system provide the required microcode for system operation, emulators, diagnostics, and any other required microprogram material to be loaded into control storage.

Integrated 3203-4 Printer Attachment: This feature allows an IBM 3203 Printer Model 4 to be attached to the Model 148.

Compatibility Features: The compatibility features for the Model 148 are:

- OS/DOS (standard)
- 1401/1440/1460
- 1401/1440/1460, 1410/7010

Integrated Storage Control: This feature permits the attachment of one or two 3333 units with associated 3330's, one or two 3340-A2 units with associated 3340-B1 or -B2 units, or one or two 3350-A2 or -A2F units with associated 3350-B2, -B2F, -C2, or -C2F units, for a maximum of eight drives per string. Up to two additional 3333/3330, 3340, or 3350 strings can be attached. Attachment of one or two 3340-A2's with 3344's is mutually exclusive with attachment of either 3333's or 3350-A2's or -A2F's. A two-channel switch attaches the integrated storage control to a second channel, providing channel sharing ability.

Programming Support

The Model 148 is supported by DOS/VS, OS/VS1, and VM/370.

System/370 Model 155

The IBM System/370 Model 155 (Figure 6-5) is a high-performance data processing system that provides the reliability, availability, and convenience demanded by business and scientific users, as well as by users with applications in communications or control.

The high performance of the Model 155 is the result in part of these features:

1. Access to 16 main-storage bytes in parallel.
2. Local storage used for CPU (general, floating-point, and control registers) and I/O applications.
3. High-speed buffer storage that stores currently used sections of main storage for faster accessing of data.
4. Read-only storage (ROS), which contains the micro-programs (ROS control words) that control CPU and I/O operations.
5. Overlap, where possible, of the instruction fetching and execution portions of CPU operations.
6. Overlap, where possible, of CPU and I/O operations.
7. Retry facilities in the CPU, channels, and control units.
8. An alter/display function that provides an easy method for storing small program loops or for making changes to programs already in storage.

Standard Features

System/370 universal instruction set
Storage protection (store and fetch)
Byte-oriented operand feature
High-speed buffer storage (8,192 bytes)
Error checking and correction (in main storage)
Time-of-day clock
Interval timer
Instruction retry
Channel retry
Command retry
Byte multiplexer channel (one: channel 0)
Block multiplexer channels (two: channels 1 and 2)
Monitoring

Optional Features

Extended-precision floating-point
Direct control (with external interrupt)
OS/DOS compatibility
1401/1440/1460, 1410/7010 compatibility
7070/7074 compatibility
Channel-to-channel adapter
Block multiplexer channel (up to three, for channels 3, 4, and 5)
Byte multiplexer channel (one more, in place of the block multiplexer channel for channel 4)
Adapter for a 3210-1 or 3215-1 console printer-keyboard (one must be specified)
Adapter for 3210-2 console printer-keyboard (standalone)

System Components

Central Processing Unit: 3155 Processing Unit

Basic Machine Cycle Time: 0.115 microsecond (115 nanoseconds).

Instruction Set: The System/370 universal instruction set is standard on the Model 155.

Monitoring: This feature provides a means of selectively recording designated events in the execution of a program.

Instruction Retry: Instruction retry automatically examines any instruction during whose execution an error is detected, and in most cases reattempts its execution.

Error Checking and Correction: For data read from main storage, error checking and correction circuits automatically detect all single- and double-bit errors and some multiple-bit errors, and automatically correct the single-bit errors.

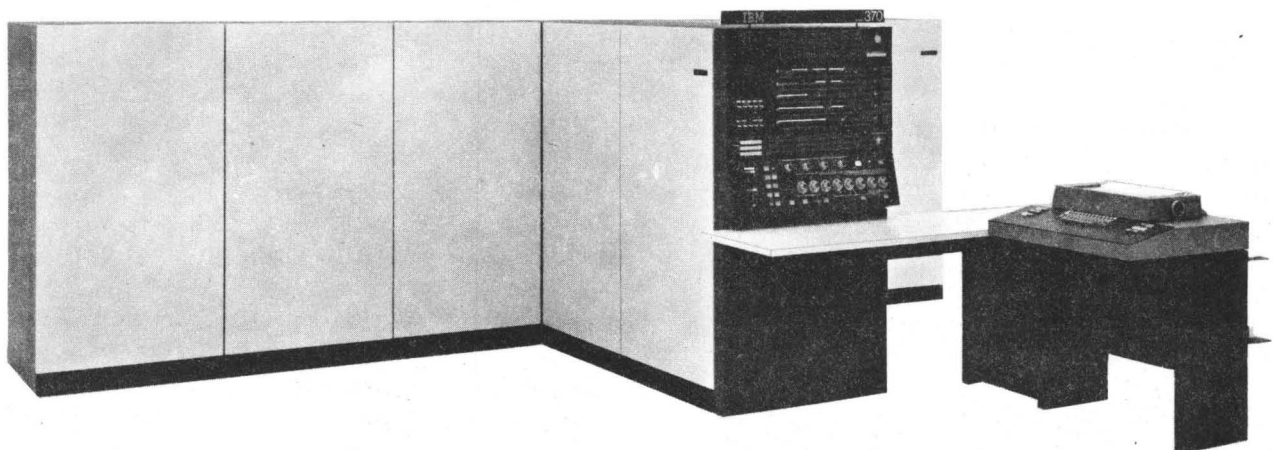

Figure 6-5. IBM System/370 Model 155 with IBM 3210 Console Printer-KeyBoard

Main Storage: IBM 3360 Processor Storage Models 1-3

Storage Capacities:

<i>Capacity (Bytes)</i>	<i>Model</i>	<i>Storage Units</i>
262,144	H	One 3360-1
393,216	HG	One 3360-2
524,288	I	One 3360-3
786,432	IH	One 3360-1 and one 3360-3
1,048,576	J	Two 3360-3's
1,572,864	JI	Three 3360-3's
2,097,152	K	Four 3360-3's

Storage Cycle Time: 2.07 microseconds.

Storage Access Width: 16 bytes (one quadword).

High-Speed Buffer Storage: The 8,192-byte buffer storage can satisfy many requests for storage, making the effective storage access time much less than the actual main-storage cycle time.

Buffer Control Unit: This unit is the intermediary between main storage and the other system units. As such, it controls the accesses to the high-speed buffer storage and to main storage.

Channels: Part of 3155 Processing Unit

The system can have one byte multiplexer channel and as many as five block multiplexer channels, or two byte multiplexer channels (the second as an optional feature) and as many as four block multiplexer channels.

System

The basic system consists of the IBM 3155 Processing Unit, one IBM 3210 or 3215 Console Printer-Key-board, and IBM 3360 Processor Storage.

Compatibility Features: The compatibility features available for the Model 155 are:

OS/DOS
1401/1440/1460, 1410/7010
7070/7074

System Control: The Model 155 is operated, monitored, and controlled via the system control panel on the 3155 Processing Unit, and via the console printer-keyboard.

Dynamic Address Translation (DAT) Facility: This facility is available for purchased installed Model 155's. Equipped with the DAT facility, a system is designated a Model 155 II. In basic control mode, a Model 155 II operates as a 155. But in extended control mode and in conjunction with a system control program, such a facility provides a Model 155 II with virtual storage capability, which permits programs to operate as though they had use of up to 16 million bytes of storage.

Programming Support

The Model 155 is supported by DOS, OS/MFT, and OS/MVT, and the Model 155 II is supported also by DOS/VS, OS/VS1, OS/VS2, and VM/370.

System/370 Model 158

The System/370 Model 158 (Figure 6-6), with either the IBM 3158 Processing Unit or the extended-performance IBM 3158-3 Processing Unit, features monolithic processor storage and virtual storage capability, and provides both high performance and expanded capabilities for a variety of applications.

The Model 158 offers:

1. Processor storage, which uses compact, high-speed circuitry, and provides real storage capacities of 512K (524,288 bytes) to 6,144K (6,291,456 bytes).
2. Virtual storage capability, which permits users to program as though the system has use of up to 16,777,216 bytes of storage.
3. High-speed buffer storage, which stores currently used sections of processor storage for faster accessing of data.
4. A display console, which provides a visual communication link with the system.
5. An attached processor capability, which, by means of the IBM 3052 Attached Processing Unit Model 1, increases the instruction execution rate of the system.
6. A multiprocessing capability, which increases flexibility and availability, permits the sharing of processor storage and I/O devices, and improves workload balance between the two processing units.
7. Retry facilities, which reattempt the execution of most failing instructions and channel commands.

Standard Features

System/370 universal instruction set
Byte-oriented operand

Storage protection (store and fetch)

Interval timer

Time-of-day clock

Clock comparator and CPU timer

Display console

Console file

Dynamic address translation

Program event recording

Basic or extended control mode

Channel indirect data addressing

Error checking and correction (in processor storage)

Instruction retry

Monitoring

High-speed buffer storage

Reloadable control storage

Channel retry information

Command retry

Byte multiplexer channel (one)

Block multiplexer channels (two)

Asymmetric storage (most 3158-3 MP models)

Alternate power down (3158-3 MP models)

Service processor (SVP)

3056 Remote System Console (part of the SVP for the 3052 Attached Processing Unit Model 1)

Optional Features

Extended-precision floating point

Direct control (with external interrupt)

OS/DOS compatibility

1401/1440/1460 and 1410/7010 compatibility

7070/7074 compatibility

Block multiplexer channel (up to three more)

Byte multiplexer channel (one more, in place of a fourth block multiplexer channel)

Channel-to-channel adapter

Integrated storage controls

3056 Remote System Console (3158 and 3158-3)

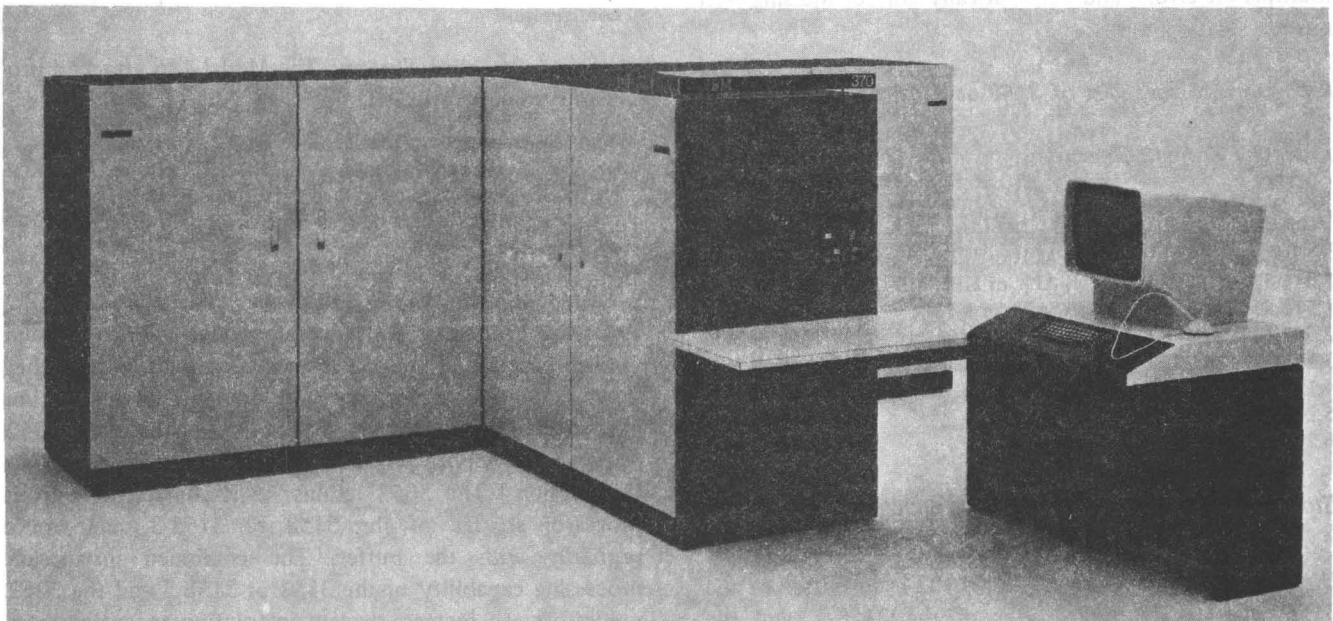

Figure 6-6. IBM System/370 Model 158 Uniprocessor with Display Console

Virtual machine assist
 Power warning
 Staging adapter

System Components

Processing Unit: IBM 3158 or 3158-3 Processing Unit

Attached Processing Unit: IBM 3052 Attached Processing Unit Model 1

Basic Machine Cycle Time: 0.115 microsecond (115 nano-seconds).

Instruction Set: The System/370 universal instruction set is standard on the Model 158. Other standard instructions include those associated with the following features listed in the *IBM System/370 Principles of Operation, GA22-7000*: translation, CPU timer and clock comparator, conditional swapping, and PSW key handling. The multi-processing feature instructions are part of the Model 158 attached processor system and the Model 158 multi-processing system.

Monitoring: Monitoring provides a means of selectively recording designated events in the execution of a program.

Instruction Retry: Instruction retry automatically examines any instruction during whose execution an error is detected, and in most cases reattempts its execution.

Error Checking and Correction: For data read from processor storage, error checking and correction circuits automatically detect all single- and double-bit errors and some multiple-bit errors, and automatically correct the single-bit errors.

Processor Storage: Part of 3158 or 3158-3 Processing Unit

Processor Storage Capacities

Capacity (Bytes)	158 Model Designation	
	If 3158 Used	If 3158-3 Used
524, 288 (512K)	I, AP1, or MP1	U31, A31, or M31
1,048,576 (1,024K)	J, AP2, or MP2	U32, A32, or M32
1,572,864 (1,536K)	JI, AP3, or MP3	U33, A33, or M33
2,097,152 (2,048K)	K, AP4, or MP4	U34, A34, or M34
3,145,728 (3,072K)	KJ, AP5, or MP5	U35, A35, or M35
4,194,304 (4,096K)	L, AP6, or MP6	U36, A36, or M36
5,242,880 (5,120K)	LJ or AP7	U37, A37, or M37
6,291,456 (6,144K)	LK or AP8	U38, A38, or M38

Storage Access Width: 16 bytes (one quadword).

High-Speed Buffer Storage: The 8,192-byte buffer of the 3158, the 16,384-byte buffer of the 3158-3, and the 16,384-byte buffer of the 3052 can satisfy many requests

for storage, making the effective storage access time much less than the actual processor-storage cycle time.

Channels: Part of 3158 or 3158-3 Processing Unit

The system can have one byte multiplexer channel and as many as five block multiplexer channels, or two byte multiplexer channels (the second as an optional feature) and as many as four block multiplexer channels.

System

System Control: The Model 158 is operated, monitored, and controlled via the display console, and via the system control panel on the 3158 or 3158-3 Processing Unit. The cathode-ray tube display provides a visual communication link with the system. It can show 25 lines per display and 80 characters per line. Manual input to the system is provided by both a light pen and a keyboard. Printed copy of the display is available via an IBM 3213 Console Printer. Execution of console functions is under microprogram control.

Remote Console: The IBM 3056 Remote System Console, an optional feature for the 3158 and 3158-3, is a stand-alone display and keyboard for the Model 158. The display and keyboard are identical to those on the 3158 and 3158-3. This console permits remote operation of the system up to 150 feet from the 3158 or 3158-3, thus providing increased flexibility in system configuration and operation.

Uniprocessing System: The Model 158 uniprocessing system consists of:

Model 158 uniprocessor (IBM 3158 or 3158-3 Processing Unit)
 Appropriate input/output devices for a minimum or larger system configuration

Attached Processor System: The Model 158 attached processor system consists of:

Model 158 uniprocessor (IBM 3158 or 3158-3 Processing Unit)
 IBM 3052 Attached Processing Unit Model 1 (with an IBM 3056 Remote System Console attached for diagnostic use)
 Appropriate input/output devices for a minimum or larger system configuration

The 3158 or 3158-3 Processing Unit and the 3052 Attached Processing Unit operate under a single system control program. The 3052 is an instruction processor that uses monolithic technology and contains an instruction execution unit and a buffer. A 3056 is attached to the 3052 as part of its service processor. (See "Service Processor" in this section.) The 3052 retains, in its buffer, data from processor storage of the 3158 or 3158-3, and works primarily with the buffer. The combined instruction processing capability of the 3158 or 3158-3 and the 3052 processors can increase system instruction execution rates beyond those of the uniprocessing system.

Multiprocessing System: The Model 158 multiprocessing system consists of:

Model 158 multiprocessors (two IBM 3158 or 3158-3 multiprocessor Processing Units)

IBM 3058 Multisystem Unit

Appropriate input/output devices for a minimum or larger system configuration

The two multiprocessor processing units operate under a single system control program. These processing units share each other's processor storage and can also share input/output devices whose control units have two-channel switching capability. The IBM 3058 Multisystem Unit, located between the two processing units, enables intersystem communication. The 3058 also has configuration control facilities for selection of the mode of operation (MP or UP), assignment of storage addresses, and attachment of I/O control units having the remote switch attachment feature.

In a 3158 multiprocessing version, both processing units must have the same real storage capacity. In a 3158-3 multiprocessing version, the two processing units (except in Models M31 and M33) may have different real storage capacities. A multiprocessor model of a 3158 and one of a 3158-3 are compatible and can be interconnected in a multiprocessing configuration if each has the same real storage capacity, in which case alternate powerdown is not operational. A Model 158 multiprocessing system can have a total of 8,388,608 bytes of processor storage.

Processing Unit Conversion: A 3158 can be field-converted to a 3158-3.

Compatibility Features: The compatibility features available for the Model 158 are:

OS/DOS

1401/1440/1460, 1410/7010

7070/7074

Integrated Storage Controls: The integrated storage controls (ISC) feature provides dual storage controls (paths), each of which can attach up to four of the following: IBM 3333 Disk Storage and Control units (with associated 3330 drives), IBM 3340-A2 Direct Access Storage Facility

units (with associated 3340-B1, 3340-B2, 3344-B2, or 3344-B2F models), or IBM 3350-A2 or 3350-A2F Direct Access Storage units (with associated 3350-B2, 3350-B2F, 3350-C2, or 3350-C2F models). If ISC control store extension, 32-drive expansion, and 3333/3340 intermix features are installed, any combination of up to four 3333's with 3330's or 3340-A2's with 3340-B1's or 3340-B2's can be attached to each control of the ISC (permitting attachment of up to 32 drives for each). A two-channel switch attaches an integrated storage control to a second channel, thus providing channel sharing ability.

Staging Adapter for ISC: The staging adapter for the ISC feature provides for direct attachment to a Model 158 of one or two IBM 3851 Mass Storage Facilities and up to four IBM 3333 Disk Storage and Control units and their associated 3330 drives to each path of the ISC (maximum 32 drives per path) in a mass storage system configuration. Sixteen of the disk drives (Model 1 or 2) or eight of the disk drives (Model 11) can be used as staging drives. This feature precludes attachment of 3340, 3344, and 3350 Direct Access Storage units.

Service Processor: The service processor (SVP) is a functionally separate realtime monitor that improves serviceability and availability in the Model 158. The 3158 or 3158-3 has a service processor in the system console. The display and keyboard of the system console are part of this SVP. The attached processor system has an additional service processor in the 3052. The display and keyboard of the 3056 that is attached to the 3052 are part of this SVP.

Programming Support

The Model 158 is supported by DOS/VS, OS/VS1, OS/VS2, and VM/370, as well as OS/MFT and OS/MVT. The Model 158 attached processor system is supported by the latest release level of OS/VS2 modified by a selectable unit (SU). The Model 158 multiprocessing system, when operating in MP mode, is supported by OS/VS2 Releases 2 and 3.

System/370 Model 165

The IBM System/370 Model 165 (Figure 6-7) is an information processing system designed for very high-speed, large-scale scientific and business applications.

Contributing significantly to the speed and power of the Model 165 are the main storage capacities, which range from 512K (524,288 bytes) to 3,072K (3,145,728 bytes), and high-speed buffer storage, which can sharply reduce the time required for fetching currently used sections of main storage. Speed in accessing main storage is further increased by using multiple storage elements.

Reliability, availability, and serviceability are enhanced through instruction retry, main-storage error checking and correction (ECC), and manual storage capabilities.

Standard Features

- System/370 universal instruction set
- Extended-precision floating-point feature
- Byte-oriented operand feature
- High-speed buffer storage (8,192 bytes)
- Direct control (with external interrupt)
- Interval timer
- Instruction retry
- Channel retry
- Command retry
- Time-of-day clock
- Storage protection (both store and fetch)

Optional Features

- Buffer storage extension (to 16,384 bytes total)
- High-speed multiply
- Extended channels feature
- 7070/7074 compatibility
- 7080 compatibility
- 709/7090/7094/7094II compatibility
- 2860 Selector Channel (as many as six units, providing as many as six selector channels)
- 2870 Multiplexer Channel (as many as two)
- Selector subchannels (as many as four on the first 2870, as many as two on a second one)
- 2880 Block Multiplexer Channel (with the extended channels feature, as many as seven units, providing as many as 11 block multiplexer channels)
- Channel-to-channel adapter
- Two-byte interface (for 2880)

System Components

Central Processing Unit: 3165 Processing Unit

Basic Machine Cycle Time: 0.080 microsecond (80 nano-seconds).

Instruction Set: The System/370 universal instruction set is standard on the Model 165.

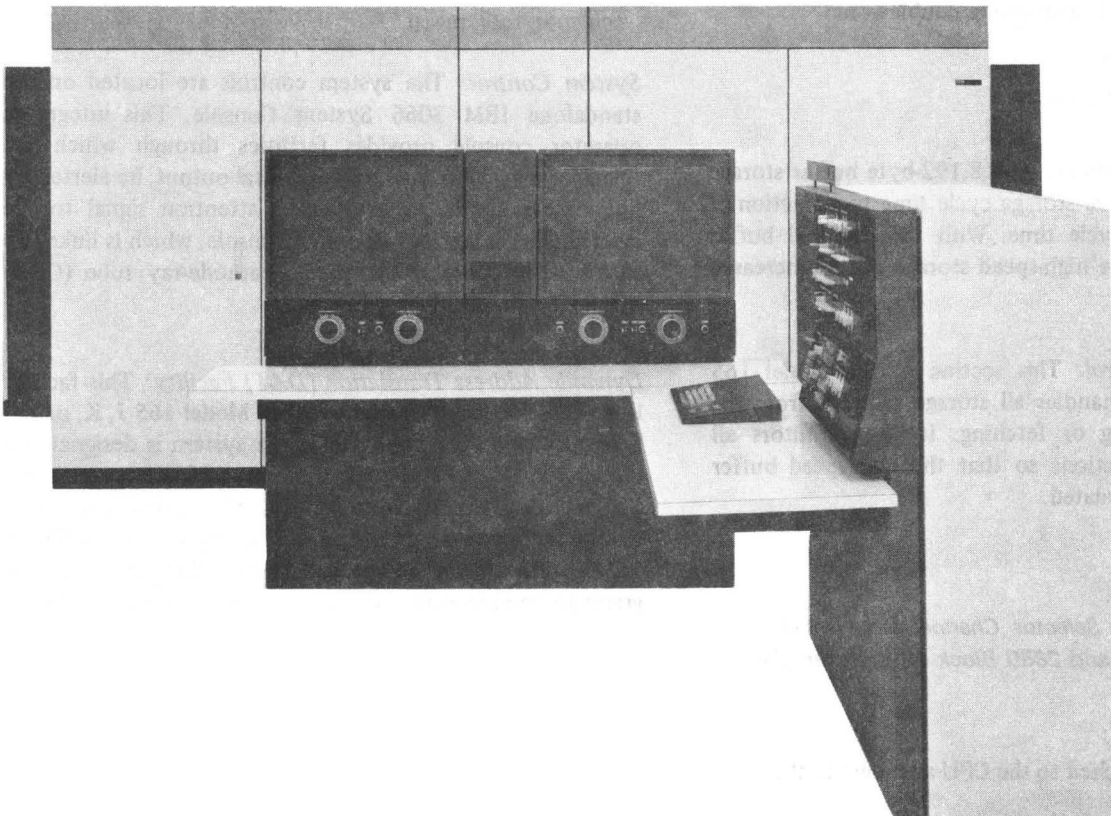

Figure 6-7. IBM System/370 Model 165 with IBM 3066 System Console

High-Speed Multiply: This feature substantially enhances internal performance on both fixed- and floating-point multiply operation by reducing multiplication time by one-half to one-third.

Instruction Retry: Instruction retry automatically examines any instruction during whose execution an error is detected, and in most cases reattempts its execution.

Error Checking and Correction: For data read from main storage, error checking and correction circuits automatically detect all single- and double-bit errors and some multiple-bit errors, and automatically correct the single-bit errors.

Main Storage: IBM 3360 Processor Storage Models 4 and 5

Storage Capacities:

Capacity (Bytes)	Model	Storage Units
524,288	I	Two 3360-4's
1,048,576	J	Two 3360-5's
1,572,864	JI	Two 3360-4's and two 3360-5's
2,097,152	K	Four 3360-5's
3,145,728	KJ	Six 3360-5's

Storage Cycle Time: 2.00 microseconds.

Storage Access Width: 8 bytes (one doubleword).

Storage Interleaving: Four-way.

High-Speed Buffer Storage: The 8,192-byte buffer storage can reduce the effective storage cycle time to a fraction of the actual storage cycle time. With the optional buffer expansion feature, the high-speed storage can be increased to 16,384 bytes.

Buffer Storage Control: This section of the Model 165 storage control unit handles all storage requests from the CPU for data storing or fetching. It also monitors all channel storage operations so that the high-speed buffer storage can be kept updated.

Channels: IBM 2860 Selector Channel Models 1-3, 2870 Multiplexer Channel, and 2880 Block Multiplexer Channel Models 1 and 2.

Channels may be attached to the CPU as shown in the chart that follows.

Maximum Number of Channels or Channel Units	Without Extended Channels Feature	With Extended Channels Feature
Channel Units (Frames)	7	7
Channels	7	12
Byte Multiplexer Channels	2	2
Block Multiplexer Channels	6	11
Selector Channels	6	6
Byte Multiplexer and Selector Channels	7	7
Byte and Block Multiplexer Channels	7	12

Two-Byte Interface: This feature permits a 2880 Block Multiplexer Channel to transfer data at rates as high as 3.0 million bytes per second.

System

The basic system consists of the IBM 3165 Processing Unit, 3360 Processor Storage, at least one 2860 Selector Channel, 2870 Multiplexer Channel with one selector subchannel, or 2880 Block Multiplexer Channel, one 3066 System Console Model 1, and one 3067 Power and Coolant Distribution Unit Model 1.

Compatibility Features: The compatibility features available for the Model 165 are:

- 7070/7074
- 7080
- 709/7090/7094/7094II

System Control: The system controls are located on the standalone IBM 3066 System Console. This integrated operator console provides facilities through which the operator may enter data, obtain visual output, be alerted by an audible alarm, or present an attention signal to the system. The integrated operator console, which is linked to the system console, shares the cathode-ray tube (CRT) display on the main control panel.

Dynamic Address Translation (DAT) Facility: This facility is available for a purchased installed Model 165 J, K, or KJ. Equipped with the DAT facility, a system is designated a Model 165 II. In basic control mode, a 165 II operates as a 165. But in extended control mode and in conjunction with a system control program, a DAT facility provides a Model 165 II with virtual storage capability, which permits programs to operate as though they had use of up to 16 million bytes of storage.

Programming Support

The Model 165 is supported by OS/MFT or OS/MVT, and the Model 165 II is supported also by OS/VS1, OS/VS2, and VM/370.

System/370 Model 168

The System/370 Model 168 (Figure 6-8), with either the IBM 3168 Processing Unit or the IBM 3168-3 Processing Unit, is designed for large-scale, high-speed scientific and commercial applications.

The Model 168 offers:

1. Integrated monolithic processor storage, which provides real storage capacities of 1,024K (1,048,576 bytes) to 8,092K (8,388,608 bytes).
2. Virtual storage capability, which permits users to program as though the system had use of as many as 16,777,216 bytes of processor storage.
3. High-speed buffer storage, which can sharply reduce the time required for fetching currently used sections of processor storage.
4. Instruction retry and processor storage error checking and correction (ECC), which improve operations.
5. An attached processor capability in the 3168-3, which, by means of the IBM 3062 Attached Processing Unit, increases the instruction execution rate of the system.
6. A multiprocessing capability, which increases flexibility and availability, permits the sharing of processor storage and I/O devices, and improves workload balance between the two processing units.

Standard Features

System/370 universal instruction set
Extended-precision floating point (with rounding)
Byte-oriented operand

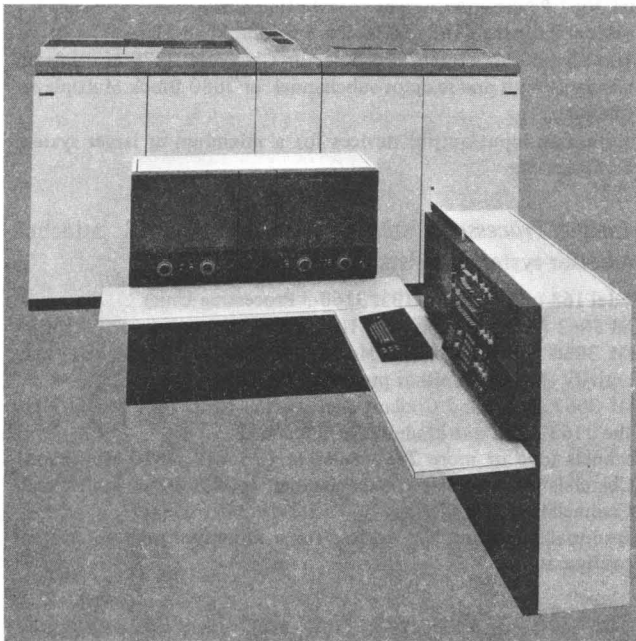

Figure 6-8. IBM System/370 Model 168 Uniprocessor with IBM 3066 System Console

Storage protection (both store and fetch)
Interval timer
Time-of-day clock
Clock comparator and CPU timer
System console with CRT display
Operator console
Storage configuration control
Dynamic address translation
Program event recording
Basic or extended control mode
Error checking and correction
Instruction retry
Monitoring
High-speed buffer storage
Reloadable control storage
Channel retry
Command retry
Direct control (with external interrupt)
Channel reconfiguration (MP models)
Service processor (SVP) (3168-3)

Optional Features

Channel indirect data addressing
Buffer expansion (3168)
High-speed multiply
7070/7074 compatibility
7080 compatibility
709/7090/7094/7094 II compatibility
2860 Selector Channel (as many as six units, providing as many as six selector channels)
2870 Multiplexer Channel (as many as two byte-multiplexer channels)
Selector subchannels (as many as four on each 2870)
2880 Block Multiplexer Channel (as many as six) (with the extended channels feature, as many as seven units, providing as many as 11 block multiplexer channels)
Extended channels feature (see channel attachment chart)
Channel-to-channel adapter (for 2860 and 2880)
Two-byte interface (for 2880)
Integrated storage controls
Power warning
Staging adapter
3213 Printer attachment (3168-3)

System Components

Processing Unit: 3168 or 3168-3 Processing Unit

Attached Processing Unit: IBM 3062 Attached Processing Unit Model 1

Basic Machine Cycle Time: 0.08 microsecond (80 nanoseconds).

Instruction Set: The System/370 universal instruction set is standard on the Model 168. Other standard instructions include those associated with the following features listed in the *IBM System/370 Principles of Operation, GA22-7000*: extended-precision floating point, translation, CPU timer and clock comparator, conditional swapping, and PSW key handling. The direct control feature and

associated instructions are standard on the 3168 and the 3168-3. The multiprocessing feature instructions are part of the Model 168 attached processor system and the Model 168 multiprocessing system.

High-Speed Multiply: This feature substantially enhances internal performance on both fixed- and floating-point multiply operations by reducing multiplication time by one-half to one-third.

Instruction Retry: Instruction retry automatically examines any instruction during whose execution an error is detected, and in most cases reattempts its execution.

Error Checking and Correction: For data read from processor storage, error checking and correction circuits automatically detect all single- and double-bit errors and some multiple-bit errors, and automatically correct the single-bit errors.

Processor Storage: Part of 3168 or 3168-3 Processing Unit

Processor Storage Capacities:

Capacity (Bytes)	168 Model Designation	
	If 3168 Used	If 3168-3 Used
1,048,576 (1,024K)	J or MP1	U31, A31, or M31
2,097,152 (2,048K)	K or MP2	U32, A32, or M32
3,145,728 (3,072K)	KJ or MP3	U33, A33, or M33
4,194,304 (4,096K)	L or MP4	U34, A34, or M34
5,242,880 (5,120K)	LJ or MP5	U35, A35, or M35
6,291,456 (6,144K)	LK or MP6	U36, A36, or M36
7,340,032 (7,168K)	LKJ or MP7	U37, A37, or M37
8,388,608 (8,192K)	M or MP8	U38, A38, or M38

Storage Cycle Time: 0.32 microsecond (320 nanoseconds).

Storage Access Width: 8 bytes (one doubleword).

Storage Interleaving: Four-way.

High-Speed Buffer Storage: The effective storage cycle time in the 3168 is reduced by using an 8K buffer storage. With the optional buffer expansion feature installed, the 3168 buffer storage capacity is increased to 16K. The 3168-3 and 3062 each have a 32K high-speed buffer storage.

Channels: IBM 2860 Selector Channel Models 1-3, 2870 Multiplexer Channel, and 2880 Block Multiplexer Channel Models 1 and 2

Channels may be attached to the processing unit as follows:

Maximum Number of Channels or Channel Units	Without Extended Channels Feature	With Extended Channels Feature
Channel Units (Frames)	7	7
Channels	7	12

Maximum Number of Channels or Channel Units	Without Extended Channels Feature	With Extended Channels Feature
Byte Multiplexer Channels	2	2
Block Multiplexer Channels	6	11
Selector Channels	6	6
Byte Multiplexer and Selector Channels	7	7
Byte and Block Multiplexer Channels	7	12

Two-Byte Interface: This feature permits a 2880 Block Multiplexer Channel to transfer data at rates as high as three million bytes per second.

System

System Control: The system controls are located on the standalone IBM 3066 System Console. Here, through a keyboard, a console (CRT) display, and a system control panel, the operator may enter data, obtain visual output, be alerted by an audible alarm, or interact with the system, for example, by presenting an attention signal.

Uniprocessing System: The Model 168 uniprocessing system consists of:

Model 168 uniprocessor (IBM 3168 or 3168-3 Processing Unit)
 IBM 3066 System Console Model 2
 IBM 3067 Power and Coolant Distribution Unit
 (Model 2 for the 3168 and Model 3 for the 3168-3)

Channels (one or more 2860 Selector Channels, 2870 Multiplexer Channels with one selector subchannel, or 2880 Block Multiplexer Channels)

Appropriate input/output devices for a minimum or larger system configuration

Attached Processor System: The Model 168 attached processor system consists of:

Model 168 uniprocessor (IBM 3168-3 Processing Unit)
 IBM 3062 Attached Processing Unit Model 1
 IBM 3066 System Console Model 3 (allows diagnostic or system activity choices for either processing unit)

IBM 3067 Power and Coolant Distribution Units (one Model 3 for the 3168-3 and one Model 5 for the 3062)

Channels (one or more 2860 Selector Channels, 2870 Multiplexer Channels with one selector subchannel, or 2880 Block Multiplexer Channels)

Appropriate input/output devices for a minimum or larger system configuration

The 3168-3 Processing Unit and the 3062 Attached Processing Unit operate under a single system control program. The 3062 is an instruction processor using

monolithic system technology that attaches to and works only with the 3168-3. The combined instruction processing capability of the two processors can increase system instruction execution rates beyond those of the uniprocessing system. The 3062 achieves high performance by retaining processor storage data on which it is currently operating in its own 32K buffer and by working primarily with the buffer. This reduces effective storage cycle time. The system channels attach only to the 3168-3.

Multiprocessing System: The Model 168 multiprocessing system consists of:

- Model 168 multiprocessors (two IBM 3168 multiprocessor or 3168-3 multiprocessor Processing Units)
- IBM 3066 System Console Model 2 (one for each processor)
- IBM 3067 Power and Coolant Distribution Units (one Model 2 for the 3168 and one Model 3 for the 3168-3)
- IBM 3068 Multisystem Communication Unit
- Channels (one or more 2860 Selector Channels, 2870 Multiplexer Channels with one selector subchannel, or 2880 Block Multiplexer Channels for each processor)
- Appropriate input/output devices for a minimum or larger system configuration

The two multiprocessor processing units operate under a single system control program. These processing units, which need not have the same processor storage capacities, share each other's processor storage and can also share input/output devices whose control units have two-channel switching capability. The 3068 Multisystem Communication Unit, located between the processing units, provides for intersystem communication. The 3068 also has configuration control facilities for selection of the mode of operation (MP or UP), assignment of storage addresses, and attachment of I/O control units having the remote switch attachment feature.

The 3168 multiprocessor and the 3168-3 multiprocessor are compatible and may be interconnected in a multiprocessing configuration.

Processing Unit Conversion: The 3168 Processing Units can be field upgraded as follows:

- 3168 to a 3168 multiprocessor, 3168-3, 3168-3 for the attached processor system, or 3168-3 multiprocessor
- 3168-3 to a 3168-3 for the attached processor system or 3168-3 multiprocessor

All conversions require appropriate changes and additions to the associated 3066 System Console and the 3067 Power and Coolant Distribution Unit.

Compatibility Features: The compatibility features available for the 3168 and the 3168-3 are:

- 7070/7074
- 7080
- 709/7090/7094/7094 II

Integrated Storage Controls: The integrated storage controls (ISC) feature provides dual storage controls (paths), each of which can attach up to four IBM 3333 Disk Storage and Control units (with associated 3330 drives), 3340-A2 Disk Storage units (with associated 3340-B1, 3340-B2, 3344-B2, or 3344-B2F models), or 3350-A2 or 3350-A2F Direct Access Storage units (with associated 3350-B2 or 3350-B2F models). If ISC control store extension, 32-drive expansion, and 3333/3340 intermix features are installed, any combination of up to four 3333's with 3330's or 3340-A2's with 3340-B1's or -B2's can be attached to each control of the ISC (permitting attachment of up to 32 drives per path). A two-channel switch attaches an integrated storage control to a second channel, thus providing channel sharing ability.

Staging Adapter for ISC: The staging adapter for the ISC feature provides for direct attachment to a Model 168 of one or two IBM 3851 Mass Storage Facilities and up to four IBM 3333 Disk Storage and Control units and their associated 3330 drives to each path of the ISC (maximum 32 drives per path) in a mass storage system configuration. Sixteen of the disk drives (Models 1 and/or 2) or eight of the disk drives (Model 11) can be used as staging drives. This feature precludes attachment of 3340 disk drives.

Service Processor: In a Model 168 uniprocessing or multiprocessing system, the 3168-3 has a service processor (SVP), a functionally separate realtime monitor to improve serviceability and availability.

In a Model 168 attached processor system, the 3062 has a realtime monitor that provides additional input to the service processor of the 3168-3 Processing Unit.

Programming Support

The Model 168 is supported by OS/VS1, OS/VS2, and VM/370, as well as OS/MFT and OS/MVT. The Model 168 multiprocessing system, when operating in MP mode, is supported by OS/VS2 Releases 2 and 3. The Model 168 attached processor system is supported by the latest level of OS/VS2 Release 3.

System/370 Model 195

The System/370 version of the Model 195 (Figure 6-9), while retaining the advanced architecture and programming support of the System/360 version, incorporates System/370 characteristics and features such as the expanded instruction set, the time-of-day clock, and the control registers.

This ultrahigh-performance data processing system is designed for high-speed large-scale scientific and commercial applications. Its scientific applications range from nuclear physics to weather forecasting and theoretical astronomy. In commercial applications, the Model 195 can be used, for example, as the control center of the most complex airline reservation systems, coast-to-coast time-sharing networks, or process control systems.

The power and speed of this advanced system are primarily the result of:

1. Improved circuit technology.
2. High performance of buffer storage for main storage accesses.
3. Buffering within the processor.
4. Very fast execution times.
5. A high degree of concurrency in operation.
6. Highly efficient algorithms, particularly in floating-point operations.

Processing proceeds concurrently in five separate highly autonomous units: main storage, the storage control unit and buffer storage, the instruction processor, the fixed-point/variable-field-length/decimal processor, and the floating-point processor. Furthermore, each unit may be

performing several functions at one time. In the floating-point processor, for example, as many as three floating-point operations may be executed concurrently.

Standard Features

- System/370 universal instruction set
- High-speed buffer storage
- Extended-precision floating-point
- Byte-oriented operands
- Storage protection (both store and fetch)
- Time-of-day clock
- Direct control (includes external interrupt)
- Interval timer (9.6 kHz—about a 104-microsecond interval)
- Display console
- Remote operator control panel attachment
- Emergency power-off control
- Channel retry
- Command retry
- Monitoring

Optional Features

- 2860 Selector Channel (as many as six units, providing as many as six selector channels)
- 2870 Multiplexer Channel (as many as two)
- Selector subchannels (as many as four on the first 2870, as many as two on a second one)
- 2880 Block Multiplexer Channel (with the extended channels feature, as many as seven units, providing as many as 13 block multiplexer channels)
- Extended channels feature
- Two-byte interface
- Channel-to-channel adapter
- 2150 Console



Figure 6-9. IBM System/370 Model 195

System Components

Central Processing Unit: 3195 Processing Unit

Basic Machine Cycle Time: 0.054 microsecond (54 nanoseconds).

Instruction Set: The universal instruction set is standard on the Model 195.

Control Signal Exchange and External Interruption: The direct control feature is standard on the Model 195 and includes the external interrupt feature.

Time-of-Day Clock: Updated every 250 nanoseconds, this clock provides a precise measure of time suitable for accurate elapsed-time measurements and time-of-day indication.

Main Storage: Part of 3195 Processing Unit

Processor Storage Capacities:

Capacity (Bytes)	Processor Model	Type of Interleaving
1,048,576	J1	8-way
2,097,152	K1	16-way
3,145,728	KJ1	8- and 16-way
4,194,304	L1	16-way

Storage Cycle Time: 0.756 microsecond.

Storage Access Width: Eight bytes (one doubleword).

High-Speed Buffer Storage: Most storage accesses are satisfied by this 32K-byte buffer storage, which in effect reduces the access time of most main storage accesses from 810 nanoseconds to 162. The buffer storage is controlled by an algorithm implemented in monolithic circuitry, thus its function is transparent to the programmer.

Storage Control Unit: This unit is the intermediary between main storage and the other system units. As such, it controls the accesses to the high-speed buffer storage and to main storage.

Channels: IBM 2860 Selector Channel Models 1-3, 2870 Multiplexer Channel, and 2880 Block Multiplexer Channel Models 1 and 2

Channels may be attached to the CPU as shown in the chart that follows.

Maximum Number of Channels or Channel Units	Without Extended Channels Feature	With Extended Channels Feature
Channel Units (Frames)	7	8
Channels	7	14
Byte Multiplexer Channels	2	2
Block Multiplexer Channels	6	13
Selector Channels	6	6
Byte Multiplexer and Selector Channels	7	7
Byte and Block Multiplexer Channels	7	13

Note: Only block multiplexer channels can be attached via the extended channels feature.

Interchannel Connection: A channel-to-channel adapter can be attached for each selector channel on the Model 195, permitting each selector channel to communicate with a multiplexer channel or with another selector channel. This adapter uses one control-unit position on each of the two channels.

System

The basic system consists of the IBM 3195 Processing Unit, at least one 2860 Selector Channel, 2870 Multiplexer Channel with at least one selector subchannel, or 2880 Block Multiplexer Channel, one 3060 System Console, 3080 Power Unit Models 1, 2, and 3 (one each), one 3085 Power Distribution Unit, and one 3086 Coolant Distribution Unit.

System Control: The system controls are located on a standalone system console (considered part of the CPU). Integrated with the system console is a display console (similar to a 2250 Display Unit Model 1), which provides the operator with visual two-way communication with the system. The operator controls can also be duplicated at a remote panel on a 2150 Console.

Programming Support

The Model 195 is supported by an MVT option of OS, with high-performance extensions available.

Features and Characteristics	Application on Models												
	115	125	135	138	145	148	155	158	165	168	195		
Central Processing Unit (CPU)													
CPU model	3115-0, 3115-2	3125-0, 3125-2	3135	3135-3	3138	3145	3145-3	3148	3155	3158, 3158-3	3165	3168 3168-3	3195
Basic machine cycle time (nanoseconds)	480	480	275-1,485	275-1,485	275-1,485	202.5,315	180-270	180-270	115	115	80	80	54
Instruction sets													
System/370 Commercial	std	std	std	std	std	std	-	-	-	-	-	-	-
System/370 Universal	opt	opt	opt	std	std	opt	std	std	std	std	std	std	std
Dynamic address translation													
Program event recording	std	std	std	std	std	std	std	std	std	Ⓧ	std	Ⓧ	std
Extended control mode	std	std	std	std	std	std	std	std	std	Ⓧ	std	Ⓧ	std
Byte-oriented operand	std	std	std	std	std	std	std	std	std	std	std	std	std
Floating-point	opt	opt	opt	std	std	opt	std	std	std	std	std	std	std
Extended-precision floating point	opt	opt	opt	opt*	std	opt	std	std	opt	opt	std	std	std
Direct control (with external interrupt)													
External signals	opt	opt	-	-	opt	opt	opt	opt	opt	opt	std	std	std
Instruction retry or microinstruction retry	-	std	std	std	std	std	std	std	std	std	std	std	-
High speed multiply	-	-	-	-	-	-	-	-	-	-	opt	opt	-
Interval timer	std	std	std	std	std	std	std	std	std	std	std	std	std
Time-of-day clock	std	std	std	std	std	std	std	std	std	std	std	std	std
Clock comparator and CPU timer	std	std	opt	std	std	opt	opt*	std	Ⓧ	std	Ⓧ	std	-
Monitoring	std	std	std	std	std	std	std	std	std	std	Ⓧ	std	std
Processor Storage													
Storage access width (number of bytes fetched per access)	2	2	2 or 4	2 or 4	2 or 4	8	8	8	16	16	8	8	8
Storage cycle time (nanoseconds)	480	480, 320	770-935 read, 935 write	770-935 read, 935 write	715-880 read, 935 write	540 read, 607.5 write	405 read, 540 write	405 read, 540 write	2,070 Ⓧ	1,035 read, 690-920 write	2,000 Ⓧ	320	756 Ⓧ
Storage interleaving	-	-	-	-	-	-	-	-	-	-	4-way	4-way	8- or 16-way
High-speed buffer storage	-	-	-	-	-	-	-	-	std	std	std	std	std
Buffer storage extension	-	-	-	-	-	-	-	-	-	-	opt	Ⓧ	-
Storage protection	std	std	std	std	std	std	std	std	std	std	std	std	std
Processor storage capacities (bytes) (Entries are system model prefixes)													
65,536	F, F2	-	-	-	-	-	-	-	-	-	-	-	-
98,304	FE, FE2	FE, FE2	FE	-	-	-	-	-	-	-	-	-	-
131,072	G, G2	G, G2	-	-	-	-	-	-	-	-	-	-	-
147,456	-	-	GO	-	-	-	-	-	-	-	-	-	-
163,840	GE, GE2	GE, GE2	-	-	-	GE	-	-	-	-	-	-	-
196,608	GF, GF2	GF, GF2	GF	-	-	-	-	-	-	-	-	-	-
212,292	-	-	-	-	-	GFD	A1	-	-	-	-	-	-
262,144	-, H2	H, H2	H	A1	-	H or H2	-	-	H	-	-	-	-
327,680	-	-	HF	A2	-	-	A2	-	-	-	-	-	-
393,216	-	-	HG	A3	-	HG or HG2	-	-	HG	-	-	-	-
458,752	-	-	-	-	-	-	A3	-	-	-	-	-	-
524,288	-	-	I	A4	I	I or I2	-	-	I	I, AP1, MP1, U31, A31, or M31	Ⓧ	-	-
720,896	-	-	-	-	-	-	A4	-	-	-	-	-	-
786,432	-	-	-	-	-	IH2	-	-	IH	-	-	-	-
983,040	-	-	-	-	-	-	A5	-	-	-	-	-	-
1,048,576	-	-	-	-	J	J2	-	J	J	J, AP2, MP2, U32, A32, or M32	J	J, MP1, U31, A31, M31	J1
1,507,328	-	-	-	-	-	-	A6	-	-	-	-	-	-
1,572,864	-	-	-	-	-	J12	-	J1	J1	J1, AP3, MP3, U33, A33, or M33	Ⓧ	-	-
2,031,616	-	-	-	-	-	-	A7	-	-	-	-	-	-
2,097,152	-	-	-	-	-	K2	-	K	K	K, AP4, MP4, U34, A34, or M34	K	K, MP2, U32, A32, M32	K1
3,145,728	-	-	-	-	-	-	-	-	-	KJ, AP5, MP5, U35, A35, or M35	KJ	KJ, MP3, U33, A33, M33	-
4,194,304	-	-	-	-	-	-	-	-	-	L, AP6, MP6, U36, A36, or M36	-	L, MP4, U34, A34, M34	-
5,242,880	-	-	-	-	-	-	-	-	-	LJ, AP7, U37, A37, or M37	-	LJ, MP5, U35, A35, M35	-
6,291,456	-	-	-	-	-	-	-	-	-	LK, AP8, U38, A38, or M38	-	LK, MP6, U36, A36, M36	-
7,340,032	-	-	-	-	-	-	-	-	-	-	-	LKJ, MP7, U37, A37, M37	-
8,388,608	-	-	-	-	-	-	-	-	-	-	-	M, MP8, U38, A38, M38	-
Compatibility Features													
1401/1440/1460, 1410/7010	-	-	-	-	-	opt	opt	opt	opt	opt	-	-	-
1401/1440/1460	opt	opt	opt	opt	opt	opt	opt	opt	opt	-	-	-	-
7070/7074	-	-	-	-	-	-	-	-	opt	opt	opt	opt	-
7080	-	-	-	-	-	-	-	-	-	-	opt	opt	-
709/7090/7094 II	-	-	-	-	-	-	-	-	-	-	opt	opt	-
OS/DOS	-	-	std	std	std	std	std	std	opt	std	-	-	-
System/360 Model 20	opt	opt	opt	opt	opt	-	-	-	-	-	-	-	-

Figure 6-10. Comparison of IBM System/370 Models (Part 1 of 2)

Features and Characteristics	Application on Models											
	115	125	135	138	145	148	155	158	165	168	195	
Programming Support												
DOS	-	yes	yes	yes	-	yes	yes	-	yes	yes	-	-
DOS/VS	yes	yes	yes	yes	yes	yes	yes	yes	(d)	yes	-	-
OS/MFT	-	-	yes	yes	-	yes	yes	-	yes	yes	yes	yes
OS/MVT	-	-	-	-	-	yes	yes	-	yes	yes	yes	yes
OS/VS1	-	-	yes	yes	yes	yes	yes	yes	(d)	yes	(d)	yes
OS/VS2	-	-	-	-	-	yes	yes	-	(d)	yes	(d)	yes
VM/370	-	-	yes	yes	yes	yes	yes	yes	(d)	yes	(d)	yes
Channels												
Max no. of channels per CPU	1	1	4 (c)	4 (c)	4 (c)	5	5	5	6	6	7	7
With extended channels feature	-	-	-	-	-	-	-	-	-	-	12	12
Block multiplexer	-	-	2	2	2	4	4	4	5	5	6	6
With extended channels feature	-	-	-	-	-	-	-	-	-	-	11	11
Byte multiplexer	1	1	1	1	1	1	1	1	2	2	2	2
Selector	-	-	3 (c)	-	-	4	4	4	-	-	6	6
Both byte and block multiplexer	-	-	3	4 (c)	4 (c)	5	5	5	6	6	7	7
With extended channels feature	-	-	-	-	-	-	-	-	-	-	12	12
Both byte multiplexer and selector	-	-	4 (c)	-	-	5	5	5	-	-	7	7
Max no. of channels units (frames) per CPU	-	-	-	-	-	-	-	-	-	-	7	7
With extended channels feature	-	-	-	-	-	-	-	-	-	-	7	7
2880 Block Multiplexer Channel	-	-	-	-	-	-	-	-	-	-	6	6
With extended channels feature	-	-	-	-	-	-	-	-	-	-	7	7
2870 Multiplexer Channel (byte mpx)	-	-	-	-	-	-	-	-	-	-	2	2
2860 Selector Channel	-	-	-	-	-	-	-	-	-	-	6	6
Subchannels (type and no., std or opt)												
(n = nonshared, s = shared) (b)												
Byte multiplexer, of 1st byte mpx channel												
16n + 0s to 8n + 8s	-	-	all	all	all	-	-	-	-	-	-	-
32n + 0s to 24n + 8s	all	all	-	-	-	all	-	-	-	-	-	-
64n + 0s to 56n + 8s	-	-	all	all	all	all	all	-	-	-	-	-
120n + 8s	-	-	-	-	-	-	-	-	all	all	-	-
128n	-	-	-	-	-	-	-	-	H	-	-	-
128n + 0s to 120n + 8s	-	-	all	all	all	all	all	all	-	-	-	-
192n	-	-	-	-	-	-	-	-	HG	-	all	all
256n	-	-	all	all	all	all	all	all	I-K	all	-	-
Byte multiplexer, of 2nd byte mpx channel												
120n + 8s	-	-	-	-	-	-	-	-	IH-K	all	-	-
128n	-	-	-	-	-	-	-	-	IH	-	-	-
192n	-	-	-	-	-	-	-	-	-	-	all	all
256n	-	-	-	-	-	-	-	-	J-K	all	-	-
Block multiplexer, of block mpx channels												
16n + 1s	-	-	all	all	all	all	-	-	-	-	-	-
16s to 512s, in increments of 16	-	-	-	-	-	all	-	-	-	-	-	-
56n (max, with 1s)	-	-	-	-	-	-	-	-	-	-	all	all
96n + 16s	-	-	-	-	-	-	-	-	H	-	-	-
64n, 128n, 256n, or 512n	-	-	-	-	-	-	all	all	-	-	-	-
160n + 16s	-	-	-	-	-	-	-	-	HG	-	-	-
224n + 16s	-	-	-	-	-	-	-	-	I	-	-	-
252n + 16s	-	-	-	-	-	-	-	-	IH	-	-	-
256n + 16s	-	-	-	-	-	-	-	-	-	-	all (1)	all (1)
480n + 16s	-	-	-	-	-	-	-	-	J-K	all 3158	-	-
480n + 0s to 448n + 32s (d) or 736n + 0s to 696n + 40s	-	-	-	-	-	-	-	-	-	all 3158-3	-	-
Selector, of 1st byte mpx channel												
4s	-	-	-	-	-	-	-	-	-	-	all	all
Selector, of 2nd byte mpx channel												
2s	-	-	-	-	-	-	-	-	-	-	all	all
4s	-	-	-	-	-	-	-	-	-	-	all	all
Channel-to-channel adapter												
Channel indirect data addressing	std	std	std	std	std	std	std	std	(d)	std	(d)	opt

std = standard
opt = optional
- = not applicable
* = required

- Notes:**
- (a) The storage cycle times given for Models 165, 168, and 195 do not reflect the time reductions that are due to storage interleaving or, additionally for Models 155, 165, 168, and 195, the time reduction resulting from the use of the high-speed buffer.
 - (b) Shared subchannels can control several I/O devices or modules having a common control unit; nonshared subchannels can control only one I/O device.
 - (c) Includes the integrated file adapter, addressed as a selector or block multiplexer channel.
 - (d) Standard on a purchased and installed Model 155 or 165 converted to a Model 155 II or 165 II.
 - (e) Not available for Model 165 II.
 - (1) With extended unit control word feature.
 - (g) If channel 4 is a second byte multiplexer channel.
 - (h) Optional on the 3168 Processing Unit.

Figure 6-10. Comparison of IBM System/370 Models (Part 2 of 2)

Section 7. Input/Output Devices

The following I/O devices and control units, arranged by category, can operate locally as part of System/370. (See Figure 7-1.)

Auxiliary Processors

3838 Array Processor Models 1, 2, and 3

Direct Access Storage Devices

2305 Fixed Head Storage Facility Models 1 and 2
2311 Disk Storage Drive Model 1
2312 Disk Storage Model A1
2313 Disk Storage Model A1
2314 Direct Access Storage Facility, A Series
and B Series
2314 Storage Control Models A1 and B1
2318 Disk Storage Model A1
2319 Disk Storage Models A1, A2, A3, B1, and B2
2835 Storage Control Models 1 and 2
2841 Storage Control Model 1
3330 Disk Storage Models 1, 2, and 11
3333 Disk Storage and Control Models 1 and 11
3340 Disk Storage Models A2, B1, and B2
3344 Direct Access Storage Models B2 and B2F
3350 Direct Access Storage Models A2, A2F, B2,
B2F, C2, and C2F
3830 Storage Control Models 1, 2, and 3

Diskette Input/Output Devices

3540 Diskette Input/Output Unit Models B1 and B2

Display Devices

2250 Display Unit Models 1 and 3
2260 Display Station Models 1 and 2
2285 Display Copier Model 1
2840 Display Control Model 2
2848 Display Control Models 1, 2, 3, 21, and 22
3272 Control Unit Models 1 and 2
3277 Display Station Models 1 and 2

Magnetic Character Readers

1255 Magnetic Character Reader Models 1-3
1419 Magnetic Character Reader
3890 Document Processor Models A1-A6 and B1-B6

Magnetic Tape Devices

2401 Magnetic Tape Unit Models 1-6 and 8
2415 Magnetic Tape Unit and Control Models 1-6
2420 Magnetic Tape Unit Models 5 and 7
2803 Tape Control Models 1, 2, and 3

2804 Tape Control Models 1, 2, and 3
2816 Switching Unit Model 1
3410 Magnetic Tape Unit Models 1, 2, and 3
3411 Magnetic Tape Unit and Control Models 1, 2, and 3
3420 Magnetic Tape Unit Models 3-8
3803 Tape Control Models 1, 2, and 3

Optical Readers

1287 Optical Reader Models 1-4
1288 Optical Page Reader Model 1
3881 Optical Mark Reader Model 1
3886 Optical Character Reader Model 1

Printer-Keyboards

1052 Printer-Keyboard Model 7
3210 Console Printer-Keyboard Models 1 and 2
3215 Console Printer-Keyboard Model 1

Printers

1053 Printer Model 4
1403 Printer Models 2, 7, and N1
1443 Printer Model N1
2821 Control Unit Models 1-3, 5, and 6
3203 Printer Models 1, 2, 3, and 4
3211 Printer Model 1
3213 Console Printer Model 1
3284 Printer Models 1 and 2
3286 Printer Models 1 and 2
3800 Printing Subsystem
3811 Control Unit Model 1
5203 Printer Model 3
5213 Printer Model 1

Punched Card Devices

1442 Card Read Punch Model N1
1442 Card Punch Model N2
2501 Card Reader Models B1 and B2
2520 Card Read Punch Model B1
2520 Card Punch Models B2 and B3
2540 Card Read Punch
2560 Multi-Function Card Machine Models A1 and A2
2596 Card Read Punch Model 1
3504 Card Reader Models A1 and A2
3505 Card Reader Models B1 and B2
3525 Card Punch Models P1, P2, and P3
5425 Multi-Function Card Unit Models A1 and A2

Punched Tape Devices

1017 Paper Tape Reader Models 1 and 2
1018 Paper Tape Punch Model 1
2671 Paper Tape Reader Model 1
2822 Paper Tape Reader Control Model 1
2826 Paper Tape Control Model 1

Systems

2790 Data Communication System
3270 Information Display System
3790 Communication System
3850 Mass Storage System

Figure 7-1. Attachment Data for Local I/O Devices and Control Units (Part 1 of 4)

Input/Output (I/O) Device or Control Unit			Attaches to	Means of Attachment to System/370 Model										Block Multiplexer Channel UCW Assignment	No. of I/O Devices or Lines Attachable			
No.	Models	Name		115	125	135 (P) ¹	138	145 (P) ²	148	155	158	165	168			195		
1017	1, 2	Paper Tape Reader	2826-1	m	m	m	m	m	m	m	-	-	-	-	(2)			
1018	1	Paper Tape Punch	2826-1	m	m	m	m	m	m	m	-	-	-	-	(2)			
1052	7	Printer-Keyboard	2150 Console	-	-	-	-	-	bm	bm	bmax	bmax	bmax	-	1 per 2150			
1053	4	Printer	2848-1,-2,-3,-21,-22	m	m	ms	bm	ms	bm	bm	bm	bmax	bmax	bmax	S	1 per 2848		
1255	1-3	Magnetic Character Reader	S/360/370 Adapter	m	m	ms	bm	ms	bm	bm	-	-	-	-	1 per system			
1287	1-4	Optical Reader	→	-	-	bms	bm	bms	bm	bm	mx	mx	-	-	8 per system			
5		Optical Reader	→	m	m	bms	bm	bms	bm	bm	mx	mx	-	-	U			
1288	1	Optical Page Reader	→	-	-	bms	bm	bms	bm	bm	mx	mx	-	-	U	8 per system		
1403	2, 7, N1	Printer	2821-1,-2,-3,-5	m	m	bms	bm	bms	bm	bm	bmax	bmax	bmax	-	U	(V)		
1419	1	Magnetic Character Reader	S/360 Adapter (#7720) S/360 Adapter (#7730)	m	m	ms	bm	ms	bm	bm	mx	mx	-	-	-	1 per system		
1442	N1	Card Read Punch	→	m	m	bms	bm	bms	bm	bm	bmax	bmax	bmax	-	-	(D)		
N2		Card Punch	→	m	m	bms	bm	bms	bm	bm	bmax	bmax	-	-	-	U		
1443	N1	Printer	→	m	m	bms	bm	bms	bm	bm	bmax	bmax	bmax	-	-	U		
2250*	1	Display Unit	→	m	m	ms	m	ms	bm	bm	bx	bx	bx	-	-	S	(D)	
3		Display Unit	2840-2	m	m	bms	bm	ms	bm	bm	bx	bx	bx	-	-	S	4 per 2840	
2260	1	Display Station	2848-3	m	m	bms	bm	bms	bm	bm	bmax	bmax	bmax	-	-	S	8 per 2848	
2		Display Station	2848-1,-2,-21,-22	m	m	bms	bm	bms	bm	bm	bmax	bmax	bmax	-	-	S	(X)	
2305	1	Fixed Head Storage (A)	2835-1	-	-	-	-	-	-	-	b	b	b	-	-	U	2 per 2835	
2		Fixed Head Storage (B)	2835-2	-	-	-	b	b	b	b	b	b	b	-	-	U	2 per 2835 (U)	
2311	1	Disk Storage Drive	2841-1	-	-	bs	b	bs	b	b	bx	bx	bs	-	-	S	8 per 2841 (W)	
2312	A1	Disk Storage	2314-A1, 2319-A1	See 2314 A-Series and 2319-A1										-	(h) (o)			
2313*	A1	Disk Storage	2314-A1, 2319-A1	See 2319-A1 (for Model 145 GE-I only) and 2314 A-Series										-	(h) (o)			
2314	A-Series	Direct Access Storage Facility (L)	→	-	-	bs	b	bs	b	b	b	bs	bs	bs	-	-	S	(d)
B-Series		Direct Access Storage Facility	→	-	-	bs	b	bs	b	b	b	bs	bs	bs	-	-	S	(j)
2314	A1*	Storage Control	→	See 2314 A-Series										-	9 drives (h)			
B1		Storage Control	→	See 2314 B-Series										-	9 drives (j)			
2318	A1	Disk Storage	2314-A1, 2319-A1	See 2314 A-Series and 2319-A1										-	(h) (o)			
2319	A1	Disk Storage	→	-	-	i	i	-	-	-	-	-	-	-	-	-	-	(o)
A2		Disk Storage	2319-A1	See 2319-A1 (for Model 145 GE-I only)										-	(o)			
A3		Disk Storage	2319-A1	See 2319-A1 (for Model 135 only)										-	(j)			
B1		Disk Storage	2314-B1	See 2314 B-Series										-	(j)			
B2		Disk Storage	2314-B1 (via 2319-B1)	See 2314 B-Series										-	(j)			
2401	1-3	Magnetic Tape Unit	2803/04-1,-2	-	-	bms	b	bs	b	b	bx	bx	bx	-	-	S	(n)	
4, 5		Magnetic Tape Unit	2803/04-2	-	-	bms	b	bs	b	b	bx	bx	bx	-	-	S	(n)	
6		Magnetic Tape Unit	2803/04-2	-	-	bs	b	bs	b	b	bx	bx	bx	-	-	S	(n)	
8		Magnetic Tape Unit	2803/04-3	-	-	bms	b	bs	b	b	bx	bx	bx	-	-	S	(n)	
2415	1-6	Magnetic Tape Unit and Control	→	-	-	bms	bm	bms	bm	bm	-	-	-	-	-	-	S	(d)
2420*	5	Magnetic Tape Unit	2803-2	-	-	bs	b	bs	b	b	bx	bx	bx	-	-	S	(n)	
7		Magnetic Tape Unit	2803-2	-	-	bs	b	bs	b	b	bs	bs	bs	-	-	S	(n)	
2501	B1, B2	Card Reader	→	m	m	bms	bm	bms	bm	bm	bmax	bmax	bmax	-	-	U	(d)	
2520*	B1	Card Read Punch	→	m	m	bms	bm	bms	bm	bm	bmax	bmax	bmax	-	-	U	(d)	
B2, B3		Card Punch	→	m	m	bms	bm	bms	bm	bm	bmax	bmax	bmax	-	-	U	(d)	
2540	1	Card Read Punch	2821-1,-5,-6	m	m	bms	bm	bms	bm	bm	bmax	bmax	bmax	-	-	U	(V)	
2560	A1	Multi-function Card Machine	→	i (C)	i	-	-	-	-	-	-	-	-	-	-	-	1 per system	
A2		Multi-function Card Machine	→	i (C)	-	-	-	-	-	-	-	-	-	-	-	-	1 per system	
2596	1	Card Read Punch	→	m	m	bms	m	ms	bm	bm	bmax	bmax	bmax	-	-	U	(d)	
2671	1	Paper Tape Reader	2822-1	m	m	bms	bm	bm	bm	bm	-	-	-	-	-	-	1 per 2822	
2701	1	Data Adapter Unit	→	m	m	bms	bm	bms	bm	bm	bmax	bmax	bmax	-	-	U	4 lines max	
2715*	1	Transmission Control Unit	→	m	m	m	m	m	m	m	m	m	m	-	-	-	(B)	
2790	-	Data Communication System	→	See 2715										-	(B)			

Figure 7-1. Attachment Data for Local I/O Devices and Control Units (Part 2 of 4)

Input/Output (I/O) Device or Control Unit			Attaches to	Means of Attachment to System/370 Model										Block Multiplexer Channel UCW Assignment	No. of I/O Devices or Lines Attachable		
No.	Models	Name		115	125	135 (P) ¹	138	145 (P) ²	148	155	158	165	168			195	
2803	1,2,3	Tape Control (M)	→	See 2401 and 2420											(N)		
2804*	1,2,3	Tape Control (M)	→	See 2401											(N)		
2816*	1	Switching Unit	→	See 2401											(V)		
2821	1-3,5,6	Control Unit	→	See 1403 and 2540											(V)		
2822	1	Paper Tape Reader Control	→	See 2671											1 2671		
2826	1	Paper Tape Control	→	See 1017 and 1018											(Z)		
2835	1,2	Storage Control	→	See 2305											2 2305's (U)		
2840*	2	Display Control	→	See 2250-3											4 2250-3's		
2841	1	Storage Control	→	See 2311											(W)		
2848	1-3,21,22	Display Control	→	See 1053 and 2260											(X)		
3203	1,2,4	Printer	→	i	i	-	-	-	-	-	-	-	-	-		1 per system	
3210	1	Console Printer-Keyboard	→	-	-	i	i	i	i	-	-	-	-	-		2 per system	
	2	Console Printer-Keyboard	→	-	-	-	-	i	bm	-	-	-	-	-		(V)	
3211	1	Printer	→	-	-	bms	bm	bms	bm	bm	bm	bmsx	bmsx	bmsx	BU	1 per 3811	
3213	1	Console Printer	→	-	-	-	-	-	-	m	-	-	-	-		1 per system	
3215	1	Console Printer-Keyboard	→	-	-	i	i	i	i	-	-	-	-	-		(V)	
3270	-	Information Display System	→	See 3272											(V)		
3272	1,2	Control Unit	→	m	m	bms	bm	bms	bm	bm	bm	bmsx	bmsx	bmsx	BS**	(V)	
3277	1,2	Display Station	→	See 3270											(V)		
3330	1,2	Disk Storage	→	See 3333											(V)		
			→	3333-1,-11													
			→	3830-1	-	-	bs	b	bs	b	b	b	b	b	BU	4 per 3830-1	
	11	Disk Storage	→	3333-1,-11	See 3333											(A)	
3333	1	Disk Storage and Control	→	-	-	bs	b	bs	b	b	b	b	b	b	BU	(A)	
			→	3830-2	-	-	bs	b	bs	b	b	b	b	b	BU	(A)	
			→	3830-3	-	-	-	-	b	b	b	b	b	b	BU	(A)	
	11	Disk Storage and Control	→	3830-2	-	-	bs	b	bs	b	b	b	b	b	BU	(A)	
			→	3830-3	-	-	-	-	b	b	b	b	b	b	BU	(A)	
			→	3830-3	-	-	-	-	b	b	b	b	b	b	BU	(A)	
3340	A2	Disk Storage	→	i	i	i	i	i	i	-	i	-	i	-		(B)	
			→	3830-2	-	-	bs	b	bs	b	b	b	b	b	BU	(B)	
	B1,B2	Disk Storage	→	3340-A2	See 3340-A2											(B)	
3344	B2,B2F	Direct Access Storage	→	3340-A2	See 3340-A2											(B)	
3350	A2,A2F	Direct Access Storage	→	-	-	-	-	i	i	-	-	i	-	-		(B)	
			→	3830-2	-	-	bs	b	bs	b	b	b	b	b	BU	(B)	
	B2,B2F,C2,C2F	Direct Access Storage	→	3350-A2,A2F	See 3350-A2,A2F											(B)	
3410	1	Magnetic Tape Unit	→	3411-1	i	i	bms	bm	bms	bm	b	b	-	-	S	3 per 3411-1	
	2	Magnetic Tape Unit	→	3411-2	i	i	bms	bm	bms	bm	b	b	-	-	S	5 per 3411-2	
	3	Magnetic Tape Unit	→	3411-3	i	i	bms	bm	bms	bm	b	b	-	-	S	5 per 3411-3	
3411	1,2,3	Magnetic Tape Unit and Control	→	i	i	bms	bm	bms	bm	b	b	-	-	-	S	(D)	
3420	3	Magnetic Tape Unit	→	3803-1,-2,-3	i	(C)	bs	b	bs	b	b	b	bsx	bsx	bsx	S	(D)
	5	Magnetic Tape Unit	→	3803-1,-2,-3	i	(C)	bs	b	bs	b	b	b	bs	bs	bs	S	
	7	Magnetic Tape Unit	→	3803-1,-2	-	-	bs	b	s	b	b	b	bs	bs	bs	S	
	4,6,8	Magnetic Tape Unit	→	3803-2	-	-	s	b	s	b	b	b	bs	bs	bs	S	
3504	A1,A2	Card Reader	→	-	-	-	-	-	-	-	-	-	-	-		1 per system	
3505	B1,B2	Card Reader	→	m	m	bms	bm	bms	bm	bm	bm	bmsx	bmsx	bmsx	BU	(D)	
3525	P1,P2,P3	Card Punch	→	3505	m	m	bms	bm	bms	bm	bm	bmsx	bmsx	bmsx	BU	(D)	
			→	-	-	i	-	-	-	-	-	-	-	-		1 per system	
3540	B1,B2	Diskette Input/Output Unit	→	m	m	bms	bm	bms	bm	bm	(I)	bm	bms	(I)	bms	-	(D)
3704	A1-A4	Communications Controller	→	Chan Adptr Type 1	m	m	m	m	m	m	m	m	m	m	m	-	32 lines
3705	All Models	Communications Controller	→	Chan Adptr Type 1	m	m	m	m	m	m	m	m	m	m	m	-	352 lines
			→	Chan Adptr Type 2 or Type 3 (C)	-	-	m	m	bms	bm	bm	bm	bmsx	bmsx	bmsx	BU	

Figure 7-1. Attachment Data for Local I/O Devices and Control Units (Part 3 of 4)

Input/Output (I/O) Device or Control Unit			Attaches to	Means of Attachment to System/370 Model											Block Multiplexer Channel UCW Assignment	No. of I/O Devices or Lines Attachable
No.	Models	Name		115	125	135 ⁽¹⁾	138	145 ⁽²⁾	148	155	158	165	168	195		
3790	—	Communication System	→	See 3791												
3791	1A,1B, 2A,2B	Controller	→	m	m	m	m	m	m	m	m	m	m	—		(1)
3800	—	Printing Subsystem	→	—	—	—	—	bms	bm	bm (1)	bm	bmsx (1)	bmsx (1)	—		(4)
3803	1,2,3	Tape Control	→	See 3420												(1)
3811	1	Control Unit	→	See 3211												1, 3, 21, 1
3830	1*,2	Storage Control	→	See 3330, 3333, 3340, and 3350												(2)
3830	3	Storage Control	→	See 3333 and 3851												(3)
3838	1,2,3	Array Processor	→	—	—	—	—	—	—	—	b	—	b	—		(4)
3850	—	Mass Storage System	→	See 3851												(5)
3851	A1-A4, B1-B4	Mass Storage Facility	→	—	—	—	—	b	b	b (1)	b	b (1)	b	—		(6)
3881	1	Optical Mark Reader	→	—	—	—	—	bm	bm	bm (1)	bm	bm (1)	bm	—		(7)
3886	1	Optical Character Reader	→	m	m	m	m	m	m	m (1)	m	—	—	—		(8)
3890	A1-A6, B1-B6	Document Processor	→	—	—	bm	bm	bm	bm	bm (1)	bm	bm (1)	bm	—		1 per system
5203	3	Printer	→	i	—	—	—	—	—	—	—	—	—	—		1 per system
5213	1	Printer	→	i	i	—	—	—	—	—	—	—	—	—		1 per system
5425	A1,A2	Multi-function Card Unit	→	i	i	—	—	—	—	—	—	—	—	—		1 per system
7770	3	Audio Response Unit	→	m	m	m	m	m	m	m	m	m	m	m	—	48 lines

Symbol

- b Block multiplexer channel (housed within a 2880 Multiplexer Channel for Models 165-195).
- bmsx Underline denotes preferred channel for attachment.
- BS Block shared mode unit control word (UCW) assignment recommended.
- BU Block unshared mode UCW assignment recommended.
- i Integrated adapter.
- m Byte multiplexer channel (housed within a 2870 Multiplexer Channel for Models 165-195).
- s Selector channel (housed within a 2860 Selector Channel for Models 165-195).
- S Selector mode UCW assignment recommended.

- x Selector subchannel (special feature for a 2870 Multiplexer Channel). See the information in the "Means of Attachment" columns.
- Not applicable.
- May not be available.
- ** Block shared mode is not available for the 3272 on the channels of the Model 155 or Model 158 (3158 only). Block unshared mode is not recommended. Selector mode should be used. When more than 16 devices attach to a 3272 Control Unit, multiple shared UCWs are required for the Models 155 and 158 (3158 only).

Notes (Circled Letters)

- a** The 3330 and 3333 Models 1 and 11 each have two disk drives, and the 3330 Model 2 has one. In general, a 3333, either model, can attach as many as three 3330s, any model, thus allowing up to eight drives per 3333. One or two 3333s can attach to a 3830-2, a Model 135 or 138 integrated file adapter, a Model 145 or 148 integrated storage control (ISC), or the Model 158 or 168 ISC. The 32-drive expansion feature provides for attachment of one or two additional 3333s (with associated 3330s) to a 3830-2, or a Model 145, 158, or 168 ISC. A 3333/3340 intermix feature permits attachment of both 3333s and 3340-A2s. The Model 125 direct disk attachment attaches one 3333 Model 1, which in turn can attach one 3330 Model 1 or 2, thus permitting up to four drives.
- b** The 3340-A2 and -B2 each have two disk drives; the 3340-B1 has one. The 3344-B2 and -B2F each have two disk drives. In general, a 3340-A2 can attach a total of three 3340-B1s and/or -B2s and, in certain configurations, 3344-B2's and/or -B2F's, for a maximum of eight drives per string. One or two 3340-A2s can be attached to a 3830 Storage Control Model 2, a Model 135 or 138 integrated file adapter (IFA), a Model 145 or 148 integrated storage control (ISC), or to each of the two paths of the ISCs of a Model 158 or 168. On a Model 135 or 138 IFA, the first of the two possible strings may contain up to three 3340 and/or 3344 B-units in any combination. The second string may contain only the 3340 units. As many as four 3340-A2s with the associated 3340 B-units (maximum of 32 drives) or four 3340-A2s with 3340 and 3344 B-units, which together use a maximum of 64 logical device addresses, can be attached to a 3830 Model 2 or to each of the two paths of the ISCs of a Model 158 or 168. 3344 B-units may be used in only the first and the third of the four possible strings. The 3333/3340 intermix feature permits attachment of the 3333/3330 strings and the 3340-A2, -B1, -B2 strings, but does not include the 3344s. The 3115-0 Processing Unit models attach one 3340-A2 and one 3340-B1 or -B2. The 3115-2 and 3125-0 Processing Unit models attach one 3340-A2 and as many as three -B1 and/or -B2 models for a maximum of eight drives. Two 3340-A2s, with as many as three -B1s and/or -B2s for a maximum of eight drives for each 3340-A2, can attach to the 3125-2. The 3344-B2 and -B2F are not supported on the Models 115 and 125.
- c** The 3330 and 3333 Models 1 and 11 have two disk drives, and the 3330 Model 2 has one. One 3333 can attach up to three 3330s for a maximum of eight drives per 3333. Up to four 3333s can attach to a 3830-3 or to each of the two paths of the integrated storage controls of a Model 158 or 168 with the staging adapter feature installed, for a maximum of 32 drives. For 3330 Models 1 and/or 2, 16 of these drives are available as staging drives. For 3330 Model 11, 8 are available as staging drives.
- d** No special restrictions; depends on number of available system channel control unit positions and, for some units, on channel loading considerations.
- e** The 3420 Magnetic Tape Unit Models 3 and 5 can be attached to Models 115 and 125 via the 3803 Tape Control Model 3 and the magnetic tape adapter.
- f** Attaches to Model 155 II or 165 II, but not to Model 155 or 165.
- g** The 2715 Transmission Control Unit Model 1, part of the 2790 Data Communication System, can attach a combination of 2790 devices to System/370 for local operation. These devices include the 2791 and 2793 Area Stations, the 2795, 2796, and 2797 Data Entry Units, and the 2798 Guidance Display Unit. With appropriate attachment features and the expanded capability feature, a 2715 can attach as many as 100 area stations, 1,024 data entry units, and 256 guidance display units.
- h** A 2314 A-Series Direct Access Storage Facility (DASDF) consists of a 2314 Storage Control Model A1 and combinations of Model A1 units of 2312, 2313, and 2318 Disk Storage, forming a single interconnected unit. Each 2312-A1 provides one disk storage drive, each 2313-A1 four drives, and each 2318-A1 two drives. A full-configuration 2314 A-Series, which consists of two 2313s and one 2312, has eight drives and one spare.
- i** Selector channel attachment is not recommended unless dedicated.
- j** A 2314 B-Series Direct Access Storage Facility consists of a 2314 Storage Control Model B1, one 2319 Disk Storage Model B1, and up to two units of 2319 Disk Storage Model B2, forming a single interconnected unit having three, six, or nine (eight active, one spare) disk drives. Each 2319-B1 and -B2 has three drives.
- k** The 3350-A2, -A2F, -B2, -B2F, -C2, and -C2F each have two drives. A 3350 string can be formed by attaching one of the two following combinations to a 3350-A2 or -A2F for a maximum of eight drives: (1) up to three 3350-B2 or -B2F units, or (2) one or two 3350-B2 or -B2F units and (at the end of the string) one 3350-C2 or -C2F unit. As many as four 3350 strings can be attached to the Models 135, 138, 145, 148, 155 II, 158, 165 II, and 168 through the 3830 Storage Control Model 2 or through the integrated storage control (ISC) of the Model 145. As many as four 3350 strings can be attached to each of the two paths of the ISCs of the Models 158 and 168. The 3350 is not supported on the Model 115 or the Model 125.
- l** The 2816 permits switching of as many as eight tape drives (2401 Models 1-6 and 2420s) among four 2803s. With a second 2816 and 16-drive addressing, 4, 8, 12, or 16 drives can be switched among two, three, or four 2803s.
- m** 2803 is a single-channel control unit; 2804 is a two-channel control unit. A 2804 requires one control-unit position on each of two channels in the same system.
- n** Up to eight:
800-bpi drives (2401-1 to -3) per 2803-1 or 2804-1.
800- and 1600-bpi drives (2401-1 to -6 and 2420-5, -7) per 2803-2.
800- and 1600-bpi drives (2401-1 to -6) per 2804-2.
800- and 1600-bpi drives (3420-3, -5, -7) per 3803-1 or -2.
800- and 1600-bpi drives (3420-3, -5) per 3803-3.
2401-8s per 2803-3 or 2804-3.
6250-bpi or 6250/1600-bpi drives (3420-4, -6, -8) per 3803-2.
The 3803 tape switching features permit switching of as many as 16 3420s among two, three, or four 3803s.
- o** The 2319 Disk Storage Model A1 has three disk drives and permits attachment of as many as five additional drives. Attachable to the 2319-A1 are the single-drive 2312-A1, two-drive 2318-A1, three-drive 2319-A2 (for Model 145 GE-1 only) or 2319-A3 (for Model 135 only), and four-drive 2313-A1 (for Model 145 GE-1 only). The 2319-A1 does not attach to Model 145 H2-J2.
- p**¹ The 3135-3 has the same attachment capabilities as the 3138, plus the capability of attaching the 3210 Console Printer-Keyboard Model 1 or the 3215 Console Printer-Keyboard Model 1. The 3135-3 also attaches the 2319 Disk Storage Model A1.
- p**² The 3145-3 has the same attachment capabilities as the 3148, plus the capability of attaching the 3210 Console Printer-Keyboard Models 1 and 2 or the 3215 Console Printer-Keyboard Model 1.
- q** One or two modules of 2305 Fixed Head Storage and a 2835 Storage Control form a 2305 Fixed Head Storage facility, a single interconnected unit.
- r** A locally attached 3270 Information Display System has a 3272 Control Unit Model 1 or 2 which directs the operation of various combinations of up to 32 3277 Display Stations Models 1 and 2, 3284 and 3286 Printers Models 1 and 2, and 3288 Line Printers Model 2. The 3272-1 controls only Model 1 devices, but the 3272-2 controls both Model 1 and 2 devices.
- s** Neither channel adapter type 2 nor channel adapter type 3 attaches to 3705-A1, -B1, -C1, or -D1.
- t** The 3272 can be plugged for disconnect command chaining on the 3158-3. The 32-device option must also be plugged if applicable.
- u** On the Model 155, 2835-2s are attachable to block multiplexer channels 1 and 2 only. Two 2835s can attach to channel 1; two can attach to channel 2.
- v** One 1403 and one 2540 per 2821-1.
One 1403 per 2821-2.
Two (or, with a third printer control, three) 1403s per 2821-3.
One 1404 and one 2540 per 2821-4.
Two (or, with a third printer control, three) 1403s and one 2540 per 2821-5.
One 2540 per 2821-6.
- w** The basic 2841 can control as many as eight 2311s.
- x** 2848-1: up to 24 2260-2s.
2848-2: up to 16 2260-2s.
2848-3: up to 8 2260-1s.
2848-21: up to 24 2260-2s.
2848-22: up to 16 2260-2s.
- y** One 3210-1 or 3215-1 is attachable (and required) on a Model 135, 145, or 155. One 3210-2 can be attached to a Model 145 or 155 in addition to either a 3210-1 or 3215-1.
- z** 2826-1 attaches up to two 1017s plus up to two 1018s; they can operate concurrently.

Auxiliary Processors

3838 Array Processor Models 1, 2, and 3

The IBM 3838 Array Processor (Figure 7-2) is a high-speed auxiliary processor that performs complex, reiterative mathematical calculations in the analysis of periodically sampled input data for petroleum industry applications. The calculations are user-defined tasks in the System/370 application program and are processed by the 3838 concurrent with the processing of other data by the System/370 processing unit. The 3838 produces either a single result or an array of results from its calculations. Input data elements can be 16-bit fixed-point halfwords, 32-bit floating-point words, or 64-bit floating-point doublewords.

The 3838 provides the following bulk storage capacities:

Capacity (Bytes)	Model
262,144 (256K)	1
524,288 (512K)	2
1,048,576 (1,024K)	3

Among the calculations performed by the 3838 are: convolution, correlation, vector and scalar multiplication, vector addition, division, square root, format conversion, and branching and sequencing control.

The 3838 consists of the following five functional elements:

The *channel interface*, which provides the link between the array processor and the processing unit via the block multiplexer channel.

The *control processor*, which receives commands from the processing unit over the channel interface, and schedules and controls processing functions in the other elements of the 3838.

The *arithmetic processor*, which performs arithmetic operations. The arithmetic processor includes: an arithmetic element control with writable control storage; arithmetic elements (2 four-stage adders, a four-stage multiplier, and a sine/cosine generator); and working storage (two 8K-byte sections).

Bulk storage, which provides storage for data buffers, coefficients, and program parameters. The interleaving operation of the storage modules in bulk storage achieves data rates of up to 40 megabytes per second.

The *data transfer controller*, which transfers data and parameters between bulk storage and the other 3838 elements. The data transfer controller performs logical operations on data during a transfer between bulk storage and the working storage of the arithmetic processor.

The 3838 is supported by OS/VS2 (MVS) and can be attached to System/370 Models 158 and 168 via a block multiplexer channel.

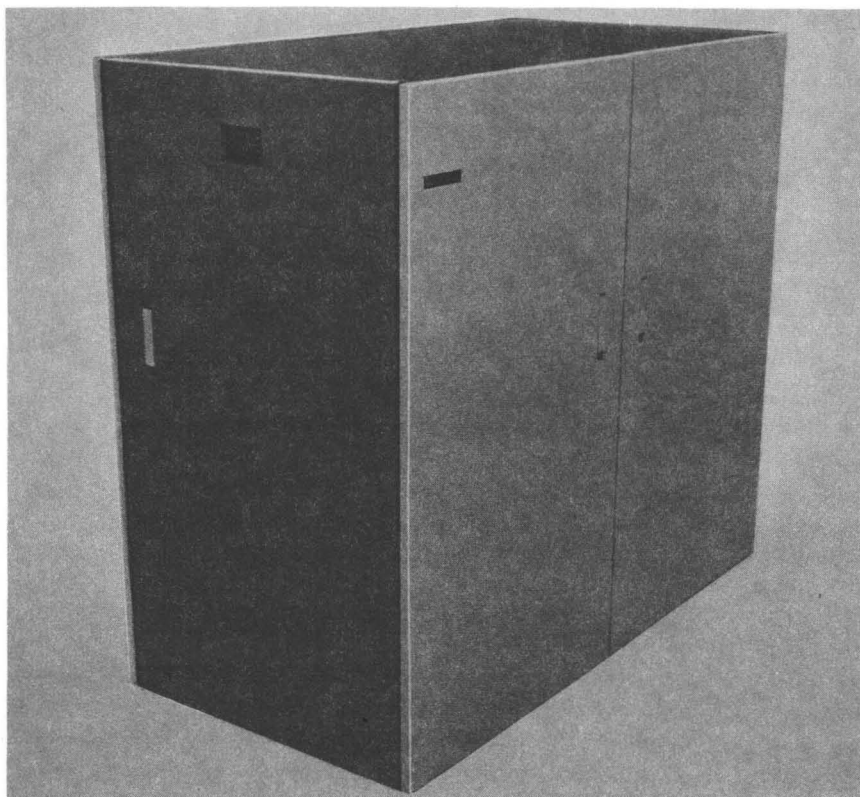

Figure 7-2. IBM 3838 Array Processor

Direct Access Devices

The direct access devices provide auxiliary storage that is large and relatively fast. These devices, which can access data directly as well as sequentially, use magnetic disks. Figures 7-3 through 7-7, 7-11, and 7-12 show these devices, and Figure 7-14 compares their more prominent characteristics.

2305 Fixed Head Storage Models 1 and 2 2835 Storage Control Models 1 and 2

An IBM 2835 Storage Control with one or two modules of IBM 2305 Fixed Head Storage forms an IBM 2305 Fixed Head Storage facility (Figure 7-3). With its short access time and medium capacity, this facility provides System/370 with disk storage especially well-suited for applications such as programming systems residence and table or index storage.

Two models of the 2305 facility are available:

Model 1 consists of one 2835 Model 1 and one or two 2305 Model 1 modules.

Model 2 consists of one 2835 Model 2 and one or two 2305 Model 2 modules.

The speed and capacities of the 2305 facilities are:

	<i>Model 1</i>	<i>Model 2</i>
Storage capacity (rounded, megabytes)	5.4 or 10.8	11.2 or 22.4
Average access time (milliseconds)	2.5	5.0
Data transfer rate (megabytes per second)	3.0	1.5

Both models of the 2305 facility attach to System/370 via a block multiplexer channel. The Model 1 facility, having a data transfer rate of 3.0 million bytes per second, requires a 2880 Block Multiplexer Channel equipped with the two-byte interface feature.

2305 Fixed Head Storage

Each 2305 module has six 14-inch, oxide-coated disks permanently mounted within the module. Each module uses read/write heads having one or two read/write elements per track.

The primary characteristics of the 2305 modules are:

	<i>Model 1</i>	<i>Model 2</i>
Number of read/write elements per track	2	1
Number of addressable tracks	384	768
Number of spare tracks	48	96
Bytes per module	5,428,224	11,258,880
Rotation time (milliseconds)	10	10
Access time, maximum (milliseconds)	5.1	10.25
Access time, average (milliseconds)	2.5	5.0
Data transfer rate (megabytes per second)	3.0	1.5

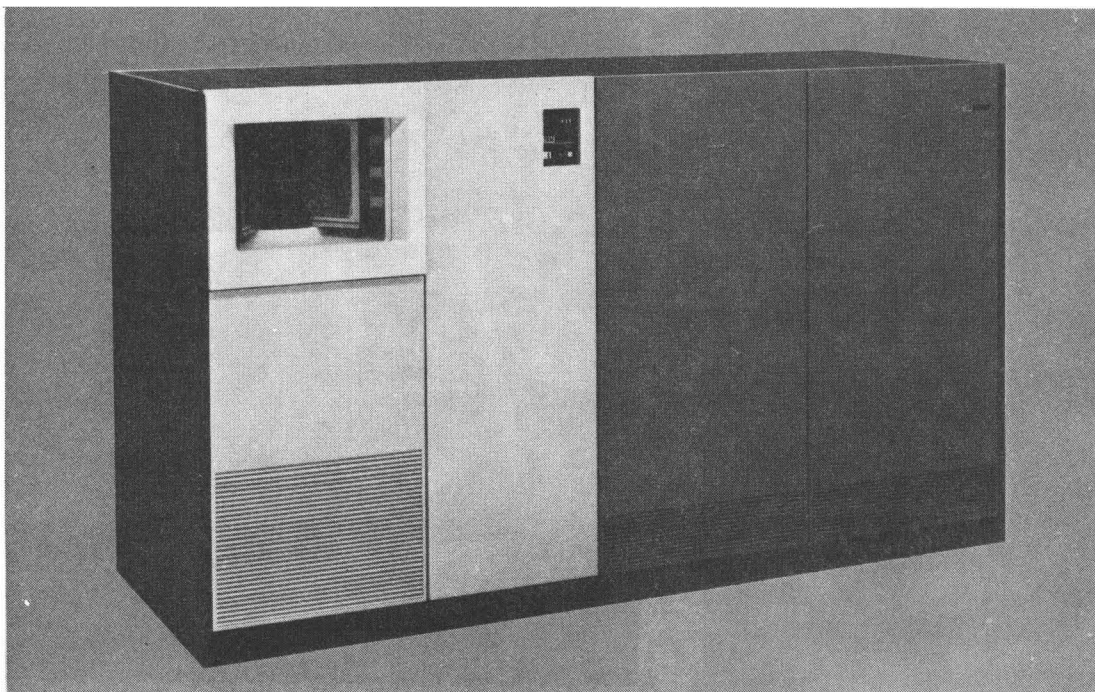

Figure 7-3. IBM 2305 Fixed Head Storage and 2835 Storage Control

2835 Storage Control

The 2835 interprets and executes all channel commands received from the block multiplexer channel. In addition, it provides the 2305 facility with error detection and correction capabilities by adding correction codes to each record.

Related to these capabilities are two methods for verification of data:

Full Read-Back Check: All just-written data is read back into main storage and compared with the original data.

Correction Code Check: The 2835 performs a non-comparative check of data validity, using the correction codes.

The 2835 standard features include:

Command Retry, which enhances error recovery by permitting the channel and control unit to retry operations without CPU program intervention.

Rotational Position Sensing, which increases channel availability by releasing the channel during most of record search time.

Multiple Requesting, which permits up to 16 record requests to be active in the storage facility, thereby permitting maximum use of the facility and contributing to improved response to system I/O requests.

An optional feature, the *two-channel switch,* permits two channels (of one system or of two separate ones) to have access to the 2305 facility.

2311 Disk Storage Drive Model 1

The IBM 2311 Disk Storage Drive (Figure 7-4) provides direct access storage for 7.25 million bytes (or 14.5 million packed decimal digits and signs) in a single disk pack. Eight disk storage drives can be attached to each IBM 2841 Storage Control, for a total online capacity of 58 million bytes per 2841. In addition, unlimited storage capacity is possible because the IBM 1316 Disk Pack in each drive can be easily removed and replaced with another (Figure 7-5).

Each disk pack has six 14-inch disks, mounted $\frac{1}{2}$ inch apart on a vertical shaft. The inside ten disk surfaces are used for recording data, and the outermost two surfaces are protective plates. When the disk pack is installed in the drive, information is written on or read from the surfaces by magnetic read/write heads, mounted in pairs between each two disks on a movable comb-like access mechanism.

The data rate of the 2311 is 156,000 bytes per second, the average access-motion time is 75 milliseconds, and the average rotational delay is 12.5 milliseconds.



Figure 7-4. IBM 2311 Disk Storage Drive



Figure 7-5. IBM 1316 Disk Pack Being Placed in an IBM 2311 Disk Storage Drive

**2314 A-Series Direct Access Storage Facility
(2314 Storage Control Model A1 and 2312, 2313,
and 2318 Disk Storage Model A1)**

**2314 B-Series Direct Access Storage Facility
(2314 Storage Control Model B1 and 2319 Disk Storage
Models B1 and B2)**

The IBM 2314 A-Series Direct Access Storage Facility (Figure 7-6) consists of combinations of Model A1 units of IBM 2312, 2313, and 2318 Disk Storage and an IBM 2314 Storage Control Model A1. These devices form an interconnected unit that provides one to nine (eight active, one spare) disk drives. The 2312 provides one drive, the 2313 provides four, and the 2318 provides two.

The B-Series 2314, however, consists of IBM 2319 Disk Storage (one Model B1 and up to two Model B2's) and an IBM 2314 Storage Control Model B1. These devices also form a single interconnected unit, but provide three, six, or nine (eight active, one spare) drives. Each 2319-B1 and -B2 provides three drives.

The drives of a 2314 (both A-Series and B-Series) operate independently and use IBM 2316 Disk Packs (Figure 7-7). Each of these interchangeable packs has a storage capacity of 29.17 million bytes. Consequently, the A-Series can have, in rounded numbers, 29 million to 233 million bytes of online disk storage, in multiples of approximately 29 million bytes; the B-Series can have 87, 175, or 233 million bytes of online storage. Both series can have unlimited offline storage.

For both series, the average access-motion time is 60 milliseconds, the average rotational delay is 12.5 milliseconds, and the data rate is 312,000 bytes per second.

Both the A- and B-Series have the same features. File scan and record overflow are both standard. File scan allows comparison on selected bytes—in effect, a search through the file for a specific record or condition. Record overflow permits more efficient use of storage by allowing a record to overflow from track to track to the end of the cylinder.

A special feature, the two-channel switch, is available to both series. Switching is under program control and may be used to switch the 2314 between two channels of a system or between two systems.

2319 Disk Storage Models A1, A2, and A3

The IBM 2319 Disk Storage Models A1, A2, and A3 provide systems with direct access storage without requiring a channel—they attach via an integrated file adapter. Each 2319 contains three disk drives. The drives use the removable and interchangeable IBM 2316 Disk Pack, which has a storage capacity of 29.17 million bytes. Consequently, each 2319 has an online storage capacity of approximately 87 million bytes and unlimited offline storage.

The Model A1 (Figure 6-4) attaches to the integrated file adapter and permits attachment of as many as five additional drives. Attachable to the 2319-A1 are the three-drive 2319-A2 or -A3, as well as the single-drive

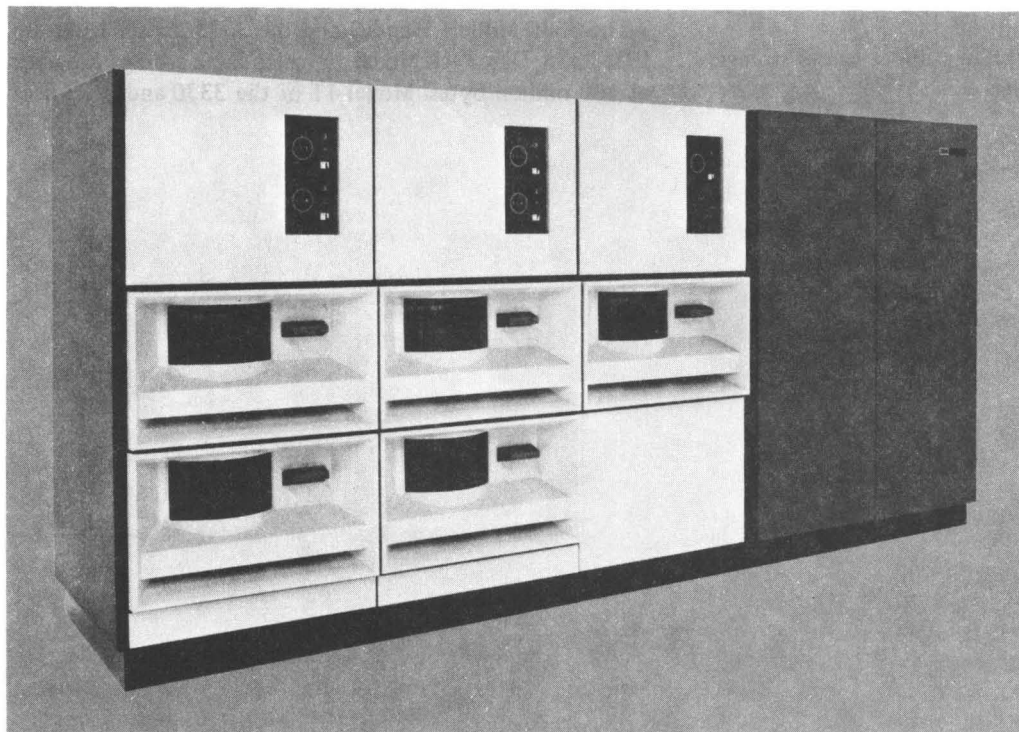

Figure 7-6. IBM 2314 A-Series Direct Access Storage Facility with Five Disk Drives

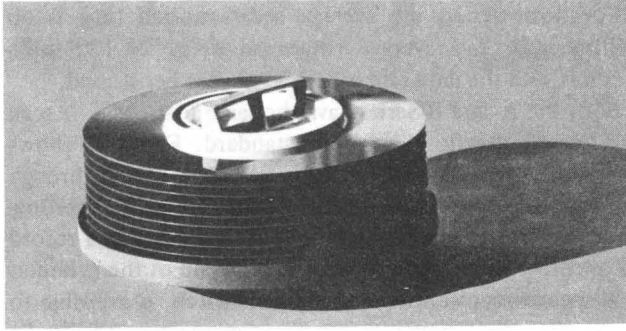

Figure 7-7. IBM 2316 Disk Pack

2312-A1, the four-drive 2313-A1, and the two-drive 2318-A1. The combinations of devices attachable to the 2319-A1 are system-dependent—the system models determine what devices can be attached.

The average access-motion time for the 2319-A's is 60 milliseconds, their average rotational delay is 12.5 milliseconds, and their data rate is 312,000 bytes per second.

2841 Storage Control

An IBM 2841 Storage Control can control as many as eight 2311's. The 2841 interprets and executes all orders from the system, and checks the validity of the data transferred to and from the "files" (direct access storage devices).

Optional Features

The *two-channel switch* permits switching a 2841 between two channels under program control.

File scan permits searching through direct access storage for a specific record or condition.

The *record overflow* feature provides greater utilization of the available storage capacity by allowing a record to "overflow" from track to track to the end of the cylinder.

3330 Disk Storage Models 1, 2, and 11

3333 Disk Storage and Control Models 1 and 11

3830 Storage Control Models 2 and 3

IBM 3330 Disk Storage and IBM 3333 Disk Storage and Control (Figure 7-11) provide System/370 with direct access storage that offers modularity, high performance, and large capacity. These qualities make 3330 and 3333 well-suited for use in a variety of applications, such as airlines reservations, inventory and manufacturing control, graphic processing, time-sharing, message switching, and systems residence.

Up to two 3333's can attach to an IBM 3830 Storage Control Model 2 or (for some System/370 models) to an integrated attachment. In turn, a 3333 can attach as many as three 3330's in any combination of models, permitting as many as eight drives per 3333.

In an IBM 3850 Mass Storage System configuration, up to four 3333's with associated 3330 drives can attach to an IBM 3830 Storage Control Model 3 or to each path of the integrated storage controls on a System/370 Model 158 or 168 that has the staging adapter special feature.

Models 1 and 11 of the 3330 and 3333 have two disk drives; Model 2 of the 3330 has one. All models have an average access time of 30 milliseconds, an average rotational delay of 8.4 milliseconds, and a data rate of 806,000 bytes per second.

The 3330 Models 1 and 2 and the 3333 Model 1 use the IBM 3336 Disk Pack Model 1, which has a storage capacity of 100 million bytes. Model 11 of the 3330 and 3333 uses

the 3336 Disk Pack Model 11, which has a storage capacity of 200 million bytes. The 3336-1 Disk Pack is interchangeable on 3330 Models 1 and 2 and 3333 Model 1 drives. The 3336-1 cannot be used with 3330 or 3333 Model 11. The 3336-11 is interchangeable on Model 11 3330's and 3333's. The 3336-11 cannot be used with 3330 Models 1 and 2 or 3333 Model 1. The 3336 Disk Pack Model 1 can be factory converted to a 3336 Disk Pack Model 11.

Standard functions provided by the 3333 and associated 3330's include:

Rotational Position Sensing, which increases channel availability by releasing the channel during most of record search time.

Multiple Requesting, which permits up to eight channel command sequences (one per disk drive) to be active in the storage facility, thereby permitting maximum use of the facility and contributing to improved response to I/O requests.

Write Format Release, which frees the subsystem while the drive erases the disk from the end of a formatted write record to the end of the track. This function is available only on Model 11 of the 3330 and the 3333.

Command Retry, which enhances error recovery by permitting the channel and control unit to retry operations without CPU program intervention.

Extensive Error Detection and Correction Capabilities, which enhance data integrity and reliability.

Optional features include:

The *two-channel switch*, which enables a 3830-2 to attach to two channels and (with appropriate programming or operator action) allows individual drives to be reserved for the exclusive use of either of the channels.

The *two-channel switch, additional*, which provides the 3830-2 with four-channel switching ability when used with the two-channel switch.

The *32-drive expansion*, which provides for attachment of two additional 3333's with their associated 3330's to a 3830-2, an integrated storage control, or an integrated file adapter.

The *string switch*, which allows a 3333 and its associated 3330's to be dynamically or statically switched, under program control, between any of two of the following: 3830-2, integrated storage control, or integrated file adapter.

Used together, 32-drive expansion and string switching provide for maximum availability and backup. For example, if two systems each have sixteen 3330-series drives and each have these two features, either system could access all 32 drives.

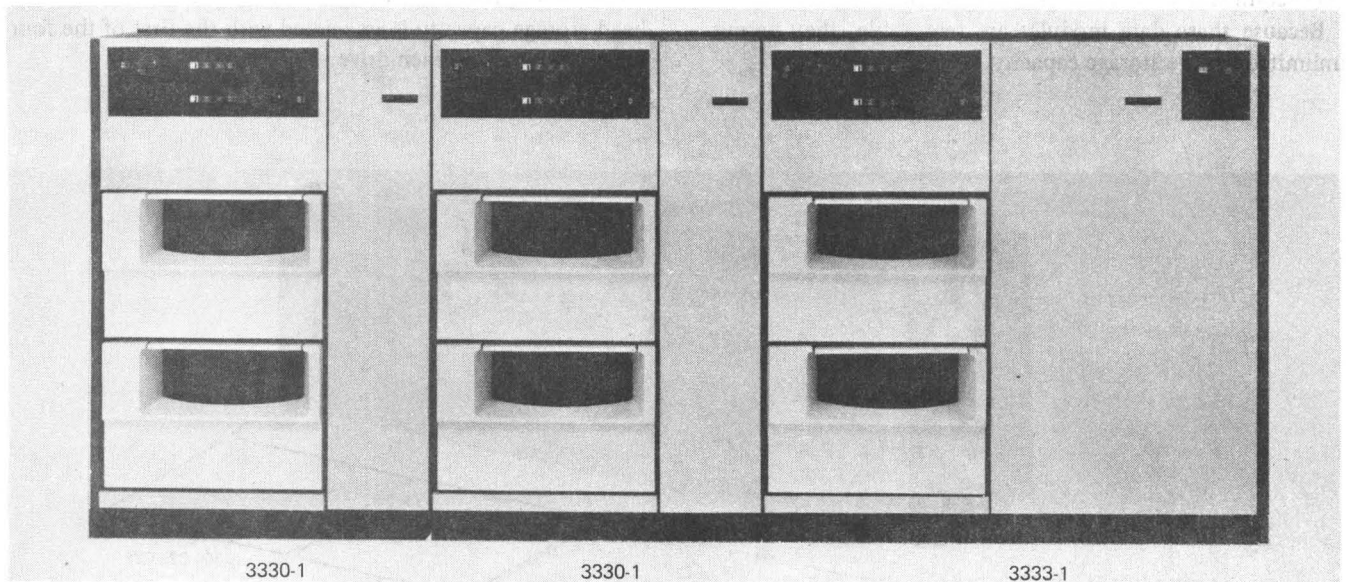

Figure 7-11. IBM 3330 and 3333 Disk Storage

**3340 Direct Access Storage Facility
 (3340 Disk Storage Drive and Control Model A2,
 3340 Disk Storage Drive Models B1 and B2)
 3344 Direct Access Storage Models B2 and B2F**

The IBM 3340 Direct Access Storage Facility with the IBM 3344 Direct Access Storage (Figure 7-12) offers large storage capacity, high performance, and increased data reliability and flexibility for System/370 models using OS/VS or DOS/VS. The recording medium is a sealed assembly (removable from the 3340 and fixed in the 3344) that contains magnetic disks, access arms, read/write heads, and spindle. Combining these components into a sealed integrated unit results in greater data reliability than that of earlier IBM disk drives, because read/write head alignment differences between drives are eliminated and also because the clean-air environment guards against airborne contamination.

The components of the 3340 Direct Access Storage Facility are:

IBM 3340 Disk Storage Drive and Control Model A2, a dual drive and control unit

IBM 3340 Disk Storage Drive Model B1, a single drive unit

IBM 3340 Disk Storage Drive Model B2, a dual drive unit

The 3340 Models A2, B1, and B2 use the removable IBM 3348 Data Module (Figure 7-13) that is available in three models: the 3348 Model 35 with a 34,944,768-byte capacity, the 3348 Model 70 with a 69,889,536-byte capacity, and the 3348 Model 70F with the same total capacity as Model 70 but with 502,080 bytes of storage accessible by fixed heads with zero seek time. Models 35 and 70 are interchangeable between drives, but the Model 70F requires the fixed head feature on the drive.

Because these data modules are removable, they permit unlimited offline storage capacity.



Figure 7-13. IBM 3348 Data Module

The IBM 3344 Direct Access Storage Models B2 and B2F (Figure 7-12), both dual drive units, use a fixed sealed assembly of disks, access arms, read/write heads, and spindle in each drive. Each of the drives has a capacity and format equal to four logical 3348 Data Modules Model 70, or 279,558,144 bytes. The Model B2F differs from the Model B2 by having fixed heads with zero seek time for 1,004,160 bytes of its storage capacity per drive. This fixed head storage capacity is associated with the first of the four logical volumes on each drive.

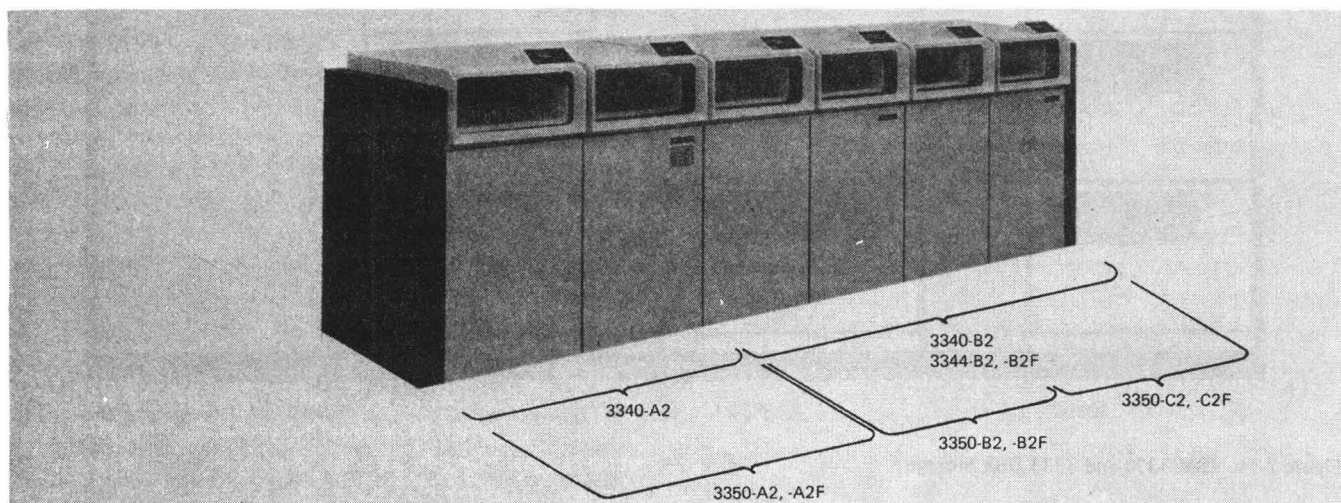

Figure 7-12. IBM 3340 Direct Access Storage Facility with IBM 3344 Direct Access Storage; and IBM 3350 Direct Access Storage

The 3340 Model A2 can attach and control a total of three B-units. These units can be a combination of 3340-B1's, 3340-B2's, 3344-B2's, or 3344-B2F's for a maximum of eight drives per string.

The number of 3340-A2's, the method of attachment to a System/370 CPU, and the number of and the types of B-units that may be attached to the 3340-A2 depend on the System/370 model and appropriate feature attachments. The 3340-A2 may attach to an IBM 3830 Storage Control Model 2, an integrated file adapter, an integrated storage control, or a direct disk attachment.

Contributing to the performance, reliability, and flexibility of the 3340 Direct Access Storage Facility and the 3344 Direct Access Storage are the following features:

Fixed head, which permits operation of the 3348 Model 70F on the 3340 drive.

Rotational position sensing, which increases channel availability by releasing the channel during most of record search time.

String switch, which allows a 3340 string to be dynamically or statically switched, under program control, between any two of the following: 3830 Model 2, integrated storage control, or integrated file adapter.

Read only switch, which provides a way to protect data from being overwritten or erased.

Read multiple count, key, and data command, which permits multiple records of data on a track to be read with a single channel command.

These features are available as follows:

Feature	3340 Models			3344 Models	
	A2	B1	B2	B2	B2F
Fixed head	Opt	Opt	Opt	-	Std
Rotational position sensing	Opt*	Opt*	Opt*	Std	Std
String switch	Opt	-	-	-	-
Read only switch	Std	Std	Std	Std	Std
Read multiple count, key, and data command	Std**	Std**	Std**	Std	Std

Legend:

Opt Optional

Std Standard

- Not available

* Recommended on 3340's in the same string with 3344's

** Available when 3344's are part of the configuration

The characteristics of the various direct access storage devices are compared in Figure 7-14.

3350 Direct Access Storage Models A2, A2F, B2, B2F, C2, and C2F

The IBM 3350 Direct Access Storage (Figure 7-12) is a high-performance, large-capacity subsystem that uses a fixed (sealed) storage medium containing disks, spindle, access arms, and read/write heads. Each drive provides high-density storage for a maximum of 317,498,850 bytes of data.

There are six models of the 3350, all dual drive units: Models A2, A2F, C2, and C2F incorporate the controller; Models B2 and B2F are drive units only. Models A2F, B2F, and C2F have fixed head access to as many as 1,144,140 bytes of the total available storage capacity per drive.

A 3350 string can be attached to System/370 by means of the 3350-A2 or 3350-A2F. A combination of 3350-B2 and 3350-B2F units, and (at the end of the string) one

Direct Access Storage Device	Data Rate (kilobytes/sec)	Capacity Available (megabytes)	Access-Motion Time, Average (milliseconds)	Rotational Delay, Average (milliseconds)	Storage Medium
2305-1 Fixed Head Storage	3,000	5.4	0	2.5	Disk
2305-2 Fixed Head Storage	1,500	11.2	0	5.0	Disk
2311 Disk Storage Drive	156	7.25 (a)	75	12.5	1316 Disk Pack
2314 A-Series DASD	312	29.17 to 233.36 (1 to 8 drives)	60	12.5	2316 Disk Pack
2314 B-Series DASD	312	87.51, 175.02, or 233.36 (3, 6, or 8 drives)			
2319 Disk Storage	312	87.51 to 233.36 (3 to 8 drives)			
3330-1, -2 Disk Storage and 3333-1 Disk Storage and Control	806	200 to 800 (2 to 8 drives per 3333-1)	30 (a)	8.4	3336-1 Disk Pack
3330-11 Disk Storage and 3333-11 Disk Storage and Control	806	400 to 1,600 (2 to 8 drives per 3333-11)			
3340 Direct Access Storage Facility with the 3344 Direct Access Storage	885	69.88 to 559.04	25	10.1	3348 Data Module
3350 Direct Access Storage	885	69.88 to 1,817.12 (2 to 8 drives per 3340-A2)	25	10.1	Fixed assembly of disks
3350 Direct Access Storage	1,198	400 to 2,540 (2 to 8 drives per 3350-A2 or -A2F)	25	8.4	Fixed assembly of disks

Note:

(a) Interchangeable storage media also provide unlimited offline capacity (except 3344 Direct Access Storage).

Figure 7-14. Comparison of Characteristics of Direct Access Storage Devices

3350-C2 or 3350-C2F unit can be attached to the 3350-A2 or 3350-A2F for a maximum of eight drives per string.

The presence of a 3350-C2 or -C2F as the last unit in the string permits the user to select the 3350-A or -C unit as the online controller when the string is powered on. If the online controller requires service, the string is powered off and then on, and recovery procedures are followed to reestablish subsystem availability.

Depending on the System/370 model, attachment of a Model A2 or A2F to a System/370 processing unit is by integrated storage control or by 3830 Storage Control Model 2.

All 3350 models have a data transfer rate of 1,198,000 bytes per second and an average rotational delay of 8.4 milliseconds. Average seek time is 25 milliseconds except for the fixed head portion of Models A2F, B2F, and C2F that has zero seek time.

Selective format, a standard feature, permits the 3350 to operate in 3350 native mode, in 3330 Model 1 compatibility mode, or in 3330 Model 11 compatibility mode. There are two logical volumes per physical device when the 3350 is in 3330 Model 1 compatibility mode.

The 3350 native mode allows use of the full drive capacity of approximately 317.5 megabytes with 1,144,140 of the bytes per drive under fixed heads in Models A2F, B2F, and C2F. In 3330 Model 1 or 3330 Model 11 compatibility mode, the format matches that of the 3330 Models 1 and 11, respectively, and storage capacity is 200,000,000 bytes per drive with 742,710 bytes per drive under fixed heads on Models A2F, B2F, and C2F. The fixed head storage capacity is associated with the first of the two logical volumes when the 3350 is in 3330 Model 1 compatibility mode.

The operational mode is initialized to customer requirements at the time of manufacture and can be different between drives on the same unit or in a string of units. The change from one mode of operation to another can be made in the field after installation.

Other standard features of the 3350 include:

Command retry, which improves error recovery by permitting the channel and control unit to retry operations without CPU program intervention.

Error correction of single data error bursts of as many as four bits.

Read multiple count, key, and data command, which permits multiple records of data on a track to be read with a single channel command.

Read-only switch for each drive, which provides a way to protect data from being overwritten or erased.

Rotational position sensing, which increases channel availability by releasing the channel during most of record search time.

Write padding, which frees the subsystem while the drive erases from the end of a formatted write record to the end of the track.

Optional features include:

String switch, which allows a 3350 string to be dynamically shared by two storage controls.

Remote switch attachment, which allows the string to be attached to the configuration control panel of a System/370 Model 158 or 168 Multiprocessor.

3851 Mass Storage Facility Models A1-A4 and B1-B4

The IBM 3851 Mass Storage Facility (MSF) provides the storage facility for data in an IBM 3850 Mass Storage System (MSS). (See Figure 7-15.)

The data is written on a new magnetic medium contained in a compact cartridge. These data cartridges are stored in cells within the 3851 MSF. Also included in the 3851 MSF are the data recording devices and controls to make the data available to the 3333/3330 disk storage for processing, a cartridge access station for the manual entry and removal of data cartridges, two accessors for the movement of cartridges within the 3851 MSF, and the control facility (mass storage control) for the 3850 MSS. See "3850 Mass Storage System" at the end of this section for more information.

Diskette Input/Output Devices

3540 Diskette Input/Output Unit Models B1 and B2

The IBM 3540 Diskette Input/Output Unit (Figure 7-16) is an efficient and economical data entry and output device for System/370. There is no contention for devices between data entry and processing programs. Designed around the IBM diskette, the recording medium used by the IBM 3740 Data Entry System, the 3540 reads up to 3,600 diskette records per minute and writes up to 2,200 records per minute. The 3540 comes in two models; Model B1 has one diskette drive and Model B2 has two. In the Model B2, each drive operates independently. Each drive has a separate hopper and a separate stacker holding up to 20 diskettes. Under program control, diskettes are automatically fed, one at a time, from the hopper and mounted on the drive spindle for a read or write operation. At the end of the operation, the diskette is automatically removed from the spindle and stacked, thus permitting uninterrupted processing. Diskettes are called and removed by the program while the unit is operating. Because each diskette goes through label checking before the reading of data, data integrity is assured.

The 3540, because it uses the IBM diskette, is also a means for entering data recorded by the 3740 directly into System/370.

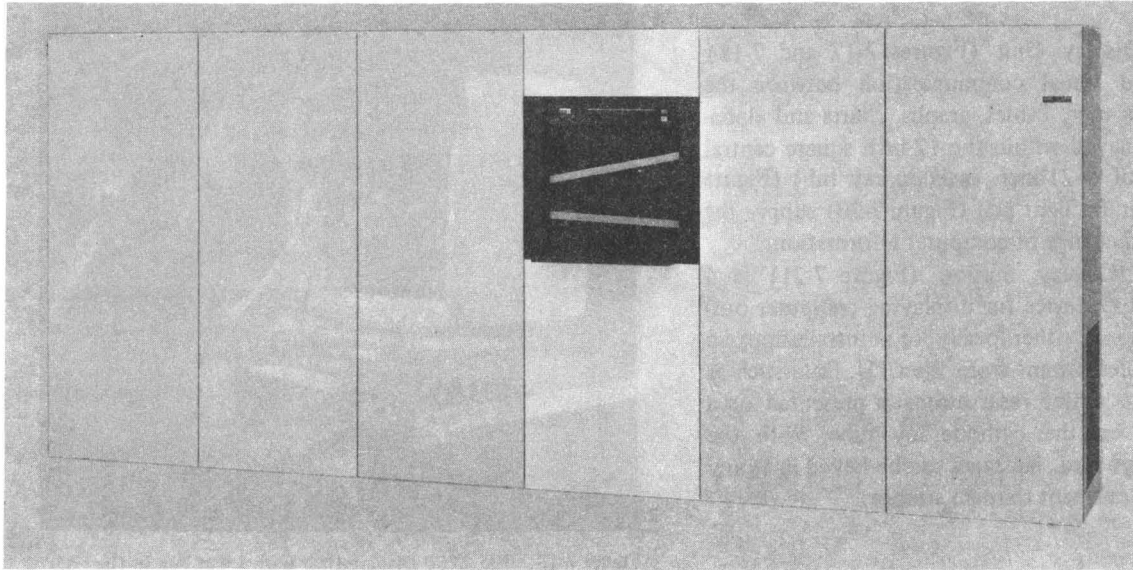

Figure 7-15. IBM 3851 Mass Storage Facility Models A1 and B1 (Design Model)

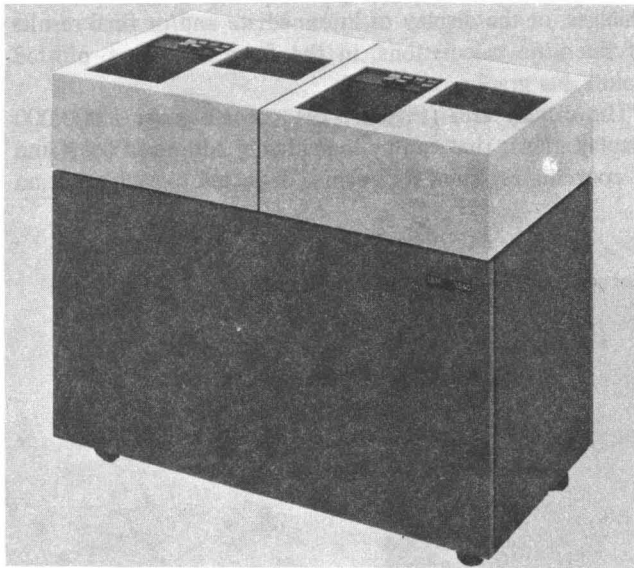

Figure 7-16. IBM 3540 Diskette Input/Output Unit Model B2

Display Devices

The IBM 2250 Display Unit (Figures 7-17 and 7-18) provides high-speed visual communication between the System/370 and its user. Tables, graphs, charts and alphanumeric data are displayed within the 12-inch square central area on the face of a 21-inch cathode ray tube (Figure 7-19). Keyboards and a light pen (Figure 7-20) supply the means for entry and change of computer information.

The IBM 2260 Display Station (Figure 7-21) is a lower-speed, table-top device for displaying computer output in alphanumeric form, either locally, or at installations up to thousands of miles distant from the CPU. Data such as insurance records or airline reservations is presented on a 4- by 9-inch area on the cathode ray tube. With the attachment of a keyboard, messages can be keyed in at any location, displayed, and sent to main storage.

2250 Display Unit Models 1 and 3

2840 Display Control Model 2

The general use of the IBM 2250 Display Unit is for on-line displaying, updating, and manipulating of drawings and alphanumeric data. It also has usage as a system operator console, in which it substantially reduces the time needed for transferring messages between the operator and the system.

Specific applications are innumerable: the display of readings from process control indicators, along with computer messages for operator guidance of the process; the

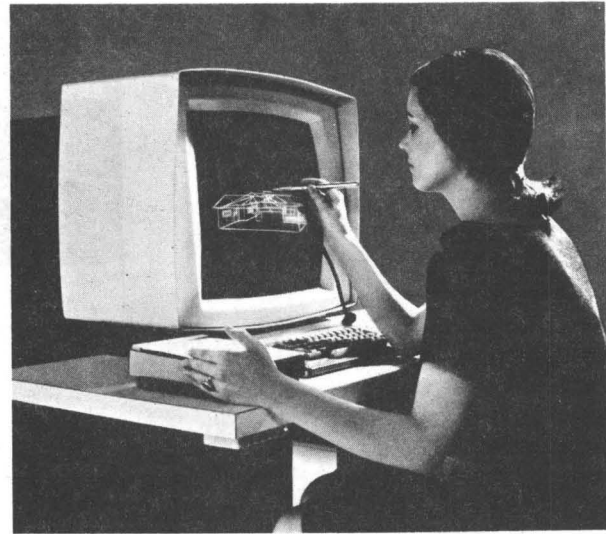

Figure 7-18. IBM 2250 Display Unit with Light Pen in Use

display of engineering drawings, with the user sketching changes on the drawings and requesting the results of the changes; or the display of intermediate and/or final results of scientific calculations, in the form of curves, plotted points, bar graphs, or symbols.

The display area (Figure 7-19) contains over 1,000,000 display points that can be individually addressed by X and Y coordinates. The CRT beam is deflected to each point on

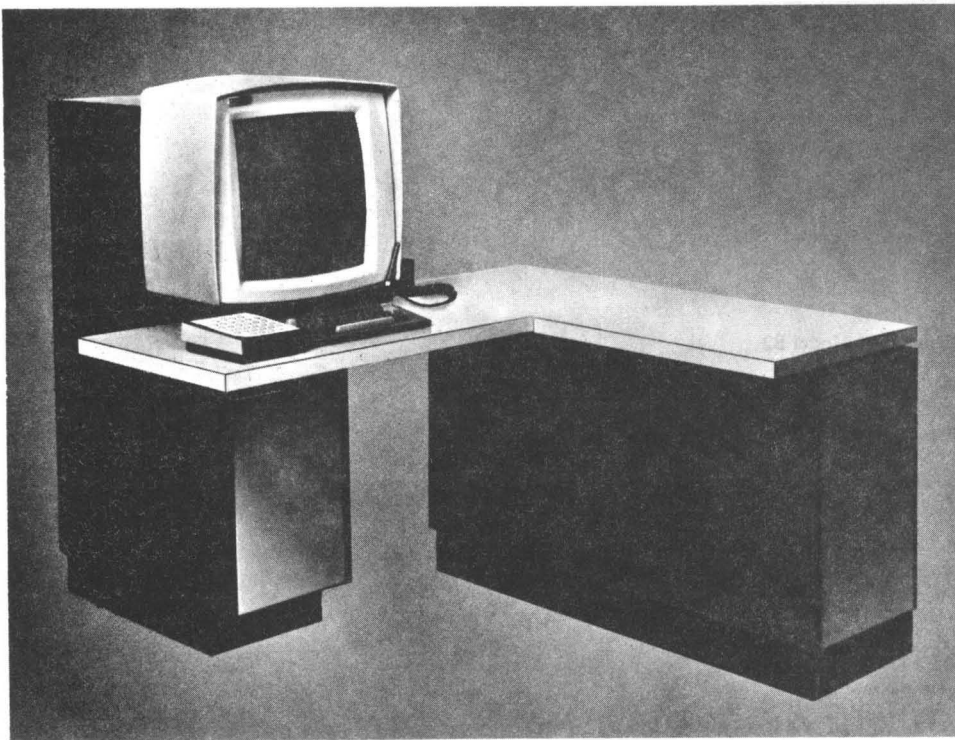







Figure 7-17. IBM 2250 Display Unit

2250 REPERTOIRE

POINT	
HORIZONTAL	
VERTICAL	
LIMITED VECTORS	
GRAPHICS	
ALPHA	ABC ABC
NUMERIC	123 123
STANDARD SYMBOL	# @ # @
SPECIAL SYMBOL	Δ Σ Γ

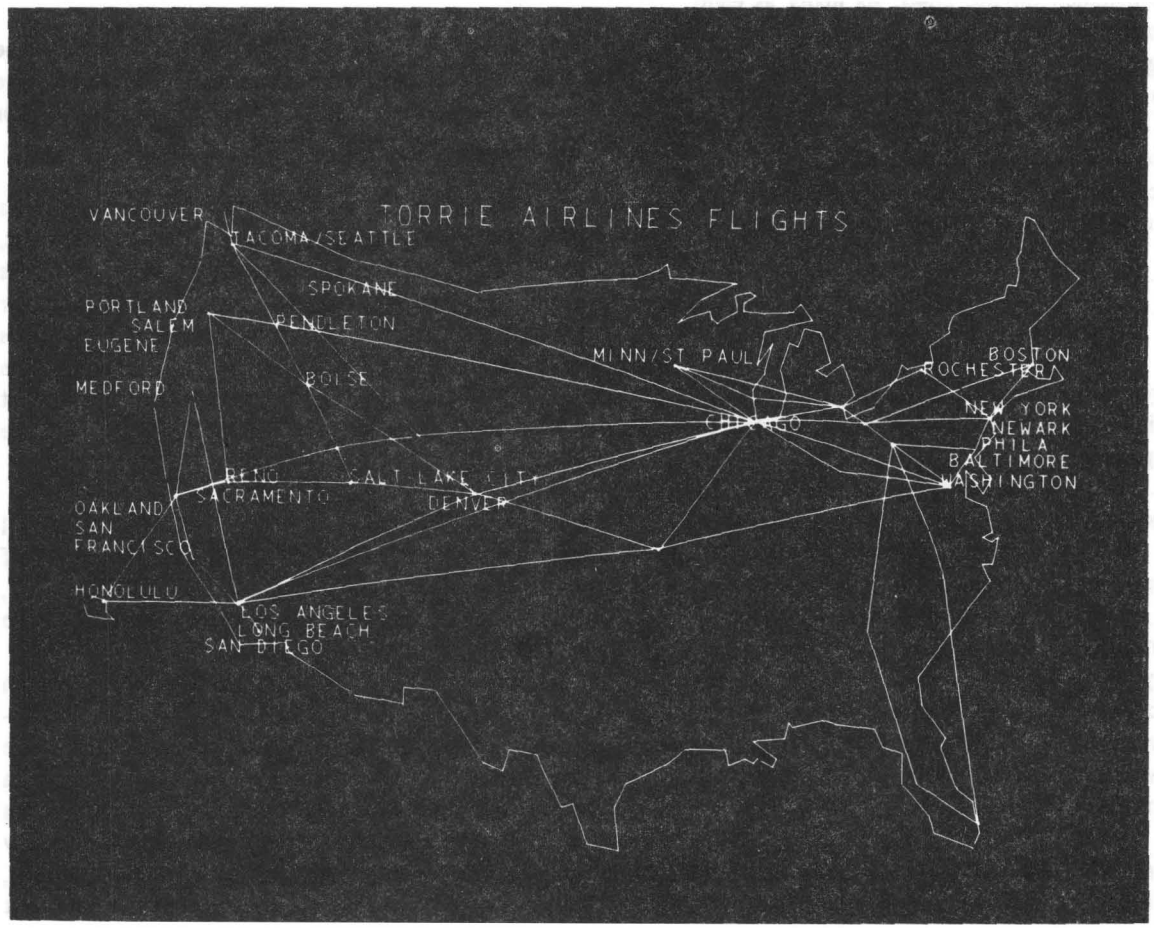

Figure 7-19. IBM Displays Showing Absolute Vector Graphics, Point Plotting, and Both Sizes of Alpha Characters

the screen that is addressed by the program, intensifying that point only if so directed by the program. If the beam motion is horizontal, vertical, or at 45 degrees, the path traversed by the beam on its way between one end point and the other can also be intensified; by this means, continuous horizontal and vertical lines of unlimited length or 45 degree lines of limited length are made visible. Lines can be displayed at any other angle as a series of dots. A further ability to display continuous straight lines of unlimited length at any angle is detailed under "Absolute Vectors and Control," discussed later in this device description.

The 2250 is available in two models, which vary in the location of the control unit, logical power in the buffer, and in the features that are standard. Model 1 has a self-contained control unit; Model 3 units are linked to the channel and CPU through an IBM 2840 Display Control Model 2.

Multiple Display

A 2840-2 can control as many as four Model 3 display units, each able to operate as far as 2,000 feet away from the 2840. The first two display units are attachable to a standard 2840; for the second two, a display multiplexer feature must be installed on the 2840. As many as eight control units can be attached to a channel.

Different images or the same image can be displayed on all display units simultaneously. The buffer storage in the 2840 is shared by all the 2250's attached, with portions being assigned to individual units by the program.

Light pen tracking can be performed simultaneously by the operator of each 2250 Model 3 without interference to the system.

Special Features

Light Pen (Figure 7-20), a standard feature for the Model 3, is a pen-like device that enables the operator to identify to the program a particular point, line, or character in the displayed image. The operator moves the pen point to the part of the image he wants to identify; the photo-detector associated with the pen, sensing light at that point, generates a signal for the program. The light pen can be used alone or in conjunction with a keyboard to rearrange or delete information, or to add lines from a base point already lighted by the CRT beam.

An "electronic" light pen can be provided alone for the Model 1. Alternatively, a "fiber optics" light pen is provided with the graphic design feature for the Model 1; it is a standard feature of the Model 3.

Programmed Function Keyboard is a 32-key general-purpose keyboard, the keys of which are basically unidentified, with their functions defined by application-oriented

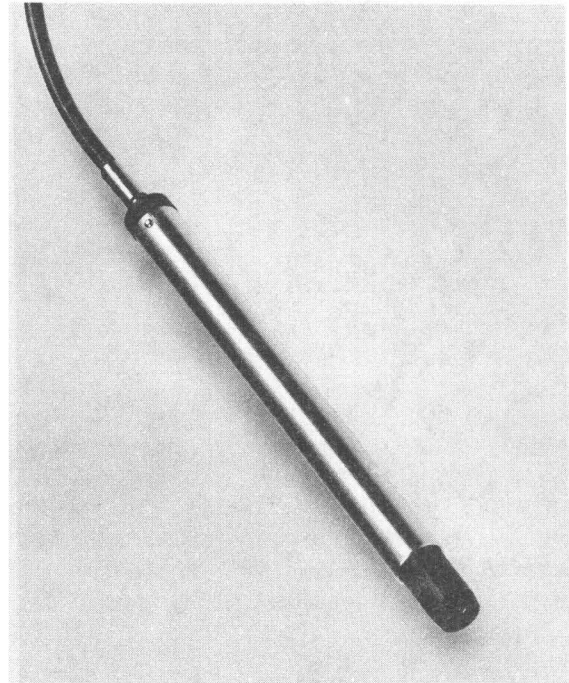

Figure 7-20. Fiber Optics Light Pen.

interpretation programs. Each key starts a subroutine associated with a particular program. For example, the subroutine might direct the CPU to enlarge, reduce, or delete the image displayed.

Alphameric Keyboard is a typewriter keyboard that permits the user to enter messages consisting of letters, numbers, and other symbols into computer storage. As the message is composed, it is displayed on the screen for verification or editing before it is transferred to main storage. This keyboard also controls the screen location of a movable dash symbol (cursor) that glows beneath the position at which the next character from the keyboard will be displayed.

Buffer (Standard Feature for Model 3) provides the Model 1 display unit with a choice of 4,096 or 8,192 bytes of internal storage. The 2840-2 provides, as a standard feature, 32,768 bytes of storage that are program-assignable to the attached Model 3 display units.

To maintain a display of information on the screen without a noticeable flicker, the display must be regenerated about 40 times per second (the maximum rate actually used). For an unbuffered display, regeneration would have to be performed by the computer. To free main storage and the channel for other functions and to allow the display unit to operate concurrently with the computer, the buffer is used to regenerate the display; the data that defines the image is transferred from main storage to the

buffer only once. Also, the buffer is used for the assembling and editing of messages before they are transferred to main storage.

Transfers between main storage and buffer are at the rate of 4.2 microseconds per byte for Model 1, and at an effective rate of 2 microseconds per byte for the 2840 used with Model 3's. Thus, the buffer can accept data from the CPU at the rate of 238,000 bytes per second for Model 1, or 500,000 bytes per second for the 2840. (The 32K buffer in the 2840 can be completely rewritten in less than a tenth of a second.) In communication between the 2840 and Model 3's, the buffer is accessed at only 1 microsecond per byte. Points can be displayed as fast as 16.8 microseconds per point.

Character Generator (Standard Feature for Model 3) translates a byte, specifying an alphameric character, into the analog signals needed to trace the character on the face of the tube. It also relieves the program of the task of individually addressing a series of dots or lines, synthesized on the display, into the specified character. A single data byte from the CPU specifies one of the characters available with the character generator. Two character sizes are program selectable: basic size or 1½ times basic size. The screen has room for 3,848 basic-size characters (on 52 lines of 74 characters each) or 1,715 1½-size characters (on 35 lines of 49 characters each). The latter case is equivalent to about two thirds of a column on this page. The average time required to display alphameric data with this feature is 15 microseconds per character for the basic size or 17 microseconds for the 1½ size. The number of characters per second depends on the program. Characters can be displayed from the buffer at the rate of 60,000 per second.

Operator Control Panel (For Model 1 Only) duplicates the facilities in the operator control section of the system control panel on the processing unit of System/370 Model 165. One or two operator control panels can be installed on the 2250 Model 1.

Absolute Vectors and Control (Standard Feature for Model 3) enables the 2250 Model 1 to trace continuous straight lines at any angular position within the 12-inch by 12-inch display area on the CRT. A line (vector) can be drawn between any two addressable points. More than a million points are addressable: 1,024 on the X axis by 1,024 on the Y axis. XY coordinates are programmed to specify the point to which each vector is drawn.

Graphic Design (Standard Feature for Model 3) provides (1) incremental vectors and point plotting, (2) a special fiber optics light pen, (3) light pen control orders. For the Model 1, the absolute vectors and control feature is a prerequisite.

In the fiber optics light pen (Figure 7-20), light is transmitted from the screen back to a sensing device in the console through a flexible connection made of glass fibers. Also, instead of being used in conjunction with a foot switch, this new light pen has a tip switch that is operated by depressing the pen tip on the screen.

Through programming, the graphic design feature enables the user to locate the light pen on a blank part of the screen, or to track the pen's path, with a minimum of CPU interruption. Locating the pen (pen search) is done by momentarily sweeping the screen with characters or short vectors and saving the XY location of the one character or vector that activated the light pen. Pen search is a good way to initiate pen tracking.

In pen tracking, a small cross or box is displayed under the pen and moves with the pen; the cross or box supplies the light to keep the pen activated, and the program updates the symbol location. In one tracking technique, a light trail can be made to follow the pen much as an ink trail follows an ordinary pen. Alternatively, a single vector can be displayed from each starting point of tracking to the pen, for an effect called rubber banding. The incremental vectors and light pen control orders provided by the graphic design feature enable pen tracking to be directed by the CPU and buffer programs. (With the 2250 Model 3, only the buffer program is needed.) With the user's program as aided by this feature, there is no need for the CPU to compute every point on the tracking symbol as it is continually relocated, because resetting the starting point of the first vector moves the entire symbol to the new location.

With the incremental vectors, a line is drawn to any point on the screen, up to 0.74 inch from the absolute X and Y values of the starting point, by specification of increments along the X and Y axes rather than by absolute specification of the destination point. The same distances and method of specification apply to incremental point plotting. With a series of changes in the starting point and by use of an appropriate subroutine within the buffer, an image such as a resistor or a rivet head can be made to appear at many places on the screen simultaneously.

Features of 2840 Model 2

The only special feature for the 2840 control is the display multiplexer, which permits the attachment of two additional 2250 Model 3's for a total of four. No more than one display multiplexer can be installed per 2840 Model 2.

Many functions can be performed totally within the standard 32K-byte buffer, thereby eliminating many interruptions and programming task-switching operations in the CPU.

Other standard features of the 2840-2 are the character generator, absolute vectors, incremental vectors, and light pen control orders that are provided with special features for the Model 1 display unit. The subroutine capability

within the buffer permits the displaying of an image such as a resistor at many places on the screen even though the control orders appear only once in the buffer program.

**2260 Display Station Models 1 and 2
2848 Display Control Models 1, 2, 3, 21, and 22**

The IBM 2260 Display Station (Figure 7-21), operating through an IBM 2848 Display Control, is an efficient and compact visual-display terminal. It provides immediate visual access to local or remote System/370 storage for data entry, retrieval, and revision.

Using the 2260, a user can store, retrieve, and display alphameric data conveniently and quickly. Via the 2260 keyboard, he can query the system for information about an account, a transaction, a production schedule, etc. The inquiry is quickly processed and the desired information is displayed on the 2260 cathode-ray-tube screen and retained there for as long as desired. The user can revise the information via the keyboard and return it to the computer for storage or additional processing. If the keyboard-equipped 2260 also has a printer feature, displayed information can be directed to a 1053 Printer, where it is printed in the same format as displayed on the 2260 screen. The basic 2260 (without a keyboard) is used when only the display of information is required.

Flexibility of Display Configuration

The 2260/2848 display configuration can vary from one display-only 2260 with one 2848 to a multiple-station complex consisting of many 2260's and 2848's in which each station can be used as a data-entry terminal. Because

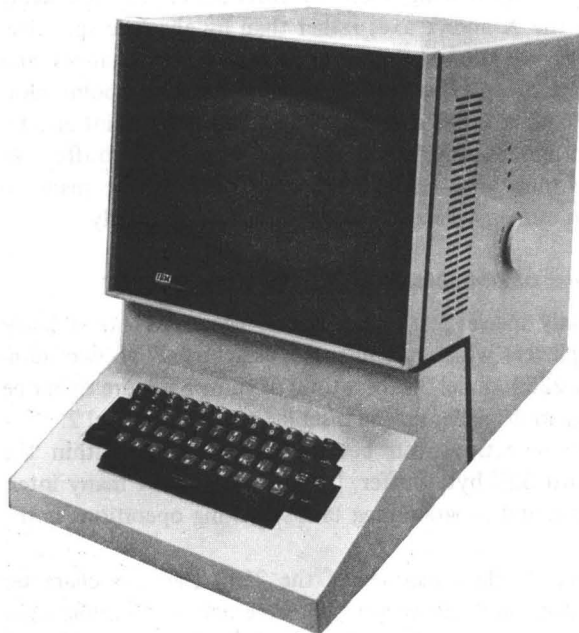

Figure 7-21. IBM 2260 Display Station with an Alphameric Keyboard

each 2260 can be operated independently, many unrelated display operations can be performed concurrently with no interaction between display stations.

A 2260 Display Station can operate within 2,000 cable-feet of its associated 2848. Display stations can be located strategically throughout an office building, manufacturing plant or similar facility, thus providing access to computer data at locations removed from the computer area.

When attached to the appropriate teleprocessing facilities, a 2260 can communicate with a computer located many miles away as easily as if both were in the same room.

Ease of Operation

After learning the functions of the special keys and characters, entering data via the keyboard is as simple as typing. The operator keys in the desired information and visually verifies it as it appears on the screen. If an error is made, the operator can backspace and correct it. The information can then be transferred to the computer by pressing another key.

Inquiries are addressed to the computer in the same way; the computer's response is displayed on the screen for action by the operator. The displayed data is updated, corrected, or deleted via the 2260 keyboard. The format of the data to be handled by the display station can be programmed beforehand to avoid entering repetitive information.

Model Differences

The basic differences between 2260 Models 1 and 2 are in the amount of data capable of being displayed within the 4-by-9-inch display area, as determined by the 2848 model, and the special features that permit expansion of the configuration.

The models of the 2848 differ in the service that they support. The 2848 Models 1, 2, and 3 are used primarily in inquiry-oriented configurations; Models 21 and 22 combine the advantages of the other models with increased data input capabilities.

2848 Model	2260 Model	Max. No. of 2260's Per 2848		Display Capacity (Characters)
		Without Expansion	With Expansion	
1	2	4	24	240 (6 lines, 40 char/line)
2	2	2	16	480 (12 lines, 40 char/line)
3	1	2	8	960 (12 lines, 80 char/line)
21*	2	12	24	240 (6 lines, 40 char/line)
22*	2	8	16	480 (12 lines, 40 char/line)

*Models 21 and 22 of the 2848 cannot be used for remote (teleprocessing) installations.

The 2848 contains a buffer that can hold up to 240, 480, or 960 bytes per display, depending on the model. It also contains the character generator that converts data from the channel or signals from the keyboard into the visual display.

All 2260's are attached to 2848's through display adapters, with each adapter providing control for two 2260's. Additional display adapters can be attached to a 2848 by adding expansion features to it, thereby extending the capability of the 2260/2848 display configuration, as shown in the preceding table.

Keyboards

Three different keyboards are available for the 2260: the alphameric, the numeric, and the alphameric with numeric inset. The alphameric keyboard is organized similarly to a typewriter keyboard. The numeric is arranged the same as a ten-key adding machine. On the alphameric with numeric inset, the numeric keys are inset in the keyboard in a block arrangement for rapid numeric data entry. All three have special symbol keys and control keys required to enter data.

The keyboard determines the characters and symbols that can be key-entered on a 2260, but does not determine which ones can be transmitted from System/370 storage (either main or auxiliary) for display on a 2260 screen. For example, a 2260 can display alphameric data even if it has only a numeric keyboard.

Printout on 1053 Printer Model 4

The contents of the 2848's buffer storage, or information from the channel, can be printed out on an IBM 1053 Printer Model 4 attached to the 2848. One printer can be attached to each 2848 in the system. The attachment requires a 1053 adapter in the 2848; when the 2848 is a Model 1 or 2, an expansion feature is also required. The buffer for a 1053 has a capacity of 1,223 bytes.

The 1053 is further described under "Printers."

3277 Display Station Models 1 and 2 3272 Control Unit Models 1 and 2

The IBM 3277 Display Station is a high-performance cathode-ray tube (CRT) for displaying alphameric data, and for entering data into and retrieving data from a System/370 via an IBM 3272 Control Unit. The 3277 permits an operator to use the keyboard and/or light pen to display and manipulate data on the CRT screen.

The 3277 is available in two models. Model 1 displays up to 480 characters in 12 lines of up to 40 characters per line and requires an IBM 3272 Control Unit Model 1 or 2; Model 2 displays up to 1,920 characters in 24 lines of up to 80 characters per line and requires an IBM 3272 Control Unit Model 2. The character set includes 36 alphameric and 27 special characters. A choice of keyboards, a selector light pen, and a set of program function keys provide input flexibility. Output flexibility is enhanced because information on the screen can be directed to another display or to an IBM 3284 or 3286 Printer.

Individual fields of data on the screen can be program-defined for protected or unprotected storage, alphameric or numeric display, nondisplay, and normal or brightened character intensity. Program definition may also allow or disallow selector light pen detection.

Optional features include:

Keylock, which provides key-operated security control of the display image.

Selector light pen, which provides the selection of parts of a display image for further processing.

Copy, which allows copying from one display to another display or to a printer.

Audible alarm, which sounds when a character is entered into the next-to-last position on the screen.

See "3270 Information Display System" in Section 8 for 3270 system configuration information.

Magnetic Character Readers

The IBM magnetic character readers use magnetic-ink character recognition (MICR) to read and sort card and paper documents in banking applications. These devices operate on documents whose type font (MICR E13B), print quality, and code line arrangement meet the specifications recommended by the American Bankers Association.

1255 Magnetic Character Reader Models 1, 2, and 3

The IBM 1255 Magnetic Character Reader (Figures 7-22 and 7-23) can read and sort a variety of magnetically inscribed documents at relatively high speeds. The documents may be intermixed, and can range from 2.5 to 4.25 inches wide, 5.75 to 8.875 inches long, and 0.003 to 0.007 inch thick.

The speed of processing depends on the 1255 model as well as on factors such as document length and paper quality. Six-inch documents, for example, can be processed at 750 per minute by Models 2 and 3, and at 500 per minute by the Model 1. The 1255 has horizontal stackers, each of which can hold a 2.5-inch pile of documents. Models 1 and 2 have six stackers in one vertical bay, and the Model 3 has 12 in two bays.

In a typical application, the 1255 can be used to perform selective data storing from MICR-encoded checks for updating of demand-deposit accounts. Continuous document loading, optimum document stacking, and simplicity of operation help improve throughput.

The operator panel contains switches, indicators, and an operator-resettable document counter. This panel is

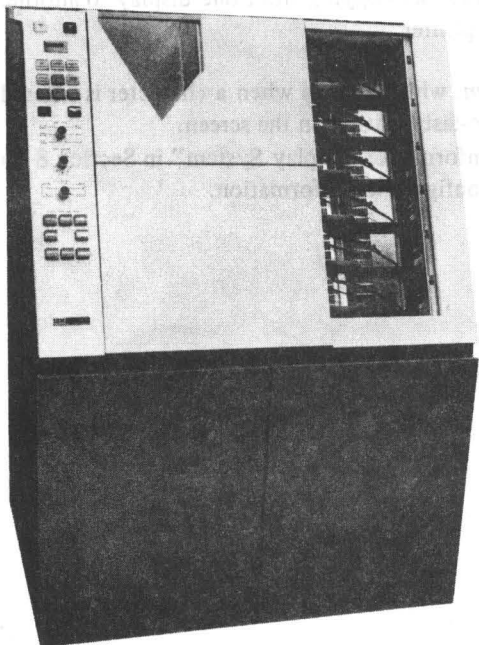

Figure 7-22. IBM 1255 Magnetic Character Reader Model 1 or 2



Figure 7-23. IBM 1255 Magnetic Character Reader Model 3

grouped with the feed hopper and the stackers for operator convenience. This grouping also makes operator training easier, and helps minimize space requirements.

Among the optional features available for the 1255 are the following:

High-order Zero and Blank Selection, an offline feature for the Model 3, permits selection of certain documents into a specific stacker. These are documents that have only blanks in the sort position and in all higher order positions of the field.

Self-checking Number/Improved Recognition, in addition to performing the basic self-checking number function, reduces account number rejects. (The account field is especially subject to folds, banding, and print specification deviations.) Character rejects are reduced in proportion to the severity of document degradation, thereby reducing customer reconciliation expense.

Dash Symbol Transmission transmits the E13B dash symbol from the transit field to storage.

51-Column Card Sorting is used for reading and sorting 51-column cards.

The 1255 can also be used offline to perform fine sorting of checks (usually by account number) or validity checking without sorting. The operator panel provides for online/offline switching.

1419 Magnetic Character Reader

Data inscribed magnetically on checks and other banking documents (Figure 7-24) is read at speeds as high as 1,600 documents per minute by the IBM 1419 Magnetic Character Reader (Figure 7-25). Specific speeds depend on document length as well as on the program.

As the documents are read, they may be sorted into as many as 13 classifications: A, B, 0-9, and R (reject). All magnetic inscriptions can be validity-checked.

Documents read may be of intermixed sizes and thicknesses, as typically encountered in check-handling operations. The standard minimum length is 6 inches; shorter documents, such as the 51-column postal money order, can be read into the system by the 1419 at a maximum rate of 1,960 per minute.

These shorter documents can be intermixed with standard-length documents, and can also be sorted if a no-charge special feature for that purpose is installed. If the feature is not installed on the 1419, 51-column cards and other documents less than 5 inches long are sent to the reject pocket. If the feature is installed, 1419 speed is reduced by an amount that increases slightly with the average length of documents and is 4.3 percent for 51-column cards, and 5.3 percent for 6-inch checks.

Many special features are available for the 1419, including an endorser to print the bank's endorsement on the back of each document at no reduction in operating speed. Other features most applicable to online operations with the System/370 are:

Feature	Purpose
Dash Symbol Transmission	Distinguish U. S. from Canadian transit-routing numbers (leftmost eight magnetic digits), to prevent duplications.
Batch Numbering	(Self-evident)
Self-Checking Number	Automatically perform mathematical proof that account numbers are correctly recorded and read.
Program Control for Pocket Lights	Improve control of output batches. Stops the reading-sorting and turns on pocket light(s) when a predetermined number of documents has entered one of the corresponding six pockets (with a second feature, 12 pockets) designated by the program.

3890 Document Processor Models A1-A6, B1-B6

The IBM 3890 Document Processor (Figure 7-26) provides continuous operation (often with only one operator) for reading magnetically inscribed data from card and paper documents into a System/370 at a rate of 2,400 6-inch documents per minute. Actual throughput depends on the length of the documents. The built-in control and logic functions permit the 3890 to operate on a basis that is time-independent of the System/370 CPU while online. The 3890 can be used offline for document sorting.

The six A-models (A1-A6) and six B-models (B1-B6) parallel each other in number of pockets, starting with six in Models A1 and B1, increasing by six for each succeeding model, to 36 in Models A6 and B6. A-models differ from B-models in storage capacity. A-models have a 13,312-byte storage capacity. B-models have a 29,696-byte storage capacity, which allows customer-written stacker-select programs to use larger sort tables than the A-models use. The storage capacity is reduced to 10,240 bytes for A-models and 26,624 bytes for B-models when the 3890 is used for image processing (sorting by comparing a document to an image in a buffer).

Standard features include:

- Machine unloading while in operation.
- Pocket capacity of 800 to 1,000 documents per pocket (36 pockets available).
- Input hopper with built-in jogger which holds approximately 4,800 documents.
- Merge feed permits merging of documents into normal input stream from a separate hopper.
- Control program is loadable online from System/370 CPU or offline from a removable IBM disk.

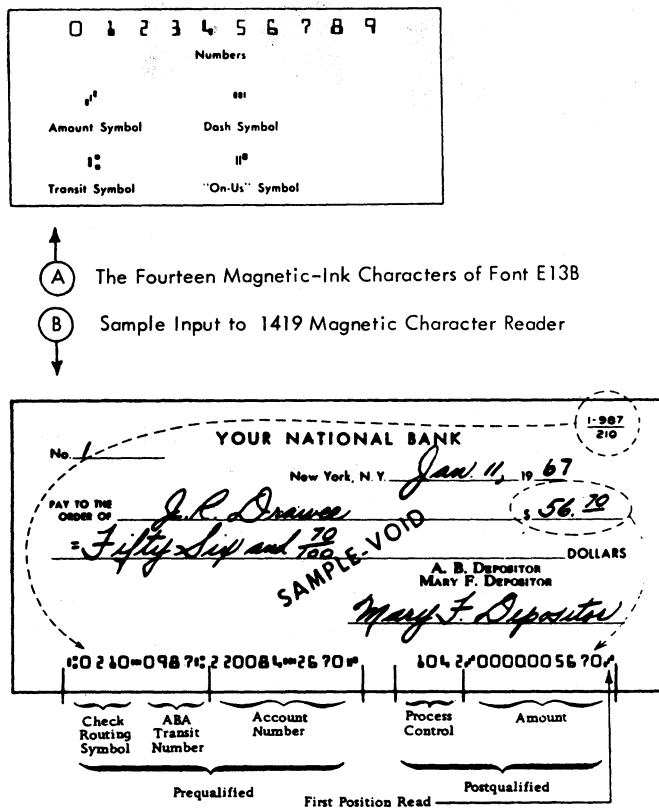

Figure 7-24. Magnetic Inscription—Translation of Characters and Definitions of Fields

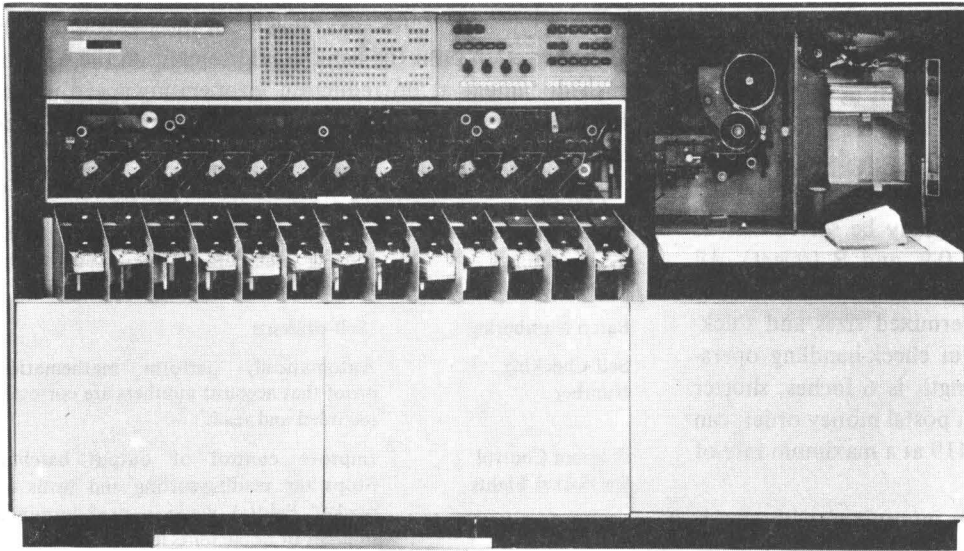

Figure 7-25. IBM 1419 Magnetic Character Reader

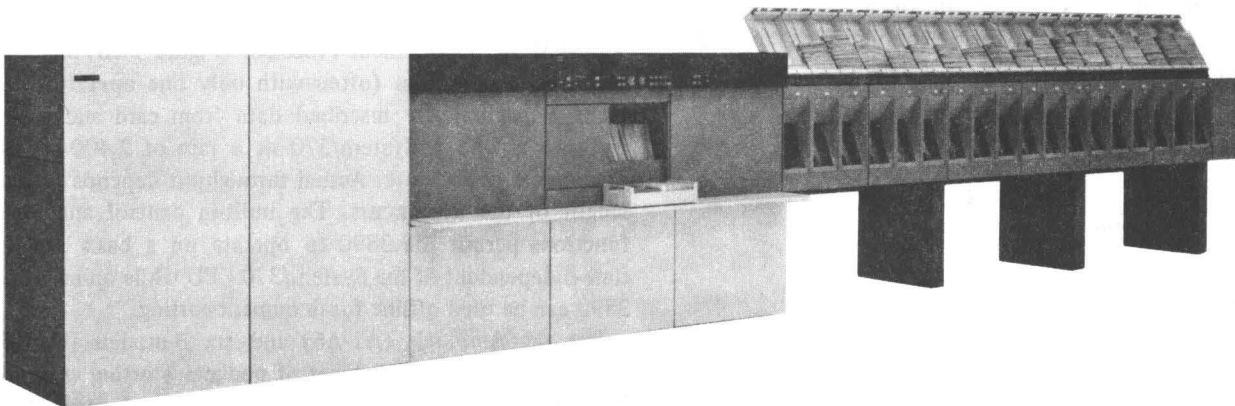

Figure 7-26. IBM 3890 Document Processor Model A3 (Design Model)

- Logical capability permits the following standard programmable functions: split field, self-check number verification, multiple column control, and base number conversion.

Item numbering/endorsing, an optional feature, provides the capability of printing an eight-digit number and/or full endorsement on the back of each document. The new endorser design speeds plate changing by the operator for users having a requirement to print different endorsements for different types of work.

The *microfilming* feature (optional) allows selective filming of some or all items being processed with no loss of speed. Document filming may be either front and back or front only. Filming and indexing are separately controlled. The film cassette (available as an accessory) has a capacity of up to 2,000 feet of 0.0027 polyester thin-base 16mm film which will record approximately 380,000 front and back images of an average document mix. Loading and unloading of film from the cassette into the film transport is automatic under operator control.

Magnetic Tape Devices

The System/370 magnetic tape units read and write on half-inch magnetic tape mounted on 8.5- and 10.5-inch reels and on minireels. The tape units, which operate at data densities up to 1,600 bytes per inch (bpi), use IBM Heavy Duty, Dynexcel, or Series/500 tape. Competitive tape formulations should meet the tape specifications described in Order Number GA32-0006.

These units operate in seven or nine-track format. The nine-track uses eight of the nine bits for data and the last one for parity. The data bits can represent an alphameric or special character, two decimal digits, one signed decimal digit, or eight binary digits.

Figures 7-27 through 7-34 illustrate the System/370 tape units, and Figure 7-35 (in table form) shows and compares the characteristics of these units.

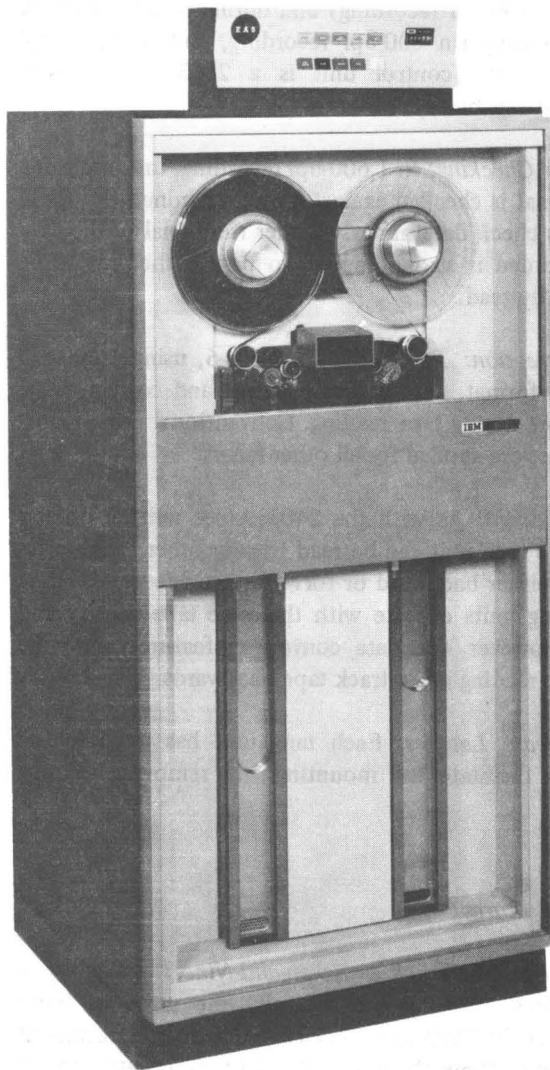

Figure 7-27. IBM 2401 Magnetic Tape Unit Model 2, 3, 5, or 6 (Using Transparent Reels)

2401 Magnetic Tape Unit Models 1-6 and 8

The IBM 2401 Magnetic Tape Unit (Figure 7-27) reads and writes on magnetic tape in seven- or nine-track format. Models 1 through 6 usually operate in nine-track format (at 800 or 1,600 bpi), but Models 1 through 3 can be made to operate in seven-track format (at 200, 556, or 800 bpi). The Model 8 operates in seven-track format only. With appropriate features on the tape control, the seven-track format is compatible with tapes written by 700- and 7000-series tape units (727, 729, 7330, 7335, 7701, 7702, and 7765).

The 2401 Models 1-3 use the non-return-to-zero-IBM (NRZI) method of recording information on tape; Models 4-6 use phase encoding. (In NRZI recording, only 1-bits are recorded; the absence of a 1-bit is interpreted as a 0-bit. In phase encoding, however, both 0-bits and 1-bits are recorded.) Phase encoding has advantages over NRZI in that it increases both reliability and data density and provides "in-flight" (during reading) correction of single track errors.

Standard Features

Parity Checking: This is done during tape reading (in both 800- and 1,600-bpi recording) and during read-back check of tape writing (in 800-bpi recording, and in 1,600-bpi recording if the control unit is a 2803-2 with 2420 attachment capability).

Amplitude Checking: In 1,600-bpi recording, the amplitude of the signal is checked against a predetermined threshold level. This check determines whether the signal of the data being recorded is strong enough to permit the data to be read.

Error Correction: Single track errors are automatically detected and corrected:

1. In flight, when using the 1,600-bpi nine-track format.
2. During the re-read of a record that contains one or more errors confined to a single track, when using the 800-bpi nine-track format. All other errors are detected, and conventional error recovery routines apply.

Read Backward: Tapes written on any 2400-series tape unit (2401, 2402, 2403, 2404, 2415, or 2420) can be read by any other 2400-series unit either backward or forward, provided the writing and reading units operate with the same tape density and format. However, the data conversion feature of a 2803 or 2804 Tape Control cannot be used when the 2401 is reading seven-track tape backwards.

Power Window: This tape access window (standard on most units) facilitates tape changes by opening automatically following a tape unload and closing automatically prior to a tape load operation. The power window can also be opened or closed at the touch of a button.

Quick-Release Latches: Each tape unit has quick-release latches to facilitate the mounting and removal of tape reels.

Optional Features

Dual Density 800-1,600 bpi (2401 Models 4-6): This feature allows a program to use a tape unit in either 800- or 1,600-bpi recording. It requires that the 2803 or 2804 Tape Control be equipped with a nine-track or seven-and-nine-track compatibility feature. (See the 2803 and 2804 descriptions for details.)

Simultaneous Read-While-Write: This feature is required on any 2401 attached to a 2804 (a two-channel simultaneous read-while-write tape control).

Mode Compatibility: This feature is required to attach 2401 Models 1-3 to a 2803 or 2804 Model 2.

2415 Magnetic Tape Unit and Control Models 1-6

The IBM 2415 Magnetic Tape Unit and Control (Figure 7-28), like the 2401, reads and writes on magnetic tape at data densities of 800 or 1,600 bpi. The operations of the 2415 are similar to those of a basic 2401, but the 2415 has data rates that are a downward extension of those available with a 2401.



Figure 7-28. IBM 2415 Magnetic Tape Unit and Control Model 1 or 4

Two, four, or six tape units are available with a 2415, depending on the model. Each tape unit operates independently, but only one can read or write at a time.

Model	No. Tape Units	Data Rate (Bytes Per Second)	Data Density (Bytes Per Inch)
1	2	15,000	800
2	4	15,000	800
3	6	15,000	800
4	2	30,000	1,600
5	4	30,000	1,600
6	6	30,000	1,600

As with the 2401, the 2415 Models 1-3 use the NRZI method of recording data; Models 4-6 use phase-encoding.

Standard Features

Parity Checking: This is done during tape reading (in both 800- and 1,600-bpi recording) and during read-back check of tape writing (in 800-bpi recording, and in 1,600-bpi recording if the control unit is a 2803-2 with 2420 attachment capability).

Amplitude Checking: In 1,600-bpi recording, the amplitude of the signal is checked against a predetermined threshold level. This check determines whether the signal of the data being recorded is strong enough to permit the data to be subsequently read.

Error Correction: The 2415 Models 4-6, using 1,600-bpi nine-track format, automatically detect and correct single track errors during tape reading. Conventional error recovery routines are applied for all other errors.

Read Backward: As with the 2401, tapes written on any 2400-series tape unit can be read by any other 2400-series tape unit either backward or forward, provided the writing and reading units operate with the same tape density and format. However, the data conversion feature cannot be used when reading seven-track tape backwards.

Quick-Release Latches: Each tape unit has quick-release latches to facilitate the mounting and removing of tape reels.

Optional Features

Seven-Track, Nine-Track, or Seven-and-Nine-Track Compatibility: These features are basically the same as those available for the 2803 and 2804 Tape Controls. Attachment of any one of these three on a 2415 precludes attachment of the others. Seven-track compatibility enables the 2415 tape unit to write or read seven-track tape; this provides

compatibility with tapes used by devices such as the IBM 727, 729, and 7330 Magnetic Tape Units. Nine-track compatibility enables the 2415 tape unit to write or read 800-bpi NRZI tapes in addition to 1,600-bpi tapes. Seven-and-nine-track compatibility (available only on Models 4, 5, and 6) satisfies the requirements of both of the other two features by permitting reading and writing both seven- and nine-track 800-bpi NRZI tapes.

Data Conversion: This feature is the same as the data conversion feature available for the 2803 Tape Control. This program-controlled feature permits seven-track tape units to read and write data in binary form rather than binary-coded form. On a write operation, three 8-bit bytes

are converted to four 6-bit tape characters; on a read operation, the sequence is reversed. This feature cannot be used when reading seven-track tapes backwards.

2420 Magnetic Tape Unit Models 5 and 7

The IBM 2420 Magnetic Tape Unit (Figure 7-29), which reads and writes at 1,600 bpi, offers increased reliability, speed, and convenience to System/370 users. It does this with features such as cartridge loading, automatic tape threading, and an advanced tape transport.

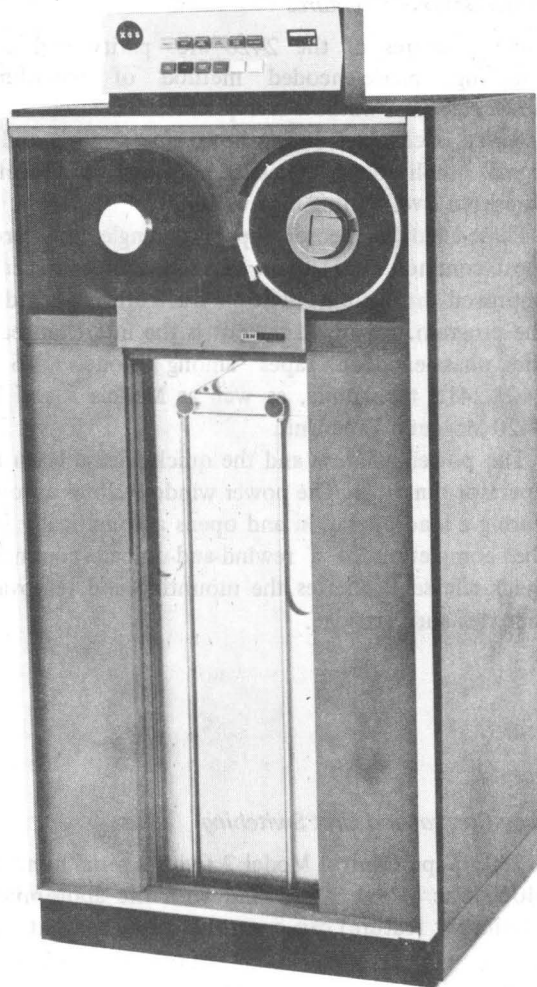

Model 5

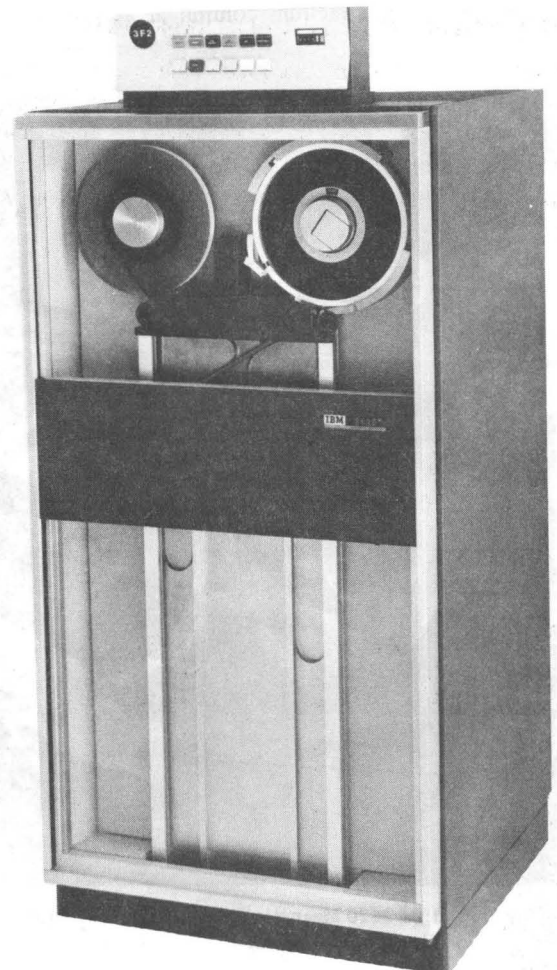

Model 7

Figure 7-29. IBM 2420 Magnetic Tape Units Models 5 and 7

Cartridge Loading

An optional accessory of the 2420 is the Wraparound Cartridge (Figure 7-30) for standard 10½-inch reels. The cartridge protects tape from dust and the hazards of handling and eliminates reel positioning. Once the cartridge is mounted, the tape automatically threads, feeds, and rewinds on command. The cartridge-enclosed tape reels can be used interchangeably with standard reels and may be removed from the cartridge for use on other 2400-series tape units.

Automatic Threading and Rewind

The 2420 provides reduced setup time because of automatic threading. The only requirements are that the free end of the tape be properly trimmed and that it be positioned on the threader chute. The tape is automatically threaded through the tape path from the supply reel to the take-up reel, loaded into the vacuum columns, and positioned at the load point. This operation takes less than 10 seconds. Tape is rewound in the vacuum column at approximately 500



Figure 7-30. IBM 2420 Magnetic Tape Unit Model 7 with Wraparound Cartridge

inches per second; therefore, a 2,400-foot reel can be rewound in about 1 minute. Rewind time for less than 2,400 feet of tape is approximately proportional to the amount of tape to be rewound; for example, 1,200 feet of tape is rewound in about 30 seconds and 600 feet is rewound in about 15 seconds.

Advanced Tape Transport

The tape transport for the 2420 uses a minimum number of mechanical parts, thereby increasing reliability and reducing tape wear. A single drive capstan moves the tape forward and backward across the read/write head while the oxide surface of the tape touches only the read/write head and the tape cleaner. During rewind operation, the tape remains in the vacuum columns, resulting in less stress on the tape.

Other Standard Features

Other features of the 2420 are: parity and amplitude checking, phase-encoded method of recording data, powered access window and quick-release latch.

Parity is checked during both tape reading and writing; signal amplitude is checked (against a predetermined threshold level) during tape writing.

Phase-encoded recording permits single track errors (the most common type) to be corrected in flight, resulting in improved throughput. Multiple track errors are indicated to the program. An added benefit is the interchangeability of the phase-encoded tapes among Models 4-6 of the 2401-2415 tape units, as well as Models 5 and 7 of the 2420 Magnetic Tape Unit.

The power window and the quick-release latch facilitate operator functions. The power window closes automatically during a load operation and opens automatically following the completion of a rewind-and-unload command. The quick-release facilitates the mounting and removal of the tape reel and cartridge.

Tape Control and Unit Switching

A 2803 Tape Control Model 2 (with a serial number above 14000 but below 30000 and with the appropriate 2420 attachment feature) can control as many as eight tape units

in any combination of 2420 Models 5 and 7 and 2401 Models 4-6. With additional features, 2401 Models 1-3 can be included in this combination. Switching among these units is provided by the 2816 Switching Unit Model 1.

2803 Tape Control Models 1, 2, and 3

2804 Tape Control Models 1, 2, and 3

The IBM 2803 and 2804 Tape Controls (Figure 7-31) can both handle as many as eight tape units. The 2803 is a one-channel control unit and requires one control-unit position on a channel. The 2804, however, is a two-channel control unit and requires one control-unit position on each of two channels. The 2804 attaches to two channels in a manner that permits a read operation on one tape unit to be overlapped with a simultaneous write operation on another unit.

The two units are each available in three models:

Model 1 of the 2803 and 2804 controls units of 2401 Models 1-3.

Model 2 of the 2803 and 2804 also controls units of 2401 Models 1-3, provided the 2803 or 2804 is equipped with either the nine-track or seven-and-nine-track compatibility feature. In addition to this, the Model 2 of the 2803 and 2804 controls units of 2401 Models 4-6. Model 2 of the 2803 can also control units of 2420 Models 5 and 7, provided the 2803 has a serial number 14001-29999 and is equipped with a 2420 attachment.

Model 3 of the 2803 and 2804 controls units of 2401 Model 8 only.

Optional Features

Seven-Track Compatibility: This feature enables a 2401 Model 1-3 to write or read seven-track tape at 200, 556, or 800 characters per inch; this provides tape compatibility with devices such as the IBM 729 and 7330 Magnetic Tape Units. The seven-track compatibility feature is required if any attached 2401 (Models 1-3) has a seven-track head. As part of the feature, a code translator is included to translate the BCD interchange code to EBCDIC.

Nine-Track Compatibility: In keeping with the flexibility that provides for any practical variation in requirements, an optional nine-track compatibility feature is available for Model 2 of the 2803 and 2804 to allow the reading and writing of nine-track tape at 800 bpi as well as 1,600 bpi. This feature is required when:

1. Any attached 2401 (Models 1-3) has a nine-track head.
2. Any attached 2401 (Models 4-6) has the dual-density feature.

Seven- and Nine-Track Compatibility: The seven-track and nine-track compatibility features are mutually exclusive on the same tape control. However, instead of either feature,

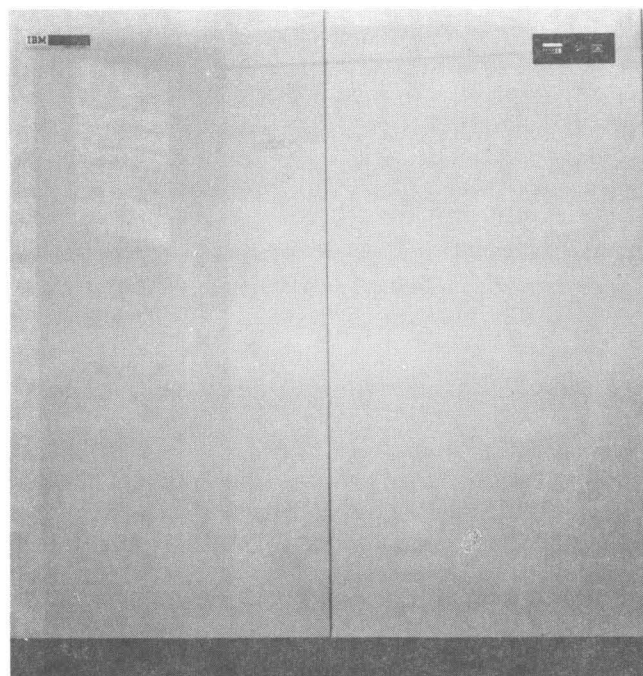

Figure 7-31. IBM 2803 or 2804 Tape Control

an optional seven- and nine-track compatibility feature can be installed on Model 2 of the 2803 or 2804 to provide all the advantages of both features.

Sixteen-Drive Addressing (2803 Models 1 and 2): This feature enables a 2803 to address as many as sixteen 2401 Magnetic Tape Units that are attached to the 2803 through 2816 Switching Unit Model 1's. This feature is not needed unless a 2803 must have the capability of addressing more than eight tape units.

Data Conversion: This program-controlled feature, available to tape controls with seven-track compatibility, permits seven-track tape units to read and write data in binary form rather than binary-coded form. On a write operation, three 8-bit bytes are converted to four 6-bit characters; on a read operation, the sequence is reversed. This feature cannot be used when reading seven-track tapes backwards.

2420 Attachment (2803 Model 2): When equipped with this feature the 2803 can attach and control any combination of 2420 Models 5 and 7 and 2401 Models 4-6 that does not exceed eight. (2401 Models 1-3 can be included in this combination if appropriate features are installed on the 2803 Model 2.) Field installation of the 2420 attachment can be made only on a 2803-2 with a serial number above 14000 but below 30000.

2816 Switching Unit Model 1

The IBM 2816 Switching Unit (Figure 7-32) provides a means of assigning a common group of magnetic tape units to more than one tape control, thus allowing still more

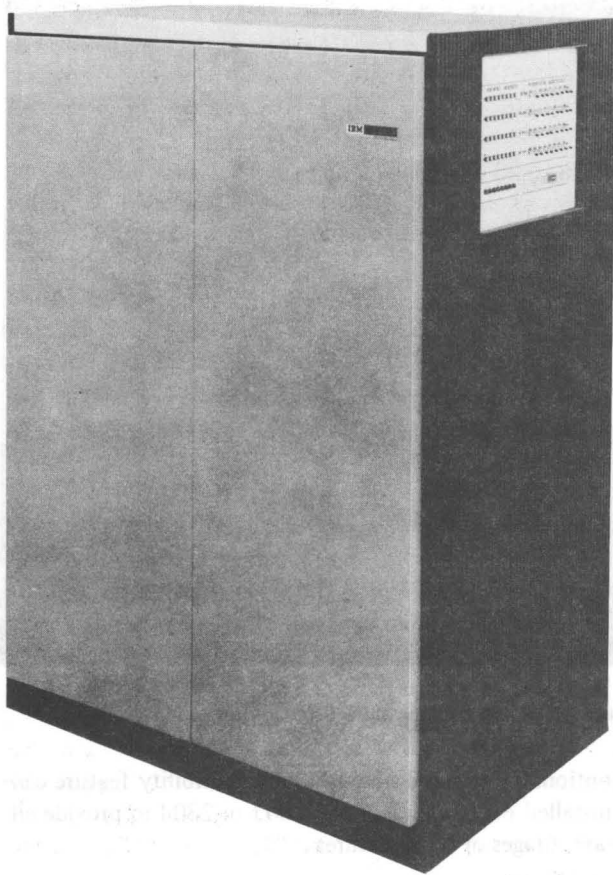

Figure 7-32. IBM 2816 Switching Unit

flexibility in tape configurations and the minimizing of such configurations: for instance, by allowing a control to have access to a tape unit that is attached to another control. The 2816 introduces other advantages, including such unbalanced sort operations as three inputs to six outputs or vice versa, with the consequent minimum of time for manual mounting and demounting of reels.

With the 16-drive addressing feature installed on the appropriate tape controls and the use of two IBM 2816 Switching Units, a maximum of 16 tape units may be controlled in common by a maximum of four tape controls. The minimum is control of four tape units by two tape controls; any combination between the minimum and maximum is available. For more than eight tape units, the second switching unit is required. The switching of tape units on the 2816 is completely under program control, on a per-record basis.

Model 1 of the switching unit is used for switching tape units in any mixture of 2401 Models 1-6 and 2420 Models 5 and 7; however, the 2816 requires a tape unit intermix feature for switching 800-bpi tape units to a 2803 Model 2.

The tape controls involved must be either 2803 Model 1 or 2803 Model 2; the 2816 cannot switch both Models 1 and 2 on the same system.

If the 16-drive addressing feature is not installed on a tape control, it can control only the first eight tape units in the tape pool.

3410 Magnetic Tape Unit Models 1, 2, and 3

3411 Magnetic Tape Unit and Tape Control Models 1, 2, and 3

- Data rates from 20 to 80 kilobytes/second.
- Compact design.
- Monolithic circuitry.
- Table-height horizontal transport deck.
- Simplified tape-threading path.
- Push-pull quick release latch.
- Extended diagnostic capabilities.
- Independent tape-unit attachment.
- Single- or dual-density operation.

The 3410 and 3411 (Figure 7-33), both available in three models, provide data rates between 20 and 80 kilobytes per second. Both the 3410 and 3411 are desk-height units with tapes mounted horizontally rather than vertically. A transparent sliding cover, similar to the cover of a roll-top desk,

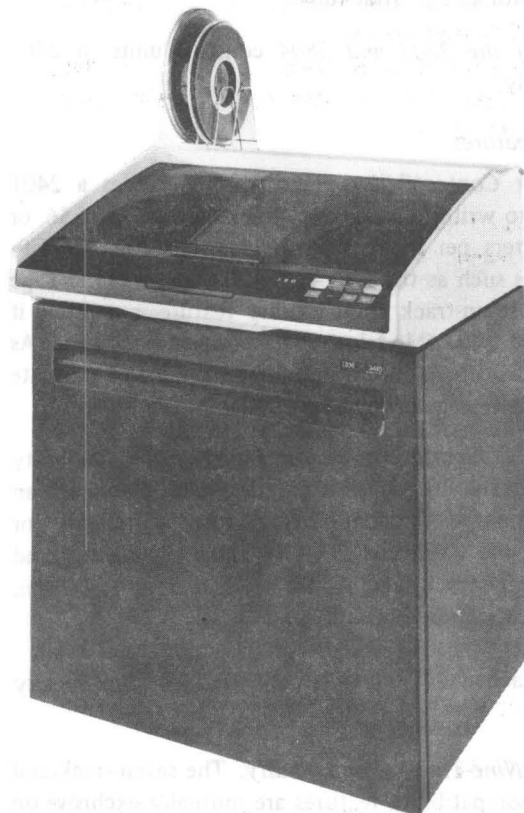

Figure 7-33. IBM 3410 Magnetic Tape Unit Model 1, 2, or 3

provides easy access to the tape reels. A simplified tape-threading path and a push-pull quick release latch (for faster mounting and removing of the tape supply reel) further increase ease of operation.

The two units look alike, and each contains one tape unit, but the 3411 also contains the common control unit and power supply. The 3411-1 can attach up to three 3410-1's, the 3411-2 up to five 3410-2's, and the 3411-3 up to five 3410-3's.

The diagnostic capabilities permit normal servicing to be done from the front, and internal cables between the tape units and the tape control eliminate under-the-floor cables. Both these features allow the units to be placed side by side and close to walls, thereby allowing better use of space. Additionally, the method of attaching a 3410 to a 3411 (radial attachment) allows a 3410 to be taken out of operation for maintenance without changing cables or interrupting any of the other units.

The *dual-density* feature, available for both the 3410 and 3411, allows these nine-track units to read and write either at 800 bpi in NRZI mode or at 1,600 bpi in phase-encoded (PE) mode. This feature is especially useful in library conversion and for data interchange between systems. Where only 1,600-bpi operations are performed, the *single-density* feature is required.

Single track read errors are corrected in flight in 1,600-bpi operation, and track-in-error correction is provided for nine-track 800-bpi operation. Parity is checked during both reading and writing, and signal amplitude is also checked during writing.

The *seven-track* feature permits a 3410 or 3411 to operate at 200, 556, or 800 bpi in NRZI mode, in seven-track format only.

3420 Magnetic Tape Unit Models 3 through 8 3803 Tape Control Models 1, 2, and 3

- Data rates from 120 to 320 kilobytes/second in 1,600-bpi operation and from 470 to 1,250 kilobytes/second in 6,250-bpi operation.
- Single- or dual-density operation.
- Automatic tape-reel latching.
- Automatic tape threading and cartridge loading.
- Rewind time as low as 45 seconds for 2,400-foot reel.
- Monolithic circuitry.
- Extended diagnostic capabilities.
- Economical tape-unit switching.
- Independent tape-unit attachment.

3420 Magnetic Tape Unit

The 3420 (Figure 7-34), available in six models, offers a wide range of data rates to better meet the needs of users.

For example, the 3420 has data rates of 120, 200, and 320 kilobytes per second in 1,600-bpi operation, and 3420 Models 4, 6, and 8 provide data rates of 470, 780, and 1,250 kilobytes per second, respectively, in 6,250-bpi operation.

A choice of tape densities and track formats is available. With the *single-density* feature, 3420 Models 3, 5, and 7 operate at 1,600 bpi with nine-track tapes. With the *dual-density* feature, operations are at both 800 and 1,600 bpi for Models 3, 5, and 7, and at 1,600 and 6,250 bpi, respectively, for Models 4, 6, and 8. If equipped with the *seven-track* feature, Models 3, 5, and 7 operate at 556 or 800 bpi when attached to either an IBM 3803 Tape Control Model 1 or 2, and also at 200 bpi when attached to a 3803 Model 2.

Each 3420 model has a shorter nominal read-access time than earlier IBM tape units. The time savings can significantly improve system throughput.

Several features built into the 3420 ensure reliability and ease of operation. An *automatic reel latch* mechanically seats the file reel in position and pneumatically locks it on the hub for tape movement. With *automatic threading and cartridge loading*, tape mounting and demounting times are significantly reduced. *Optical tachometers*, built into the drive, sense small variations in the speed of the capstan and the tape, and generate corrective signals. This precise control is one of the keys to the 3420's fast read-access and rewind times.

Tape wear and contamination are minimized by extensive use of air bearings and surface treatments. The path that the tape takes through the drive, from reel to reel, allows the recording side of the tape to touch only two surfaces during read/write operations: the tape cleaner and the read/write head. Additionally, the cleaning mechanism provided on Models 4, 6, and 8 removes loose contaminants from the tape and protects the read/write head from tape media contamination during high-speed rewind and tape loading and unloading.

3803 Tape Control Models 1, 2, and 3

The IBM 3803 Tape Control (Figure 7-34) is half the size of earlier IBM tape control units and uses monolithic circuitry for all logic and control functions. The monolithic read-only control storage of the 3803 contains all the information needed to coordinate efficient operation of the 3420 Magnetic Tape Unit. The 3803 also provides diagnostic capabilities that can quickly pinpoint problems.

The 3803 Models 1 and 2 can be attached to System/370 Models 135 through 195 to provide control for 3420 Models 3, 5, and 7. With appropriate features, seven- and nine-track 3420's and multiple densities can be mixed on the 3803 Model 2.

The 3803 Model 3 can be attached to System/370 Models 115 and 125 to provide control for 3420 Models 3 and 5.

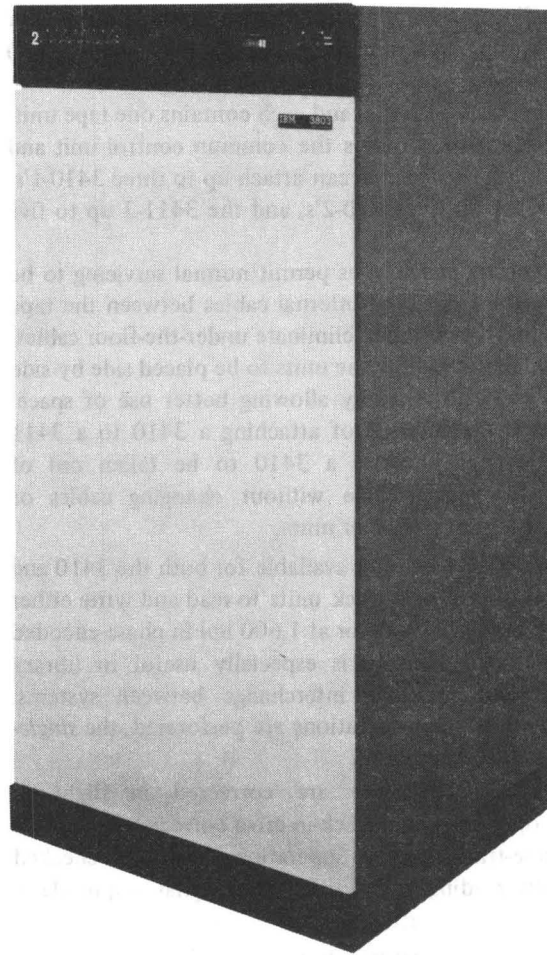
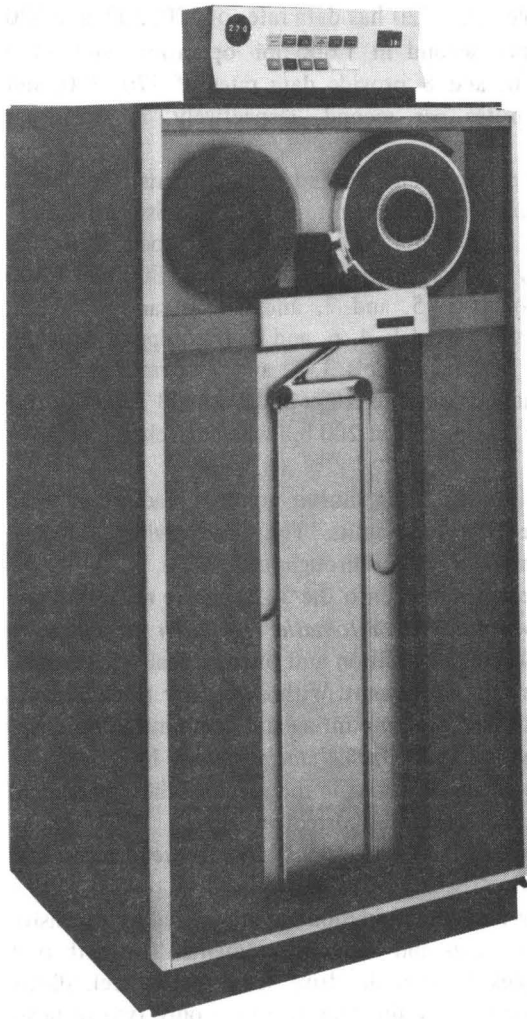

Figure 7-34. IBM 3420 Magnetic Tape Unit Model 3, 5, or 7 and IBM 3803 Tape Control Model 1

The 3803 Model 2 uses an improved encoding-checking method which allows error correction in 6,250-bpi mode for any single track, or a combination of two tracks simultaneously, while the tape is in motion.

Via a *radial interface attachment*, up to eight 3420's can be connected to a 3803 in a way that allows a 3420 to be taken out of operation for maintenance without changing cables or interrupting any of the other units. This attachment makes it possible to switch tape units online and offline for easier maintenance. (Earlier IBM tape units are connected to their control units serially through adjacent units.)

The 3803 Models 1 and 2 can have the *tape switching* feature that permits as many as sixteen 3420's to be switched among two, three, or four 3803's.

With the *two-channel switch*, a 3803 can attach to a second channel and therefore can switch between two channels under program control. This capability permits one or more CPU's to access tape units that otherwise might not be available to them.

Features corresponding to those determining operating tape densities and track formats for the 3420 (such as single density, dual density, and seven track) are also required for the 3803.

Magnetic Tape Unit		Nominal Data Rates (kilobytes/sec)					Tape Speed (inches/sec)	Nominal Read Access Time* (ms)	Nominal Interblock Gap (inch)			Nominal Interblock-Gap Time (ms)			Rewind Time (sec) (2,400' reel)	Rewind and Unload Time (2,400' reel)
		at 200 bpi (7-track NRZI)	at 556 bpi (7-track NRZI)	at 800 bpi (7- or 9-track NRZI)	at 1,600 bpi (9-track PE)	at 6,250 bpi			7-track	9-track	at 6,250 bpi	7-track	9-track	at 6,250 bpi		
Number	Model															
2401	1	7.5	20.85	30	--	--	37.5	10.8	0.75	0.6	--	20	16	--	180	132
	2	15	41.7	60	--	--	75	6.4	0.75	0.6	--	10	8	--	84	90
	3	22.5	62.5	90	--	--	112.5	5.2	0.75	0.6	--	6.6	5.3	--	60	66
	4	--	--	--	60	--	37.5	10.8	--	0.6	--	--	16	--	180	132
	5	--	--	--	120	--	75	6.4	--	0.6	--	--	8	--	84	90
	6	--	--	--	180	--	112.5	5.2	--	0.6	--	--	5.3	--	60	66
	8	15	41.7	60	--	--	75	8.4	0.75	--	--	10	--	--	84	90
	2415	1-3	3.75	10.425	15	--	--	18.75	11.5	0.75	0.6	--	40	32	--	240
	4-6	3.75	10.425	15	30	--	18.75	12.8	0.75	0.6	--	40	32	--	240	240
2420	5	--	--	--	160	--	100	3.9	--	0.6	--	--	6	--	72	78
	7	--	--	--	320	--	200	2.5	--	0.6	--	--	3	--	60	66
3410/3411	1	--	--	--	20	--	12.5	15	--	0.6	--	--	48	--	--	180
	2	--	--	20	40	--	25	12	--	0.6	--	--	24	--	--	180
	3	--	--	40	80	--	50	6	--	0.6	--	--	12	--	--	120
3420	3	--	41.7	60	120	--	75	4	0.75	0.6	--	10	8	--	60	66
	4	--	--	--	120	470	75	2.3	--	0.6	0.3	--	8	4	60	66
	5	--	69.5	100	200	--	125	2.9	0.75	0.6	--	6	4.8	--	60	66
	6	--	--	--	200	780	125	1.6	--	0.6	0.3	--	4.8	2.4	60	66
	7	--	111.2	160	320	--	200	2	0.75	0.6	--	3.75	3	--	45	51
	8	--	--	--	320	1,250	200	1.1	--	0.6	0.3	--	3	1.5	45	51

* The read access time is the interval of time from the beginning of a forward read, when the tape is not at load point, until the first data byte is read after the tape is brought up to speed from a stopped state. The times given for the 2401 and 2415 are estimates for a properly adjusted unit. The times given for 3420 Models 4, 6, and 8 are for 6,250-bpi operation.

Note: bpi = bytes per inch.

Figure 7-35. Comparison of Characteristics of IBM Magnetic Tape Units

Optical Readers

Online optical readers can enter data into a system directly from machine-readable source documents, thereby eliminating transcription operations such as card punching, verifying, and taping. This also reduces transcription errors, one of the most significant problems in data entry. Consequently, optical readers offer reduced processing costs, faster turnaround, fewer data-entry errors, and improved overall system efficiency. Nurses, teachers, salesmen, sales clerks, meter readers, driver's license applicants, and many others can originate data that can be directly entered into System/370 for processing.

1287 Optical Reader Models 1, 2, 3, 4, and 5

The IBM 1287 (Figure 7-37) can read typed and machine-printed alphanumeric data and hand-printed numbers, letters, and marks from cut-form documents having a variety of formats, orientations, types of data, and field lengths. The data of source documents can be organized in fixed- or variable-length fields, in columns or rows, and can be read in any sequence. Just as easily, the 1287 can also read numeric data and special symbols from journal rolls, such as cash-register and adding-machine tapes.

The 1287 reads data from input forms of a variety of widths and lengths:

Document	Width		Length	
	Min.	Max.	Min.	Max.
Cut-form documents	2.25 in.	5.91 in.	3 in.	9 in.
Journal rolls	1.31 in.	4.5 in.	3 ft.	200 ft.*

* If a tape is 3-1/2 inches or wider, the maximum length is 175 feet.

Throughput Rates: The speed of document processing depends primarily on the size of each document and the

number of characters and fields to be read, and is calculated from formulas. Maximum document throughput can be as high as 665 documents per minute for 3-inch stubs, each with one field of 20 machine-printed characters.

Journal-roll throughput depends primarily on the number of characters per line and the number of lines per inch. For example, a cash-register tape 2.5 inches wide with four 10-character lines per inch can be read at about 3,300 lines per minute.

Character Recognition: The 1287 reads the symbols and characters of the OCR-A font Sizes I and IV (Figure 7-38). Reading ability can be expanded with the features discussed later in this device description.

When the 1287 encounters a character that it does not recognize, it automatically initiates a rescan. If the character is not recognized after 10 rescans, the 1287 either displays the character on a cathode-ray tube for keyboard (online) correction, then goes to the next character. When journal rolls are read on Models 2 and 4, the operator can correct unrecognizable characters online, or the lines containing unrecognizable characters can be marked for offline correction.

Model Differences: The Model 1 reads up to 24 lines of data from a document, each line having as many as 84 characters. The Model 2 has this same ability, and in addition can read as many as 38 characters per line from journal rolls. (The Model 2 is designed for changeover from paper sheets to journal rolls, or vice versa, in seconds.) The Model 3 has the abilities of the Model 1, and the Model 4 has the abilities of the Model 2, but both the Model 3 and the Model 4 have the additional ability to read the alphanumeric OCR-A font size 1 (Figure 7-38) produced by the IBM SELECTRIC® typewriter or IBM 1403 Printer.



Figure 7-37. IBM 1287 Optical Reader Model 5

IBM 1428 Font	OCR-A Font		Farrington Selfchek 7B* Font	Handprinted Character Set	NCR Optical Font (NOF)**	OCR-A Font Size I	
	Size I	Size IX				IBM SELECTRIC [®] (or equivalent)	IBM 1403 (or equivalent)
0 1 2 3 4 5 6 7 8 9 C N S T X Z blank	0 1 2 3 4 5 6 7 8 9 C N S T X Z blank	0 1 2 3 4 5 6 7 8 9	0 1 2 3 4 5 6 7 8 9 C S T X	0 1 2 3 4 5 6 7 8 9 C S T X	0 1 2 3 4 5 6 7 8 9	0 A N : 1 B O ; 2 C P . 3 D Q , 4 E R / 5 F S - 6 G T * 7 H U # 8 I V & 9 J W V K X - P L Y H M Z blank	0 A N 1 B O 2 C P . 3 D Q , 4 E R / 5 F S - 6 G T * 7 H U # 8 I V & 9 J W V K X P L Y H M Z blank
						Expanded Symbol Set	
						+ % = # { : } "	

*Farrington Selfchek 7B shown by permission of Farrington Manufacturing Co.
**NCR Optical Font shown by permission of National Cash Register Co.

Note: Characters and symbols are shown reduced in size.

Figure 7-38. Fonts, Letters, and Symbols Acceptable by 1287

The Model 5 (Figure 7-37), as its basic function, reads multiple lines of handprinted numeric digits and certain alphabetic characters (0-9 and C, S, T, X, and Z) from cut-form documents. The capabilities of each of the five models can be expanded with additional features (Figure 7-39).

When the combined 1428 and OCR-A fonts feature is used, Models 1-4 of the 1287 can read each font separately in preidentified fields in the document.

The machine-printed OCR font feature provides the Model 5 with the ability to read numeric 1428, OCR-A, and Farrington Selfchek 7B font, each in separate preidentified fields in a document.

The NCR Optical Font (NOF) feature permits Models 2 and 4 to read journal tapes printed in NOF. The reading of this font and the IBM 1428 or OCR-A font is interchangeable and is controlled by the operator.

The Farrington Selfchek 7B font feature enables Models 1-4 to read characters imprinted on documents by credit plate imprinters.

The numeric handwriting feature permits the 1287 to read handprinted numbers and letters (0-9 and C, S, T, X, and Z, blockprinted with a No. 2 pencil or with HB lead) and numbers preprinted in Gothic 3/16-inch font.

The optical mark reading feature permits Models 1-5 to recognize penciled marks entered as data. The marks (made with a No. 2 pencil) may be vertical, at an angle of 45 degrees, or horizontal.

The expanded symbol set increases the reading capability of 1287 Models 3 and 4 by enabling them to read the symbols + = [] % " ' made by an IBM SELECTRIC[®] typewriter or its equivalent.

The serial numbering feature permits operator-controlled numbering of documents for visual reading. Documents as

small as 3 by 4-3/4 inches can be numbered from 00000 to 99999.

Features	1287 Model				
	1	2	3	4	5
IBM 1428 Font	Either is standard; available -				
OCR-A Font	together as an optional feature. -				
Machine-printed OCR Font	-	-	-	-	opt
Farrington Selfchek* 7B Font	opt	opt	opt	opt	-
Numeric Handwriting	opt	opt	opt	opt	std
NCR Optical Font (NOF)	-	opt	-	opt	-
Optical Mark Reading	opt	opt	opt	opt	opt
Expanded Symbol Set	-	-	opt	opt	-
Serial Numbering	opt	opt	opt	opt	opt

* Trademark of the Farrington Manufacturing Company
opt = optional; std = standard; - = not applicable

Figure 7-39. IBM 1287 Optical Reader Features

1288 Optical Page Reader

The IBM 1288 Optical Page Reader (Figure 7-40) reads data from cut-form documents that range in size from 3 by 6-1/2 inches to 9 by 14 inches. Because the 1288 can read mixed data on documents smaller than punched cards and as large as legal-size forms, it can be used in a variety of applications in government, business, and industry.

The 1288 can process both formatted and unformatted documents. In formatted mode, the 1288 reads fixed- and variable-length fields in any sequence. In unformatted mode, however, the machine reads multiple and continuous variable-length lines of alphanumeric data, up to six lines per inch, right- or left-justified.

The speed of document processing depends primarily on the size of each document, the format (if any), and the organization of the processing program, and can be calculated from formulas.

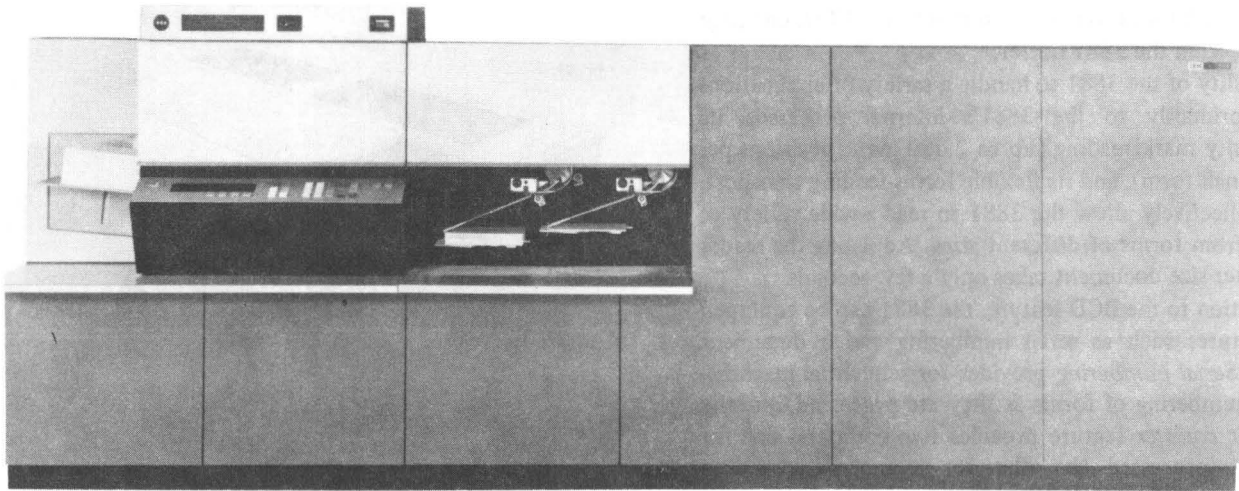

Figure 7-40. IBM 1288 Optical Page Reader

The input hopper of the 1288 can hold a 10-inch stack of documents, and the two output stackers can hold either a 4-1/2-inch stack of short documents or a 3-inch stack of long documents. Each document, after being read, is routed to one of the two output stackers, one of which is normally reserved for documents that contain unrecognizable characters.

When the 1288 encounters a preprinted Gothic or handprinted character that it does not recognize, it automatically rescans it. If the character remains unreadable, the 1288 transmits a substitute character to the CPU and, under program control, routes the applicable document to the stacker for offline correction.

Features available for the 1288 include numeric handwriting, optical mark reading, the expanded symbol set, and serial numbering. *Numeric handwriting* enables the 1288 to read handprinted numbers and letters (0-9 and C, S, T, X, and Z) and preprinted numbers in 3/16-inch Gothic font. *Optical mark reading* enables the 1288 to read vertical or 45-degree-angle penciled lines entered as data. The *expanded symbol set* enables the 1288 to also read the symbols + = [] % ? “ ’ made by an IBM SELECTRIC® typewriter or its equivalent. *Serial numbering* permits the 1288 to number documents sequentially, under operator control, for visual reading.

3881 Optical Mark Reader Model 1

The IBM 3881 Optical Mark Reader Model 1 (Figure 7-41) is well suited for convenient, fast, and economical data input in a variety of applications in industry, commerce, and institutional organizations. This high-speed optical mark reader reads penciled and machine-printed marks on a variety of document sizes, weights, and formats.

The 3881 is flexible. It can be easily adjusted so as to read data from forms ranging in size from 3-by-3-inch bill stubs to 9-by-12-inch sheets. It accepts paper ranging from

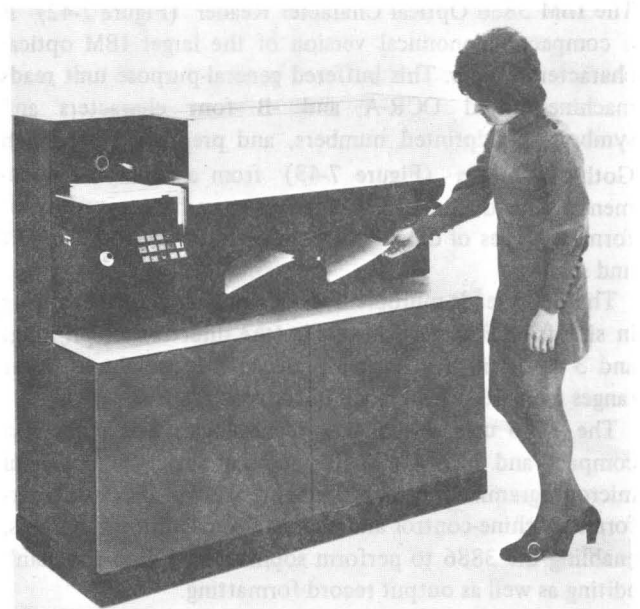

Figure 7-41. IBM 3881 Optical Mark Reader Model 1

20-pound stock to card stock. And it can read as many as six different formats on the same-size document, in a single pass.

When equipped with the *BCD feature*, the 3881 can read turnaround documents, which are forms printed by line printers as output from a data processing system, distributed for action, then returned to be read as input to the system.

Documents are fed through the read area from a 600-sheet hopper and are routed into one of two stackers, in the sequence in which they are entered. The processed documents go into a 600-sheet stacker, and those with errors are routed to a 100-sheet select stacker.

The 3881 can read as many as one hundred 3-by-3-inch documents per minute and sixty-six 8-1/2-by-11-inch docu-

ments per minute. Data is transferred to the CPU, one page at a time, from the 3881 buffer.

The ability of the 3881 to handle a variety of applications is due primarily to the 3881's internal processor, its high-density mark reading (up to 2,480 mark positions per 9-by-12-inch form), and its flexible forms-feeding transport, which collectively allow the 3881 to read a wide variety of formats from forms of different sizes. Adjusting the reader for another-size document takes only a few seconds.

In addition to the BCD feature, the 3881 can be equipped with features such as serial numbering and a document counter. *Serial numbering* provides for sequential machine-printed numbering of forms as they are processed, and the *document counter* feature provides two counters—one for documents processed, the other for documents routed to the select stacker.

3886 Optical Character Reader Model 1

The IBM 3886 Optical Character Reader (Figure 7-42) is a compact, economical version of the larger IBM optical character readers. This buffered general-purpose unit reads machine-printed OCR-A and -B font characters and symbols, handprinted numbers, and preprinted 3/16-inch Gothic numbers (Figure 7-43) from a variety of documents. The documents themselves may have a variety of formats, types of data, field lengths, and background colors and shades.

The 3886 reads multiple lines of print from forms ranging in size from 3 to 9 inches wide (the direction of printing) and 3 to 12 inches long. The acceptable weight of paper ranges from 16-pound stock to card stock.

The 3886 uses several new technologies that make it a compact and highly reliable modular device. A powerful microprogrammed recognition and control processor performs machine-control and character-recognition functions, enabling the 3886 to perform sophisticated data and blank editing as well as output record formatting.

The 3886 has one input hopper and two output stackers, each of which can hold a 1-inch stack of documents. The two stackers permit separation of the processed documents from the documents containing errors.

The speed of document processing depends on factors such as document length, number and kind of characters to be read, amount of editing and formatting specified, and the programs used. Speeds range from about 4.4 to 94 documents per minute. The low rate could be, for example, for 8-1/2-by-11-inch sheets with 29 lines per sheet, 78 characters per line (about 2,260 characters), and the high rate could be for 3-inch machine-printed turnaround documents, each with a single eight-character line.

Features available for the 3886 include line and page marking, numeric handwriting, serial numbering, and additional hopper and stacker capacity.

The *line and page marking* feature enables a 3886 to print any one of 15 codes on any line of a document and at the



Figure 7-42. IBM 3886 Optical Character Reader

bottom of a page. The user chooses the meaning and application of the codes, such as to point to a field in error or to indicate one type of error in the line.

The *numeric handwriting* feature provides for machine reading of handprinted numbers and the letter x.

The *serial numbering* feature permits sequential numbering of forms as they are processed.

The *additional hopper and stacker capacity* feature permits the 3886 hopper and stackers to hold 4-inch stacks of documents.

Alphanumeric OCR-A Font

ABCDEFGHIJKLMNOPQRSTUVWXYZ

0123456789 . : ; = + / * * " & | ' -

{ } % ^ & # . @ # Blank

0 1 2 3 4 5 6 7 8 9 X
one one one

Alphanumeric OCR-B Font

ABCDEFGHIJKLMNOPQRSTUVWXYZ

0123456789 | . < > + * - / , Blank

U S R £ ¥ X A E Ø ■
one one one

Numeric Handprint Character Shapes

0 1 2 3 4 5 6 7 8 9 X

3/16-inch Gothic Font

0123456789

Note: Characters and symbols are shown reduced in size.

Figure 7-43. Fonts, Letters, Numbers, and Symbols Read by the IBM 3886 Optical Character Reader Model 1

Printer-Keyboards

1052 Printer-Keyboard Model 7

The IBM 1052 Printer-Keyboard (Figure 7-44) can be attached to the system for communication between the operator and the system (for example, such operator-program changes as program checking or correcting and job logging). Facilities are provided for interrupting the CPU and for signalling the end of the operator's transmission.

The typewriter-style keyboard and the printing function can be used independently—the keyboard for system input and the printer for computer output. The 1052 has a stationary carriage and a spherical, interchangeable printing element.

The nominal speed of the Model 7 is 15.5 characters per second. Line spacing is set at 6 lines per inch and character spacing is set at 10 characters per inch. The maximum line length is 12.5 inches, for up to 125 characters.

The 1052, which requires a control-unit position, attaches to a System/370 channel via a 1052 adapter in an IBM 2150 Console (Figure 7-45).

A 2150 provides the System/370 with a duplication of the operator's controls at a station removed from the CPU. A location is provided on the freestanding 2150 for mounting one or two operator control panels.



Figure 7-44. IBM 1052 Printer-Keyboard

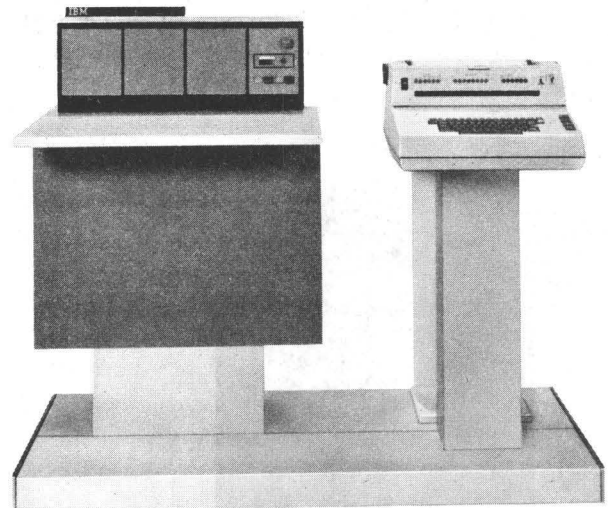

Figure 7-45. IBM 2150 Console and 1052 Printer-Keyboard

3210 Console Printer-Keyboard Models 1 and 2

The IBM 3210 Console Printer-Keyboard Model 1 permits communication between the system and the operator. The printer-keyboard can also interrupt the CPU and signal the end of the operator's transmission.

The printer-keyboard is mounted on the system table with a form stand located on the floor behind it.

The typewriter-style keyboard contains 44 character keys, Shift, Lock, New Line keys, and a Space Bar that manually perform the usual typewriter functions. In addition, there are keys and lights provided for generating control signals for, and signaling answers from, the CPU.

The printer, a low-profile IBM SELECTRIC® printer especially adapted for the 3210, uses a spherical print element having 88 graphic characters, any of which may be printed either from the system or manually from the keyboard. The characters have an optimized arrangement on the element that permits minimal machine wear. The machine uses a fabric ribbon in a standard SELECTRIC® cartridge, and operates at approximately 15.5 characters per second when either printing or spacing. Carrier return speed is about 15 inches per second.

In addition to printing, the printer provides spacing, carrier-return, indexing, and shifting functions.

The printer uses a 15-inch carriage, featuring a pin-feed platen for positive feeding of marginally punched forms. This platen accommodates a maximum of one original and five carbon copies of pin-feed forms having a hole-to-hole width of 13-1/8 inches. Vertical line spacing is six lines per inch when single spacing, or three lines per inch when double spacing. The horizontal print line is 12.5 inches long, equalling 125 characters per line.

The 3210 Model 2 (Figure 7-46) has all of the basic features of the Model 1, but is used some distance from the central processing unit.

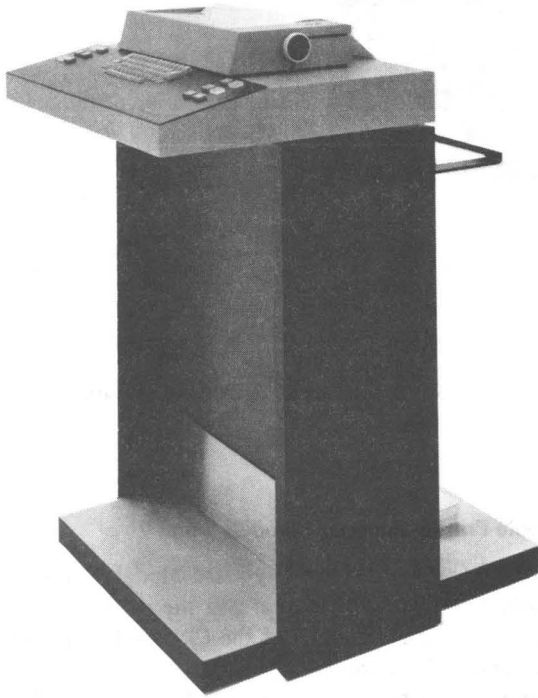

Figure 7-46. IBM 3210 Console Printer-Keyboard Model 2

3215 Console Printer-Keyboard

The 3215 Console Printer-Keyboard (Figure 7-47) permits communication between the system and the operator, and

provides printed output. Under program control, printing occurs at up to 85 characters per second, depending on the system. Character spacing is 10 characters per inch and up to 126 characters per line. Both left and right margins are fixed according to the platen width used. Vertical single spacing is six lines per inch; double spacing is three lines per inch.

All power, control, and data signals come from the central processing unit. The 3215 prints 26 alphabetic, 10 numeric, and up to 29 special characters from Extended Binary Coded Decimal Interchange Code (EBCDIC).

Other unique graphics are available to accommodate language and special character needs.

All functions of the 3215 are controlled by the system either manually or by program control: printing, spacing, carrier-return, and vertical spacing.

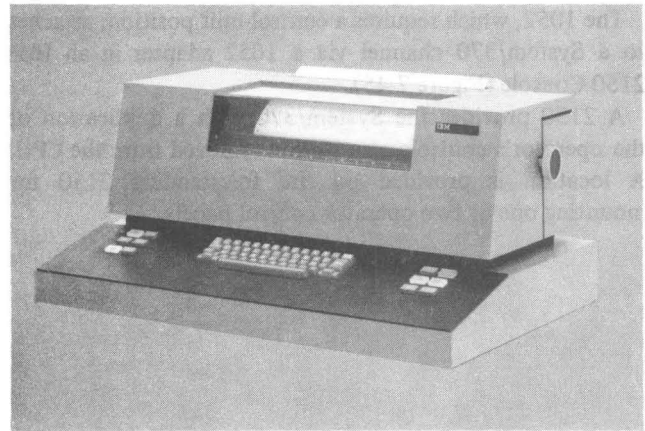

Figure 7-47. IBM 3215 Console Printer-Keyboard

Printers

1053 Printer Model 4

The IBM 1053 Printer is a small unit similar to the IBM 1052 Printer-Keyboard (Figure 7-44) but has the printer function only and no keyboard for entry of data. The 1053 prints at 14.8 characters per second.

The 1053 connects to a system via the IBM 2848 Display Control for printout in a display application. (See "2260 Display Station.")

1403 Printer Models 2, 7, and N1

Three different models of the IBM 1403 Printer (Figures 7-48 and 7-49) can be attached to the System/370:

<i>Printer Model</i>	<i>Printing Positions</i>	<i>Maximum Rated Speed (Lines Per Minute)</i>
1403-2	132	600
1403-7	120	600
1403-N1	132	1,100

Models 2 and N1 can operate at still higher speeds with the universal character set feature, described later.

Control for attaching 1403's to System/370 is provided by an IBM 2821 Control Unit or, for some System/370 models, by an integrated printer attachment. Up to three 1403's can be controlled by a 2821, depending on the 2821 model. One 1403 can be controlled by an integrated printer attachment.

Models 2 and 7 use a chain of linked characters for printing, and the Model N1 uses a train of characters not

linked together. As an optional feature, an interchangeable chain cartridge adapter is available for the Models 2 and 7. (At least one IBM 1416 Interchangeable Train Cartridge is required for each Model N1.) Either cartridge adapts the 1403 for quick and convenient changing of type fonts or character arrangements for special printing jobs.

Characters are printed ten to the inch, and lines are spaced either six or eight to the inch under operator control. An auxiliary ribbon-feeding special feature adapts the Models 2 and 7 for the use of polyester ribbons, which give sharper impressions. This feature is standard on the Model N1.

The Model 7 is the only model that does not have a dual-speed carriage—a feature that provides high-speed skips at 75 inches per second when skipping is more than eight lines. Skipping speed on the Model 7 is 33 inches per second.

The 1403 Model N1 (Figure 7-49) differs from the other models in featuring sound-absorbent covers extending to the floor, power-operated front and top covers, and a forms cart.

The selective tape listing feature and the universal character set feature are available for Models 2 and N1.

Selective Tape Listing

The selective tape listing feature provides the capability of substituting longitudinal strips for the normal paper sheet forms. Four 3.1-inch tapes, eight 1.5-inch tapes, or a combination of these less than 13.2 inches wide, may be printed. Up to 29 characters can be printed on a 3.1-inch tape, or up to 13 on a 1.5-inch tape. Each tape is

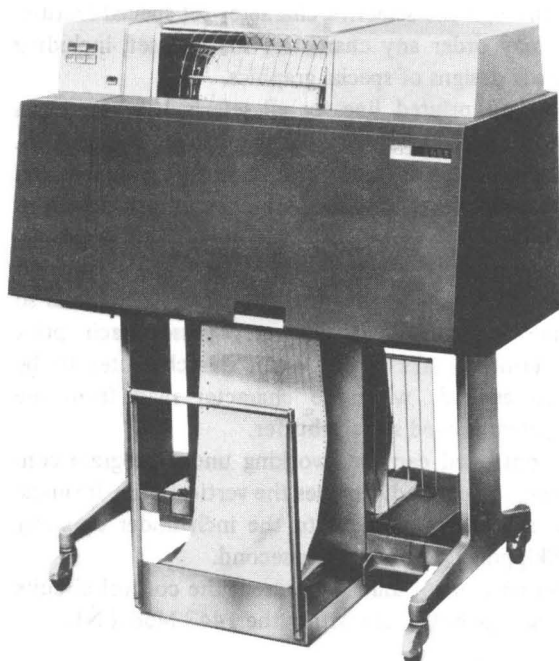

Figure 7-48. IBM 1403 Printer Models 2, 3, and 7

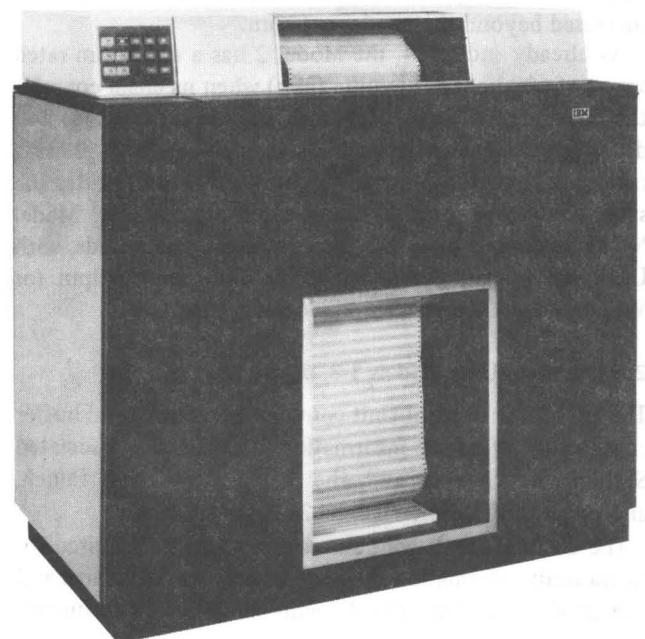

Figure 7-49. IBM 1403 Printer Model N1

individually line-spaced under program control, with no skipping permitted. Changing from tapes to standard forms, or vice versa, is easily accomplished by an operator.

A newer selective tape listing feature is available for a Model N1. This feature permits skipping at the rate of 33 inches per second over a distance fixed by Field Engineering adjustment at a value within the range of 3 to 22 inches; this is in lieu of the repetitive line spacing required by the other version of the feature. Operation is quieter. Change-over from tape listing mode to full-sheet printing is made still easier; this and other new operator conveniences have a beneficial effect on the feature's overall efficiency.

Universal Character Set

The universal character set feature (UCS) provides the user with the ability to load from cards, into a special storage area in the IBM 2821 Control Unit, any set of discrete codes up to a maximum of 240. The codes in 2821 storage correspond specifically and sequentially with the characters on the train or chain. The user may order any characters for a given set, including custom designs for special applications.

The chain or train has 240 type positions, which, prior to UCS, were divided into five identical sets of 48 characters each. The rated maximum printing speed of a given printer is based, partially, on this division into five identical sets. If characters are included only one, two, or even four times on the chain or train, the rated maximum printing speed is necessarily reduced. The reduction, however, is not linear, because of other factors than the number of character sets (e.g., single spacing vs. skipping). Conversely, if the characters are included *more* than five times, the printing speed is increased beyond the rated maximum.

As already indicated, the Model 2 has a maximum rated speed of 600 lines per minute (lpm) when its chain contains the conventional five sets. If the installed set contains 240 different characters—the widest possible variety—printing takes place on the Model 2 at up to 140 lpm. Under the same conditions, printing takes place on the 1403 Model N1 at up to 310 lpm. The maximum printing speeds, with UCS, are controlled electronically and are 750 lpm for Model 2, and 1400 lpm for Model N1.

2821 Control Unit Models 1-3, 5, and 6

The IBM 2821 Control Unit contains the control and buffer circuitry to transmit information between the associated System/370 channel and the 2540 Card Read Punch, and/or one 1403 Printer Model 2, 7, or N1.

The 2821 Model 6 contains controls and buffer circuitry to transmit information between its associated channel and one 2540 Card Read Punch, with no printer attachment.

Each of the five models of the 2821 provides control for the following types and quantities of I/O devices:

2821 Model	Max. No.	Printers Type and Model	Also	Max. Units Controlled
			2540 Card Read Punch?	
1	1	1403-2, 7, or N1*	yes	2
2	1	1403-2, 7, or N1*	no	1
3	2(or 3*)	1403-2, 7, or N1*	no	2(or 3*)
5	2(or 3*)	1403-2, 7, or N1*	yes	3(or 4*)
6		None	yes	1

*Requires a special feature.

The buffers in the 2821 permit the transfer of accumulated data to and from the channel at a much faster rate per byte than would be possible by direct transfer to or from the attached device.

The column binary special feature can be installed on the 2821 Model 1, 5, or 6 to allow multiple punching in rows 1-7 of a card column, or reading of such multiple punches, by the 2540. This feature is *not* required to read or punch EBCDIC. (See "2540 Card Read Punch.")

1443 Printer Model N1

The IBM 1443 Printer Model N1 (Figure 7-50) prints from 200 to 600 (maximum) lines per minute, depending on the number of characters in the set being used.

13-character set—600 lines per minute
 39-character set—300 lines per minute
 52-character set—240 lines per minute
 63-character set—200 lines per minute

The 52-character set is standard, and the other sets are available through the selective character set special feature. The user may order any characters for any set, including custom-made designs of special graphics.

The standard printed line for all sets is 120 characters long, spaced horizontally at 10 characters to the inch. Twenty-four additional printing positions are available as a special feature, raising the total number of printing positions to 144.

All characters of the print set are on a single type bar that moves back and forth across the paper. The bar is so made that each different character passes each print position. Printing takes place when the character to be printed corresponds with the character read from the printer's self-contained storage buffer.

A tape-controlled carriage, working under program control, advances paper and provides the vertical print formats. Lines are spaced six or eight to the inch under operator control. Skipping is 15 inches per second.

No external control unit is required; the control circuits and print storage buffer are within the 1443 Model N1.

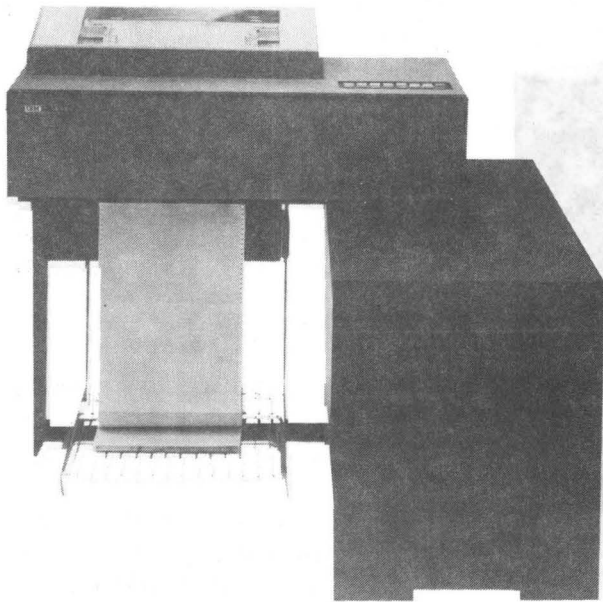

Figure 7-50. IBM 1443 Printer Model N1

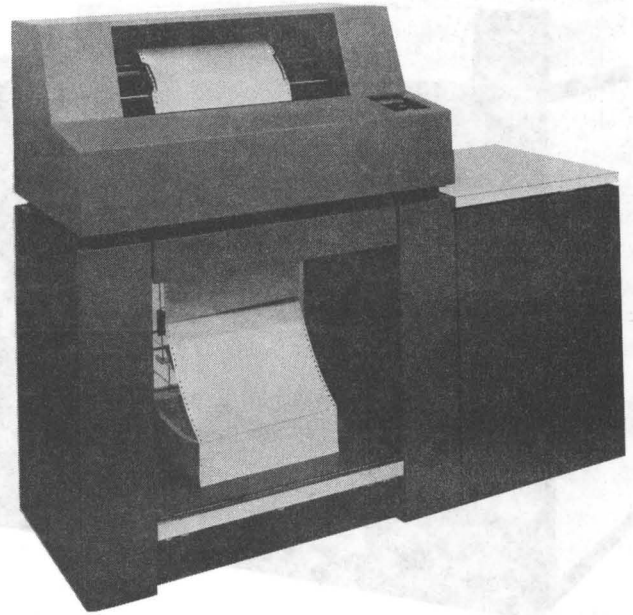

Figure 7-51. IBM 3203 Printer

3203 Printer Models 1, 2, 3, and 4

The IBM 3203 Printer (Figure 7-51) combines advanced functions and features to offer greater speed, quieter operation, improved efficiency, and greater reliability than is currently available with the IBM 1403 Printer. The 3203 uses the proven train-printing principle of the 1403 Model N1 and maintains comparable high-quality printing.

The 3203 attaches to System/370 models that have an integrated 3203 printer attachment, thereby eliminating the need for a separate channel or control unit.

Models 1 and 2 can be attached to System/370 Models 115 and 125, Model 3 can be attached to the 3777 Communication Terminal, and Model 4 can be attached to System/370 Models 138 and 148. The printing rates in alphameric lines per minute are: 600 for Model 1; 1,000 for Model 3; and 1,200 for Models 2 and 4. All models print either six or eight lines per inch, controlled by the operator.

The 3203 uses margin-punched pin-fed continuous forms. The size of individual documents that make up the continuous forms can range from 3-1/2 to 20 inches wide and from 3 to 24 inches long.

The 3203 also uses the IBM 1416 Interchangeable Train Cartridge, which is the same cartridge that is used by the IBM 1403 Model N1.

Standard features include a universal character set, a power-assisted stacker, a forms control buffer, and a cleaning system. The universal character set allows for selection of character sets best suited for the user's applications. The power-assisted stacker improves the stacking of forms and reduces required operator attention.

The forms-control buffer controls the vertical format and movement (spacing and skipping) of the forms, and eliminates the need for separate carriage-control tapes. The vacuum cleaning system continuously cleans the print train, and the operator can also use it to clean the print area.

3211 Printer

3811 Control Unit

The IBM 3211 Printer (Figure 7-52) is a high-speed printer with speeds of 2,000 lines per minute single spacing, using a 48-element character set. The printer uses a train of characters that are not linked together. Characters are printed 10 to an inch, and lines are spaced either six or eight to the inch under program control. In addition to the high-speed printing, other features of the printer are:

- Interchangeable train cartridge
- Universal character set
- Program-controlled carriage
- Self-adjusting power stacker
- Automatic forms-thickness control
- Motorized cover

Interchangeable Train Cartridge: This cartridge contains a continuous train of 432 characters. EBCDIC permits using up to 254 different characters (alphabetic, numeric, and special) on a print train.

Universal Character Set: The universal character set permits optimizing the character arrangement to maximum printing speeds. This feature allows selecting the characters best suited for maximum speed for different applications.

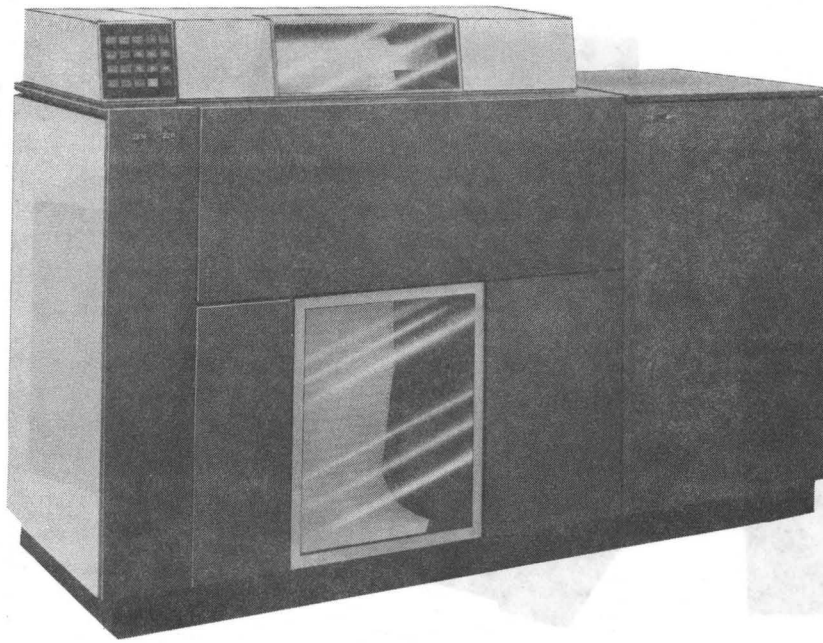

Figure 7-52. IBM 3211 Printer and IBM 3811 Control Unit

Program-Controlled Carriage: The vertical format for each form is stored in the control unit by the program. Forms movement (spacing and skipping) is initiated by the program in accordance with the stored format. Line feeding (6 or 8 lines per inch) is also controlled by the stored format.

Self-Adjusting Power Stacker: The self-adjusting power stacker advances and stacks the forms for optimum high-speed forms movement according to the thickness of the forms.

Automatic Forms-Thickness Control: The automatic forms-thickness control adjusts the platen to the correct setting for the forms used. This assures maximum print quality and maintains sufficient clearance for high-speed forms movement.

Motorized Cover: The cover on the printer gives controlled access to the forms transport area. When a forms condition arises, the cover movement immediately alerts the operator that attention is required.

The printer speed depends on the arrangement of the characters within the type array and the number of arrays in the print train. Optimizing the universal character set permits each application to attain maximum printing speeds, depending on the frequency of the characters in the print train. Speeds of up to 2,500 lines per minute, with reduced character sets and customized print trains, are possible.

The 3211 is controlled and buffered by the 3811 Control Unit. The control unit, physically attached to the 3211, contains the electronic circuitry needed to adapt the printer to the channel.

3800 Printing Subsystem

The IBM 3800 Printing Subsystem (Figure 7-52.1) is a high-speed, nonimpact printer that produces characters on paper through electrophotographic and laser technology. It can be attached to System/370 Models 145, 148, 155 II, 158 (using the 3158 or 3158-3 Processing Unit), 165 II, and 168 (using the 3168 or 3168-3 Processing Unit) via standard channel attachment. It is supported by OS/VS1, including JES1, and by OS/VS2, including JES2 and JES3 (except when OS/VS1 or OS/VS2 is running under VM/370).

The basic 3800 has:

1. Continuous forms input, transport, and stacking mechanism.
2. Control electronics with 54K page buffer.
3. Writable character generation storage organized into two 64-character writable character generation modules to hold 128 characters.
4. Eighteen different character sets, including five special underscored sets, and 10-, 12-, and 15-pitch (characters per inch) sets, all of which may be printed separately or any combination of up to four may be mixed on a line.
5. The electrophotographic process, which includes the following:
 - a. A continually revolving drum on which a charged photoconductive surface is selectively discharged by a low-power laser to produce images of the printed data.
 - b. A developer station where black toner is attracted to the images.
 - c. A transfer station where the toner is transferred to the paper forms.
 - d. A fuser station to fuse the toner into the paper.

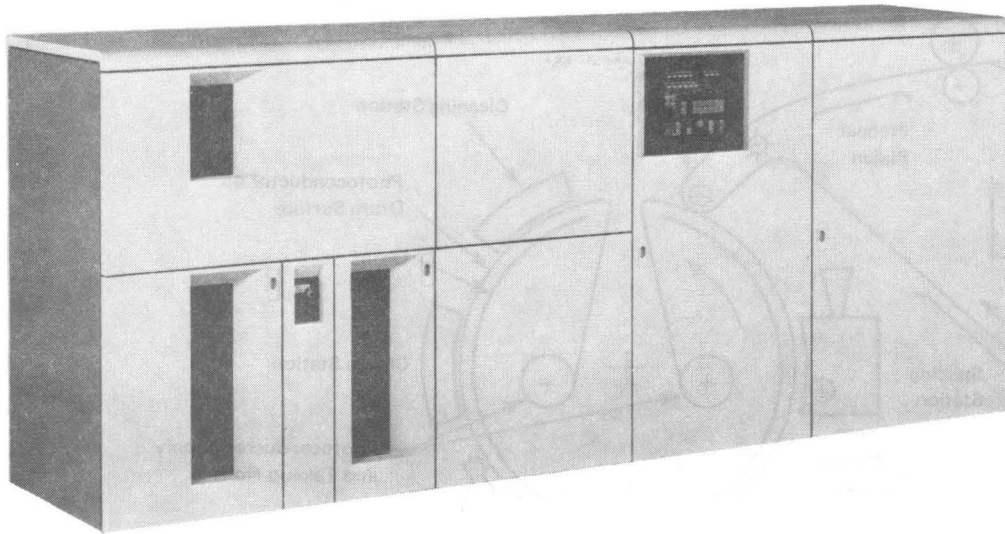

Figure 7-52.1. IBM 3800 Printing Subsystem

- e. A cleaning station to remove any residual toner from the drum after the page has been printed.
 - f. A charge station to prepare the photoconductor.
6. A forms overlay station to expose the drum with form images or other fixed data.

In operation, data to be printed is moved from the CPU to the 3800 a line at a time, is translated into graphic code using a set of translate tables, and is stored in the page buffer. When the page buffer contains a full page, the code is used, through interaction with character generation storage, to modulate the laser in exposing the revolving drum. Exposure is by horizontal line scanning, similar to the way a cathode-ray gun scans a TV screen to produce a picture. The image is developed with toner, transferred to paper, and fused. The photoconductor surface of the drum is cleaned and reconditioned after each exposure. Finished copies are refolded and stacked in the continuous forms stacker, complete with job separation marking (optional). Figure 7-52.2 is a schematic diagram of the 3800 printing mechanism.

Graphic character modification allows user- or IBM-designed characters to take the place of an equal number of standard characters in character-generation storage.

Line spacing is either six or eight lines per inch and can be intermixed within a page.

The 3800 uses single-ply, edge-punched, perforated, and stacked continuous forms in any combination of five lengths and ten widths (common-use sizes). ISO (International Standards Organization) sizes are available for World Trade, except in North America. Preprinted forms may be used, or the form image can be printed simultaneously with text by the use of a forms overlay negative, by

character formatting, or by any combination of these to suit the application.

The forms overlay negative, bearing the image of the form, is installed by the operator prior to printing. The image from the overlay negative may then be printed on any number of copies, starting with the first. Forms overlay may also be used for printing pictorial line art, or halftones, on copies.

The character formatting method uses a character set working under program control to create a line image.

Copy modification allows printing of predefined data on specified copies of the pages of a data set. The data may be legends, column headings, or other information; or it may be blanks to eliminate the printing of data. The modification may vary from copy to copy.

The overall effect of forms overlay, character formatting, and copy modification is functionally equivalent to the use of conventional numbered, preaddressed, multiple-part forms with standard features such as legends, spot carbons, short plies, and printed blockout areas.

Optional Features

1. Additional character-generation storage for 127 characters, providing a maximum print capability of 255 different characters.
2. A manual two-channel switch, which allows the 3800 to obtain data from two separate CPU's, and a remote switch attachment, which provides two-channel switching at a configuration control panel. Automatic switching is provided by the dynamic two-channel switch for two processors sharing main storage, and for two channels on a single CPU.

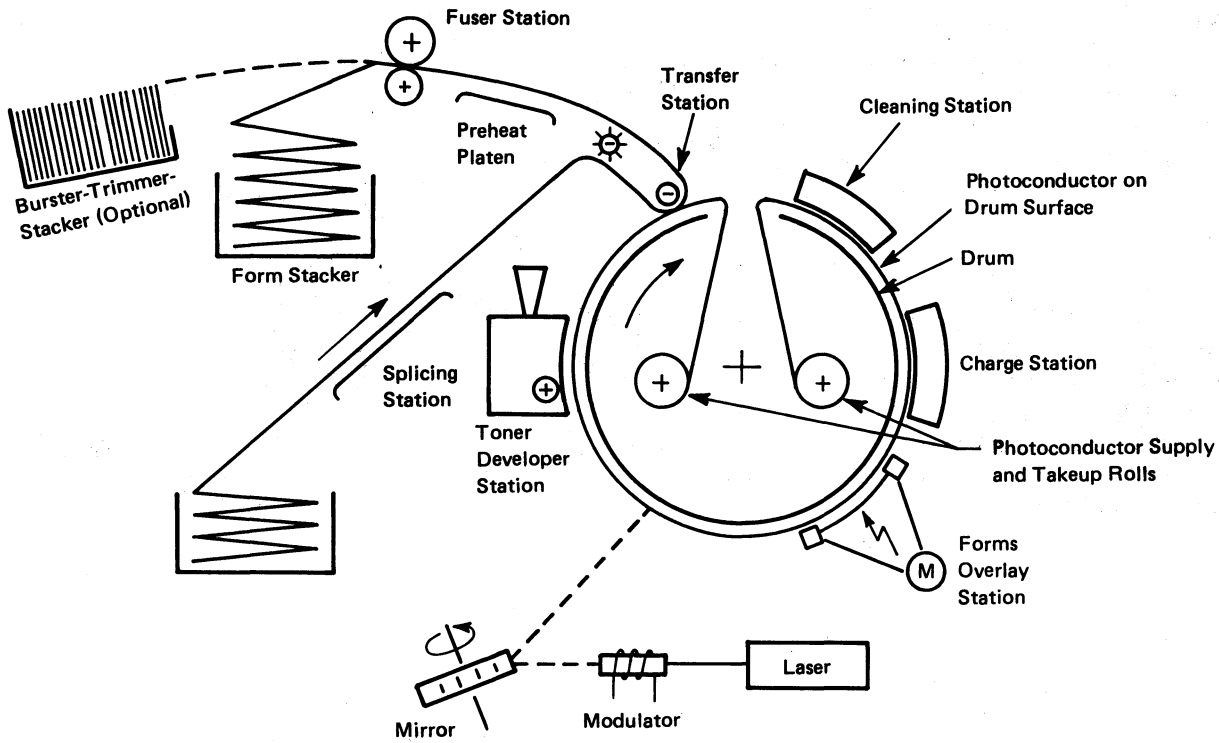

Figure 7-52.2. Path of Paper Forms through the IBM 3800 Printing Subsystem

3. A forms burster-trimmer-stacker that bursts printed output into individual sheets with the right and left carrier strips trimmed off. Jobs and/or single copies are

separated by offsetting one job or copy from another in the stacker, and are ready for distribution without postprinting delays.

5203 Printer Model 3

Using the standard 48-character set, the IBM 5203 Printer Model 3 (Figure 7-53) prints 300 lines per minute on continuous forms that are margin-punched and pin-fed. The individual documents that make up the continuous forms can range from 3-7/8 to 16-3/4 inches in width and from 3 to 14 inches in length.

Additional train cartridges, changeable by the operator, provide various character sets, and with the universal character set attachment feature, expanded character sets from 49 to 120 characters can be used.

Also expandable is the number of print positions per line. The standard 5203 has 96 print positions. This can be expanded, via optional features, to 120 or 132 positions.

The forms control buffer controls the vertical format and movement (spacing and skipping). The operator controls the number of lines per inch (six or eight) that the 5203 prints.

The 5203 Model 3 can attach to a System/370 model equipped with an integrated 5203 printer attachment, thereby eliminating the need for a separate channel or control unit.

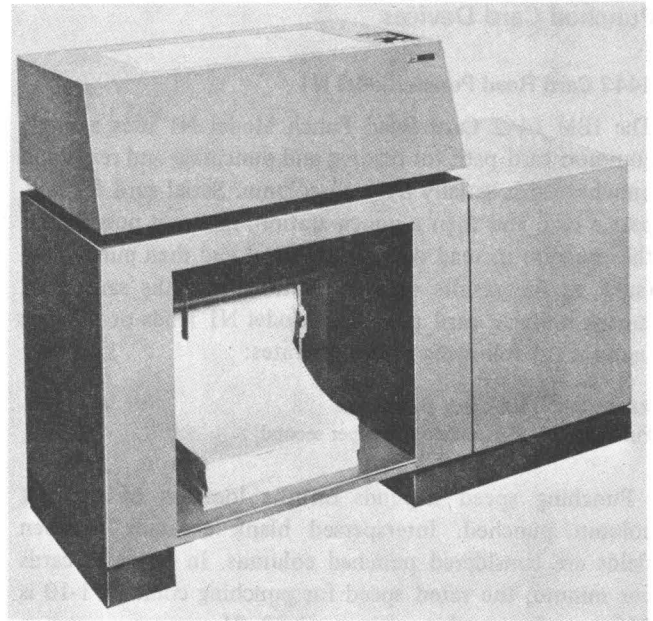

Figure 7-53. IBM 5203 Printer Model 3

5213 Printer Model 1

The IBM 5213 Printer Model 1 (Figure 7-54) can operate as a table-mounted console printer for some System/370 models. It uses a 62-character set and prints serially at 85 characters per second.

The 5213 uses continuous forms that are pin-fed and margin-punched. The individual documents that make up the continuous forms can range from 3 to 14 inches in length; document width is 13-7/8 inches from left to right margin-punch centers. The maximum print line is 132 positions at ten characters per inch, with line spacing of six lines per inch. Multiple-part forms can be printed, with a maximum thickness of 0.018 inch.

This printer is equipped with a pin-feed platen and a high-speed carrier-return left. It also provides single-space forms indexing under program control.

The 5213 Model 1 can attach to System/370 models equipped with an integrated 5213 printer attachment, thereby eliminating the need for a separate channel or control unit.

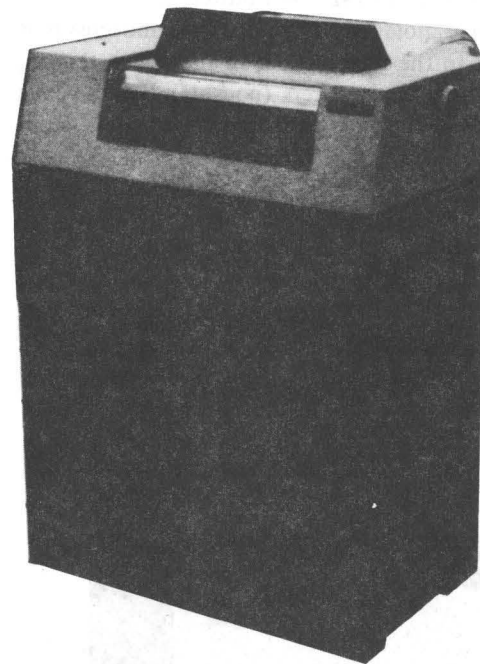

Figure 7-54. IBM 5213 Printer Model 1

Punched Card Devices

1442 Card Read Punch Model N1

The IBM 1442 Card Read Punch Model N1 uses a single common card path for reading and punching, and reads and punches cards serially by card column. Serial card feeding, past a read and then a punch station, makes it possible for the program to read data from a card and then punch data (such as the results of a calculation) into the same card during a single card pass. The Model N1 reads or punches cards at the following maximum rates:

Reading – 400 cards per minute
Punching – 160 card columns per second

Punching speed depends on the location of the last column punched. Interspersed blank columns between fields are considered punched columns. In terms of cards per minute, the rated speed for punching columns 1-10 is 265 cpm; for punching columns 1-80, 91 cpm.

No external control unit is required; the control circuits are within the 1442. The 1442 is not buffered.

The read hopper holds 1,200 cards. Card movement is from the hopper to the read station, to the punch station, then to one of the two stackers (pockets). The stackers hold 1,300 cards each, and cards can be removed from either stacker without stopping the machine.

The appearance of the unit is similar to that of the 1442 Model N2 shown in Figure 7-55.

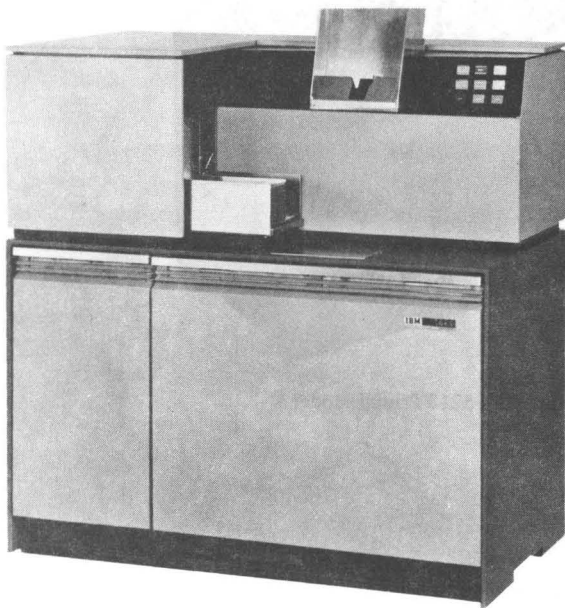

Figure 7-55. IBM 1442 Card Punch Model N2

Data Mode 1

In data mode 1, the Model N1 can read and punch the 256 different combinations of holes required for the extended binary coded decimal interchange code (EBCDIC). For 256 combinations, multiple punches in a single card column are required; however, no more than one punch is permitted in rows 1-7. (Rows 12, 11, 0, 8, and 9 allow 32 possible combinations, which, multiplied by the eight possibilities in rows 1-7, equal the required 256.) For multiple punches in rows 1-7, the special card image feature is required.

Data Mode 2

Operations using the card image feature are in data mode 2, which is the card image or column binary mode. The card image feature permits the low-order six bits of bytes read from the CPU to be punched alternately into the upper six and lower six rows of a card, enabling 160 such truncated bytes to be placed in the card. When reading, the information is read column by column and transmitted to the CPU byte by byte, the two high-order bits (0 and 1) set to zero.

1442 Card Punch Model N2

The IBM 1442 Card Punch Model N2 (Figure 7-55) may be connected to the System/370 to provide the card punching function only. Punching operations, speeds, internal controls, punching in data mode 2, and all other features related to punching are identical to those of the 1442 Card Read Punch Model N1, except that the Model N2 has only a single 1,300-card stacker.

2501 Card Reader Models B1 and B2

Models B1 and B2 of the IBM 2501 Card Reader (Figure 7-56) are externally identical, but the maximum card-reading rate of Model B1 is 600 per minute; of Model B2, 1,000 per minute. The Model B1 can be used for primary card input or as a console reader. Model B2 can be used for primary card input, often with the 2520 Card Punch Model B2 for maximum card processing speeds.

No external control unit is required; the control circuits are within the 2501. The 2501 is not buffered.

Reading of cards is accomplished by photocells that convert the light passing through punched holes into electrical energy. Cards are read serially by column. The feed hopper has a 1,200-card capacity, and cards can be removed from the single 1,300-card stacker without stopping the reader.

The 2501 can read EBCDIC in standard data mode 1. For the 256 combinations in EBCDIC, multiple punches in a single card column are required; however, no more than one punch is permitted in rows 1-7. For multiple punches in

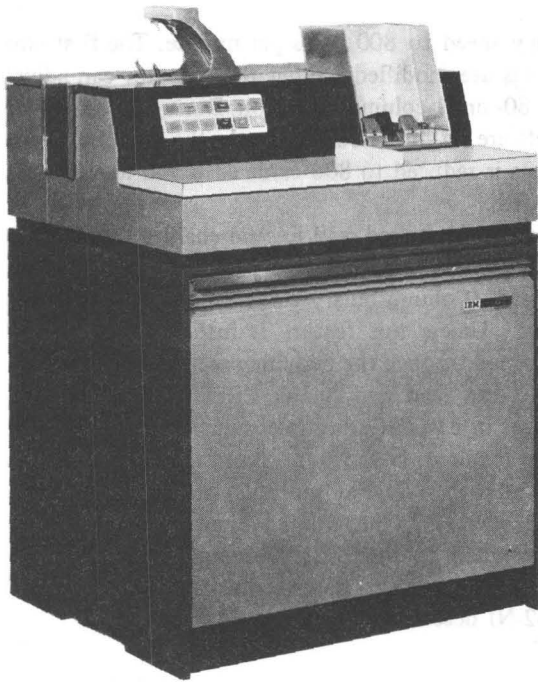

Figure 7-56. IBM 2501 Card Reader

rows 1-7, the special card image feature is required. For a description of reading in card image mode, see "Data Mode 2" in the 1442-N1 description.

2520 Card Read Punch Model B1

The IBM 2520 Card Read Punch Model B1 (Figure 7-57) reads and punches cards at a maximum rate of 500 per minute. Operation of the 2520 Model B1 is the same as for the 1442-N1 or 2501 with respect to serial-by-column card reading, and is like the 1442-N1 in that:

1. The feed hopper has a 1,200-card capacity.
2. Cards can be removed from either 1,300-card stacker while the machine is running.
3. Cards are moved past a read station and then past a punch station.
4. Prepunched cards can be fed through the punching station without a special feature.

As in the 2501, cards are read by photocells that convert the light passing through punched holes into electrical energy.

The punching operation of the 2520 differs from that of the 1442; punching is parallel by row instead of serial by column. Each card is fed in parallel and read serially while the preceding card, its axis turned 90 degrees, is passing the punching station (Figure 7-58).

No external control unit is required; the control circuits are internal. The 2520 punching operations are buffered; the reading operations are not buffered.

The 2520 can read and punch EBCDIC in the standard data mode 1. For the 256 combinations in EBCDIC, multiple punches in a single card column are required;

however, no more than one punch is permitted in rows 1-7. For multiple punches in rows 1-7, the special card image feature is required. For a description of reading and punching in the card image mode, see "Data Mode 2" in the 1442-N1 description.

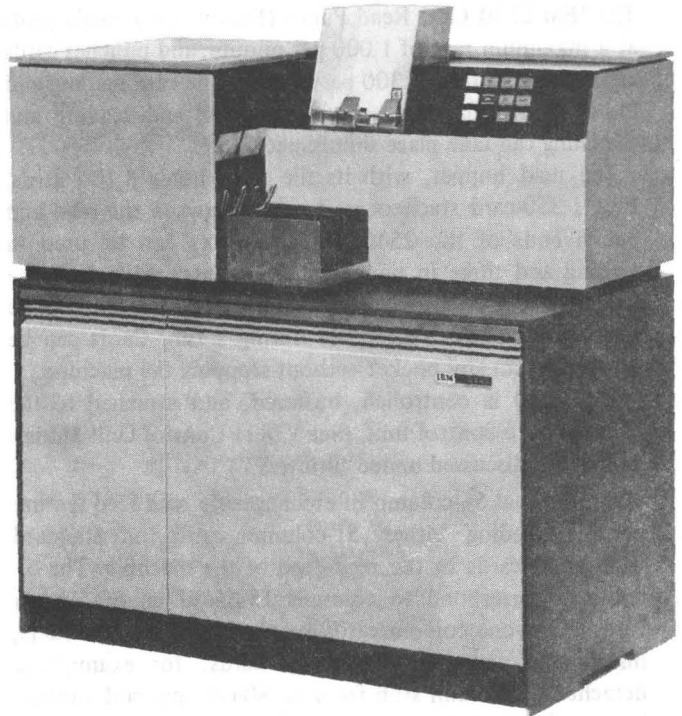

Figure 7-57. IBM 2520 Card Read Punch Model B1

2520 Card Punch Models B2 and B3

The IBM 2520 Card Punch Model B2 or B3 may be connected to the System/370 to provide the punching function only. Models B2 and B3 are externally identical (and the same as the 2520-B1 shown in Figure 7-57), but the maximum card-punching rate of Model B2 is 500 per minute; of Model B3, 300 per minute.

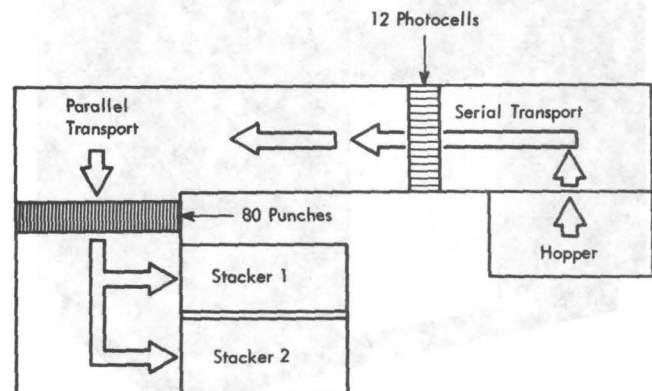

Figure 7-58. Card Path in IBM 2520 Card Read Punch Model B1

Internal controls, punch buffering, punching in data mode 2, the punching speed of Model B2, and all other features related to punching are identical to those of the 2520 Card Read Punch Model B1.

2540 Card Read Punch

The IBM 2540 Card Read Punch (Figure 7-59) reads cards at a maximum rate of 1,000 per minute, and punches cards at a maximum rate of 300 per minute. The card reading and punching sections are separate entities, and reading and punching can take place simultaneously.

The read hopper, with its file feed, holds 3,100 cards. Five 1,350-card stackers are located between the read and punch ends of the 2540; three stackers can be used in reading and three in punching. The center pocket can be fed with either punched or read cards, but should be reserved for one or the other during a run. Cards can be removed from any pocket without stopping the machine.

The 2540 is controlled, buffered, and attached to the channel by a control unit. (See "2821 Control Unit Models 1-3, 5, 6," discussed under "Printers.")

An optional 51-column interchangeable read feed feature permits feeding either 51-column cards or standard 80-column cards in the read feed of the machine. The 51 columns correspond to columns 15-65 of an 80-column card. (Fifty-one column cards may be postal money orders, installment payments, inventory cards; for example, a detached 51-column stub from an 80-column card.) Installation of this feature permanently reduces the maximum

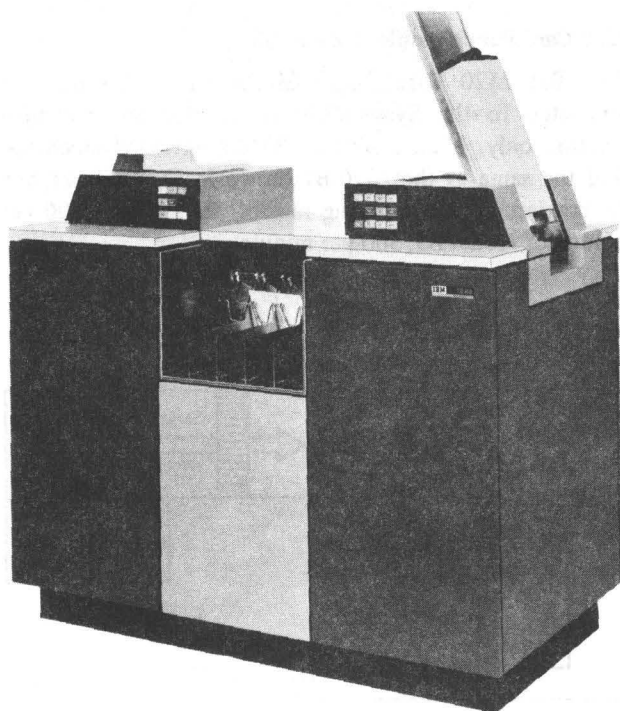

Figure 7-59. IBM 2540 Card Read Punch

card-reading speed to 800 cards per minute. The first two read pockets are modified so that the operator can adjust for either 80- or 51-column operation. During the time that the pockets are set for 51-column cards, the capacity of the two pockets is reduced to 800 cards each and longer cards cannot be fed.

An optional punch feed read feature enables the 2540 to punch output data into the same card from which input data was read. (Column binary cards cannot be read in the punch feed.) Unless this feature is installed, only blank cards can be fed through the punching section.

The 2540 can read and punch EBCDIC. For the 256 combinations in EBCDIC, multiple punches in a single card column are required; however, no more than one punch is permitted in rows 1-7. For multiple reading or multiple punches in rows 1-7, the column binary special feature must be installed on the 2821. Column binary cards are read or punched exactly as described under "Data Mode 2" in the 1442-N1 description.

2560 Multi-Function Card Machine Models A1 and A2

The IBM 2560 Multi-Function Card Machine (Figure 7-60) enables cards to be collated, gangpunched, reproduced, summary punched, and classified in a single pass, under program control. The Model A1, when equipped with the optional card print feature, enables cards to be printed (interpreted) in the same pass with the other operations.

Both models have two 1,200-card hoppers, a read station, a punch station, and five 1,300-card radial stackers. Cards from either the primary or secondary hopper can be read, punched, and fed into any of the five stackers.

Cards are read serially by the Model A1 at 500 cards per minute and by the Model A2 at 310 cards per minute. While in the read station, cards are checked for data validity, off-register punching, and proper alignment. Cards are punched by the Model A1 at 160 columns per second and by the Model A2 at 120 columns per second, the output per minute varying with the number of columns punched per card. For example, the output rates for Models A1 and A2 vary from 91 and 65 cards per minute, respectively, when column 80 is the last column punched, to 260 and 173 cards per minute, respectively, when punching stops at column 10.

The *card print* feature, if installed on a Model A1, provides two, four, or six printing heads for serial printing as the card moves through the print station. Each printing head can be manually adjusted to print in any one of 25 line positions not occupied by another head. Line positions are above the 12-punch position, on each row of punch positions, between the rows of punch positions, and below the 9-punch position.

Each printing head can print 62 different characters plus a blank, as transmitted from main storage. Character spacing is ten to the inch, and each line can be 64

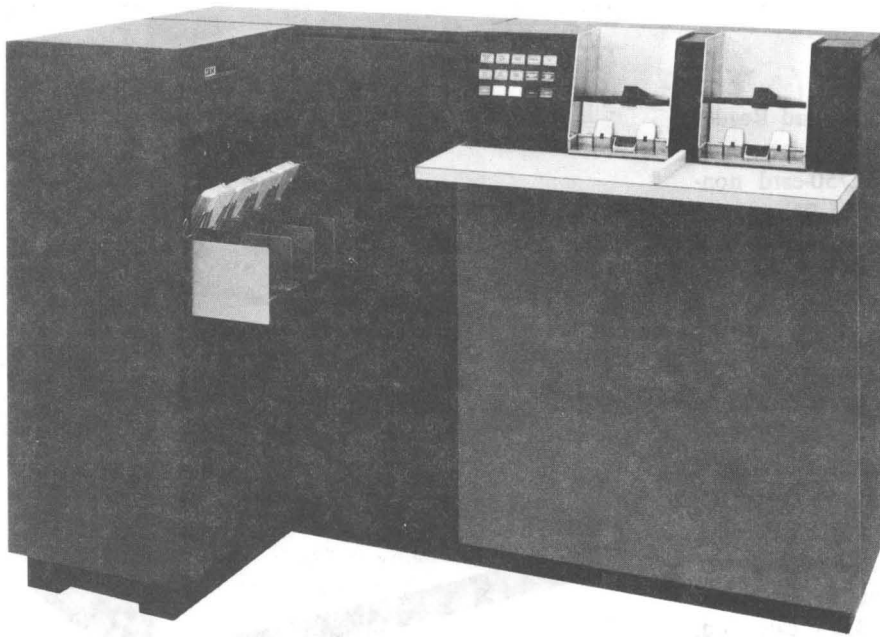

Figure 7-60. IBM 2560 Multi-Function Card Machine

characters long. Printing extends from approximately column 2 to column 75.

Printing speed is 140 characters per second, regardless of the number of lines printed. Six hundred 64-character lines per minute (100 cards per minute) can be printed if six lines are printed on each card; this time includes card movement and registration.

2596 Card Read Punch Model 1

The IBM 2596 Card Read Punch (Figure 7-61) reads and punches 96-column cards and provides 96-column card data interchange between System/3 and System/370. This unit reads cards at a maximum rate of 500 per minute, with buffering to prevent overrun. The fully buffered punch unit punches cards at a maximum rate of 120 per minute.

The read and punch sections each have a 2,000-card hopper, and two 600-card stackers, one for normal stacking and one for selective stacking. No external control unit is required; the control circuits are within the 2596.

As an option, the special interpretive printing feature is available. This permits printing of three lines of 32 characters each on the card, in the same pass as it is being punched, without loss of card punching speed. The interpreter function is operator-controlled by an on-off switch on the operator panel.

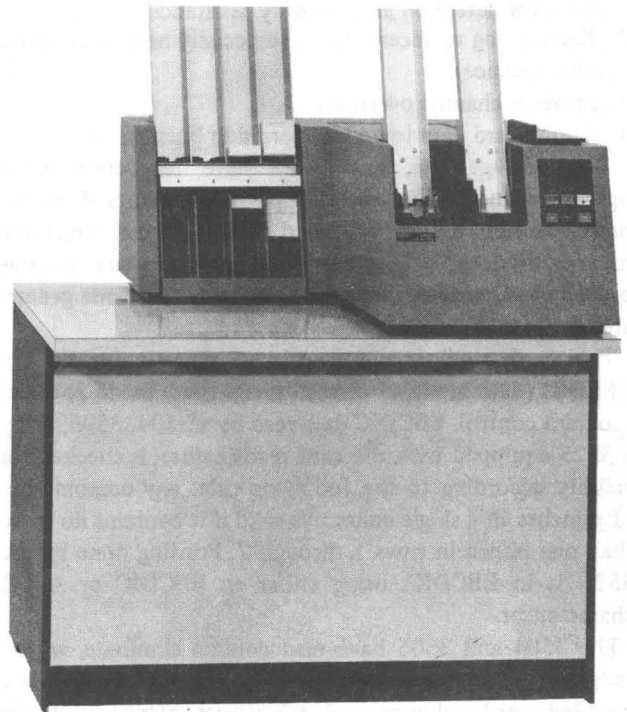

Figure 7-61. IBM 2596 Card Read Punch

3504 Card Reader Models A1 and A2

3505 Card Reader Models B1 and B2

3525 Card Punch Models P1, P2, and P3

The IBM 3504 Card Reader and IBM 3505 Card Reader (Figure 7-62) are high-speed fully buffered devices, each with a 3,000-card file feed and two 1,750-card non-programmable stackers. The 3504-A1 and 3505-B1 can read 800 cards per minute, and the 3504-A2 and 3505-B2 can read 1,200 cards per minute.

The 3504 and 3505 look essentially alike and are functionally equivalent; they differ primarily in that the 3504 attaches to a System/370 model by way of an integrated attachment, and the 3505 attaches by way of a channel.

The I/O device associated with a 3504 or 3505, the IBM 3525 Card Punch (Figure 7-63), operates at rates up to 100, 200, or 300 cards per minute (Model P1, P2, or P3, respectively). The 3525 attaches to a system via the control unit of a 3505, or attaches directly via an integrated attachment. With special features, the 3525 can read, punch, and print, all in a single pass, feeding cards from a 1,200-card hopper and loading them into either of two program-selectable 1,200-card stackers.

The fully buffered control unit, housed within the 3505:

1. Contains its own processing unit and resident programs for error detection and recovery assistance
2. Keeps a log of recent errors (especially helpful in device maintenance).
3. Prevents channel overrun.
4. Allows card data to be transferred in burst mode.

The 3504, 3505, and 3525 have recovery-oriented operator panels. The operator panel indicators show the precise action to be performed for all normal stops and most error stops, or they direct the operator to a corrective procedure. Operating keys are situated in the same general area for ease of control.

For card reading and punching, data is handled in EBCDIC (data mode 1) or card image (data mode 2) under program control. EBCDIC data read by a 3504, 3505, or by a 3525 equipped with the card read feature, is checked for validity according to the following rule: any combination of punches in a single column is valid if it contains no more than one punch in rows 1 through 7. Printing done by the 3525 is in EBCDIC, using either an EBCDIC or ASCII character set.

The 3504 and 3505 have read column eliminate, which under program control suppresses the reading of data from specified card columns and substitutes blanks in these columns in the buffer.

Card reading in a 3504 or 3505 is serial by column; in a 3525 equipped with the card read feature, it is parallel by row.

The error-recovery support needed for a 3504, 3505, or 3525 is less than that needed for I/O devices such as the 2540 Card Read Punch, because many of the functions



Figure 7-62. IBM 3504 or 3505 Card Reader

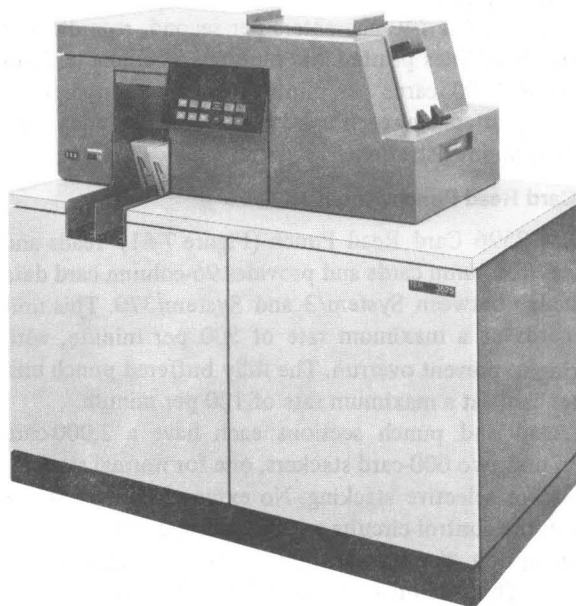

Figure 7-63. IBM 3525 Card Punch

performed by program support are performed by the 3504, 3505, and 3525 (for example, automatic feed retry and automatic punch retry).

The 3504, 3505, and 3525 have error-retry capabilities. Both the 3504 and the 3505 retry cards which fail to feed on the first try, and signal a hopper misfeed if subsequent retries are unsuccessful. On recognizing a card with a punch

error, the 3525 sends that card to an error stacker for later examination and reattempts correct punching.

Some of the more prominent special features of the 3504 and 3505 are:

1. The *selective stacker*, which adds a 1,750-card third stacker that permits time-independent card selection under program control.
2. *Optical mark read*, which gives the card reader the ability to read penciled marks and machine-printed nonreflective ink marks from cards.

Special features of the 3525 are:

1. The *card read* feature, which provides the punch with optical punched-hole sensing, allowing the 3525 to execute 3504 and 3505 read programs compatibly. (Read column eliminate is included with this feature.)
2. *Two-line card print*, which allows printing of two lines near the top of the card.
3. *Multiline card print*, which provides the 3525 with printing of up to 25 lines on the card, under program control.

5425 Multi-Function Card Unit Models A1 and A2

Using 96-column cards, the IBM 5425 Multi-Function Card Unit (Figure 7-64) combines functions of a card reader, card punch, collator, and interpreter. Consolidating these functions into one unit reduces card handling and overall job time.

In a single pass and under program control, the 5425 enables 96-column cards (Figure 7-65) to be collated, gangpunched, reproduced, summary punched, printed, and

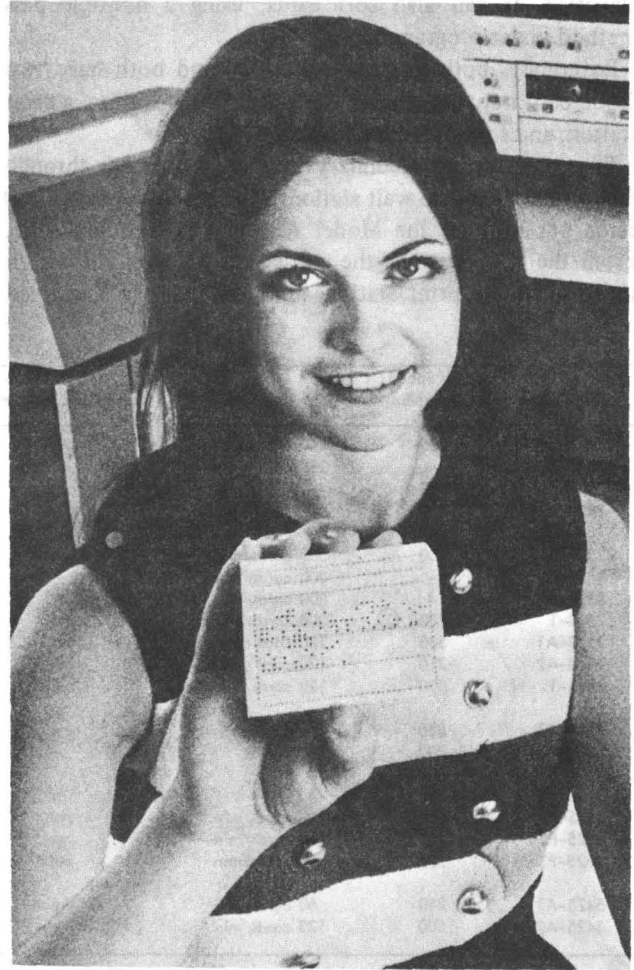

Figure 7-65. The 96-Column Punched Card

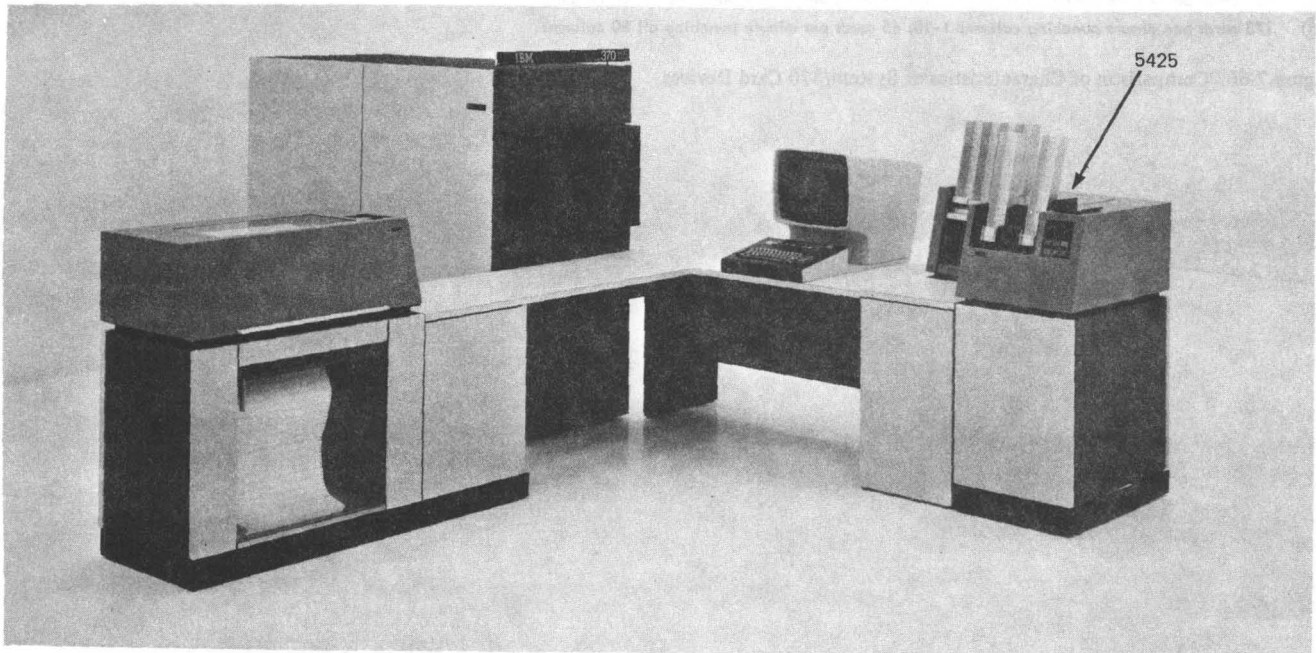

Figure 7-64. IBM 5425 Multi-Function Card Unit with a System/370 Model 115

classified. It can also sort cards, using a multiple pass method under program control.

Externally, both models look alike, and both have two 2,000-card hoppers, a read station, a punch station, a print station, and four 600-card stackers.

The primary and secondary hoppers feed cards through the read station into wait stations. The Model A1 reads 250 cards per minute, the Model A2, 500 cards per minute. From the wait stations the cards pass through the punch station and the print station, and proceed into a selected

stacker. The Model A1 punches 60 cards per minute, the Model A2, 120. At the print station, up to four lines (with as many as 32 characters per line) can be printed, using characters from the standard 64-character set. The printing rate is 60 cards per minute for the Model A1 and 120 for the Model A2 for the first, second, and third lines, but this rate is reduced if the fourth line is printed.

Figure 7-66 summarizes the essential characteristics of all card equipment discussed.

Card Unit	Read Speed (Cards/Min)	Punch Speed	Read and Punch Same Card in One Pass	Self-Contained Control Unit	Buffers
1442-N1	400	160 card col/sec	yes	yes	none
1442-N2	-	160 card col/sec	-	yes	none
2501-B1	600	-	-	yes	none
2501-B2	1,000	-	-	yes	none
2520-B1	500	500 cards/min	yes	yes	punch
2520-B2	-	500 cards/min	-	yes	punch
2520-B3	-	300 cards/min	-	yes	punch
2540-1	1,000 ①	300 cards/min	yes	no	read, punch
2560-A1	500	160 card col/sec	yes	no	none
2560-A2	310	120 card col/sec	yes	no	none
2596-1	500	120 cards/min	no	yes	read, punch
3504-A1	800	-	-	no	read
3504-A2	1,200	-	-	no	read
3505-B1	800	-	-	yes	read
3505-B2	1,200	-	-	yes	read
3525-P1	100	100 cards/min	yes	no	read, punch, print
3525-P2	200	200 cards/min	yes	no	read, punch, print
3525-P3	300	300 cards/min	yes	no	read, punch, print
5425-A1	250	60 cards/min	yes	no	none
5425-A2	500	120 cards/min	yes	no	none

- ① 800 If 51-column interchangeable read feed feature is installed.
- ② With read feature installed.
- ③ 265 cards per minute punching columns 1-10; 91 cards per minute punching all 80 columns.
- ④ 260 cards per minute punching columns 1-10; 91 cards per minute punching all 80 columns.
- ⑤ 173 cards per minute punching columns 1-10; 65 cards per minute punching all 80 columns.

Figure 7-66. Comparison of Characteristics of System/370 Card Devices

Punched Tape Devices

1017 Paper Tape Reader Models 1 and 2

1018 Paper Tape Punch

2826 Paper Tape Control Unit Model 1

The IBM 1017 Paper Tape Reader (Figure 7-67) reads 5-, 6-, 7-, and 8-track paper tape and laminated polyester tape at a rate of up to 120 characters per second. Tape width is 11/16 inch for 5-track telegraphic code, 7/8 inch for 6- and 7-track codes (including 6-track advanced feed hole and Japanese format), and 1 inch for 8-track codes. Reading and backspacing are program-controlled on a character-by-character basis. Bit configurations transmitted correspond directly with character hole patterns read. Any code translation must be performed by the program after characters have been read into main storage. Parity checking (odd, even, or none) is determined by a switch on the operator panel.

The 1017 Model 1 reads strips of tape only. The Model 2 is equipped with a reeler, for reading both tape strips and reeled tape.

The IBM 1018 Paper Tape Punch (Figure 7-68) punches 5-, 6-, 7-, and 8-track paper tapes and most laminated polyester tapes at a speed of up to 120 characters per second. Tape width is 11/16 inch, 7/8 inch, or 1 inch. Three punching options are available:

- Standard punching (5-, 6-, 7-, or 8-track)
- Advanced feed hole punching (6-track)
- Japanese tape punching (6-track)

Punching is program-controlled on a character-by-character basis. Character hole patterns punched correspond directly to bit configurations transmitted. Any code translation must be done by programming before characters are transferred for punching. Backspacing capability is available as a part of the error correction special feature and

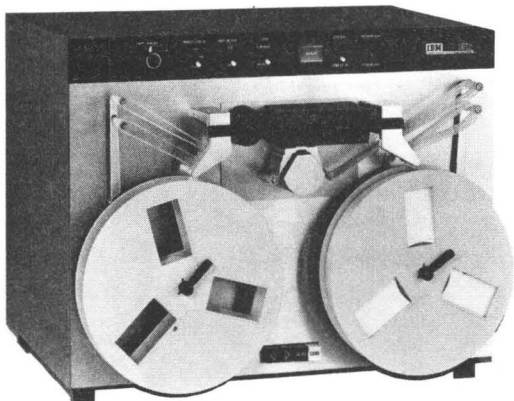

Figure 7-67. IBM 1017 Paper Tape Reader

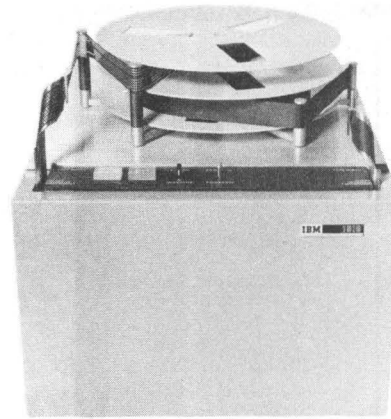

Figure 7-68. IBM 1018 Paper Tape Punch

is program-controlled. The standard 1018 punches strips of tape from a supply roll on top of the machine. The take-up mechanism (special feature) allows winding of tape on a take-up reel on top of the supply reel.

The 1017 and the 1018 can be attached to the 2826 Paper Tape Control Unit (Figure 7-69). The 2826 attaches to the byte multiplexer channel of System/370. Input records can be separated by an end-of-record (EOR) character. Any character not used for other purposes can serve as an EOR character. The character to be recognized during read operations as the EOR character is determined by the setting of eight toggle switches on the 2826 control panel.

The 2826 can control as many as two readers and two punches, all of which can operate simultaneously.

A special feature of the 2826, punch checking, in conjunction with the 1018's error correction feature, permits recognition and correction of parity discrepancies during punching operations.

2671 Paper Tape Reader

2822 Paper Tape Reader Control

The IBM 2671 Paper Tape Reader (Figure 7-70) photoelectrically reads strips of 5-, 6-, 7-, or 8-channel paper tape at a rate of up to 1,000 characters per second. Tape width is 11/16 inch (for 5-track telegraphic code), 7/8 inch (6- and 7-track codes), or 1 inch (8-track codes). Tape code translation is under program control.

Various switches on the 2671 provide operator convenience and program efficiency. Examples are: end-of-record indications, parity checking (odd, even, or none), track suppression, and transmission or nontransmission to the CPU of the indications of deleted positions on tape.

The paper tape reader and the 2822 Paper Tape Reader Control (Figure 7-70) are normally attached to System/370 through the byte multiplexer channel, but may be attached to another channel on some models (Figure 7-1).

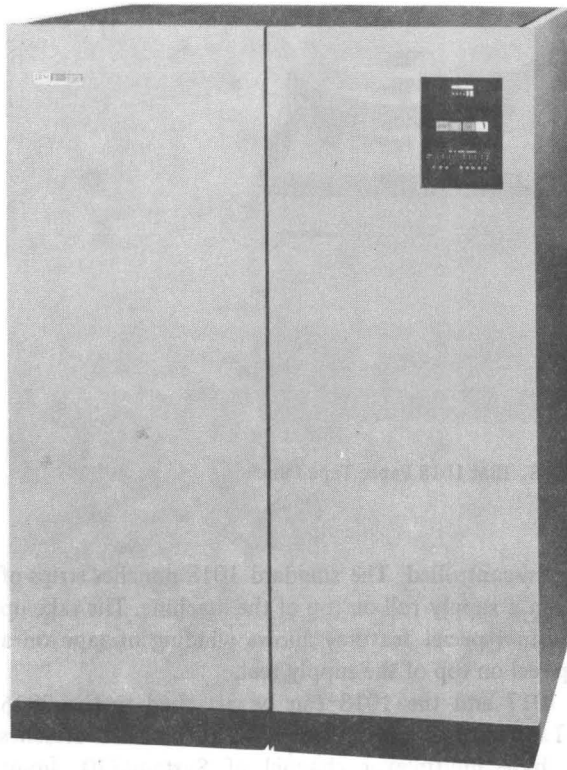

Figure 7-69. IBM 2826 Paper Tape Control Unit

The basic 2671 reads strips of paper tape from 9 inches to 20 feet in length, including a 6-inch leader and 3-inch trailer. Spooling facilities are optional. With the supply option feature, 10½-inch reels of paper tape can be fed (from the outside of the reel). If the optional center roll feeding feature is added, tape can also be fed from the center of 10½-inch rolls. With the take-up option feature, the tape can be rewound on 10½-inch reels.



Figure 7-70. IBM 2671 Paper Tape Reader and 2882 Paper Tape Reader Control

After acceleration time (about 8 milliseconds), the data rate reaches 1,000 characters per second for strips. With the spooling facilities, the data rate varies between 500 and 1,000 characters per second, depending on the length of a record.

The 2671 is especially designed for data communications, source recording, scientific data processing, and data acquisition.

Systems

2790 Data Communication System

The IBM 2790 Data Communication System may be attached to System/370 either locally or remotely. See the overview of 2790 in Section 8.

3270 Information Display System

The IBM 3270 Information Display System may be attached to System/370 either locally or remotely. See the overview of 3270 in Section 8.

3850 Mass Storage System

The IBM 3850 Mass Storage System (Figure 7-71) provides low-cost mass storage for as many as 472 billion bytes of data under the control of a virtual-storage System/370. Direct access device utilization is improved because only active data occupies direct access device space. The 3850 combines many of the advantages of tape and disk systems.

Data under control of the 3850 Mass Storage System is stored on data cartridges. When data is requested by System/370, it is transferred by the mass storage system from the cartridges to 3330 disk storage drives in a process called *staging*. Once data has been staged, it behaves the same way as any other data resident on a 3330 drive in terms of organization and accessing. After the data has been updated, it is *destaged* back onto the data cartridge.

The 3850 Mass Storage System is composed of two subsystems: the 3851 Mass Storage Facility and the 3330 Disk Storage Series (Figure 7-72). The 3851 provides the storage facility for data and the controllers and data recording devices to make data available to 3330 disk storage.

Standard features of the 3851 Mass Storage Facility include:

- Mass storage control
- Data recording devices and their associated data recording controls
- Storage cells for data cartridges
- Accessors and accessor controls
- Cartridge access station

The mass storage control coordinates the operation of the 3850 Mass Storage System.

The mass storage control

- Accepts requests for data from System/370 central processing unit.
- Maintains an inventory of data cartridges stored within the 3851 Mass Storage Facility to determine the location of data requested.
- Allocates space on 3330 disk storage drives for data to be staged.
- Allocates a data recording device to the data cartridge containing the requested data.
- Instructs the accessor to retrieve the data cartridge from its cell and load it into the data recording device.
- Initiates and monitors the staging/destaging operation.
- Performs error recovery procedures including alternate path retry and device reallocation for the staging/destaging operation.

The data recording devices and their associated data recording controls read and record data on cartridges.

The data cartridge is a plastic cylinder approximately 4 inches long and 2 inches in diameter. It contains a spool of

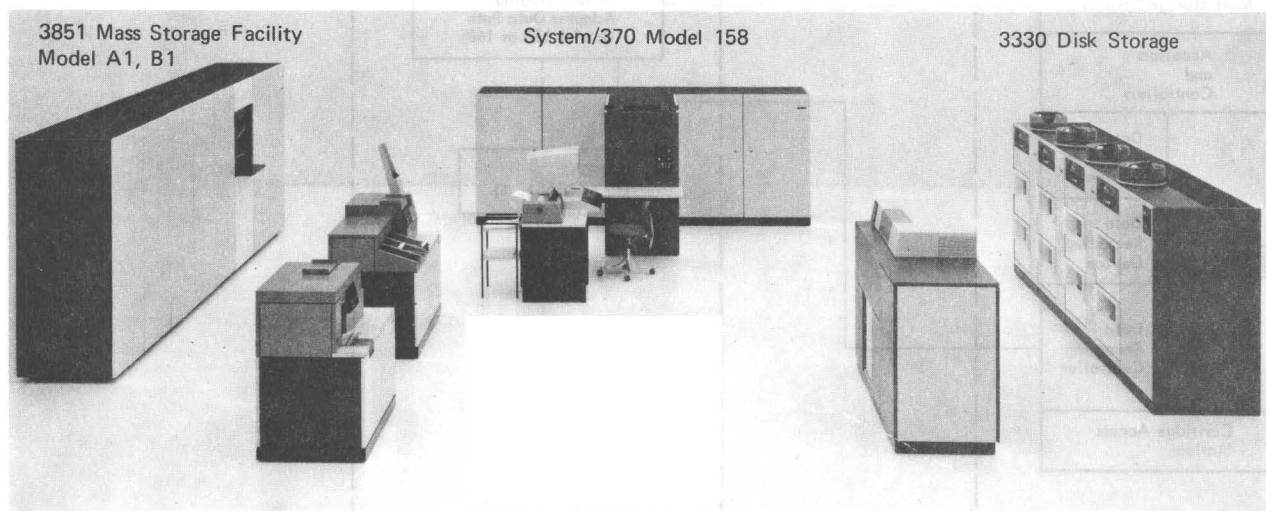

Figure 7-71. IBM 3850 Mass Storage System with 3851 Mass Storage Facility, System/370 Model 158, and 3330 Disk Storage

magnetic tape approximately 3 inches wide and 770 inches long. This spool is removed from the cartridge when it is loaded into a data recording device. Data is written on the magnetic tape in the form of 3336 Disk Pack (Model 1) images. Two cartridges equal the capacity of one 3336 Disk Pack (Model 1). A pair of cartridges is called a *mass storage volume*. Data cartridges reside in *cartridge storage cells*. Since all cartridges under control of the mass storage system are physically resident within the 3851 Mass Storage Facility, floor space required for storage can be greatly reduced.

Two accessors and their associated accessor controls move data cartridges from one location to another within the mass storage facility. Locations can be a storage cell, a data recording device, or the cartridge access station.

The cartridge access station permits manual entry and/or removal of data cartridges into and/or out of the mass storage facility.

The 3851 Mass Storage Facility has eight models, A1-A4 and B1-B4. Cartridge capacity and standard features vary according to the 3851 model. The A-series models each contain one cartridge access station, two accessors, and one mass storage control. The B-series models each contain one cartridge access station, two accessors, and two mass

storage controls. One mass storage control is the prime (active) control, the second is an alternate (backup) control. Storage capacity ranges from 706 cartridges (Models A1 and B1) to 4,720 cartridges (Models A4 and B4). The number of data recording devices increases from two in Models A1 and B1 to eight in Models A4 and B4.

Attachment of the 3851 to System/370 is via a byte or block multiplexer channel.

The 3330 Disk Storage Series subsystem makes data available to System/370 for processing. Components of this series are the 3830 Storage Control Model 3, the staging adapter special feature for the integrated storage controls on System/370 Models 158 and 168, the 3333 Disk Storage and Control Models 1 and 11, and the 3330 Disk Storage Models 1, 2, and 11.

The 3330 Disk Storage Series configuration is dependent on the 3851 configuration. A maximum of thirty-two 3330 disk storage drives can be attached to a 3830-3 or to each path of the integrated storage controls of a System/370 Model 158 or Model 168 with a staging adapter special feature installed. For 3330 Model 1 and Model 2, sixteen of these drives can be used as staging drives for the mass storage system. For 3330 Model 11, a maximum of eight of these drives can be used as staging drives.

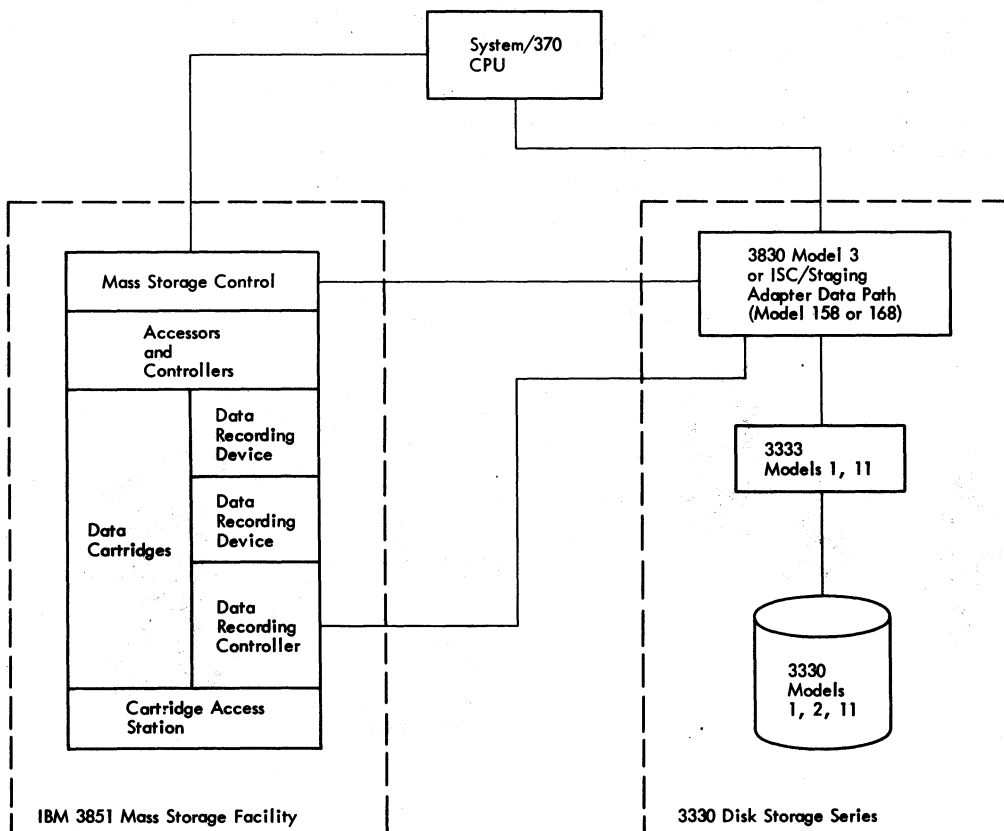

Figure 7-72. Logical Components of IBM 3850 Mass Storage System

Section 8. Teleprocessing Equipment

The following I/O devices and systems are remotely attachable online to System/370. The possible connections to System/370 are listed in Figure 8-1.

Audio Response Devices

7770 Audio Response Unit Model 3*

Data Terminal Devices

1001 Data Transmission Terminal
1013 Card Transmission Terminal
2740 Communication Terminal Models 1 and 2
2741 Communication Terminal
2780 Data Transmission Terminal Models 1-4
3735 Programmable Buffered Terminal
3767 Communication Terminal
3780 Data Communications Terminal

Data Transmission Multiplexers

2701 Data Adapter Unit*
3704 Communications Controller*
3705 Communications Controller*

Display Devices

2260 Display Station Models 1 and 2
2265 Display Station Model 1
2845 Display Control
2848 Display Control Models 1, 2, and 3

*Locally attached to a System/370 CPU, used to connect various terminals and/or control units to System/370.

3271 Control Unit Models 1, 2, 11, and 12
3275 Display Station Models 1, 2, 11, and 12
3277 Display Station Models 1 and 2

Modulator/Demodulator Devices

2711 Line Adapter Unit
3872 Modem
3874 Modem
3875 Modem

Systems

1030 Data Collection System
1050 Data Communication System
1060 Data Communication System
1070 Process Communication System
1130 Computing System
1800 Data Acquisition and Control System
2770 Data Communication System
2790 Data Communication System
3270 Information Display System
3600 Finance Communication System
3650 Retail Store System
3660 Supermarket System
3740 Data Entry System
3770 Data Communication System
3790 Communication System
5230 Data Collection System
System/3 Models 4, 6, 8, 10, 12, and 15
System/7
System/32
System/360 Models 20-195
System/370 Models 115-195

Terminal			Remote Attaching Unit	Local Attaching Unit *	Local System/370 Model										Block Multiplexer Channel UCV Assignment	
No.	Models	Name			115	125	135 (f)	138	145 (g)	148	155	158	165	168		195
1001	1	Data Transmission Terminal	-	7770	-	-	m	m	m	m	m	m	-	m	-	
1013*	1	Card Transmission Terminal	-	2701	m	m	bms	b _{uu}	bms	b _{uu}	b _m	b _m	bmsx	bmsx	bmsx	U
1030	-	Data Collection System	1031#	2701 3704, 3705 (a) 3705 (b)	m	m	bms	b _{uu}	bms	b _{uu}	b _m	b _m	bmsx	bmsx	bmsx	U
					-	-	bms	b _{uu}	bms	b _{uu}	b _m	b _m	bmsx	bmsx	bmsx	U
					i	i	-	-	-	-	-	-	-	-	-	-
1050	-	Data Communication System	1051#	2701 3704, 3705 (a) 3705 (b)	m	m	bms	b _{uu}	bms	b _{uu}	b _m	b _m	bmsx	bmsx	bmsx	U
					-	-	bms	b _{uu}	bms	b _{uu}	b _m	b _m	bmsx	bmsx	bmsx	U
					i	i	i	i	-	-	-	-	-	-	-	-
1060	-	Data Communication System	1061#	2701 3704, 3705 (a) 3705 (b)	m	m	bms	b _{uu}	bms	b _{uu}	b _m	b _m	bmsx	bmsx	bmsx	U
					-	-	bms	b _{uu}	bms	b _{uu}	b _m	b _m	bmsx	bmsx	bmsx	U
					i	i	-	-	-	-	-	-	-	-	-	-
1070	-	Process Communication System	1071#	2701	m	m	bms	b _{uu}	bms	b _{uu}	b _m	b _m	bmsx	bmsx	bmsx	U
1092*	1, 2	Programmed Keyboard	-	7770	-	-	m	m	m	m	m	m	-	m	-	
1093*	1, 2	Programmed Keyboard	-		-	-	-	-	-	-	-	-	-	-	-	
1130	-	Computing System	1131#	2701 3704, 3705 (a) 3705 (b)	m	m	bms	b _{uu}	bms	b _{uu}	b _m	b _m	bmsx	bmsx	bmsx	U
1800	-	Data Acquisition and Control System	Communication Adapter		-	-	bms	b _{uu}	bms	b _{uu}	b _m	b _m	bmsx	bmsx	bmsx	U
2260	1	Display Station	2848-3	2701 3704, 3705 (a)	m	m	bms	b _{uu}	bms	b _{uu}	b _m	b _m	bmsx	bmsx	bmsx	U
	2	Display Station	2848-1, -2		-	-	-	-	-	-	-	-	-	-	-	
2265	1	Display Station	2845	2701	m	m	i	i	-	-	-	-	-	-	-	
2740	1, 2	Communication Terminal	-	2701 3704, 3705 (a) 3705 (b)	m	m	bms	b _{uu}	bms	b _{uu}	b _m	b _m	bmsx	bmsx	bmsx	U
	1	Communication Terminal	-		-	-	bms	b _{uu}	bms	b _{uu}	b _m	b _m	bmsx	bmsx	bmsx	U
2770	-	Data Communication System	2772#	2701	i	i	i	i	-	-	-	-	-	-	-	
2780	1-4	Data Transmission Terminal	-	2701 3704, 3705 (a) 3705 (b)	m	m	bms	b _{uu}	bms	b _{uu}	b _m	b _m	bmsx	bmsx	bmsx	U
2790	-	Data Communication System	2715-2#		m	m	m	m	m	m	m	m	m	m	m	
3270	-	Information Display System	3271-1, -2#	3705 (b)	-	-	bms	b _{uu}	bms	b _{uu}	b _m	b _m	bmsx	bmsx	bmsx	U
3275	1, 2	Display Station	-	2701	i	i	i	i	-	-	-	-	-	-	-	
3270	-	Information Display System	3271-11, 12#	3704, 3705 (a)	m	m	m	m	m	m	m	m	m	m	m	
3275	11, 12	Display Station	-	3705 (b)	-	-	bms	b _{uu}	bms	b _{uu}	b _m	b _m	bmsx	bmsx	bmsx	U
3600	-	Finance Communication System	3601#	3704, 3705 (a) 3705 (b)	-	m	m	m	m	m	m	m	m	m	m	
3614	1, 2	Consumer Transaction Facility	-		-	-	bms	b _{uu}	bms	b _{uu}	b _m	b _m	bmsx	bmsx	bmsx	
3650	-	Retail Store System	3651-50#	3704, 3705 (a) 3705 (b)	-	m	m	m	m	m	m	m	m	m	m	
3660	-	Supermarket System	3651-60#		-	-	bms	b _{uu}	bms	b _{uu}	b _m	b _m	bmsx	bmsx	bmsx	
3735	1	Programmable Buffered Terminal	-	2701 3704, 3705 (a) 3705 (b)	m	m	bms	b _{uu}	bms	b _{uu}	b _m	b _m	bmsx	bmsx	bmsx	U
3740	-	Data Entry System	3741-2, 3747#		m	m	m	m	m	m	m	m	m	m	m	
3767	1, 2	Communication Terminal	-	3705 (b)	-	-	bms	b _{uu}	bms	b _{uu}	b _m	b _m	bmsx	bmsx	bmsx	U
					i	i	i	i	-	-	-	-	-	-	-	
					i	i	i	i	-	-	-	-	-	-	-	
3770	-	Data Communication System	-	3704, 3705 (a) 3705 (b) 3705 (c)	m	m	m	m	m	m	m	m	m	m	m	
					-	-	bms	b _{uu}	bms	b _{uu}	b _m	b _m	bmsx	bmsx	bmsx	U
					i	i	i	i	-	-	-	-	-	-	-	
3780	1	Data Communication Terminal	-	2701	m	m	bms	b _{uu}	bms	b _{uu}	b _m	b _m	bmsx	bmsx	bmsx	U
				3704, 3705 (a)	m	m	m	m	m	m	m	m	m	m	m	
				3705 (b)	-	-	bms	b _{uu}	bms	b _{uu}	b _m	b _m	bmsx	bmsx	bmsx	U
				3705 (c)	i	i	i	i	-	-	-	-	-	-	-	

Figure 8-1. Attachment Data for Remote I/O Devices and Systems (Terminals) (Part 1 of 2)

Data Transmission Multiplexers

Just as local cable-connected input/output devices require a control unit to interface their attachment to the system channels, devices that transmit over communications lines also require a control unit to perform interface matching, character assembly, and transmission control. In System/370 teleprocessing configurations, these functions may be performed by the IBM 2701 Data Adapter Unit and the IBM 3704 and 3705 Communications Controllers.

2701 Data Adapter Unit

The IBM 2701 Data Adapter Unit (Figure 8-2) provides for the online connection to System/370 of a variety of local and remote systems and devices. The connection can occur over private or common-carrier communications facilities (Figure 8-3).

Eight 2701's can be attached to a System/370 channel, each occupying one control unit position. With the second channel interface special feature, the 2701 can be attached to any other channel on the same CPU or to a channel on another CPU. This means that different terminal devices on the 2701 can operate via separate channels. However, the assignment of terminals to channels is permanent; once a terminal is assigned to a particular channel, it can operate only via that channel.

Each 2701 provides for the attachment of up to four half-duplex (two ways, alternately) asynchronous communications lines with line speeds up to 600 bits per second, or up to four (maximum of two operating simultaneously) half-duplex synchronous communications lines with line

speeds up to 230,400 bits per second, or up to four parallel data acquisition devices (word width of 16 to 48 bits). Various combinations of the data communications and data acquisition devices are possible within any given 2701.

All necessary bit-byte and word-byte conversions, interface matching, and data control for attaching specific terminal devices are accomplished by the functional sections of the 2701. Many optional features are available for further refinement in meeting user requirements.

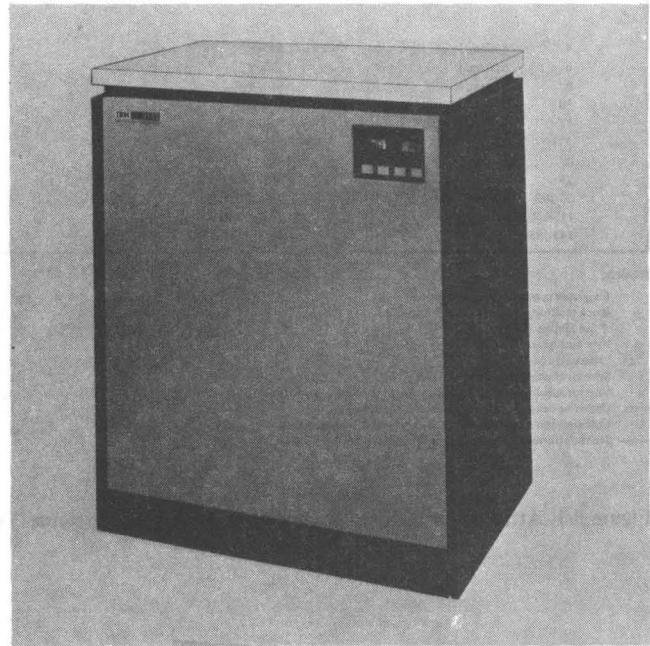

Figure 8-2. IBM 2701 Data Adapter Unit

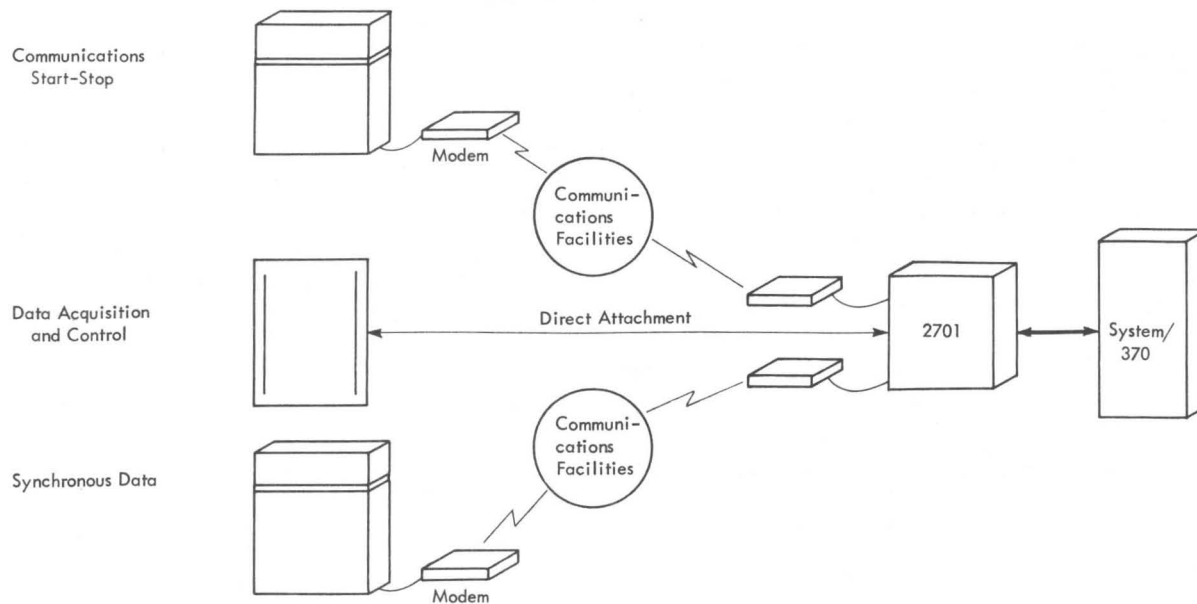

Figure 8-3. An IBM 2701 in a System Environment

Optional Features

Optional features available for the 2701 include:

Autocall, which provides automatic dialing capabilities on appropriate communications facilities.

Second Channel Interface, which provides for the attachment of a second channel to the 2701.

Dual Code, available only with binary synchronous communications (BSC) attachment features, which allows either of two codes to be program-selected.

Station Selection, which allows the 2701 with a BSC attachment feature to operate as a tributary station on a leased communications line.

Transparency, which provides the capability for a BSC attachment to transmit and receive 8-bit binary data as well as EBCDIC or ASCII codes, or 6-bit binary data as well as Six-Bit Transcode.

3704 Communications Controller Models A1, A2, A3, and A4

The IBM 3704 Communications Controller (Figure 8-4) is a modular programmable unit that provides expanded teleprocessing capabilities for System/370 users. Designed to be an evolutionary replacement for the IBM 2701 Data Adapter Unit, the 3704 can attach as many as 32 communications lines.

The 3704 consists of a single module that contains a control function, a control panel, a channel adapter for attachment to a System/370 CPU, a communications scanner, and required line attachment hardware for communications lines. This hardware permits the 3704 to communicate with a variety of teleprocessing devices.

This communications controller operates over common-carrier or equivalent customer-owned communication facilities at 45.5 bps to 50,000 bps. It is available in four models, representing various combinations of line and channel attachment hardware with storage capacities of 16K bytes to 64K bytes in 16K-byte increments. The 3704, with appropriate programming and the remote support feature, is able to operate as a remote network concentrator, collecting data from low-speed terminals and sending it at high speed to a System/370 CPU. Thus, the 3704 provides a high degree of flexibility in matching the requirements of a teleprocessing network.

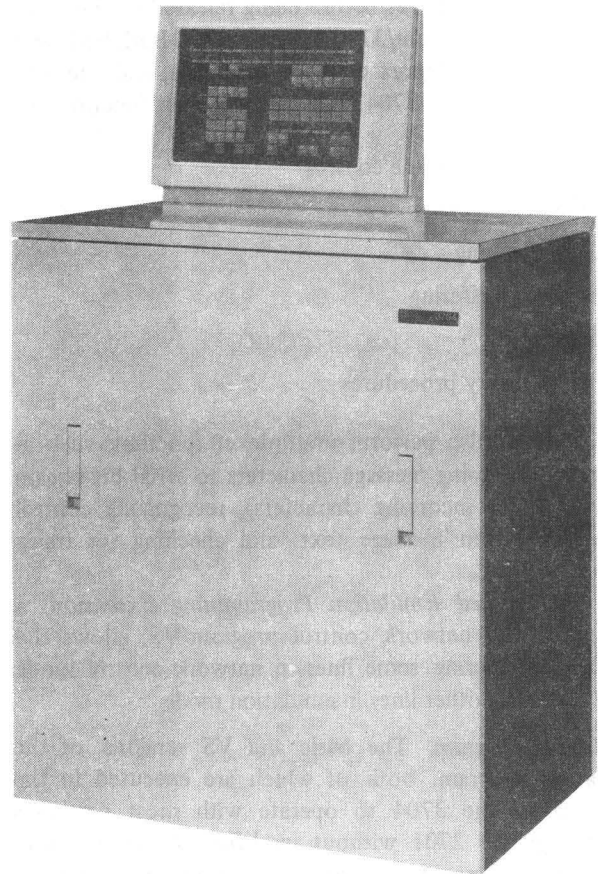

Figure 8-4. IBM 3704 Communications Controller

Prior to the 3704, many functions now being executed in the 3704 were performed by access methods in a central processing unit. When these teleprocessing functions are executed in the 3704, the CPU is freed to do more message processing and batch processing work.

Programming Support

Programming support for the 3704 includes a basic version and virtual storage (VS) version of both the network control program and the emulation program, as well as system support programs. When executing either version of the network control program, the 3704 requires only a single System/370 subchannel address, regardless of the number of communications lines attached. This represents a significant advantage over the 2701 Data Adapter Unit, which requires a separate subchannel address for each line.

Network Control Program: The basic and VS versions of the network control program, both of which are executed in the 3704, assume a major portion of line management and buffering responsibility. Characters are decoded and

Terminal			Remote Attaching Unit	Local Attaching Unit †	Local System/370 Model										Block Multiplexer Channel UCW Assignment			
No.	Models	Name			115	125	135 (1)	138	145 (2)	148	155	158	165	168		195		
3790	-	Communication System	3791#	{ 3704, 3705 (a) 3705 (b)	-	m	m	m	m	m	m (c)	m	m (c)	m	-	-		
					-	-	bms	bm	bms	bm	bm (c)	bm	bmsx (c)	bmsx	-	U		
5230	-	Data Collection System	5231#	→	i	i	i	-	-	-	-	-	-	-	-	-		
-	-	System/7	5010#	{ 2701 3704, 3705 (a) 3705 (b)	m	m	bms	bm	bms	bm	bm	bm	bmsx	bmsx	bmsx	U		
					-	m	m	m	m	m	m	m	m	m	m	-		
					-	-	bms	bm	bms	bm	bm	bm	bmsx	bmsx	bmsx	U		
					i	i	i	i	-	-	-	-	-	-	-	-		
-	-	System/32	5320#	{ 2701 3704, 3705 (a) 3705 (b)	m	m	bms	bm	bms	bm	bm	bm	bmsx	bmsx	bmsx	U		
					m	m	m	m	m	m	m	m	m	m	m	-		
					-	-	bms	bm	bms	bm	bm	bm	bmsx	bmsx	bmsx	U		
-	4	System/3	5404#	}	{ 2701 3704, 3705 (a) 3705 (b)	m	m	bms	bm	bms	bm	bm	bm	bmsx	bmsx	bmsx	U	
-	6	System/3	5406#			m	m	m	m	m	m	m	m	m	m	m	m	-
-	8	System/3	5408#			m	m	m	m	m	m	m	m	m	m	m	m	-
-	10	System/3	5410#			-	-	bms	bm	bms	bm	bm	bm	bmsx	bmsx	bmsx	U	
-	12	System/3	5412#			i	i	i	i	-	-	-	-	-	-	-	-	-
-	15	System/3	5415#			m	m	bms	bm	bms	bm	bm	bm	bm	bmsx	bmsx	bmsx	U
-	20	System/360	-			m	m	m	m	m	m	m	m	m	m	m	m	-
-	25	System/360	2701, 3704, 3705, i	m	m	m	m	m	m	m	m	m	m	m	m	-		
-	22-195	System/360	2701, 3704, 3705	m	m	m	m	m	m	m	m	m	m	m	m	-		
-	115-138	System/370	2701, 3704, 3705, i	-	-	bms	bm	bms	bm	bm	bm	bm	bmsx	bmsx	bmsx	U		
-	145-195	System/370	2701, 3704, 3705	i	i	i	i	-	-	-	-	-	-	-	-	-		

Symbols:

- i Integrated communications adapter.
- b Block multiplexer channel (housed within a 2880 Block Multiplexer Channel for Models 165-195).
- m Byte multiplexer channel (housed within a 2870 Multiplexer Channel for Models 165-195).
- s Selector channel (housed within a 2860 Selector Channel for Models 165-195).
- x Selector subchannel (special feature for 2870 Multiplexer Channel).
- bmsx Underline denotes preferred channel for attachment.
- U Unshared unit control word (UCW) assignment recommended.
- See the information in the "Local System/370 Model" columns.

- # Part of the remote system.
- † The local attaching units are:
2701 Data Adapter Unit
3704 Communications Controller
3705 Communications Controller
7770 Audio Response Unit Model 3
- Not applicable.
- * May not be available.

Notes:

- (a) 3705 equipped with a channel adapter type 1.
- (b) 3705 equipped with a channel adapter type 2 or type 3 (channel adapters type 2 and type 3 are mutually exclusive).
- (c) Attaches to Model 155 II or 165 II but not to Model 155 or 165.
- (d) 3767 equipped with Start/Stop.
- (e) 3770 equipped with SDLC/BSC Switch Control.
- (1) The 3135-3 has the same attachment capabilities as the 3138.
- (2) The 3145-3 has the same attachment capabilities as the 3148.

Figure 8-1. Attachment Data for Remote I/O Devices and Systems (Terminals) (Part 2 of 2)

assembled into messages before being released to the CPU, thus conserving System/370 CPU resources. Both basic and VS versions can support controls, terminals, and lines (up to 32) attached to a 3704, and perform such functions as:

- Communications line control
- Character checking
- Block checking
- Character buffering
- Polling
- Error-recovery procedures

Both versions also perform multiplexer functions such as converting outgoing message characters to serial bit stream (vice versa for incoming characters), recognizing control characters within message text, and checking for transmission errors.

The *Partitioned Emulation Programming Extension*, a feature of the network control program/VS, allows the program to operate some lines in network control mode while operating other lines in emulation mode.

Emulation Program: The basic and VS versions of the emulation program, both of which are executed in the 3704, allow the 3704 to operate with most programs written for the 2701 without modification. In addition, both versions provide an easy conversion path from the 2701 to the 3704. With either version, the 3704 can attach as many as 32 lines.

System Support Programs: These programs, which are executed in a CPU, generate control programs, load them into controller storage, and also dump controller storage.

3705 Communications Controller Models A1, A2, B1-B4, C1-C6, D1-D8, E1-E8, F1-F8, G1-G8, and H1-H8

The IBM 3705 Communications Controller (Figure 8-5) is a modular programmable control unit that can attach as many as 352 communications lines and requires only one channel interface to a System/370 CPU. It operates in asynchronous mode at 45.5 bps to 1200 bps, and in synchronous mode at 600 bps to 56,000 bps.

The 3705 consists of one to four modules that contain a central controller, storage, a control panel, one or two channel adapters for attachment to a System/370 CPU, one to four communications scanners, and the required hardware for attachment to communications lines. This hardware permits the 3705 to communicate with a variety of teleprocessing devices.

There are two versions of the 3705. The 3705-I has core storage with a cycle time of 1.2 microseconds and is available as Models A1 (16K) through D8 (240K) with storage housed in each module in quantities of one or two 32K-byte increments. The 3705-II has monolithic storage

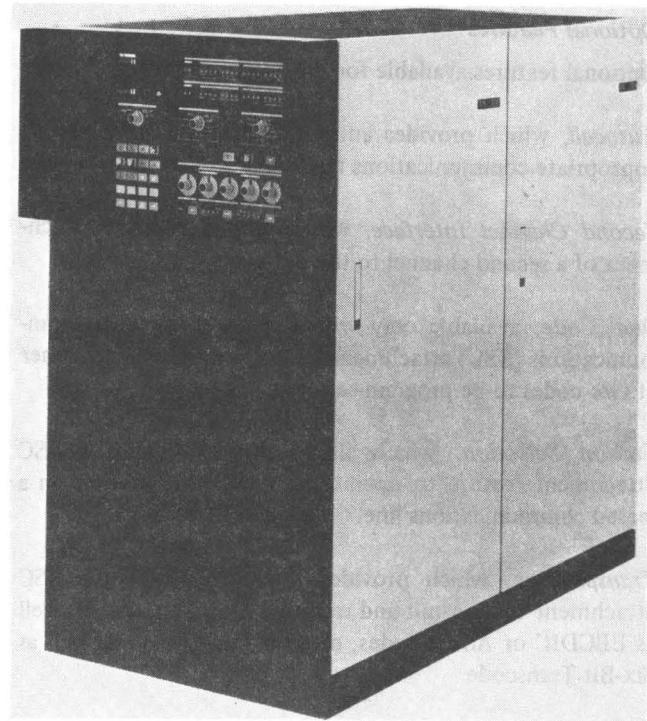

Figure 8-5. IBM 3705 Communications Controller

with a cycle time of 1.0 microsecond and is available as Models E1 (32K) through H8 (256K) with storage housed entirely in the first module.

The *Channel Adapter Type 3* feature (optional), with automatic two-processor switching capability for multiprocessor systems, helps to increase the accessibility of virtual multiprocessing systems, such as System/370 Models 158 MP and 168 MP. This feature allows a 3705 to operate simultaneously with two CPU's of a multiprocessing system.

The 3705, with appropriate programming and the remote support feature, is able to operate as a remote network concentrator, collecting data from low-speed terminals and sending it at high speed to the CPU. Thus, the activity of the 3705 can be closely matched to the requirements of a teleprocessing network.

Because teleprocessing functions generally require highest priority in a data processing system and demand a considerable amount of time and storage space, executing these functions in the 3705 frees the CPU to do more message-processing and batch-processing work.

Programming Support

Programming support for the 3705 includes a basic version and a virtual storage (VS) version of both the network control program and the emulation program, as well as system support programs. When executing either version of the network control program, the 3705 requires only a single System/370 subchannel address, regardless of the number of communications lines attached.

Network Control Program: The basic and VS versions of the network control program, both of which are executed in the 3705, provide the 3705 with its optimal capabilities. Both versions control terminals and lines (up to 352) attached to the 3705 and perform such functions as polling and addressing of stations, adding and deleting of framing characters around message text, and executing error-recovery procedures. Both versions also perform multiplexer functions such as converting outgoing message characters to serial bit streams (and vice versa for incoming characters), recognizing control characters within message text, and checking for transmission errors.

The *Partitioned Emulation Programming Extension*, a feature of the network control program/VS, allows the

program to operate some lines in network control mode while operating other lines in emulation mode.

Emulation Program: The basic and VS versions of the emulation program, both of which are executed in the 3705, allow the 3705 to operate with most programs written for the 2701, without modification. In addition, both versions provide an easy conversion path from the 2701 to the 3705. With either version, the 3705 can attach as many as 255 lines.

System Support Programs: These programs, which are executed in a CPU, generate control programs and load them into controller storage, and also dump controller storage.

Modulator/Demodulator Units

2711 Line Adapter Unit

The IBM 2711 Line Adapter Unit (Figure 8-6) attaches to System/370 processing units equipped with an ICA feature and to IBM 3704 and 3705 Communications Controllers. Each 2711 can contain as many as 32 line adapters. The IBM line adapters modulate and demodulate signals over communications facilities in a manner similar to that of the common-carrier data sets that would otherwise be needed to perform these functions. Use of the 2711 Line Adapter Unit with IBM line adapters in lieu of common-carrier data sets offers improved flexibility of system design and economy.

Three types of line adapters can be installed. They provide facilities for:

1. Communication over limited distances (8 miles or less).
2. Communication over privately owned or leased common-carrier facilities.
3. Simultaneous sharing of a voice-grade line by as many as four low-speed terminal lines. (Each low-speed line may be operated either point to point or multipoint.)

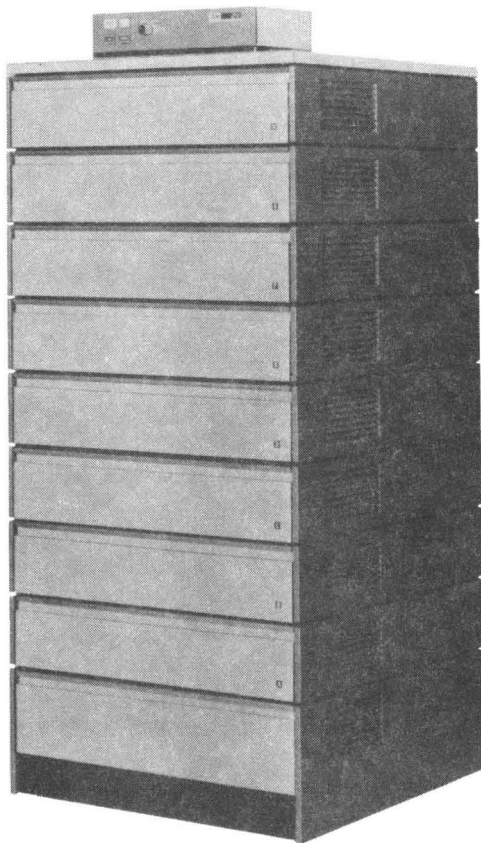

Figure 8-6. IBM 2711 Line Adapter Unit (with Maximum Number of Line Adapter Modules)

Functional Sections

The 2711 Line Adapter Unit contains two functional sections, the line adapter module and the line adapter.

Line Adapter Module: Each feature provides for the attachment of four line adapters. The basic 2711 can accommodate up to four IBM line adapters. If more than four are required, up to seven additional line adapter modules can be added to provide for a total of 32 line adapters per 2711.

Line Adapters: Line adapters serve as modems for use on appropriate communications facilities, permitting communication with similarly equipped IBM terminals.

3872 Modem

3874 Modem

3875 Modem

The IBM 3872 (Figure 8-7), 3874 (Figure 8-7.1), and 3875 (Figure 8-8) Modems comprise a family of synchronous modems with half-speed capability that provides teleprocessing products with the modulation/demodulation function required for transmitting data over common-carrier nonswitched voice-grade lines, equivalent privately owned nonswitched lines, or public switched telephone networks.



Figure 8-7. IBM 3872 Modem



Figure 8-7.1. IBM 3874 Modem



Figure 8-8. IBM 3875 Modem

These three modems can accommodate configurations which include point-to-point, multipoint, and switched network operation. The operator panel controls and indicators allow the operator to quickly localize problems by performing local and end-to-end testing.

Transmission may be full duplex, half duplex, or half speed. Speeds range from 2400 bps to 7200 bps: the 3872 transmits data at 2400 bps and 1200 bps half-speed, the 3874 transmits data at 4800 bps and 2400 bps half-speed, the 3875 transmits data at 7200 bps and 4800 bps half-speed. The three modems can be used with SDLC, BSC or IBM Type III line controls.

Optional features include:

Alternate voice, which provides signaling capability and a socket on the operator panel to plug in a handset for voice communication.

Fan-out, which allows attachment of up to three IBM teleprocessing machines at one location. This feature also allows up to three IBM multiplexers, or integrated communications adapters at a central site to share the same modem for backup purposes.

Audio Communications Devices

7770 Audio Response Unit Model 3

The IBM 7770 Audio Response Unit Model 3 (Figure 8-9), designed for operation with System/370, provides a composed audio response to digital inquiries from a 1001 Data Transmission Terminal, a telephone set, or other inquiry-type terminals. The spoken response is composed from an American English vocabulary prerecorded in a male or female voice on a magnetic drum within the 7770. The response is transmitted over appropriate common-carrier communications facilities back to the inquiring terminal. When the 7770 is operating in conversational mode, the inquiry-response sequence may be repeated any number of times without redialing the 7770.

To make an inquiry of the 7770, the calling party enters a series of characters from his terminal. The 7770 passes these characters one by one via the byte multiplexer channel to the System/370, which processes the inquiry and sends a response message back, character by character, to the 7770. This response message is a series of drum word addresses that the 7770 uses to select the proper words for its spoken reply. There is no limitation on the length of the inquiry or of the response.

The 7770 Audio Response Unit Model 3 attaches to System/370 via the byte multiplexer channel. Each 7770 occupies one control-unit position and requires one byte multiplexer subchannel for each communications line. The basic 7770 handles four half-duplex, voice-grade communications lines, but this capacity can be expanded in four-line increments to 48 lines. Random inquiries on all input/output lines can be responded to simultaneously. All data sets must be provided by a common carrier.

Each 7770 comes with a 32-word vocabulary that can be expanded in 16-word increments to a maximum of 128 words. Vocabulary words may be specified by the user according to message requirements. However, lengthy words must be split and will count as two words. The vocabulary can be changed at any time by removing the drum and replacing it with another having a different vocabulary. One word of each user vocabulary must be silence.

Special Features

I/O Line Expander: Each I/O line expander feature provides for four additional input/output lines. A maximum of 11 of these features is allowed.

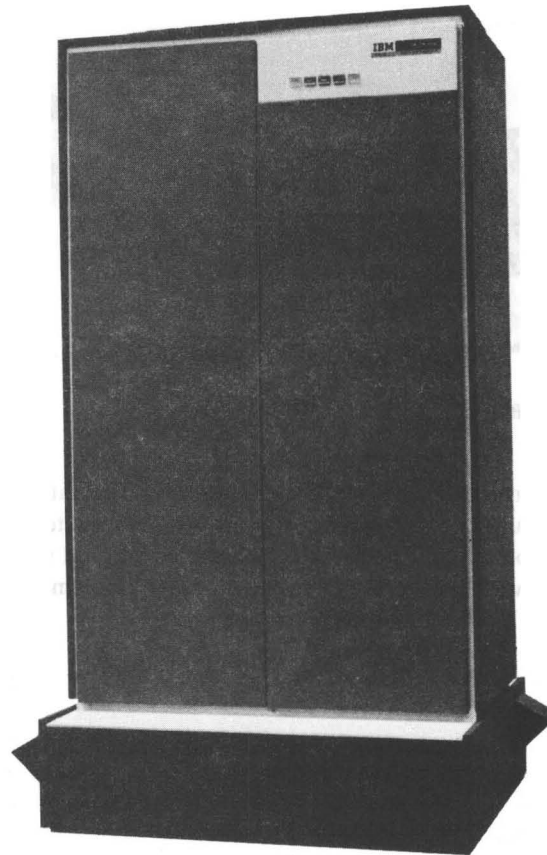

Figure 8-9. IBM 7770 Audio Response Unit

I/O Line Frame: This feature provides an additional frame when the number of input/output lines exceeds 16.

I/O Line Panel: An I/O line panel is required for each group of eight input/output lines or portion thereof added beyond the first eight lines. A maximum of five panels is allowed.

Additional Vocabulary Words: Increments of 16 words may be added up to the maximum of 128 words.

End of Inquiry (EOI) Disable: Allows EOI character on pushbutton telephones to be used as a data character instead of an EOI character.

Data Terminal Devices

1001 Data Transmission Terminal

The IBM 1001 Data Transmission Terminal (Figure 8-10) is a combination punched card and keyboard unit used for direct transmission to a 7770 Model 3 Audio Response Unit. The audio response unit is, in turn, connected to System/370 via a byte multiplexer channel. The 1001 transmits at 12 characters per second over common-carrier nonswitched communications lines, common-carrier switched telephone networks, or privately owned voice-grade facilities. The connection between the 1001 and the audio response unit is established by dialing a telephone.

2740 Communication Terminal Models 1 and 2

The IBM 2740 Communication Terminal (Figure 8-11) features a SELECTRIC® typewriter appropriately modified for use as a general-purpose communication terminal. Thus, the 2740 can function alternately as a typewriter (local mode) or as a data sending and receiving unit (communicate mode).

Data is transmitted in half-duplex mode over the attached communications lines. The maximum transmission rate is 14.8 characters per second for the 2740-1 and 60 characters per second for the 2740-2. Effective transmission rates may be less, because varying typing speeds affect the 2740-1 operating speed. Special features available for the 2740-2 may also increase or decrease the transmission rate. In either mode, the 2740 can be operated by any typist with a minimum of additional training. System control keys and indicator lights are conveniently located alongside the typewriter keyboard.

The 2740 is available in two models. The 2740-1 can communicate with other 2740-1 terminals directly or with



Figure 8-11. IBM 2740 Communication Terminal Model 1

System/370; the 2740-2 is designed exclusively for communication with System/370.

The types of operation that can be specified for the 2740-1 are:

1. Between two terminals over either leased common-carrier private lines or common-carrier switched networks.
2. Between a terminal and a System/370 over the above-mentioned facilities.

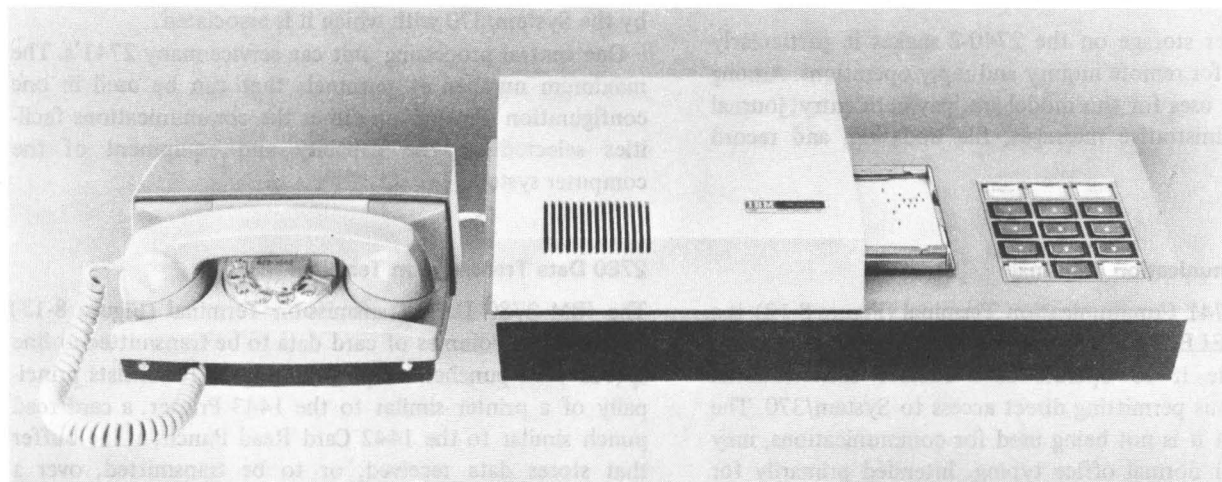

Figure 8-10. IBM 1001 Data Transmission Terminal

3. Between a terminal and two or more other terminals over leased common-carrier private lines.
4. Between a System/370 and two or more terminals over leased common-carrier private lines.

When the 2740-1 is operating in communicate mode, each message character keyed at the sending terminal is printed at both the sending and receiving terminals. The 2740-2 is designed to enable the key input from the typewriter keyboard to be printed at the sending terminal, stored in a buffer, and subsequently transmitted to a System/370.

The buffer storage on the 2740-2 provides improved operation through:

Faster transmission to and from the CPU buffer.
 Visual verification before transmission.
 Easier correction of keying errors.

Some of the many applications for which the 2740-1 is designed are:

Intracompany Communication: Internal communication between company departments can be easily handled with the 2740-1.

Intercompany Correspondence: To aid in sales and to expedite customer orders, a 2740-1 can be installed in the purchasing department of major customers.

Executive Correspondence: Effective two-way communications can be easily maintained between the executive offices and the sales or manufacturing locations by using the 2740-1.

Remote Inquiry and Reply: Using the 2740-1, persons having access to a central processing unit can handle inquiry and reply operations without leaving their department areas.

The buffer storage on the 2740-2 makes it particularly well-suited for remote inquiry and reply operations. Among the specific uses for this model are: payment entry, journal entry, administrative messages, file updating, and record renewal.

2741 Communication Terminal

The IBM 2741 Communication Terminal (Figure 8-12) is a modified SELECTRIC® typewriter with electronic controls that enable it to operate as a remote conversational terminal, thus permitting direct access to System/370. The 2741, when it is not being used for communications, may be used for normal office typing. Intended primarily for text-handling and scientific applications, the 2741 Communications Terminal permits persons at remote points to



Figure 8-12. IBM 2741 Communication Terminal

utilize the problem-solving capability of the System/370 on a time-sharing basis. Some of the uses of the terminal are:

Online scientific computation.
 Online computer programming.
 Text handling (especially technical writing, proposal writing, and editing).

The 2741, considered by itself, is a typewriter capable of encoding the characters typed and presenting the signal to a communications channel. Therefore, the applications of this terminal are mostly determined by the program used by the System/370 with which it is associated.

One central processing unit can service many 2741's. The maximum number of terminals that can be used in one configuration depends on either the communications facilities selected or the capacity and equipment of the computer system.

2780 Data Transmission Terminal

The IBM 2780 Data Transmission Terminal (Figure 8-13) enables large volumes of card data to be transmitted at line speeds with punched or printed output. It consists principally of a printer similar to the 1443 Printer; a card read punch similar to the 1442 Card Read Punch; a line buffer that stores data received, or to be transmitted, over a communications line; and a binary synchronous adapter, which controls the flow of data over the communications

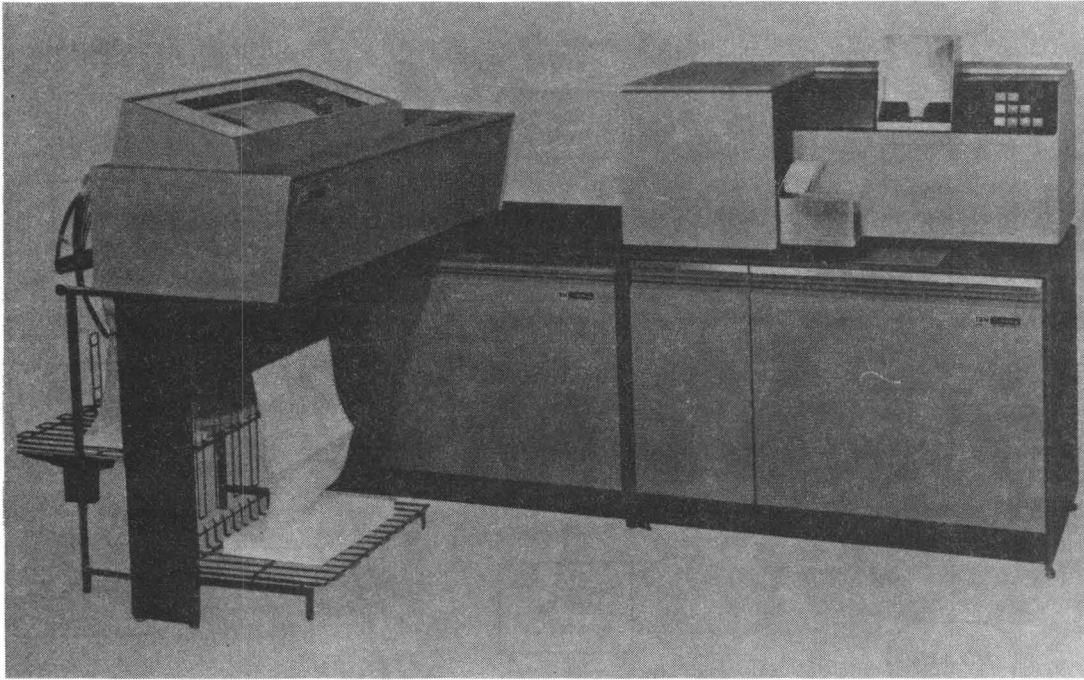

Figure 8-13. IBM 2780 Data Transmission Terminal

lines and maintains synchronization between the transmitting and receiving terminals.

The 2780, available in four models with any of three codes, permits a variety of system configurations. The four models are:

- Model 1—Card read or print
- Model 2—Card read or card punch or print
- Model 3—Print only (used as a receiving terminal only)
- Model 4—Card read or card punch

Models 1-3 print at a maximum speed of 300 lines per minute. The actual speed depends on the communications facilities used and the number of characters in the character set:

- 39-character set —300 lines per minute
- 47/52-character set—240 lines per minute
- 63-character set —200 lines per minute

Models 1, 2, and 4 read at a maximum speed of 400 cards per minute; each contains one card stacker.

Models 2 and 4 punch at a maximum speed of 355 cards per minute.

The actual throughput speed of the card read punch depends on the number of card columns that are read or punched, the code used, and the communications facilities selected.

The 2780 can also be used offline to perform a card-reader-to-printer listing operation. The 2780 is capable of operating with any one of three code structures. The

choice depends on the application. However, for system compatibility, the same code must be chosen for all terminals on a particular communications line. The three available codes are: the six-bit transcode (six-bit transmission code), EBCDIC (extended binary coded decimal interchange code), and ASCII.

The communication can be point to point with another 2780 (Figure 8-14), or it can be either point to point or multipoint (special feature) with the System/370 through a 2701 Data Adapter Unit (Figure 8-15). The 2701 Data Adapter Unit must have a synchronous data adapter type II (SDA II). The 2780 operates in half-duplex mode over any of the following five communications facilities:

1. Common-carrier switched telephone network.
2. Common-carrier leased private line telephone service, either two-wire or four-wire.
3. Western Union class E channels.
4. Western Union class F channels.
5. Privately owned communications facilities.

3735 Programmable Buffered Terminal

The IBM 3735 Programmable Buffered Terminal consists of a specially designed keyboard coupled with an IBM SELECTRIC® II Printer (Figure 8-16). Under program control, the 3735 stores information generated during source-document preparation for later transmission to a central System/370. Typically, the Selectric keyboard

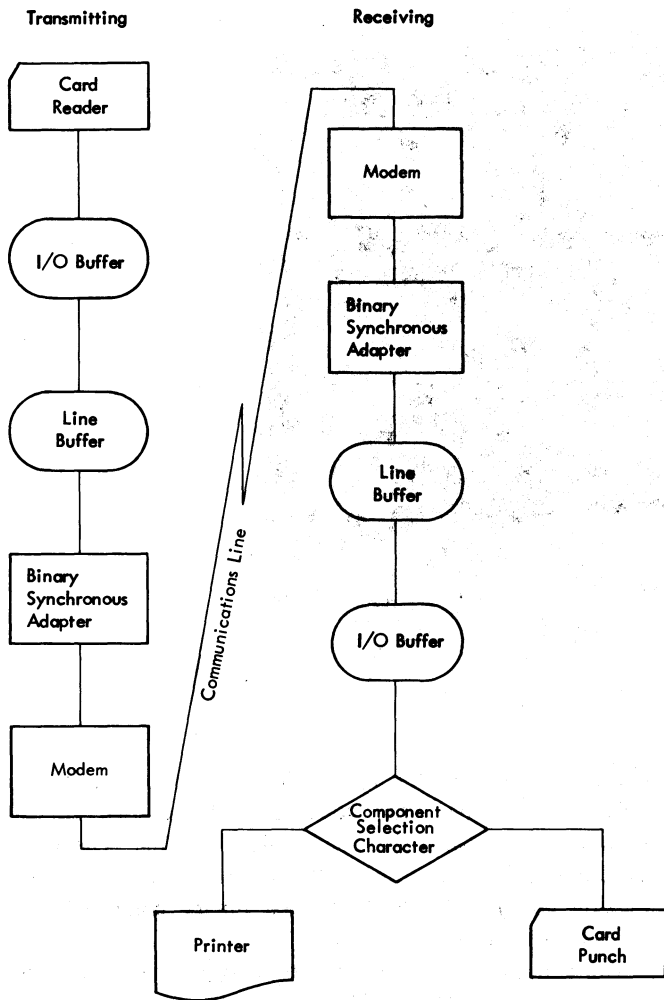

Figure 8-14. Data Flow, Terminal-to-Terminal Operation

printer prepares preprinted (fixed-format) forms and stores a full day's operator output for unattended transmission to the CPU, and the CPU can return data for use in the next day's operation.

In a typical installation, the 3735 can be used in an office for order entry, billing, inventory control, claims (related policies), or any accounting operations. During daily document preparation, the 3735 provides operator guidance (setup instructions, exception messages, indication of keying or procedural errors): programmed forms control (automatically positioning data within the predefined fields); format and edit operations (center, left/right justify, underline, character fill, decimal-comma insertion); logical decisions (conditional field skipping and entry); arithmetic operations (add, subtract, multiply, and divide); and power typing (automatic printing of information previously entered or internally generated).

A disk storage device within the control unit contains the terminal control program, form description programs, and user data storage. Basic storage capacity is about 62,800

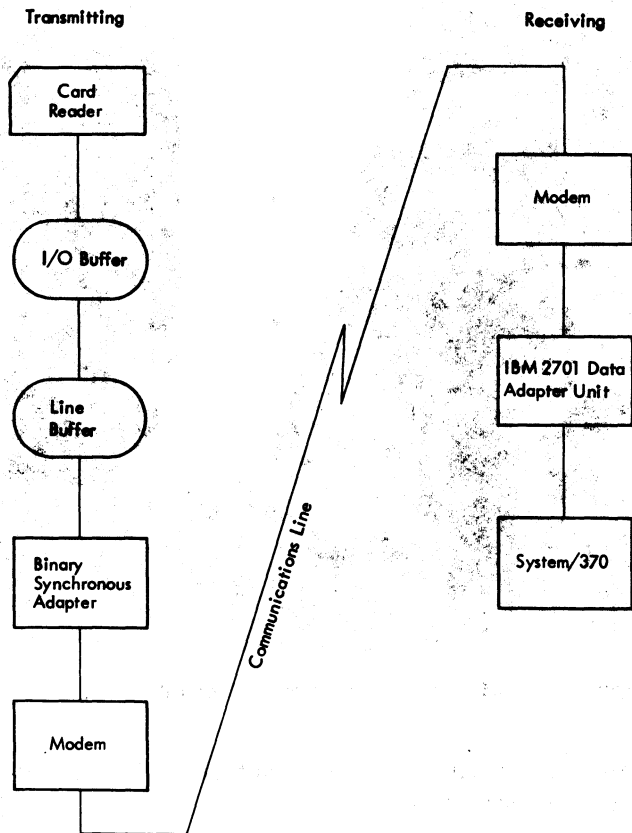

Figure 8-15. Data Flow, Terminal-to-Computer Operation

bytes. The storage capacity is expandable in three increments to a maximum capacity of approximately 314,100 bytes.

The 3735 uses the binary synchronous method of communications line control; thus it is compatible with most systems and programs using this method of line control. Transmission may be 1200, 2000, 2400, or 4800 bps.

Standard features include:

Switched Network Operation, which permits communications transfer through telephone lines normally used for dialed telephone calls.

Auto Answer, which permits transmission and reception of messages on an unattended basis.

Optional features include:

Synchronous Clock, for use with data sets that do not have an internal clock.

Keylock, a key-operated security switch on the control unit, which limits I/O operation of the keyboard/printer.



Figure 8-16. IBM 3735 Programmable Buffered Terminal

Forms Stacker, which permits placement of continuous forms (out of carton) on the stand above floor level, and provides for forms stacking after printing.

Multipoint Data Link Control, which allows multiple 3735's to be used on the same communications line with a CPU.

5496 Attachment, which permits a 3735 to attach to an IBM 5496 Data Recorder.

3767 Communication Terminal

The IBM 3767 Communication Terminal (Figure 8-17) is a compact, movable, desk-top terminal that furnishes access

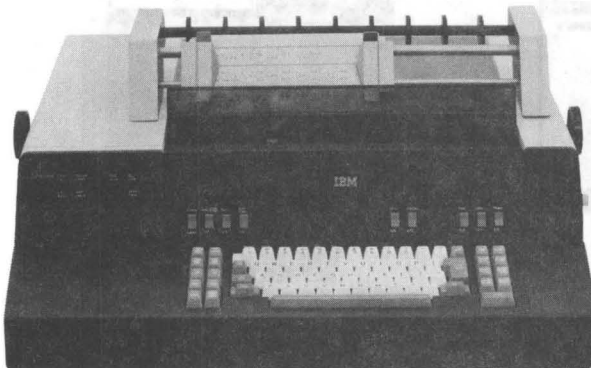

Figure 8-17. IBM 3767 Communication Terminal (Design Model)

to a remote IBM System/370 via SNA (systems network architecture). To provide a migration path from start-stop to synchronous data link control (SDLC), the 3767 offers special start-stop features for 2741, 2740 Model 1, or 2740 Model 2 support. If a start-stop feature is installed, a switch allows selection between start-stop and SDLC line control, for connection to a corresponding start-stop or SDLC multiplexer port.

Some of the online uses of the 3767 are:

- Computer programming
- Data entry
- Data base inquiry and update

When it is not communicating with System/370, the 3767 may be used for normal secretarial typing.

The IBM 3767 is available in three models, with standard characteristics as follows:

Model	Printing Rate (Characters per second)	Buffer Size
3767-1	40 cps average	512 bytes optional
3767-2	80 cps maximum	512 bytes basic
3767-3	120 cps maximum	512 bytes basic

Buffer expansion special features for up to 1,024 bytes are available for all three models.

Safeguards against unauthorized use of the terminal are provided by:

Security keylock (optional), which provides a key-operated switch.

Magnetic stripe reader (optional), which reads information from a magnetically striped and encoded ID card.

Print suppress (standard), which allows selected data fields to be entered without being printed.

Other features include:

Bidirectional printing (standard), which increases throughput by reducing the number of carriage returns.

Alternate character set (optional), which provides a switch control for printed graphics alternate to those selected by keyboard specification.

Calculate-scientific (optional), which, in offline mode under switch control and using the same keyboard, allows the following calculations to take place:

Addition	Exponential
Subtraction	Common logarithm
Multiplication	Natural logarithm
Division	Exponential constant
Inverse calculation	Circular constant
Square root	Trigonometrical functions
Statistical value	

Two memories are provided for temporary storage of totals.

3780 Data Communications Terminal

3781 Card Punch

The IBM 3780 Data Communications Terminal (Figure 8-18) enables batched card data or source programming data to be transmitted at line speeds with printed output for remote data transmission applications. The 3780 consists of a printer, a card reader, and two 512-character buffers with buffer checking. The buffers act as an interface between the communications line and the 3780 card reader and printer.

The 3780 is especially suited for industry, government, and private users such as:

- Educational institutions and systems
- Federal government supply depots
- State and local government functions requiring centralized control
- Hospital or shared-hospital accounting systems

The 3780 uses the binary synchronous method of communications line control; thus it is compatible with most systems and programs using this method of line control. Transmission may be 1200, 2000, 2400, 4800, or 7200/3600 bps.

Binary synchronous communications (BSC), with basic data link control, provides transmission checking and a choice of transmission codes. The choice depends on the application. However, for system compatibility, the same code must be chosen for all terminals on a particular communications line. The two available codes are the EBCDIC 256-character set and the ASCII 128-character set.

The 3780 operates in half-duplex mode via appropriate IBM modems over common-carrier or equivalent privately owned facilities. Private line channels may be half-duplex or duplex (required for speeds greater than 2400 bps), point-to-point or multipoint.

The 3780 prints 300 to 425 lines per minute with the printer providing 120 print positions, expandable to 144 positions. The actual print speed depends on the communications facilities used and the number of characters in the character set.

<i>Characters</i>	<i>Print Rate</i>
39-character set	425 lines per minute
52-character set	350 lines per minute
63-character set	300 lines per minute

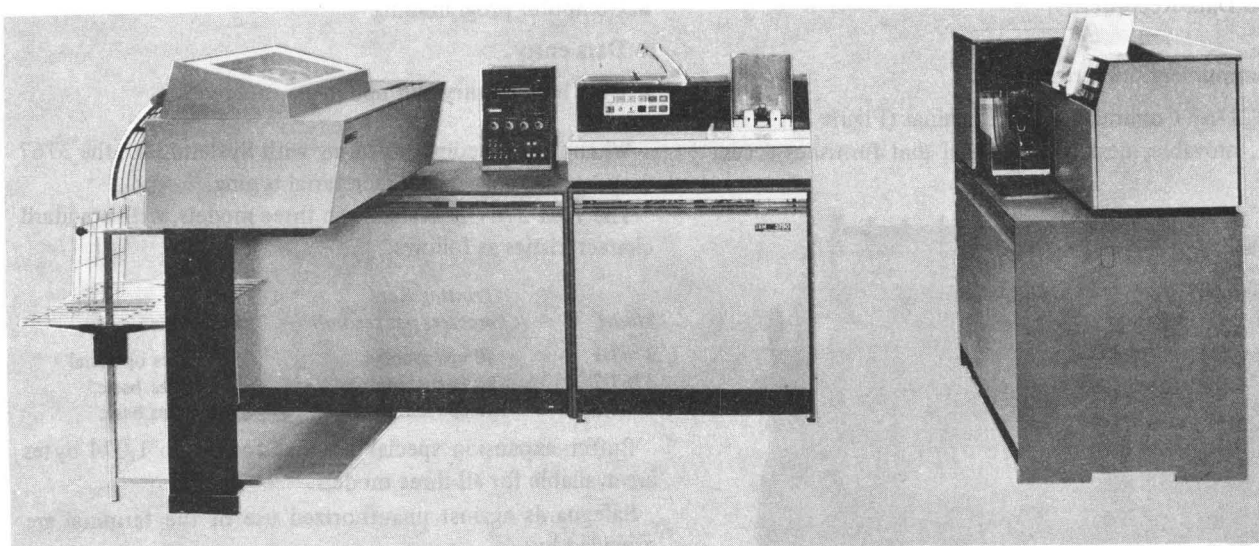

Figure 8-18. IBM 3780 Data Communications Terminal with IBM 3781 Card Punch

The card reader reads punched cards at rates as high as 600 cards per minute. The actual throughput speed of the card reader depends on the number of card columns that are read.

Standard features include:

- *Home mode*, which allows data read by the card reader to be printed but not transmitted over the communications line. When the terminal is operating in home mode, the binary synchronous communications (BSC) adapter monitors the line to determine if a remote terminal or processor desires to transmit to or receive from the 3780.
- *Conversation mode*, which improves line efficiency in applications where an immediate processor message to the 3780 is required in response to a message from the 3780 terminal.

Optional features include:

- The *integrated 2400/1200 bps modem*, which allows data to be transmitted at 2400 bps with 1200 bps backup over both public and private communications facilities.
- *EBCDIC transparency*, which allows the 3780 to receive and transmit all 256 EBCDIC bit combinations as data characters.

- *Multipoint data link control*, which enables multiple 3780's to be used on the same communications line with the CPU.
- The *print position* feature, which permits the printed output of the 3780 to use 144 print positions rather than 120.
- *Component selection*, which gives the 3780 the capability of attaching the 3781 Card Punch. This feature, which is compatible with other 3780 features and functions, provides the ability to select (1) I/O devices, (2) a multipoint data link control component, and (3) output data in accordance with predetermined priority.

3781 Card Punch

The 3781 Card Punch, which is attachable to the 3780, has a maximum punched card output of 160 columns per second, a 1,200-card hopper, a 1,300-card primary stacker, and a secondary stacker for error cards.

The output rate of the 3781, when all 80 columns are punched, is approximately 91 cards per minute. Throughput depends on the number of columns punched, the 3780 features used, and the communication facility used.

An *echo impulse check*, which causes incorrectly punched cards to be fed into a secondary stacker, is also provided. This feature allows the 3781 to make three attempts to punch a card correctly before terminating transmission.

Display Devices

2260 Display Station Models 1 and 2

2848 Display Control Models 1, 2, and 3

The IBM 2260 Display Station operates through the IBM 2848 Display Control in both local and remote applications. In remote applications, the 2848 communicates with a central System/370 installation via common-carrier communications facilities, a 2701 Data Adapter Unit, and appropriate data sets.

A choice of two data set adapters permits data transmission, in duplex mode, at 1200 or 2400 bits per second (120 or 240 bytes per second). The bytes include the start, stop, and check bits transmitted with each seven-bit character.

For more information about the 2260 and 2848, see "Display Devices," Section 7.

2265 Display Station

2845 Display Control

An IBM 2265 Display Station (Figure 8-20), coupled with an IBM 2845 Display Control, forms a display system that provides rapid visual access (via communications facilities) to data stored in a remotely located System/370. This display system is ideally suited to applications that require immediate data acquisition capabilities at a relatively low cost. Inquiries concerning an account, a transaction, or a

production schedule can be sent quickly and easily to a remote System/370 from the keyboard of the 2265. After computer processing, the desired visual data is displayed on the 2265 screen and can then be analyzed, modified if necessary, and, when desired, returned to the computer for further processing and storing.

The 2265/2845 display system is similar in function to the 2260/2848 display system and is fully compatible with those units. A possible 2265/2845 configuration is shown in Figure 8-21. Note that only one 2265 can be attached to a 2845.

The 2265 contains a 14-inch cathode-ray tube on which as many as 960 alphameric characters can be displayed. Two display formats are available: 15 lines with 64 characters per line (10.4-inch by 4.8-inch frame) and 12 lines with 80 characters per line (10.4 inch by 3.12 inch frame). The 2265 is equipped with an alphameric keyboard, which can be located up to 5 feet from the display screen.

A nondestructive cursor, an automatically inserted visual marker denoting the position on the 2265 screen that the next character to be entered will occupy, is standard on the 2265. It appears as \wedge immediately below the next character to be entered and may be moved about freely without interference to characters on the screen. The destructive cursor, an optional feature, appears on the screen as a heavy horizontal bar (—). When the destructive cursor is moved to a character position containing a character, the character is erased.



Figure 8-20. IBM 2265 Display Station with Alphameric Keyboard

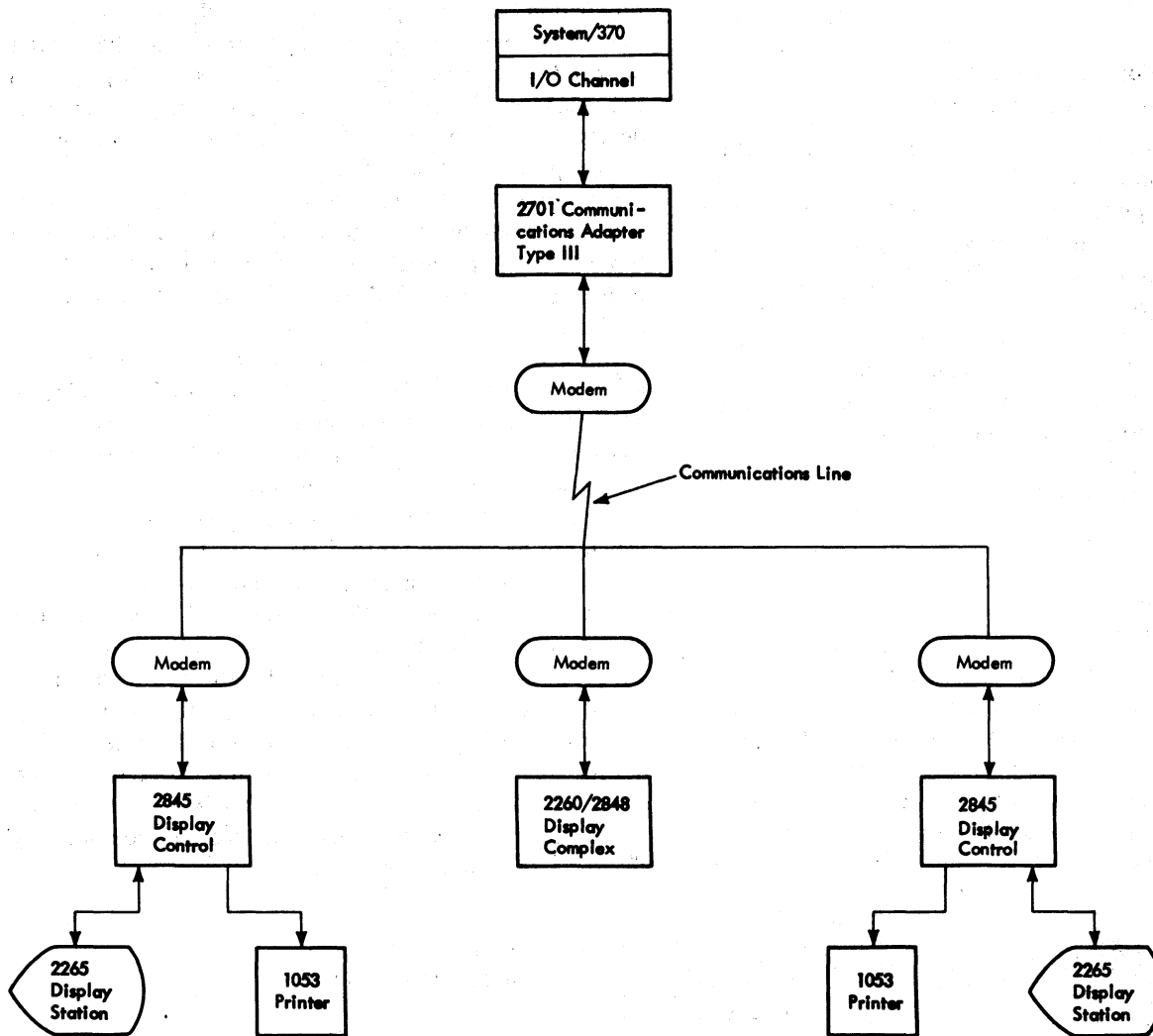

Note: A maximum of sixteen 2845's may be attached to the same communications line.

Figure 8-21. IBM Typical Connection on an IBM 2845 Display Control to a Remote CPU in a Multidrop (Multistation) Communication Network

The 2845 is designed for remote attachment to a System/370 I/O channel through a 2701 Type III Communications Adapter. The 2845 transmits data over ordinary leased telephone lines in stop/start, half-duplex mode at speeds of 1200 or 2400 bits per second. As many as sixteen 2845's may be attached to the same communications line.

An optional line addressing feature and a 1053 adapter feature are available. The line addressing feature permits the writing of a CPU-generated message to begin at the start of any chosen line. The 1053 adapter feature permits the attachment of a 1053 Printer Model 4 to a 2845 Display Control for obtaining paper copy of data sent from the CPU or displayed on the 2265 screen.

3275 Display Station Models 1, 2, 11, and 12

The IBM Display Station (Figure 8-22) is a remotely attached, standalone display station. For BSC (binary synchronous communications) operating mode, the 3275 Models 1 and 2 communicate with a System/370 via an integrated communications adapter, an IBM 2701 Data Adapter Unit, or an IBM 3704 or 3705 Communications Controller. For SDLC (synchronous data link control) operating mode, the 3275 Models 11 and 12 attach to System/370 via an IBM 3704 or 3705 Communications Controller.

The 3275 provides control and display of alphanumeric information on a CRT screen. The 3275 Model 1 or 11

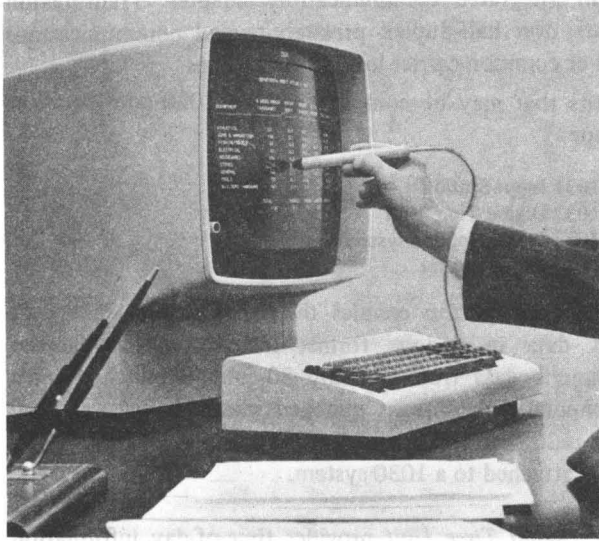

Figure 8-22. IBM 3275 Display Station

displays up to 480 characters in 12 lines of up to 40 characters each; Model 2 or 12 displays up to 1,920 characters in 24 lines of up to 80 characters each. The EBCDIC character set is basic; 3275 Model 1 or 2 has an optional ASCII character set.

The 3275 does not require a control unit, and is appropriate for locations requiring a single display device. Transmission rates for Models 1 and 2 are 2000 and 2400 bps, with 1200, 4800, or 7200 bps rates available as options. Transmission rates for Models 11 and 12 are 2000, 2400, 4800, or 7200 bps, with 1200 bps available as an option.

The 3275 may be multidropped on the same facility with other BSC devices as tributary stations on a multipoint line with System/370 as the control station.

Systems

1030 Data Collection System

The IBM 1030 Data Collection System (Figure 8-23) provides a fully integrated online data collection system, capable of operating within one plant or between plants. The various components of the 1030 system together form an effective management information system that diminishes the gap between the time when data is originated and the time when it becomes available for use. Some of the applications of the 1030 system include:

- Scheduling
- Dispatching
- Attendance reporting
- Inventory maintenance
- Labor distribution and performance

The 1030 system collects digital information from diverse reporting stations and transmits it at 60 characters per second to a central System/370 for recording, processing, and analyzing.

Connection to the System/370 is effected via a 2701 Data Adapter Unit, a 3704 or 3705 Communications Controller

or an integrated communications adapter. Transmission occurs over half-duplex privately-owned communications lines or common-carrier leased private lines.

Units that may be combined into a 1030 configuration include:

- IBM 1031 Input Station
- IBM 1032 Digital Time Unit
- IBM 1033 Printer (online systems only)
- IBM 1035 Badge Reader

1031 Input Station enables the 1030 system to accept input data in various forms; the system can accept alphameric data from standard 80-column punched cards and numeric data from punched plastic badges, manual entry units, and data cartridges. As many as 24 IBM 1031's can be attached to a 1030 system.

1032 Digital Time Unit provides time-of-day information for the entire data collection system.

1033 Printer provides online 1030 Data Collection Systems with printed output at locations remote from the central System/370. 1033 printers, in combination with 1031 input stations, offer full online inquiry and reply capabilities with the System/370 processing unit.

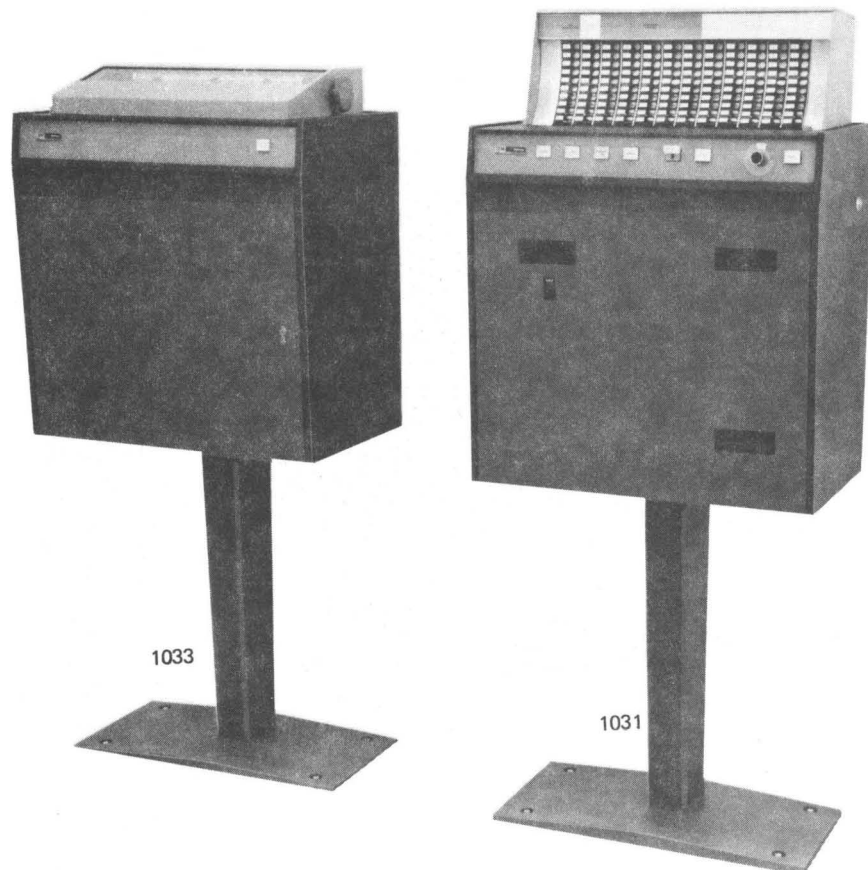

Figure 8-23. Units of an IBM 1030 Data Collection System: IBM 1033 Printer and IBM 1031 Input Station

1035 Badge Reader transmits numeric data at 60 characters per second from 22-column (card-stub size) badges via a 1031 Input Station. As many as four 1035's can be connected to a 1031. Functionally, the 1035 Badge Reader units can be thought of as providing an extension of the badge reading capability of the 1031 unit with which they are associated.

1050 Data Communication System

The IBM 1050 Data Communication System (Figure 8-24) is a multipurpose office-oriented teleprocessing system. This versatile system is designed for a wide range of applications in such industries as:

Transportation	Distribution
Manufacturing	Insurance
Research	Refining

In particular, the 1050 system can perform such functions as:

Document Writing of sales orders, insurance policies, pay-rolls, engineering specifications, etc.

Direct Inquiry and Response (real-time operation) with a central processing unit.

Remote Printing of business records and invoices, thus supplying to remote locations full documentation of business transactions.

Exception Reporting of data about work orders, credit ratings, inventory adjustments, traffic movements, etc.

Intracompany Communication to provide rapid distribution of memorandums, directives, administrative reports, etc.

The 1050 Data Communications System can be connected to System/370 via the 2701 Data Adapter Unit or the 3704 or 3705 Communications Controller. Transmission can occur at 14.8 characters per second in half-duplex mode over leased private, common-carrier switched, or privately owned telephone networks, and either directly between locations, through switching centers, or through message exchanges. The 1050 system is capable of simultaneous home-loop operation (local operation between units of the same 1050 configuration) and line-loop operation (over communications lines to another 1050 system or a System/370).

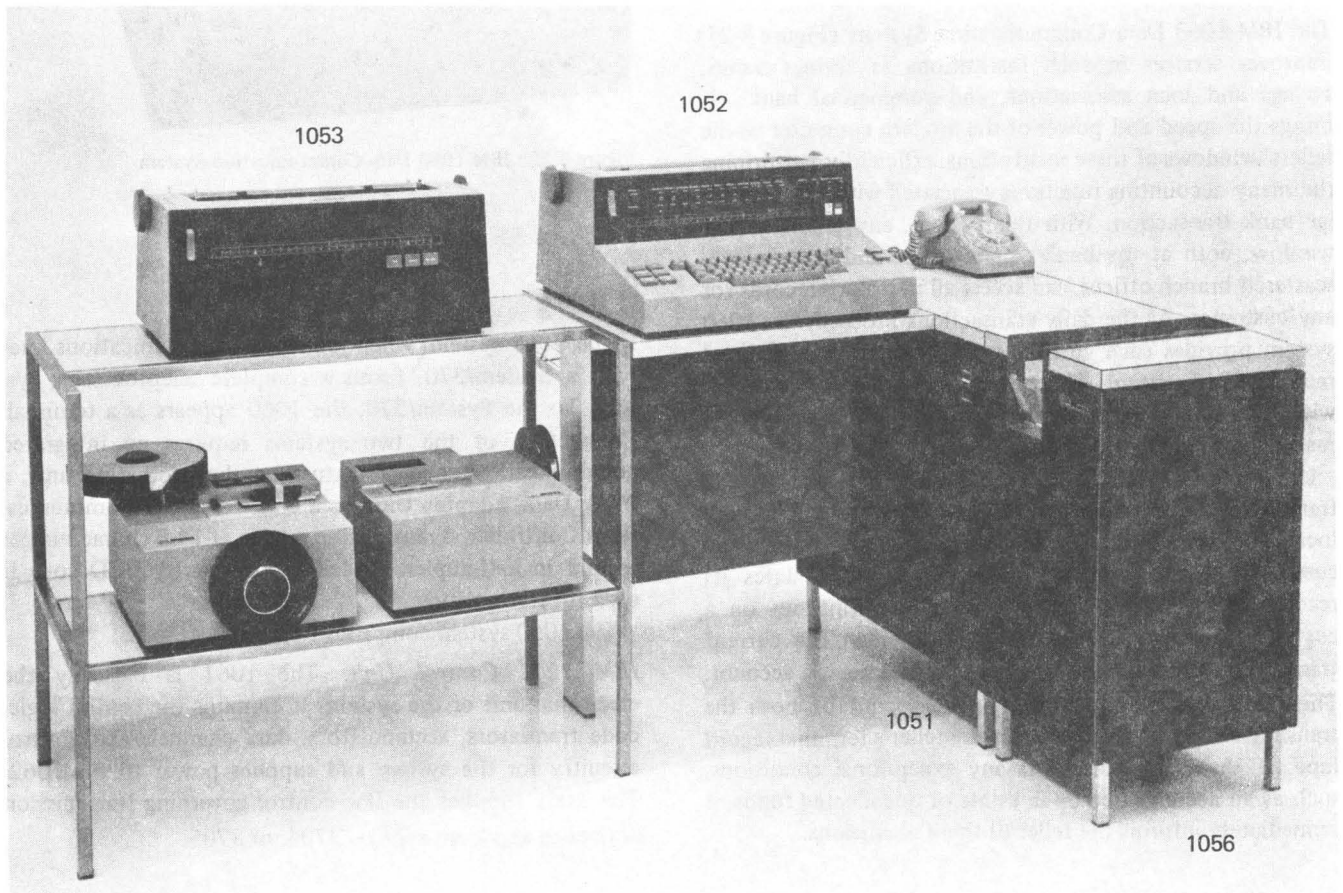

Figure 8-24. IBM 1050 Data Communication System

Data may be entered into the 1050 system by manual keying, by punched cards, by punched paper tapes, and by edge-punched documents. Output from the system may be printed documents, punched cards, punched paper tape, or edge-punched documents.

The versatility of the 1050 system is due in large part to the many configurations it may assume. The minimum configuration contains only an IBM 1051 Control Unit and a receive-only printer; configurations for a wider variety of uses may be designed from combinations of the following available components:

- 1051 Control Unit
- 1052 Printer-Keyboard
- 1053 Printer
- 1054 Paper-Tape Reader
- 1055 Paper-Tape Punch
- 1056 Card Reader
- 1058 Printing Card Punch
- 1092 Programmed Keyboard

The 1051 Control Unit is required in all configurations. It contains the power supply, code translator, data channels, and control circuitry for the 1050 system. All components are electrically connected through the control unit.

1060 Data Communication System

The IBM 1060 Data Communication System (Figure 8-25) improves services in such institutions as savings banks, savings and loan associations, and commercial banks. It brings the speed and power of the modern computer to the tellers' windows of these institutions, efficiently performing the many accounting functions associated with any particular bank transaction. With this system, any teller, at any window, both at the bank's main office and at its widely scattered branch offices, can access all necessary records for any customer. As the daily transactions proceed, the 1060 system provides each customer with an accurate, updated record of his account. The system also provides each teller with this same account information and continuously maintains his balance on hand.

Using the IBM 1062 Teller Terminal, a teller can key transaction information from his window to a remotely located System/370. After System/370 verifies the accuracy of the transmitted information and updates its records, it causes the teller terminal to print out on a customer's passbook any unposted interest, the current transaction amount, and the new balance in his account. The terminal also prints a complete record of both the transmitted and received data on the teller's terminal-record tape. If the system discovers any exceptional conditions, such as an account tied up in estate or uncollected funds, it immediately informs the teller of these conditions.

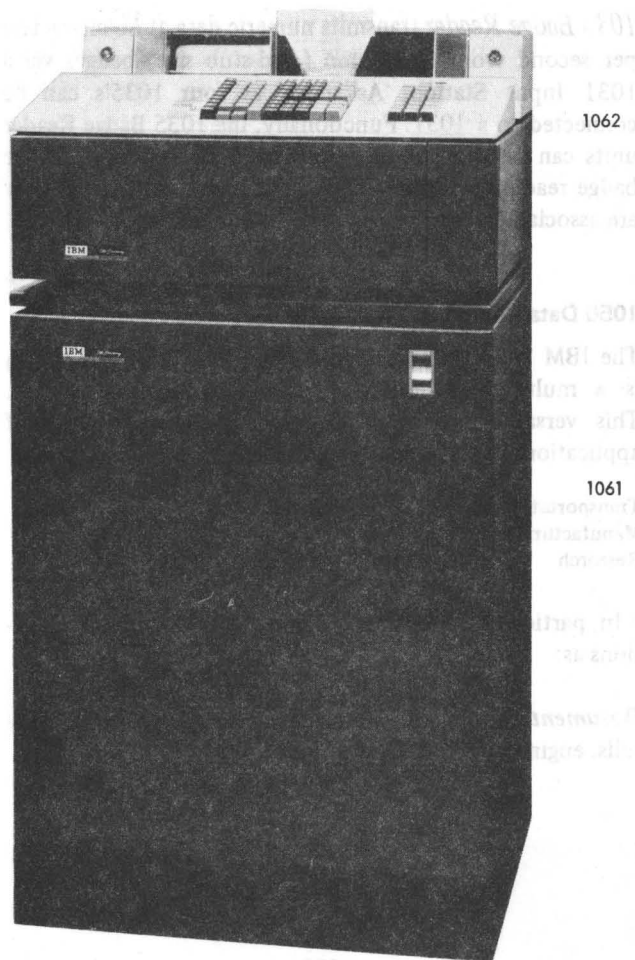

Figure 8-25. IBM 1060 Data Communication System

The 1060 system, when joined via communications lines with a System/370, forms a complete teleprocessing system. To the System/370, the 1060 appears as a terminal. Connection of the two systems requires an integrated communications adapter feature on the processing unit, a 2701 Data Adapter Unit or a 3704 or 3705 Communications Controller. Transmission occurs at 14.8 characters per second in half-duplex mode. An odd parity BCD code is used for transmission.

The 1060 system comprises two compact units:

IBM 1061 Control Unit: The 1061 is basically the electronic unit of the system. It contains the central logic, code translators, accumulators, data channels and control circuitry for the system and supplies power to the 1062. The 1061 supplies the line control governing transmission of data to and from a 2701, 3704, or 3705.

A 1061 Model 1 controls one 1062 Teller Terminal Model 1. A 1061 Model 2 controls one 1062 Model 1 and one 1062 Model 2 or, if the offline feature is installed, two 1062 Model 1's.

IBM 1062 Teller Terminal: The 1062 is basically the mechanical unit of the system. The 1062 contains a print unit, a terminal-record tape, a document feed, a keyboard, a program tape unit (Model 1 only), and various keys, lights and switches. Each 1062 terminal can serve two tellers.

1130 Computing System

The IBM 1130 Computing System, when equipped with a synchronous communications adapter, can function as a remote processor terminal to a centrally located System/370 and as a local standalone computer, and can easily switch from one function to the other.

The 1130 itself, a compact general-purpose system, is particularly easy to use. The person needing computer solutions to his problems can learn to use the system with a minimum of training and experience. In addition, IBM relieves the user of detailed programming and provides for the statement of problems in familiar language.

The basic system consists of an IBM 1131 Central Processing Unit (Figure 8-26) with an integral console printer and keyboard, and either punched card or paper tape I/O devices. The central processing unit (CPU) contains main storage, logic circuits, and attachment controls for the I/O devices. The 1131 uses a high-speed data channel for effective simultaneous operation of I/O devices. This unit features parallel arithmetic and indirect addressing, and has three index registers.

The I/O devices available to the 1130 include:

- 1055 Paper Tape Punch Model 1
- 1132 Printer Model 1 or 2
- 1134 Paper Tape Reader Model 1 or 2
- 1231 Optical Mark Page Reader Model 1
- 1403 Printer Model 6 or 7
- 1442 Card Punch Model 5
- 1442 Card Read Punch Model 6 or 7
- 1627 Plotter Model 1 or 2
- 2250 Display Unit Model 4
- 2310 Disk Storage Models B1 and B2
- 2311 Disk Storage Drive Model 11 or 12
- 2501 Card Reader Model A1 or A2

Operated as a remote processor terminal, the 1130 system (equipped with a synchronous communications adapter) can communicate with a System/370 over common-carrier-provided facilities or over privately owned facilities. Data communications are half-duplex and are transmitted at 600, 1200, 2000, 2400 or 4800 bits per second, the rate depending on what communications facilities are used. Common-carrier services for these communications may be either half-duplex or duplex.

2770 Data Communication System

The IBM 2770 (Figure 8-27) is a general-purpose terminal system designed for batched-data transmission as well as for inquiry-and-response communications. It transmits and receives data through a variety of input and output devices, and can communicate with System/370 via point-to-point and multipoint communications lines.

This terminal provides for transmission of bulk data via punched cards, punched tape, magnetic tape (IBM 50 Magnetic Data Inscribe cartridges), or magnetic-ink-encoded documents. For inquiry and data-entry applications, the 2770 uses a keyboard, display station, or printer.

Available to the system in different combinations are:

- 50 Magnetic Data Inscribe
- 545 Output Punch Model 3 (nonprinting) or 4 (printing)
- 1017 Paper Tape Reader Model 1 or 2
- 1018 Paper Tape Punch
- 1053 Printer Model 1
- 1255 Magnetic Character Reader Model 1, 2, or 3
- 2203 Printer Model A1 or A2
- 2213 Printer Model 1 or 2
- 2265 Display Station Model 2
- 2502 Card Reader Model A1 or A2
- 5496 Data Recorder

The 2770 uses an IBM 2772 Multi-purpose Control Unit to attach and control the different I/O devices, and to transmit data. This unit transmits data on telephone-grade lines at 1200, 2000, and 2400 bits per second, using binary synchronous communications (BSC) techniques. The 2772 can attach to a multipoint line facility with other BSC-equipped devices and systems, such as a 2780 Data Transmission Terminal, 1130 Computing System, or System/360 Model 20, using a System/370 as the control station for the multipoint network.

Among the 2770's standard features are an alphanumeric keyboard, two 128-character buffers, and an audible alarm (to alert the operator when intervention is required).

The 2770 system has applications in diverse areas of business, government, and private and public institutions. In a business operation for example, it may be used in management offices for data collection and for inquiry and display; in business offices for payrolls and accounting; in manufacturing plants for production and quality reports; in warehouses for shipping and receiving information and for parts inventory; and in sales offices for ordering, invoicing, and sales information.

Optional Features

Buffer Expansion doubles the capacity of the two buffers, which increases line efficiency.

EBCDIC Line Transparency enables the 2770 to send and receive control characters as data, negating their control function. This feature is required in some applications.

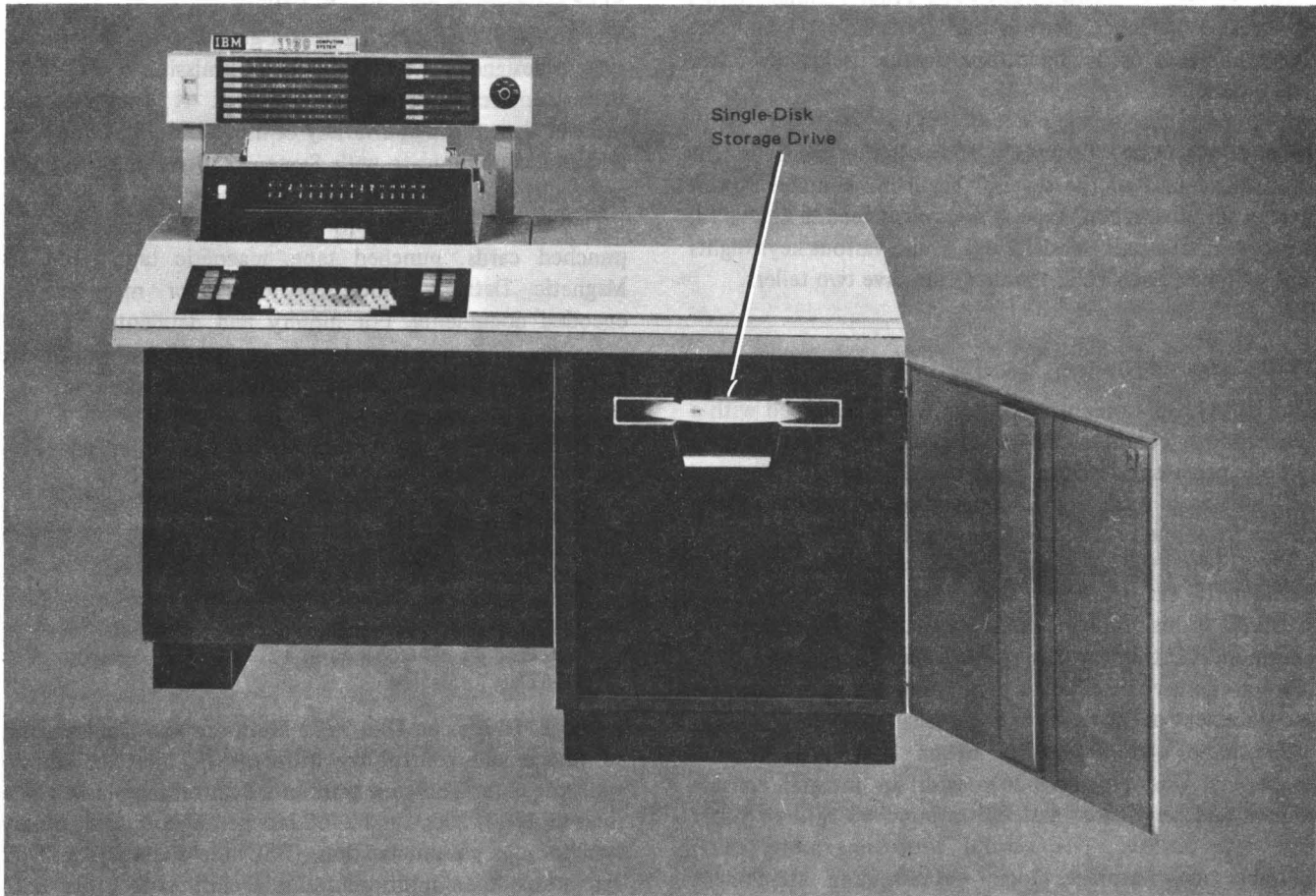

Figure 8-26. IBM 1131 Central Processing Unit Model 2A or 2B, with Single-Disk Storage Drive

Multipoint Data Link Control allows more than one 2770 to be connected to a multipoint line.

Identification allows a 2770 on a switched network to identify itself as a 2770.

Keyboard Correction provides for correcting keyed data in the buffer.

Automatic Answering permits automatic handling of incoming calls from a central computer or another terminal, over common-carrier switched facilities.

2790 Data Communication System

The 2790 Data Communication System (Figure 8-28) is a two-way data communication system designed to accommodate a large volume of short messages from many in-plant locations and from smaller groups of terminals at remote locations. It provides for rapid information transfer from 2795 or 2796 Data Entry Units (located at various plant sites) to 2791 or 2793 Area Stations, which connect

to a system controller and processor. The 2790 also provides for interrogation of a System/370.

In a typical application, the 2790 system can be used as a shop-floor control system to collect information on machine operations, work progress, stock status, material availability, and quality control. The area stations and 1035 Badge Readers can be used as a high-speed attendance-reporting system. The area stations can also be used to retrieve information stored in System/370.

The 2790 system, when attached to a System/370, can consist of various combinations of the following units:

- 2715 Transmission Control Unit (one)
- 2791/2793 Area Stations (up to 100)
- 2795/2796/2797 Data Entry Units (up to 32 per 2791 Model 1 or 2793, to a maximum of 1,024)
- 1035 Badge Readers (up to three per 2791-1)
- 1053 Printers (one per 2791-1 or 2793)
- 2740 Communication Terminal (one)
- 2798 Guidance Display Units (up to 12)
- Customer-provided digital devices

2715 Transmission Control Unit Models 1 and 2 provide terminal control, transaction assembly, data-entry checking, message routing, transaction storage, and transfer of data to and from a System/370. The 2715 Model 1 is used for local



Figure 8-27. IBM 2770 Data Communication System

operation with a System/370, and the 2715 Model 2 (with binary synchronous communications adapter) is used for remote operations.

The 2790 permits data entry through 2795, 2796, and 2797 Data Entry Units attached to 2791-1 or 2793 Area Stations. The 2791-1 permits data entry by punched card, employee badge, and key entry. A program-controlled display panel guides the operator in entering data, and a visual display panel permits verification of keyed data prior to transmission. (All these functions are also performed by the 2791-2).

Both the 2791-1 and 2793 can attach up to 32 data entry units and a 1053 Printer. The 2791-1, however, can also attach customer-provided digital read-in devices and up to three 1035 Badge Readers.

The 2795, 2796, and 2797 Data Entry Units are compact industrial units for reporting job and machine status and production information. Designed for use by production

employees at their work location, these units transmit up to 40 characters per second to the 2791 Model 1 or 2793 Area Station by way of a two-wire line.

The 2795, 2796, and 2797 are similar in that they permit data entry by punched card, badge, and ten-position code-selection dials. They differ in that the 2795 and 2797 have two dials compared to the 2796's four. They differ also in that the 2796 and 2797 both have manual entry—the 2796 via four rocker thumbwheel switches, the 2797 via a ten-key keyboard with six-digit visual display.

The 2798 Guidance Display Unit is a versatile and compact data entry and output unit for multistep interactive transactions. This buffered unit features a 56-character alphameric keyboard, eight control keys, and a 16-position visual display for verification of keyed data before transmission. The 2798 attaches via a 2791-1 or 2793 Area Station.

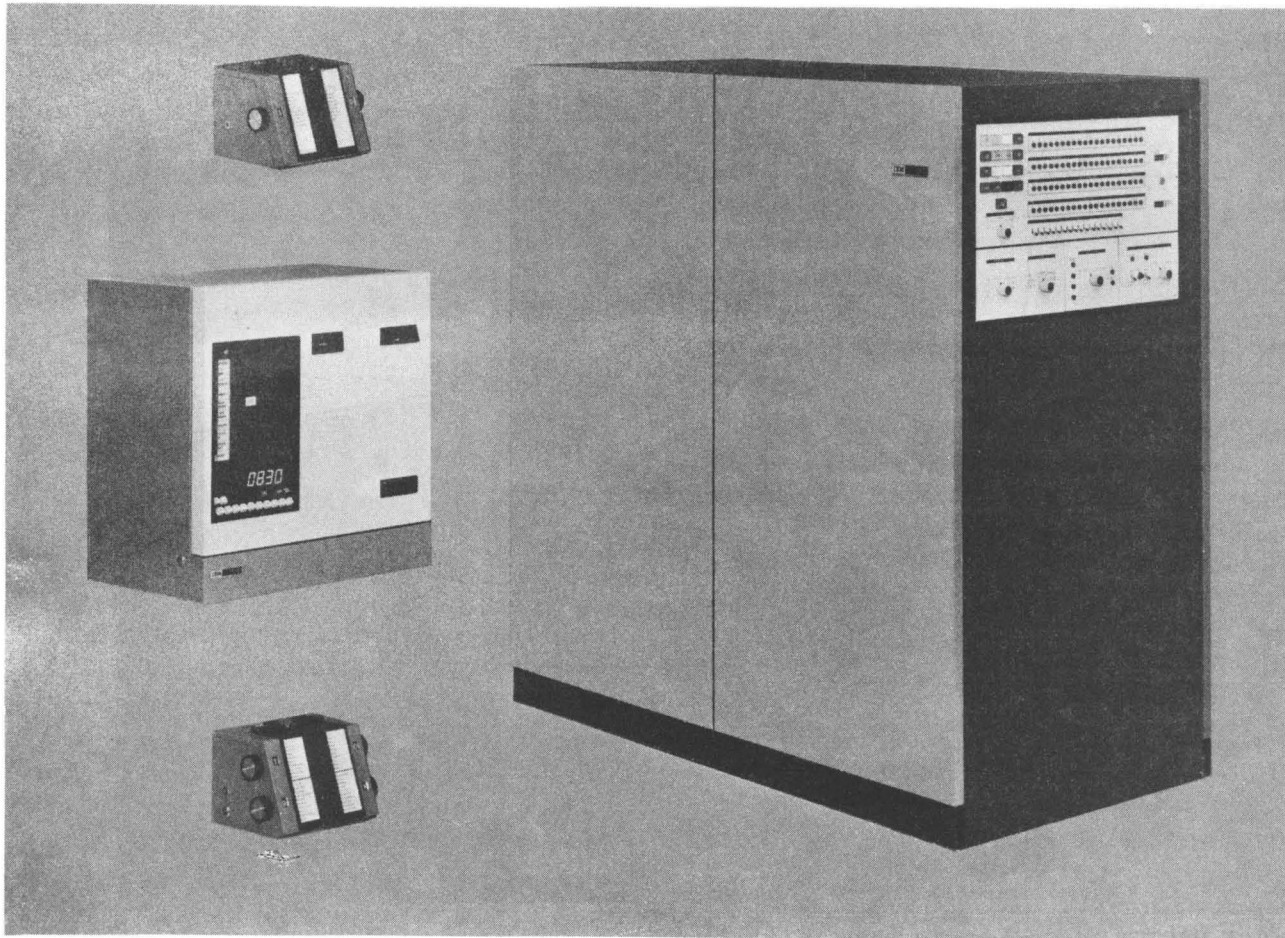

Figure 8-28. Several Units of the IBM 2790 Data Communication System

3270 Information Display System

The IBM 3270 Information Display System (Figure 8-29) is a family of display products that can be tailored to meet the needs of all alphanumeric display applications. It offers improved response times and transaction rates based on increased transmission and operator efficiency. In addition, the 3270 display system is easy to operate and well suited to an office environment.

The 3270 display system has outstanding configuration flexibility.

- It can be a standalone unit, a small cluster, or a large cluster (of up to 32 units).
- It can include 480-character display stations or large-capacity 1,920 character display stations or both.
- It can also include printers (40 or 66 characters per second).
- It can be attached locally (directly to the channel of a System/370) or remotely via binary synchronous communications (BSC) or synchronous data link control (SDLC) line discipline (through communications facilities).

- It offers increased flexibility in the number of display stations which can be attached to each communications line, and it is compatible with other BSC or SDLC devices.

The 3270 system also has exceptional feature flexibility.

- It offers typewriter, data entry, and operator console keyboards and a selector pen.
- It provides local data transfer rates of up to 650,000 characters per second and remote line speeds of up to 7200 bits per second.
- It includes data security enhancement features, such as keylock and operator identification card reader, and the ability to enter data without displaying it.

Components of the 3270 Information Display System include:

3271 Control Unit (Remote Attachment)

- Models 1 and 11—480-character buffer capacity.
- Models 2 and 12—1,920-character buffer capacity.



Figure 8-29. IBM 3270 Information Display System

- Models 1 and 2 attach to System/370 via modems and a BSC data link, and an integrated communications adapter or data transmission multiplexer.
- Models 11 and 12 attach to a System/370 via modems and a SDLC communications link, and a 3704 or 3705 Communications Controller.

3272 Control Unit (Local Attachment)

- Model 1—480-character buffer capacity.
- Model 2—1,920-character buffer capacity.
- Attachment to System/370 is via a selector, multiplexer, or block multiplexer channel.

3275 Display Station (Remote Attachment)

- Models 1 and 11—480-character buffer capacity.
- Models 2 and 12—1,920-character buffer capacity.
- Models 1 and 2 are standalone units that attach to System/370 via modems and data transmission multiplexers or integrated communications adapters.
- Models 11 and 12 are standalone units that attach to System/370 via modems and a SDLC communications link, and a 3704 or 3705 Communications Controller.

3277 Display Station

- Model 1—480-character display image.
- Model 2—1,920-character display image.

- Model 1 attaches to a 3271 Control Unit (all models) or to a 3272 Control Unit Model 1 or 2.
- Model 2 attaches to a 3271 Control Unit Model 2 or 12 or to a 3272 Control Unit Model 2.

3284 Printer

- Model 1—480-character buffer capacity with a 40-character-per-second printout rate.
- Model 2—1,920-character buffer capacity with a 40-character-per-second printout rate.
- Model 3—No buffer is provided; the printout rate is 40 characters per second.
- Model 1 attaches to a 3271 or 3272 Control Unit (all models).
- Model 2 attaches to a 3271 Model 2 or 12 or to a 3272 Model 2.
- Model 3 attaches to a 3275 Display Station (all models).

3286 Printer

- Model 1—480-character buffer capacity with a 66-character-per-second printout rate.
- Model 2—1,920-character buffer capacity with a 66-character-per-second printout rate.
- Model 1 attaches to a 3271 or 3272 Control Unit (all models).
- Model 2 attaches to a 3271 Model 2 or 12 or to a 3272 Model 2.

3288 Line Printer (Model 2 Only)

- Model 2—1,920-character buffer capacity. The print rate is 120 lines per minute.
- Model 2 attaches to a 3271 Control Unit Model 2 or 12 or to a 3272 Control Unit Model 2.

A 3270 display system may attach locally or remotely to a host System/370 (Figure 8-30).

Local (direct) attachment of a 3272 Control Unit Model 1 or 2 to System/370 is through a selector, multiplexer, or block multiplexer channel. Buffer storage in the devices stores digitally coded data from the control unit for display or printing. The buffer permits simultaneous display image presentation and message composition from a keyboard at each display station.

The 3272 Control Unit Model 1 can direct the operation of up to 32 attached units:

- 3277 Display Stations Model 1 or 2
- 3284 Printers Model 1 or 2
- 3286 Printers Model 1 or 2
- 3288 Line Printers Model 2

At least one display station with a keyboard must be attached to any control unit. Locally attached control units can be positioned up to 200 feet from the system channel,

depending upon the System/370 model and channel configuration. Each attached device can operate up to 2,000 feet from a control unit, allowing computer access from a display operator's normal working area.

Remote attachment of a 3271 Control Unit is via modems and communications lines and a data transmission multiplexer or an integrated communications adapter. Data transmission can be in BSC or SDLC mode of operation.

When using BSC operating mode to communicate with a System/370, a 3270 display system can be remotely attached to the teleprocessing network with a 3271 Control Unit Model 1 or 2, or with a 3275 Display Station Model 1 or 2.

The 3271 Control Unit Model 1 can attach up to 32 of the following units:

- 3277 Display Stations Model 1
- 3284 Printers Model 1
- 3286 Printers Model 1

The 3271 Control Unit Model 2 can communicate with up to 32 of the following attached units:

- 3277 Display Stations Model 1 or 2
- 3284 Printers Model 1 or 2
- 3286 Printers Model 1 or 2
- 3288 Line Printers Model 2

Local Information Path

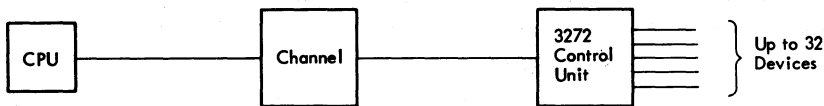

Remote Information Path

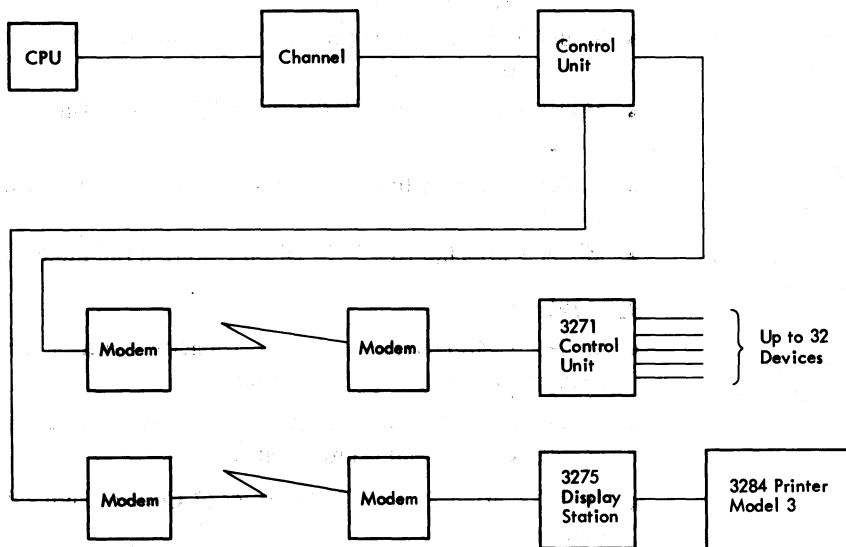

Figure 8-30. Information Path Comparison (Local and Remote) for IBM 3270 Information Display System

As in local configurations, at least one display station with a keyboard must attach to any control unit.

A standalone remote display system, the 3275 Display Station Model 1 or 2, provides added convenience for locations that require a single display device. The 3275 does not require a control unit to communicate with a System/370. The 3275 Display Station can be expanded by attaching a 3284 Printer to provide a paper copy of computer messages. The 3275 Display Station Model 1 or 2 can be attached (multidropped) to the same remote communications line as other 3270 display systems and other IBM products that use the BSC mode of operation, or the 3275 can operate on a switched communications line, using the Dial feature.

When using SDLC operating mode, a 3270 display system is remotely attached to a System/370 via a 3271 Control Unit Model 11 or 12, or a 3275 Display Station Model 11 or 12.

The 3271 Control Unit Model 11 directs the operation of up to 32 attached units of the following:

- 3277 Display Stations Model 1
- 3284 Printers Model 1
- 3286 Printers Model 2

The 3271 Control Unit Model 12 can attach up to 32 units of the following:

- 3277 Display Stations Model 1 or 2
- 3284 Printers Model 1 or 2
- 3286 Printers Model 1 or 2
- 3288 Line Printers Model 2

At least one display station with a keyboard must attach to any control unit. The 3275 Display Station Model 11 or 12 does not require a control unit for attachment to the teleprocessing network. A 3284 Printer Model 3 can be attached to the 3275 Display Station when a paper copy of the computer message is desired. The 3275 Display Station Model 11 or 12 can be attached to the same remote communications line as other 3270 systems and other IBM products that use the SDLC mode of operation.

3600 Finance Communication System

The IBM 3600 Finance Communication System (Figure 8-31) consists of a programmable controller and a selection of compact terminals and associated devices. The 3600 connects to a System/370 via SNA (systems network architecture), and can be configured to accommodate the requirements of a variety of users. Bank tellers, for example, can use it to debit or credit checking and savings accounts, to post interest, and to record loan payments; management can use it to maintain a record of cash flow through an institution; customers can use it for self-service banking at any hour.

Components of the system include:

- 3601 Finance Communication Controller
- 3603 Terminal Attachment Unit
- 3604 Keyboard Display Models 1, 2, 3, and 4
- 3606 Financial Services Terminal
- 3608 Printing Financial Services Terminal
- 3610 Document Printer Models 1, 2, and 3
- 3611 Passbook Printer Models 1 and 2
- 3612 Passbook and Document Printer Models 1, 2, and 3
- 3614 Consumer Transaction Facility Models 1 and 2
- 3618 Administrative Line Printer

The IBM 3601 Finance Communication Controller, a device with as much as 40K bytes of programmable storage, can supervise the 3600's terminals and associated devices, and can control data transmission between the 3600 system and a central System/370. The 3601 uses synchronous data link control (SDLC) for improved communication efficiency, and has a removable diskette for storing user data and programs as well as control and diagnostic data.

Special features for the 3601 include an optional integrated 1200-bps modem.

The IBM 3603 Terminal Attachment Unit is used for remote loop attachment of the IBM 3606 Financial Services Terminal and the IBM 3608 Printing Financial Services Terminal to the 3601 Finance Communication Controller. It has self-checking facilities on a local loop and can use a public switched network if the normal nonswitched communications line fails.

The IBM 3604 Keyboard Display, a compact interactive terminal, can be used for a variety of applications, including deposit and withdrawal transactions, customer account inquiry, and calculation verification.

The 3604 has an easy-to-read display and a choice of keyboards. The maximum number of characters that can be displayed is 240 for Models 1 and 2, 480 for Model 3, and 1,024 for Model 4. The display allows visual check of keyed data prior to transmission or printing and can provide operator guidance messages for training or for complex or infrequent transactions. The 3604 can have one of four keyboards—numeric, alphameric, or expanded numeric or alphameric. All four keyboards have function keys whose use is assigned by the user through the application programs in the 3601 controller.

Special features for the 3604 include a magnetic stripe reader or encoder/reader. The reader can read data such as a teller's security code or a customer's account number from a magnetic stripe on a customer's card or passbook. The encoder/reader can encode information on a passbook stripe, as well as read it.

The IBM 3606 Financial Services Terminal has a keyboard that includes ten numeric and six function keys, an eight-digit numeric display that shows data as it is keyed, nine indicator lights that signal transaction results and terminal status, and a magnetic stripe reader that reads the coded stripe on plastic identification cards.

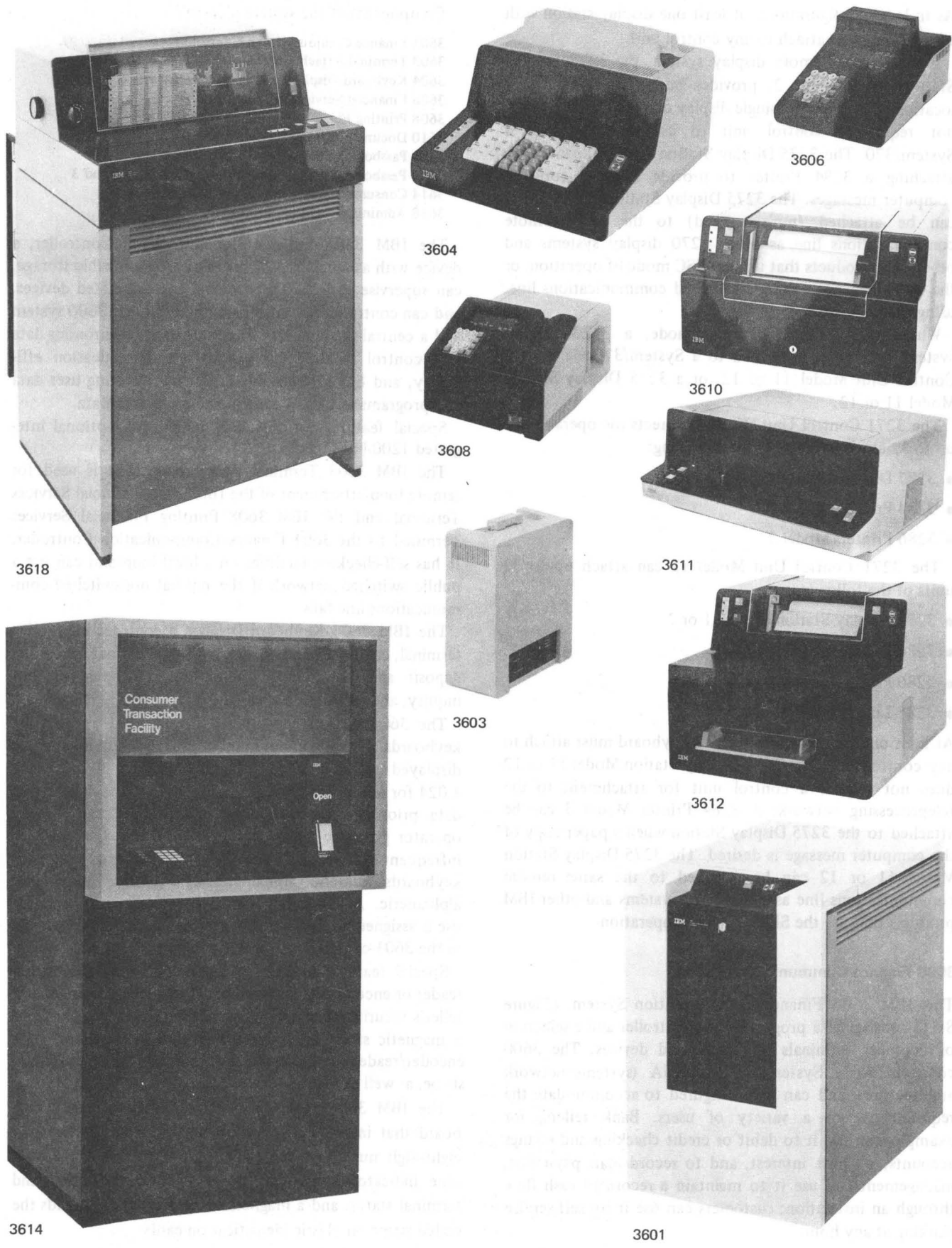

Figure 8-31. Components of IBM 3600 Finance Communication System (Design Models)

The 3606 allows financial institutions to extend their online service to their branch offices or to their customer's point-of-sale locations. At the branch office, it may be used by tellers in paying and receiving functions or by customers in checking their account status. At point-of-sale locations, it may be used for customer identification, customer account status checking, funds transfer, and data capture.

The IBM 3608 Printing Financial Services Terminal has all of the functions and features of the 3606 plus an alphameric (45-character set) printing capability of up to three lines. An entry chute on the right side of the terminal allows insertion of sales slips and other documents for printing.

The IBM 3610 Document Printer is used for printing tasks such as document validation, checks, statements, low-volume reports, printouts for error tracking, and audit trails. When a 3610 is combined with a 3604, the two together form an administrative or teller work station.

Using a 64-character set, the 3610 prints at a rate of 15 characters per second, printing 10 characters per inch on lines up to 80 characters long, with vertical spacing of five or six lines per inch.

The 3610 is available in three models. All three can print on cut-form documents. Additionally, the Model 2 can print on journal rolls, and the Model 3 can print on continuous forms. Paper widths can be 4.0 to 9.25 inches for cut-form documents, 4.0 to 8.5 inches for journal rolls, and 9.5 inches (9.0 inches between margin-punch centers) for continuous forms.

Special features for the 3610 include a 96-character set that allows printing at a rate of 30 characters per second, and a feature that permits a 3610 to be shared by two tellers.

The IBM 3611 Passbook Printer Models 1 and 2 each print one or more lines of up to 100 characters on a horizontal- or vertical-fold passbook placed in the passbook chute of the printer. Model 1 prints passbooks and padded cut forms of identical length and width, and of specified dimensions. Model 2 prints passbooks and single- or multiple-part documents of varied size within a maximum width dimension.

The 3611 prints 12 characters per inch and is available with vertical line spacing of either five or six lines per inch. It can have either a 64-character set for printing at a rate of 15 characters per second or a 96-character set for printing at a rate of 30 characters per second. A feature that permits two tellers to share the same 3611 is also available. A 3611 and a 3604 Keyboard Display placed together form an administrative or teller work station.

The IBM 3612 Passbook and Document Printer has two printing mechanisms—one for passbooks, the other for cut-form documents. When a 3612 is combined with a 3604, the two together form a full-function teller work station for handling a wide range of transactions.

A basic 3612 has a 64-character set and prints 15 characters per second. The passbook mechanism prints information on horizontal- or vertical-fold passbooks, 12 characters per inch on a 100-character line, and the document mechanism prints 10 characters per inch on an 80-character line. Vertical spacing for both mechanisms is either five or six lines per inch.

The 3612 is available in three models, all of which can print in passbooks and on cut-form documents. In addition, the Model 2 can print on journal rolls, and the Model 3 can print on continuous forms.

Special features for the 3612 include a 96-character set that allows printing at a rate of 30 characters per second, and a feature that permits sharing of the printer by two tellers.

The IBM 3614 Consumer Transaction Facility, an online banking terminal, allows customers self-service access to their accounts. Using a 3614, a customer can withdraw cash from his account, make deposits, check his account's status, and perform other transactions programmed by the financial institution.

An optional depository feature allows a customer to make deposits or pay certain bills; the optional transaction statement printer gives the customer a printed record of these transactions.

Two models are available. The Model 1 is for inside use, as in a lobby, and the Model 2 is for outside use, mounted in a wall. The Model 2 allows a 3600 system to be available on a 24-hour basis.

To use a 3614 a customer needs a special identification card and an identification number. When the card is inserted, the customer can use the display and keyboard to direct the transaction. The 40-character display tells the customer how to use the system and how to correct operation errors, and supplies him with requested information about his account, but no one else's. The 3614 can retain stolen cards, and can signal an alarm system when tampered with.

The IBM 3618 Administrative Line Printer, a compact medium-speed device, can handle a variety of items, such as trial balances, exception notices, customer statements, transaction journals, and management reports.

Using the 48-character set, the 3618 can print at speeds up to 155 lines per minute. Other sets available have 64 and 96 characters, with print rates as high as 120 and 80 lines per minute, respectively.

The basic 3618 prints 10 characters per inch on lines up to 80 characters in length, with vertical spacing of six lines per inch on pin-fed continuous-form paper.

Special features for the 3618 include an expanded print line and dual independent forms feed. The first feature expands the print line to 132 characters on a 13.2-inch line. The second feature provides two independently indexed pin-feed mechanisms which enable different-size forms to be handled concurrently.



3653



3275-3

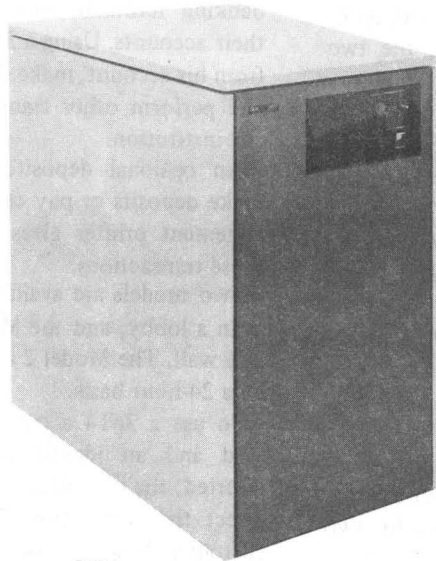

3651

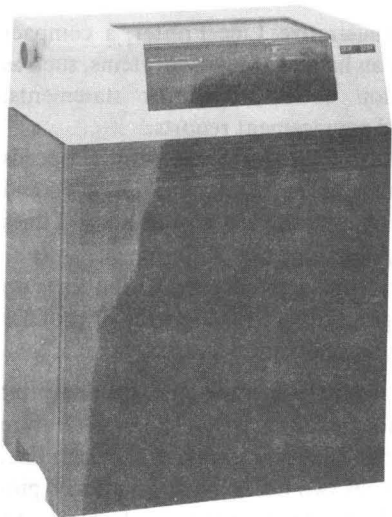

3284-3

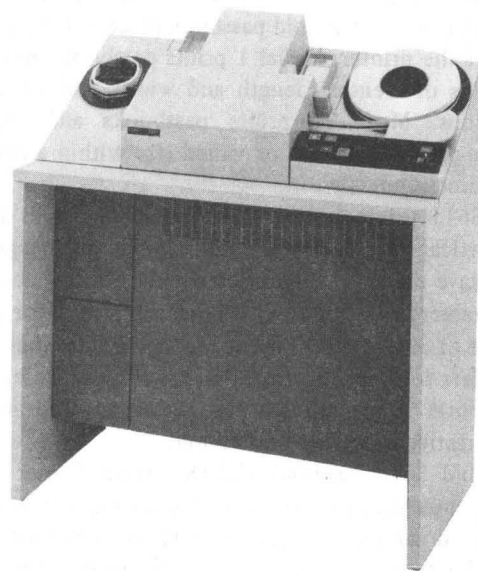

3657

Figure 8-32. Components of IBM 3650 Retail Store System (Design Models)

3650 Retail Store System

The IBM 3650 Retail Store System (Figure 8-32) is a comprehensive system that can handle point-of-sale transactions, data entry and inquiry, report printing, and merchandise receiving and marking.

Online connection to a System/370 via SNA (systems network architecture) enables the 3650 system to operate on an interactive or batch basis with central System/370 applications.

Components of the 3650 system include:

- 3651 Store Controller Model A50 or Model B50
- 3653 Point of Sale Terminal
- 3657 Ticket Unit
- 3659 Remote Communications Unit
- 3275 Display Station Model 3
- 3284 Printer Model 3
- 3784 Line Printer

The IBM 3651 Store Controller Model A50 or Model B50 is the controlling link between a central System/370 and the point-of-sale, receiving-marking, credit authorization, and management operations of the store. Model A50 differs from Model B50 in integral disk storage capacity: Model A50 has a 5-megabyte capacity, and Model B50 has a 9.3-megabyte capacity. The 3651 collects data from the various parts of the system, performs edit, logical, and arithmetic operations, and then stores and/or forwards the data to its destination in the system. It communicates by way of a store loop with the various terminals on an interactive basis, processes inquiries against various files, and communicates with System/370 on a batch or interactive basis. The basic transmission rate is 2400 bps over leased or switched networks.

The 3651 provides for point-of-sale functions and basic terminal support. The functions include basic sales and logging support, negative in-store credit, support of the I/O devices, and basic interfaces for user program execution.

The 3651 uses synchronous data link control (SDLC) for improved communication efficiency, and has both control storage and integrated disk storage.

The IBM 3653 Point of Sale Terminal has a keyboard, a three-station printer, an operator guidance panel, a transaction display, a cash drawer with a removable till, and a store loop adapter for communication with a 3651.

The keyboard is the normal input device for recording customer transactions. An optional wand reader permits a 3653 to read magnetically encoded tickets, credit cards, and employee badges; and the three-station printer allows a 3653 to issue cash receipts, put out a journal of transactions, and print on inserted documents.

The operator guidance panel has 20 short descriptive messages which are backlit, one at a time or in combination as needed, to provide operators with step-by-step instructions.

The transaction display is a composite of an eight-position numeric display plus the symbols

\$, .

with five backlit captions, and shows numeric data as it is being keyed and/or calculated. The display provides the operator with visual verification of output.

The IBM 3657 Ticket Unit is an online high-speed batch ticket encoder that can also batch-read 2-inch tickets. Tickets are 1 inch wide by 1, 2, or 3 inches long, and contain a 1/4-inch-wide magnetic stripe. The 3657 encodes this stripe with up to 19, 40, or 60 characters of data readable by the 3657 batch-read function or by the wand available for the 3653. The 3657 also prints up to 22, 42, or 64 characters of visually readable data in two lines on tickets.

The IBM 3659 Remote Communications Unit, a 2400-bps signal converter, provides store-loop capability to retail establishments that are remote from a 3651. The 3659 interfaces with leased-line facilities for data transmission, and with the store loop for retail store operations.

The IBM 3275 Display Station Model 3 is a 1,920-character alphanumeric display station with a keyboard. The 3275 can be used for a variety of operations, such as entering purchase orders, controlling and checking merchandise received, controlling ticket production and price changes, and making inquiries to a 3651 or to System/370 files for many other inventory, credit, and management control functions needed to efficiently operate a retail store.

The IBM 3284 Printer Model 3 can be attached to a 3275-3 for printing such data as store reports, due-in orders, and receiving lists. The 3284 is a wire matrix printer that prints at 40 characters per second.

The IBM 3784 Line Printer can be attached to the 3651 Store Controller Model A50 or B50 for faster output than by attaching the 3284 Printer. The 3784 prints a maximum of 155 lines per minute, using a 48-character set on a metal print belt.

3660 Supermarket System

The IBM 3660 Supermarket System (Figure 8-33), available as either the IBM 3660 Supermarket Scanning System or the IBM 3660 Supermarket Key-Entry System, performs normal checkout operations and meets the data collection and dissemination needs of the supermarket industry. The system speeds customer checkout, increases personnel productivity, and improves customer service. The 3660 system also accumulates data from customer checkout and various store operations, which can be transmitted over appropriate communications facilities to an IBM System/370 host processor at a remote location, for analysis and report generation. These reports provide information required for ordering stock items, allocating shelf space,

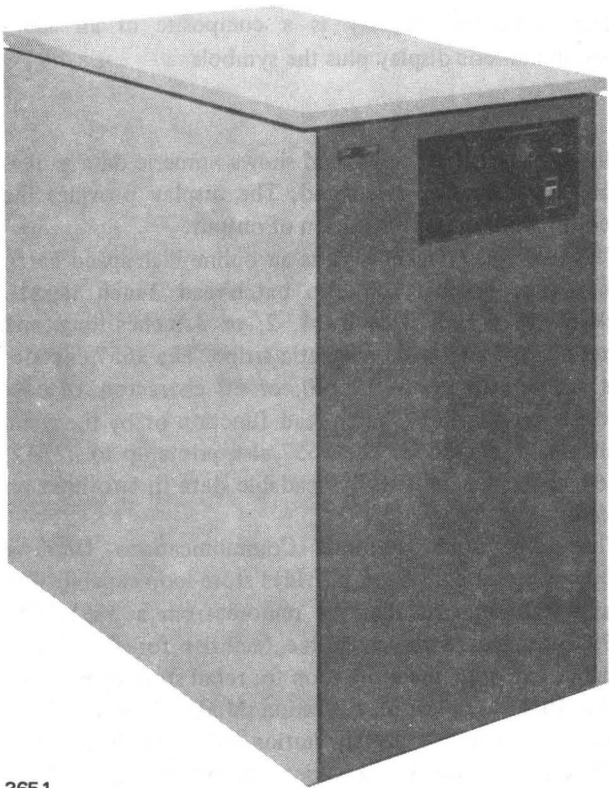

3651

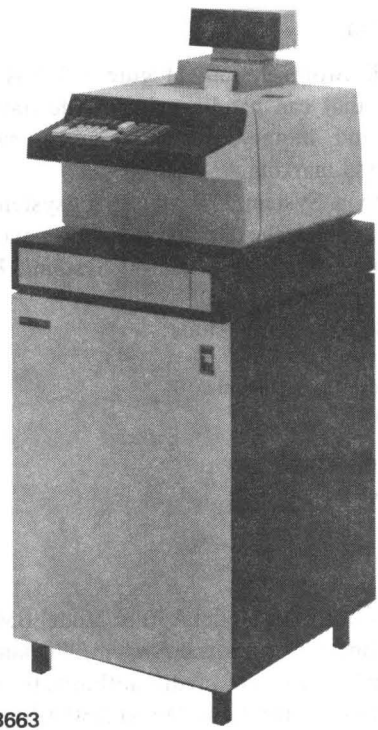

3663

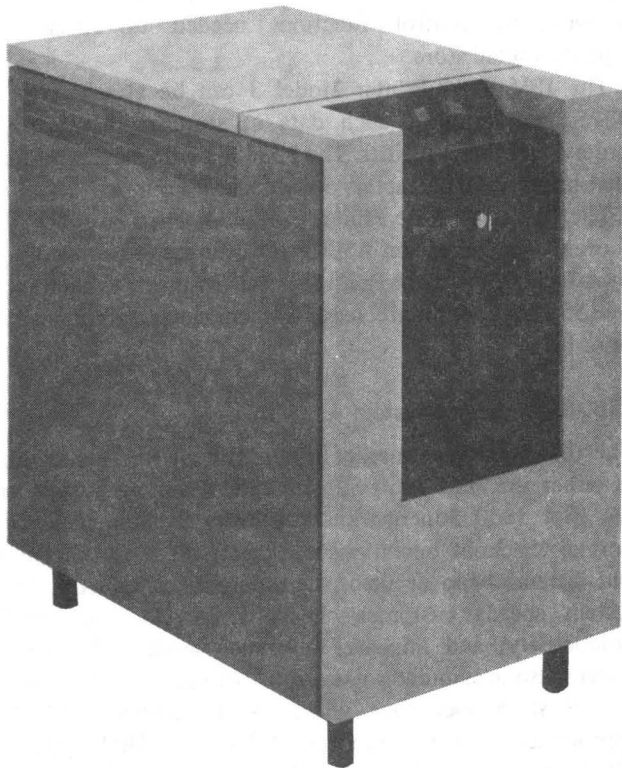

3661

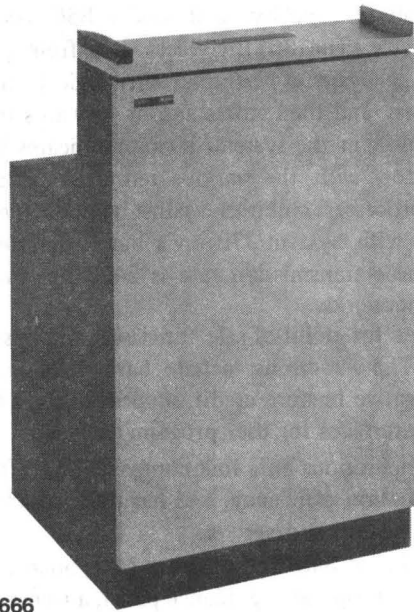

3666

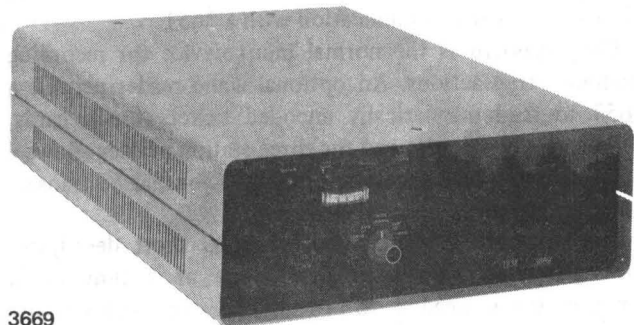

3669

Figure 8-33. Components of IBM 3660 Supermarket System (Design Models)

pricing merchandise, scheduling labor, planning weekly sales, managing the store, and maintaining good customer relations.

Components of the 3660 system include:

3651 Store Controller Model A60 or Model B60 (for the scanning system)

3661 Store Controller (for the key-entry system)

3663 Supermarket Terminal Model 1 or Model 2

3666 Checkout Scanner

3669 Store Communications Unit

The *IBM 3660 Supermarket Scanning System* speeds customer checkout through electronic scanning of the Universal Product Code printed on purchased items. It consists of one IBM 3651 Store Controller Model A60 or B60; as many as 24 of the IBM 3663 Supermarket Terminals Models 1 and 2 (a maximum of 12 of each model), each of which can have an IBM 3666 Checkout Scanner attached; and one IBM 3669 Store Communications Unit. Connection is by a two-wire loop.

The *IBM 3660 Supermarket Key-Entry System* offers the advantages of the 3660 to enterprises that do not require the capacity and throughput of the IBM 3660 Supermarket Scanning System. The key-entry system consists of one IBM 3661 Store Controller with one or two locally attached IBM 3663 Supermarket Terminals Model 2 and may have additional 3663 Models 1 and 2 connected by a store loop. A maximum of twelve 3663 terminals can be attached to a 3661.

The store controller in the 3660 Supermarket Scanning or Key-Entry System controls the operation of all supermarket terminals and provides the communications link between the store and the host System/370 on a batched basis. This unit has teleprocessing, logic, and computational capabilities, and contains data for:

- Item records such as department number, and data for pricing (single price or multiprice, mix or match), tax, and stamps.
- Check verification records to control check cashing.
- Operator records with a user-assigned password and table of store support procedures permitted.
- Item movement summary data of accumulated statistics for predesignated items sold during a defined period.
- Reconciliation records containing the total transaction dollars for each operator and the store office.
- Station productivity data.
- Miscellaneous log entries for special events such as price and check verification overrides, cancels, refunds, and discounts.

The main difference in the controllers for the 3660 scanning and key-entry systems is in their storage capacities.

The *IBM 3651 Store Controller Model A60* (with 5 megabytes of integral storage) or *Model B60* (with 9.3

megabytes of integral storage) supports electronic product code scanning and maintains up to 22,000 item records, up to 24,000 check verification records for positive or negative verification control, and up to 200 operator records. The 3651 provides station productivity data in 15-minute increments.

The *IBM 3661 Store Controller* maintains up to 1,275 item records. The number of check verification records (limited to negative type) and operator records that can be maintained depends on the number of item records. The 3661 provides station productivity data in one-hour increments.

The *IBM 3663 Supermarket Terminal Model 1 or Model 2* provides the input and output facilities required for a supermarket checkout station. It replaces and extends the function of a supermarket register. Model 1 contains the control segment and I/O equipment. The I/O equipment consists of a keyboard that can be ordered in one of several key arrangements, a cash drawer, a display, and a printer that can be ordered with a document insert feature (optional). One Model 2 attaches to a Model 1 and contains only the I/O equipment. The 3663 is available as an integrated station, as shown in Figure 8-33, or as a distributed station. In the distributed station configuration, all units are packaged separately to allow maximum flexibility in checkstand design.

The *IBM 3666 Checkout Scanner* is an optical recognition device designed to read the Universal Product Code symbols (Figure 8-33.1) on items as they are pulled across the scanner slot in the checkstand. Item symbols are read at a rate of up to 100 inches per second as they are moved across the scanner window. The scanner improves checker productivity and accuracy, and provides automatic recording of item movement data.



Figure 8-33.1. Universal Product Code Symbols

The *IBM 3669 Store Communications Unit* provides communications for the 3660 Scanning System with a System/370 virtual storage processor and with a predesignated supermarket when backup is required to continue store operation. When the backup operation is terminated, the 3669 continues communicating with the predesignated supermarket until data reconciliation has been completed. Data is transmitted over common-carrier, switched, voice-grade lines at 2400 bps. The 3669 has an automatic answering facility.

3740 Data Entry System

The IBM 3740 Data Entry System (Figure 8-35), designed for use in centralized, decentralized, and remote key-entry operations, is a group of related devices that use the IBM diskette as the recording medium.

The diskette used by the 3740 (Figure 8-36) is a single magnetic disk, sealed in a plastic jacket about 8 inches square. It weighs less than 2 ounces, is reusable, is interchangeable with other diskette units, and can be easily corrected and updated.

The diskette can store as many as 1,898 128-character records, equivalent to as many characters as can be put on 3,036 80-column cards. Up to 19 data sets, each of which may be a different logical record length, can be entered on one diskette.

The size, capacity, and portability of diskettes make them a convenient storage medium for data bases of appropriate size, and with the search capabilities of the 3740 system, diskettes can readily be used for local or remote inquiry.

The components that make up a 3740 system include:

- 3741 Data Station Models 1 and 2
- 3741 Programmable Work Stations Models 3 and 4
- 3742 Dual Data Station
- 3713 Printer
- 3715 Printer
- 3717 Printer
- 3747 Data Converter

All four models of the IBM 3741 have a 64-character alphanumeric keyboard, a 240-character display, a diskette

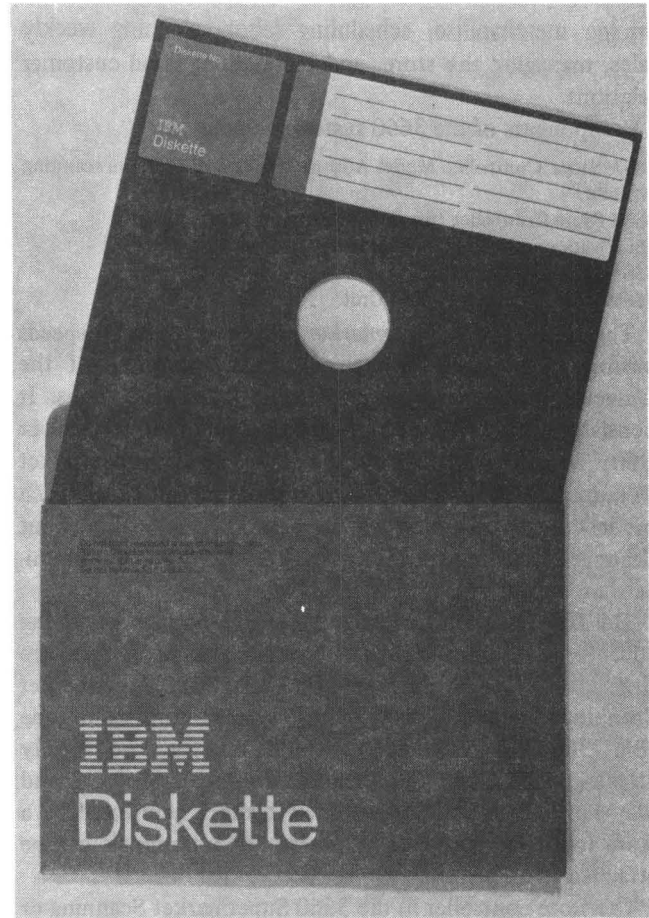

Figure 8-36. IBM Diskette

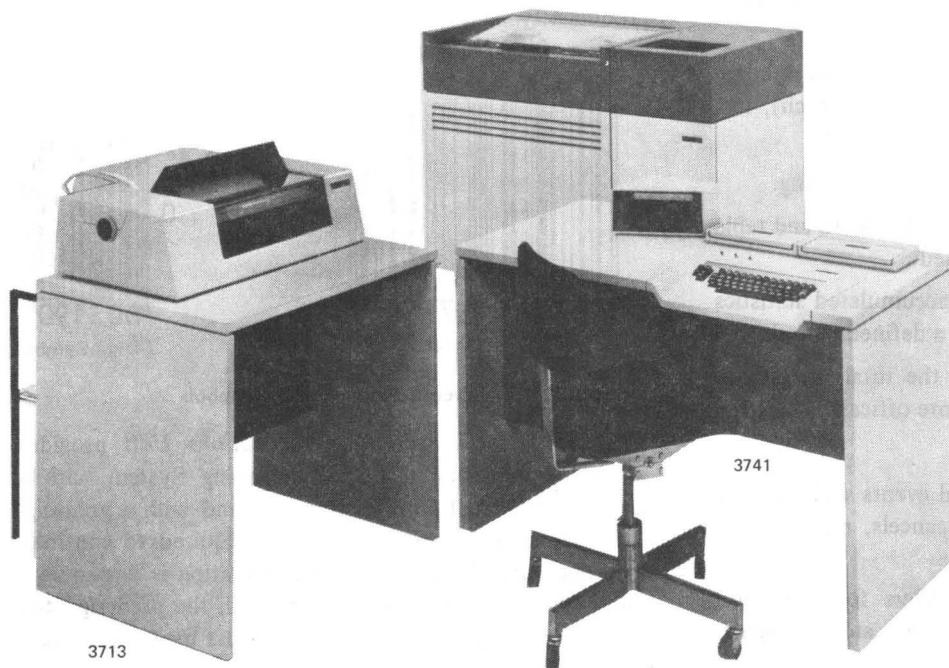

Figure 8-35. IBM 3740 Data Entry System

drive, and a microprogrammed control unit. When in use they provide:

- Operator guidance, which features CRT-displayed messages to guide the operator step by step through each field transaction.
- Program chaining, which enables the operator to key a logical record as large as 1,280 characters.
- Variable record lengths of up to 128 characters.
- Ten program levels which provide automatic functions such as skipping, duplicating, and field definition.
- End-of-data search to the last record when resuming a suspended job.
- Search by track and sector address.
- Search by comparing a search argument to the contents of a record.

In operation, data enters buffered storage prior to being recorded on a diskette. This allows for correction of detected errors before writing the record. Six 40-character lines of data, including a 30-character prompting field, can be displayed. The 3741-1, designed for use in decentralized operations, operates offline only.

The IBM 3741 Data Station Model 2 differs from the Model 1 in that it is equipped with a binary synchronous communications (BSC) adapter, which permits half-duplex point-to-point telecommunication between a 3740 system and System/370.

Optional features for 3741 Models 1 and 2 make it possible to: verify and correct in verify mode, total fields online, perform self-check of modulus 10 and 11 numbers for accuracy in keying selected numbers, initialize diskettes, add a second diskette drive, and attach a 3713, 3715, or 3717 Printer.

The IBM 3741 Programmable Work Station Models 3 and 4 operate in two modes: as a fixed function data station like the 3741 Models 1 and 2, or under control of a program written in Application Control Language (ACL). Program control provides capacity for arithmetic operations, data manipulation and reformatting, logical branching, table building and lookup, flexible control of input/output devices, editing, file search by address, accessing of up to four disk data sets at one time, and writing on a second diskette. An optional language translator converts source statements into executable code. Program control allows printing to overlay keying, thereby increasing throughput.

The IBM 3741 Model 4, like the Model 2, is equipped with a binary synchronous communications adapter for telecommunication in data station mode.

Both models of the 3741 have buffered storage into which data is keyed prior to recording on a diskette, thus allowing for correction of detected errors prior to writing

the record. Both models can display six lines of data, with up to 40 characters in each line. The two models differ in that the Model 2 is equipped with a binary synchronous communications (BSC) adapter, which permits half-duplex point-to-point telecommunication between a 3740 and System/370. The 3741-1, designed for use in decentralized operations, operates offline only.

The IBM 3742 Dual Data Station has two keyboards, two drives, a display unit with two displays, and a shared microprogrammed control unit. It is designed for use in centralized high-production areas, and operates offline only.

The IBM 3713 Printer can provide printed copy at a rate of 40 characters per second from keyed data or from data received by a 3741-2 from System/370 via a telecommunications line. Individual records or an entire data set can be printed; the latter may be continued from one diskette to another without interruption.

Maximum line length is 128 characters. If equipped with the adjustable margins feature, the 3713 can handle 12 form widths that range from 7-1/2 to 13-7/8 inches.

Formatting can be controlled locally by programs loaded in the 3741 program buffers, or remotely by use of control characters intermixed with data from a central processor.

The 3713 has a complete vertical and horizontal format control and can rearrange fields within records, print fields selectively, suppress or print leading zeros, replace leading zeros with asterisks, and print negative numbers with a sign.

The IBM 3715 Printer is available in two models, each using a matrix print mechanism that will print left-to-right and right-to-left. Model 1 produces copy at 40 characters per second and Model 2 at 80 characters per second. It has the functional and formatting capabilities of the 3713 Printer and can also: insert floating dollar signs, decimal points, and slashes; automatically print page heads and numbers; automatically insert store constants; expand compressed data streams; chain format instructions through program levels; and print disk addresses with each record.

The IBM 3717 Printer is a line printer with the same functional, formatting, and editing capabilities as the 3715 Printer, but it operates at a faster rate. The 3717 prints as many as 155 lines per minute using a 48-character print belt, and as many as 120 lines per minute using a 64-character print belt.

The IBM 3747 Data Converter is a buffered high-speed unit used primarily to convert batched data from diskettes to 1/2-inch magnetic tape. As many as 20 diskettes can be loaded at a time. Feeding, reading, and stacking are automatic, and the hopper can be reloaded without interrupting operations. The 3747 can convert about 300 records per minute. When equipped with a communications adapter, the 3747 can provide for half-duplex point-to-point telecommunication between a 3740 and System/370.

3770 Data Communication System

The IBM 3770 Data Communication System (Figure 8-37) is a family of communication terminals that offers keyboard and printer combinations, with a selection of I/O equipment and communications features. This system provides systems network architecture (SNA) with a variety of multiple-purpose terminal configurations.

Terminals of the 3770 Data Communication System include:

3771 Communication Terminal Models 1, 2, and 3
3773 Communication Terminal Models 1, P1*, 2, P2*, 3, and P3*
3774 Communication Terminal Models 1, P1*, 2, and P2*
3775 Communication Terminal Models 1 and P1
3776 Communication Terminal Models 1 and 2
3777 Communication Terminal Model 1

*Models with a *P* designation are user programmable for one or more operations.

The 3770 communication terminals are desk console style and offer:

- Communication features for operation over switched lines at rates of up to 2400 bps or over nonswitched lines at rates of up to 4800 bps (9600 bps for the 3777)
- Synchronous data link control (SDLC)
- Binary synchronous communication (BSC)
- Dual 256-byte buffering with buffer edit for the 3771-3775; dual 256- and 512-byte buffering with buffer edit for the 3776 and 3777
- Electronic horizontal and vertical print forms control (except on programmable models)
- Automatic answering on switched communication lines
- Terminal identification

The range of 3770 system operation covers: online-batch, online-interactive, offline, and dual data-path operation. For a given installation, the choice of terminal models, features, and attached I/O equipment determines the operational limits within the range of operation.

Each 3770 terminal has an associated printer, integral (3771-3776) or standalone (3777), that prints a 132-position line at ten characters per inch. Models differ from one another in: printer type and print speed, features such as diskette and display, operations that can be user-

programmed (P-models), and I/O equipment that can be attached; these characteristics are compared in Figure 8-37.1.

Input and output devices attachable to one or more 3770 terminals are:

The *IBM 2502 Card Reader*, which reads 80-column cards at speeds up to 150 cards per minute (Model A1), up to 300 cards per minute (Model A2), or up to 400 cards per minute (Model A3). Special features permit the electronic reading of 51- or 80-column cards or of 66- or 80-column cards; or the optical reading of marked data, except on the 3777.

The *IBM 3203 Printer Model 3*, which uses the train printing principle to produce high-quality printing, and prints up to 1000 lines per minute using a 48-character set cartridge. The 3203 supports 15 different selectable graphic sets, which may be optimized to the user's requirements. Print speed depends on the character arrangement of the cartridge in use.

The *IBM 3501 Card Reader*, which reads 80-column cards at 50 cards per minute (maximum). This compact unit is suitable for desk-top use.

The *IBM 3521 Card Punch*, which punches 80-column cards at 50 cards per minute (maximum). Special features permit card reading, or card punching with checking; and card printing.

The *IBM 3782 Card Attachment Unit*, which provides facilities and mounting for attaching the 2502 or the 3521 to any 3770 terminal except the 3777.

The *IBM 3784 Line Printer*, which provides the second-printer function when attached to the 3774. The 3784 is an engraved-font printer with an interchangeable print belt, a variable-width forms tractor, paper-jam detection, and 132 print positions. The maximum printing rate is 80 lines per minute with a 94-character set print belt, 120 lines per minute with a 64-character set print belt, or 155 lines per minute with a 48-character set print belt.

The 3770 Data Communication System communicates with System/370, over the appropriate communications lines, via a 3704 or 3705 Communications Controller, a 2701 Data Adapter Unit, or an integrated communications adapter.

3521

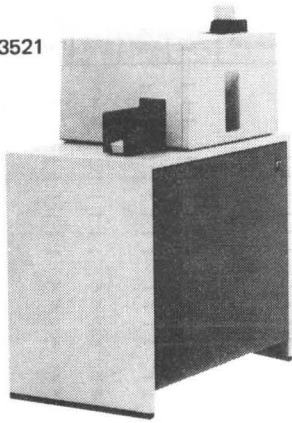

3782

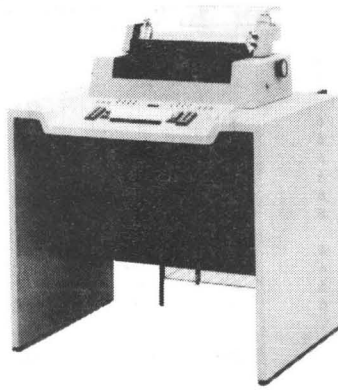

3771

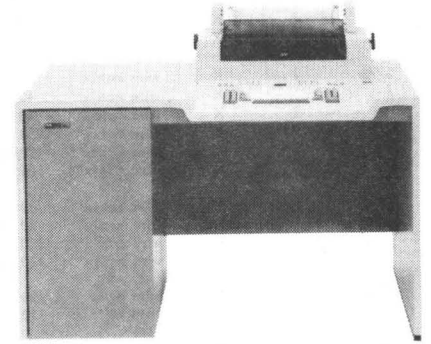

3773

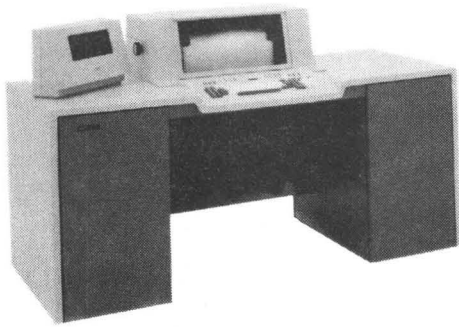

3774

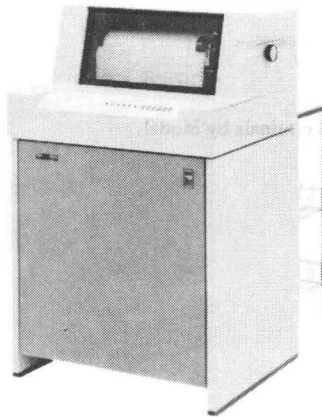

3784

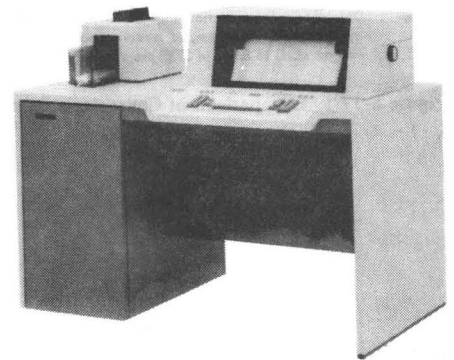

3775

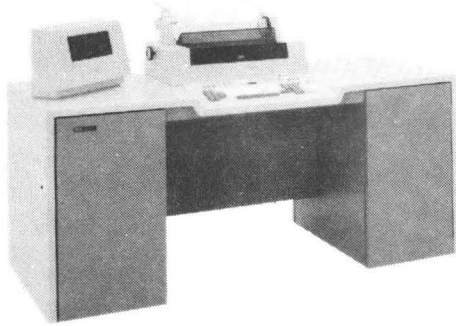

3776

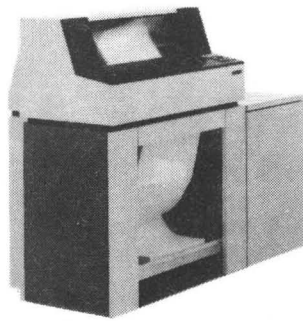

3203-3

2502

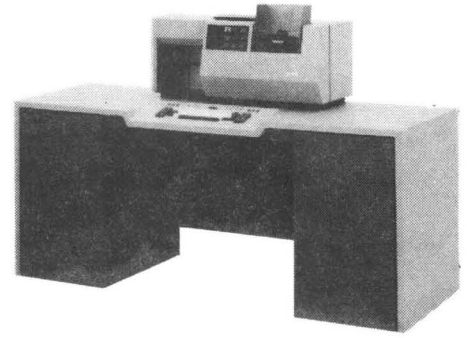

3777

Figure 8-37. Components of IBM 3770 Data Communication System (Design Models)

Terminal		Integrated Printer	Printer Type	Print Speed (Maximum)	Line Spacing per Inch	Standard Diskette	Optional Diskette (1 or 2)	User-programmable functions supported	480-character Display Feature	Attachable I/O					
Number	Model									2502	3203	3501	3521	3782	3784
3771	1	X	wire matrix**	40 cps*	6	--	--	--	--	--	X	X	X	--	
	2	X	wire matrix**	80 cps	6	--	--	--	--	--	X	X	X	--	
	3	X	wire matrix**	120 cps	6	--	--	--	--	--	X	X	X	--	
3773	1	X	wire matrix**	40 cps*	6	X***	--	--	--	--	--	--	--	--	
	P1	X	wire matrix**	40 cps*	6	X***	--	A	--	--	--	--	--	--	
	2	X	wire matrix**	80 cps	6	X***	--	--	--	--	--	--	--	--	
	P2	X	wire matrix**	80 cps	6	X***	--	A	--	--	--	--	--	--	
	3	X	wire matrix**	120 cps	6	X***	--	--	--	--	--	--	--	--	
	P3	X	wire matrix**	120 cps	6	X***	--	A	--	--	--	--	--	--	
3774	1	X	wire matrix**	80 cps	6	--	X***	--	--	X	--	X	X	X	
	P1	X	wire matrix**	80 cps	6	X****	X***	ABC	X	X	--	X	X	X	
	2	X	wire matrix**	120 cps	6	--	X***	--	--	X	--	X	X	X	
	P2	X	wire matrix**	120 cps	6	X****	X***	ABC	X	X	--	X	X	X	
3775	1	X	print belt	120 lpm	6 or 8	--	X***	--	--	X	--	X	X	X	
	P1	X	print belt	120 lpm	6	X****	X***	ABC	X	X	--	X	X	X	
3776	1	X	print belt	300 lpm	6 or 8	--	X***	--	--	X	--	X	X	X	
	2	X	print belt	400 lpm	6 or 8	--	X***	--	--	X	--	X	X	X	
3777	1	--	train	1000 lpm	6 or 8	--	X***	--	--	X	X	--	--	--	

Symbols:

- X Yes
- No
- * Rated
- ** Bidirectional printing
- *** Removable
- **** Nonremovable
- A Data check, form control, logical, arithmetic, format, and edit operations
- B Interrupt offline program, to receive unsolicited message from CPU
- C Address stop, to assist in 3770 program debugging

Figure 8-37.1. Comparison of Characteristics of 3770 Terminals by Model

3790 Communication System

The IBM 3790 Communication System (Figure 8-38) is an operator-oriented remote system that consists of an IBM 3791 Controller and its attached operator stations and auxiliary control units. The operator stations can be keyboard-printers, keyboard-displays, or a mixture of these devices.

Multiple 3790 systems can form a communications network that links remote 3790 systems with the central system. A 3790 communications network consists of one or more 3790 Communication Systems, communications facilities, and the System/370 central processing system.

Components of the 3790 system include:

- 3791 Controller Models 1A, 1B, 2A, and 2B
- 3792 Auxiliary Control Unit
- 2741 Communication Terminal
- 3277 Display Station Models 1 and 2
- 3284 Printer Models 1 and 2
- 3286 Printer Models 1 and 2
- 3288 Line Printer Model 2
- 3760 Dual Key Entry Station Models 1 and 2
- 3793 Keyboard-Printer

The *IBM 3791 Controller*, with the local channel attachment, can be attached directly to a System/370 byte multiplexer or block multiplexer channel. The 3791 also communicates over communications lines via an IBM 3704 or 3705 Communications Controller with the System/370, using systems network architecture (SNA). Functions performed by the 3790 system are specified by programs that are sent to the 3791 Controller from the System/370. These programs allow the 3790 system to operate without supervision from, or interaction with, the System/370, except when data or programs are being exchanged between systems.

The controller contains:

- Control storage for supporting features, functions, and operator stations
- Diskette storage for packed transmission data and for backup of application data sets
- Disk storage for 3790 programs, transaction records, and application data sets; depending on the model, the 3791 can have up to 26.9 million bytes of storage

Communication with the System/370 CPU is by non-switched or switched communications facilities. For switched lines, automatic calling and answering are supported at the 3704 or 3705 Communications Controller; manual dial and auto-answer are supported at the 3791. A 1200-bps integrated modem is available, or an external 1200- or 2400-bps modem may be attached.

The *IBM 3792 Auxiliary Control Unit*, which may be located up to 2,000 feet from the 3791 Controller, allows

for additional operator stations in the system (some of which can be remote from the 3790 site) and provides:

- The capability for attaching up to four 3793 Keyboard-Printers
- A line printer as a special feature
- Special features for communicating with 2741 Communication Terminals
- A security keylock special feature that controls power to the 3792

The *IBM 3793 Keyboard-Printer* is a data entry operator station that can be attached to the 3791 or to the 3792 to provide printed output. The 3793 has a friction-feed platen, with a pinfeed platen available as a special feature. A maximum print line has 130 positions at 10 characters per inch; line spacing is 6 lines per inch.

The 3793 keyboard includes control keys, operator guidance indicators, and system indicators. Included on the normal office typewriter keyboard is a 10-key configuration of dual-function keys that can be used for entering numeric data. A special feature provides a power-line keylock for security.

The *IBM 3277 Display Station* can be attached to the 3791. The 3277 can display on its CRT screen up to 480 characters in 12 lines of 40 characters each (Model 1), or up to 1,920 characters in 24 lines of 80 characters each (Model 2). The last line on either model is reserved for controller use. Basic features of both models include:

- A 63-character set
- Editing features
- Dual brightness control
- Protection of data

The *Line Printer*, which is available as a special feature on the 3791 or 3792, prints continuous forms with line spacing of six lines per inch. Printing characteristics of the versions available are:

Available on	Print Positions	Speed (Lines per Minute)	Characters in Set
3791, 3792	80* or 132**	155	48
	80* or 132**	120	64
	80* or 132**	80	96
3791	132***	410	48
	132***	300	64
	132***	230	96

Maximum line length (print positions) must match on 3791 and 3792 controllers attached to the same system.

* Feature 4710 (3791), 4712 (3792)

** Feature 4711 (3791), 4713 (3792)

*** Feature 4715

IBM 3284 Printer Models 1 and 2, IBM 3286 Printer Models 1 and 2, and IBM 3288 Line Printer Model 2 can be attached to the 3791 to provide hard-copy output at six

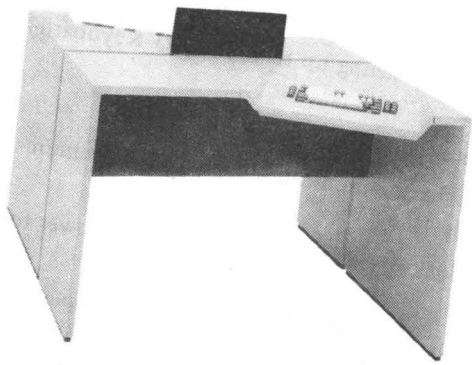

3760

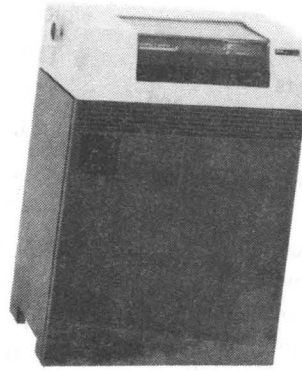

3284-1, -2
3286-1, -2



2741

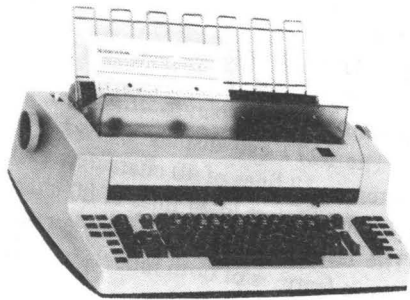

3793

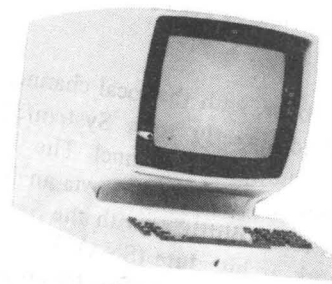

3277-2

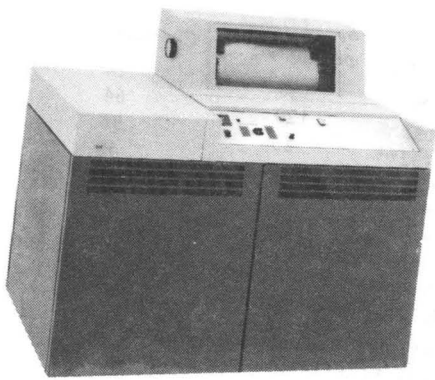

3791-1

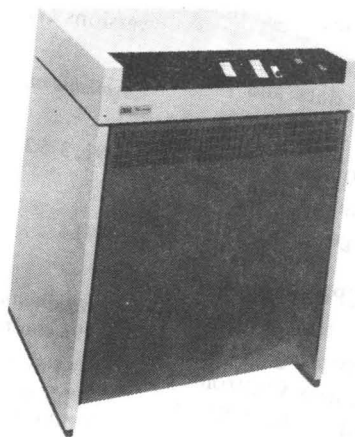

3792

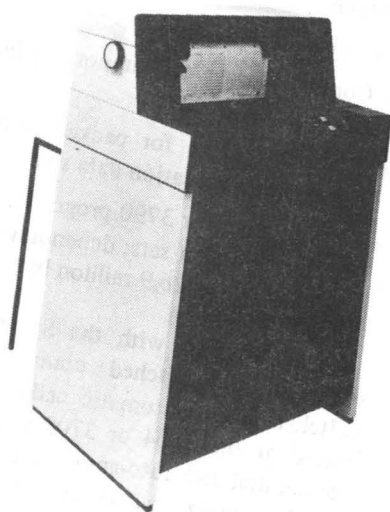

3288-2

Figure 8-38. Components of IBM 3790 Communication System and Attachable I/O Devices (Design Models)

lines per inch on continuous fanfold paper. Some characteristics of these printers are compared in the following chart:

	<i>Model</i>	<i>Printer Type</i>	<i>Print Speed</i>	<i>Print Positions***</i>
3284	1	Wire Matrix	40 cps*	120, 126, or 132
	2	Wire Matrix	40 cps*	120, 126, or 132
3286	1	Wire Matrix	66 cps*	120, 126, or 132
	2	Wire Matrix	66 cps*	120, 126, or 132
3288	2	Line	120 lpm**	132

* Rated
 ** Maximum
 *** Specify

The IBM 3790 Communication System/Data Entry Configuration, designed for production keying of transcriptive data, consists of the IBM 3760 Dual Key Entry Station Model 1 or Models 1 and 2; the 3791 Controller Model 1A or 1B; and the host System/370, any of Models 125 through 168.

Each model of the 3760 provides two key-entry operator positions with keyboard and display area. Model 1 contains logic and storage, to perform control and display functions

and to perform data editing and checking. Model 2 can be attached to Model 1 and is an expansion unit only, without the logic and control function. Another Model 2 can be attached to the first Model 2 to form a six-station group. The 3791 supports up to twelve 3760 Dual Key Entry Stations with a maximum of eight 3791 connections.

The 3790 Communication System/Data Entry Configuration cannot be used with other 3790 configurations. However, the 80-position line printer can be used with the data entry configuration, except when data is being transmitted between the 3791 and the host System/370.

5230 Data Collection System

The IBM 5230 Data Collection System (Figure 8-38.1) is a group of components used to collect data from activities as they occur in the operational areas of a business. The collected data can then be batch-processed by the computer.

Components of the 5230 Data Collection System include:

- 5231 Controller Models 1, 2, and 3
- 5234 Time Entry Station Models 1 and 2
- 5235 Data Entry Station
- 5230 Data Collection System Accessory Package

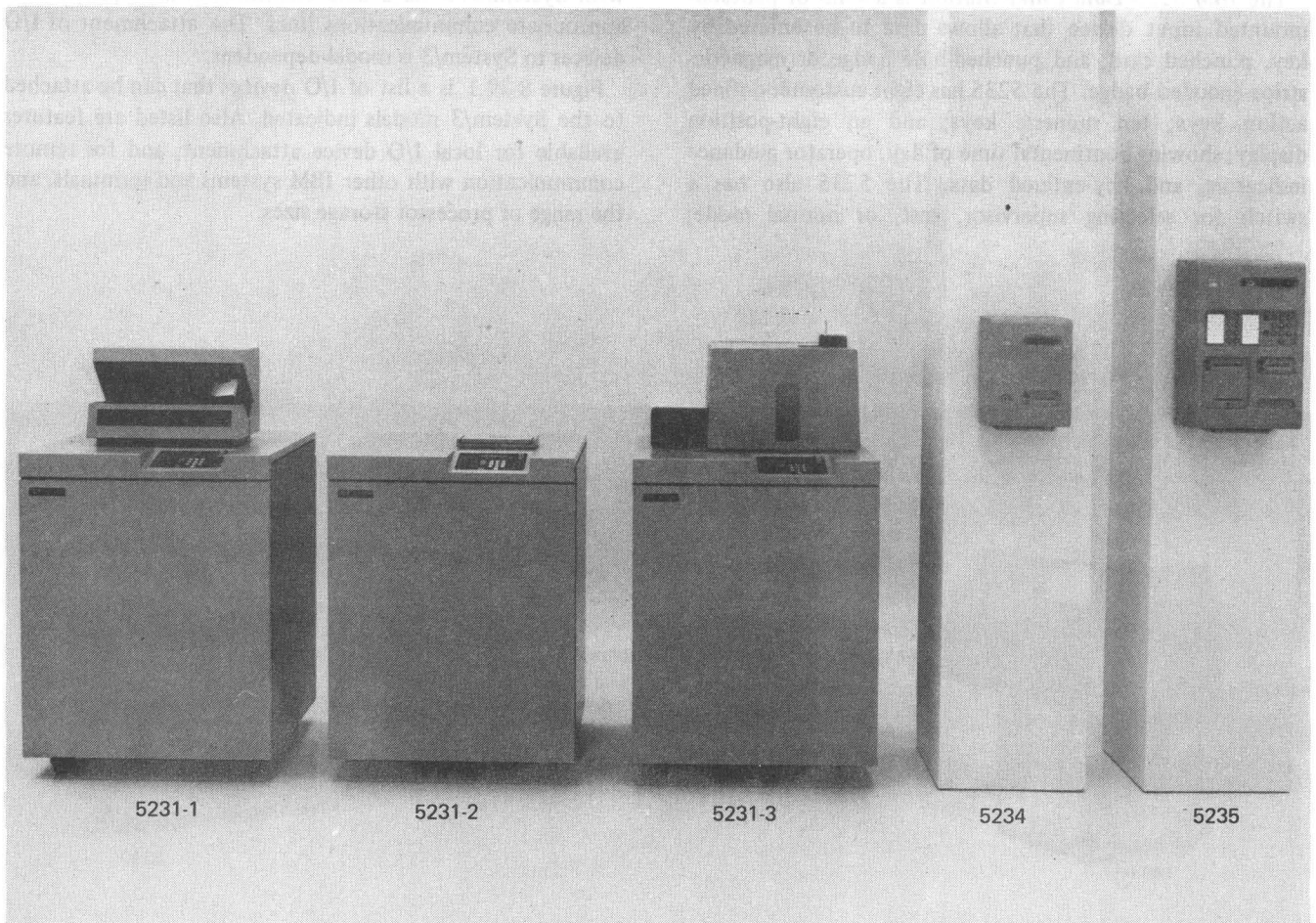

Figure 8-38.1. IBM 5230 Data Collection System

The *IBM 5231 Controller* is a standalone unit that collects data from as many as 15 time-entry and data-entry stations. The 5231 has an operator console for user response-to-status messages, a clock for continental time-of-day display, an audible alarm for alerting the operator, and a function for 5230 system diagnosis. System diagnosis is performed continuously whenever the 5231 is on but is not processing data. If a problem is detected, the 5231 displays a status message and sounds an alarm. From data entered, Model 1 interprets and punches 96-column output card records and Model 3 interprets and punches 80-column output card records. Model 2 stores data on a diskette. The data can then be batch transmitted, or each transaction can be transmitted as received, to a System/370 Model 115, 125, or 135 running under DOS/VS BTAM. Transmission is via the binary synchronous communications adapter (BSCA).

The *IBM 5234 Time Entry Station Models 1 and 2* are wall- or pedestal-mounted input devices that read 22-column card size badges. Each model has a four-position continental time-of-day display, and a switch for supervisor, test, or normal mode. Model 1 reads punched-hole badges, and Model 2 reads magnetic-stripe-encoded badges.

The *IBM 5235 Data Entry Station* is a wall- or pedestal-mounted input device that allows data to be entered by key, punched card, and punched-hole badge or magnetic-stripe-encoded badge. The 5235 has eight customer-defined action keys; ten numeric keys; and an eight-position display, showing continental time of day, operator guidance indicators, and key-entered data. The 5235 also has a switch for selecting supervisor, test, or normal mode;

control keys for entering and clearing data; and indicators for read, processed, or checked data. Optional features consist of an 80- or 96-column card reader and a punched-hole or magnetic-stripe-encoded badge reader.

The *IBM 5230 Data Collection System Accessory Package* consists of prerequisite physical installation accessories.

System/3

IBM System/3 (Figure 8-39) is a low-cost, general-purpose system for commercial data processing and interactive problem solving. The system offers integrated card processing, stored-program capability, calculating and logic capabilities, and the flexibility of disk storage. In addition, local and binary synchronous communications adapters are available for attaching a wide variety of teleprocessing devices. System/3, which is primarily for small business, extends the use of stored-program data processing to the small data processing user.

Six models of System/3 are available: Model 4, Model 6, Model 8, Model 10, Model 12, and Model 15. Processor storage ranges in capacity from 8K (8,192 bytes) to 256K (262,144 bytes). All models of System/3 can communicate with System/370 via a data transmission multiplexer over appropriate communications lines. The attachment of I/O devices to System/3 is model dependent.

Figure 8-39.1 is a list of I/O devices that can be attached to the System/3 models indicated. Also listed are features available for local I/O device attachment, and for remote communication with other IBM systems and terminals, and the range of processor storage sizes.

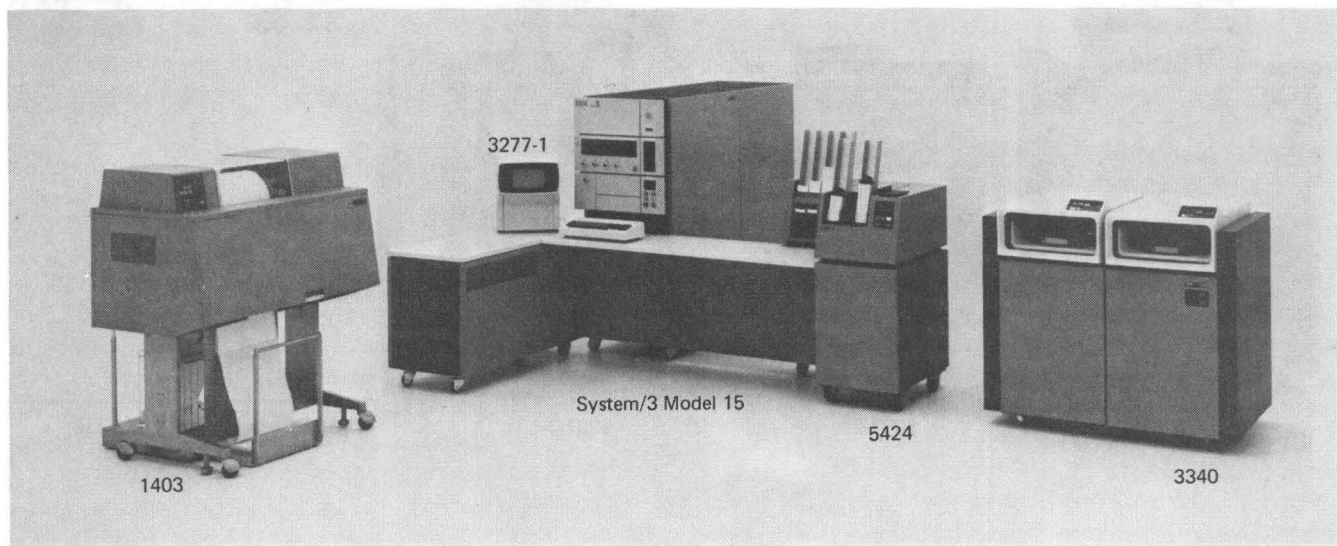

Figure 8-39. IBM System/3 Model 15

The type of printing and the printing speed depend on the system model. Printing is done either serially or by line, and speeds range from 40 characters per second (cps) to 155 lines per minute (lpm).

Attachment of the IBM 129 Card Data Recorder Model 2 provides the capability for 80-column cards to be read, punched, or printed during punching. Machines with the Variable Length Feed feature will handle 51, 60, 66, or 80 columns of data. Attachment of the IBM 5496 Data Recorder Model 1 provides the capability for 96-column cards to be read, punched, or printed during punching.

Depending on appropriate attachments and control programs, System/32 communicates with System/370 in either of two ways: through synchronous data link control (SDLC) communication via a 3704 or 3705 Communications Controller, or through binary synchronous communication (BSC) via a 2701 Data Adapter Unit or a 3704 or 3705 Communications Controller. Communication is under stored program control at speeds as high as 7200 bps on a nonswitched point-to-point or multipoint line, or as high as 4800 bps on a switched point-to-point line.

Printing speeds and disk storage capacities of the System/32 are listed in the following chart:

<i>System/32 Models</i>		
<i>Model</i>	<i>Printing Speed</i>	<i>Disk Storage Capacity (Bytes)</i>
A12	40 cps	5,053,440
A13	40 cps	9,169,920
A14	40 cps	13,777,920
A22	80 cps	5,053,440
A23	80 cps	9,169,920
A24	80 cps	13,777,920
B12	50 lpm	5,053,440
B13	50 lpm	9,169,920
B14	50 lpm	13,777,920
B22	100 lpm	5,053,440
B23	100 lpm	9,169,920
B24	100 lpm	13,777,920
B32	155 lpm	5,053,440
B33	155 lpm	9,169,920
B34	155 lpm	13,777,920

Note: Main storage capacity for each model is 16K (16,384 bytes), with the option of adding storage for a 24K or 32K capacity.

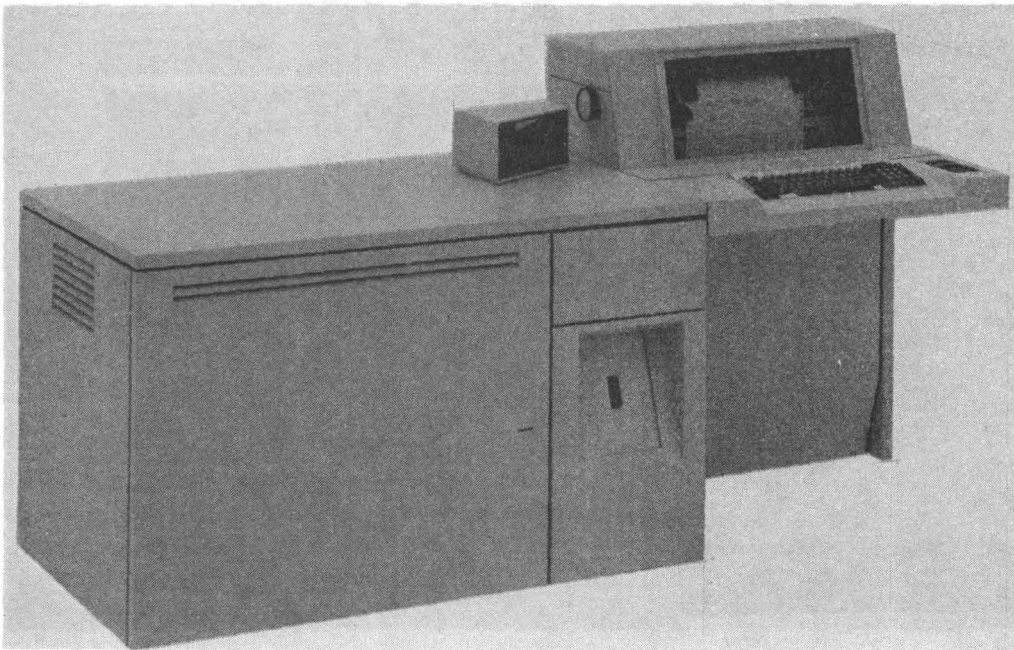

Figure 8-39.2. IBM System/32

	<i>System/3 Model</i>					
	<i>4</i>	<i>6</i>	<i>8</i>	<i>10</i>	<i>12</i>	<i>15</i>
129 Card Data Recorder		X				
1255 Magnetic Character Reader		X	X			
1403 Printer (via 5421)				X	X	X
1442 Card Read Punch				X	X	X
2222 Printer		X				
2265 Display Station		X				
2501 Card Reader						X
2560 Multi-Function Card Machine						X
3275 Display Station	X		X	X	X	X
3277 Display Station	X		X	X	X	X
3284 Printer	X		X	X	X	X
3286 Printer	X		X	X	X	X
3288 Line Printer	X		X	X	X	X
3340 Direct Access Storage Facility					X	X
3410 Magnetic Tape Unit			X	X	X	X
3411 Magnetic Tape Unit and Control			X	X	X	X
3741 Data Station		X	X	X	X	X
3741 Programmable Work Station		X	X	X	X	X
3881 Optical Mark Reader			X	X	X	X
5203 Printer			X	X	X	
5213 Printer	X	X				
5424 Multi-Function Card Unit				X	X	X
5444 Disk Storage Drive		X	X	X		X
5445 Disk Storage				X		X
5447 Disk Storage and Control	X					
5471 Printer-Keyboard			X	X	X	
5475 Data Entry Keyboard				X		
5496 Data Recorder		X				
Binary Synchronous Communications Adapter	X	X	X	X	X	X
Local Communications Adapter		X		X		X
Integrated Communications Adapter			X		X	
Local Display Adapter			X		X	
Display Adapter						X
Local Work Station Attachment	X					
<i>Processor Storage Sizes</i>						
Minimum	64K	8K	16K	8K	32K	48K
Maximum	64K	16K	64K	48K	64K	256K

Figure 8-39.1. System/3 Models: Attachable I/O Devices and Storage Sizes

System/32

IBM System/32 (Figure 8-39.2) is a desk-size, operator-controlled, general-purpose computing system, designed for use as a data processing tool in a wide variety of industries. It is composed of the IBM 5320 System Unit, which features keyboard data entry and disk processing. Components of the 5320 include a keyboard, a processing unit, disk storage, a display screen, a diskette drive, and a printing unit.

The keyboard has the familiar typewriter layout with a dual-defined top row that provides 24 command keys. A 10-key proof keyboard and system function keys are included.

The processing unit uses EBCDIC internal coding and features a solid-state main storage capacity of 16K (16,384 bytes) with the option of adding storage for a capacity of 24K or 32K.

A fixed disk storage provides capacity of 5.0, 9.1, or 13.7 million bytes, depending on system model. Access time averages less than 73 milliseconds for each of the three storage sizes, and the data transfer rate is 889 kilobytes per second.

The display screen uses a 64-character set displaying six lines of 40 characters each, providing operator guidance and output under program control.

The diskette drive, using standard diskettes available from IBM, reads at rates as high as 3,400 128-byte records per minute, and writes and verifies at rates as high as 1,800 128-byte records per minute. The drive is used for reading data that is recorded offline on a diskette at an IBM 3741 Data Station or an IBM 3742 Dual Data Station; for storage of information from the larger fixed disk storage; for data interchange with other systems via diskette; and for program distribution.

Data Acquisition and Process Control Systems

There are three systems which, when attached to System/370, offer configurations uniquely designed to satisfy the requirements for realtime data acquisitions, analysis, and process control:

1. IBM System/7
2. IBM 1070 Process Communication System
3. IBM 1800 Data Acquisition and Control System

Each of these basic configurations can accept both analog and digital electrical signals from such devices as thermocouples, pressure transducers, flow meters, analytical instruments, and contacts. They can also provide both analog and digital electrical signals to actuators, analog controllers, annunciators, lights, and contacts.

System/7

The IBM System/7 (Figure 8-40) is a high-performance, low-price modular system tailored to meet the diverse needs of a wide range of sensor-based applications. Three models

offer storage ranging from 2K words (a word is 16 bits with two parity bits) to 64K words. Attachment to System/370 is via asynchronous or binary synchronous communications adapters to an integrated communications adapter or a data transmission multiplexer.

Compact design, modularity, built-in features, and extensive programming support make this system well suited for data acquisition and process control.

In a typical installation, the System/7 can be used for pipeline monitoring, for in-process plant operations, as a continuous-control monitor for refining fossil fuels, and for general manufacturing and chemical processing. The data acquisition facilities are especially useful in medical-clinical analysis and for monitoring-feedback control of sophisticated processes in the fields of chemistry, physics, and astronomical research.

System/7 consists of combinations of the following units:

- 5010 Processing Module (always required), which provides the arithmetic, logical, and control functions for System/7.

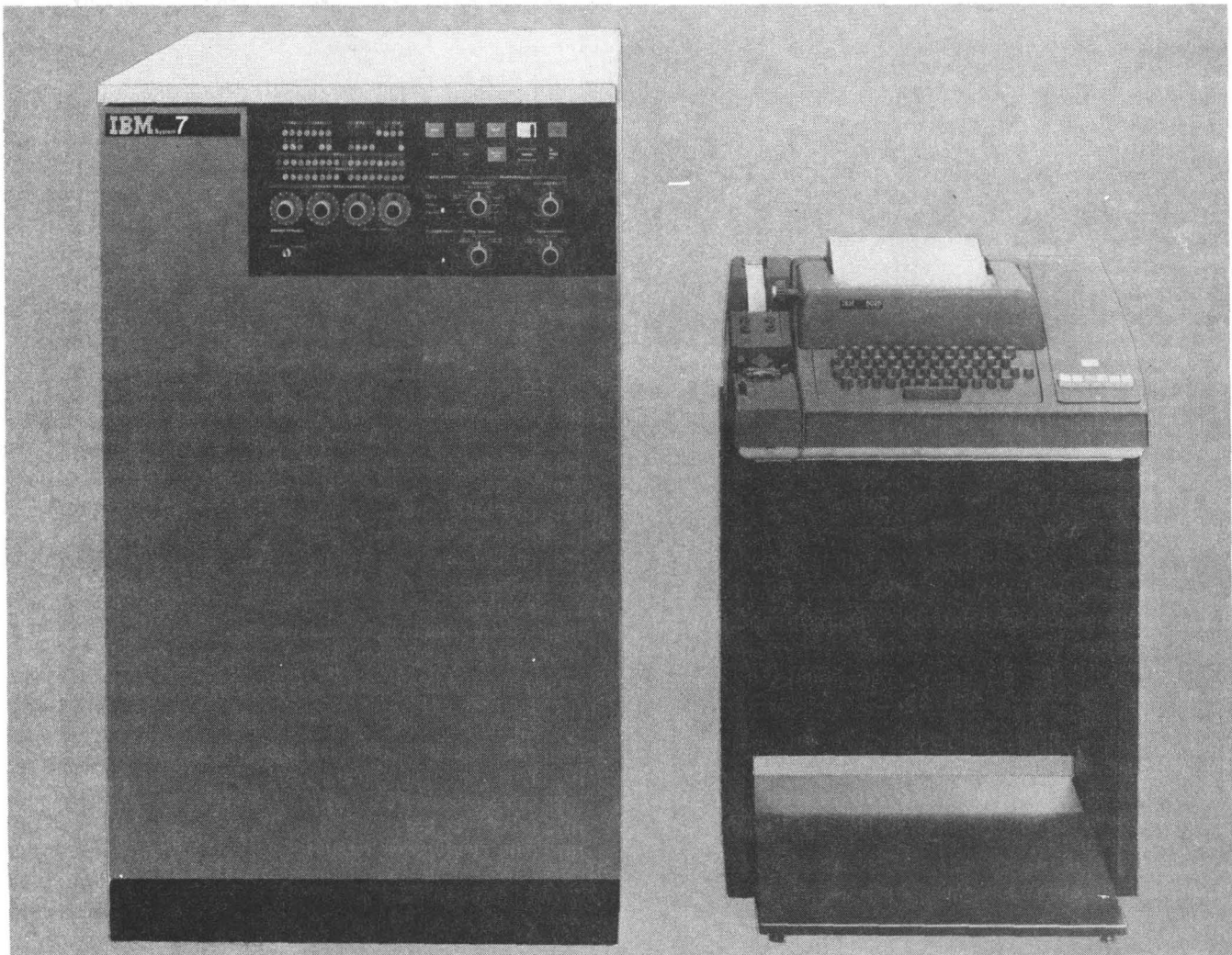

Figure 8-40. IBM System/7

- 5012 Multifunction Module, which provides digital input/output, analog input/output, and 2790 control.
- 5013 Digital Input/Output Module, which provides digital input/output, expansion capability for custom products, and 2790 control.
- 5014 Analog Input Module, which provides the capability to use voltage signals as input data.
- 5022 Disk Storage Unit.
- 5026 Enclosure, which provides housing and power for the processor and input/output modules.
- 5028 Operator Station, which provides a keyboard, printer, paper tape punch, and paper tape reader for System/7.

1070 Process Communication System

The IBM 1070 Process Communication System (Figure 8-41) is a data acquisition and control system designed for two-way data communication over standard communications lines between remote process locations and a central data processing system. The 1070 system has the necessary ruggedness and compactness to allow its use in a wide variety of industrial environments. The 1070, for example, can collect and transmit data from refineries, chemical plants, paper mills, steel mills, and manufacturing areas. The 1070 equipment at each process area can be either operator-oriented or fully automatic. Except for the 1053 printer, all 1070 units can be mounted in a standard 19-inch rack.

When the 1070 is connected to System/370, the two systems form a complete management information system. With this system, management can supervise quality and production, schedule jobs to take advantage of available equipment or to meet emergency needs, and perform online accounting. The 1070 system connects the System/370 through a 2701 Data Adapter Unit or a 2702 or 2703 Transmission Control. As many as twenty-six 1070 terminals may be attached to one communications line. The 1070 transmits and receives in half-duplex mode over voice- or subvoice-grade lines at 14.8 or 66.6 binary-coded-decimal characters per second, depending on which model of the 1071 Terminal Control is chosen. When operating at 134.5 bits per second, 1070 and 1050 systems may be mixed on the same communications line. Transmission at this rate may take place over leased common-carrier telephone lines, Western Union leased subvoice-grade service, or privately-owned communications lines. Transmission at 600 bits per second may take place over leased common-carrier or privately-owned communications facilities. All data transmitted and received is checked for validity.

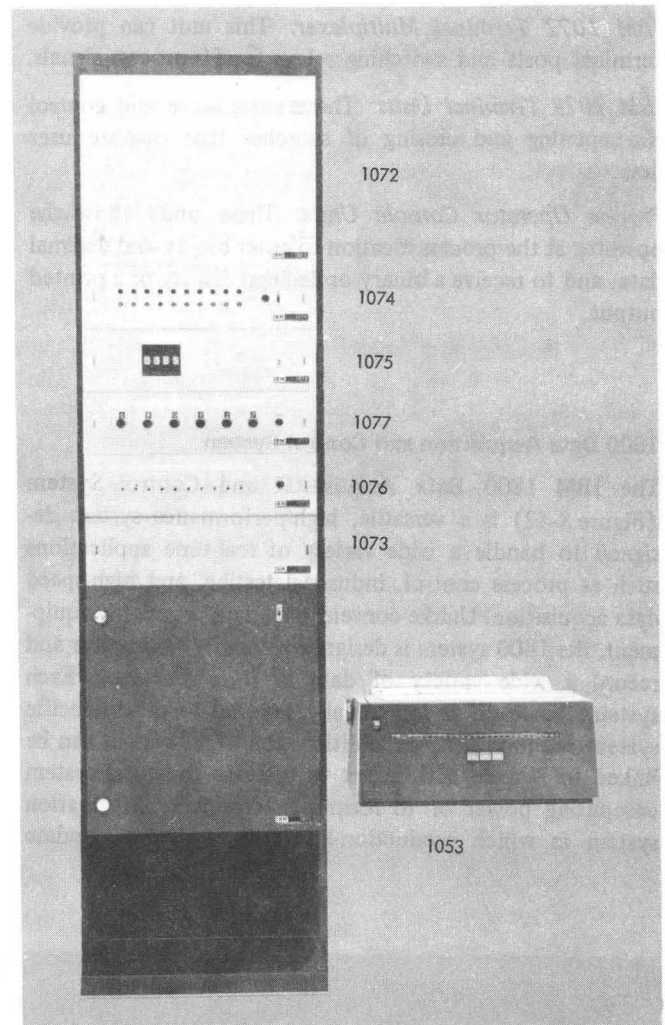

Figure 8-41. IBM 1070 Communication System

The 1070 system consists of the following units:

- 1071 Terminal Control (one required in each system)
- 1072 Terminal Multiplexer (one required in each system; up to six can be installed)
- 1073 Terminal Units
- Process Operator Console Units
 - 1074 Binary Display
 - 1075 Decimal Display
 - 1076 Manual Binary Input
 - 1077 Manual Decimal Input
 - 1078 Pulse Counter
 - 1053 Printer

IBM 1071 Terminal Control: This unit is the control center of the 1070 terminal. All data to and from System/370 is channeled through it. The basic 1071 contains logic for addressing 50 input/output points. This capacity can be expanded to 300 points, in modules of 50. (A point is a termination for a pair of wires.) The 1071 provides contact sense, decimal, and BCD input; in addition, it performs contact operate functions, analog-to-digital conversion (via set-point stations) and controls all operator communication units.

IBM 1072 Terminal Multiplexer: This unit can provide terminal posts and switching relays for 50 process signals.

IBM 1073 Terminal Units: These units sense and control the opening and closing of switches that operate user devices.

Process Operator Console Units: These units allow the operator at the process location to enter binary and decimal data, and to receive a binary or decimal display or a printed output.

1800 Data Acquisition and Control System

The IBM 1800 Data Acquisition and Control System (Figure 8-42) is a versatile, high-performance system designed to handle a wide variety of real-time applications such as process control, industrial testing, and high-speed data acquisition. Unlike conventional data processing equipment, the 1800 system is designed primarily to monitor and record a wide variety of data as it is generated. Each system, however, is individually tailored to meet specific system requirements. In addition, the 1800 system can be linked to System/370, either to increase the total system computing power or to form a management information system in which production-line data is used to update

inventory records, perform cost accounting, or handle other general business data processing jobs.

Among the continuous process control applications for which the 1800 system is suited are petroleum refining, chemical processing, steel rolling, pipeline monitoring, and power generation. The high-speed data acquisition facilities of the 1800 system are especially useful in missile pre-launch and manufacturing checkout, nuclear reactor analysis, medical-clinical analysis and monitoring, medical research, and many other applications.

1801/1802 Processor-Controller

The 1800 system is available with either the 1801 or 1802 Processor-Controller. The 1802 includes circuitry and control for connection and operation of the IBM 2401 and 2402 Magnetic Tape Units. Both the 1801 and 1802 are available in two models: the Model 1 has a main storage cycle of 4 microseconds; and the Model 2, 2 microseconds. Both models are available with four main storage capacities, ranging from 4K to 32K words (K=1,024, and each 18-bit word has 16 data bits, one storage protection bit, and one parity bit). Main storage capacity may be expanded by adding an IBM 1803 Core Storage Unit, permitting main storage to expand to 40K, 48K, 56K, or 64K words. Systems equipped with this unit have a storage cycle time of 2.25 microseconds.

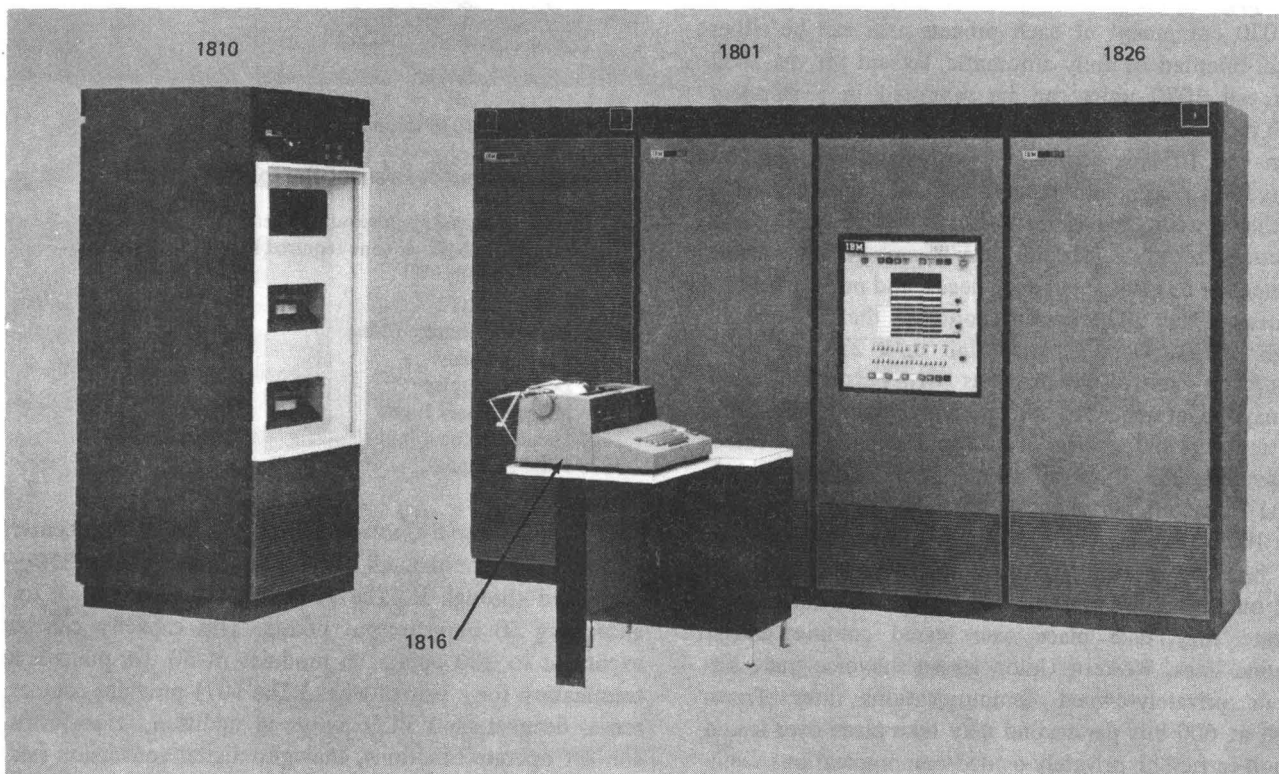

Figure 8-42. IBM 1800 Data Acquisition and Control System

Each processor-controller provides three data channels (operating at speeds up to 500,000 words per second in burst mode with the 2-microsecond main storage), three index registers, three interval timers, a powerful instruction set, indirect addressing, 12 levels of interrupt, and a storage protection feature. As many as 12 more data channels, a selector channel, and 12 additional levels of interrupt may be added as special features. The selector channel provides the facilities for attaching up to eight 2311 Disk Storage Drives. Through the use of shared files on the 2311's, the 1800 can exchange data with System/370 or another 1800.

The 1800 system can have a variety of I/O devices for realtime process control and data processing.

Realtime process I/O devices enable the 1800 system to accept either analog or digital input signals and provide analog or digital output signals for control or display purposes.

Data-processing I/O devices enable the 1800 system to perform the necessary data processing for data analysis, editing, and control purposes. These devices are also used to provide instructions for process and control room operators as well as reports for management review.

The I/O devices available to the 1800 include:

- 1053 Printer Model 3
- 1054 Paper Tape Reader Model 2
- 1055 Paper Tape Punch Model 2
- 1442 Card Read Punch Models 6 and 7
- 1443 Printer Model 1 or 2
- 1627 Plotter Model 1 or 2
- 1810 Disk Storage
- 1816 Printer-Keyboard
- 2311 Disk Storage Drive with 2841 Storage Control
- 2401 Magnetic Tape Unit Models 1-3

Remote Terminal Operation

Operated as a remote processor terminal, the 1800 system (with a synchronous communications adapter in an 1826 Data Adapter Unit) can communicate with a System/370 over common-carrier facilities or over privately owned facilities. The 1800 communicates with System/370 by way of the 2701 Data Adapter Unit. Data communications are half-duplex and are transmitted at 600, 1200, 2000, 2400, or 4800 bits per second, depending on what communications facilities are used. Common-carrier service for these communications may be either half-duplex or duplex.

IBM System/370 System Summary

Order No. GA22-7001-6

Cut or Fold Along Line

This manual is part of a library that serves as a reference source for systems analysts, programmers, and operators of IBM systems. This form may be used to communicate your views about this publication. They will be sent to the author's department for whatever review and action, if any, is deemed appropriate.

IBM shall have the nonexclusive right, in its discretion, to use and distribute all submitted information, in any form, for any and all purposes, without obligation of any kind to the submitter. Your interest is appreciated.

Note: *Copies of IBM publications are not stocked at the location to which this form is addressed. Please direct any requests for copies of publications, or for assistance in using your IBM system, to your IBM representative or to the IBM branch office serving your locality.*

Possible topics for comment are:

Clarity Accuracy Completeness Organization Coding Retrieval Legibility

If you wish a reply, give your name and mailing address:

What is your occupation? _____

Number of latest Newsletter associated with this publication: _____

Thank you for your cooperation. No postage stamp necessary if mailed in the U.S.A. (Elsewhere, an IBM office or representative will be happy to forward your comments.)

Reader's Comment Form

Cut or Fold Along Line

Fold

Fold

Business Reply Mail
No postage stamp necessary if mailed in U.S.A.

FIRST CLASS
PERMIT NO. 419
POUGHKEEPSIE, N.Y.



Postage will be paid by:
International Business Machines Corporation
Department B98
P.O. Box 390
Poughkeepsie, New York 12602

Fold

Fold



International Business Machines Corporation
Data Processing Division
1133 Westchester Avenue, White Plains, New York 10604
(U.S.A. only)

IBM World Trade Corporation
821 United Nations Plaza, New York, New York 10017
(International)

- access method 4-6, 4-10, 5-5
- access techniques 4-10
- addressing, storage 2-2, 3-1
- allocation 4-4, 4-5, 4-21
- alternate path retry (APR) 4-8
- American Standard Code for Information Interchange (ASCII) 4-11, 5-4
- APF (authorized program facility) 4-13
- applications
 - teleprocessing 5-6
 - VM/370 4-25
- APR (alternate path retry) 4-8
- arithmetic
 - decimal 2-4
 - fixed-point 2-4
 - floating-point 2-5
 - operations 2-4
- arithmetic/logic unit 2-4
- ASCII (American Standard Code for Information Interchange) 4-11, 5-4
- asynchronous transmission in teleprocessing 5-3
- attachment data for
 - data acquisition systems 8-2
 - I/O devices 7-3
 - process control systems 8-2
 - teleprocessing systems and devices 8-2
- audio response devices 8-10
- authorized program facility (APF) 4-13
- automated system initialization 4-15
- automatic volume recognition (AVR) 4-15
- auxiliary processors 7-6.1

- basic direct access method (BDAM) 4-11
- basic indexed sequential access method (BISAM) 4-11
- basic partitioned access method (BPAM) 4-11
- basic sequential access method (BSAM) 4-11
- basic telecommunications access method (BTAM) 4-12, 5-5
- BDAM (basic direct access method) 4-11
- binary synchronous communications (BSC) 5-4
- BISAM (basic indexed sequential access method) 4-11
- bits 2-1
- BLDL table 4-15
- block multiplexer channel 2-8
- boundaries, integral 2-2
- BPAM (basic partitioned access method) 4-11
- BSAM (basic sequential access method) 4-11
- BSC (binary synchronous communications) 5-4
- BTAM (basic telecommunications access method) 4-12, 5-5
- buffer storage 3-1
- burst mode 2-7
- byte mode 2-7
- byte multiplexer channel 2-7
- byte-oriented operand 3-2
- bytes 2-1

- catalog management 4-7
- CCH (channel check handler) 4-3, 4-8

- central processing units (CPU's)
 - comparison of 6-19
 - features 3-2
 - individual descriptions (*see* System/370 models)
 - interconnection of 3-3
- channel check handler (CCH) 4-3, 4-8
- channel facilities of each System/370 model
 - comparison of 6-19
 - (*see also* System/370 models)
- channel features 3-3
- channel indirect data addressing 3-3
- channels 2-7
 - block multiplexer 2-8
 - byte multiplexer 2-7
 - of specific System/370 models (*see* System/370 models)
 - selector 2-7
 - (*see also* selector channels)
- channel-to-channel adapter 3-3
- check bit (parity bit) 2-1
- checkpoint/restart 4-15
- clock comparator 3-3
- close processing 4-7
- CMS (conversational monitor system) 4-23 through 4-26
- codes 2-2, 5-3
- command processing 4-5
- command retry 3-3
- commands, compatibility 4-3
- commercial instruction set 3-2
- communications (devices and lines) 5-2
- comparison of System/370 models 6-19
- compatibility, program 4-3
- compatibility with other IBM systems
 - comparison of features for 6-19
 - features for 3-3
 - individual descriptions (*see* System/370 models)
- console file 6-3
- control
 - panel 2-6
 - programs 2-8
 - registers 2-4
 - unit function 2-8
- control program (CP) 4-23
- conversational remote job entry (CRJE) 4-13
- core storage (*see* main storage)
- CP (control program) 4-23
- CPU timer 3-3
- CPU's (central processing units)
 - comparison of 6-19
 - features 3-2
 - individual descriptions (*see* System/370 models)
 - interconnection of 3-3
- CRJE (conversational remote job entry) 4-13
- cycle, main storage (storage cycle time) 2-4

- DAT (dynamic address translation) 3-3, 4-1
- data
 - fields
 - fixed-length 2-1
 - variable-length 2-1

- data (*continued*)
 - formats 2-1
 - positioning 2-2
 - sets, teleprocessing 5-3
- data acquisition 5-6
 - systems 8-44
- data link 5-2
- data management 4-6
- data management services 4-7
- DDR (dynamic device reconfiguration) 4-8
- data terminal devices 8-11
- data transmission multiplexers 8-4
- decimal arithmetic 2-4
- decimal feature 3-2
- demodulation 5-2
- device independent display operator console support (DIDOCS) 4-16
- direct
 - access storage devices 7-7
 - comparison of 7-14
 - control feature 3-2
- direct access device space management 4-7
- disallowed interruptions 2-9
- Disk Operating System/Virtual Storage (DOS/VS) 4-1, 4-25
- Diskette (IBM) 8-38
- diskette I/O devices 7-14
- display devices 7-16, 8-19
- distributed intelligence system 4-15
- DOS/VS 4-1, 4-25
- doubleword 2-1
- DSS (dynamic support system) 4-16
- duplex communications lines in teleprocessing 5-2
- dynamic address translation (DAT) 3-3, 4-1
 - facility for Model 155 II 6-10
 - facility for Model 165 II 6-14
- dynamic allocation 4-21
- dynamic device reconfiguration (DDR) 4-8
- dynamic support system (DDS) 4-16

- EBCDIC (Extended Binary-Coded Decimal Interchange Code) 2-2, 4-11, 5-4
- editing of data 2-5
- emulator programs 4-20
- emulators 3-3
- end-of-volume processing 4-8
- Extended Binary-Coded Decimal Interchange Code (EBCDIC) 2-2, 4-11, 5-4
- extended control mode 3-3
- extended-precision floating-point feature 3-2
- external interrupt feature 3-2
- external interruptions 2-8

- fetch protection 3-1, 4-18
- fixed-point arithmetic 2-4
- floating-point
 - arithmetic 2-5
 - extended-precision (feature) 3-2
 - feature 3-2
 - number formats 2-5
 - registers 2-4
- formats
 - data 2-1
 - instruction 2-5
- formatting and printing trace or dump input files 4-8
(*see also* service aids)

- fractions, floating-point 2-5
- fullword (same as word) 2-1

- general registers 2-4
- generalized trace facility (GTF) 4-8
- graphic job processor (GJP) 4-3
- graphic programming services 4-13
 - functions of 4-13
- GTF (generalized trace facility) 4-8

- half-duplex communications lines in teleprocessing 5-2
- halfword 2-1
- high-speed
 - buffer storage 3-1
 - multiply 6-14
- host processor 5-2

- industry-oriented teleprocessing subsystems 4-13
- initialization, automated system 4-15
- input/output support 4-7
 - close processing 4-7
 - end-of-volume processing 4-7
 - open processing 4-7
- inspecting and modifying instructions/data (HMASPZAP) 4-9
- installation-tailored standalone dump facility (HMDSADMP) 4-9
- installation verification procedure (IVP) 4-20
- instruction
 - addressing 2-5
 - formats 2-5
 - length 2-5
 - retry 6-19
- instruction sets 3-2
- integral boundaries 2-2
- interactive use 4-26
- interface, I/O 2-8
- interleaving 2-4
- interpreter 4-5
- interruption system 2-8
- interruptions
 - classes of 2-8
 - disallowing of 2-9
 - priority 2-9
- interval timer 3-2
- I/O (input/output)
 - attachment data 7-3
 - control of 2-7
 - devices 2-8
 - interface 2-8
 - interruptions 2-8
 - specific (indexed by machine number) 7-3, 8-2
- IVP (installation verification procedure) 4-20

- JCL (job control language) 4-4, 4-25
- JECS (job entry central services) 4-5
- JEPS (job entry peripheral services) 4-5
- JES (job entry subsystem) 4-3
- JES2 4-21
- job control language (JCL) 4-4, 4-25
- job entry central services (JECS) 4-5
- job entry peripheral services (JEPS) 4-5
- job entry subsystem (JES), spooling and scheduling 4-3

- job flow through VS1 4-5
- job
 - initiation 4-5
 - log facility 4-17
 - management 4-4
 - scheduling services 4-4
 - termination 4-5
- K(=1,024) 2-4
- leased communications lines 5-3
- line adapters 5-2
- line adapter units 8-8
- linkage editor 4-19
- load balancing, I/O 4-17
- loader 4-19
- logical operations 2-5
- machine check handler (MCH) 4-3, 4-8
- machine-check interruption 2-9
- magnetic character readers 7-22
- magnetic ink character recognition (MICR) 4-2, 4-3
- magnetic tape devices 7-25
 - comparison of 7-33
- main storage
 - comparison for each System/370 model 6-19
 - features 3-1
 - hierarchies 4-3
 - in individual System/370 models (*see* System/370 models)
 - structure of 2-2
- management
 - catalog 4-7
 - data 4-6
 - job 4-4
 - recovery 4-8
 - system 4-18
 - task 4-6
 - VS2 4-22
- MCH (machine check handler) 4-3, 4-8
- MCS (multiple console support) 4-15
- message control programs 4-12
- message processing programs 4-13
- MF/1 (system activity measurement facility) 4-22
- MFT
 - features in VS1 4-1
 - features not supported in VS1 4-3
 - program compatibility 4-3
- MIC (missing interruption checker) 4-8
- MICR (magnetic ink character recognition) 4-2, 4-3
- minimum configuration for OS/VS system requirements 4-4
- missing interruption checker (MIC) 4-8
- modems in teleprocessing 5-2
- modulation 5-2
- modulator/demodulators (modems) 5-2, 8-8
- monitoring feature 6-19
- multipath control units 2-8
- multiple console support (MCS) 4-15
- multiple virtual storage (MVS) 4-21, 4-22, 4-23
- multiplexer channels (*see* block or byte multiplexer channels)
- multipoint communications lines 5-2
- multiprocessing 2-9, 4-21
- MVS (multiple virtual storage) 4-21, 4-22, 4-23
- NCP/VS (network control program/virtual storage) 5-5
- network control program/virtual storage (NCP/VS) 5-5
- network, in teleprocessing 5-1
 - elements of 5-2
- nonprivileged instructions 3-2
- nonshared (unshared) subchannels 2-7
- nonswitched communications lines 5-3
- NRZI (Non-Return-to-Zero IBM) 7-27
- O/C/EOV (open/close/end-of-volume) 4-7
- OLTEP (online test executive program) 4-17
- online I/O devices 7-1
- online test executive program (OLTEP) 4-17
- op codes (operation codes) 2-5
- open processing 4-7
- open/close/end-of-volume (O/C/EOV) 4-7
- operation codes (op codes) 2-5
- operator controls 2-5
- optical readers 7-35
- OS/DOS 4-25
- OS/DOS compatibility 3-3
- OS/MFT 4-2
- OS/VS1 4-1
 - advantages 4-2
 - differences (MFT) 4-3
 - devices supported 4-4
 - standard optional features 4-13
 - starter system 4-20
- OS/VS2 4-21
 - features and facilities 4-21
 - handling the job stream 4-21
 - handling data sets 4-21
 - operating 4-22
 - managing 4-22
 - RAS (reliability, availability, serviceability) 4-22
- packed format (decimal arithmetic) 2-4
- PAGETUNE command 4-17
- paper tape devices 7-53
- parity bit (check bit) 2-1
- partition deactivation/reactivation 4-17
- partition redefinition 4-3, 4-6
- point-to-point communications lines 5-2
- positioning of data 2-2
- power warning feature (PWF) 4-17, 4-23
 - (*see also* individual S/370 models)
- printer-keyboards 7-39
- printers 7-41
- private communications lines 5-3
- privileged instructions 3-2
- process control systems 8-44
 - attachment data 8-2
- processing units (*see* CPUs)
- processor storage 2-1, 3-1
- program
 - event recording 3-3
 - interruptions 2-8

- program products 4-21
- program reset 3-3
- programming
 - support (VS1) 4-19
 - VM/370 4-25
- programming support for individual S/370 models
 - comparison of 6-19
 - (see also System/370 models)
- programming systems 4-1, 5-5
- program temporary fix (PTF) 4-9, 4-25
- protection
 - key 3-1
 - storage 3-1, 4-18
- PSW (program status word) 2-8, 4-3
- PTF (program temporary fix) 4-9, 4-25
- punched card devices 7-46
 - comparison of 7-52
- punched tape devices 7-53
- PWF (power warning feature) 4-17, 4-23
 - (see also individual System/370 models)
- QISAM (queued indexed sequential access method) 4-11
- QSAM (queued sequential access method) 4-11
- QTAM (queued telecommunications access method) 4-3, 5-5
- queued
 - access methods 4-11
 - access technique 4-10
 - indexed sequential access method (QISAM) 4-11
 - sequential access method (QSAM) 4-11
 - telecommunications access method (QTAM) 4-3, 5-5
- RAS (reliability, availability, and serviceability) 4-8, 4-22
- RAS components 4-8
 - checkpoint/restart 4-8, 4-15
 - dynamic support system (DSS) 4-8, 4-16
 - online test executive program (OLTEP) 4-8, 4-17
 - power warning feature (PWF) 4-8, 4-17, 4-23
 - recovery management 4-8
 - service aids 4-8
 - teleprocessing online test executive program (TOLTEP) 4-8, 4-19
- real facility 4-2
- real storage
 - definition of 4-1
 - unused 4-2
- recovery management 4-8
- recovery terminal management (RTM) 4-22
- registers 2-4
- reliability, availability, and serviceability (RAS) 4-8, 4-22
- remote
 - entry services (RES) 4-3, 4-13
 - job entry (RJE) 4-3, 5-6
 - processing 4-11
 - spooling communication system (RSCS) 4-23, 4-24
 - terminal access method (RTAM) 4-22
- RES (remote entry services) 4-3, 4-13
- RJE (remote job entry) 4-3, 5-6
- rollout/rollin 4-4
- RR instruction format 2-5
- RS instruction format 2-5
- RSCS (remote spooling communication system) 4-23, 4-24
- RTAM (remote terminal access method) 4-13

- RTM (recovery termination management) 4-22
- RX instruction format 2-5
- S instruction format 2-5
- satellite graphic job processor (SGJP) 4-3
- scheduler work area (SWA) 4-5, 4-18, 4-21
- SCP (system control program) 4-4, 4-19
- scheduler work area data set (SWADS) 4-5, 4-18
- scientific instruction set 3-2
- SDLC (synchronous data link control) 4-12, 5-4
- SDS (status display support) 4-16
- selector channels 2-7
- service aids 4-3, 4-14
 - GTF 4-8
 - HMBLIST 4-8
 - HMASPZAP 4-9
 - HMSADMP 4-9
 - HMDPRDMP 4-9
 - HMAPTFLE 4-9
 - IMCJOBQD and IMCOSJQD 4-9
 - HMASMP 4-9
- SGJP (satellite graphic job processor) 4-3
- shared subchannels 2-7
- SI instruction format 2-5
- SMF (system management facilities) 4-18
- SMP (system modification program) 4-9, 4-23
- SNA (systems network architecture) 5-6
- software error recording 4-23
- spooling 4-3
- SRM (system resources manager) 4-22
- SS instruction format 2-5
- standard instruction set 3-2
- starter system (VS1) 4-20
- status display support (SDS) 4-16
- storage
 - addressable 2-4
 - addressing 2-2, 3-1
 - buffer 3-1
 - cycle time 2-4
 - external page 4-1
 - main (see main storage)
 - processor 2-1, 3-1
- store protection 3-1
- store status 3-3
- supervisor call interruption 2-8
- supervisor services (task management) 4-6
- support programming 4-19
- SWA (scheduler work area) 4-5, 4-18, 4-21
- SWADS (scheduler work area data set) 4-18
- switched communications lines 5-3
- synchronous data link control (SDLC) 4-12, 5-4
- synchronous transmission in teleprocessing 5-2
- system
 - activity measurement facility (MFH) 4-22
 - assembler 4-19
 - control panel 2-6
 - control program components 4-4
 - control section 2-4
 - initialization 4-15
 - log 4-18
 - management facilities (SMF) 4-18
 - modification program (SMF) 4-9, 4-23
 - resources manager (SRM) 4-22
- system, distributed intelligence 4-15

systems network architecture (SNA) 5-6
 System/3 8-42.2
 System/7 8-44
 System/32 8-43
 System/360 8-2
 System/370
 addressing capability 2-2
 basic structure 2-1
 System/370 models
 comparison of 6-19
 description of
 Model 115 6-1
 Model 125 6-3
 Model 135 6-5
 Model 138 6-6.1
 Model 145 6-7
 Model 148 6-8.1
 Model 155 6-9
 Model 155 II 6-10
 Model 158 6-11
 Model 165 6-13
 Model 165 II 6-14
 Model 168 6-15
 Model 195 6-17
 System/370 programming systems 4-1

 task management 4-6
 TCAM (telecommunications access method) 4-3, 4-12, 5-5
 telecommunications access method (TCAM) 4-3, 4-12, 5-5
 teleprocessing
 access methods (BTAM and TCAM) 4-12
 introduction to 5-1
 network 5-1
 systems and devices 8-1
 attachment data 8-2
 teleprocessing online test executive program (TOLTEP) 4-19
 terminal connections in teleprocessing
 multipoint 5-2
 point-to-point 5-2
 terminals in teleprocessing 5-2
 termination, job 4-5
 TESTRAN 4-3
 time-of-day clock 3-2
 time-sharing option (TSO) 4-21
 time slicing 4-19
 TOLTEP (teleprocessing online test executive program) 4-19
 translation of characters 2-5
 transmission direction 5-2
 transmission modes in teleprocessing 5-3
 TSO (time-sharing option) 4-21
 two-byte interface 6-14
 type I and type II programs 4-21

 universal instruction set 3-2
 Universal Product Code 8-37
 unprivileged (nonprivileged) instructions 3-2
 user modification of logical cylinder definition 4-19
 utility programs 4-19
 data set 4-19
 independent 4-20
 system 4-20

 VIO (virtual I/O) 4-22
 virtual facility 4-2
 virtual machine assist 4-24
 Virtual Machine Facility/370 (VM/370) 4-1, 4-23
 virtual storage
 access method (VSAM) 4-1, 4-10, 4-22
 address space 4-1
 applications 4-25
 capability 2-9
 description of 4-1
 elements of 4-23
 MVS 4-21
 operating systems 4-23
 virtual telecommunications access method (VTAM) 4-1, 4-12, 5-5
 VM/370 (Virtual Machine Facility/370) 4-1, 4-23
 VSAM (virtual storage access method) 4-1, 4-10, 4-22
 VTAM (virtual telecommunications access method) 4-1, 4-12, 5-5

 word (fullword) 2-1

 zoned format (decimal arithmetic) 2-4

 96-column punched-card device 7-49
 1001 Data Transmission Terminal 8-11
 1013 Card Transmission Terminal 8-2
 1017 Paper Tape Reader 7-53
 1018 Paper Tape Punch 7-53
 1030 Data Collection System 8-22
 1050 Data Communication System 8-23
 1052 Printer-Keyboard 7-39
 1053 Printer 7-41
 attached to a 2848 7-21
 1060 Data Communication System 8-24
 1070 Process Communication System 8-45
 1130 Computing System 8-25
 1255 Magnetic Character Reader 7-22
 1287 Optical Reader 7-35
 1288 Optical Page Reader 7-36
 1316 Disk Pack 7-8
 1403 Printer 7-41
 1419 Magnetic Character Reader 7-23
 1442 Card Read Punch Model N1 7-46
 1442 Card Punch Model N2 7-46
 1443 Printer 7-42
 1800 Data Acquisition and Control System 8-45

 2150 Console 6-17, 7-39
 2250 Display Unit 7-16
 2260 Display Station 7-20
 in teleprocessing 8-19
 2265 Display Station 8-19
 2305 Fixed Head Storage 7-7
 2311 Disk Storage Drive 7-8
 2312 Disk Storage 7-9
 2313 Disk Storage 7-9
 2314 Direct Access Storage Facility (DASF) 7-9
 2316 Disk Pack 7-10
 2318 Disk Storage 7-9
 2319 Disk Storage 7-9

2401 Magnetic Tape Unit 7-25
2415 Magnetic Tape Unit and Control 7-26
2420 Magnetic Tape Unit 7-27
2501 Card Reader 7-46
2520 Card Read Punch Model B1 7-47
2520 Card Punch Models B2 and B3 7-47
2540 Card Read Punch 7-48
2560 Multi-Function Card Machine 7-48
2596 Card Read Punch 7-49
2671 Paper Tape Reader 7-53
2701 Data Adapter Unit 8-4
2711 Line Adapter Unit 8-8
2715 Transmission Control Unit 8-26
2740 Communication Terminal 8-11
2741 Communication Terminal 8-12
2770 Data Communication System 8-25
2790 Data Communication System 7-55, 8-26
2803 Tape Control 7-29
2804 Tape Control 7-29
2816 Switching Unit 7-29
2821 Control Unit 7-42
2822 Paper Tape Reader Control 7-53
2826 Paper Tape Control 7-53

2835 Storage Control 7-7, 7-8
2840 Display Control 7-16
2841 Storage Control 7-10
2845 Display Control 8-19
2848 Display Control 7-20, 8-19
2860 Selector Channel 2-7
2870 Multiplexer Channel 2-7
2880 Block Multiplexer Channel 2-8

3052 Attached Processing Unit 6-11
3056 Remote System Console 6-12
3062 Attached Processing Unit 6-15
3066 System Console 6-16
3068 Multisystem Communication Unit 6-16.1
3115-0 and 3115-2 Processing Units 6-2
3125-0 and 3125-2 Processing Units 6-3
3135 and 3135-3 Processing Units 6-5
3138 Processing Unit 6-6.2
3145 and 3145-3 Processing Units 6-7
3148 Processing Unit 6-8.2
3155 Processing Unit 6-9
3158 and 3158-3 Processing Units 6-11
3165 Processing Unit 6-13
3168 and 3168-3 Processing Units 6-18
3195 Processing Unit 6-18
3203 Printer 7-43
3210 Console Printer-Keyboard 7-39
3211 Printer 7-43

3213 Console Printer 6-12, 7-4
3215 Console Printer-Keyboard 7-40
3270 Information Display System 7-55, 8-28
3272 Control Unit 7-21
3275 Display Station 8-20
3277 Display Station 7-21
3330 Disk Storage 7-10
3333 Disk Storage and Control 7-10
3336 Disk Pack 7-11
3340 Disk Storage 7-12
3344 Direct Access Storage 7-12
3345 Storage and Control Frame 6-7
3348 Data Module 7-12
3350 Direct Access Storage 7-13
3410 Magnetic Tape Unit 7-30
3411 Magnetic Tape Unit and Control 7-30
3420 Magnetic Tape Unit 7-31
3504 Card Reader 7-50
3505 Card Reader 7-50
3525 Card Punch 7-50
3540 Diskette Input/Output Unit 7-14
3600 Finance Communication System 8-31
3650 Retail Store System 8-35
3660 Supermarket System 8-35
3704 Communications Controller 8-5
3705 Communications Controller 8-6
3735 Programmable Buffered Terminal 8-13
3740 Data Entry System 8-38
3767 Communication Terminal 8-15
3770 Data Communication System 8-40
3780 Data Communications Terminal 8-16
3781 Card Punch 8-16
3790 Communication System 8-41
3800 Printing Subsystem 7-44
3803 Tape Control 7-31
3811 Control Unit 7-43
3830 Storage Control 7-10
3838 Array Processor 7-6.1
3850 Mass Storage System 7-55
3851 Mass Storage Facility 7-14, 7-56
3872 Modem 8-8
3874 Modem 8-8
3875 Modem 8-8
3881 Optical Mark Reader 7-37
3886 Optical Character Reader 7-38
3890 Document Processor 7-23

5203 Printer 7-45
5213 Printer 7-45
5230 Data Collection System 8-42.1
5425 Multi-Function Card Unit 7-51

7770 Audio Response Unit 8-10

IBM

International Business Machines Corporation
Data Processing Division
1133 Westchester Avenue, White Plains, New York 10604
(U.S.A. only)

IBM World Trade Corporation
821 United Nations Plaza, New York, New York 10017
(International)