

3745 Communication Controller All Models
3746 Nways Multiprotocol Controller Model 900

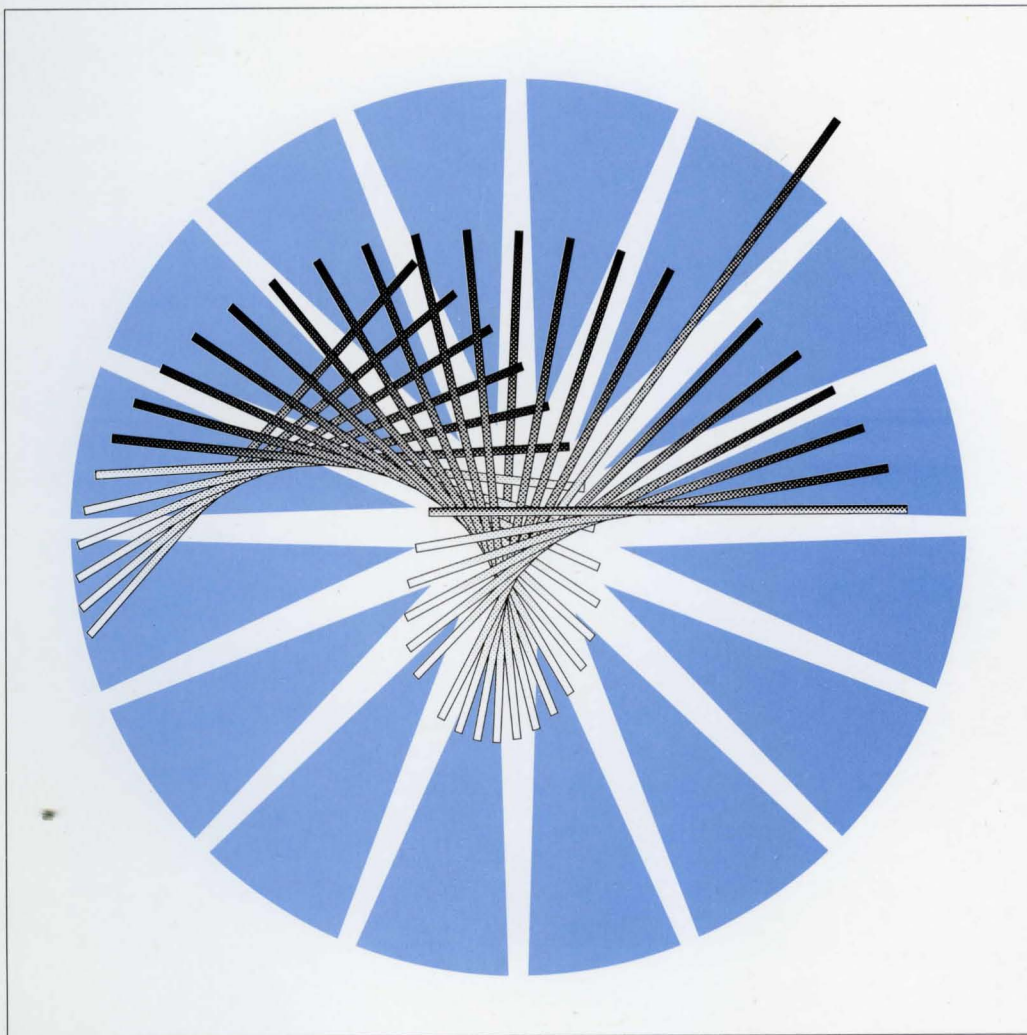

Console Setup Guide



O 3745 Communication Controller All Models
3746 Nways Multiprotocol Controller Model 900



Console Setup Guide



Note!

Before using this information and the product it supports, be sure to read the general information under "Notices" on page xi.

Tenth Edition (June 1998)

The information contained in this manual is subject to change from time to time. Any such changes will be reported in later revisions.

Order publications through your IBM* representative or the IBM branch office serving your locality. Publications are not stocked at the address given below.

A form for readers' comments appears at the back of this publication. If the form has been removed, address your comments to:

IBM France
Centre d'Etudes et Recherches
Service 0798 - BP 79
06610 La Gaude
France

- FAX: 33 4 93 24 77 97
- IBM Internal Use: LGERCF at IBMFR
- Internet: lgercf@fr.ibm.com

When you send information to IBM, you grant IBM a non-exclusive right to use or distribute the information in any way it believes appropriate without incurring any obligation to you.

© Copyright International Business Machines Corporation 1989, 1998. All rights reserved.

Note to U.S. Government Users — Documentation related to restricted rights — Use, duplication or disclosure is subject to restrictions set forth in GSA ADP Schedule Contract with IBM Corp.

Contents

Figures	ix
Tables	ix
Notices	xi
European Union (EU) Statement	xi
Electronic Emission Notices	xi
Trademarks and Service Marks	xiii
Safety	xiii
About this Guide	xv
Conventions Used in this Guide	xv
Who Should Use this Guide	xvi
How this Guide is Organized	xvi
What is New in this Edition	xvii
Where to Find More Information	xvii
World Wide Web	xvii

Part 1. 3745 Models A and 3746 Model 900

Chapter 1. Introduction to Remote Consoles and DCAF	1-1
Consoles	1-2
Diskettes with Example Configurations	1-3
DCAF Logon Password and Service Processor Security	1-3
Regaining Control of the Service Processor	1-4
Minimum Workstation (Remote Console) Configuration	1-4
Programming Requirements	1-4
Hardware Requirements and Recommendations	1-5
Chapter 2. DCAF Session Installation	2-1
Summary of Procedures	2-1
Preparation	2-1
Physical Installation	2-2
Installing DCAF	2-2
Upgrading DCAF	2-3
Installing TCP/IP	2-3
Customizing CS/2 and CM/2	2-3
Customizing a Remote Workstation	2-3
Loading Example Configurations	2-4
Starting CS/2 and CM/2 Configuration	2-4
Configuring Data Link Control (DLC) for a Service Processor	2-4
Chapter 3. Using DCAF to Remotely Log On to the Service Processor	3-1
Starting a Session	3-1
Closing a Session	3-2
From the Remote Workstation	3-2
From the Target Service Processor	3-2
Chapter 4. TCP/IP LAN-Attached Remote Workstation Configuration	4-1

Configuring a Target Service Processor	4-1
Configuring a TCP/IP LAN-Attached Remote Workstation	4-4
Configuring DCAF for TCP/IP	4-4
Configuring TCP/IP	4-6
Chapter 5. APPC LAN-Attached Remote Workstation Configuration	5-1
Configuring a Target Service Processor	5-1
Parameter Values that Must Be the Same	5-2
Configuring the Service Processor in MOSS-E	5-2
Configuring a APPC LAN-Attached Remote Workstation	5-5
Configuring CS/2	5-5
Configuring DCAF for APPC	5-11
Chapter 6. Modem-Attached Remote Workstation Configuration	6-1
Configuring a Target Service Processor	6-1
Parameter Values that Must Be the Same	6-2
Configuring the Service Processor in MOSS-E	6-2
Configuring Workstation Modems	6-4
Configuring CS/2 and CM/2 in Workstations	6-6
Configuring Workstation for an IBM Modem	6-6
Procedures for Service Processors 9577 and 9585	6-7
Procedures for Service Processor 3172	6-8
Procedures for Service Processor 7585	6-9
Modem 7855 in Synchronous Mode to Service Processor 9577, 9585, and 3172 via MPA Card in Synchronous Mode (I7855SYN)	6-10
Modem 7855 in Asynchronous Mode to Service Processor 9577, 9585, 3172, and 7585 via Serial Port (I7855ASY)	6-15
Modem 7857 in Synchronous Mode to Service Processor 9577, 9585, and 3172 via MPA Card in Synchronous Mode (I7857SYN)	6-20
Modem 7857 in Asynchronous Mode to Service Processor 9577, 9585, 3172, and 7585 via Serial Port (I7857ASY)	6-25
Modem 7857 in AutoSync Mode to Service Processor 9577, 9585, and 3172 via MPA Card in Sync Mode (I7857AUT)	6-30
Hayes Modem in Asynchronous Mode to Service Processor 9577, 9585, 3172, and 7585 via Serial Port (HAYESASY)	6-35
Hayes Modem in AutoSync Mode to Service Processor 9577, 9585, and 3172 via MPA Card in Sync Mode (HAYESAUT)	6-40
Configuring DCAF for a Modem	6-45
Chapter 7. SNA-Attached Remote Workstation	7-1
Configuring a Target Service Processor	7-1
Parameter Values that Must Be the Same	7-2
Configuring the Service Processor in MOSS-E	7-2
Configuring a SNA-Attached Remote Workstation	7-5
Configuring CS/2	7-5
Configuring DCAF for SNA	7-10
NCP Definitions	7-12
Remote Controlling Workstation	7-12
Target Service Processor	7-13
VTAM Definitions	7-14
Start Definitions	7-14
Logmode Table	7-14
Major Node Definitions	7-15
Remote Workstation	7-15

Target Service Processor	7-15
Chapter 8. APPN-Attached Remote Workstation	8-1
Configuring a Target Service Processor	8-1
Parameter Values that Must Be the Same	8-2
Configuring the Service Processor in MOSS-E	8-2
Configuring an APPN-Attached Remote Workstation	8-4
Configuring CS/2	8-4
Configuring DCAF for APPN	8-10
Chapter 9. Telnet-attached Remote Workstation	9-1
Introduction	9-1
Consoles	9-1
Logon Password	9-2
Programming Requirements	9-2
Hardware Requirements and Recommendations	9-2
Installation	9-2
Using Telnet to Remotely Log On to the Network Node Processor	9-2
Starting a Session	9-2
Closing a Session	9-2

Part 2. 3745 Models 130 to 610

Chapter 10. Setting Up a Local or an Alternate Console	10-1
General Information on Local or Alternate consoles	10-1
3151 in Native Mode (Local or Alternate)	10-2
3151 in 3101 Emulation Mode (Local or Alternate)	10-3
3153 in 3151 Emulation Mode (Local or Alternate)	10-5
Recommended Settings	10-5
Starting the Console Configuration	10-5
Leaving the Console Configuration	10-6
3161 or 3163 (Local or Alternate)	10-6
IBM PS/2 (Local or Alternate)	10-6
MOSS Local or Alternate Console Emulation with CM/2 and Softerm	10-9
3727	10-9
Testing a Connection with the Local or Alternate Console	10-10
Chapter 11. Setting Up a Remote Console	11-1
General Information (Remote)	11-1
3151 in Native Mode (Remote)	11-2
3151 in 3101 Emulation Mode (Remote)	11-3
3153 in 3151 Emulation Mode (Remote)	11-5
Recommended Settings	11-5
Starting the Console Configuration	11-5
Closing the Console Configuration	11-6
3161 or 3163 (Remote)	11-6
IBM PC	11-6
IBM PS/2 (Remote)	11-7
MOSS Remote Console Emulation with CM/2 and Softerm	11-10
Starting Custom Plus	11-10
Defining a New Session	11-10
Defining the Terminal Emulation Profile	11-10
Defining Connection Path Profile	11-12

Ending Definition of a New Session	11-12
Other Types of Consoles	11-13
Testing the Modem Connection to a Remote Console	11-13
Chapter 12. Modem Setup	12-1
Modems for 3745 Models 130 to 160	12-1
Setting Up	12-1
Switch Settings for IBM Modems 5841, 5842, and 5853	12-2
IBM 5841 Modem	12-2
IBM 5842 Modem	12-2
IBM 5853 Modem	12-2
Modems for 3745 Models A	12-3
Setting the IBM 7855 Modem	12-3
Setting the IBM 7857 Modem Connected to MPA Card (SYN)	12-4
Setting the 7857 Modem Connected to COM1 (ASYN)	12-5
Setting the 7857 Modem Connected to MPA Card on COM2 (ASYN)	12-5
Setting the IBM 7858 Modem Connected to MPA Card (SYN)	12-6
Setting the 7858 Modem Connected to COM1 (ASYN)	12-6
Setting the 7858 Modem Connected to MPA Card on COM2 (ASYN)	12-6
Chapter 13. RSF Modems	13-1
IBM 5858 Modem	13-1
IBM 7855 Modem	13-1
IBM 7857 Modem	13-1

Part 3. Appendixes for 3745 Model A and 3746 Model 900

Appendix A. Configuration for a Two-Target Remote Workstation	A-1
NCP Definitions	A-2
VTAM Definitions	A-2
Start List	A-2
Logmode Table	A-3
Switched Major Nodes	A-3
DCAF Remote Workstation Configuration	A-4
Appendix B. Configuring DLC for DCAF	B-1
Create or Change the Token-Ring Network DLC Adapter Profile	B-1
Create or Change the SDLC DLC Adapter Profile	B-1

Part 4. Appendixes for 3745 Models 130 to 610

Appendix C. Location of 3745 Console Connectors	C-1
3745 Communication Controller Models 130, 150, 160, and 170	C-1
3745 Communication Controller Models 210, 310, 410, and 610	C-1
Appendix D. Console and RSF Interface Cables	D-1
Cable from the 3745 to a Local Console	D-1
Local Console Cable Assembly	D-1
Cable from the 3745 to an Alternate Console	D-2
Alternate Console Cable Assembly	D-2
Cable Adapters for Local/Alternate Console	D-2
Console Connection through the IBM 7427 Console Switching Unit	D-3

Cable from the 3745 to the 7427 Switching Unit (A)	D-3
Cable Assembly for Local Console	D-3
Cable Assembly for Alternate Console	D-3
Cable from the 7427 to a 31xx, PS/2, or PC Console (B)	D-3
Cable Assembly for 31xx Console	D-3
Cable Assembly for PS/2 or PC Console	D-3
Cable from the 7427 to a 3727 Console (B)	D-3
Cable Assembly	D-3
Remote Console Cable	D-4
Cable to Modem for Remote Console	D-4
Cable to Modem for RSF	D-4
RSF Modem Cable	D-4

Part 5. Bibliography, Abbreviations, Glossary, and Index

Bibliography	X-1
Customer Documentation for the IBM 3745 (Models 210, 310, 410, 610, 21A, 31A, 41A, and 61A), and 3746 (Model 900)	X-1
Additional Customer Documentation for the IBM 3745 Models 130, 150, 160, 170, and 17A	X-5
List of Abbreviations	X-1
Glossary	X-3
Index	X-7



Figures

1-1.	DCAF Console Attachments	1-2
4-1.	Types of TCP/IP Service LAN-Attached Remote Workstations	4-1
5-1.	APPC Service LAN-Attached Remote Workstation	5-1
5-2.	NetView Link/Reporting Customization	5-3
5-3.	DCAF Customization	5-4
6-1.	Modem-Attached Remote Workstation	6-1
6-2.	NetView Link/Reporting Customization	6-3
6-3.	DCAF Customization	6-4
7-1.	SNA-Attached Remote Workstation	7-1
7-2.	NetView Link/Reporting Customization	7-3
7-3.	DCAF Customization	7-4
8-1.	APPN Remote Workstation	8-1
8-2.	DCAF Customization	8-3
9-1.	Telnet Workstation Configuration	9-1
A-1.	A Two-Target Configuration	A-1

Tables

2-1.	DCAF Session Installation Procedures	2-1
5-1.	Identical Target and Controlling Parameters	5-2
6-1.	Identical Target and Controlling Parameters	6-2
6-2.	Recommended IBM Modems, their Settings, and CS/2 (or CM/2) Configurations	6-5
6-3.	IBM Modems for Remote Workstations and Target Service Processors 9577 and 9585	6-7
6-4.	IBM Modems for Remote Workstations and a Target Service Processor 3172	6-8
6-5.	IBM Modems for Remote Workstations and a Target Service Processor 7585	6-9
7-1.	Identical Target and Controlling Parameters	7-2
8-1.	Identical Target and Controlling Parameters	8-2
X-1.	Customer Documentation for the 3745 Models x10 and x1A, and 3746 Model 900	X-1
X-2.	Additional Customer Documentation for the 3745 Models 1x0 and 17A	X-5



Notices

References in this publication to IBM products, programs, or services do not imply that IBM intends to make these available in all countries in which IBM operates. Any reference to an IBM product, program, or service is not intended to state or imply that only IBM's product, program, or service may be used. Any functionally equivalent product, program, or service that does not infringe any of IBM's intellectual property rights may be used instead of the IBM product, program, or service. Evaluation and verification of operation in conjunction with other products, except those expressly designated by IBM, is the user's responsibility.

IBM may have patents or pending patent applications covering subject matter in this document. The furnishing of this document does not give you any license to these patents. You can send license inquiries, in writing, to the IBM Director of Licensing, IBM Corporation, 500 Columbus Avenue, Thornwood, New York 10594, U.S.A.

European Union (EU) Statement

This product is in conformity with the protection requirements of EU Council Directive 89/336/EEC on the approximation of the laws of the Member States relating to electromagnetic compatibility. IBM can not accept responsibility for any failure to satisfy the protection requirements resulting from a non-recommended modification of the product, including the fitting of non-IBM option cards.

Electronic Emission Notices

Federal Communications Commission (FCC) Statement

Note: This equipment has been tested and found to comply with the limits for a Class A digital device, pursuant to Part 15 of the FCC Rules. These limits are designed to provide reasonable protection against harmful interference when the equipment is operated in a commercial environment. This equipment generates, uses, and can radiate radio frequency energy and, if not installed and used in accordance with the instruction manual, may cause harmful interference to radio communications. Operation of this equipment in a residential area is likely to cause harmful interference, in which case the user will be required to correct the interference at his own expense.

Properly shielded and grounded cables and connectors must be used in order to meet FCC emission limits. IBM is not responsible for any radio or television interference caused by using other than recommended cables and connectors or by unauthorized changes or modifications to this equipment. Unauthorized changes or modifications could void the user's authority to operate the equipment.

This device complies with Part 15 of the FCC Rules. Operation is subject to the following two conditions: (1) this device may not cause harmful interference, and (2) this device must accept any interference received, including interference that may cause undesired operation.

Industry Canada Compliance Statement

This Class A digital apparatus meets all requirements of the Canadian Interference-Causing Equipment Regulations.

Avis de conformité aux normes d'Industrie Canada

Cet appareil numérique de la classe A respecte toutes les exigences du Règlement sur le matériel brouilleur du Canada.

Japanese Voluntary Control Council For Interference (VCCI) Statement

This equipment is in the 1st Class category (information equipment to be used in commercial and/or industrial areas) and conforms to the standards set by the Voluntary Control Council for Interference by Information Technology Equipment aimed at preventing radio interference in commercial and industrial areas.

Consequently, when used in a residential area or in an adjacent area thereto, radio interference may be caused to radios and TV receivers, and so on.

Read the instructions for correct handling.

Korean Communications Statement

Please note that this device has been approved for business purpose with regard to electromagnetic interference. If you find this is not suitable for your use, you may exchange it for a non-business one.

New Zealand Radiocommunications (Radio) Regulations

Attention: This is a Class A product. In a domestic environment this product may cause radio interference in which case the user may be required to take adequate measures.

Trademarks and Service Marks

The following terms, denoted by an asterisk (*), used in this publication, are trademarks or service marks of IBM Corporation in the United States or other countries:

AIX	OS/2
APPN	PC/AT
CM/2	PC/XT
CS/2	PS/2
DCAF	RETAIN
HPR	S/390
IBM	Softerm
NetView	VTAM
Nways	

Safety

This product meets IBM Safety standards as referred to in *Safety Information*, GA33-0400.



About this Guide

This guide includes information:

- For the 3745 Communication Controller Models A (17A, 21A, 31A, 41A, and 61A) about:
 - Installing and using the IBM Distributed Console Access Facility (DCAF*) program for remote consoles of the 3745 Models A. The service processor operates as a DCAF target workstation for the IBM 3745 Communication Controller Models A (and IBM 3726 Nways Multiprotocol Controller Model 900, if installed).
 - Installing, upgrading, and customizing Communications Server (CS/2*) or Communications Manager/2 (CM/2*) for the Local Area Network (LAN) - Advanced Program-to-Program Communication (APPC), Modem, System Network Architecture (SNA), and Advanced Peer-to-Peer Networking (APPN*)/ High Performance Routing (HPR*) links.
 - Installing, upgrading, and customizing DCAF for LAN-APPC, LAN-TCP/IP, Modem, SNA, APPN/HPR, and Telnet links.
 - Installing and using Telnet Client in remote consoles to access network node processors for Internet Protocol (IP) communications.
- For the 3745 Communication Controller Models 170 to 610 about installing local, alternate, and remote Maintenance and Operating Subsystem (MOSS) consoles.

Conventions Used in this Guide

When used in this guide, the term:

- | | |
|---------------------|--|
| 3745 | Refers to the IBM 3745 Models 130 to 170 and 210 to 610 with 3746 Expansion Unit Models A11, A12, L13, L14, and L15. |
| 3745 Model A | Refers to the IBM 3745 Models 17A, 21A, 31A, 41A and 61A with a service processor. |
| 3746-900 | Refers to the IBM 3746 Nways Multiprotocol Model 900. |
| 3746-900NN | Refers to a function of the IBM 3746-900 operating as an APPN/HPR Network Node. |
| 3746-900IP | Refers to a function of the IBM 3746-900 operating as an IP router. |

Who Should Use this Guide

This guide is intended for non-IBM personnel such as:

- Network engineers
- System programmers
- System service personnel.

These personnel would be responsible for configuring:

- Local, alternate, or remote MOSS operator consoles for the 3745.
- Remote consoles connected to the service processor for a 3745 Model A. The service processor runs the Maintenance and Operating Subsystem-Extended (MOSS-E).

The user should have an understanding of teleprocessing, modem operations, APPN/HPR, and IP networking. Teleprocessing specialists can also access online resources (help, guides and other materials) for information on:

- MOSS-E
- Controller Configuration and Management (CCM) application
- APPN/HPR and IP Control Point functions
- DCAF
- TCP/IP environment.

For more information, see the publications listed in "Bibliography" on page X-1.

How this Guide is Organized

This guide has been divided into the following parts:

Part 1, "3745 Models A and 3746 Model 900"

Describes how to configure remote consoles in DCAF as remote workstations for monitoring and controlling the service processor running MOSS-E. Example configurations are given of five types of link (LAN-APPC, LAN-TCP/IP, Modem, SNA, and APPN) via DCAF to a target service processor.

Also describes how to configure a remote console as a Telnet remote workstation, with access to the Network Node Processor (NNP) for IP communications.

Part 2, "3745 Models 130 to 610"

Describes how to configure the IBM 3151 and 3153 Display Station, IBM 3163 and IBM 3161 ASCII Display Station, IBM Personal System/2* (Models 30 286, 50, 50Z, 60, 70, or 80), IBM Personal Computer (PC), IBM Personal Computer AT*, and IBM Personal Computer XT* Model 286, to function as a local, alternate, or remote MOSS console attached to an IBM 3745 Communication Controller.

Part 3, "Appendixes for 3745 Model A and 3746 Model 900"

Contains the appendixes for Part 1.

Part 4, "Appendixes for 3745 Models 130 to 610"

Contains the appendixes for Part 2.

Part 5, "Bibliography, Abbreviations, Glossary, and Index."

What is New in this Edition

This revised edition has been extensively restructured, especially the DCAF target service processor configuration procedures, to make it easier for you to access the information in this guide.

Where to Find More Information

For more information, see the Bibliography on page X-1 and the additional publications listed below:

- *DCAF: Installation and Configuration Guide*, SH19-4068.
- IBM Redbooks:
 - *TCP/IP Tutorial and Technical Overview*, GG24-3376
 - *TCP/IP Implementation in an OS/2 Warp Environment*, SG24-4730.

For OS/2*, consult the documents delivered as part of the OS/2 product package.

For the 3151, 3153, 3161, and 3163 display stations, refer to the terminal documentation. The following book should not normally be needed for setting up a PS/2 as a MOSS console; it does however contain supplementary information that you may find useful:

- *IBM Operating System/2 Extended Edition: System Administrator's Guide for Communications*, P/N 90X7908.

World Wide Web

You can access the latest news and information about IBM network products, customer service and support, and microcode upgrade via Internet at the Uniform Resource Locator (URL):

<http://www.networking.ibm.com>.



Part 1. 3745 Models A and 3746 Model 900

Chapter 1 to Chapter 8 refers to DCAF consoles.

Chapter 9 refers to Telnet consoles for IBM 3746-900 IP routers.



Chapter 1. Introduction to Remote Consoles and DCAF

PS/2 (or equivalent) workstations can be used to remotely access the service processor (and network node processor, if installed). These workstations access the service processor MOSS-E and Controller Configuration and Management (CCM) by using DCAF. The operator at a remote workstation using DCAF can either:



- Control the target service processor input in a DCAF active session, using the remote workstation keyboard and mouse to operate the service processor.
- Monitor the target service processor display in a DCAF monitor session via a remote workstation DCAF window.

The **remote workstation operates** as a DCAF **controlling workstation** and the **service processor** as a DCAF **target workstation**. When an active session connection is established between a remote workstation and the service processor, you can perform MOSS-E, CCM, APPN and IP functions as though seated in front of the service processor.

Chapter 1 to Chapter 8 and Part 3 of this guide include:

- Information about the parameters needed to configure consoles as remote (controlling) workstations
- Procedures for configuring remote (controlling) workstations.

Notes:

- In the parts of this guide that refer to the 3746 Models A, "console" means an "OS/2 workstation."
- When remotely controlled, the keyboard and mouse of the service processor cannot be used. However, you can regain control of the keyboard and mouse by using DCAF hot keys. The default hot keys are pressing   together.

Before reporting a service processor not working, check if it is under the control of a DCAF remote console.

- A service processor can be controlled by only one remote workstation at a time.
- A remote workstation can be configured to have access to more than one service processor.
- The service processor is shipped pre-configured as a DCAF target workstation.
- DCAF is a separate product from the IBM Communication Controllers. Installing DCAF on a PS/2 (or equivalent) workstation is the customer's responsibility. See Chapter 2, "DCAF Session Installation" for details.

Consoles

There are five types of remote consoles that can use DCAF, each type defines how the workstation is connected to the service processor. Refer to Figure 1-1.

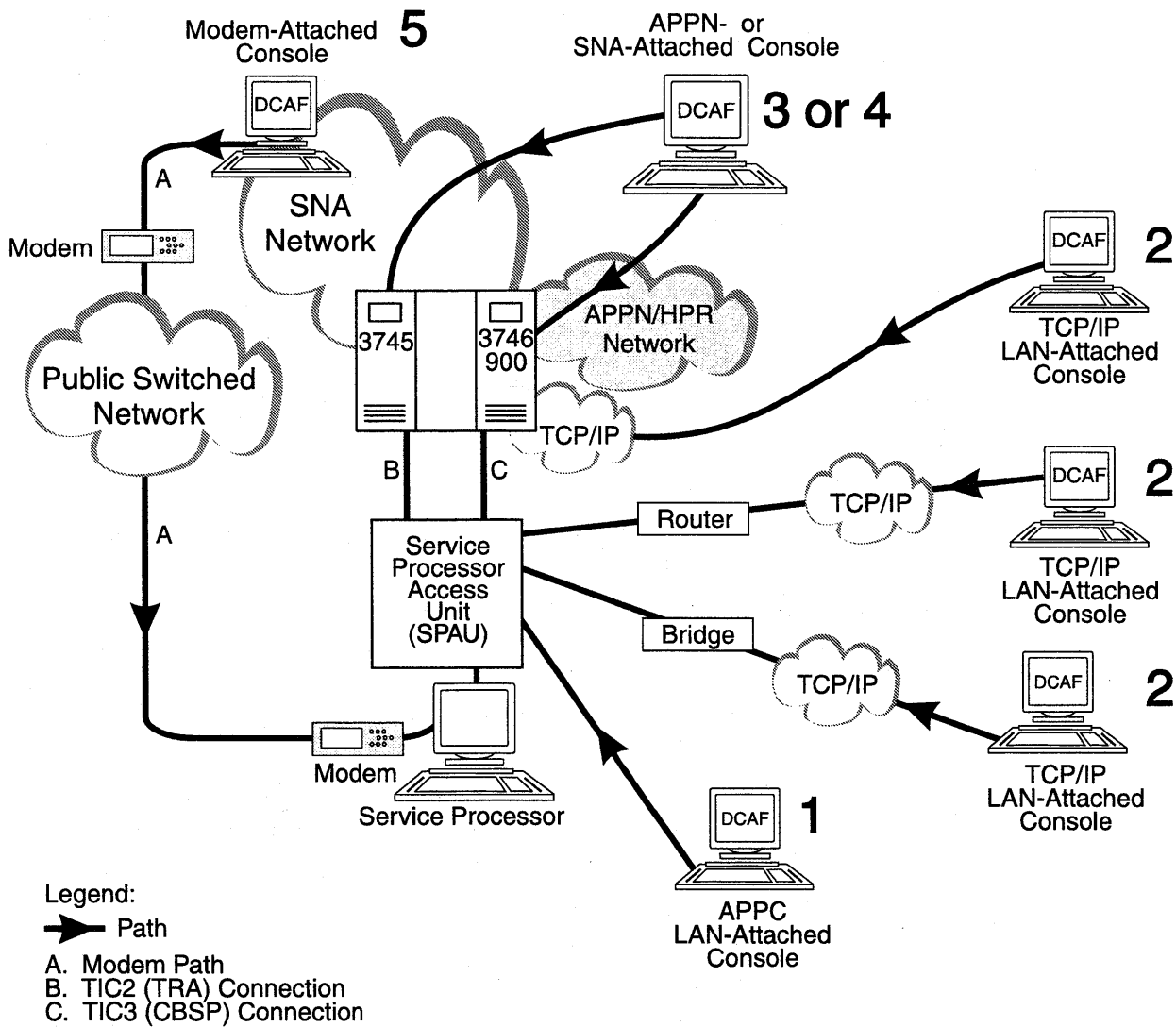

Figure 1-1. DCAF Console Attachments

The numbers in the figure above represent the following console connections to the service processor:

- 1**, APPC LAN-attached console attached directly to the Service Processor Access Unit (SPAU), or indirectly through a token-ring LAN bridge.
- 2**, TCP/IP LAN-attached console attached to the SPAU via a bridge or a router with appropriate filtering.
- 3**, SNA-attached console communicating with the service processor via an Logical Unit (LU) 6.2 session over the network backbone.
- 4**, APPN-attached console communicating with the service processor via an LU.6.2 session over the network backbone.

5, **Modem-attached** consoles that use the public switched telephone network to access the service processor via a Synchronous Data Link Control (SDLC) port and modem.

Note: The port and modem can also be used for Remote Support Facility (RSF), Remote Technical Assistance Information Network (RETAIN*), and Alert calls.

A remote console can be configured for all categories of access. This means that a single console at a central control site could be LAN-attached to a local service processor while providing APPN and modem access to other service processors.

Attention

Sending an alert to NetView via a service processor SDLC port or calling RSF has a higher priority for the MOSS-E than DCAF, SDLC, or SNA remote sessions.

Information on how to configure CS/2, CM/2, DCAF, and CCM, is contained in:

- Chapter 4, "TCP/IP LAN-Attached Remote Workstation Configuration."
- Chapter 5, "APPC LAN-Attached Remote Workstation Configuration."
- Chapter 6, "Modem-Attached Remote Workstation Configuration."
- Chapter 7, "SNA-Attached Remote Workstation."
- Chapter 8, "APPN-Attached Remote Workstation."

A more complex two-target (two service processors) configuration is described in Appendix A, "Configuration for a Two-Target Remote Workstation." Each target uses a LAN, a Modem, and SNA to link to the remote workstation.

Diskettes with Example Configurations

Included with this guide are diskettes 02L3825 for CS/2 and 02L3851 for CM/2. These diskettes contain example configurations that you can load into your CMLIB directory. These configurations are primarily designed to help you with configuring modem attached workstations. However, if you are using another configuration for your workstation, (LAN-attached, for example) any of the configurations can help you. To load the configurations, see "Customizing CS/2 and CM/2" on page 2-3 for details.

DCAF Logon Password and Service Processor Security

To access a target service processor using a remote workstation, you must first establish a DCAF link with certain parameters unique to the target service processor. This is explained later in this guide.

Passwords provide additional security for the service processor:

1. The **DCAF target password** establishes the link for accessing the target service processor. It can be unique for each target service processor.

There is no factory default password. Press  when you are asked for the password. To install or change a password, use **Customize DCAF Target Settings** on the service processor **Configuration Management** menu.

2. You must enter a **local MOSS-E password** (controller or service processor password) to log onto the MOSS-E and remotely control the service processor. See the *Planning Guide*, GA33-0457 for more information on these passwords.

Note: By default, the security level of the DCAF sessions between a remote console and the service processor is *non-secure* (password-only).

The security administrator and authentication components of DCAF can be used with the service processor to increase the security of the DCAF link.

Regaining Control of the Service Processor

During an active DCAF session, the remote workstation prevents the target service processor from responding to input from the keyboard or mouse.

However, the local service processor operator can use a hot key combination to override the controlling workstation and regain control of the service processor.

The default hot keys are   pressed together.

Minimum Workstation (Remote Console) Configuration

This section contains an overview of the system requirements for remote workstations. For detailed information, refer to the *DCAF Installation and Configuration Guide*, SH19-4068, provided with the DCAF installation diskettes.

Programming Requirements

You need the following minimum program levels on your workstation to remotely access the service processor:

- DCAF, Version 1.3.3 (also known as TME10 Remote Control, PN 5697RCL).
- OS/2 Version 2.1 or higher with Warp 3.x and LAPS Version 5.10, or Warp 4.x, with Multiple Protocol Transport Services (MPTS) for OS/2 4.x.
- CM/2 Version 1.11 or higher.
- CS/2 Version 4.1, with OS/2 Warp, MPTS, and TCP/IP.
- MPTS Version 2.2 or higher for LAN-attached workstations.
- Transmission Control Protocol/Internet Protocol (TCP/IP) Version 2.0 or higher for TCP/IP-attached workstations.

The following additional program support is needed for specific types of console attachment:

- Network Transport Services/2 (NTS/2) for LAN-attached and SNA-attached consoles that connect to SNA networks via a LAN.
- To access the service processor via an SNA or APPN network backbone, check that the following programming support is available:
 1. DCAF remote workstations and gateway workstations are configured as physical units (PUs) type 2.1. If the DCAF workstation is downstream from a 3174 control unit, then the 3174 must have either one of the following:
 - Configuration Support B plus 8Q0800 Programming Request for Price Quotation (PRPQ).
 - Configuration Support C (APPN feature).
 2. NCP V5 R2, operating under Virtual Telecommunications Access Method (VTAM*) V3 R2 for 3720 and 3745 Communication Controllers on the network backbone.
 3. NCP V4 R3, operating under VTAM V3 R2 for 3725 Communication Controllers on the network backbone.

Later releases of these programs may be used unless otherwise stated.

Hardware Requirements and Recommendations

For remote workstations, IBM recommends using the following items:

- PS/2s (or equivalent) with at least a 80386 microprocessor and Video Graphics Adapter (VGA) display such as an IBM 8515 color display. A Pentium**-level microprocessor is recommended.
- A hard disk of at least 80 MB and at least 10 MB of RAM.
- A pointing device (usually a mouse).

To find the equivalent keys on IBM non-QWERTY keyboards, refer to OS/2 documentation for keyboard layouts or codes.

The following is recommended for different types of console attachments:



- LAN-attached console (APPC or TCP/IP type), an IBM Token-Ring Network Adapter/A operating at 16 Mbps.
- Modem-attached console, a synchronous modem (such as IBM 7857 or equivalent) and a multi-protocol adapter (MPA) card.
- SNA- or APPN-attached modem, an IBM token-ring network adapter with a MPA card.

Technical information on the service processor is provided in the *Planning Guide*.

Chapter 2. DCAF Session Installation

Summary of Procedures

First collect the worksheets from the *Planning Guide*, GA33-0457, at your workstation, then consult the summary of procedures in Table 2-1.

Procedures	For the Remote Workstation	For the Service Processor
Verifying hardware and programming requirements.	See Chapter 1, "Introduction to Remote Consoles and DCAF."	Pre-configured as a DCAF target workstation.
DCAF program installation or upgrade.	See "Installing DCAF" on page 2-2.	Non applicable. Already pre-configured.
TCP/IP program installation or upgrade.	See TCP/IP installation guide delivered with the product.	Non applicable.
CS/2 and CM/2 customization.	See "Customizing CS/2 and CM/2" on page 2-3 and Chapter 5 to Chapter 8, according to the type of session.	See Chapter 5 to Chapter 8 according to the type of session.
DCAF customization.	According to the type of session, see Chapter 5 to Chapter 8.	Not applicable.
TCP/IP customization.	See Chapter 4.	Done by IBM representative at installation.
CCM definitions.	Not applicable.	Available for APPN sessions only. See Chapter 8.
Opening a session.	See Chapter 3, "Using DCAF to Remotely Log On to the Service Processor."	Not applicable.
Closing a session.	See Chapter 3, "Using DCAF to Remotely Log On to the Service Processor."	Use DCAF hotkeys  

For more information, see the *DCAF: Installation and Configuration Guide*, SH19-4068, that comes with DCAF.

Preparation

Before starting the installation process, make sure that you have the workstation already installed and running OS/2 (see "Minimum Workstation (Remote Console) Configuration" on page 1-4).

Use the OS/2 command **SYSLEVEL** to verify the programs you have already installed on the workstation and the Service Pak levels you are using.

Prepare the following:

- Installation diskettes for CS/2 Version 4.1 or higher or CM/2 Version 1.11 or higher.
- LAPS Version 2.2 or higher.
- DCAF Version 1.3 or higher installation diskettes.
- TCP/IP Version 2.0 or higher installation diskettes.
- Diskettes shipped with this *Console Setup Guide*.
- Information from the *Planning Guide* worksheets.

Physical Installation

Any remote console or associated modem is installed by using procedures in the documentation provided with the product. See "Configuring CS/2 and CM/2 in Workstations" on page 6-6 for IBM 7855, 7857, 7858, or Hayes Modems.

Installing DCAF

Important

DCAF is also known as TME10 Remote Control, PN 5697RCL.

The DCAF secure (or password-only security) target component is automatically installed in the MOSS-E during delivery of the service processor.

The remote console is a DCAF controlling component. Follow the procedure below to install DCAF on the remote workstation:

- Step 1.** Insert the DCAF diskette 1 into drive A.
- Step 2.** Open an OS/2 full screen or window.
- Step 3.** Change to drive A.
- Step 4.** Type `install` and press **Enter**.
- Step 5.** Double-click **Controller**.
- Step 6.** Select **Install with defaults**, then click **OK**.
- Step 7.** Wait until **Ready to install** is displayed under **Status** field.
- Step 8.** In the **Install** pull-down menu, click **Install included component(s)**.
- Step 9.** At this step you may define your own DCAF path and backup CONFIG.SYS file. Record this information, and click **OK**.
- Step 10.** Change the diskette and click **OK** when you are prompted.
- Step 11.** When a message displays saying that the installation was successful, click **OK**. A new **Distributed Console Access Facility** icon appears.
- Step 12.** Verify that there is no diskette in drive A.
- Step 13.** Shutdown and restart your workstation.
- Step 14.** Go to "Customizing CS/2 and CM/2" on page 2-3.

Upgrading DCAF

Attention

If the DCAF on your workstation is a level lower than 1.3, de-install it and then install DCAF 1.3.3. See "Installing DCAF" on page 2-2.

This section describes how to upgrade DCAF 1.3 with the CSD UB20924.

- Step 1.** Insert DCAF diskette 1 into drive A.
- Step 2.** Open an OS/2 full screen or window.
- Step 3.** Change to drive A.
- Step 4.** Type service and press **ENTER**.
- Step 5.** Follow the prompts:
 - a. Insert DCAF diskette 1.
 - b. Insert DCAF diskette 2.
 - c. Insert DCAF diskette 3. (Also called CSD diskette 1)
 - d. Click **Service**.
 - e. Click **OK**.
 - f. Insert DCAF diskette 4. (Also called CSD diskette 2)
- Step 6.** Click **OK**.
- Step 7.** Click **No**.
- Step 8.** Click **Cancel**.
- Step 9.** Click **OK**.
- Step 10.** Use Desktop Manager to shut down and restart the workstation.

Important

After upgrading DCAF, it is recommended that you access the following URL to download any required fixes and APARs:

<ftp://ftp.software.ibm.com/ps/products/dcaf/fixes/v133/us-english/apar/>

Installing TCP/IP

Follow the procedures in the TCP/IP installation procedure that come with the product that you are using.

Customizing CS/2 and CM/2

This procedure will help you navigate from a remote workstation to the service processor and complete the customization of DCAF. For more information, see the *Planning Guide*.

Customizing a Remote Workstation

The procedures in this section apply to the following types of consoles:

- APPC LAN-attached
- SNA-attached
- APPN-attached
- Modem-attached.

Loading Example Configurations

The CS/2 and CM/2 example configurations on the diskette included with this guide include one example of each type of remote DCAF workstation. Using the diskette that corresponds to program (CS/2 or CM/2) installed on your workstation, copy the configurations onto your workstation hard disk. In an OS/2 window, use the command

```
XCOPY a:*. * c:\cmlib /s
```

You can replace the default directory cmlib with another if you want to.

Starting CS/2 and CM/2 Configuration

Important

The procedure below is the same in CM/2 unless otherwise indicated.

Step 1. From **Desktop Manager**, double-click the **CS/2** icon.

Step 2. Double-click the  **Communications Manager Setup** icon.

Step 3. Click **Setup**.

Step 4. Select a configuration from the **Configurations** list, and click **OK**.

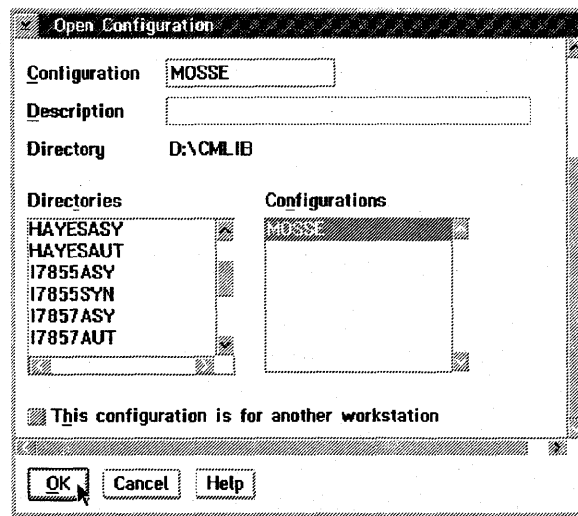

Step 5. Depending on the console type you are installing, go to:

- Chapter 5, "APPC LAN-Attached Remote Workstation Configuration"
- Chapter 6, "Modem-Attached Remote Workstation Configuration"
- Chapter 7, "SNA-Attached Remote Workstation"
- Chapter 8, "APPN-Attached Remote Workstation."

Configuring Data Link Control (DLC) for a Service Processor

For more information on configuring Data Link Control (DLC) see Appendix B, "Configuring DLC for DCAF."

Chapter 3. Using DCAF to Remotely Log On to the Service Processor

For more information about DCAF functions, including opening multiple concurrent sessions, switching between sessions, and keyboard shortcuts, see the *DCAF: Installation and Configuration Guide*, SH19-4068.

In this procedure, the service processor is the DCAF target workstation, and the remote console is the DCAF controlling workstation.

Starting a Session

Use the following procedure to start a DCAF session that controls the service processor and the network node processor (NNP).

Step 1. Double-click the **Distributed Console Access Facility** icon.

Step 2. Double-click the  **DCAF Controller** icon.

Step 3. In the **Session** pull-down menu, select **Open Workstation directory**.

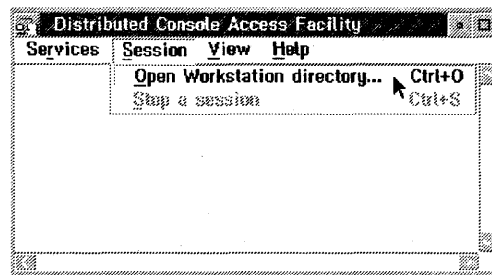

Step 4. Double-click the icon of the target service processor that you want.

Step 5. Enter the DCAF target password defined at "DCAF Logon Password and Service Processor Security" on page 1-3. If there is no password for the target workstation, click **OK**.

Step 6. Click **Yes** if you have a non-QWERTY keyboard (see "Hardware Requirements and Recommendations" on page 1-5).

Step 7. Click **Start a session** from the **Session** pull-down menu.

Step 8. Maximize the window to see the target service processor screen.

Note: If you are using an SDLC link that seems too slow, check your modem speed. If it is not at full speed, close the DCAF session and try a new SDLC connection. A better line might reduce the target response time.

Closing a Session

From the Remote Workstation

In the **Session** pull-down menu on the DCAF window action bar, click **Stop a session**.

Attention

Do not close the session by de-selecting "Enable DCAF Link/Operations" from the "SP Customization" function.

From the Target Service Processor

To close the session of the target service processor, use the DCAF hot keys,

  pressed together.

Note

When your DCAF session is finished, make sure that SDLC link has ended. This frees SDLC resources for other tasks.

Chapter 4. TCP/IP LAN-Attached Remote Workstation Configuration

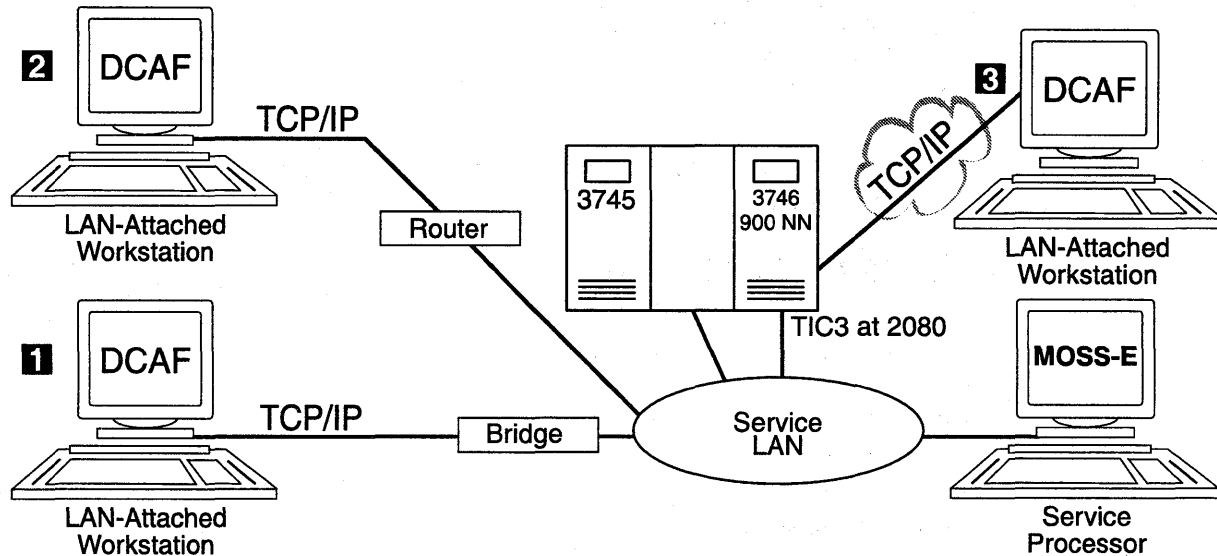

Figure 4-1. Types of TCP/IP Service LAN-Attached Remote Workstations

This chapter shows you how to configure a DCAF session for controlling a target service processor.

The path between the controlling workstation and the service processor can be either through:

- A **bridge** with filtering to the service LAN (see **1** in Figure 4-1).
- A **router** to the service LAN, which can be either:
 - A **non-3746** router (see **2** in Figure 4-1)
 - The **3746** router (see **3** in Figure 4-1).

A controlling workstation can be connected as in **2** or **3**, but you cannot have both types of connections at the same time.

Configuring a Target Service Processor

Important

You can use the worksheets in the *Planning Guide*, GA33-0457 to record the necessary parameter values described in this section.

The following procedure configures the MOSS-E to answer a controlling workstation:

- Step 1.** Open the **Service Processor Menu**.
- Step 2.** Click **Configuration Management**.

Step 3. Double-click SP Customization.

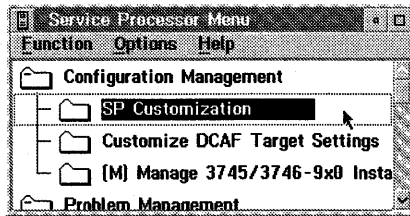

Step 4. Select Service LAN Addresses in the View Customize button list and click Next.

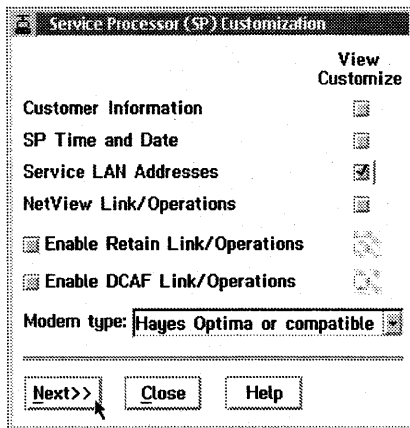

Step 5. Click **Next** to display the **Service LAN Addresses** screen.

	IP address	Subnet mask	Hostname	UAA/LAA
Service Processor:	11.100.76.101	255.255.255.0	SP11111	400000201111
NNP- A:	9.100.76.102	255.255.255.0	CA134568	
NNP- B:	not installed			
TIC3 2080:	9.100.76.103	255.255.255.0		
SP default router:	9.100.76.103			
MAE:	11.100.76.104	255.255.255.0	DA134568	

-LAN Manager-

Do you have a LAN manager? Yes No C&SM LAN ID: MOSSF

<<Previous Next>> Help

Step 6. Record the **Service Processor IP address** to be used later in Step 7 on page 4-5.

Step 7. If you have a link through the 3746 (see **3** in Figure 4-1 on page 4-1), enter the **TIC3 2080** address in the **SP default router** field and click **Next** and **Close**.

Otherwise, click **Next** and **Close**.

Step 8. The installation is complete. Go to "Configuring a TCP/IP LAN-Attached Remote Workstation" for using this new DCAF session.

Configuring a TCP/IP LAN-Attached Remote Workstation

The following procedures shows you how to establish a link between a controlling workstation and the target service processor.

Configuring DCAF for TCP/IP

The following procedure configures a service processor in the remote DCAF.

Step 1. From Desktop Manager, double-click the **Distributed Console Access Facility** icon.

Step 2. Double-click the  icon.

Step 3. Click **Session**, then **Open workstation directory**.

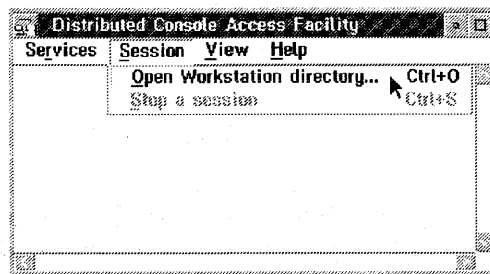

Step 4. Click **OK** for a first installation. Otherwise continue with next step.

Step 5. From the DCAF Directory window, click **Workstation** then on **Add**.

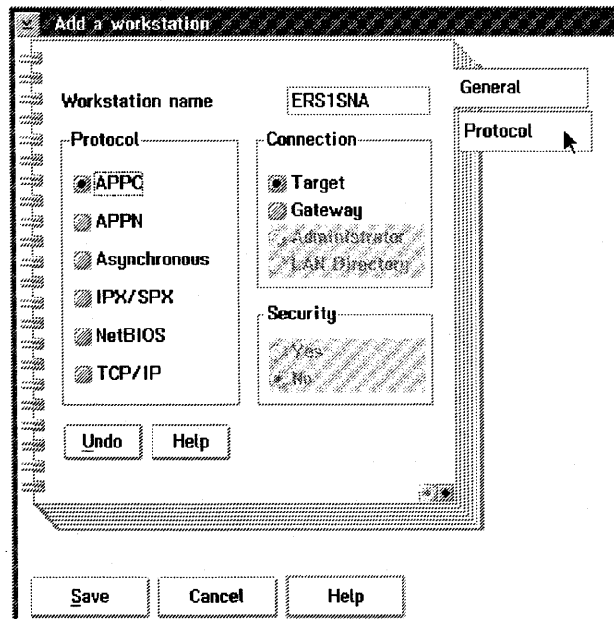

Step 6. Fill in the **Workstation name** field, select **TCP/IP** and click **Protocol**.

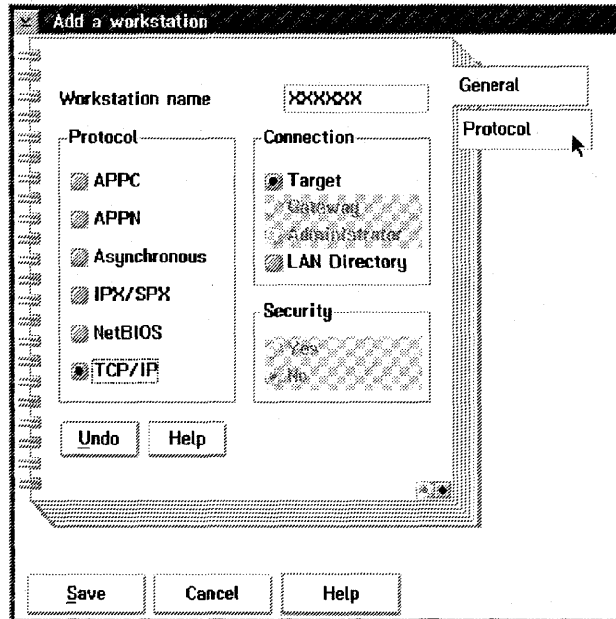

Step 7. Fill in the **Remote host name** (the IP address of the target service processor recorded in Step 6 on page 4-3) and **Port number** fields. Then click **Save** and **Cancel**.

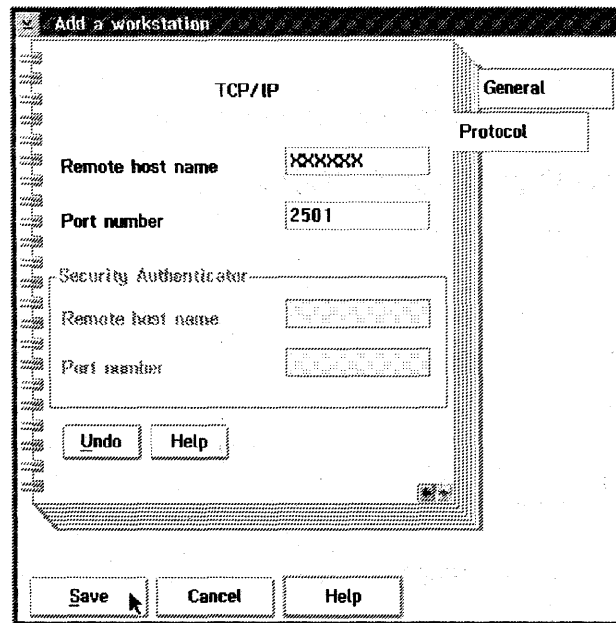

Step 8. Continue with "Configuring TCP/IP" on page 4-6.

Configuring TCP/IP

The following procedure adds a service processor in the remote workstation TCP/IP.

- Step 1.** Double click the **TCP/IP Configuration** icon on your desktop.
- Step 2.** Click **Host names**, open **page 2**, and click **Add**.

Note: If you are using an earlier version of TCP/IP, click **Services** and select **page 3 of 3**.

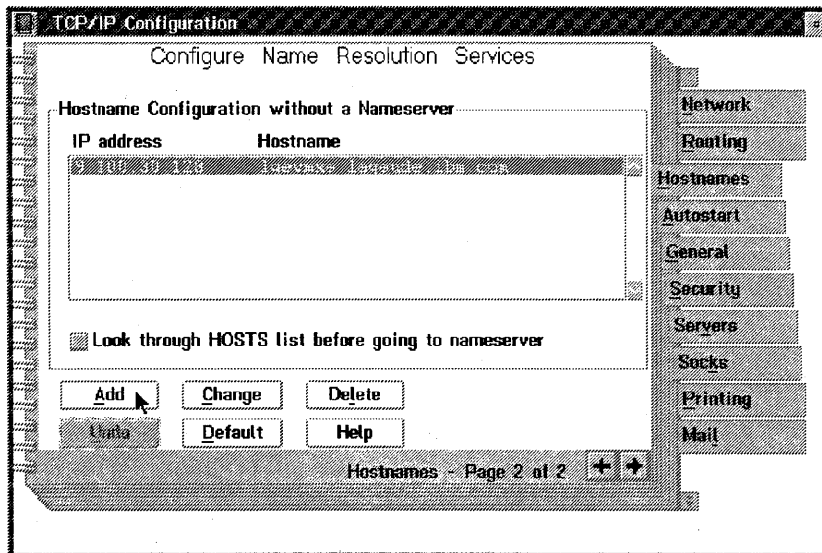

- Step 3.** Fill in the **IP address** field of the target workstation (the IP address of the TIC 2080), the **Host name** field (optional) and click **Add**.

- Step 4.** Close the TCP/IP window.
- Step 5.** Click **Save**.
- Step 6.** The installation is complete. Go to Chapter 3, "Using DCAF to Remotely Log On to the Service Processor" for using this new DCAF session.

Chapter 5. APPC LAN-Attached Remote Workstation Configuration

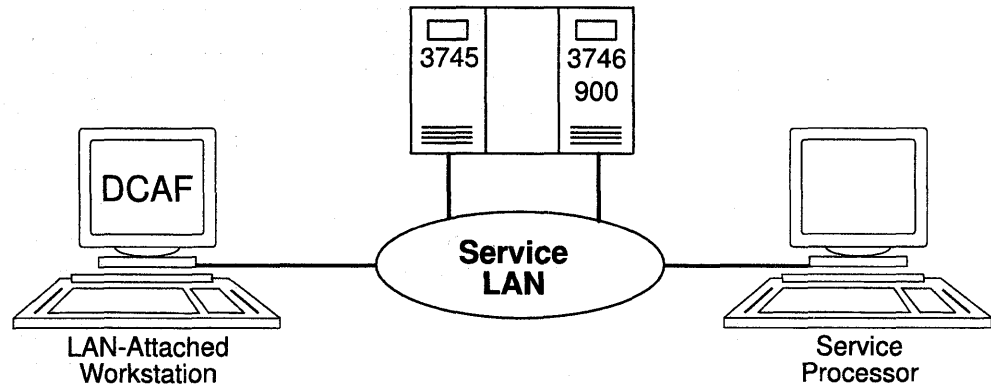

Figure 5-1. APPC Service LAN-Attached Remote Workstation

This chapter describes how to configure a DCAF session for controlling a target service processor (see Figure 5-1).

If you have more than one target service processor

You must respect the parameter value matching rules given in Appendix A, "Configuration for a Two-Target Remote Workstation."

Configuring a Target Service Processor

Important

You can use the worksheets in the *Planning Guide*, GA33-0457 to record the necessary parameter values described in this section.

This section describes:

- How to configure the MOSS-E for a DCAF link to the communication controller
- Which MOSS-E parameters to record for use in the controlling workstation.

Parameter Values that Must Be the Same

Table 5-1 gives the sets of MOSS-E parameters that must have the same value in both the remote workstation and the target service processor.

<i>Table 5-1. Identical Target and Controlling Parameters</i>	
In Service Processor	In Remote Workstation
Local Node Network ID (Figure 5-2 on page 5-3)	Partner network ID (Step 15 on page 5-9) and Network ID (Step 17 on page 5-10)
SDLC LU name (Figure 5-3 on page 5-4)	Partner node name (Step 15 on page 5-9) and Partner LU alias (Step 7 on page 5-13) and LU name (Step 17 on page 5-10)
TIC2 or TIC3 LAA (Figure 5-2 on page 5-3)	LAN Destination address (Step 15 on page 5-9)
TIC3 RSAP (Figure 5-2 on page 5-3)	Remote SAP (Step 15 on page 5-9)

The workstation configuration procedure in this chapter explains how to find these parameters in the remote workstation.

Configuring the Service Processor in MOSS-E

The following procedure explains how to find, record, and configure the service processor parameters:

- Step 1.** In the MOSS-E primary window, double click the **Service Processor** object.
- Step 2.** Click **Configuration Management**.
- Step 3.** Double click **SP customization**.

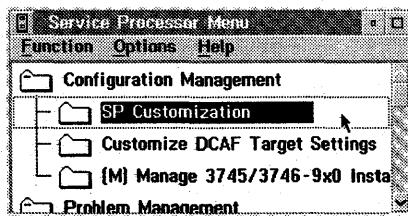

Step 4. Select **Enable DCAF Link/Operations** and select **View Customize** for it and **NetView Link/Operations**.

	View Customize
Customer Information	<input type="checkbox"/>
SP Time and Date	<input type="checkbox"/>
Service LAN Addresses	<input type="checkbox"/>
NetView Link/Operations	<input checked="" type="checkbox"/>
<input type="checkbox"/> Enable Retain Link/Operations	<input type="checkbox"/>
<input checked="" type="checkbox"/> Enable DCAF Link/Operations	<input checked="" type="checkbox"/>

Modern type: IBM 7855

Next>> Close Help

Step 5. Click **Next**.

Step 6. Click **Next**.

Step 7. Record the values in the Network ID, **TIC2 or TIC3 LAA**, and **TIC3 RSAP** fields (see Figure 5-2 and refer to Table 5-1 on page 5-2).

Generate alerts

NetView Link(s)
Link(s) through? SNA APPN
How many? 1 2
Link type? LAN SDLC

Machine Identification

Machine type	Model	Serial number
3745	61A	12 - 34567

Local Node Characteristics

Network ID	Local node name
SPNETID	MOSSNMVT

LAN Link

TIC2 or TIC3 LAA: 400000502080 hex
TIC3 RSAP: hexadecimal [04-9C]
Customize 3270 sessions? Yes No

Switched SDLC Link Telephone Number
0492112233

<<Previous Next>> Help

Figure 5-2. NetView Link/Reporting Customization

Step 8. Click **Next**.

Step 9. Record the value in the **SDLC LU name** field.

	LU name	Destination address (hexadecimal)	RSAP (hex [04-9C])
<input checked="" type="checkbox"/> SNA	DCAFSHA	40000002060	04
<input checked="" type="checkbox"/> APPN	DCAFAPPN	40000012060	00
<input type="checkbox"/> LAN	DCAFLAN		

SDLC Attached Console

SDLC DCAFSDLC

Accept any incoming calls on SP? Yes No

Local phone number: 1111111111

<<Previous Next>> Help

Figure 5-3. DCAF Customization

Step 10. Set **Accept any incoming calls on SP?** to **Yes**.

Step 11. Enter the **Local phone number**.

Step 12. The configuration is finished. From Desktop Manager, shutdown and restart the service processor.

Step 13. Go to "Configuring a APPC LAN-Attached Remote Workstation" on page 5-5.

Configuring a APPC LAN-Attached Remote Workstation

The following procedure shows you how to establish a link between the controlling workstation and a service processor, using an APPC type LAN environment.

Configuring CS/2

Important

The procedure below is the same in CM/2 unless otherwise indicated.

Step 1. From **Desktop Manager**, double-click the **CS/2** icon.

Step 2. Double-click the  **Communications Manager Setup** icon.

Step 3. Click **Setup**.

Step 4. Select a configuration from the **Configurations** list, and click **OK**.

Step 5. Select **Additional definitions, Token-ring or other LAN types**, and **APPC APIs**, then click **Configure**.

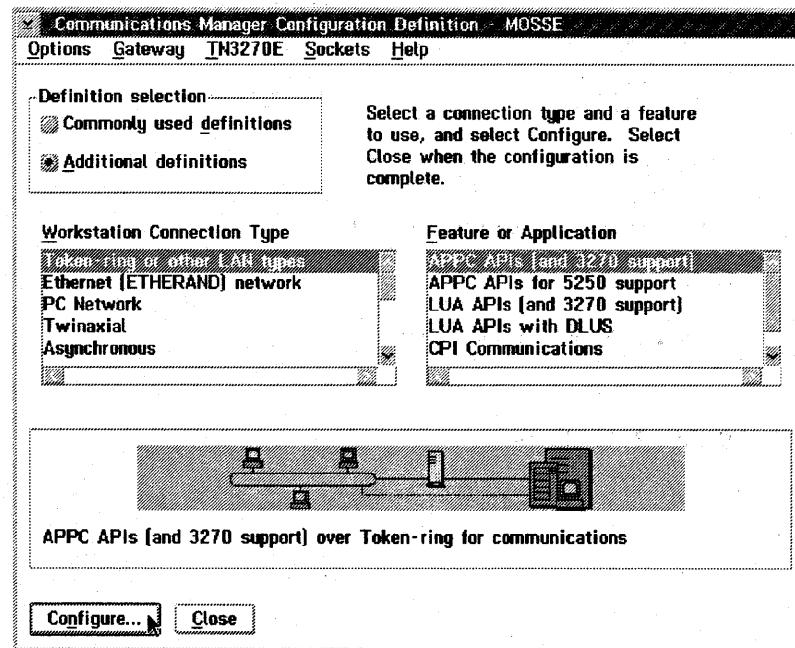

Step 6. Select **DLC - Token-ring or other LAN types** and click **Configure**.

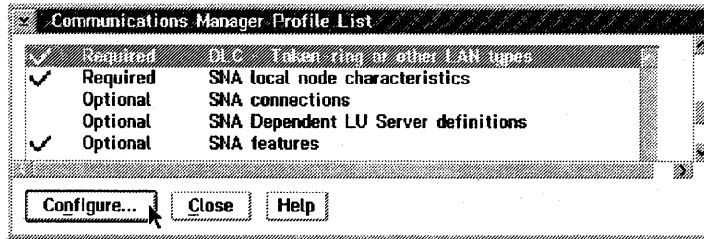

Step 7. Select **Free unused links** (in CM/2, select **Free unused links** and click **OK**). From the **Additional Parameters** list, highlight and check the following, using the **Change** button.

- Select **HPR parameters** and de-select **HPR support**.
- Check that the defaults apply to **Link station protocol parameters**, **Network management parameters**, and **Resource parameters**.

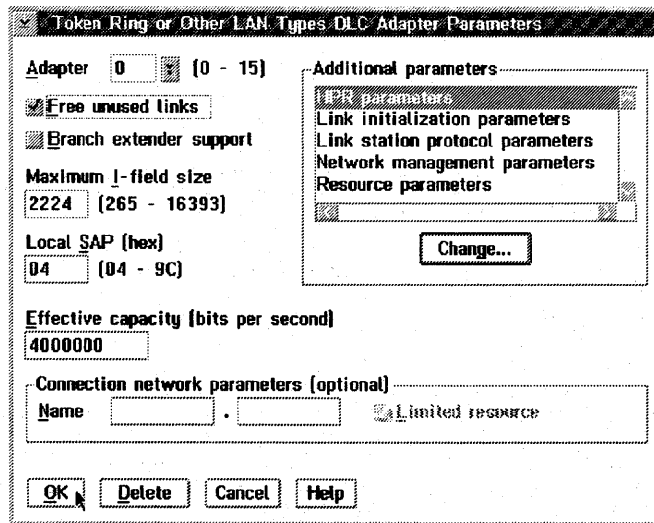

Step 8. Click **OK**.

Step 9. Select SNA local node characteristics and click **Configure**.

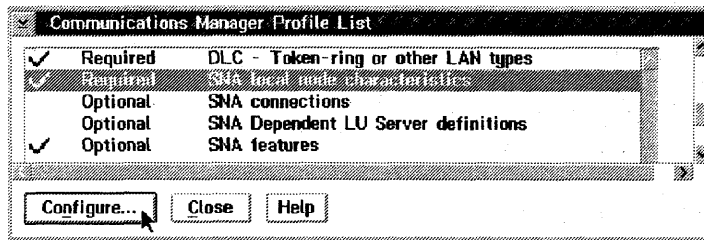

Step 10. Modify the **Network ID** and **Local node name** fields, select **End node**.

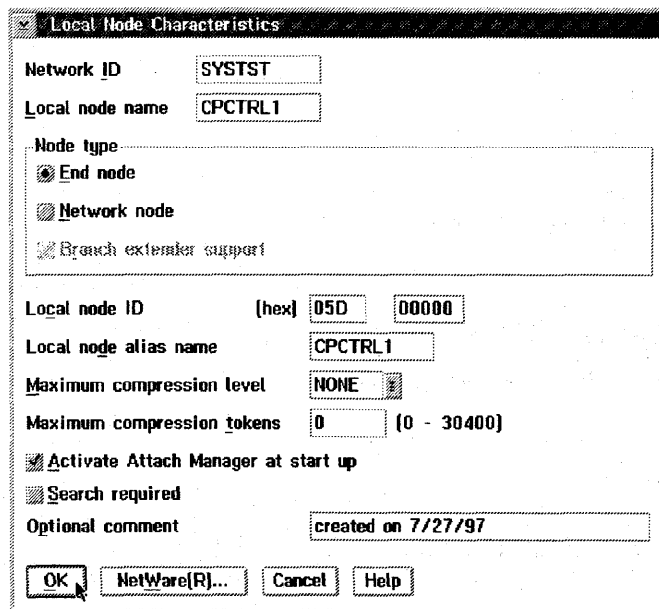

Step 11. Click **OK**.

Step 12. Select SNA connections and click Configure.

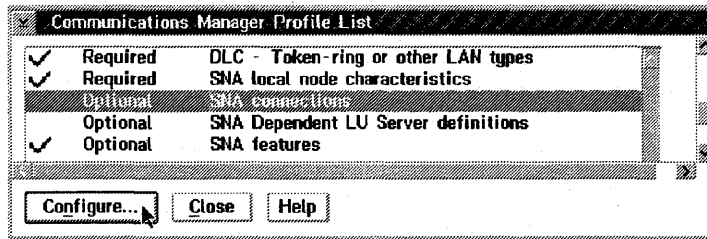

Step 13. Click To peer node, select DCAFLAN from the list and click Change.

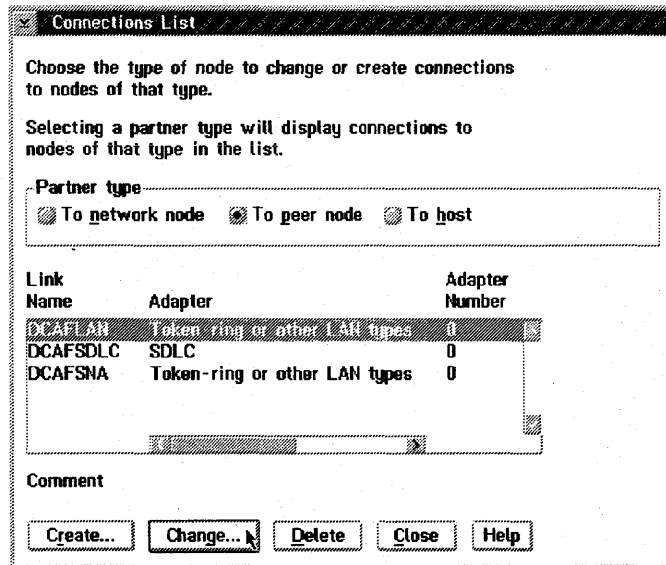

Step 14. Select Token-ring or other LAN types and click Continue.

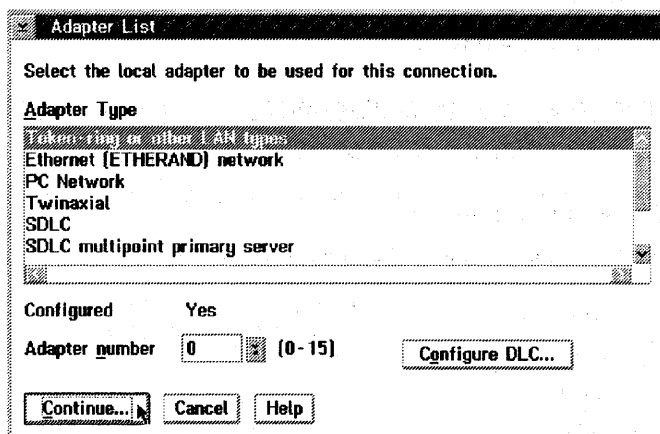

Step 15. Referring to Table 5-1 on page 5-2, fill in the LAN destination address (the address of the service processor), Remote SAP, the Partner network ID (the network name), and Partner node name (the network that contains the target service processor) fields.

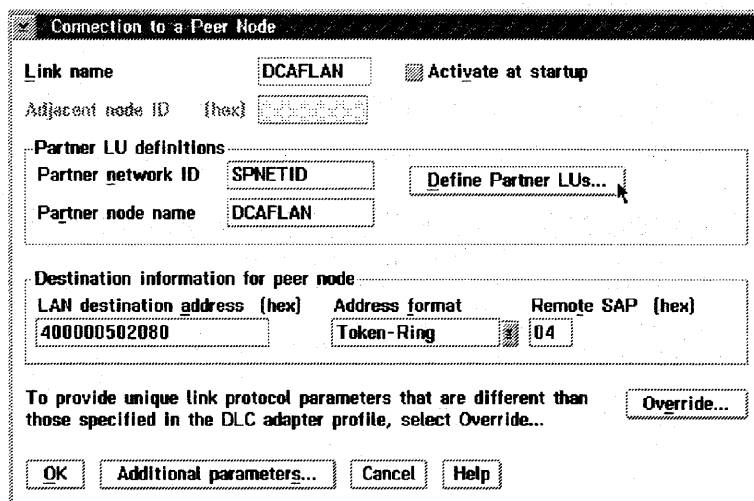

Step 16. Click Define Partner LUs.

Step 17. Referring to Table 5-1 on page 5-2, fill in the **Network ID**, and **LU name** fields.

Fill in the **Alias** field.

Partner LUs

To add a Partner LU, enter the LU name, alias, and comment. Then select **Add**.

To change a Partner LU, select an LU from the list, change the LU name, alias, and/or comment fields and select **Change**.

To delete a Partner LU, select an LU from the list and select **Delete**.

Network ID:

LU name:

Alias:

Dependent partner LU

Partner LU is dependent

Uninterpreted name:

LU name	Alias
SPNETID\DCAFLAN	DCAFLAN

Optional comment:

Step 18. Click **OK** and then **Close**.

Step 19. Select **SNA features** and click **Configure**.

Communications Manager Profile List

<input checked="" type="checkbox"/>	Required	DLC - Token-ring or other LAN types
<input checked="" type="checkbox"/>	Required	SNA local node characteristics
<input type="checkbox"/>	Optional	SNA connections
<input type="checkbox"/>	Optional	SNA Dependent LU Server definitions
<input checked="" type="checkbox"/>	Optional	SNA features

Step 20. Click **Add** and **OK**.

Step 21. Select **Local LUs** and **CTRLLAN**, then click **Change**.

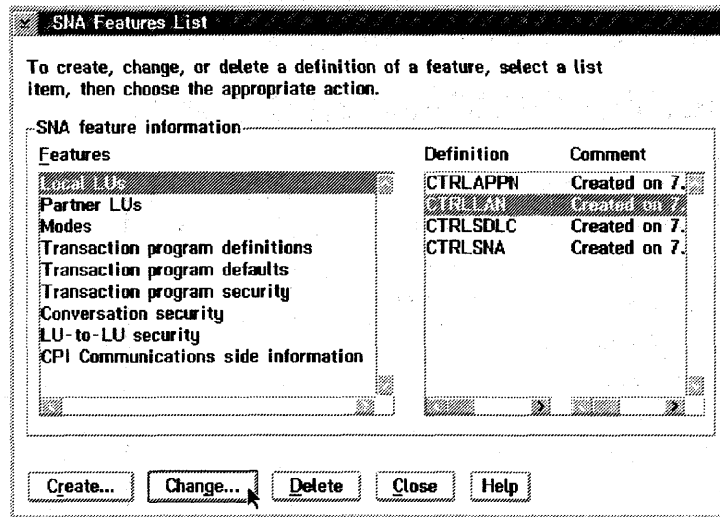

Step 22. Referring to Table 5-1 on page 5-2, fill in the **LU name** and **Alias** fields and select **use this local LU as your default local LU alias**.

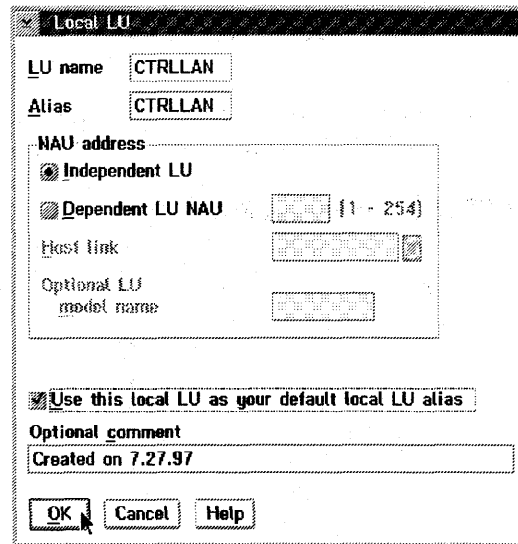

Step 23. Click **OK**.

Step 24. Click **Close** on each subsequent screen until you exit CS/2.

Step 25. Continue with "Configuring DCAF for APPC."

Configuring DCAF for APPC

Step 1. From **Desktop Manager**, double-click the **Distributed Console Access Facility** icon.

Step 2. Double-click the  **DCAF Controller** icon.

Step 3. Click **Session**, then **Open workstation directory**.

Step 4. Click **OK** for a first installation.

Otherwise, continue with next step.

Step 5. Click **Add** in the **Workstation** directory.

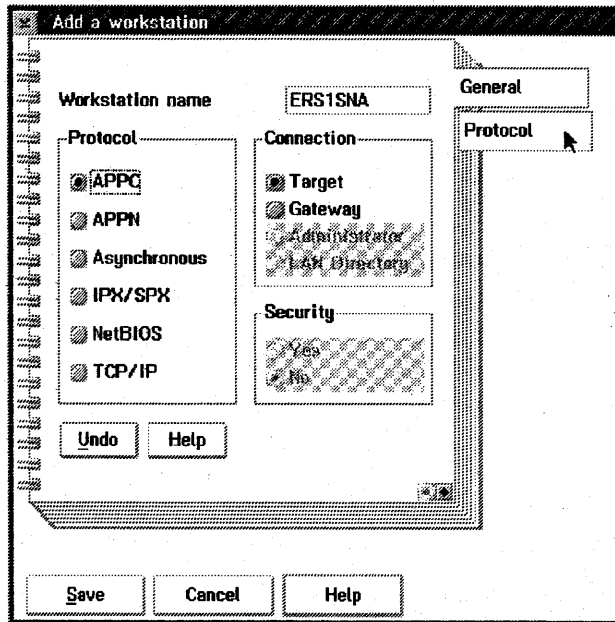

Step 6. Fill in the **Workstation name** field (refer to **Local LU name** in Step 22 on page 5-11), select **APPC**, **Target**, and click **Protocol**.

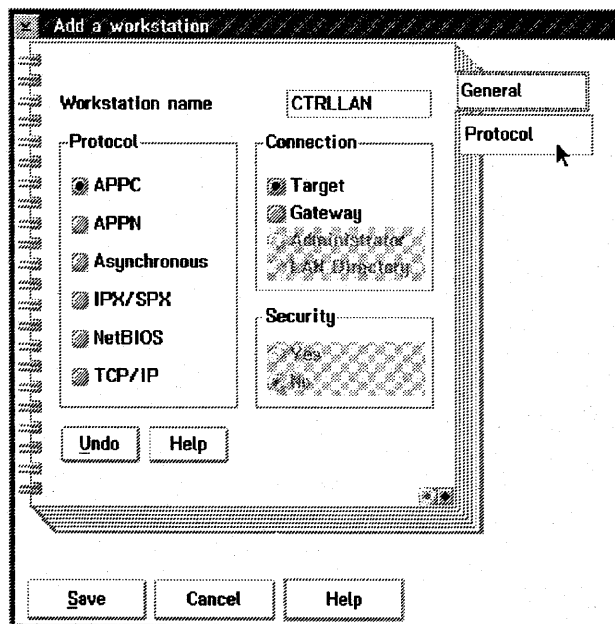

- Step 7.** Fill in the **Local LU alias** field (refer to **Local LU name** in Step 22 on page 5-11), and **Partner LU alias** field (refer to Table 5-1 on page 5-2).
Enter DCAFMODE in the **Mode name** field.

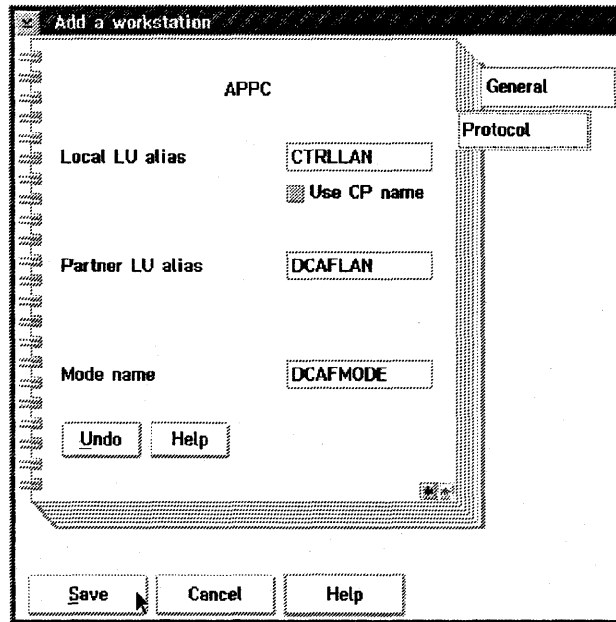

- Step 8.** Click **Save** and **Cancel**. The new workstation icon appears in the DCAF Directory window.
- Step 9.** From Desktop Manager, shutdown and restart the workstation.
- Step 10.** The installation is complete. Go to Chapter 3, "Using DCAF to Remotely Log On to the Service Processor" for using this new DCAF session.

Chapter 6. Modem-Attached Remote Workstation Configuration

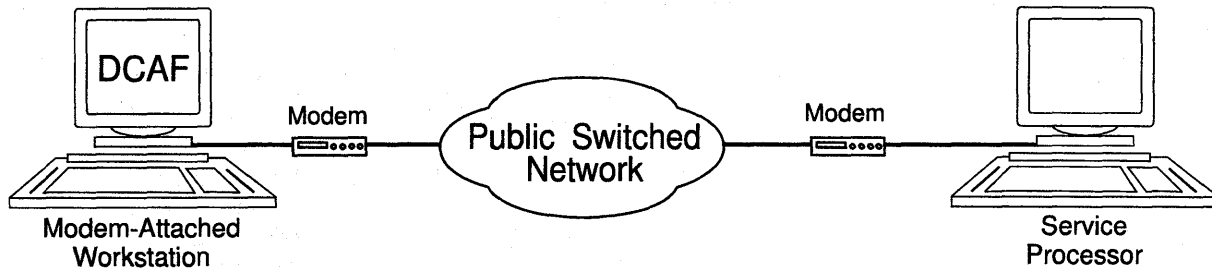

Figure 6-1. Modem-Attached Remote Workstation

This chapter shows you how to configure a DCAF session for controlling the service processor (see Figure 6-1).

If you have more than one target service processor

You must respect the parameter value matching rules given in Appendix A, "Configuration for a Two-Target Remote Workstation."

Configuring a Target Service Processor

Important

You can use the worksheets in the *Planning Guide*, GA33-0457 to record the necessary parameter values described in this section.

This section describes:

- How to configure the MOSS-E for a DCAF link to the communication controller
- Which MOSS-E parameters to record for use in the controlling workstation.

Parameter Values that Must Be the Same

Table 6-1 gives the sets of MOSS-E parameters that must have the same value in both the remote workstation and the target service processor.

In Service Processor	In Remote Workstation
Local Node Network ID (Figure 6-2 on page 6-3)	Partner network ID (Step 19 in each configuration procedure)
SDLC LU name (Figure 6-3 on page 6-4)	Partner node name (Step 19 in each configuration procedure) and Partner LU alias (Step 19 in each configuration procedure)

Each modem configuration procedure in this chapter explains how to find these parameters in the remote workstation.

Configuring the Service Processor in MOSS-E

The following procedure explains how to find, record, and configure the service processor parameters:

- Step 1.** In the MOSS-E primary window, double click the **Service Processor object**.
- Step 2.** Click **Configuration Management**.
- Step 3.** Double click **SP customization**.

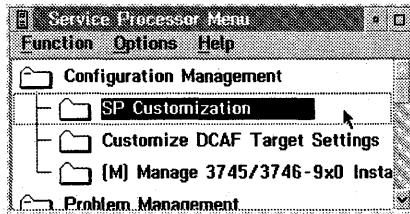

Step 4. Select **Enable DCAF Link/Operations** and select **View Customize** for it and **NetView Link/Operations**.

The screenshot shows a dialog box titled "Service Processor (SP) Customization". On the right side, there is a "View Customize" button. The main area contains several sections with checkboxes and a dropdown menu:

- Customer Information:
- SP Time and Date:
- Service LAN Addresses:
- NetView Link/Operations:
- Enable Retain Link/Operations:
- Enable DCAF Link/Operations:
- Modem type: IBM 7855 (dropdown menu)

At the bottom, there are three buttons: "Next>>", "Close", and "Help". A mouse cursor is pointing at the "Next>>" button.

Step 5. Click **Next**.

Step 6. Record the values in the **Network ID** field (see Figure 6-2 and refer to Table 6-1 on page 6-2).

The screenshot shows a dialog box titled "NetView Link/Reporting Customization". It contains several sections with various input fields and radio buttons:

- Generate alerts:**
- NetView Link(s):** Link(s) through? SNA APPN
- How many?:** 1 2
- Link type?:** LAN SDLC
- Machine Identification:** Machine type: 3745, Model: 61A, Serial number: 12 - 34567
- Local Node Characteristics:** Network ID: SPNETID, Local node name: MOSSNMVT
- LAN Link:** TIC2 or TIC3 LAA: 400000502080 hex; TIC3 RSAP: 04 hexadecimal [04-9C]; Customize 3270 sessions? Yes No
- Switched SDLC Link Telephone Number:** 0492112233

At the bottom, there are three buttons: "<<Previous", "Next>>", and "Help". A mouse cursor is pointing at the "Next>>" button.

Figure 6-2. NetView Link/Reporting Customization

Step 7. Click **Next**.

Step 8. Record the value in the **SDLC LU name** field.

	LU name	Destination address (hexadecimal)	RSAP (hex [04-9C])
<input type="checkbox"/> SNA	DCAF SNA	300000002000	04
<input type="checkbox"/> APPN	DCAF APPN	300000002000	06
<input type="checkbox"/> LAN	DCAF LAN		

SDLC Attached Console: DCAFSDLC

Accept any incoming calls on SP? Yes No

Local phone number: 2564589

Figure 6-3. DCAF Customization

Step 9. Set **Accept any incoming calls on SP?** to **Yes**.

Step 10. Enter the **Local phone number**.

Step 11. The configuration is finished. From Desktop Manager, shutdown and restart the service processor.

Step 12. Go to "Configuring Workstation Modems."

Configuring Workstation Modems

Modem Settings

Modem configurations in CS/2 (or CM/2) will not work unless your modem is set correctly.

Table 6-2 on page 6-5 lists the recommended IBM modems for use with DCAF remote controlling workstations. The procedures in Chapter 12, "Modem Setup" on page 12-1 and "Configuring CS/2 and CM/2 in Workstations" on page 6-6 have been optimized for DCAF.

Modem Settings

If one of the recommended modem is **not** used in the workstation, make sure that the modem is equivalent to one of the recommended modems and uses the same mode (ASYNC or SYNC) as the service RSF modem.

For each of the IBM modems listed in Table 6-2, this guide supplies the following to help you configure the modem setting and your workstation:

- Example configuration file on the included diskettes¹
- A modem setup procedure in Chapter 12, "Modem Setup" on page 12-1.

<i>Table 6-2. Recommended IBM Modems, their Settings, and CS/2 (or CM/2) Configurations</i>		
Modem (Mode)	Settings (Procedure Page)	CS/2 Configuration (File Name)
7855 (SYNC)	12-3	I7855SYN
7855 (ASYNC)	12-3	I7855ASY
7857 (SYNC on MPA card)	12-4	I7857SYN
7857 (ASYNC on COM1)	12-5	I7857ASY
7857 (Auto-SYNC for MPA card on COM2)	12-5	I7857AUT
7858 (SYNC on MPA card)	12-6	I7857SYN
7858 (ASYNC on COM1)	12-6	I7857ASY
7858 (ASYNC for MPA card on COM2)	12-6	I7857AUT
Hayes (ASYNC)	None needed	HAYESASY
Hayes (Auto-SYNC)	None needed	HAYESAUT

To use the example configuration files, load them into the CMLIB directory on your workstation hard disk.

¹ CS/2 configurations are on diskette 02L3852.

CM/2 configurations are on diskette 02L3851.

Configuring CS/2 and CM/2 in Workstations

Important

The procedures in this section are for CS/2, and are the same in CM/2 unless otherwise indicated.

The tables in this section give the page number of the procedures for configuring CS/2 (or CM/2) in your workstation. The specific procedure that you need depends on the your specific combination of:

- Target service processor type
- Target service processor modem type
- Workstation IBM modem.

Configuring Workstation for an IBM Modem

The following procedure helps you find the CS/2 (or CM/2) configuration procedure that corresponds to your equipment:

Step 1. Choose the table that corresponds to the type of target service processors:

- 9577 and 9585: Table 6-3 on page 6-7
- 3172: Table 6-4 on page 6-8
- 7585: Table 6-5 on page 6-9.

Step 2. In the service processor table, find on the right side the **row** of the type of service processor modem with its connection type and mode

Step 3. In the service processor table, find across the top the **column** of the type of remote workstation modem with its connection type and mode.

Step 4. The intersection of the row and column gives the page number of the procedure you should use to configure CS/2 (or CM/2).

Procedures for Service Processors 9577 and 9585

Table 6-3. IBM Modems for Remote Workstations and Target Service Processors 9577 and 9585

Service Processor Connection Type and Mode	Service Processor Modem Type	Remote Workstation DCAF Modem Type									
		MPA Card Connection			COM1 Port Connection						
		7855	7857	7858	7855	7857		7858		Hayes	
		SYNC			ASY	ASY	AUTO	ASY	AUTO	ASY	AUTO
MPA Card SYNC	7855	Page 6-10	Page 6-20	Page 6-20	-	-	Page 6-30	-	Page 6-30	-	Page 6-40
	7857	Page 6-10	Page 6-20	Page 6-20	-	-	Page 6-30	-	Page 6-30	-	Page 6-40
	7858	Page 6-10	Page 6-20	Page 6-20	-	-	Page 6-30	-	Page 6-30	-	Page 6-40
	INT	Page 6-10	Page 6-20	Page 6-20	-	-	Page 6-30	-	Page 6-30	-	Page 6-40
COM1 ASY	7857	-	-	-	Page 6-15	Page 6-25	-	Page 6-25	-	Page 6-35	-
	7858	-	-	-	Page 6-15	Page 6-25	-	Page 6-25	-	Page 6-35	-
	Hayes	-	-	-	Page 6-15	Page 6-25	-	Page 6-25	-	Page 6-35	-
Legend:											
ASY		Asynchronous Mode									
AUTO		Auto-Synchronous Mode									
INT		Internal									
MPA		Multi-protocol Adapter Card									
SYNC		Synchronous Mode									

Procedures for Service Processor 3172

Table 6-4. IBM Modems for Remote Workstations and a Target Service Processor 3172

Service Processor Connection Type and Mode	Service Processor Modem Type	Remote Workstation DCAF Modem Type									
		MPA Card Connection			COM1 Port Connection						
		7855	7857	7858	7855	7857		7858		Hayes	
		SYNC			ASY	ASY	AUTO	ASY	AUTO	ASY	AUTO
MPA Card SYNC	7855	Page 6-10	Page 6-20	Page 6-20	-	-	Page 6-30	-	Page 6-30	-	Page 6-40
	7857	Page 6-10	Page 6-20	Page 6-20	-	-	Page 6-30	-	Page 6-30	-	Page 6-40
	7858	Page 6-10	Page 6-20	Page 6-20	-	-	Page 6-30	-	Page 6-30	-	Page 6-40
COM1 ASY	7857	-	-	-	Page 6-15	Page 6-25	-	Page 6-25	-	Page 6-35	-
	7858	-	-	-	Page 6-15	Page 6-25	-	Page 6-25	-	Page 6-35	-
	Hayes	-	-	-	Page 6-15	Page 6-25	-	Page 6-25	-	Page 6-35	-
MPA Card COM2	7857	-	-	-	Page 6-15	Page 6-20	-	Page 6-25	-	Page 6-35	-
	7858	-	-	-	Page 6-15	Page 6-20	-	Page 6-25	-	Page 6-35	-

Legend:
ASY Asynchronous Mode
AUTO Auto-Synchronous Mode
MPA Multi-protocol Adapter Card
SYNC Synchronous Mode

Procedures for Service Processor 7585

Table 6-5. IBM Modems for Remote Workstations and a Target Service Processor 7585

Service Processor Connection Type and Mode		Service Processor Modem Type		Remote Workstation DCAF Modem Type									
				MPA Card Connection			COM1 Port Connection						
				7855	7857	7858	7855	7857		7858		Hayes	
				SYNC			ASY	ASY	AUTO	ASY	AUTO	ASY	AUTO
COM1 ASY	7857	-	-	-	Page 6-15	Page 6-25	-	Page 6-25	-	Page 6-35	-		
	7858	-	-	-	Page 6-15	Page 6-25	-	Page 6-25	-	Page 6-35	-		
	Hayes	-	-	-	Page 6-15	Page 6-25	-	Page 6-25	-	Page 6-35	-		
Legend: ASY Asynchronous Mode AUTO Auto-Synchronous Mode MPA Multi-protocol Adapter Card SYNC Synchronous Mode													

Modem 7855 in Synchronous Mode to Service Processor 9577, 9585, and 3172 via MPA Card in Synchronous Mode (I7855SYN)

The following procedure uses configuration file I7855SYN.

- Step 1.** Double-click the **Communications Server** icon on your desktop.
- Step 2.** Click **Setup**.
- Step 3.** Under **Directories**, double-click the CMLIB directory and double-click **I7855SYN** to display the configuration file.
- Step 4.** Click **OK**. A message prompts you to select the configuration file for your workstation. Click **OK** and then **Continue**.
- Step 5.** Select **SDLC** (in CM/2, **SDLC using SNA Phone Connections**), **APPC APIs**, and click **Configure**.
- Step 6.** Select **SNA Phone Connect - Port Connection Manager**, click **Configure** and **Continue**.

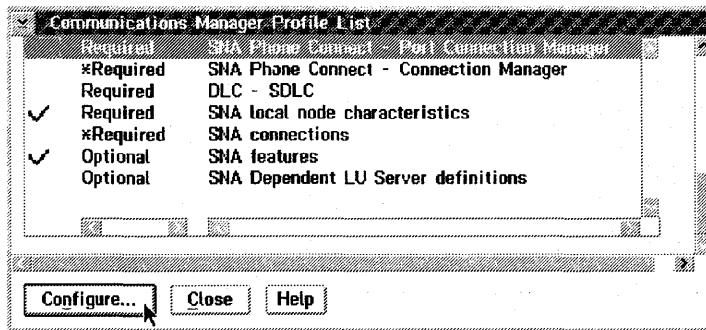

- Step 7.** Select **Synchronous switched**, a modem type and click **Configure**.

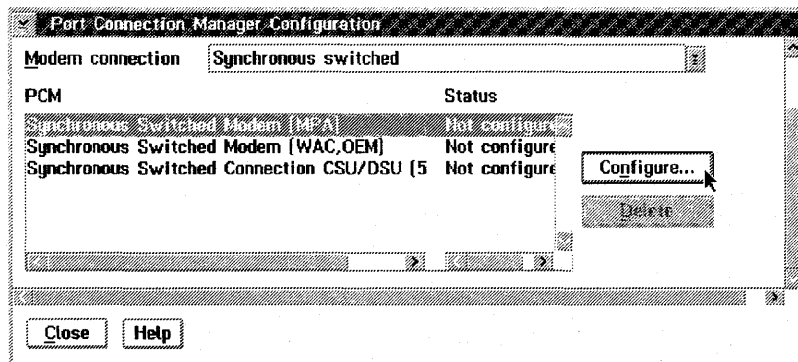

Step 8. Enter the MPA number in the **Port name** field, the number of your modem in the **Local phone number** field, click **OK** and **Close**.

Parameters for Synchronous Switched Modem (MPA)
Edit the parameters as needed.

Modem connection type	Synchronous
Port name	MPA0
Accept incoming calls	NO
Local phone number	12345678
Encoding scheme	NRZI

OK Cancel Help

Step 9. Select **SNA Phone Connect - Connection Manager** and click **Configure**.

Step 10. Select **SP123456** and click **Change**.

Note: The directory entry file contains information on the target service processor that you are dialing. You can use **SP123456** and rename it for your own purposes. If you add a new workstation, you must create a new name.

Connection Manager Configuration

Incoming Call Directory Entries	Outgoing Call Directory Entries
	SP123456

Create... Change... Delete Create... Change... Delete

Close Help

Step 11. Select **Modem/Line characteristics** and click **Change**.

Outgoing Call Directory Entry

Entry name: SP123456

Currently Configured Subfields

Modem/Line characteristics

Change..

Delete

Type of Subfield to Create

Called party number

Create..

OK Cancel Help

Step 12. Select **Synchronous, NRZI** for the encoding scheme and click **OK**.

Step 13. Select the **Called party number** (in CM/2, this is **SP123456**) and click **Change**.

Step 14. Enter the phone-number of the service processor modem and click **OK**, then **OK** again on the subsequent screen.

Called Party Number

Phone number: 12345678

OK Cancel Help

Step 15. Select **SNA local node characteristics**, click **Configure** and **Continue**.

Step 16. Modify the **Network ID** and **Local node name** fields for your remote workstation and click **OK**.

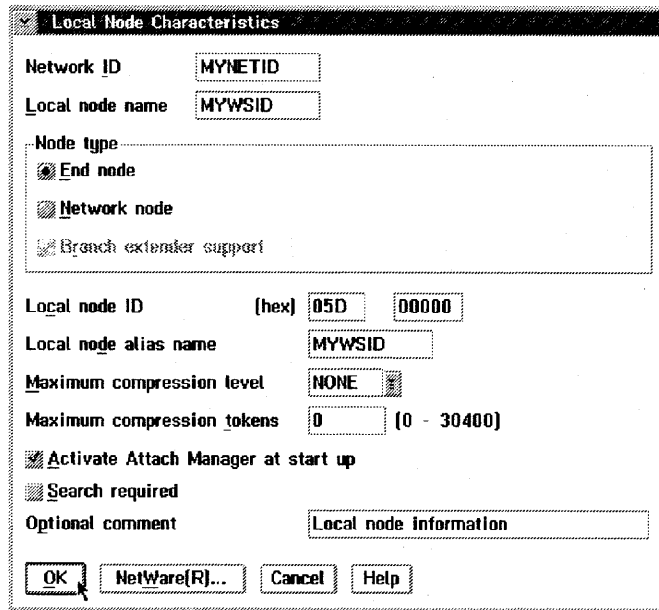

The dialog box titled "Local Node Characteristics" contains the following fields and options:

- Network ID:** MYNETID
- Local node name:** MYWSID
- Node type:**
 - End node
 - Network node
 - Branch extender support
- Local node ID (hex):** 05D 00000
- Local node alias name:** MYWSID
- Maximum compression level:** NONE
- Maximum compression tokens:** 0 (0 - 30400)
- Activate Attach Manager at start up
- Search required
- Optional comment:** Local node information

Buttons at the bottom: OK, NetWare(R)!, Cancel, Help.

Step 17. Select **SNA connections**, click **Configure** and **Continue**.

Step 18. Select **To peer node**, the service processor link name and click **Change** and **Continue**.

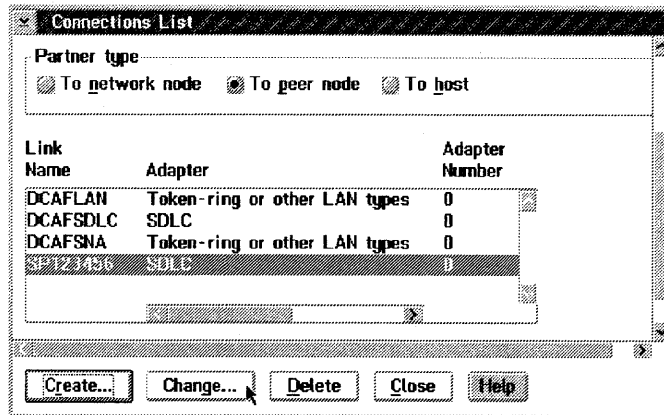

The dialog box titled "Connections List" contains the following elements:

- Partner type:**
 - To network node
 - To peer node
 - To host
- Table:**

Link Name	Adapter	Adapter Number
DCAFLAN	Token-ring or other LAN types	0
DCAFSDLC	SDLC	0
DCAFSNA	Token-ring or other LAN types	0
SP123456	SDLC	0

Buttons at the bottom: Create..., Change..., Delete, Close, Help.

Step 19. Check that the entries in the **Partner network ID** and **Partner node name** fields match the entries in the MOSS-E (see Table 6-1 on page 6-2). Select the service processor directory name in the **Outgoing call directory entry** field.

Connection to a Peer Node

Link name: SP123456 Activate at startup

Adjacent node ID (hex):

Partner LU definitions

Partner network ID: SPNETID

Partner node name: DCAFSDLC

Secondary station address (hex): 01 (01-FE)

SNA Phone Connect parameters

Connection type:

Permanent connection name:

Outgoing call directory entry: SP123456

To provide unique link protocol parameters that are different than those specified in the DLC adapter profile, select Override...

Step 20. Click **OK**.

Step 21. Close the subsequent screens until you exit CS/2.

Step 22. See "Configuring DCAF for a Modem" on page 6-45 for installing a target service processor.

Modem 7855 in Asynchronous Mode to Service Processor 9577, 9585, 3172, and 7585 via Serial Port (I7855ASY)

The following procedure uses configuration file I7855ASY.

- Step 1.** Double-click the **Communications Server** icon on your desktop.
- Step 2.** Click **Setup**.
- Step 3.** Under **Directories**, double-click the CMLIB directory and double-click **I7855ASY** to display the configuration file.
- Step 4.** Click **OK**. A message prompts you to select the configuration file for your workstation. Click **OK** and then **Continue**.
- Step 5.** Select **SDLC** (in **CM/2, SDLC using SNA Phone Connections**), **APPC APIs**, and click **Configure**.
- Step 6.** Select **SNA Phone Connect - Port Connection Manager**, click **Configure** and **Continue**.

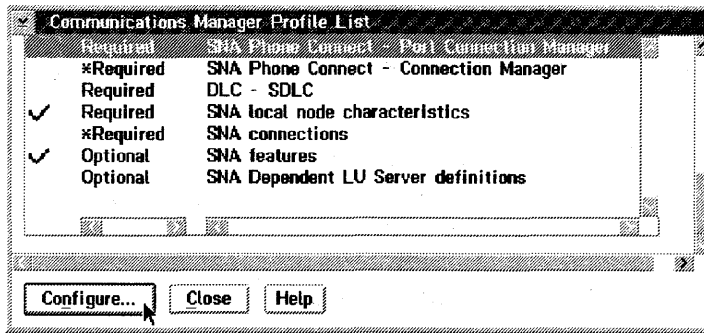

- Step 7.** Select **Asynchronous switched**, a 7855 modem type and click **Configure**.

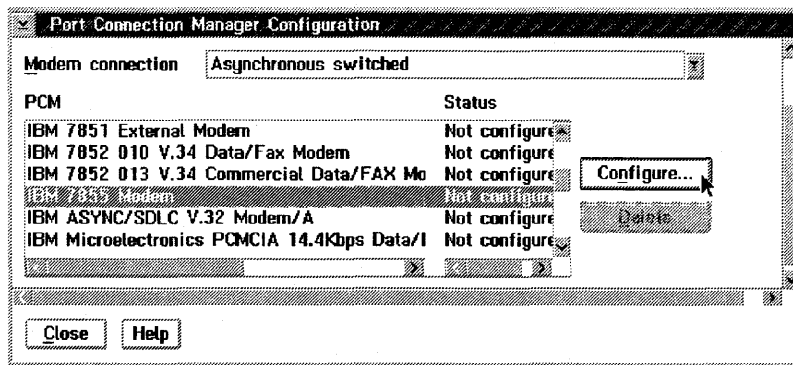

Step 8. Enter the port number in the **Port name** field, the number of your modem in the **Local phone number** field, click **OK** and **Close**.

Parameters for IBM 7855 Modem
Edit the parameters as needed.

Modem connection type	Asynchronous
Port name	COM1
Accept incoming calls	NO
Serial port speed	19200
Local phone number	12345678
Dial prefix string	ATDT

OK Cancel Help

Step 9. Select **SNA Phone Connect - Connection Manager** and click **Configure**.

Step 10. Select **SP123456** and click **Change**.

Note: The directory entry file contains information on the target service processor that you are dialing. You can use **SP123456** and rename it for your own purposes. If you add a new workstation, you must create a new name.

Connection Manager Configuration

Incoming Call Directory Entries	Outgoing Call Directory Entries
	SP123456

Create... Change... Delete Create... Change... Delete

Close Help

Step 11. Select Modem/Line characteristics and click Change.

Outgoing Call Directory Entry

Entry name SP123456

Currently Configured Subfields

Modem/Line characteristics

Change...
Delete

Type of Subfield to Create

Modem/Line characteristics
Called party number

Create

OK Cancel Help

Step 12. Select Asynchronous, ISO3309 as the framing standard and click OK.

Step 13. Select the Called party number (in CM/2, this is SP123456) and click Change.

Step 14. Enter the phone-number of the service processor modem and click OK, then OK again on the subsequent screen.

Called Party Number

Phone number 12345678

OK Cancel Help

Step 15. Select SNA local node characteristics and click Configure and Continue.

Step 16. Modify the **Network ID** and **Local node name** fields for your remote workstation and click **OK**.

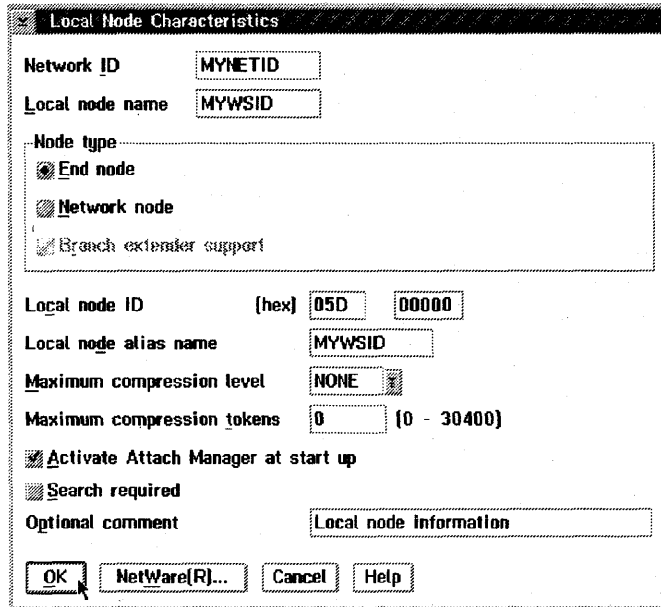

The dialog box 'Local Node Characteristics' contains the following fields and options:

- Network ID:** MYNETID
- Local node name:** MYWSID
- Node type:**
 - End node
 - Network node
 - Branch extender support
- Local node ID (hex):** 05D 00000
- Local node alias name:** MYWSID
- Maximum compression level:** NONE
- Maximum compression tokens:** 0 (0 - 30400)
- Activate Attach Manager at start up
- Search required
- Optional comment:** Local node information

Buttons at the bottom: OK, NetWare(R)..., Cancel, Help.

Step 17. Select **SNA connections**, click **Configure** and **Continue**.

Step 18. Select **To peer node**, the service processor link name and click **Change** and **Continue**.

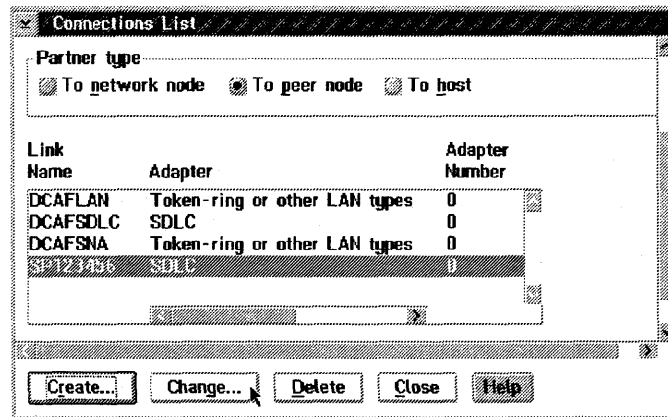

The dialog box 'Connections List' contains the following elements:

- Partner type:**
 - To network node
 - To peer node
 - To host
- Table:**

Link Name	Adapter	Adapter Number
DCAFLAN	Token-ring or other LAN types	0
DCAFS DLC	SDLC	0
DCAFSNA	Token-ring or other LAN types	0
SP123456	SDLC	0

Buttons at the bottom: Create..., Change..., Delete, Close, Help.

Step 19. Check that the entries in the **Partner network ID** and **Partner node name** fields match the entries in the MOSS-E (see Table 6-1 on page 6-2). Select the service processor directory name in the **Outgoing call directory entry** field.

Connection to a Peer Node

Link name: SP123456 Activate at startup

Adjacent node ID (hex):

Partner LU definitions

Partner network ID: SPNETID Define Partner LUs...

Partner node name: DCAFS DLC

Secondary station address (hex): 01 (01-FE)

SNA Phone Connect parameters

Connection type:

Permanent connection name:

Outgoing call directory entry: SP123456

To provide unique link protocol parameters that are different than those specified in the DLC adapter profile, select Override...

OK Additional parameters... Cancel Help

Step 20. Click **OK**.

Step 21. Close the subsequent screens until you exit CS/2.

Step 22. See "Configuring DCAF for a Modem" on page 6-45 for installing a target service processor.

Modem 7857 in Synchronous Mode to Service Processor 9577, 9585, and 3172 via MPA Card in Synchronous Mode (I7857SYN)

The following procedure uses configuration file I7857SYN.

- Step 1.** Double-click the **Communications Server** icon on your desktop.
- Step 2.** Click **Setup**.
- Step 3.** Under **Directories**, double-click the CMLIB directory and double-click **I7857SYN** to display the configuration file.
- Step 4.** Click **OK**. A message prompts you to select the configuration file for your workstation. Click **OK** and then **Continue**.
- Step 5.** Select **SDLC** (in **CM/2**, **SDLC using SNA Phone Connections**), **APPC APIs**, and click **Configure**.
- Step 6.** Select **SNA Phone Connect - Port Connection Manager** and click **Configure** and **Continue**.

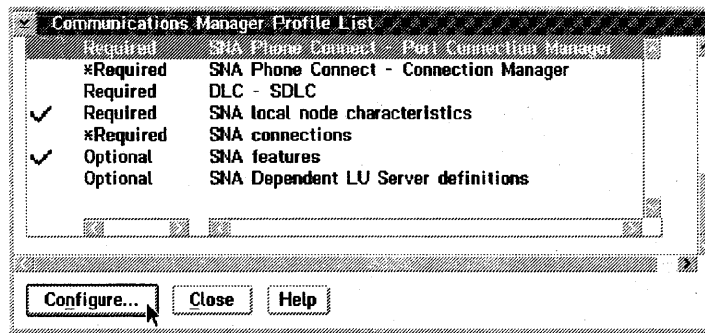

- Step 7.** Select **Synchronous switched**, **CSU/DSU** modem type and click **Configure**.

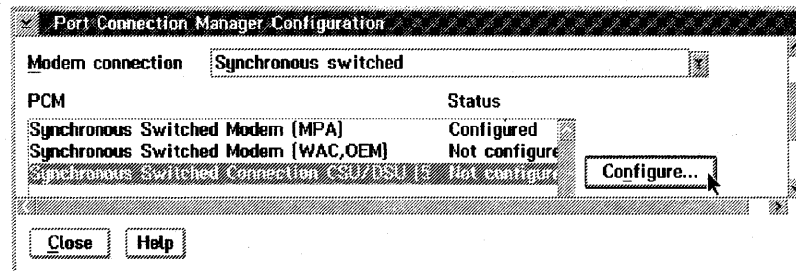

Step 8. Enter the MPA number in the **Port name** field, the number of your modem in the **Local phone number** field, click **OK** and **Close**.

Parameters for Synchronous Switched Modem [MPA]
Edit the parameters as needed.

Modem connection type	Synchronous
Port name	MPAD
Accept incoming calls	NO
Local phone number	12345678
Encoding scheme	NRZI

OK Cancel Help

Step 9. Select **SNA Phone Connect - Connection Manager** and click **Configure**.

Step 10. Select **SP123456** and click **Change**.

Note: The directory entry file contains information on the target service processor that you are dialing. You can use **SP123456** and rename it for your own purposes. If you add a new workstation, you must create a new name.

Connection Manager Configuration

Incoming Call Directory Entries	Outgoing Call Directory Entries
	SP123456

Create... Change... Delete... Create... Change... Delete

Close Help

Step 11. Select Modem/Line characteristics and click Change.

Outgoing Call Directory Entry

Entry name: SP123456

Currently Configured Subfields

- Modem/Line Characteristics

Change...
Delete

Type of Subfield to Create

- Modem/Line Characteristics
- Called party number

Create...

OK Cancel Help

Step 12. Select Synchronous, NRZI for the encoding scheme and click OK.

Modem/Line Characteristics

Modem connection type

- Asynchronous
- Synchronous
- AutoSync

Asynchronous parameters

Framing standard: SOJ009

Synchronous/AutoSync parameters

Encoding scheme: NRZI

OK Cancel Help

Step 13. Select the **Called party number** (in CM/2, this is **SP123456**) and click **Change**.

Step 14. Enter the phone-number of the service processor modem and click **OK**, then **OK** again on the subsequent screen.

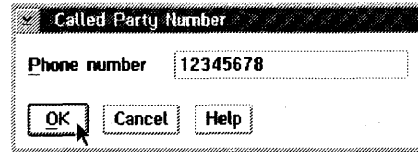

A dialog box titled "Called Party Number" with a dark header. It contains a text field labeled "Phone number" with the value "12345678". Below the field are three buttons: "OK", "Cancel", and "Help". A mouse cursor is pointing at the "OK" button.

Step 15. Select **SNA local node characteristics** and click **Configure** and **Continue**.

Step 16. Modify the **Network ID** and **Local node name** fields for your remote workstation and click **OK**.

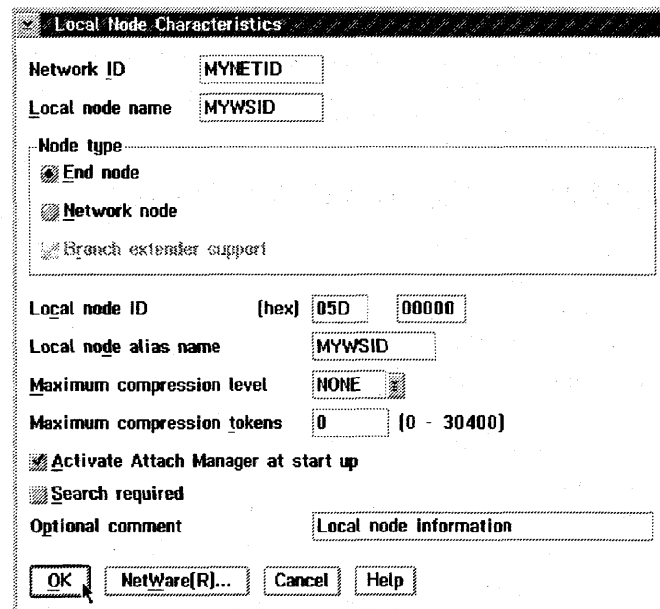

A dialog box titled "Local Node Characteristics" with a dark header. It contains several fields and checkboxes:

- Network ID:** MYNETID
- Local node name:** MYWSID
- Node type:** A group box containing three radio buttons: "End node" (selected), "Network node", and "Branch extender support".
- Local node ID (hex):** 05D 00000
- Local node alias name:** MYWSID
- Maximum compression level:** NONE
- Maximum compression tokens:** 0 (0 - 30400)
- Activate Attach Manager at start up:** Checked
- Search required:** Checked
- Optional comment:** Local node information

At the bottom are four buttons: "OK", "NetWare(R)...", "Cancel", and "Help". A mouse cursor is pointing at the "OK" button.

Step 17. Select **SNA connections**, click **Configure** and **Continue**.

Step 18. Select **To peer node**, the service processor link name and click **Change** and **Continue**.

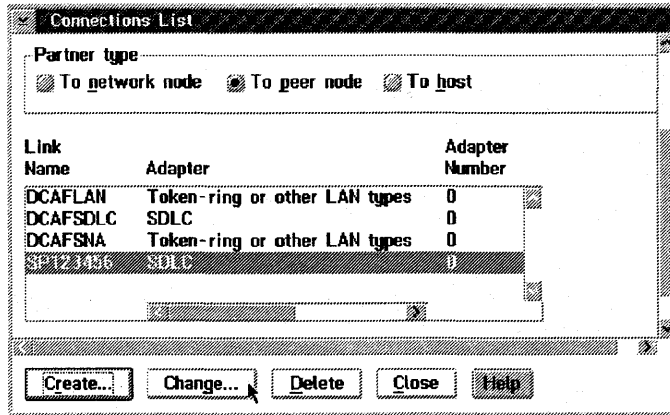

Step 19. Check that the entries in the **Partner network ID** and **Partner node name** fields match the entries in the MOSS-E (refer to Table 6-1 on page 6-2). Select the service processor directory name in the **Outgoing call directory entry** field.

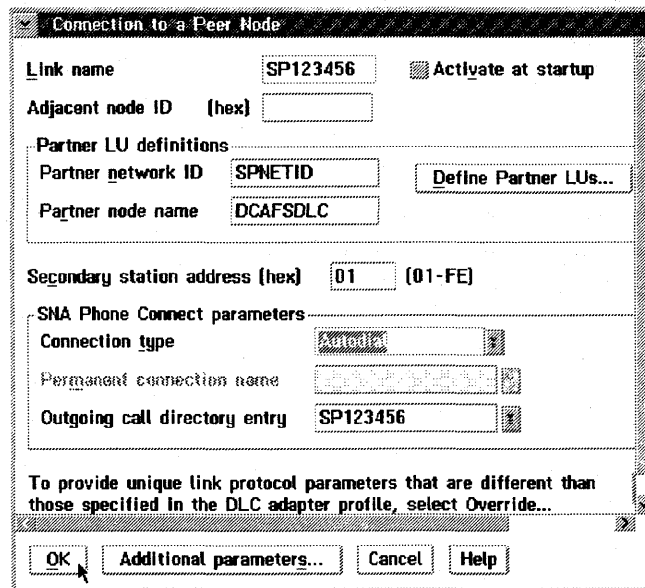

Step 20. Click **OK**.

Step 21. Close the subsequent screens until you exit CS/2.

Step 22. See "Configuring DCAF for a Modem" on page 6-45 for installing a target service processor.

Modem 7857 in Asynchronous Mode to Service Processor 9577, 9585, 3172, and 7585 via Serial Port (I7857ASY)

The following procedure uses configuration file I7857ASY.

- Step 1.** Double-click the **Communications Server** icon on your desktop.
- Step 2.** Click **Setup**.
- Step 3.** Under **Directories**, double-click the CMLIB directory and double-click **I7857ASY** to display the configuration file.
- Step 4.** Click **OK**. A message prompts you to select the configuration file for your workstation. Click **OK** and then **Continue**.
- Step 5.** Select **SDLC** (in **CM/2, SDLC using SNA Phone Connections**), **APPC APIs**, and click **Configure**.
- Step 6.** Select **SNA Phone Connect - Port Connection Manager**, click **Configure** and **Continue**.

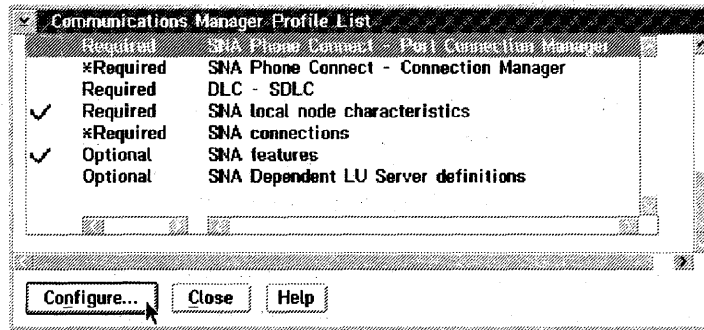

- Step 7.** Select **Asynchronous switched**, **User defined** and click **Configure**.

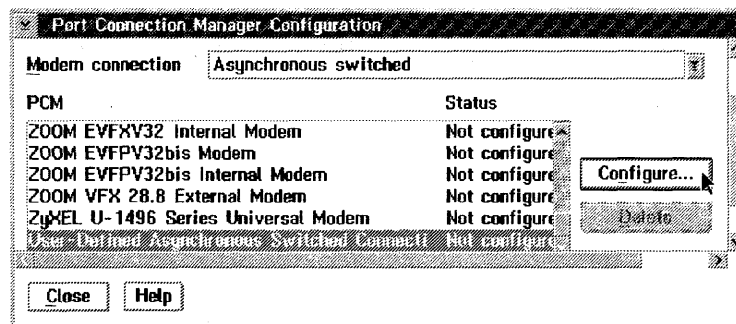

Step 8. Enter the port number in the **Port name** field, the number of your modem in the **Local phone number** field, click **OK** and **Close**.

Parameters for User-Defined Asynchronous Switched Connection Modem
Edit the parameters as needed.

Modem connection type	Asynchronous
Port name	COM1
Accept incoming calls	NO
Modem class	Unspecified
Serial port speed	9600
Local phone number	12345678

Step 9. Select **SNA Phone Connect - Connection Manager** and click **Configure**.

Step 10. Select **SP123456** and click **Change**.

Note: The directory entry file contains information on the target service processor that you are dialing. You can use **SP123456** and rename it for your own purposes. If you add a new workstation, you must create a new name.

Connection Manager Configuration

Incoming Call Directory Entries	Outgoing Call Directory Entries
	SP123456

Create... Change... Delete Create... Change... Delete

Close Help

Step 11. Select Modem/Line characteristics and click Change.

Outgoing Call Directory Entry

Entry name: SP123456

Currently Configured Subfields

Modem/Line characteristics

Change...
Delete

Type of Subfield to Create

Modem/Line characteristics
Called party number

Create...

OK Cancel Help

Step 12. Select Asynchronous, ISO3309 as the framing standard and click OK.

Modem/Line Characteristics

Modem connection type

Asynchronous
 Synchronous
 AutoSync

Asynchronous parameters

Framing standard: ISO3309

Synchronous/AutoSync parameters

Encoding scheme: Use default

OK Cancel Help

Step 13. Select the Called party number (in CM/2, this is SP123456) and click Change.

Step 14. Enter the phone-number of the service processor modem and click **OK**, then **OK** again on the subsequent screen.

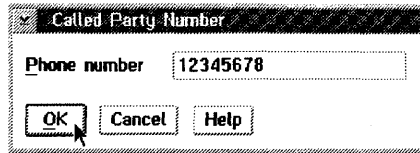

Called Party Number

Phone number: 12345678

OK Cancel Help

Step 15. Select **SNA local node characteristics**, click **Configure** and **Continue**.

Step 16. Modify the **Network ID** and **Local node name** fields for your remote workstation and click **OK**.

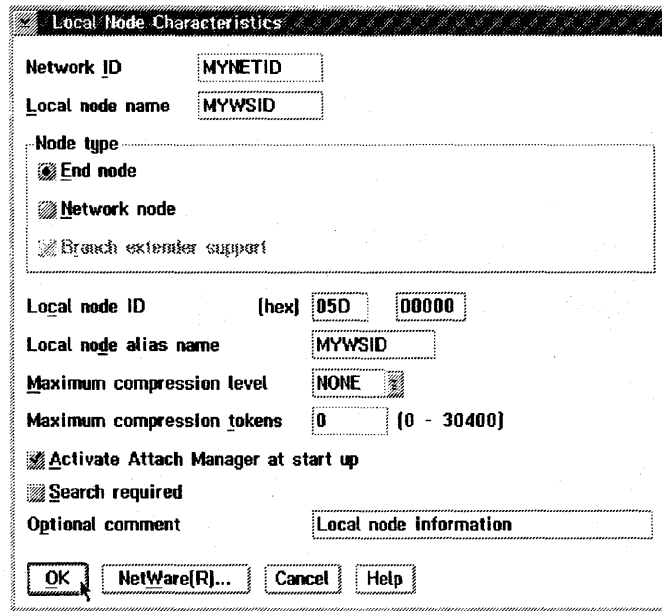

Local Node Characteristics

Network ID: MYNETID

Local node name: MYWSID

Node type:

- End node
- Network node
- Branch extender support

Local node ID (hex): 05D 00000

Local node alias name: MYWSID

Maximum compression level: NONE

Maximum compression tokens: 0 (0 - 30400)

Activate Attach Manager at start up

Search required

Optional comment: Local node information

OK NetWare[R]... Cancel Help

Step 17. Select **SNA connections**, click **Configure** and **Continue**.

Step 18. Select **To peer node**, the service processor link name and click **Change** and **Continue**.

Link Name	Adapter	Adapter Number
DCAFLAN	Token-ring or other LAN types	0
DCAFSDLC	SDLC	0
DCAFSNA	Token-ring or other LAN types	0
SP123456	SDLC	0

Step 19. Check that the entries in the **Partner network ID** and **Partner node name** fields match the entries in the MOSS-E (refer to Table 6-1 on page 6-2). Select the service processor directory name in the **Outgoing call directory entry** field.

Step 20. Click **OK**.

Step 21. Close the subsequent screens until you exit CS/2.

Step 22. See "Configuring DCAF for a Modem" on page 6-45 for installing a target service processor.

Modem 7857 in AutoSync Mode to Service Processor 9577, 9585, and 3172 via MPA Card in Sync Mode (I7857AUT)

The following procedure uses configuration file I7857AUT.

- Step 1.** Double-click the **Communications Server** icon on your desktop.
- Step 2.** Click **Setup**.
- Step 3.** Under **Directories**, double-click the CMLIB directory and double-click **I7857AUT** to display the configuration file.
- Step 4.** Click **OK**. A message prompts you to select the configuration file for your workstation. Click **OK** and then **Continue**.
- Step 5.** Select **SDLC** (in **CM/2, SDLC using SNA Phone Connections**), **APPC APIs**, and click **Configure**.
- Step 6.** Select **SNA Phone Connect - Port Connection Manager**, click **Configure** and **Continue**.

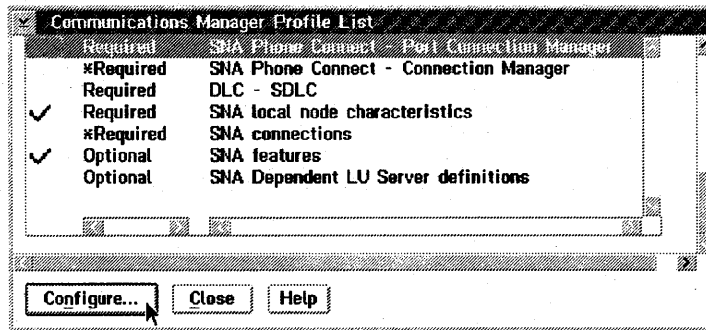

- Step 7.** Select **AutoSync, User defined** and click **Configure**.

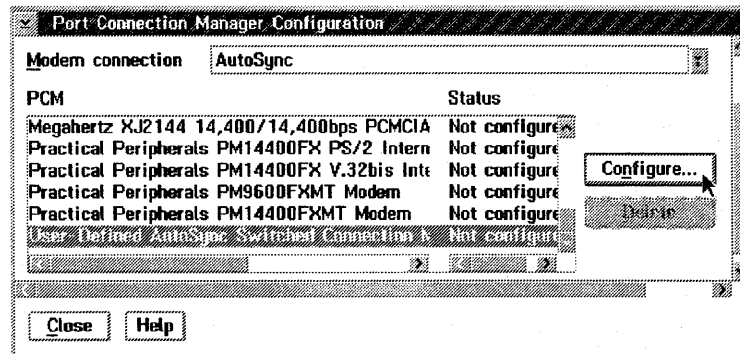

Step 8. Enter the MPA number in the **Port name** field, the number of your modem in the **Local phone number** field, click **OK** and **Close**.

Parameters for User-Defined AutoSync Switched Connection Modem
Edit the parameters as needed.

Modem connection type	AutoSync
Port name	MPA0
Accept incoming calls	NO
Serial port speed	9600
Local phone number	1234567
Encoding scheme	NRZ1

Step 9. Select **SNA Phone Connect - Connection Manager** and click **Configure**.

Step 10. Select **SP123456** and click **Change**.

Note: The directory entry file contains information on the target service processor that you are dialing. You can use **SP123456** and rename it for your own purposes. If you add a new workstation, you must create a new name.

Connection Manager Configuration

Incoming Call Directory Entries	Outgoing Call Directory Entries
	SP123456

Create... Change... Delete Create... Change... Delete

Close Help

Step 11. Select Modem/Line characteristics and click Change.

Outgoing Call Directory Entry

Entry name: SP123456

Currently Configured Subfields

- Modem/Line characteristics

Change...
Delete

Type of Subfield to Create

- Modem/Line characteristics
- Called party number

Create...

OK Cancel Help

Step 12. Select AutoSync, NRZI as the encoding scheme and click OK.

Modem/Line Characteristics

Modem connection type

- Asynchronous
- Synchronous
- AutoSync

Asynchronous parameters

Framing standard: ISO3309

Synchronous/AutoSync parameters

Encoding scheme: NRZI

OK Cancel Help

Step 13. Select the Called party number (in CM/2, this is SP123456) and click Change.

Step 14. Enter the phone-number of the service processor modem and click **OK**, then **OK** again on the subsequent screen.

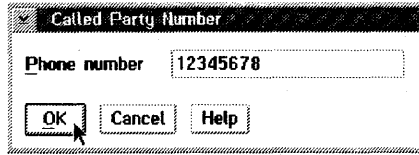

Called Party Number

Phone number 12345678

OK Cancel Help

Step 15. Select **SNA local node characteristics**, click **Configure** and **Continue**.

Step 16. Modify the **Network ID** and **Local node name** fields for your remote workstation and click **OK**.

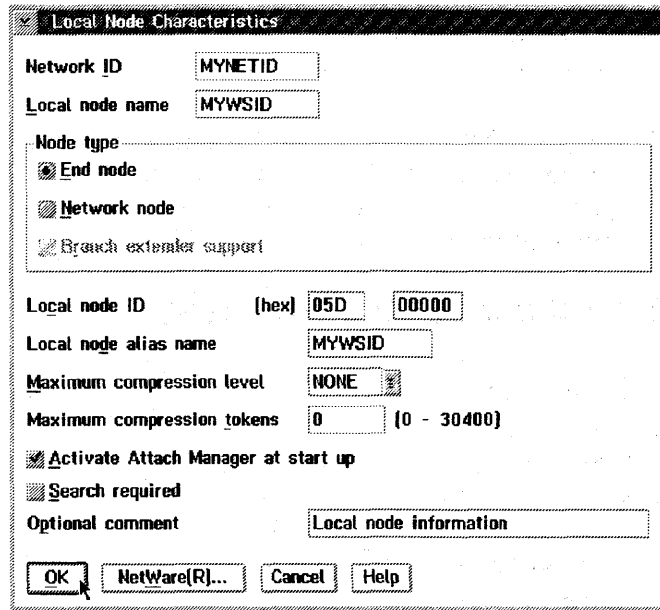

Local Node Characteristics

Network ID MYNETID

Local node name MYWSID

Node type

- End node
- Network node
- Branch extender support

Local node ID (hex) 05D 00000

Local node alias name MYWSID

Maximum compression level NONE

Maximum compression tokens 0 (0 - 30400)

Activate Attach Manager at start up

Search required

Optional comment Local node information

OK NetWare(R)... Cancel Help

Step 17. Select **SNA connections**, click **Configure** and **Continue**.

Step 18. Select **To peer node**, the service processor link name and click **Change** and **Continue**.

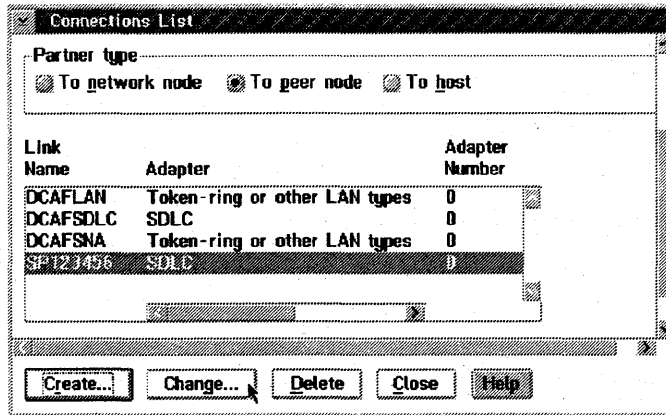

Step 19. Check that the entries in the **Partner network ID** and **Partner node name** fields match the entries in the MOSS-E (refer to Table 6-1 on page 6-2). Select the service processor directory name in the **Outgoing call directory entry** field and click **OK**.

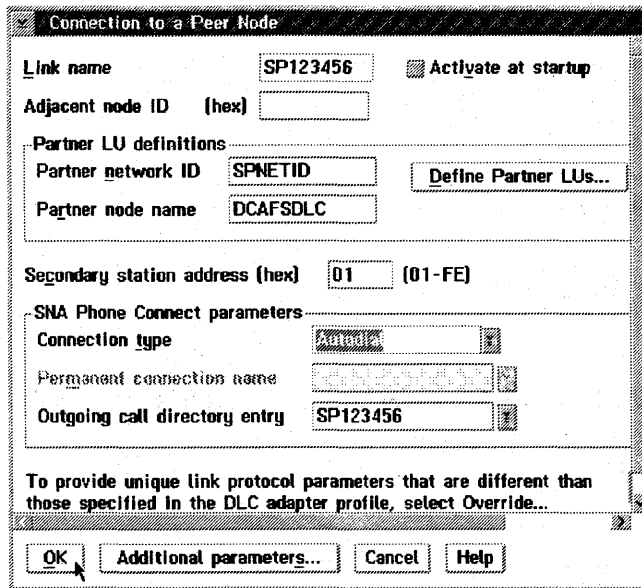

Step 20. Close the subsequent screens until you exit CS/2.

Step 21. See "Configuring DCAF for a Modem" on page 6-45 for installing a target service processor.

Hayes Modem in Asynchronous Mode to Service Processor 9577, 9585, 3172, and 7585 via Serial Port (HAYESASY)

The following procedure uses configuration file HAYESASY.

- Step 1.** Double-click the **Communications Server** icon on your desktop.
- Step 2.** Click **Setup**.
- Step 3.** Under **Directories**, double-click the CMLIB directory and double-click **HAYESASY** to display the configuration file.
- Step 4.** Click **OK**. A message prompts you to select the configuration file for your workstation. Click **OK** and then **Continue**.
- Step 5.** Select **SDLC** (in **CM/2, SDLC using SNA Phone Connections**), **APPC APIs**, and click **Configure**.
- Step 6.** Select **SNA Phone Connect - Port Connection Manager**, click **Configure** and **Continue**.

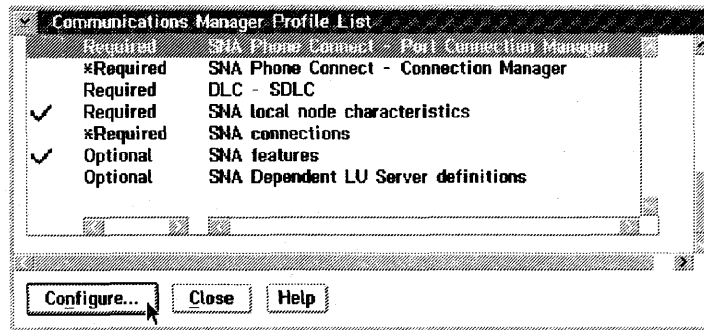

- Step 7.** Select **Asynchronous switched**, a Hayes modem type and click **Configure**.

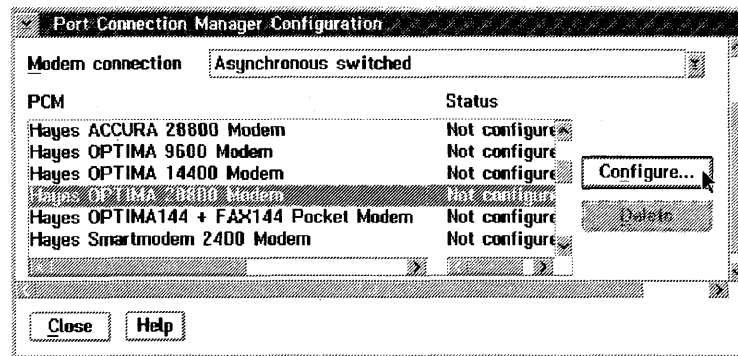

Step 8. Enter the port number in the **Port name** field, the number of your modem in the **Local phone number** field, click **OK** and **Close**.

Parameters for Hayes OPTIMA 28800 Modem
Edit the parameters as needed.

Modem connection type	Asynchronous
Port name	COM1
Accept incoming calls	NO
Serial port speed	57600
Local phone number	12345678
Dial prefix string	ATDT

OK Cancel Help

Step 9. Select **SNA Phone Connect - Connection Manager** and click **Configure**.

Step 10. Select **SP123456** and click **Change**.

Note: The directory entry file contains information on the target service processor that you are dialing. You can use **SP123456** and rename it for your own purposes. If you add a new workstation, you must create a new name.

Connection Manager Configuration

Incoming Call Directory Entries	Outgoing Call Directory Entries
	SP123456

Create... Change... Delete... Create... Change... Delete

Close Help

Step 11. Select Modem/Line characteristics and click Change.

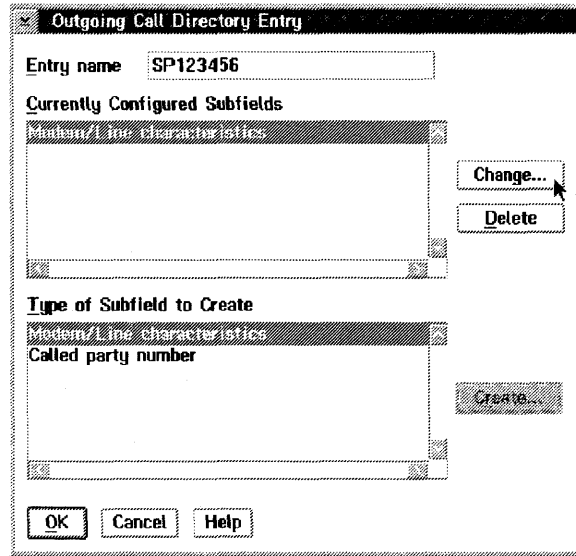

Step 12. Select Asynchronous, ISO3309 as the framing standard and click OK.

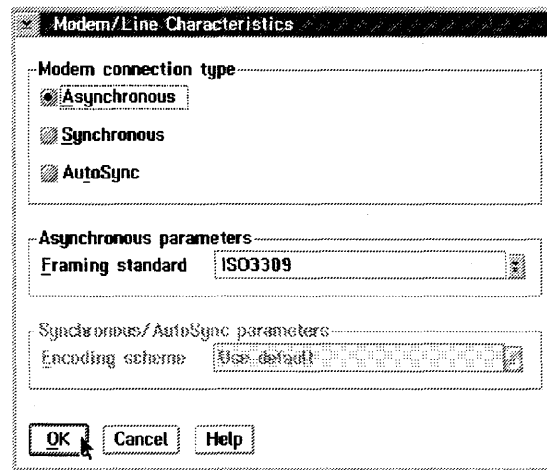

Step 13. Select Called party number (in CM2, this is SP123456) and click Change.

Step 14. Enter the phone-number of the service processor modem and click **OK**, then **OK** again on the subsequent screen.

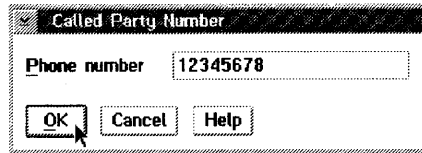

Called Party Number

Phone number 12345678

OK Cancel Help

Step 15. Select **SNA local node characteristics**, click **Configure** and **Continue**.

Step 16. Modify the **Network ID** and **Local node name** fields for your remote workstation and click **OK**.

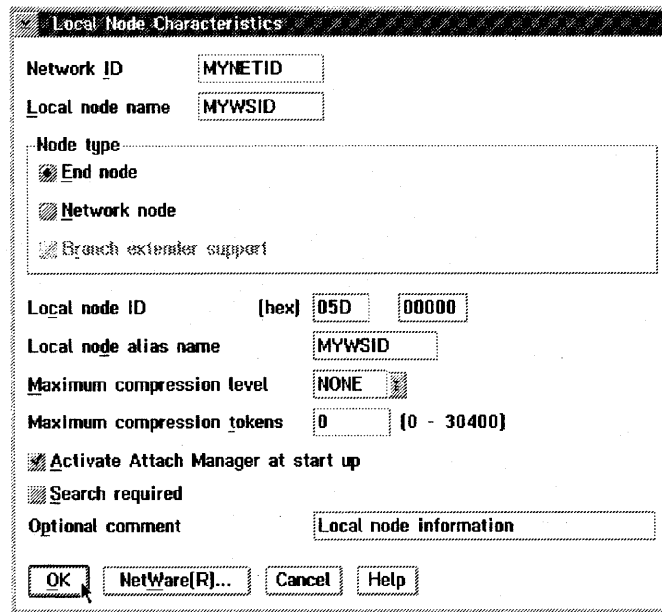

Local Node Characteristics

Network ID MYNETID

Local node name MYWSID

Node type

- End node
- Network node
- Branch extender support

Local node ID (hex) 05D 00000

Local node alias name MYWSID

Maximum compression level NONE

Maximum compression tokens 0 (0 - 30400)

Activate Attach Manager at start up

Search required

Optional comment Local node information

OK NetWare(R)... Cancel Help

Step 17. Select **SNA connections**, click **Configure** and **Continue**.

Step 18. Select **To peer node**, the service processor link name and click **Change** and **Continue**.

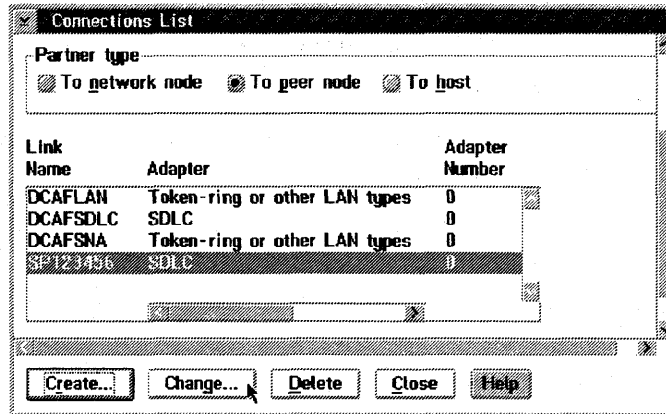

Step 19. Check that the entries in the **Partner network ID** and **Partner node name** fields match the entries in the MOSS-E (refer to Table 6-1 on page 6-2). Select the service processor directory name in the **Outgoing call directory entry** field and click **OK**.

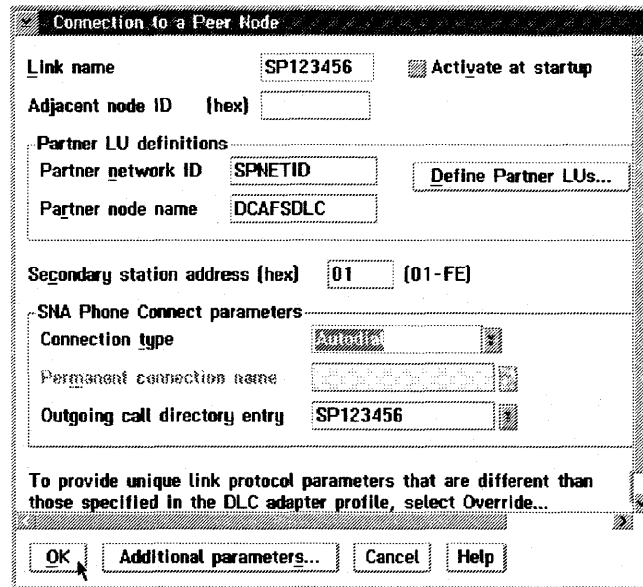

Step 20. Close the subsequent screens until you exit CS/2.

Step 21. See "Configuring DCAF for a Modem" on page 6-45 for installing a target service processor.

Hayes Modem in AutoSync Mode to Service Processor 9577, 9585, and 3172 via MPA Card in Sync Mode (HAYESAUT)

The following procedure uses configuration file HAYESAUT.

- Step 1.** Double-click the **Communications Server** icon on your desktop.
- Step 2.** Click **Setup**.
- Step 3.** Under **Directories**, double-click the CMLIB directory and double-click **HAYESAUT** to display the configuration file.
- Step 4.** Click **OK**. A message prompts you to select the configuration file for your workstation. Click **OK** and then **Continue**.
- Step 5.** Select **SDLC** (in **CM/2, SDLC using SNA Phone Connections**), **APPC APIs**, and click **Configure**.
- Step 6.** Select **SNA Phone Connect - Port Connection Manager**, click **Configure** and **Continue**.

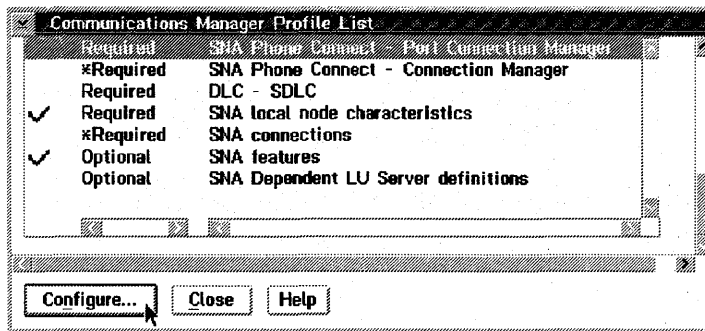

- Step 7.** Select **AutoSync**, a Hayes modem type and click **Configure**.

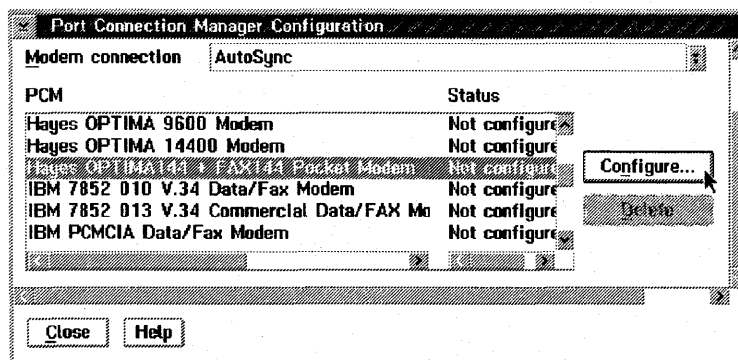

Step 8. Enter the MPA number in the **Port name** field, the number of your modem in the **Local phone number** field, click **OK** and **Close**.

Parameters for Hayes OPTIMA144 FAX144 Pocket Modem
Edit the parameters as needed.

Modem connection type	AutoSync
Port name	MPAD
Accept incoming calls	NO
Serial port speed	38400
Local phone number	12345678
Encoding scheme	NRZI
Dial prefix string	ATDT

OK Cancel Help

Step 9. Select **SNA Phone Connect - Connection Manager** and click **Configure**.

Step 10. Select **SP123456** and click **Change**.

Note: The directory entry file contains information on the target service processor that you are dialing. You can use **SP123456** and rename it for your own purposes. If you add a new workstation, you must create a new name.

Connection Manager Configuration

Incoming Call Directory Entries	Outgoing Call Directory Entries
	SP123456

Create... Change... Delete Create... Change... Delete

Close Help

Step 11. Select Modem/Line characteristics and click Change.

Outgoing Call Directory Entry

Entry name: SP123456

Currently Configured Subfields

Modem/Line characteristics

Change...
Delete

Type of Subfield to Create

Modem/Line characteristics
Called party number

Create...

OK Cancel Help

Step 12. Select AutoSync, NRZI as the encoding scheme and click OK.

Modem/Line Characteristics

Modem connection type

Asynchronous
 Synchronous
 AutoSync

Asynchronous parameters

Framing standard: ISO3309

Synchronous/AutoSync parameters

Encoding scheme: NRZI

OK Cancel Help

Step 13. Select the Called party number (in CM/2, this is SP123456) and click Change.

Step 14. Enter the phone-number of the service processor modem and click **OK**, then **OK** again on the subsequent screen.

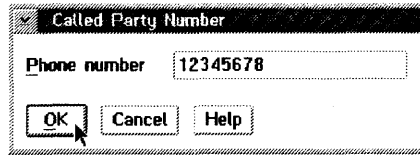

A dialog box titled "Called Party Number" with a "Phone number" field containing "12345678" and buttons for "OK", "Cancel", and "Help".

Step 15. Select **SNA local node characteristics**, click **Configure** and **Continue**.

Step 16. Modify the **Network ID** and **Local node name** fields for your remote workstation and click **OK**.

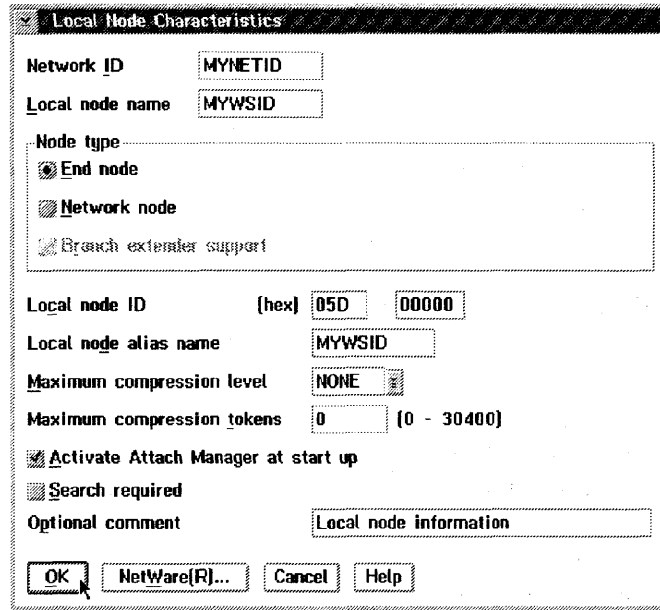

A dialog box titled "Local Node Characteristics" with the following fields and options:

- Network ID: MYNETID
- Local node name: MYWSID
- Node type:
 - End node
 - Network node
 - Branch extender support
- Local node ID (hex): 05D 00000
- Local node alias name: MYWSID
- Maximum compression level: NONE
- Maximum compression tokens: 0 (0 - 30400)
- Activate Attach Manager at start up
- Search required
- Optional comment: Local node information

Buttons: OK, NetWare[R]..., Cancel, Help

Step 17. Select **SNA connections**, click **Configure** and **Continue**.

Step 18. Select **To peer node**, the service processor link name and click **Change** and **Continue**.

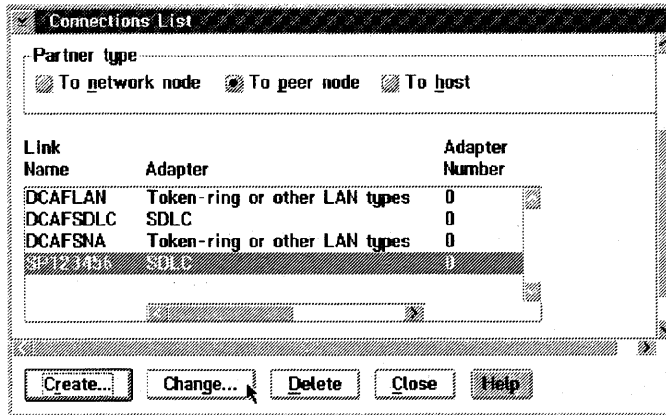

Step 19. Check that the entries in the **Partner network ID** and **Partner node name** fields match the entries in the MOSS-E (refer to Table 6-1 on page 6-2). Select the service processor directory name in the **Outgoing call directory entry** field and click **OK**.

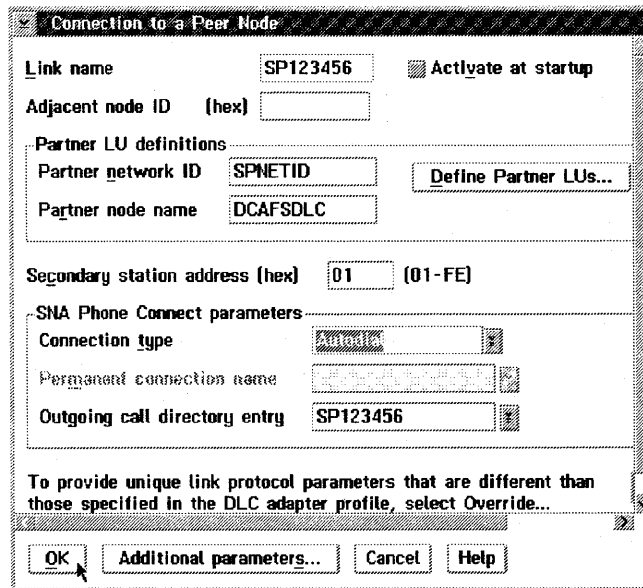

Step 20. Close the subsequent screens until you exit CS/2.

Step 21. See "Configuring DCAF for a Modem" on page 6-45 for installing a target service processor in DCAF.

Configuring DCAF for a Modem

Step 1. From Desktop Manager, double-click the **Distributed Console Access Facility** icon.

Step 2. Double-click the  icon.

Step 3. Select **Session** then **Open workstation directory**.

Step 4. Click **OK** for a first installation. Otherwise continue with next step.

Step 5. In the DCAF Directory window, select **Workstation** then **Add**.

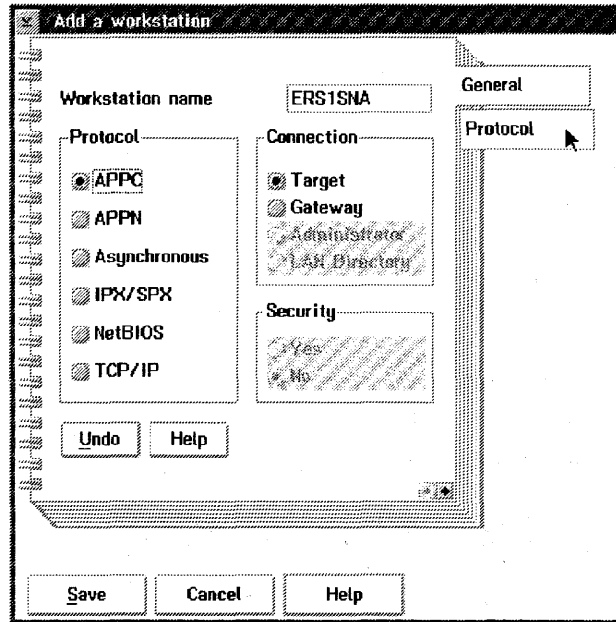

Step 6. Enter a name in the **Workstation name** field and click **Protocol**.

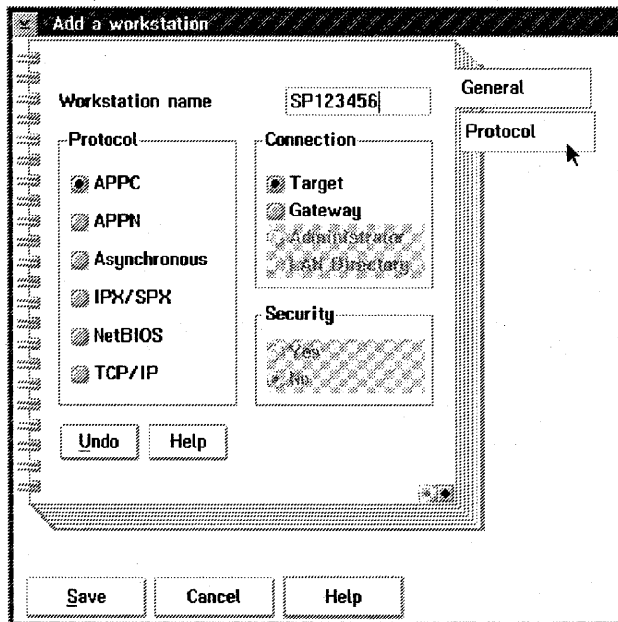

Step 7. Fill in the **Local LU alias** field, the **Partner LU alias** field (refer to Table 6-1 on page 6-2).

Enter DCAFMODE in the **Mode name** field.

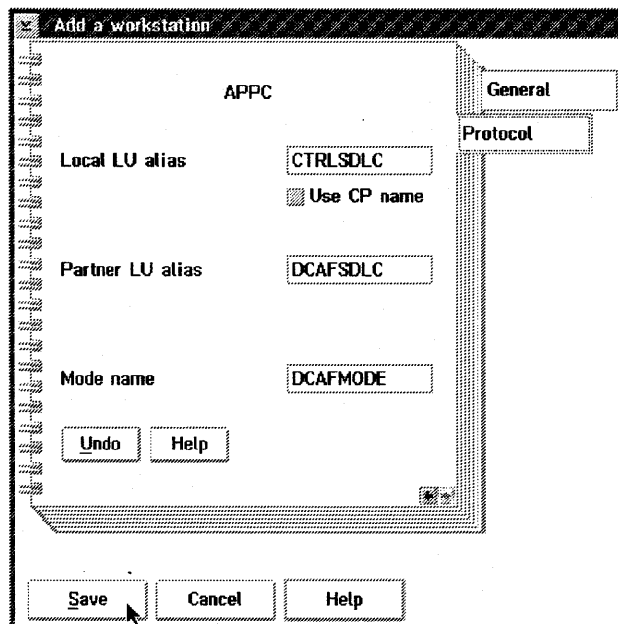

Step 8. Click **Save** and **Cancel**. The new workstation icon appears in the DCAF Directory window.

Step 9. From Desktop Manager, shutdown and restart the workstation.

Step 10. The installation is complete. Go to Chapter 3, "Using DCAF to Remotely Log On to the Service Processor" for using this new DCAF session.

Chapter 7. SNA-Attached Remote Workstation

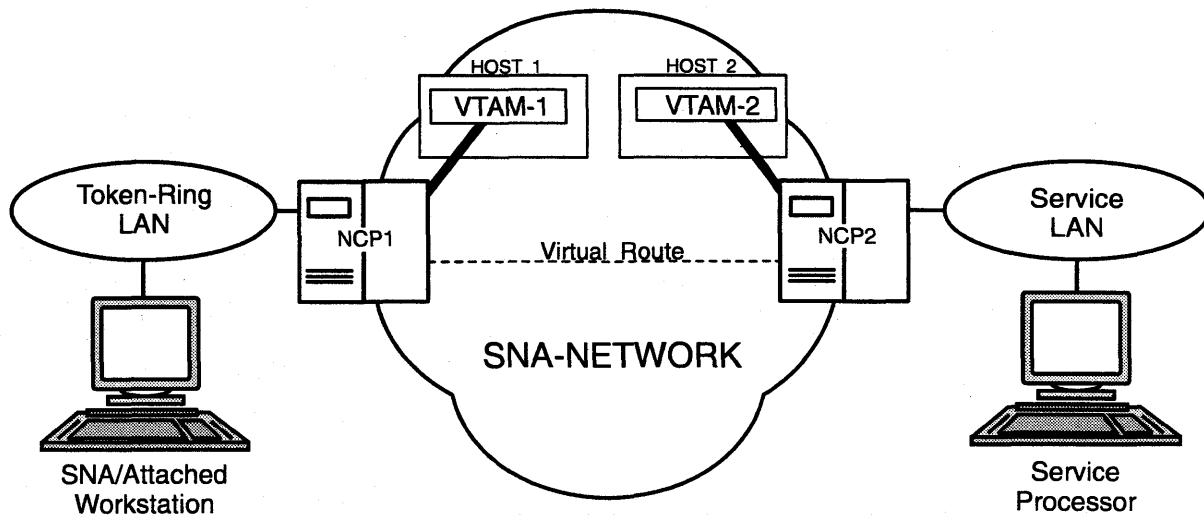

Figure 7-1. SNA-Attached Remote Workstation

This chapter shows you how to configure a DCAF session for controlling the service processor (see Figure 7-1).

— If you have more than one target service processor —

You must respect the parameter value matching rules given in Appendix A, "Configuration for a Two-Target Remote Workstation."

Configuring a Target Service Processor

— Important —

You can use the worksheets in the *Planning Guide*, GA33-0457 to record the necessary parameter values described in this section.

This section describes:

- How to configure the MOSS-E for a DCAF link to the communication controller.
- Which MOSS-E parameters to record for use in the controlling workstation.

Parameter Values that Must Be the Same

Table 7-1 gives the sets of MOSS-E parameters that must have the same value in both the remote workstation and the target service processor.

In Service Processor	In Remote Workstation
Local Node Network ID (Figure 7-2 on page 7-3)	Partner network ID (Step 9 on page 7-8) and Network ID (Step 11 on page 7-9)
SDLC LU name (Figure 7-3 on page 7-4)	Partner node name (Step 9 on page 7-8) and LU name (Step 11 on page 7-9) and Partner LU alias (Step 7 on page 7-12)
TIC2 or TIC3 LAA (Figure 7-2 on page 7-3)	LAN Destination address (Step 9 on page 7-8)
TIC3 RSAP (Figure 7-2 on page 7-3)	Remote SAP (Step 9 on page 7-8)

The configuration procedure in this chapter explains how to find these parameters in the remote workstation.

Configuring the Service Processor in MOSS-E

The following procedure explains how to find, record, and configure the service processor parameters:

- Step 1.** In the MOSS-E primary window, double click the **Service Processor object**.
- Step 2.** Click **Configuration Management**.
- Step 3.** Double click **SP customization**.

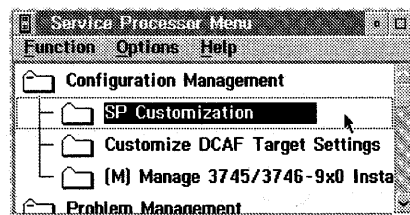

Step 4. Select **Enable DCAF Link/Operations** and select **View Customize** for it and **NetView Link/Operations**.

	View Customize
Customer Information	<input type="checkbox"/>
SP Time and Date	<input type="checkbox"/>
Service LAN Addresses	<input type="checkbox"/>
NetView Link/Operations	<input checked="" type="checkbox"/>
<input type="checkbox"/> Enable Retain Link/Operations	<input type="checkbox"/>
<input checked="" type="checkbox"/> Enable DCAF Link/Operations	<input checked="" type="checkbox"/>

Modem type: IBM 7855

Next>> Close Help

Step 5. Click **Next**.

Step 6. Record the values in the **Local Node Network ID**, **TIC2 or TIC3 LAA**, and **TIC3 RSAP** fields (see Figure 7-2 and refer to Table 7-1 on page 7-2).

NetView Link(s)/Reporting Customization

Generate alerts

NetView Link(s)

Link(s) through? SNA APPN

How many? 1 2

Link type? LAN SDLC

Machine Identification

Machine type	Model	Serial number
3745	61A	12 - 34567

Local Node Characteristics

Network ID	Local node name
SPNETID	MOSSNMVT

LAN Link

TIC2 or TIC3 LAA: 400000502080 hex

TIC3 RSAP: hexadecimal [04-9C]

Customize 3270 sessions? Yes No

Switched SDLC Link Telephone Number

0492112233

<<Previous Next>> Help

Figure 7-2. NetView Link/Reporting Customization

Step 7. Click **Next**.

Step 8. Record the value in the **SNA LU name** and **SNA Destination address** fields (refer to Table 7-1 on page 7-2). They are used in 9 on page 7-8.

	LU name	Destination address (hexadecimal)	RSAP (hex [04-9C])
<input checked="" type="checkbox"/> SNA	DCAFSNA	400000502080	<input checked="" type="checkbox"/>
<input checked="" type="checkbox"/> APPN	DCAFAPPN	400000502080	<input checked="" type="checkbox"/>
<input checked="" type="checkbox"/> LAN	DCAF LAN		

SDLC Attached Console

<input checked="" type="checkbox"/> SDLC	DCAFSDLC
--	----------

Accept any incoming calls on SP? Yes No

Local phone number: 18-9900

<<Previous Next>> Help

Figure 7-3. DCAF Customization

Step 9. The configuration is finished. From Desktop Manager, shutdown and restart the service processor.

Step 10. Go to "Configuring a SNA-Attached Remote Workstation" on page 7-5.

Configuring a SNA-Attached Remote Workstation

The following procedure shows you how to establish a link between the controlling workstation and the target service processor.

Configuring CS/2

Important

The procedure below is the same in CM/2 unless otherwise indicated.

Step 1. Perform Steps 1 to 5 on page 5-5.

Step 2. Select **DLC - Token-ring or other LAN types** and click **Configure**.

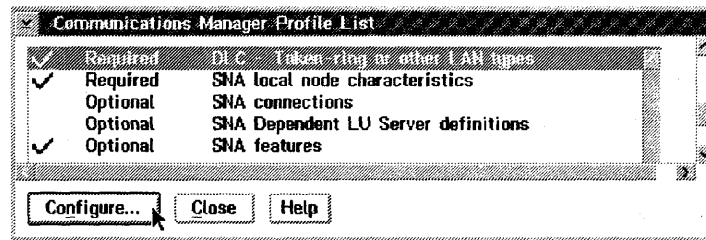

Step 3. Select **Free unused links** (in CM/2, select **Free unused links** and click **OK**). From the **Additional Parameters** list, highlight and check the following, using the **Change** button.

- Select **HPR parameters** and de-select **HPR support**.
- Check that the defaults apply to **Link station protocol parameters**, **Network management parameters**, and **Resource parameters**.

Then click **OK**.

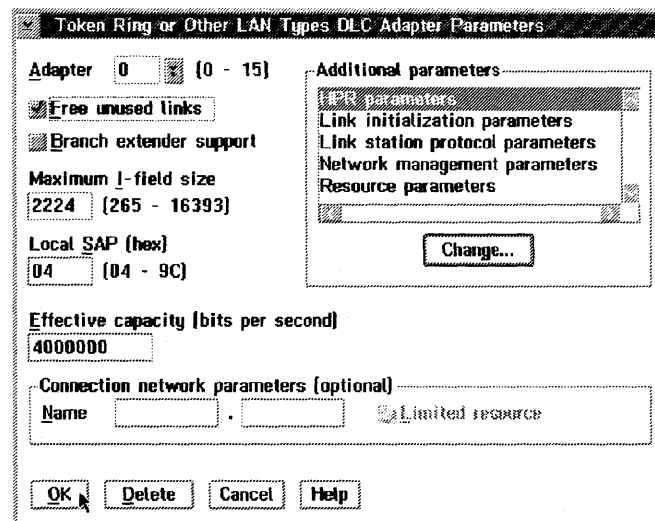

Step 4. Select SNA local node characteristics and click Configure.

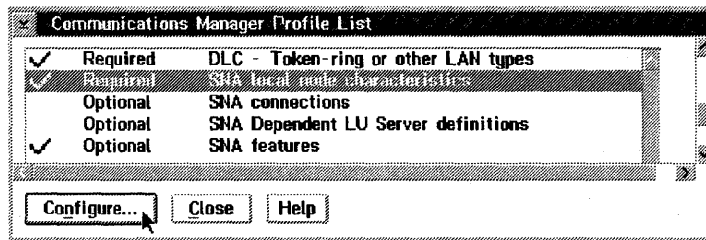

Step 5. Fill in the Network ID and Local node name fields, select End node and click OK.

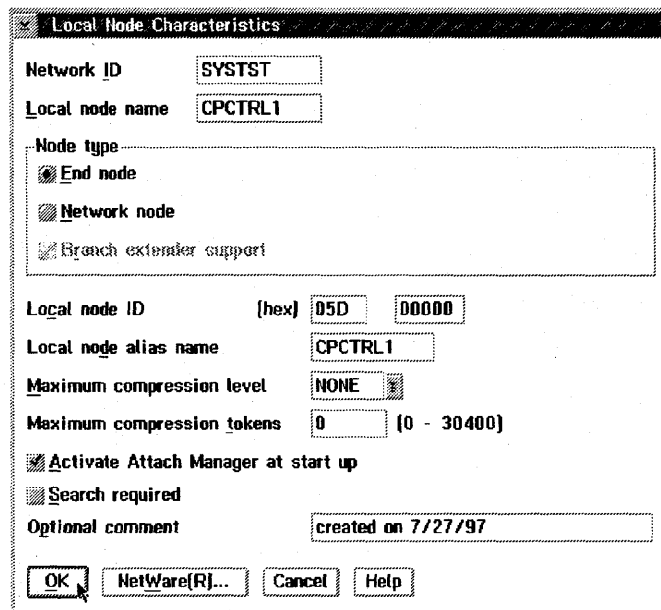

Step 6. Select SNA connections and click Configure.

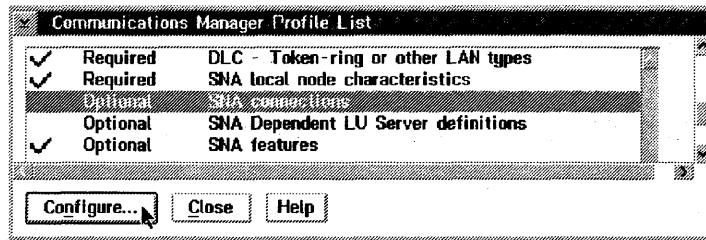

Step 7. Click To peer node, select DCAFSNA from the list and click Change.

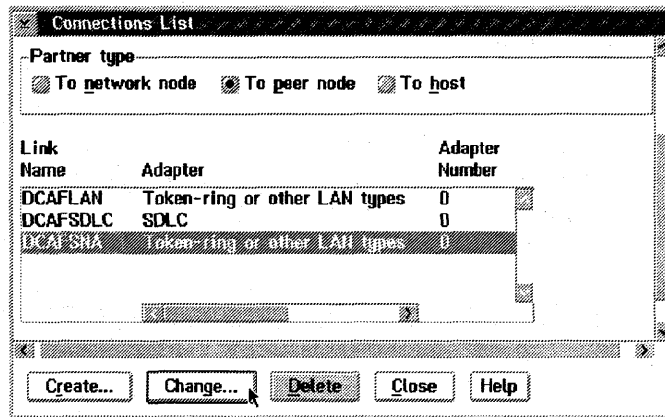

Step 8. Select Token-ring or other LAN types and click Continue.

Adapter List

Select the local adapter to be used for this connection.

Adapter Type

All types

Ethernet (ETHERAND) network

PC Network

Twinaxial

SDLC

SDLC multipoint primary server

Configured Yes

Adapter number 0 (0 - 15) Configure DLC...

Continue... Cancel Help

Step 9. Referring to Table 7-1 on page 7-2, fill in the Partner network ID, (the network that contains the target processor) Partner node name, LAN destination address (the MAC address of the target service processor), and Remote SAP fields.

Connection to a Peer Node

Link name DCAFSNA Activate at startup

Adjacent node ID (hex) 00000000

Partner LU definitions

Partner network ID SPNETID Define Partner LUs...

Partner node name DCAFSNA

Destination information for peer node

LAN destination address (hex) 400000502080 Address format Remote SAP (hex)

Token-Ring 08

To provide unique link protocol parameters that are different than those specified in the DLC adapter profile, select Override... Override...

OK Additional parameters... Cancel Help

Step 10. Click Define Partner LUs.

Step 11. Referring to Table 7-1 on page 7-2, fill in the **Network ID** and **LU name** (the service processor LU name) fields.

Fill in the **Alias** field.

Partner LUs

To add a Partner LU, enter the LU name, alias, and comment. Then select Add.

To change a Partner LU, select an LU from the list, change the LU name, alias, and/or comment fields and select Change.

To delete a Partner LU, select an LU from the list and select Delete.

Network ID	LU name	Alias
SYSTST	SYSTST.DCAFSNA	DCAFSNA

LU name: DCAFSNA
Alias: DCAFSNA

Dependent partner LU
 Partner LU is dependent
Uninterpreted name: []

Optional comment: []

[Add] [Change] [Delete] [OK] [Cancel] [Help]

Step 12. Click **Add** and **OK**.

Step 13. Click **OK** on the intermediate window and **Close**.

Step 14. Select **SNA features** and click **Configure**.

Communications Manager Profile List

<input checked="" type="checkbox"/>	Required	DLC - Token-ring or other LAN types
<input checked="" type="checkbox"/>	Required	SNA local node characteristics
<input type="checkbox"/>	Optional	SNA connections
<input type="checkbox"/>	Optional	SNA Dependent LU Server definitions
<input checked="" type="checkbox"/>	Optional	SNA features

[Configure...] [Close] [Help]

Step 15. Select **Local LUs**, **CTRLSNA** and click **Change**.

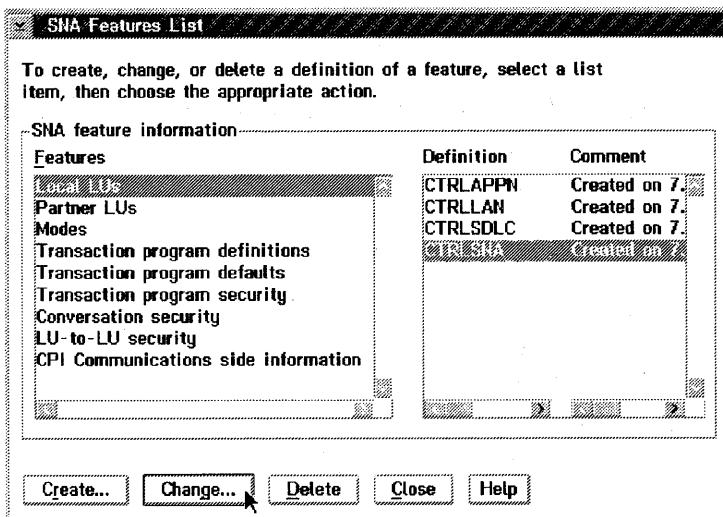

Step 16. Fill in the **LU name** and **Alias** fields, select **use this local LU as your default local LU alias** and click **OK**.

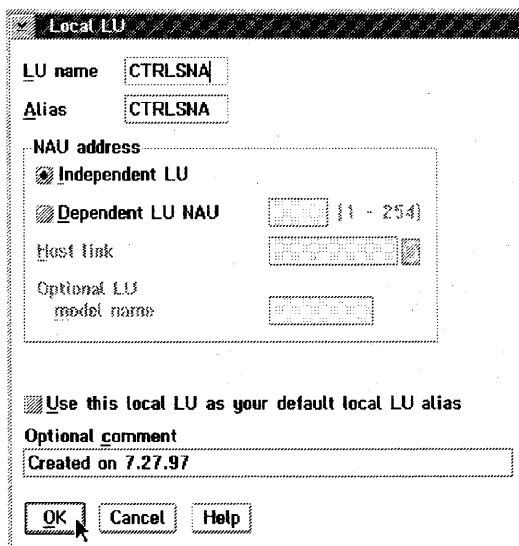

Step 17. Click **Close** on each subsequent screen until you exit CS/2.

Step 18. Continue with "Configuring DCAF for SNA."

Configuring DCAF for SNA

Step 1. From Desktop Manager, double-click the **Distributed Console Access Facility** icon.

Step 2. Double-click the  **DCAF Controller** icon.

Step 3. Click **Session** and **Open workstation directory**.

Step 4. Click **OK** for a first installation, otherwise continue with next step.

Step 5. Click Workstation, then Add.

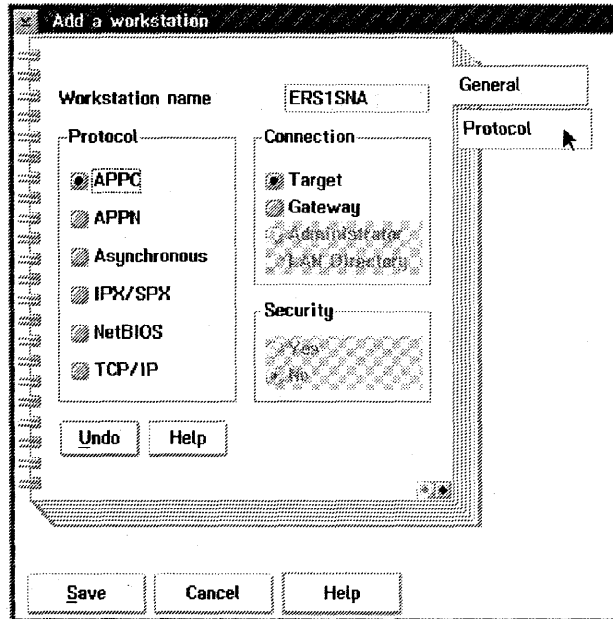

Step 6. Fill in the Workstation name field (see Step 16 on page 7-10), select APPC, Target, and click Protocol.

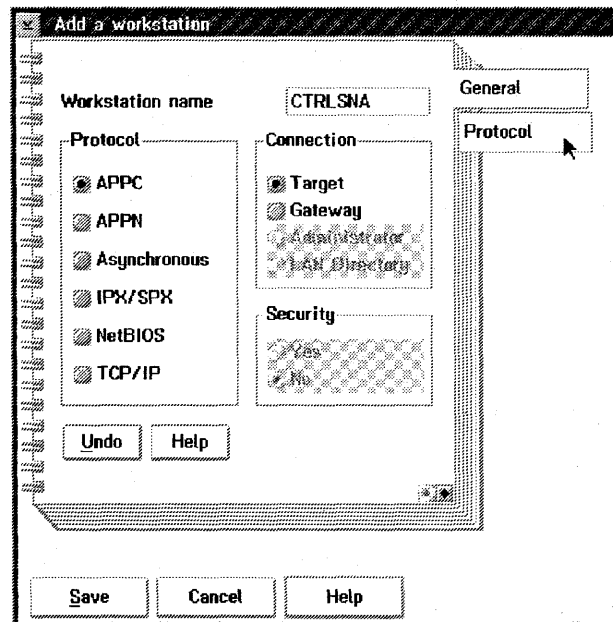

Step 7. Fill in the **Local LU alias** field, the **Partner LU alias** field (refer to Table 6-1 on page 6-2).

Enter DCAFMODE in the **Mode name** field.

The screenshot shows a dialog box titled "Add a workstation" for the "APPC" protocol. It contains three text input fields: "Local LU alias" (CTRLSNA), "Partner LU alias" (DCAFSNA), and "Mode name" (DCAFMODE). A checkbox labeled "Use CP name" is checked. On the right side, there are two tabs: "General" (selected) and "Protocol". At the bottom of the dialog are buttons for "Undo", "Help", "Save", "Cancel", and "Help".

Step 8. Click **Save**, **OK** (on the subsequent window), and **Cancel**.

Step 9. From **Desktop Manager**, shutdown and restart the workstation.

NCP Definitions

The definitions in this section apply to NCP Version 6 Release 2.

All NCP generations attached to LUs that support LU 6.2 DCAF sessions must contain the following statement:

```
LUDRPOOL NUMILU=(any number > 0)
```

Remote Controlling Workstation

The following definitions apply to NCP1 between the controlling workstation LAN and the SNA network (see Figure 7-1 on page 7-1).

The address must be the same as defined in Step 9 on page 7-8.

1. Physical line and physical PU:

```

*-----*
* TIC3 BNN/INN:  PORT 2144                                     *
*-----*
K23C2144 LINE  ADDRESS=(2144,FULL),PORTADD=0,LOCADD=400000232144 *
                MAXTSL=16732,LSPRI=PU,PUTYPE=1,ANS=CONTINUE,   *
                ADAPTER=TIC3,TRSPPEED=16,TRANSFR=254           *
S23C2144 PU    ADDR=01,*                                       *
                INNPORT=YES                                     *

```

2. Logical group with at least one LINE/PU to be used by the service processor:

```

*****
*
* TIC3          GROUP L23G2144: LAN LOGICAL DEFINITIONS FOR 37CS *
*
*
*****
L23G2144 GROUP DIAL=YES,LNCTL=SDLC,TYPE=NCP,ECLTYPE=(LOGICAL,PER), *
                CALL=INOUT,PHYSRSC=S23C2144,                   *
                LINEAUT=YES,                                    *
                MAXPU=1,                                        *
                NPACOLL=NO,                                    *
                PUTYPE=2,                                       *
                RETRIES=(6,0,0,6)                               *
R23A0001 LINE
Z23A0001 PU

```

Target Service Processor

The following definitions apply to NCP2 between the service LAN and the SNA network (see Figure 7-1 on page 7-1).

1. Physical line and physical PU:

```

*-----*
* TIC3 BNN/INN:  PORT 2080 ATT TO CONTROLLER FF PORT 1092 - PHYSICAL *
*-----*
K50C2080 LINE  ADDRESS=(2080,FULL),PORTADD= 0 P ,LOCADD=400000502080,*
                MAXTSL=16732,LSPRI=PU,PUTYPE=1,ANS=CONTINUE,   *
                ADAPTER=TIC3,TRSPPEED=16,TRANSFR=254           *
S50C2080 PU    ADDR=01,*                                       *
                INNPORT=YES                                     *

```

2. Logical group with at least one LINE/PU to be used by the service processor:

```

*****
*
* TIC3          GROUP L78G2080: LAN LOGICAL DEFINITIONS FOR 37CS
*
*
*
*****
L50G2080  N  GROUP DIAL=YES, LNCTL=SDLC, TYPE=NCP, ECLTYPE=(LOGICAL, PER), *
          CALL=INOUT, PHYRSC=S50C2080,
          LINEAUT=YES,
          MAXPU=1,
          NPACOLL=NO,
          PUTYPE=2,
          RETRIES=(6,0,0,6)
R50A0001 LINE
Z50A0001 PU

```

VTAM Definitions

The VTAM* definitions in this section are for Version 3 Release 4.1.

Start Definitions

The following VTAM start definitions must be used in both VTAM1 and VTAM2, as shown in Figure 7-1 on page 7-1:

```

*
*          VTAM START DEFINITIONS
*
HOSTSA=10,SSCPID=10,MAXSUBA=63,
CONFIG=10,NETID= SYSTST  A ,SSCPNAME=CDRM12,

XNETALS=YES,DYNLU=YES,

NOPROMPT,DLRTCB=32,SUPP=NOSUP,NOTNSTAT,NOTRACE,TYPE=VTAM,
LPBUF=(120,,0,,60,60),      LARGE GENERAL PURPOSE _ PAGEABLE
LFBUF=(96,,0,,24,10),      LARGE GENERAL PURPOSE _ FIXED
SFBUF=(128,,0,,32,10),     SMALL GENERAL PURPOSE _ FIXED
CRPLBUF=(160,,13,,80,80),  RPL_COPY _ PAGEABLE
IOBUF=(256,256,34,,68,68)  I/O BUFFERS _ FIXED (NP & PP BUF REMOVED)

```

Logmode Table

The following VTAM logmode table must be used in both VTAM1 and VTAM2 as shown in Figure 7-1 on page 7-1:

```

SOCMOTAB M  MODETAB
DCAFMODE MODEENT LOGMODE=DCAFMODE I ,
        TYPE=0,
        FMPROF=X'13',
        TS_PROF=X'07',
        PRIPROT=X'B0',
        SECPROT=X'B0',
        COMPROT=X'50B1',
        SSNDPAC=X'08',
        SRCVPAC=X'08',
        RUSIZES=X'8787',
        PSNDPAC=X'08',
        PSERVIC=X'06020000000000000002F00'
        MODEEND
        END  SOCMOTAB

```

Major Node Definitions

Remote Workstation

The following VTAM major node definitions must be used in VTAM1 as shown in Figure 7-1 on page 7-1:

```

*****
*
*   MAJNODE FOR CONNECTION : Remote console <==> VTAM V3R4
*
*
*
*****
NTVCTRL  VBUILD TYPE=SWNET,MAXGRP=1,MAXNO=1
-----*
CTRL     PU     ADDR=04,PUTYPE=2,NETID=SYSTST E ,CPNAME=CPCTRL F X
          MAXPATH=8,MAXDATA=265,MAXOUT=1, X
          DISCNT=NO,
CTRL1    LU     LOCADDR=0,MODETAB=SOCMOTAB M

```

Target Service Processor

The following VTAM major node definitions must be used in VTAM-2, shown in Figure 7-1 on page 7-1:

```

*****
*
*   MAJNODE FOR CONNECTION : MOSS-E <==> VTAM V3R4
*
*
*
*****
NTVMOSSE VBUILD TYPE=SWNET,MAXGRP=1,MAXNO=1
-----*
MOSSE    PU     ADDR=04,PUTYPE=2,NETID= SYSTST A ,CPNAME= MOSSNMVT X C
          MAXPATH=8,MAXDATA=265,MAXOUT=1, X
          DISCNT=NO,
PATHMOSS PATH  DIALNO= P 00 04 400000000007 D ,GRPNM=L50G2080 N
          DCAFSA B LU LOCADDR=0,MODETAB=SOCMOTAB M

```



Chapter 8. APPN-Attached Remote Workstation

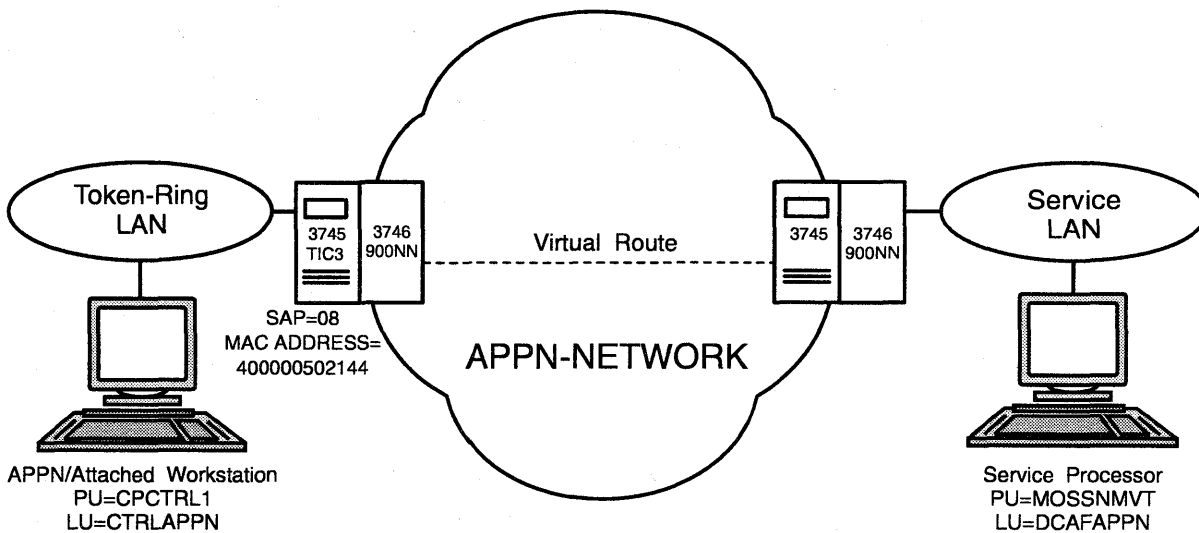

Figure 8-1. APPN Remote Workstation

This chapter shows you how to configure a DCAF session for controlling the service processor (see Figure 8-1 above).

If you have more than one target service processor

You must respect the parameter value matching rules in Appendix A, "Configuration for a Two-Target Remote Workstation."

Configuring a Target Service Processor

Important

You can use the worksheets in the *Planning Guide*, GA33-0457 to record the necessary parameter values described in this section.

This section describes:

- How to configure the MOSS-E for a DCAF link to the communication controller
- Which MOSS-E parameters to record for use in the controlling workstation.

Parameter Values that Must Be the Same

Table 8-1 gives the sets of MOSS-E parameters that must have the same value in both the remote workstation and the target service processor.

<i>Table 8-1. Identical Target and Controlling Parameters</i>	
In Service Processor	In Remote Workstation
APPN LU name (Figure 8-2 on page 8-3)	LU name (Step 11 on page 8-7)
APPN Destination address (Figure 8-2 on page 8-3)	LAN Destination address (Step 11 on page 8-7)
RSAP (Figure 8-2 on page 8-3)	Remote SAP (Step 11 on page 8-7)

The configuration procedure in this chapter explains how to find these parameters in the remote workstation.

Configuring the Service Processor in MOSS-E

The following procedure explains how to find, record, and configure the service processor parameters:

- Step 1.** In the MOSS-E primary window, double click the **Service Processor object**.
- Step 2.** Click **Configuration Management**.
- Step 3.** Double click **SP customization**.

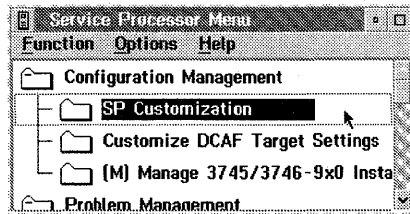

Step 4. Select **Enable DCAF Link/Operations** and select **View Customize**.

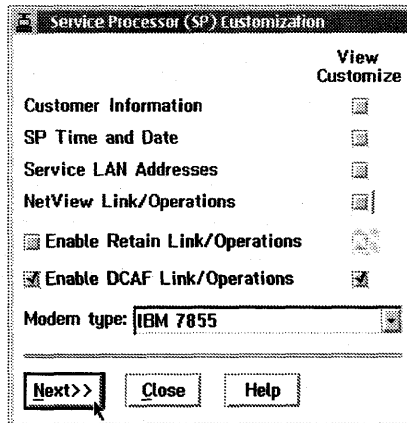

Step 5. Click **Next**.

Step 6. Record the value in the **APPN LU name** and **APPN Destination address** fields (refer to Table 8-1 on page 8-2). They are used in Step 11 on page 8-7.

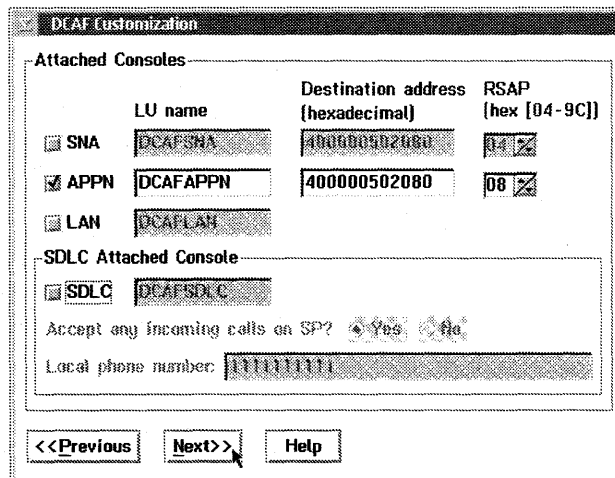

Figure 8-2. DCAF Customization

Step 7. From Desktop Manager, shutdown and restart the service processor.

Step 8. The MOSS-E configuration is finished. Go to "Configuring an APPN-Attached Remote Workstation" on page 8-4.

Configuring an APPN-Attached Remote Workstation

The following procedure shows you how to establish a link between a controlling workstation and the target service processor.

Configuring CS/2

Important

The procedure below is the same in CM/2 unless otherwise indicated.

Step 1. Perform steps 1 to 5 on page 5-5

Step 2. Select **DLC - Token-ring or other LAN types** and click **Configure**.

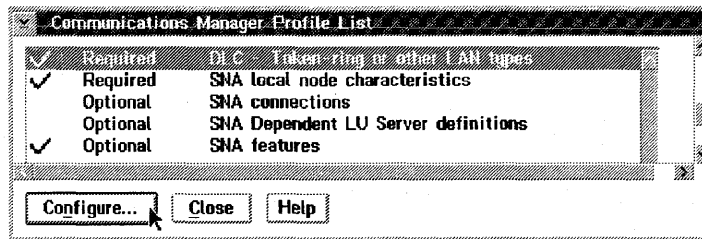

Step 3. Select **Free unused links** (in CM/2, select **Free unused links** and click **OK**). From the **Additional Parameters** list, highlight and check the following using the **Change** button.

- Select **HPR parameters** and de-select **HPR support**.
- Check that the defaults apply to **Link station protocol parameters**, **Network management parameters**, and **Resource parameters**.

Then click **OK**.

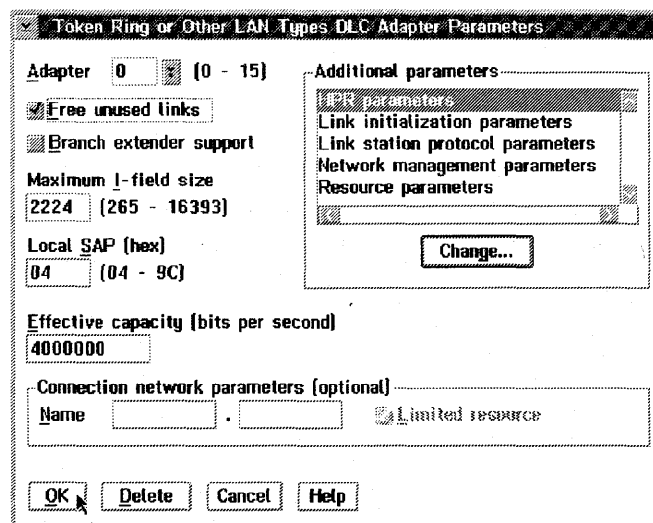

Step 4. Select **SNA local node characteristics** and click **Configure**.

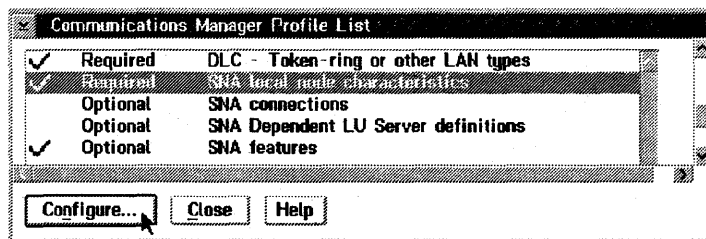

Step 5. Enter SPNETID in the **Local Node Network ID** field.

Step 6. Enter the name that you are using for the **Local node name** in its field.

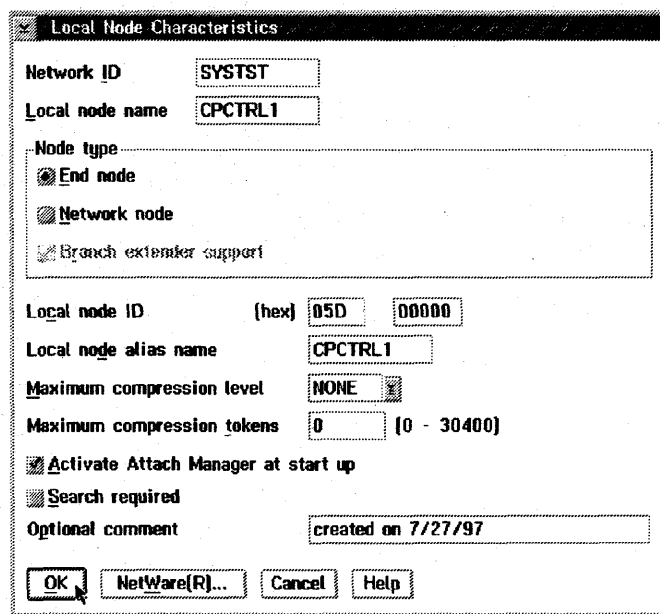

Step 7. Select **End node** and click **OK**.

Step 8. Select SNA connections and click Configure.

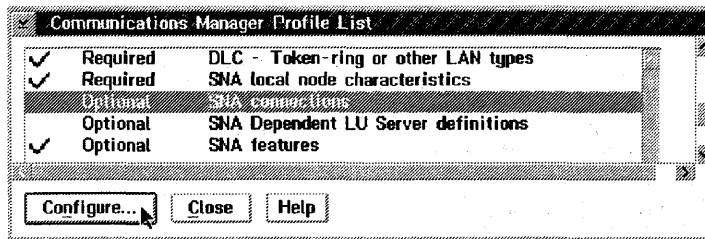

Step 9. Select To network node, DCAFAPPN in the Link name list, and click Change.

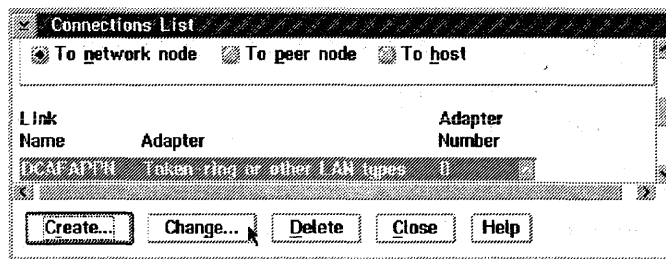

Step 10. Select Token-ring or other LAN types and click Continue.

Adapter List

Select the local adapter to be used for this connection.

Adapter Type

Token-ring or other LAN types
Ethernet (ETHERAND) network
PC Network
Twinaxial
SDLC
SDLC multipoint primary server

Configured Yes

Adapter number 0 (0-15) Configure DLC...

Continue... Cancel Help

Step 11. Referring to Table 8-1 on page 8-2, fill in the Link name, LAN destination address, and Remote SAP fields.

Connection to a Network Node

Link name DCAFAPPN Activate at startup

Adjacent node ID (hex) 00000000

Partner LU definitions

Partner network ID SPNETID Define Partner LUs...

Partner node name DCAFAPPN

Destination information for network node

LAN destination address (hex) 400000502080 Address format Token-Ring Remote SAP (hex) 08

To provide unique link protocol parameters that are different than those specified in the DLC adapter profile, select Override... Override...

OK Additional parameters... Cancel Help

Step 12. Click OK.

Step 13. Click Close on the intermediate window.

Step 14. Select SNA features and click Configure.

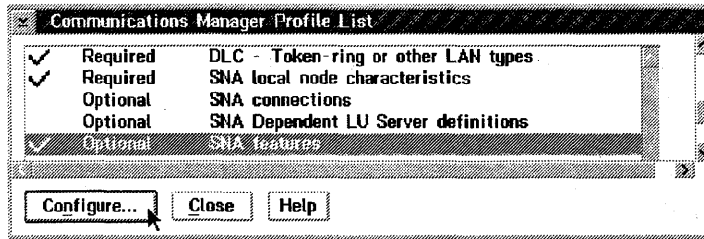

Step 15. Select Local LUs in the Features list, CTRLAPPN in the Definition list, and click Change.

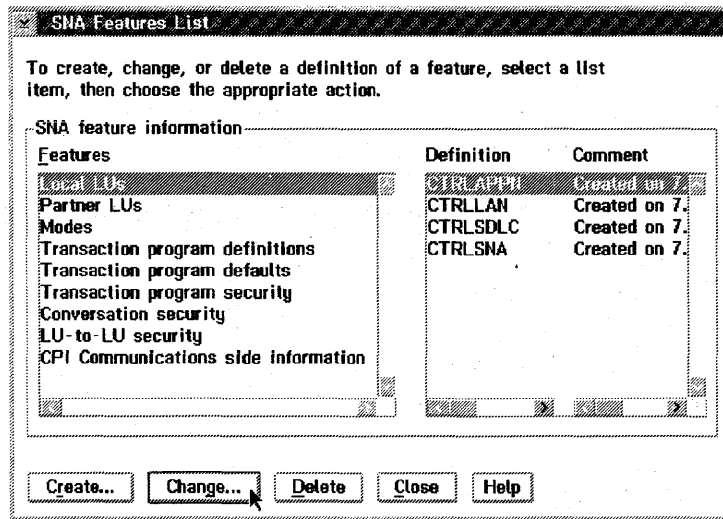

Step 16. Modify the **LU name** and **Alias** fields and select **use this local LU as default local LU alias**. Then select **Independent LU** and click **OK**.

Local LU

LU name: CTRLAPPN

Alias: CTRLAPPN

NAU address

Independent LU

Dependent LU NAU [1 - 254]

Host link: []

Optional LU model name: []

Use this local LU as your default local LU alias

Optional comment: Created on 7.27.97

OK Cancel Help

Step 17. Select **Modes** and verify that **DCAFMODE** is in the **Definition** list. If you do not find **DCAFMODE**, add it to the list with the **Create** button.

Step 18. Select **Transaction program definitions** from the **SNA Features List** and click **Create**.

Step 19. Enter the command line in the **Transaction program (TP) name** field, the path of the DCAF directory in the **OS/2 program path and file name** field, and click **Continue**.

Transaction Program Definition

Transaction program definition

Service TP

Transaction program (TP) name: IBM.DCAF.CONTROLLING.TRANSACTION.PROG

OS/2 program path and file name: C:\DCAF13\EONCTRAM.EXE

Optional comment: []

Optional values

Program Initialization Parameter (PIP) allowed

Conversation security required

Program parameter string: LU62

Icon path and file name: []

Continue... Cancel Help

Step 20. Click **Close** on the subsequent screens until you exit CS/2.

Step 21. Continue with "Configuring DCAF for APPN" on page 8-10.

Configuring DCAF for APPN

Step 1. From **Desktop Manager**, double-click the **Distributed Console Access Facility** icon.

Step 2. Double-click the  **DCAF Controller** icon.

Step 3. Click **Session**, then **Open workstation directory**.

Step 4. Click **OK** for a first installation. Otherwise continue with next step.

Step 5. From the DCAF Directory window, click **Workstation**, then on **Add**.

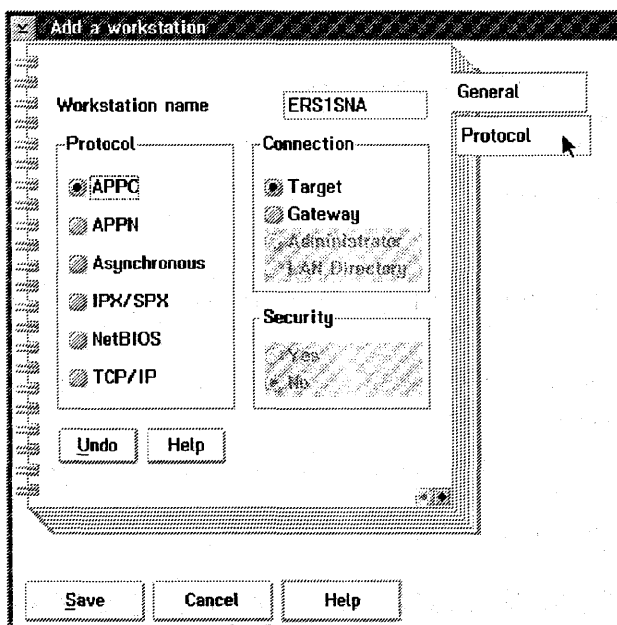

Step 6. Fill in the **Workstation name** field, select **APPN, Target**, and click **Protocol**.

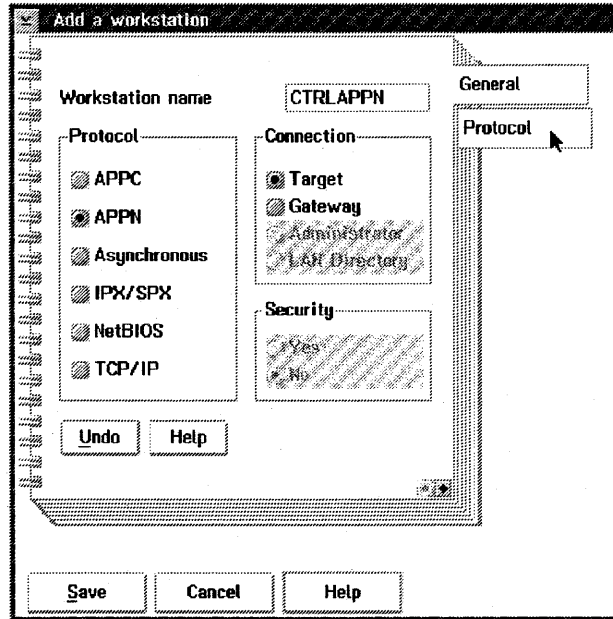

Step 7. Fill in the **Local LU alias** (see Step 16 on page 8-9), and the **Fully qualified PLU**:

- a. First part matches the **Local Node Network ID** in Step 5 on page 8-5
- b. Second part matches the **APPN LU name** in Figure 8-2 on page 8-3.

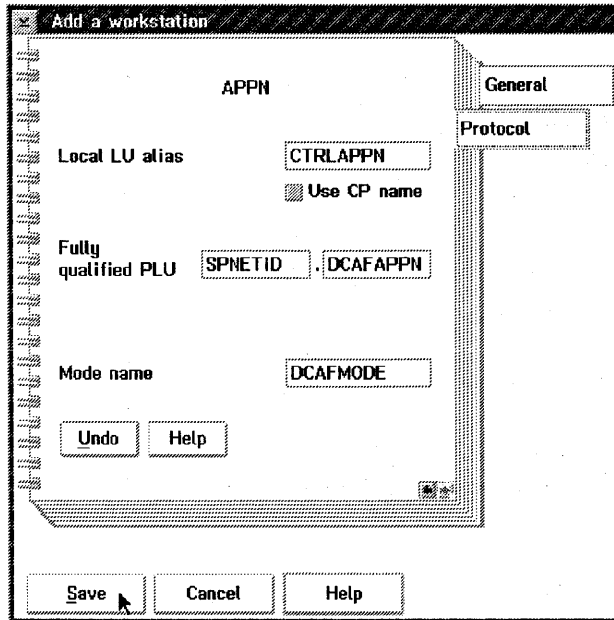

Step 8. Enter DCAFMODE in the **Mode name** fields.

Step 9. Click **Save, OK** (on the subsequent window), and then **Cancel**.

Step 10. In **Desktop Manager**, shutdown and restart the workstation.

Step 11. The configuration is now complete. Go to Chapter 3, "Using DCAF to Remotely Log On to the Service Processor" for working with your remote workstation.

Chapter 9. Telnet-attached Remote Workstation

Introduction

Any workstation that runs the Telnet Client program can remotely access the IP functions of a Network Node Processor (NNP). You can Telnet on a remote workstation to configure and manage IP functions without disturbing the operations of the service processor.

However, when using Telnet:

- You cannot access the MOSS-E functions
- Only one remote workstation can access a NNP at a time.

Any remote workstation can access a NNP via Telnet.

Notes:

TCP/IP and Telnet Client programs are separate products from IBM applications for Communication Controllers. See the documentation that comes with these products for information on installation procedures.

Consoles

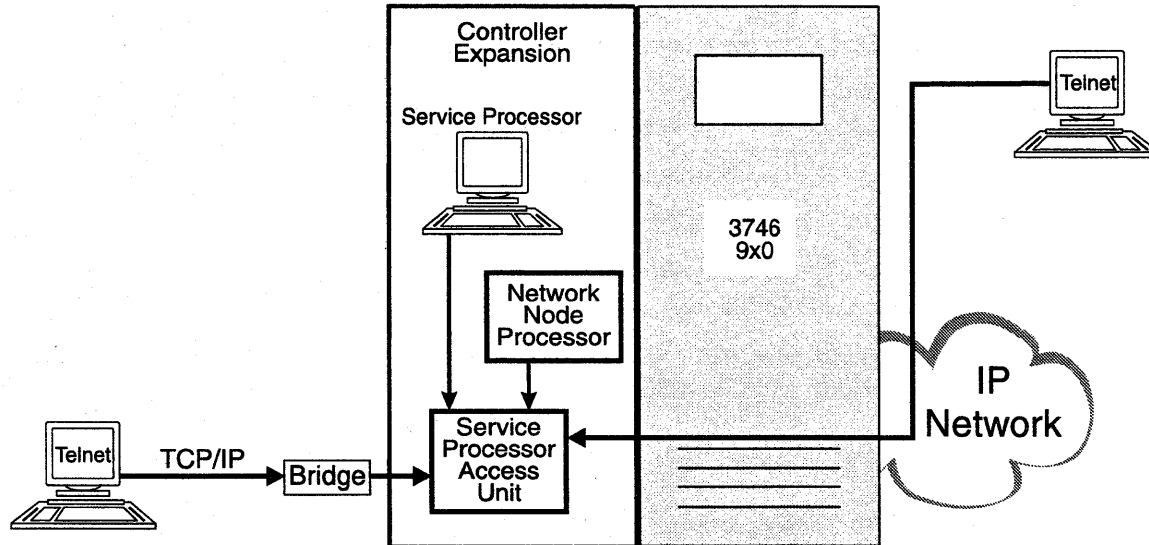

Figure 9-1. Telnet Workstation Configuration

A Telnet remote console can be attached to the service LAN (the Service Processor Access Unit in Figure 9-1) via a bridge with appropriate filtering, or via an IP network using resources controlled by the target Network Node Processor (NNP). See Figure 9-1 above.

These workstation attachments can be through either:

- LAN (Token-ring, Ethernet)
- WAN links (Frame-relay, Point-to-Point Protocol).

Logon Password

Telnet passwords are defined for access to the service processor during the installation of the NNP. If you have problems, see your network administrator.

Programming Requirements

For remote access to the functions of a NNP, your workstation must have an operating system (OS/2, for example) that can run TCP/IP.

Hardware Requirements and Recommendations

Any remote workstation can be used that supports IP and runs the Telnet Client program.

Installation

Before you begin the installation procedure for the network node processor, make sure that your workstation can run TCP/IP.

For installing or upgrading the TCP/IP application including the Telnet Client program, refer to the TCP/IP installation guide that comes with the product.

Using Telnet to Remotely Log On to the Network Node Processor

Starting a Session

- Step 1.** Open an operating system window (OS/2, for example).
- Step 2.** On the command line, type `telnet` followed by the IP address or nickname of the network node processor.
- Step 3.** Enter the Telnet password. The Telnet user session starts automatically.
- Step 4.** Enter one of the following:
 - T 6 to configure
 - T 5 to manage.

For more information, refer to the *3745 Communication Controller Models A, 3746 Nways Multiprotocol Controller Model 900: Basic Operations Guide, SA33-0177*.

Closing a Session

To close the session, press  and  together.

Part 2. 3745 Models 130 to 610



Chapter 10. Setting Up a Local or an Alternate Console

This chapter applies to **3745 Models 130 to 610**. It does not apply to **Model A**.

General Information on Local or Alternate consoles

A local console is required, while an alternate console is optional. You can use any of the following:

- An IBM 3151 Display Station (Models 110, 160, 310, 360, 410, or 460) in native mode (recommended) or in IBM 3101 emulation mode.

Note: Models which do not support block mode cannot be used as consoles for the IBM 3745 Communication Controller.

- An IBM 3153 Display Station in IBM 3151 emulation mode.
- An IBM 3161 ASCII Display Station (Model 11, 12, 21, or 22) in IBM 3101 emulation mode.
- An IBM 3163 ASCII Display Station (Model 11, 12, 21, or 22) in IBM 3101 emulation mode (feature code 8235).
- An IBM PS/2, running OS/2 Extended Edition, Release 1.1 or higher.
- An IBM 3727 Operator Console with adhesive keypad labels (part number 03F7773), or any equipment providing equivalent functions (including cable and keyboard).

Check your console cables (for more information, refer to Appendix C in this manual, and the *Technical News Letter*, GN22-5490 part of *Input/Output Equipment Installation Manual - Physical Planning*, GN22-5490).

If a cable or console does not work correctly, contact your installation coordinator.

Notes:

1. Consoles can be shared by an IBM 7427 Console Switching Unit. A maximum of four IBM 3745 or IBM 3725 Communication Controllers can share a local console. The maximum distance is 7 meters (23 feet). A maximum of six 3745 or 3725 Communication Controllers can share an alternate console. The maximum distance is 122 meters (400 feet).
2. If you set up certain consoles in an established system, you will need to reload MOSS (IML). Refer to the *Advanced Operations Guide*, SA33-0097.

3151 in Native Mode (Local or Alternate)

Notes:

1. **Native mode is the recommended mode of operation.**
2. The 3151 Model 110 can only be used in native mode because it does not support 3101 emulation.
3. The MOSS function keys are PF1 through PF8.
4. The line **not Model 110** does not appear on the Model 110 menu.

Setting Up

1. Hold down the Ctrl key (bottom left) and press the Setup key (top right) to display the Setup menu.

Note: If the 3151 is new, the Setup menu appears automatically when you power ON.

2. Fill in the fields as follows, using the ↑ and ↓ keys to move between items and the spacebar to select the parameter values:

Machine Mode	IBM3151
Screen	NORMAL
Row and Column	24 X 80
Scroll	JUMP
Auto LF	ON
CRT Saver	OFF
Line Wrap	ON
Forcing Insert	OFF
Tab	FIELD

3. Press Send for the next menu.
4. Open the Setup Menu and fill in the fields as follows:

Operating Mode	BLOCK
Line Speed (bps)	2400
Word Length (bits)	7
Parity	EVEN
Stop Bit	1
Turnaround Character	DC3
Line Control	PRTS
Break Signal (ms)	500
Send Null Suppress	ON

5. Press Send.

6. Open the Keyboard/Printer Menu and fill in the fields as follows:

Keyboard

Enter	RETURN (not Model 110)
Return	FIELD
New line	CR
Send	PAGE
Insert character	MODE

Printer

Line speed	2400
Word length (bits)	7
Parity	EVEN
Stop bit	1
Characters	NATIONAL (not Model 110)

7. Press Enter.
8. Use the arrow keys to highlight **Save data**.
9. Press the spacebar to save the configuration.
10. Hold down the Ctrl key (bottom left) and press the Setup key (top right) to return.
11. Go to "Testing a Connection with the Local or Alternate Console" on page 10-10 and check the connection to the 3745.

3151 in 3101 Emulation Mode (Local or Alternate)

Notes:

1. **Native mode is the recommended mode of operation.**
2. The 3151 Model 110 must be used in native mode because it does not support 3101 emulation.
3. The line **not Model 110** does not appear on the Model 110 menu.

Setting Up

1. Hold down the Ctrl key (bottom left) and press the Setup key (top right) to obtain the Setup display.

Note: If the 3151 is new, Setup displays automatically when you turn the power ON.

2. Fill in the fields as follows, using the ↑ and ↓ keys to move between items and the spacebar to select the parameter values:

Machine Mode	IBM3101
Screen	NORMAL
Row and Column	24 X 80
Scroll	NO
Auto LF	ON
CRT Saver	OFF
Line Wrap	ON
Forcing Insert	OFF
Tab	FIELD

3. Press Send for the next menu.

4. Open the Setup Menu and enter the following:

Operating Mode	BLOCK
Line Speed (bps)	2400
Word Length (bits)	7
Parity	EVEN
Stop Bit	1
Turnaround Character	DC3
Line Control	PRTS
Break Signal (ms)	500
Send Null Suppress	ON
Pacing	OFF

(Pacing is set to ON in native mode)

5. Open the Keyboard/Printer Menu and enter the following:

Keyboard

Enter	RETURN (not Model 110)
Return	FIELD
New line	CR
Send	PAGE
Insert character	MODE

Printer

Line speed	2400
Word length (bits)	7
Parity	EVEN
Stop bit	1
Characters	NATIONAL (not Model 110)

6. Press Enter.
7. Use the arrow keys to highlight **Save data**.
8. Press the spacebar to save the configuration.
9. Hold down the Ctrl key (bottom left) and press the Setup key (top right) to return.
10. Go to "Testing a Connection with the Local or Alternate Console" on page 10-10 and check the connection to the 3745.

3153 in 3151 Emulation Mode (Local or Alternate)

Recommended Settings

Refer to the *Users Guide*, SA33-0356 for information on console settings in the country where you reside.

Starting the Console Configuration

To start the Setup menu, hold down **Ctrl** and press **Minus** on the numeric keypad.

Key F1 (QUICK)

Emulation=3151	EIA Baud Rate=2400	EIA Data Format=7/1/E
Enhanced=OFF N/A	AUX Baud Rate=2400	Aux Data Format=7/1/E
Comm Mode=FULL BLOCK	Language=US	Sessions=ONE
Host/Printer=EIA/AUX		

Key F2 (GENERAL)

Emulation=3151	Enhanced=OFF N/A	Auto Wrap=ON
Curs Dir= LEFT TO RIGHT	Auto Scroll=ON	Monitor Mode=OFF
Screen Saver=OFF	Bell Vol=06	Warning Bell=ON
Bell Length=140ms	Setup Lang=US	Sessions=ONE

Key F3 (DISPLAY)

Display Cursor=ON	Cursor=STEADY BLOCK	Viewports=ONE
Pages=01	Page Length=24	Screen Video=NORMAL
Columns=80	Scroll=JUMP	Overscan Borders=ON
Width Change Clear=OFF	Speed=FAST	Refresh Rate=71 HZ

Key F4 (KEYBOARD)

Language=US	Char Set=NATIONAL	Key Mode=ASCII
Keyclick=OFF	Key Repeat=ON	Key Rate=20 CPS
Margin Bell=OFF	Key Lock=CAPS	Caps Lock=TOGGLE
Num Lock=TOGGLE		

Key F5 (KEYS)

Return Key=field	Enter Key=RETURN	New Line=CR
Send Key=PAGE	Insert Character=MODE	Backspace=BS BS
Desk Acc=ctrl <-	Pound Key=US	Return Key REPEAT=OFF
UDKS=EMUL DEPENDENT		

Key F6 (PORTS)

EIA Baud Rate=2400	EIA Data Format=7/1/E	EIA Parity Check=off
AUX Baud Rate=2400	AUX Data Format=7/1/E	Aux Parity Check=off
EIA Xmt=Xon-Xoff	EIA Recv= Xon-Xoff(XPC)	EIA Xmt Pace= Baud
Aux Xmt=Xon-Xoff	Aux Recv= Xon-Xoff(XPC)	Aux Xmt Pace= Baud

Key F7 (HOST)

Comm Mode= FULL BLOCK	Local= OFF	Null Suppress=OFF
Break= 500MS	Line Control=PRTS	Disconnect=2 SEC
Recv <CR>=<CR><LF>	Recv =IGNORE	Send Ack=OFF
Alt Input DATA=ON	Turnaround Char=DC3	Send Null=ON

Leaving the Console Configuration

1. Press Ctrl and the Minus key on the numeric keypad.
 - Type Y to save the configuration.
 - Type N to cancel the new configuration or keep the previous one.
 - Type C to review the configuration.

3161 or 3163 (Local or Alternate)

1. Hold down the Ctrl key (bottom left) and press the Setup key (top right).
2. Fill in the fields as follows, using the ↑ and ↓ keys to move between items and the spacebar to select the parameter values:

Machine Mode	IBM3101
Operating Mode	BLOCK
Interface	RS232C
Line Control	PRTS
Line Speed (bps)	2400
Parity	EVEN
Turnaround Character	DC3
Stop Bit	1
Word Length (bits)	7 (3161 only)
Response Delay	100 (3161 only)
Break Signal (ms)	500 (3161 only)

3. Press Send.
4. Press Select.
5. Use the spacebar to enter as follows:

Scroll=OFF	Return=CR	Line Wrap=ON
AutoLf=ON	Send=PAGE	Null Supp=ON

6. Press Select to return.
7. Go to "Testing a Connection with the Local or Alternate Console" on page 10-10 for checking the connection to the 3745.

IBM PS/2 (Local or Alternate)

Note: To complete this procedure successfully, you must be running OS/2 Extended Edition, Version 1.1 or higher, at SYSLEVEL 03030 or higher. If you are not sure of the level, refer to Appendix A.

To configure a PS/2 as a local or alternate console, do the following:

1. Open an OS/2 screen.
2. Type CD \CMLIB at the prompt.
3. Type COPY ACSCFG.CFG MOSSL0C.CFG. at the prompt.

4. Edit CONFIG.SYS to add the following line:

```
DEVICE=C:\CMLIB\ASYNCCDB.SYS COM1
```

Notes:

a. If you are using a PC/AT* or a PC/XT* equipped with an 80286 microprocessor, use ASYNCCDDA.SYS instead of ASYNCCDB.SYS.

b. Open your CONFIG.SYS file and search for the line:

```
DEVICE=C:\OS2\COMxx.SYS (where xx = 01, 02, or 03)
```

If you find it, insert this line before it:

```
ASYNCCDB/A
```

5. Press Ctrl and Esc to go to Task Manager.

6. Select Start Programs to display the main menu.

7. Select Communication Manager (this takes ten seconds to load).

8. When the CMM Menu appears, go to the top of the screen and select **Advanced**.

9. Select **Configuration**.

10. Type MOSSL0C, then press **Enter**. The Communications Configuration menu displays.

11. Select **Workstation profile**.

12. Select **Change** and customize as follows:

Error log file name	ERROR.DAT (for example)
Error log size	16 (for example)
Error log overflow option	WRAP
Message log file name	MESSAGE.DAT (for example)
Message log size	500 (for example)
Message log overflow option	WRAP
Enable auto-start options	YES

13. Press **Enter** to go to the next screen, and continue with the Auto-Start Options:

- ACDI service
- ▶ ASCII terminal emulation
- 3270 terminal emulation (DFT)
- 3270 terminal emulation (SDLC)

Display this screen first:

- Communication Manager main menu
- ▶ ASCII Terminal Emulation
- 3270 Terminal Emulation

14. Press **Enter**. The message **The profile has been saved** displays.

15. Select **Asynchronous feature profiles**.

16. Select **Asynchronous communication port profile**.

17. Select **Create** and enter the following:

Country code xxx

(where xxx is your country code)

Profile name COM1

18. Press **Enter**, then select **Other modem or device**.

19. Press **Enter** and a window opens. Select **NON-SWITCHED**.

20. Press **Enter**. The message **The profile has been saved** displays.

21. Select **ASCII terminal emulation profiles**.

22. Select **ASCII terminal emulation profiles** again.

23. Select **Create**. Use model profile name **M6** and new profile name **MOSSL**.

24. Press **Enter**.

25. Customize the **MOSSL** profile as follows:

Communication port name COM1

(same as port profile name)

Emulation mode IBM 3101

Line speed 2400

Bits per character 7

Parity type EVEN

Number of stop bits 1

Local display NO

Auto return YES

Enter key CR/LF

Line ending control YES

26. Press **F8** and enter the following:

Turnaround character DC3

Scrolling NO

Mode BLOCK

Null suppression YES

27. Press **Enter** and enter the following:

Type of connection DIRECT

Automatic XON/XOFF flow control YES

Minimum time for break signal 500

Enhanced keyboard profile name ACSAENUS *

At keyboard profile name ACSAATUS *

Transfer to IBM protocol converter NO

Change parameters for ASCII text files NO

Data capture file name CAPTURE.XXX (for example)

Auto-start data capture NO

Auto-activate data filter YES

* These are the default U.S.A. profiles. For other countries, use **F4** to select the relevant profile. For more information, see Appendix A.

28. Press **Enter**.

29. Select **Default ASCII terminal emulation profile name**.

30. Type **MOSSL** and press **Enter**. The message **The profile has been saved** displays.

31. Press **Esc** twice to display the Communications Configuration menu.
32. Select **Verify**, then **Run Verify**. The **Verified** message displays. If the message does not display, check that you have entered the data correctly. Press Enter.
33. Select **Exit**.
34. Select **Exit communication configuration**.
35. Select **Exit**.
36. Select **Exit Communication Manager**.
37. Select **Yes**.
38. When the **Display Feature Status** screen disappears, select **F3=Exit**.
39. The Start Programs menu displays.
40. Select **OS/2 full-screen command prompt**.
41. Use the system editor to create a STARTUP.CMD file with the following lines:

```
@ECHO OFF
CD\CMLIB
START "COMM.MGR MOSSL" /FS /N DMPC ACS.CNF /A:ACS ACS.EXE
EXIT
```
42. Restart the system by simultaneously pressing Ctrl, Alt, and Del.
43. Go to "Testing a Connection with the Local or Alternate Console" on page 10-10 and check the connection to the 3745.

Note: When you finish a communications task, CM/2 should be closed carefully. For more information, refer to Appendix A.

MOSS Local or Alternate Console Emulation with CM/2 and Softerm

For a description of how to set up a 3101 terminal emulator, using CM/2 and Softerm as a connections to 3745 MOSS, see "MOSS Remote Console Emulation with CM/2 and Softerm" on page 11-10.

Attention

The Baud Rate for a local or alternate console is 2400 bps.

3727

Call your IBM service representative.

Testing a Connection with the Local or Alternate Console

1. Turn on the operator console.
2. A **CA INTERFACE DISPLAY** screen similar to the following one should be displayed (for the alternate console, wait 25 seconds):

```
----- mm/dd/yy/ hh : mm
CA INTERFACE DISPLAY

INTERFACE  CHANGE  E/D  INTERFACE  HOST OR  CHANNEL  NSC
NUMBER    E/D REQ  REQUEST  STATUS SWITCH  UNIT  ADDRESS  ADDRESS
1A        -        -        -          -          -          -
2A        -        -        -          -          -          -
3A        -        -        -          -          -          -
4A        -        -        -          -          -          -
5A        ==>   E        -          ENABLED          -          -          40
5B        ==>   D        -          DISABLED         -          -          41
7A        ==>   D        -          DISABLED         -          -          42
8A        -        -        -          -          -          -
- TYPE E OR D TO CHANGE THE ENABLE/DISABLE REQUEST, THEN PRESS SEND
  F4: MOSS FUNCTIONS          F5: UPDATE
```

3. If this screen displays, the console setup was successful.
4. If the screen is not displayed, check that the console cables are connected, and that power is on, then try again to connect.

Other possible causes of a faulty console setup are as follows:

- The console is set to 1200 bps instead of 2400.
- The cable adapter P/N 54F0490 is plugged wrongly. Check that the arrow on the adapter points toward the console.
- The 3151 console is set up in both native and emulation modes.

If the problem continues, refer to the *Problem Determination Guide*, SA33-0096.

Note: You can also diagnose problems by using the console link test, as described in the *Problem Determination Guide*.

Chapter 11. Setting Up a Remote Console

This chapter applies to **3745 Models 130 to 610**. It does not apply to **Model A**.

General Information (Remote)

A remote console is optional. You can use any of the following:

- 3151 Display Station (Models 110, 160, 310, 360, 410, and 460) in native mode (recommended) or in 3101 emulation mode.

Note: Models which do not support block mode cannot be used as consoles for the 3745 Communication Controller.

- 3153 Display Station in 3151 emulation mode.
- 3161 ASCII Display Station (Model 11, 12, 21, or 22) in 3101 emulation mode.
- 3163 ASCII Display Station (Model 11, 12, 21, or 22) in 3101 emulation mode (feature code 8235).
- PS/2 running with an OS/2 Extended Edition, Release 1.1 or higher.
- Personal Computer with an asynchronous communications adapter (or equivalent), running in 3101 emulation mode.

Note: If an adapter card is installed in slot 8 of the PC/XT or Portable or in an expansion unit, you must also install signal jumper (J13).

- Any equipment that can emulate the 3101 with an EIA 232D or ITU-T V.24 interface.

Check your console cables (for more information, refer to Appendix C in this manual, and the *Technical News Letter*, GN22-5490 part of *Input/Output Equipment Installation Manual - Physical Planning*, GN22-5490).

If a cable or console is not correct, contact your Installation coordinator.

Note: If you setup certain consoles in an already established system, you will need to reload MOSS (IML). Refer to the *Advanced Operations Guide*, SA33-0097.

3151 in Native Mode (Remote)

Important Note: If you have difficulty in using the 3151 as a remote console for a 3745 Model 210 or 410, contact your IBM service representative to ensure that you have the correct MOSS Console Adapter (MCA) card installed.

Notes:

1. **Native mode is the recommended mode of operation.**
2. The 3151 Model 110 can only be used in native mode because it does not support 3101 emulation.
3. The MOSS function keys are PF1 through PF8.
4. The line **not Model 110** does not appear on the Model 110 menu.

Setting Up

1. Hold down the Ctrl key (bottom left) and press the Setup key (top right).

Note: If the 3151 is new, Setup displays automatically when you power ON.

2. Fill in the fields as follows (use the ↑ and ↓ to move between items and the spacebar to select parameter values):

Machine Mode	IBM3151
Screen	NORMAL
Row and Column	24 X 80
Scroll	JUMP
Auto LF	ON
CRT Saver	OFF
Line Wrap	ON
Forcing Insert	OFF
Tab	FIELD

3. Press Send to get the next menu.
4. Open the Setup Menu and fill in the fields as follows:

Operating Mode	BLOCK
Line Speed (bps)	1200
Word Length (bits)	7
Parity	EVEN
Stop Bit	1
Turnaround Character	DC3
Line Control	PRTS
Break Signal (ms)	500
Send Null Suppress	ON

5. Press Send.

6. Open the Keyboard/Printer Menu and fill in the fields as follows:

Keyboard

Enter	RETURN (not Model 110)
Return	FIELD
New line	CR
Send	PAGE
Insert character	MODE

Printer

Line speed	2400
Word length (bits)	7
Parity	EVEN
Stop bit	1
Characters	NATIONAL (not Model 110)

7. Press Enter.
8. Use the arrow keys to highlight **Save data**.
9. Press the spacebar to save the configuration.
10. Hold down the Ctrl key (bottom left) and press the Setup key (top right) to return.
11. Go to "Testing the Modem Connection to a Remote Console" on page 11-13 and check the connection to the 3745.

3151 in 3101 Emulation Mode (Remote)

Important Note: If you have difficulty in using the 3151 as a remote console for a 3745 Model 210 or 410, contact your IBM service representative to ensure that you have the correct MCA card installed.

Notes:

1. **Native mode is the recommended mode of operation.**
2. The 3151 Model 110 can only be used in native mode because it does not support 3101 emulation.
3. The line **not Model 110** does not appear on the Model 110 menu.

Setting Up

1. Hold down the Ctrl key (bottom left) and press the Setup key (top right).

Note: If the 3151 is new, Setup displays automatically when you power ON.

2. Fill in the fields as follows (use the ↑ and ↓ keys to move between items and the spacebar to select parameter values):

Machine Mode	IBM3101
Screen	NORMAL
Row and Column	24 X 80
Scroll	NO
Auto LF	ON
CRT Saver	OFF
Line Wrap	ON
Forcing Insert	OFF
Tab	FIELD

3. Press Send for the next menu.
4. Open the Setup Menu and fill in the fields as follows:

Operating Mode	BLOCK
Line Speed (bps)	1200
Word Length (bits)	7
Parity	EVEN
Stop Bit	1
Turnaround Character	DC3
Line Control	PRTS
Break Signal (ms)	500
Send Null Suppress	ON
Pacing	OFF

5. Press Send.
6. Open the Keyboard/Printer Menu and fill in the fields as follows:

Keyboard

Enter	RETURN (not Model 110)
Return	FIELD
New line	CR
Send	PAGE
Insert character	MODE

Printer

Line speed	2400
Word length (bits)	7
Parity	EVEN
Stop bit	1
Characters	NATIONAL (not Model 110)

7. Press Enter.
8. Use the arrow keys to highlight **Save data**.
9. Press the spacebar to save the configuration.
10. Hold down the Ctrl key (bottom left) and press the Setup key (top right) to return.
11. Go to "Testing the Modem Connection to a Remote Console" on page 11-13 and check the connection to the 3745.

3153 in 3151 Emulation Mode (Remote)

Recommended Settings

Refer to the *Users Guide*, SA33-0356 for information on console settings in the country where you reside.

Starting the Console Configuration

See the example below for an IBM 5842 Modem configuration.

To display Setup, press Ctrl and the Minus key on the number keypad.

Key F1 (QUICK)

Emulation=3151	EIA Baud Rate=1200	EIA Data Format=7/1/E
Enhanced=OFF N/A	AUX Baud Rate=2400	Aux Data Format=7/1/E
Comm Mode=HALF BLOCK	Language=US	Sessions=ONE
Host/Printer=EIA/AUX		

Key F2 (GENERAL)

Emulation=3151	Enhanced=OFF N/A	Auto Wrap=ON
Curs Dir= LEFT TO RIGHT	Auto Scroll=ON	Monitor Mode=OFF
Screen Saver=OFF	Bell Vol=06	Warning Bell=ON
Bell Length=140ms	Setup Lang=US	Sessions=ONE

Key F3 (DISPLAY)

Display Cursor=ON	Cursor=STEADY BLOCK	Viewports=ONE
Pages=01	Page Length=24	Screen Video=NORMAL
Columns=80	Scroll=JUMP	Overscan Borders=ON
Width Change Clear=OFF	Speed=FAST	Refresh Rate=71 HZ

Key F4 (KEYBOARD)

Language=US	Char Set=NATIONAL	Key Mode=ASCII
Keyclick=OFF	Key Repeat=ON	Key Rate=20 CPS
Margin Bell=OFF	Key Lock=CAPS	Caps Lock=TOGGLE
Num Lock=TOGGLE		

Key F5 (KEYS)

Return Key=field	Enter Key=RETURN	New Line=CR
Send Key=PAGE	Insert Character=MODE	Backspace=BS BS
Desk Acc=ctrl <-	Pound Key=US	Return Key REPEAT=OFF
UDKS=EMUL DEPENDENT		

Key F6 (PORTS)

EIA Baud Rate=1200	EIA Data Format=7/1/E	EIA Parity Check=off
AUX Baud Rate=2400	AUX Data Format=7/1/E	Aux Parity Check=off
EIA Xmt= No Protocol	EIA Recv= No Protocol	EIA Xmt Pace= Baud
Aux Xmt=Xon-Xoff	Aux Recv= Xon-Xoff(XPC)	Aux Xmt Pace= Baud

Key F7 (HOST)

Comm Mode= HALF BLOCK	Local= OFF	Null Suppress=OFF
Break= 500MS	Line Control=PRTS	Disconnect=2 SEC
Recv <CR>=<CR><LF>	Recv =IGNORE	Send Ack=OFF
Alt Input DATA=ON	Turnaround Char=DC3	Send Null=ON

Closing the Console Configuration

1. Press Ctrl and the minus key on the number keypad.
 - a. Type Y to save the configuration
 - b. Type N to cancel the new configuration or keep the previous one
 - c. Type C to review the configuration.

3161 or 3163 (Remote)

1. Hold down the Ctrl key (bottom left) and press the Setup key (top right).
2. Fill in the fields as follows (use the ↑ and ↓ to move between items, and the spacebar to select parameter values):

Machine Mode	IBM3101
Operating Mode	BLOCK
Interface	RS232C
Line Control	PRTS
Line Speed (bps)	1200
Parity	EVEN
Turnaround Character	DC3
Stop Bit	2
Word Length (bits)	7 (3161 only)
Response Delay	100 (3161 only)
Break Signal (ms)	500 (3161 only)

3. Press Send.
4. Press Select.
5. Use the spacebar to fill in the fields as follows:

Scroll=OFF	Return=CR	Line Wrap=ON
Autoff=ON	Send=PAGE	Null Supp=ON
6. Press Select to return.
7. Go to "Testing the Modem Connection to a Remote Console" on page 11-13 and check the connection to the 3745.

IBM PC

1. Start a 3101 emulation session.
2. Type 3 to create a specification file. Fill in the fields as follows:

Line Speed	1200
Block Mode	Y (yes)
Parity	E (even)
Stop Bits	2
Automatic Line Feed	Y (yes)
Carriage Return	Y (CR/LF)
Null Suppress	ON
Character at End	4 (XOFF)
Scrolling	N (no)

3. After entering the change and key definitions, enter the file name, for example REMMOSS.
4. Enter 1 to select a specification file and enter REMMOSS for the file name.
5. Go to "Testing the Modem Connection to a Remote Console" on page 11-13 and check the connection to the 3745.

Note: The asynchronous communications adapter should be configured as COM1 (the primary adapter) for EIA 232-D operations.

IBM PS/2 (Remote)

Note: To successfully complete this procedure, you must have installed OS/2 Extended Edition, Version 1.1 or higher, at SYSLEVEL 03030 or higher. If you are not sure of the level, refer to Appendix A.

To configure a PS/2 as a remote console, do the following:

1. Open an OS/2 full screen.
2. Type CD \CMLIB.
3. Type COPY ACSCFG.CFG MOSSREMM.CFG.
4. Type CD \.
5. Edit the CONFIG.SYS file by adding the following line at the end:
DEVICE=C:\CMLIB\ASYNCDDB.SYS COM1
6. Save the CONFIG.SYS file.

Notes:

- a. If you are using a PC/AT or a PC/XT equipped with an 80286 microprocessor, type ASYNCDDB.SYS instead of ASYNCDDB.SYS.
- b. Open your CONFIG.SYS file and look for the line (or lines):
DEVICE=C:\OS2\COMxx.SYS (where xx = 01, 02, or 03)

If you find it, insert this line before it:

ASYNCDDB/A

7. Open Desktop Manager.
8. Double-click Communication Manager/2 (this takes ten seconds to load).
9. In the CM/2 main menu, select **Advanced**.
10. Select **Configuration**.
11. Type MOSSREMM and press Enter.
12. The Communications Configuration menu displays.
13. Select **Workstation profile**.
14. Select **Change** and fill in the fields as follows:

Error log file name	ERROR.DAT (for example)
Error log size	16 (for example)
Error log overflow option	WRAP
Message log file name	MESSAGE.DAT (for example)
Message log size	500 (for example)
Message log overflow option	WRAP
Enable auto-start options	YES

15. If you need to, press **Enter** to display the Auto-Start Options menu and fill in the following fields:

- ACDI service
- ▶ ASCII terminal emulation
- 3270 terminal emulation (DFT)
- 3270 terminal emulation (SDLC)

16. Fill in the fields as follows:

- Communication Manager main menu
- ▶ ASCII Terminal Emulation
- 3270 Terminal Emulation

17. Press **Enter**, and a message **The profile has been saved** displays.

18. Select **Asynchronous feature profiles**.

19. Select **Asynchronous communication port profile**.

20. Select **Create** and customize as follows:

Country code	xxx
Profile name	COM1

21. Press **Enter**, then select **Other modem or device**.

22. Press **Enter**.

23. In the following window, select **SWITCHED** and press Enter.

24. When the message displays **Data Set Ready Always Asserted**, select **YES**.

25. Press **Enter** and the message **The profile has been saved** displays.

26. Select **ASCII terminal emulation profiles** in the next two screens.

27. Select **Create**. Enter the model profile name as M6 and the new profile name as MOSSR.

28. Press **Enter**.

29. Fill in the **MOSSR** profile fields as follows:

Communication port name	COM1
-------------------------	------

(port profile name)

Emulation mode	IBM 3101
Line speed	1200
Bits per character	7
Parity type	EVEN
Number of stop bits	2
Local display	NO
Auto return	YES
Enter key	CR/LF
Line ending control	YES

30. Press F8 to continue.

Turnaround character	DC3
Scrolling	NO
Mode	BLOCK
Null suppression	YES

31. Press Enter to continue.

Type of connection	DIRECT
Automatic XON/XOFF flow control	YES
Minimum time for break signal	500
Enhanced keyboard profile name	ACSAENUS *
AT keyboard profile name	ACSAATUS *
Transfer to IBM protocol converter	NO
Change parameters for ASCII text files	NO
Data capture file name	CAPTURE.XXX (for example)
Auto-start data capture	NO
Auto-activate data filter	YES

* These are the default U.S.A. profiles. For other country profiles, press **F4**. For more information, refer to Appendix A.

32. Press Enter.

33. Select **Default ASCII terminal emulation profile name**.

34. Type **MOSSR** and press **Enter**.

The message **The profile has been saved** displays.

35. Press **Esc** twice to display the Communications Configuration menu.

36. Select **Verify**, then **Run Verify**.

The **Verified** message displays.

If the message does not display, check that you have entered the data correctly.

Press Enter.

37. Select **Exit**.

38. Select **Exit Communication Configuration**.

39. Select **Exit**.

40. Select **Exit Communication Manager**.

41. Select **Yes**.

42. When the **Display Feature Status** screen closes, select **F3=Exit**.

43. The Start Programs menu displays.

44. Select **OS/2 full-screen command prompt**.

45. Use the system editor to create STARTUP.CMD file, containing the following lines:

```
@ECHO OFF
CD\CMLIB
START "COMM.MGR MOSSR" /FS /N DMPC ACS.CNF /A:ACS ACS.EXE
EXIT
```

46. Restart the system by pressing Ctrl, Alt, and Del.

47. Go to "Testing the Modem Connection to a Remote Console" on page 11-13 for information on checking the connections to the 3745.

Note: When a communications task is finished, close CM/2 carefully.

MOSS Remote Console Emulation with CM/2 and Softerm

The following is the setup procedure for a 3101 terminal emulator connection with a 3745 MOSS, using CM/2 and Softerm. To install Softerm, use the following procedure:

- Step 1.** Open an OS/2 window or screen.
- Step 2.** Insert the Softerm diskette into drive A.
- Step 3.** Type a: and press Enter.
- Step 4.** Type cd\ and press Enter.
- Step 5.** Type a:\install and press Enter.
- Step 6.** Wait for the installation to complete. A new **Custom Plus** icon displays.

Note: In the following procedure, window displays are indicated by an ⇒ followed by the title of the window.

Starting Custom Plus

- Step 1.** To start, click the **Custom Plus** icon twice.
⇒ window **Custom Plus - Icon View**
- Step 2.** Click twice on **Custom Plus** icon.
⇒ window **Softerm Session Manager - CUSTOM.MDB**

This window lists several predefined sessions.

Defining a New Session

- Step 1.** Click **Session** and then **Add**.
⇒ window **Add Session - Untitled**
- Step 2.** Click **Setup Profiles**.
⇒ window **Setup Profiles**

There are two setup profiles, Terminal Emulation and Connection Path.

See the following procedures to setup the Terminal Emulation profile, and the Connection Path profile.

Defining the Terminal Emulation Profile

- Step 1.** Click **Terminal**.
⇒ window **Terminal Emulation Profile Module - CUSTOM.MDB**
- Step 2.** Click **Add**.
⇒ window **Terminal Emulation**
- Step 3.** In the terminal types list, select **3101-2X** and click **OK**.
⇒ window **Terminal Emulation Settings - Untitled**
- Step 4.** In the **Comment** entry field, type: 3101-2X Settings for MOSS Console.
For the keyboard profile:
 - a. Click **Setup**.

⇒ window **Keyboard Profile Module - CUSTOM.MDB**

b. Click **Add**.

⇒ window **Add keyboard**

c. In the keyboard type list, select **AT 84 key**, or **101 Enhanced** or **102 Enhanced** depending on your key board.

d. In the terminal keyboard type list, select **IBM 3101-2X**.

e. In the nationality list, select the country where you reside.

f. Click **OK**.

⇒ window **Keyboard Settings - Untitled**

The default keyboard mapping is displayed. The Control, Alt and Function keys are used for 3101 functions.

Note: Function keys F1 to F10 correspond to the same keys, and F11 to F20 correspond to Shift-F1 through Shift-F10.

If you want to change the keyboard mapping, use the following procedure:

1) On window **Keyboard Settings - Untitled**, click **Change**.

⇒ window **Keyboard Remap**

2) When the keyboard map displays on the screen, click a key to see the corresponding 3101 definition. For example, if you want to remap the **Send** key to **Enter** instead of the default **Control-F1**, click the **Enter** key on the map, and then click **Open Base**.

⇒ window **Open/Edit Key**

3) In the **Key contents** entry field, delete Return and type Send.

4) Click **OK**. You can remap any other key(s).

g. When you have finished, click **Remap**.

⇒ window **Keyboard Settings - Untitled**

h. Click **Save as** to save the keyboard profile.

⇒ window **Save Keyboard - CUSTOM.MDB**

i. Enter the keyboard profile name, for example, 3101 keyboard.

j. Click **Save**.

⇒ window **Keyboard Profile Module - CUSTOM.MDB**

k. Click **Close**.

⇒ window **Terminal Emulation Profile Module - CUSTOM.MDB**

Step 5. Customize the 3101 terminal settings, and change the following parameters:

- Operating mode,
- Line Turn Around Character.

All the other parameters keep their default values.

Step 6. In **Terminal Emulation Settings** list, select the parameter and click **Change**:

- For Operating mode, click **Block** and then **OK**.
- For Line Turn Around Character, click **Xoff(\$13)** and **OK**.

- Step 7.** Click **Save as**.
⇒ window **Save Terminal Emulation - CUSTOM.MDB**
- Step 8.** Enter the terminal emulation profile name, for example, 3101 emulation.
- Step 9.** Click **Save**.
⇒ window **Terminal Emulation Profile Module - CUSTOM.MDB**
- Step 10.** Click **Close**.

Defining Connection Path Profile

Click **Setup Profiles**.
⇒ window **Setup Profiles**

- Step 1.** Click **Connection**.
⇒ window **Connection Path Profile Module - CUSTOM.MDB**
- Step 2.** Click **Add** twice.
⇒ window **Add Connection Path**
- Step 3.** Enter Standard COM for the communication interface and click **OK**.
⇒ window **Connection Path Settings - Untitled**
- COM1 (default setting) for the COM port
 - Select **(None)** for the modem profile name.
- Note:** You can add a customized profile with modem-supported features, such as auto-dial and auto-answer.
- Connection Path Settings:
 - Select an item in the list and click **Change** then **OK**.
 - Communications parameters:
 - Baud rate = 1200
 - Data bits = 7
 - Stop bits = 1
 - Parity = Even
 - Flow Control: None (default setting).
- Step 4.** Click **Save as**.
⇒ window **Save Connection Path - CUSTOM.MDB**
- Step 5.** Enter the connection path profile name, for example connection.
- Step 6.** Click **Save**.
⇒ window **Connection Path Profile Module - CUSTOM.MDB**
- Step 7.** Click **Close**.

Ending Definition of a New Session

- Step 1.** In the ⇒ window **Add Session - Untitled**, click **Add**.
⇒ window **Admittance data**
- Step 2.** Click **Save as**.
⇒ window **Save Session**
- Step 3.** Enter the session name, for example MOSS Console.
- Step 4.** Click **Save**.
⇒ window **Softterm Session Manager - CUSTOM.MDB**

Notes:

This window includes a **MOSS Console** session. You can start the session by double-clicking it. If you want to remotely connect to MOSS, attach a modem (1200 or 2400 bauds) to the COM1 port of your PS/2, and establish a connection to the 3745 modem.

Other Types of Consoles

Refer to the console's documentation, and use the information in the preceding sections to setup any operating characteristics.

Testing the Modem Connection to a Remote Console

1. Make sure that the modem associated with your remote console is powered ON and in voice mode.
2. Turn on the console.
3. Dial the telephone number of the 3745 with your modem.

You will hear the **ringback** tone. When you hear the **answer** tone (steady tone), go to the next Step.

If you do not hear the answer tone, the local console could be logged on. Try again later.

4. Set the modem associated with your remote console to data mode.
5. Hang up the handset, and the following screen displays:

```
3745 MICROCODE (C) COPYRIGHT IBM CORP. 1988  
MAXIMUM ADAPTER CONFIGURATION: CHANNEL ADAPTERS 5,6,7,8  
                                LINE   ADAPTERS 1,2,3,9,10,11,12  
  
ENTER PASSWORD ==>  
  
F4: CHANNEL INTERFACE DISPLAY
```

6. If this screen is displayed, setup was successful.
7. If the screen is not displayed, check that the console cables are connected and that power is ON to both console and modem, then try to connect again.

Other possible causes of a faulty console setup are as follows:

- The console is set to 2400 bps instead of 1200.
- The 3151 console is set in both native and emulation modes.

If the problem still persists, refer to the *Problem Determination Guide*, SA33-0096.

Note: You can also diagnose problems by using the console link test, described in the *Problem Determination Guide*.

Chapter 12. Modem Setup

Modems for 3745 Models 130 to 160

The following is a list of modems that can be set up to operate between the remote console and the 3745:

In the U.S.A.:

- IBM 5841 Modem.
- IBM 5842 Modem.

In the U.S.A., Canada, and Japan:

- IBM 5853 Modem (set to half speed).
- Equivalent compatible with Bell 212 A or ITU-T V.22 (1200 bps).

In other countries:

- Modems compatible with ITU-T V.22 alternative B (1200 bps).

For information about setting up RSF modems, refer to Chapter 13, "RSF Modems" on page 13-1.

Setting Up

For the modem to be compatible between the remote console and the 3745, refer to the modem's documentation and set the following modem characteristics:

- Switched line connection
- Duplex operation
- Asynchronous operation
- 1200 bps speed
- 3745 modem set to auto-answer
- Remote console modem set to manual dialing.

Notes:

1. Review the modem documentation to ensure compatibility with the 3745. In particular, check the following:
 - Error Checking Link (ECL) is disabled.
 - If the modem has a 'Test Mode', turn it off at the 3745 end.
 - If the modem is programmable, set the control of the Data Set Ready (DSR) signal to normal, so that it does not get raised by the Data Terminal Ready (DTR).
2. Some IBM PC modems disconnect from the switched network when the carrier signal drops. To prevent this, set the modem at the PC end to RTS Permanent. For more information, refer to your modem documentation.

Switch Settings for IBM Modems 5841, 5842, and 5853

IBM 5841 Modem

Set the modem switches of the remote console as follows:

1. Set back panel DIP switches SW7 and 8 DOWN, all others UP.
2. Set all front panel switches OUT.

Set the modem switches of the 3745 as follows:

1. Set back panel DIP switches SW7 and 8 DOWN, all others UP.
2. Set all front panel switches OUT.

IBM 5842 Modem

Set the switches at the remote console site as follows:

1. Set back panel DIP switches SW7 and 8 DOWN, all others UP.
2. Set front panel switches FS IN, all others OUT.

Set the switches at the 3745 site as follows:

1. Set back panel DIP switches SW7 and 8 DOWN, all others UP.
2. Set front panel switches FS IN, all others OUT.

IBM 5853 Modem

Set the switches at the 3745 site as follows:

1. Set back panel DIP switches to UP.
2. Set front panel switches FS IN, all others OUT.

Set the switches at the remote console site as follows:

1. Set back panel DIP switches to UP.
2. Set front panel switches FS IN, all others OUT.

Note: Before you set any modem configurations, make sure that both modems have been initialized and then do the following:

1. Push in all the front panel switches.
2. Turn power ON and wait five seconds.
3. Turn power OFF.
4. Set the front panel switches as described above.
5. Turn power ON again.

Modems for 3745 Models A

The procedures in this section explain how to manipulate the IBM modems recommended for DCAF.

Note: The Hayes modem does not need to be set manually.

Setting the IBM 7855 Modem

1. Press both the ← and → buttons on the front panel of the modem. The modem displays the message '<Exit Enter>'.
2. Press the → button. If the modem displays View Only, go to Step 3. If the modem displays 'Password.....■■■■', use the → and the ↑ buttons to change the display to 'Password....B293' by changing one character at a time. Press the → button one more time, and then check the display again to make sure it shows 'View Only'.
3. Press and release the ↑ or ↓ button as needed to change the display to 'First Setup'.
4. Press the → button **once**, press and release the ↑ or ↓ button to change the display to 'Reset to Factory'.
5. Press the ← button. The lights on the front panel flash briefly.
6. Set the modem speed to 12000 bps by doing the following:
 - a. Press both the ← and → buttons. The modem displays: '<Exit Enter>'.
 - b. Press and release the → button. The modem displays: 'View Only'.
 - c. Press the ↓ button **twice**. The modem displays: 'Quick Customize'.
 - d. Press the → button. The modem displays: 'DTE interface'.
 - e. Press the ↓ button **twice**. The modem displays: 'PSN Telco speed'.
 - f. Press the → button. The modem displays: 'PSN Bps 9600'.
 - g. Press the ↓ button. The modem displays: 'PSN Bps 12 000'.
 - h. Press the ← button **6 times**. The modem displays: 'SYNC INT 12 000'.
7. Turn the modem off.

Setting and Saving the Target Service Processor Phone Number

1. Press both the ← and → buttons on the front panel of the modem. The modem displays the message '<Exit Enter>'.
2. Press the → button. If the modem displays 'View Only', go to Step 3. If the modem displays 'Password.....■■■■', use the → button and the ↑ button to change the display to 'Password....B293' by changing one character at a time. Press the → button one more time, and then check the display again to make sure it shows 'View Only'.
3. Press and release the ↑ or ↓ button as needed to change the display to 'Directories'.
4. Press the → button to display 'No Password'. If the display shows 'Password needed', use the ↑ button and the ↑ button once to change the display to 'Local Pass B293' by changing one character at a time.

5. Press the → button to display 'Store and View'.
6. Press the → button to display 'Directories xx'.
7. Set the target service processor phone number with the ↑ and ↓ buttons. Switch to the next number with the → button.
8. Press the ← button 8 times to exit.

Setting the IBM 7857 Modem Connected to MPA Card (SYN)

1. Press the ↓ key until the 'CONFIG' message displays at the top of the screen.
2. Press the → key until the 'Sel Factory' message displays at the bottom of the screen.
3. Press **Enter**.
4. Press the ↑ key until '3' displays.
5. Press **Enter** to load the predefined factory configuration 3.
6. Press the ↑ key until 'U1' displays at the top of the screen.
7. Press the → key until 'Sync mode 3' displays. Press **Enter** to validate.
8. Press the ↑ key until 'U2' displays.
9. Press the → key until 'Internal' displays. Press **Enter** to validate.
10. Press the ↑ key until 'U3' displays.
11. Press the → key until 'Autobaud' displays. Press **Enter** to validate.
12. Press the ↑ key until 'U4' displays.
13. Press the → key until 'CCITT' displays. Press **Enter** to validate.
14. Press the ↑ key until 'U5' displays.
15. Press the → key until '9600 V32 TRE' displays. Press **Enter** to validate.
16. Press the ↑ key until 'U6' displays.
17. Press the → key until 'V42Bis/MNP5 Enabled' displays. Press **Enter** to validate.
18. Press the ↑ key until 'U7' displays.
19. Press the → key until 'Auto Reliable/V42/MNP' displays. Press **Enter** to validate.
20. Press the ↑ key until 'U8' displays.
21. Press the → key until 'Xon/Xoff passed' displays. Press **Enter** to validate.
22. Press the ↑ key until 'U9' displays.
23. Press the → key until 'Xon/Xoff' displays. Press **Enter** to validate.
24. Press the ↑ key until 'U10' displays.
25. Press the → key until 'C108/2' displays. Press **Enter** to validate.
26. Press the ↑ key until 'U11' displays.
27. Press the → key until 'C106 Always follow C105' displays. Press **Enter** to validate.
28. Press the ↑ key until 'U12' displays.

29. Press the → key until 'C107/C109 Normal Mode' displays. Press **Enter** to validate.
30. Press the ↑ key until 'U13' displays.
31. Press the → key until 'C107 Follow C109(CD)' displays. Press **Enter** to validate.
32. Press ↓ until 'Mode' displays.
33. Press → until the message 'V25HDLN NRZIASC' displays.
34. Press **Enter**.

The modem is now in ITU-T V.25 bis synchronous mode. See "Saving the Modem Configuration" below.

Setting the 7857 Modem Connected to COM1 (ASYN)

1. Power OFF the modem
2. Press and hold the ↑ key while power ON the modem.
3. The modem is set to Factory 0 in AT command mode.

See "Saving the Modem Configuration" below.

Setting the 7857 Modem Connected to MPA Card on COM2 (ASYN)

1. Power OFF the modem
2. Press and hold the ↑ key while power ON the modem.
3. The modem is set to Factory 0 in AT command mode.

See "Saving the Modem Configuration" below.

Saving the Modem Configuration

1. Press the ↓ key until the 'CONFIG' message displays at the top of the screen.
2. Press the → key until the 'Store User Conf' message displays at the bottom of the screen.
3. Press **Enter**.
4. Press the ↑ key, to select the User Configuration Location (0 to 9) where you want to save the configuration.
5. Press **Enter** to save the current modem configuration.

The defined configuration is now active and saved. Every time the modem is reset (powered ON), this configuration is loaded.

Transmission Speed The IBM 7857 uses an **Adaptive line rate facility** which can automatically decrease or increase the modem's transmission speeds. This means that if telecommunication line conditions deteriorate, the modem can still function at the highest possible efficiency.

Setting and Saving the Target Service Processor Phone Number

1. Press the ↓ key until 'Store phone number' displays at the top of the screen.
2. Press the → key to select the first location number.
3. Press **Enter**.

4. Press the ↑ key to select a digit. Press the → key to move to the next position (↓ key can be used for backspacing).
5. Press **Enter** twice to save the target service processor's phone number.

Setting the IBM 7858 Modem Connected to MPA Card (SYN)

1. Press the ↓ key until the 'CONFIG' message displays at the top of the screen.
2. Press the → key until the 'Sel Factory' message displays at the bottom of the screen.
3. Press **Enter**.
4. Press the ↑ key until 3 displays.
5. Press **Enter** to load the predefined factory configuration 3.
6. Press the ↑ key until 'U4' displays at the top of the screen.
7. Press the → key until '9600bps V32' displays. Press **Enter** to validate.
8. Press the ↑ key until 'U7' displays.
9. Press the → key until 'Xon/Xoff Passed' displays. Press **Enter** to validate.
10. Press the ↑ key until 'U8' displays.
11. Press the → key until 'Xon / Xoff' displays. Press **Enter** to validate.
12. Press the ↑ key until 'U10' displays.
13. Press the → key until 'Forced on' displays. Press **Enter** to validate.
14. Press the ↑ key until 'U12' displays.
15. Press the → key until Follow CD displays. Press **Enter** twice to select this option.
16. Press ↓ until 'Mode' displays.
17. Press → until the message 'V25HDLC NRZIASC' displays.
18. Press **Enter** twice.

The modem is now in V.25 bis synchronous mode. See "Saving the Modem Configuration" on page 12-7 below.

Setting the 7858 Modem Connected to COM1 (ASYN)

1. Power OFF the modem
2. Press and hold the ↑ key while power ON the modem.
3. The modem is set to Factory 0 in AT command mode.

See "Saving the Modem Configuration" on page 12-7 below.

Setting the 7858 Modem Connected to MPA Card on COM2 (ASYN)

1. Power OFF the modem
2. Press and hold the ↑ key while power ON the modem.
3. The modem is set to Factory 0 in AT command mode.

See "Saving the Modem Configuration" on page 12-7 below.

Saving the Modem Configuration

1. Press the ↓ key until the 'CONFIG' message displays at the top of the screen.
2. Press the → key until the 'Store User Conf.' message displays at the bottom of the screen.
3. Press **Enter**.
4. Press the ↑ key, to select the User Configuration Location (0 to 9) where you want to save the configuration.
5. Press **Enter** to save the current modem configuration.

The defined configuration is now active and saved. Every time the modem is reset (powered ON), this configuration is loaded.

Transmission Speed The IBM 7858 uses an **Adaptive line rate facility** which can automatically decrease or increase the modem's transmission speeds. This means that if telecommunication line conditions deteriorate, the modem can still function at the highest possible efficiency.

Setting and Saving the Target Service Processor Phone Number

1. Press the ↓ key until 'Store phone number' display at the top of the screen.
2. Press the → key to select the first location number.
3. Press **Enter**.
4. Press the ↑ key to select a digit. Press the → key to move to the next position (↓ key can be used for backspacing).
5. Press **Enter** twice to save the target service processor's phone number.



Chapter 13. RSF Modems

This chapter applies to **3745 Models 130 to 610**. It does not apply to **Model A**.

If you have an RSF link to the Remote Technical Assistance Information Network (RETAIN), your IBM service representative will install the RSF modem.

If a RSF modem is not provided with the 3745, follow the installation procedure below for compatibility with ITU-T V.23. This will set your modem in half-duplex mode, with BSC protocol set at 1200 bps, and without clocking.

Note: Operating characteristics for RSF modems are country-dependent.

IBM 5858 Modem

1. Set the rear panel switches for a V.23 modem as below:

U			U	U			U			U	U	U	U	U	U	U
	D	D				D	D									
1	2	3	4	5	6	7	8	1	2	3	4	5	6	7	8	

2. Set all the front panel switches to OUT.

IBM 7855 Modem

Refer to "Setting the 7857 Modem Connected to COM1 (ASYN)" on page 12-5.

IBM 7857 Modem

Refer to "Modems for 3745 Models 130 to 160" on page 12-1.



Part 3. Appendixes for 3745 Model A and 3746 Model 900

Appendix A. Configuration for a Two-Target Remote Workstation

The following example shows the configuration for a remote workstation controlling two target service processors, ERS1 and BS12 (see Figure A-1 below).

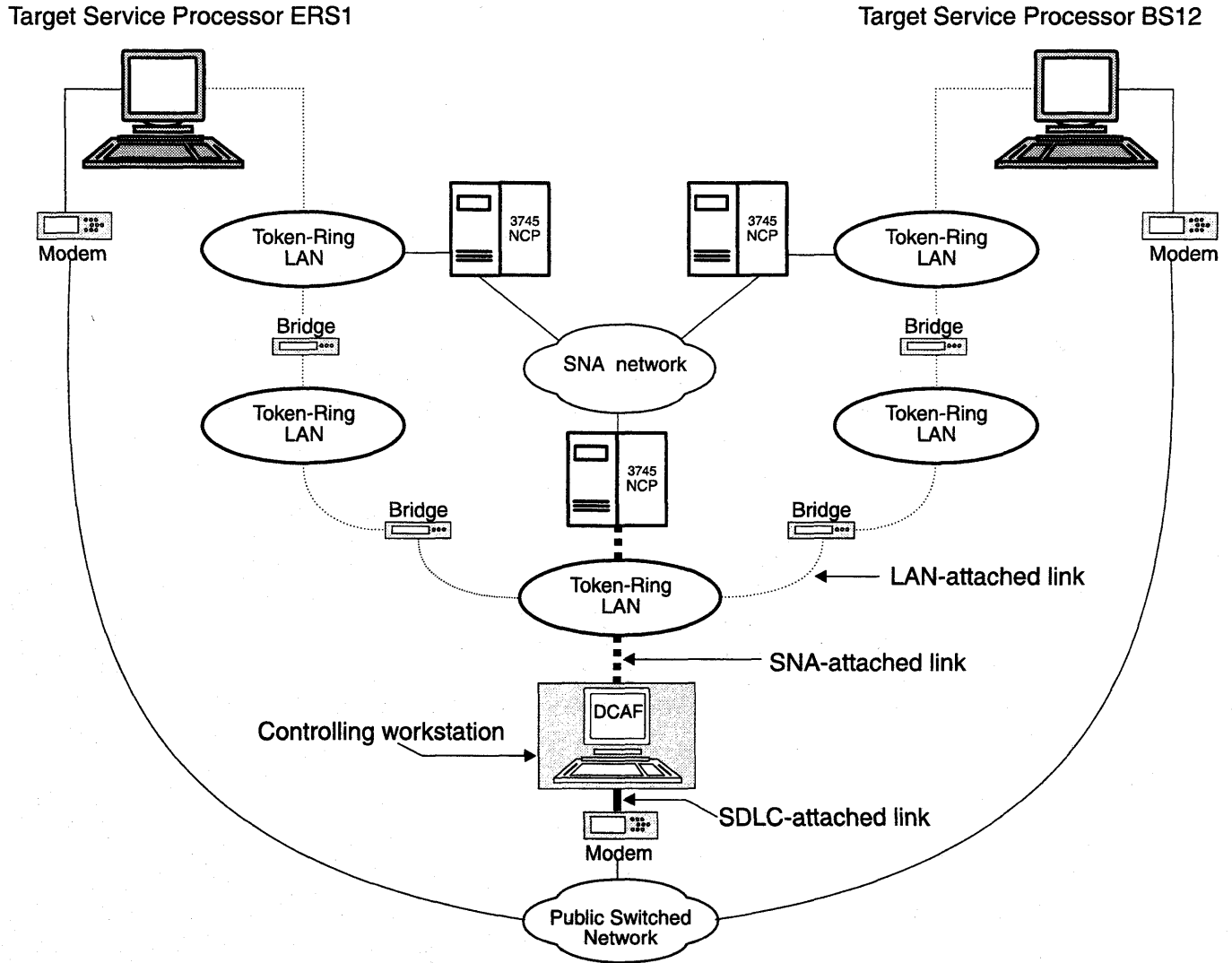

Figure A-1. A Two-Target Configuration

The example in Figure A-1 on page A-1 assumes that the workstation is running:

- CS/2 or CM/2.
- NCP Version 6, Release 2 or higher with 3746-900 features.
- VTAM Version 3, Release 4.1.

NCP Definitions

NCP must contain definitions for the TIC2 or TIC3. These ports are used to attach the controlling workstation and the two service processors to token-ring LANs.

The only other requirement is to manage dynamic LUs by entering the following definition:

```
LUDRPOOL NUMILU=(a number > 0)
```

VTAM Definitions

Start List

The VTAM start list below should contain the XNETALS=YES statement to enable the cross-network SSCP-PU session activation (without SNI), and the statement DYNLU=YES to handle dynamic LUs (see the example below).

```
HOSTSA=10,SSCPID=10,MAXSUBA=63  
CONFIG=10,NETID=SYSTST,SSCPNAME=CDRM20,  
XNETALS=YES,DYNLU=YES,  
NOPROMPT,DLRTCB=32,SUPP=NOSUP,NOTNSTAT,NOTRACE,TYPE=VTAM,  
LPBUF=(120,,0,,60,60), LARGE GENERAL PURPOSE_PAGEABLE  
LFBUF=(96,,0,,24,10), LARGE GENERAL PURPOSE_FIXED  
LFBUF=(128,,0,,32,10), SMALL GENERAL PURPOSE_FIXED  
CRPLBUF=(160,,13,,80,80), RPL_COPY_PAGEABLE  
IOBUF=(256,256,34,,68,68) I/O_BUFFERS_FIXED (NP&PP BUF REMOVED)
```

Logmode Table

The logmode table below is called SOCMOTAB:

```
DCAFMODE MODEENT LOGMODE=DCAFMODE 22 ,
      TYPE = 0,
      FMPROF = X'13',
      TSPROF = X'07',
      PRIPROT = X'B0',
      SECPROT = X'B0',
      COMPROT = X'50B1',
      SSNDPAC = X'08',
      SRCVPAC = X'08',
      RUSIZES = X'8787',
      PSNDPAC = X'08',
      PSERVIC = X'06020000000000000002F00'
```

Switched Major Nodes

```
*****
*
*   MAJNODE FOR CONNECTION : CONTROLLING <==> NETVIEW V2R3
*
*
*
*****
DCAFCTRL VBUILD TYPE=SWNET,MAXGRP=1,MAXNO=1
-----*
CPCTRL  PU   ADDR=04,PUTYPE=2,NETID=SYSTST 1 ,CPNAME=CPCTRL 2 , X
          MAXPATH=8,MAXDATA=265,MAXOUT=1, X
          DISCNT=NO
CTRL1   LU   LOCADDR=0,MODETAB=SOCMOTAB

*****
*
*   MAJNODE FOR CONNECTION : MOSS-E ERS1 <==> NETVIEW V2R3
*
*
*
*****
NTVERS1 VBUILD TYPE=SWNET,MAXGRP=1,MAXNO=1
-----*
CPERS1  PU   ADDR=04,PUTYPE=2,NETID=SYSTST 10 ,CPNAME=CPERS1 23 , X
          MAXPATH=8,MAXDATA=265,MAXOUT=1, X
          DISCNT=NO
PATHERS1 PATH DIALNO=0204400000761111,GRPNM=L76G2080
MOSSERS1 LU   LOCADDR=0,MODETAB=SOCMOTAB

*****
*
*   MAJNODE FOR CONNECTION : MOSS-E BS12 <==> NETVIEW V2R3
*
*
*
*****
NTVBS12 VBUILD TYPE=SWNET,MAXGRP=1,MAXNO=1
-----*
CPBS12  PU   ADDR=04,PUTYPE=2,NETID=SYSTST 10 ,CPNAME=CPBS12 22 , X
          MAXPATH=8,MAXDATA=265,MAXOUT=1, X
          DISCNT=NO
PATHBS12 PATH DIALNO=0204400000761112,GRPNM=L76G1088
MOSSBS12 LU   LOCADDR=0,MODETAB=SOCMOTAB
```

DCAF Remote Workstation Configuration

- Step 1.** From Desktop Manager, double-click the Distributed Console Access Facility icon.
- Step 2.** Double-click the DCAF Controller icon.
- Step 3.** Click **Session**, then **Open workstation directory**.
- Step 4.** Click **OK** for a first installation. Otherwise continue with next step.
- Step 5.** From the DCAF Directory window, click **Workstation** then **Add**.

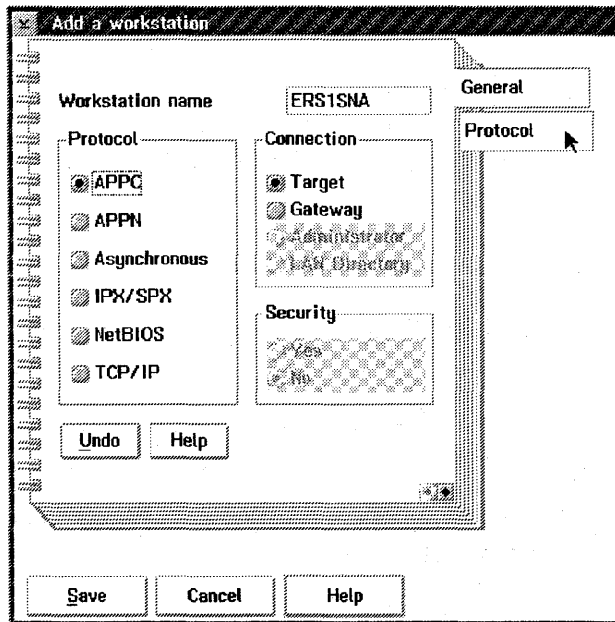

- Step 6.** Enter ERS1SNA in the **Workstation name** field and click **Protocol**.

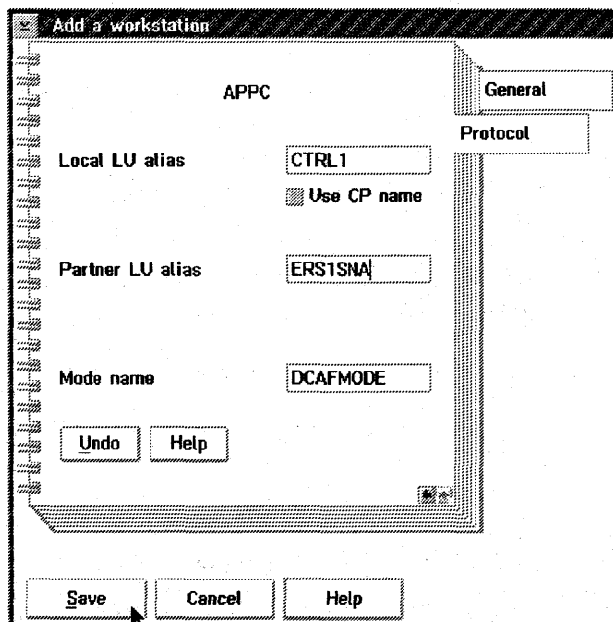

- Step 7.** Fill in the **Local LU alias**, **Partner LU alias**, and **Mode name** fields respectively with CTRL1, ERS1SNA, DCAFMODE, and click **Save**.
- Step 8.** Repeat Step 6 and Step 7 by entering the following in the **Workstation name** and **Partner LU alias** fields:
- a. ERS1SDLC, then click **Save**.
 - b. ERS1LAN, then click **Save**.
 - c. BS12SNA, then click **Save**.
 - d. BS12SDLC, then click **Save**.
 - e. BS12LAN, then click **Save**.
- Step 9.** Click **Cancel** to finish.
- Step 10.** Run the EQNSFPAR program to verify link records.

Appendix B. Configuring DLC for DCAF

The following is a list of recommended CM/2 and CS/2 parameters for a remote workstation, enabling it to correspond with the DLC definitions of the service processor. Although they are a guide to help you with selecting parameters, you must supply the actual values that correspond to your network.

Create or Change the Token-Ring Network DLC Adapter Profile

The parameters for this screen apply to LAN- (APPC-type), SNA-, and APPN- (via a LAN) attached consoles.

<i>Adapter number</i>	0
<i>Load DLC</i>	Yes
<i>Maximum number of link stations</i>	4
<i>Percent of incoming calls</i>	50
<i>Free unused link</i>	No
<i>Congestion tolerance</i>	80
<i>Maximum RU size</i>	2024
<i>Send Window Count</i>	4
<i>Receive Window Count</i>	4
<i>C&SM LAN ID</i>	(Customer defined)
<i>Send alert for beaconing</i>	Yes

Create or Change the SDLC DLC Adapter Profile

The parameters for this screen apply to modem- and SNA- (SDLC) attached consoles.

<i>Adapter number</i>	0
<i>Load DLC</i>	Yes
<i>Free unused link</i>	No
<i>Maximum RU size</i>	4096
<i>Send Window Count</i>	4
<i>Receive Window Count</i>	4
<i>Line type</i>	Switched
<i>Link station role</i>	Primary
<i>Line mode</i>	Constant request to send
<i>NRZI</i>	Yes
<i>Modem rate</i>	Full speed
<i>Data set ready timeout</i>	5
<i>XID repoll count</i>	10
<i>Non-XID repoll count</i>	7

Part 4. Appendixes for 3745 Models 130 to 610

Appendix C. Location of 3745 Console Connectors

This appendix applies to 3745 Models 130 to 610.

3745 Communication Controller Models 130, 150, 160, and 170

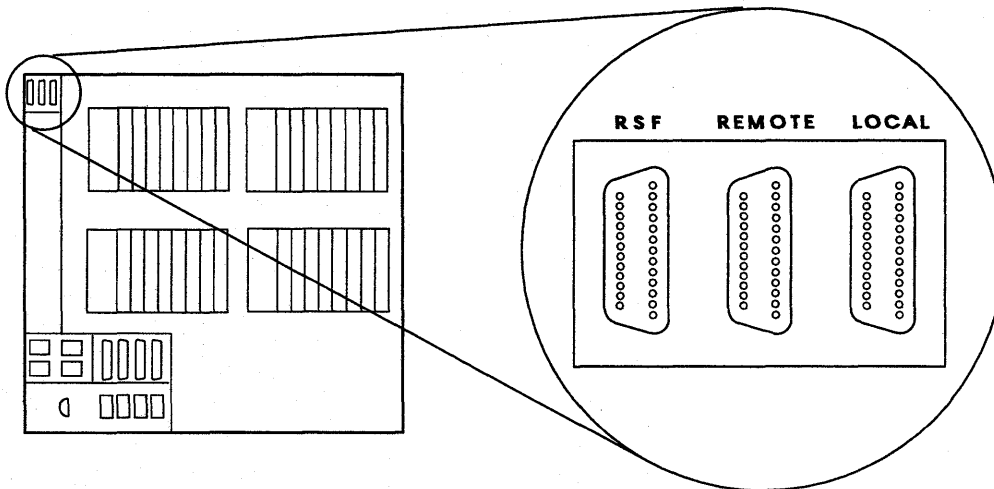

3745 Communication Controller Models 210, 310, 410, and 610

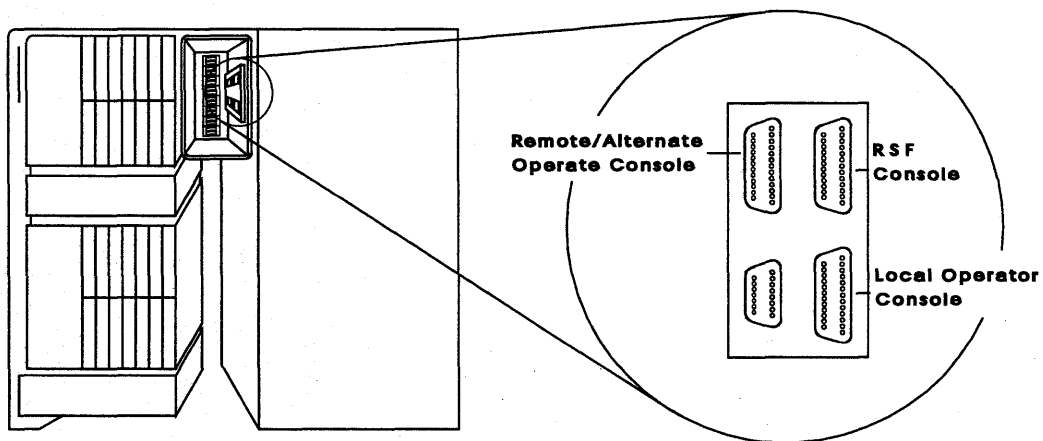

Appendix D. Console and RSF Interface Cables

This appendix applies to **3745 Models 130 to 610**.

Cable from the 3745 to a Local Console

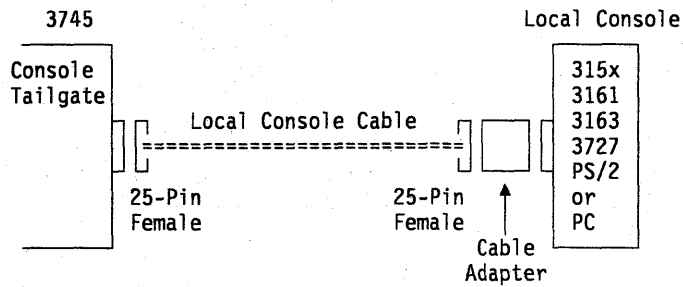

Local Console Cable Assembly

This cable assembly is for a 3745-to-7427 with three adapters to connect with 31xx, 3727, and PS/2 or PC consoles (see "Cable Adapters for Local/Alternate Console" on page D-2).

World Trade Only

3745 Model	Cable Type	Length, m (ft)	Cable Group	Assembly PN	Cable PN
130/150/160/170	Fixed Length	7 m (23)	Shipped	26F1794	03F4948
210/310/410/610	Fixed Length	7 m (23)	Shipped	26F1792	03F4487

U.S.A. Only

3745 Model	Cable Type	Length, m (ft)	Cable Group	Assembly PN	Cable PN
130/150/160/170	Fixed Length	7 m (23)	Shipped	76F8600	76F8639
210/310/410/610	Fixed Length	7 m (23)	Shipped	76F8607	76F8640

Cable from the 3745 to an Alternate Console

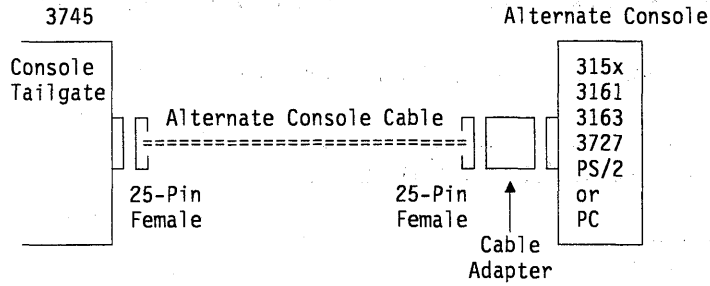

Alternate Console Cable Assembly

This cable assembly is a variable length with three adapters to connect with 31xx, 3727, and PS/2 or PC consoles (see "Cable Adapters for Local/Alternate Console").

3745 Model	Cable Type	Length, m (ft)	Cable Group	Assembly PN	Cable PN
130/150/160/170	Variable Length	Up to 35 m (115) Up to 122 m (400)	6147 NA	26F1799 26F1799	03F5026 03F5026
210/310/410/610	Variable Length	Up to 35 m (115) Up to 122 m (400)	5826 NA	34F1262 34F1262	65X8984 65X8984

Cable Adapters for Local/Alternate Console

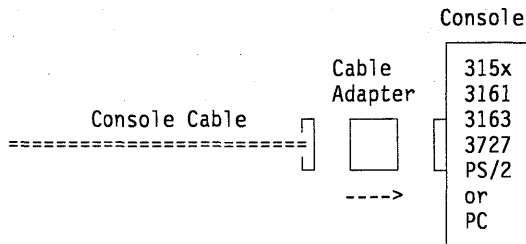

Notes:

For console 3727, use Cable Adapter P/N 54F0488. For console PS/2 or PC, use Cable Adapter P/N 54F0490. For console 31xx, use Cable Adapter P/N 54F0489.

Warning: When you install the 31xx adapter (P/N 54F0489), ensure that the arrow on the side of the adapter points towards the console. If the arrow is reversed, the console will not work.

Console Connection through the IBM 7427 Console Switching Unit

The 7427 can switch one console (3151/3153/3161/3163/3727, PS/2, or PC) to as many as four 3745s for a local console, or up to six 3745s for an alternate console.

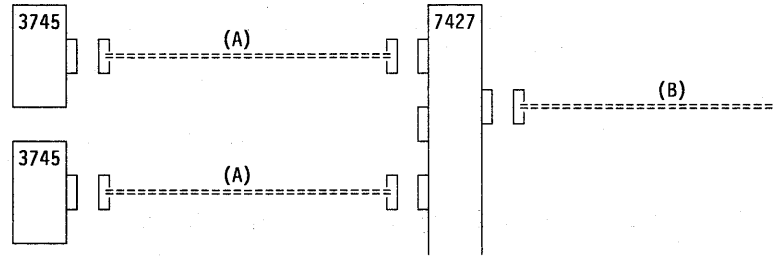

Cable from the 3745 to the 7427 Switching Unit (A)

Cable Assembly for Local Console

Refer to "Local Console Cable Assembly" on page D-1. The cable is used without any console adapter.

Cable Assembly for Alternate Console

Refer to "Alternate Console Cable Assembly" on page D-2. The cable is used without any console adapter.

Cable from the 7427 to a 31xx, PS/2, or PC Console (B)

Cable Assembly for 31xx Console

3745 Model	Cable Type	Length, m (ft)	Cable Group	Cable PN
All Models	Fixed Length	1 (3)	5828	65X8985

Cable Assembly for PS/2 or PC Console

3745 Model	Cable Type	Length, m (ft)	Cable Group	Cable PN
All Models	Fixed Length	2 (6.5)	8148	26F0317

Cable from the 7427 to a 3727 Console (B)

Cable Assembly

The cable for the 3727 console is delivered with the 7427 switching unit.

3745 Model	Cable Type	Length, m (ft)	Cable Group	Cable PN
All Models	Fixed Length	1 (3)	NA	6081308

Remote Console Cable

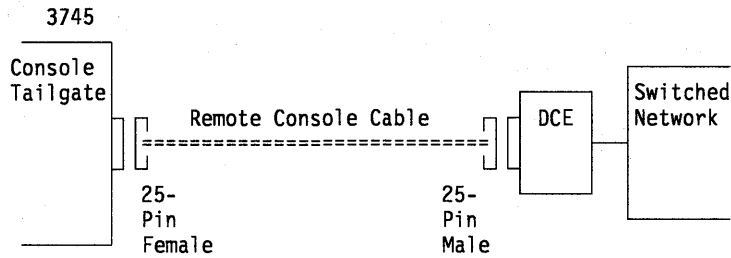

Cable to Modem for Remote Console

3745 Model	Cable Type	Length, m (ft)	Cable Group	Cable PN
130/150/160/170	Variable Length	Up to 13.5 m (45) Up to 122 m (400)	6148 NA	03F5027 03F5028
210/310/410/610	Variable Length	Up to 13.5 m (45) Up to 122 m (400)	6153 NA	03F4404 03F4405

Cable to Modem for RSF

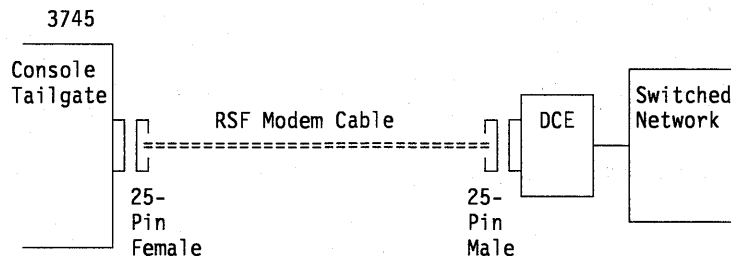

RSF Modem Cable

World Trade Only

3745 Model	Cable Type	Length, m (ft)	Cable Group	Cable PN
130/150/160/170	Fixed Length	13.5 m (45)	Shipped	03F4945
210/310/410/610	Fixed Length	13.5 m (45)	Shipped	65X8920

U.S.A. Only

3745 Model	Cable Type	Length, m (ft)	Cable Group	Cable PN
130/150/160/170	Fixed Length	13.5 m (45)	Shipped	76F8604
210/310/410/610	Fixed Length	13.5 m (45)	Shipped	76F8611

Part 5. Bibliography, Abbreviations, Glossary, and Index

Bibliography

Customer Documentation for the IBM 3745 (Models 210, 310, 410, 610, 21A, 31A, 41A, and 61A), and 3746 (Model 900)

Table X-1 (Page 1 of 4). Customer Documentation for the 3745 Models x10 and x1A, and 3746 Model 900

This customer documentation has the following formats:



Finding Information

3745 Models A and 3746 Books

Starting with engineering change (EC) F12380, all of the books in the 3745 Models A and 3746 library are available on the CD-ROM that contains the Licensed Internal Code (LIC) for this EC.



SA33-0172

IBM 3745 Communication Controller Models 210 to 61A
IBM 3746 Expansion Unit Model 900
Customer Master Index¹

Provides references for finding information in the customer documentation library.

Evaluating and Configuring



GA33-0092

IBM 3745 Communication Controller Models 210, 310, 410, and 610

Introduction

Gives an introduction about the IBM Models 210 to 610 capabilities. For Models A refer to the *Overview*, GA33-0180.



GA33-0180

IBM 3745 Communication Controller Models A²
IBM 3746 Nways Multiprotocol Controller Models 900 and 950

Overview

Gives an overview of connectivity capabilities within SNA, APPN, and IP networking.



GA33-0457

IBM 3745 Communication Controller Models A²
IBM 3746 Expansion Unit Model 900 Models 900 and 950

Planning Guide

Planning for:

- Field upgrades
- Service processor and alert management configuration
- Network integration (NCP, APPN, and IP control)
- Physical installation.

Table X-1 (Page 2 of 4). Customer Documentation for the 3745 Models x10 and x1A, and 3746 Model 900







Preparing Your Site		
	GC22-7064	<p>IBM System/360, System/370, 4300 Processor</p> <p>Input/Output Equipment Installation Manual-Physical Planning (Including Technical News Letter GN22-5490)</p> <p>Provides information for physical installation of the 3745 Models 130 to 610. For 3745 Models A and 3746 Model 900, refer to the <i>Planning Guide</i>, GA33-0457.</p>
	GA33-0127	<p>IBM 3745 Communication Controller Models 210, 310, 410, and 610</p> <p>Preparing for Connection</p> <p>Helps for preparing the 3745 Models 210 to 610 cable installation. For 3745 Models A refer to the <i>Connection and Integration Guide</i>, SA33-0129.</p>
Preparing for Operation		
	GA33-0400	<p>IBM 3745 Communication Controller All Models³ IBM 3746 Nways Multiprotocol Controller Models 900 and 950</p> <p>Safety Information¹</p> <p>Provides general safety guidelines.</p>
	SA33-0129	<p>IBM 3745 Communication Controller All Models³ IBM 3746 Nways Multiprotocol Controller Model 900</p> <p>Connection and Integration Guide¹</p> <p>Contains information for connecting hardware and integrating network of the 3745 and 3746-900 after installation.</p>
	SA33-0416	<p>Line Interface Coupler Type 5 and Type 6 Portable Keypad Display</p> <p>Migration and Integration Guide</p> <p>Contains information for moving and testing LIC types 5 and 6.</p>
	SA33-0158	<p>IBM 3745 Communication Controller All Models³ IBM 3746 Nways Multiprotocol Controller Model 900</p> <p>Console Setup Guide¹</p> <p>Provides information for:</p> <ul style="list-style-type: none"> • Installing local, alternate, or remote consoles for 3745 Models 130 to 610 • Configuring user workstations to remotely control the service processor for 3745 Models A and 3746 Model 900 using: <ul style="list-style-type: none"> – DCAF program – Telnet Client program.
Customizing Your Control Program		
	SA33-0178	<p>Guide to Timed IPL and Rename Load Module</p> <p>Provides VTAM procedures for:</p> <ul style="list-style-type: none"> • Scheduling an automatic reload of the 3745 • Getting 3745 load module changes transparent to the operations staff.
Operating and Testing		

Table X-1 (Page 3 of 4). Customer Documentation for the 3745 Models x10 and x1A, and 3746 Model 900







	SA33-0098	<p>IBM 3745 Communication Controller All Models⁴</p> <p>Basic Operations Guide¹</p>
Provides instructions for daily routine operations on the 3745 Models 130 to 610.		
	SA33-0177	<p>IBM 3745 Communication Controller Models A² IBM 3746 Nways Multiprotocol Controller Model 900</p> <p>Basic Operations Guide¹</p>
Provides instructions for daily routine operations on the 3745 Models 17A to 61A, and 3746 Model 900 operating as an SNA node (using NCP), APPN/HPR Network Node, and IP Router.		
	SA33-0097	<p>IBM 3745 Communication Controller All Models³</p> <p>Advanced Operations Guide¹</p>
Provides instructions for advanced operations and testing, using the 3745 MOSS console.		
	On-line Information	<p>Controller Configuration and Management Application</p>
Provides a graphical user interface for configuring and managing a 3746 APPN/HPR Network Node and IP Router, and its resources. Is also available as a stand-alone application, using an OS/2 workstation. Defines and explains all the 3746 network node and IP configuration parameters through its on-line help.		
	SH11-3081	<p>IBM 3746 Nways Multiprotocol Controller Models 900 and 950</p> <p>Controller Configuration and Management: User's Guide⁵</p>
Explains how to use CCM and gives examples of the configuration process.		
Managing Problems		
	SA33-0096	<p>IBM 3745 Communication Controller All Models³</p> <p>Problem Determination Guide¹</p>
A guide to perform problem determination on the 3745 Models 130 to 61A.		
	On-line Information	<p>Problem Analysis Guide</p>
An on-line guide to analyze alarms, events, and control panel codes on: <ul style="list-style-type: none"> • IBM 3745 Communication Controller Models A² • IBM 3746 Nways Multiprotocol Controller Models 900 and 950. 		

Table X-1 (Page 4 of 4). Customer Documentation for the 3745 Models x10 and x1A, and 3746 Model 900



SA33-0175

IBM 3745 Communication Controller Models A²
IBM 3746 Expansion Unit Model 900
IBM 3746 Nways Multiprotocol Controller Model 950

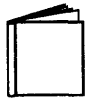
Alert Reference Guide

Provides information about events or errors reported by alerts for:

- IBM 3745 Communication Controller Models A²
- IBM 3746 Nways Multiprotocol Controller Models 900 and 950.

¹ Documentation shipped with the 3745.





² 3745 Models 17A to 61A.

³ 3745 Models 130 to 61A.

⁴ Except 3745 Models A.

⁵ Documentation shipped with the 3746-900.

Additional Customer Documentation for the IBM 3745 Models 130, 150, 160, 170, and 17A

<i>Table X-2. Additional Customer Documentation for the 3745 Models 1x0 and 17A</i>		
This customer documentation has the following format:		
		
Finding Information		
	SA33-0142	<p>IBM 3745 Communication Controller Models 130, 150, 160, 170, and 17A</p> <p>IBM 3746 Expansion Unit Model 900</p> <p>Customer Master Index¹</p> <p>Provides references for finding information in the customer documentation library.</p>
Evaluating and Configuring		
	GA33-0138	<p>IBM 3745 Communication Controller Models 130, 150, and 170</p> <p>Introduction</p> <p>Gives an introduction about the IBM Models 130 to 170 capabilities, including Model 160.</p> <p>For Model 17A refer to the <i>Overview</i>, GA33-0180.</p>
Preparing Your Site		
	GA33-0140	<p>IBM 3745 Communication Controller Models 130, 150, 160, and 170</p> <p>Preparing for Connection</p> <p>Helps for preparing the 3745 Models 130 to 170 cable installation.</p> <p>For 3745 Model 17A refer to the <i>Connection and Integration Guide</i>, SA33-0129.</p>
<p>¹ Documentation shipped with the 3745.</p>		

List of Abbreviations

ac	Alternating Current	IP	Internet Protocol
ACF	Advanced Communications Function	IPL	Initial Program Load
APPC	Advanced Program-to-Program Communication	ISDN	Integrated Services Digital Network
APPN	Advanced Peer-to-Peer Networking	ITU-T	International Telecommunications Union-Telecommunications (Formerly: CCITT)
AUI	Attachment Unit Interface	LAN	Local Area Network
BAN	Boundary Access Node	LAPS	LAN Adapter Protocol Support
BNN	Boundary Network Node	LIC	Line Interface Coupler
bps	bits per second	LU	Logical Unit
Bps	Bytes per second	m	meter; 1.09 yards; 3.28 feet; 39.37 inches
BSC	Binary Synchronous Communication	MAC	Medium Access Control
CCM	Controller Configuration and Management	MAE	Multiaccess Enclosure
CCITT	Comité Consultatif International Télégraphique et Téléphonique The International Telegraph and Telephone Consultative Committee (Now: ITU-T)	MAU	Multistation Access Unit
CM	Communications Manager	Mbps	Megabits per second; 1 048 476 bits per second
CP	Control Point	MCA	MOSS Console Adapter
CSD	Corrective Service Diskette	MOSS	Maintenance and Operator Subsystem
DCAF	Distributed Console Access Facility	MOSS-E	Maintenance and Operator Subsystem-Extended
DLC	Data Link Control	MPA	Multi-protocol Adapter
DNNP	Dual Network Node Processor	MPTS	Multiple Protocol Transport Services
DTE	Data Terminal Equipment	NCP	Network Control Program
EC	Engineering Change	NDF	Network Definition File
ECL	Error Checking Link	NN	Network Node
EIA	Electronic Industries Association	NNP	Network Node Processor
ES	Extended Services	NPM	NetView Performance Monitor
ESCON	Enterprise System Connection	NZRI	Non-Return-to-Zero Inverted
FCC	Federal Communications Commission	NTS	Network Transport Services
HPR	High Performance Routing	OS	Operating System
IBM	International Business Machines Corporation	PE	Product Engineer
IDF	Internet Protocol Definition File	PLU	Partner Logical Unit
IML	Initial Microcode Load	PPP	Point-to-Point Protocol
		PRPQ	Programming Request for Price Quotation

PS Personal System
PU Physical Unit
RAM Random Access Memory
RETAIN Remote Technical Assistance
Information Network
RSF Remote Support Facility
RTS Ready To Send
SAP Service Access Point
SDLC Synchronous Data Link Control
SNA Systems Network Architecture
SPAU Service Processor Access Unit

TCP/IP Transmission Control Protocol/Internet
Protocol
TIC Token-ring Interface Coupler
TP Transaction Program
URL Uniform Resource Locator
VCCI Japanese Voluntary Control Council for
Interference
VGA Video Graphics Adapter
VTAM Virtual Telecommunications Access
Method
WAN Wide Area Network

Glossary

This glossary defines all new terms used in this manual. It also includes terms and definitions from the *IBM Dictionary of Computing*, SC20-1699.

addressing. Where a controlling workstation with access to DTEs sharing transmission lines, selects a DTE to send a message.

Advanced Program-to-Program

Communication (APPC). An implementation of the SNA/SDLC LU6.2 protocol that allows interconnected systems to communicate and share the processing of programs.

advanced peer-to-peer networking (APPN).

An extension of SNA featuring: (a) greater distributed network control that avoids critical hierarchical dependencies, thereby isolating the effects of single point failure; (b) dynamic exchange of network topology information to foster ease of connection reconfiguration, and adaptive route selection; (c) dynamic definition of network resources; and (d) automated resource registration and directory lookup. APPN extends the LU 6.2 peer orientation for end-user services to network control and supports multiple LU types, including LU 2, LU 3, and LU 6.2.

alarm. A message sent to the MOSS operator console. In case of an error, a reference code identifies the nature of the error.

alert. A message sent to the host console. In case of an error, a reference code identifies the nature of the error.

communication controller. A device that directs the transmission of data over the data links of a network; its operation can be controlled by a program in the processor connected to the controller is connected, or controlled by a program within the device. Examples are the IBM 3705, IBM 3720/3725/3726, IBM 3745 models 130 to 61A, and IBM 3746 models 900/950.

communications manager. A function of the OS/2, allowing a workstation to connect to a host computer and use the host resources and resources of other personal computers attached to the workstation, either directly or through the host.

configuration data file (CDF). A 3745 MOSS file that contains a description of all the hardware features (presence, type, address, and characteristics).

configuration data file - extended (CDF-E). A 3746 MOSS-E file that contains a description of all the hardware features (presence, type, address, and characteristics).

control panel. A panel of switches and indicators for the operator and service personnel.

control point (CP). A collection of tasks which provide the directory and route selection functions for APPN. An end node control point provides the configuration, session, and management services in conjunction with the control point of the serving network node. A network node control point provides session and routing services.

control program. A program designed to schedule and supervise the execution of programs for the controller.

Customer engineer. See: *IBM service representative*.

data link control (DLC). In SNA, a set of rules used by two nodes on a data link to accomplish an orderly exchange of information. Synonymous with line control.

data terminal equipment (DTE). That part of a data station that serves as a data source, data link, or both, and provides for the data communication control function according to protocols. For example, the IBM 3745 can be a DTE.

Distributed Console Access Facility (DCAF).

(1) This program product provides a remote console function that allows a user at one programmable PS/2 workstation to remotely control the keyboard input and monitor the display of output of another programmable workstation. The DCAF program does not affect the application programs that are running on the workstation that is being controlled. (2) An icon that represents the Distributed Console Access Facility.

host processor. (1) A processor that controls all or part of a user application network. (2) In a network, the processing unit in which the access method for the network resides. (3) In an SNA network, the processing unit that contains a system services control point (SSCP). (4) A processing unit that executes the access method for attached communication controllers. Also called *host*.

IBM service representative. An individual in IBM who carries out maintenance services for IBM products or systems. Also called the *Customer engineer*.

integrated services digital network (ISDN). A digital end-to-end telecommunication network that supports multiple services including, but not limited to, voice and data.

International Telecommunication Union (ITU). The specialized telecommunication agency of the United Nations, established to provide standardized communication procedures and practices, including frequency allocation and radio regulations worldwide. (Formerly CCITT).

Internet Protocol (IP). In TCP/IP, a protocol that routes data from its source to its destination in an Internet environment.

line interface coupler (LIC). A circuit that attaches up to four transmission cables to the controller (from DTEs, DCEs, or telecommunication lines).

local area network (LAN). A computer network located on a user's premises within a limited geographical area. Communication within a LAN is not subject to external regulation; however, communication across the LAN boundary may be subject to some form of regulation.

logical unit (LU). In SNA, a port through which an end user accesses the SNA network in order to communicate with another end user and through which the end user accesses the functions provided by system services control points (SSCPs). An LU can support at least two sessions, one with an SSCP and one with another LU, and may be capable of supporting many sessions with other logical units.

maintenance and operator subsystem - extended (MOSS-E). The licensed internal code loaded on the service processor hard disk to provide maintenance and operator facilities to the user and IBM service representative.

medium access control (MAC). For LAN, the method of determining which device has access to the transmission medium at any time.

microcode. A program that is loaded in a processor (for example, the MOSS-E processor) to replace a hardware function. The microcode is not accessible to the customer.

multistation access unit (MAU). In the IBM token-ring network, a wiring concentrator that connect up to eight lobes to a ring.

NetView Performance Monitor (NPM). An IBM licensed program that collects, monitors, analyses, and displays data relevant to the performance of a VTAM telecommunication network. It runs as an on-line VTAM application program.

network. See *user application network*.

Network Control Program (NCP). An IBM licensed program that provides communication controllers supports for single-domain, multiple domain, and interconnected network capability.

network node processor (NNP). The processor that is attached to the 3746-950 via a token-ring LAN, running the APPN Network Node functions.

on-line information and help. Information stored in a computer system than can be displayed, used, and sometimes modified in an interactive manner without any need to obtain a hard copy.

physical unit (PU). In SNA, the component that manages and monitors the resources, such as attached links and adjacent link stations, associated with a node, as requested by an SSCP via an SSCP-PU session. An SSCP activates a session with the physical unit in order to indirectly manage, through the PU, resources of the node such as attached links. This term applies to type 2.0, type 4, and type 5 nodes only.

received line signal detector (RLSD). A signal defined in the EIA-232 standard that indicates to the data terminal equipment (DTE) that it is

receiving a signal from the remote data circuit-terminating equipment (DCE).

remote console. A PS/2 attached to the IBM 3746-950 either by a switched line (with modems) or by one of communication lines of the user network.

remote support facility (RSF). RSF provides IBM maintenance assistance when requested via the public switched network. It is connected to the IBM RETAIN database system.

service processor. The processor that is attached to the 3746-950 via a token-ring LAN, running the MOSS-E functions.

shutdown. The process of ending a operation of a system or subsystem, following a defined procedure.

subarea network. Connected subareas, their directly attached peripheral nodes, and the lines that connect them.

Synchronous Data Link Control (SDLC). A discipline for managing synchronous, code transparent, serial-by-bit information transfer over a link connection. Transmission exchanges may be duplex or half-duplex over switched or nonswitched links. The configuration of the link connection may be point-to-point, multipoint, or loop. SDLC conforms to subsets of the Advanced Data Communication Control Procedures of the American National Standards Institute and High-Level Data Link Control (HDLC) of the International Standard Organization (ISO).

token ring. A network with a ring topology that passes tokens from one attaching device to another.

token-ring adapter (TRA). Line adapter for IBM Token-Ring Network, composed of one token-ring processor card (TRP), and two token-ring interface couplers (TICs).

token-ring interface coupler type 3 (TIC3). A circuit that attaches an IBM Token-Ring network to an IBM 3746-900 or 3746-950.

transmission interface. The interface between the controller and the user application network.

transmission line. The physical means for connecting two or more DTEs (via DCEs). It can be nonswitched or switched. Also called a *line*.

user application network. A configuration of data processing products, such as processors, controllers, and terminals, for data processing and information exchange. This configuration may use circuit-switched, packet-switched, and leased-circuit services provided by carriers or the PTT. Also called *user network*.

Virtual Telecommunication Access Method (VTAM). A set of programs that maintain control of the communication between terminals and application programs running under DOS, OS/1, and OS/2 operating systems.

V.24 and V35. ITU-T recommendations on transmission interfaces.

Index

Numerics

3151
 in 3101 emulation mode 10-3, 11-3
 in native mode 10-2, 11-2
3153 in 3151 emulation mode 10-5, 11-5
3161 10-6, 11-6
3163 10-6, 11-6
3727 10-9
7427 D-3

A

adapters
 for 3745 consoles D-2
alternate console (3745) D-2
APPC LAN-attached DCAF workstation 1-2, 5-1
APPN-attached DCAF workstation 1-2, 8-1
attached DCAF workstation
 via APPN backbone 1-2, 8-1
 via LAN (APPC-type) 1-2, 5-1
 via modem 1-3, 6-1
 via SNA backbone 1-2, 7-1
 via TCP/IP 1-2, 4-1
attached Telnet workstation
 via TCP/IP 9-1

C

cable
 3745 alternate console D-2
 3745 local console D-1
 adapters for 3745 consoles D-2
 to modem for 3745 remote console D-4
closing
 DCAF remote session 3-2
 Telnet remote session 9-2
communications manager/2
 customizing 2-3
configuration 6-6
 DLC for DCAF 2-4
 modem 13-1
configuration file HAYESASY 6-35
configuration file HAYESAUT 6-40
configuration file I7855ASY 6-15
configuration file I7855SYN 6-10

configuration file I7857ASY 6-25
configuration file I7857AUT 6-30
configuration file I7857SYN 6-20
configuring workstation modems 6-4
console
 3151 10-2, 11-2
 3153 10-5, 11-5
 3161 10-6, 11-6
 3163 10-6, 11-6
attachment
 alternate D-2
 local D-1
 remote D-4
 RSF D-4
 through 7427 D-3
DCAF
 attachment 1-2
 installation 2-1
IBM PC 11-6
IBM PS/2 10-6, 11-7
Telnet attachment 9-1
customer
 Telnet consoles 9-1
customizing
 CM/2 on a DCAF remote workstation 2-3
customizing DCAF for a modem

D

DCAF 6-45
 APPC LAN-attached workstation 5-1
 APPN-attached workstation 8-1
 closing a remote session 3-2
 DCAF consoles 1-1
 hardware requirements and
 recommendations 1-5
 hot keys 1-1
 installing a remote workstation 2-1
 installing the program 2-2
 Modem-attached workstation 6-1
 preparation 2-1
 programming requirements 1-4
 remote logon password 1-3
 security level 1-4
 service processor DLC configuration B-1
 service processor security 1-3
 SNA-attached workstation 7-1

DCAF (continued)

- starting a remote session 3-1
- target service processor
 - NCP definitions 7-13
 - VTAM major node definitions 7-15
- TCP/IP-attached workstation 4-1
- upgrading the program 2-3
- definitions
 - NCP for DCAF 7-12
 - VTAM
 - logmode table 7-14
 - major node for remote workstation 7-15
 - major node for target service processor 7-15
 - start 7-14
- determining the OS/2 code level 2-2
- diskette with example configurations 1-3
- DLC configuration for service processor 2-4, B-1

E

- example configurations diskette 1-3

H

- hardware
 - recommendations for DCAF 1-5
 - recommendations for Telnet 9-2
 - requirements for DCAF 1-5
 - requirements for Telnet 9-2
- hot keys 1-1

I

- IBM 5858 modem 13-1
- IBM 7855 modem setting 12-3
- IBM 7857 modem setting 12-4
- IBM 7858 modem setting 12-6
- IBM PC as 3745 console 11-6
- IBM PS/2 as 3745 console 10-6, 11-7
- installing
 - APPN-attached DCAF remote workstation 8-4
 - DCAF
 - program 2-2
 - session 2-1
 - SNA-attached DCAF remote workstation 7-5
 - TCP/IP
 - attached DCAF remote workstation 4-4
 - attached Telnet workstation 9-1

L

- local console connection (3745) D-1
- locating
 - 3745 console connectors C-1
- logmode table, VTAM 7-14
- logon
 - from DCAF remote workstation 3-1

M

- major node definitions
 - DCAF remote workstation 7-15
 - DCAF target service processor 7-15
- minimum
 - DCAF workstation configuration 1-4
 - Telnet workstation configuration 9-2
- modem
 - 5858 setting 13-1
 - 7855 setting 12-3
 - 7857 setting 12-4
 - 7858 setting 12-6
- modem configuration types for CS/2
- modem-attached DCAF workstation 1-3, 6-1
- modems

N

- NCP definitions
 - DCAF remote workstation 7-12
 - DCAF target service processor 7-13

P

- password
 - DCAF remote logon 1-3
 - Telnet remote logon 9-2
- procedure 2 6-15
- procedure 3 6-20
- procedure 4 6-25
- procedure 5 6-30
- procedure 6 6-35
- procedure 7 6-40
- procedure for service processor 3172 6-10, 6-15, 6-20, 6-25, 6-30, 6-35, 6-40
- procedure for service processor 7585 6-15, 6-25, 6-35
- procedure for service processor 9577 6-10, 6-15, 6-20, 6-25, 6-30, 6-40
- procedure for service processor 9585 6-10, 6-15, 6-20, 6-25, 6-30, 6-35, 6-40

- procedures for configuring CS/2 6-6
- procedures for service processor 3172 6-8
- procedures for service processor 7585 6-9
- procedures for service processors 9577 and 9585 6-7
- programming
 - requirements for DCAF 1-4
 - requirements for Telnet 9-2

R

- recommendations
 - for remote DCAF workstations 1-5
 - for remote Telnet workstations 9-2
- regaining control of the service processor 1-4
- remote console
 - 3745 connection D-4
- remote DCAF workstation
 - APPC LAN-attached 1-2, 5-1
 - APPN-attached 1-2, 8-1
 - installation 2-1
 - Log On 3-1
 - modem-attached 1-3, 6-1
 - NCP definitions 7-12
 - SNA-attached 1-2, 7-1
 - TCP/IP LAN-attached 1-2
 - two-target configuration example A-1
 - VTAM major node definitions 7-15
- remote Telnet workstation
 - TCP/IP-attached 9-1
- RSF
 - 3745 modem cable D-4
 - 3745 modems 13-1

S

- saving operations
 - modem configuration 12-5, 12-7
- service processor
 - DCAF DLC configuration 2-4, B-1
 - regaining control 1-4
 - remote DCAF Log On 3-1
- service processor 3172 6-10, 6-15, 6-20, 6-25, 6-30, 6-35, 6-40
- service processor 7585 6-15, 6-25, 6-35
- service processor 9577 6-10, 6-15, 6-20, 6-25, 6-30, 6-35, 6-40
- service processor 9585 6-10, 6-15, 6-20, 6-25, 6-30, 6-35, 6-40

- setting
 - 3745 alternate console 10-1
 - 3745 local console 10-1
 - 3745 remote console 11-1
 - 5858 modem configuration 13-1
 - 7855 modem configuration 12-3
 - other IBM modems 12-1
- SNA-attached DCAF workstation 1-2, 7-1
- start definitions, VTAM 7-14
- starting
 - DCAF remote session 3-1
 - Telnet remote session 9-2

T

- TCP/IP
 - attached DCAF workstation 1-2, 4-1
 - attached Telnet workstation 9-1
 - installing the program 2-3
- Telnet
 - customer console 9-1
 - hardware requirements and recommendations 9-2
 - installing a remote workstation 9-1
 - programming requirements 9-2
 - remote logon password 9-2
 - starting a remote session 9-2
 - TCP/IP-attached workstation 9-1
- testing connection
 - from 3745 alternate console 10-10
 - from 3745 local console 10-10
 - from 3745 remote console 11-13
- two-target DCAF configuration example A-1

U

- upgrade
 - DCAF program 2-3

V

- VTAM
 - logmode table 7-14
 - major node for DCAF remote workstation 7-15
 - major node for DCAF target service processor 7-15
 - start definitions 7-14

W

workstation (DCAF)

APPC LAN-attached 1-2, 5-1

APPN-attached 1-2, 8-1

installation 2-1

minimum configuration 1-4

modem-attached 1-3, 6-1

NCP definitions 7-12

SNA-attached 1-2, 7-1

TCP/IP LAN-attached 1-2

two-target configuration example A-1

VTAM major node definitions 7-15

workstation (Telnet)

TCP/IP-attached 9-1

Readers' Comments — We'd Like to Hear from You

**3745 Communication Controller All Models
3746 Nways Multiprotocol Controller Model 900
Console Setup Guide**

Publication No. SA33-0158-09

Please send us your comments concerning this book. We will greatly appreciate them and will consider them for later releases of the present book.

If you prefer sending comments by FAX or electronically, use:

- FAX: 33 4 93 24 77 97
- IBM Internal Use: LGERCF at IBMFR
- Internet: lgercf@fr.ibm.com

In advance, thank you.

Your comments:

Name

Address

Company or Organization

Phone No.

Readers' Comments — We'd Like to Hear from You
SA33-0158-09



Cut or Fold
Along Line



Fold and Tape

Please do not staple

Fold and Tape

PLACE
POSTAGE
STAMP
HERE



IBM France
Centre d'Etudes et Recherches
Service 0798 - BP 79
06610 La Gaude
France



Fold and Tape

Please do not staple

Fold and Tape



SA33-0158-09

Cut or Fold
Along Line



.

,



.

.





Part Number: 34F1251

Printed in the United Kingdom

