

IBM 402, 403 and 419

Accounting Machines

Manual of Operation

MINOR REVISION (October 1963)

This edition, Form 224-5654-13, is a minor revision but does not obsolete the previous edition, Form 224-5654-12. Principal change in this edition is to include series 50 machines.

© 1949, 1951, 1952 and 1953 by International Business Machines Corporation

Copies of this and other IBM publications can be obtained through IBM Branch Offices.

Address comments regarding the content of this publication to IBM Product Publications, Endicott, New York.

CONTENTS

SECTION I

TYPE 402 AND TYPE 403 ACCOUNTING MACHINE

Introduction	5
Control Panel	7
Operating Switches and Signals	8
The Print Unit	9
Detail Printing: Numerical Information	9
Detail Printing: Alphabetic Information	13
Zero Printing	16
Addition	17
Program Control	21
Group Printing	26
Subtraction	26
X Selection	36
Digit Selection	38
Selective Printing	39
Offset Total Printing	40
Hammerlock Control	42
Group Indication	45
Setup Change	48
Total Transfer, Net Balance Machine	50
Total Transfer, Non-Net Balance Machine	55
Crossfooting, Net Balance Machine	56
Crossfooting, Non-Net Balance Machine	58
Field Selection	61
Class Selection	65
Space Control	68
Multiple X Selection	72
Machine Stop	74
Recognizing Negative Balances	75
Split Column Control	76
Summary Punching	77

Progressive Total Printing	86
Run Out Buttons and Switches	87
Special Program	88

SECTION II

IBM TAPE-CONTROLLED CARRIAGE

Introduction	93
Control Tape	95
Operating Features	97
Form Control	100
Single Heading Forms	102
Multiple Heading Groups—Overflow Sheet Identification	107
Inverted Form Operations	109
Single Sheet Form Feeding	112

SECTION III

TYPE 403 ACCOUNTING MACHINE

Introduction	113
Multiple Line Printing	116
MLP Selector System	121
MLP Cards Followed by Normal Cards	124
Successive Feed — MLP Selector Expansion	127
Single Card Total Elimination	130
Crossfooting Using MLP Selector System	133

SECTION IV

FORM FEEDING DEVICES	135
CONTROL PANEL SUMMARY	143
SPACING CHART	151
TIMING CHARTS	152
INDEX	156

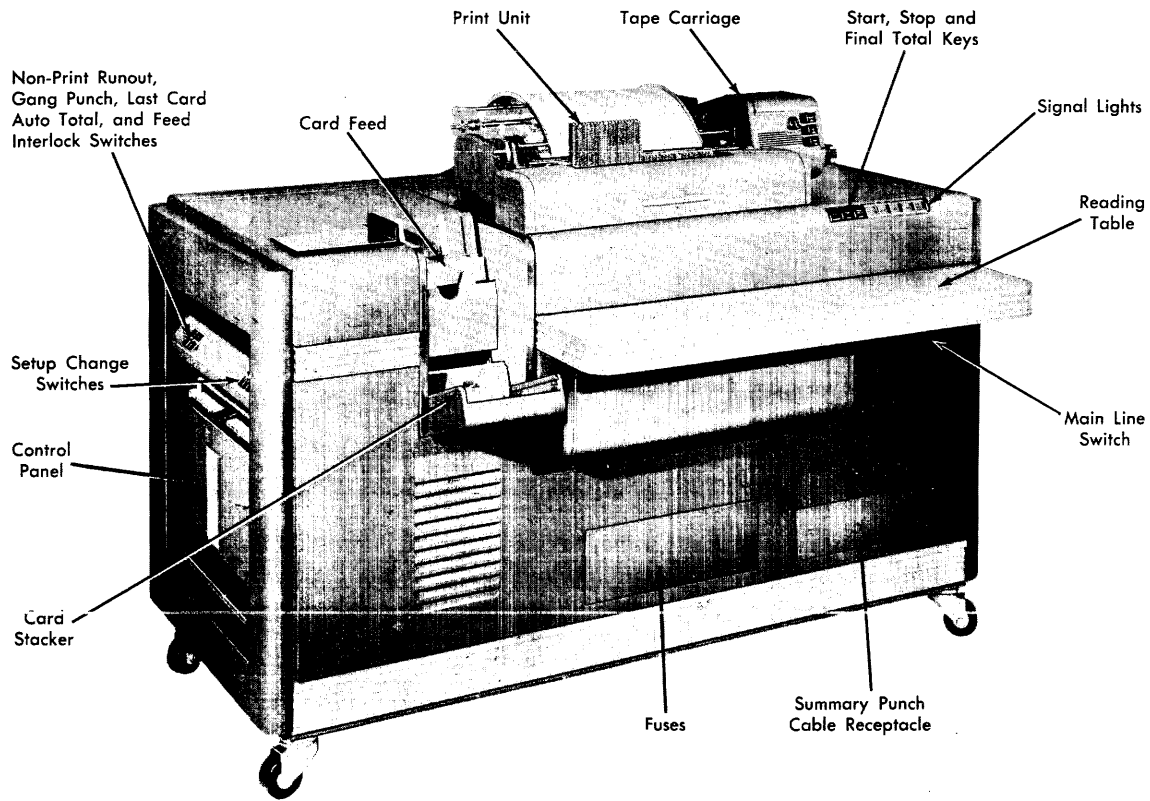

IBM ACCOUNTING MACHINE
TYPE 402

IBM

ALPHABETIC ACCOUNTING MACHINES, TYPES 402, 403 NUMERICAL ACCOUNTING MACHINE, TYPE 419*

THE IBM Accounting principle consists of three basic steps. First, information written or otherwise recorded on an order, job ticket, material requisition or other source document is transcribed to an IBM card in the form of punched holes. Second, the punched cards are arranged in sequence by the Sorter. Third, printed reports are prepared automatically by an Accounting Machine, which reads the holes in the cards and prints a report. This function is performed by both the Type 402 Accounting Machine and the Type 403 Accounting Machine with the Multiple Line Printing feature.

The Type 402 and the Type 403 operate automatically in both the feeding of cards and the printing of results. The information punched in the card is read and printed at a maximum speed of 50 or 100 cards per minute; at the same time, it may be added, subtracted, compared or selected according to the requirements of the report. Complete flexibility is provided in the arrangement of the printed data on the report form, and summary cards can be punched simultaneously with the preparation of reports.

The two machines differ only in the number of lines which can be printed from one card. The Type 402 normally prints only one line from a card. The Type 403, on the other hand, can print three lines from a single card, and for this reason it is called a Multiple Line Print (MLP) machine. In other respects, the machines are alike, and the same basic principles of operation apply to both.

The Tape-Controlled Carriage, a feature of both the Type 402 and 403 machines, controls the feeding and spacing of report forms or documents which are prepared by the Accounting Machine.

Both the Type 402 and Type 403 machines may be obtained in two speed combinations, namely 50/50 and 100/150.

The operation of both Accounting Machines and the Tape-Controlled Carriage are described in the first three sections.

To obtain an understanding of the Type 402, section 1 and 2 should be read. To obtain an understanding of the Type 403, sections 1, 2, and 3 should be read. The explanation of the Carriage should be read before the explanation of the Type 403, since MLP operations by their very nature deal with many carriage functions.

The functions described in each of the first three sections are illustrated by typical examples, with sample cards, reports, and wiring diagrams. The control panel hubs are explained as they are first introduced.

The fourth section is devoted to a description of several miscellaneous items.

Ready reference to the function of each control panel hub may be found in the index. Although a general description of a particular feature precedes its use in a problem, it is sometimes necessary to read a problem explanation in order to obtain more detailed information regarding its application.

The sections are arranged in order of complexity, and each presupposes a knowledge of features already explained in preceding sections. To learn the operation of the machines, therefore, most effective results will be obtained by reading the sections in order.

*This manual applies specifically to the Types 402 and 403 Alphabetic Accounting Machines, but numerical operations described for the Type 402 apply also to the Type 419 Numerical Accounting Machine. The Type 419 operates at a speed of 150 cards per minute.

403

9

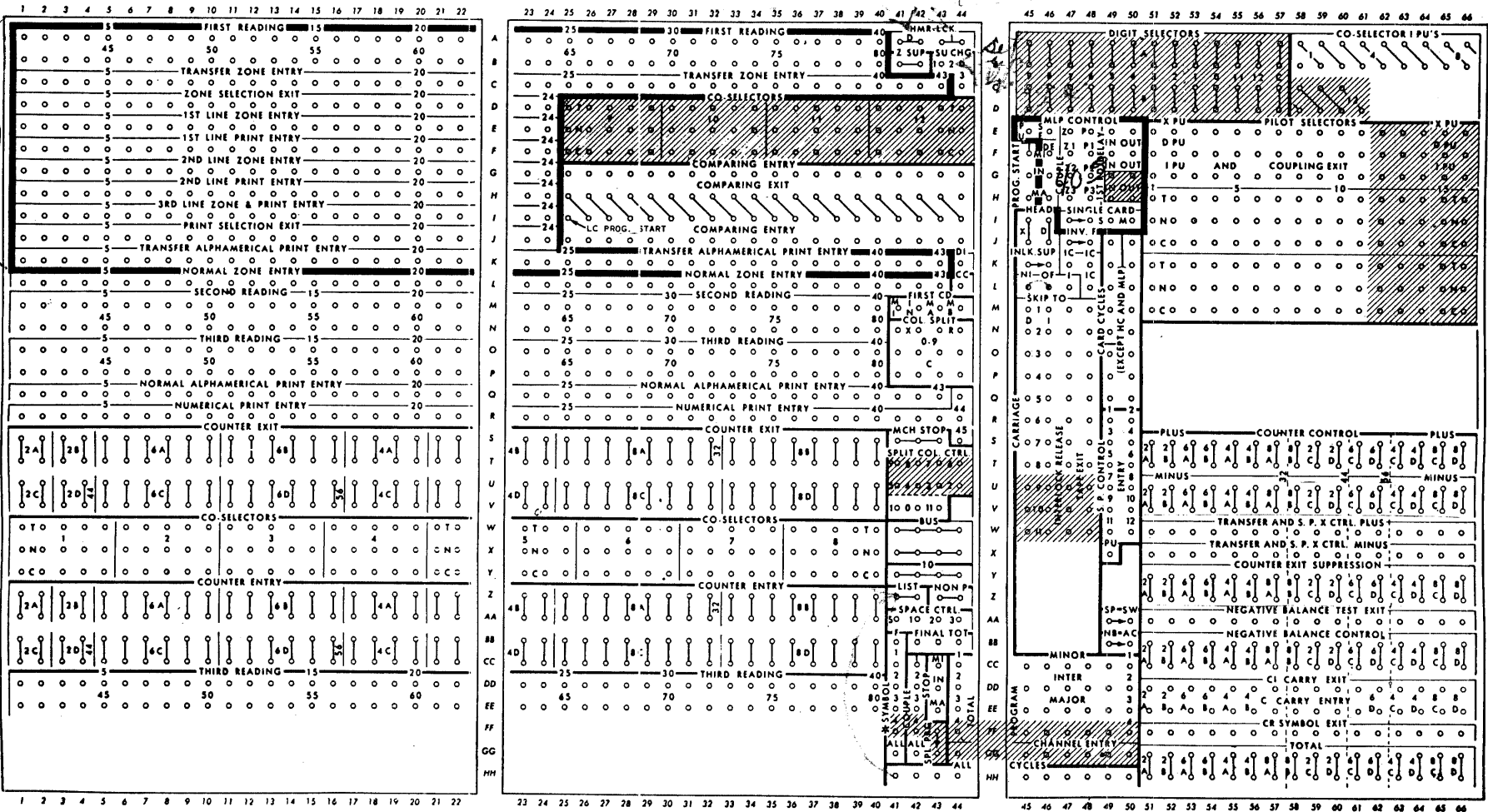

FIGURE 1. CONTROL PANEL

CONTROL PANEL

THE AUTOMATIC operation of the Accounting Machines is obtained through a control panel, which directs the machine to perform various functions according to the requirements of the report being prepared. The same control panel arrangement (Figure 1) serves both the Types 402 and 403 Accounting Machines.

The machines operate from electrical impulses which result from sensing the holes in a card. An impulse originates when a contact is made between a brush and a metal roll. Such a contact is possible when there is a hole in a card which is passing between the brush and the roll. The impulse travels by internal connections to the control panel, and by means of external wires it can be directed to perform the required operation.

There are two kinds of hubs on the control panel, exits and entries. An exit is one which emits an impulse. Some exits are under the control of the hole in the card, and others result from some function previously performed or are automatic for every card. An entry hub is one which can accept an impulse wired to it. A connection must always be made from an exit to an entry, by placing one end of a wire in the exit hub and the other end in the entry hub. Which exits and entries are used will depend entirely upon the job the machine is called upon to do. The control panel wiring may be changed to prepare each new report, thereby giving to one machine the flexibility to produce different types of documents or reports for many different applications.

Whenever two or more hubs are connected by lines, as shown below, these hubs are common,



that is, two or more exits or entries serve the same purpose. Such an arrangement reduces the need for split wires (wires with more than two ends) since these hubs are actually connected together and serve the same purpose as split wires. An arrow between two hubs identifies them as a switch which is turned on by connecting the two hubs. A curved arrow indicates the switch can be connected through a selector.



The control panel is divided into three parts, each part having 22 vertical rows of hubs. The rows are numbered across the top and bottom and lettered between each section of the panel for ease in identification. For example, the card cycle hubs may be readily located by reference to rows J through Q and the numbers 49 and 50.

The hubs enclosed in the heavy black lines are for use on MLP (403) machines only. The remaining hubs are used on both the 402 and 403 machines. The shaded hubs show additional or optional features, which may be added to the 80-counter machine.

OPERATING SWITCHES AND SIGNALS

Main Line Switch

To operate the machine, the main line switch, located beneath the right end of the reading table, must be turned ON.

Start Key

The start key must be depressed to start the feeding of cards through the machine. It must also be depressed to resume operation after the machine has stopped for any reason other than feed interlock, as explained on page 87.

Stop Key

When the stop key is depressed, the machine will stop before the next card is fed. If a total cycle is in process or about to be started when the stop key is depressed, the cycle will be completed before the machine stops.

Final Total Key

This key provides for manual control over total printing. When a counter is controlled from a final total hub on the control panel, that counter cannot be cleared until the following conditions are satisfied:

- A. The machine must be idling.
- B. The hopper must be empty.
- C. The last card must be in the stacker.
- D. Depress the start key while the final total key is being held depressed.

Light (Unlabelled)

The red light (unlabelled) will go ON when the main line switch is turned ON and the machine is idling.

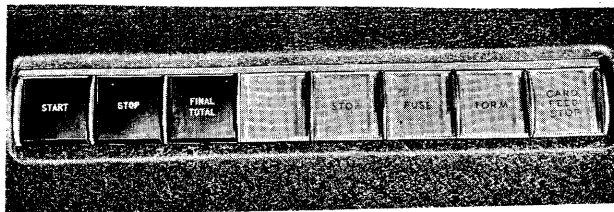

FIGURE 2. OPERATING KEYS AND LIGHTS

Stop Light

The red stop light will go ON whenever the machine stops because of an impulse received by a machine stop hub on the control panel. While the stop light is ON, the machine cannot be restarted. To turn it OFF, the final total key must be depressed.

Fuse Light

The red fuse light goes ON and the machine stops whenever a fuse burns out. The fuses are located toward the bottom of the machine below the reading table.

Form Light

The red form light goes ON and the machine stops whenever the last form is within 10 inches of the platen.

Card Feed Stop Light

The red card feed stop light goes ON whenever a summary punch operation is started by the accounting machine. It will remain on and prevent further operation of the accounting machine if for any reason the summary punch operation is not satisfactorily completed. This light also goes on if a card fails to feed from the hopper of either the accounting machine or the summary punch.

THE PRINT UNIT

THE function of the print unit is to record information on the report form or document. This information may be alphabetical or numerical, and it may be printed one line for each card (detail printing) or one line for a group of cards (group printing).

The print unit (Figure 3) consists of a variable number of type bars, depending upon the size of the machine. The maximum number of type bars is 88, of which 43 will print both alphabetic and numerical information and 45 will print numerical information only. The 43 alphabetic and numerical (alphanumeric) type bars are located on the left side of the print unit, and the 45 numerical type bars on the right side. The two sets of type bars are separated from each other by a space equivalent to one type bar.

Each alphanumeric type bar consists of 26 alphabetic characters, the numbers 0 through 9, and a special character position which contains the ampersand character (&). Each numerical type bar consists of 10 numerals and one symbol. In odd-numbered type bars the symbol is an asterisk (*), and in even-numbered type bars it is a credit symbol (CR.).

A ribbon similar to that used on typewriters, moves behind the type bars from a spool on the

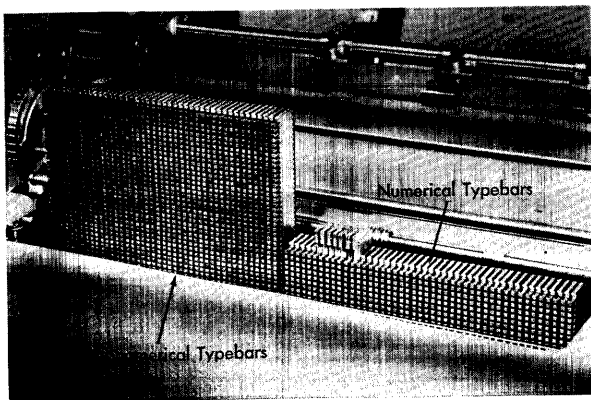

FIGURE 3. PRINT UNIT

right to a spool on the left. When the right spool is completely wound, the action is automatically reversed.

The character in the type bar which will be positioned for printing is determined by the holes punched in the card, or by the totals which the machine has accumulated. Behind each type bar is a hammer which fires after the type bar has been positioned, forcing the type bar character against the paper.

DETAIL PRINTING: NUMERICAL INFORMATION

DETAIL PRINTING is the printing of information from each card as it passes through the machine. The machine prints the information which is punched in the card as directed by control panel wiring. Numerical information is punched in the card as shown in Figure 4.

The Type 403 has three sets of brushes labelled first, second and third reading. The Type 402 has only two sets of brushes labelled second and third reading. On the 402, the card is read at the

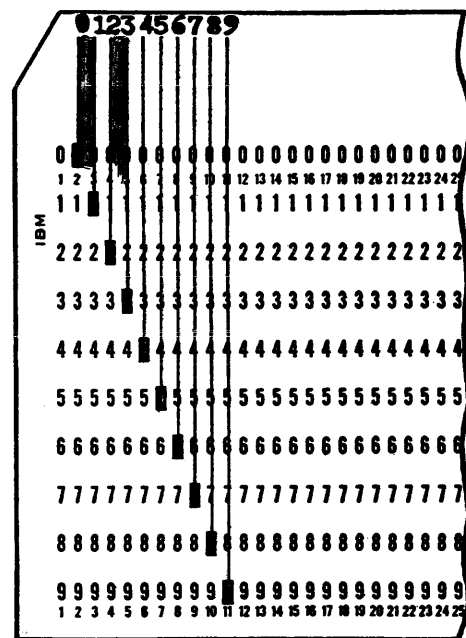

FIGURE 4. NUMERICAL PUNCHING

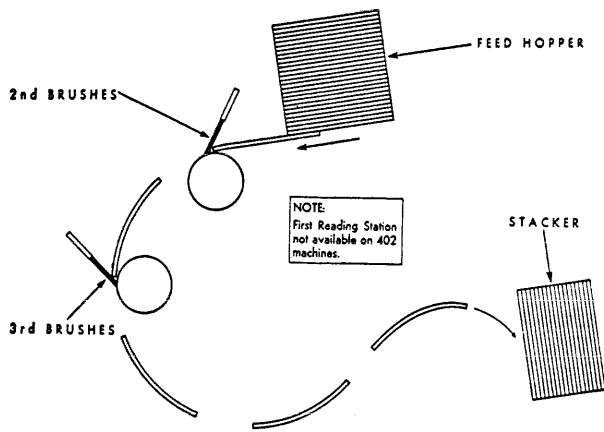
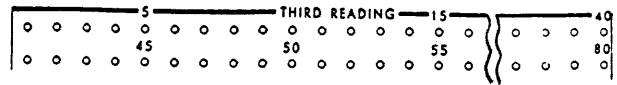

FIGURE 5. PATH OF CARD THROUGH THE TYPE 402

third reading station for printing. The location of the 80 brushes of the third reading station in the machine is shown in Figure 5, one station below the second reading station. The cards are placed in the feed hopper face down, 9's toward the throat. When the start key is depressed, the cards begin to feed into the machine. One by one they are moved out of the hopper, pass the second and third reading brushes, and from there to the stacker. As the card passes the third reading station, each of the 80 columns is read by one of the 80 brushes, and when a hole is sensed, an impulse is made available at the hub on the control panel corresponding to the card column in which the hole is punched. For example, if a 5 is punched in column 45 of the card, a 5 impulse will be available at hub 45 of third reading, regardless of whether or not that hub is wired to print.

The card moves past the brushes one row at a time. If all 80 columns were punched 9, all 80 third reading hubs would emit 9 impulses at the same time. If all 80 columns were punched 5, all 80 third readings hubs would emit five impulses at the same time. These impulses are used to actuate the type bars to cause printing.



O-P, 1-40; DD-EE, 1-40

Third Reading. There are two sets of third reading hubs, one set in the middle of the control panel and the other set at the bottom. The corresponding hubs in both sets are common and can be used interchangeably.

The third reading brushes are used for all normal reading operations. In order to print information that is punched in a card, impulses from the third reading brushes must be directed to either normal alphanumerical or numerical print entry hubs.



Q, 1-43

Normal Alphanumerical Print Entry. Each alphanumerical type bar has a corresponding normal print entry hub on the control panel; when these hubs are wired from the third reading brushes, the type bars print the numerical information punched in the corresponding columns of the card.



R, 1-44; S, 44

Numerical Print Entry. Each numerical type bar has a corresponding print entry hub on the control panel. The hub for print entry 45 is located below 44.

When a numerical print entry hub is impelled from a third reading brush hub, the type bar prints the numerical information punched in the corresponding column of the card.

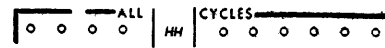

HH, 41-50

All Cycles. These ten hubs emit impulses which can be used to control many functions in the machine. They are available on every machine cycle, including those cycles when the cards are standing still.

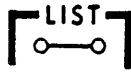

Z, 41-42

List. When these hubs are impulsed, all 88 type bars rise every time a card passes the third reading station. If there are holes in the card and the control panel is properly wired, the type bars will print every time they rise. This operation, called detail printing, is done at the rate of 80 or 100 cards per minute. Single spacing is automatic before each line prints.

If every card is to be printed, the list hubs are wired directly from all cycles.

In the report shown in Figure 7, the vendor number, punched in columns 18-22 of the card, must print in the vendor number column of the cash requirements statement. Likewise the vendor abbreviation, due date, discount, etc., must print under their respective headings.

The easiest way to determine which type bars to use in order to print vendor number in the report column set aside for it is to superimpose the report itself on a spacing chart as shown in Figure 6. The numbers across the top and bottom of the spacing chart represent type bar positions and the numbers between type bars 43 and

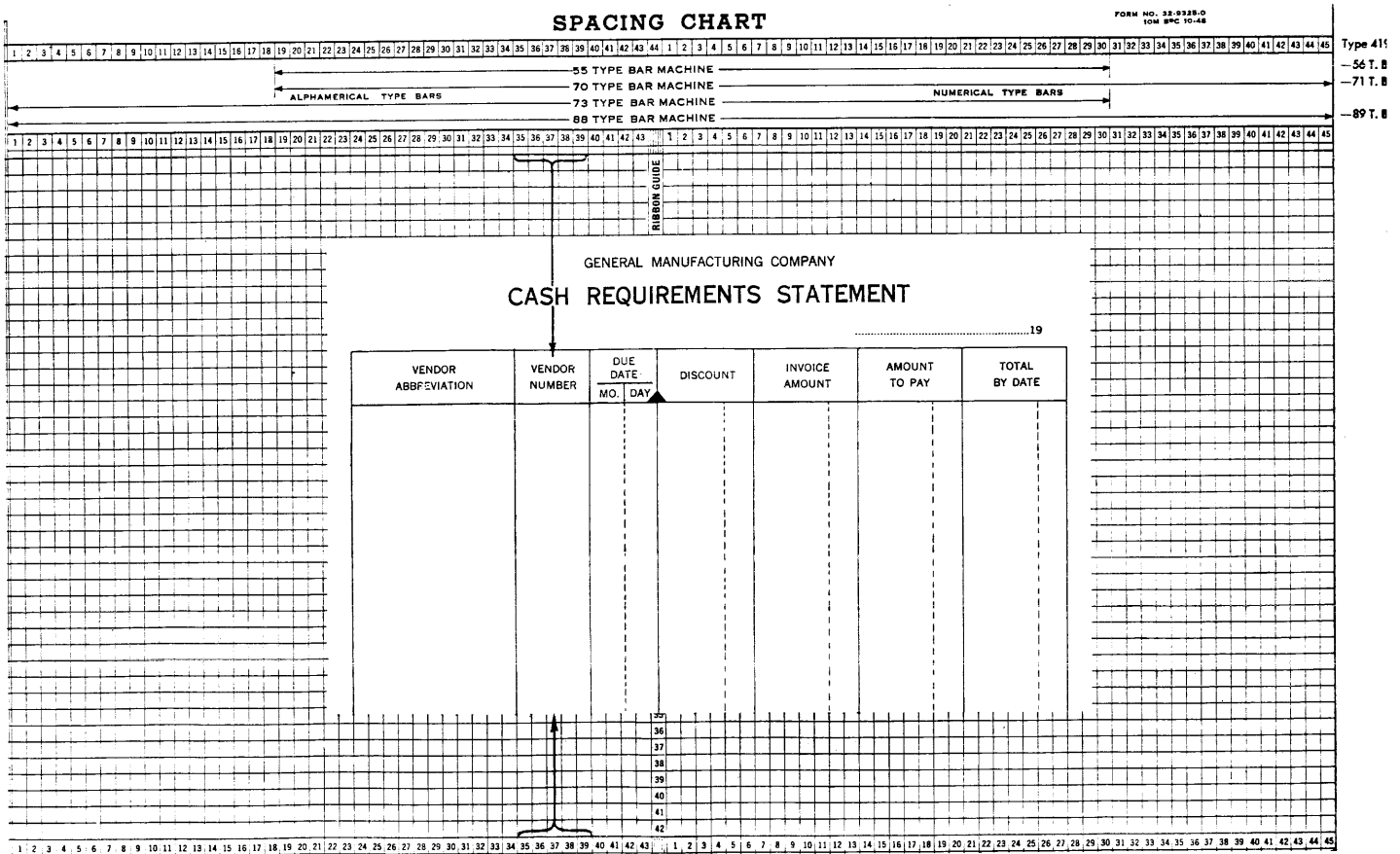

NOTE: On the Types 402, 403 Alphabetic Accounting Machines, the alphanumerical type bars (1-43) are separated from the numerical type bars (1-45) by a ribbon guide position. On the Type 419 Numerical Accounting Machine the ribbon guide is removed and an additional type bar (44) is inserted in its place. Thus, the numerical type bars on the Type 419 are numbered 1-44 on the left and 1-45 on the right.

FIGURE 6. REPORT AND SPACING CHART

K23K21										ABBOT BRASS										011791212030211										K310031800158780015560									
ENTRY	DATE	INVT	DATE	VENDOR		NO.	OUR	INVT	EN	GEN.	DATE	PAID	DUE	DATE	DISCOUNT	INVOICE	AMOUNT	AMOUNT	TO	PAY	DETAIL																		
0	0	0	0	0	0	0	0	0	0	0	0	0	0	0	0	0	0	0	0	0	0																		
1	1	1	1	1	1	1	1	1	1	1	1	1	1	1	1	1	1	1	1	1	1																		
2	2	2	2	2	2	2	2	2	2	2	2	2	2	2	2	2	2	2	2	2	2																		
3	3	3	3	3	3	3	3	3	3	3	3	3	3	3	3	3	3	3	3	3	3																		
4	4	4	4	4	4	4	4	4	4	4	4	4	4	4	4	4	4	4	4	4	4																		
5	5	5	5	5	5	5	5	5	5	5	5	5	5	5	5	5	5	5	5	5	5																		
6	6	6	6	6	6	6	6	6	6	6	6	6	6	6	6	6	6	6	6	6	6																		
7	7	7	7	7	7	7	7	7	7	7	7	7	7	7	7	7	7	7	7	7	7																		
8	8	8	8	8	8	8	8	8	8	8	8	8	8	8	8	8	8	8	8	8	8																		
9	9	9	9	9	9	9	9	9	9	9	9	9	9	9	9	9	9	9	9	9	9																		

CASH REQUIREMENTS STATEMENT

VENDOR ABBREVIATION	VENDOR NUMBER	DUE DATE		DISCOUNT	INVOICE AMOUNT	AMOUNT TO PAY	TOTAL BY DATE
		MO.	DAY				
ABBOT BRASS	1179	12	31	318	15878	15560	
ABBOT BRASS	1179	12	31	196	9813	9617	
ABRAMS COAL	1180	12	31	831	27735	26904	
ABRAMS COAL	1180	12	31	1050	30000	28950	
BARR MACH	3076	12	31	15077	301527	286450	
EL TRUST CO	2952	12	31		5125	5125	
KARTAGE INC	4486	12	31		21875	21875	
LEHIGH COAL	4867	12	31	1384	69178	67794	
MAIZE REF	5809	12	31		11823	11823	
N MILT SUPP	6003	12	31		21415	21415	
N Y GAS EL	6122	12	31		67595	67595	
STATE N Y	7421	12	31		179286	179286	
W COR TEL	8146	12	31		23729	23729	
WICKWIRE BR	8634	12	31		36043	36043	
WISELO INC	8821	12	31		19518	19518	

FIGURE 7

1 represent line numbers. The space between 43 and 1 represents the ribbon guide which divides the alphanumerical from the numerical type bars.

When the cash requirements statement is placed on the spacing chart so that the ribbon guide mark

on the report lines up with the ribbon guide line on the spacing chart, all other columnar headings will line up with the type bars from which they will be printed. Vendor number covers alphanumerical type bars 35-39.

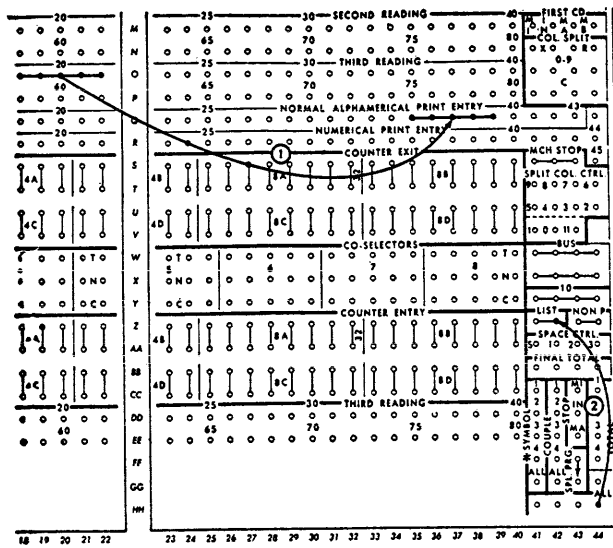

FIGURE 8. DETAIL PRINTING, NUMERICAL

Wiring for Numerical Detail Printing (Figure 8)

1. The vendor number is detail printed by wiring card columns 18-22 from third reading to normal alphanumerical print entry 35-39.
2. All cycles is wired to LIST, so that every card will print as it passes the third reading station.

DETAIL PRINTING: ALPHABETIC INFORMATION

LETTERS as well as numbers may be printed from the 43 alphanumerical type bars located on the left side of the print unit. In order to print letters, a type bar must be impulsed from two holes in the same column, a zone punch and a digit punch, as shown in Figure 9. A zone punch may be a 0, 11, or 12 punch. A digit punch is any number from 1 through 9. The card form in Figure 9 shows how these punches are used in combination to form the letters A through Z. Combinations of 12 punches, with the digits 1 through 9 are recognized by the machine as the letters A through I. Combinations of 11 punches, with digits 1 through 9 are recognized by the machine as the letters J through R. Combinations of 0 punches, with digits 2 through 9 are recognized by the machine as the letters S through Z. These are permanently assigned codes for the letters in the alphabet, and when the control panel is properly wired, the machine will always recognize a

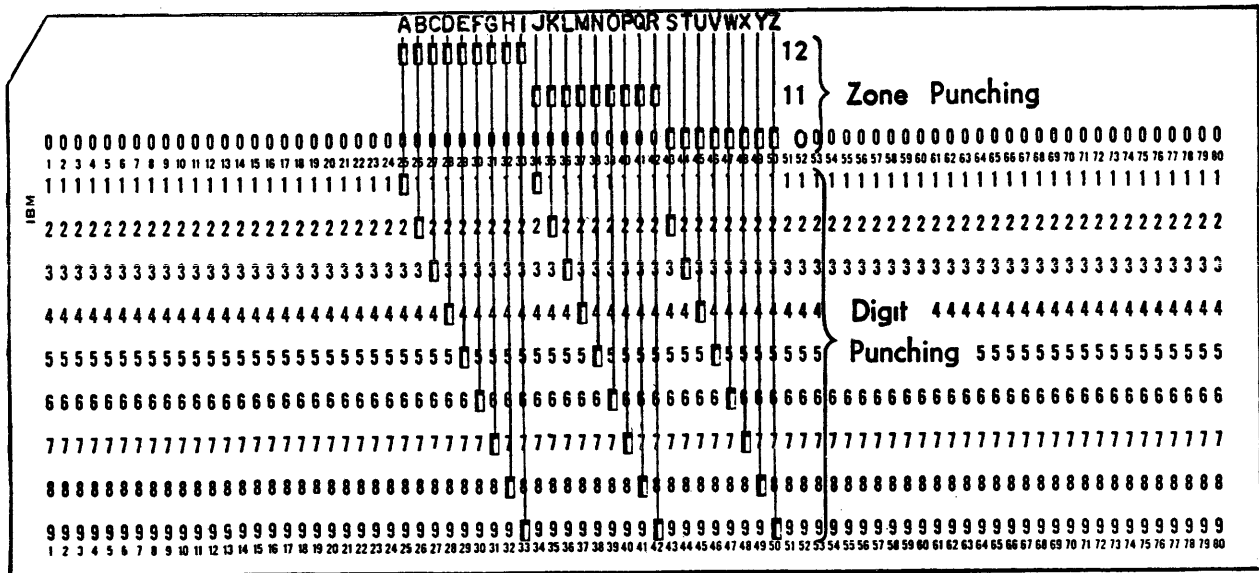
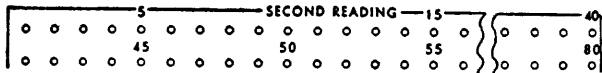

FIGURE 9. ALPHABETIC PUNCHING

12 and a 1 as the letter A; an 11 and a 1 as the letter J, and so on.

In detail printing, the upward movement of the type bars is synchronized with the reading of a card. As the card is being read from the 9 to the 12 position, the type bars are moving up. As soon as a brush senses a punched hole, the type bar stops moving. For example, if a 4 were punched, the type bar would stop when the 4 character is at the printing position. After the brushes have read all of the punching positions, 9 through 12, the type bars have been properly positioned for printing.

An alphanumerical type bar, when zoned, is stopped at the proper letter position by the reading of the two holes punched in a single column. The zone punches are read at the second reading station and the digit punches at the third reading station. Each type bar has a hammer which, when fired, pushes the printing type against the platen. All of the hammers are fired at one time.



M-N, 1-40

Second Reading. The 80 second reading hubs are outlets for another set of 80 brushes located just above the third reading brushes, as shown in Figure 5. Like the third reading brushes, they read all 80 columns of the

card. They differ in function, however, in that they are used primarily on the Type 402 to prepare the machine to print letters instead of numbers or to perform other specific functions on the following cycle such as adding, or subtracting.



L, 1-43

Normal Zone Entry. To print an alphabetic character, the type bar must receive a zone impulse on one cycle and a digit impulse on the next cycle. Zone punches are read from the second reading brushes and are accepted by any of the 43 normal zone entry hubs to zone the type bars so that the proper letter will print on the following cycle when the digit punch is read.

Normal zone entry hubs will accept only zone impulses. They are called "normal" to distinguish them from the special zone entries used for multiple line printing on the Type 403.

By referring to Figure 6 it will be seen that the report column headed *Vendor Abbreviation* covers alphanumerical type bar positions 24-34. These type bars will therefore be used to print vendor abbreviation from the card as shown in Figure 10.

ENTRY DATE		INV. DATE		VENDOR ABBREV.		VENDOR NO.		OUR INV. NO.		ENTRY GEN. LEDG.		DATE PAID		DUE DATE		DISCOUNT		INVOICE AMOUNT		AMOUNT TO PAY		DETAIL	
K23		K21		ABBOT BRASS		01179		12120		30211		K31		00318		00158		7800		15560			
0	0	0	0	0	0	0	0	0	0	0	0	0	0	0	0	0	0	0	0	0	0	0	0
1	1	1	1	1	1	1	1	1	1	1	1	1	1	1	1	1	1	1	1	1	1	1	1
2	2	2	2	2	2	2	2	2	2	2	2	2	2	2	2	2	2	2	2	2	2	2	2
3	3	3	3	3	3	3	3	3	3	3	3	3	3	3	3	3	3	3	3	3	3	3	3
4	4	4	4	4	4	4	4	4	4	4	4	4	4	4	4	4	4	4	4	4	4	4	4
5	5	5	5	5	5	5	5	5	5	5	5	5	5	5	5	5	5	5	5	5	5	5	5
6	6	6	6	6	6	6	6	6	6	6	6	6	6	6	6	6	6	6	6	6	6	6	6
7	7	7	7	7	7	7	7	7	7	7	7	7	7	7	7	7	7	7	7	7	7	7	7
8	8	8	8	8	8	8	8	8	8	8	8	8	8	8	8	8	8	8	8	8	8	8	8
9	9	9	9	9	9	9	9	9	9	9	9	9	9	9	9	9	9	9	9	9	9	9	9

CASH REQUIREMENTS STATEMENT

VENDOR ABBREVIATION	VENDOR NUMBER	DUE DATE		DISCOUNT	INVOICE AMOUNT	AMOUNT TO PAY	TOTAL BY DATE
		MO.	DAY				
ABBOT BRASS	1179	12	31	318	15878	15560	
ABBOT BRASS	1179	12	31	196	9813	9617	
ABRAMS COAL	1180	12	31	831	27735	26904	
ABRAMS COAL	1180	12	31	1050	30000	28950	
BARR MACH	3076	12	31	15077	301527	286450	
EL TRUST CO	2952	11	31		5125	5125	
KARTAGE INC	4486	12	31		21875	21875	
LEHIGH COAL	48678	12	31	1384	69178	67794	
MAIZE REF	5809	11	31		11823	11823	
N MILT SUPP	60035	12	31		21415	21415	
N Y GAS EL	6122	11	31		67595	67595	
STATE N Y	74213	12	31		179286	179286	
W COR TEL	81469	12	31		23729	23729	
WICKWIRE BR	86341	12	31		36043	36043	
WISELO INC	88213	12	31		19518	19518	

FIGURE 10

Wiring for Alphabetic Printing (Figure 11)

ZERO PRINTING

1. Vendor abbreviation is printed on the cash requirements statement by wiring columns 7 through 17 from the second reading to normal zone entry 24-34 to zone the type bars and by wiring columns 7 through 17 from the third reading to normal alphanumerical print entry 24-34 to cause the type bars to print alphabetically. The type bars receive the zone signals when the cards pass the second reading station, and the proper digit punch signals within the zones when the cards pass the third reading station.

2. All cards are detail printed by wiring all cycles to LIST.

PRINTING OF zeros from both alphanumerical and numerical type bars is controlled by the hammer-split levers, also referred to as the zero suppression levers (Figure 12). There are 88 of these levers, one for each type bar. When any hammer-split lever is raised, zeros and special character positions to the right of it, up to the next significant digit, are suppressed.

The alphanumerical type bars print zeros only if a zero is punched in a card column or a zero is present in a counter, if the column or counter position is wired to a type bar, and if there is a significant digit printing to the left of the zero. If the unnecessary zeros to the left of significant digits in a field are to be eliminated, the hammer-

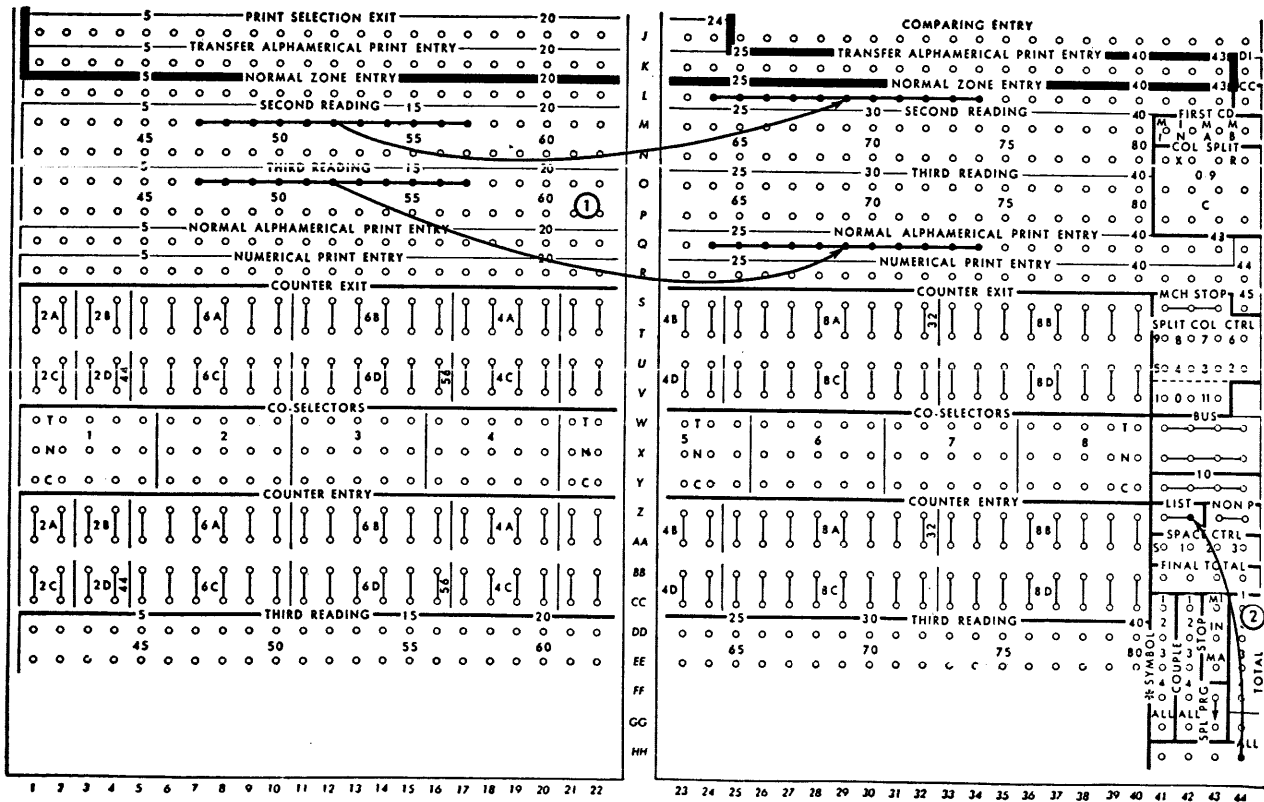

FIGURE 11. DETAIL PRINTING, ALPHABETIC

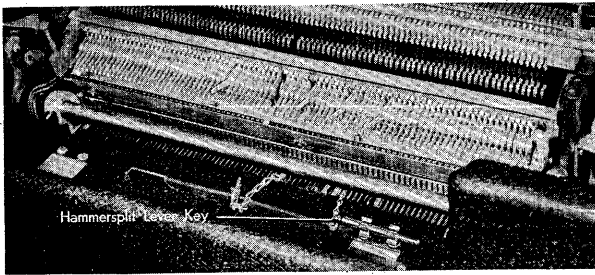

FIGURE 12. HAMMERSPLIT LEVERS

split levers corresponding to the type bar printing the units positions of the field to the left should be raised.

A special character can be printed on the alphabetical type bars by a single 12 punch. The printing of this character is under the control of the hammersplit levers in the same way as is the zero position.

It is possible to print a zero from any type bar without a significant digit to the left in one of the following ways: The combination of a 1 and a 0 punch in a card column will always print a zero, if the type bar is wired for alphabetic printing. A clip, called "left zero carry clip," can be placed on the hammersplit lever of a type bar printing the units position and on the hammersplit levers of as many as 6 type bars to the left of this position to cause zero printing. Figure 12a shows a one-position and a six-position left zero carry clip.

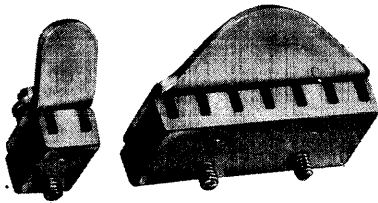

FIGURE 12a. ZERO CARRY CLIP

Unwired numerical type bars print zeros to the right of any significant digit. To eliminate these mechanical zeros, the hammersplit lever corresponding to the units position of the field should be raised.

When zeros are not suppressed, a maximum of ten zeros will print to the right of a significant digit. On Series 50 machines, three zeros normally print to the right. If a hammersplit is raised or if a type bar prints, up to 10 zeros print to the right.

ADDITION

ONE of the functions of the Type 402 and Type 403 is that of accumulation. It is performed by a series of single-position accumulators, each capable of adding up to 9. These single position accumulators or counter wheels are grouped into units called counters, which vary in size from a 2-position counter to an 8-position counter. Within each counter a single position will add up to 9 and then carry over to the next position to its left. These two counter positions in turn add up to 99 and carry over into the third position, and so on. The carry-over within each counter is automatic.

Each counter is identified by a number and a letter, the number indicating how many positions the counter contains and the letter identifying the counter. For example, 2A is the first 2-position counter; 8D is the fourth 8-position counter. There are two types of machines as far as number of counter positions is concerned: 56 and 80. An 80 counter machine consists of four 2-position counters (2A, 2B, 2C, 2D); four 6-position counters (6A, 6B, 6C, 6D); four 4-position counters (4A, 4B, 4C, 4D); and four 8-position counters (8A, 8B, 8C, 8D). The counter units in the 56-counter machines can be determined by a glance at the counter entry or counter exit hubs on the control panel.

The number 56 is printed to the right of 6D. All counters from 2A through 6D are standard on the 56-counter machine.

Counters may be coupled with one another in any desired arrangement. An 8-position counter may be coupled with a 2-position counter to form a 10-position counter. A 6-position counter may be coupled with a 4-position counter to form a 10-position counter. Two 4-position counters may be coupled to form an 8-position counter. For best operation, no more than 16 counter positions should be coupled.

There are four basic steps in wiring for adding:

1. What information is to be accumulated? (Counter entry)
2. Which cards are to be added? (Counter control)
3. When should the total be printed? (Counter read-out and reset)
4. Where should the total be printed? (Counter exit to type bars)

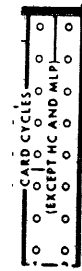

J-Q, 49-50

ever, since card cycles impulses are not active on total cycles, all totals would print on the same lines as the last listed item.

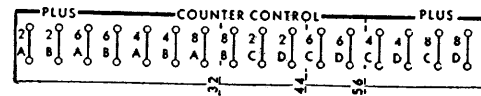

S-T, 51-66

Counter Control Plus. Each counter has a corresponding plus entry, which must be impulsed to cause the counter to add as the card passes the third reading station. If a counter is to add a field from every card, a card cycles impulse is wired to the plus hubs of that counter. If only certain types of cards are to be added, the card cycles impulse must be controlled so that it reaches the counter plus hubs only for the particular cards to be added.

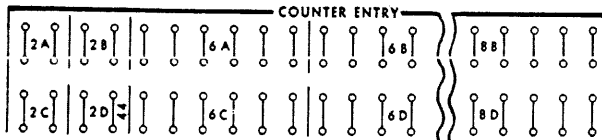

Z-CC, 1-40

Counter Entry. The counter entry hubs accept information to be added or subtracted in a counter. They are normally wired directly from third reading for addition or subtraction. Each counter is identified with a number representing its size, and a letter identifying its location.

Card Cycles. The upper 5 hubs in the left column are active on every card feed cycle including heading and multiple line printing cards. The other 11 hubs are active for cards that are not heading or multiple line printing cards. They are normally used, directly or through selectors, to control counters to add or subtract.

They may also be used to cause detail printing by wiring them to the LIST hubs. How-

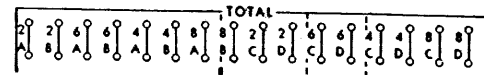

GG-HH, 51-66

Counter Total. Each counter has a pair of common total entry hubs. When they are impulsed, the counter will read out (print the total) and clear (reset to zero). When the total will print depends upon the type of impulse wired to the total entry hubs. Normally they are wired from minor, intermediate or major program hubs, described on page 22, or from final total hubs. They may also be wired from a selected card cycles hub

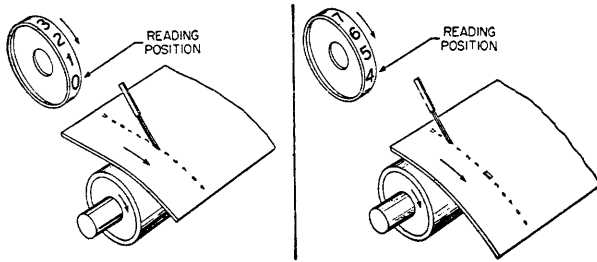

FIGURE 15. MOVEMENT OF COUNTER WHEEL WHEN ADDING

Method of Addition

In adding, the counter wheel must advance the number of positions indicated by the digit punched in the column to be added. The reading of the card is related to the movement of the counter wheel. As soon as a brush reads a punched hole, the counter wheel starts moving and moves one point for each position on the card until the zero position of the card is reached, at which time the counter wheel stops moving. Therefore, if a 4 is punched in a card, the wheel will advance 4 points, 1 point for each position as the card progresses from 4 to 3, 3 to 2, 2 to 1 and 1 to 0 on the card. At the same time that the card is moving from 4 to 3, 3 to 2, 2 to 1 and 1 to 0, the counter wheel moves from 0 to 1, 1 to 2, 2 to 3, and 3 to 4, leaving the wheel standing at 4.

PROGRAM CONTROL

PROGRAM control is the function by means of which the machine can distinguish the cards of one classification from those of another. The cards in a single classification are referred to as a program group; for example, after payables distribution cards have been sorted by department number, the cards for one particular department are referred to as a single program group.

The machine, by the use of the second and third sets of brushes, can read simultaneously the holes punched in two successive cards. Each card, when it is at the second station, is compared with the preceding card which is at the third station. When a card passes the third station, it is compared with the succeeding card which is at the second station. Thus, each card passing through

the machine is compared twice, once with the card ahead of it and once with the card following it. If the fields are punched the same, thus indicating that the cards are of the same program group, the machine will continue to feed cards. When the punching in one card does not compare with the punching in the card preceding it and the panel is properly wired, the machine will automatically start a total program cycle.

Three types of totals are possible on the Type 402 and Type 403: minor, intermediate and major. They are also known as program levels 1, 2, and 3, or, as minor program, intermediate program, and major program. A minor program is used for the classification representing the smallest grouping, intermediate program for the next larger grouping, and major program for the largest group. If totals of sales amount were to be printed by state, by city, and by customer number, customer number would be considered a minor group, city an intermediate group, and state a major group. When the proper programs are used for these groups, the machine automatically stops at the end of each group and will not start until the required number of total cycles is taken. For a minor program change, only one total cycle is required; for an intermediate program change, two total cycles are required; and for a major program change, three total cycles are required. This is known as a triple reset.

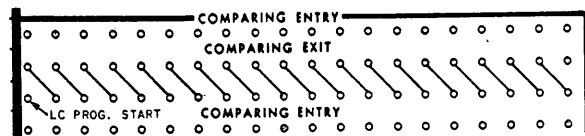

G-J, 25-44

Comparing Unit. Ten or twenty positions of comparing are available on the 32- and 44-counter 402; twenty are available on the 56- and 80-counter 402 and any model of the 403. Each position consists of two comparing entry hubs and two comparing exit hubs. The two common comparing exit hubs are diagonally arranged to facilitate wiring.

Comparison is accomplished by wiring the field to be compared from the second reading hubs to one row of comparing entries, and from the third reading hubs to the other row of comparing entries. Either row of comparing entries may be wired from either set of brushes. Although any hubs within a comparing entry row may be used, the corresponding hubs in the other comparing entry row must be wired. It is not possible, for example, to wire the second brushes to comparing entries 1 through 5 and the third brushes to comparing entries 6 through 10. The hubs used in both sets of entries must line up with each other.

During each card cycle, the readings to both sides of the comparing entries are compared. If the two readings for any comparing position are not identical, a comparing exit impulse is available in the two comparing exit hubs. The lower left exit hub labelled LC Prog. Start emits an impulse as the last card passes the last control station, and also as the first card passes the first control station, and may be used to initiate programs on the run-in and on the run-out. It is wired to Program Start-Immediate on the Type 402 and Program Start-Delay on the Type 403. *The LC hub must never be connected to a comparing exit hub.*

The two cards shown in Figure 16 pass their respective reading stations at the same time. Because the cards are fed into the machine face down, 9's first, the 3 hole at the third reading station is read before the 2 hole at the second reading station. Therefore, the 3 impulse reaches

the comparing unit before the 2 impulse, setting up an unequal condition in the unit and making an impulse available at the comparing exit. The impulse can be used to stop the feeding of cards and start total programs.



F-H, 45

Program Start. The three I (immediate) hubs labelled minor, intermediate and major receive comparing exit impulses from comparing exit hubs to stop card feeding and start total programming; one program for minor, two for intermediate and three for major. If intermediate program start were wired alone, a minor total cycle would be forced before the intermediate total cycle. If major program start were wired alone, both a minor and an intermediate total cycle would be forced before the major total cycle.

A card count may also be wired to program start to cause a program start on every card.

Program start for MLP operations is covered on page 124.

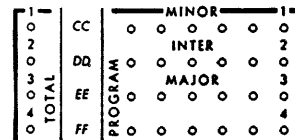

CC-FF, 44-50

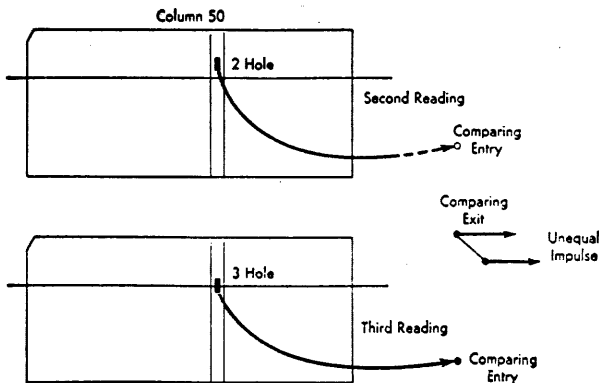

FIGURE 16. COMPARING

Total Program. Each program level has seven exit hubs which emit all cycles impulses whenever the corresponding program start is impulsed. Program start must be impulsed before these hubs become active. Minor program exits emit impulses when the minor program start is impulsed. Minor and intermediate program exits emit impulses when the intermediate program start is impulsed. Minor, intermediate, and major program exits emit impulses only when the major program start is impulsed.

Each row of hubs is completely independent of the other row of hubs and only one row is active at a time.

Counters read out and reset automatically when a total program is wired to a counter total entry. After total printing, the machine re-starts automatically for the following group.

These hubs may also be wired to control hammerlocking or carriage operations as described under those headings.

The fourth level shown on the diagram is special and will be described under *Special Program*.

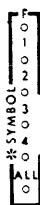

BB-GG, 41

Asterisk (*) Symbol. Asterisk may be printed from all odd-numbered numerical type bars, by wiring one of the asterisk symbol hubs to numerical print entry. The asterisk symbol hubs emit "10" impulses, hub F to print an asterisk for final totals, hub 1 for minor totals, hub 2 for intermediate totals, and hub 3 for major totals. Hub 4 is used with the special program. The hub labelled ALL, will emit a 10 impulse to print an asterisk for all programs.

Detail Printing: Minor, Intermediate and Major Program

The expense distribution shown in Figure 17 is a detail-printed report. The smallest group on this report is sub-ledger number and is therefore

referred to as the minor group. The largest group is department and is referred to as the major group. The group in between the minor and major is general ledger and is referred to as the intermediate group.

For each of the three groups mentioned, there is a corresponding total. The first minor total, \$1,409.42, was printed from one counter when the machine recognized a change from 660 to 700 in the sub-ledger number. The first intermediate total, \$2,085.37, was printed from another counter when the machine recognized a change from 913 to 915 in the general ledger number. The first major total, \$4,204.87, was printed from a third counter when the machine recognized a change from 41 to 43 in department number.

Just as the three groups are known as the minor, intermediate, and major groups, the totals are known as minor, intermediate, and major totals.

Wiring for Programming (Figure 18)

1. Sub-ledger is wired from columns 33-35 of both second and third reading to comparing entry. Two jack plugs in the corresponding comparing exits make all three comparing positions common so that if there is an unequal condition in any one of the three, a comparing exit impulse will be available either from the fourth hub in the top row or the seventh hub in the second row. This impulse is directed to program start minor, and causes the machine to initiate a program cycle for every change in sub-ledger group.

2. General ledger is wired from columns 30-32 of both second and third reading to comparing entry. The comparing exit is wired to program start intermediate to initiate a second program cycle for every change in general ledger group.

PAYABLES DISTRIBUTION																			
DAY	DAY	VENDOR		VENDOR	OUR	GEN.	SUB.	MATERIAL	ORDER	DEPT.	DAY	QUANTITY	UNIT	ITEM	AMOUNT				
ENTRY	INVOICE	ABBREVIATION	NUMBER	NUMBER	INVOICE	LEGG	LEGG	OR PART	NUMBER	USING	DUE								
DATE	DATE				NUMBER	ACCOUNT	NO.	NUMBER	NUMBER		DATE								
00	00	00	000000000000	000000	000000	000000	00	000000	000000	000000	00	000000	00	000000	000000000000				
11	11	11	111111111111	111111	111111	11	111111	111111	111111	111111	11	111111	11	111111	111111111111				
22	22	22	222222222222	222222	222222	22	222222	222222	222222	222222	22	222222	22	222222	222222222222				
33	33	33	333333333333	333333	333333	33	333333	333333	333333	333333	33	333333	33	333333	333333333333				
44	44	44	444444444444	444444	444444	44	444444	444444	444444	444444	44	444444	44	444444	444444444444				
55	55	55	555555555555	555555	555555	55	555555	555555	555555	555555	55	555555	55	555555	555555555555				
66	66	66	666666666666	666666	666666	66	666666	666666	666666	666666	66	666666	66	666666	666666666666				
77	77	77	777777777777	777777	777777	77	777777	777777	777777	777777	77	777777	77	777777	777777777777				
88	88	88	888888888888	888888	888888	88	888888	888888	888888	888888	88	888888	88	888888	888888888888				
99	99	99	999999999999	999999	999999	99	999999	999999	999999	999999	99	999999	99	999999	999999999999				

EXPENSE DISTRIBUTION
BY DEPARTMENT OR BRANCH

DEPT. OR BRANCH	ACCOUNT No.		OUR INVOICE NUMBER	DATE		AMOUNT	AMOUNT BY ACCOUNT	AMOUNT BY DEPT. OR BRANCH
	GEN. LEGG.	SUB. LEGG.		NO.	DAY			
41	913	660	12042	12	07	687:50		
41	913	660	12084	12	14	721:92		
						1409:42 *		
41	913	700	12125	12	23	675:95		
						675:95 *	2085:37	
41	915	760	12086	12	15	2119:50		
						2119:50 *	2119:50	
								4204:87
43	913	730	12171	12	31	47:40		
						47:40 *		
43	913	740	12164	12	31	611:93		
						611:93 *		
43	913	750	12089	12	15	200:00		
						200:00 *		

FIGURE 17

EXPENSE DISTRIBUTION BY DEPARTMENT OR BRANCH								
DEPT. OR BRANCH	ACCOUNT No.		OUR INVOICE NUMBER	DATE		AMOUNT	AMOUNT BY ACCOUNT	AMOUNT BY DEPT. OR BRANCH
	GEN. LEDG.	SUB. LEDG.		MO.	DAY			
82	431	112	12066	12	10	300:00		
82	431	112	12153	12	28	300:00		
						600:00*		
82	431	113	12066	12	10	150:00		
82	431	113	12066	12	10	150:00		
82	431	113	12066	12	10	125:00		
82	431	113	12153	12	28	150:00		
82	431	113	12153	12	28	150:00		
82	431	113	12153	12	28	125:00		
						850:00*		
82	431	114	12066	12	10	50:00		
82	431	114	12066	12	10	75:00		
82	431	114	12066	12	10	50:00		
82	431	114	12153	12	28	50:00		
82	431	114	12153	12	28	50:00		
82	431	114	12153	12	28	75:00		
						350:00*		
82	431	520	12149	12	28	360:43		
						360:43*		
82	431	700	12082	12	14	2:25		
						2:25*		
82	431	750	12003	12	01	100:00		
						100:00*		
82	431	810	12112	12	18	70:20		
						70:20*		
82	431	850	12043	12	07	24:75		
						24:75*	2357:63	
82	432	841	12151	12	28	1792:86		
						1792:86*	1792:86	4150:49

FIGURE 20A. DETAIL PRINTED REPORT

EXPENSE DISTRIBUTION BY DEPARTMENT OR BRANCH								
DEPT. OR BRANCH	ACCOUNT No.		OUR INVOICE NUMBER	DATE		AMOUNT	AMOUNT BY ACCOUNT	AMOUNT BY DEPT. OR BRANCH
	GEN. LEDG.	SUB. LEDG.		MO.	DAY			
82	431	112				600:00		
82	431	113				850:00		
82	431	114				350:00		
82	431	520				360:43		
82	431	700				2:25		
82	431	750				100:00		
82	431	810				70:20		
82	431	850				24:75	2357:63	
82	432	841				1792:86	1792:86	4150:49

FIGURE 20B. GROUP PRINTED REPORT

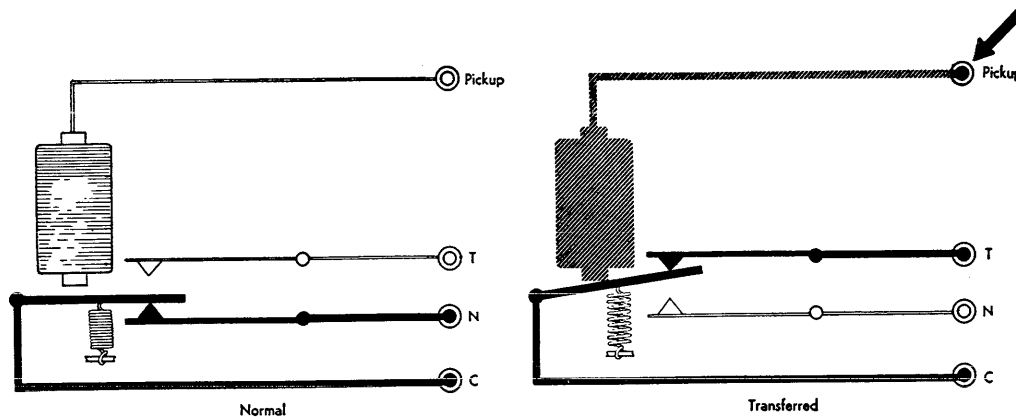

FIGURE 21. SCHEMATIC DIAGRAM OF A SELECTOR

pickups is that a D pickup will accept any digit impulse from 9 through 12, while an X pickup will accept only X or 12 impulses.

The immediate pickup hubs for each selector will accept any impulse and transfer the selector immediately instead of one cycle later. When the X or D hubs are impulsed, the I hub will emit an impulse as the selector transfers for the following cycle and will emit this impulse once each cycle thereafter, if the selector remains transferred. This impulse is a short pickup impulse which can be used as a means of expanding the pilot selector beyond two positions, by picking up co-selectors. When an I pickup hub is used in this manner, it is called a COUPLING EXIT. Thus, any co-selector to which it is wired functions exactly like the pilot selector.

Whenever the X or D hub of a selector is impulsed, the selector transfers on the following cycle and remains transferred until the controlling card has been read at third reading. Thus, if card feeding is interrupted for any reason, such as for total printing, the selector would be transferred during the printing cycle and the following card cycle.

Exceptions to this rule are covered on page 152 under SELECTORS.

Whenever the I hub of the selector is impulsed, the selector transfers during the same cycle and remains transferred for that cycle only.



DD-EE, 51-66

Carry Exit; Carry Entry. These hubs have two functions: counter coupling, and carry-back in subtraction. Two or more counters, up to a maximum of 16 positions, may be coupled together by wiring the CI of the counter containing the units position to the C of the coupled counter. A 12-position counter is obtained by coupling two 6-position counters, an 8-and a 4-position counter, or three 4-position counters. If 6A is to be coupled with 6B and 6B contains the units position, the CI of 6B is wired to the C of 6A. The example below shows how counter coupling functions when 1 is added to 999999 in two 6-position counters.

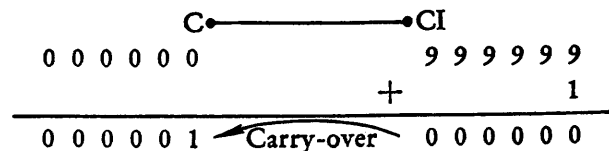

The CI and C hubs are also used for carry-back from the left position of a counter to the units position of the same counter, or from CI to C. This is necessary when subtracting, to compensate for the shortages that would result because of the use of the 9's complement method. In each of the examples below the carry-over is added back into the units position by wiring CI to C of the same counter. If the carry-back is omitted, every positive total would be short and every negative total would be over, after being converted.

POSITIVE PROBLEM	RESULT COUNTER ACTION	NEGATIVE PROBLEM	RESULT COUNTER ACTION
+175	(6 position) 000175	- 175	(6 position) 999824
- 96	999903	+ 96	000096
	<u>000078</u>		<u>999920</u>
	(1) → 1		
	000079		
- 102	999897	+102	000102
	<u>999976</u>		<u>(1)000022</u>
			→ 1
			000023
+ 75	000075	- 75	999924
	<u>(1)000051</u>		<u>999947</u>
	→ 1		
+ 52	000052	- 52	(9's complement of 52)



AA, 51-66

Negative Balance Test Exit. Each counter has a negative test exit hub which emits an impulse when the counter is negative on a program cycle. Negative balance test exit is normally wired to negative balance control to convert complements to true figures, or to a pilot selector pickup. These hubs have another function when NB-AC is connected (page 75).

The left-hand (high order) position of the counter must be left free to signal the pres-

ence of a 9 to indicate a negative balance, or the absence of a 9 to indicate a positive balance.

A negative balance test exit also emits an impulse for a zero balance in the counter when zero balances are indicated by 9's.

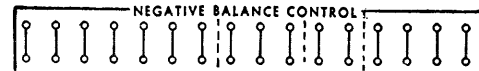

BB-CC, 51-66

Negative Balance Control. Each counter has a pair of common negative balance control entry hubs which, when impulsed from negative balance test exit, cause a complement figure to be converted to a true figure before it is printed. Conversion takes place just before a total prints, and requires one cycle.

When counters to be converted are coupled, the negative balance control hubs for those counters must also be coupled. The negative balance test exit of the high order counter only must be wired to negative balance control.

Negative balance control hubs are standard only on net balance machines.



FF, 51-66

CR Symbol Exit. Each counter has a credit symbol exit hub which emits a 10 impulse which can be used to print a CR symbol either for a subtracted item or for a negative total. Credit symbols print from all even-numbered numerical type bars. If the CR hub is wired to such a type bar, it will print a CR symbol whenever the minus hub of the counter is impulsed on a card cycle, and whenever the counter prints a converted negative total. Whenever counter exits are suppressed, the CR symbol exit is also suppressed. Zero balances are indicated in a counter as 9's, and therefore a CR symbol would print for zero balances. It can be eliminated by selection, since a method is available for detecting zero balances as they occur (page 82).

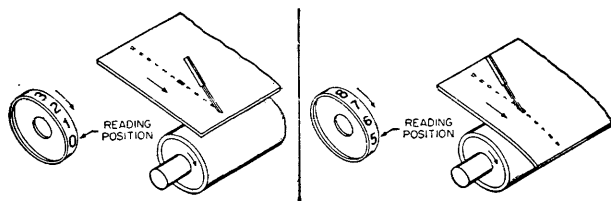

FIGURE 22. MOVEMENT OF COUNTER WHEEL WHEN SUBTRACTING

Method of Subtraction

When subtracting, the counter wheels turn in the same direction as when adding. To add automatically the complement of a punched field, each counter wheel of a group starts rotating when the third reading brushes read the 9's position of a card (Figure 22). The wheel then moves one point for each position passed by the brushes. As soon as a punched hole is sensed, the counter wheel stops moving. If a 4 were to be subtracted, the counter wheel would turn five positions while the card is moving from 9 to 4; this leaves the counter wheel standing at the 5 position, which is the 9's complement of 4.

Method of Net Balance Conversion

A 9's complement total in a net balance counter is automatically converted into a true figure when a negative balance test exit impulse enters the negative balance control unit on a program cycle. Whenever a negative balance test impulse enters this control unit, a conversion cycle will take place before the total prints. The conversion cycle takes 0.4 seconds. The conversion is accomplished by adding the conversion factor to each complement digit in the total. The conversion factor is that number which, when added to a number, gives the complement of the original number. Therefore, if the conversion factor is added to a number which is a complement, the result will be a true credit figure. The conversion factor is added to each counter position independently, at the same time, and no carry-overs occur.

COUNTER WHEEL STANDING AT:		CONVERSION FACTOR		DIGIT WHICH IS COMPLEMENT OF ORIGINAL FIGURE
0	+	9	=	9
1	+	7	=	8
2	+	5	=	7
3	+	3	=	6
4	+	1	=	5
5	+	9	=	4
6	+	7	=	3
7	+	5	=	2
8	+	3	=	1
9	+	1	=	0

In the operation:

+	1256	Sales
-	1389	Returns
-	133	Net Sales

The machine adds in a 6-position counter:

1256
998610
999866

The conversion cycle takes place, adding:

+	111377	(Conversion factor)
	000133	CR

(No carry-overs in conversion addition.)

Conversion cycles occur only immediately prior to each individual program change. In a problem with three programs, the conversion cycle for the minor total would occur just prior to the minor program, the conversion cycle for the intermediate total just prior to the immediate program, and the conversion cycle for the major total just prior to the major program.

The X punch in one of the sales accounting cards shown in Figure 23 identifies it as a charge back to the salesman's commission account. The NX card is a debit card and is punched with the commission amount. Whenever the X card is read, the amount punched in the commission field is subtracted in counter 8A; whenever an NX card is read, the amount punched in the commission field is added in counter 8A.

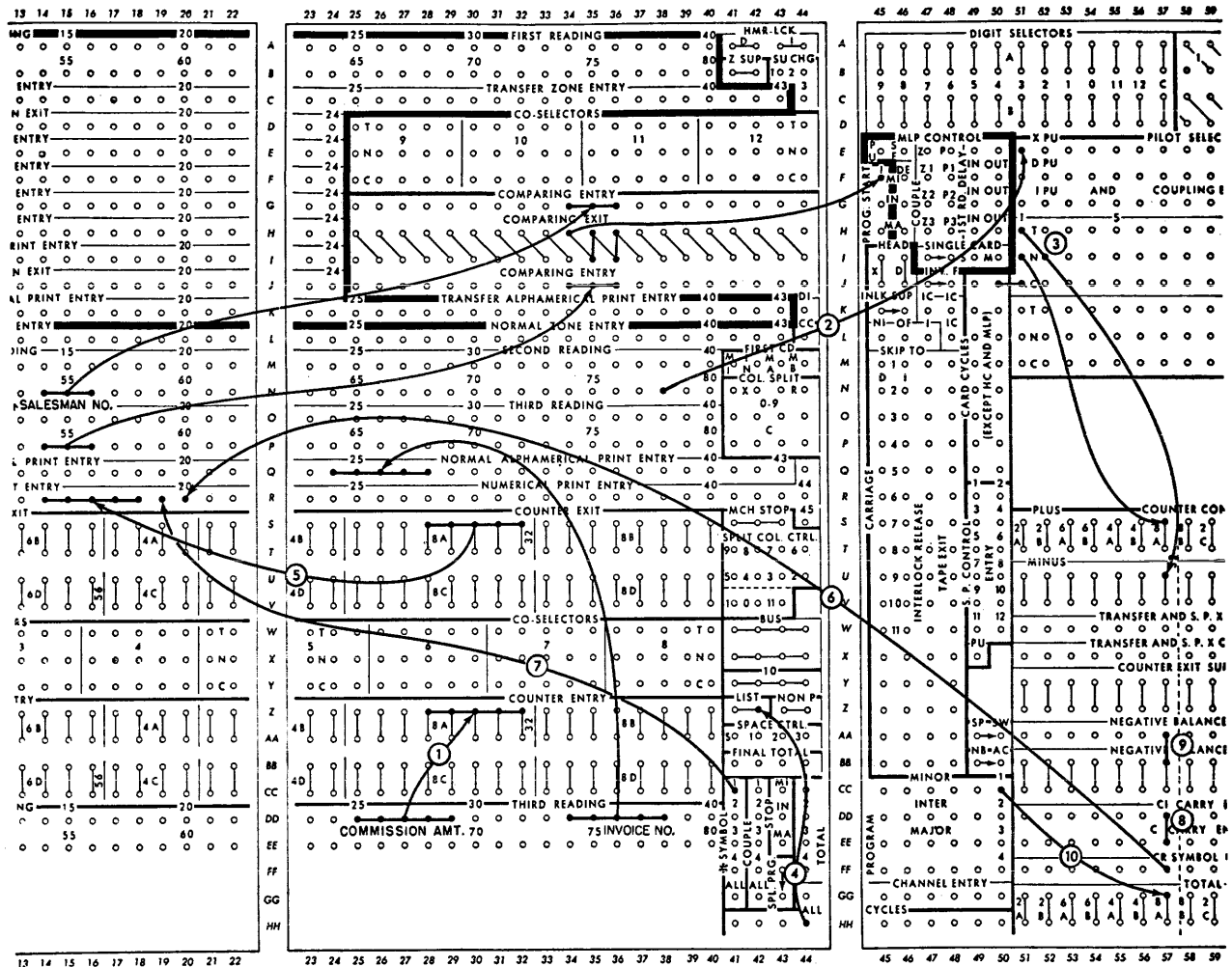

FIGURE 24. NET BALANCE SUBTRACTION

does not transfer the selector and the card cycles impulse controls counter 8A to add.

4. An all cycles impulse is wired to LIST, to detail print every card.

5. Both the detail amount and the total amount are obtained by wiring from 8A exit to numerical print entry 14-18.

6. Credit listings and credit totals are identified by wiring the credit symbol exit of 8A to numerical print entry 20.

7. Minor totals are identified by wiring the * symbol hub (minor) to print entry 19.

8. Whenever amounts are to be subtracted in a counter, the CI and C of that counter must be wired.

9. A complement amount standing in counter 8A is converted to a true figure by wiring the negative balance test exit of 8A to the negative balance control of 8A. Negative balance test exit of 8A emits an impulse on a total program, whenever there is a 9 standing in the left on high order position of 8A. Negative balance control receives an impulse from negative balance test exit on a total program to cause conversion factors to be added to the complement figure.

10. Counter 8A is cleared for total printing on a minor total program. The program is initiated by an impulse from the comparing exit resulting from a change in salesman number.

Non-Net Balance Subtraction

On a non-net balance machine, negative balance control hubs are not active, and therefore automatic conversion of negative balances is not possible. In order to print a negative balance as a true figure, it is necessary to perform balance selection. This is accomplished by the use of two counters, with their plus and minus controls cross-wired, so that when one adds the other subtracts, and when one subtracts the other adds. In this way, one of the counters will always contain a positive result. The object is to select the true figure from either counter and suppress the printing of the complement.

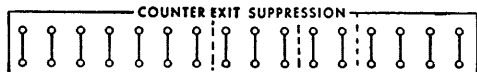

Y-Z, 51-66

Counter Exit Suppression. Each counter has a pair of counter exit suppression hubs. They are entries for: *negative balance test exit* impulses to suppress total printing when a counter is negative; *card cycle* impulse to suppress detail printing from a counter; *first card minor, intermediate or major* impulses to suppress first card printing in a group printing operation; and *total program* impulses, to suppress total printing, even though the counter may be wired to clear. When counter exits are suppressed, CR symbol exit is also suppressed.

Wiring for Non-Net Balance Subtraction

The same problem (Figure 23) used to explain net balance subtraction wiring is used to illustrate the wiring (Figure 25) for non-net balance subtraction.

1. The commission amount field is wired to counter 8A entry. The amount field enters 8B through the exit wiring from 8A to 8B.

2. All NX cards add in 8A and subtract in 8B. All X cards subtract in 8A and add in 8B.

3. Both counter exits are wired to numerical print entry 14-18 to print both the detail amount and the total.

4. Although both counter exits are in effect ~~split-wired to the print entry~~, only the positive total will print because the counter containing the negative total is suppressed. This suppression is accomplished by wiring the negative balance test exit of 8A and 8B to the 8A and 8B counter exit suppression hubs. Whenever there is a 9 in the left position of either counter on a program cycle, the negative balance test exit hub for that counter will emit an impulse, and printing of the complement total for that counter is suppressed. The same commission amount, as punched in the card, is printed from both counter 8A and 8B and therefore counter exits need not be suppressed during detail printing.

If coupled counters are used, negative totals are suppressed by wiring test exit of the high order counter to the counter exit suppression of both counters.

5. On non-net balance machines, the CR symbol exit hubs emit impulses only on the detail print cycle and may be wired directly to numerical print entry 20 to print the credit symbol. They do not emit impulses on program cycles. Therefore, another means of printing the CR symbol for negative totals must be used. The asterisk symbol hub 1 emits a 10 impulse on a minor program which is suitable for printing the CR symbol. If this impulse were wired directly to an even-numbered type bar, a CR symbol would print for every minor total. In order to control this 10 impulse so that it will reach type bar 20 only for negative totals, it is wired through the transferred hubs of pilot selector 2. The pilot selector is transferred by the negative balance test exit of counter 8A, wired to the D pickup. The D pickup is used to keep the selector transferred through the first card of the next group. If the immediate pickup were used and summary punching or carriage skip cycles intervened, the selector would return to normal before the total printed and the credit symbol could not print through the transferred side of the selector.

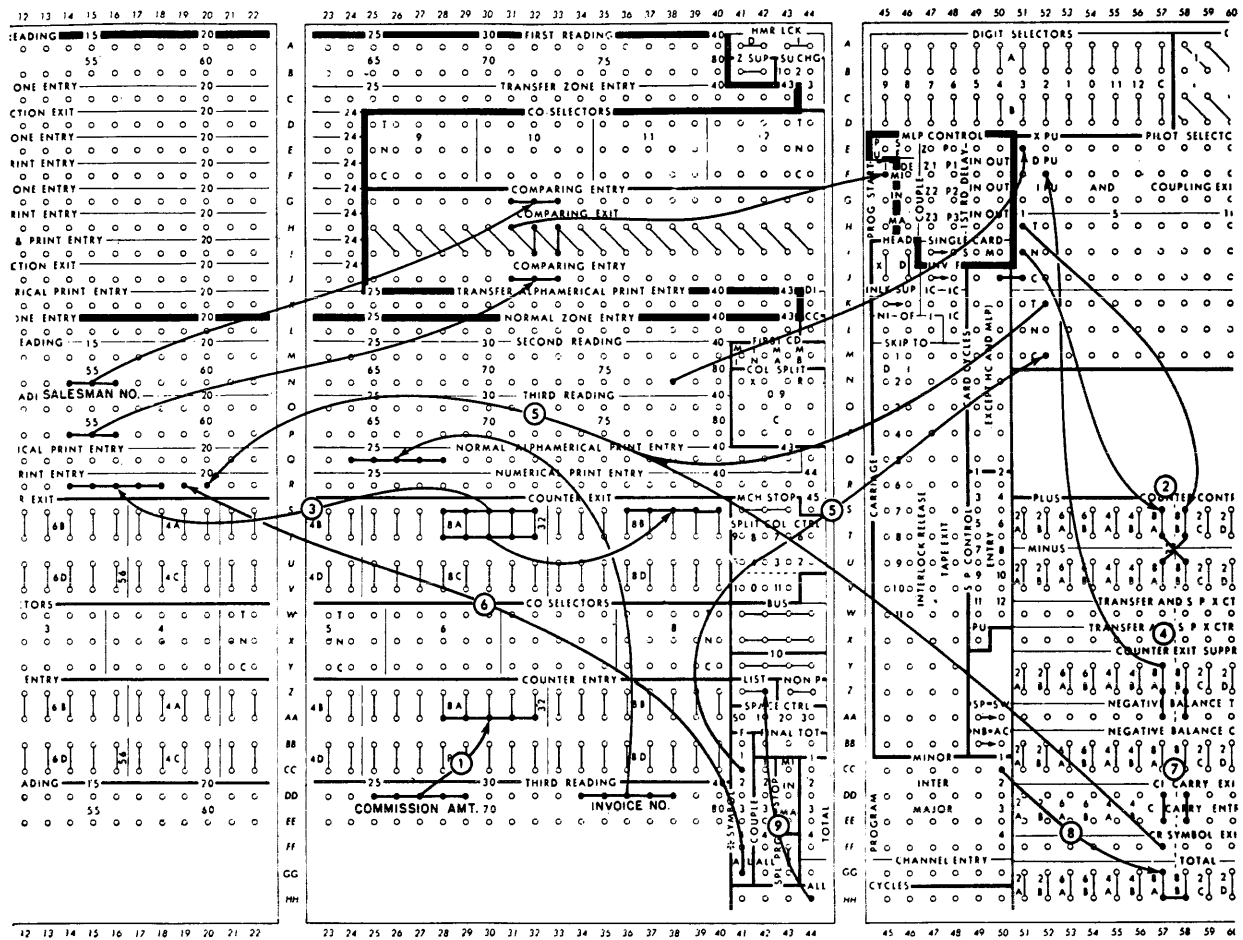

FIGURE 25. NON-NET BALANCE SUBTRACTION

Counter 8A is the controlling counter, as it reflects the true nature of the total, even though printing may take place from 8B. Therefore, if 8A is negative, the true figure is printed from 8B and a CR symbol is printed because 8A contains a complement total.

6. Asterisks are printed for positive or negative minor totals by wiring the all symbol hub to numerical print entry 19.

7. Both 8A and 8B are wired for carry-back, CI to C.

8. Counters 8A and 8B are impuled to read out and clear by wiring the minor program exit to the total hubs of 8A and 8B.

9. The machine is wired to detail print every card.

X SELECTION

represents sales on NX cards and returns and allowances on X cards.

AMOUNTS for different types of transactions may be added in separate counters even though the amount is punched in the same field of the card. This is done by means of X or digit selection. In the example in Figure 26, the item amount field

Wiring for X Selection

In this report, the item amount is detail printed and total printed in the sales amount column of the report for all NX cards, and in the returns and

SALES ACCOUNTING																			
ENTRY DATE		UNIT COST	COST AMOUNT	GROSS PROFIT	COMMISSION AMOUNT	INVOICE DATE		INVOICE NUMBER	CUSTOMER NUMBER		LOCATION		TRADE CLASS	SALES- MAN NO.	QUANTITY	COMMODITY NUMBER	ITEM AMOUNT	INVOICE AMOUNT	
MO.	DAY					MO.	DAY		MO.	DAY	ST.	CITY							NO.
0	0	0	0	0	0	0	0	0	0	0	0	0	0	0	0	0	0	0	0
1	1	1	1	1	1	1	1	1	1	1	1	1	1	1	1	1	1	1	1
2	2	2	2	2	2	2	2	2	2	2	2	2	2	2	2	2	2	2	2
3	3	3	3	3	3	3	3	3	3	3	3	3	3	3	3	3	3	3	3
4	4	4	4	4	4	4	4	4	4	4	4	4	4	4	4	4	4	4	4
5	5	5	5	5	5	5	5	5	5	5	5	5	5	5	5	5	5	5	5
6	6	6	6	6	6	6	6	6	6	6	6	6	6	6	6	6	6	6	6
7	7	7	7	7	7	7	7	7	7	7	7	7	7	7	7	7	7	7	7
8	8	8	8	8	8	8	8	8	8	8	8	8	8	8	8	8	8	8	8
9	9	9	9	9	9	9	9	9	9	9	9	9	9	9	9	9	9	9	9

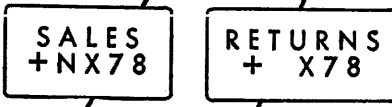

COMMISSION STATEMENT				
SALESMAN: M A C Y		67		DATE 12 31
INVOICE NO.	COMMODITY	SALES AMOUNT	RETURNS AND ALLOWANCES	COMMISSION AMOUNT
12176	14202	22:00		99
12176	14702	81:00		365
12176	16102	68:85		310
12176	63706	223:50		335
99590	35106		239:25	718 CR
99590	46106		286:50	1146 CR
		7621:43	525:75	12613 *

FIGURE 26

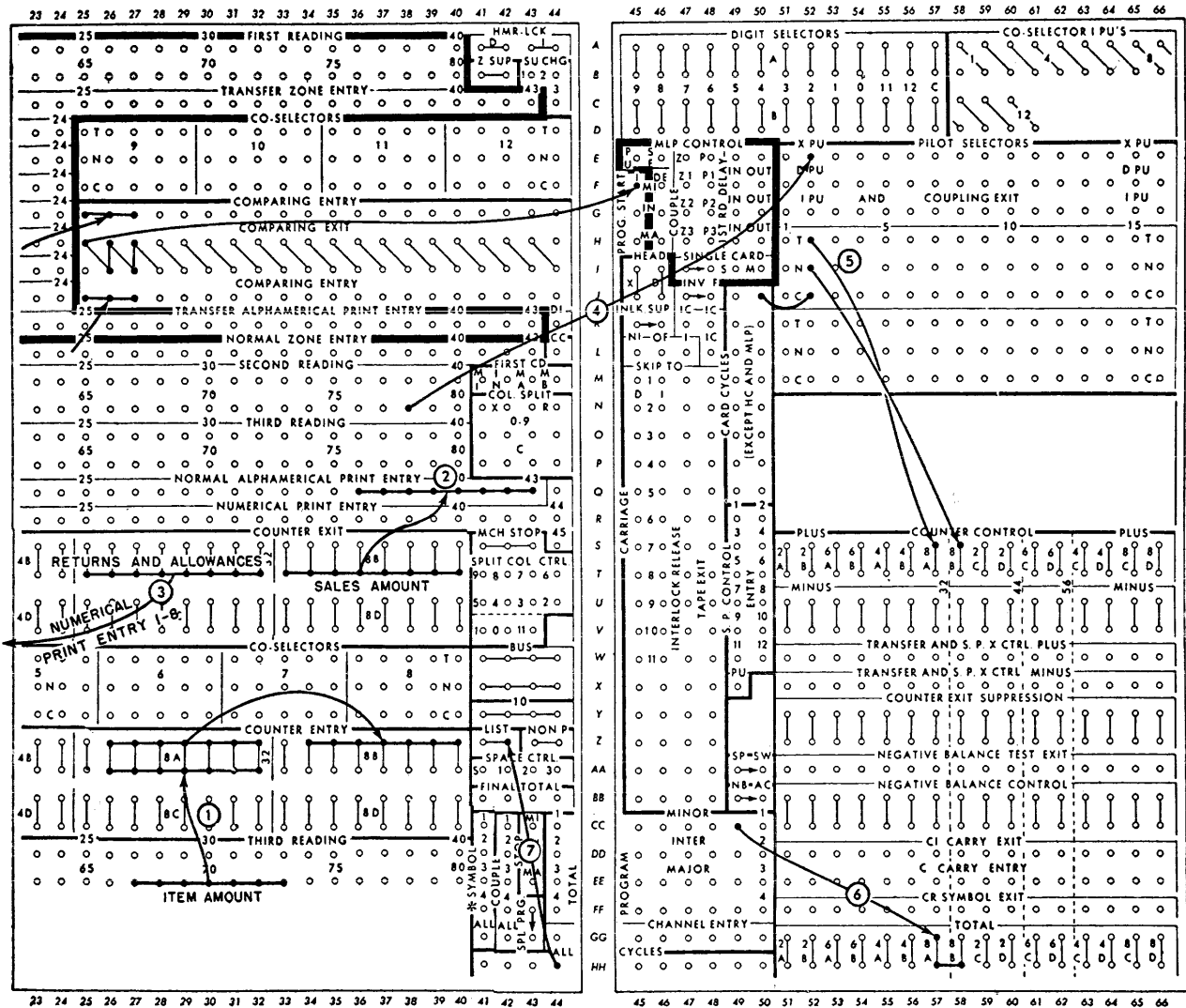

FIGURE 27. X SELECTION

allowances column for X78 cards. Only the wiring for control of the counters is shown in Figure 27.

1. The item amount is wired to both counter 8A and 8B entry.
2. The sales amount is detail printed and total printed by wiring counter 8B exit to alphamerical print entry 36-43.
3. Returns and allowances are detail printed and total printed by wiring counter 8A exit to numerical print entry 1-8.

4. Pilot selector 2 is picked up from X78 at the second reading station.

5. Card cycles impulse for NX cards is wired to the plus of 8B; for X cards it is wired to the plus of 8A.

6. Minor total program is wired to 8A and 8B total, to cause both counters to read out and reset for every change in salesman number.

7. The machine is wired to detail print.

DIGIT SELECTION

DIGIT punching as well as X punching may be used to control pilot selectors. If the presence of any digit in a card column is sufficient to identify a particular type of transaction, then the column containing the digit may be wired directly to the D pickup of a pilot selector. If a particular type of transaction is identified by a specific digit, then a digit selector is necessary.

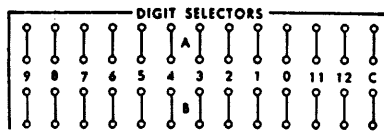

A-D, 45-57

Digit Selector (Optional). There are two digit selectors shown on the control panel, A and B. Each selector has a pair of C (common) entry hubs and exits for each of the digits from 9 through 0, and for 11 and 12. When C is wired from a card column, the hubs from 9 through 12 will emit impulses corresponding to the digits punched in the column. These digits may be used to pick up pilot selectors or to operate functions of the machine that may be digit controlled, such as hammerlock (D) or head control (D). Digit selectors are operative on card-feed cycles only.

Wiring for Digit Selection

The examples used in explaining X selection (Figure 26) is used also for the purpose of explaining digit selection. Returns and allowances are identified by digit 5 in column 7. The wiring is shown in Figure 28.

1. Column 7 is wired from second reading to the C of digit selector A.
2. Digit 5 is wired to the D pickup of a pilot selector.

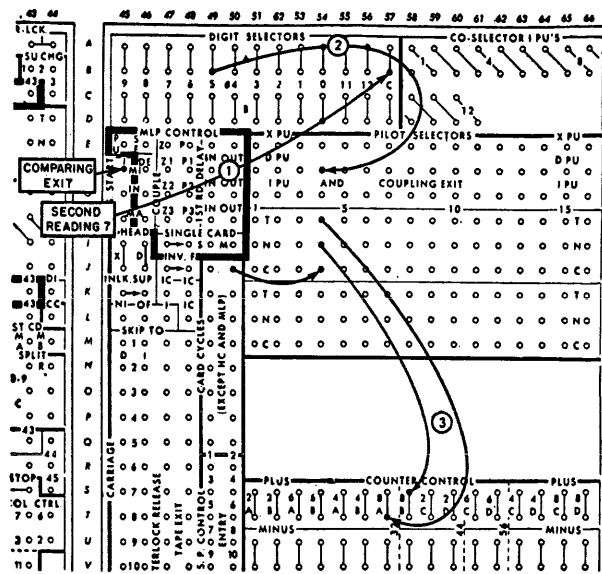

FIGURE 28. DIGIT SELECTION

3. A card cycles impulse is wired through the normal side of the pilot selector to the plus of 8B to add sales amount, and through the transferred side to the plus of 8A to add returns and allowances.

Digit Selectors Used as Digit Emitters

The digit selector can be used as a digit emitter when it is impulsed by the DI hub. *Cycles impulses should never be wired through a digit selector.*



K, 44

DI (Digit Impulse). The DI (digit impulse) hub emits an impulse for every digit 9 through 0 and for 11 and 12, for every machine cycle, including run-in and run-out cycles. When it is wired to the C of a digit selector, all digits are active for every card feed cycle. The digit selector then becomes a digit emitter.

Wiring (Figure 30)

1. The columns to be printed are wired to print entry.
2. A pilot selector is picked up from an X at the second reading station.
3. If X cards are to be printed, a card cycles impulse is wired through the transferred side of the pilot selector to LIST.
4. If NX cards are to be printed, a card cycles

impulse is wired through the normal side of the pilot selector to LIST, as shown by the dotted lines.

OFFSET TOTAL PRINTING

It is often necessary to detail print amounts from one set of type bars and print their total from another set of type bars, directly beneath other printed information. In the example in Figure 31,

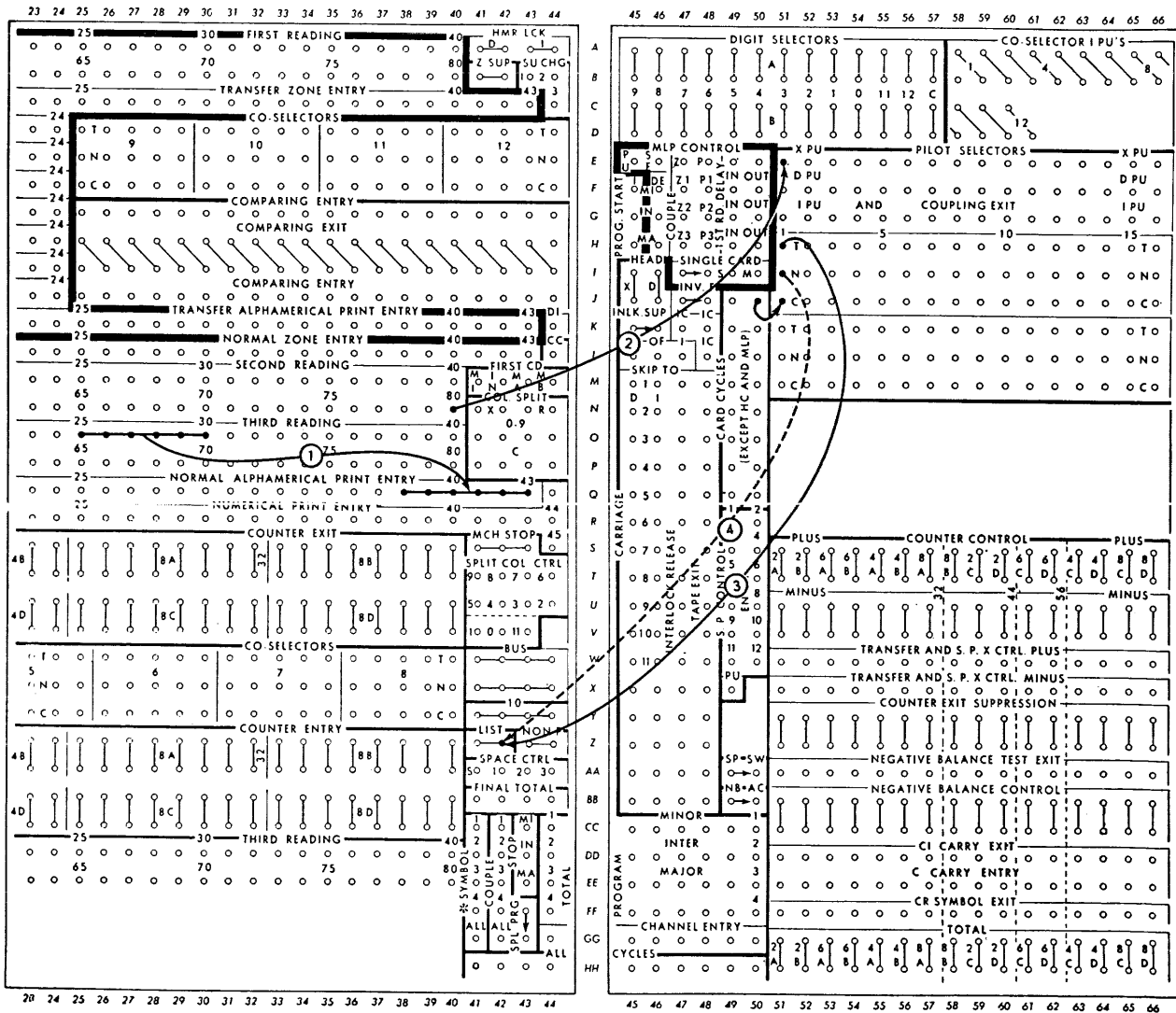

FIGURE 30. SELECTIVE PRINTING

the name of the insured is printed from alphabetical type bars 11-25 and the amount of insurance is printed from alphabetical type bars 27-31.

The total amount of insurance would normally print beneath the detail amounts. The total may be offset (type bars 16-20) as shown in the illustration by wiring the exit of the counter containing the amount of insurance to the same type bars that are printing the "name of insured." Counter detail printing is suppressed by wiring a card cycles impulse to counter exit suppression. Thus, the name of the insured will print without interference from the counter exit. The amount of insurance is printed by wiring it directly from third reading to the type bars.

POLICY NUMBER	NAME OF INSURED	AMOUNT OF INSURANCE
91846702	EVELYN SMITH	1500
60942301	DOROTHY GREEN	2500
66450398	ANDREW HERRON	5000
138149275	DONALD GREW	2000
POLICIES	TRANSFERS	TOTAL AMT. INSURANCE
		11000
		REVIVALS

FIGURE 31. OFFSET TOTAL PRINTED REPORT

When offset totals are printed from numerical type bars, care must be taken that the hammer-split levers raised for suppressing zeros in detail printing will not interfere with the printing of zeros in the offset total.

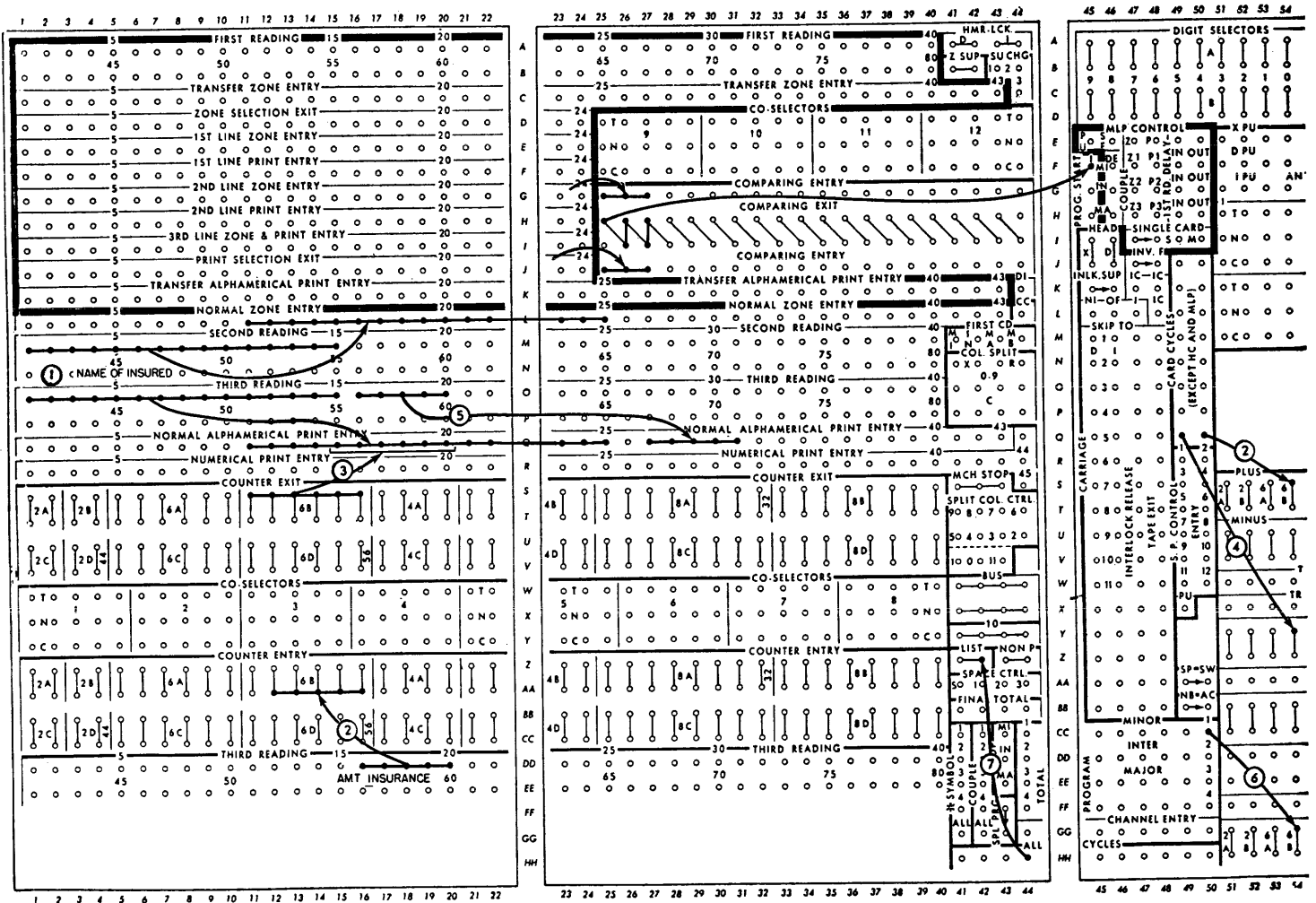

FIGURE 32. OFFSET TOTAL PRINTING

Wiring (Figure 32)

1. Name of insured is wired directly to type bars 11-25.
2. Amount of insurance is wired to counter entry 6B, which is impulsed to add from card cycles.
3. The exit of counter 6B is split wired to alphabetical type bars 16-20.
4. Card cycles impulse is wired to counter exit suppression 6B. This also suppresses all possible entry into the counter through the counter exit.
5. Amount of insurance is wired from third reading directly to type bars 27-31.
6. Counter 6B is impulsed to read out and reset on a minor program. Minor program start is impulsed from comparing exit.
7. The machine is wired to print every card.

HAMMERLOCK CONTROL

EACH type bar on the Type 402 and Type 403 is equipped with two hammerlock levers; a short lever on the right, and a long lever on the left. When both levers are down (Figure 33A), the hammer will hit the type bar on every cycle. When the short hammerlock lever is raised (Figure 33B), the hammer will never hit the type bar and therefore no printing will take place.

When the long hammerlock lever is raised, the firing of the hammer is under the control of the hammerlock hubs on the control panel. When the hammerlock hubs do not receive an impulse, the hammer will fire, because the support bar remains in a normal position (Figure 33C). When the

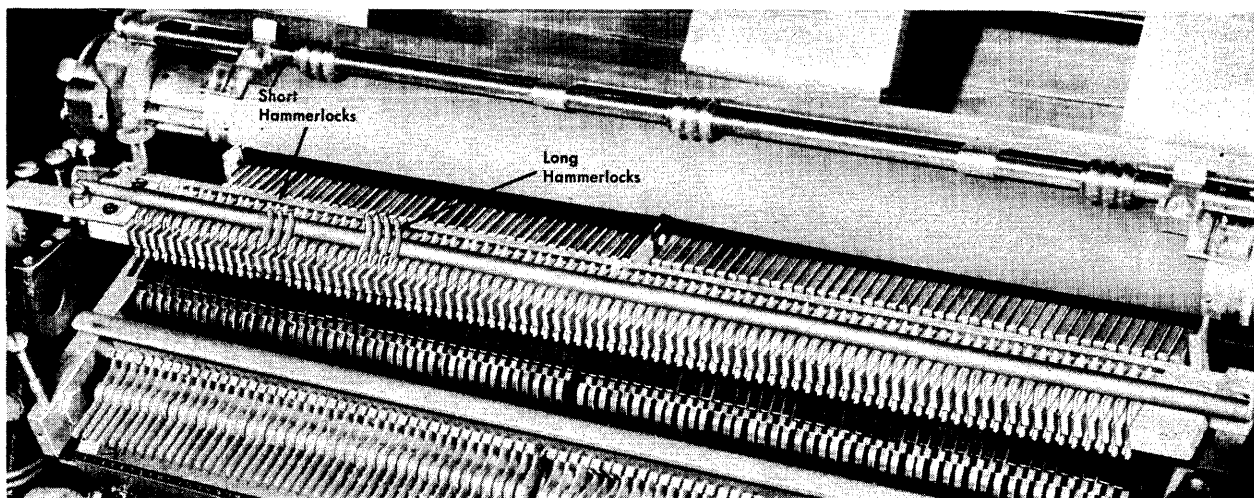
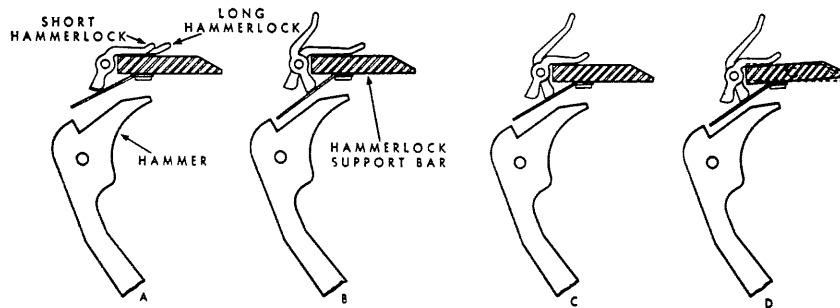
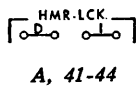

FIGURE 33. HAMMERLOCK LEVERS

hammerlock hubs do receive an impulse, the hammer will not fire, because the support bar is tilted just enough to stop it from firing (Figure 33D). Hammerlock levers should not be raised while type bars are printing.



Hammerlock Hubs. When these hubs are impulsed, printing will be suppressed from those type bars for which the long hammerlock levers are raised. The D pickup hubs receive X or digit impulses to control hammerlocking on the following cycle. If hammerlocking is to take place as the card passes the third reading station, the X or digit must be wired from the second reading station. If the X is punched in a column which is also digit punched, a column split unit must be used. The immediate pickup hubs receive impulses to control hammerlocking on the same cycle, and normally wired from total program to suppress printing on program cycles or from the first card hubs to suppress printing for the first card of a group. If hammerlocking is desired for NX or no digit cards, a card cycles impulse must be controlled through a pilot selector.

It is not possible to hammerlock some of the type bars with one kind of impulse, and other type bars with another kind of impulse. All 88 type bars are subject to hammerlock control from a single impulse.

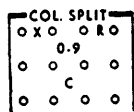

Column Split. The four standard column splits are active on card cycles only. Normally they are used to separate X-R (11 and 12) impulses from 0-9 impulses read from a card column or the DI (digit impulse) hub.

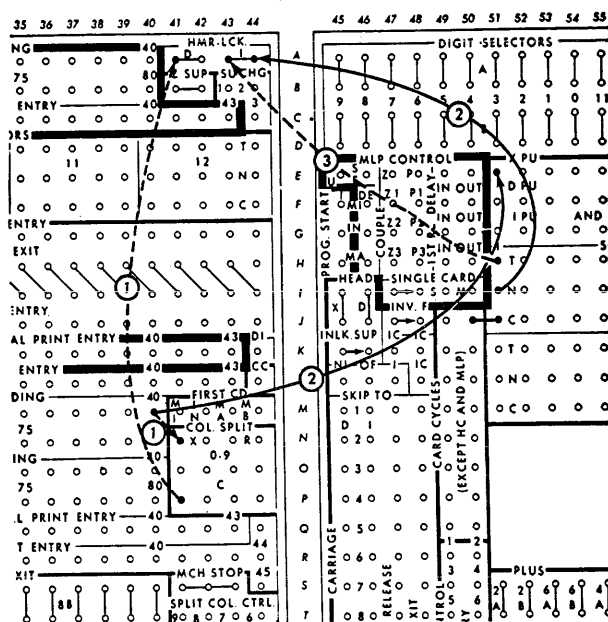

FIGURE 34. HAMMERLOCKING FOR X OR NX CARDS

Wiring, X Control (Figure 34)

1. Hammerlocking may be controlled from an X card by raising the long hammerlock levers for those type bars from which the information will print. For X hammerlock the X is wired from the second reading station through a column split, to hammerlock D pickup. Hammerlocking will take place on the following cycle, or as the card passes the third station.

2. Heavy lines on the diagram show the wiring for hammerlocking for NX cards. Column 40 is wired from second reading to the X pickup of a pilot selector. A card cycles impulse is wired through the normal hubs of the selector to hammerlock immediate pickup.

As each NX card passes the third reading station, a card cycles impulse controls hammerlocking immediately, and if the long hammerlock levers are raised, printing will be suppressed.

3. The dotted wire from the transferred hub of the selector to I hammerlock shows the wiring for X cards.

Whenever a card cycles impulse is used to control hammerlocking, it must be wired to the I hub. Whenever X or digit impulses are used, they must be wired to the D hub.

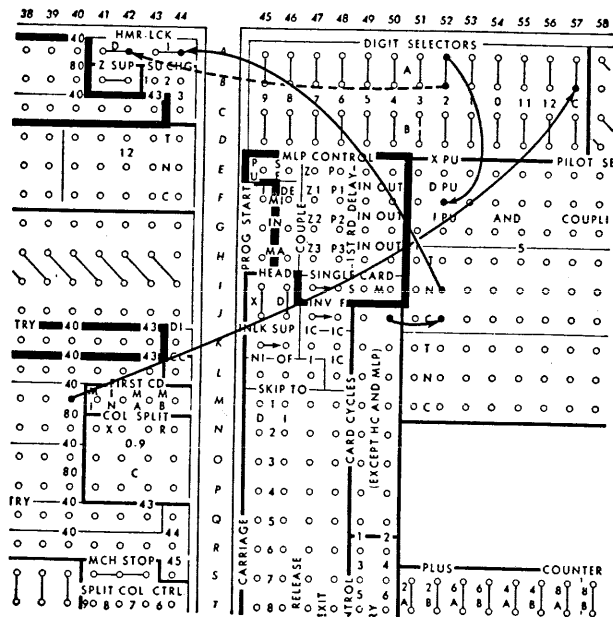

FIGURE 35. HAMMERLOCKING FOR D OR NO D CARDS

Wiring, Digit Control (Figure 35)

Column 40 is wired from second reading to the C of digit selector A and the digit 2 is wired to the hammerlock D pickup as shown by the dotted line. Hammerlocking takes place on the following cycle, or as the card is passing the third station.

If no digit 2 cards are to control hammerlocking, the 2 from digit selector A is wired to the D pickup of a pilot selector. A card cycles impulse is wired through the normal points of the pilot selector to hammerlock I pickup.

Wiring, Comparing Exit (Figure 36)

Hammerlocking may be controlled from the first card of a group of cards by wiring the control field to the comparing entry and the comparing exit to hammerlock D pickup. If hammerlocking is to be controlled from all but the first card of a group, the comparing exit will be wired to the D pickup of a pilot selector and a card cycles impulse through its normal points to the hammerlock immediate pickup, as shown by the

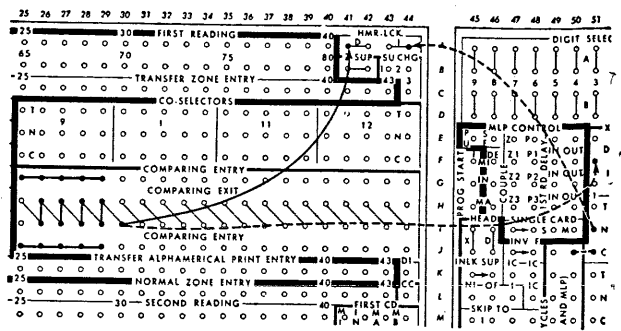

FIGURE 36. HAMMERLOCKING FROM COMPARING EXIT

dotted lines. It is not necessary to initiate a program start to accomplish this type of hammerlock control.

Another method of controlling hammerlocking from the first card of a group is discussed under group indication, and requires the use of the first card hubs.

Wiring, Total Program (Figure 37)

Total printing may be hammerlocked by wiring the minor, intermediate or major program exit to the hammerlock I pickup and by raising the long hammerlock levers for those type bars from which the total would normally print. Total program must always be wired to the I pickup.

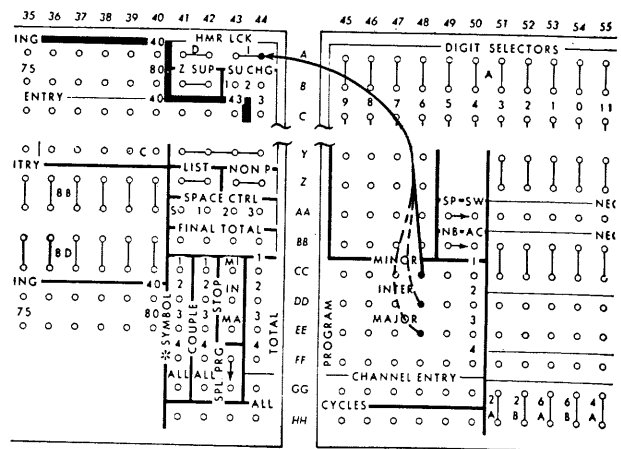

FIGURE 37. HAMMERLOCKING FROM TOTAL PROGRAM EXITS

GROUP INDICATION

THE printing of information from only the first card of a group, as shown in Figure 38, is called group indication. In detail printing, normally the indicative information is printed repetitively from every card in the control group. This repetitive printing may be suppressed by selection, by hammerlocking, and by printing from counter exits. Each method is discussed in detail, following the explanation of the hubs which are used for group indication.



M, 41-44

First CD (First Card). The MI (minor) IN (intermediate) and MA (major) first card hubs emit impulses during the print cycle of the first card of their respective program groups. They are normally wired to counter plus to add the first card of a group, to a co-selector pickup for group indication, to hammerlock control, or to carriage skip to hubs to cause skipping before the first card of a group.

The MB (minor body) hub emits an impulse for the first card of every minor group in the body when heading control is wired. This hub is more fully explained under *Head Control*.

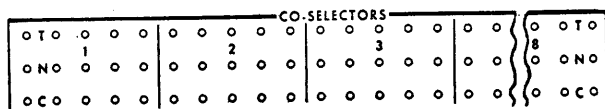

W-Y, 1-40

Co-Selectors. Co-selectors are so named because they often operate in conjunction with pilot selectors. Each selector has 5 positions, each position having a C (common), N (normal) and a T (transferred) hub. In principle they function like pilot selectors, in that when they are transferred, there is a common connection between C and T, and when they are not transferred, there is a common connection between C and N.

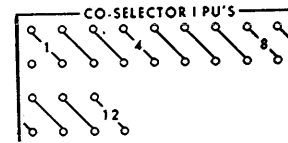

A-D, 58-66

Each selector has two common pickup hubs, which are diagonally arranged for convenience in jackplugging. When these hubs are impulsed, the selector transfers immediately and holds for the duration of the cycle. When these hubs are wired from the coupling exit (immediate pickup row) of a pilot selector, they transfer with the pilot selector and hold for the same length of time as the pilot selector. In other words, when a co-selector is picked up from the coupling exit of a pilot selector, the number of positions available for selection is increased from 2 to 7.

Four co-selectors are standard on the 32- and 44-counter machines, 8 on the 56- and 80-counter machines. Four others are optional.

Wiring, Group Indication (Figure 39)

This illustration demonstrates three methods of wiring for group indication.

A. Selector method. The commodity class is wired from third reading, through the transferred points of co-selector 6 to print entry. The co-selector is picked up from minor first card, since commodity class is wired for minor program start. The selector transfers for the first card of every minor group, at which time commodity class prints, and is normal for all other cards in the same commodity class.

B. Hammerlock method. The trade class is wired from third reading directly to print entry. Intermediate first card is wired to the immediate pickup of a pilot selector. A card cycles impulse is wired through normal of the selector to ham-

SALES SUMMARY																											
ENTRY DATE		UNIT COST	COST AMOUNT	GROSS PROFIT	SALES YR. - TO - DATE	CUSTOMER NUMBER	LOCATION		TRADE CLASS	SALES-MAN NO.	QUANTITY	COMMODITY NUMBER	SALES AMOUNT														
NO.	DAY	ENTRY					ST.	CITY																			
00	00	00	00	00	00	00	00	00	00	00	00	00	00	00													
11	11	11	11	11	11	11	11	11	11	11	11	11	11	11													
22	22	22	22	22	22	22	22	22	22	22	22	22	22	22													
33	33	33	33	33	33	33	33	33	33	33	33	33	33	33													
44	44	44	44	44	44	44	44	44	44	44	44	44	44	44													
55	55	55	55	55	55	55	55	55	55	55	55	55	55	55													
66	66	66	66	66	66	66	66	66	66	66	66	66	66	66													
77	77	77	77	77	77	77	77	77	77	77	77	77	77	77													
88	88	88	88	88	88	88	88	88	88	88	88	88	88	88													
99	99	99	99	99	99	99	99	99	99	99	99	99	99	99													

SALES BY STATE								
STATE	TRADE CLASS	COMM CLASS	SALES AMOUNT	COST AMOUNT	GROSS PROFIT	SALES AMOUNT BY STATE	COST AMOUNT BY STATE	GROSS PROFIT BY STATE
37	288	1	160.60	122.78	37.82	1177.20	913.69	263.51
			100.03	80.20	19.83			
			260.63 *	202.98 *	57.65 *			
	2	527.58	411.37	116.21				
		527.58 *	411.37 *	116.21 *				
		788.21 *	614.35 *	173.86 *				
300	1	96.04	73.89	22.15				
		292.95	225.45	67.50				
		388.99 *	299.34 *	89.65 *				
		388.99 *	299.34 *	89.65 *				
40	686	1	217.81	117.52	100.29			
			327.50	255.95	71.55			

FIGURE 38

merlock immediate pickup, and the long hammerlock levers are raised for the type bars to which trade class is wired. For every intermediate program change, the pilot selector will pick up and the hammerlock will not be impulsed, thus allowing trade class to print once for each intermediate group.

C. Counter method. The state is wired to counter entry 2D and the major first card is wired to the plus of that counter. The counter exits are wired to print entry. The counter will add the first card of a major group. Since counter exits are active when the counter is impulsed, state will list once for every major group.

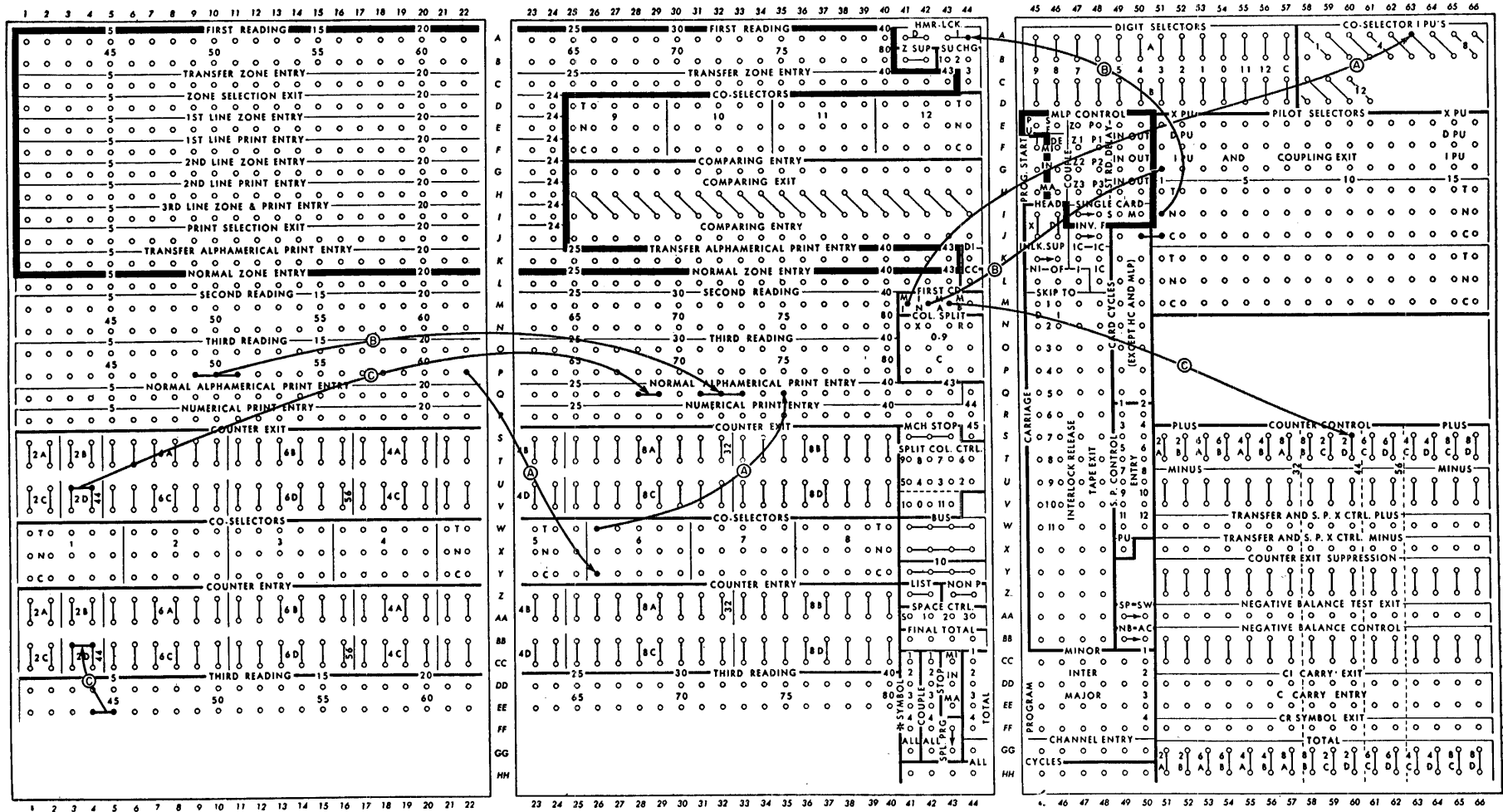

FIGURE 39. GROUP INDICATION

SETUP CHANGE

SUCHG
1020
3
0

B, 43-44; C, 44

SU CHG (Setup Change) 1, 2, 3. Within reasonable limitations one control panel may be used for several different reports, without any change in control panel wiring, by the use of the setup change switches, located on the side of the machine. Each setup change switch has a hub on the control panel which emits an impulse each machine cycle when the corresponding setup change switch (Figure 40) is turned on.

The setup change exits may be wired directly to the list hubs or to the pickup of a co-selector or a pilot selector. The selector can then be used to change machine functions according to the position of the setup change switch. The following impulses cannot be selected: all first card impulses; NBAC, inverted form and special program switches.

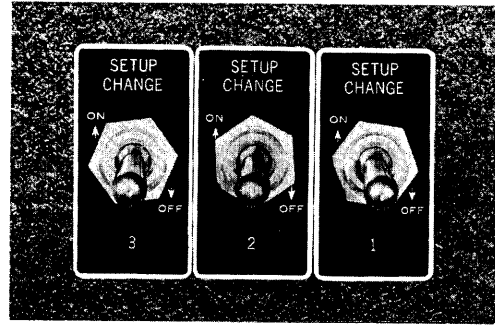

FIGURE 40. SETUP CHANGE SWITCHES

Changing from Detail Printing to Group Printing

In the example in Figure 41, the first report is detail printed, (all cycles to LIST); the second and third reports are group printed (no wiring to LIST). Without setup change this would necessitate the manual removal of the wire to LIST as well as the insertion of a card cycles impulse to counter exit suppression to eliminate overprinting, as shown in the deduction column of the second

DEDUCTION REGISTER					19__	
EMPLOYEE NAME	EMPL. No.		DEDUCTION CODE	DEDUCTIONS		
	DEPT.	CLOCK				
FRED ACKERLY	1	13	215		50	
FRED ACKERLY	1	13	314		75	
FRED ACKERLY	1	13	573		500	
					625	
MILTON CARGIN	1	100	334		35	
MILTON CARGIN	1	100	414		50	

DEDUCTION REGISTER					19__	
EMPLOYEE NAME	EMPL. No.		DEDUCTION CODE	DEDUCTIONS		
	DEPT.	CLOCK				
JOSEPH						
JOSEPH	1	13	215		685 *	
	1	100	334		85 *	
	1	145	215		138 *	
			334		85 *	
			334		65 *	
			215		160 *	
			334		85 *	
			215		165 *	
			334		85 *	
			334		85 *	
			334		135 *	
			215		150 *	
			215		700 *	
			334		135 *	
			414		50 *	

DEDUCTION REGISTER					19__	
EMPLOYEE NAME	EMPL. No.		DEDUCTION CODE	DEDUCTIONS		
	DEPT.	CLOCK				
FRED ACKERLY	1	13			625	
MILTON CARGIN	1	100			85	
GERALD DRISCOLL	1	145			135	
JOSEPH DUHLMEIER	1	150			85	
CLEMENT EDWARDS	1	170			65	
PATRICK EGGLESTON	1	175			100	
WILLIAM FRISBIE	1	220			85	
SOCRATES GLEZEN	1	230			165	
BERT GRAHAM	1	245			85	

(Deduction code and asterisk suppressed with short hammerlocks)

FIGURE 41. DEDUCTION REGISTER, DETAIL AND GROUP PRINTED

report. The total of the group prints over the amount printed from the first card of the group. These wiring changes can be made automatically by making use of the setup change feature of the machine. There are many other uses of the setup change switches to vary machine function from one report to another, such as programming, hammerlocking, or counter clearing.

Wiring for Setup Change

Figure 42 shows wiring for this operation when setup change switch 1 is changed from OFF to ON.

1. Setup change hub 1 is wired to the immediate pickup of pilot selector 1 and switch 1 is turned ON.

2. All cycles, wired through the normal side of this selector to LIST, is eliminated when the switch is ON.

3. The card cycles impulse, wired through the transferred side of the pilot selector, reaches counter exit suppression when the switch is ON, to prevent printing of deductions from the first card of the group.

More extensive changes can be made by wiring the setup change hubs to one or more co-selector pickups. The extent of the changes to be made depends entirely upon the selector capacity available for making them.

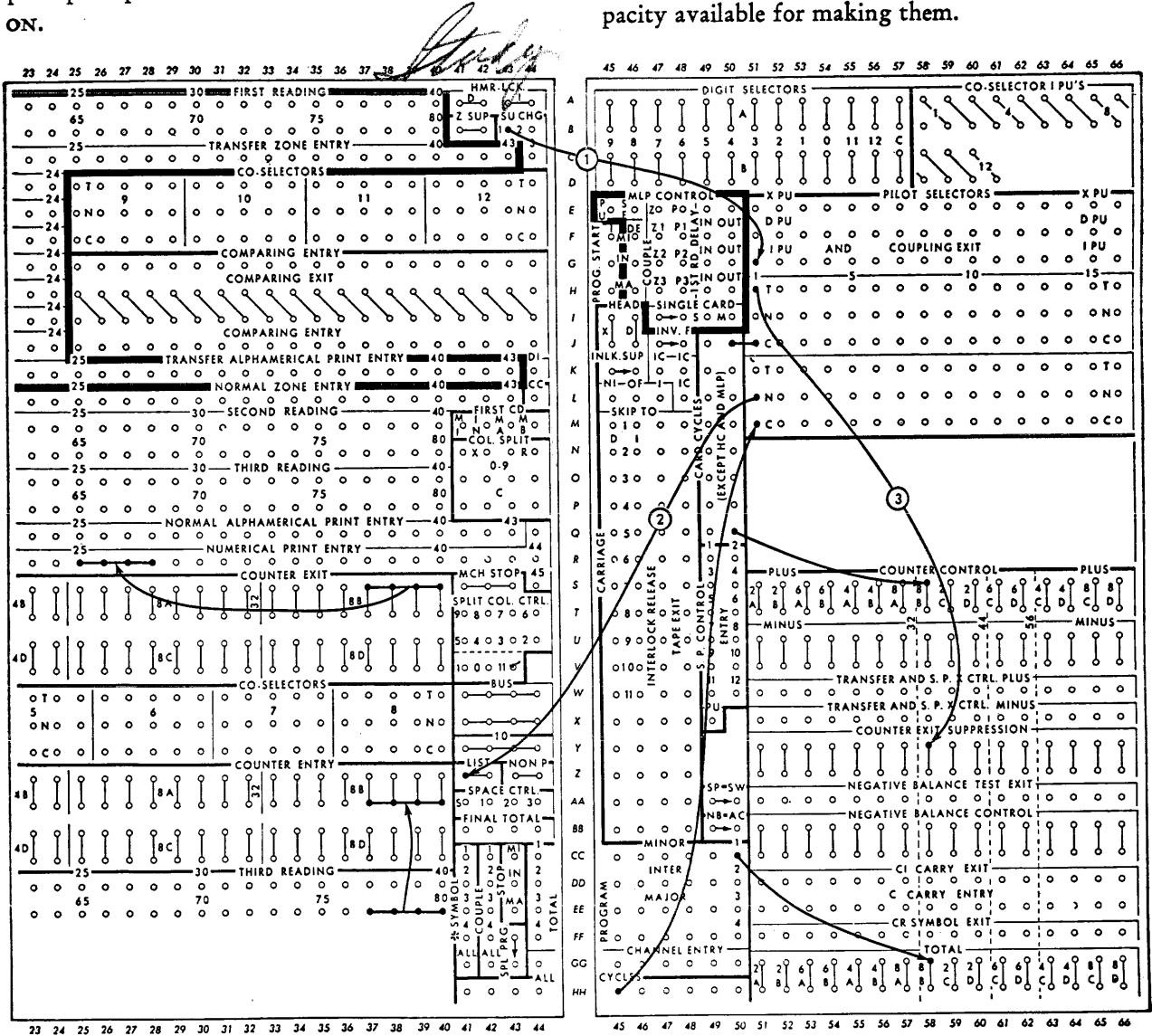

FIGURE 42. CHANGING FROM DETAIL PRINT TO GROUP PRINT

TOTAL TRANSFER, NET BALANCE MACHINE

Total Printing from the Same Type Bars

More than one type of total may be printed from the same type bars, without the use of selectors. This operation is sometimes referred to as total transfer, and is based upon the principle of rolling totals, as they are obtained, from one counter to another.

Each total requires a separate counter. Only the minor counter adds or subtracts from the card, however. On the minor program change, the minor total prints and rolls into the intermediate counter. On an intermediate program change the intermediate total prints and rolls into the major counter. On a major program change, the major total prints. Thus, the major total is the sum of all the intermediate totals and the intermediate total is the sum of all the minor totals. This method of accumulating intermediate and major totals provides substantial proof that if the major total is correct, the intermediate and minor totals which contribute to the major total are also correct.

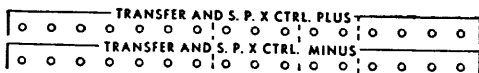

W-X, 51-66

Transfer and S.P. X Control. Plus and Minus. These hubs may be used on net-balance machines only. They emit impulses under the following conditions:

1. The transfer plus hub of a counter emits an impulse whenever the total hub of that counter is impulsed and negative balance control is not wired. If negative balance control is wired, transfer plus emits for plus totals, and transfer minus emits for minus totals. They are normally wired to the counter control hubs of receiving counters.

2. When the accounting machine is connected to a summary punch, the summary punch X control plus hub emits a summary punch X impulse whenever the total hub of that counter is impulsed. If negative balance control is also wired, summary punch control X plus emits an X impulse for plus totals, and summary punch control X minus emits an X impulse for minus totals. For summary punch operations, these hubs are normally wired to the summary punch control entries so that X's may be punched in summary cards for plus or minus balances.

During MLP operations, counters 2A through 4B are internally controlled to clear when an MLP-3 card passes the second and fourth stations. However, transfer plus and minus hubs do not emit at these times.

Figure 43 illustrates the printing of minor, intermediate and major totals from the same type bars. It is a group printed report with a minor program on city, an intermediate program on county, and a major program on state. All three totals are printed from the same type bars, the intermediate totals being indicated by one asterisk and the major totals by two asterisks.

STATE	COUNTY	CITY	SALES		
1	1	1	100	} Minor Totals	
		2	200		
		3	95		
				395 *	} Intermediate Total
	2	2	1	50	} Minor Totals
			2	49	
3			24		
				123 *	} Intermediate Total
				518 **	} Major Total

FIGURE 43. PRINTING THREE TOTALS — SAME TYPE BARS

Wiring (Figure 44)

1. Sales amount is wired from third reading to counter entry 8A.

2. Returns are identified by an X punch in Column 40. This column is wired from second reading to the X pickup of pilot selector 2. A

card cycles impulse is wired through the normal side of the pilot selector to the plus of 8A, and through the transferred side to the minus of 8A.

3. Counters 8A, 8B, and 8D are controlled to read out and reset on minor, intermediate and major programs, respectively.

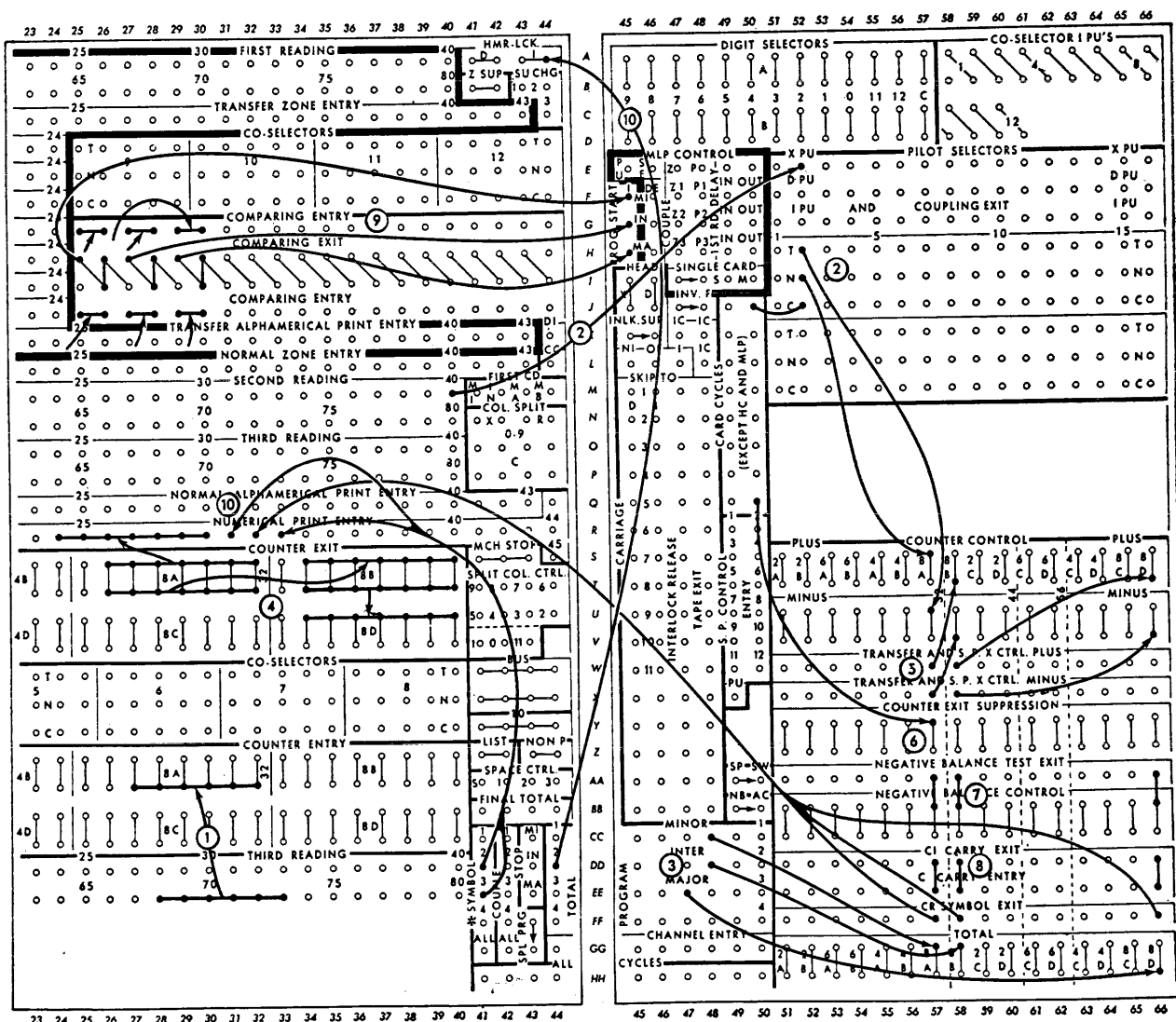

FIGURE 44. TOTAL TRANSFER — NET BALANCE

4. The exit of 8A is wired to the exit of 8B and the exit of 8B is wired to the exit of 8D. Counter 8A is also wired to numerical print entry 23-30. Counter 8A is the only counter that will add or subtract each individual card as it passes the third reading station. Counters 8B and 8D will add or subtract totals only as they are transferred from one counter to the other.

On a minor program, the total prints directly from counter 8A, but it also transfers to the intermediate counter 8B, where it adds or subtracts according to whether it is a plus or a minus. On a net balance machine, a negative total is always converted as it reads out, so a true figure will always be transferred.

On an intermediate program, the intermediate total prints from counter 8B, and also transfers to the major counter 8D, where it will add or subtract according to whether it is a plus or a minus.

On a major program, the major total prints from counter 8D.

Transfer between counters is made over wires connecting counter exits, when the counters are impulsed to read out and reset.

5. When minor totals are transferred from counter 8A they are either added or subtracted in 8B by wiring the transfer control plus of 8A to 8B plus, and the transfer control minus of 8A to 8B minus.

When intermediate totals are transferred from counter 8B, they are either added or subtracted into 8D by wiring the transfer control plus of 8B to 8D plus, and the transfer control minus of 8B to 8D minus.

6. Since the report is group printed, printing from 8A counter exit must be suppressed during detail print cycle. This is done by wiring a card cycles impulse to the counter exit suppression of 8A. Counter exit suppression wiring would not be necessary if the report were to be detail printed.

7. Negative totals in all three counters are converted to true figures.

8. Each counter used is wired for carry-back, because each is wired to subtract.

9. Program controls are wired normally.

10. One asterisk is printed for intermediate totals by wiring the asterisk symbol 2 to print entry 31. Two asterisks are printed for major totals by wiring asterisk symbol 3 to print entries 31 and 33. The asterisk in 33 is prevented from printing on an intermediate total by wiring the intermediate total program exit to the immediate pickup of the hammerlock control and by raising the long hammerlock lever for type bar 33.

Credit symbols are printed for all negative totals by wiring the credit symbol exit of all three counters to print entry 32. When counter exit is suppressed, the corresponding credit symbol exit is also suppressed.

Total Printing from Different Type Bars

Minor, intermediate and major totals can be total-transferred and also total printed from different type bars. The difference between the wiring for this and the previous example is that the counter exits of transferring counters must be wired to counter entries of receiving counters. Wiring from exit to exit would cause detail or total printing in three places, from any one counter.

Wiring (Figure 45)

1. The field to be added is wired to 8A entry and the counter is impulsed to add.

2. Minor, intermediate and major program starts are impulsed.

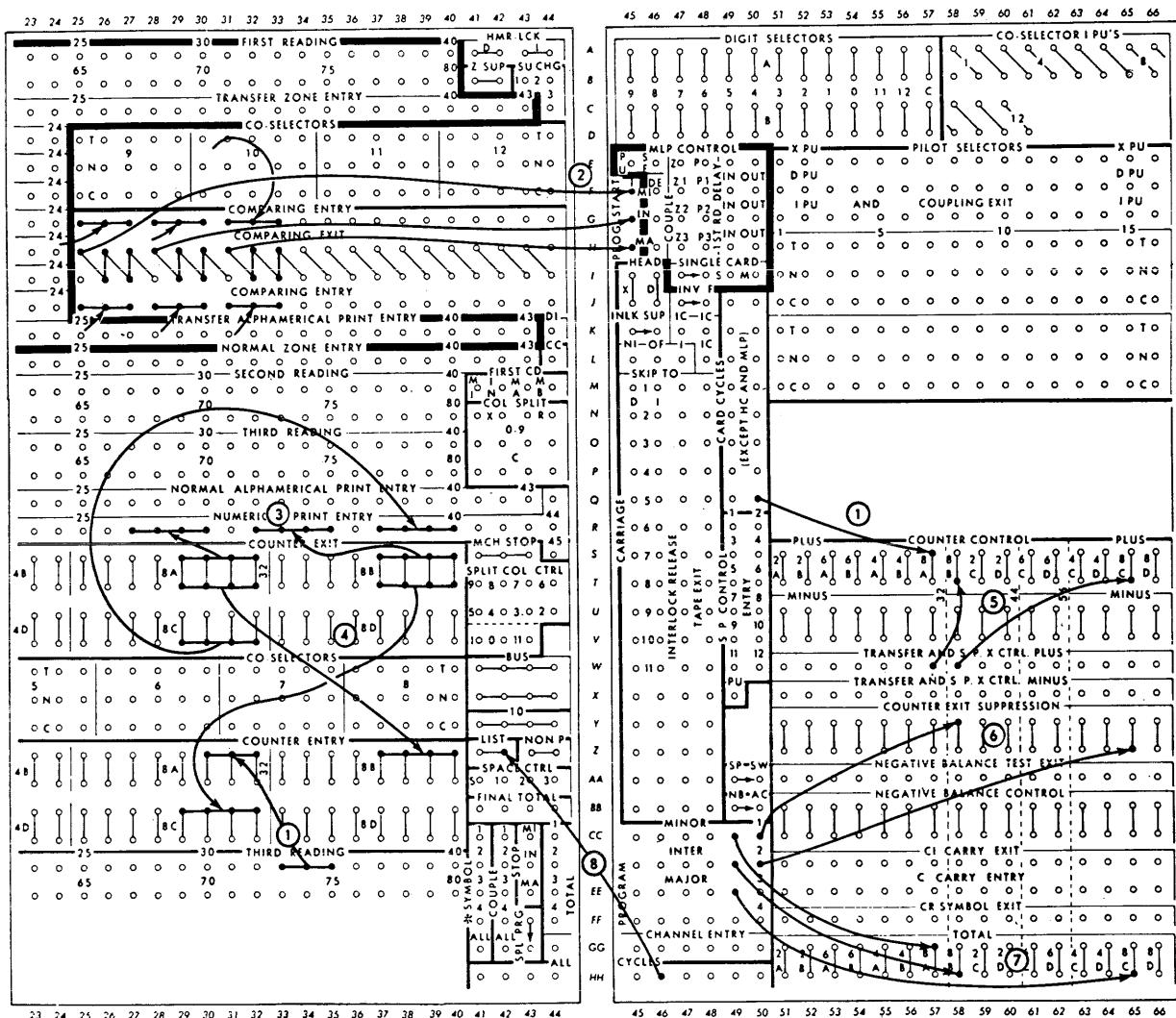

FIGURE 45. MINOR, INTERMEDIATE, MAJOR TOTALS — DIFFERENT TYPE BARS

3. The minor total prints from type bars 27-30 from 8A exit. The intermediate total prints from type bars 32-35 from 8B exit. The major total prints from type bars 37-40 from 8C exit.

4. 8A exit is wired to 8B entry so that when the minor total is read out to print it can also add in the intermediate counter 8B. 8B exit is wired to 8C entry so that when the intermediate total is read out to print it can also add in the major counter 8C.

5. Transfer control plus of 8A is wired to the plus of 8B and the transfer control plus of 8B is wired to the plus of 8C.

6. The intermediate counter 8B is adding minor totals which will print unless suppressed. The major counter 8C is adding intermediate totals which will print unless suppressed.

7. Counters 8A, 8B and 8C are wired to read out and reset on their respective programs.

8. The machine is wired to detail print.

TOTAL TRANSFER, NON-NET BALANCE MACHINE

As explained under *Subtraction*, on a non-net balance machine, two counters are required to print complement balances as true figures. While one counter adds, the other subtracts; thus, one or the other will always contain a true figure.

Total transfer on non-net balance machines requires two counters for every program step, if subtraction is involved. All counter exits will be suppressed for negative balances, and only true figures will be printed and transferred from one set of counters to the other.

Since the transfer control plus and minus are not active on non-net balance machines, another method of adding or subtracting in the receiving counters must be used. The negative balance test exits for the minor and the intermediate counters are used to control the minor and intermediate total program exits to the counter plus and minus hubs. Thus, the minor total will add in the intermediate counter when the total is plus and subtract when it is minus. Likewise, the intermediate total will add and subtract in the major counter according to the sign of the total, as shown in Figure 47.

Wiring (Figure 46)

1. The field to be accumulated is wired to counter entries 6A directly and 6B indirectly through counter exits. Counter 6A will be the original minor counter and 6B the alternate minor counter. The original counter is the counter wired to add or subtract according to the presence

or absence of a control punch. The control wiring in the alternate counter is reversed.

2. A positive minor total will print from either 6A or 6B from type bars 26-30. The minor total also adds or subtracts into the intermediate counters 8A and 8B.

3. A positive intermediate total will print from either 8A or 8B from type bars 24-30. The intermediate total will also add or subtract into the major counters 8C and 8D.

4. A positive major total will print from either 8C or 8D from type bars 24-30.

5. Counters 6A and 6B are the only counters that add or subtract information from the card. X40 is wired from the second reading station to a pilot selector pickup. A card cycles impulse is wired through the transferred side of this selector to the minus of 6A and the plus of 6B, and through the normal side of the selector to the plus of 6A and the minus of 6B.

6. The minor total should be added in the intermediate counter 8A if it is plus and subtracted if it is minus. The plus or minus position of the original minor counter can be determined by the negative balance test exit of 6A. It is wired to the D pickup of pilot selector 2. When the D pickup is impulsed from a negative balance test exit, the selector picks up and holds through the first card of the following group. A minor total program is wired through the transferred hubs of the selector to the minus of 8A and the plus of 8B, and through the normal hubs of the selector to the plus of 8A and the minus

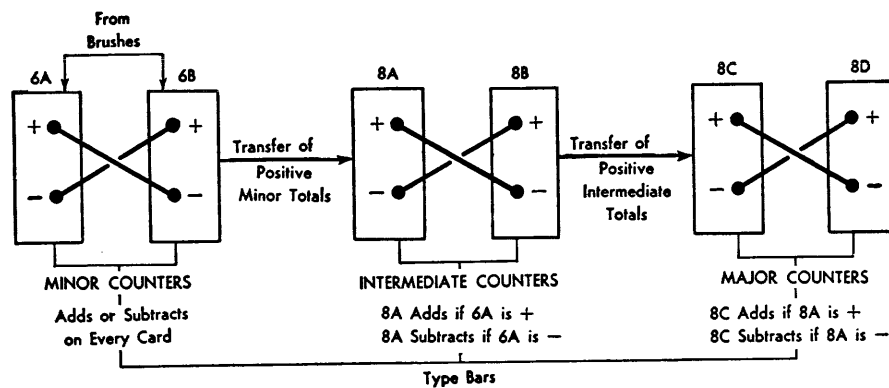

FIGURE 47. SCHEMATIC DIAGRAM OF TOTAL TRANSFER ON NON-NET BALANCE MACHINE

of 8B. Counter 8B is the alternate intermediate counter.

7. The intermediate total should be added in the major counter 8C if it is plus and subtracted if it is minus. The plus or minus position of the intermediate counter can be determined by the negative balance test exit of 8A. It is wired to the D pickup of pilot selector 4. An intermediate total program exit is wired through the transferred hubs of the selector to the minus of 8C and the plus of 8D, and through the normal points to the plus of 8C and the minus of 8D. Counter 8D is the alternate major counter.

8. Negative minor totals are suppressed by wiring negative balance test exit to counter exit suppression. Since intermediate and major totals may change their signs from plus to minus, or *vice versa*, when receiving totals from lower order counters, the negative balance test exits must first be selected before impulsing counter exit suppression. The selectors are picked up by total program couple hubs, which are explained on page 69.

9. All counters used are wired CI to C.

10. Counters 6A and 6B read out and reset on a minor total program, 8A and 8B on an intermediate total program, and 8C and 8D on a major total program.

11. Credit symbols are printed for negative totals by wiring the minor, intermediate and major asterisk symbol hubs through the transferred side of pilot selectors 2, 4 and 5 (picked up from the negative balance tests exits of 6A, 8A and 8C) to numerical print entry 32 (split wiring). The asterisk symbol hubs emit a 10 impulse that can be used to print CR symbols in even-numbered numerical type bars. Because the selectors were picked up through their D hubs, they will remain transferred through any intervening summary punch or carriage skip cycles.

12. The minor, intermediate and major program starts are wired normally.

13. Counter detail printing for the first card of each group is suppressed by wiring the minor first card hub to hammerlock immediate pickup and by raising the long hammerlocks for type bars 24-30.

CROSSFOOTING, NET BALANCE MACHINE

As many as three fields may be crossfooted on the standard machine either from each individual card or from a group of cards. (Additional crossfooting may be done using MLP or special program features.) The three fields to be crossfooted are entered into three counters as the card passes the third reading station. Three programs are used in three-field crossfooting, the minor level for crossfooting the first two fields, and the intermediate level for crossfooting the total of the first two fields with the third field. These two crossfooting cycles occur at the rate of 80 or 150 cycles per minute. The major level is used to print the result.

By impulsing major program start with a card count, all three levels will be operative for every card. The type bars must be prevented from rising during the two crossfooting cycles, and this is one of the functions of the non-print hubs.

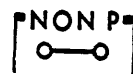

Z, 43-44

Non-Print. When these hubs are impulsed, the type bars will not rise, spacing will be suppressed, and the machine will operate at the rate of 80 to 150 cycles per minute.

If the print cycle is not needed for the first card of a group (group indicate elimination), the minor, intermediate or major first card is wired directly to non-print.

To prevent printing and spacing on a total cycle, a total program is wired directly to non-print.

If printing is to be prevented for a particular card, the designating punch for that card must be wired to the X or D pickup of a pilot selector from the station preceding the printing station. A card cycles impulse is then wired through the normal hubs of the pilot selector to non-print, to suppress printing for NX cards, or through the transferred hubs of the pilot selector to non-print to

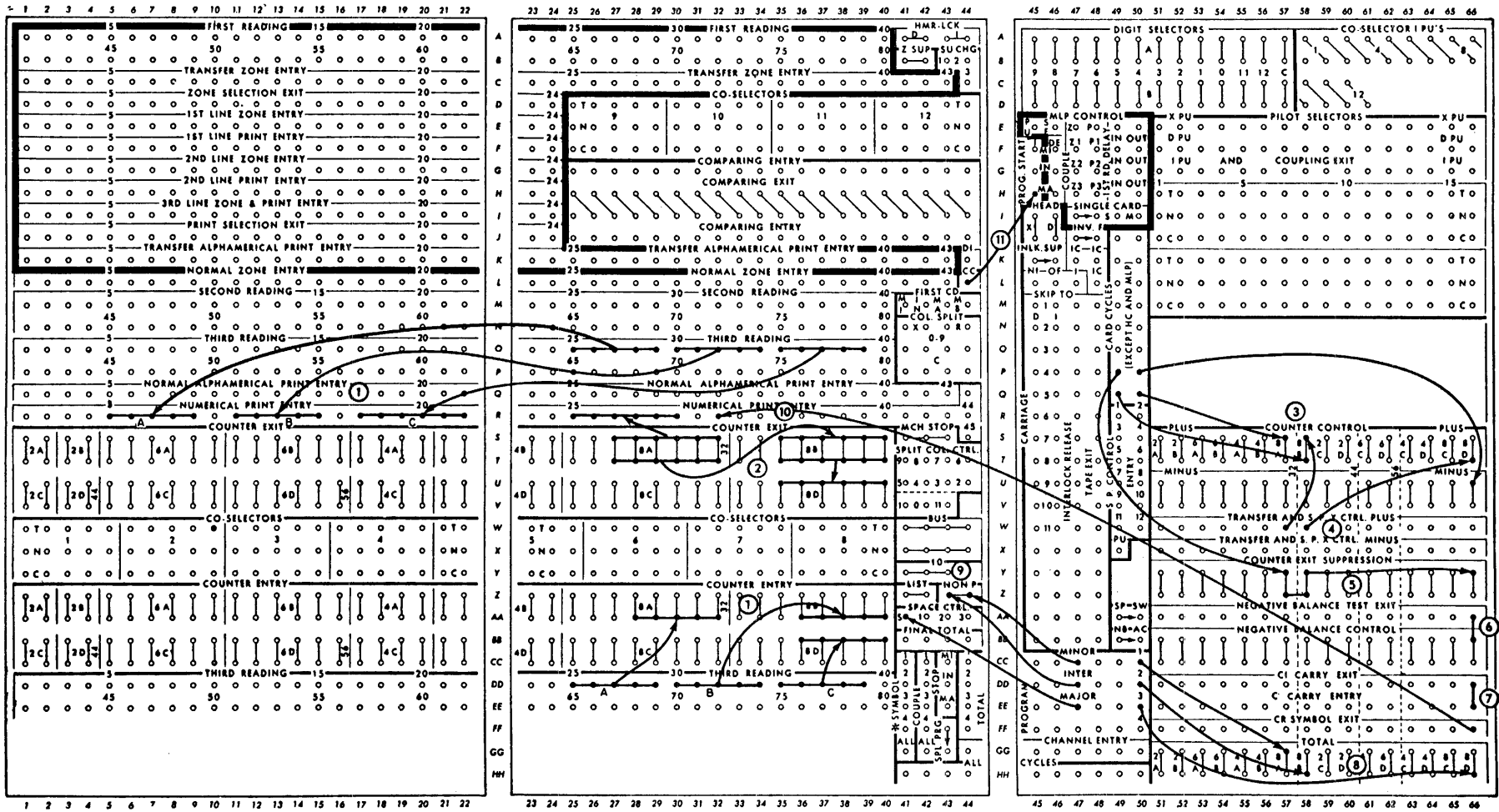
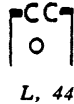

FIGURE 48. THREE FIELD CROSSFOOTING — NET BALANCE

suppress printing for X cards. The X or digit impulse itself cannot be wired directly to non-print.



Card Count. This hub emits a 1 impulse as each card passes the third reading station. It may be wired to a counter entry directly or through selectors to count cards, to numerical print entry hubs to force printing of zeros to the right, or to program start to cause a program start for every card.

Wiring, Crossfooting

This example (Figure 48) shows three-field crossfooting, adding two factors and subtracting a third ($A + B - C = R$).

1. Field A is entered into 8A, field B into 8B and field C into 8D. These three fields are also wired from third reading to numerical print entry.

2. All three counter exits are connected to provide a path for rolling factors from one counter into another. The exit of counter 8A is wired to print entry to print the result.

3. A card cycles impulse is wired to add in 8A and 8B, and to subtract in 8D.

4. Transfer control plus of 8A is wired to the plus of 8B. Transfer control plus emits an impulse, when the counter is plus, at the time the counter is read out. Since 8A is read out on a minor program, factor A will read out of 8A and add in 8B.

Transfer control plus of 8B is wired to the plus of 8D. Since 8B is read out on an intermediate program, the sum of A and B will read out of 8B and add to a minus figure in 8D.

5. Detail printing from all counters is prevented by wiring a card cycles impulse to counter exit suppression of each counter.

6. If the balance in 8D is negative it will be

converted to a true figure by wiring the negative balance test exit to negative balance control.

7. CI and C for counter 8D are connected. This is the only counter subtracting.

8. 8A is read out and cleared on a minor program, 8B on an intermediate program and 8D on a major program.

9. Both printing and spacing for the minor and intermediate program levels are suppressed, by wiring the corresponding program exit hubs to non-print. These two programs are used to cross-foot A, B and C, and the operations will take place at the rate of 150 cycles per minute.

The major program is used to read out the result from 8D. To print the total on the same line as the printed amounts, major program is wired to space control S, a more detailed discussion of which will be found on page 69.

10. The credit symbol is printed for a negative total by wiring the CR symbol exit of 8D to numerical print entry 32.

11. All three programs are taken for each card, by wiring a card count to major program start. A major program is always preceded by a minor and an intermediate program. Since the card count hub emits a "1" impulse only at third reading, the first card through the machine will not print unless it is preceded by a blank card.

The blank card serves to break control when it passes the third station, thus clearing out any totals which may be standing in the counters from a previous operation, and providing a print cycle for the first punched card.

Crossfooting of three totals at the end of a group may be done by wiring a comparing exit impulse to major program start.

CROSSFOOTING, NON-NET BALANCE MACHINE

CROSSFOOTING ($A + B - C = R$) on a non-net balance machine follows the same wiring principles as those used for net balance machines, with two exceptions. First, since transfer control plus and minus hubs are not available on non-

net balance machines, the minor and intermediate program exits must be used to impulse counters that are receiving totals from other counters. Second, if the result of crossfooting could be plus or minus, two counters must be used for the major total so that one of them will always contain a positive figure for printing. This is explained more fully under *Non-Net Balance Subtraction*.

Wiring, (Figure 49)

1. A is entered into counter 8A, B into counter 8C, and C into 8B and 8D. Counter 8A is the minor counter, 8C the intermediate counter, and 8B and 8D the major counters.
2. The minor counter 8A and the intermediate

counter 8C both add from the card. At the same time, major counter 8B is impulsed to add, while major counter 8D is impulsed to subtract.

3. The counter exits of 8A, 8B, 8C and 8D are connected and are wired to numerical print entry 23-28.

4. Factor A is added into counter 8C on the minor program by wiring a minor total program to the plus of 8C.

The sum of $A + B$ is added into counter 8D (which already contains $- C$) on the intermediate program. The sum of $A + B$ is also subtracted into counter 8B (which already contains $+ C$) on the intermediate program.

5. Detail printing from counters 8A, 8B and 8C is suppressed from a card cycles impulse directly.

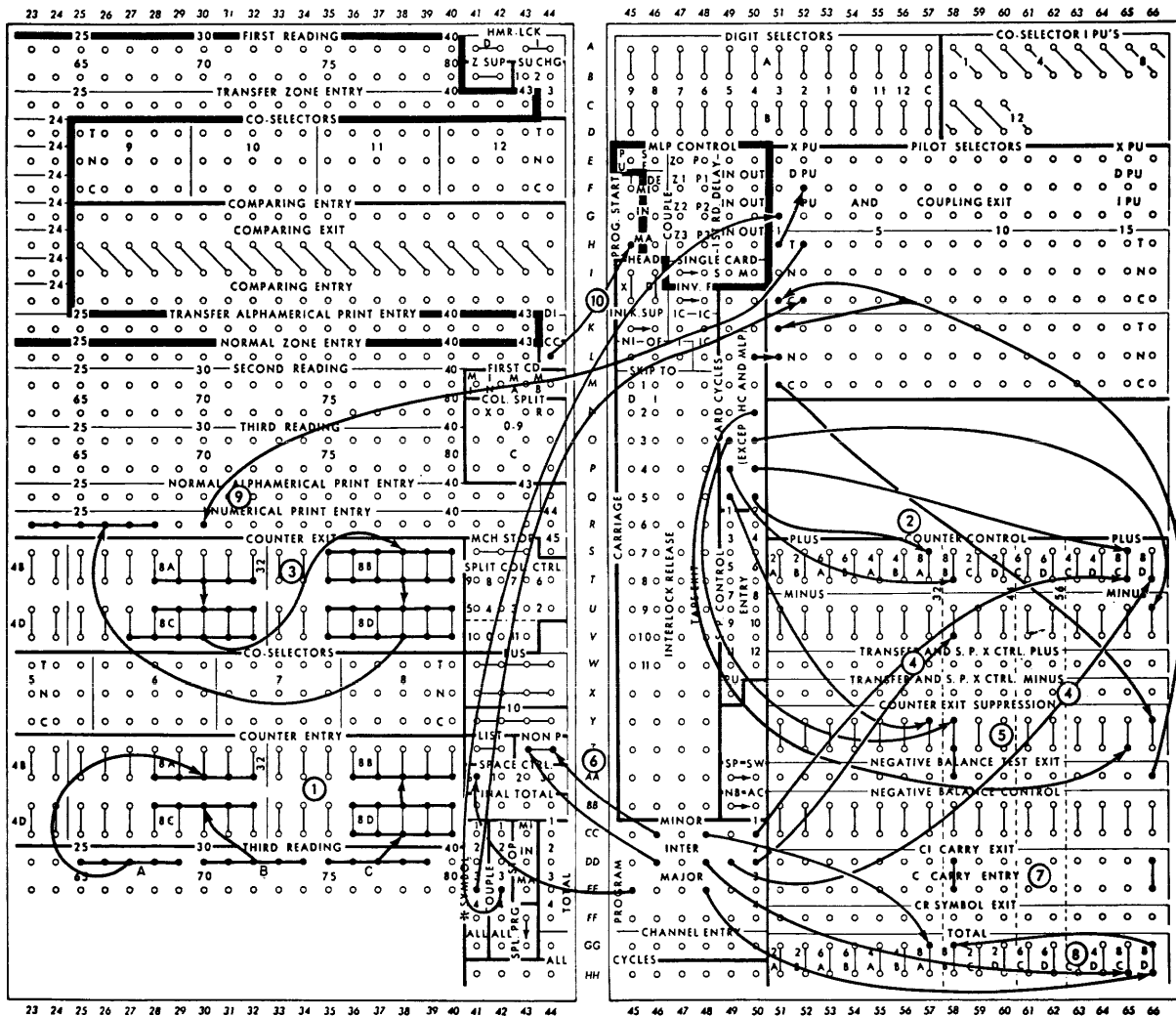

FIGURE 49. THREE FIELD CROSSFOOTING — NON-NET BALANCE

Printing of negative balances from 8B is also suppressed by wiring negative balance test exit to counter exit suppression. Counter 8D must be suppressed in the same way as counter 8B, but because the negative balance test exit of that counter must also be used to control CR symbol printing through a pilot selector, selection to the counter exit suppression is necessary. The negative balance test exit for 8D is wired through the transferred side of the selector to suppress negative balance total printing on the major program cycle. A card cycles impulse is wired through the normal side to suppress all other detail printing from the counter.

6. Total printing and spacing are suppressed for the minor and intermediate steps by wiring the minor and intermediate program exits to non-print. To print the total on the same line as the

printed amounts, major program is wired to space control S.

7. The counters wired for subtraction, 8B and 8D, are wired for carry-back.

8. Counter 8A is wired to read out and clear on a minor program, counter 8C to read out and clear on an intermediate program, and counters 8B and 8D on a major program.

9. Credit symbols are printed for negative totals by wiring the asterisk symbol hub 3 (10 impulse) through the transferred hubs of pilot selector 2, picked up from the negative balance test exit of 8D. Test exit 8D is used because, when the result of $A + B - C$ is negative, counter 8D will contain the complement figure.

10. A card count wired to major program start will cause all three program steps to be taken for every card. A blank card must precede the first card through the machine.

DAILY TIME TICKET

01145 GERALD DRISCOLL 11151231

HOURS	RECORD NO.	PHILLS	DEPT	END	ORDER NO.	WAGE	EXP.	TOTAL	IN	OUT
7								0000000000		
6								1001111111		
5								2222222222		
4								3333333333		
3								4444444444		
DEC 31 5.0								5555555555		
DEC 31 3.0								6666666666		
DEC 31 8.0								7777777777		
TOTAL HOURS								8888888888		

STATEMENT OF EARNINGS

DATE	REG. RATE	O.T. RATE	DEPT.	CLOCK	EMPLOYEE NO.	HOURS	AMOUNT
12/31	115					8.0	920
12/31	115					2.0	230
12/31	115					6.0	690
12/31	1725					2.0	345
12/31	1725					2.0	345
						10.0*	1265*
						10.0*	1265*

LABOR DISTRIBUTION REGISTER											
EMPLOYEE NAME	EMPL. No.		DATE		ENTRY	RATE	PART No.	OPER.	ORDER No.	HOURS	LABOR COST
	DEPT.	CLOCK	NO.	DAY							
GERALD DRISCOLL	1	145	12	31	51	115				8.0	920
	1	145	12	31	51	115	11872	2	109396	2.0	230
	1	145	12	31	51	115	11892	2	309397	6.0	690
	1	145	12	31	52	1725				2.0	345
	1	145	12	31	51	1725	11872	2	109396	2.0	345
											10.0*
JAMES DUHLMEIER	1	150	12	31	51	65				8.0	520
	1	150	12	31	51	65	12067	3	409399	8.0	520
	1	150	12	31	52	975				2.0	195

FIGURE 50. LABOR DISTRIBUTION REGISTER (NUMERICAL FIELD SELECTION)

FIELD SELECTION

WHEN a choice must be made between different fields on different cards, and the chosen field is to be printed from one set of type bars or entered into one counter, field selection is necessary. This is accomplished by the use of selectors controlled by an identifying punch in one of the cards. The field in the X or the digit card is then wired to the transferred row of the selector, the field in the NX or no-digit card to the normal row, and the common to the print entry or to a counter entry.

Wiring, Numerical Field Selection (Figure 51)

1. Regular rate is wired from 35-37 of the NX card to the normal side of co-selector 8, and overtime rate from columns 38-41 of the X card to the transferred side of co-selector 8. The common side of the selector is wired to alphabetical print entry 34-37.

2. The co-selector is picked up as follows:

The controlling X is wired from second reading to the X pickup of pilot selector 1. The coupling exit of the pilot selector is wired to the pickup of co-selector 8. The co-selector will transfer exactly like the pilot selector. When

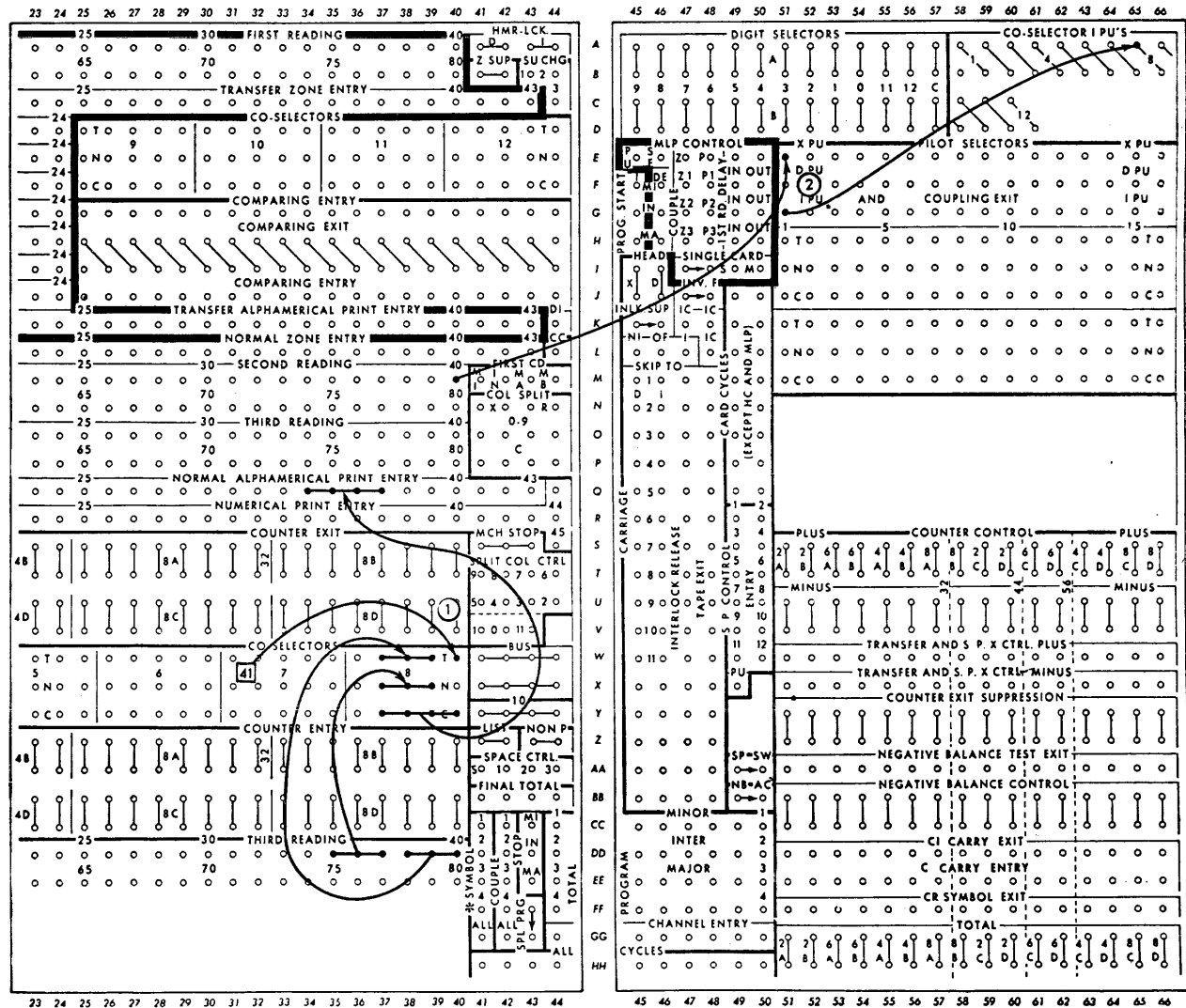

FIGURE 51. NUMERICAL FIELD SELECTION

the NX card passes third reading, both selectors will be normal and the regular rate will print from card columns 35-37. When the X card passes third reading, both selectors will be transferred and the overtime rate will print from card columns 38-41.

Alphabetic Field Selection

Alphabetic as well as numerical information can be field selected, in which case one pilot selector and two co-selectors are required. One co-selector is needed to select zone impulses and another to select digit impulses. The selector used to select

zone impulses must be picked up from second reading, and in time to select the 0, 11 and 12 (zone) punches. Any identifying digit from 9 through 1 may be punched in the card and wired directly from second reading to the co-selector immediate pickup. The co-selector used to select the digit impulses must be controlled from the coupling exit of a pilot selector.

Wiring, Alphabetic Field Selection (Figure 52)

1. Zone impulses are selected by wiring columns 70-74 of the digit card from second reading to the transferred side of co-selector 8,

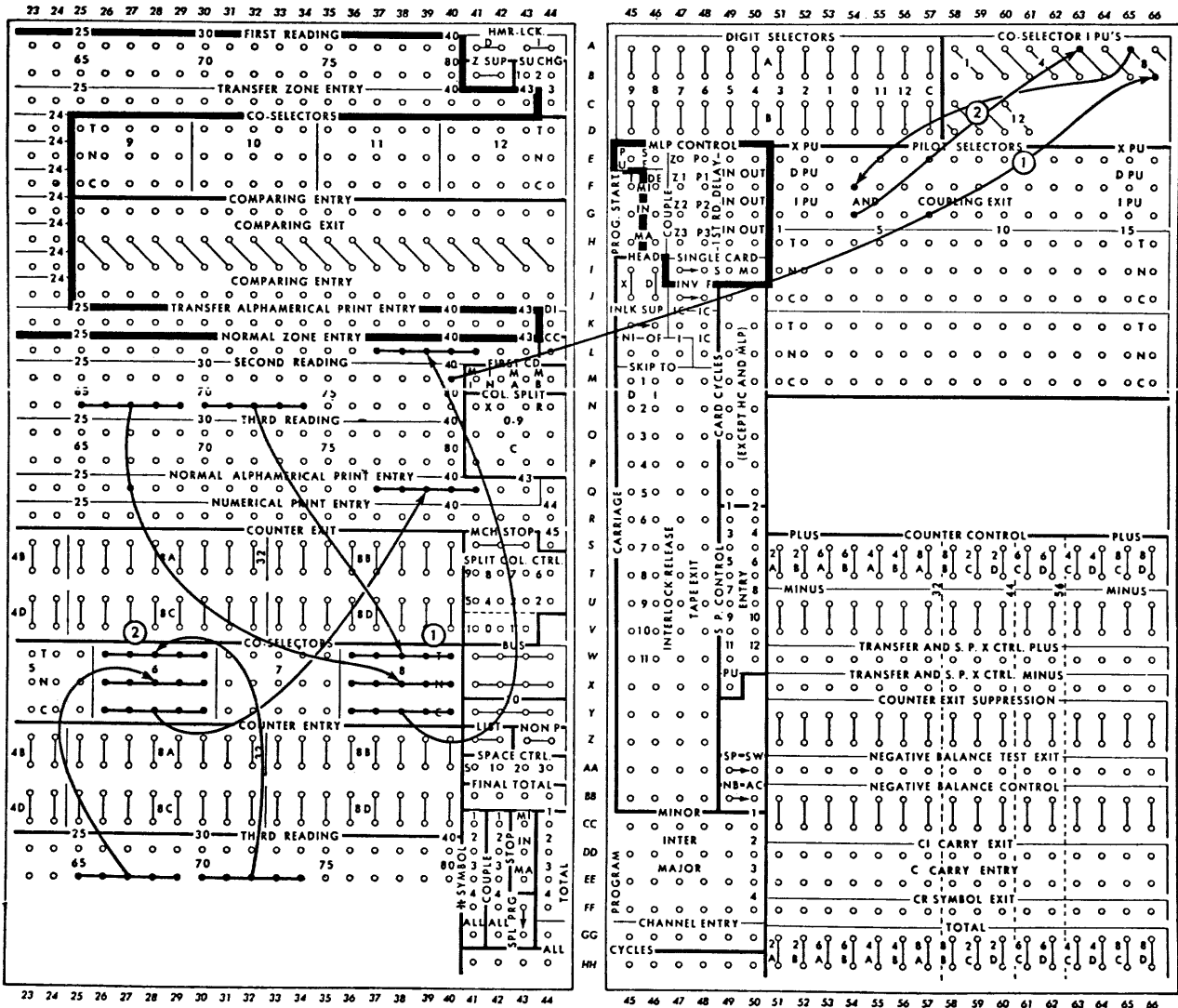

FIGURE 52. ALPHABETIC FIELD SELECTION

and columns 65-69 of the no digit card to the normal side of the same co-selector. The common is wired to normal zone entry. The co-selector is picked up from a control digit in column 40 wired from second reading.

2. Digit impulses are selected by wiring columns 70-74 of the digit card from third reading to the transferred side of co-selector 6, and columns 65-69 of the no digit card to the normal side of the same co-selector. The common is wired to normal alphanumerical print entry. The co-selector is picked up from the coupling exit of pilot selector 4. The same digit used to select zone impulses may be used to select the digit impulses. Column 40 is wired from second reading to the D pickup of pilot selector 4.

Alphabetic and Numerical Field Selection

When alphabetic and numerical fields are to be field-selected, the zone impulses do not need to be selected because they can be controlled by zone suppression.

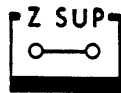

B, 41-42

Z SUP (Zone Suppress). These common hubs receive X, 12, all cycles, or card cycles impulses to suppress zoning for all 43 alphanumerical type bars. An X or 12 may be wired directly to z-sup to suppress zoning for all cards punched X or 12. To suppress NX or no-12 punched cards, a card cycles impulse is wired to z-sup through the normal hubs of a selector picked up on the X or 12. A comparing exit may also be used to suppress zoning for NX cards by wiring the DI through the X-R (11-12) side of a column split to one side of the comparing entry and the column containing the X to the other side of the comparing entry. The comparing exit is then wired

to z-sup. A digit may be used to control zone suppression if it is first wired to the D pickup of a pilot selector. A card cycles may then be wired through the selector to z-sup.

Zone suppression is necessary whenever an alphanumerical type bar is zoned from one column and is impulsed to print numerical information from another. Zero punches in the column wired to zone entry would zone the type bar, thus causing the printing of a letter instead of a number.

As will be seen from the example in Figure 53, the numerical 0 in the first field of an X card will zone the type bars and the 3 punch in the second numerical field of the same card will print the letter T instead of the figure 3. This can be prevented by impulsing z-sup, which eliminates such interference by rendering the zone entries inoperative for X cards.

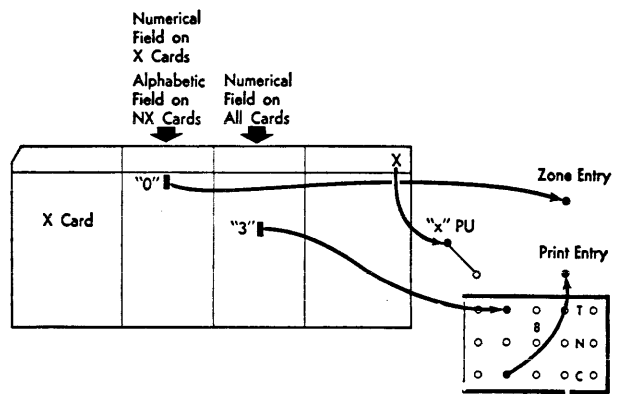

FIGURE 53

Wiring (Figure 54)

1. The alphabetical field, columns 30-34, is wired from the third reading station to the normal side of co-selector 8, since this field is to print for NX cards.
2. The numerical field, columns 35-39, is wired from the third reading station to the transferred side of co-selector 8, since this field is to print for X cards.

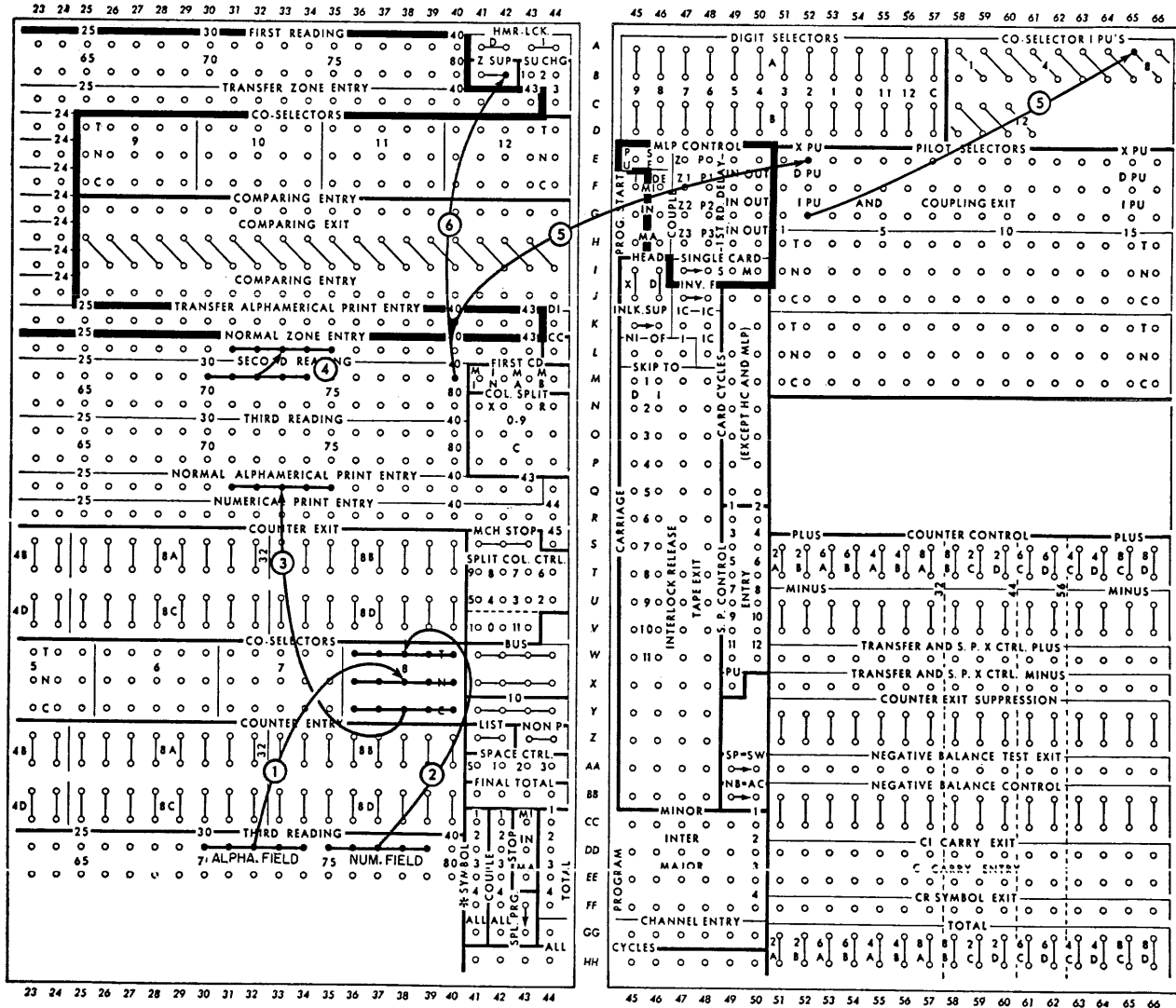

FIGURE 54. FIELD SELECTION OF ALPHABETIC AND NUMERICAL FIELDS

3. The common of this co-selector is wired to normal alphanumerical print entry 31-35.

4. Type bars 31-35 are zoned by wiring directly from second reading columns 30-34.

5. Cards from which the numerical field is to print are X punched in column 40, which is wired from second reading to the X pickup of pilot

selector 2. The coupling exit of pilot selector 2 is wired to the pickup of co-selector 8.

6. When printing from the numerical field, zoning is suppressed by wiring the X in column 40 directly to z-sup, making it impossible for zone punches in columns 30-34 to interfere with digits in columns 35-39.

CLASS SELECTION

CLASS selection is necessary whenever a choice must be made between several printing locations wired from the same field in different cards. The different classes of cards must be identified by X's or digits, which are used to control selection.

When a field is to be selected to one of two printing locations, the field punched in the cards is wired to the common of a co-selector, the normal to one set of print entry hubs and the transferred to another set of print entry hubs. Although the information is punched in the same columns of two types of cards, the printing location will vary with the type of card being read.

DAILY TIME TICKET

EMPLOYEE NO.		NAME		BASE RATE		DATE		MARK TOTAL HOURS	
7								00000000	
6								00000000	
5								00000000	
4								00000000	
3								00000000	
2								00000000	
1								00000000	
TOTAL HOURS		SIGNATURE OF FOREMAN						88888888	
RING JOB TIME ABOVE IN SEQUENCE FROM BOTTOM UP		DATE		REG. RATE		O.F. RATE		NAME	
		MO. DAY		AMT.		RATE		EMPLOYEE NO.	

TOTAL HOURS
00000000

NX76 X76

PRELIMINARY PAYROLL

EMPLOYEE NO.		HOURS		AMOUNT			
DEPT.	CLOCK	REG.	OVER.	TOTAL	REG.	OVER.	TOTAL
1	170	80			640		
1	170	80			640		
1	170	80			640		
1	170		20			240	
1	170	80		340 *	640		2800 *
1	175	80			640		
1	175	80			640		
1	175	80			640		
1	175		20			240	
1	175	80		340 *	640		2800 *

FIGURE 55

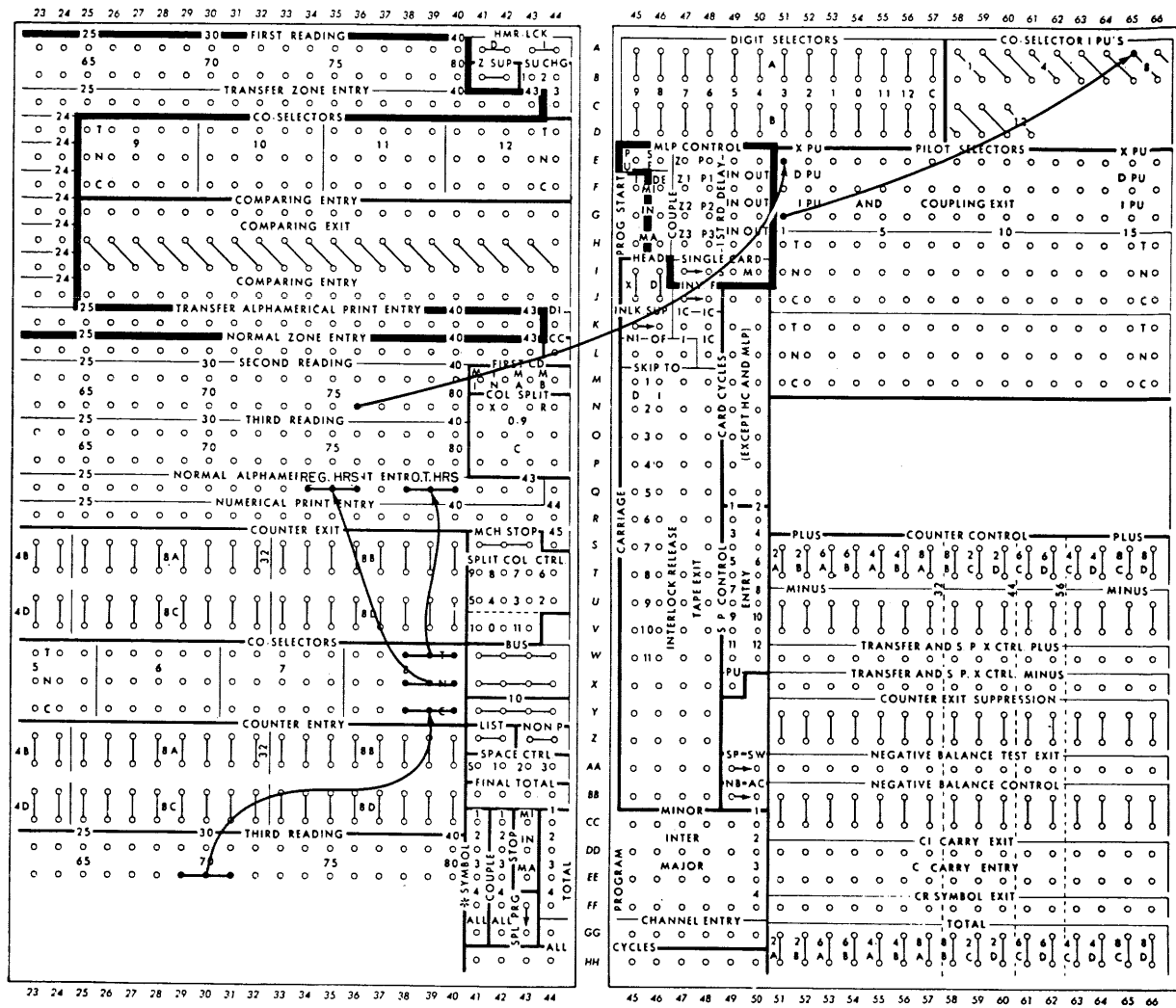

FIGURE 56. NUMERICAL CLASS SELECTION

Wiring, Numerical Class Selection (Figure 56)

The hours in the NX card are regular hours, and will be printed in the regular hours column of the report. The hours in the X card are over-time hours and will be printed in the overtime hours column of the report.

Hours, punched in columns 69-71, is wired to the common of co-selector 8. The normal of the selector is wired to alphamerical print entry 34-36, and the transferred side of the selector to alphamerical print entry 38-40. The selector is transferred by wiring the X from the second

reading station to the X pickup of a pilot selector, and from the coupling exit of that selector to the pickup of co-selector 8.

Class Selection of Alphabetic Information

An alphabetic field may be selected by controlling both the digit punching and the zone punching. Split wiring to zone entry is not possible because of the special characters that would print whenever the alphameric type bars receive a 12 impulse. Therefore, zone impulses as well as numerical impulses need to be class selected.

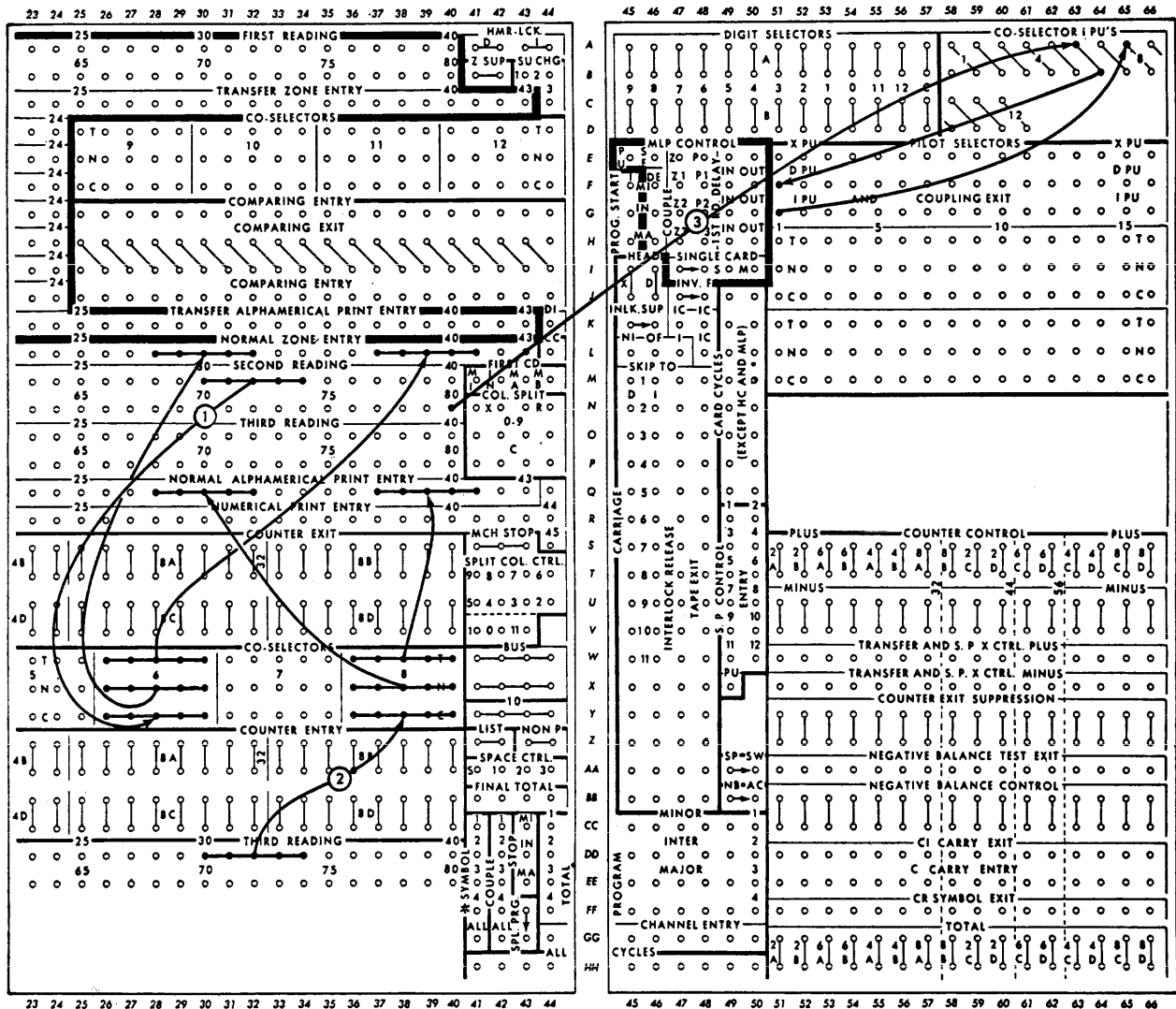

FIGURE 57. ALPHABETIC CLASS SELECTION

Wiring, Alphabetic Class Selection (Figure 57)

1. Normal zone entries 28-32 are wired from second reading 30-34 through the normal side of co-selector 6. Normal zone entries 37-41 are wired from the same columns through the transferred side of the selector.

2. Alphamerical print entries 28-34 are wired from third reading 30-34 through the normal side of co-selector 8. Alphamerical print entries 37-41

are wired from the same columns through the transferred side of the selector.

3. Both co-selectors are picked up from the same digit in column 80. Co-selector 6 is wired from second reading to pick up immediately, so that the zone impulses may be selected. Co-selector 8 is wired from the coupling exit of pilot selector 1 to pick up on the following cycle so that the digit impulses may be selected. Column 80 is wired to the D pickup of pilot selector 1.

SPACE CONTROL

ALL printing is normally single-spaced, six lines to the inch. In detail printing, two spaces are taken before the first card of a group is printed. In group printing, the minor total will print on the same line as the indication and the intermediate and major totals will each single space. One space is taken before the first card of a minor group and two spaces before the first card of an intermediate or major group. Variations from this spacing may be obtained by the use of the space control hubs.

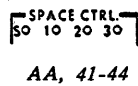

Space Control. Space control hub 1 will receive an impulse to single space (6 lines to the inch); hub 2 will receive an impulse to double space (3 lines to the inch); hub 3 will receive an impulse to triple space (2 lines to the inch). The hub labelled S will receive an impulse to suppress all spacing.

These controls take precedence over all automatic spacing. If all printing is to be double or triple spaced, an all cycles impulse is wired to space control 2 or 3. If spacing is to be varied for a particular card, an all cycles or card cycles impulse is wired through the transferred points of a pilot selector picked up from the second reading station. The X or digit cannot be wired directly to space control.

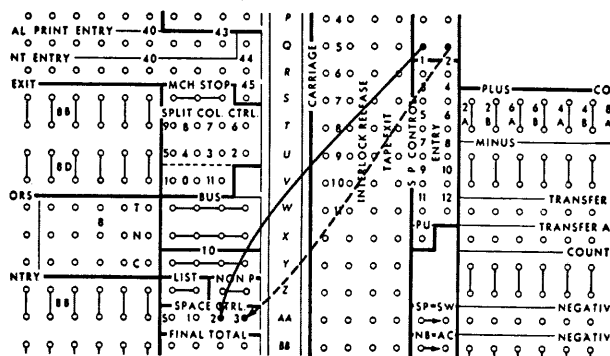

FIGURE 58. SPACE CONTROL

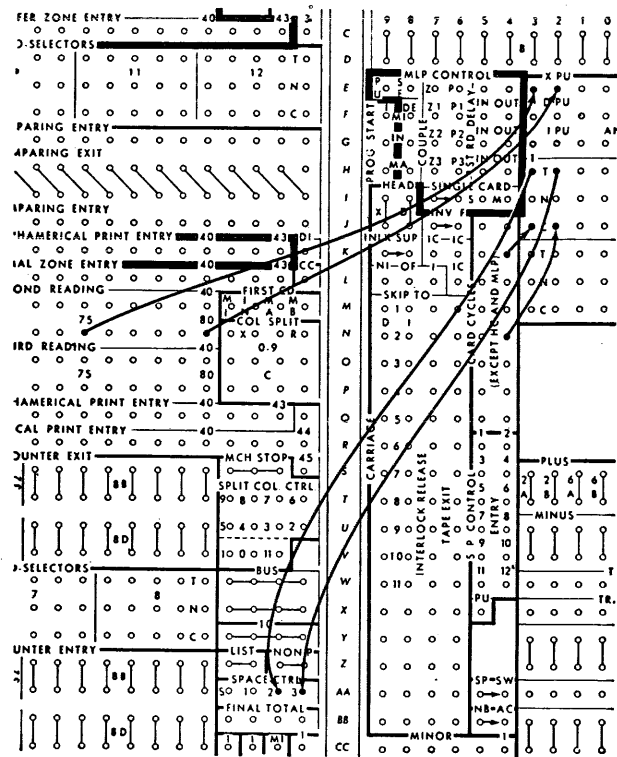

FIGURE 59. SELECTED SPACE CONTROL

To vary the spacing for total printing, a total program is wired directly to space control. To vary the normal spacing before the first card of a group, the minor, intermediate or major first card is wired directly to space control.

Detail Printed Items

Double or triple spacing all items (Figure 58). Three items to the inch (double space) are obtained by wiring a card cycles impulse directly to space control hub 2. Two items to the inch (triple space) are obtained by wiring the card cycles impulse to space control hub 3. The dotted line on the diagram shows the wiring for triple spacing.

This wiring will not affect the normal spacing for totals. If an all cycles impulse is substituted for card cycles, the total would also be spaced accordingly.

Single, double or triple spacing under selector control (Figure 59). All NX cards are single

spaced. No wiring is necessary for this function, since single spacing is normal.

All X75 cards are double spaced by wiring column 75 from the second reading station to the X pickup of a pilot selector. A card cycles impulse is wired through the transferred side of the selector to space control hub 2.

All X80 cards are triple spaced by wiring column 80 from the second reading station to the X pickup of a second pilot selector. A card cycles impulse is wired through the transferred side of the selector to space control hub 3.

Space suppression (Figure 60). Spacing is suppressed for all X40 cards by wiring column 40 from second reading to the X pickup of pilot selector 2. A card cycles impulse is wired through the transferred side of the selector to the space control S hub. All other cards will space normally, that is, single space.

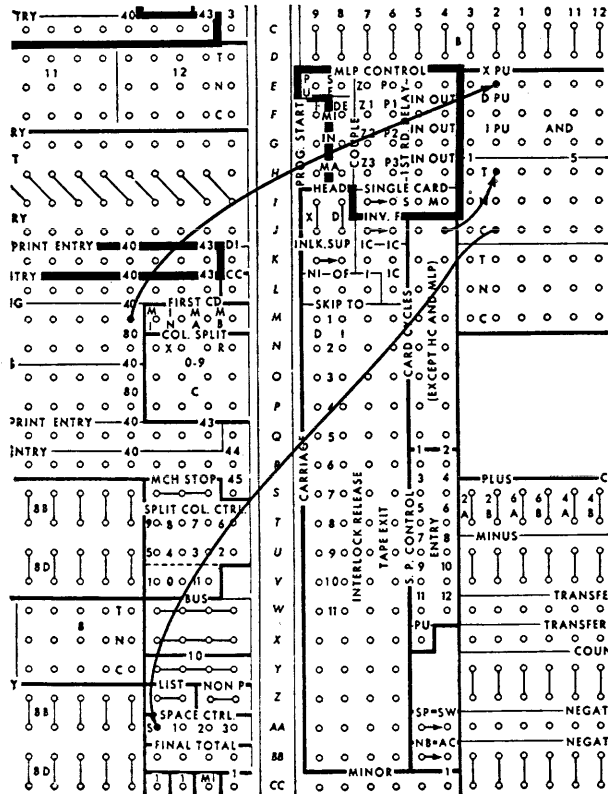

FIGURE 60. SPACE SUPPRESS

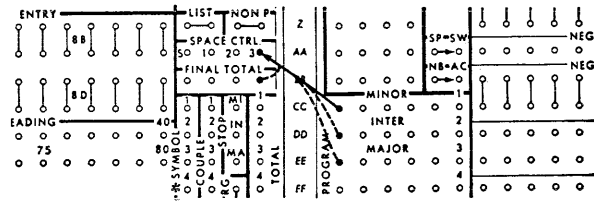

FIGURE 61. PROGRAM SPACE CONTROL

Total Spacing

Printing minor totals three spaces below the last printed item (Figure 61). Normally a minor total prints directly beneath the last printed item. It may be made to print three lines below the last item by wiring a minor total program to space control hub 3. The spacing for the individual cards is entirely independent of the spacing for totals and may be varied by the wiring already discussed.

Dotted lines show the wiring for triple spacing intermediate, major, and final totals.

Printing minor, intermediate and major totals on the same line. Minor, intermediate and major totals may be printed on the same line in one machine cycle, by program couple wiring.

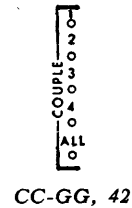

Total Program Couple. Each of these hubs emits an impulse at a specific program level. Hub 1 emits an impulse at the minor level, hub 2 at the intermediate level, hub 3 at the major level, hub 4 at the fourth level when special program is wired, and the ALL hub at all levels. The impulses are of a slightly longer duration than the total program exits, beginning earlier and ending later.

Two or more program totals may be made to print on the same line by joining their couple hubs. If couple 1 is joined with couple 2 and in turn with couple 3, all three program totals will print on the same line and

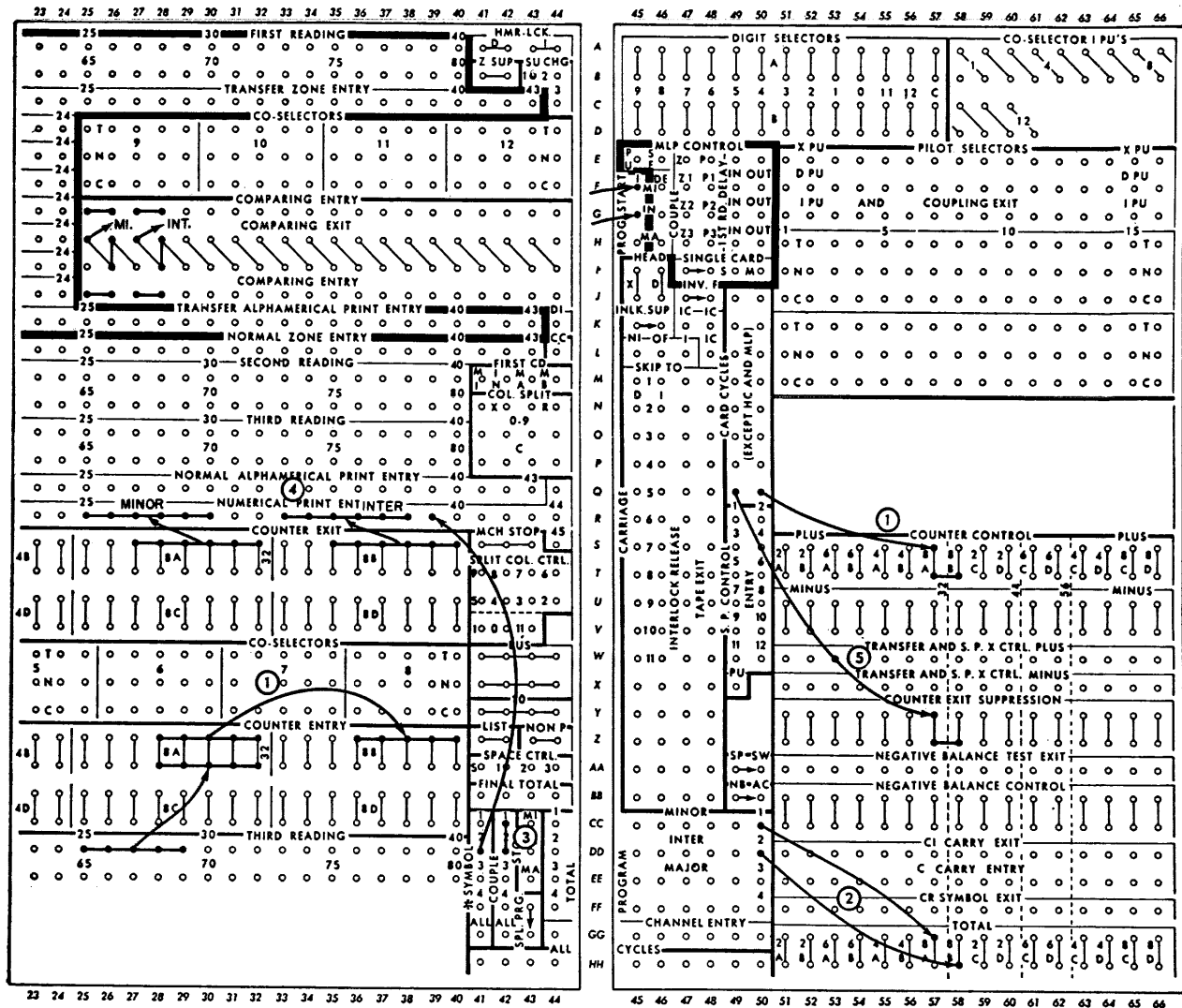

FIGURE 62. MINOR AND INTERMEDIATE TOTALS ON THE SAME LINE

on the same cycle. All minor totals are printed normally, but when an intermediate program change is recognized, both the minor and the intermediate totals print in one cycle instead of two, and they print on the same line. By the same reasoning, a minor, intermediate and major total may be printed in one cycle and on the same line, upon detection of a major program change.

When this method of total printing is used, it is not possible to transfer totals from one counter to another, because only one cycle is taken to print all totals. Therefore,

the wiring must be from third reading to the counter entry of each of the counters in use, instead of from third reading to the counter entry of the minor counter and from the exits of the minor counter to the exit of the intermediate counter, and so on. Furthermore, counter plus and minus functions must be controlled on a card cycle basis.

The wiring for printing minor and intermediate totals on the same line is shown in Figure 62.

1. The amount to be added is wired to the entry of 8A and to the entry of 8B. Both counters are controlled to add from card cycles.

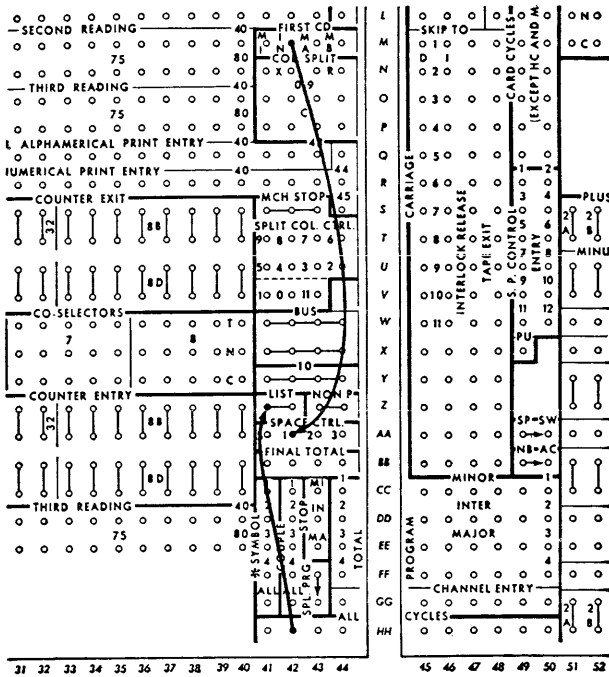

FIGURE 63. FIRST CARD SPACE CONTROL

2. Counter 8A is read out and cleared on a minor program change and counter 8B is read out and cleared on an intermediate program change.

3. The couple hubs of both levels are connected, thus causing the minor and the intermediate totals to print in one cycle and on the same line, whenever an intermediate program change occurs.

4. Minor totals are wired to numerical print entry 25-30. Intermediate totals are wired to numerical print entry 33-38. Asterisk symbol hub 2 is wired to numerical print entry 39. The asterisk will print only for intermediate totals.

5. Detail printing from counters 8A and 8B is suppressed.

First Card Spacing

Normally the first card of a group prints two spaces from the previous total when the machine is wired to LIST. This spacing may be altered by wiring first card control (minor, intermediate or

major) to space control (Figure 63). If the minor first card is wired to space control 1 and the machine is wired to LIST, one space instead of two will be taken before the first card of the following group.

Expanding Program Exits

There are 7 exits for each program level. The number of exits may be increased by controlling a co-selector from a couple exit and by wiring all cycles impulses through its transferred hubs. If one co-selector is used, the exits are expanded from 7 to 12.

Wiring (Figure 64)

The couple exit hub for the minor program is wired to the pickup of a co-selector. All cycles impulses are wired through the transferred hubs of the co-selector to expand the minor program exits from 7 to 12. To expand intermediate or major program exits, the co-selector is picked up from the intermediate or major couple exits.

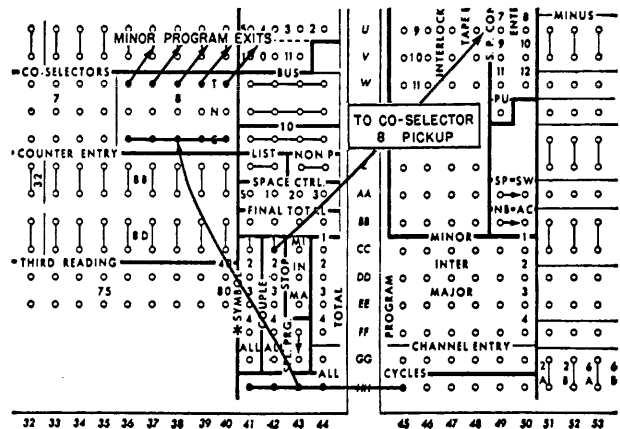

FIGURE 64. EXPANDING PROGRAM EXIT

MULTIPLE X SELECTION

WHEN A single card field is used in punching amounts or other quantitative data, for different types of transactions, each transaction must be

distinguished from the others by an identifying punch. In Figure 65, quantities for six different transactions are punched in the same field of the card. Each transaction is identified by a significant punch, five having X punches and one hav-

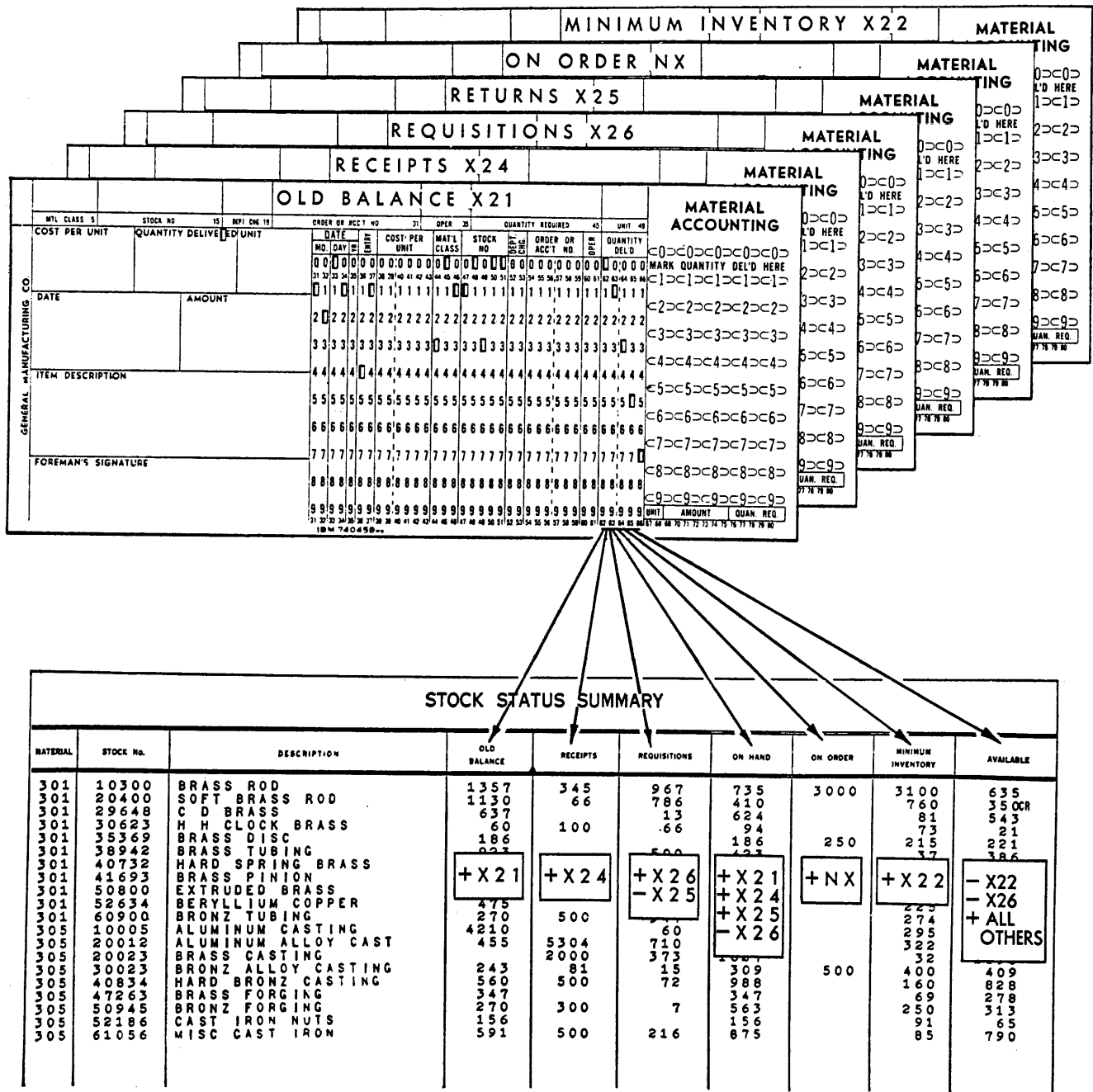

FIGURE 65. STOCK STATUS SUMMARY (MULTIPLE X SELECTION)

ing no X. These distinguishing punches are used to control the plus or minus functions of seven counters.

A counter is required for each quantitative column on the report. Each counter adds or subtracts according to the requirements of the report columns. For example, the on-hand total is determined by adding the previous balance, receipts, and returns, and by subtracting requisitions. Only the X distribution and counter coupling wiring is shown.

Wiring (Figure 66)

1. Pilot selector 1 is picked up from an X21 representing an old balance card, pilot selector 2 from X24 representing receipts, pilot selector 3 from X25 representing returns, pilot selector 4 from X26 representing requisitions, and pilot selector 5 from X22 representing minimum inventory. These columns are wired from the second reading station.

2. A card cycles impulse is wired through the selectors as follows:

- Through the transferred side of pilot selector 1 to add old balance in 2B and 6A, which are coupled.
- Through the transferred side of pilot selector 2 to add receipts in 6B.
- Through the transferred side of pilot selector 3 to subtract returns in 4A and 4B which are coupled.
- Through the transferred side of pilot selector 4 to add requisitions in 4A and 4B which are coupled, and to subtract requisitions in the on-hand counter 8A.
- Through the transferred side of pilot selector 5 to add minimum inventory in 8C.

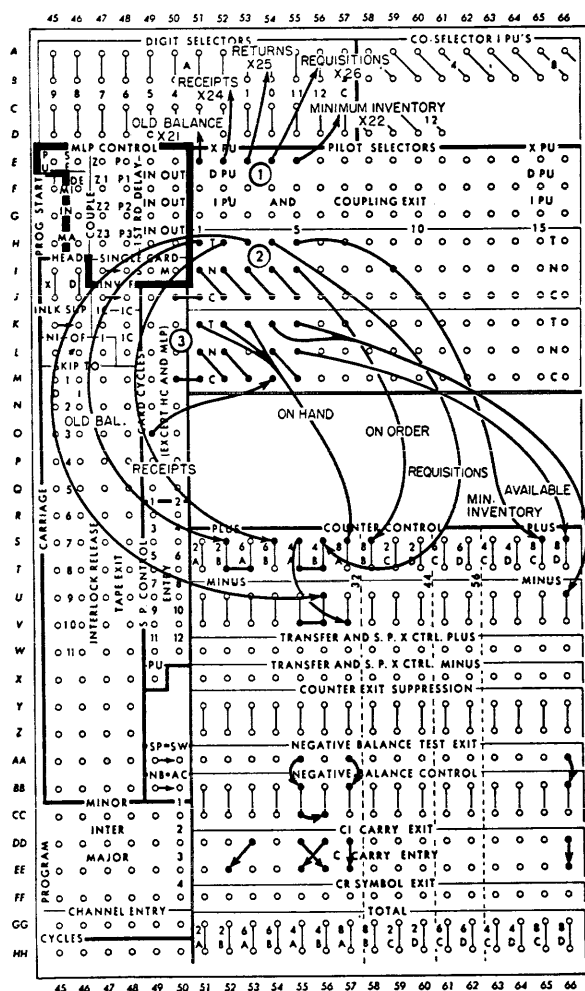
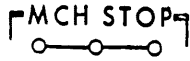

FIGURE 66. MULTIPLE X SELECTION

A card cycles impulse is wired through the normal hubs of each selector and is available out of the normal side of selector 5 if a card does not contain any X punch. It is used to add on order cards in 8B.

3. A card cycles impulse is wired through the transferred side of the first three pilot selectors to add old balance, receipts and returns in the on-hand counter 8A. A card cycles impulse is wired through the transferred side of the fourth and fifth selectors to subtract requisitions and minimum inventory in the available counter, 8D. All other cards add in 8D.

MACHINE STOP



S, 41-43

Machine Stop. Three common stop hubs may be impulsed to stop the machine immediately and turn ON the stop light.

Some of the uses of these hubs are listed below:

1. Stop the machine before total printing by wiring from a total program exit.
2. Stop the machine before the first card of a group by wiring from a first card minor, intermediate or major.
3. Stop the machine when a counter turns negative by connecting NB-AC and by

wiring negative balance test exit to machine stop.

To restart the machine, the stop light must first be turned off by depressing the final total key. The start key may then be depressed to continue the machine operation.

Wiring (Figure 67)

1. Minor total program is wired to machine stop.
2. First card minor is wired to machine stop.
3. NB-AC is connected. Negative balance test exit of 8B is wired to machine stop. This stops the machine at the end of the cycle whenever counter 8B turns negative.

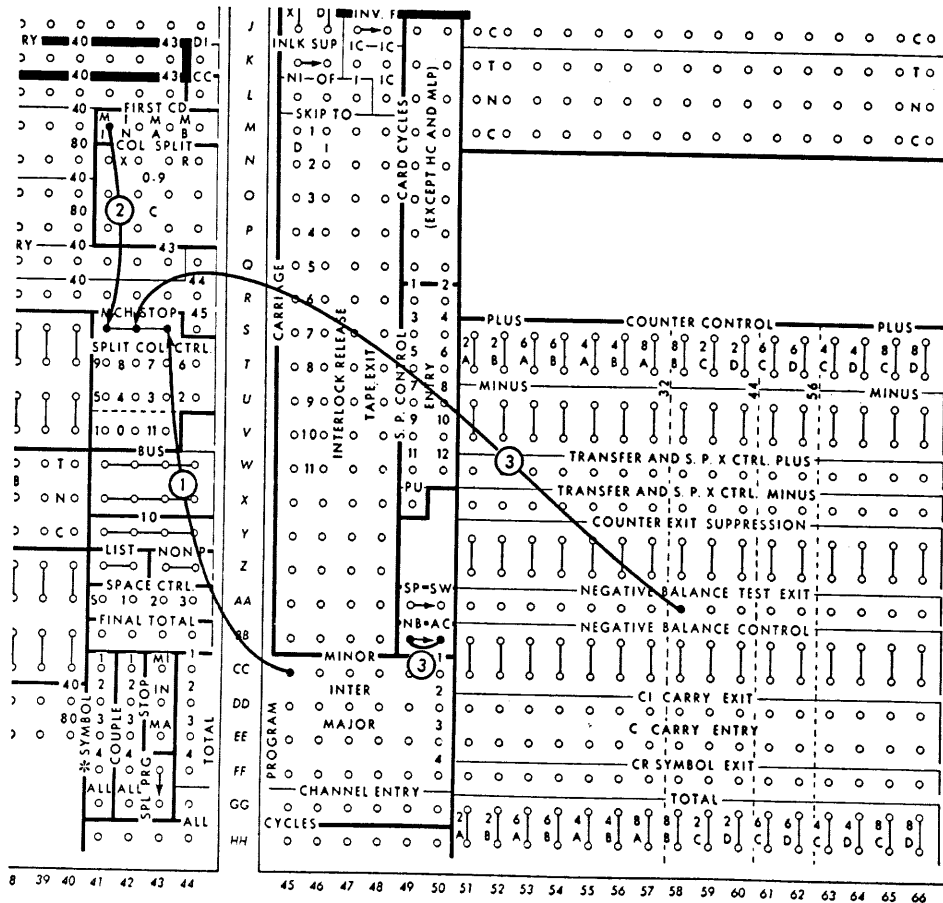
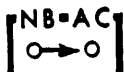

FIGURE 67. MACHINE STOP

RECOGNIZING NEGATIVE BALANCES

NORMALLY the negative balance test exit hubs emit an impulse when a counter is negative on a total program only. When NB-AC is connected, they emit impulses on *any* cycle during which a counter is negative.



BB, 49-50

NB-AC (Negative Balance All Cycles). When the NB-AC hubs are connected, the negative balance test exit hub emits an impulse on every cycle during which a counter is negative, including zero balances. Some of the uses for these hubs are listed below:

1. Change from group print to detail print

whenever a counter changes from positive to negative.

2. Change from detail print to group print whenever a counter changes from positive to negative.
3. Stop the machine at the end of the cycle during which a counter turns negative.
4. Cause a program to be initiated whenever a counter turns negative.

Wiring (Figure 68)

1. Counter 8A is adding NX cards and subtracting X cards.
2. NB-AC is connected.
3. The negative balance test exit of 8A is wired to LIST.

The machine will group print as long as the total in the counter remains positive and will detail print when the counter turns negative.

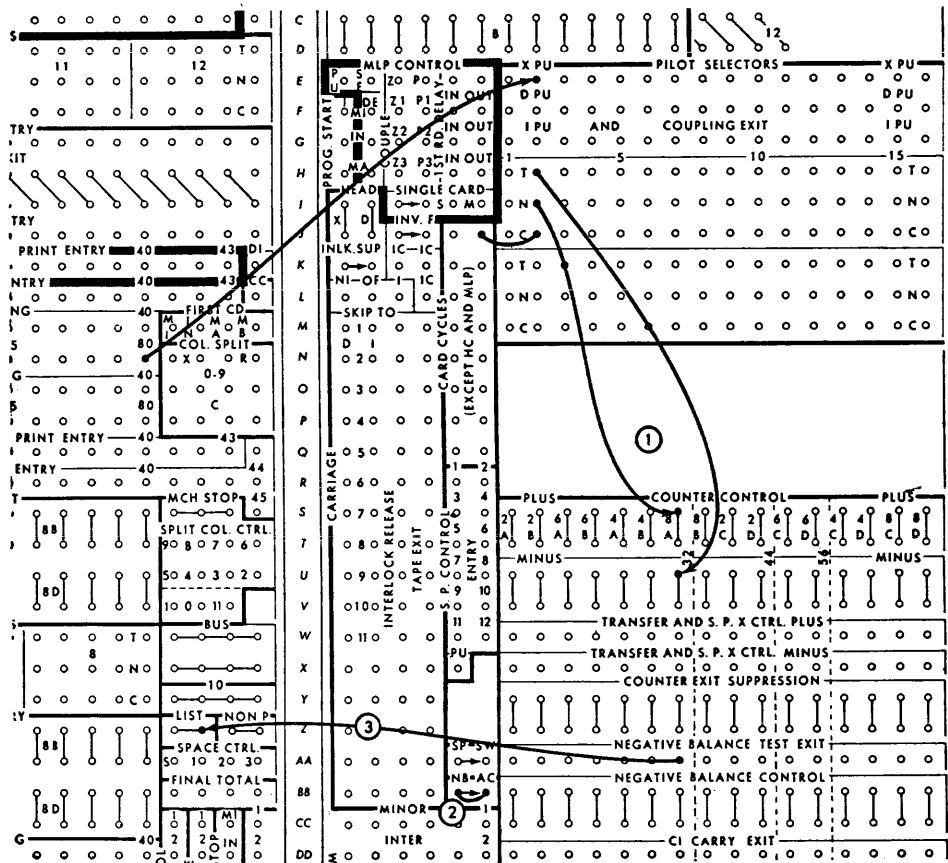

FIGURE 68. DETAIL PRINTING NB-AC

SPLIT COLUMN CONTROL

WITH split column control (Figures 69 and 70), multiple punching in one column can be split into two groups, between any two punching positions. It differs from normal column split (which is always between 0 and X) in that the split may be between 9 and 8, 0 and X, etc. The 1, 0, 11 split is standard, and 9 through 2 is optional. They emit impulses at half after the number indicated. For example, 9 emits an impulse between 9 and 8; 0 emits an impulse between 0 and 11. These hubs are active on every cycle.

The split column control hubs are normally wired to a selector pickup (immediate), making the selector operate the same as a column split device. For example, if the 1 is wired to a selector I (immediate) pickup, the C and N hubs of the selector are common from 9 through 1, and the C and T hubs are common from 0 through 12. Thus, zone impulses may be separated from digit impulses punched in the same column. If the 0 is wired to the selector I pickup, the C and N hubs are common from 9 through 0, and the C and T hubs are common for 11 and 12. Note that this arrangement is the same as a normal column split. A column may be split between 11 and 12 by using the 11 hub as a pickup for the selector.

When co-selectors or pilot selectors are controlled to operate as column splits, selection of carryback impulses, as shown in Figure 75, cannot be accomplished because of a difference in drop out between selectors and normal column splits.

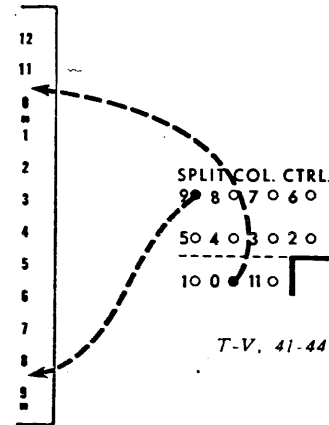

FIGURE 69

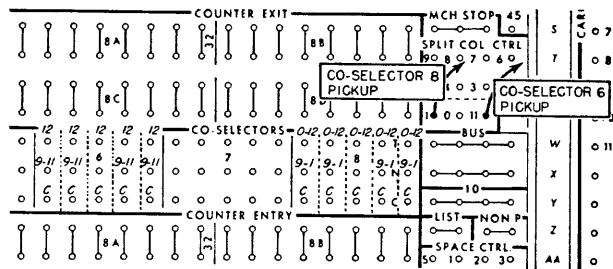

FIGURE 70. SPLIT COLUMN CONTROL

SUMMARY PUNCHING

SUMMARY punching is the automatic preparation of one total card to replace a group of detail cards. A total or summary card contains the identification of a group and one or more totals accumulated for that group. The primary purpose of summary cards is to reduce the card volume and thus accelerate the preparation of periodic reports. When totals or balances are carried forward from one period to another, as in stock status summary or accounts receivable, the summary cards are called "balance forward" cards.

Summary cards are generally punched during the preparation of detail reports by a summary punch machine, connected to the accounting machine by a cable, as shown in Figure 71.

The Types 513, 514, 517, 519, or 523 Summary Punch Machines may be used with the Types 402 and 403 Accounting Machines. The summary punch machine has a cable which must be connected to the receptacle provided for it on the accounting machine. When the control panels on both machines are properly wired, the exits of all the counters are made available on the summary punch control panel. Only information intro-

duced into the counters of the accounting machine may be summary punched.

A card feed stop light will go on whenever summary punching is started by the accounting machine. It will remain ON and prevent further operation of the accounting machine if for any reason the summary punch operation is not satisfactorily completed. Summary punching may be selected by means of a setup change switch.

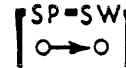

AA, 49-50

Summary Punch Switch. These two hubs are located on the accounting machine control panel and must be connected for summary punching. The two hubs may be connected through the transferred side of a pilot or a co-selector picked up by a setup change switch. The purpose of this switch is to synchronize the operation of both machines. If either machine runs out of cards, the operation stops and the card feed stop light goes on.

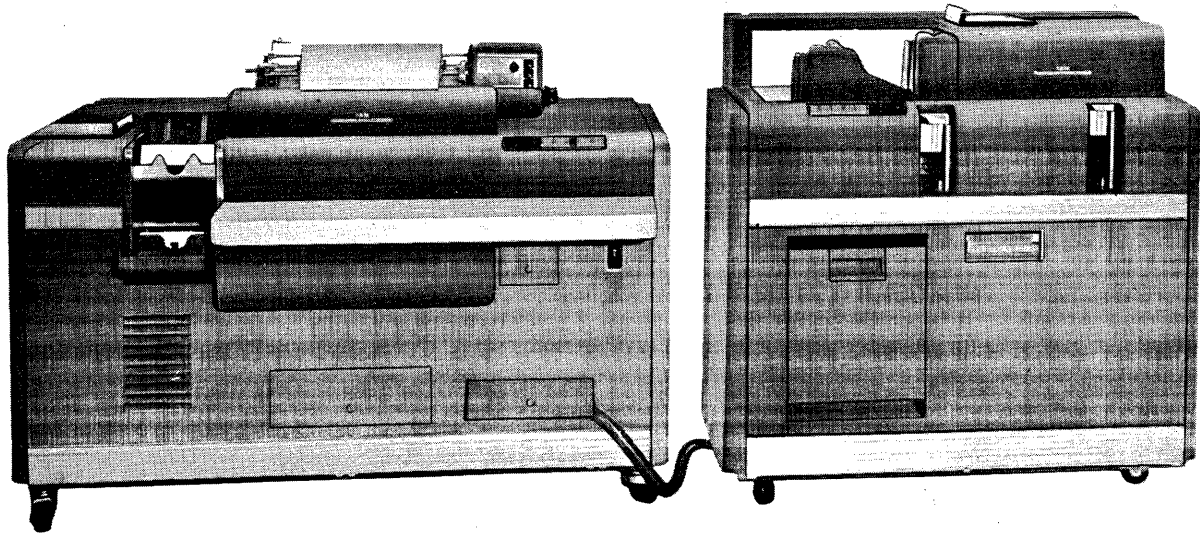

FIGURE 71. TYPE 403 ACCOUNTING MACHINE AND TYPE 519 SUMMARY PUNCH



R-X, 49-50

Summary Punch Control. Summary punching may be initiated on any program change by impulsing the pickup (PU) hub, directly or through selectors. If a total program exit is wired to the pickup, and the summary punch switch hubs are connected, summary punching will take place just before the total prints. More than one type of total may be summary punched in the same run.

When summary punching is initiated, the advancement of the program will be delayed until summary punching is completed, at which time programming will continue and totals will print.

There are twelve summary punch entries from the accounting machine to the summary punch. The entries on the accounting machine are identified by twelve summary punch control entry hubs, and on the summary punch, by the column splits. The entry hub on the accounting machine is internally connected with a corresponding 11-12 column split hub on the summary punch, as shown in Figure 72. Entry 1 is connected to the 11-12 hub of column split 1; entry 2 is connected to the 11-12 hub of column split 2, and so on.

There are 8 standard and 2 optional column splits on the Types 513, 514, 517, and 523 Summary Punch Machines. There are 12 standard

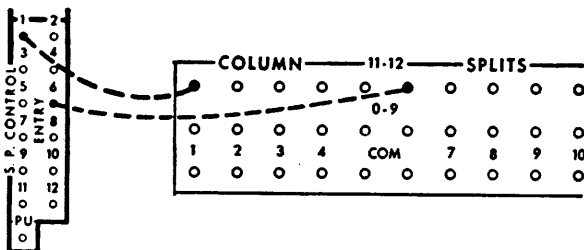

FIGURE 72

column splits on the Type 519, of which the first 8 are connected to SP control entry 1 to 8.

The SP entry hubs receive SP X control—plus or minus impulses for the purpose of punching an identifying X for positive or negative balances. The SP entry hubs may be used in any desired sequence.

The SP X control hubs are not available on a non-net balance machine. The identifying X must be obtained on the summary punch through selection.

Wiring, Net Balance Machine (Figure 73)

Wiring for the summary punch is included to show the relationship between the two machines when summary punching.

This example is identical with that shown in Figure 24 but only the summary punch wiring is explained.

1. The summary punch switch is turned ON.
2. Summary punch control is picked up from the minor program level. A summary card will be punched for each salesman, since the minor program start is impulsed every time a group of cards changes from one salesman to another.
3. The summary punch X control minus of 8A is wired to summary punch entry 1 for the purpose of identifying credit balances summary punched from that counter with an X. The X impulse can be obtained on the summary punch from the 11-12 hub of column split 1. If debit instead of credit balances are to be identified with an X punch, the summary punch control plus would be wired to SP entry 1. Any of the 12 entries may be used, providing there is a corresponding column split available on the summary punch panel.
4. Counter 8A exits on the summary punch are wired to punch columns 76-80. All but the units position of 8A are wired directly to punch.
5. The units position of 8A is wired to column 80 through the 0-9 hub of column split 1. The credit balance summary card will be identified by an X punch in column 80.
6. Salesman number is wired to 4C.
7. The salesman number will be used to identify

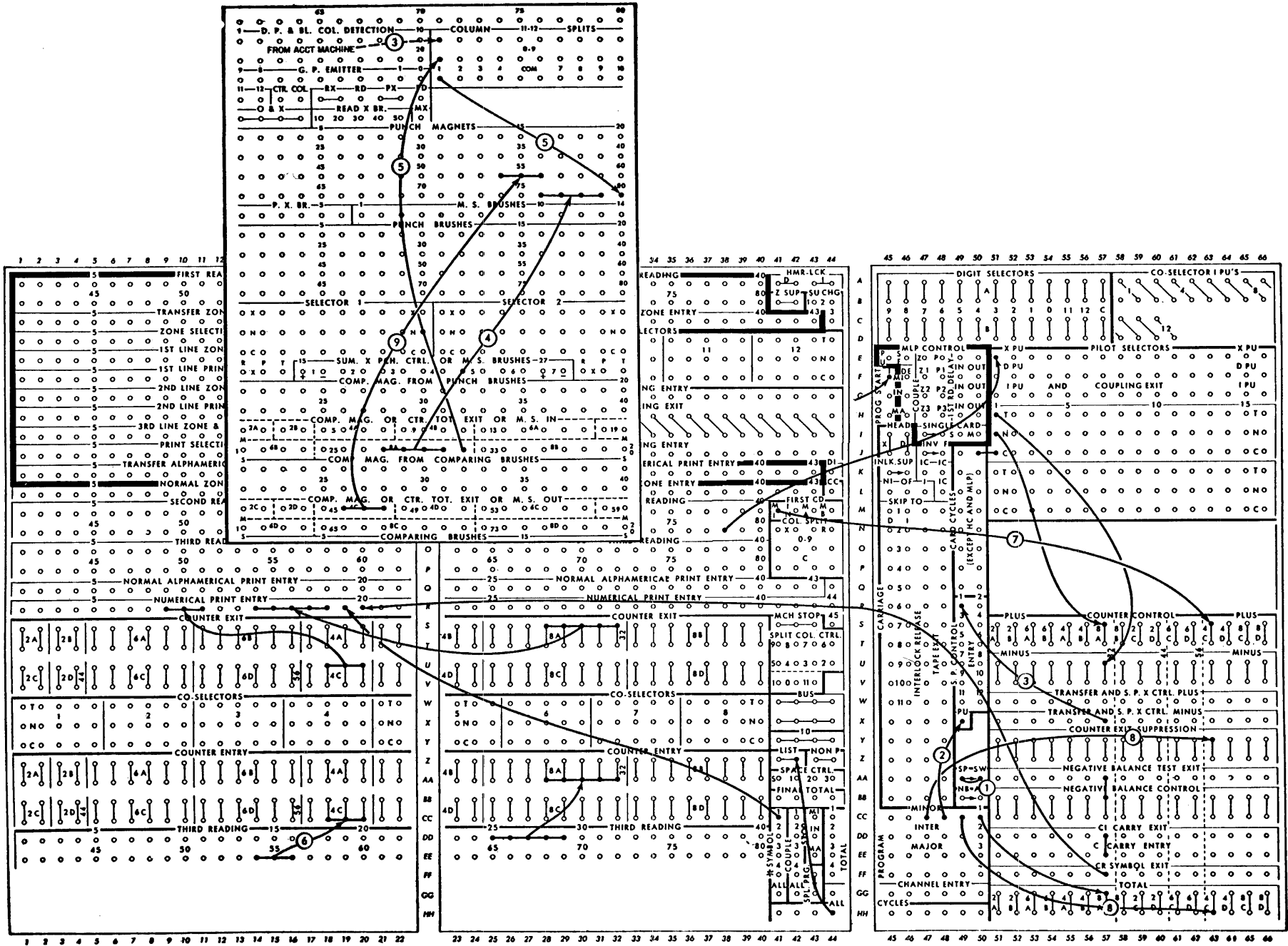
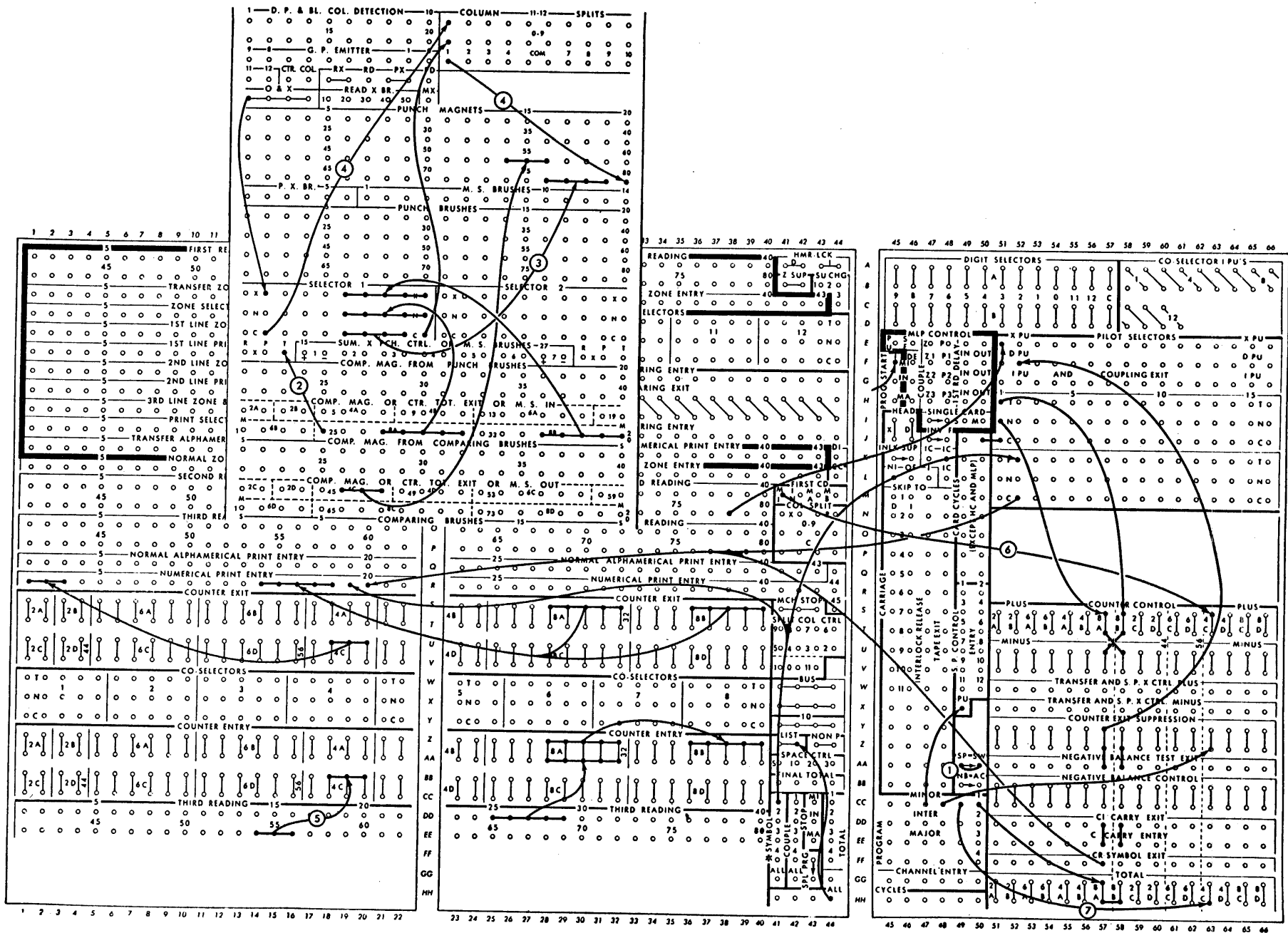

FIGURE 73. NET BALANCE SUMMARY PUNCHING

FIGURE 74. NON-NET BALANCE SUMMARY PUNCHING



the summary card, and hence must add in the counter only once for each salesman. Minor first card is wired to 4C plus, causing the card to add on only the first card of the group.

8. Counter 4C is cleared on every minor program. Printing of the group indication is suppressed on the total cycle.

9. Counter 4C exits on the summary punch are wired to punch columns 54-56.

Wiring, Non-Net Balance Machine (Figure 74)

Printing credit balances in true figures on a non-net balance machine requires the use of two counters, so wired that one of them will always contain a positive result. Printing of complement balances can be suppressed on the accounting machine without selection. The punching of complement balances on the summary punch, however, must be eliminated by selection. Since the transfer and SP control plus and minus hubs are not active on the non-net machine, the identifying X must be obtained from the summary punch panel.

1. The summary punch switch is wired ON.
2. Selector 1 on the summary punch is picked

up from the complement 9 of the original counter 8A.

3. If counter 8A is negative, punching will take place from 8B. If 8A is positive, punching will take place from 8A. Therefore, counter 8A is wired through its normal hubs and 8B through its transferred hubs to punch.

4. A 0 - X impulse is wired through the transferred side of selector 1 and to the 11-12 hub of a column split to eliminate the zero. The units position of the counter is wired to the 0-9 hub. Whenever the balance is negative, as determined by 8A, an X will punch over the units position.

5. Salesman number is wired to counter 4C.

6. Counter 4C is wired to add the first card of each group only.

7. Counter 4C is cleared on each minor program and total printing is suppressed.

If summary punching is not eliminated for zero balances on a non-net machine, 9's (complement of 0) will punch in the summary card. To punch zeros instead of 9's another selector is needed on the summary punch, through which constant zeros are selected when both the original and alternate counters are negative.

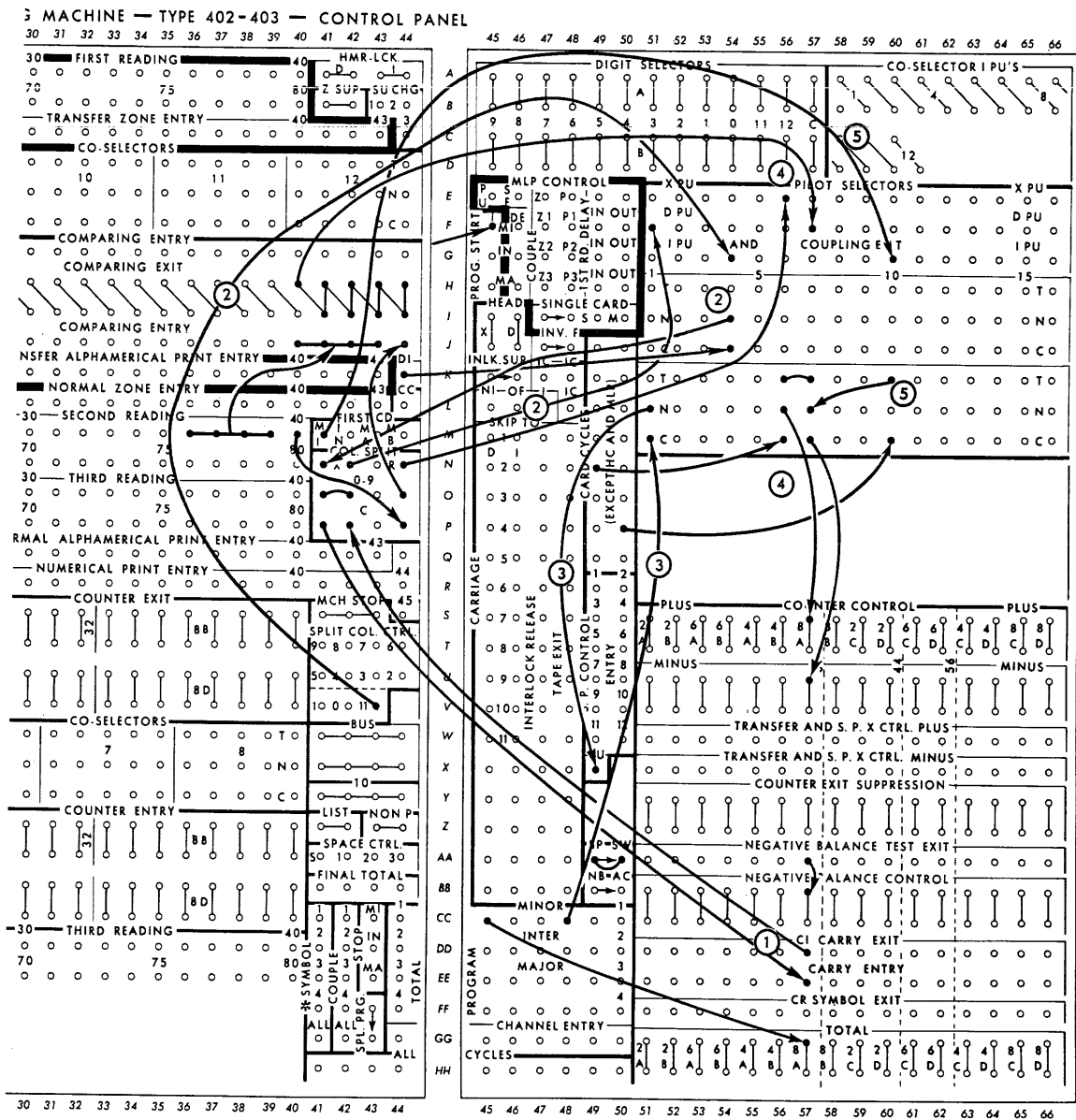

FIGURE 75. SUMMARY PUNCH ELIMINATION OF ZERO BALANCES

Elimination of Zero Balance Summary Punching

Elimination of summary punching for zero balances may be accomplished with certain limitations on the standard machine. If the result in a

counter is a zero balance, all positions of the counter stand at 9 as shown in the example below. After 72 is subtracted from 125 in a 4-position counter the result is 52 just prior to the carry-

back, and 53 just after carry-back. The 1 is carried back immediately after the 12 position of the card passes the reading brushes.

Problem	Counter
+ 125	0125
- 72	<u>9927</u>
	(1) 0052
	1 Carry-back
	<u>0053</u>
- 53	<u>9946</u>
<u>000</u>	9999 Test for Zero
	<u>0000</u> Carry Time
	9999

Note that a carry-back does not occur for a zero balance. When the complement of 53 is added to a plus 53, the result standing in the 4-position counter is 9999 before the time that the carry-back would normally occur. When all the wheels of a given counter stand at 9, a path for an X impulse is created from one end of the counter to the other by way of the CI and the C hubs of that counter. Thus, a zero balance may be determined by wiring an X through the CI and C hubs of a counter to a selector pickup. The selector can then be used to control the summary punch PU.

Wiring, Zero Balance Elimination (Figure 75)

1. The CI is wired to the common of one column split and the C to the common of another column split. The 0-9 hubs of each column split are connected with a wire. This wiring will take care of normal carry-back through the 0-9 and common hubs of the column splits.

2. The DI hub is wired through the normal side of pilot selector 4 picked up by a split column control 11 to eliminate a 12. From the pilot selector the DI is wired to X-R of a column split to eliminate the digits 9 through 0. The resulting X will reach pilot selector 1 pickup through the CI and C of 8A only if 9's are standing in all positions of the counter. Thus, pilot selector 1 is transferred for zero balances.

3. The minor program exit reaches the sum-

mary punch pickup only when pilot selector 1 is normal. Pilot selector 1 will be normal whenever the balance is not zero in counter 8A.

4. Counter 8A is controlled to add NX40 and subtract X40 cards. The card cycles impulse to the minus hub of counter 8A is eliminated through pilot selector 7 when a card is punched X in column 40 and the amount field (columns 36-40) is either blank or punched zeros. Since the comparing unit does not compare zero or blank positions, a comparing exit will not be emitted and pilot selector 7 remains normal. Thus, the card cycles impulse is eliminated for X40 blank or zero amounts. Unless this is done, zero balance summary punching would not be eliminated for zero balances arrived at by subtracting zeros from zero balances at the end of the group. For example, if a blank card is subtracted in a 4-position counter, already standing at 9999, the result would be:

9999	zero balance resulting from addition and subtraction
9999	zero subtracted last card of a group
8888	test made here for zero balance at X time
<u>(1)</u>	carry 111 and carry-back (1)
9999	

Since the X impulse originates before carry time, it cannot get through the CI and C hubs while the counter wheels are standing at 8. Therefore, pilot selector 1, through which summary punching is controlled, would remain normal and summary punching would take place. The condition is overcome by eliminating the subtraction of blank or zero amounts punched X as described above.

5. With the wiring description above, a card would still be summary punched for counters which had a zero balance as a result of no counter activity.

The wiring numbered 5 has been added to overcome this limitation. Impulsing the counter to subtract on the first card, regardless of X-punching, if the card is blank or punched with zeros, changes the counter from 0000 (positive zero) to 9999 (negative zero).

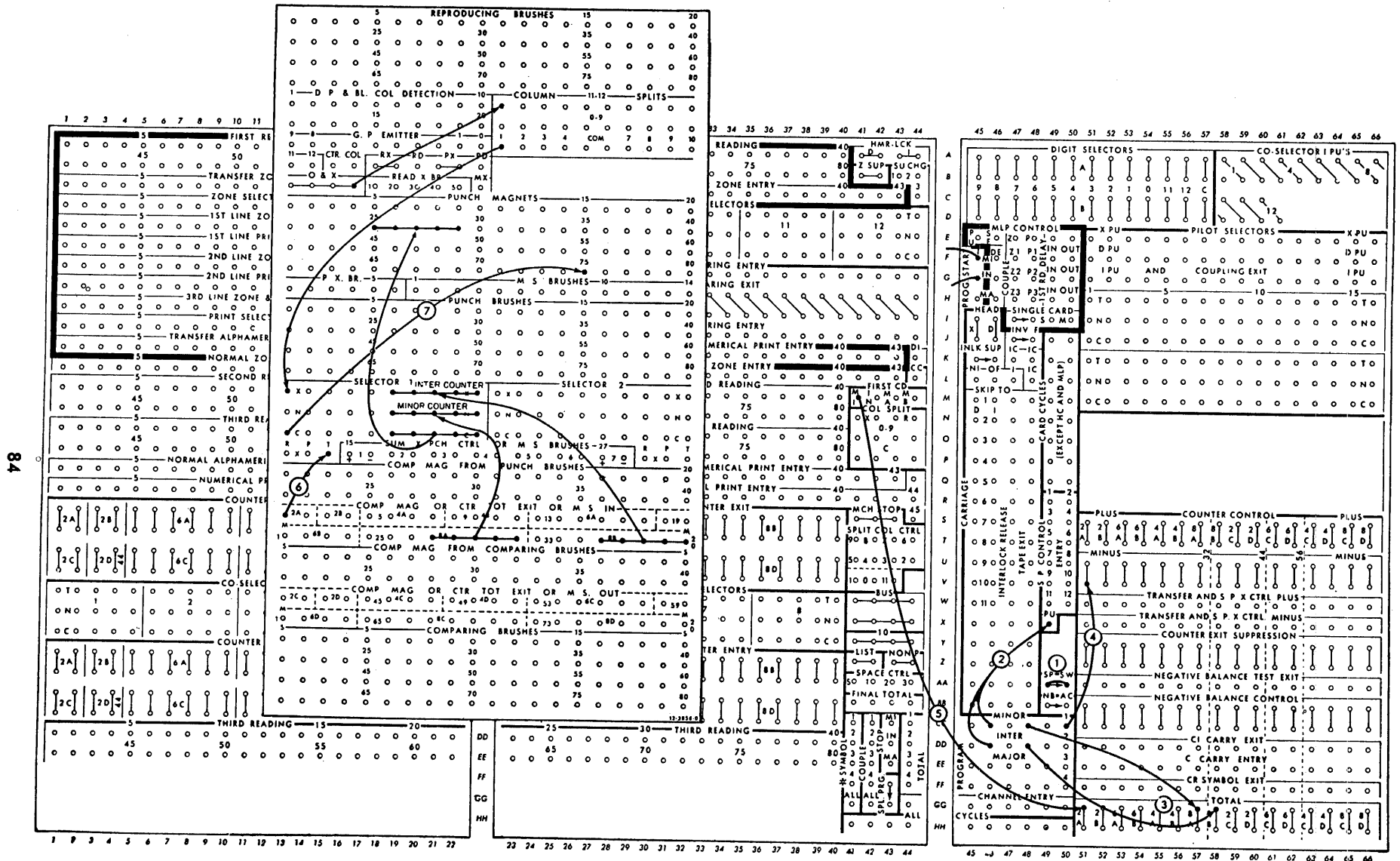

FIGURE 76. SUMMARY PUNCHING TWO CLASSES OF TOTALS

Summary Punching More Than One Class of Total

As many as three classes of totals may be summarized on separate cards during the same operation. In this type of operation, the totals to be summary punched must be selected on the summary punch control panel so that they punch in turn, that is, minor first, intermediate second, and major third. Otherwise, all three totals will be punched whenever any one of them is punched.

The selection for summary punching three types of totals is accomplished by wiring two 2-position counters on the accounting machine, one to subtract on the minor program, and the other to subtract on the intermediate program. This will cause one counter to stand at 99 after the minor program and the other counter to stand at 99 after the intermediate program. The left-hand 9 of each counter can be used to control selectors in the summary punch. The totals are then wired through these selectors to punch.

The 2-position counters should be reset from first card control, so that counter clearing and counter subtraction will not take place at the same time. These counters therefore subtract on a total program and clear on the first card of the following group.

A distinguishing X may be punched to identify minor, intermediate or major summary cards.

Wiring, Summary Punching Two Cards (Figure 76)

1. The summary punch switch is wired ON.
2. The minor and intermediate programs are wired to summary punch pick up.
3. Counter 8A clears on a minor program and 8B clears on an intermediate program.
4. Counter 2A is wired to subtract on a minor program. When a counter is wired to subtract and nothing is entered from third reading, the counter wheels turn to 9 where they remain until the counter is cleared. This counter exit will be wired on the summary punch panel to control a selector, which will be used to prevent both counter exits from summary punching at the same time.
5. Counter 2A is cleared on a minor first card control. It cannot be cleared on the minor program, because the counter is subtracting at that time.
6. Selector 1 on the summary punch panel is picked up from the left-hand 8 in a counter 2A. The total in the minor counter is wired to punch through the normal side of the selector and the total in the intermediate counter is wired to punch through the transferred side of the selector. Counter 2A stands at 00 when the minor total is summary punched and at 99 when the intermediate total is summary punched.
7. An X punch will identify intermediate summary cards and NX will identify minor summary cards.

PROGRESSIVE TOTAL PRINTING

TOTALS printed from counters without resetting the counters are called "progressive totals."

Counter resetting can be prevented by impulsing the plus and minus hub of the counter at the same time that the total hub is impulsed. This wiring keeps the counter reading wheels from stopping at zero and allows them to continue all the way around to where they originally stood. For example, if a counter contains the digit 6 and is impulsed to clear normally, the counter wheel turns from 6 to 7 to 8 and on to zero, where it stops. However, if the plus and minus hubs are impulsed, the stop at zero is suspended and the wheel keeps turning until it reaches 6 again.

Although this feature is designed primarily for printing totals without clearing the counter, it may also be used for printing any common numerical information such as a date. The information is stored in a counter from a master card and read out progressively whenever desired.

Wiring (Figure 78)

1. The field to be added is wired to counter entry 8B.
2. The totals are printed from 8B exit into print entry 36-40.
3. Counter 8B is impulsed to add from the card.
4. Since the operation is group printing, 8B counter exit must be suppressed on the indicate cycle.
5. A minor and intermediate program start is wired.
6. Counter 8B is wired to read out on every minor program change by wiring the minor program exit to the 8B total hub. The counter is prevented from clearing out by wiring the minor program exit to both the plus and minus hubs of 8B.
7. Counter 8B is reset on the intermediate total program.

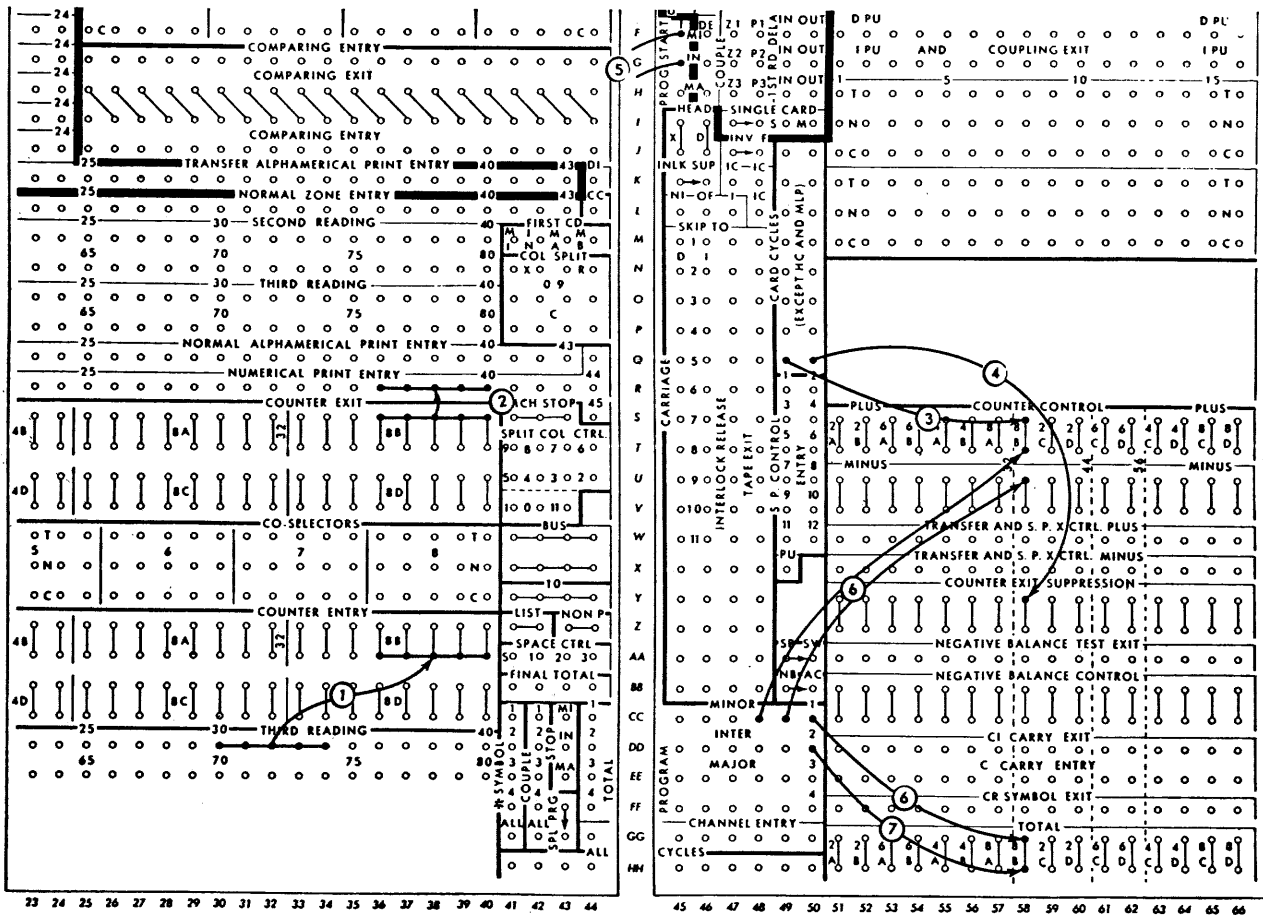

FIGURE 78. PROGRESSIVE TOTAL PRINTING

RUN OUT BUTTONS AND SWITCHES

Non-Print Run Out Button

The non-print run out button, located on the far end of the left side of the machine (Figure 79), may be depressed if for any reason (except card-feed failure) it is desired to run cards out of the machine without printing on the report. Cards will run out only when the hopper is empty.

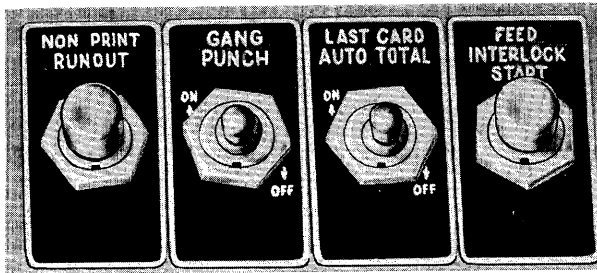

FIGURE 79. RUN OUT BUTTONS AND SWITCHES

Feed Interlock Start Button

The purpose of feed interlock is to stop the machine and prevent accidental total printing in the event of a card feed failure, as shown in Figure 80. If a card fails to feed from the hopper to position A, the machine stops, and the card feed stop light goes on. At this point there are cards in the hopper, no card at position A, and a card at position B. The machine cannot be re-started except by depressing the feed interlock start button, at which time card B runs out into the stacker. Card B performs all normal functions except programming.

The card in the hopper that failed to feed must be corrected. Card B must then be placed in front of the corrected card and the rest of the file and inserted in the hopper. To restart the machine the feed interlock start button (Figure 79) must be depressed. On the run in, card B does not add, subtract or print, but only compares. The operation for succeeding cards will be normal.

If it is not desirable to continue the run, after a card feed failure, it will be necessary to clear the feed interlock before a new run may be started. This is done by passing a blank card through the machine.

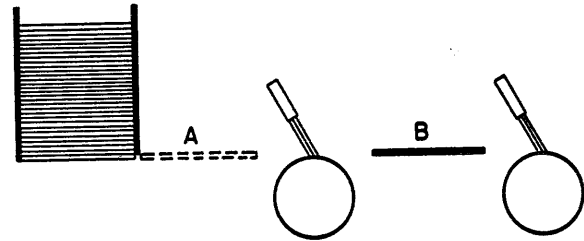

FIGURE 80. FEED INTERLOCK SCHEMATIC

Last Card Auto Total Switch

The primary purpose of the last card auto total switch (Figure 79) is to provide a means of obtaining total program cycles on the run out, thus permitting the automatic clearing of counters without program control. When the switch is ON, comparing exits are inactive and a major program change is forced on both the run-in and run-out regardless of control panel wiring. Detail printing will not be suspended for MLP or heading cards if the machine is set for group printing. Carriage skipping, if initiated by one of the cards being processed, will not be suspended. When the switch is OFF, program control wiring will function in the normal manner. Whether the switch is on or off, only those counters will be cleared whose total hubs are wired to clear.

Gang Punch Switch

The gang punch switch (Figure 79) is used with the Type 517 or 523 Gang Summary Punch only, when these machines do not operate under their own power. When the switch is turned ON, the accounting machine will not operate but the gang summary punch will, providing the cable between the two machines is connected.

Hopper Stop Switch

The hopper stop switch is not a standard feature, but it may be installed without charge. The purpose of this switch is as follows: (1) When ON, the hopper stop contact is effective, and the machine will stop as the last card leaves the hopper. Cards must be run out in order to print totals for the last control group. (2) When OFF, the hopper stop contact is ineffective, and the machine will stop as the last card is read by the third reading station. Totals for the last control group will print automatically.

SPECIAL PROGRAM

ON THE standard machine there are three types of program starts, resulting in a maximum of three total program cycles. When the minor program start is impulsed, only one total program cycle is taken. When the intermediate program start is impulsed, two total program cycles are taken, and when major program start is impulsed, three total program cycles are taken.

When the machine is equipped with a special program device, any number of total program cycles may be initiated for any one program start. For example, four total program cycles may be initiated by a minor start for the purpose of cross-footing four minor totals or printing them one underneath the other.

Four Minor Totals from the Same Type Bars

Four minor totals can be printed from the same type bars by use of a special program and other features.

SPL. PRG. STOP	MI	1								
	MI	2								
	MI	3								
	MI	4								
	TOTAL	1								
	TOTAL	2								
	TOTAL	3								
	TOTAL	4								
	ALL									
	0									

CC-HH, 43-50

Special Program (Optional). When these two hubs are connected, and any program start is impulsed, the normal minor, intermediate and major total program levels lose their identity and become instead program steps, 1, 2, 3, 4, 1, 2, 3, 4, etc., until a stop hub is impulsed. When special program is wired, an automatic space is taken for each step.

Channel Entry. Each vertical row of total program hubs has a corresponding channel entry hub. They are called channel entries because they accept impulses to control the activity of hubs immediately above them. Unless the channel entry hub is impulsed, the program exits above it will be inactive. When special program is not wired, each channel entry hub is internally connected, with an all cycles

impulse, making available program exit impulses at each of the program levels. When special program is wired, this internal connection is broken so that the channel entry does not receive an impulse unless externally wired from all cycles. This arrangement permits selection of one channel for the first 4 steps, another channel for the second 4 steps, a third channel for the next 4 steps, and so on.

Stop Minor, Intermediate, Major. More than one program cycle may be taken for each of the three program starts. For example, four program cycles may be taken for minor, two for intermediate, and two for major. When a change occurs in minor programming, four program cycles would be taken; when a change occurs in intermediate programming, six program cycles would be taken; when a change occurs in major programming, eight program cycles would be taken. In this case two channels would be necessary. The first channel would be operative for steps 1 through 4 and the second channel would be operative for steps 5 through 8. Step 4 of the first channel would be wired to minor stop, step 2 of the second channel would be wired to intermediate stop, and step 4 of the second channel would be wired to major stop.

When more than one program stop is impulsed, program stopping and counter clearing cannot be wired from the same program hub. This is because minor, intermediate and major stop hubs are common internally when minor program start is impulsed; intermediate and major stop hubs are common internally when intermediate program start is impulsed. Therefore, in the above example, two additional channels (wired exactly like the first two) are necessary to provide impulses for counter clearing. Steps 1 through 4 of the third channel would be used to clear the minor counters, steps 1 and 2 of the fourth channel would be used to clear the intermediate counters, and steps 3 and 4 of the fourth channel would be used to clear the major counters.

Wiring (Figure 81)

1. The field to be added is wired to four counters.
2. The exits of the four counters are connected and wired to print entry.
3. Counter 8A adds X35 cards, counter 8B adds X37 cards, counter 8C adds X39 cards, and counter 8D adds all NX cards.
4. All four counter exits are suppressed on the read cycle.
5. The special program is wired.
6. An all cycles impulse is wired to the channel entry corresponding to hubs in the total program unit, to be used.

7. The minor program start is impulsed, and machine takes four cycles before it is stopped. Step 1 is wired to read out and reset counter 8A; step 2 to read out and reset 8B; step 3 to read out and reset 8C; and step 4 to read out and reset 8D, and to minor stop.

Spacing for these totals may be altered by impulsing the space control hubs.

8. Program steps are stopped by wiring the last program used (step 4) to minor stop.

9. An asterisk is printed for the last total by wiring the asterisk symbol 4 hub to print entry 37.

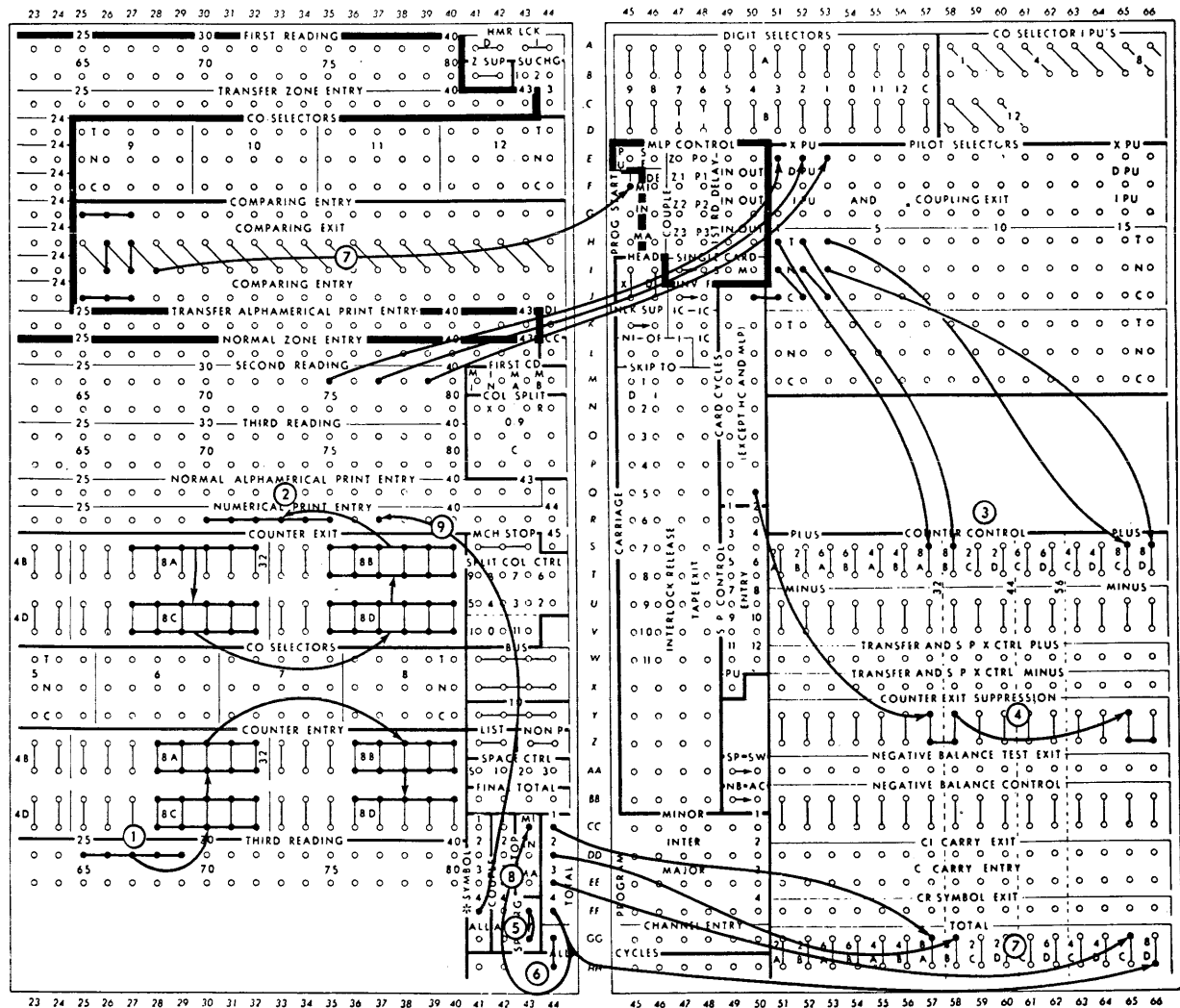

FIGURE 81. FOUR MINOR TOTALS — SAME TYPE BARS

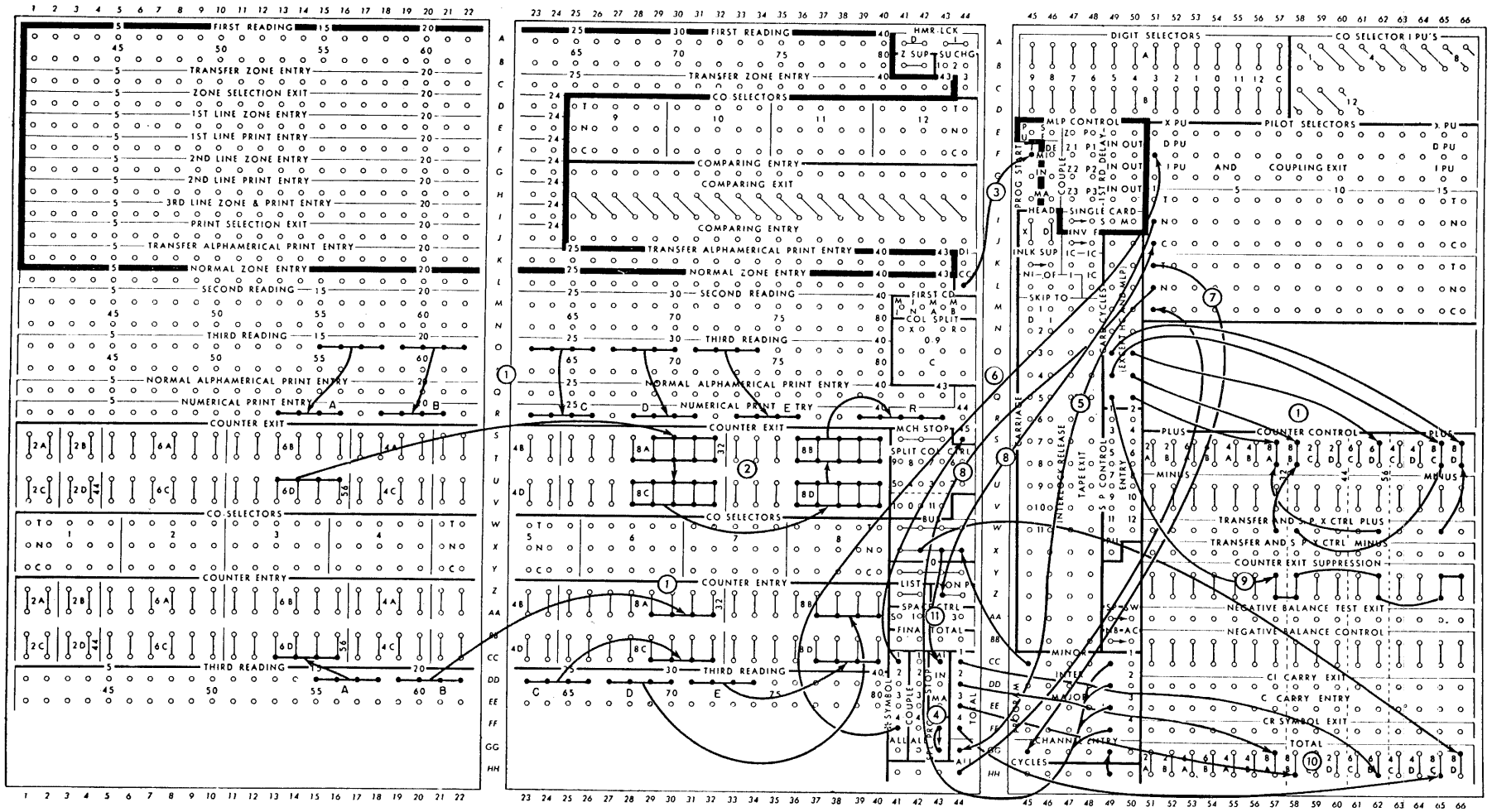
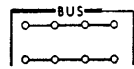

FIGURE 82. FIVE-FIELD CROSSFOOTING

Five-Field Crossfooting

Five or more fields may be crossfooted from a single card by the use of special program. The crossfooted factors may be added or subtracted.

This example demonstrates how extra cycles beyond four may be taken for minor program start. Although a card count is wired to minor program start so that five steps will be taken for every card, a comparing exit impulse can be used so that the five steps can be taken for a group of cards. Thus crossfooting may be done on every card or at the end of a group of cards.



W-X, 41-44

Bus Hubs. There are two independent rows of bus hubs, each row having four common hubs. When an impulse is entered into one of them, it is available from each of the remaining three hubs. Likewise three different impulses entered into three hubs will be available out of the fourth hub.

Bus hubs are used to avoid split wiring.

Wiring (Figure 82)

1. The five fields are added into the counters as shown. They are also wired to print.
2. A reads out of 6D and rolls into 8A to add to B. A + B reads out of 8A and rolls into 8B to add to D. A + B + D reads out of 8B and rolls into 8C to add to C. A + B + C + D read out of 8C and rolls into 8D to add to E. A + B + C + D + E reads out of 8D to print.
3. CC is wired to minor program start.
4. The special program is wired; therefore, once the program start is impulsed, the program levels begin stepping off 1, 2, 3, 4, 5, 6, etc., until they are stopped by an impulse to minor stop.
5. An all cycles impulse must be wired to the channel entry hub corresponding to the vertical row of total program hubs to be used. If four or less cycles are desired, the all cycles impulse can be wired directly to the channel entry hub. If more than four cycles are desired, as in this problem, a pilot selector must be used to control the all cycles impulse so that it reaches one channel on the first four steps and another channel on the

second four steps. To do this, the asterisk symbol (10 impulse) hub for the fourth level is wired to the digit pickup of pilot selector 1. When the fourth step has been reached on the minor program, pilot selector 1 is impulsed, and transfers on the fifth cycle.

6. The pilot selector will be normal for the first four steps, and an all cycles impulse is directed to the first channel entry on the left. The hubs immediately above this channel entry will be active at their respective levels on the first round or for steps 1 through 4.

7. The pilot selector will be transferred for the fifth step, and the all cycles impulse is directed to the next channel. The hubs immediately above this channel entry will be active for their respective levels, on the second round, or the fifth through the eighth steps.

8. All cycles is wired to channel entry 6. Program steps 1, 2, 3, and 4 are split-wired through the normal side of pilot selector 1 to non-print. Program step 1 will emit for programs 1 and 5 but since pilot selector 1 transfers on the fifth step, non-print is impulsed only on programs 1-4. When non-print is impulsed, printing and spacing are suppressed.

9. The card cycle is wired to counter exit suppression of all five counters to render counter exit wiring inoperative during the card reading cycle. If counter exit suppression were omitted, all the counters would accumulate the highest digits punched in all five fields.

10. Counter 6D reads out and clears on step 1, counter 8A on step 2, counter 8B on step 3, counter 8C on step 4, and counter 8D on step 5 via bus.

11. Step 5, being the last step in the problem, is wired to minor stop, via the bus. The minor stop is used because minor program start initiated the extra steps for the problem. If this hub were not wired, programming would continue indefinitely.

Crossfooting Ten Totals

For every four programs taken during a special program operation, a separate channel is required. An all cycles impulse must be wired to each channel used. It can be wired directly to the

channel entry if only four steps are required. For every additional four steps, a pilot selector is needed to select the all cycles impulses to the channel entries, in turn. When ten cycles are required, two pilot selectors are necessary, one to control steps 5 through 8 and the other to control steps 9 and 10.

The wiring shown in Figure 83 is for a 10-field group printed report. Whenever a program change is recognized, the totals of all ten fields will crossfoot on nine cycles and the grand total will print on the tenth cycle before continuing with the following group. Counter entry and exit wiring is not shown, as it is the same as that shown in Figure 82. However, on any crossfooting or total transfer operation, the number of cycles may be reduced by transferring more than one counter on each step, but counter exit selection is necessary to eliminate interference.

Wiring (Figure 83)

1. Minor program start is wired.
2. Ten counters are impulsed to add from card cycles.

3. Card cycles is wired to the exit suppression of all 10 counters.

4. Receiving counters are impulsed to add transferred totals.

5. All cycles is wired through the normal side of pilot selector 1 to the first channel. This channel will be operative for steps 1 through 4.

6. Pilot selector 1 is picked up from asterisk symbol 4 (10 impulse at the fourth level). The selector will be normal for the first four steps and transferred for all remaining program steps through the first card of the following group.

7. Asterisk symbol 4 is also wired through the transferred hubs of pilot selector 1 to the D pickup of selector 2. When symbol 4 emits an impulse for the eighth step, selector 2 will be transferred for step 9 and all remaining program steps through the first card of the following group.

8. All cycles is wired through the transferred side of pilot selector 1, and through the normal side of selector 2 to channel entry 2. This channel will be operative for steps 5 through 8 only.

9. All cycles is wired through the transferred sides of pilot selectors 1 and 2 to channel entry 3. Pilot selector 1 is picked up for step 5 and remains transferred for all the remaining program cycles. Pilot selector 2 is picked up for step 9 and remains transferred for all the remaining program cycles. The third channel will be operative starting with step 9.

10. Pilot selector 4 is picked up from the asterisk symbol 1 hub, wired through the transferred hubs of pilot selector 2. When the asterisk symbol hub emits an impulse on the ninth step, pilot selector 4 will transfer for the tenth step.

11. All cycles is wired to channel entry 6. Program steps 1, 2, 3, and 4 are split-wired through the normal side of pilot selector 4 to non-print. Since pilot selector 4 transfers on the tenth step, non-print is impulsed for the first nine programs, thus suppressing printing and spacing during the crossfooting cycles.

12. The counters are impulsed to read out and reset on specific programs as shown. The last program used (step 10) is wired to minor stop.

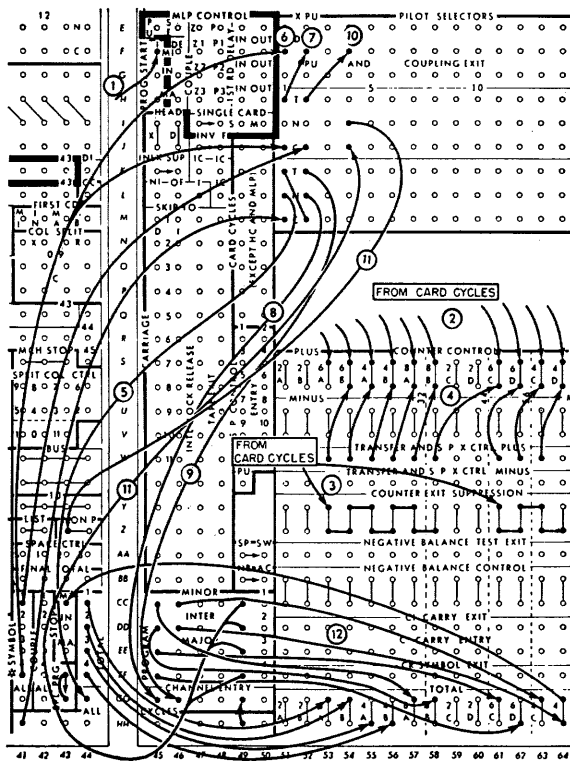

FIGURE 83. CROSSFOOTING TEN TOTALS

IBM TAPE-CONTROLLED CARRIAGE

THE Tape-Controlled Carriage controls the feeding and spacing of forms at high speed while documents or reports are being prepared on Type 402 and Type 403 Accounting Machines. This carriage is controlled by punched holes in a narrow paper tape which exactly corresponds in length to the length of one or more forms. Holes punched in the tape stop the form when it reaches any predetermined position. One of the punched holes in the tape can be used to control the Accounting Machine for taking page totals or to start overflow skipping to the next form.

This carriage is standard on both the Type 402 and Type 403 Accounting Machines.

Flexibility in Form Design

The carriage will accommodate continuous forms measured in 6ths of an inch up to a maximum of 22 inches in length and 19½ inches in width, including punched margins. While forms of any size within these limits can be handled by the carriage, forms of standard sizes available from the forms manufacturers can be obtained more quickly and economically.

Forms can be designed to permit printing in practically any desired arrangement. Skipping can be controlled to 8 different sections of the form. The number of sections can be increased by 3 as an optional feature, or in some instances by repeated use of the same holes in the tape.

Variable Line Spacing and Uniform Skipping

Single, double or triple spacing can vary between lines as controlled by wiring on the control panel. Thus, the heading section of a form may be single spaced and the body section double spaced.

When more than half inch (triple) spacing is required, it must be controlled by the tape. Spaces up to 3-2/3 inches between lines can be skipped at the same rate of speed as normal spacing. This skipping is a smooth, high-speed advance of the form similar to "ejection" in the Type 921

Automatic Carriage. Successive lines can be printed up to 3-2/3 inches apart at the rate of 100 lines per minute, the normal printing speed of the Types 402 and 403 machines.

Overflow Skipping

When one form is completely filled, it can be ejected and the next form can be advanced to the first printing line or to the first body line. This "overflow skipping" is caused by sensing a punch in a specific position of the tape, which starts advancing the paper to the required line on the next form. If the last card of a group prints on the last available detail printing line, the total will print before skipping to the next form takes place. Overflow is slower than other skipping, therefore, it is desirable to reduce overflow skipping to a minimum.

Page Totals

The overflow punch in the tape can also be used to start other operations, if desired, before ejecting the completely filled form. For example, a total may be printed at the bottom of each page before advancing to the next form.

Predetermined Total Line

Any class of total can be printed on a predetermined line, whether the form is completely filled or not. For example, although only two or three items have printed on a form, the total of these items may be printed on a designated line of the form instead of directly beneath the last item printed.

Single Sheet Forms

Single sheet forms can be fed easily without moving the carriage in any way. With tape control, each form can be advanced to any desired line for printing. After one or more lines or sections have been printed, the form can be ejected automatically.

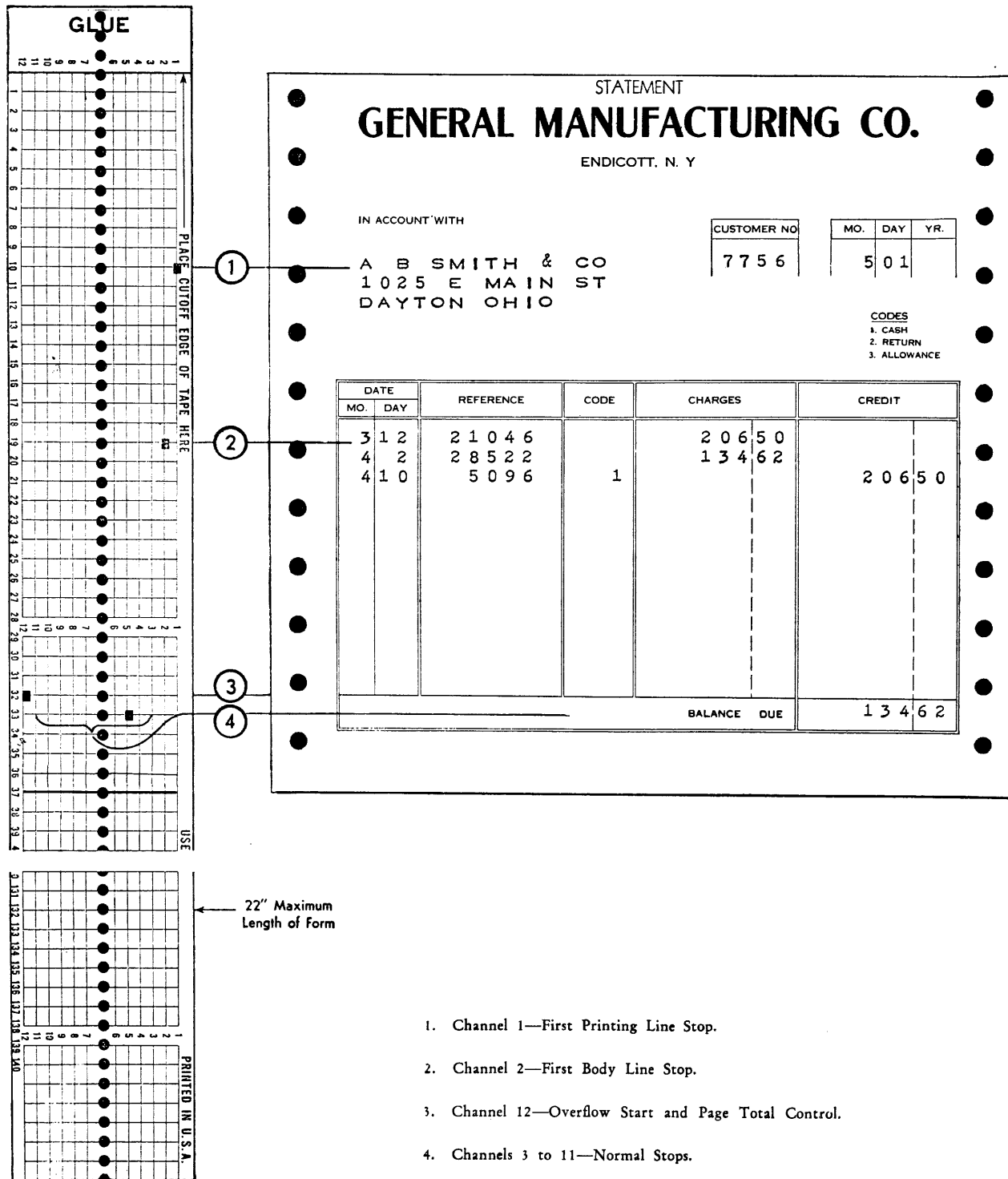

FIGURE 84. CONTROL TAPE

CONTROL TAPE

THE control tape (Figure 84) has 12 columnar positions indicated by vertical lines. These positions are called "channels." Holes can be punched in each channel throughout the length of the tape. A maximum of 132 lines can be used for control of a form, although for convenience the tape blanks are slightly longer. This will allow form depths of 22 inches when using 6 lines to the inch spacing, or $16\frac{1}{2}$ inches when using the 8 lines to the inch spacing device. All forms 22 lines in depth or less are considered "short forms." Using 6 lines to the inch, a short form is $3\text{-}\frac{2}{3}$ inches or less; using 8 lines to the inch, a short form is $2\text{-}\frac{3}{4}$ inches or less. Round holes in the center of the tape are prepunched for a pin-feed drive in a tape sensing mechanism which controls the carriage. The tape advances through the mechanism in synchronism with the movement of a printed form through the carriage. The effect is exactly the same as though the control holes were punched along the edge of each form when 6 lines to the inch spacing is used. All illustrations in this manual are on the basis of 6 lines to the inch.

Tape Channels

Channels are punched to control the following functions:

First Printing Line Stop. Channel 1 is always punched for the first printing line of a form. This is the starting or "home" position.

First Body Line Stop. Channel 2 is always punched for the first body line of a conventional two-part form whenever heading cards are used. Without heading control, channel 2 may be used as a normal skip stop.

Note: When Channel 2 is used for the first body line, it should be at least two lines after the punch in Channel 1.

Normal Skip Stops. Channels 3 through 8 are used to stop a form at one of 6 positions after skipping has been started. They may be used in any order or sequence. Three additional normal skip stops (9 through 11) may be specified as an optional feature. A control impulse, such as X, digit, or comparing exit, can be used to start skipping to any position on the form. Other impulses that can be used are first card (minor, intermediate, and major) and total program exits.

All of the above punches in the tape not only stop skipping, but they can also serve as interlock releases.

Overflow and Page Total Control. The 12th channel of the tape must be punched in a position corresponding to the last printing line of the form. This punch is normally used to cause immediate overflow skipping but may also be used to start a program to perform other operations before overflow skipping takes place.

This punch can be sensed only while printing and not while skipping.

When head control is not wired, an overflow skip is made to the first printing line of the next form (channel 1). When head control is wired, overflow skipping is made to the first printing line if overflow page identification is to be printed; if not, the skip is made directly to the first body line (channel 2).

Interlock Release

Normally, the tape-controlled carriage stops the feeding of cards through the accounting machine during every skip regardless of its length. The feeding of cards is resumed after the skip is completed, but at least one card cycle is lost for every skip taken. This is called "interlocking" and its primary purpose is prevent printing in flight for skips longer than $3\text{-}\frac{2}{3}$ inches. (This figure is $2\text{-}\frac{1}{3}$ " for the 419 due to the increased speed of operation.) If a skip is $3\text{-}\frac{2}{3}$ inches or less, the control panel can be wired to release the interlock and thereby cause continuous operation of the accounting machine. When the distance is more than $3\text{-}\frac{2}{3}$ inches, the machine is interlocked at the start of the skip. However, the interlock may be released at the time that the remaining distance to be skipped is $3\text{-}\frac{2}{3}$ inches or less. This feature will reduce to a minimum the number of cycles lost whenever long skips are required. (Figure 111 wiring 8-tape exit 3 to interlock release 1).

In designing forms, distances which are to be skipped frequently should, if possible, be kept within $3\text{-}\frac{2}{3}$ inches for most efficient operation. These distances may or may not be between 2 successive sections of a form. For example, in a billing form with sections for SOLD TO, SHIP TO, and BODY, skips may frequently be made over the

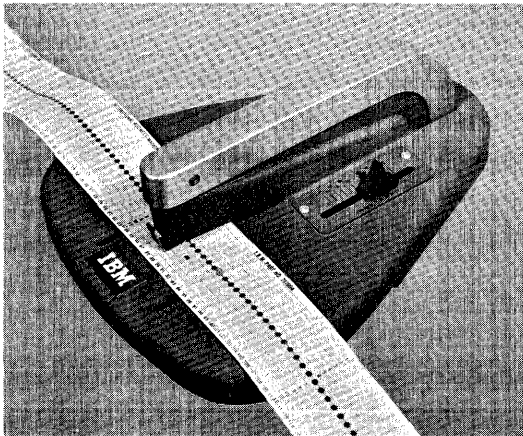

FIGURE 85. TAPE PUNCH

SHIP TO section, because there is no shipping address. In this case it is desirable, for increased operating speed, to make the distance from the SOLD TO line to the BODY line 3-2/3 inches or less.

Tape Punching

A small compact punch (Figure 85) is provided for punching the tape. The tape is first marked in the channels in which the holes are to be punched. This can be done easily by laying the tape beside the left edge of the form which it is to control, with the top line (immediately under the GLUE portion) even with the top edge of the form. A mark is then made in the first channel on the line which corresponds to the first printing line on the form. When 6 lines to the inch spacing is being used, the tape itself can be used as a ruler and additional marks are made in the appropriate channels for each of the other skip stops and the overflow signal required for the form. When 8 lines to the inch spacing is being used, distances to be skipped between one section and another should be measured by an ordinary ruler which has an 8th scale. Each 1/8 inch of the form represents a line indication on the tape. Thus, if a skip is 1½ inches, the skip represents 12 lines on the tape.

The marking for one form should be repeated as many times as the usable length of the tape (22 inches) will allow. Thus, the tape can serve to control several forms in one revolution through the sensing mechanism, thereby increasing the life

of the tape. Finally, the line corresponding to the bottom edge of the last form should be marked for cutting after the tape is punched.

The tape is inserted in the punch by placing the line to be punched over a guide line on the base of the punch and placing the center feed holes of the tape over the pins projecting from the base. The dial is then turned until the arrow points at the number of the channel to be punched. Pressing on the top of the punch, toward the back, cuts a rectangular hole at the intersection of a vertical and horizontal line in the required channel of the tape. Under no circumstances should the tape be punched with holes in more than one channel on the same line.

After the tape is punched, it is cut and looped into a belt. *The bottom line is glued to the top line by use of the section marked GLUE, after the glaze has been removed by an ink eraser. If the glaze is not removed, the tape ends may not hold together.* The center feed holes should coincide when the two ends of the tape are glued together.

The last hole punched in the tape should not be less than 4 lines from the cut edge, as approximately the last half inch of the tape overlaps the glue section when the two ends are spliced. If it is necessary to punch a hole lower than 4 lines from the bottom of the form, the tape should be placed with the top line (immediately under the GLUE portion) 4 lines lower from the top edge of the form before marking the channels. To compensate for this loss, the tape should then be cut 4 lines lower than the bottom edge of the form.

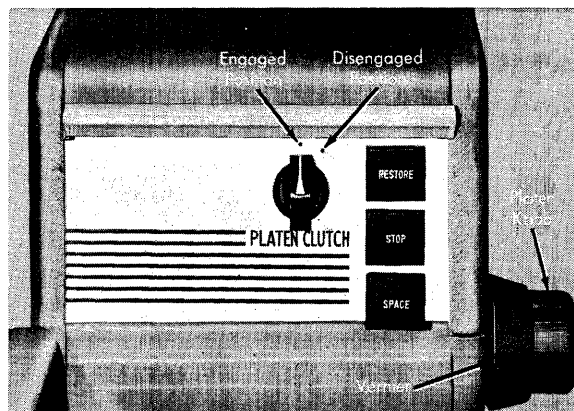

FIGURE 86. CARRIAGE FEATURES

OPERATING FEATURES

Platen Clutch

When the arrow on the platen clutch is pointing upward, as shown in Figure 86, the platen is engaged and can be turned manually only by the vernier knob. To disengage the platen from machine control, the platen clutch is turned to the right. The platen can then be turned manually by the platen knob.

Restore Key

The carriage is set at the start or home position by depressing the restore key. This is done while the platen is disengaged. Restoring is necessary because the distance which each form travels through the carriage, as it is being printed, is measured by the tape. Starting from the first printing line of one form, the tape moves in synchronism with the form, until the first printing line of the next form is reached.

Stop Key

Depression of this key stops the carriage operation instantly and the accounting machine at the end of the cycle.

Space Key

When the accounting machine is stopped, a form can be advanced by depressing the space key. The form advances one space for each key depression, regardless of the spacing for which the space control is wired. The first form can be fed into position by depressing the space key if the platen clutch is engaged, but the platen clutch should then be disengaged to permit restoring the tape without advancing the form.

Platen Knob

The platen knob can be turned backward or forward to position the form only when the platen clutch is disengaged.

Vernier Knob

The vernier knob is used to obtain exact registrations in relation to the horizontal lines. The platen advances, thus lowering the printing on the form, when the knob is turned counterclockwise. Turning the knob in a clockwise direction will cause the printing to occur higher on the form. In either case, the carriage tape is not

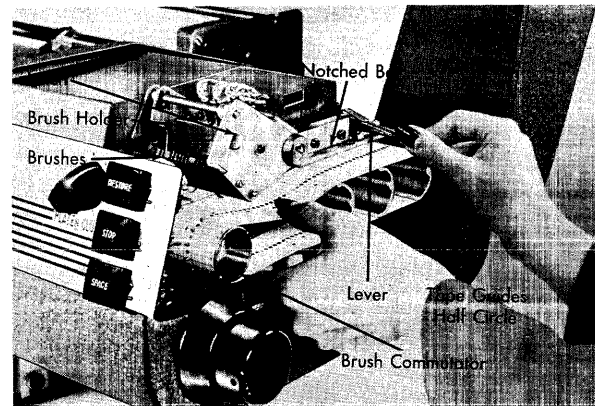

FIGURE 87. INSERTING TAPE IN CARRIAGE

affected and adjustments can be made while the platen is engaged or while the machine is in operation.

Inserting Tape in Carriage

The cover of the carriage is tilted back to gain access to the tape reading mechanism. The platen clutch is turned to a disengaged position, and the brushes are raised by moving to the left the latch located on the side of the brush holder. With the tape held so that the printed captions can be read, one end of the loop is placed over the pin feed drive wheel so that the pins engage the center drive holes. The opposite end of the loop is placed over the nearest half-circle guide piece. The excess slack is removed from the tape by lifting the lever away from the notched bar and by moving the guide piece unit to the right. The tape should be just tight enough so that it will give slightly when the top and bottom portions of the loop are pressed together as shown in Figure 87. It should not fit too tightly or the pin-feed holes will be damaged.

After the tape is in position, the brushes are pressed down and the cover is closed. The restore key is depressed to bring the tape to its home position and the platen clutch is turned back to the engaged position. The carriage is then ready to operate.

Tapes can be changed readily and used repeatedly over a considerable period of time.

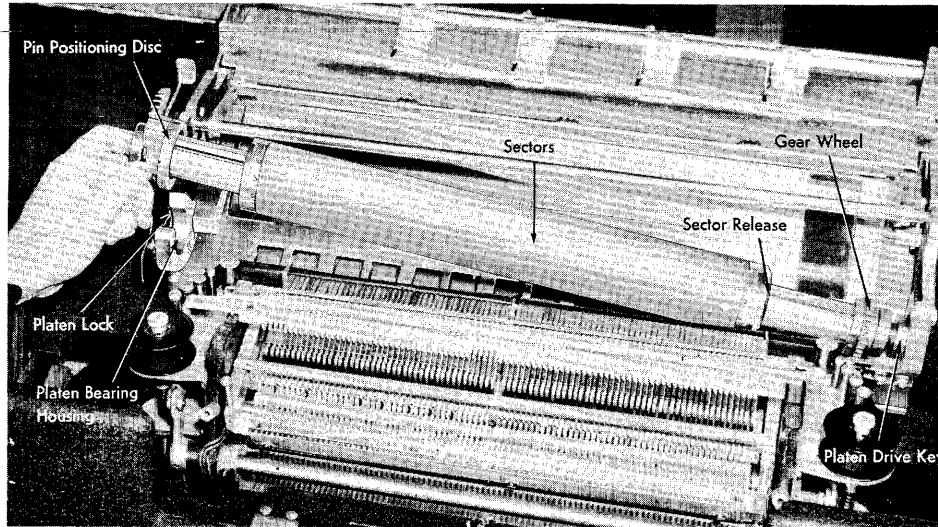

FIGURE 88. PLATEN ASSEMBLY

Form Feed

As in a typewriter, the first form is placed on the paper table and advanced into printing position by turning the platen knob. The carriage need not be moved in any way except for minute adjustments in horizontal registration and vertical alignment.

Platen

The carriage can be equipped with an IBM Pin-Feed Platen device, or a solid platen assembly for use with an IBM Forms Tractor or approved feeding devices of other manufacturers.

The Pin-Feed Platen Device and the Forms Tractor are described under *Form Feeding Devices*.

Either the pin-feed or the solid platen assembly may be easily removed (Figure 88) by raising the platen lock on the left side, pulling the assembly to the left and lifting it from the platen bearing housing. When the platen assembly is inserted, the end with the gear wheel should be placed in the slot on the right of the carriage, and the left end should be dropped into the platen bearing housing. The platen assembly must then be moved to the right, turning it back and forth in order to fit the platen drive key into the carriage drive mechanism. The platen lock is then closed.

If pin feeding is not desired, the pins may be made inoperative by turning the pin positioning disc clockwise.

The removable platen sectors are either split or tubular and are available in varying sizes to ac-

commodate forms of different widths. Split sectors may be easily removed by loosening the sector release, shifting it to the right and pulling the two sectors apart. To remove the tubular type of platen sector, the left platen bearing and tightening nut must be pulled from the shaft.

To operate properly with IBM form feeding devices, forms with marginally punched holes should be specified in accordance with the *Recommended Specifications for Forms Used with IBM Form Feeding Devices* (Form X24-5235).

Form Thickness Adjustment Device

The distance between the type bars and the platen is adjustable, for thickness of paper stock or for varying number of copies, by the use of the form thickness adjustment device (Figure 89) located under the covers between the brushes and

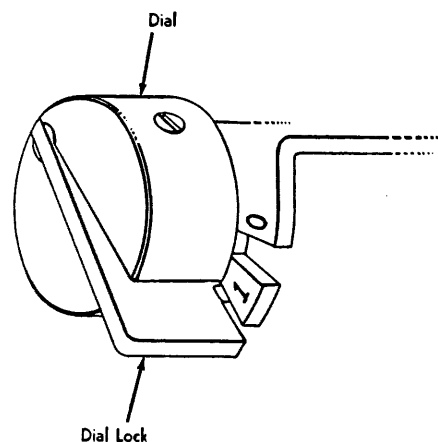

FIGURE 89. FORM THICKNESS ADJUSTMENT DEVICE

the print unit. This device contains 7 notches numbered from 0 through 6. When the dial is in the 0 notch the type bars are $1/8$ (.125) of an inch from the platen. Each of the remaining six notches add to the $1/8$ inch distance by approximately the thickness of 1-1/2 cards. When the dial is set to 6, the distance is increased to approximately .178 of an inch. The dial should be set wherever the best results are obtained. To adjust for varying thicknesses, the dial lock is pulled out and the dial is turned clockwise to increase the distance between the type bars and the platen, and counterclockwise to decrease the distance.

Paper Brake and Form Stop Device

In back of the platen is a paper brake device (Figure 90) for adjusting the drag or tension on the paper. As a part of the brake device there are four form stop controls which stop the machine when the carriage runs out of paper. The form feeds under the form stop controls. When

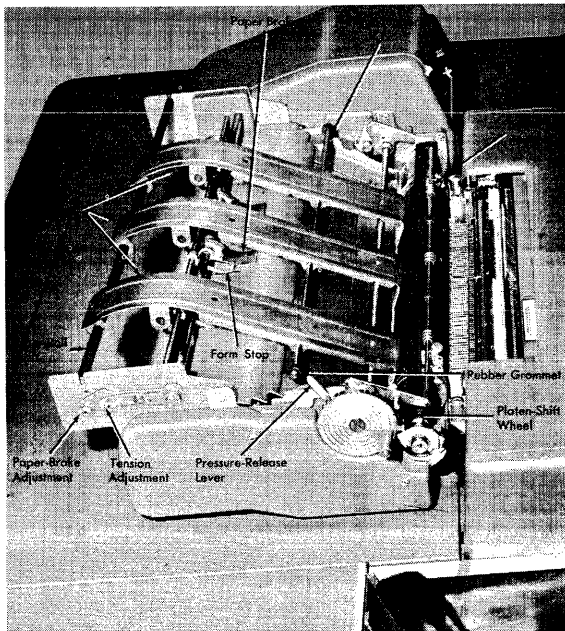

FIGURE 90

the bottom edge of the last form passes the form stops, all four form stops drop into slots as shown, and the machine stops. The distance between these stops and the printing line is about ten inches.

Both paper brake and form stop control are made operative, separately or together, by a lever at the left side of the carriage. When the lever is in the top notch, as illustrated, both the paper brake and form stop are operative. When the lever is in the middle notch, the paper brake device is OFF and the form control is ON. When the lever is in the bottom notch, the paper brake and the form control are OFF.

Tension Adjustment

The drag on a form may be increased or decreased to obtain the best operation for a specific form, by regulating the tension adjustment lever located on the outside of the paper brake device. The lever may be set in one of four positions above the middle line on the dial to decrease tension, or in one of four positions below the middle to increase tension.

Pressure Release Lever

When this lever is pushed backward, the feed rolls are released so that the paper can be moved freely around the platen. Pressure should always be released when form feeding devices are in use. Pressure should be applied when form feeding devices are not in use.

Platen Shift

The platen may be shifted laterally a total of $5-3/4$ inches to the left or right by turning the platen shift wheel. This adjustment can be made while the machine is in operation.

FORM CONTROL

SKIPPING is started by wiring on the control panel and is stopped by holes in the tape. The control panel wiring illustrated in the following examples is based on the use of the Type 402 Accounting Machine, and only that wiring is shown which relates directly to the carriage operation.

The examples illustrate operating principles and are not necessarily the only arrangements of tape channel punching which can be used.

Short Form Skipping

Short form skipping describes the preparation of forms 3-2/3 inches or less in depth, as illustrated in Figure 91. This operation can be used for any type of form requiring skips of not over 3-2/3 inches. Printing of checks, address labels and many other documents can be accomplished with short form skipping.

Punches in channel 1 of the tape correspond to the first printing line of each form.

Skipping for short forms can be started by a comparing exit, card count, X, or digit impulse. Skipping is stopped at the first line of each form by the punches in the tape.

Forms of 3-2/3 inches or less in depth, requiring only one line of printing from single cards, can be prepared at the rate of 100 forms per minute. This is made possible by the interlock suppress switch on the control panel.

This method of operation can be used for skipping from section to section if the sections are 3-2/3 inches or less apart, and printing for each section is assured.

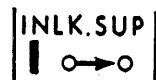

K, 45-46

Interlock Suppress. Normally all functions of the machine are stopped until a skip is completed, regardless of its length. This stop and the re-starting to continue machine operation are referred to as interlocking. However, a skip of 3-2/3 inches or less may be completed between printing cycles and does not require interlocking. Likewise, any form that is 3-2/3

inches or less in length does not require interlocking. If a form is 3-2/3 inches or less in length, or if all skips on a longer form are 3-2/3 inches or less, interlocking may be suppressed by connecting the interlock suppress switch.

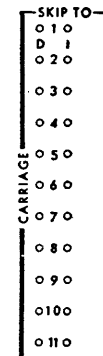

M-W, 45-46

Skip to — D and I. With the exception of skipping from heading to body, which is automatic when head control is wired, all skipping is started before printing by impulsing the D or I skip to hubs. The D hub should be impulsed on one cycle to cause skipping before printing on the next cycle.

The following impulses must be wired to the D hub:

- X wired from preceding station to cause skipping before an X card prints.
- Digit wired from preceding station to cause skipping before a digit card prints.
- Comparing exit to D to cause skipping before the first card of the following group prints. If a program intervenes, skipping is delayed until after the total cycle.

An impulse to the I hub will cause immediate skipping. The I hub will not accept digit impulses (9 through 12) since they would cause skipping during card reading. The following impulses must be wired to the I hub:

- First card Mi, In, or Ma wired to the I hub causes skipping before the first card of a group prints.
- Total program minor, int, or major wired to the I hub causes skipping before the total prints.

NOTE: This form is used to illustrate form to form skipping, but the design does not conform exactly to the W-2 Withholding Statement currently in use.

First Printing Line Stop (1)—punched for the first printing position on each form. It is the "home" position to which the carriage restores for starting any form printing operation.

FIGURE 91

- c. Negative balance test exit.
- d. Card cycles or all cycles through a selector controlled by X or D for NX or ND skipping.

Each D and I hub is numbered, the numbers representing the channels on the tape. Eight channels are standard (1-8), and three are optional (9-11). If an impulse is introduced into one of

these hubs and a hole is punched in the tape in the corresponding channel, a skip will take place to the position where the hole is punched in the tape. For example, if hub 3 is impulsed on the control panel and a hole is punched in channel 3 of the tape, the impulse will start the skip and the hole in the tape will stop it. As previously described, channel 1 identifies the first printing

line, channel 2 the first body line and channel 12 the overflow. All other channels identify other stops within the same form and may be used interchangeably.

Wiring for Short Form Skipping (Figure 92)

1. Since the form is 3-2/3 inches in length, interlock suppress is wired.

2. Social security number is compared and the comparing exit wired to skip to 1D. It is unnecessary to initiate a program start since totals are not required. Each new group is identified by a change in social security number and the comparing exit resulting from this change will cause skipping before the first card of each group.

If the information printed to the right of the name is punched in a card preceding the name card, spacing can be suppressed from an X or digit in the name card.

3. The machine is wired to print every card.

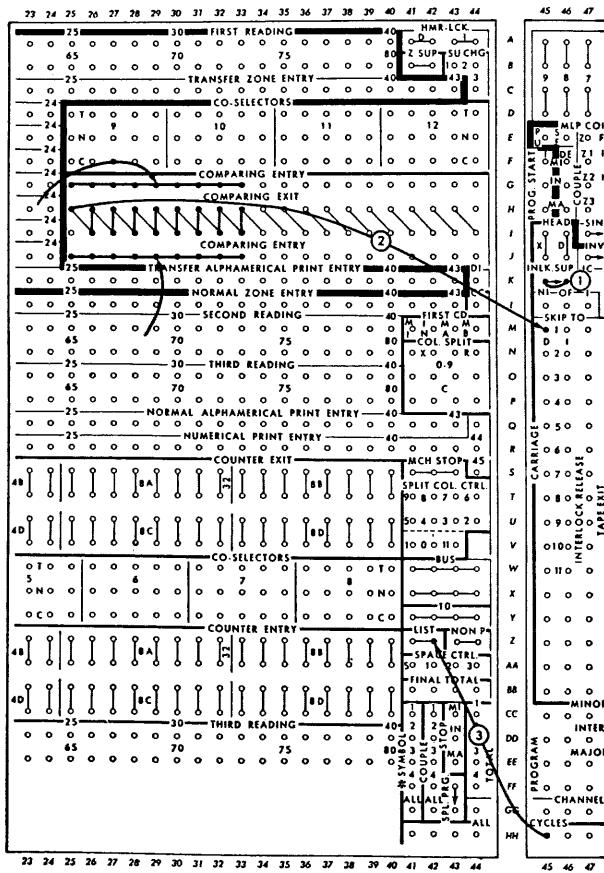
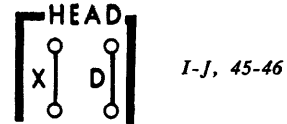

FIGURE 92. SHORT FORM SKIPPING

SINGLE HEADING FORMS

IN ANY operation in which heading and detail cards are used (Figure 93), the machine can be controlled to print the heading cards in the heading section of a form and the detail cards in the body section, as well as provide for overflow.



Head Control. Heading cards are usually identified by a significant punch, such as an X or digit. The head control X and D hubs receive impulses to cause the following functions to take place:

- a. Print all heading cards.
- b. Suspend all programming during printing of heading cards.
- c. Cause an automatic skip from the heading to the body, before the first body card is printed.
- d. Make eleven card cycles hubs inoperative during the printing of heading cards.
- e. Activate the first card MB (minor body) hub so that it will emit an impulse for the first card of each minor group in the body. Without head control wiring, the MB hub is the same as the first card minor. Head X or D should be wired from second reading on the Type 402.

For head control on the Type 403, see Figure 111, wiring 5.

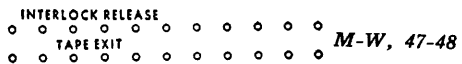

Tape Exit — Interlock Release. Each channel on the tape has a corresponding tape exit hub on the control panel. These hubs are active as the hole in the tape is read by the carriage brushes.

Each channel on the tape also has a corresponding interlock release hub which may receive an impulse from a tape exit hub to release the interlock providing the distance to be skipped is 3-2/3 inches or less.

GLUE

PLACE CUTOFF EDGE OF TAPE HERE

USE

PRINTED IN U.S.A.

STATEMENT

GENERAL MANUFACTURING CO.

ENDICOTT, N. Y.

IN ACCOUNT WITH

A B SMITH & CO
1025 E MAIN ST
DAYTON OHIO

CUSTOMER NO
7756

MO.	DAY	YR.
5	01	

CODES
1. CASH
2. RETURN
3. ALLOWANCE

DATE		REFERENCE	CODE	CHARGES		CREDIT	
MO.	DAY						
3	12	21046		206	50		
4	2	28522		134	62		
4	10	5096	1			206	50
BALANCE DUE						134	62

← 22" Maximum Length of Form

FIGURE 93. SINGLE HEADING FORM

As previously described, if forms are 3-2/3 inches or less in length, the interlock suppress is jackplugged and the channel releases are unnecessary.

Without interlock suppression or interlock release, one or more cycles are lost for every skip. To speed up the operation for forms longer than 3-2/3 inches, interlock may be released when skipping from one point to another, if the distance between these points is 3-2/3 inches or less. Any tape exit wired to any interlock release will suppress the interlock between those two points. For example, the interlock may be released from heading to body by wiring the tape exit of channel 1 to interlock release of channel 2.

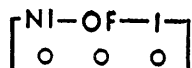

L, 45-47

Overflow:

NI — OF — I Channel 12 on the tape is always reserved for overflow control. It is punched to identify the last printing line on the form. When it is sensed, an impulse will be available out of the OF (overflow) hub. When OF is wired to NI (non-indicate), overflow skipping will be to the first printing line of the next form (channel 1) when heading control is not wired. When heading control is wired, overflow skipping will be to the first body line (channel 2). When OF is wired to I (indicate) overflow skipping will be to the first printing line (channel 1) to allow printing of sheet identification. If heading control is also wired, an automatic skip to channel 2 (first body line) will follow printing of sheet identification. In this manner, the items which could not be accommodated in the body of one form will print in the body of the overflow sheet.

The OF hub emits an impulse only when the hole in the 12th channel of the tape is reached during a printing cycle. It will continue to emit impulses until ejection is completed. Impulses are not emitted by the OF hub if the hole is passed while skipping.

When double or triple spacing in the body

of the form, it may be necessary to punch the 12th channel of the tape one or two lines higher than would ordinarily be the case for single spacing.

In a simple detail printing operation when minor page totals are desired, OF may be wired directly to minor program start. When this is done, NI or I should not be wired. If page totals are desired on a predetermined total line, OF is also wired to skip to I of the appropriate channel. The ejection to the first line of the next form is then accomplished by wiring first card minor to skip to I.

Wiring for Heading Forms (Figure 94)

1. A minor program start is wired for customer number.
2. All heading cards have an X in column 75 which is wired from second reading to head control X.
3. Counter 8A adds the charges and subtracts the credits. CI and C are connected because the counter is wired to subtract.
4. When the last printing line on the form is reached, the OF hub emits an impulse because channel 12 is punched at this point. OF is wired to NI which causes a skip to the first body line on an overflow.
5. A hole in channel 5 of the tape, in this example, identifies the predetermined total line. Skipping to the predetermined total line is caused by wiring minor total program to skip to 5I.
- Whenever a skip before total is desired, the minor, intermediate or major total program level is wired to the particular skip to I hub identifying the predetermined total line.
6. Counter 8A is wired to read out and reset on a minor program.
7. Skipping from the predetermined total line to the first line of the next form is taken care of by wiring the MI (minor) first card to the skip to 1I hub.
8. The distance between the first heading line and the first body line is less than 3-2/3 inches. Similarly, the distance between the first body line and the predetermined total line is less than 3-2/3 inches. The distance between the predetermined total line and the first printing line is less than

GLUE

PLATE SHEET EDGE OF TAPE HERE

USE WITH FORM NO.

INTERNATIONAL BUSINESS MACHINES CORP.

18 M. PART NO. 21584

GENERAL MANUFACTURING CO.

- ①
- ②
- ②
- ②
- ②
- ③
- ④
- ⑤

EAST AND WEST R R
2152 VERNOR HIGHWAY
DETROIT 16 MICHIGAN

EM.	TER.	CUSTOMER NO.	TYPE	COPIES	MO.	DAY	YR.	NUMBER	PAGE
12	16	4218	10	6	10	16		21587	1

EAST AND WEST RR STATION
ERIE N Y

VIA C & C BUFFALO
R W R R

TERMS 2/10 DAYS NET 30

MO.	DAY	YR.	CUSTOMER ORDER NUMBER	F. O. B.	S. D.	REGISTER NO.	ORIGINAL INVOICE		
10	11		2A2695D	DETROIT		502			
SERIAL NO.	CL.	CATALOGUE NUMBER AND DESCRIPTION				UNIT	QUANTITY	UNIT PRICE	NET AMOUNT
3112	71	WD SCREWS FH STL CDM 7/8 7				GR	6	214	1284
3113	71	WD SCREWS FH STL CDM 7/8 8				GR	6	220	1320
3114	71	WD SCREWS FH STL CDM 7/8 9				GR	6	228	1368
3129	71	WD SCREWS FH STL CDM 1 6				GR	15	234	3510
3130	71	WD SCREWS FH STL CDM 1 7				GR	9	240	2160
3131	71	CRGE BLTS STL 1/4 3/4				C	20	58	1160
3132	71	CRGE BLTS STL 1/4 1				C	15	65	975
3133	71	CRGE BLTS STL 1/4 1 1/4				C	30	71	2130
3152	71	CRGE BLTS STL 1/4 1 1/2				C	15	76	1140
3153	71	CRGE BLTS STL 1/4 2				C	15	82	1230
INVOICE TOTAL									

GENERAL MANUFACTURING CO.

- ①
- ②
- ②
- ②
- ②
- ③
- ④
- ⑤

DETROIT

EM.	TER.	CUSTOMER NO.	TYPE	COPIES	MO.	DAY	YR.	NUMBER	PAGE
					10	16		21587	2

MO.	DAY	YR.	CUSTOMER ORDER NUMBER	F. O. B.	S. D.	REGISTER NO.	ORIGINAL INVOICE		
SERIAL NO.	CL.	CATALOGUE NUMBER AND DESCRIPTION				UNIT	QUANTITY	UNIT PRICE	NET AMOUNT
3155	71	MACH SCREWS BRS RH 4/40 1/4				GR	20	36	720
3156	71	MACH SCREWS BRS RH 4/40 3/8				GR	6	45	270
INVOICE TOTAL								17267*	

FIGURE 95

106

MULTIPLE HEADING GROUPS — OVERFLOW SHEET IDENTIFICATION

THE flexibility of the tape-controlled carriage for controlling skipping is illustrated in Figure 95. Provision is made on the form for five sections in the heading and two sections in the body.

The first printing line is signalled by a punch in tape channel 1. The first line of the second heading is identified by a normal skip stop in channel 3. Similarly, the first lines for shipping instructions, terms, and miscellaneous data are signalled by punches in channels 4, 5, and 6 respectively.

Overflow Skipping. An overflow skip start is always signalled by a punch in channel 12. An overflow skip from a completely filled form can be made to either the first printing line or the first body line of the next form. Both of these lines are identified by punches in specific channels (1 and 2). The particular line to which an overflow skip is made is determined by wiring the overflow switch. In the illustration a skip is made to the first printing line by wiring OF to I. When this is done, the accounting machine automatically takes one cycle during which information stored in counters can be printed on the first printing line. An automatic skip is then made to the first body line.

Predetermined Total Line. After the last commodity is printed on the invoice, a minor program change causes skipping to a predetermined total line. This line is identified by a punch in channel 7. The overflow punch is passed, but it is not effective during a skipping operation. The minor total is printed and the form is then skipped to the first printing line of the next form.

For a billing form, all types of cards shown may be present or any one or more of the types may be missing. If the heading cards are identified by a common X or digit, detail cards may be identified as No X. An identification X in the first card for each section causes skipping to the proper position of the form for printing in each section.

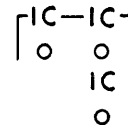

K, 47-48; L, 48

Indicate Control — IC. When OF (Overflow) is wired to I (indicate) the three IC hubs each emit an all cycles impulse during the first (sheet identification) cycle following an overflow. All sheet identification information must be printed from counters which must be controlled to function as progressive total counters. One of the IC hubs is wired to total in order to read the information out of the counter. The other two IC hubs are wired to the plus and minus of the counter to prevent it from clearing. All overflow sheets will be properly identified by wiring from counter exits to type bar entries.

The counter used for sheet identification must also be impulsed from first card minor, intermediate or major, depending upon the type of control. It is cleared by the corresponding total program exit. It should be noted at this point that, if for any reason a total is wired to print from the same type bars that are being used to detail print from second reading, second reading should be wired through the transferred points of a co-selector picked up by a 1st card impulse.

FIGURE 95

1. First Printing Line Stop (1)—punched as for any form. On an overflow sheet, this line is used for indication printing (from counters) before skipping to the first body line.
2. Normal Skip Stops (channels 3, 4, 5, 6)—used for the different types of heading cards. The first card of each group is identified by a different X or digit punch. These stops are made ineffective on an overflow sheet.
3. First Body Line Stop (2)—punched in channel 2. On an overflow sheet, a skip to this line occurs after the sheet indication is printed.
4. Overflow (12)—punched in channel 12 to cause skipping to the first printing line of the next form. This punch is ineffective when passed while skipping.
5. Predetermined Total Line Stop (7) — punched in normal skip stop channel 7 for printing totals.

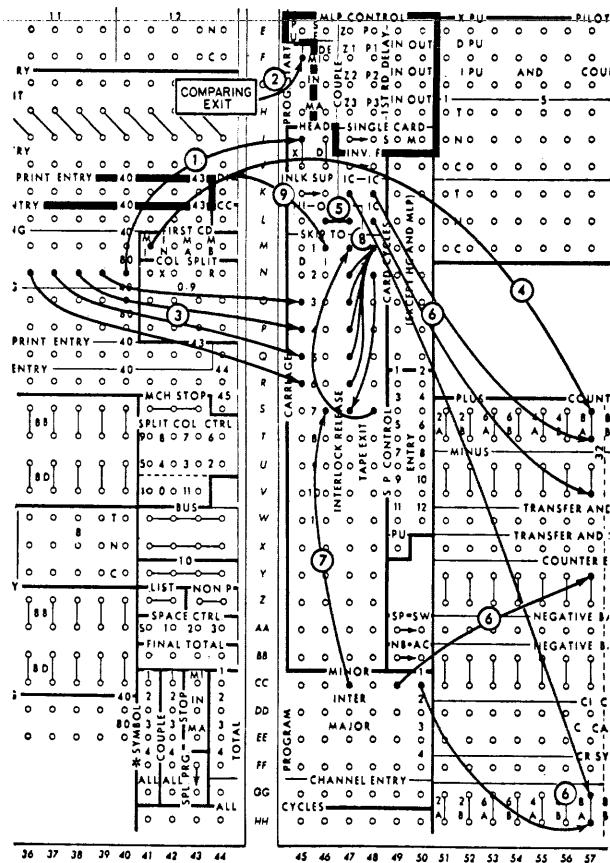

FIGURE 96. MULTIPLE HEADING GROUPS

Wiring for Figure 96

1. All heading cards have a common X in column 80 which is wired to head control X from second reading.

2. Minor program start is wired from comparing exit.

3. In addition to the common X for all heading cards, the first card of the shipping instruction group contains an X in column 79; the first card of VIA contains an X in column 78; the terms card contains an X in column 77; and the miscellaneous data card contains an X in column 76.

These X punches are necessary to cause skipping from one section of the heading to another. A skip between SOLD and SHIP is caused by wiring X79 from second reading to skip to 3D. A skip between SHIP and VIA is caused by wiring X78 from second reading to skip to 4D. A skip between VIA and TERMS is caused by wiring X77 from

second reading to skip to 5D. A skip between TERMS and miscellaneous data is caused by wiring X76 from second reading to skip to 6D.

4. Minor first card is wired to the plus of 8A to add sheet identification information from the first card of the group.

5. OF is wired to I to stop skipping at the first printing line (sheet identification) on an overflow. This wiring also makes all three IC (indicate control) hubs active on the indicate cycle following an overflow.

6. IC (indicate control) is wired to the plus, minus and total of 8A. The IC hubs emit impulses on the indicate cycle after overflow and cause the counter to read out without clearing. Counter 8A is reset on a minor program. Printing of the sheet identification information on the total cycle is prevented by wiring minor total program to counter exit suppression.

7. The minor program is wired to skip to 7I to cause skipping to a predetermined total line identified by a hole in channel 7.

8. To release the interlock between each of the heading skips, tape exit 1 is wired to the interlock release of 2, 3, 4, 5 and 6, since the distance between the first printing line and the first body line is less than 3-2/3 inches. When the hole in channel 1 of the tape is sensed, the interlock for 2, 3, 4, 5 and 6 are released. Therefore, whenever a skip to any of these channels is started, no interlock will occur.

The distance from the first body line to the predetermined total line is 3-2/3 inches. Therefore, interlock is released by wiring tape exit 2 to interlock release 7. The distance between the predetermined total line and the first line of the next form is less than 3-2/3 inches. Therefore, interlocking is released by wiring tape exit 7 to interlock release 1.

9. Skipping from the predetermined total line to the first printing line of the next form is caused by wiring minor first card skip to 1I. The wiring shown does not cause counter 8A to clear when there are missing detail cards. Programming is suspended (head X wiring) between heading cards.

INVERTED FORM OPERATIONS

VOUCHER checks, such as the one illustrated in Figure 97, are known as inverted forms because detail cards are printed first, followed by the heading cards. This type of operation is necessary when totals from the detail cards must be printed with the heading information. In this example, check identification and amount are printed with an address on a check.

The control tape for an inverted form is punched in tape channel 1 for the first printing line of the first half of the form. Tape channel 2 is punched for the first line of the address. This is

not the body line, although the body line stop is used. A normal skip stop is punched for the predetermined total line. Channel 12 is used for the overflow; a punch in this channel is ineffective when passed by skipping. Wiring a control panel switch changes the operation of the machine so that an overflow skip advances the form to the first printing line of the next form.

Overflow sheet indications can be printed on the first address line of inverted forms. For this, OF is wired to I to cause a skip to the first address line where the indication is printed from counters. A skip then occurs to the first printing line of the next form.

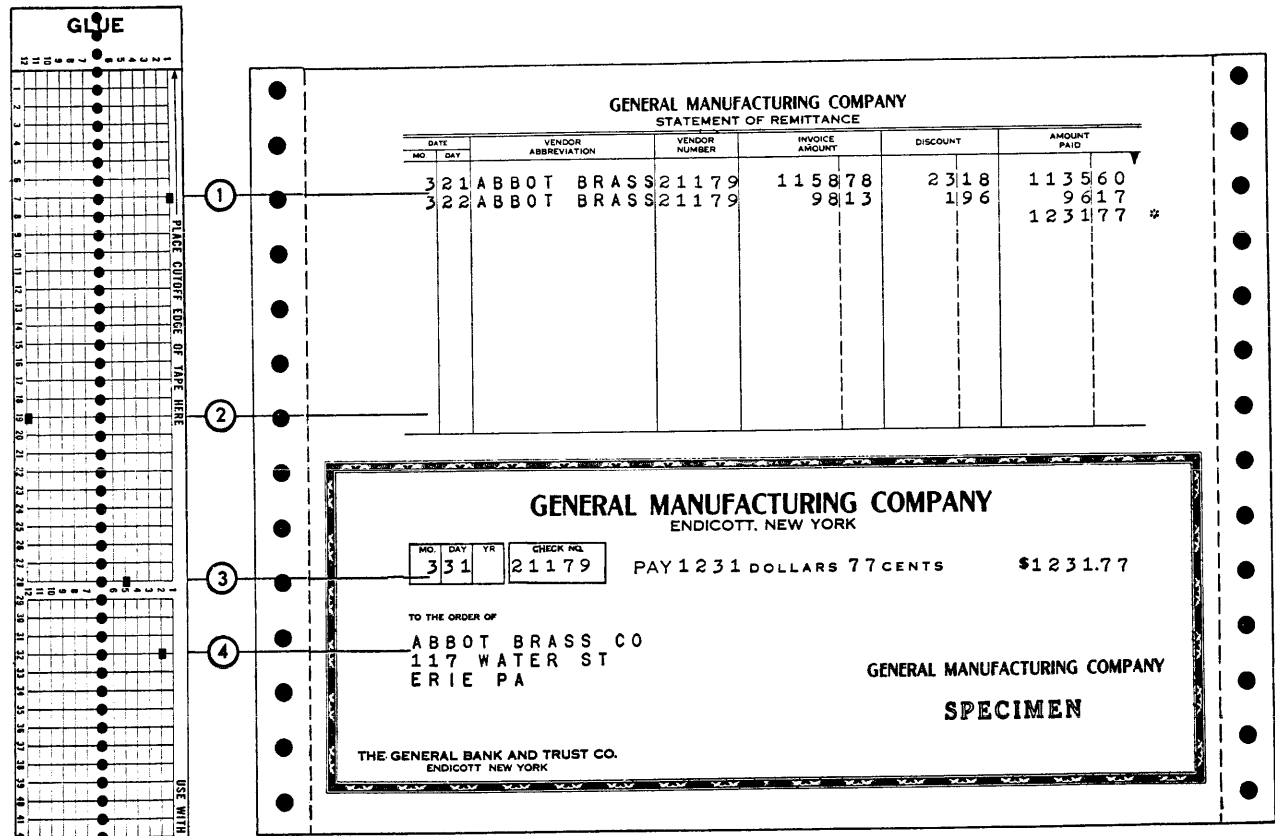

1. First Printing Line Stop (1)—punched as for any other type of form. Control panel wiring caused skipping to this line on an overflow.
2. Overflow (12)—causes skipping over the check to the first line of the next form for listing overflow items.
3. Normal Skip Stop (5)—used for predetermined total line.
4. Body Line Stop (2)—used for first address line on inverted form.

FIGURE 97

As in the billing application previously illustrated, the number of sections into which the form is divided can be increased in either the body section, the check section, or both. Thus, complete flexibility is available for designing voucher checks and similar forms to meet practically any requirements.

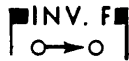

J, 47-48

Inverted Form (Inv. F). Whenever body cards precede heading cards, the form is inverted and the INV-F (inverted form) switch must be connected. When head control is wired, automatic skipping always takes place from channel 1 in the tape to channel 2. Normally, this skipping takes place whenever there is a change from heading cards to body cards. When the inverted form switch is ON, skipping is caused by a change from body cards to heading cards. Similarly, the inverted form switch also operates the overflow skip in the reverse manner. Normally, the overflow skip is from channel 12 to channel 2. For inverted form operation, the overflow skip is from channel 12 to channel 1. Moreover, when body cards are missing and a program change is recognized between two sets of heading cards, skipping takes place automatically to channel 2.

Wiring (Figure 98)

1. All address cards have an X in column 80, which is wired from second reading to head X.
2. The inverted form switch is connected, which causes automatic skipping from body to heading.
3. Overflow is wired to non-indicate and causes skipping over the check to the first line of the next form, for printing overflow items. If overflow indication is desired, OF would be wired to

I and the information would be printed from a counter on the first address line on the check.

4. The amount paid is wired from third reading to counter 8A, from which it is detail printed and total printed. Counter 8A is impulsed to add from a card cycles which is active for body cards only when head control is wired.

5. A program change is recognized between body and address cards by the X wiring to intermediate program start. After the last body item is printed, the intermediate program start is impulsed, causing a minor and an intermediate total program. On the minor program the total of the amount paid is printed in the statement portion of the form. Counter 8A is wired as a progressive counter so that the minor total of the amount paid field may also print on the intermediate program. The second printing takes place on the check.

6. The intermediate program exit is wired to skip to 5I, which causes skipping to a predetermined total line (check amount) before the intermediate total is printed. The second total is identical to the first and represents the amount of the check.

7. Counter 8A is cleared on an intermediate program.

8. Vendor number is wired to the comparing entry and the comparing exit to major program start.

9. Skipping from one form to another is controlled by a change in vendor number. Major first card is wired to skip to 1I to cause skipping before the first card of the following group is printed. Major total program is suspended because of head control wiring but major first card is not.

10. The interlock is released, for skipping from any portion of the body to the predetermined total line on the check by wiring from tape exit 1 to interlock release 5. The interlock is released

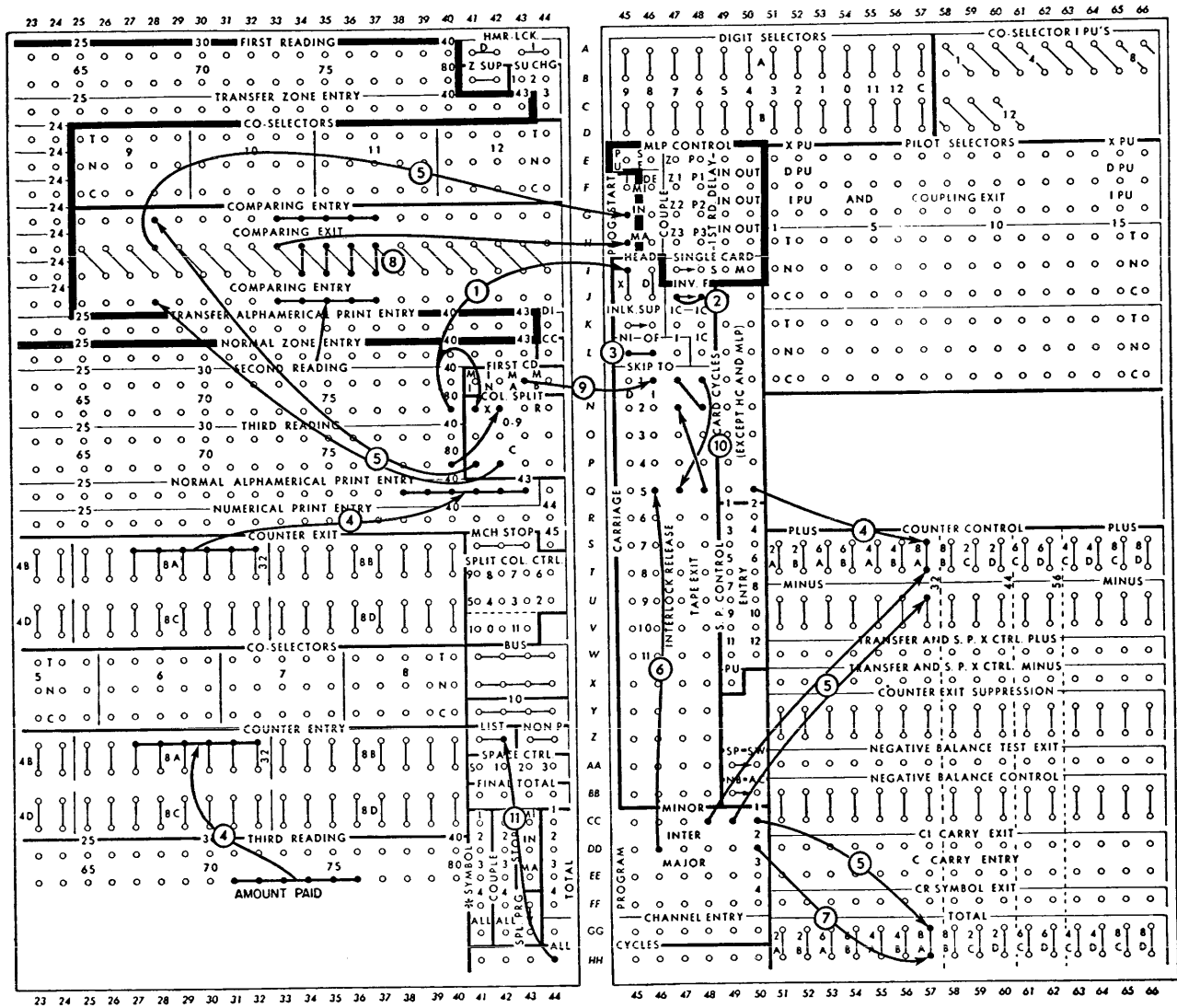

Note: This diagram is for a Type 402, and the controls (steps 1, 5, and 8) are wired from second and third reading. If the wiring is to be applied to a Type 403, the controls should be wired from first and second reading.

FIGURE 98. INVERTED FORM

during skipping from the total line on the check to the first address line by wiring tape exit 5 to interlock release 2. The interlock is released during skipping from the last heading line to the first printing line by wiring tape exit 2 to interlock release 1. These distances are 3-2/3 inches or less and therefore interlock may be released.

11. Machine is wired to detail print.

Missing Heading or Missing Body Cards (Inverted Form)

When a program change occurs between heading cards (missing body cards), the total program is suspended and skipping occurs to the first address line of the next form (channel 2).

When a program change occurs between body cards (missing heading cards), the total program is taken and skipping occurs to the first printing line of the next form (channel 1).

When a program change occurs between body and heading cards and the body card precedes the

heading card (missing heading cards of one group and missing body cards of the other), the total program is taken and skipping occurs to the first address line of the next form (channel 2).

SINGLE SHEET FORM FEEDING

MANY business forms and documents prepared as single sheets can be completed with prepunched cards or with cards used otherwise for record-keeping. These forms must be sufficiently flexible so that they will bend around the platen without the leading edge of the form catching the ribbon. Sufficient heading space should be allowed so that the tear bar may hold down the top of the form before printing is started. Single sheets can be inserted in the carriage by placing each form on the paper table in back of the platen. Adjustable side guides can be set to facilitate hand feeding of each form. The first form is fed and positioned manually. Each additional form placed on the paper table is inserted manually and positioned automatically to first printing line by depressing the restore key. It is not necessary ever to raise

and lower the entire platen mechanism for any sheet insertion.

For single sheet forms, a hole must be punched in the tape three lines below the bottom edge of the form. Any available channel can be used that is not already used for other purposes. The reason for this skip stop punch is to insure ejection of the sheet out of the platen upon sensing a minor program change. The feeding of the first card of the next control group is stopped by wiring minor first card to machine stop.

The tape must be cut 14 spaces beyond the last hole punched to compensate for the distance which a single sheet form must travel around the platen before it can be advanced from the top edge to the first printing line.

Depressing the restore key feeds the single sheet form from the paper table to the first printing line.

The first card of the next control group is fed by first depressing the final total key to turn off the machine stop light and then by depressing the start key.

ACCOUNTING MACHINE, TYPE 403 WITH MULTIPLE LINE PRINTING FEATURE

THE TYPE 403 will perform all the operations possible with the Type 402, and in the same manner. Moreover, a control panel wired for the Type 402 can be placed in the Type 403, to accomplish the same results.

In addition, the Type 403 provides for the printing of three lines of alphabetic or numerical information from a single card. To accomplish this, an extra set of 80 reading brushes is provided which is shown in the schematic diagram (Figure 99).

The extra reading station, labelled the first brushes, is located between the hopper and the second set of brushes. The other two sets of brushes are in the same location as on the Type 402 and retain the same names, that is, second brushes and third brushes. Thus, with three sets of brushes, a card may be read three times in succession.

The fourth station (not a reading station) is used for printing the third line of a three-line card.

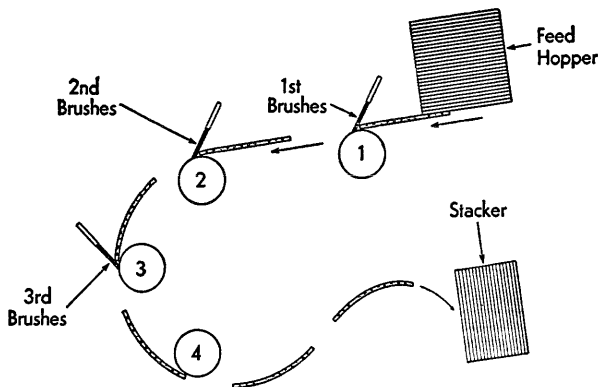

FIGURE 99. PATH OF CARD THROUGH THE TYPE 403

Multiple Line Printing Card

Since the primary function of the Type 403 is to print more than one line from a single card, it is called a multiple line printing machine (MLP) and the card used for printing more than one line is called an MLP card. It is distinguished from a normal card by a 9, an 8 and a 1, 2, or 3 punch in the same column of the card.

The card in Figure 100 is an MLP3 card and is divided into three parts, part A containing the name, part B the address, and part C the city and state. Normally 24 columns of the card are allowed for each, but these may be expanded, as described under *MLP Control Couple*.

Path of the Card Through the Machine

The first line of a multiple line card prints at station 2, the second line at station 3, and the third line at station 4, as shown in Figure 101. All normal cards (non-MLP cards) print at station 3.

Following the schematic diagram of the path of the card through the machine, fields A, B, and C from the card shown in Figure 100, are printed as follows:

MLP Cards

Field A, 1st Line. Zone punches are read as station 1 and type bars are zoned. Digit punches are read at station 2 and field A prints.

Field B, 2nd Line. Zone punches are read at station 2 and the type bars are zoned. Digit punches are read at station 3 and field B prints.

Field C, 3rd Line. Zone punches are read at station 3 and the type bars are zoned. Digit

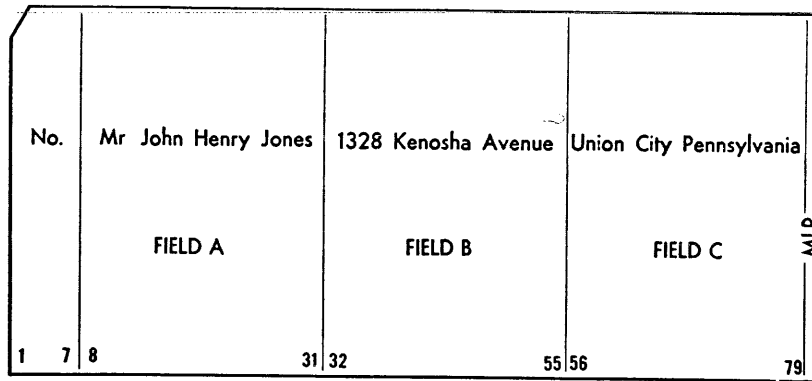

FIGURE 100

punches are also read at station 3 and stored in counters 2A through 4B. The digit punching is combined with the zoning at station 4 when the counters read out, and field C prints. The use of the 24 counter positions (2A through 4B) for storage of third line digit punches, prohibits the use of these counters for the accumulation of any totals which are not cleared before the next MLP card is printed. The counters may be used for the accumulation of detail totals between the printing of MLP heading cards.

Normal Cards

Zone punches are read at station 2 and the type bars are zoned. Digit punches are read at station 3 and combined with the zone punches to print alphabetically. Numerical printing from normal cards is done from station 3.

Card Feeding

In MLP operations, a card may be held up at the first station between the 1 and 0 positions of the card. This type of delay is necessary to prevent overlap in zoning since the same type bars cannot be zoned simultaneously from two different cards—one card read at the first station and the other at the second. Consequently, alphabetic comparison between these two stations is impractical. Moreover, a comparing exit resulting from numerical comparison (digits 9 through 1) can-

not initiate a program start until the card held up at the first station moves past the 0, 11, and 12 positions. Hence, program start cannot be immediate.

The delay in feeding may vary from one to two cycles depending upon the types of cards being read and the relationship of one card to another. For example, when an MLP2 card is read at the second station, the following card is held up one cycle if it is another MLP card, but it is not held up if it is a normal card. This occurs because an MLP card would ordinarily print the first line on the next cycle while a normal card would not, since all printing from normal cards is done from the third reading station.

An MLP card is held up two cycles if the card ahead is an MLP3 card, but a normal card is held up one cycle. This occurs because an MLP3 card requires two extra printing cycles to print the second and third line during which a following MLP card must be delayed to prevent overlap in printing. In the case of the normal card, it is delayed only one cycle so that it will not pass the third station while the preceding MLP3 card is printing the third line as it passes the fourth station. Even though a card is held up for one or two cycles, no actual time is lost if printing continues for the card ahead.

All MLP1, MLP2, and MLP3 cards are delayed one cycle when they follow a normal card. This delay of MLP cards is necessary to permit a normal card to advance to the third station for printing without interference from any MLP card be-

PATH OF CARD	PRINTING FROM CARD	OPERATION
		<p>Zone punching from Field A zones the type bars.</p>
	<p>MR JOHN HENRY JONES</p>	<p>Digit punching in Field A is combined with zone punching for Field A, and Field A is printed.</p> <p>Zone punching from Field B zones the type bars.</p>
	<p>MR JOHN HENRY JONES 1328 KENOSHA AVENUE</p>	<p>Digit punching in Field B is combined with zone punching for Field B, and Field B is printed. The normal card following an MLP3 card remains stationary at the first station (between 0 and 1) as the second line prints.</p> <p>Digit punching for Field C is stored in counters. Type bars are zoned for Field C.</p>
	<p>MR JOHN HENRY JONES 1328 KENOSHA AVENUE UNION CITY PENNSYLVANIA</p>	<p>Digit punching and zone punching for Field C are combined, and Field C is printed. The normal card advances from the first to the second station.</p>

FIGURE 101

MLP 4

hind it. An MLP 1 card followed by a normal card will cause one high-speed feed cycle during which no printing takes place. Feeding of the normal card is not delayed, but a cycle is lost because the MLP 1 card prints from the second station while the normal card following it prints from the third station. This cycle can be saved if the information to be printed is punched in field B instead of field A, and the MLP control is punched 9, 8, 4 instead of 9, 8, 1.

From the standpoint of feed control, an MLP4 card is treated as a normal card, that is, it is not held up at the first station except when it follows an MLP3 card and then only for one cycle.

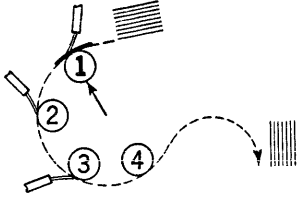
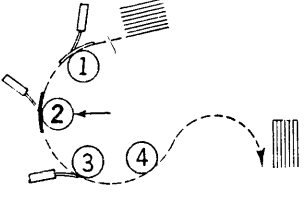
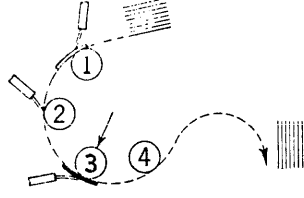
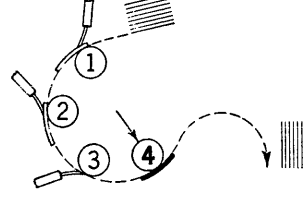
From the standpoint of printing, it functions like the second line of an MLP2 card, that is, any printing from it must be done through the MLP selector system as it passes the third station (Figure 102). Hence, the reason for punching the information in field B instead of field A.

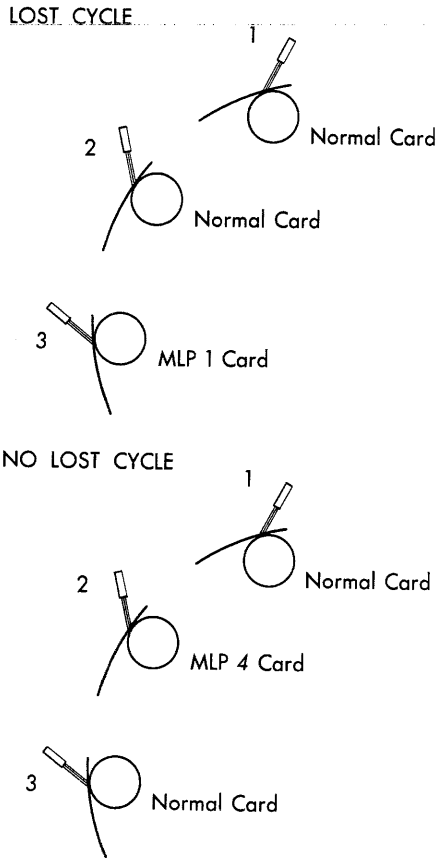

FIGURE 102

Card Feed Delay

Card feeding delay may be summarized in the two following statements.

1. All MLP cards are delayed for one cycle at station 1 with the following exceptions:
 - a. The MLP card is not delayed when preceded by an MLP1 card.
 - b. The MLP card is delayed 2 cycles when preceded by an MLP3 card.
2. A normal card or an MLP4 card is never delayed except when preceded by an MLP3 card, and then only for one cycle.

MULTIPLE-LINE PRINTING

ONE, two, or three lines of alphabetic information may be printed from a single card as illustrated in Figure 103. Each card has a 9 and 8 punched in column 80, in addition to a 1, 2, 3 or 4 punch, depending on whether 1, 2, or 3 lines are to be printed.



MLP Control PU. The card column in which the 9 and 8 are punched is wired to MLP pick-up from first reading. Both the 9 and 8 must be punched in the column before MLP will function. Both digits must be punched in order to prevent a normal card, which may be punched with either an 8 or 9 in the same column used for MLP control, from picking up the MLP unit. In this way, the card column used for MLP control need not be sacrificed on normal cards.

The purpose of the 9-8 punches is to open up an electrical path in the machine, through which the 1, 2, 3, or 4 may be recognized for printing one, two or three lines from the same card.

A card punched with a 9-8 without the 1, 2, 3, or 4 will be treated by the machine as a normal card, with the exception that it would be delayed for one cycle before passing to station 2. A card punched with a 1, 2, 3 or 4 without the 9-8 punch would be treated by the machine as a normal card. Both the 9-8 punch and the 1, 2, 3 or 4 punch must be present for multiple line printing.

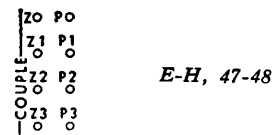

MLP Control Couple. Z1 emits an impulse as any MLP card passes first reading.

Z2 emits an impulse as an MLP2, 3, or 4 card passes second reading.

Z3 emits an impulse as an MLP3 card passes third reading.

Z emits an impulse during every MLP zone cycle.

The primary function of these hubs is to expand the internal zone selector system beyond the normal 24 positions by picking up (coupling) co-selectors. For example, if Z2 is wired to a co-selector pickup the normal side can be used to expand 1st line zone and the transferred side to expand 2nd line zone.

P1 emits an impulse during the first line print cycle.

P2 emits an impulse during the second line print cycle.

P3 emits an impulse during the third line print cycle.

P emits an impulse during every MLP printing cycle.

The primary function of these hubs is to expand the internal numerical selector system beyond the normal 24 positions by picking up (coupling) co-selectors. For example, if P2 is wired to a co-selector pickup, the normal side can be used to expand 1st line printing and the transferred side to expand 2nd line printing.

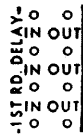

E-H, 49-50

First Read Delay. Four delay units are provided on the Type 403, each unit independent of the other. The first two are standard and the other two are optional. The primary purpose of these units is to delay the action of any digit impulse (9-1) read at the first station to control any feature of the machine with a D pickup, such as selector, hammerlock, or carriage skip. This is necessary because in MLP operations, a card read at the first station may stop between 1 and 0. Consequently, any function to be controlled on a digit basis from that card will have to be delayed since the digits have already been read.

The IN hub receives the impulse as it is read and the OUT hubs emit an impulse as the card moves to the second station.

Zone Selection

In Figure 104, a single column is wired from each of the three fields to be zoned from one card, to illustrate the wiring principle. Field A represents the name, field B the address, and field C the city and state.

First Reading. The first reading station consists of a set of 80 brushes, one for each column of the card.

1st Line Zone Entry. These 24 hubs accept zone impulses from the first reading station to zone the type bars for the first line of an MLP card. A wire from column 15 of the first reading station to 1st line zone entry 17 will read zone impulses for the purpose of zoning field A.

2nd Line Zone Entry. These 24 hubs accept zone impulses from the second reading station to zone the type bars for the second line of an MLP card. A wire from column 20 of the second reading station to 2nd line zone entry 17 will read zone impulses for the purpose of zoning field B.

3rd Line Zone. These 24 hubs accept zone impulses from the third reading station to zone the type bars for the third line of an MLP

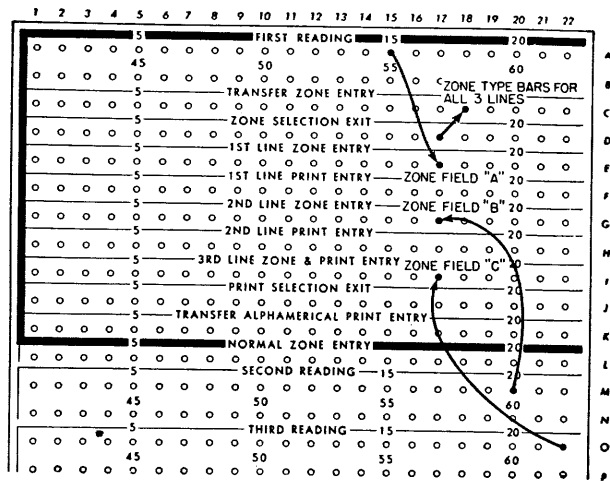

FIGURE 104. ZONE SELECTION — SINGLE COLUMN

card. A wire from column 22 of the third reading station to 3rd line zone and print entry 17 will read zone impulses for the purpose of zoning field C.

Zone Selection Exit. The impulses received at the three zone entries are emitted from these 24 zone selection hubs, in turn, by means of an internal selector system which will be described later. In the example, they are wired to transfer zone entry in order to zone alphabetical type bar 18.

Transfer Zone Entry. There are 43 transfer zone entry hubs, one for each alphabetical type bar. They differ from the normal zone entry hubs in that they are used for MLP zoning only. They are wired from zone selection exit to zone the type bars for all three lines of an MLP card.

Print Selection

In Figure 105, a single column is wired for the digit impulse of the three fields to illustrate the wiring principle. Again, field A represents the name, field B the address, and field C the city and state.

1st Line Print Entry. These 24 hubs accept digit impulses from the second station, which combine with the 1st line zone entry to print the first line of an MLP card.

Column 15 is wired from second reading to 1st line print entry 17, to print field A.

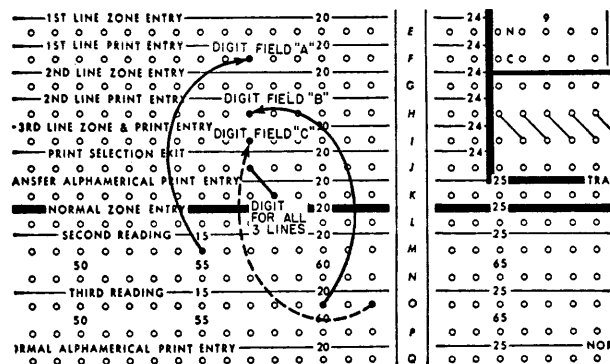

FIGURE 105. PRINT SELECTION — SINGLE COLUMN

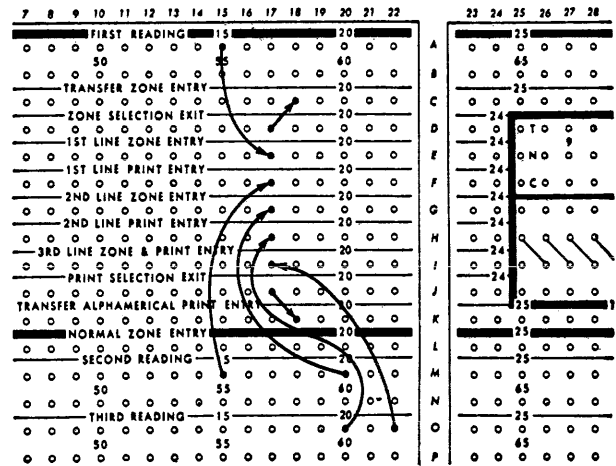

FIGURE 106. COMBINED ZONE AND PRINT SELECTION — SINGLE COLUMN

2nd Line Print Entry. These 24 hubs accept digit impulses from the third station which combine with the 2nd line zone entry to print the second line of an MLP card.

Column 20 is wired from third reading to 2nd line print entry 17, to print field B.

3rd Line Print. These 24 hubs not only accept zone impulses for third line zone but also digit impulses for third line print. The digit impulses enter the first 24 counters at the third reading station and are automatically transferred out at the fourth station. Column 22 is wired from third reading to print field C.

Print Selection Exit. The impulses received at the three print entries are emitted by these 24 print selection exits, in turn, line by line, by means of the internal selector system. They are wired to transfer alphabetical print entry.

Transfer Alphamerical Print Entry. There are 43 transfer alphabetical print entry hubs to match the 43 transfer zone entry hubs, one for each of the 43 Alphabetical type bars. They are wired from print selection exit to receive the digit impulses for all three lines. Print selection exit 17 is wired to transfer alphabetical print entry 18.

Figure 106 shows the combined wiring of zones and digit impulses for one letter in each of the three fields.

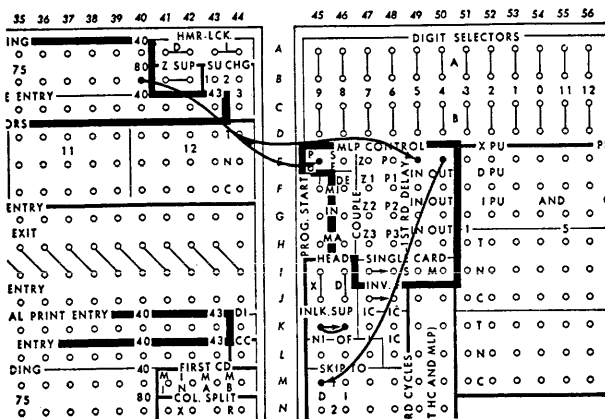

FIGURE 108

Alternate Wiring for Address Printing (Figure 108)

Skipping from one form to another may be accomplished in another way, by wiring the MLP column to first read delay IN, and from first read delay OUT to carriage skip to ID. This is possible when only MLP cards are present in the operation.

MLP SELECTOR SYSTEM

If three-line printing from an MLP card could be done in three separate places, as shown in the example below, no internal selector system would be necessary.

Mr Pat Smith
13 Milton Pl
Peoria Ill

The need for selection arises from the necessity of printing all three lines from the same type bars, or in other words, printing one line underneath the other, as shown below.

Mr Pat Smith
13 Milton Pl
Peoria Ill

Both the zone impulses and the digit impulses must be selected, and as shown in the schematic diagram of the MLP selector system (Figure 109), the three selectors on the left are for zone selection and the three selectors on the right are for numerical selection.

All MLP selection is internal and automatic. It can best be explained by following an MLP3 card from the time it feeds from the hopper until the last line is printed.

The whole selector system is made operative by the 9 and 8 and the 1, 2 or 3 punch in the same column. The 9-8 opens a path for the 1, 2, or 3 punch to pick up two or more of the 6 selectors shown. Digit 1 starts selector operation at first reading and stops it at second reading. Digit 2 starts selector operation at first reading and stops it at third reading. Digit 3 starts selector operation at first reading and stops it at the 4th station.

First Line

To zone the first line of an MLP card, the card field is wired from first reading to 1st line zone entry and from zone selection exit to transfer zone entry. The selector operation would be as follows:

When the MLP card passes first reading, selectors 1 and 2 are normal and 3 is transferred. First line zone entry reads from the normal side of selector 1 internally to the normal side of selector 2, and externally from zone selection exit (common of selector 2) to transfer zone entry (transferred side of selector 3). Since selector 3 is transferred at this time, the zone impulses for the first line reach the type bars.

To print the first line, the card field is wired from second reading to 1st line print entry and from print selection exit to transfer alphanumerical print entry. The selector operation is as follows:

When the MLP card passes second reading, selectors 4 and 5 are normal and 6 is transferred. First line print entry reads from the normal side of selector 4, internally to the normal side of selector 5 and externally from print selection exit (common of selector 5) to transfer alphanumerical print entry (transferred side of selector 6). Since

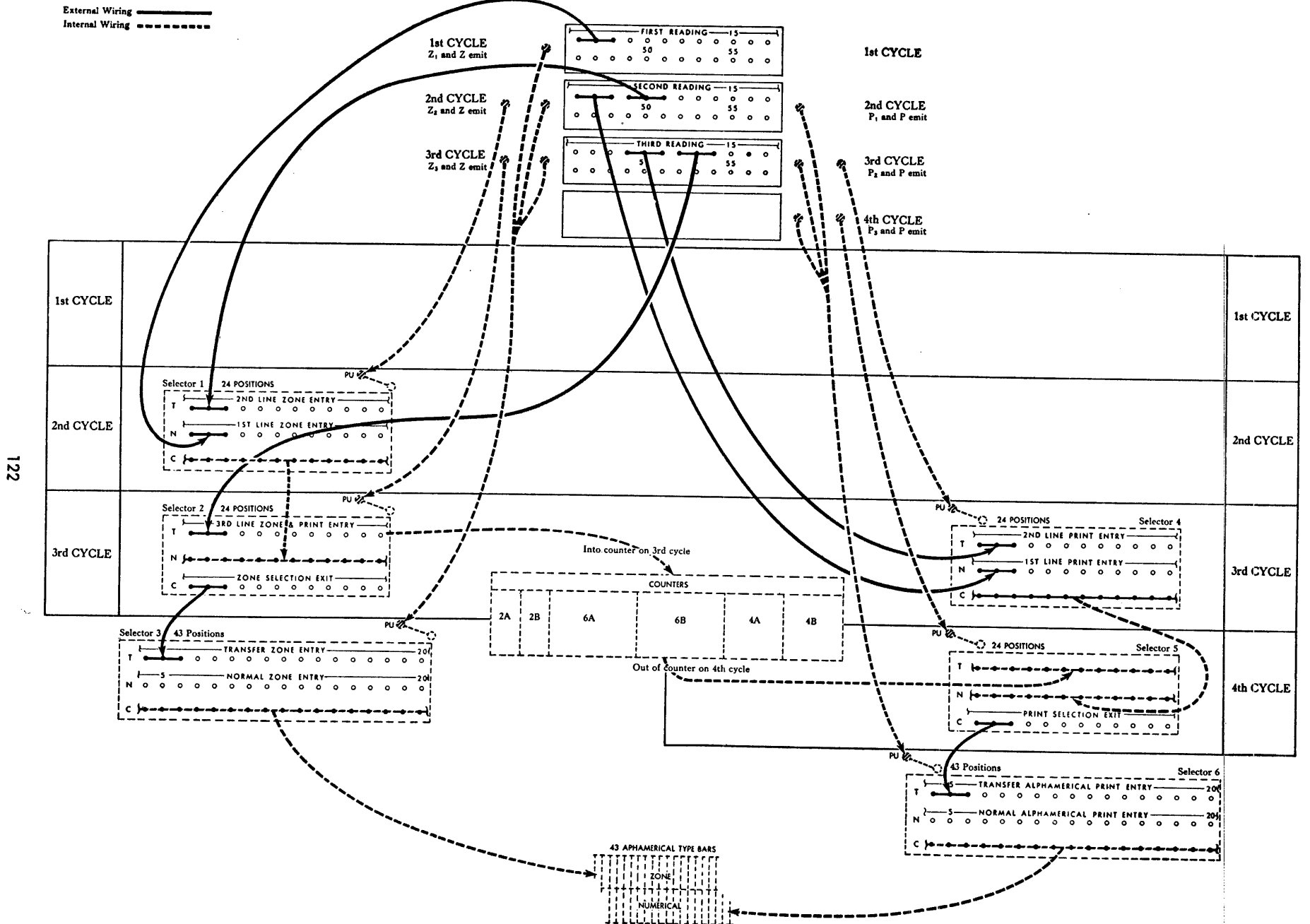

122

FIGURE 109. MLP SELECTOR SYSTEM

selector 6 is transferred at this time, the digit impulses reach the type bars and print the first line.

Second Line

To zone the second line of an MLP card, the card field is wired from second reading to 2nd line zone entry and from zone selection exit to transfer zone entry. The selector operation is as follows:

When an MLP card passes second reading, selector 1 is transferred, selector 2 is normal and selector 3 is transferred. Second line zone entry reads from the transferred side of selector 1 internally to the normal side of selector 2 and externally from zone selection exit (common of selector 2) to transfer zone entry (transferred side of selector 3). Since selector 3 is transferred at this time, the zone impulses for the second line reach the type bars.

To print the second line, the card field is wired from third reading to 2nd line print entry and from print selection exit to transfer alphanumerical print entry. The selector operation is as follows:

When the MLP card passes third reading, selector 4 is transferred, selector 5 is normal and selector 6 is transferred. Second line print entry reads from the transferred side of selector 4, internally to the normal side of selector 5 and externally from print selection exit (common of selector 5) to transfer alphanumerical print entry (transferred side of selector 6). Since selector 6 is transferred at this time, the digit impulses reach the type bars and print the second line.

Third Line

To zone the third line of an MLP card, the card field is wired from third reading to 3rd line zone and print entry and from zone selection exit to transfer zone entry. The selector operation is as follows:

When an MLP card passes third reading, selectors 2 and 3 are transferred. Third line zone and print entry reads the zone impulses through the trans-

ferred side of selector 2 and out of common (zone selection exit) to transferred zone entry. Since selector 3 is transferred, the zone impulses reach the type bars.

To print the third line, the card field is wired from third reading to 3rd line zone and print entry. The digit impulses are directed internally to counters 2A through 4B, as the card passes third reading. They come out of counters 2A through 4B on the fourth cycle and are internally wired to the transferred side of selector 5. Selector 5 is transferred as the card passes the fourth station, allowing the digit impulses to be available from print selection exit. They are externally wired to the transferred side of selector 6 (transfer alphanumerical print entry hubs) and since selector 6 is transferred at this time, they reach the type bars and print the third line.

It will be seen that selector 3 is transferred for the zoning of every MLP card, and that selector 6 is transferred for the digit punching in every MLP card. The first line zones and prints through the normal sides of selectors 1 and 4. The second line zones and prints through the transferred sides of selectors 1 and 4. The third line zones and prints through the transferred sides of selectors 2 and 5.

When normal cards are passing through the machine, all selectors are normal, including selectors 3 and 6, in which case normal zone entry and normal alphanumerical print entry are used.

The functions of Z1, Z2, Z3, P1, P2 and P3 become clearer by reference to the schematic diagram (Figure 109). They are the internal impulses that pick up the selectors, and have been brought to the control panel for purposes of expanding the selector system through use of co-selectors. Z2 picks up selector 1, Z3 picks up selector 2, and Z1, Z2, and Z3 pick up selector 3. P2 picks up selector 4, P3 picks up selector 5, and P1, P2 and P3 pick up selector 6.

MLP CARDS FOLLOWED BY NORMAL CARDS

FIGURE 110 illustrates a statement prepared by using both MLP and normal cards. The MLP cards are the address cards and appear in the heading of the form. In MLP operations, all heading cards must be punched as MLP cards. One line heading cards must be punched 9, 8, 1 or 9, 8, 4. They are followed by normal cards which are unpaid invoices and partial payments and appear in the body of the form. The example also

illustrates the printing of more than 24 positions on the first MLP line.

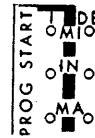

F-H, 45-46

MLP Program Start. When the Type 403 machine is used for MLP operations, comparison must be made between the first and second station

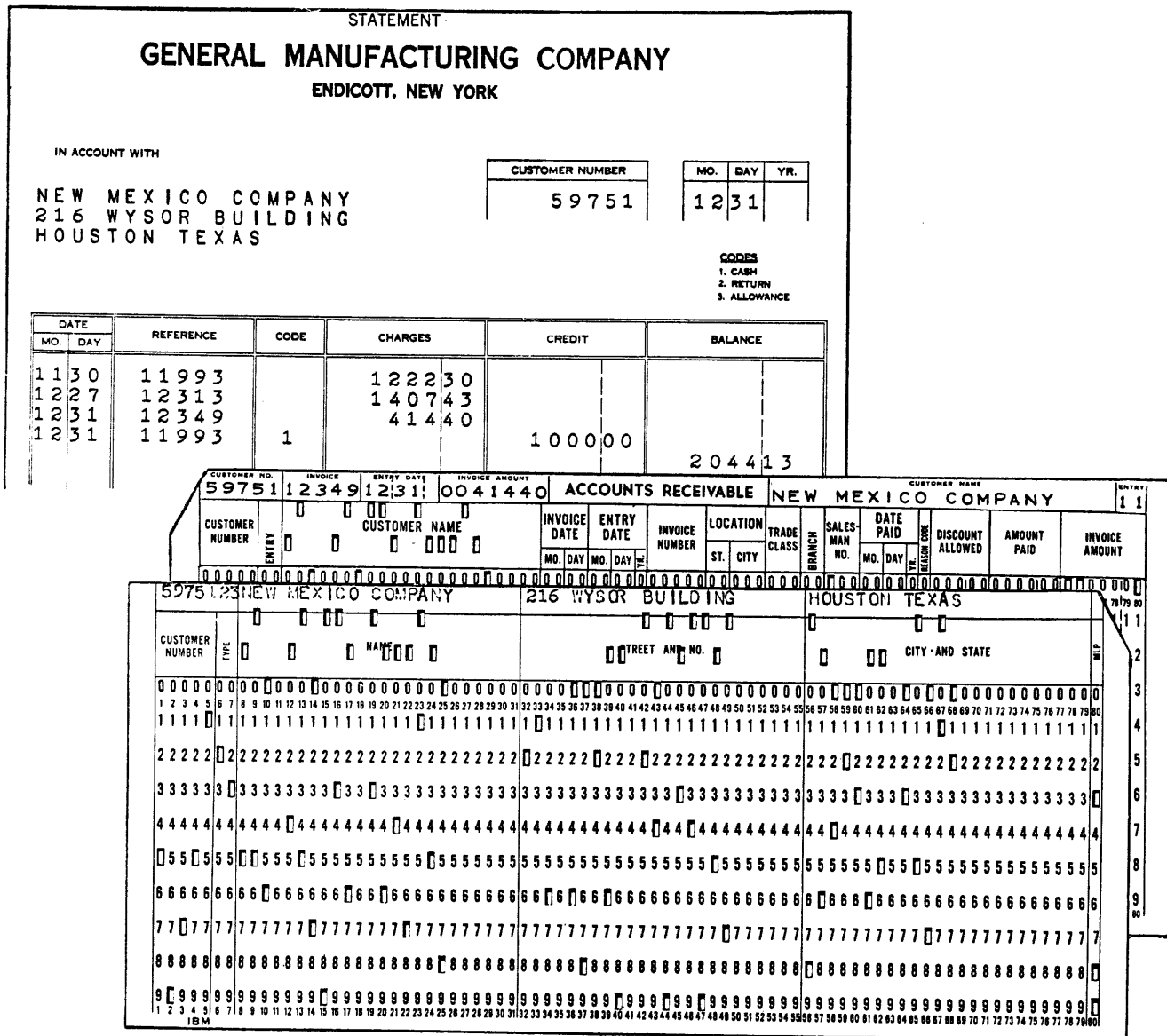

FIGURE 110

because the first line of each MLP card prints at the second station. The comparing exit is wired to DE (delay) program start because of the delay in feeding that occurs in MLP operations. Upon a change in program, the program start may be delayed for one or two cycles depending upon the kind of MLP card being printed.

It is important to note that because of the delay of cards at the first station between 1 and 0, alphabetic control is not practical.

Wiring (Figure 111)

1. Column 80 is wired from first reading to MLP control PU.
2. Customer number is compared at the first and second stations and the comparing exit is wired to minor program start delay. Even though the comparing exit is available while the last card of a group is at the second station, it is delayed so that the last normal card advances to the third station before the program start is initiated.
3. The customer number is printed on the first MLP line by wiring columns 1-5 from second reading to transfer alphanumerical print entry 31-35.
4. Date is emitted from digit selector B, which has been made into a digit emitter by impulsing the C from DI (digit impulse). The digit impulse must be controlled so that C receives it for

first line printing only. This is done by wiring DI through the transferred side of pilot selector 2 to C of the digit selector. Pilot selector 2 is picked up immediately as the first line prints, by wiring P1 to the immediate pickup. Date is wired to transferred alphanumerical print entry 39-43.

5. Head control D is impulsed from Z1. This Z1 wiring functions in the same manner as X or D head control wiring on the Type 402, but it can be used only when there are no MLP cards to print in the body of the form. When MLP cards print in the body of the form, an X must be punched in the MLP heading cards, and the X punch used as head control.

6. Skipping to a new form before each new customer group is accomplished by wiring first card minor to skip to 11.

7. Overflow is wired to NI (non-indicate) since first line indication for each overflow form is not desired.

8. Tape exit 1 is wired to interlock release 2 since the distance between the first printing line and the first body line is less than 3-2/3 inches. The distance between the first body line of one form and the first printing line of the next form is greater than 3-2/3 inches. However, interlocking is not necessary when the last line printed on one form is within 3-2/3 inches of the first line of the next form. The interlock may be released by punching a hole in any available channel, back

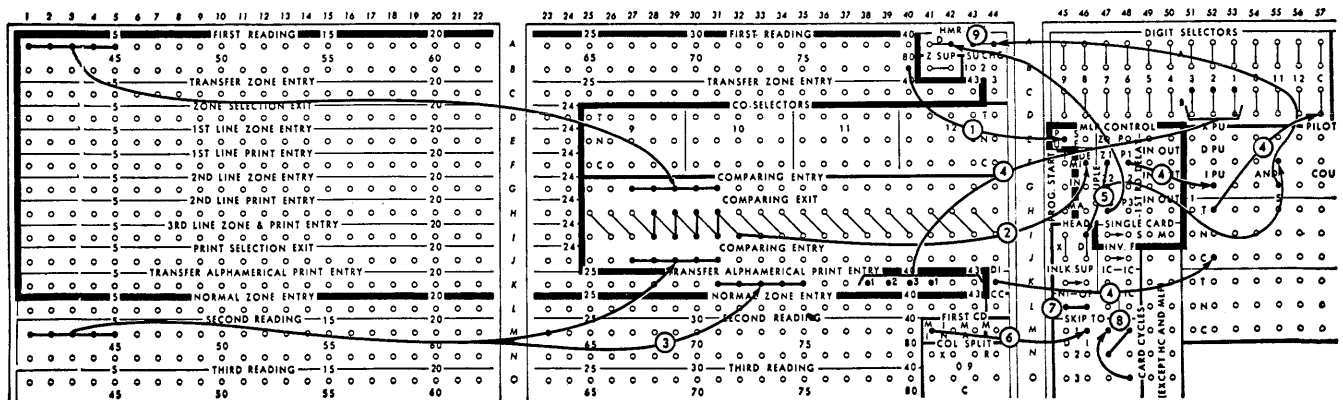

FIGURE 111. MLP FOLLOWED BY NORMAL CARDS

~~3-2/3 inches from the first printing line, and by wiring the corresponding tape exit hub to interlock release 1. In this example, channel 3 is used for this type of interlock release.~~

9. When an MLP 3 card is printing the third line, it is passing the fourth station and the transfer alphamerical print entry is active. At the same time, the first normal card is passing the second station. Customer number, wired from second reading to transfer alphamerical print entry, would therefore print from a normal card on the third line of the heading. Printing of customer number is eliminated by hammerlock control. Z3 emits an impulse as the MLP3 card passes the third station, and when it is wired to D hammerlock, the hammerlocks are controlled on the following cycle.

~~When an MLP2 card is printing the second line, it is passing the third station while the following normal card is passing the second station. Customer number printing from the normal card is suppressed by wiring Z2 to the D pickup of a pilot selector and the coupling exit of that selector to the hammerlock I.~~

Name, address and city from the MLP card print from the same type bars as date, reference and code from the normal card. Even though different fields are used in each case, no interference results, because the MLP fields are selected by the internal selector system. Fields from normal cards are wired to normal zone entry and normal alphamerical print entry.

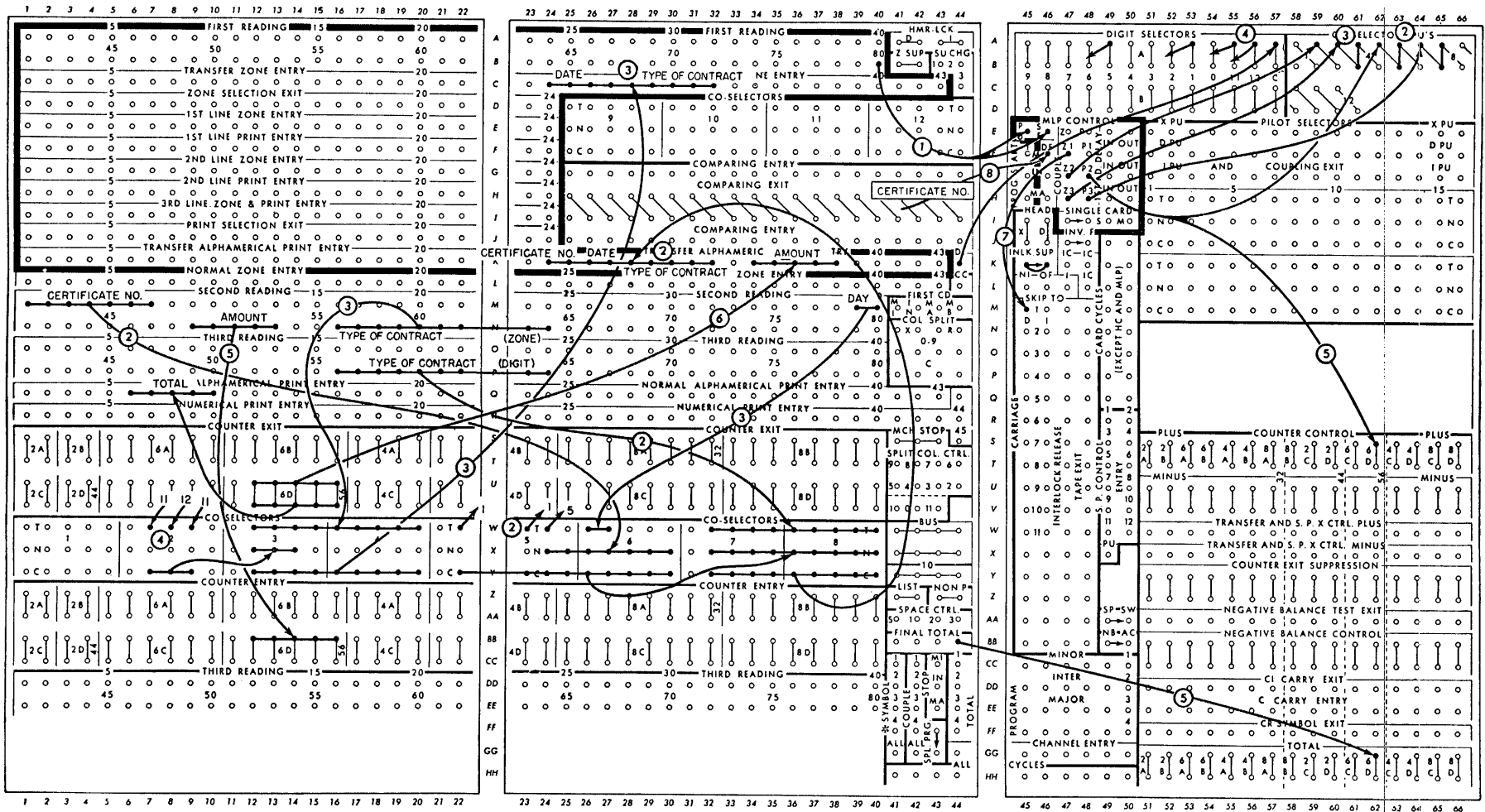

FIGURE 113. SUCCESSIVE FEED

print from the second station. As line 3 from the MLP card is printing at the fourth station, the detail card will print from the third station.

In order to accomplish such an operation, the detail card behind the MLP card must be punched with a 6 and wired to SF (successive feed) from first reading. The 6 may be punched in any column of the detail card, including the column used for MLP control.

Normal head control action suspends total program when an MLP card prints. When successive feed is wired and the comparison is made between the MLP card and a 6 card of a different control number, the total program is suspended but the machine stops automatically since the comparing exit is directed internally to machine stop. The machine stops after the first line prints and the stop light turns ON.

Wiring (Figure 113)

1. MLP control is punched in column 80 of the MLP card and the successive feed punch control (6) is punched in the same column of the normal card. Column 80 is therefore split-wired from first reading to MLP pickup and to SF. MLP pickup will accept only the 9-8, 1, 2, 3 or 4 impulses and SF will accept only the 6 impulse.

2. It will be seen that the printing of certificate number, due date and type of contract exceed the capacity of the internal selector system, making MLP selector expansion necessary. The first and second lines are expanded by way of co-selectors 5 and 6 and the third line is expanded by way of co-selectors 7 and 8. Therefore, co-selectors 5 and 6 are picked up by P2 and co-selectors 7 and 8 are picked up by P3.

Paralleling the internal selector system, the normal side of selectors 5 and 6 represents first line print to which the certificate number is wired. The transferred side of 5 and 6 represents second line print to which the date is wired. The trans-

ferred side of selectors 7 and 8 represent third line print to which type of contact is wired.

The certificate number is read from columns 1-7 of second reading. This prints from the MLP card. The date is read from both the digit emitter and column 39-40 second reading. It prints from the normal (6) card. The type of contact is read from columns 56-64 of third reading. It prints from the normal (6) card.

3. Since type of contact is alphabetic, columns 56-64 are wired through selectors 3 and 4 from second reading for zoning. The common is wired to transfer zone entry 24-32. Co-selectors 3 and 4 are picked up from Z3.

4. The zone impulses for month are wired from a digit emitter through the transferred side of co-selector 2, picked up from Z2, and the normal side of selector 3 to the zone entry hubs.

5. The amount due is punched in columns 49-53 of the normal (6) card, and should be printed alongside the second MLP line. Since a grand total is required, the amount due is wired to counter 6D and cleared as a final total. The counter is impulsed to add as the second line is being printed by wiring P2 to 6D plus. P2 emits an impulse as an MLP card passes station 3.

6. The amount due is wired from 6D exit to transfer alphanumerical print entry 34-38.

7. Skipping from one form to another is accomplished by wiring Z1 to skip to 1D. Z1 emits an impulse as an MLP card is read at the first station for zoning.

8. To provide for incorrect 6 cards following MLP cards, the certificate number is compared and the comparing exit wired to minor program start. If the certificate number of the MLP card does not agree with the certificate number in the normal card behind it, the comparing exit is directed to machine stop, causing the stop light to turn on.

single card totals may be eliminated by Single Card wiring.



I, 47-50

Single Card. The hub labelled "S" emits a card cycles impulse when single cards are passing the third station, if the program control is between the first and second station. The machine recognizes a single card by two successive program changes, as illustrated in Figure 115. The cards labelled 1 and 3 are multiple cards. Card 2 is identified as a single card because of the change from 2 to 3 immediately following a change from 1 to 2.

The S hub may be wired to any inlet that will accept a card cycles impulse. One of the most common uses of the hub would be to control a counter to add single card groups in an intermediate counter.

The M hub emits a card cycles impulse as each multiple card passes the third station. It may be wired to any entry hub that will accept a card cycles impulse, the most common being to control a minor counter to add only multiple card groups.

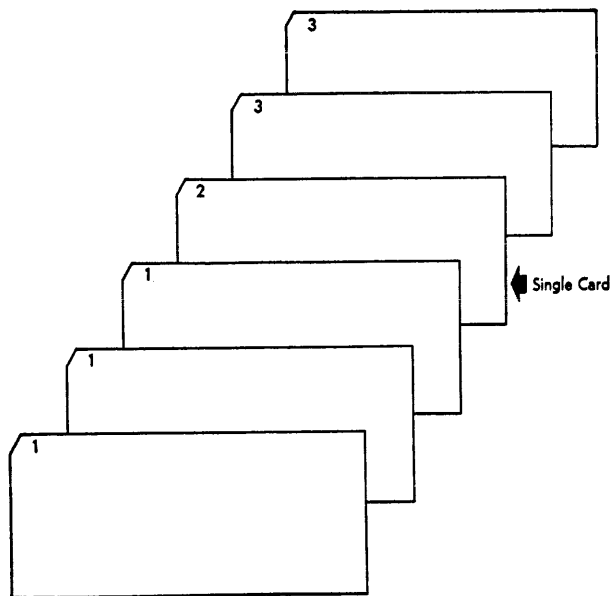

FIGURE 115

When the single card switch (hubs to the left of the S hub with the arrow between them) is wired, totals for single card groups are eliminated and the following internal functions are performed.

a. When a single card group is recognized, minor program start is suspended. Any information that is wired to the type bars will print.

b. Even though programming is suspended, the first card of the following multiple group will group indicate.

c. If the last card of the intermediate group is a single card, the intermediate program will be initiated but the minor total program is suspended.

Wiring (Figure 116)

1. Comparing exit for commodity number is wired to minor program start and the comparing exit for customer number is wired to intermediate program start.

2. Sales amount from the detail cards is wired to counter 8A to add totals by commodity and to 8B to add totals by customer number. Counter 8A is read out and cleared on a minor program and 8B is read out and cleared on an intermediate program.

Minor and intermediate totals and single card amounts print from alphanumerical type bars 36-43.

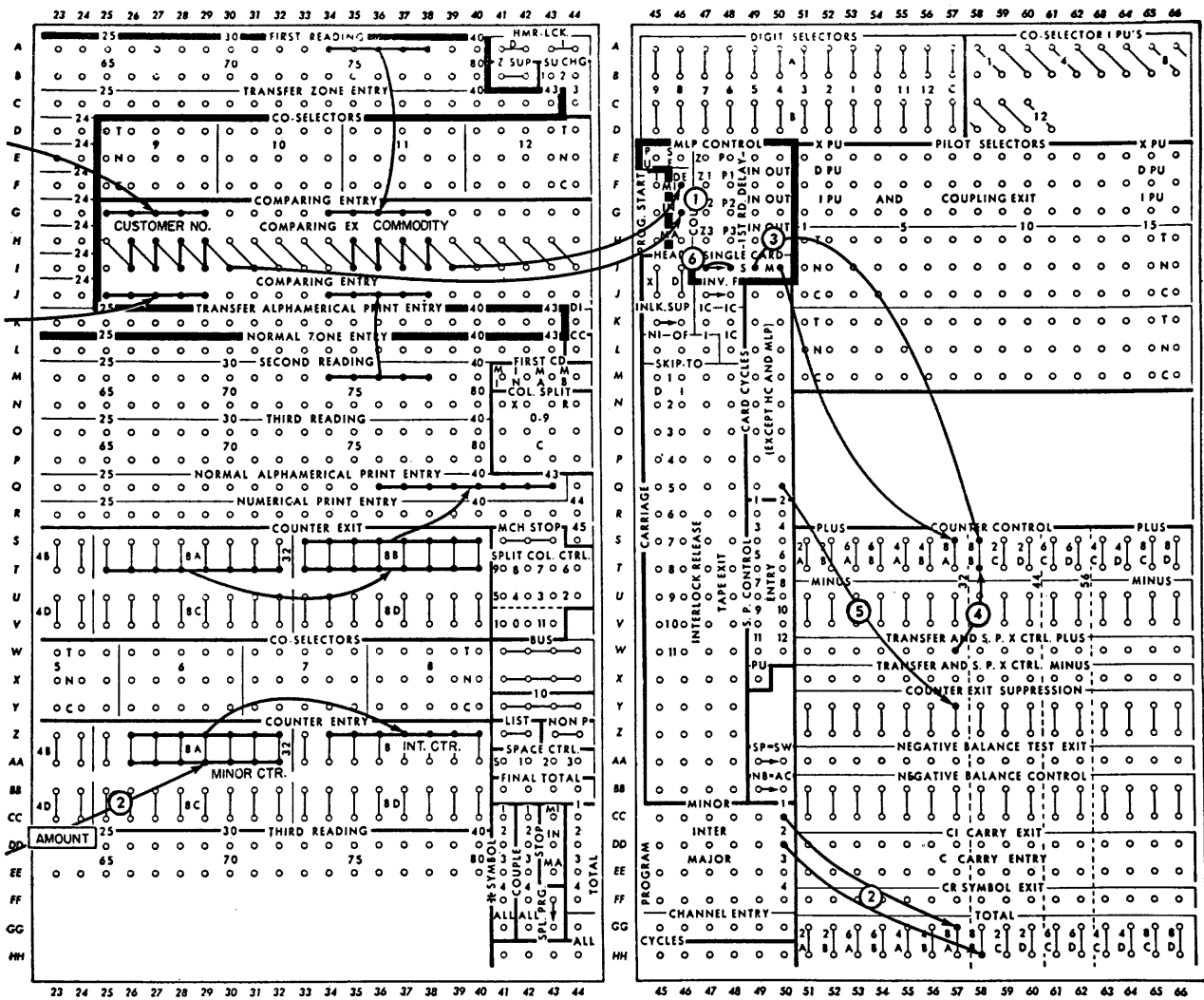

FIGURE 116. SINGLE CARD TOTAL ELIMINATION

3. Amounts from single cards are added into the intermediate counter by wiring S to 8B plus. They are printed from counter 8B exit. Amounts on multiple cards are added into the minor counter 8A by wiring M to 8A plus. The multiple group totals print from 8A exit.

4. When counter 8A reads out on a minor program, it is transferred to counter 8B by wiring the transfer control plus of 8A to counter 8B

plus. Thus, the multiple card totals in 8A add to the single card totals in 8B. Counter 8B is cleared during printing of the invoice total.

5. Printing of the amount of the first card of a multiple group is suppressed by wiring a card cycles impulse to 8A counter exit suppression.

6. Single card totals are eliminated by connecting the single card switch.

CROSSFOOTING USING MLP SELECTOR SYSTEM

CROSSFOOTING may be accomplished on the Type 403 by the use of the MLP selector system as well as by the methods previously explained for the Type 402 machine.

The schematic diagram of the MLP selector system (Figure 108) will assist in understanding MLP crossfooting operations. The card to be crossfooted must be punched with the MLP control punches, that is, 9, 8 and also 2 or 3, depending upon the number of fields to be crossfooted. A 2 would be punched for two-field crossfooting and a 3 for three-field crossfooting.

Field A is then wired to 1st line print entry from the second station, field B to the 2nd line print entry from the third station, and field C to the 3rd line print entry from the third station. Print selection exit is wired to a counter entry.

Wiring (Figure 117)

1. Column 80 is wired from first reading to MLP control pickup. Since three fields are to be crossfooted, column 80 is punched with 9, 8, 3.

2. Card count is wired to minor program start DE to initiate a program change for each card.

3. The indication and the fields to be crossfooted (A, B, C) are wired from second reading to transfer alphanumerical print entry. The indicate cycle occurs when the card to be crossfooted is at the second station.

4. Field A is wired from second reading to 1st line print entry.

5. Field B is wired from third reading to 2nd line print entry.

6. Field C is wired from third reading to 3rd line zone and print entry.

7. Through the internal selector system the three fields enter counter 8A by wiring print selection exit to counter entry.

8. All three fields are added in counter 8A by wiring P to 8A plus. P emits an impulse at the second, third and fourth stations.

9. Counter A is cleared on a minor program.

10. Counter 8A exit is wired to normal alphanumerical print entry where the total of A, B and C will print.

11. Printing is suppressed from counter 8A on the group indication cycle during which factor A is adding.

12. Printing and spacing is suppressed on the second and third MLP crossfooting cycles by wiring an all cycles impulse to NON-PRINT through the transferred side of a pilot selector. The selector is picked up by wiring P1 to the X pickup and P2 to the D pickup. The X pickup transfers the selector at the third station and D pickup transfers the selector one cycle later. Thus, the crossfooted total prints on the same line as the indication.

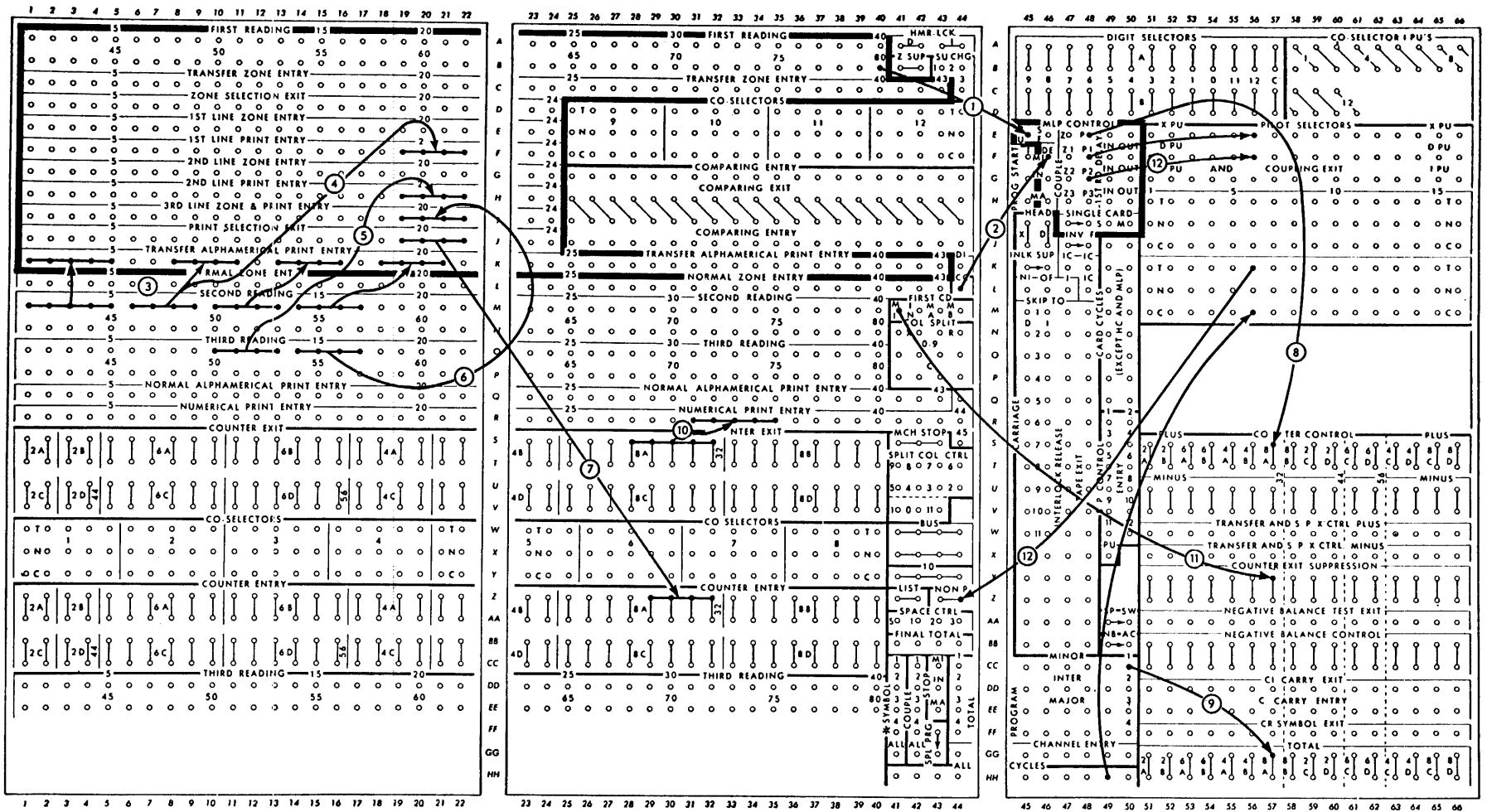

FIGURE 117. CROSSFOOTING THREE FIELDS, MLP SYSTEM

FORM FEEDING DEVICES

FORMS can be fed through the carriage by one of the following methods:

1. IBM Pin Feed Platen Device (Model P-2 or P-3)
2. IBM Forms Tractor (Model F-3)
3. Feeding devices of other manufacture.

IBM PIN FEED PLATEN DEVICE

THE IBM Pin Feed Platen (Figure 118) advances forms by means of the retractable pin feed mechanisms located on each end of the platen. As the platen and pin wheels revolve, the pins engage in the marginal holes of the forms and pull the forms forward and up, thus advancing the forms without the use of pressure rollers.

To obtain continuous accurate form alignment when using the IBM Pin Feed Platen, the pressure rollers on all IBM carriages *must be in the inoperative position*. The pins alone *must* control the advancing of the forms. The forms *must* also flow under the platen and out of the carriage without undue pull, drag, or interference of any kind.

The operator can change all operations and functions of the platen without the use of tools. The distance between the pin wheels is changed to fit any width form by replacing the platen with one of the proper length. The lateral position of the platen on the shaft is determined by the location of the left-hand, or fixed, pin wheel. The retractable pin wheels may be shifted to the inoperative position so that the pins emerge at the rear rather than the front of the platen when friction-feeding forms.

The IBM Pin Feed Platen does not detract in any way from the general utility of the machines with which it is used. Friction fed forms and above platen form feeding devices may still be used whenever desirable. Forms without marginal holes, or paper of a shorter width than the platen may be friction fed without making any changes. However, when forms the same size as the platen are to be friction fed or fed by an above platen feeding device, the pin wheels must be shifted to the inoperative position. Any size platen may be used this way, provided that the form is not wider than the platen. Type characters should never be al-

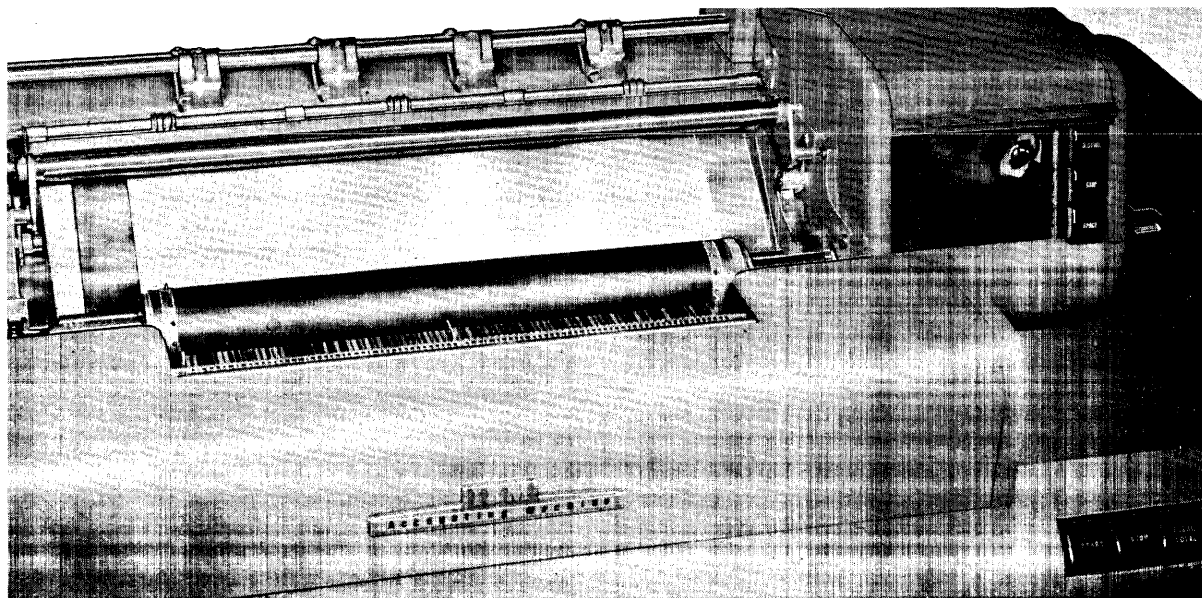

FIGURE 118. IBM PIN FEED PLATEN

lowed to print against, or directly strike, the metal pin wheels.

The IBM Pin Feed Platens (Model P-2 and Model P-3) are interchangeable. However, the earlier model (Model P-2) shaft assembly will accommodate only split platen sectors. Either tubular or split platen sectors may be installed easily on the Model P-3 shaft assembly.

Platen Sectors

Two different types of platens are manufactured for use with the IBM Pin Feed Platen Device. They are:

1. The two piece split platen shown in Figure 119.
2. The one piece tubular type platen shown in Figure 120.

Split platen sectors are split lengthwise into two halves. Changing the platens is thus simplified on machines with the non-removable type platen shaft assemblies. These sectors are manufactured as matched pairs and should be used as such. An identifying number is stamped on the inner core of each sector half; therefore, the sectors are a matched pair when the numbers agree. Each sector half also has a red mark painted on one corner of the inner metal sleeve. The sector halves fit together properly only when these marks touch each other.

Tubular platens are designed for use with the platen shaft assemblies that may easily be removed from the machine by the operator.



FIGURE 119. SPLIT PLATEN SECTORS

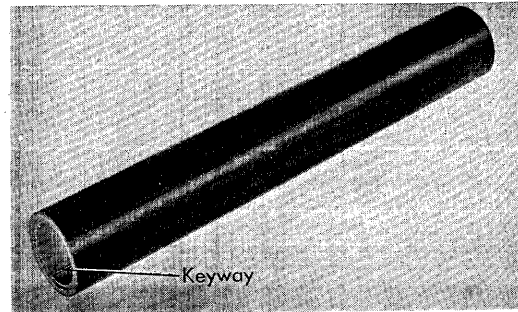

FIGURE 120. TUBULAR PLATEN SECTOR

Platen Hardness

Both types of platens are available in medium and hard densities of sector cover. Medium sectors are designed for use with one-to five-part forms. Hard sectors are for use with forms of more than five parts.

Platen Length

Both types of platens are available in various standard lengths, to accommodate forms whose overall widths are: $4\frac{3}{4}$ " , $5\frac{3}{4}$ " , $6\frac{1}{2}$ " , 8" , $8\frac{1}{2}$ " , $9\frac{7}{8}$ " , $10\frac{5}{8}$ " , 11" , $11\frac{3}{4}$ " , $12-27/32$ " , $13\frac{5}{8}$ " , $14\frac{7}{8}$ " , $15\frac{1}{2}$ " , 16" , $17-25/32$ " , $18-15/16$ " .

Storage of Platen Sectors

Cardboard tubes are provided for shipping the sectors and should be used for storing the extra sectors. Do not store the sectors near heat. Keep the split platen sectors together as matched pairs at all times.

Special Platens

Soft and extra hard platen covers are available on a special order basis. Soft platens are preferred by some customers for use with single-part forms. Extra hard platens may be used for greater legibility of carbon copies when multiple-part forms of heavy stock are used.

Off standard length. Platens of a different length than those listed as standard may be obtained on a special order basis.

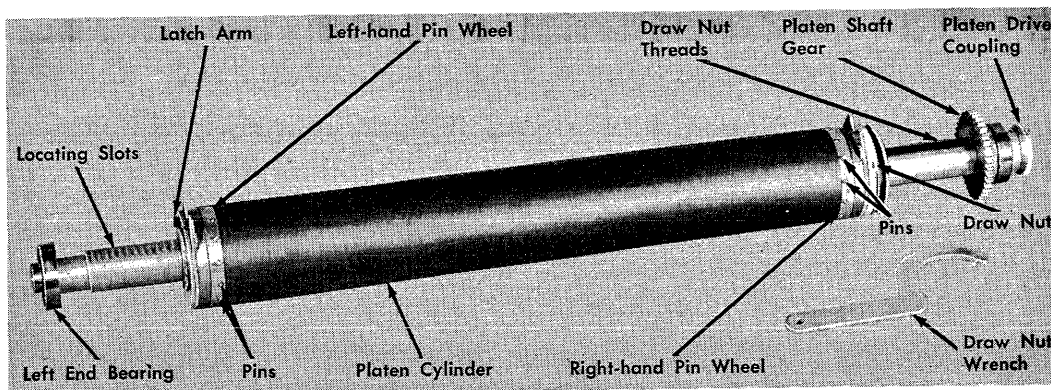

FIGURE 121. MODEL P-3 IBM PIN FEED PLATEN

Undercut Platens. Platens used to feed multiple-part forms of exceptionally thick stock are manufactured with a diameter slightly smaller than standard. These platen sectors should be ordered only when recommended by the forms manufacturer.

Changing Model P-3 Platen Sectors

Remove the platen assembly from the carriage in the normal manner.

After the assembly (Figure 121) has been taken out of the machine, remove the left end bearing, which is held in place by a slight amount of spring tension. Next, the pressure placed on the platen must be relaxed by rotating the draw nut of the right-hand pin wheel counterclockwise until the stud in the side of the draw nut lifts the draw nut latch up out of the threads in the platen shaft. When the pressure has been released, the latch arm of the left-hand pin wheel may be depressed and the assembly will slide off the shaft. The tubular platen sector may then be removed from the left end of the shaft.

To reassemble the pin feed platen, place the tubular sector, left-hand pin wheel and left-hand bearing on the shaft in that order. Next bring the tubular sector up against the left pin wheel; then slide the right pin wheel to the left, aligning the key with the keyway of the platen. When the right pin wheel is as tight against the platen as possible, rotate the draw nut clockwise so that the stud will allow the draw nut latch to engage with the threaded portion of the platen shaft. Turn the

draw nut as tight as possible. A wrench is provided to facilitate this operation. Place the platen on the reading board with the wrench engaged and under the platen, and turn the platen with both hands thus tightening it against the wrench.

When removing split platen sectors from the Model P-3 shaft, release the right-hand pin wheel draw nut latch as previously described, and move the pin wheel to the right. Now the split platen sectors may be pulled apart for removal.

When replacing split platen sectors, place the two halves around the shaft. See that the *red mark* on each sector half is at the left end of the shaft and over the key in the left-hand pin wheel assembly. Next, butt the sectors against the left-hand pin wheel; then move the right-hand pin wheel in position, and tighten as previously described.

Changing Model P-2 Platen Sectors

The Model P-2 shaft assembly (Figure 122) is designed with a non-removable left-hand bearing and pin wheel; therefore, this model accommodates only split platen sectors.

When removing or installing platen sectors on the Model P-2, follow the procedure previously described for removing and installing split platen sectors on the Model P-3.

Positioning Platen on Shaft

A platen sector may be located laterally to align the form with the type bars. The lateral position of the platen sectors on the shaft is determined by the location of the left-hand or fixed pin wheel.

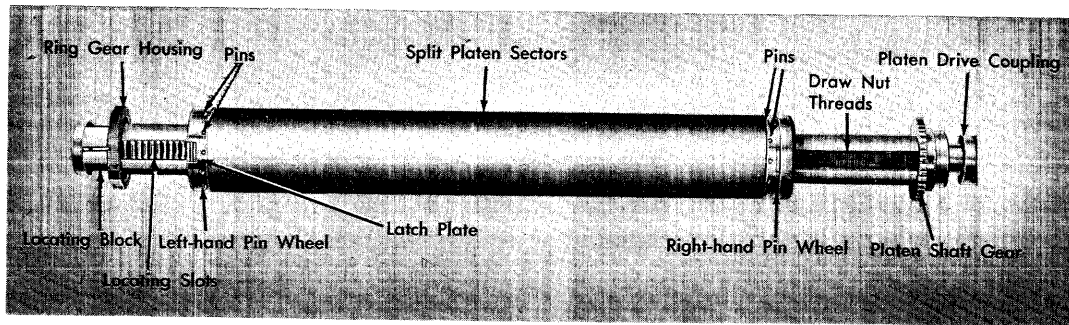

FIGURE 122. MODEL P-2 IBM PIN FEED PLATEN

The left-hand pin wheel may be moved by loosening the draw nut and depressing the latch arm (latch plate on Model P-2) and sliding the pin wheel along the shaft to a new location. Make sure that the latch is firmly seated in one of the large cross cut locating slots in the platen shaft.

Figure 122 shows the location of the latch plate on the Model P-2 pin feed assembly.

Figure 121 shows the location of the latch arm on the Model P-3 pin feed assembly.

Changing the Position of the Pins on Model P-3

The Model P-3 platen shaft assembly is designed

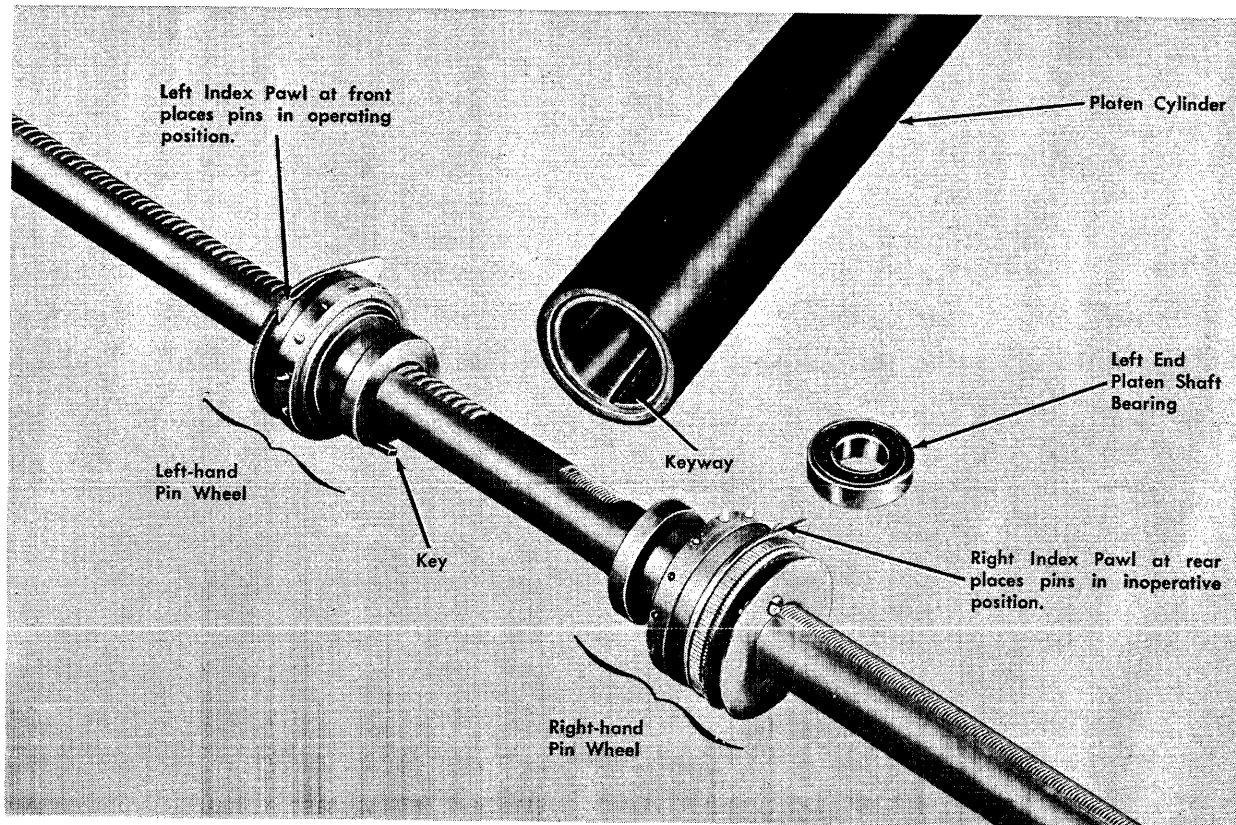

FIGURE 123. MODEL P-3 PINS IN OPERATING AND INOPERATIVE POSITION

so that each pin wheel operates as an independent assembly. Therefore, it is necessary to position the left and right index pawls so that the pins will be in the operating or non-operating position at the same time.

To change the pins to the inoperative position, depress and move the index pawls to the rear latching position (right-hand pin wheel, Figure 123). The pins are in the operating position when the index pawls are in the forward latching position (left-hand pin wheel, Figure 123).

Changing Position of the Pins on Model P-2 (Figures 124 and 125)

The Model P-2 shaft assembly is designed so that the operating position of the pins in both pin wheels is changed simultaneously.

The pins are placed in the operative position by pulling outward on the locating block key and rotating the ring gear housing until the key can be placed in the rear slot in the ring gear housing. This causes the pins of the pin wheel to emerge in the operative position at approximately the front of the platen (Figure 124).

The pins are placed in the inoperative position by pulling outward on the locating block key and rotating the ring gear housing so that the key can fall into the slot in the ring gear housing at the flat spot (Figure 125). This causes the pins of the pin wheels to emerge at a point near the top of the platen.

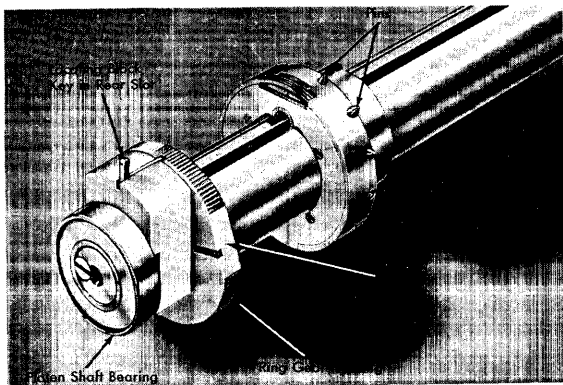

FIGURE 124. MODEL P-2 PINS IN THE OPERATING POSITION

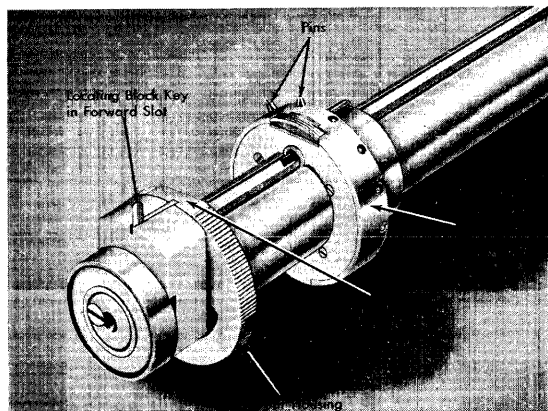

FIGURE 125. MODEL P-2 PINS IN THE INOPERATIVE POSITION

Tear Bar Position

The carriage tear bar rollers may be raised off the platen when the pin feed mechanism is in the operating position.

The tear bar adjusting lever, mounted on the left-hand arm of the tear bar, pivots forward and may be latched at three positions. When the lever is at the lowest position, the tear bar rollers rest on the platen. As the lever is raised, it causes the tear bar rollers to be raised further off the platen for each succeeding latching position. The adjusting lever should be latched in the position that raises the rollers an amount corresponding to the thickness of the forms in use.

Form Feed Guides (Figure 126)

The upper form guides are mounted on two shafts. The paper roll shaft extends through the rear set of holes in each guide. A front support shaft extends through the front holes and rubber grommets are mounted on each end of this shaft to hold it in position.

Set the guides equidistantly across the carriage so that the center guide supports the center of the form and the outer guides support the marginal edges of the form.

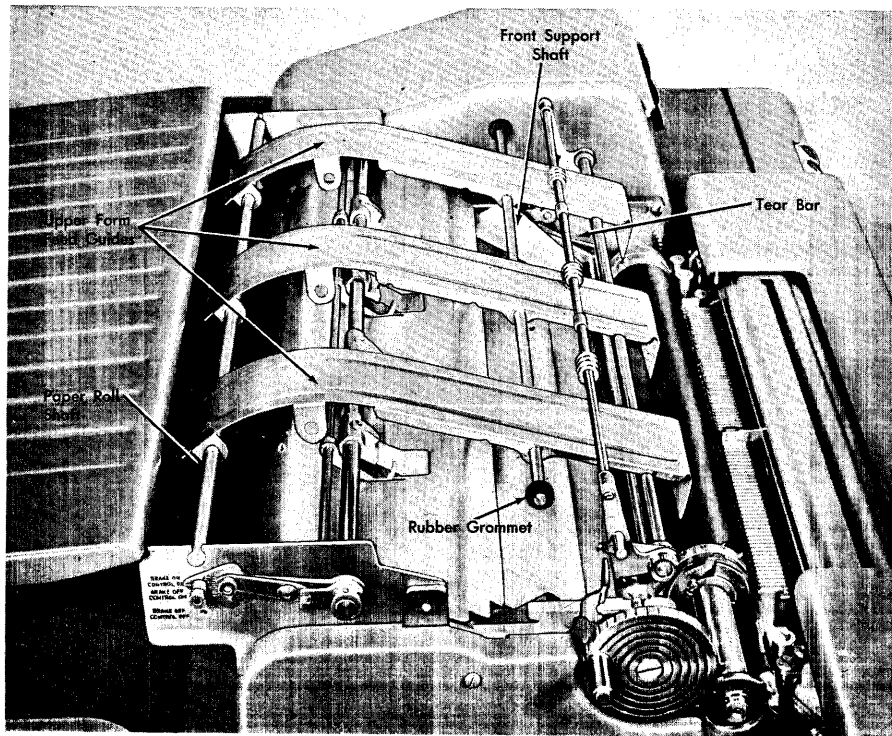

FIGURE 126. FORM FEED GUIDES

IBM FORMS TRACTOR

THE MODEL F-3 IBM Forms Tractor (Figure 127) designed for use with the tape-controlled carriage, accommodates forms up to 19" in width, including the punched margins.

The forms tractors can be attached or removed from the carriage by the operator without the use of tools. When the device is in use, marginally punched forms are fed by two tractor assemblies located above the platen. Both tractors may be located laterally to accept forms of various widths. If forms narrower than the minimum width that can be obtained between the tractors are used, these forms may be advanced by one tractor operating through the pin holes in only one side of the form.

The accounting machine carriage pressure rolls must be in the inoperative position at all times when using the IBM Forms Tractor to feed forms.

With the use of this form feeding device, six or eight line spaces per inch may be obtained without

altering the accounting machine carriage in any way. The operator simply shifts a drive gear plate on the forms tractor to one of two indicated positions for the desired spacing results. Eight lines per inch feeding with the forms tractor is less accurate than with the special Line-Spacing Device for the carriage.

To attach the forms tractor to the carriage:

1. Rest the forms tractor lower paper guides on the carriage paper table at the rear of the platen.
2. Hook the rear forms tractor mounting studs in the rear slots in the carriage side frames.
3. Lower the front of the forms tractor assembly, and latch the front forms tractor mounting studs in the front slots in the carriage side frames.

See that the platen gear and the forms tractor drive gear are fully meshed. Be sure the forms tractor and platen turn freely by hand before operating under power. Because the paper guides are free to disengage from the tractor adjusting wheels when the device is not attached to the carriage, these units must be guided into engagement.

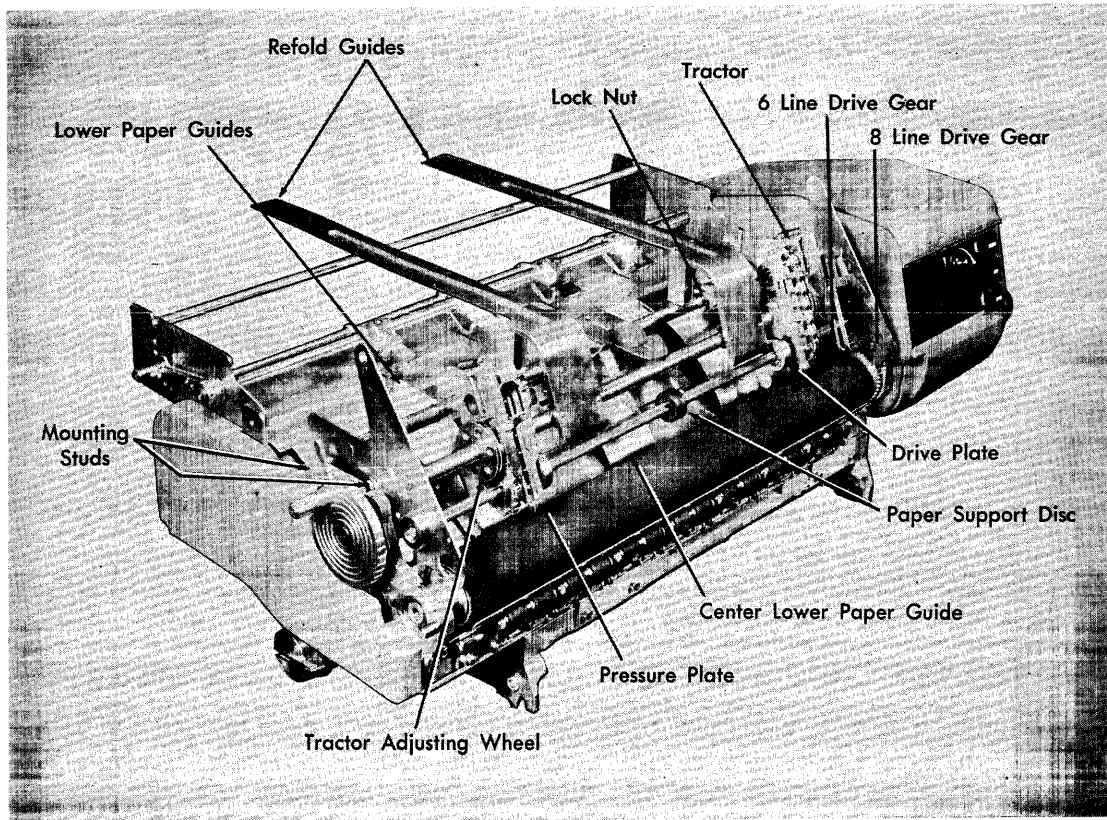

FIGURE 127. MODEL F-3 IBM FORMS TRACTOR ON TAPE-CONTROLLED CARRIAGE

When removing the device, reverse the above procedure. The front forms tractor mounting stud latches are simply cammed out of the way as the front of the device is raised.

Steps in Using the Model F-3 IBM Forms Tractor

1. Loosen both lower paper guide lock nuts.
2. Move the left-hand paper guide and tractor laterally to the desired position and tighten that lock nut.
3. Insert forms over the lower paper guides and under the platen.
4. Move the right-hand paper guide and tractor in toward the form. Allow a slight amount of clearance between the form and the right- and left-hand guides so that forms will feed without binding. Tighten the right-hand paper guide lock nut.
5. Center the paper support disc between the tractor assemblies.

6. Locate the center lower paper guide midway between the outer paper guides.

7. Clip the refold guides onto the tractor guide rod and position them approximately midway between each tractor assembly.

8. With the carriage pressure rolls in the inoperative position and the tractor pressure plates raised, draw the forms up and attach the forms margins to the tractors. Lower the tractor pressure plates.

9. Center the tractor pins laterally in the marginal holes of the form by rotating the knurled adjusting wheel on each tractor assembly in the proper direction. Improperly centered pins may cause crooked feeding.

10. Usually, printing is started on the second form because the first form is needed to attach to the forms tractor. However, if it is necessary to start printing on the first form, place that form on the tractor pins and engage the carriage pressure rolls. Next, turn the platen backwards until the first line of the form is in position to be

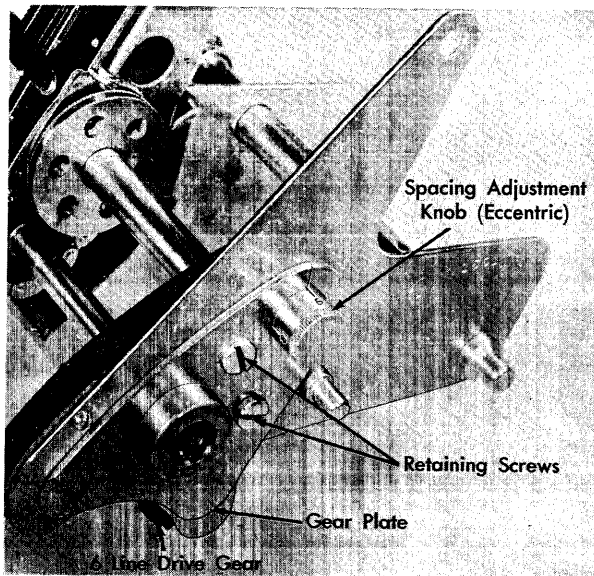

FIGURE 128. 6 OR 8 LINE DRIVE (MODEL F-3)

printed. Depress the start key to begin the operation. After the form has advanced to the tractors, stop the machine, attach the form to the tractor chain pins, and disengage the pressure feed mech-

anism. Note: If 8-line-per-inch spacing is required, it will be necessary to adjust manually each line space on the first form until it can be attached to the tractor chain pins.

6 or 8 Line Drive

The 6 or 8 lines quick-change drive gear mechanism is shown at the 6 lines per inch setting in Figure 128. The scribed line alignment provides only a general drive gear to platen gear relationship. These lines may be moved away from each other in either direction to obtain proper gear mesh.

When 8 lines per inch are required, loosen the two retaining screws and revolve the spacing adjustment knob until the scribed line opposite the "8" is aligned with the scribed line on the gear plate. Attach the device to the carriage and see that the forms tractor drive gear fully engages in the platen gear without binding. Re-position the spacing adjustment knob if necessary. Be sure the retaining screws are tight. An improperly engaged drive gear will result in non-uniform spacing.

Reverse the above procedure to shift the mechanism back to the 6 lines per inch position.

RIBBON REPLACEMENT

THE RIBBON feeds from one spool to the other approximately $\frac{1}{4}$ of an inch on each print cycle. It feeds in one direction until a metal eyelet about ten inches from the end of the ribbon on either spool strikes the ribbon reversing lever, thus reversing the feed.

When installing a new ribbon, it is important that the leading end of the ribbon is firmly hooked onto the empty spool. Enough ribbon should be wound around the empty spool so that the metal eyelet is somewhere between the spool and the ribbon reversing lever. The threading of the ribbon around guide rollers is shown in Figure 129.

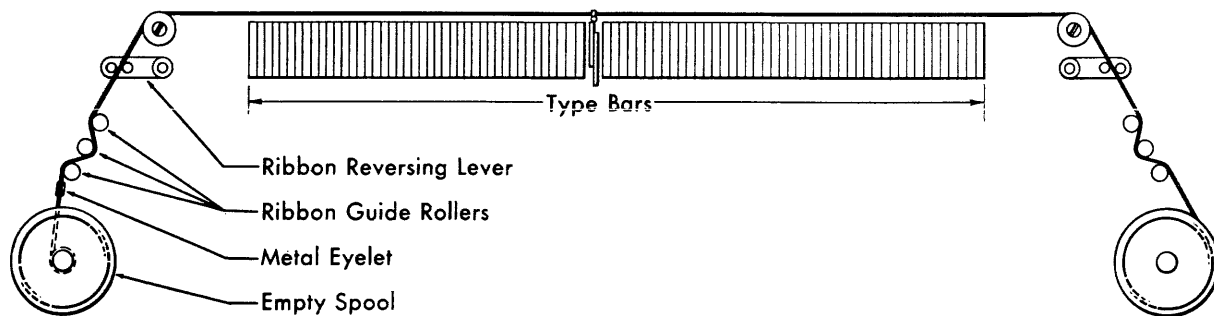

FIGURE 129. SCHEMATIC OF RIBBON FEED

CONTROL PANEL SUMMARY

Each section of the control panel (Figure 130) is assigned a number under which the hubs are briefly described. The hubs enclosed by the heavy solid lines are active only on the Type 403. All other hubs are active on both the Type 402 and Type 403.

1. *First Reading.* Exits on the 403 only. These hubs represent the 80 brushes that read the card at the first station. They are normally used for zoning the first line of an MLP card and for comparing in MLP operations. They are also used to control other functions of the machine, such as selector, carriage skip, hammerlock, and MLP control.

2. *Transfer Zone Entry.* Entry on the 403 only. These hubs represent the transferred side of an internal selector which is picked up for the zoning of all three lines of an MLP card. They are entries to the 43 zone magnets for zoning MLP cards, and are normally wired from zone selection exit.

3. *Zone Selection Exit.* Exit on the 403 only. There are 24 zone selection exit hubs that emit zone impulses for all three lines of an MLP card. They are normally wired to transfer zone entry.

4. *1st Line Zone Entry.* Entry on the 403 only. These 24 hubs are normally wired from first reading to zone the type bars for the first line of an MLP card.

5. *1st Line Print Entry.* Entry on the 403 only. These 24 hubs are normally wired from second reading to print the first line of an MLP card.

6. *2nd Line Zone Entry.* Entry on the 403 only. These 24 hubs are normally wired from second reading to zone the type bars for the second line of an MLP card.

7. *2nd Line Print Entry.* Entry on the 403 only. These 24 hubs are normally wired from third reading to print the second line of an MLP card.

8. *3rd Line Zone and Print Entry.* Entry on the 403 only. These 24 hubs are normally wired from third reading to zone and print the third line of an MLP card.

9. *Print Selection Exit.* Exit on the 403 only. There are 24 print selection exit hubs that emit digit impulses to print numerical or alphabetic information on three lines of an MLP card. They are normally wired to transfer alphamerical print entry for MLP printing, or to a counter entry for crossfooting.

10. *Transfer Alphamerical Print Entry.* Entry on the 403 only. These hubs represent the transferred side of an internal selector which is picked up for the printing of all three lines of an MLP card. They are entries to the 43 alphamerical type bars for MLP cards.

11. *Normal Zone Entry.* The 43 normal zone entries are used to zone the type bars for normal cards. They are normally wired from second reading.

12. *Second Reading.* These exit hubs represent the 80 brushes that read the card at the second station. They are normally used for comparing with the first station in MLP operations or with the third station in normal operations. They are also used for printing the first line of an MLP card, for zoning normal cards, and for controlling features such as selectors, hammerlock, or carriage skip for normal cards.

13. *Third Reading.* These exit hubs represent the 80 brushes that read the card at the third station. They are used to print the second and third lines of an MLP card, to print normal cards, to add from normal cards, and to compare with the second station in normal operations.

14. *Normal Alphamerical Print Entry.* These hubs are print entries to the alphamerical type bars, and are normally wired from third reading, or from a counter exit.

15. *Numerical Print Entry.* These hubs are print entries to the numerical type bars, and are normally wired from third reading, or from a counter exit. The 45th entry hub is located below hub 44. The hub above 44 is inactive.

16. *Counter Exit.* These hubs are normally exits from the counters for both detail printing and total printing. They may be wired to alphamerical

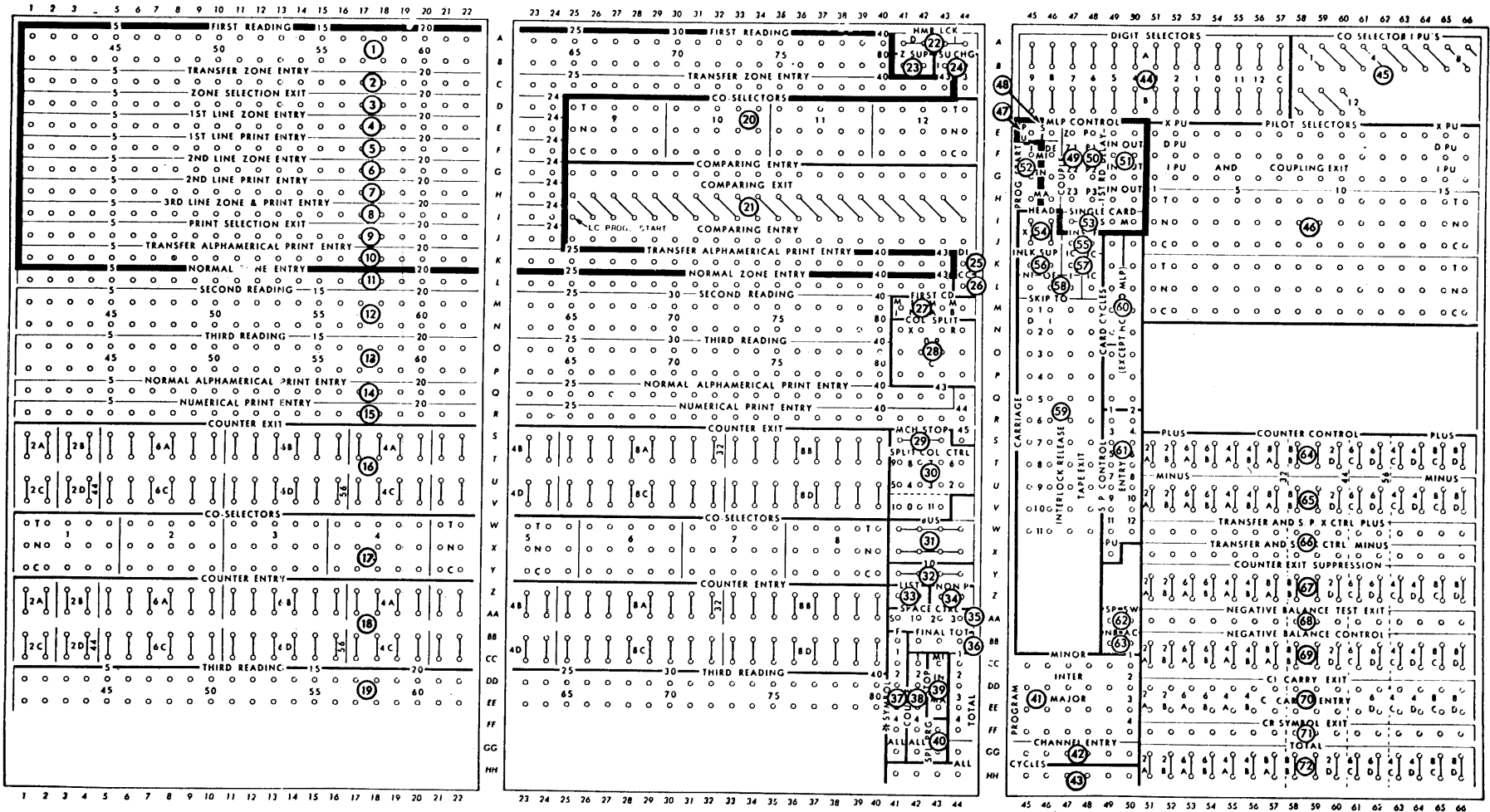

FIGURE 130. CONTROL PANEL SUMMARY

or numerical print entry or to the exits of other counters, in which case exits for receiving counters serve as entries. They may also be wired to entries of other counters.

17. *Co-Selectors (1-8)*. The number of standard co-selectors varies with the number of counters. Four co-selectors are standard with the 32- and 44-counter machines and eight are standard with the 56- and 80-counter machines. Each selector has five positions and may be used independently or may be coupled with a pilot selector. When the selector is picked up, there is an internal connection between C (common) and T (transferred). When the selector is not picked up, there is a connection between C and N (normal).

18. *Counter Entry*. All counters to the left of the vertical printed number 32 (located to the right of 8A) are standard on a 32-counter machine. Likewise, all counters to the left of the numbers 44 and 56 (starting with 2A) are standard on the 44- and 56-counter machines. The number on each counter identifies its size and the letter its location. Counter entries are normally wired from third reading. All information to be summary punched must be wired to counters.

The first 24 counter positions (2A-4B) are internally reserved for printing the third line of an MLP card. They will not accept external impulse during MLP cycles. Any information in these counters will automatically clear out as an MLP card passes the second and fourth stations.

19. *Third Reading*. These exit hubs are common with the third reading hubs described in 13, and may be used interchangeably.

20. *Co-Selectors (9-12)*. These selectors are optional and operate the same as those described under 17.

21. *Comparing Entry — Exit*. On the Type 402, 20 positions of comparing are standard on all 56- and 80-counter machines. Ten positions are standard on 32- and 44-counter machines. On the Type 403, 20 positions are standard for all machines.

The comparing entry hubs are wired from first and second reading in MLP operations and from second and third reading in normal operations. The entry hubs may be used interchangeably, but their relationship must be the same, that is, if the

first five hubs are used in one set of entries, the corresponding five hubs must be used in the other set of entries.

Each set of entry hubs has a corresponding set of common comparing exit hubs. They are diagonally arranged for convenience in jackplugging. Whenever a reading from one station does not compare with the reading at another station, the comparing hubs emit an impulse, which is normally wired to program start. The comparing exit may also be used to control other functions, such as hammerlock control, or carriage skip, when wired to D pickup. The lower left exit hub labelled LC Prog. Start emits an impulse as the last card passes the last control station, and also as the first card passes the first control station.

22. *Hmr. Lck. (Hammerlock) D-I*. The D (delay) entry hub will accept digits, X's, 12's and comparing exits to control hammerlocking on the following cycle. The I (immediate) hub will accept first card, total programs, negative balance test exits, and selected card cycles impulses to control hammerlocking on the same cycle. When either hub is impulsed and the long hammerlock levers are raised, printing from those type bars is suppressed.

23. *Z Sup (Zone Suppress)*. These common entry hubs will accept an X, 12 or selected card cycles to suppress all zoning for any designated card. The X and R (12) punch may be wired directly to zone suppress from the station preceding the printing of the card. If a card cycles is wired to zone suppress, it must first be controlled through a selector.

24. *SU CHG (Setup Change)*. These three hubs are exits only when the three toggle switches on the side of the machine are turned ON. When a toggle switch is ON the corresponding SU CHG hub emits an impulse each machine cycle. They are used to pick up selectors through which wiring changes can be controlled. Immediate (I) pickup must be used.

25. *DI (Digit Impulse)*. This exit emits an impulse for every digit and for 11 and 12 on every machine cycle, including run-in and run-out cycles. It is normally wired to the C of a digit selector to change the digit selector to a digit emitter.

26. *CC (Card Count)*. This exit hub emits a 1 impulse every time a card passes the third reading station. This impulse is normally wired to a counter to count cards, or to program start to cause a program change for every card.

27. *First Card MI, IN, MA, MB*. These exit hubs are normally wired to counter add, carriage skip to (I), hammerlock (I), I pickups of selectors, and machine stop.

MI (Minor). This hub emits an impulse for the first card of every minor group, including groups with heading cards. If it is wired to a counter plus, the counter will add the first card of a minor group. If it is wired to a carriage skip to I, skipping will take place before the first card of each group. If it is wired to hammerlock I, it suppresses minor first card printing for those type bars having the long hammerlock levers raised.

IN (Intermediate). This hub emits an impulse for the first card of every intermediate group. It is similar in function to first card minor.

MA (Major). This hub emits an impulse for the first card of every major group. It is similar in function to first card minor.

MB (Minor Body). This hub emits an impulse for the first card of every minor group in the body, when head control is wired. It is normally wired to control group indicate counters during summary punching operations. When wired to hammerlock I, it may also be used to control hammerlocks.

28. *Col Split (Column Split)*. Each column split has a C (common), 0-9, and X-R hub. They are used to separate 11 and 12 impulses from 0-9 impulses read from a card column or the DI hub. They are active on card cycles only.

29. *Mch Stop (Machine Stop)*. The three common entry hubs accept first card, total programs, negative balance test exits or selected card cycle impulses. When these hubs are impulsed, the machine stops and the stop light turns on. It can be turned off only by depressing the final total key, after which the machine may be restarted by depressing the start key.

30. *Split Col Ctrl (Split Column Control)*.

These hubs emit impulses at half after the number. Hub 1 emits an impulse halfway between 1 and 0. Hub 0 emits an impulse halfway between 0 and 11. Hub 11 emits an impulse halfway between 11 and 12. They are normally wired to I pickups of selectors, which in turn may be used as column splits.

The hubs labelled 9 through 2 are optional and function the same way as the 1, 0 and 11 hubs.

31. *Bus*. Two rows of 4 common hubs may be used to expand exits or entries.

32. *"10"*. These 4 common exit hubs may be used for symbol printing. They emit "10" impulses on every card cycle.

33. *List*. These entry hubs receive card cycles, all cycles, negative balance test exit and setup change impulses to cause detail printing. When they are not impulsed, the machine will group print.

Digits or X-12 impulses may not be wired directly to list. Normally, the list hub is impulsed from all cycles to cause detail printing, and spacing for all cards including the total. For selective printing, card cycles may be wired to list through a selector.

34. *Non-P (Non-Print)*. When these entry hubs are impulsed, all spacing and printing is suppressed and the machine operates at a speed of 150 cycles per minute. They are normally wired from total program exits in crossfooting operations, or from first card minor for group indication elimination.

35. *Space Control*. These entry hubs are normally wired from card cycles, all cycles, or total program exits. When S is impulsed, spacing is suppressed. When 1, 2, or 3 is impulsed, printing is single-spaced, double-spaced, or triple-spaced. Space control takes precedence over normal spacing (6 lines to the inch).

36. *Final Total*. These three independent exit hubs emit an impulse to read out and clear counters under the following conditions:

1. The machine must be idling.
2. The hopper must be empty.
3. The last card must be in the stacker.

Depress the start key with the final total key being held down.

They are normally wired to counter TOTAL hubs. Normal spacing is suppressed on final total cycles. Spacing may be obtained by wiring final total to 1, 2, or 3 space control hubs.

37. * *Symbol*. These exit hubs emit "10" impulses during program cycles and are normally wired to numerical type bars directly or through selectors to print asterisk or credit symbols. The F hub emits a 10 impulse on final total cycles, the 1 hub on minor programs, 2 on intermediate programs, 3 on major programs and ALL on all programs. Hub 4 can be used only when SPECIAL PROGRAM is wired.

These hubs may also be wired to the D pickup of pilot selectors to control all cycles impulses to channel entry when the special program feature is being used.

38. *Couple*. These exit hubs are normally wired to the I pickup of selectors to expand program exits, or to each other to cause two or more totals to print on the same line. Hub 1 emits an impulse for the minor program, hub 2 for the intermediate program, hub 3 for the major program and ALL for all programs. Hub 4 can be used only when SPECIAL PROGRAM is wired.

39. *Stop, MI, IN, MA (not standard)*. These hubs are entries to stop programming when SPECIAL PROGRAM is used. MI, IN or MA stop is wired from the last step used, depending upon the type of program start that initiated the special program.

40. *SPL PRG (Special Program - not standard)*. When this switch is connected, normal programming is inoperative. Each channel may then be independently controlled by wiring all cycles to channel entry directly or through pilot selectors. This feature provides a means of obtaining extra program cycles following a program change. Programming is started by impulsing a program start, and stopped by impulsing a program stop corresponding to the particular program start that initiated the special program.

41. *Total Program*. These exit hubs emit impulses whenever program start is impulsed. When minor, intermediate or major program start is impulsed, minor, intermediate or major total program is active. Each program requires a separate cycle, unless coupled as explained under 38.

Each total program has 7 independent exit hubs which are normally wired to counter TOTAL to cause a counter to read out and clear. The nature of the total will depend on the type of program wired. They may also be wired: to carriage SKIP TO I to cause skipping before predetermined total printing; to HAMMERLOCK I to control hammerlocks; to COUNTER CONTROL to add transferred totals from transmitting counters on non-net machines. Program 4 can be used only when SPECIAL PROGRAM is wired.

42. *Channel Entry*. Each vertical row of hubs has a corresponding channel entry which must be wired from all cycles directly or through selectors when special program is wired. If all cycles is wired directly to any channel entry, the hubs immediately above it may be used to control functions on the 1st, 2nd, 3rd and 4th steps. Wiring for programs beyond 4 is explained in Figure 82.

43. *All Cycles*. These ten independent exit hubs emit an impulse for every machine cycle.

44. *Digit Selectors (not standard)*. Used to select specific digits on a card column, or to emit constant digits on every card feed cycle. The C hub is impulsed from a reading station if a specific digit is to be selected, or from DI (digit impulse) if the selector is to be used as a digit emitter. Cycles impulses must not be wired through digit selectors.

45. *Co-Selector I (Immediate) PU (Pickup)*. Entries to transfer co-selectors. The selector transfers immediately and remains transferred until the end of the cycle. Co-selectors may be coupled to pilot selectors by controlling them from the pilot selector coupling exit.

46. *Pilot Selectors*. Six pilot selectors are standard on the 32-counter machine and eleven are standard on the 44-, 56-, and 80-counter machines. Five additional pilot selectors are optional. They are 2-position selectors, each having an X, D, and I pickup. The X pickup receives an X or 12 impulse to transfer the selector on the following cycle. The D pickup receives a digit or X-12 impulse to transfer the selector on the following cycle. *Exceptions to the rule are covered on page 152 under SELECTORS*. The I (immediate) pickup receives any impulse to transfer the selector immediately. The I hubs are also used as coupling

exits when the X or D pickup is used, that is, I hubs emit an impulse for each cycle that the selector is transferred and may be wired to any I hub.

47. *MLP PU (Pickup)*. Entry on the 403 only. All MLP cards are punched with a 9-8 and a 1, 2, 3, or 4 in the same column which, when wired to MLP pickup from first reading, causes the machine to print one, two, or three lines from one card. When listing MLP cards only and OF is wired to NI or I, the list switch must also be wired from all cycles or card cycles.

48. *SF (Successive Feed)*. Entry on the 403 only. To print information from a normal card on the 2nd MLP line, a 6 is punched in the normal card and wired to SF, from first reading. This forces the normal card to feed immediately behind an MLP card. SF will accept only a 6 impulse, one cycle after MLP PU is impulsed.

49. *Couple Z, Z1, Z2, Z3*. Exit on the 403 only. Z1 emits an impulse as an MLP card moves past the first station. Z2 emits an impulse as an MLP card moves past the second station. Z3 emits an impulse as an MLP card passes the third station. They are normally wired to a co-selector pickup to expand the internal MLP selector system.

Z1 can be used to impulse head control and carriage skip to D hubs when MLP cards are being used, provided they are not to print in the body of the form.

Z is both an emitting and a receiving hub. It may be used as a receiving hub during non-MLP operations to pick up a 43-position internal selector, the transferred side of which is identified by the transfer zone entry hubs, and the normal side by the normal zone entry hubs.

50. *Couple P, P1, P2, P3*. Exit on the 403 only. P1 emits an impulse when an MLP card passes the second station. P2 emits an impulse when an MLP card passes the third station. P3 emits an impulse when an MLP card passes the fourth station. They are normally used to expand the internal MLP selector system by wiring them to a co-selector pickup.

P is both an exit and an entry hub. It may be used as a receiving hub during non-MLP operation to pick up a 43-position internal selector, the trans-

ferred side of which is identified by the transfer alphanumerical print entry hubs and the normal side by the normal alphanumerical print entry hubs.

51. *1st Read Delay—IN, OUT*. Two standard and two optional on the 403 only. When the MLP PU is impulsed, a digit may be wired to IN from first reading. An impulse will be available from the OUT hub when the MLP card at station 1 moves to station 2. First read delay is normally used for digit selection from an MLP card, by wiring the column containing the digit from first reading to the C of a digit selector and the selected digit to the IN hub. Out is then wired to the D pickup of a pilot selector.

52. *Program Start MI, IN, MA; I (Immediate) DE (Delayed)*. Program start I is standard on both the 402 and 403. Program start DE is standard on the 403 only. The I hubs accept an impulse to cause a program change on the same cycle. The DE hubs delay the program change for one or two cycles. The I hubs are normally used for comparing between the second and third reading stations and the DE hubs for comparing between the first and second reading stations. They are wired from comparing exit to cause a program change for every group, or from CC or DI, to cause a program change for every card.

The MI, IN, and MA hubs accept impulses to activate the minor, intermediate and major total program hubs.

53. *Single Card S M*. Exit on the 403 only. The S hub emits a card cycles impulse whenever a single card passes the third station. A single card is recognized by two consecutive program changes. The M hub emits a card cycles impulse for each multiple card as it passes the third station. The S and M hubs are normally wired to counter plus or minus.

The switch to the left of the S hub must be connected for single card total elimination. The following results are then obtained:

1. Minor programming is suspended for all single cards.
2. All single cards detail print even though the machine is group printing.
3. The group following the single card is group indicated.

4. If the last card of the group is a single card and an intermediate program is wired, the minor program is suspended and the intermediate program is taken.

54. *Head X, D*. These are entry hubs used to distinguish heading cards from body cards. The X may be wired directly from the reading brushes. The impulse to the D hub may have to be selected. The X hub accepts an X-12 impulse and the digit hub accepts any digit or X-12 impulse. Z1 may be wired to the D hub to identify MLP heading cards when there are no MLP cards in the body. If there are MLP cards in the body, all heading MLP cards must also be X punched and the X punch used as head control. When head X or D is wired, the following results are obtained:

1. All heading cards are printed.
2. Programming is suspended during heading card printing.
3. Skip from heading to first body line is automatic.
4. Skip to the first body line of a form is automatic when heading cards are missing.

55. *INV F (Inverted Form)*. These hubs must be connected when inverted forms are used. Automatic skipping is effective between body and heading cards instead of heading and body cards.

56. *INLK SUP (Interlock Suppression)*. When these hubs are connected, interlocking will be suppressed for all skipping. They are used when every skip is 3-2/3 inches or less.

57. *IC (Indicate Control)*. These three independent exit hubs emit impulses on the sheet identification cycle following an overflow when OF is wired to I (indicate). One hub is wired to counter plus, one to counter minus, and the other to counter total, for two purposes: (1) To print sheet identification information from counters. (2) To prevent counter clearing.

58. *NI - OF - I (Non-Indicate-Overflow-Indicate)*. OF emits an impulse whenever the 12 hole in the carriage tape is sensed. It is wired to I (indicate) if sheet identification is desired after an overflow, and to NI (non-indicate) if sheet identification is not desired after an overflow. When I is wired, the carriage skips to the first printing

line of the next form. When NI is wired the carriage skips to the first body line of the next form.

59. *Carriage Skip To D-I, Interlock Release, Tape Exit*. Channels 1-8 are standard. Channels 9-11 are optional.

Skip to D-I.

All digits and X-12 impulses as well as Z1 must be wired to D. Skip to I will not accept digits, X's, 12's, or Z1. Skip to I is normally wired from first card or total program exits.

Tape Exit

As each hole in the tape is reached or passed, the corresponding tape exit on the control panel emits an impulse. Tape exits are wired to interlock release to suppress interlocking when distances of 3-2/3 inches or less are skipped. They should never be wired to any other function.

Interlock Release

These entry hubs are wired from tape exit to suppress interlocking. Interlocking should never be suppressed for more than 3-2/3 inches.

60. *Card Cycles*. The upper five hubs in the left column emit impulses as any card passes the third station. The other eleven hubs are not active for MLP or heading cards. Card cycles are normally wired to counter control plus or minus, to counter exit suppression, or through a selector to control zone suppression or hammerlocking. One card cycles hub should not be wired to more than eight entry hubs.

61. *SP Control Entry — PU*. These hubs are common to 11-12 hubs of corresponding column splits on the summary punch control panel. When an entry hub is impulsed from summary punch X control + or -, an X is available from the column split to identify the summary card.

The PU (pickup) hub must be impulsed before summary punching will take place and is normally wired from one or more total program exits, to summary punch minor, intermediate and major totals. The impulse to the PU hub may be selected to eliminate summary punching for certain conditions, such as zero balances.

62. *SP-SW (Summary Punch Switch)*. These hubs must be connected for all summary punching. They synchronize the operation of the accounting machine and the summary punch.

63. *NB-AC (Negative Balance All Cycles)*. When these hubs are connected, an impulse will be available out of the negative balance test exit hub of a counter whenever the counter turns negative; the impulse continues as long as the counter remains negative. It is a means of detecting negative balances in counters on card cycles as well as on program cycles.

64. *Counter Control — Plus*. Each counter has two common plus entry hubs. When they are impulsed from card cycles, first card, total program or transfer control, the counter adds.

65. *Counter Control Minus*. Each counter has two common minus entry hubs. When they are impulsed from card cycles, first card, total program, or transfer control, the counter subtracts.

66. *Transfer and S.P. X Control. Plus and Minus*. These hubs may be used on net-balance machines only. They emit impulses under the following conditions:

a. The transfer plus hub of a counter emits an impulse whenever the total hub of that counter is impulsed, and negative balance control is not wired. If negative balance control is wired, transfer plus emits for plus totals, and transfer minus emits for minus totals. They are normally wired to the counter control hubs of receiving counters.

b. When the accounting machine is connected to a summary punch, the summary punch X control plus hub emits a summary punch X impulse whenever the total hub of that counter is impulsed. If negative balance control is also wired, summary punch control X plus emits an X impulse for plus totals, and summary punch control X minus emits an X impulse for minus totals. For summary punch operations, these hubs are normally wired to the summary punch control entries so that X's may be punched in summary cards for plus or minus balances.

During MLP operations, counters 2A through 4B are internally controlled to clear when an MLP-3 card passes the second and fourth stations. However, transfer plus and minus hubs do not emit at these times.

67. *Counter Exit Suppression*. When a counter exit suppression hub of a given counter is impulsed, exits from that counter are suppressed. They are normally wired from card cycles to suppress detail printing from the counter; from first card minor, intermediate or major to suppress printing from first cards of corresponding groups; from total programs to suppress total printing; and from negative balance test exit to suppress printing of negative balances.

68. *Negative Balance Test Exit*. Each counter has a negative balance test exit hub which emits an impulse when the counter is negative on a program cycle. When NB-AC is connected they emit impulses as described under 63. They are normally wired to counter exit suppression, to a pilot selector D pickup, to negative balance control, or to LIST.

69. *Negative Balance Control*. These hubs are standard on net balance machines only. Each counter has a pair of hubs which receive negative balance test exit impulses to convert complement balances to true figures.

70. *CI Carry Exit; C Carry Entry*. Whenever a counter is wired for subtraction, the corresponding counter CI-C must be connected. Whenever a counter is to be coupled with another, the CI of the counter containing the units position must be wired to C of the coupled counter, and CI of the coupled counter to C of the counter containing the units position. When a zero balance stands in the counter, an X impulse can be wired through C and CI to pick up a selector.

71. *CR Symbol Exit*. Standard for detail printing and total printing on a net balance machine, but only for detail printing on a non-net balance machine. When a CR is wired to an even-numbered numerical type bar, a CR symbol prints.

72. *Total*. Each counter has two common TOTAL hubs, which are normally wired from total program to cause the counter to read out and clear. They may also be wired from first card minor, intermediate or major, from selected card cycles, or from IC (indicate control).

INTERNATIONAL BUSINESS MACHINES CORPORATION

IBM 402, 403, AND 419 ACCOUNTING MACHINE, SPACING CHART

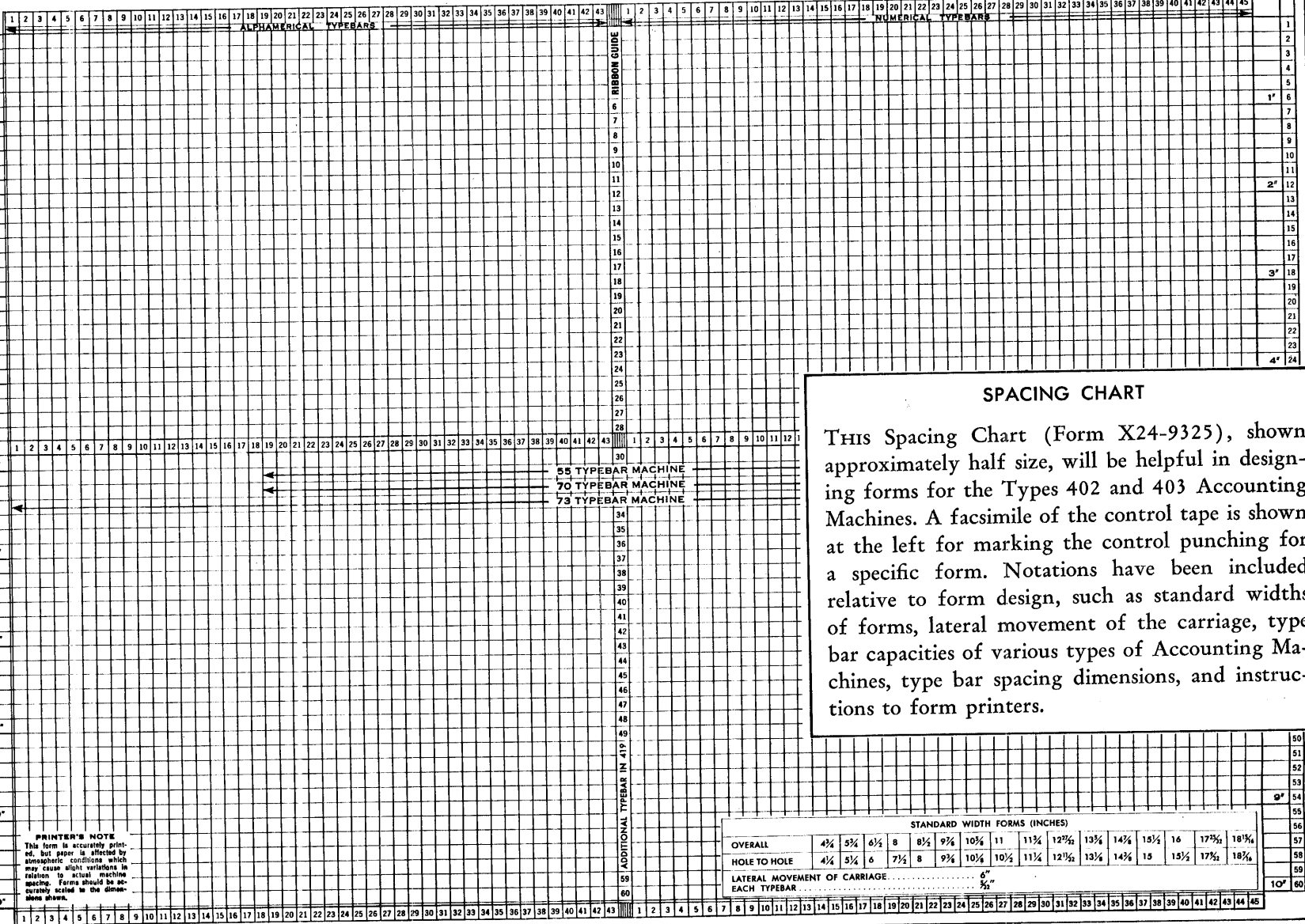
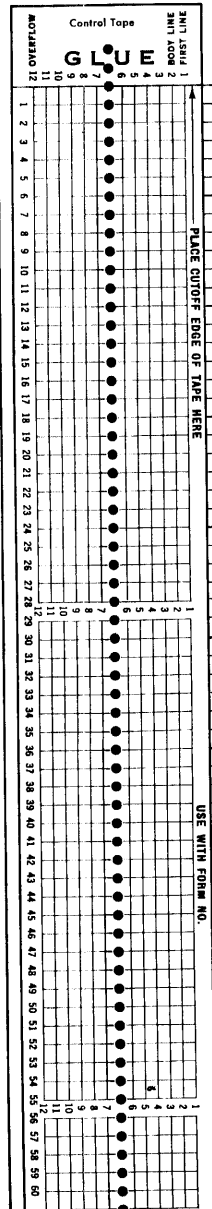

SPACING CHART

THIS Spacing Chart (Form X24-9325), shown approximately half size, will be helpful in designing forms for the Types 402 and 403 Accounting Machines. A facsimile of the control tape is shown at the left for marking the control punching for a specific form. Notations have been included relative to form design, such as standard widths of forms, lateral movement of the carriage, type bar capacities of various types of Accounting Machines, type bar spacing dimensions, and instructions to form printers.

STANDARD WIDTH FORMS (INCHES)																
OVERALL	4 $\frac{1}{4}$	5 $\frac{1}{4}$	6 $\frac{1}{2}$	8	8 $\frac{1}{2}$	9 $\frac{1}{2}$	10 $\frac{1}{2}$	11	11 $\frac{1}{2}$	12 $\frac{1}{2}$	13 $\frac{1}{2}$	14 $\frac{1}{2}$	15 $\frac{1}{2}$	16	17 $\frac{1}{2}$	18 $\frac{1}{2}$
HOLE TO HOLE	4 $\frac{1}{4}$	5 $\frac{1}{4}$	6	7 $\frac{1}{2}$	8	9 $\frac{1}{2}$	10 $\frac{1}{2}$	10 $\frac{1}{2}$	11 $\frac{1}{2}$	12 $\frac{1}{2}$	13 $\frac{1}{2}$	14 $\frac{1}{2}$	15	15 $\frac{1}{2}$	17 $\frac{1}{2}$	18 $\frac{1}{2}$
LATERAL MOVEMENT OF CARRIAGE EACH TYPEBAR	6 $\frac{1}{2}$ "													10"		

PRINTERS NOTE
This form is accurately printed, but paper is affected by atmospheric conditions which may cause slight variations in relation to actual machine spacing. Forms should be accurately scaled to the dimensions shown.

TIMING CHARTS

A CYCLE is a period of time required to complete a given series of events, at the end of which the series is repeated. On the Types 402 and 403, each cycle is divided into 20 equal parts called points. Each point of a cycle is further divided into 18 degrees. Thus, there are 360 degrees in a cycle measured on a scale from 0 to 0 (0 same as 360). The time required to read a card is from 0 to 216 (12 positions times 18). The part of the cycle from 226 to 360 normally represents the space between the cards as they go through the machine.

Control panel hubs are generally classified as exit or entry. Exit hubs emit impulses at a specified time during a 360-degree cycle, and entry hubs receive them.

The purpose of the timing charts (Figures 131 and 132) is to show in degrees the approximate time at which exit hubs emit and entry hubs receive. The Location column shows the position of the hubs on the control panel. For example, all-cycles hubs are located in horizontal row HH and in vertical rows 41-50. Codes under the Machine Cycle and Notes columns are described at the bottom of page 154.

It will be seen that all cycles, card cycles, and total program impulses start at the end of one cycle, break, and continue through the beginning of the next cycle. The first part (approximately 246 to 270), often referred to as EAC (early all cycles), is a setup impulse emitted at the end of one cycle to prepare the machine for the next cycle. The second part, referred to as LAC (late all cycles), is available at approximately 320 degrees of one cycle and lasts until 180 degrees of the next cycle. It is during this part of the cycle that cards are read and counters add, subtract or clear.

Program couple hubs emit uninterrupted impulses that start before EAC and end after LAC so that they may be used to pick up selectors through which normal EAC-LAC impulses may be controlled. The EAC impulse from the first card hubs are available earlier than the normal EAC for the same reason.

Cycles impulses should never be wired through digit selectors. Digit selectors are used only to

select digits read from the card or impulses available from digit impulse exit hubs.

Some impulses, for example, OF and negative balance test exit, start during the EAC part of the cycle. If these hubs are wired directly to minor program start, the EAC portion of card cycles impulses emits on the minor program cycle; the EAC portion of minor program exits and minor couple does not emit. For these reasons, functions controlled from the EAC portion of card cycles, such as counter exit suppression and immediate hammerlock control, would operate not only on card cycles but also on the minor program cycle. Therefore, minor totals would fail to print from a counter which was exit suppressed on card cycles, or from type bars hammerlocked on card cycles. In addition, functions controlled from the EAC portion of the minor program exit, such as carriage skip to I, would not receive an impulse. Furthermore, negative totals would not be converted because the EAC portion of minor program exit must reach the counter total hub in order to allow negative balance control to receive a negative balance test exit impulse.

The following entry hubs on the control panel accept only EAC impulses: List, Non-print, Hammerlock I, Skip to I, Machine Stop, Space Control S, 1, 2, 3.

These hubs cannot be wired directly from the reading brushes, since digits read from the card are available during LAC time.

Selectors. Reference to the Timing Chart (page 155) will show that the DPU of pilot selectors may be impulsed at normal entry time (9 through 12), and at other times not considered normal. Pilot selector operation under all conditions is described below:

DPU	SELECTOR TRANSFERS	SELECTOR DROPS
Digits (9-12) "10" impulse	235° of cycle impulsed	225° of next CF cycle
(program only) LAC time	235° of cycle impulsed	225° of next CF cycle
(320° to 180°) EAC time	235° of cycle impulsed	225° of next CF cycle
(235° to 270°) NB Test Exit	Immediately	225° of next CF cycle
(255° to 267°)	275° of cycle impulsed	225° of next CF cycle

First Card MI, INT, and MAJ impulses wired to DPU will transfer selectors for the first and second cards of the group. Program couple and program exits will transfer the selector for that program, all subsequent programs, and the first card of the next group.

Any impulse to the I pickup of a pilot selector or co-selector (except CI CARRY EXIT) will cause the selector to transfer immediately and remain transferred until 225° of the *same* cycle.

As a general rule, allowance of from 4 to 7 degrees should be made between the time the selector begins to transfer and the starting time of the impulse to be selected because of the variable lag in the actual transfer of selectors. For this reason, co-selectors or pilot selectors impulsed to transfer at 235 degrees do not actually transfer until approximately 239 degrees. It would not be safe,

therefore, to select an impulse beginning or ending during this lag period. For example, first card impulses should not be selected through a selector picked up from a setup change switch since the timing of both impulses is the same (235 degrees).

Line Impulses. Line impulses (those that are active for 360°) are the inverted form, special program, and summary punch switches. Each switch has an exit hub and an entry hub. They operate as switches when the exit hub is connected to the entry hub. Exit and entry hubs of the inverted form and special program switches cannot be connected together through selectors because they burn selector points when the selectors transfer. Exit and entry hubs of the summary punch switch may be connected together through the transferred side of selectors because of internal circuits not shown on the timing chart.

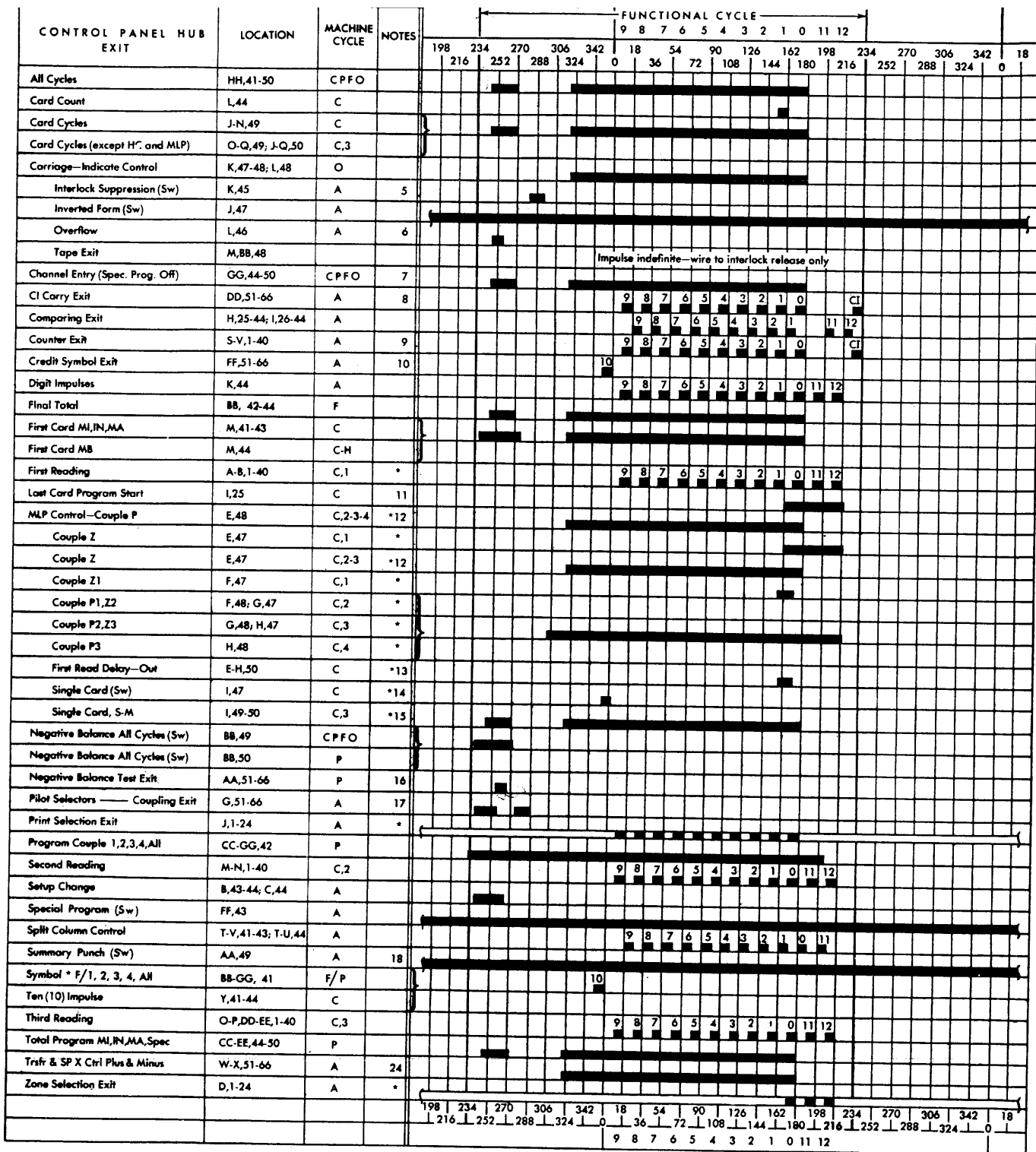

* TYPE 403 ONLY

MACHINE CYCLES CODE

- A All cycles
- A-M All cycles except third and fourth stations MLP cards
- A-Z All cycles except second, third and fourth stations MLP cards
- C Card cycles
 - 1 First reading station
 - 2 Second reading station
 - 3 Third reading station
 - 4 Fourth station
- C-H Card cycles except heading cycles
- F Final total cycle
- O Overflow indicate cycle
- P Program cycles

NOTES



- 5 Except overflow cycles
- 6 Caused by sensing "12" hole from tape. Ineffective when sensed during a skip
- 7 Active only when special program device is installed
- 8 Except when total hub is impuised
- 9 Except on run-in cycles; also, on first and third line cycles of MLP-3 cards for counters 1-24
- 10 On non-net balance machines, exit for card cycles only
- 11 First card in and last card out
- 12 May be used as entries for selected cycle impulses to pick up MLP selector during non-MLP operations
- 13 MLP control first read delay IN wired
- 14 Single card group when programming between first and second reading stations

- 15 Not active for MLP and heading cards
- 16 Also card cycles when NB-AC switch is ON
- 17 Active as an exit for every cycle that the selector is transferred
- 18 360° (line) impulse. May be selected under control of setup change switch. Other line impulses should not be selected
- 19 When C carry entry and total hubs are impuised on the same cycle, carry does not go beyond the units position
- 20 Effective for overflow except for simultaneous skip to 1 or head control pickup. Action delayed for program cycles and for space suppression when impuised from coupling exits
- 21 Except during summary punch cycles
- 22 Not to be used as entries
- 23 Effective for entry as an MLP-3 card passes second reading station

- 24 When respective counter total hub is impuised
- 25 First reading station on MLP cards
- 26 Not receptive on MLP cards
- 27 If impuised between 246-270 (usually from overflow or negative balance test exit) EAC portion of card cycles will emit on minor program, while EAC of minor program and minor program couple will not emit
- 28 MLP cards; also when couple P is impuised on non-MLP cycles
- 29 MLP cards; also when couple Z is impuised on non-MLP cycles
- 30 Counters 2A through 4B (1-24) not receptive when MLP-3 card is at second and fourth stations

WIRING DIAGRAM NO. 318201-N

FIGURE 131. TIMING CHART, EXITS

ENTRY NORMAL  OTHER 

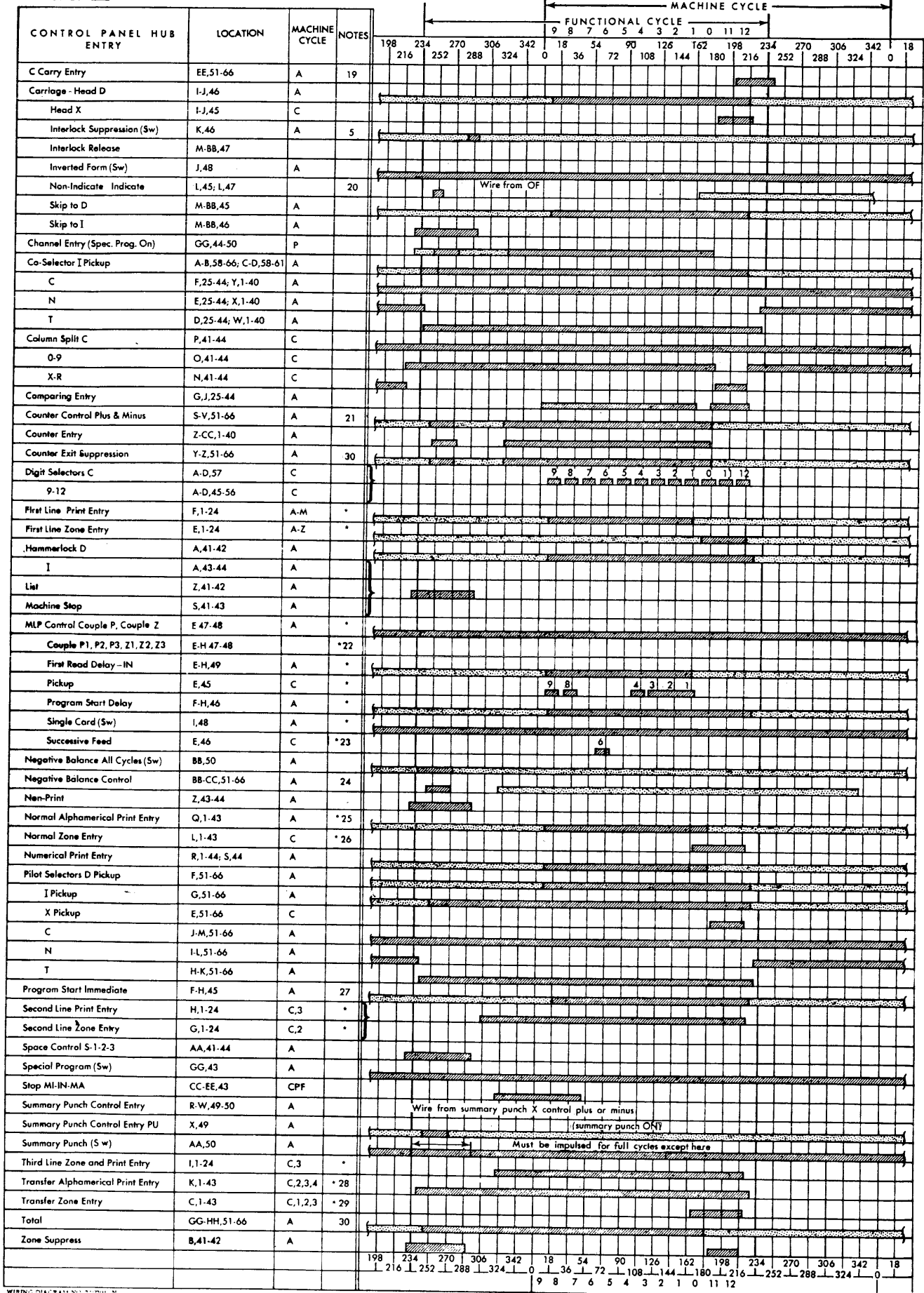

FIGURE 132. TIMING CHART, ENTRIES

INDEX

	Page		Page
Addition	17	Group Indication Elimination (non-print)	56
All Cycles,	10, 147	Group Printing	26
Alphabetic Control	26	Hammerlock Control	42
Asterisk Symbol	23, 147	Hammerlock Hubs	43, 145
Bus Hubs	91, 146	Hammerlock Levers (Figure 33)	42
C (Carry Entry)	29, 150	Hammersplit Levers (Figure 12)	17
Card Count	58, 146	Head Control	102, 149
Card Cycles	18, 149	Hopper Stop Switch	87
Card Feed Delay	116	Idling Light	8
Card Feed Stop Light	8	Indicate Control (IC)	107, 149
Card Feeding 403	114	Inserting Tape in Carriage (Figure 87)	97
Carriage, Tape-Controlled	93	Interlock Release	95, 102, 149
Channel Entry	88, 147	Interlock Suppress	100, 149
CI (Carry Exit)	29, 150	Intermediate First Card	45, 146
Class Selection	65	Introduction	5
Column Split	43, 146	Inverted Form (INV-F)	110, 149
Comparing Entry	21, 145	Inverted Form Operations	109
Comparing Exit	21, 145	Keys	8, 96
Comparing Unit	21	Last Card Auto Total Switch	87
Control	21	Last Card Program Start	22, 145
Control Panel	6, 144	Lights	8
Control Panel Summary (Figure 130)	143	List	11, 146
Control Tape (Figure 84)	95	Long Hammerlock Levers (Figure 33)	42
Co-Selector	45, 145, 152	Machine Stop	74, 146
Co-Selector Pickup	45, 147	Main Line Switch	8
Counter Control Minus	28, 150	Major First Card	45, 146
Counter Control Plus	18, 150	Method of Addition	21
Counter Entry	18, 145	Method of Net Balance Conversion	31
Counter Exit	20, 143	Method of Subtraction	31
Counter Exit Suppression	34, 150	Minor Body	45, 146
Counter Total	18, 150	Minor First Card	45, 146
Couple MLP Control	116, 148	Missing Heading or Missing Body Cards	105, 111
Couple Total Program	69, 147	MLP Cards Followed by Normal Cards	124
CR Symbol Exit	30, 150	MLP Control Couple	116, 148
Crossfooting Five Fields	91	MLP Control Pickup	116, 148
Crossfooting Net Balance Machine (three fields)	56	MLP 4	115
Crossfooting Non-Net Balance Machine (three fields)	58	MLP Program Start—DE	124, 148
Crossfooting Ten Totals	91	MLP Selector Expansion	127
Crossfooting Using MLP Selector System (three fields)	133	MLP Selector System (Figure 109)	121
Date Printing	39, 86	Multiple Heading Group	107
Detail Printing, Alphabetic	13	Multiple Line Printing	116
Detail Printing, Numerical	9	Multiple Line Printing Card	113
Detail Printing with Minor, Intermediate and Major Program	23	Multiple X Selection	72
DI	38, 145	Negative Balance Control	30, 150
Digit Emitters	38	Negative Balance	75
Digit Selection	38	Negative Balance Test Exit	30, 150
Digit Selectors	38, 147	Net Balance Subtraction	28
Double Spacing	68	NB-AC Switch	75, 150
Expanding Program Exits	71	Non-Net Balance Subtraction	34
Feed Interlock Start Button	87	Non-Print	56, 146
Field Selection, Alphabetic	62	Non-Print Run Out Button	87
Field Selection, Alphabetic and Numerical	63	Normal Alphanumerical Print Entry	10, 143
Field Selection, Numerical	61	Normal Skip Stop	95
Final Total	19, 146	Normal Zone Entry	14, 143
Final Total Key	8	Numerical Control	22
First Body Line Stop	95	Numerical Print Entry	10, 143
First Card Minor, Intermediate, Major and MB	45, 146	Offset Total Printing	40
First Card Spacing	71	Operating Switches and Signals	8
First Line Print Entry	119, 143	Overflow Control	95
First Line Zone Entry	118, 143	Overflow NI-OF-I	104, 149
First Printing Line Stop	95	Overflow Sheet Identification	107
First Read Delay	118, 148	Overflow Skipping	107
First Reading	118, 143	Page Total Control	95
Five Field Crossfooting	91	Paper Brake and Form Stop Device (Figure 90)	99
Form Control	100	Path of Card 402	10
Form Feed	98	Path of Card 403	113, 115
Form Feeding Devices	135	Pilot Selectors	28, 147, 152
Form Light	8	Pin-Feed Platen Device	135
Form Stop Device	99	Platen (Figure 88)	98
Form Thickness Adjusting Device (Figure 89)	98	Platen Clutch (Figure 86)	97
Forms Tractor	140	Platen Knob (Figure 86)	97
Four Minor Totals from the Same Type Bars	88	Platen Shift (Figure 90)	99
Fuse Light	8	Predetermined Total Line	107
Gang Punch Switch	87	Pressure Release Lever (Figure 90)	99
Group Indication	45	Print Selection Exit	119, 143

INDEX (continued)

	Page		Page
Print Selection MLP	119	Transfer and SP X Control—Plus, Minus	50, 150
Print Unit	9	Transfer Zone Entry	119, 143
Program Control	21	Triple Spacing	68
Program Control, Alphabetic (Figure 19)	26	Vernier Knob (Figure 86)	97
Program Control, Numerical (Figure 17)	23	Wiring Diagrams	
Program Exit Expansion	71	Addition (Figure 14)	20
Program Start DE	124, 148	Address Printing (Figure 107)	120
Program Start I	22, 148	Class Selection, Alphabetic (Figure 57)	67
Progressive Total Printing	86	Class Selection, Numerical (Figure 56)	66
Restore Key (Figure 86)	97	Crossfooting, Net Balance (Figure 48)	58
Ribbon Replacement	142	Crossfooting, Non-Net Balance (Figure 49)	59
Run Out Buttons	87	Crossfooting Ten Totals (Figure 83)	92
Schematic Diagram of MLP Selector System	121	Crossfooting Using MLP Selector System (Figure 117)	133
Schematic Diagram of Selector	29	Detail Printing, Alphabetic (Figure 11)	16
Second Line Print Entry	119, 143	Detail Printing, Numerical (Figure 8)	13
Second Line Zone Entry	118, 143	Digit Emitting (Figure 29)	39
Second Reading	14, 143	Digit Selection (Figure 28)	38
Selective Printing	39	Field Selection, Alphabetic (Figure 52)	62
Selectors, Co-Selectors	45, 145, 152	Field Selection, Alphabetic and Numerical (Figure 54)	63
Selectors, Pilot	28, 147, 152	Field Selection, Numerical (Figure 51)	61
Setup Change	48, 145	First Card Spacing (Figure 63)	71
Sheet Identification, Overflow	107	Five Field Crossfooting (Figure 82)	91
Short Form Skipping	100	Four Minor Totals from Same Type Bars (Figure 81)	89
Short Hammerlock Levers (Figure 33)	42	Group Indication (Figure 39)	45
Single Card S, M	131, 148	Hammerlock Comparing Exit Control (Figure 36)	44
Single Card Switch	131, 148	Hammerlock D and ND Control (Figure 35)	44
Single Card Total Elimination	130	Hammerlock Total Program Control (Figure 37)	44
Single Heading Forms	102	Hammerlock X and NX Control (Figure 34)	43
Single Sheet Form Feeding	112	Heading Forms (Figure 94)	104
Skip to D-I	100, 149	Inverted Form (Figure 98)	110
Skipping, Overflow	107	Machine Shop (Figure 67)	74
Space Control	68, 146	Minor and Intermediate Totals on the Same Line (Figure 62)	70
Space Key (Figure 86)	97	MLP Cards Followed by Normal Cards (Figure 111)	125
Space Suppression	69	Multiple Heading Groups (Figure 96)	108
Spacing Chart	11, 151	Multiple X Selection (Figure 66)	73
Special Character	17	Negative Balance (Figure 68)	75
Special Program	88	Offset Total Printing (Figure 32)	42
Special Program Switch	88, 147	Printing Minor, Intermediate and Major Totals from the Same Type Bars Net (Figure 44)	51
Split Column Control	76, 146	Printing Minor, Intermediate and Major Totals from the Same Type Bars Non-Net (Figure 46)	55
Start Key	8	Printing Minor, Intermediate and Major Totals from Different Type Bars (Figure 45)	52
Stop Key	8	Program Exit Expansion (Figure 64)	71
Stop Key, Carriage (Figure 86)	97	Programming Alphabetic (Figure 19)	26
Stop Light	8	Programming Numerical (Figure 18)	23
Stop—Minor, Intermediate, Major	88, 147	Progressive Total Printing (Figure 78)	86
Subtraction	26	Selective Printing (Figure 30)	40
Successive Feed (SF)	127, 148	Selector Expansion (Figure 113)	129
SP Control Entry	78, 149	Setup Change (Figure 42)	49
SP-SW (Summary Punch Switch)	77, 149	Sheet Identification (Figure 96)	108
Summary Punching	77	Short Form Skipping (Figure 92)	102
Summary Punch Elimination of Zero Balance	83	Single Card Total Elimination (Figure 116)	131
Summary Punching More than One Class of Total	85	Space Control (Figures 58, 59, 60, 61)	68
Suppression, Counter Exit	34, 150	Subtraction, Net Balance (Figure 24)	32
Switches	8, 87	Subtraction, Non-Net Balance (Figure 25)	34
Tape Channels	95	Successive Feed (Figure 113)	129
Tape-Controlled Carriage	93	Summary Punch, Net Balance Machine (Figure 73)	78
Tape Exit	102, 149	Summary Punch, Non-Net Balance Machine (Figure 74)	81
Tape Punching	96	Summary Punching Totals on Two Cards (Figure 76)	84
Ten ("10")	146	Summary Punching Elimination of Zero Balance (Figure 75)	82
Tension Adjustment (Figure 90)	99	Total Program Couple (Figure 62)	70
Third Line Print	119	X Selection (Figure 27)	36
Third Line Zone	118	Zone Suppress (Figure 54)	63
Third Line Zone and Print Entry	143	X Selection, Single	36
Third Reading	10, 143, 145	X Selection, Multiple	72
Timing Charts (Figures 131, 132)	152	Zero Balance Summary Punch Elimination	83
Total	18, 150	Zero Carry Clip (Figure 12a)	17
Total Printing from Different Type Bars	52	Zero Printing	16
Total Printing from Same Type Bars	50	Zone Selection Exit	119, 143
Total Printing (Offset)	41	Zone Selection MLP	118
Total Program	22, 147	Zone Suppress	63, 145
Total Program Couple	69, 147		
Total Space Control	69		
Total Transfer Net Balance Machine	50		
Total Transfer Non-Net Balance Machine	55		
Transfer Alphanerical Print Entry	119, 143		



International Business Machines Corporation
Data Processing Division
112 East Post Road, White Plains, New York