

**Reference Manual**

**IBM 85 and 87 Collators**



**Reference Manual**

**IBM 85 and 87 Collators**

MINOR REVISION (May, 1960)

This edition, A24-1005-2, is a minor revision of the preceding edition, but does not obsolete A24-1005-1. Principal changes in this edition are:

<u>PAGE</u>	<u>SUBJECT</u>
28	Cycle delay, pickup
35	Wiring (Figure 31), Steps 4 and 5
38, 39	Wiring (Figure 35), Steps 4 and 5
107	Item 16, Cycle delay PU
110	85 Timing Chart, Note 10
111	85 Timing Chart: DI, Error Stop
113	87 Timing Chart: DI, Error Stop

© 1958, 1960 by International Business Machines Corporation

Copies of this and other IBM publications can be obtained through IBM Branch Offices. Address comments concerning the content of this publication to:  
IBM, Product Publications Department, Rochester, Minnesota.

# Contents

INTRODUCTION . . . . .	5	Selecting the First Card of a Group — Both Feeds (IBM 85 Only) . . . . .	68
Operations . . . . .	5	Selecting Zero-Balance Cards — More than 16 Columns . . . . .	70
Machine Features . . . . .	6	Checking Sequence — More than 16 Columns (IBM 85 Only) . . . . .	71
OPERATING PRINCIPLES . . . . .	8	Merging — More than 16 Columns (IBM 85 Only) . . . . .	72
Sequence . . . . .	8	Mixed Merging . . . . .	73
Schematic Diagram . . . . .	8	Matching Card-for-Card . . . . .	74
Analysis Chart . . . . .	9	Merging Small Groups of Cards . . . . .	76
Run-In Feeding . . . . .	10	Merging Primaries behind Secondaries . . . . .	77
PRINCIPLES OF CONTROL PANEL WIRING . . . . .	11	Merging, Selecting Single Unmatched Primaries	79
Merging Two Groups of Unpunched Cards . . . . .	13	Merging or Matching by a Range of Numbers	81
Selecting X-Cards — Primary Feed . . . . .	14	ALPHABETIC COLLATING FEATURE (IBM 85 Only)	84
Selecting X-Cards — Both Feeds . . . . .	16	COLLATOR COUNTING FEATURE . . . . .	86
Blank-Column Detection . . . . .	17	Inserting a Predetermined Number of Cards ahead of Each Master Card . . . . .	86
Checking Sequence . . . . .	19	Inserting a Predetermined Number of Cards behind Each Master Card . . . . .	88
Recognizing a Change between Control Groups	24	Inserting a Variable Number of Cards ahead of Each Master Card . . . . .	89
Selecting the Last Card of a Group if an X-Card	26	Inserting a Variable Number of Cards behind Each Master Card . . . . .	90
Selecting the First Card of a Group . . . . .	27	Inserting up to 199 Cards behind Each Master Card . . . . .	92
Selecting Single-Card Groups, or Multiple-Card Groups . . . . .	29	Inserting a Single Card ahead of a Predetermined Number of Cards within a Control Group . . . . .	93
Selecting Zero-Balance Cards . . . . .	30	Inserting a Set of Cards ahead of a Predetermined Number of Cards within a Control Group . . . . .	95
Merging . . . . .	32	Merging a Predetermined Number of Primaries and Secondaries . . . . .	96
Merging with Selection . . . . .	40	Checking Consecutive Numbers . . . . .	97
Basic Setup Summary . . . . .	47	SPLIT SELECTOR AND SEQUENCE UNIT FEATURE (IBM 85 ONLY) . . . . .	99
Matching . . . . .	50	Coupling Two Groups . . . . .	100
TYPICAL OPERATIONS . . . . .	52	Selecting Cards by Any One of Four Control Numbers . . . . .	100
Selecting Alternate Cards . . . . .	52	Merging by Major and Minor Control; Selecting Unmatched Majors . . . . .	102
Comparing Two Fields in the Same Card — Primary Feed . . . . .	53	CONTROL PANEL SUMMARY . . . . .	104
Comparing Two Fields in the Same Card — Secondary Feed . . . . .	54	85 COLLATOR TIMING CHART . . . . .	110
Selecting Cards by a Control Number . . . . .	55	87 COLLATOR TIMING CHART . . . . .	112
Selecting Cards by a Control Number, Interspersed X-Finder Cards — Primary Feed . . . . .	56	INDEX . . . . .	114
Selecting Cards by a Control Number, Interspersed Finder Cards — Secondary Feed . . . . .	58		
Selecting Cards by Either of Two Control Numbers . . . . .	59		
Selecting Cards between Two Control Numbers	60		
Checking Master-and-Detail Groups . . . . .	62		
Checking that an X-Card Is Last in a Group	63		
Inserting Cards behind Specific Groups . . . . .	64		
Checking Sequence, Selecting All Low Cards	65		
Checking Sequence — Both Feeds (IBM 85 Only) . . . . .	66		



IBM 85 COLLATOR

## IBM 85 and 87 Collators

THE IBM 85 Collator and the IBM 87 Collator are filing machines that arrange cards in the order desired for subsequent operations. These two machines are essentially alike in design, features, and operation; the main difference is that cards punched with numerical characters can be processed in the 85 Collator, but cards punched with numerical, alphabetic or special characters can be processed in the 87 Collator. After the cards are arranged, they are either processed through another machine, such as an accounting machine to prepare a printed report, or they are filed for future reference.

The principal function of the collator is to feed and compare two files of punched cards simultaneously to match them or combine them into one file. At the same time, cards in each file that do not match those in the other can be separated automatically from the rest of the file.

Two hoppers and feed units are provided to accommodate the two files of cards, and four pockets are provided to stack the cards in the desired groupings. When cards are fed from the hoppers, the punching in them is compared, and card feeding and stacking are controlled by this comparison.

The basic operations that can be performed on the collator are: selecting specific cards from a file; checking the sequence of cards in a file; combining two files into one complete file, with or without the selection of cards; matching two files of cards by selecting any unmatched cards from each file; and detecting

unpunched columns. These operations, and combinations of them, are explained in the following paragraphs and illustrated throughout the manual.

Basically both the 85 and 87 Collators function in the same manner. In this manual, the wiring for each operation is illustrated for the 85; however, most operations can easily be adapted to the 87. Any change required for 87 operation is described for each diagram.

### OPERATIONS

THE OPERATIONS of the collator fall into six general classifications:

- Card Selection
- Checking Sequence
- Merging
- Merging with Selection
- Matching
- Blank-Column Detection

*Card Selection.* A particular card may be selected from a file of cards. The type of card to be selected may be an X-card, an NX-card, the first card of a group, the last card of a group, a single-card group, a zero card, a card with a particular number, a card with a particular name, or a card out of sequence.

*Checking Sequence.* The collator checks a file of cards to determine whether or not they are in order. As the cards are fed through the machine, each card

is compared with the one ahead and, if it is out of sequence, the machine stops and an error light turns on.

*Merging.* The collator combines two files of cards, already in sequence, into a single file. The cards in one file are compared with those in the other, and feeding from the two files is thereby controlled so that the combined file is in numerical sequence.

*Merging with Selection.* Cards in one file that do not have corresponding cards in the other file are selected as the two files are merged. Cards can be selected from either or both files and, when the operation is completed, there may be three groups of cards: one merged file and two groups of selected cards.

*Matching.* The collator compares two files of cards to determine that there is a card or group of cards in one file to match each card or group of cards in the other file. Unmatched cards in either or both files are selected. When the operation is completed, there may be four groups of cards: two groups that match and two groups of selected cards.

*Blank-Column Detection.* Cards in both feeds can be checked for blank columns. Whenever a blank occurs in a field wired for detection, card feeding stops and a blank-column-detection light turns on. Blank-column detection can be combined with any of the other operations.

## MACHINE FEATURES

### Main Line Switch

The main line switch, located on the right side of the machine, controls the power and must be on before the machine can be operated. This switch must not be turned off while cards are being fed.

### Operating Keys and Lights (Figure 1)

*Start Key.* Depression of the start key will start card feeding. It must be held down for three cycles before automatic operation begins.

*Stop Key.* The stop key is depressed to stop card feeding. It has a slightly raised surface for easy identification.

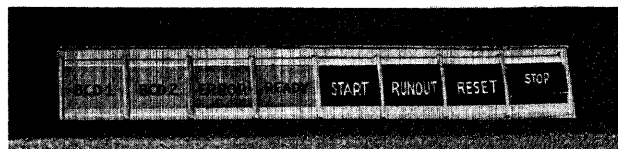

FIGURE 1. KEYS AND LIGHTS

*Run-Out Key.* The machine stops after the last card is fed from either hopper. The run-out key must be held depressed to move the cards remaining within the machine to the pockets.

*Error Light.* The red error light turns on when the machine stops because of an error condition recognized by control panel wiring. For example, the machine can be controlled so that it will stop if an error in sequence is detected.

*Reset Key.* When the error light or a blank-column-detection light is on, the reset key must be depressed before the machine can be restarted.

*Ready Light.* The green ready light turns on whenever the main line switch is on and cards are not passing through the machine.

*BCD 1 (Blank-Column-Detection 1).* This red light turns on whenever a blank column is detected in a field wired to BLANK COLUMN DETECTION ENTRY ONE on the control panel.

*BCD 2 (Blank-Column-Detection 2).* This red light turns on whenever a blank column is detected in a field wired to BLANK COLUMN DETECTION ENTRY TWO on the control panel.

### Hoppers

The collator has two separate feed units — primary and secondary. The secondary feed is located above the primary feed. Cards placed in the primary feed hopper are called primary cards, and those placed in the secondary feed hopper are called secondary cards.

Cards are placed in the hoppers face down, 9's toward the throat. Each hopper holds about 800 cards and is equipped with a hopper stop contact. As soon as the last card is fed from either hopper, the machine stops. Additional cards can be placed in the hopper, and card feeding can be resumed by depressing the start key.

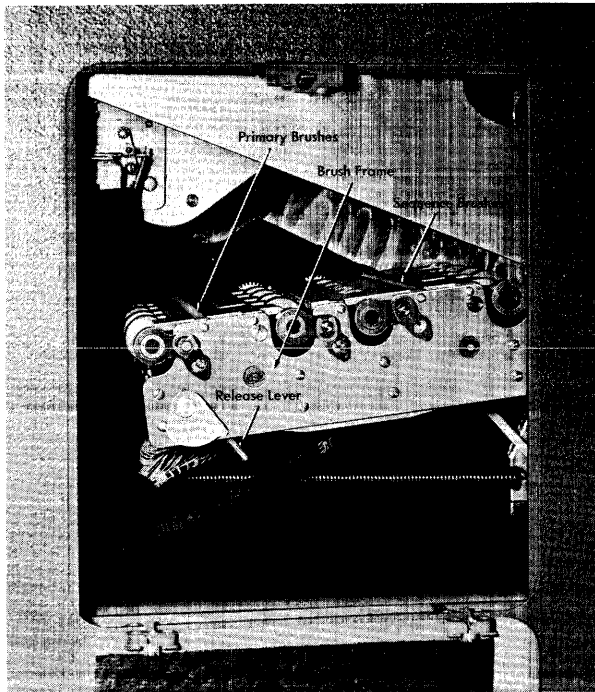

FIGURE 2. PRIMARY FEED BRUSHES

Cards fed from the primary feed hopper pass two sets of 80 brushes — sequence and primary. The brushes are located on an angle when locked into position. They become accessible when the access door on the front of the machine is opened, the release lever is moved to the right, and the brush frame is lowered (Figure 2).

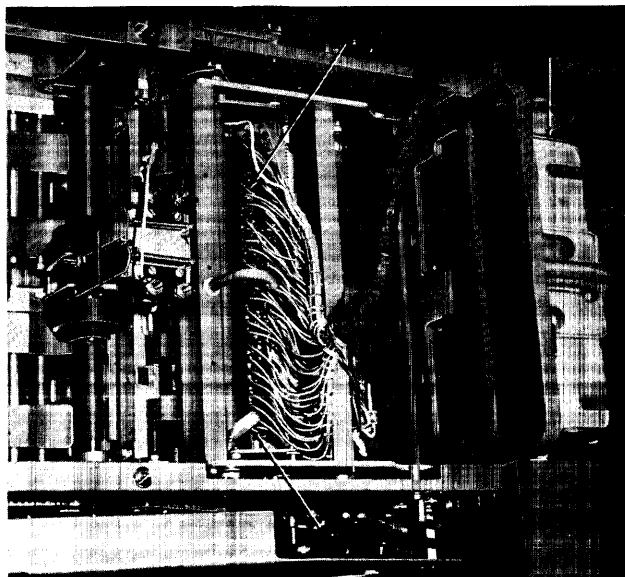

FIGURE 3. SECONDARY FEED

Cards fed from the secondary feed hopper pass only one set of 80 brushes (Figure 3). These brushes are located on the top of the machine and become accessible when the release lever is moved to the extreme right and the brushes are raised.

### Pockets

After cards are read by the brushes, they pass into one of four pockets, or stackers (Figure 4). Each pocket holds about 1,000 cards and is equipped with a contact to stop the machine when the pocket is full. The four pockets are numbered 1 to 4, from right to left. Cards fed from both hoppers will be stacked in pocket 2 unless directed by control panel wiring to one of the other three pockets. Cards fed from the primary feed hopper can be selected into pocket 1; those from the secondary feed hopper can be selected into pocket 3 or 4. Thus, pocket 1 is for selected primary cards, pocket 2 is for merged cards, and pockets 3 and 4 are for selected secondary cards.

### Operating Speed

Each feed can operate at a speed of 240 cards per minute. When both feeds are operating simultaneously, 480 cards per minute can be fed. The number of cards fed will range between 240 and 480 cards per minute depending on the control of the feeds required by the operation.

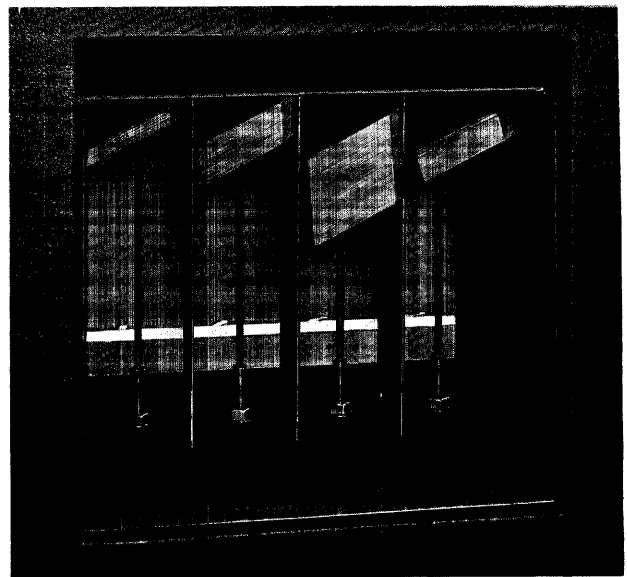

FIGURE 4. CARD POCKETS



# Operating Principles

MOST of the operations mentioned previously (such as checking sequence or merging) require that two numbers be compared. This is true regardless of whether the operation is performed manually, or automatically by the collator. In checking sequence for example, the number in one card must be compared to that in the preceding card to insure that the cards are in order; or, in a merging operation, the number in a card in one file must be compared with the number in a card in another file to determine which card should be filed first in the merged file.

In a collator operation, after the cards are read and their numbers are compared, the result of the comparison is used to control the advancing of the cards to the pockets and the feeding of the following cards.

## SEQUENCE

CARDS are arranged in numerical order, 0-9, in the 85 Collator. In the 87 Collator, cards punched with the various types of information are arranged in ascending order as follows:

1. Blank Column

2. Special Characters

12-3-8	(.)
12-4-8	(□)
12	(&)
11-3-8	(\$)
11-4-8	(*)
11	(-)
0-1	(/)
0-3-8	(,)
0-4-8	(%)
3-8	(#)
4-8	(@)

3. Letters A through Z

4. Digits 0 through 9

## SCHEMATIC DIAGRAM

THE SCHEMATIC DIAGRAMS in Figure 5 show the paths of the cards from the hoppers to the pockets, the reading stations, and the comparing units. They are, in effect, cutaway views of the collators. In each schematic the lower line, drawn at an angle, represents the primary feed, and the upper line represents the secondary feed; the four pockets at the left are labeled to indicate the types of cards that are usually stacked in them.

*Primary Feed.* As cards are fed from the primary feed hopper to a pocket, they pass two reading stations — sequence read and then primary read. Each reading station consists of a set of 80 brushes that read all columns of the card. Sequence read and pri-

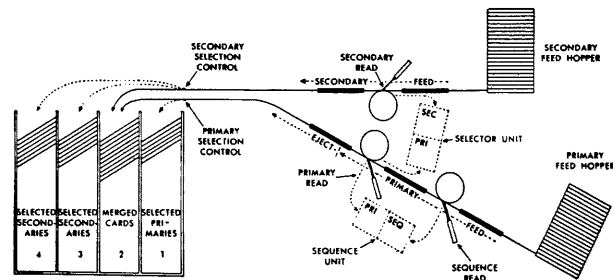

A. IBM 85 COLLATOR

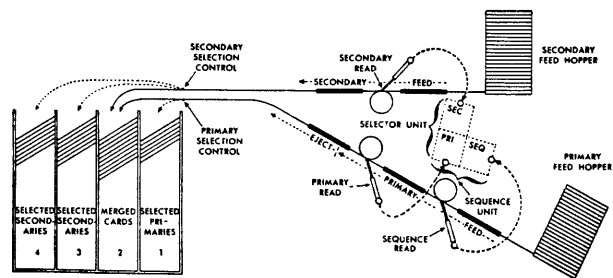

B. IBM 87 COLLATOR

FIGURE 5. SCHEMATICS OF CARD FEEDS

primary read are normally connected, by control panel wiring, to the sequence unit to compare the cards at the two reading stations. In addition, primary read is normally connected to the selector unit to compare the primary card to a card in the secondary feed.

If card feeding is stopped in the midst of a run, cards in the primary feed are positioned as indicated in the schematics: before sequence read, between sequence read and primary read, and after primary read (eject position).

*Secondary Feed.* As cards are fed from the secondary feed hopper to one of the pockets, they pass one reading station — secondary read. This reading station consists of a set of 80 brushes that read all the columns of the card. Secondary read is normally connected, by control panel wiring, to the selector unit to compare the secondary card to the card passing primary read.

If card feeding is stopped in the midst of a run, cards in the secondary feed are positioned as indicated: before secondary read, and after secondary read.

*Selector Unit.* The selector unit consists of 16 comparing positions in the 85 Collator and 19 comparing positions in the 87 Collator. Each position has two entries: primary and secondary. A number read into the primary selector entry is compared to a number read into the secondary selector entry in the corresponding positions. The selector unit is normally used to compare primary and secondary cards to determine whether they are equal, or if unequal, which of the two is lower. These conditions may be recognized by control panel wiring to cause feeding and selection of cards.

In the 87 Collator, primary selector entry is also used as the entry to the primary sequence side of the sequence unit (Figure 5B).

*Sequence Unit.* The sequence unit consists of 16 comparing positions in the 85 Collator and 19 comparing positions in the 87 Collator (Model I).

In the 85 Collator, each comparing position has two entries: primary sequence and sequence. A number read into the sequence entry is compared with a number read into primary sequence entry in the corresponding positions. The sequence unit is normally

used to compare two cards in the primary feed to determine whether the card passing sequence read is higher than, equal to, or lower than the card passing primary read. These conditions may be recognized by control panel wiring to indicate errors in sequence and to cause feeding and selection of cards.

In the 87 Collator, the two entries to the sequence unit are the primary selector entry (instead of the primary sequence entry used on the 85) and the sequence entry (Figure 5B).

In the 85 Collator, the functions of the selector and sequence units are identical and, therefore, the units can be used interchangeably. That is, two numbers read from any reading stations can be compared in any position of either unit. The only time the units cannot be used interchangeably is when feeding is controlled by an internal system known as "basic setup"; the units must then be used in the manner described.

In the 87 Collator, as in the 85, the functions of the selector and sequence units are identical. However, in the 87 Collator, primary selector entry serves as an entry to both the selector and sequence units. Therefore, anything read into primary selector entry is automatically compared with a reading in the secondary side of the selector unit and also with a reading in the sequence side of the sequence unit. This differs from the 85, which has separate pairs of entry hubs for the two comparing units. This means that in the 87 the comparing units cannot be used independently in the same operation, nor can they be as freely interchanged as in the 85.

## ANALYSIS CHART

OPERATIONS to be performed on either collator should be thoroughly analyzed before any attempt is made at control panel wiring. The various conditions that may arise as cards are fed should be studied, and the relationship between the cards translated into machine terms. An analysis chart can be used to aid this study. This chart is a modification of the schematic diagram, with the following places provided to write in representative numbers: three "cards" in the primary feed, two "cards" in the secondary feed, four squares representing the entries to the selector and sequence units, and four "pockets."

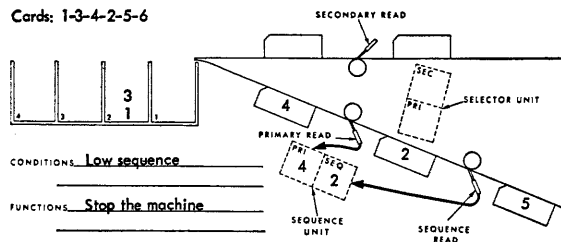

FIGURE 6. ANALYSIS CHART — IBM 85

An example of the use of the analysis chart for the 85 Collator is shown in Figure 6. The numbers in this illustration are singled out for analysis from a file of cards numbered 1-3-4-2-5-6. The cards are to be checked for sequence. The number (4) in the card that has just passed primary read is entered in the primary sequence entry, and the number (2) in the card that has just passed sequence read is entered in the sequence entry. It can readily be seen that whenever a card is out of sequence (the 2-card following the 4-card in this case) sequence entry is lower than primary sequence entry. This low condition, translated to control panel terminology, is *low sequence*. This can be used, by control panel wiring, to stop card feeding and turn on the error light.

In some cases it will be advantageous to use several charts to study the relationship between several successive cards fed through the machine. The schematic diagram and analysis charts are provided on the back of the control panel diagrams, Form X24-6395 for the 85 Collator, and Form X24-6396 for the 87 Collator.

Analysis charts are used in this manual when they contribute to a better understanding of the wiring.

### RUN-IN FEEDING

ALTHOUGH card feeding is controlled automatically by control panel wiring during an operation, it must be started manually at the beginning of a run. The start key must be held depressed for three cycles to run cards in from both hoppers. Figure 7 (A, B, C) shows the cards in the feed at the end of each cycle.

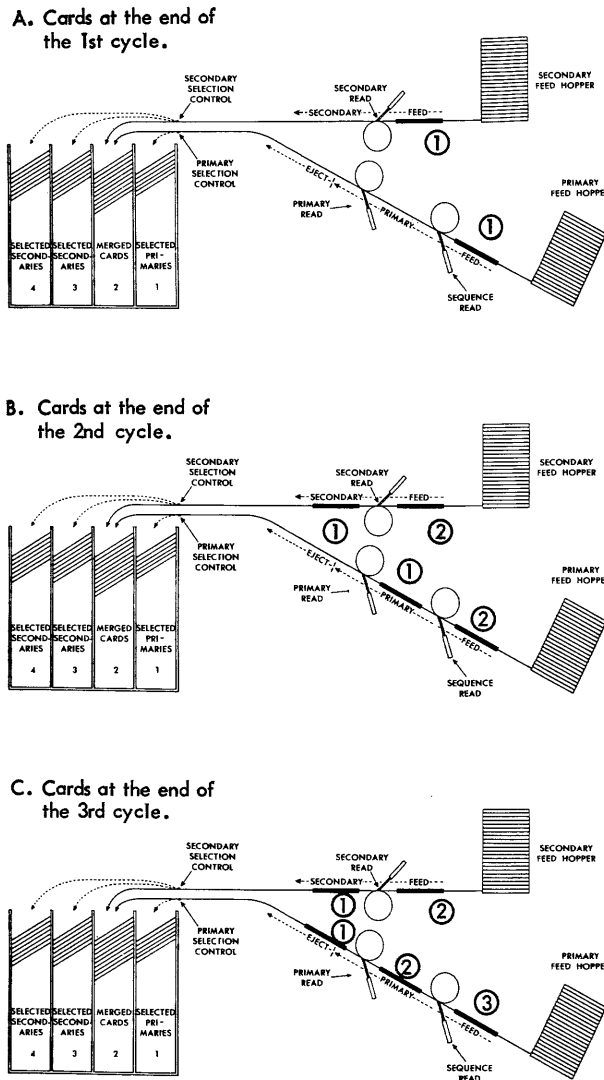

FIGURE 7. SCHEMATIC OF RUN-IN FEEDING

On the 1st cycle (A), one card is fed from the primary feed hopper and one from the secondary feed hopper; on the 2nd cycle (B), a second card is fed from each hopper; and on the 3rd cycle (C), a third card is fed from the primary feed hopper, and secondary feeding is normally inoperative. Secondary feeding can be made operative on the third run-in cycle by control panel wiring.

## Principles of Control Panel Wiring

THE CONTROL PANELS (Figures 8 and 9) contain 44 columns of hubs numbered 1 through 44, and 34 rows of hubs lettered A through AK. The location of any hub can be identified by the use of these co-ordinates. For example, primary read brush 20 is located at co-ordinates U, 20.

The shaded areas on the control-panel diagrams indicate special features. The 87 diagram shows 19 positions for each comparing unit (Model I); the 87 Model II has 16 positions.

There are two types of hubs on the control panel — exits and entries. An exit hub emits an impulse, and an entry hub accepts an impulse wired to it. Some exits emit impulses that correspond to the holes in the card, and others emit impulses that result from some function previously performed or are automatic for every card. A connection must always be made from an exit to an entry, by placing one end of a wire in the exit hub and the other end in the entry hub. The exits and entries used depend entirely upon the job the machine is called upon to do. The control panel wiring may be changed to perform each operation, thereby giving to one machine the flexibility to perform different operations for different applications.

Two or more hubs connected by lines are common; that is, two or more exits or entries serve the same purpose. Such an arrangement reduces the need for split wires (wires with more than two ends), because these hubs are actually connected together and serve the same purpose as split wires.

The control panel is used to control card feeding automatically. When a card passes a reading station, the punching is read by the brushes that contact a metal roll through the holes in the card. The impulses representing the card punching are available on the control panel. These impulses are directed, by control panel wiring, to comparing units where they are compared with the reading from another card. The comparing units determine a high, low, or equal comparison between the two readings and make a corresponding impulse available on the control panel. This impulse is then directed, by control panel wiring, to the functional units that control card feeding and selection.

The hubs on the control panel are labeled in groups in Figures 8 and 9, and a description of the general function of each group of standard features follows. A more detailed explanation of the hubs is given when they are first used in a problem.

*Control Exits (Selector-Sequence)* emit impulses resulting from a high, low, or equal comparison in the selector and sequence units. The first three rows of hubs emit impulses resulting from comparisons in the selector unit, and the second three rows emit impulses resulting from comparisons in the sequence unit. They are normally wired to functional entry hubs or to pick up selectors.

*Functional Entries* accept impulses to control selection, feeding, and ejection of cards, and are normally wired from control exits or PLUG TO C. ERROR STOP is used to stop card feeding and is wired from a control exit.

*Selectors* provide a means of controlling different operations for different conditions. PLUG TO C impulses are normally wired through them to the functional entries for the control of card feeding and selection under various conditions.

*Read* hubs are the exits for the three sets of brushes: SECONDARY READ for the secondary brushes, PRIMARY READ for the primary brushes, and SEQUENCE READ for the sequence brushes. Impulses emitted from the read hubs correspond to the numbers read by the brushes.

*Comparing Entries* in the 85 Collator accept numbers (1 through 9) for comparison in the selector and sequence units, and are normally wired from the read hubs. Two numbers are compared in the selector unit by wiring one number to SECONDARY SELECTOR ENTRY and the other to the corresponding positions of PRIMARY SELECTOR ENTRY. They are compared in the sequence unit by wiring one number to PRIMARY SEQUENCE ENTRY and the other to the corresponding positions of SEQUENCE ENTRY.

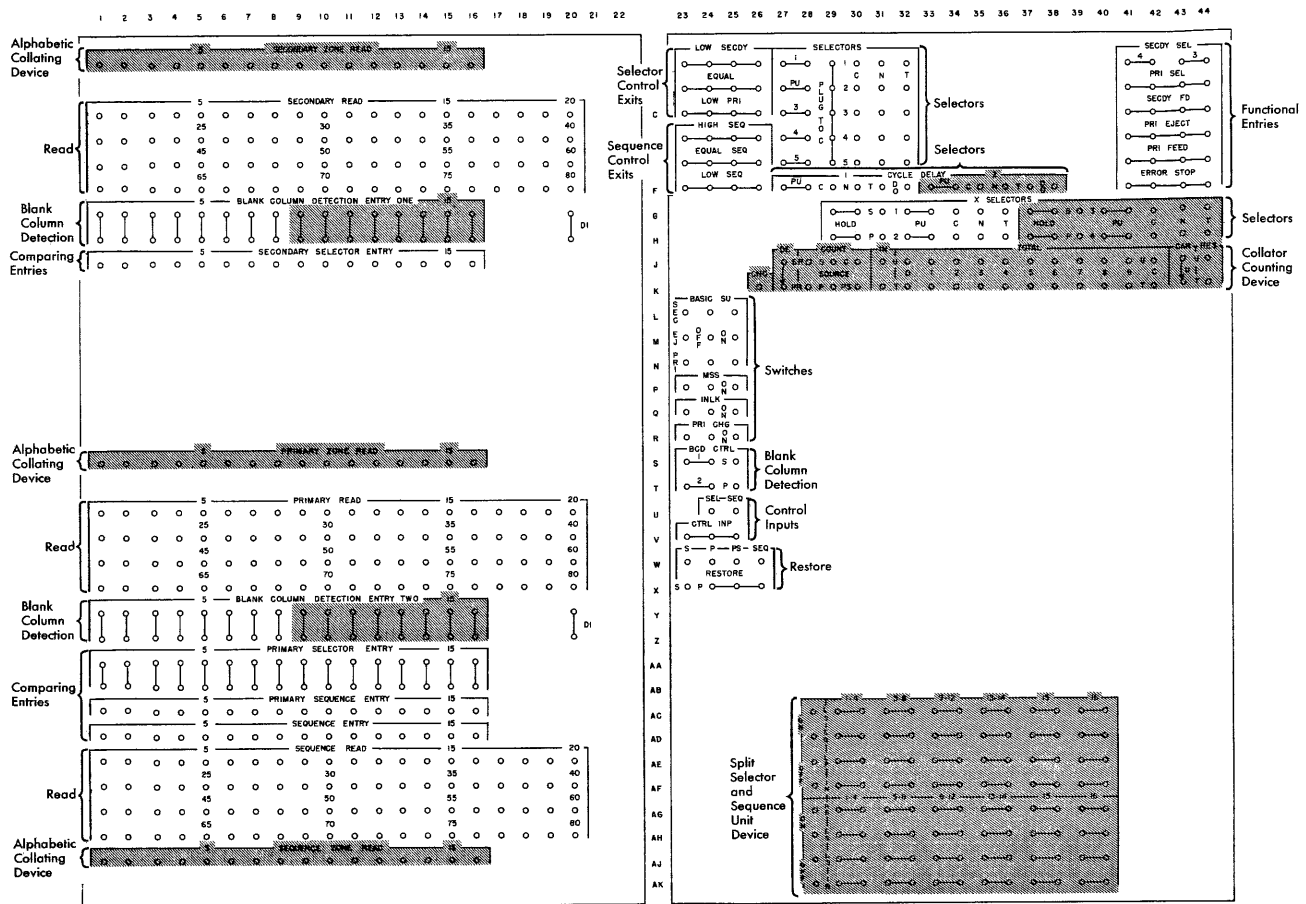

FIGURE 8. CONTROL PANEL — IBM 85

The selector unit is normally used to make comparisons between a primary card and secondary card. The sequence unit is normally used to make comparisons between cards at the two reading stations in the primary feed. However, any two numbers can be compared in either unit because the units are interchangeable. The control panel terminology merely indicates the manner in which they are generally wired for basic operations.

In this manual the units are used, for the most part, according to this standard wiring practice. However, some special operations in the manual illustrate the interchangeability, using the sequence unit to compare a primary and a secondary card, and the selector unit to compare two cards in the primary feed.

Comparing entries in the 87 Collator accept special characters, alphabetic characters (A through Z), and

digits (0 through 9). The comparing units and their entries are basically the same as in the 85, with the exception that numbers are compared in the sequence unit by wiring one number to PRIMARY SELECTOR ENTRY and the other number to SEQUENCE ENTRY.

Switches are used to supplement or eliminate wiring from the control exit hubs, or to control feeding under specific conditions. They are explained as they are used. The ZONE switch on the 87 Collator allows alphabetic and special characters to be compared.

Control Inputs on the 85 Collator test comparisons in the selector and sequence units. The SEL (selector) and SEQ (sequence) hubs are entries and are normally wired from the three common exit hubs directly below. The exit hubs emit impulses whenever a card is fed. This feature is not on the 87 Collator control panel because the tests are performed through internal wiring.



cards per minute (combined speed from both feeds) will be merged.

A secondary card can be merged behind *two* primary cards. For this operation, see the note under the wiring for Figure 45, *Selecting Alternate Cards*.

### Control Panel Hubs

**Plug to C.** These five common exit hubs emit an impulse as each card feeds. They are normally wired to functional entry hubs, directly or through a selector, to cause primary and secondary feeding and selection.

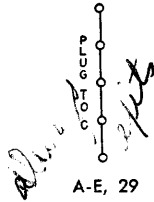

**Secdy Fd (Secondary Feed).** These four common functional entry hubs are normally wired from control exit hubs or from **PLUG TO C**, directly or through selectors, to cause feeding of secondary cards.

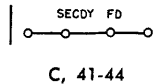

**Pri Feed (Primary Feed).** These four common functional entry hubs are normally wired from control exit hubs or from **PLUG TO C**, directly or through selectors, to cause feeding of primary cards.

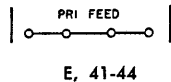

### Wiring

The wiring necessary for merging two groups of unpunched cards is a **PLUG TO C** impulse to **PRIMARY FEED** and **SECONDARY FEED**.

### SELECTING X-CARDS — PRIMARY FEED

**ALL X-PUNCHED CARDS** may be selected from the primary feed and stacked in pocket 1. All **NX-cards** will stack normally in pocket 2. This operation can be performed separately or in combination with other operations.

### Control Panel Hubs

**Primary Read.** The 80 primary read hubs are exits from the 80 primary brushes. They are normally wired through **BLANK COLUMN DETECTION ENTRY TWO** to **PRIMARY SELECTOR ENTRY** or **PRIMARY SEQUENCE ENTRY**. For **X-selection**, primary read is wired direct to the pickup of an **X-selector**.

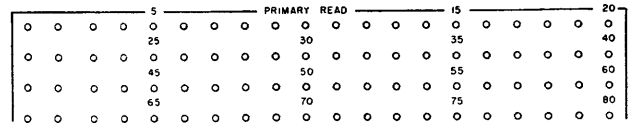

U-X, 1-20

**X-Selectors.** The **X-selectors** (1 and 2 standard) are normally used to control feeding, ejection, or selection of **X-** or **NX-cards**. Each selector has a **c** (common), **N** (normal), and **T** (transferred) hub, two common **PU** (pickup) hubs, and two common **HOLD** hubs. Normally, there is an internal connection between the **c** and **N** hubs (Figure 10). When the pickup is impulsed, the selector transfers and there is an internal connection between **c** and **T**. The selector is normally picked up by an **X-impulse**, but a control-input timed impulse can also be used.

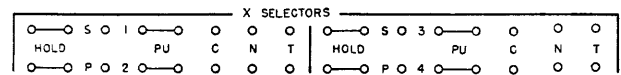

G-H, 29-44

Each **X-selector** is controlled to operate with either the primary or secondary feed by wiring its **HOLD** hubs from the **P** (primary) or **S** (secondary) hub. **P** emits an impulse to hold a selector between primary feed cycles, and **S** emits an impulse to hold a selector between secondary feed cycles.

When hold is wired and the pickup is impulsed, the selector transfers immediately and remains transferred until the **X-card** moves to the next station. If hold is wired from the **P** hub and **PU** is wired from primary read, the selector will be transferred when the **X-card** is in the eject position and, therefore, the selection of **X-cards** (or **NX-cards**) into pocket 1 can be controlled. If **PU** is wired from sequence read, selection of the card preceding the **X-card** can be controlled.

If hold is wired from the **S** hub and **PU** is wired from secondary read, secondary **X-cards** (or **NX-cards**) can be selected into pocket 3 or 4.

A PLUG TO C is normally wired through the c and N hubs or the c and T hubs of an X-selector to the functional entry hubs. A control-input timed impulse should not be selected through an X-selector in the 85.

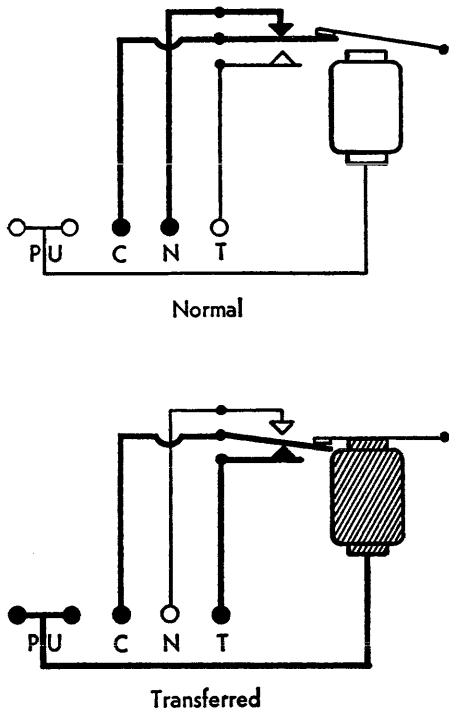
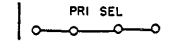

FIGURE 10. SCHEMATIC OF SELECTOR OPERATION

*Pri Sel (Primary Select)*. These four common functional entry hubs are normally wired from control exit hubs, or from PLUG TO C directly or through a selector, to cause a primary card to stack in pocket 1 (selected primaries). When these hubs are not impulsed, primary cards stack in pocket 2.



B, 41-44

Wiring (Figure 11)

1. PLUG TO C is wired to PRIMARY FEED to cause continuous feeding of primary cards.
2. The X (column 20) is wired from primary read to X-selector 1 PU. The X-selector is transferred as the X-card reaches the eject position.
3. X-selector 1 HOLD is wired from P (primary), so that the selector will hold for a primary feed cycle.
4. PLUG TO C is wired to c of the selector. This impulse will be available out of the N hub for all NX-cards, and out of the T hub for all X-cards.
5. The transferred (T) side of the selector is wired to PRIMARY SELECT, thus causing all X-cards to stack in pocket 1. All NX-cards will stack in pocket 2.

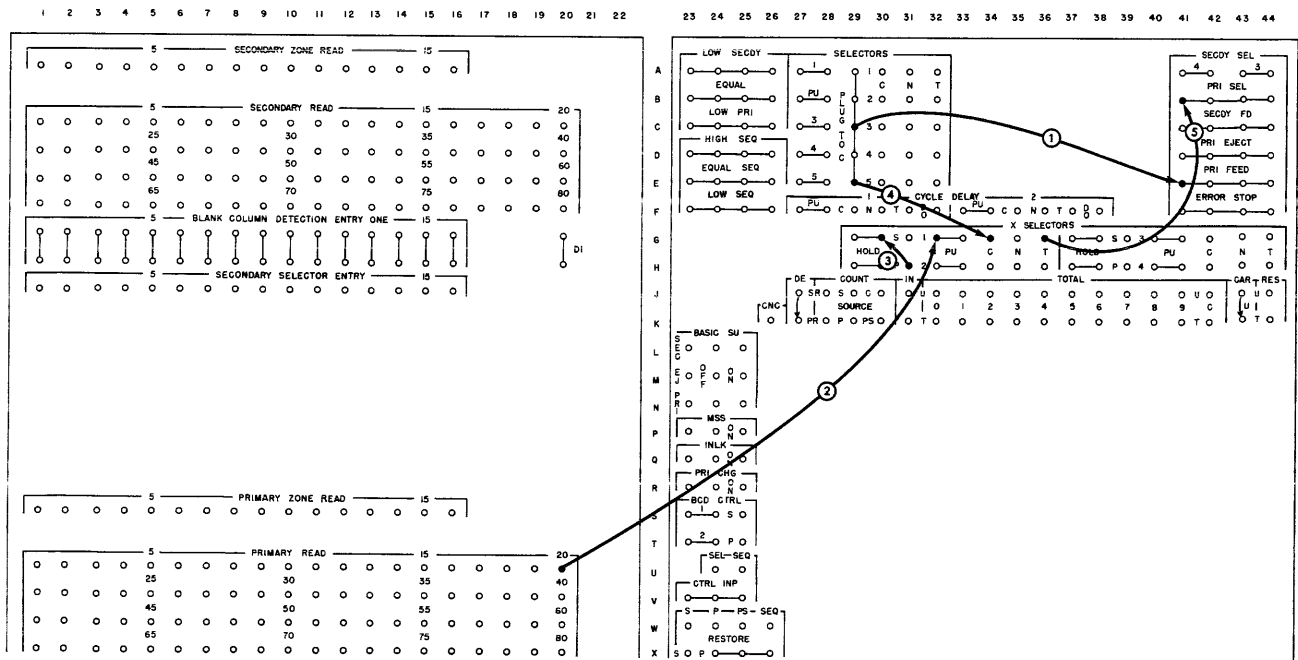

FIGURE 11. SELECTING X-CARDS — PRIMARY FEED



## SELECTING X-CARDS — BOTH FEEDS

ALL X-PUNCHED CARDS may be selected from both feeds at the same time. If half of the file is placed in the secondary feed hopper and the other half is placed in the primary feed hopper, the processing time is reduced fifty per cent. All four pockets are used in this operation, X-cards stacking in pockets 1 and 4, and NX-cards stacking in pockets 2 and 3.

### Control Panel Hubs

*Secondary Read.* These hubs are exits from the 80 secondary brushes. They are normally wired through BLANK COLUMN DETECTION ENTRY ONE to SECONDARY SELECTOR ENTRY. For X-selection, secondary read is wired direct to the pickup of an X-selector.

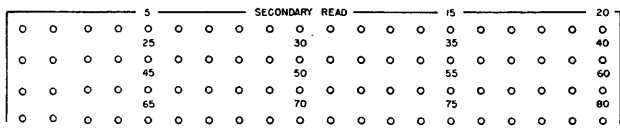

C-F, 1-20

*Secdy Sel 3-4 (Secondary Select).* The two common secondary select 3 hubs are functional entry hubs that cause a secondary card to stack in pocket 3 (selected secondaries); the two common secondary select 4

hubs are functional entry hubs that cause a secondary card to stack in pocket 4 (selected secondaries). When both 3 and 4 are impulsed at the same time, 4 takes precedence and the cards stack in pocket 4. Both sets of hubs are normally wired from PLUG TO C or from control exit hubs. When neither 3 nor 4 is impulsed, the cards stack in pocket 2.

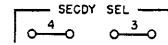

A, 41-44

### Wiring (Figure 12)

1. PLUG TO C is wired to PRIMARY FEED and SECONDARY FEED to cause continuous feeding of primary and secondary cards.

2. The X-cards in the primary feed are selected by wiring from primary read (column 20) to the PU of X-selector 2, and wiring a PLUG TO C through the transferred side of this selector to PRIMARY SELECT. The selector is controlled to hold for the duration of the primary feed cycle. All X-cards in the primary feed will stack in pocket 1, and all NX-cards will stack in pocket 2.

3. The X-cards in the secondary feed are selected by wiring from secondary read (column 20) to the PU of X-selector 1, and wiring a PLUG TO C through the

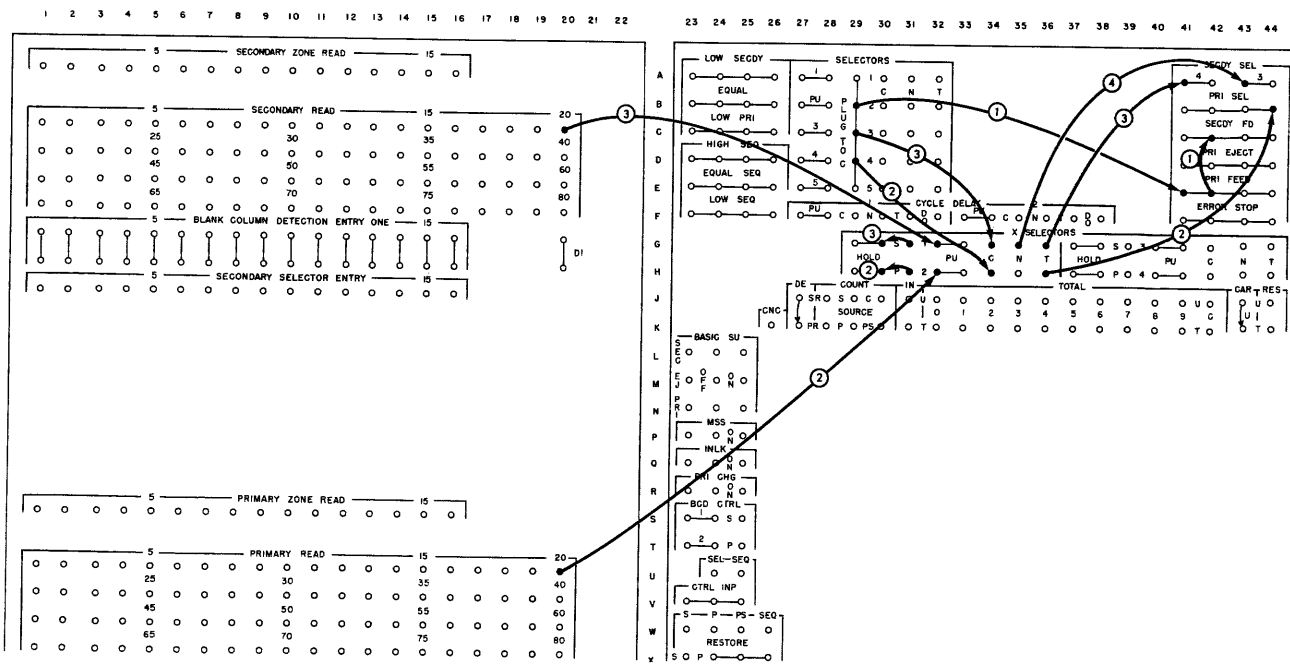

FIGURE 12. SELECTING X-CARDS — BOTH FEEDS

transferred side of this selector to SECONDARY SELECT 4. The selector is controlled to hold for the duration of the secondary feed cycle. All X-cards in the secondary feed will stack in pocket 4.

4. PLUG TO C is wired through the normal side of X-selector 1 to SECONDARY SELECT 3 so that all NX-cards in the secondary feed will fall in pocket 3. If this wire were omitted, NX secondary cards would merge with NX primary cards in pocket 2.

### BLANK-COLUMN DETECTION

CARDS can be checked for blank columns as they are fed in the collator. When detection is required in both feeds, eight columns of each card can be checked; when detection is required in one feed only, up to sixteen columns can be checked in each card. If a blank column is detected, card feeding stops and a blank-column-detection light (BCD 1 or BCD 2) turns on, indicating the unit that detected the blank column. The BCD light can be turned off and card feeding can be re-started by pressing the reset key and then the start key. The error card will then be the next card stacked from the feed containing the blank column. This operation can be performed separately or in combination with other operations.

#### Control Panel Hubs

*Blank Column Detection Entry One; Blank Column Detection Entry Two.* On the standard machine, there are two 8-position groups of blank-column detection. Each group can be controlled to check cards independently in either feed, or the two groups can be used together to check up to 16 columns in one feed. Blank column

detection entry one is normally wired from secondary read, and blank column detection entry two is normally wired from primary read.

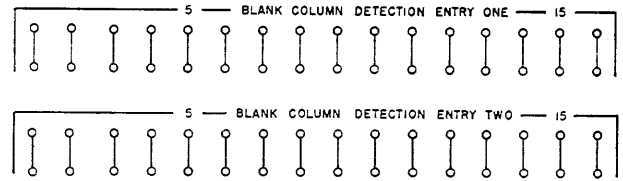

G-H, 1-16; Y-Z, 1-16

*BCD Ctrl (Blank-Column-Detection Control).* These hubs control the blank-column-detection entries so that they are operative on either a primary or secondary feed cycle. The control entry hubs are normally wired from either the s or P hub. The s hub emits an impulse to hold a unit between secondary feed cycles, and the P hub emits an impulse to hold a unit between primary feed cycles. Thus, blank column detection entry one can be controlled to operate in conjunction with the secondary feed by wiring from the s hub to CONTROL 1. To check 16 columns in one feed, the s (or P) hub is wired to both CONTROL 1 and CONTROL 2.

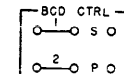

S-T, 23-25

*DI (Direct Impulse).* These hubs supply an impulse that must be wired to unused blank column detection entry hubs. The purpose of this impulse is to de-activate the unused positions and thereby prevent the machine from stopping due to a false blank-column indication.



G-H, 20; Y-Z, 20

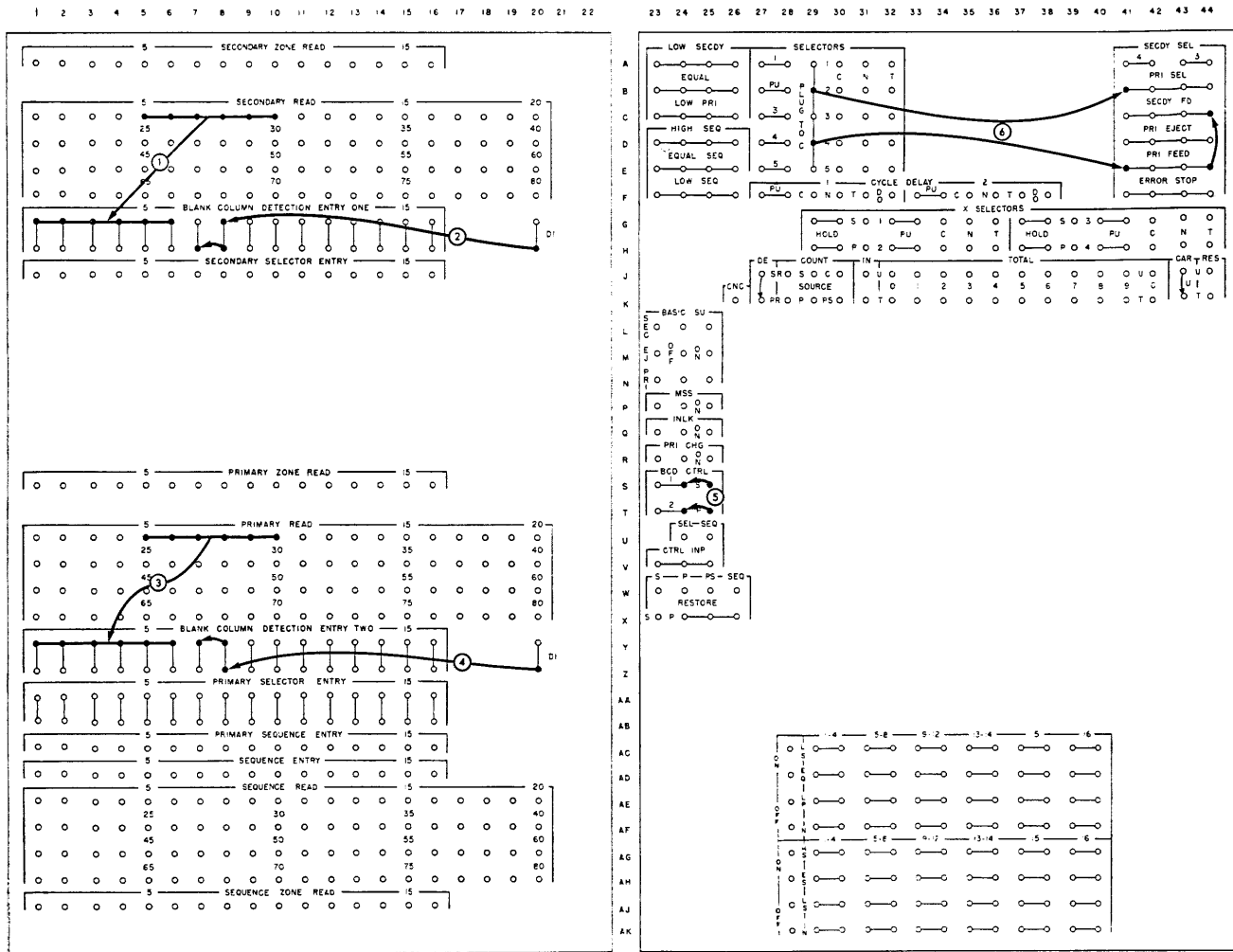

FIGURE 13. BLANK COLUMN DETECTION — BOTH FEEDS

### Wiring (Figure 13)

1. Columns 5-10 in secondary cards are to be checked for blank columns, and are wired to blank column detection entry one.

2. A direct impulse is wired to positions 7 and 8 of blank column detection entry one to prevent a false indication of a blank column.

3. Columns 5-10 in primary cards are to be checked for blank columns and are wired to blank column detection entry two.

4. A direct impulse is wired to positions 7 and 8 of blank column detection entry two to prevent a false indication of a blank column.

5. BCD CONTROL 1 is wired from the s hub to cause blank column detection one to function on a secondary feed cycle, and BCD CONTROL 2 is wired from the p hub to cause blank column detection two to function on a primary cycle.

6. PLUG TO c is wired to PRIMARY FEED and SECONDARY FEED to cause continuous feeding of primary and secondary cards; it is also wired to PRIMARY SELECT to stack all primary cards in pocket 1.

### Wiring (Figure 14)

1. 16 columns in primary cards are to be checked for blank columns. Columns 1-8 are wired to BCD entry one, and columns 9-16 are wired to BCD entry two.

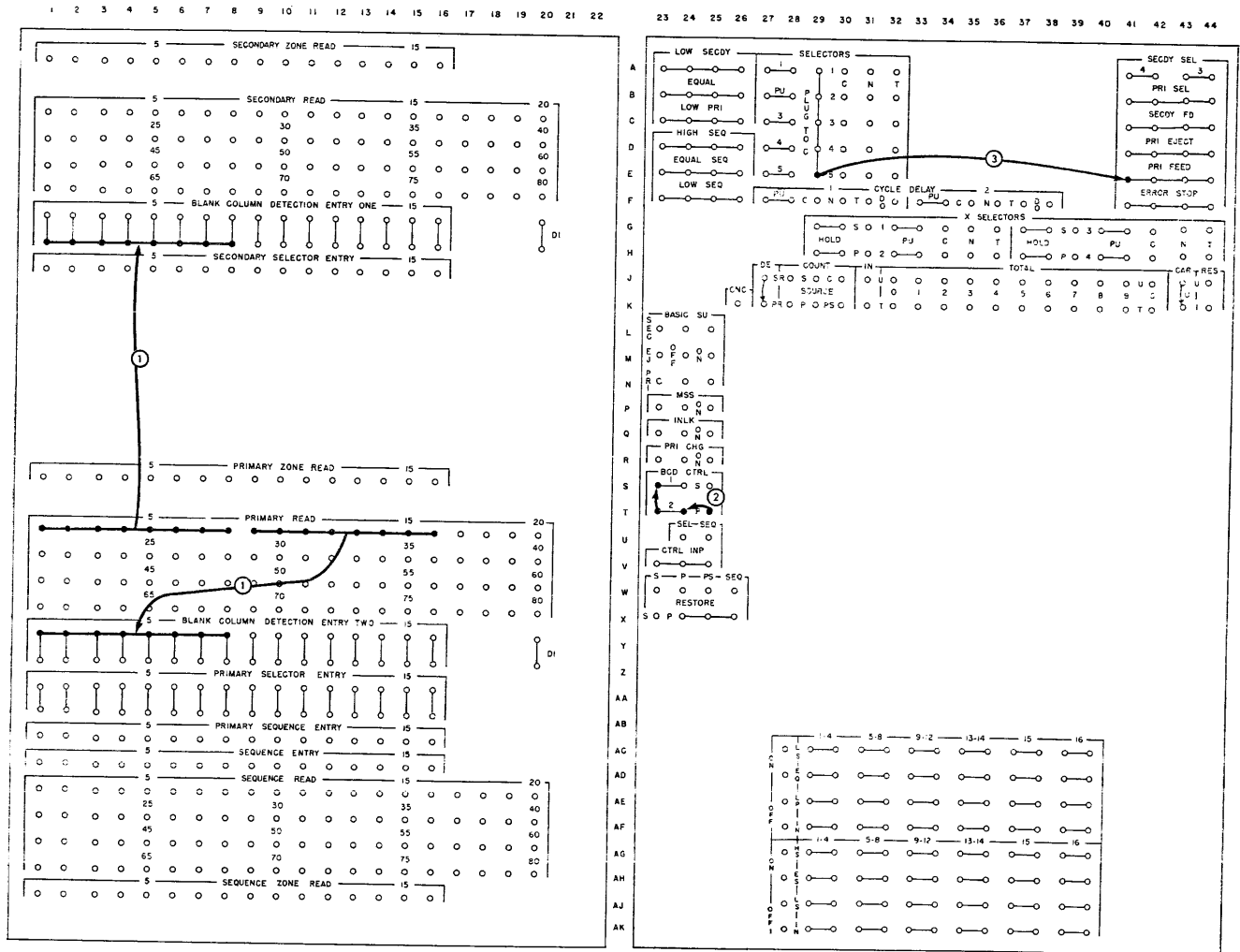

FIGURE 14. BLANK COLUMN DETECTION — 16 COLUMNS, ONE FEED

2. BCD CONTROL is wired so that BCD one and two will function with the primary feed.
3. PLUG TO C is wired to PRIMARY FEED to cause continuous feeding of primary cards.

### CHECKING SEQUENCE

A FILE OF CARDS can be checked to insure that all the cards are in sequence. The two sets of brushes in the primary feed make it possible to compare each card twice: once with the card ahead, and on the following cycle with the card behind. Each comparison may be either high, low, or equal.

### CARDS IN ASCENDING ORDER

Because a file should normally be in ascending sequence, the cards are in order if any card is either higher than or equal to the card ahead. However, if a card is lower than the card ahead (a "step-down" condition), an error in sequence is indicated. An error is recognized as a "low sequence" condition, and an impulse is available on the control panel from the corresponding control exit hubs. This impulse may be used to stop card feeding and turn on the error light.

Figure 15 illustrates a card (124) out of order. Card 125 has just passed primary read, and the number has been stored in the primary side of the sequence unit.

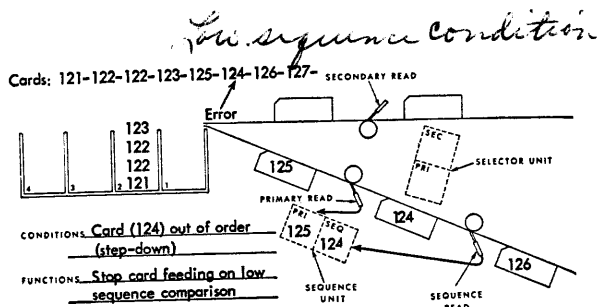

FIGURE 15. CHECKING SEQUENCE

At the same time, card 124 has just passed sequence read and the number has been stored in the sequence side of the sequence unit. Thus, a step-down, or a low sequence comparison, exists.

When card feeding stops because of an error in sequence, the cards should be removed from both the hopper and the stacker. Then, after depressing the reset key, the cards in the machine should be run out. The step-down card will be the second one run out, but may or may not be the card out of sequence. A check must be made of several cards from both the stacker and the hopper to determine exactly which card or cards are out of order. Figure 16 illus-

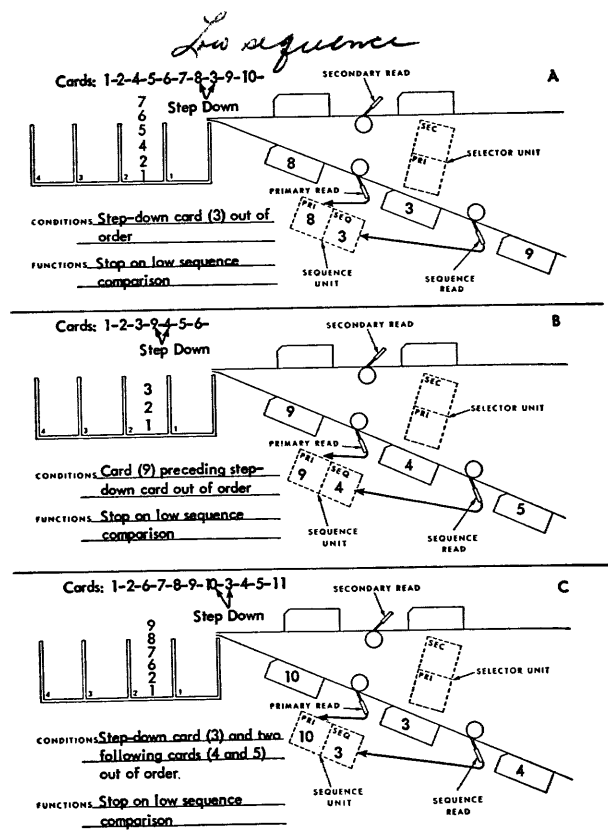

FIGURE 16. THREE TYPES OF SEQUENCE ERRORS

trates three different errors in sequence: in A, the step-down card (3) is out of order; in B, the card (9) preceding the step-down card is out of order; and in C, the step-down card (3) and the two cards (4 and 5) following it are out of order.

### Control Panel Hubs

**Sequence Read.** These hubs are exits from the 80 sequence brushes. They are normally wired to SEQUENCE ENTRY or to the pickup of an X-selector.

	5		SEQUENCE	READ		15		20
○	○	○	○	○	○	○	○	○
○	○	○	○	○	○	○	○	○
○	○	○	○	○	○	○	○	○
○	○	○	○	○	○	○	○	○
○	○	○	○	○	○	○	○	○
○	○	○	○	○	○	○	○	○
○	○	○	○	○	○	○	○	○
○	○	○	○	○	○	○	○	○

AE-AH, 1-20

**Primary Sequence Entry; Sequence Entry.** These hubs are the two sets of entries to the 16 comparing positions in the sequence unit of the 85 or 87 Model II (19 positions in the 87 Model I). Any positions may be used to compare two numbers, provided the same positions are used in both entries. The entries may be wired from any of the three reading stations. They are normally wired to compare a card at the sequence station with a card at the primary station, thereby comparing each card of a primary group with the preceding card. The result of the comparison may be high sequence, low sequence, or equal sequence, and an impulse is available from one of the corresponding sets of sequence control exit hubs.

	5		PRIMARY	SEQUENCE	ENTRY		15
○	○	○	○	○	○	○	○
○	○	○	○	○	○	○	○
○	○	○	○	○	○	○	○
○	○	○	○	○	○	○	○

AC, 1-16; AD, 1-16

PRIMARY SEQUENCE ENTRY is not available on the 87 Collator control panel; instead, information wired to PRIMARY SELECTOR ENTRY enters the primary sequence side of the sequence unit and is compared with information wired to SEQUENCE ENTRY.

**Restore: PS, Seq; P (exits).** Before numbers can be read into the sequence unit from cards passing the brushes, the unit must be restored, or cleared. Both the clearing and subsequent reading into the unit are controlled by RESTORE hubs. PS and SEQ are entry hubs to restore the primary sequence and sequence sides of the sequence unit, respectively. They are normally wired from the P exit hubs directly below, which emit an impulse on every primary feed cycle.

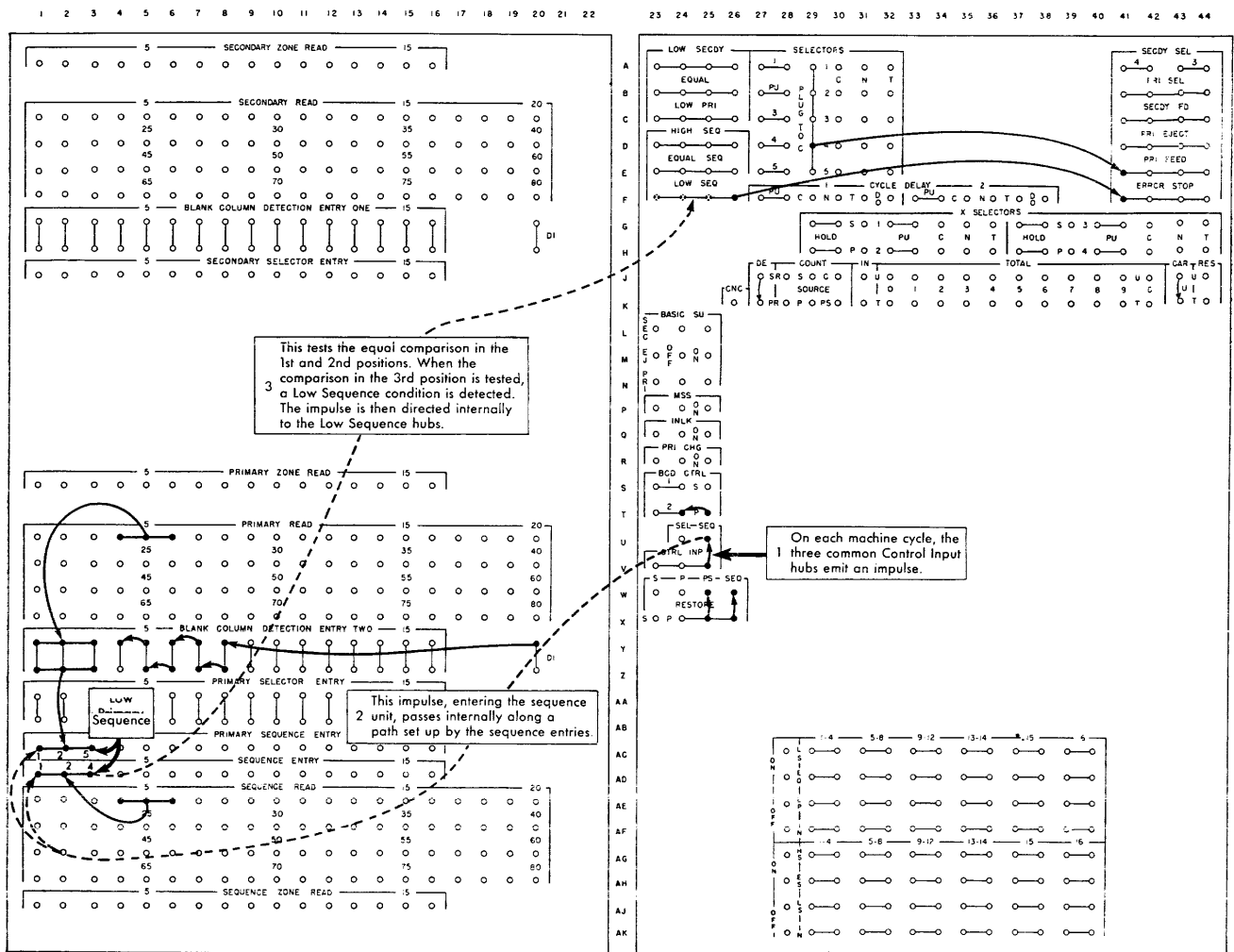
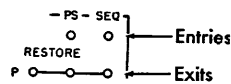

FIGURE 17. PATH OF CONTROL INPUT TEST IMPULSE — IBM 85

In the first two run-in cycles in the 85, these two restore entry hubs (PS and SEQ) and the two restore entry hubs for the selector unit (s and P) are common internally. Therefore, if any one of these four hubs is wired on the control panel, all four comparing entries will be restored (cleared and read into) on the run-in. After the first two run-in cycles, all four restore hubs become independent and the comparing entries are restored separately according to the control panel wiring.



W, 25-26; X, 24-26

In the 87, three differences in restoring are: First, the comparing units are automatically restored on the run-out; on the run-in, they are restored separately according to control-panel wiring. Second, ps (primary sequence) RESTORE is inactive; wiring the P (primary) RESTORE hub restores the primary sequence

side of the sequence unit. Third, if selection of restore exit impulses is required, X-selectors must be used.

*Ctrl Inp (Control Inputs): Seq; exits.* The SEQ (sequence) entry hub is normally wired from one of the three common exit hubs below to test the comparison of the numbers entered in the sequence unit. The three common exit hubs emit an impulse on every machine cycle.

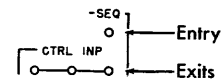

U, 25; V, 23-25

The control impulse wired to SEQ travels internally through the sequence unit to one of the sequence control exit hubs. It is available from either high sequence, equal sequence, or low sequence depending on the comparison between the numbers in the unit.

As shown in Figure 17, which is wired to check the sequence, the control input impulse enters the sequence unit starting with the 1st (left-hand) position

and travels to the right, testing each position for an equal comparison. If all 16 positions are equal (or not wired), the control input impulse is emitted from the equal sequence hubs. If an unequal comparison is detected, the control impulse is directed internally to either the high sequence or the low sequence control exit hubs. If the sequence entry position is higher than the corresponding primary sequence entry position, the impulse is directed to HIGH SEQUENCE. If the sequence entry position is lower than the corresponding primary sequence entry position, the impulse is directed to LOW SEQUENCE.

In Figure 17, the number 124 in sequence entry is compared with the number 125 in primary sequence entry. The control input impulse starts in the 1st position and travels to the right until it reaches the 3rd position. At that time the impulse is directed internally to the low sequence hubs.

Because the test starts at the left of the comparing unit and works to the right, major fields must be wired to the left when two or more fields are to be compared. As shown in the example, the major field (State) is positioned at the left, the intermediate field (County) next, and the minor field (City) at the right.

<i>Major</i>	<i>Intermediate</i>	<i>Minor</i>
State Code	County Code	City Code

A control input impulse should not be wired through an X-selector in the 85.

The control input hubs are not shown on the 87 control panel because their function is performed by internal wiring.

*High Seq (High Sequence).* These four common hubs emit the control input impulse when the number in sequence entry is higher than the number in primary sequence entry (primary selector entry on the 87). In a normal sequence-checking operation, this impulse represents a change in sequence in ascending order.

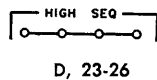

*Equal Seq (Equal Sequence).* These four common hubs emit the control input impulse when the number in

sequence entry equals the number in primary sequence entry (primary selector entry on the 87).

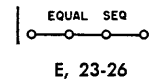

*Low Seq (Low Sequence).* These four common hubs emit the control input impulse when the number in sequence entry is lower than the number in primary sequence entry (primary selector entry on the 87). In a normal sequence-checking operation this impulse represents a change in sequence in descending order (a step-down), and therefore an error. It is normally wired to ERROR STOP to stop card feeding, for an error in sequence.

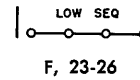

*Error Stop.* These four common functional entry hubs are normally wired from LOW SEQUENCE to signal an error in sequence. They cause card feeding to stop and an error light to turn on. To turn off the error light and permit card feeding to be restarted, the reset key must be depressed. ERROR STOP must not be impulsed from a PLUG TO C because this would cause card jams.

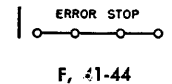

After an error has been reset, a primary feed cycle must occur before a low-sequence error condition will be recognized.

*Zone.* This switch is found on the 87 Collator only. When it is wired ON, all comparing units recognize zone punches (0, 11, 12) as well as digit punches, thus making it possible to compare alphabetic as well as numerical information. When the zone switch is wired OFF, the comparing units recognize digit punches (1-9) only. This switch should be ON whenever alphabetic or special character punching is to be compared.

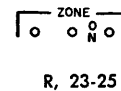

### Wiring (Figure 18)

1. The card columns to be checked for sequence are wired from primary read through BCD entry two

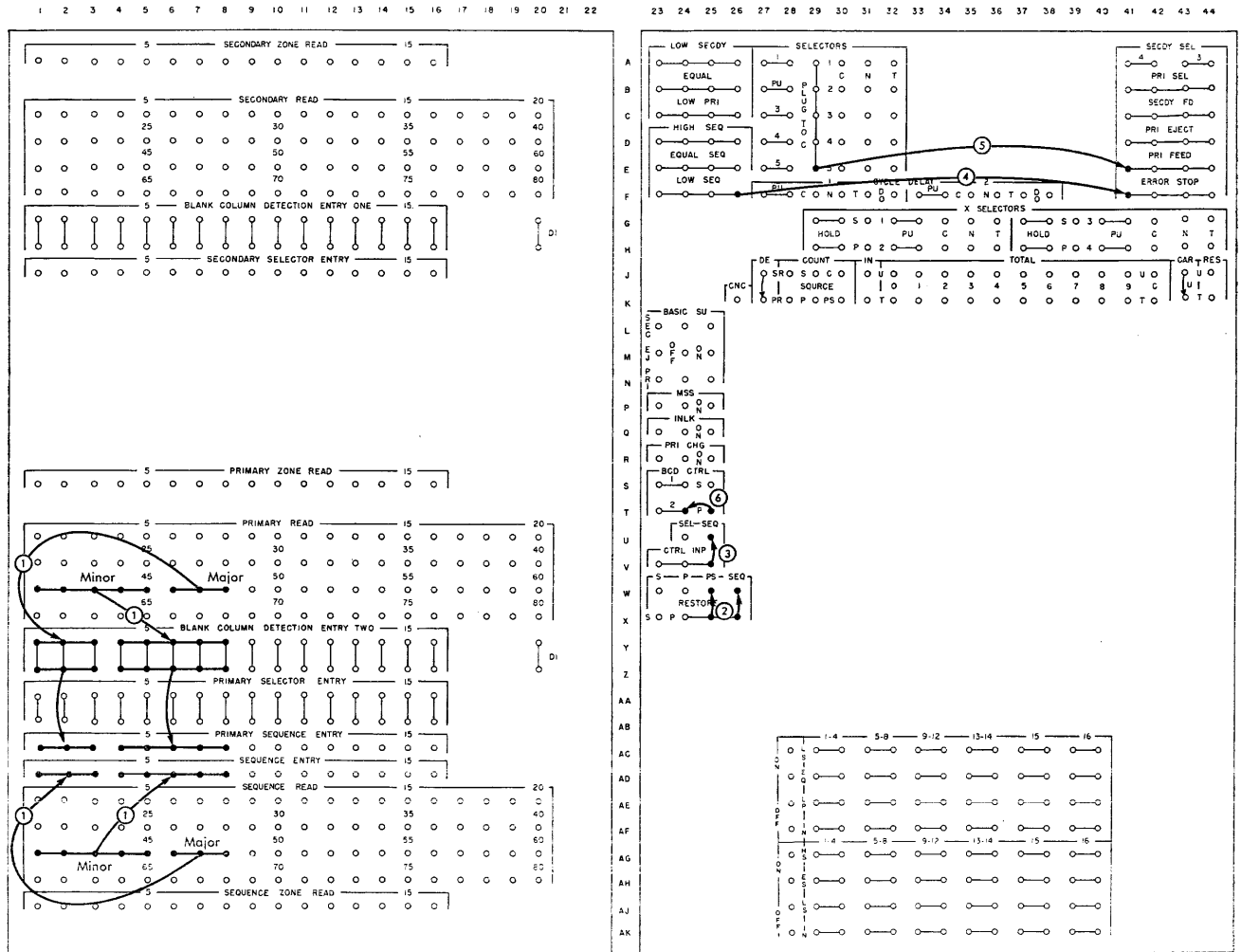

FIGURE 18. CHECKING SEQUENCE

to primary sequence entry, and from sequence read to sequence entry. The major field, punched in columns 46-48, is wired to the left of the minor field, columns 41-45.

2. PS and SEQ RESTORE are wired to clear the comparing unit and read in new numbers each time a card is fed.

3. SEQ CONTROL INPUT is wired to test the comparison between the reading in the primary sequence entries and the reading in the sequence entries.

4. A card out of order will be indicated by a low sequence comparison. Low sequence is wired to ERROR STOP to stop card feeding and turn on the error light.

5. PLUG TO C is wired to PRIMARY FEED to cause continuous feeding of primary cards.

6. BCD 2 is controlled to operate with the primary feed.

#### Wiring Changes, 87 Collator

1. Wire to primary selector entry instead of primary sequence entry.

2. Wire p restore instead of ps restore.

3. Omit control input wiring.

7. If letters or special characters are checked, wire the zone switch ON.

*When 3 & 4 pocket are impulsed at same time 4 pocket gets card*



## CARDS IN DESCENDING ORDER

Cards in descending order may be checked by changing one wire in Figure 18; that is, by wiring error stop from high sequence, instead of from low sequence (wire 4). The example (Figure 19) shows the error card to be a step-up in sequence rather than a step-down. A step-up in sequence is recognized as a high sequence condition and would make an impulse available at the corresponding control exit hubs.

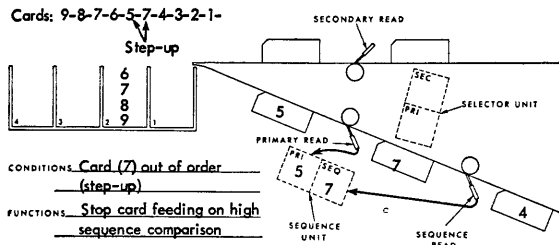

FIGURE 19. CHECKING SEQUENCE — CARDS IN DESCENDING ORDER

Another method of checking cards in descending order is by reversing the wiring to the comparing entries; that is, by wiring from PRIMARY READ to SEQUENCE ENTRY and from SEQUENCE READ to PRIMARY SEQUENCE ENTRY. The error would then be indicated by a low sequence comparison, the same as when checking cards in ascending order.

## INSERTING INDICATOR CARDS

During a sequence-checking operation it is possible to insert an indicator card, of a different color or with an opposite corner cut, each time a step-down (or step-up) in sequence occurs. This operation can be used in place of the error-stop feature to cause an indicator card to be inserted while the machine remains in continuous operation. The cards to be sequence-checked are placed in the primary feed hopper, and the indicator cards are placed in the secondary feed hopper. Each indicator card will be inserted in the file immediately ahead of the step-down card (Figure 20). The indicator card and the card preceding the step-down are stacked simultaneously.

The wiring for this operation is the same as that shown in Figure 18, with the exception that low sequence is wired to secondary feed rather than to error stop (wire 4). This causes a secondary card to be fed whenever a step-down in sequence occurs.

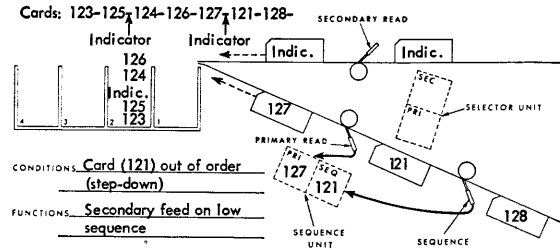

FIGURE 20. CHECKING SEQUENCE — INSERTING INDICATOR CARDS

If indicator cards are to be inserted for errors in a file in descending sequence, high sequence is wired to secondary feed.

## RECOGNIZING A CHANGE BETWEEN CONTROL GROUPS

THE END of one control group and the beginning of another is recognized by a change in control numbers. If the cards are in ascending order and the control fields are compared in the same manner as in sequence-checking, the change is recognized by a high sequence comparison. This is shown in Figure 21, in which the last card of one group (102) is compared with the first card of the following group (103).

## SELECTING THE LAST CARD OF A GROUP

The last card of each control group can be selected to stack in pocket 1; all other cards will stack normally in pocket 2. When the high sequence comparison is recognized (Figure 21), the last card of the group (102) is in the eject position and can, therefore, be selected.

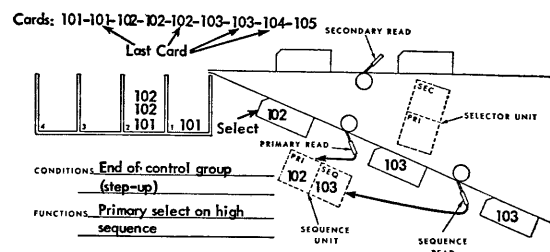

FIGURE 21. SELECTING THE LAST CARD OF A GROUP

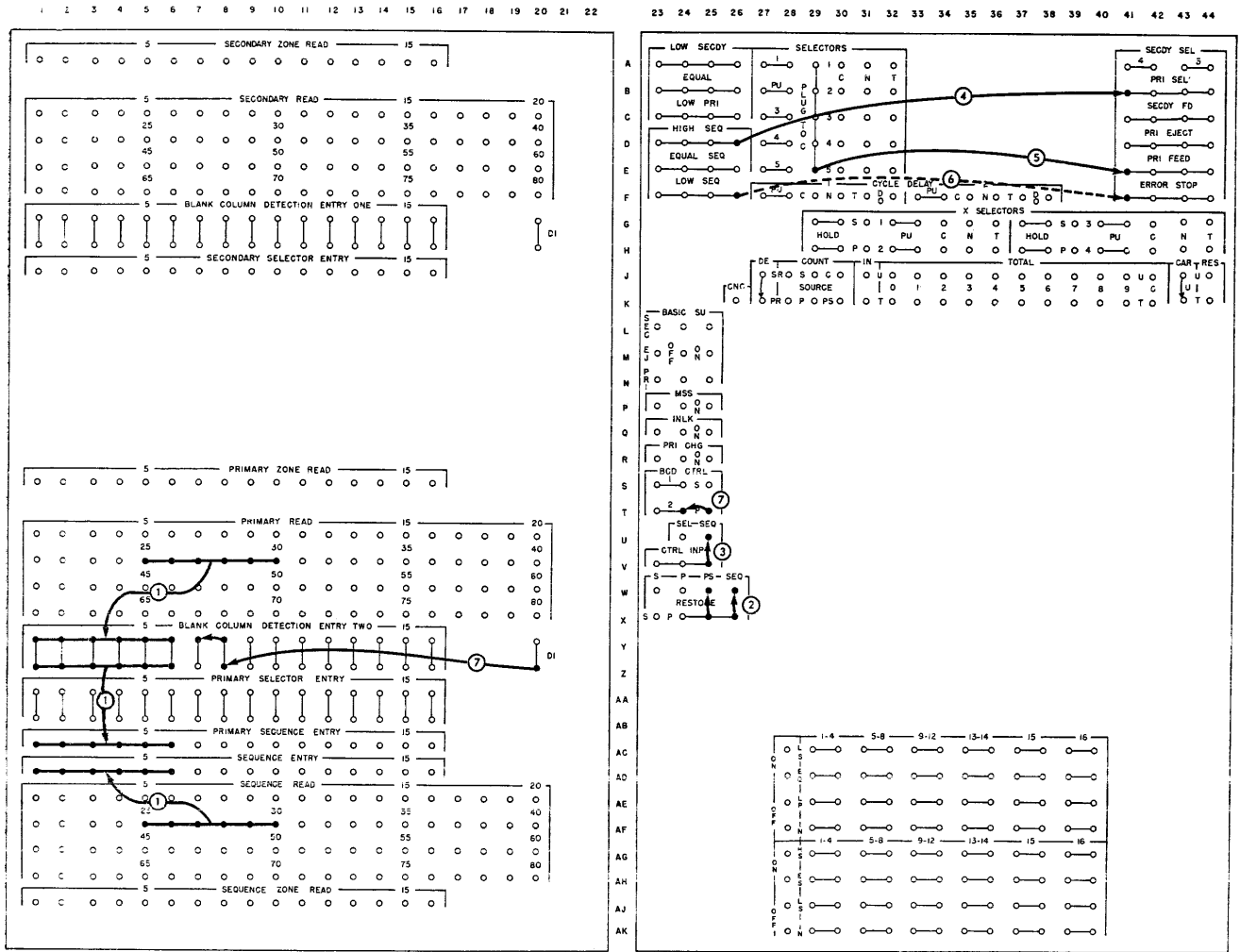

FIGURE 22. SELECTING THE LAST CARD OF A GROUP

### Wiring (Figure 22)

1. The control fields to be compared (columns 25-30) are wired from primary read through BCD entry two to primary sequence entry, and from sequence read to sequence entry.
2. PS and SEQ RESTORE are wired to clear the comparing entries and read in new numbers each time a card is fed.
3. SEQ CONTROL INPUT is wired to test the comparison in the sequence unit.
4. High sequence is wired to PRIMARY SELECT to cause the last card of each group to stack in pocket 1.
5. PLUG TO C is wired to PRIMARY FEED to cause continuous feeding of primary cards.

6. This dotted wire can be added to stop card feeding for an error in sequence, if sequence-checking is also desired.

7. BCD 2 is controlled to operate with the primary feed. Direct impulse is wired to the two unused BCD entry two positions.

### Wiring Changes, 87 Collator

1. Wire to primary selector entry instead of primary sequence entry.
2. Wire P restore instead of ps restore.
3. Omit control input wiring.
8. If letters or special characters are compared, wire zone switch ON.

## INSERTING AN INDICATOR CARD BEHIND EACH GROUP

Indicator cards can be inserted behind each control group. The punched cards are placed in the primary feed hopper, and the indicator cards are placed in the secondary feed hopper. The high sequence comparison, indicating a control change, can cause an indicator card to be fed. The last primary card of each group and the indicator card are stacked simultaneously.

The wiring for this operation is the same as that shown in Figure 22, with the exception that high sequence is wired to secondary feed rather than to primary select (wire 4). This causes a secondary card to be fed whenever a control change occurs.

## SELECTING THE LAST CARD OF A GROUP IF AN X-CARD

THE PRINCIPLES explained in both Figures 11 and 22 are used to select the last card of each control group, only if it is an X-card. That is, both the X-punching in the cards and the control change between groups must be considered in the control panel wiring. Therefore, in reference to Figure 11, the PLUG TO C impulse must be made available only on a high sequence condition (control change), before it is wired to select X-cards. The high sequence impulse itself should not be wired through an X-selector.

### Control Panel Hubs

**Selectors.** Five selectors are standard, and each has a pair of common PU (pickup) hubs and a C (common), N (normal), and T (transferred) hub. When the pickup is impulsed, the selector transfers immediately and remains transferred for the duration of the pickup impulse. As shown in Figure 10, the C and N hubs are common internally when PU is not impulsed, and the C and T hubs are common internally when PU is impulsed.

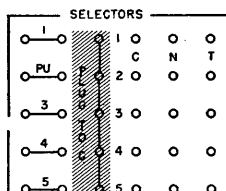

A-E, 27-28, 30-32

The pickup hubs are normally wired from a control exit, and a PLUG TO C is wired through the C, N, and T hubs to a functional entry to control card feeding, ejection, and selection. This accomplishes the same results as would be obtained by wiring directly from a control exit to a functional entry. However, wiring through the selector is preferable because *back-circuits* that may occur by wiring directly are eliminated. A back-circuit is a term commonly applied to control panel wiring that may improperly connect two or more hubs together. The pickup hubs cannot be wired from a reading station.

### Wiring (Figure 23)

1. The X (column 80) is wired from primary read to X-selector 2 PU, to transfer X-selector 2 when the X-card is ready to be ejected. X-selector HOLD is wired from the P hub to control the X-selector to operate on a primary feed cycle. The control field (columns 25-30) is compared in the normal manner.

2. High sequence is wired to the pickup of selector 4 to transfer the selector whenever there is a control change.

3. PLUG TO C is wired through the transferred side of selector 4 and the transferred side of X-selector 2 to PRIMARY SELECT. If the last card of a control group is an X-card, it will be stacked in pocket 1. All other cards will be stacked in pocket 2.

4. Primary cards are fed continuously.

5. Low sequence is wired to ERROR STOP to stop card feeding for an error in sequence, if sequence-checking is also desired.

6. BCD 2 is controlled to operate with the primary feed. Direct impulse is wired to the two unused positions of BCD entry two.

### Wiring Changes, 87 Collator

1. Wire to primary selector entry instead of primary sequence entry. Wire P restore instead of PS restore. Omit control input wiring.

7. If letters or special characters are compared, wire the zone switch ON.

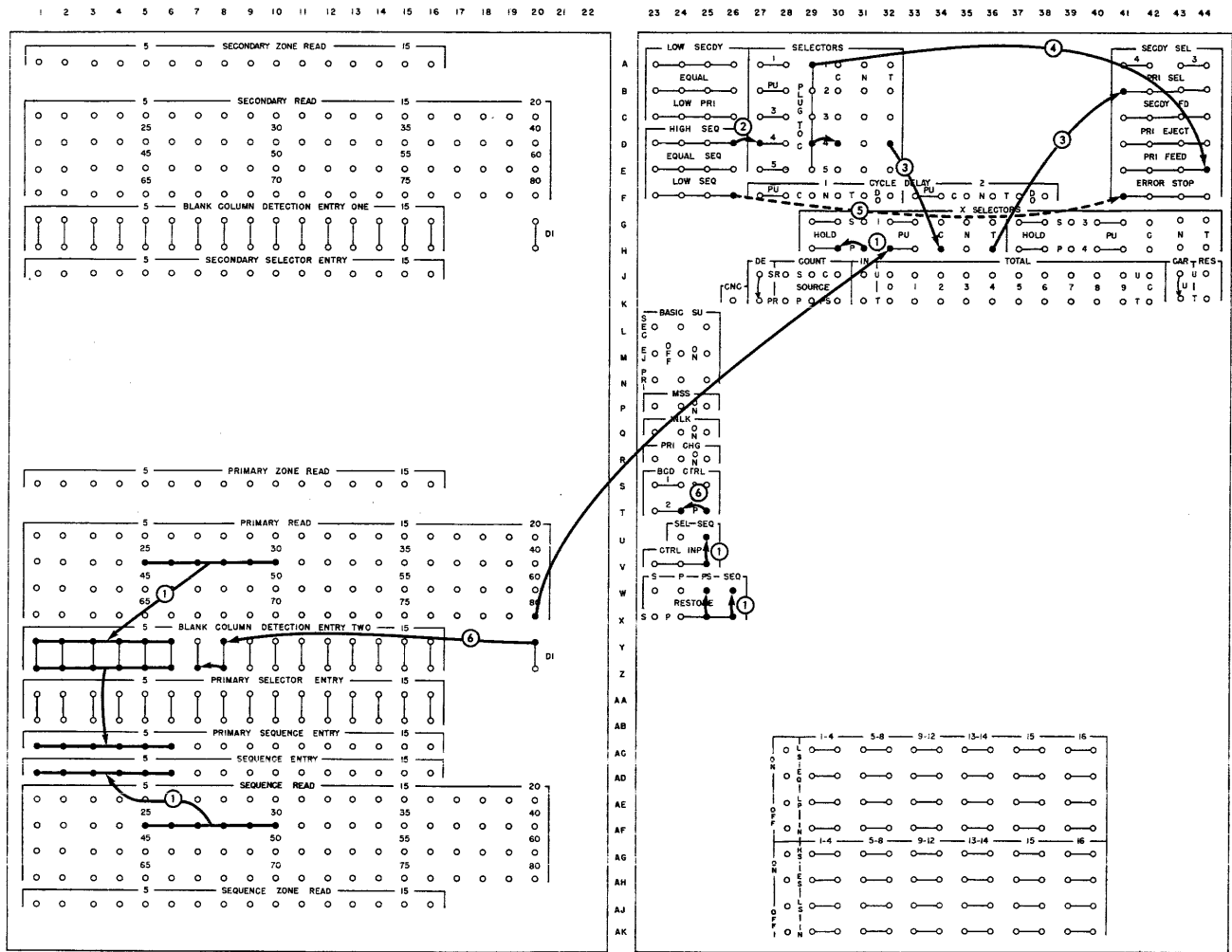

FIGURE 23. SELECTING THE LAST CARD OF A GROUP IF AN X-CARD

### SELECTING THE FIRST CARD OF A GROUP

THE FIRST CARD of each group, like the last card, is recognized by a change in control number. As shown in Figure 24, the first card of a group (103) has been read by the sequence brushes, and a high sequence comparison exists. Because the first card is not in the

eject position at this time, an impulse to select the card on a high sequence comparison must be made available one cycle later.

### Control Panel Hubs

*Cycle Delay.* The cycle delay unit (one standard) is a selector that, when picked up, transfers on the following cycle, rather than immediately like other selectors on this machine.

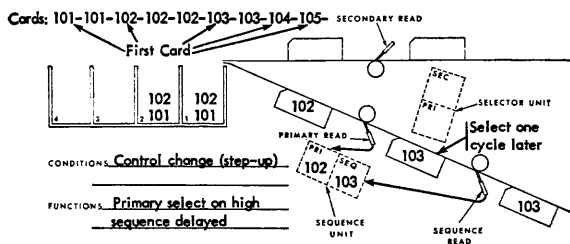
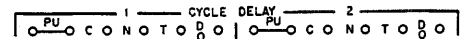

FIGURE 24. SELECTING THE FIRST CARD OF A GROUP



Like other selectors, the cycle delay selector has a PU (pickup), a C (common), an N (normal), and a T (transferred) hub. In addition, a DO (drop out) hub is provided to drop out the selector.

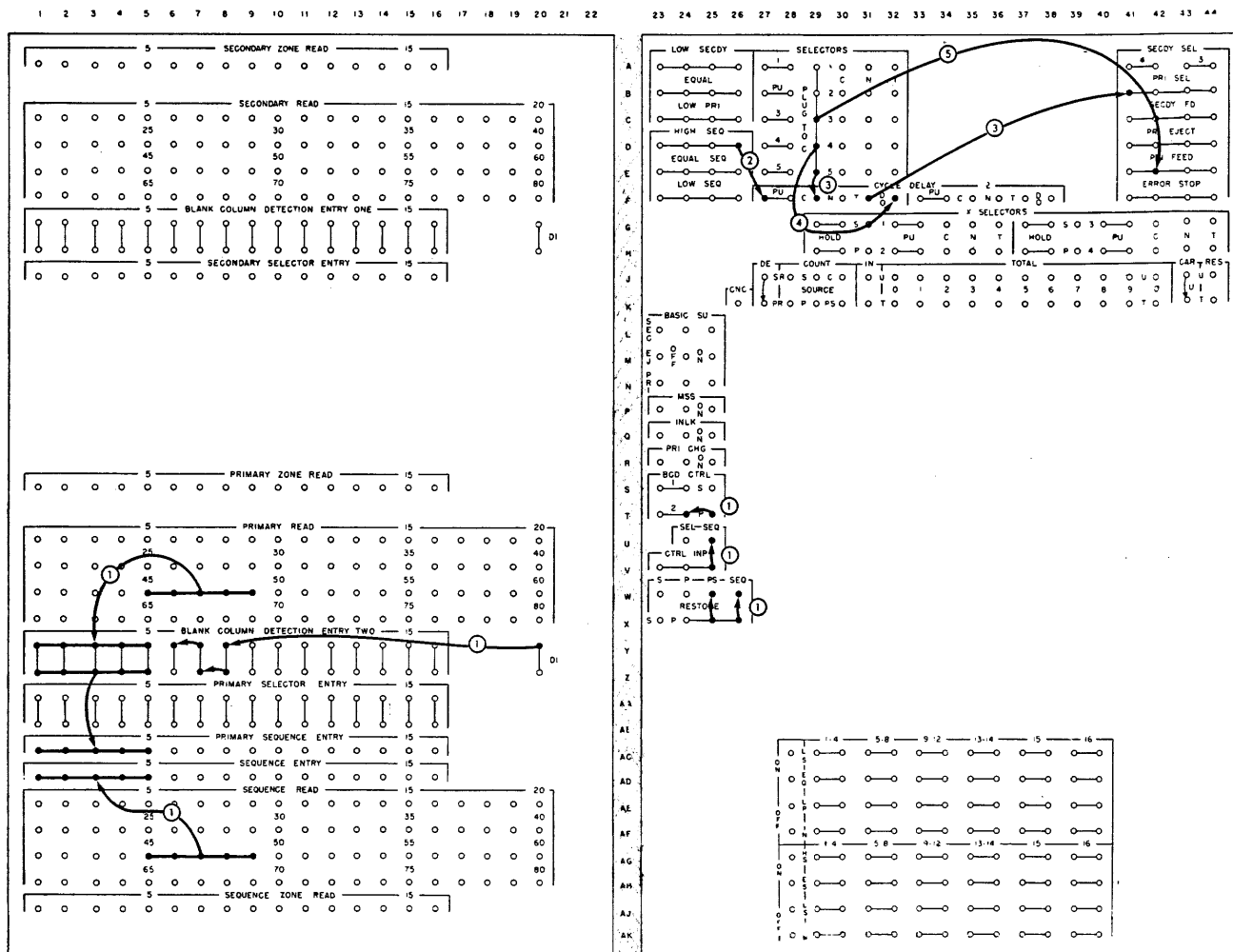

FIGURE 25. SELECTING THE FIRST CARD OF A GROUP

Normally, PU is wired from a control exit, and a PLUG TO C is wired through the C, N, and T hubs to control operations on the following cycle; PU can also be wired from a selected PLUG TO C. However, the pickup cannot be impulsed by any digit or zone impulse.

The cycle delay selector, once transferred, remains transferred until dropped out by an impulse wired to its DO hub. When DO is impulsed, the selector will be normal on the following cycle. The drop out is normally wired, either directly or through other selectors, from PLUG TO C or from PRIMARY or SECONDARY FEED. Whenever both the pickup and drop out are impulsed on the same cycle, the selector will be transferred for the following cycle.

**Wiring (Figure 25)**

1. The control information (columns 45-49) is checked for blank columns and compared in the normal manner.
2. High sequence is wired to cycle delay 1 PU.

The cycle delay selector will be transferred on the following cycle.

3. PLUG TO C is wired through the transferred side of the cycle delay selector to PRIMARY SELECT. Therefore, primary select will be impulsed on the cycle after the high sequence comparison, and will cause the first card of a group to stack in pocket 1. All other cards will stack in pocket 2.

4. PLUG TO C is wired to cycle delay 1 DO. The selector will be normal on the next card feed cycle, unless another high sequence comparison has been detected.

5. Primary cards are fed continuously.

**Wiring Changes, 87 Collator**

1. Wire to primary selector entry instead of primary sequence entry. Wire P RESTORE instead of PS RESTORE. Omit control input wiring.
6. If letters or special characters are compared, wire the zone switch ON.

## SELECTING SINGLE-CARD GROUPS, OR MULTIPLE-CARD GROUPS

SINGLE-CARD GROUPS are recognized by a high sequence followed by another high sequence as shown in Figure 26. Card 103 followed by card 104 (in A)

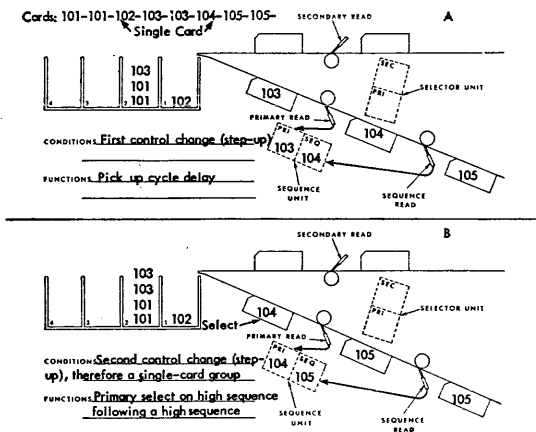

FIGURE 26. SELECTING SINGLE- OR MULTIPLE-CARD GROUPS

is recognized as a high sequence comparison; and card 104 followed by card 105 (in B) immediately causes another high sequence comparison. Therefore, a single card is always recognized when two consecutive high sequence comparisons occur. When the second high sequence comparison occurs, the single card is in the eject position and may be selected to stack in pocket 1.

Because single-card groups are stacked in pocket 1, the groups stacked in pocket 2 are multiple-card groups.

### Wiring (Figure 27)

1. The control information (columns 45-49) is checked for blank columns and compared in the normal manner.
2. High sequence is wired to cycle delay 1 pu. The cycle delay selector will be transferred on the following cycle.
3. High sequence is wired through the transferred side of the cycle delay selector to PRIMARY SELECT.

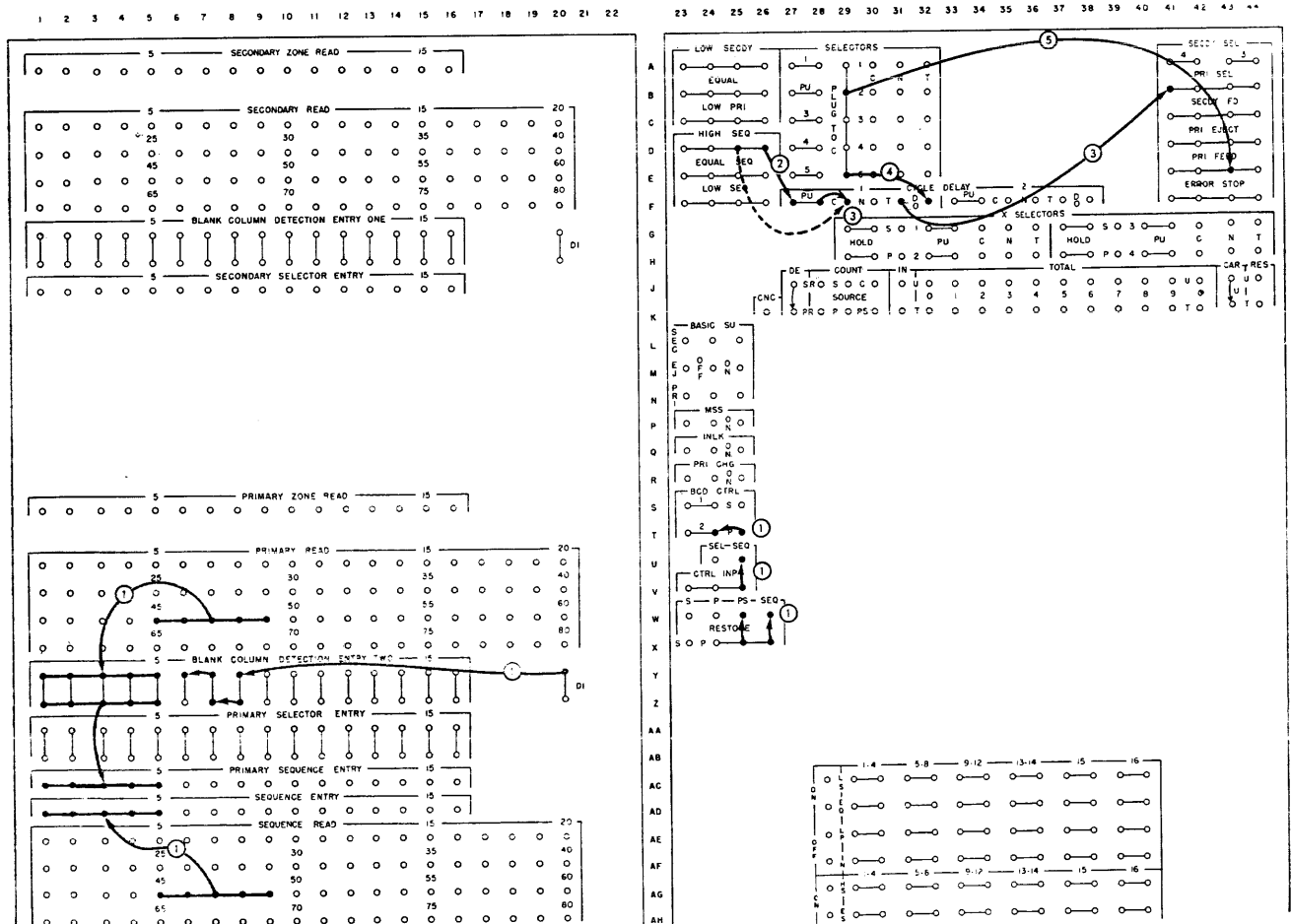

FIGURE 27. SELECTING SINGLE- OR MULTIPLE-CARD GROUPS

Therefore primary select will be impulsed whenever a high sequence comparison follows a high sequence comparison, and will cause single-card groups to stack in pocket 1. All other cards (multiple-card groups) will stack in pocket 2. The dotted wire may be substituted for the wire from PU to c.

4. PLUG TO c is wired to cycle delay 1 DO. The selector will be normal on the next card feed cycle, unless another high sequence comparison has been detected.

5. Primary cards are fed continuously.

#### Wiring Changes, 87 Collator

1. Wire to primary selector entry instead of primary sequence entry. Wire P restore instead of ps restore. Omit control input wiring.

6. If letters or special characters are compared, wire the zone switch ON.

### SELECTING ZERO-BALANCE CARDS

ZERO-BALANCE CARDS can be selected from either the primary or secondary feed, or from both feeds simultaneously. By placing one-half of the file in the primary feed and the other half in the secondary, the processing time is reduced. When both feeds are used, 16 columns per card can be checked for a zero balance.

Zero balances are detected by entering the field to be checked into one side of a comparing unit, and nothing into the other side. Zeros (or blanks) are then recognized as an equal comparison. In this problem the file is split, and the cards in the primary feed are checked using the sequence unit, and those in the secondary feed are checked using the selector unit.

If desired, blanks can be distinguished from zeros by wiring through the available blank-column-detection positions.

Thirty-two columns per card can be checked for zeros (or blanks) if all cards are fed in one feed and both comparing units are used. This is described in the *Typical Operations* section of this manual.

It is possible to expand the number of positions checked for zeros by split-wiring two or more read positions to each comparing entry position.

#### Control Panel Hubs

*Secondary Selector Entry; Primary Selector Entry.* These hubs are the two sets of entries to the 16 comparing positions in the selector unit of the 85 or 87 Model II

(19 positions in the 87 Model I). The entries may be wired from any of the three reading stations. They are normally wired to compare a secondary card with a card at the primary station. The cards may be equal, or one card may be lower than the other, and an impulse is available from one of the corresponding sets of selector control exit hubs.

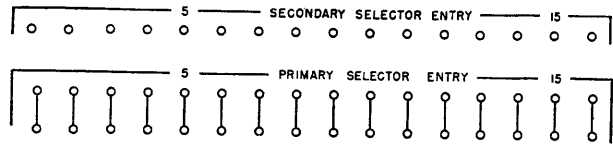

J, 1-16; AA-AB, 1-16

On the 87 control panel, primary selector entry also serves as the entry to the primary sequence side of the *sequence unit*. Information wired to primary selector entry is compared to information wired to sequence entry, and the high, low, or equal impulse for this comparison is available from the sequence control exit hubs.

*Restore: S, P (entries); S, P (exits).* Before numbers can be read into the selector unit from cards passing the brushes, the unit must be restored, or cleared. Both the clearing and subsequent reading into the unit are controlled by the restore hubs. S and P (W, 23-24) are entry hubs to restore the secondary and primary sides of the selector unit, respectively. They are normally wired from the exit hubs directly below, s from the single s exit hub and P from one of the three common P exit hubs. The single s exit hub emits an impulse on every secondary feed cycle, and the three common P exit hubs emit an impulse on every primary feed cycle.

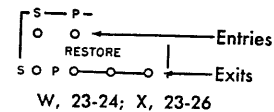

On the first two run-in cycles in the 85, these two RESTORE entry hubs (s and P) and the two RESTORE entry hubs for the sequence unit (ps and SEQ) are common internally. Therefore, if any one of these four hubs is wired on the control panel, all four comparing entries will be restored (cleared and read into) on the run-in. After the first two run-in cycles, all four restore hubs become independent, and the comparing entries are restored according to the control panel wiring.

In the 87, three differences in restoring are: First, the comparing units are automatically restored on the run-out; on the run-in, they are restored separately according to control-panel wiring. Second, ps (primary sequence) RESTORE is inactive; wiring the P (primary) RESTORE hub restores the primary sequence side of the sequence unit, as well as the primary side of the selector unit. Third, if selection of restore exit impulses is required, X-selectors must be used.

**Ctrl Inp (Control Inputs): Sel.** The SEL (selector) entry hub is normally wired from one of the three common exit hubs below to test the comparison of the numbers entered in the selector unit. The three common exit hubs emit an impulse on every card feed cycle.

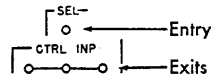

U, 24; V, 23-25

The control impulse wired to SEL travels internally through the selector unit to one of the selector control exit hubs. It is available from either low secondary, equal, or low primary depending on the comparison between the numbers in the unit. This comparison is tested internally in the same manner as described for the sequence unit (see Figure 17).

A control input impulse should not be wired through an X-selector on the 85.

In the 87 Collator, the function of the control input hubs is performed through internal wiring, and these hubs are not available on the control panel.

**Low Secdy (Low Secondary).** These four common hubs emit the control input impulse when the number in sec-

ondary selector entry is lower than the number in primary selector entry.

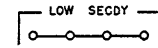

A, 23-26

**Equal.** These four common hubs emit the control input impulse when the number in secondary selector entry is equal to the number in primary selector entry.

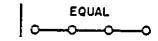

B, 23-26

**Low Pri (Low Primary).** These four common hubs emit the control input impulse when the number in primary selector entry is lower than the number in secondary selector entry.

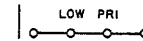

C, 23-26

### Wiring (Figure 28)

1. The balance field (columns 45-49) in the primary cards is wired from primary read through BCD entry two to sequence entry.

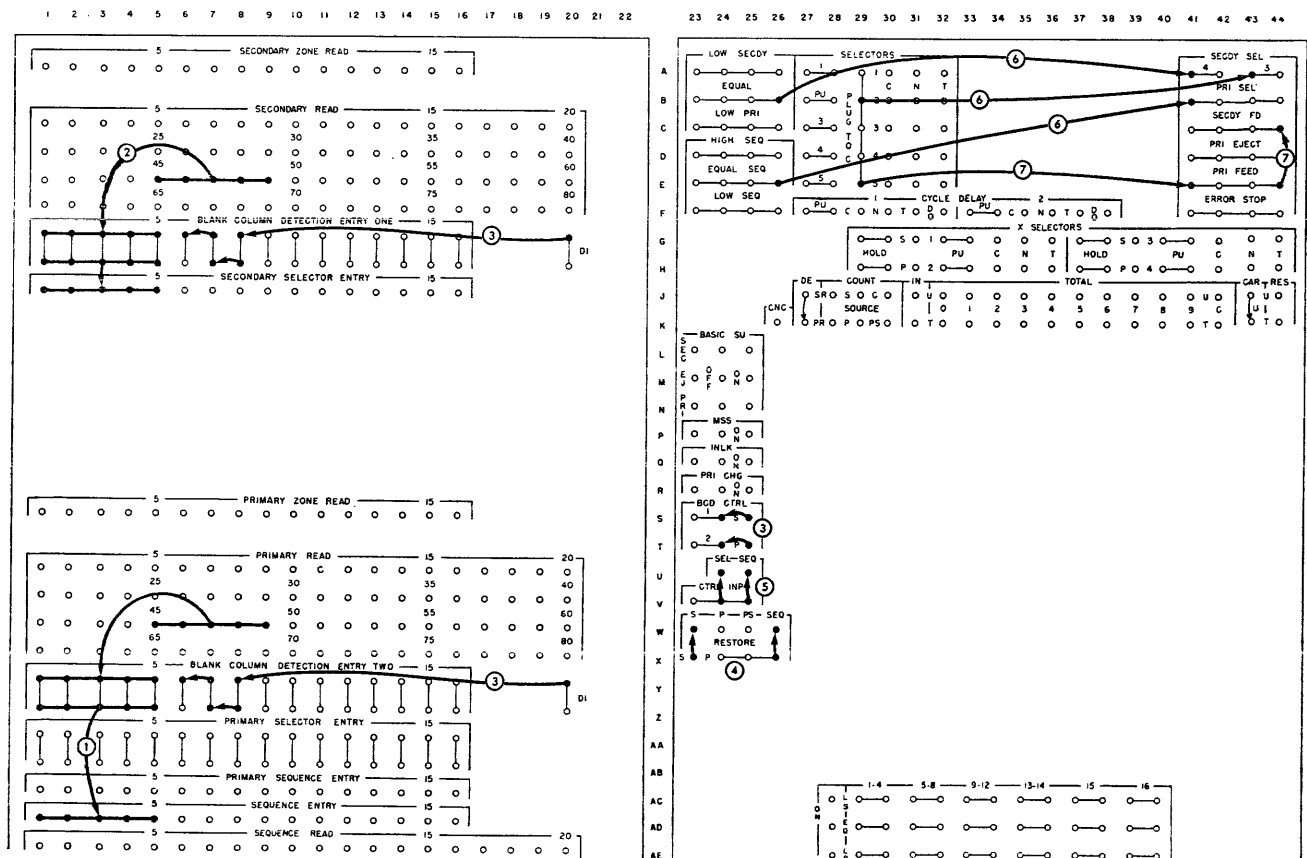

FIGURE 28. SELECTING ZERO-BALANCE CARDS



2. The balance field (columns 45-49) in the secondary cards is wired from secondary read through BCD entry one to secondary selector entry.

3. A direct impulse is wired to the unused blank column detection entry positions, and BCD control is wired.

4. S RESTORE is wired to clear the secondary side of the selector unit and read in a new number each time a secondary card is fed; SEQ RESTORE is wired to clear and read in each time a primary card is fed. Only the entries wired need to be restored. The other entries (primary selector and primary sequence) remain at zero.

5. Control input is wired for both the sequence unit and the selector unit.

6. Zero-balance primary cards are recognized by an equal sequence comparison. Equal sequence is wired to PRIMARY SELECT to cause all zero-balance primary cards to stack in pocket 1. All other primary cards will stack in pocket 2.

Zero-balance secondary cards are recognized by an equal comparison in the selector unit. Equal is wired to SECONDARY SELECT 4 to cause all zero-balance secondary cards to stack in pocket 4. PLUG TO C is wired to SECONDARY SELECT 3 to stack all other secondary cards (not zeros) in pocket 3. When pockets 3 and 4 are impulsed at the same time, pocket 4 takes precedence. If SECONDARY SELECT 3 is not wired, non-zero secondary cards will stack in pocket 2 along with non-zero primary cards.

7. Primary and secondary cards are fed continuously.

#### Wiring Changes, 87 Collator

1. Omit control input wiring.

8. If letters or special characters are compared, wire the zone switch ON.

### MERGING

MERGING is an operation in which two files of cards, already in numerical sequence, are combined to produce one complete file also in numerical sequence. For example, a file of master name and address cards may be combined with a file of detail cards to produce

a complete file that can be used to prepare invoices or checks.

The cards to be merged are usually arranged in ascending order, and therefore the merged file is also in ascending order. In all operations in this section of the manual, the cards are assumed to be in that order; operations with cards in descending order are described in the *Typical Operations* section.

When any two files of cards are to be merged (Figure 29A), either manually or automatically, the cards must be moved from the individual files to the merged file in such a way that the merged file (Figure 29G) will be in order. The card to be moved at any one time is determined by comparing the first card in one file with the first card in the other file. One card may be lower than the other, or the cards may be equal. If the cards are unequal, the lower-numbered card is moved into the merged file (Figure 29A, B, E, F, G); if the cards are equal, the card from the master file is usually fed first (Figure 29C, D). Which cards should be fed first, in case of equals, depends upon the subsequent use of the merged file and must be determined before the operation is started.

If there are several cards with the same number in both files, all those from the master file are usually fed ahead of those from the detail file.

When the collator is used to merge two files of cards, one file is placed in the primary feed hopper and the other in the secondary feed hopper. In normal operation, primary cards will be merged ahead of secondary cards whenever the cards in both feeds are equal. Therefore, those cards that should be first in the completed file should be placed in the primary feed hopper.

After the third run-in cycle, three cards will have been fed in the primary feed and two cards, in the secondary feed (see Figure 7C). During this initial feeding operation, the first primary card is read by the primary brushes, and the first secondary card is read by the secondary brushes. The cards are then compared, and their subsequent feeding and ejection are controlled by the comparisons recognized and the control panel setup involved. The selector unit is normally used to compare the cards in the two feeds. The cards from both feeds will stack in pocket 2.

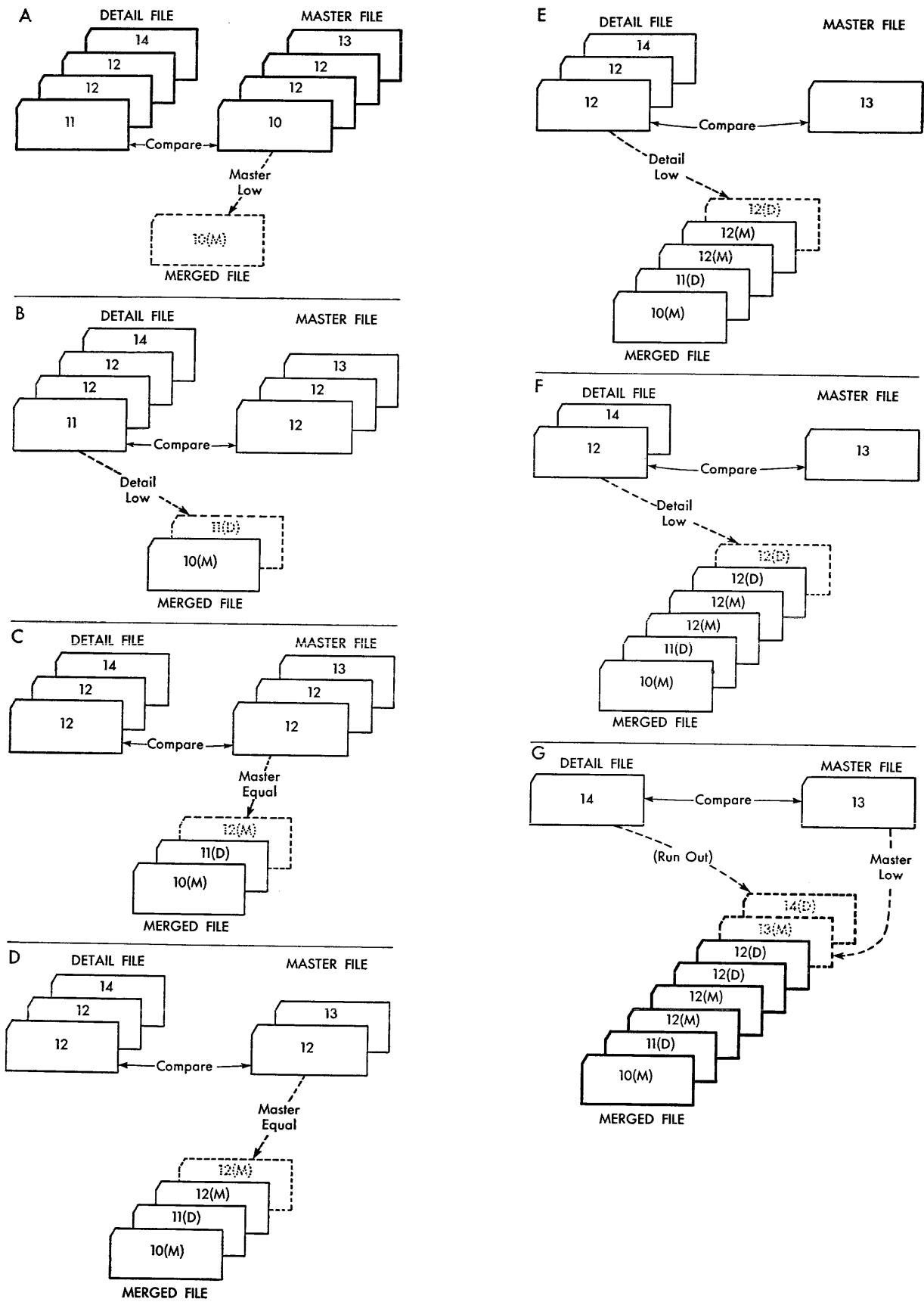

FIGURE 29. MERGING

## FEEDING FROM ONE FEED AT A TIME

Figure 30 illustrates schematically the machine operation to merge the cards shown in Figure 29, feeding from one feed at a time. When the cards in the two feeds are compared, one of three possible results is indicated by the machine:

- Low Secondary — secondary card lower than primary
- Equal — primary and secondary cards the same
- Low Primary — primary card lower than secondary

Feeding from either the primary or secondary feed is controlled by this comparison, and the lower-numbered card is fed first. In Figure 30, steps B, E, and F illustrate secondary-card feeding on a low secondary comparison; A and G illustrate primary-card feeding on a low primary comparison. When the cards are equal, only the primary card is fed (Figure 30C, D) so that all primary cards will be ahead of the secondary cards with the same control number. If secondary cards were fed on an equal comparison, primary and secondary cards with the same control number would alternate in the merged file. However, a secondary card could be fed, on an equal comparison, with the *last* primary card of a group. This operation is described in the next section, *Feeding from Both Feeds Simultaneously*.

The comparisons and feeding required to merge cards, feeding from one feed at a time, can be summarized as follows:

- Low Secondary — Secondary feed
- Equal — Primary feed
- Low Primary — Primary feed

Thus, all secondary cards are fed on a low secondary comparison, and primary cards are fed on either an equal or low primary comparison.

Cards in the primary feed can be sequence-checked during the merging operation by comparing the cards using the sequence unit in the normal manner. In the 85 Collator, either the card field that is used for merging or a different field can be sequence-checked; in the 87 Collator, the field that is used for merging is the only field that can be sequence-checked.

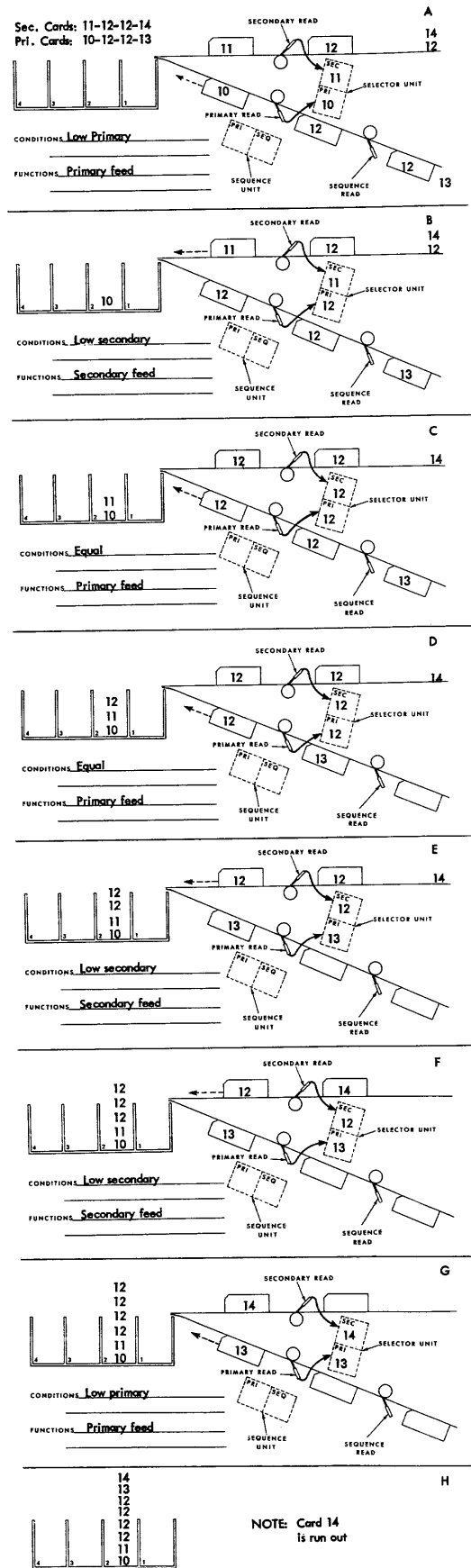

FIGURE 30. MERGING — FEEDING FROM ONE FEED AT A TIME

## Wiring (Figure 31)

1. The cards are compared by wiring the control number in the primary cards (columns 5-9) from primary read through BCD entry two to primary selector entry, and the control number in the secondary cards (columns 5-9) from secondary read through BCD entry one to secondary selector entry. Direct impulse and BCD control are wired.

2. S and P RESTORE are wired normally. The secondary selector entries are restored when a secondary card is fed, and the primary selector entries are restored when a primary card is fed.

3. SEL CONTROL INPUT is wired normally.

4. Low secondary is wired to the pickup of selector 1, and a PLUG TO C is wired through the transferred side of the selector to SECONDARY FEED. This causes

a secondary card to be fed when it is lower than the primary card.

5. PLUG TO C is wired through the normal side of selector 1 to PRIMARY FEED, to cause a primary card to be fed when it is equal to, or lower than, the secondary card.

6. The dotted wiring can be added to sequence-check the cards in the primary feed, if desired.

### Wiring Changes, 87 Collator

3. Omit control input wiring.

6. Omit wiring to primary sequence entry, PS restore wiring, and control input wiring.

7. If letters or special characters are compared, wire the zone switch ON.

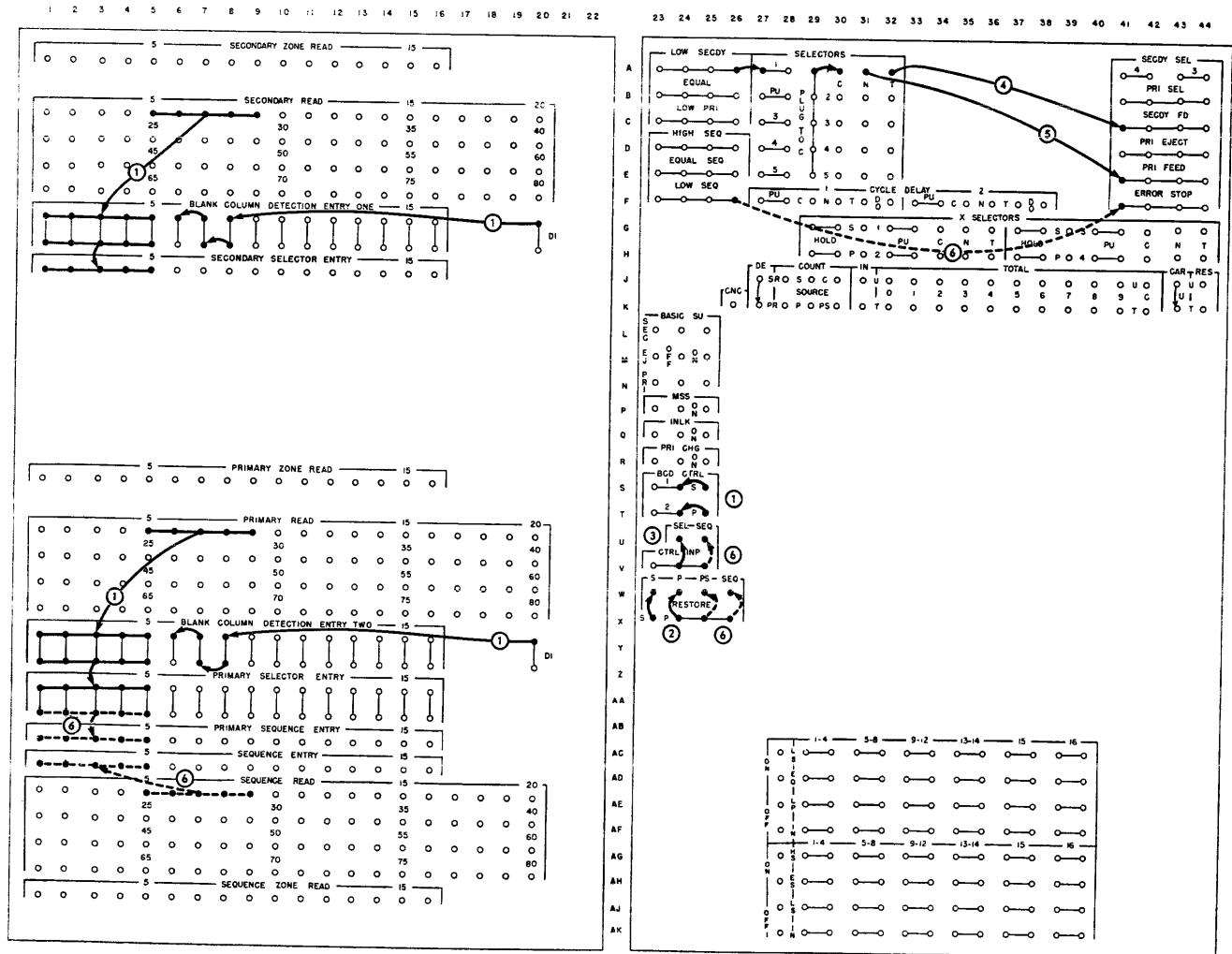

FIGURE 31. MERGING — FEEDING FROM ONE FEED AT A TIME

## Basic Setup, Plan 1 (Figure 32)

The wiring to control primary and secondary feeding in Figure 31 (wiring 4, 5, and 6) can be replaced by wiring three BASIC SU switches (SEC, PRI, and MSS) on the 85 control panel (Figure 32). This is the first of three basic setup wiring plans that can replace functional wiring to control all card feeding for normal merging, merging with selection, and matching operations. Normal operations assume that cards are arranged in ascending sequence and that all primary cards will be fed ahead of all secondary cards with the same control number.

The basic consideration in any of these operations is to control the feeding of primary and secondary cards to produce a merged (or matched) file that is in sequence. Five BASIC SU switches (SEC, EJ, PRI, MSS, and PRI CHG) are provided on the 85 control panel to control this feeding. The switches are wired ON or OFF according to the conditions involved in each operation. For a complete understanding of these five switches, the various conditions that must be provided for are discussed individually, and the functional wiring is diagrammed; then the switches that will handle the various functions are explained. All the functions of the five switches are summarized under *Basic Setup Summary*.

Four BASIC SU switches are provided on the 87 control panel to control feeding. The PRI CHG switch is eliminated, and its ON functions are performed by internal wiring. The hub location of the PRI CHG switch on the 85 panel (R, 23-25) is used for the ZONE switch on the 87 panel.

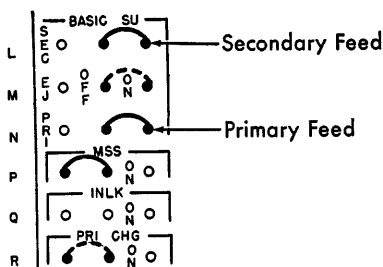

FIGURE 32. BASIC SETUP, PLAN 1 — MERGING, FEEDING FROM ONE FEED AT A TIME

The functions of the three switches (Figure 32) required for *Merging — Feeding from One Feed at a Time* are:

**Sec — Secondary Feed.** When this switch is wired ON, a secondary card is fed whenever a low secondary comparison is detected. Therefore this switch replaces wire 4.



L, 23-25

**Pri — Primary Feed.** When this switch is wired ON, a primary card is fed whenever a low primary comparison is detected.

In addition, when this switch is wired ON and the MSS switch is wired OFF, a primary card is fed whenever an equal comparison is detected.



N, 23-25

**MSS — Multiple Secondaries and Selection.** This switch must be wired ON in a merging or matching operation whenever there are two or more secondary cards with the same control number *and* selection is required. The use of this switch, when ON, is explained under *Merging with Selection — Multiple Secondaries*. For all other operations, this switch *must* be wired OFF.

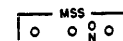

P, 23-25

The two remaining switches, PRI CHG (primary change) and EJ (primary eject), are not required in this operation and are explained in Basic Setup Plans 2 and 3, respectively. However, for convenience, all five of these switches are usually wired either ON or OFF. In this plan, PRI CHG can be wired OFF and EJ ON, as shown by the dotted wiring. If a field is sequence-checked during this merging operation, the PRI CHG switch *must* be wired OFF.

MSS. Multiple secondary sel.

Because the function of the primary change switch is performed by internal wiring in the 87 Collator and this affects the operation of the secondary feed switch as explained under Basic Setup, Plan 2, it is not possible to use the basic setup switches on the 87 for this operation, *Merging — Feeding from One Feed at a Time*.

### FEEDING FROM BOTH FEEDS SIMULTANEOUSLY

In the preceding section one card was fed, from either feed, on each machine cycle. The speed of a merging operation can be greatly increased, however, by feeding cards simultaneously from both feeds whenever possible.

This is possible under *one* condition that may occur when two files of cards are merged: that is, when a secondary card is *equal* to the *last* primary card of a group. For example, in Figure 29 the first detail 12-card can be moved to the merged file at the same time as the last master 12-card and, therefore, steps D and E can be taken at the same time. This is illustrated in Figure 33A. Because the secondary feed is above the primary feed, the detail 12-card from the secondary feed, will be stacked after the master 12-card from the primary feed.

Under all other conditions only one card can be fed at a time, in order for the merged file to be in sequence with all primary cards filed ahead of all corresponding secondary cards. One card is fed under each of the following conditions: low primary, low secondary, and equal when it is not the last card of the primary group.

Figure 33B shows that additional secondary cards, after the first, with the same control number (12) are fed on a low secondary comparison.

To determine that a secondary card and the *last* primary card of the *same* control group are ready to be stacked, two comparisons must be made at the same time:

1. The regular comparison for merging to detect an equal condition between the primary and secondary cards.
2. A comparison between two primary cards to detect the last card of a control group. As described under *Recognizing a Change between Control Groups*,

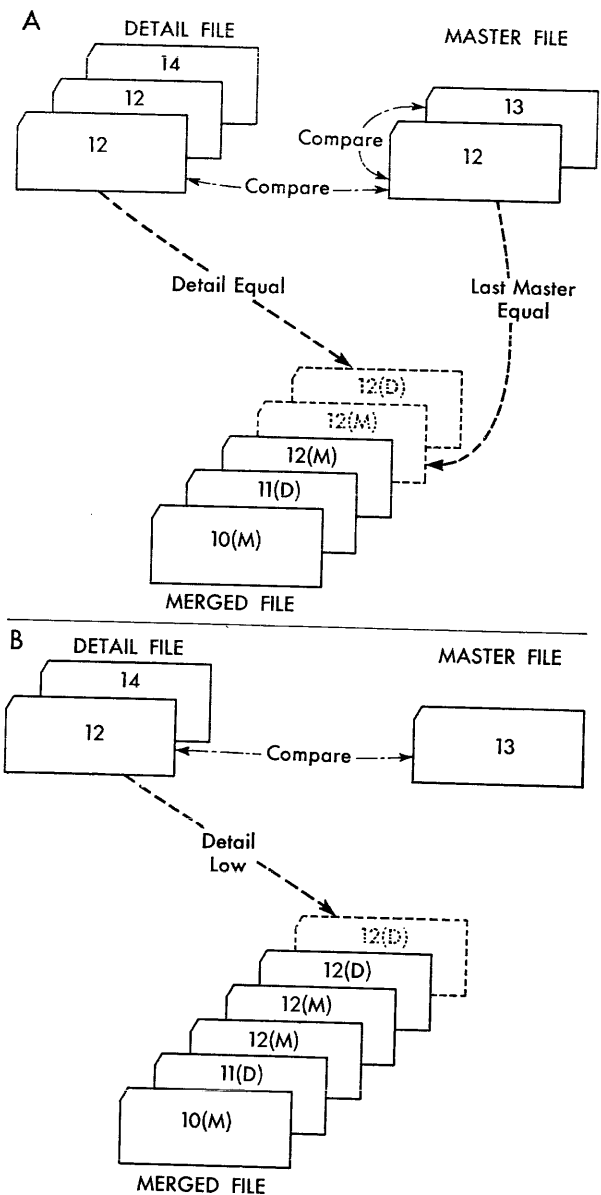

FIGURE 33. MERGING — FEEDING FROM BOTH FEEDS SIMULTANEOUSLY

the last card is recognized when a high (unequal) sequence comparison is detected.

Therefore, both comparing units must be used for this operation. On an equal comparison in the selector unit, both a primary and secondary card are fed if the sequence unit is unequal; if the sequence unit is equal, indicating that there are more primary cards of the same control group, only a primary card is fed.

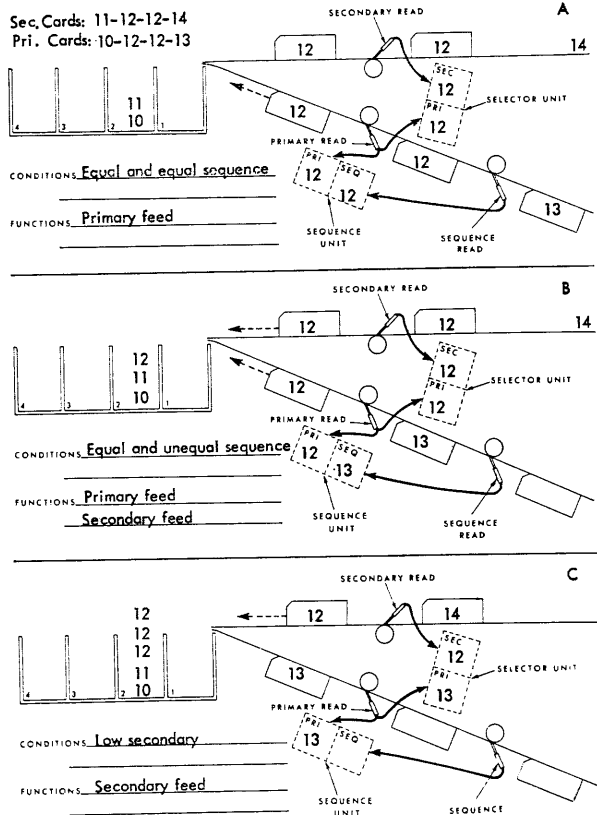

FIGURE 34. MERGING — FEEDING FROM BOTH FEEDS SIMULTANEOUSLY

Figure 34 illustrates these two conditions: step A shows an equal and equal sequence condition in which only the primary 12-card is fed; step B corresponds to Figure 33A and illustrates an equal and unequal sequence condition in which both the primary and secondary 12-cards are fed. Step C shows that additional secondary 12-cards are fed on a low secondary comparison.

The comparisons and feeding required to merge cards, feeding from both feeds simultaneously whenever possible, can be summarized as follows:

Low Secondary — Secondary feed	} Same as <i>Feeding from One Feed at a Time</i>
Equal — Primary feed	
Low Primary — Primary feed	
Equal and Unequal Sequence — Secondary feed	

Thus, as in the previous section, primary cards are fed on an equal or low primary comparison, and secondary cards are fed on a low secondary comparison. In addition to this, secondary cards are fed on an

equal comparison, provided there is also an unequal sequence comparison.

If sequence-checking is desired in this operation, it *must* be performed on the card field that is used for merging.

This operation is diagrammed in Figure 35, and the basic setup plan that replaces the functional wiring is shown in Figure 36.

### Wiring (Figure 35)

1. The cards in the two feeds are compared by wiring the control number in the primary cards (columns 5-9) from primary read through BCD entry two to primary selector entry, and the control number in the secondary cards (columns 5-9) from secondary read through BCD entry one to secondary selector entry. The cards in the primary feed are compared with each other by wiring from primary read to primary sequence entry, and from sequence read to sequence entry. DI and BCD control are wired.

2. S, P, PS, and SEQ RESTORE are wired normally. The secondary selector entries are restored when a secondary card is fed; the primary selector entries, primary sequence entries and sequence entries are restored when a primary card is fed.

3. SEL and SEQ CONTROL INPUT are wired normally.

4. Low secondary is wired to the pickup of selector 1, and a PLUG TO C is wired through the transferred side of the selector to SECONDARY FEED. This causes a secondary card to be fed when it is lower than the primary card.

5. PLUG TO C is wired through the normal side of selector 1 to PRIMARY FEED, to cause a primary card to be fed when it is equal to, or lower than, the secondary card.

6. Equal is wired to the pickup of selector 4, and equal sequence to the pickup of selector 5. PLUG TO C is wired through the transferred side of selector 4 and the normal side of selector 5 to SECONDARY FEED. This causes the secondary card to be fed when it is equal to the last primary card.

7. Low sequence can be wired to ERROR STOP to stop card feeding for an error in primary-card sequence (dotted wiring).





The functions of the four switches (Figure 36) required for *Merging — Feeding from Both Feeds Simultaneously* are:

**Sec — Secondary Feed.** This switch replaces wire 4. (Same as in Plan 1.) In addition, when this switch is wired ON and the PRI CHG switch is also wired ON, a secondary card is fed whenever both an equal (selector) comparison and an unequal sequence comparison are detected. Therefore, this switch, together with the PRI CHG switch ON, also replaces wiring 6. On the 87, this switch always performs both these functions, because the effect of the primary change switch is accomplished by internal wiring.

**Pri — Primary Feed.** This switch, together with the MSS switch OFF, replaces wire 5. (Same as in Plan 1.)

**MSS — Multiple Secondaries and Selection.** This switch must be wired OFF. (Same as in Plan 1.)

**Pri Chg — Primary Change.** This switch on the 85 control panel is wired ON whenever a control change in the primary cards is to affect card feeding during a merging operation. When ON, it conditions the function of the secondary feed (SEC) switch. That is, if the SEC switch is ON, a secondary card is fed whenever both an equal (selector) comparison and an unequal sequence comparison are detected. This is in addition to the normal function of the SEC switch — feeding low secondaries. In the 87 Collator, the function of the primary change switch is performed through internal wiring.

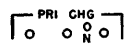

R, 23-25

As in Plan 1, the EJ switch can be wired ON as shown by the dotted wiring.

### MERGING WITH SELECTION

CARDS may be selected from both files during a merging operation. For example, if master name and address cards are being merged with detail cards, it may be desirable to remove those master cards for which there are no corresponding detail cards, and *vice versa*. By doing this, the merged file will contain only "equal" cards, that is, master and detail cards with the same control numbers. Primary cards to be selected are recognized by a low primary comparison, and secondary cards to be selected are recognized by a low secondary comparison.

Selected primary cards stack in pocket 1, and selected secondary cards stack in either pocket 3 or pocket 4.

The conditions to be considered and the control panel wiring required for this operation are affected by the card groups in the secondary feed; that is, whether they are single- or multiple-card groups.

### SINGLE SECONDARIES

When the file in the secondary feed contains only single-card groups, cards can be selected by adding the wiring for selection to the wiring for straight merging.

Figure 37 illustrates schematically the feeding and selection of cards, with single-card groups in the secondary feed. Steps A and E show the selection of low primary cards; steps B and F show the selection of low secondary cards; and step G shows how the cards are stacked after all have been fed.

### Control Panel Hubs

**Inlk (Interlock).** If cards are to be selected in a merging or matching operation, this switch must be wired ON to insure proper selection on the run-out. On a standard machine (see Figures 8 and 9) it may be wired OFF or disregarded at all other times.

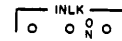

Q, 23-25

Normally, whenever either feed runs out of cards, 9's are read automatically into the corresponding side of the selector unit. For example, the secondary feed may run out of cards:

Secondary Selector Entry — (9999) Automatic 9's

Primary Selector Entry — 9995 Control Field in Primary Card

When the run-out key is depressed from this point on, the primary cards, except those punched all 9's, will be recognized as low primaries thus causing primary feeding and selection. However, if the control field in the primary cards is punched all 9's and the interlock switch is OFF, an equal comparison will be detected. Because primary cards are normally selected on a low primary comparison, these unmatched cards would not be selected. Similarly, unmatched secondary cards punched 9's would not be selected on the run-out. If the interlock switch is wired ON, an equal condition occurring on the run-out is changed internally to both low primary and low secondary so that any unmatched cards punched 9's will be properly selected if they are run out of either feed.

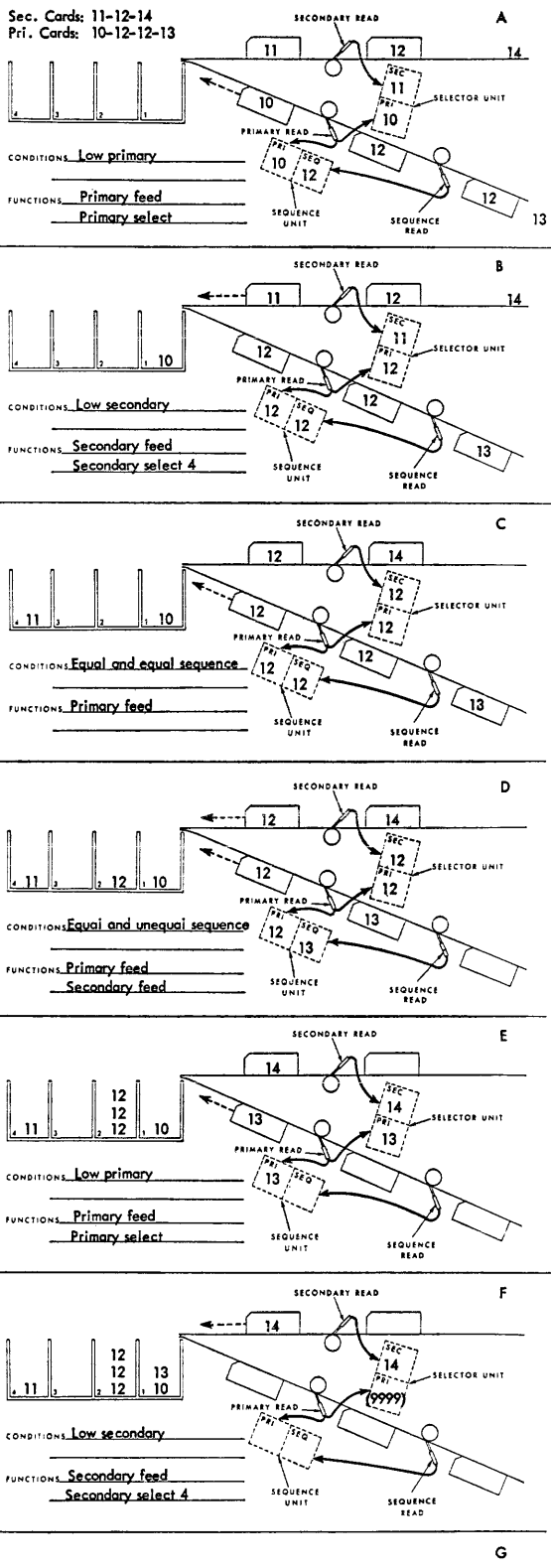

FIGURE 37. MERGING WITH SELECTION — SINGLE SECONDARIES



## MULTIPLE SECONDARIES

In a straight merging operation without selection, multiple secondary cards are fed as illustrated in Figure 34. The first secondary card of an equal group is fed on an equal and unequal sequence condition (step B), and additional secondary cards in the same group are fed on a low secondary (step C). However, when secondary cards are to be selected during a merging operation, they are selected on a low secondary. Thus, all secondary cards after the first in an equal group would be selected erroneously if the plan used for selection with single-card secondaries were used with multiple-card secondary groups.

To correct this condition, feeding must be controlled so that *all* cards in an equal secondary group are fed as *equals*. This can be done by eliminating a primary feed and causing only a primary ejection when the last card of the primary group is detected. A "primary ejection" moves the card that has been read by the primary brushes to the stacker without causing a primary feed cycle. No other cards in the primary feed are moved, and the restore exit hubs are inactive. Therefore, the number read from the last primary card is held in the comparing units, and all multiple secondary cards are compared, as equals, with the last primary card of the corresponding group.

Figure 39 illustrates schematically the feeding of cards when there are multiple-card groups in the secondary feed *and* selection is required. In step B, the last primary card of a group (12) is ejected (stacked), but another primary card is *not* fed, and the first equal secondary card (12) is fed. In step C, the additional secondary card (12) in the equal group is compared to the number held from the last primary card (12) and therefore fed on an equal and unequal sequence condition. In step D, a low primary causes a primary feed, thus moving card 13 past primary read.

The comparisons and feeding required to merge cards, when there are multiple-card groups in the secondary feed and selection is required, can be summarized as follows:

Low Secondary — Secondary feed	} Same as straight merging without selection
Low Primary — Primary feed	
Equal and Unequal Sequence — Secondary feed	
Equal and Equal Sequence — Primary feed	
Equal and Unequal Sequence — Primary eject	

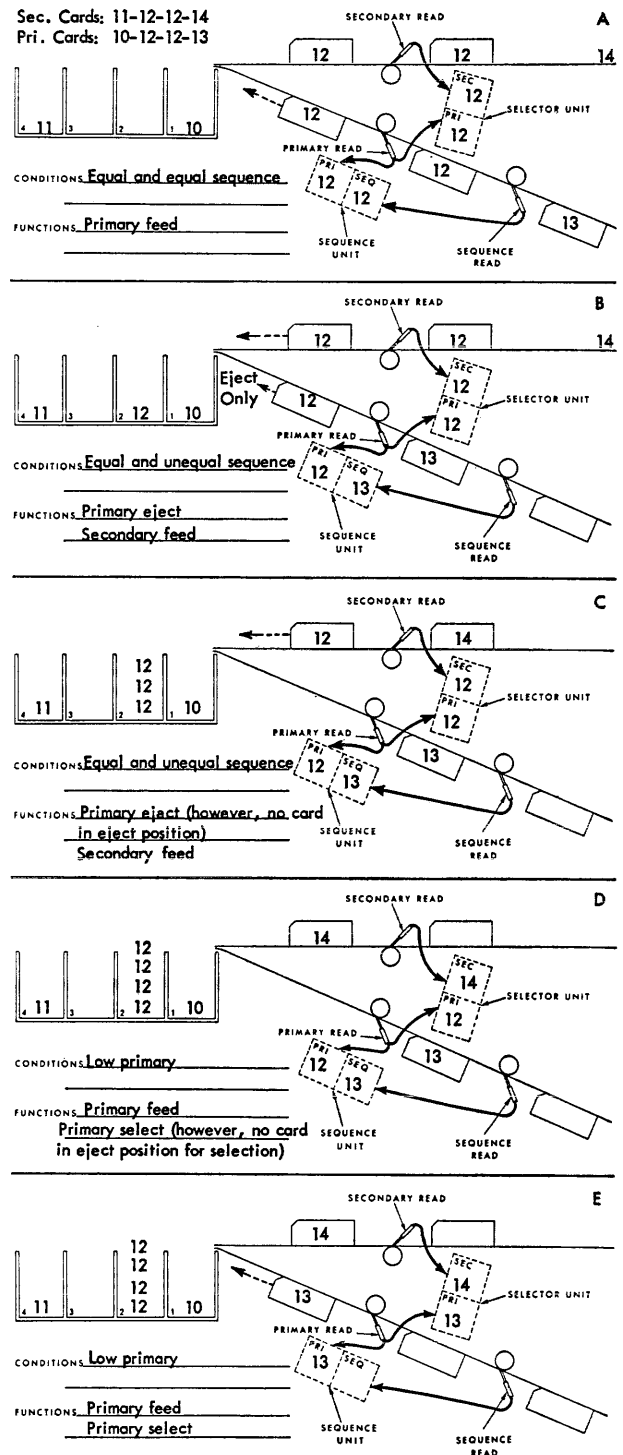

FIGURE 39. MERGING WITH SELECTION — MULTIPLE SECONDARIES

Thus, primary cards are fed on a low primary or on an equal and equal sequence condition; primary cards are ejected on an equal and unequal sequence condition. Secondary cards are fed on a low secondary or on an equal and unequal sequence condition.

Primary cards are selected on a low primary, and secondary cards, on a low secondary.

This operation is diagrammed in Figure 40, and the basic setup plan that replaces the functional wiring is shown in Figure 41.

### Control Panel Hubs

*Pri Eject (Primary Eject)*. These four common functional entry hubs are normally wired from control exit hubs or from PLUG TO C, directly or through selectors, to cause a primary card to be moved from the eject position to the stacker. A primary ejection does not cause a primary feed, and all other primary cards remain stationary.

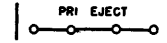

D, 41-44

This primary ejection is an inherent part of a primary feed operation, and PRI EJECT need not be wired on a primary feed cycle.

### Wiring (Figure 40)

1. The card fields are wired for blank-column detection and comparison in the normal manner for a merging operation.
2. S, P, PS and SEQ RESTORE are wired normally.

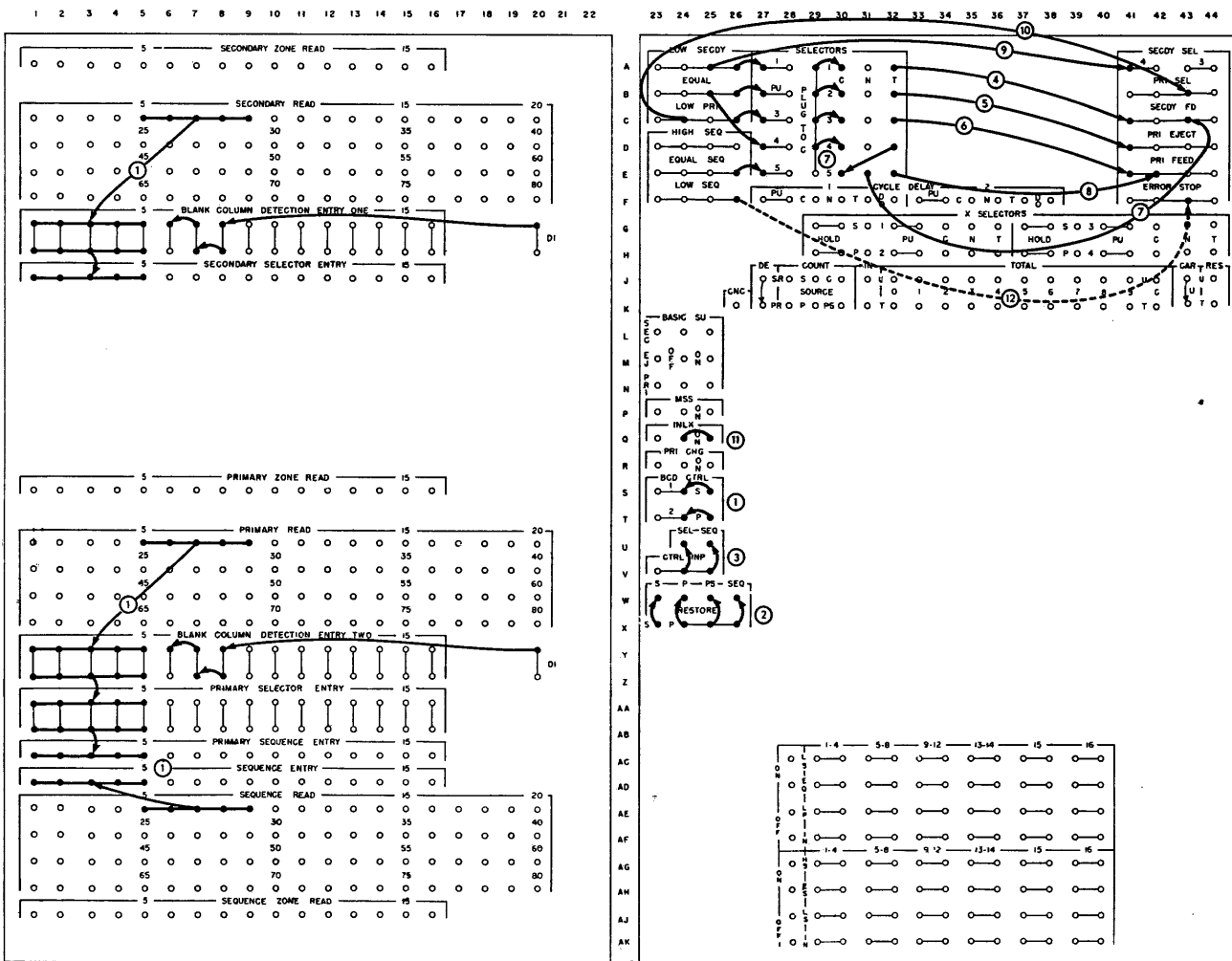

FIGURE 40. MERGING WITH SELECTION — MULTIPLE SECONDARIES



8. PLUG TO C is wired through the transferred side of both selectors 4 and 5 to PRIMARY FEED. This causes a primary feed cycle when the primary card is equal to the secondary card and is *not* the last card of a group. A primary feed must not occur when the equal primary card is the last card of a group. This is prevented by selector 5.

9. Low secondary is wired to SECONDARY SELECT 4 to cause secondary cards without corresponding primary cards to stack in pocket 4.

10. Low primary is wired to PRIMARY SELECT to cause primary cards without corresponding secondary cards to stack in pocket 1.

11. Interlock is wired ON to insure proper selection on the run-out.

12. Low sequence can be wired to ERROR STOP to stop card feeding for an error in primary-card sequence (dotted wiring).

#### Wiring Changes, 87 Collator

1. Omit wiring to primary sequence entry.
2. Omit ps restore wiring.
3. Omit control input wiring.
13. If letters or special characters are compared, wire the zone switch ON.

### Basic Setup, Plan 3 (Figure 41)

The wiring to control primary and secondary feeding in Figure 40 can be replaced by wiring all five basic setup switches as shown in Figure 41. This is the third basic setup wiring plan that can replace functional wiring to control all card feeding for normal merging, merging with selection, and matching operations.

Merging with multiple secondaries and selection differs from the operation of straight merging without selection (Basic Setup, Plan 2) only in the feeding of primary cards on an equal (selector) condition. If an equal primary card is the last card of a group, it must be ejected, but another primary card must *not* be fed; if the equal primary card is not the last card of a group, it must be ejected, and another primary

card must be fed. The EJ, MSS, and PRI CHG switches are wired ON to control this operation.

Figure 41 shows the complete diagram for *Merging with Selection — Multiple Secondaries* using the basic setup switches. This control panel wiring performs exactly the same operation as that in Figure 40. Wiring 1, 2, 3, 9, 10, 11, and 12 is identical to that in Figure 40, and the basic setup switches replace wiring 4, 5, 6, 7, and 8. The functions of the five switches as related to this operation are:

*Sec — Secondary Feed.* This switch replaces wiring 4 and 7. (Same as in Plan 2.)

*Ej — Primary Eject.* When this switch is wired ON, a primary card is ejected whenever a low primary or equal comparison is detected. However, an impulse to primary feed on a low primary or on an equal and equal-sequence condition will also cause a primary ejection. Therefore the main purpose of this switch is to cause only a primary ejection on an equal and unequal sequence condition. This switch replaces wire 5.

E J   O   F   O   N   O   |

M, 23-25

*Pri — Primary Feed.* This switch replaces wire 6. (Same as in Plan 2.) In addition, when this switch and the PRI CHG and MSS switches are wired ON, a primary card is fed on an equal and equal-sequence condition. Therefore this switch, together with the PRI CHG and MSS switches ON, also replaces wiring 8.

*MSS — Multiple Secondaries and Selection.* When this switch is wired OFF, a primary feed occurs on every equal comparison. When multiple secondaries and selection are required, however, a primary feed must occur on an equal (selector) comparison, only if there is also an equal sequence comparison. When the MSS switch is wired ON, or not wired, it prevents the primary feed from occurring on only an equal (selector) comparison; instead both the selector and the sequence comparisons must be equal for primary feed to be internally impulsed.

*Pri Chg — Primary Change.* This switch on the 85 control panel must be wired ON whenever a sequence comparison is to affect card feeding during a merging operation.

In addition to its effect on the secondary feed switch (see Plan 2), it also conditions the primary feed (PRI) switch. That is, if both the PRI and MSS switches are ON, a primary card is fed only when both an equal (selector) comparison and an equal sequence comparison are detected. This is in addition to the normal function of the PRI switch — feeding low primaries.

In the 87 Collator, the ON functions of the primary change switch are performed through internal wiring.

### BASIC SETUP SUMMARY

THE FUNCTIONS of the five basic setup switches that control card feeding are explained as they are used in the preceding sections, *Merging* and *Merging with Selection*. In this section all the functions of each switch are summarized, and illustrated in Figures 42 and 43.

Figure 42 shows an enlarged drawing of the switch hubs, and each hub is labeled to show its function. The dotted lines represent common internal connections between various hubs.

Each switch can be wired ON or OFF. A switch is ON when the center and right-hand hubs are connected, and OFF when the center and left-hand hubs are connected. The center hub in each of the first three switches is an entry to cause feeding or ejecting; these hubs are internally common with the corresponding functional entry hubs. The center hub in the PRI CHG switch is an entry to the pickup of an internal mechanism that conditions the SEC and PRI ON hubs. The hubs labeled "blank" have no function, and all other hubs emit impulses resulting from a comparison detected in the selector unit or the sequence unit, as labeled.

The diagram in Figure 43 is included to assist the operator in understanding the *conditions* under which the BASIC SU switches, when wired ON or OFF, control card feeding and ejection. This is a *schematic* diagram of the internal wiring for these switches, and is not a wiring diagram showing actual mechanisms through which impulses travel (such as relays). The ovals at

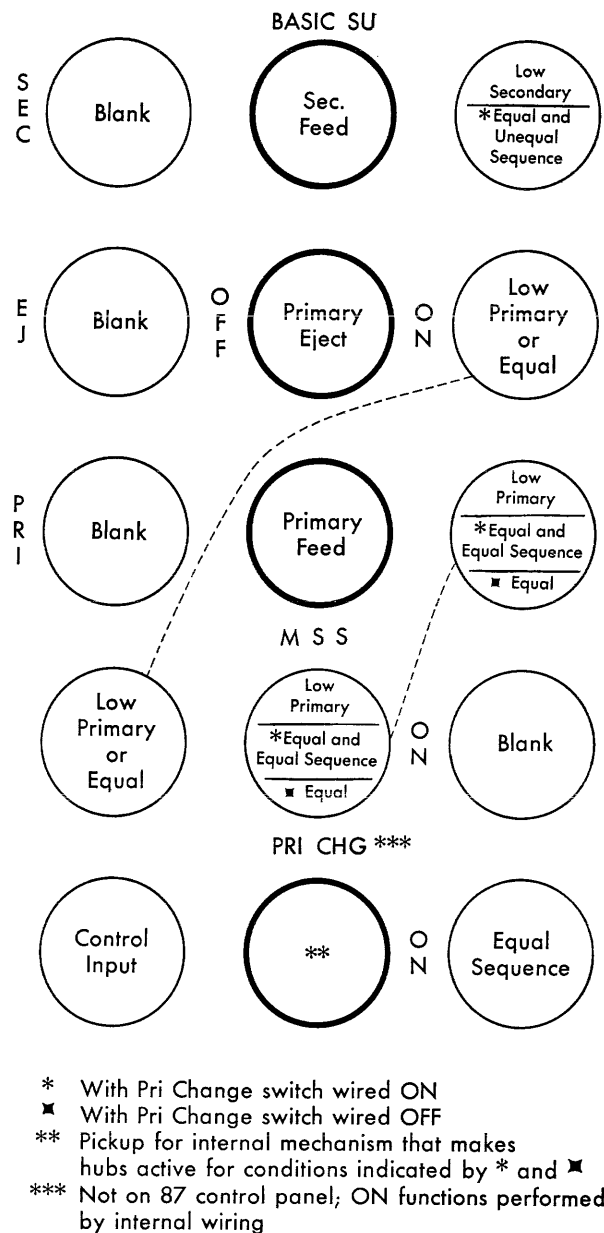

- \* With Pri Change switch wired ON
- \* With Pri Change switch wired OFF
- \*\* Pickup for internal mechanism that makes hubs active for conditions indicated by \* and \*
- \*\*\* Not on 87 control panel; ON functions performed by internal wiring

FIGURE 42. BASIC SETUP SWITCHES

the bottom (Selector Unit Conditions) represent the results whenever two numbers are compared in the selector unit; directly associated with each of these ovals are the corresponding selector control exit hubs (located on the control panel at A-C, 23-26).



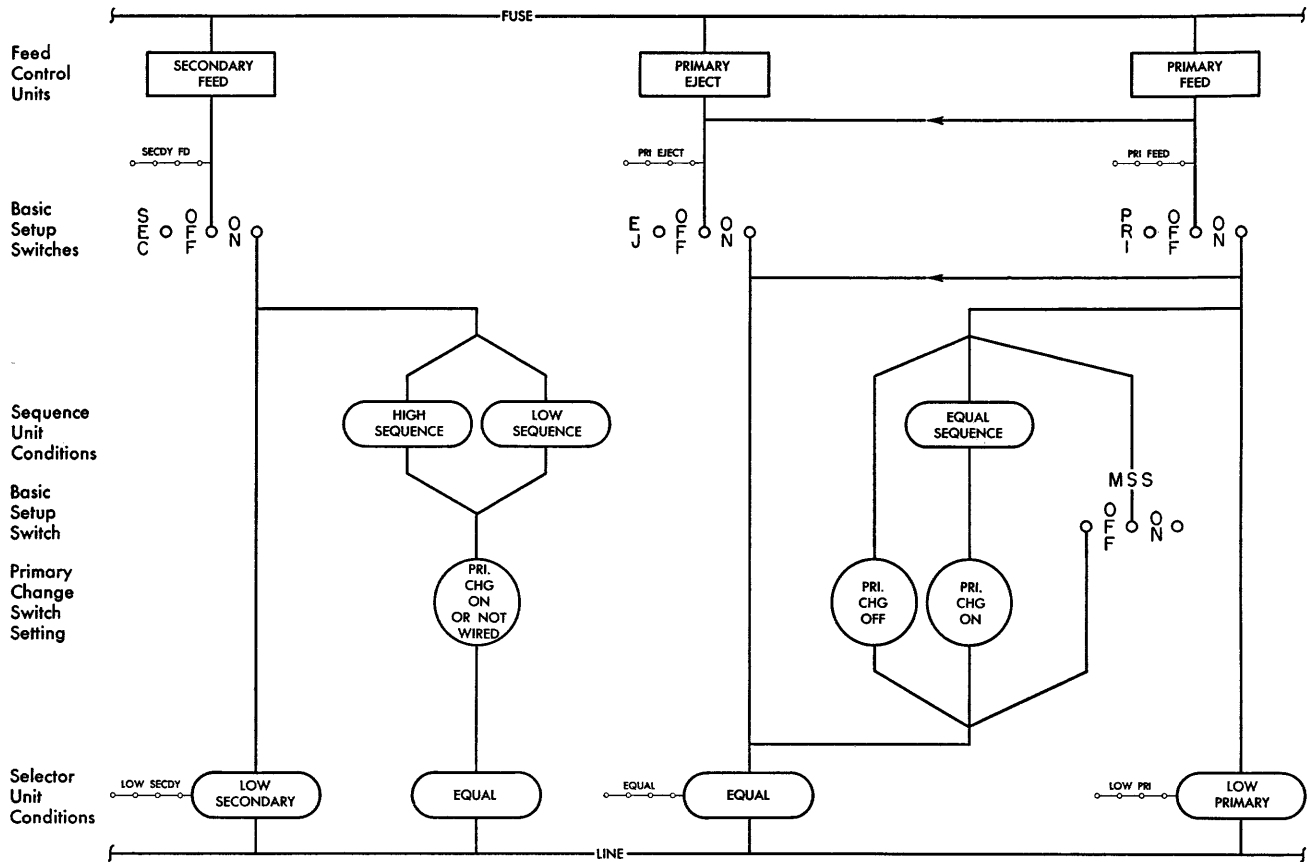

Note: 1. Impulses available from Sec, Ej, Pri, and MSS switches are "plug to C" timed impulses.  
 2. Impulses available from Selector Unit hubs are "control input" timed impulses.  
 3. For the 87, always consider the Primary Change switch ON.

FIGURE 43. SCHEMATIC OF BASIC SETUP SWITCH OPERATION

The row of ovals in the center of the diagram (Sequence Unit Conditions) represents the results when two numbers are compared in the sequence unit. The rectangles at the top (Feed Control Units) represent the clutch mechanisms that must be impulsed to cause feeding and ejection of cards; directly associated with these rectangles are the corresponding functional entry control panel hubs.

Four of the five basic setup switches (SEC, EJ, PRI, MSS) are shown on the diagram, and the effect of the PRI CHG basic setup switch on the 85 is represented by circles for both the ON and OFF positions. The PRI CHG switch is not in this schematic, but the results

of its setting affect the SEC and PRI BASIC SU switches on the 85. Because the PRI CHG switch is eliminated on the 87 control panel and its ON functions are performed by internal wiring, always consider this switch as ON when using this schematic for the 87.

The two arrows in the diagram indicate that an impulse can travel only in the direction shown in these two places.

This schematic can be used in analyzing a problem to determine whether or not card feeding will occur, and under what conditions, when the various basic setup switches are wired ON or OFF. A feed will occur

whenever a path for an impulse can be traced from the "line" (bottom horizontal line) to the "fuse" (top horizontal line). For example, if the basic setup SEC switch is wired ON, a secondary feed will occur whenever a low secondary comparison is recognized in the selector unit. The path for an impulse can be traced as follows:

1. From the "line"
2. Through the mechanism set up by the low secondary comparison and represented by the oval labeled "low secondary"
3. To the control panel ON hub of the SEC switch
4. By control panel wiring to the center (entry) hub of the SEC switch
5. Through the secondary feed control unit represented by the rectangle labeled "secondary feed"
6. To the "fuse."

Similarly, by tracing other paths from the line to the fuse, secondary feeding under other conditions, and primary feeding and ejection can be analyzed.

By further examination of the diagram, it can be seen that a secondary feed will occur if the LOW SECYD control exit hubs are wired to the SECYD FD functional entry hubs. The path is traced as follows:

1. From the line
2. Through the low secondary setup
3. To the LOW SECYD control exit hubs
4. By control panel wiring to the SECYD FD functional entry hubs
5. Through the secondary feed control unit
6. To the fuse.

Thus, wiring the SEC switch ON and wiring LOW SECYD to SECYD FD perform the same operation—either wiring causes a secondary feed on a low secondary comparison.

As shown in the Timing Chart in this manual, the exit hubs of the basic setup SEC, EJ, PRI, and MSS switches emit "plug to c" timed impulses, and the control exit hubs for the selector unit emit "control input" timed impulses.

The conditions under which card feeding occurs when each of the five switches is wired ON or OFF, as seen in the two figures (42 and 43), are summarized below. The feeding conditions apply to both collators except when indicated for the 85 or 87 only.

#### *Sec — Secondary Feed*

- ON: 1. Low secondary  
 2. Equal and unequal sequence, if the PRI CHG switch is wired ON (85)  
 3. Equal and unequal sequence (87)
- OFF: No function

#### *Ej — Primary Eject*

- ON: 1. Low primary  
 2. Equal
- OFF: No function

#### *Pri — Primary Feed*

- ON: 1. Low primary  
 2. Equal if the MSS switch is wired OFF  
 3. Equal if the PRI CHG switch is wired OFF (85)  
 4. Equal and equal sequence if the MSS switch is wired ON (or not wired) and the PRI CHG switch is wired ON (85)  
 5. Equal and equal sequence if the MSS switch is wired ON, or not wired (87)
- OFF: No function

#### *MSS — Multiple Secondaries and Selection*

PURPOSE: To condition the primary feed switch

ON OR NOT WIRED:

1. Primary feed on an equal and equal sequence condition, if the PRI CHG switch is also wired ON (85)
2. Primary feed on an equal and equal sequence condition (87)

OFF: Primary feed on an equal condition.

#### *Pri Chg — Primary Change (85 Collator Only)*

PURPOSE: To condition the primary feed and secondary feed switches depending on a control change in the primary cards.

- ON: 1. Primary feed on an equal and equal sequence condition, if the MSS switch is also wired ON or is not wired.  
 2. Secondary feed on an equal and unequal sequence condition.

OFF: Primary feed on an equal condition.

NOTE: Whenever a secondary feed, primary ejection, or primary feed is controlled through the basic setup switches, an impulse is available from the corresponding functional entry hubs. Thus, these hubs, which are normally *entries*, become *exits*. This can be traced in Figure 43.



## Wiring (Figure 44)

1. The card fields are wired for blank-column detection and comparison in the same manner as in a merging operation.

2. Interlock is wired ON to insure proper selection on the run-out.

3. The basic setup switches are wired ON according to Plan 3, which provides for proper card feeding when there are multiple secondaries and selection is required.

4. Low secondary is wired to SECONDARY SELECT 4 to stack unmatched secondary cards in pocket 4.

5. Equal is wired to SECONDARY SELECT 3 to stack equal secondary cards in pocket 3.

6. Low primary is wired to PRIMARY SELECT to stack unmatched primary cards in pocket 1.

7. Low sequence can be wired to ERROR STOP to stop card feeding for an error in sequence in the primary cards (dotted wiring).

## Wiring Changes, 87 Collator

1. Omit wiring to primary sequence entry, ps restore wiring, and control input wiring.

3. Omit primary change switch.

8. If letters or special characters are compared, wire the zone switch ON.



## COMPARING TWO FIELDS IN THE SAME CARD — PRIMARY FEED

TWO FIELDS in the same card can be compared with each other to determine whether they are equal or, if unequal, which of the two is lower (or higher). In the illustration (Figure 46), it is desired to select from a file all cards in which field B is less than field A. This can be done by comparing the two fields in the selector (or sequence) unit and selecting on a low comparison.

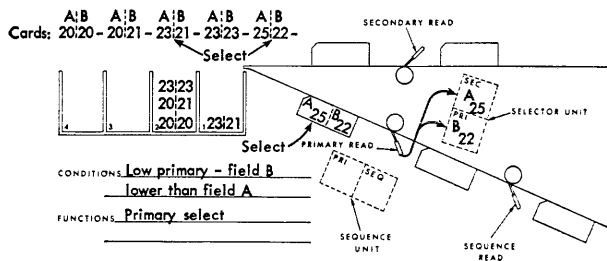

FIGURE 46. COMPARING TWO FIELDS IN THE SAME CARD — PRIMARY FEED

## Wiring (Figure 47)

1. Field A (columns 9-14) is wired from primary read through BCD entry one to secondary selector entry, and field B (columns 15-20) is wired through BCD entry two to primary selector entry. DI is wired to the unused BCD entry positions.

2. Because numbers are read into both sides of the selector unit from a primary card, both s and p RESTORE are wired from the three common p exit hubs below to restore the unit whenever a primary card is fed. BCD control 1 and 2 are both wired from p to operate in conjunction with the primary feed.

3. SEL control input is wired normally.

4. Low primary is wired to PRIMARY SELECT to cause the cards in which field B is less than field A to stack in pocket 1. All other cards will stack in pocket 2.

5. Primary cards are fed continuously.

## Wiring Changes, 87 Collator

3. Omit control input wiring.

6. If letters or special characters are compared, wire the zone switch ON.

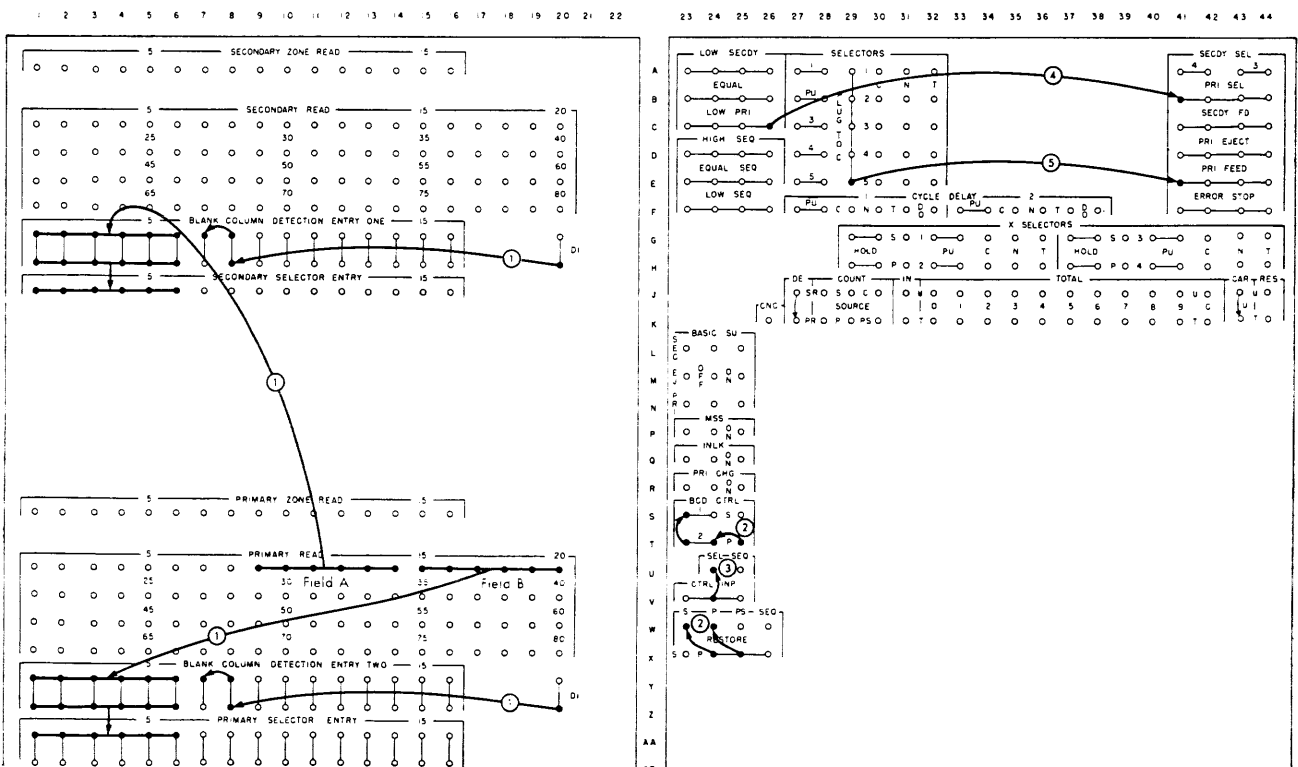

FIGURE 47. COMPARING TWO FIELDS IN THE SAME CARD — PRIMARY FEED



## SELECTING CARDS BY A CONTROL NUMBER

CARDS punched with a specific number can be selected from a file regardless of the sequence of the cards in that file. The control number is punched in a finder card, which is placed ahead of the cards to be searched. When the file is run through the machine, the control number from the finder card is read and "remembered," and the number in each following card is compared with it. The control number may be punched anywhere in the finder card.

The control number is remembered by reading it into one side of a comparing unit and omitting the restore wiring for that side. The numbers read from the file cards are entered in the other side of the same unit, which is restored normally. Because all comparing entries are restored on the run-in cycles if any one of them has been wired to restore, the control number will be cleared from the comparing unit on each run-in. Therefore, each time a run is started, or restarted after a run-out, a finder card must precede the file of cards.

A file of cards to be searched can be fed through either the primary feed or the secondary feed, or it can be split in half and the halves fed simultaneously using both feeds. If the primary feed is used, the control number in the finder card must be read from the primary sequence brushes, not the primary brushes. Because the comparing entries are restored automatically for only the first *two* run-in cycles and a card does not pass the primary brushes until the *third* cycle, this would be too late to enter the control number from the finder card. If the secondary feed

is used, the number from both the finder card and the file cards is read from the secondary brushes to a comparing unit.

Once the control number has been read in and remembered, cards punched with numbers equal to, higher than, or lower than the control number can be selected.

In Figure 49, the file is searched for cards punched with number 125. The cards are fed in the primary feed. The control number is read into the primary selector entries as the finder card passes sequence read on the run-in (Figure 49A). The primary selector entries are not wired to restore so that the number (125) will remain in this unit until a new run-in occurs. Numbers from the file cards are read into the secondary selector entries (Figure 49B), which clear on every card. An equal comparison will indicate that a file card is punched with the control number (125), and these cards can be selected from the file to stack in pocket 1.

NOTE: This operation as illustrated can be performed on the IBM 85 only. To select cards by a control number in the IBM 87, an X-master card punched with the finder number must be used. This is necessary because comparing units on the 87 restore on the run-in *only as wired*. The method described in the next example should be used for the 87.

### Wiring (Figure 50)

1. The control number in the finder card (columns 10-15) is wired from sequence read to primary selector entry.

2. The number in the file cards (columns 10-15) is wired from primary read through BCD entry one to secondary selector entry. DI and BCD control are wired.

3. S RESTORE is wired to restore on every primary card. P RESTORE is not wired so that the primary selector entries are cleared and a new number is entered on the run-in only.

4. SEL control input is wired normally.

5. Equal is wired to PRIMARY SELECT to cause all cards punched with the control number to stack in pocket 1. All other cards will stack in pocket 2.

The alternate wiring shows the other two conditions that can be selected: file cards punched with numbers higher than the control number, or those with numbers lower than the control number. Low primary represents a file card higher than the control number (finder card low); low secondary represents

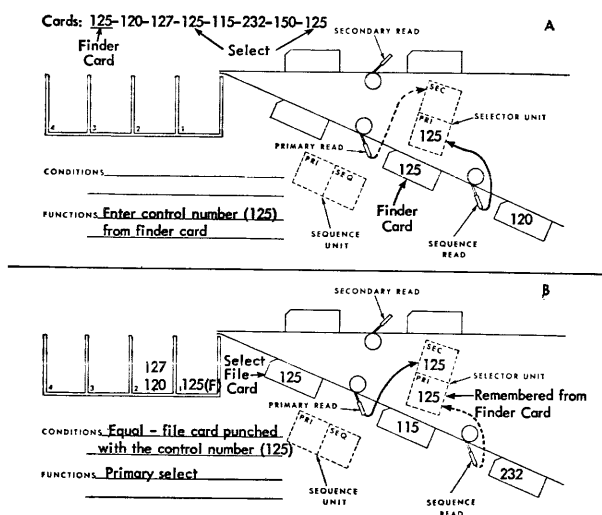

FIGURE 49. SELECTING CARDS BY A CONTROL NUMBER IN THE IBM 85



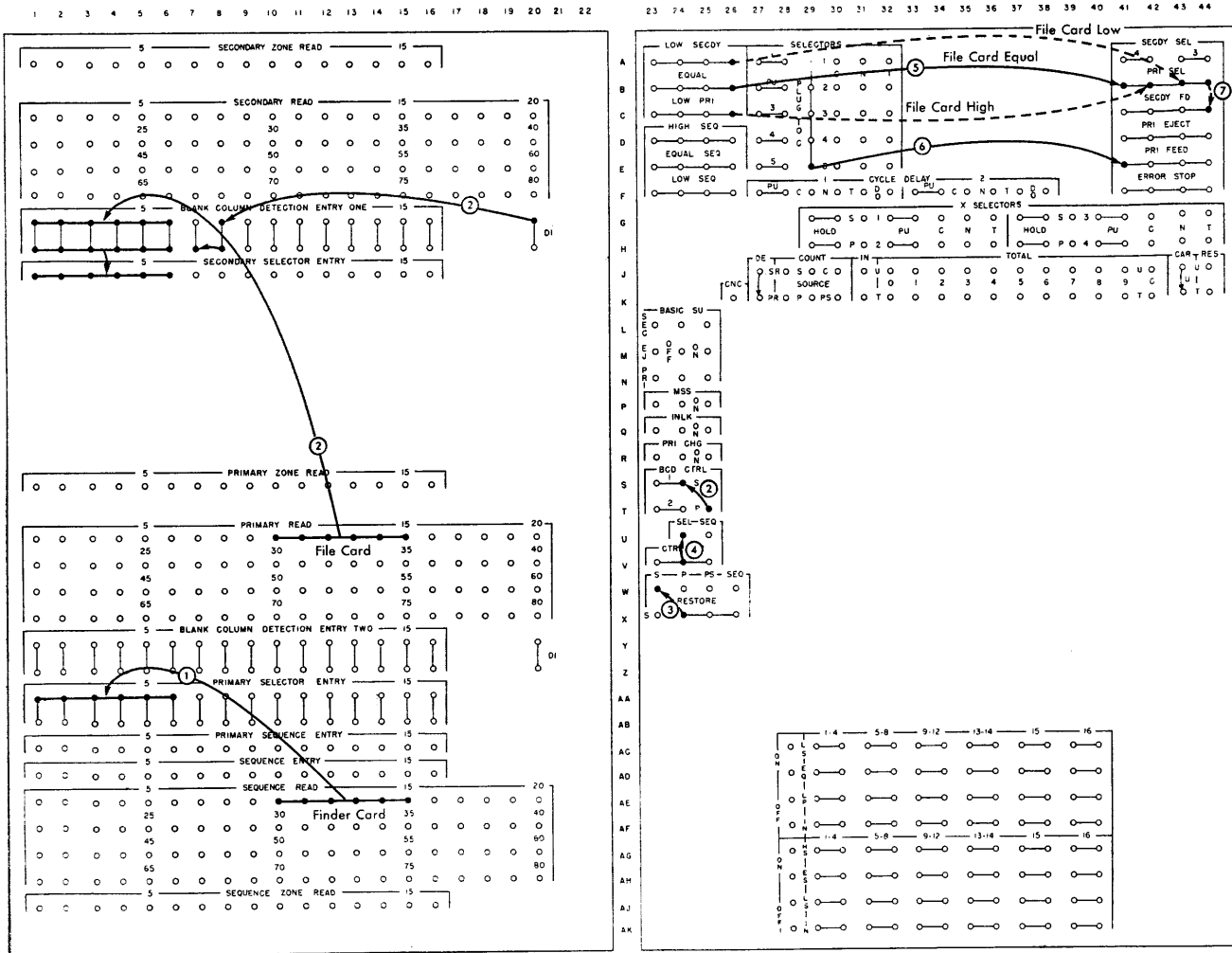

FIGURE 50. SELECTING CARDS BY A CONTROL NUMBER IN THE IBM 85

a file card lower than the control number (finder card high). In this case the finder card will stack in pocket 2 because it causes an equal condition.

6. Primary cards are fed continuously.

7. Indicator cards can be inserted in the file in place of the selected cards by placing indicator cards in the secondary feed hopper and impulsing secondary feed whenever a primary card is selected.

### SELECTING CARDS BY A CONTROL NUMBER, INTERSPERSED X-FINDER CARDS — PRIMARY FEED

IF FINDER CARDS are interspersed throughout a file, they must be identified by X-punching. The X is normally punched in the finder cards, and the cards

are fed through the primary feed. (If the secondary feed is to be used, the X must be punched in a card preceding the finder card, as described in the next example.)

The X is read when the X-finder card passes the sequence brushes. It is used to control the restoring of the comparing entry in which the finder-card control number is held. Then, when the X-finder card passes the primary brushes, the new control number is read in. Because two reading stations are required (one to identify the X-finder card, and the following to read in the control number from the X-finder card), this operation can be performed in the primary feed only.

As in the preceding example, cards punched with numbers equal to, higher than, or lower than the control number can be selected.

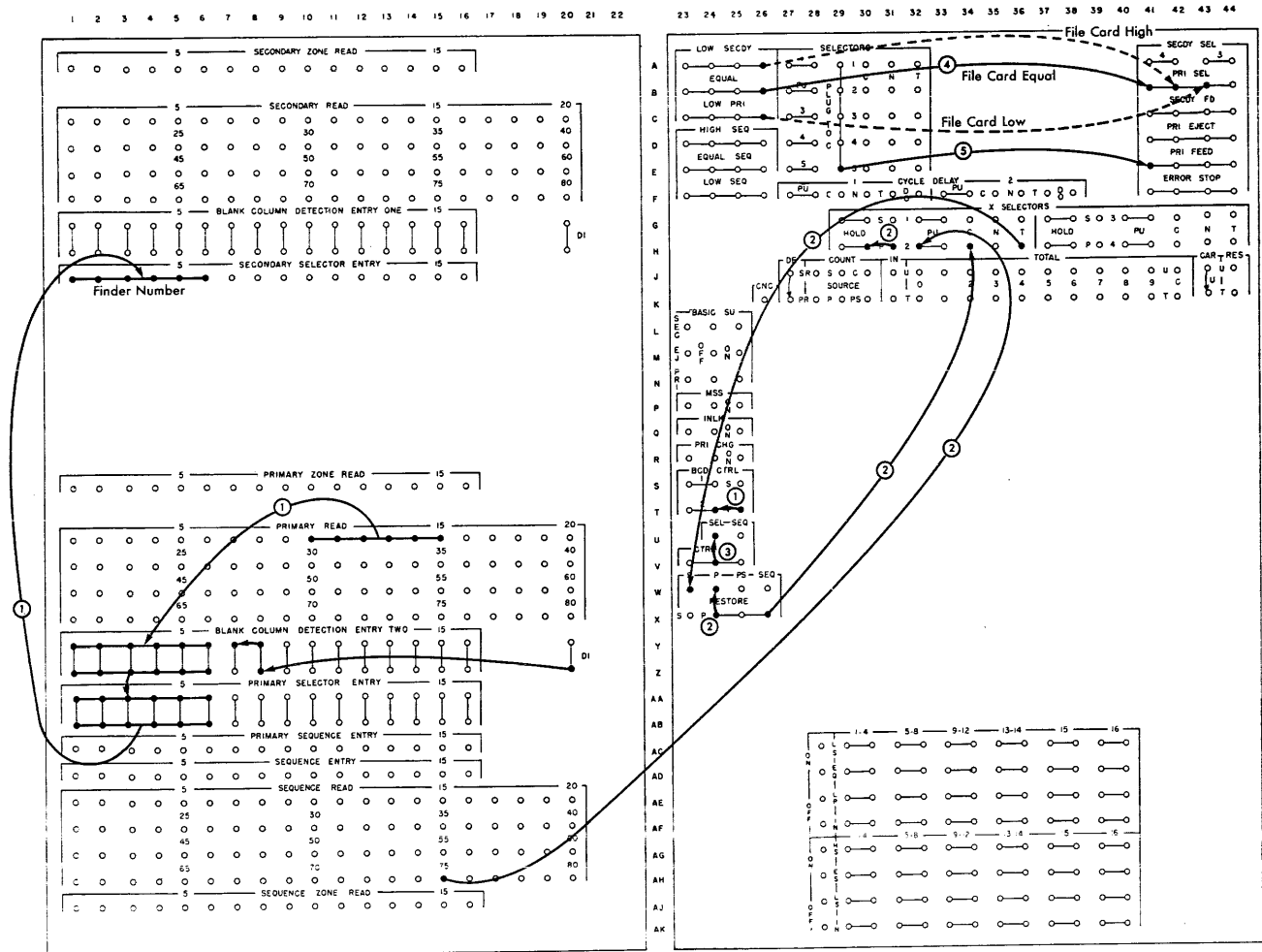

FIGURE 51. SELECTING CARDS BY A CONTROL NUMBER, INTERSPERSED X-FINDER CARDS — PRIMARY FEED

In the illustration (Figure 51), both the control number in the finder card and the numbers in the file cards are punched in the same card field, and the selector unit is used to compare the numbers. Finder cards are X-punched in column 75.

### Wiring (Figure 51)

1. The number field (columns 10-15) is wired from primary read through BCD entry two to both primary selector entry and secondary selector entry. The control number from the X75 finder card will be read into both sides of the selector unit, but the number from the file cards will be read into the primary side only. DI and BCD control are wired.
2. The X75 in the finder card is wired from sequence read to X-selector 2 PU, and HOLD is wired from P so that the selector will operate in conjunction with the primary feed. One of the three common restore exits (P) is wired through the transferred side of the X-selector to s RESTORE. This causes the sec-

ondary side of the selector unit to be cleared and a new number to be read in, only when an X75 primary card is fed. P RESTORE is wired normally to restore on every card.

3. SEL control input is wired normally.

4. Equal is wired to PRIMARY SELECT. Each finder card and the following file cards that are punched with the control number will stack in pocket 1. All other cards will stack in pocket 2.

By wiring low secondary or low primary to PRIMARY SELECT, cards higher or lower than the finder card can be selected (dotted wiring). In this case, the finder cards will stack in pocket 2 because they cause an equal condition.

5. Primary cards are fed continuously.

### Wiring Changes, 87 Collator

3. Omit control input wiring.
6. If letters or special characters are compared, wire the zone switch ON.

## SELECTING CARDS BY A CONTROL NUMBER, INTERSPERSED FINDER CARDS — SECONDARY FEED

IF A FILE OF CARDS with interspersed finder cards is fed in the secondary feed, each finder card must be preceded by an X-punched control card, instead of controlling by an X in the finder card itself as described in the preceding example. X-finder cards cannot be used because, for control purposes, the X must be read ahead of the "finder" number. This would be impossible if the X were punched in the same card with the finder number, because there is only one set of brushes in the secondary feed and cards are fed 9's edge first. The two cards (X-punched control card and finder card) accomplish the same results in the secondary feed, with the one set of brushes, as are accomplished in the primary feed with two sets of brushes. That is, the X is read first for controlling purposes, and on the following cycle the number is read from the finder card into the comparing entries.

As in the preceding example, cards punched with numbers equal to, higher than, or lower than the control number can be selected. Because three pockets

are available in the secondary feed, it would be possible to select the cards into three groups: equal to, higher than, and lower than the finder card.

In the illustration (Figure 52), both the control number in the finder card and the numbers in the file cards are punched in the same card field, and the selector unit is used to compare the numbers. The X in the control cards is punched in column 75.

### Wiring (Figure 52)

1. The number field (columns 10-15) is wired from secondary read through BCD entry two to both primary selector entry and secondary selector entry. The number from the finder card will be read into both sides of the selector unit, but the number from the file cards will be read into the primary side only. DI and BCD control are wired.

2. X75 in the control card is wired from secondary read to X-selector 2 PU, and HOLD is wired from s so that the selector will operate in conjunction with the secondary feed. The single restore exit (s) is wired through the transferred side of the X-selector to s RESTORE. This causes the secondary side of the selector unit to be cleared and a new number to be read in,

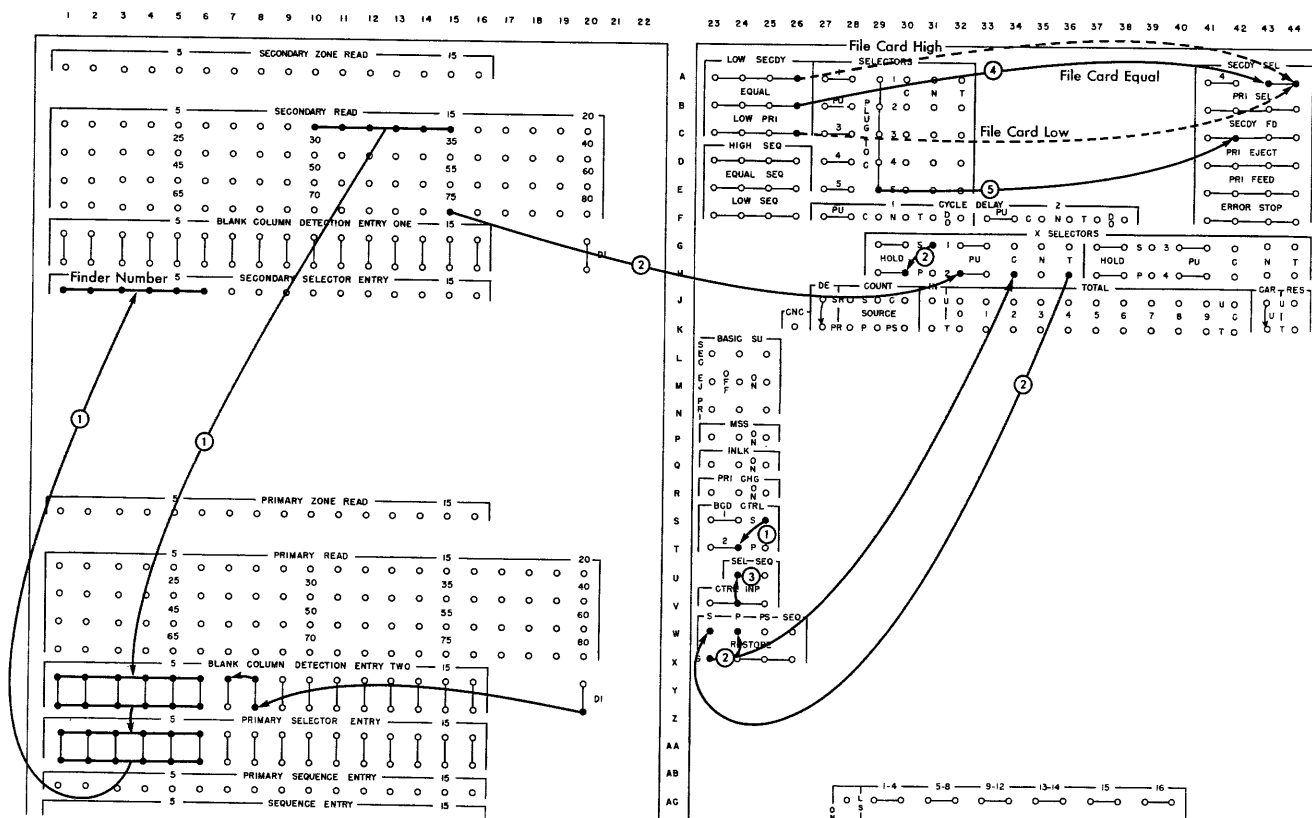

FIGURE 52. SELECTING CARDS BY A CONTROL NUMBER, INTERSPERSED FINDER CARDS — SECONDARY FEED

only when a finder card (card following the X-punched control card) is read. P RESTORE is wired from the single s exit hub to restore whenever a card is fed in the secondary feed.

3. SEL control input is wired normally.

4. Equal is wired to SECONDARY SELECT 3. Each finder card and the following cards that are punched with the control number will stack in pocket 3. All other file cards will stack in pocket 2. The first X-control card will stack in pocket 3, and all others will stack in pocket 2.

By wiring low secondary or low primary to SECONDARY SELECT 3, cards higher or lower than the finder card can be selected (dotted wiring), or the cards can be selected into three groups (see Figure 48). The finder cards will always stack with the equal file cards; the first X-control card will stack with the equal file cards, and all other X-control cards will stack with the low file cards.

5. Secondary cards are fed continuously.

#### Wiring Changes, 87 Collator

3. Omit control input wiring.

6. If letters or special characters are compared, wire the zone switch ON.

### SELECTING CARDS BY EITHER OF TWO CONTROL NUMBERS

CARDS punched with either of two control numbers may be pulled from a file in one run of the cards through the machine. If the selected cards are to be stacked together, this operation can be performed in either the primary or secondary feed. If they are to be stacked separately, however, the secondary feed must be used so that the selected cards can be stacked in two groups, in pockets 3 and 4, and all other cards in pocket 2.

Both control numbers are punched in the same finder card (field A and field B), and the number in the file cards can be punched in the same field as either of the control numbers, or in a separate field.

Both comparing units are required in this operation: one to compare each file card with the control number in field A, and the other to compare with the control number in field B. The two control numbers must be entered from the finder card and "remembered" throughout the run. Therefore, the sides of the comparing units in which the control numbers are entered from the finder card must be restored on the run-in only. If interspersed finder cards are re-

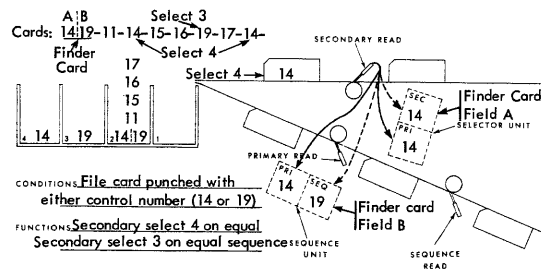

FIGURE 53. SELECTING CARDS BY EITHER OF TWO CONTROL NUMBERS

quired, X-control must be provided as described in the two preceding examples.

In the illustration (Figure 53), the secondary feed is used, and the cards are stacked in three groups: cards punched with the number in field A (14) in pocket 4, those punched with the number in field B (19) in pocket 3, and all others in pocket 2. The field-A number (14) is stored in the secondary selector entries, and the field-B number (19) is stored in the sequence entries. Therefore, file cards punched with the number 14 are recognized by an equal comparison in the selector unit, and those punched 19, by an equal sequence comparison. The file-card number is punched in a separate field (not field A or B), and therefore the finder card is stacked in pocket 2.

As in the preceding examples, cards higher or lower than either field in the finder card can be selected, instead of those equal to either field.

#### Wiring (Figure 54)

1. Field A in the finder card (columns 10-14) is wired from secondary read to secondary selector entry, and field B (columns 15-19) is wired to sequence entry.

2. The field in the file cards (columns 21-25) is wired from secondary read through BCD entry two to both primary selector entry and primary sequence entry. DI and BCD control are wired.

3. P and PS RESTORE are wired from the single s exit hub to restore whenever a secondary card is fed. S and SEQ RESTORE are not wired, so that these sides of the comparing units are cleared and new numbers are entered in the run-in only.

4. SEL and SEQ control input are wired normally.

5. Equal is wired to SECONDARY SELECT 4. All file cards punched with the same number in field A will stack in pocket 4. Equal sequence is wired to SECONDARY SELECT 3. All file cards punched with the same number as field B will stack in pocket 3. The finder card and all other file cards will stack in pocket 2.

6. Secondary cards are fed continuously.

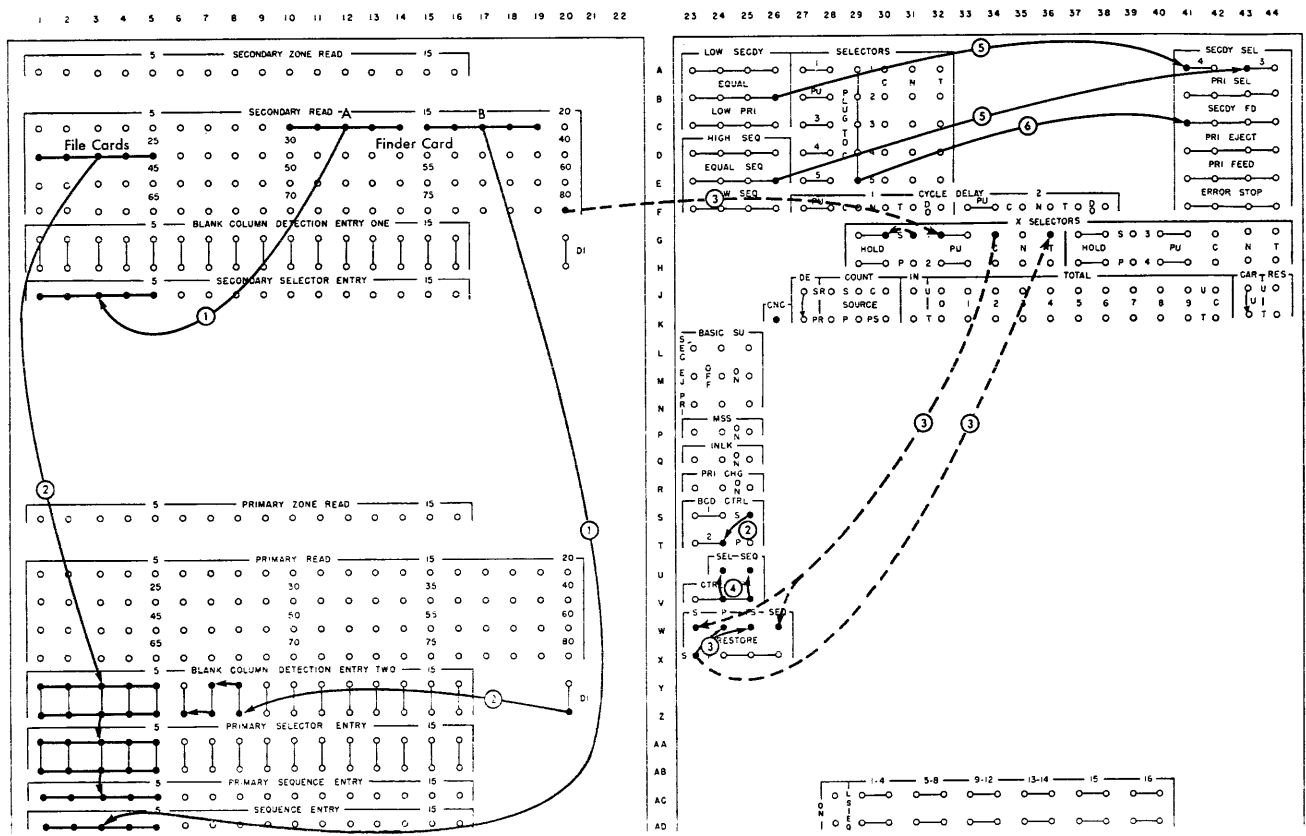

FIGURE 54. SELECTING CARDS BY EITHER OF TWO CONTROL NUMBERS

Wiring Changes, 87 Collator

To perform this operation with the 87, an X-punched control card must precede the finder card, to control the read-in of the finder number.

2. Omit wiring to primary sequence entry.
3. Omit ps restore wiring. Select s and SEQ restore (dotted wiring).
4. Omit control input wiring.
7. If letters or special characters are compared, wire the zone switch ON.

SELECTING CARDS BETWEEN TWO CONTROL NUMBERS

CARDS with numbers that are higher than a minimum and lower than a maximum can be selected. The minimum and the maximum limits are punched in the same finder card.

Both comparing units are required in this operation: one to compare each file card with the minimum limit, and the other to compare with the maximum limit. The minimum and maximum limits must be entered from the finder card and remembered

throughout the run. Therefore, the sides of the comparing units in which the limits are entered must be restored on the run-in only.

The cards can be fed through either the primary feed or the secondary feed. If the primary feed is used, the limits must be read from the sequence brushes because the run-in restore operates for only the first two run-in cycles.

In the illustration (Figure 55), the primary feed is used, the minimum limit (49) is stored in the secondary selector entries, and the maximum limit (100) in the sequence entries. Therefore, any number (50-99) between the two limits is recognized by a combination of a low secondary comparison and a high sequence comparison.

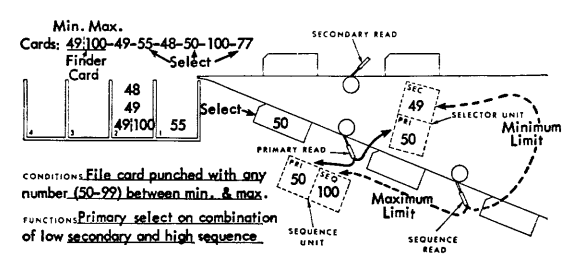

FIGURE 55. SELECTING CARDS BETWEEN TWO CONTROL NUMBERS

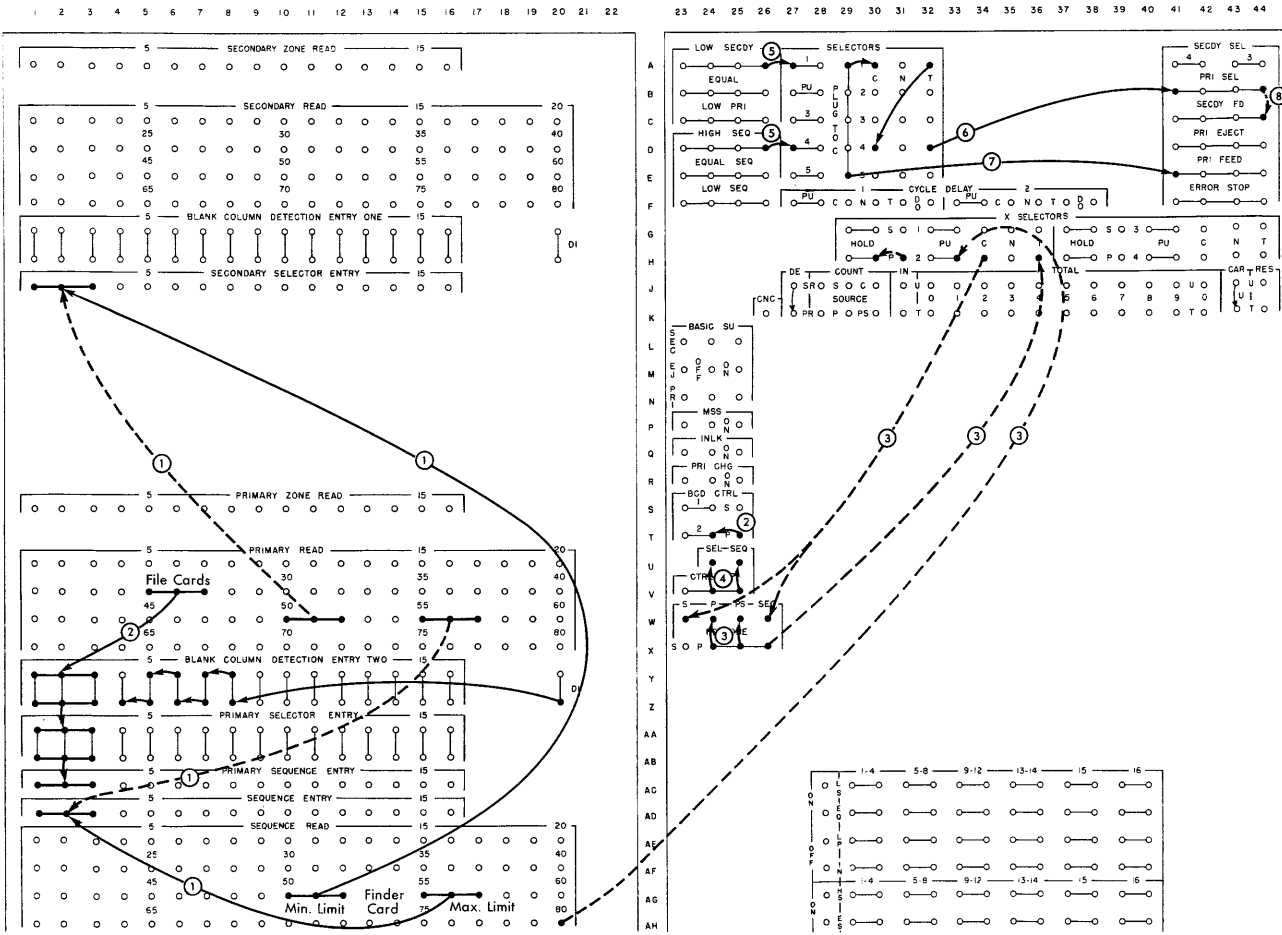

FIGURE 56. SELECTING CARDS BETWEEN TWO CONTROL NUMBERS

**Wiring (Figure 56)**

1. The minimum limit (columns 50-52) is wired from sequence read to secondary selector entry, and the maximum limit (columns 55-57) is wired to sequence entry.
2. The field in the file cards (columns 25-27) is wired from primary read through BCD entry two to both primary selector entry and primary sequence entry. DI and BCD control are wired.
3. P and PS RESTORE are wired normally to restore on each card. S and SEQ RESTORE are not wired, so that these sides of the comparing units are cleared and new numbers are entered on the run-in only.
4. SEL and SEQ control input are wired normally.
5. Low secondary is wired to selector 1 PU to transfer the selector when a number is higher than the minimum limit (minimum low). High sequence is wired to selector 4 PU to transfer the selector when a number is lower than the maximum limit (maximum high). Therefore, both selectors 1 and 4 are transferred whenever a number is between the two limits.
6. PLUG TO C is wired through the transferred sides

of selectors 1 and 4 to primary select, to cause all cards punched with a number between the two limits to stack in pocket 1. All other cards will stack in pocket 2.

7. Primary cards are fed continuously.
8. Indicator cards can be inserted in the file in place of the selected cards by placing indicator cards in the secondary feed hopper and impulsing secondary feed whenever a primary card is selected.

**Wiring Changes, 87 Collator**

To perform this operation with the 87, the finder card must be X-punched to control the read-in of the limits.

1. Wire the limits from primary read instead of sequence read (dotted wiring).
2. Omit wiring to primary sequence entry.
3. Omit ps restore wiring. Select s and SEQ restore (dotted wiring).
4. Omit control input wiring.
9. If letters or special characters are compared, wire zone switch ON.

## CHECKING MASTER-AND-DETAIL GROUPS

A FILE OF CARDS consisting of groups (master card and details) can be checked to insure that each detail card follows the proper master card. If the groups were in sequence, this could be done by a normal sequence-checking operation. However, if the groups are not in any particular order, they can be checked by the wiring shown in Figure 57.

The master cards are X-punched, and the control number is punched in the same field in both the master and detail cards. The master-card number is entered in one side of a comparing unit and held until the next master card is fed. Each detail-card number is entered in the other side of the comparing unit, and an equal comparison indicates that the detail card follows the correct master card. An unequal impulse (either high or low) will indicate that a detail card does not follow its corresponding master, and therefore should be selected and refiled properly.

## Wiring (Figure 57)

1. The master X (column 5) is wired from sequence read to X-selector 2 PU, and s RESTORE is controlled through the transferred side of the X-selector.
2. The card field (columns 45-48) is wired from primary read through BCD entry two to both primary selector entry and secondary selector entry. Each master card is entered in both sides of the comparing unit, but each detail is entered in the primary side only, as controlled by the wiring of the restore hubs DI and BCD control are wired.
3. P RESTORE is wired normally.
4. SEL control input is wired normally.
5. Any detail card that is not equal to the preced-

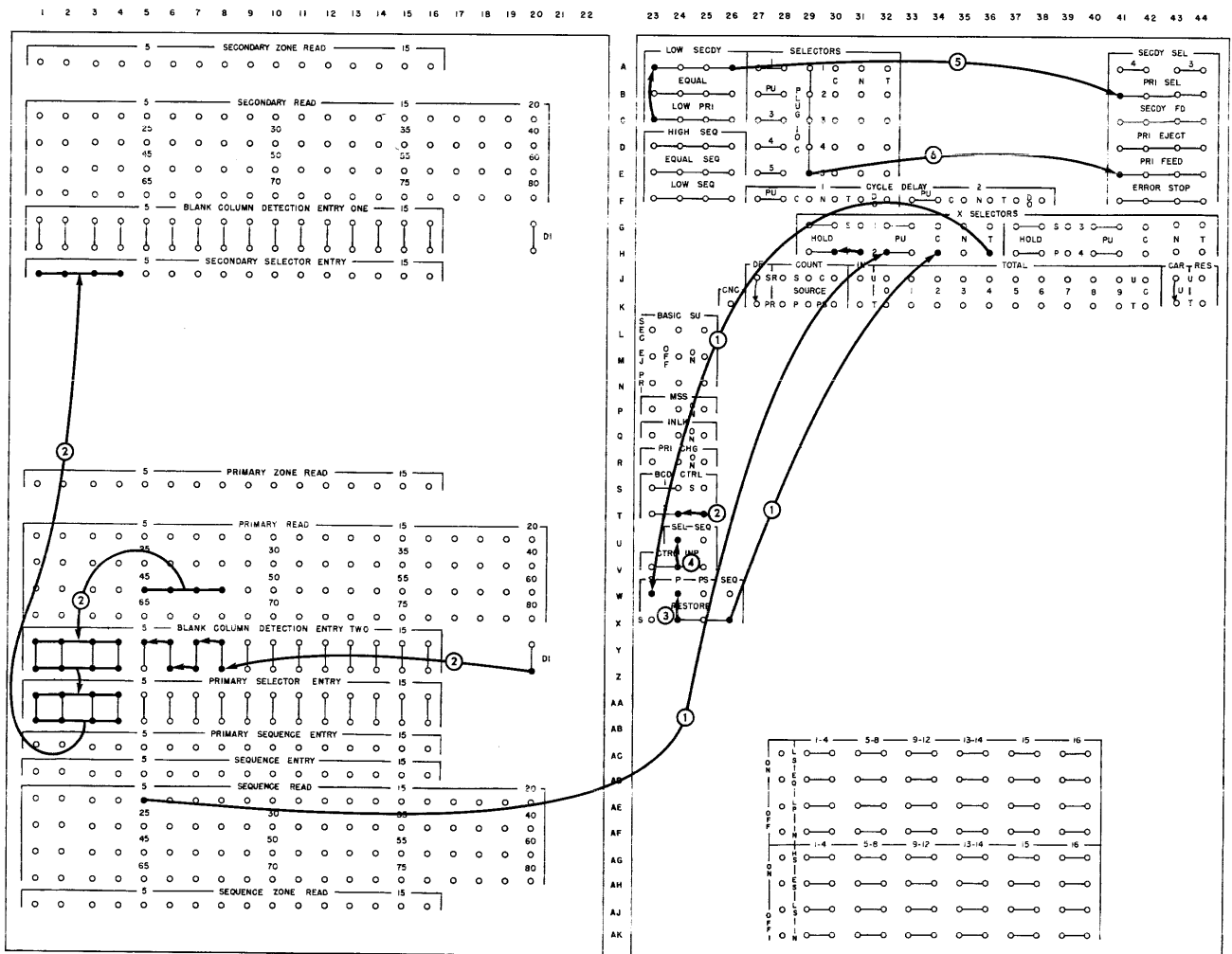

FIGURE 57. CHECKING MASTER-AND-DETAIL GROUPS

ing master is stacked in pocket 1 by wiring both low secondary and low primary to PRIMARY SELECT.

6. Cards are fed continuously.

Wiring Changes, 87 Collator

4. Omit control input wiring.

7. If letters or special characters are compared, wire the zone switch ON.

### CHECKING THAT AN X-CARD IS LAST IN A GROUP

IN SOME accounting machine operations the last card of each control group must be an X-card. For example, in a payroll operation it may be necessary that the last card for each employee be a summary earnings card punched with a specific X. This can be checked on the collator before the cards are placed in the accounting machine.

In this illustration the last card of each group is

selected if it is not an X80 card, and any X80 card that is not last in a group is selected. The selected cards will indicate, to the operator, which groups should be adjusted before the cards are processed further.

The wiring principles for this operation are similar to those shown in Figure 23.

### Wiring (Figure 58)

1. The cards are wired normally for blank-column detection and sequence-checking. The control X (column 80) is wired from primary read to X-selector 2 PU to transfer the selector when the X-card is in eject position.

2. The last card of the group is selected if it is not an X-card. High sequence is wired to pick up selector 4, and PLUG TO C is wired through the transferred side of selector 4 and the normal side of X-selector 2 to PRIMARY SELECT.

3. An X-card that is not the last card in a group is selected. An X-card at primary read and an equal

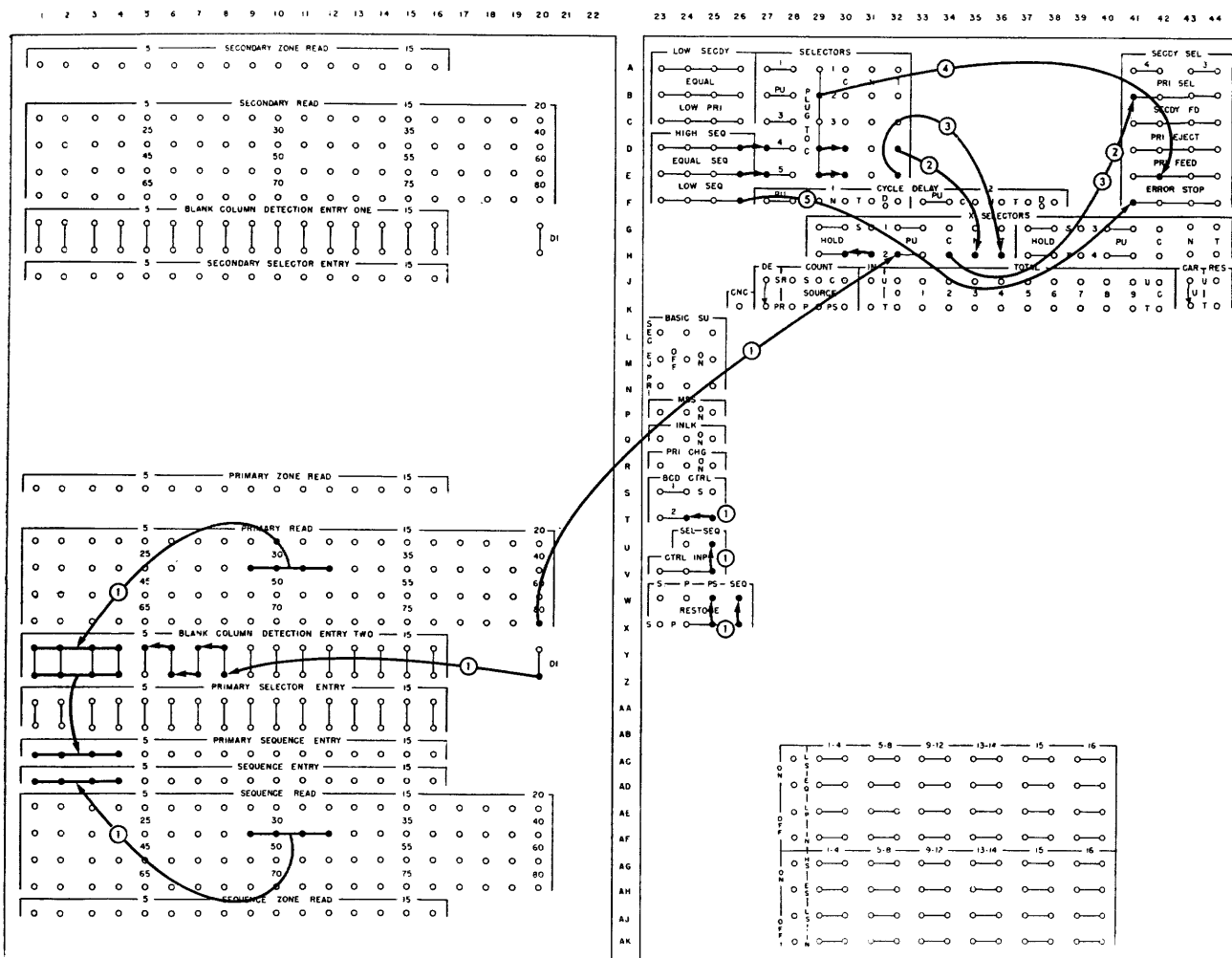

FIGURE 58. CHECKING THAT AN X-CARD IS LAST IN A GROUP





high sequence occurs, cycle delay is dropped out. Therefore, the cycle delay selector returns to normal at the beginning of each new group, and an X5 card in the new group is required to again pick up the selector.

4. A secondary card is fed at the end of a control group if there was an X5 card in the group, by wiring PLUG TO C through the transferred sides of selector 4 and the cycle delay selector to SECONDARY FEED.

5. Primary cards are fed continuously.

6. The machine is stopped for an error in sequence.

#### Wiring Changes, 87 Collator

1. Wire to primary selector entry instead of primary sequence entry. Wire P restore instead of PS restore. Omit control input wiring.

7. If letters or special characters are compared, wire the zone switch ON.

### CHECKING SEQUENCE, SELECTING ALL LOW CARDS

WHEN an error in sequence is detected, one or more low cards may follow the step-down card. By control panel wiring, all low cards can be recognized and selected.

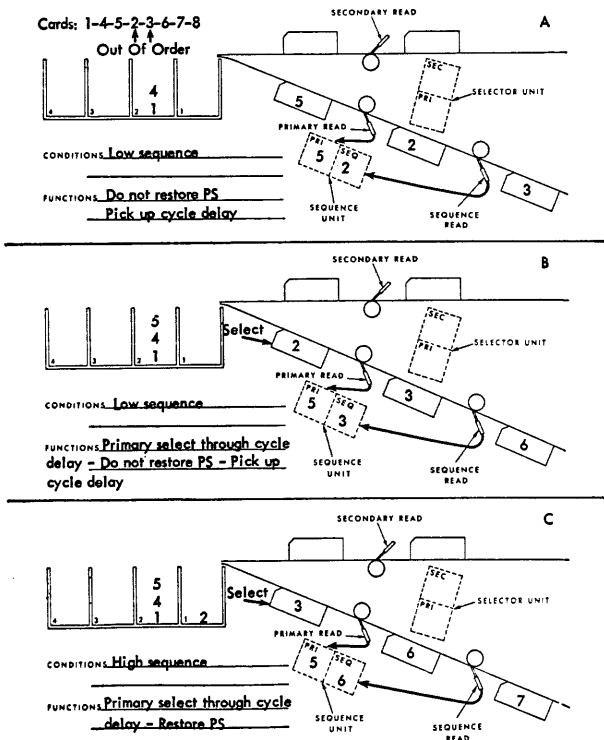

FIGURE 60. CHECKING SEQUENCE, SELECTING ALL LOW CARDS

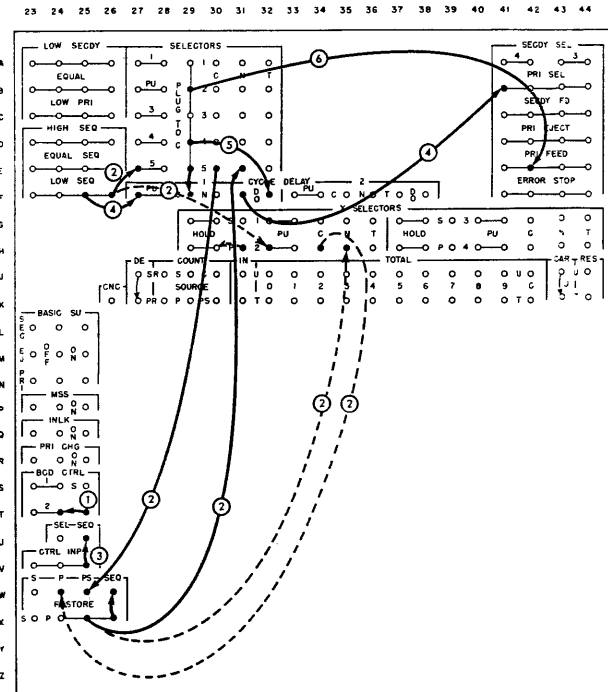

FIGURE 61. CHECKING SEQUENCE, SELECTING ALL LOW CARDS

To do this, the number read from primary read when the step-down occurs ("5" in Figure 60) is held in the primary sequence entries. Then, each following card is compared with it and additional low cards are detected. The number is cleared out when an equal or high sequence comparison is detected, and sequence-checking continues in the normal manner.

Because each low card is ejected one cycle after the low condition is recognized, the low cards are selected through the cycle delay unit.

As in any sequence-checking operation, a step-down indicates an error in sequence but does not indicate which card is out of order. Therefore, the cards selected in this operation may be the cards out of sequence, as shown in Figure 60, or they may not. For example, in a file of cards 1-2-3-4-8-5-6-7-9-10, card 8 is out of sequence but low cards 5-6-7 will be selected.

The cards that are selected in this operation cannot be assumed to be in sequence within the selected group.

#### Wiring (Figure 61)

1. The card fields are wired normally for blank-column detection and sequence-checking (wiring not shown); BCD two is controlled to operate with the primary feed.

2. SEQ is restored on every card. PS is restored only on an equal or high sequence comparison, not on a low sequence comparison, so that two or more low cards can be detected. Low sequence is wired to the pickup of selector 5, and PS is restored through the normal side of the selector.

3. SEQ control input is wired normally.

4. Low cards are selected one cycle after the low sequence condition is detected. Low sequence is wired to the pickup of cycle delay selector 1, and PLUG TO C is wired through the transferred side of the selector to PRIMARY SELECT.

5. The cycle delay selector is dropped out on each cycle.

6. Primary cards are fed continuously.

#### Wiring Changes, 87 Collator

1. Wire to primary selector entry instead of primary sequence entry.

2. Wire P restore rather than PS restore, and control the restore impulse through an X-selector (dotted wiring).

3. Omit control input wiring.

7. If letters or special characters are compared, wire the zone switch ON.

### CHECKING SEQUENCE — BOTH FEEDS (IBM 85 ONLY)

CARDS can be checked for sequence in the secondary feed, as well as in the primary feed. Using both feeds to check a file of cards makes it possible to complete the operation in half the time required when only the primary feed is used. This operation can be performed on the 85 Collator only; it cannot be performed on the 87 Collator, because four independent entries are required for the selector and sequence units.

When both feeds are used, an error in sequence in either feed can stop card feeding and turn on the error light. When card feeding is restarted, the step-down card is selected, and the pocket containing the step-down card indicates, to the operator, which feed contains the error in sequence. Because only the first step-down card is selected, several cards from the corresponding hopper and stacker should be examined to locate the error in sequence. This is the same as in normal sequence-checking.

Because there is only one set of brushes in the secondary feed, sequence-checking cannot be wired in the same manner as for cards in the primary feed.

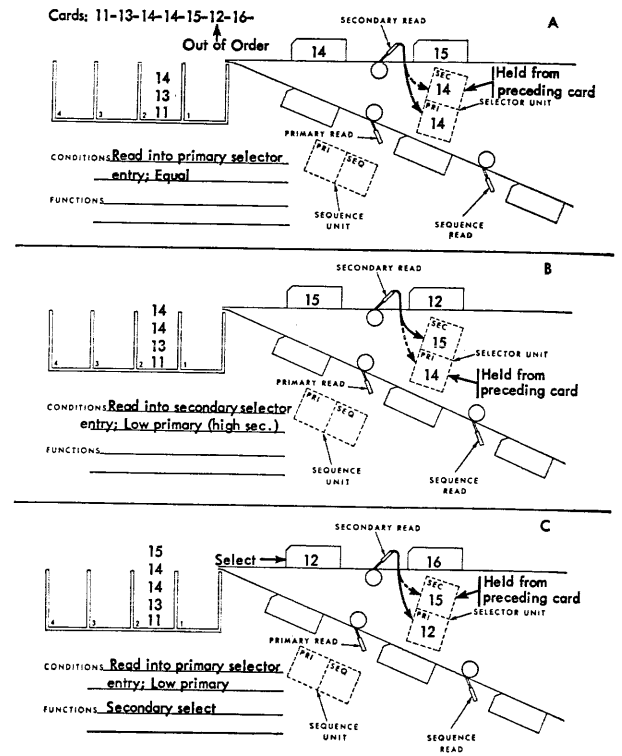

FIGURE 62. CHECKING SEQUENCE — SECONDARY FEED

That is, it is impossible to read two cards and compare them simultaneously. Instead, the reading from one card at a time is entered alternately in the two sides of a comparing unit, as shown in Figure 62 in which the selector unit is used. When a number is entered in the primary side of the selector unit, it is compared with the preceding number held in the secondary side (step A); on the following cycle a number is read into the secondary side and compared with the preceding number held in the primary side (step B).

In this operation the cards are assumed to be in ascending order. Therefore, on any one cycle, the side (primary or secondary) in which the number is entered should be equal to or higher than the other side (steps A and B). If the number entered is lower than that held in the other side of the unit (step C), an error in sequence is indicated.

In this illustration, the same principles are used to check both the primary and secondary cards, with the primary cards entered in the sequence unit, and the secondary cards entered in the selector unit. Although the primary cards could be sequence-checked in the normal manner, a step-down card could not be selected, and thus card handling for the two feeds would differ.

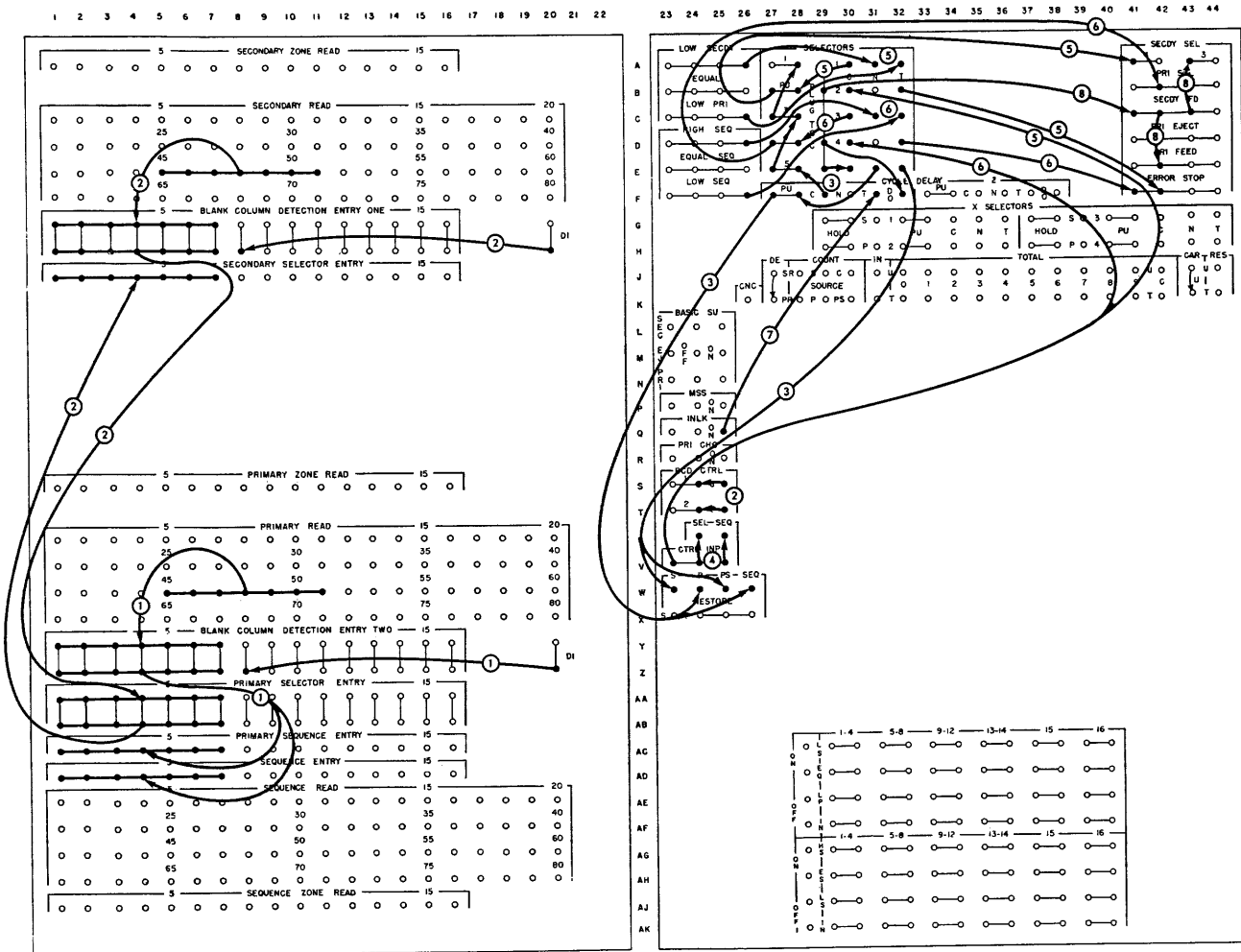

FIGURE 63. CHECKING SEQUENCE — BOTH FEEDS

The conditions under which a sequence error is detected can be summarized as follows:

**Selector Unit**

- Read into Primary Selector Entry — Low Primary
- Read into Secondary Selector Entry — Low Secondary

**Sequence Unit**

- Read into Primary Sequence Entry — High Sequence (low reading in primary sequence entry)
- Read into Sequence Entry — Low Sequence

When the file of cards is divided, the larger group should always be fed in the primary feed so that secondary cards will not be fed without a primary feed cycle at the same time. This is necessary because, after one error has been detected, a primary feed cycle must occur before another error will be recognized. If extra cards were fed through the secondary feed only, two or more errors in sequence would not be detected.

**Wiring (Figure 63)**

1. The field to be checked in the primary cards (columns 45-51) is wired from primary read through

BCD entry two to both primary sequence and sequence entry. A number is read into one entry or the other, depending on the control of *ps* and *SEQ RESTORE*.

2. The field to be checked in the secondary cards (columns 45-51) is wired from secondary read through BCD entry one to both primary and secondary selector entry. The number is read into one entry or the other, depending on the control of *p* and *s RESTORE*. BCD control is wired normally.

3. Selector 5 and cycle delay selector 1 are used to control the alternate reading into the two sides of both comparing units. When selector 5 is normal, *p* and *SEQ* are restored so that a new number can be entered on the following cycle. Also when selector 5 is normal, the pickup of the cycle delay selector is impulsed.

Then on the following cycle, an impulse through the transferred side of the cycle delay selector transfers selector 5, and *s* and *ps* are restored. At the end

of this cycle, the cycle delay selector is dropped out so that on the next cycle selector 5 will again be normal and P and SEQ again restored.

PLUG TO C is wired through the normal and transferred sides of selector 5 for this control.

4. SEL and SEQ control input are wired normally.

5. Selectors 1 and 2 are used to control error stop and secondary selection for an error in sequence in the secondary cards. If the side of the selector unit is low on the cycle in which a number is entered, an error is indicated. This is determined by selector 1, which is transferred on alternate cycles. To indicate a step-down condition, low secondary and low primary are wired through the normal and transferred sides of the selector, respectively. The comparison to be wired through the normal and transferred sides is determined by the alternate control of the restore hubs.

The C of selector 1 is wired, via the common pickup hubs of selector 2, to SECONDARY SELECT 4. SECONDARY SELECT 4 and ERROR STOP cannot be split-wired because a back-circuit would occur. Therefore, selector 2 is picked up and a control input is wired through its transferred side to ERROR STOP.

6. Selectors 3 and 4 are used to control error stop and primary selection for an error in sequence in the primary cards. The wiring principles for these selectors are the same as for selectors 1 and 2, described in step 5.

7. Interlock ON is used to transfer selectors 1, 3, and 5 on alternate cycles because this hub emits an impulse that comes earlier in each cycle than the control exit or PLUG TO C impulses.

8. Primary and secondary cards are fed continuously. Secondary cards are stacked in pocket 3.

### SELECTING THE FIRST CARD OF A GROUP — BOTH FEEDS (IBM 85 ONLY)

THE FIRST CARD of a group can be selected from cards in the secondary feed, as well as from those in the primary feed. Using both feeds makes it possible to reduce the processing time for a file of cards. This operation can be performed on the 85 Collator only; it cannot be performed on the 87 Collator, because four independent entries are required for the selector and sequence units.

The wiring principles described for this operation are similar to those in the preceding operation, *Checking Sequence — Both Feeds*. The only difference is that, in this operation, a card is selected if it is

*higher* than the preceding card, rather than lower as required for the detection of an error in sequence. When cards are in ascending order, the first card of a new group is always recognized by the fact that it is higher than the preceding card.

Because there is only one set of brushes in the secondary feed, this operation cannot be wired in the same manner as for cards in the primary feed. That is, it is impossible to read two cards and compare them simultaneously. Instead, the reading from one card at a time is entered alternately in the two sides of a comparing unit. When a number is entered in the primary side of the selector unit, for example, it is compared with the preceding number held in the secondary side; on the following cycle a number is read into the secondary side and compared with the preceding number held in the primary side.

Because the cards are assumed to be in ascending order, the side (primary or secondary) in which the number is entered on any one cycle will be equal to or higher than the other side. If the number entered is higher than that held in the other side of the unit, the first card of a new group is indicated.

When the principles described in this operation are used, they must be used to check the primary cards as well as the secondary cards. In this illustration the primary cards are read into the sequence unit, and the secondary cards are read into the selector unit.

The conditions under which the first card of a new group is detected can be summarized as follows:

#### Selector Unit

Read into Primary Selector Entry — Low Secondary  
(high reading in primary entry)

Read into Secondary Selector Entry — Low Primary  
(high reading in secondary entry)

#### Sequence Unit

Read into Primary Sequence Entry — Low Sequence  
(high reading in primary sequence entry)

Read into Sequence Entry — High Sequence

In order to select the first secondary card, a blank card must be fed first in the secondary feed.

### Wiring (Figure 64)

1. The field to be checked in the primary cards (columns 45-51) is wired from primary read through BCD entry two to both primary sequence and sequence entry. A number is read into one entry or the other, depending on the control of PS and SEQ RESTORE.

2. The field to be checked in the secondary cards (columns 45-51) is wired from secondary read





## CHECKING SEQUENCE — MORE THAN 16 COLUMNS (IBM 85 ONLY)

UP TO 32 COLUMNS may be sequence-checked in one run by coupling the sequence and selector units. Sixteen columns are compared in the sequence unit in the normal manner, and 16 columns are compared in the selector unit. If the columns are entered in the comparing units as shown in Figure 66, a card

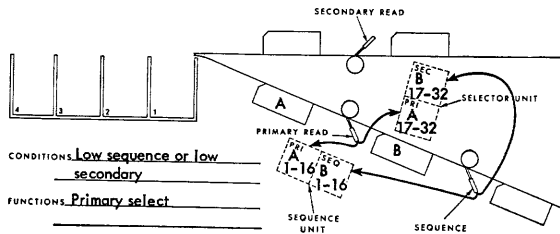

FIGURE 66. CHECKING SEQUENCE — MORE THAN 16 COLUMNS

out of sequence will be recognized by either a low sequence comparison or a low secondary comparison.

This operation can be performed on the 85 Collator only; it cannot be performed on the 87 Collator, because four independent entries are required for the selector and sequence units.

### Wiring (Figure 67)

1. Columns 1-16 are compared by wiring from primary read to primary sequence entry, and from sequence read to sequence entry.
2. Columns 17-32 are compared by wiring from primary read to primary selector entry, and from sequence read to secondary selector entry.
3. All entries are restored on a primary feed.
4. SEQ control input is wired normally to check columns 1-16. If the first 16 columns are equal, the second 16 columns must be checked. Therefore, equal

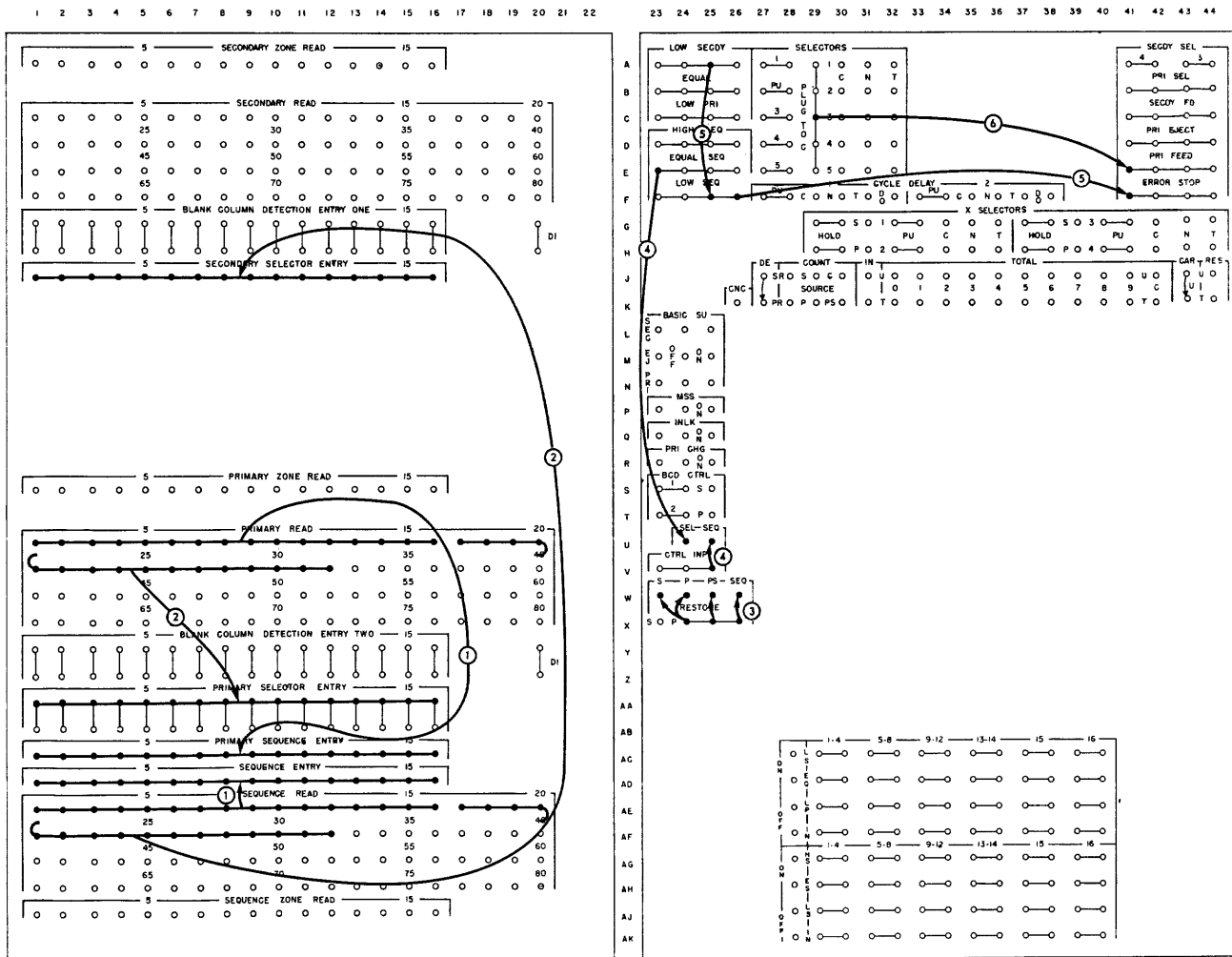

FIGURE 67. CHECKING SEQUENCE — MORE THAN 16 COLUMNS



sequence is wired to SEL control input to check columns 17-32.

5. Both low sequence and low secondary are wired to ERROR STOP. Low sequence represents a step-down for columns 1-16, and low secondary represents a step-down for columns 17-32.

6. The cards are fed continuously.

### MERGING — MORE THAN 16 COLUMNS (IBM 85 ONLY)

CARDS can be merged on a maximum of 32 columns if both the selector and sequence units are used to compare the primary and secondary cards. Sixteen columns are compared in the selector unit in the normal manner, and 16 columns are compared in the sequence unit. Cards must be fed from one feed at a time, because the sequence unit is used to compare the cards in the two feeds and cannot be used to determine a control change in the primary cards.

This operation can be performed on the 85 Collator only; it cannot be performed on the 87 Collator, because four independent entries are required for the selector and sequence units.

If the card columns are entered as shown in Figure 68, a low sequence comparison for columns 1-16 is the same as a low secondary comparison for columns 17-32, and either comparison must cause a secondary feed. A high sequence for columns 1-16 is the same as a low primary for columns 17-32, and either comparison must cause a primary feed. Equal in both units causes a primary feed.

If the low-order columns of the field are entered in the selector unit, as shown in Figure 68, the basic setup switches can be used to control card feeding. Because the cards must be fed from one feed at a time, Basic Setup Plan 1 is used.

#### Wiring (Figure 69)

1. The low-order columns (17-32) are compared in the normal manner by wiring from primary read

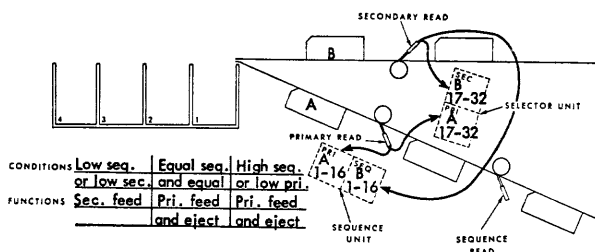

FIGURE 68. MERGING — MORE THAN 16 COLUMNS

to primary selector entry, and from secondary read to secondary selector entry.

2. Columns 1-16 are compared by wiring from primary read to primary sequence entry, and from secondary read to sequence entry.

3. S and SEQ are restored on a secondary feed; p and PS are restored on a primary feed.

4. SEQ control input is wired normally to compare columns 1-16. If the high-order columns are equal, the low-order columns must be compared. Therefore, equal sequence is wired to SEL control input to compare columns 17-32.

5. Low sequence is wired to low secondary because either of these comparisons must cause a secondary feed. Internally this makes an impulse available at the secondary feed (SEC) basic setup switch, and a secondary card is fed on each low sequence comparison, as well as normally on each low secondary comparison.

6. High sequence is wired to low primary because either of these comparisons must cause a primary feed. Internally this makes an impulse available at the primary feed (PRI) basic setup switch, and a primary card is fed on each high sequence comparison, as well as normally on each low primary comparison.

7. Basic Setup Plan 1 is wired. In conjunction with wiring 4, 5, and 6, card feeding is controlled as a result of comparisons in both the selector and sequence units. Because primary cards cannot be checked for a control change and only one feed can operate at a time, both the MSS and the PRI CHG switches are wired OFF.

8. Cards can be selected as follows by adding the dotted wiring.

A. Primary cards without corresponding secondaries can be selected by wiring from low primary (and high sequence) to PRIMARY SELECT.

B. Secondary cards without corresponding primaries can be selected only if the cards in both feeds are single-card groups. Equal secondary cards are fed as *equals*, not as low *secondaries*, and low secondary (and low sequence) is wired to SECONDARY SELECT 4. The selector is required because a direct connection from equal to secondary feed would allow a secondary feed impulse on a low secondary condition to back-circuit through the equal hubs to the basic setup switches and cause erroneous primary-card feeding.

When selection is required, interlock must be wired ON to insure proper selection on the runout.

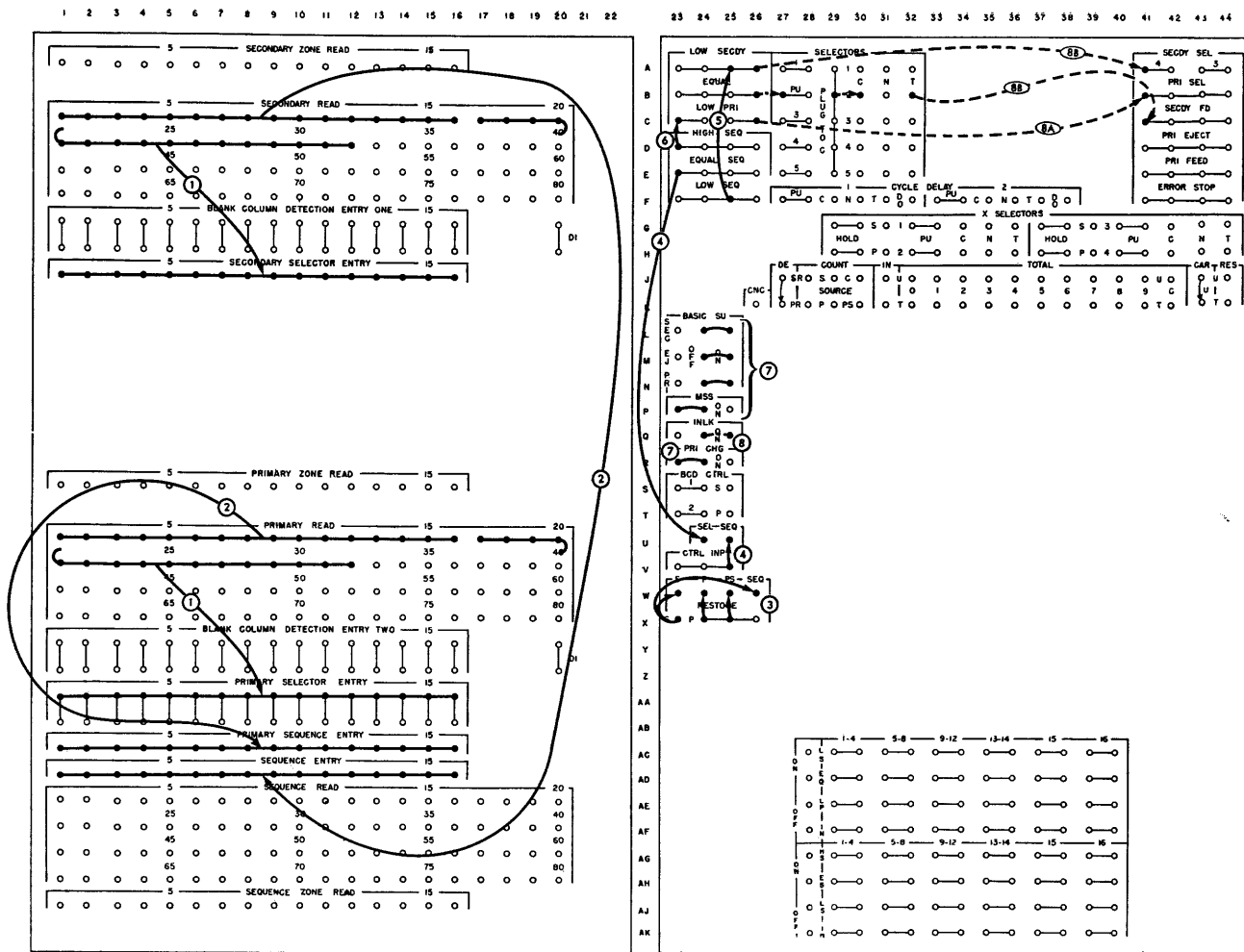

FIGURE 69. MERGING—MORE THAN 16 COLUMNS

### MIXED MERGING

IN A NORMAL MERGING OPERATION all primary cards of a group are filed ahead of the secondary cards with the same control number. Whenever it is not necessary that equal secondary cards merge behind an equal primary group, operating time can be reduced by feeding equal primary and secondary cards simultaneously. Any additional primary or secondary cards with the same control number are fed on a low comparison.

Figure 70 illustrates this operation with three 12-cards in the secondary feed and two 12-cards in the primary feed. The pairs of equal cards are stacked simultaneously on an equal comparison as shown in A; the third 12-card in the secondary feed is stacked on a low secondary comparison as shown in B. This requires 3 cycles; in normal merging, these 5 cards would require 4 (MSS OFF) or 5 (MSS ON) cycles.

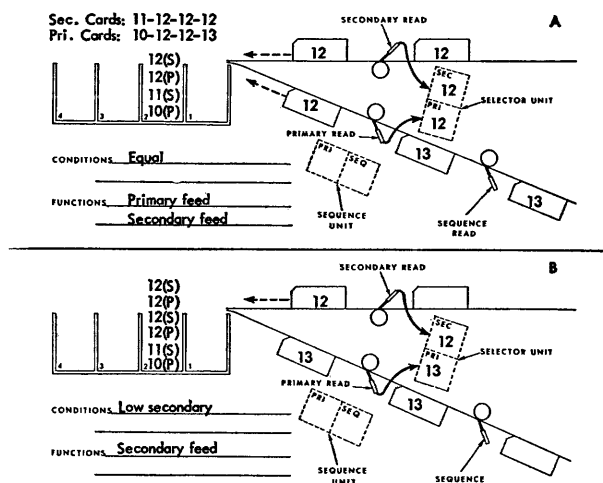

FIGURE 70. MIXED MERGING

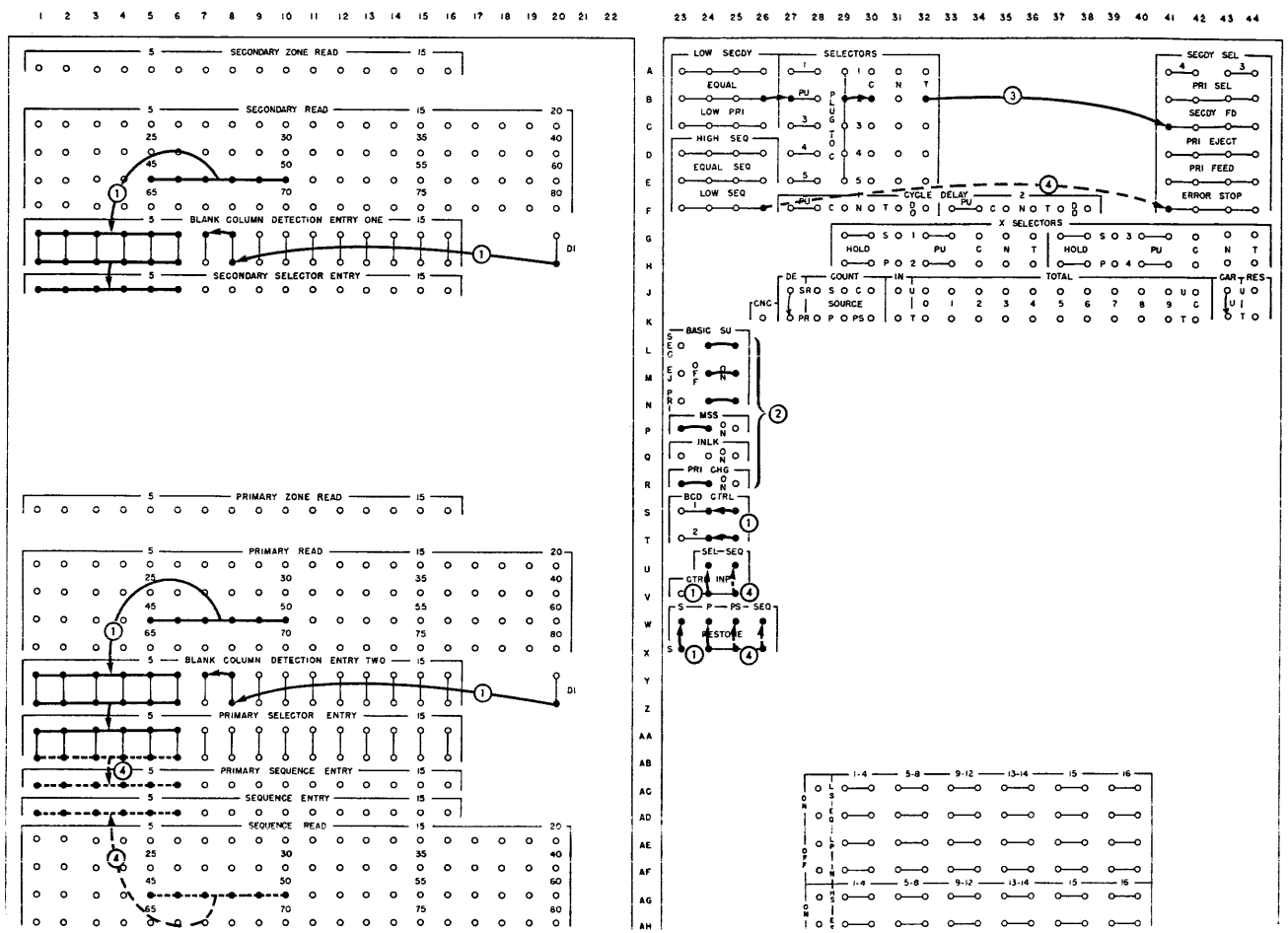

FIGURE 71. MIXED MERGING

**Wiring (Figure 71)**

1. The primary and secondary cards are checked for blank columns and compared in the normal manner.

2. Basic Setup Plan 1 is wired to merge cards without regard to a control change in the primary cards. This feeds cards as follows:

- Low Secondary — Secondary feed
- Equal or Low Primary — Primary feed

3. An equal secondary card is stacked along with an equal primary card. This functional wiring is necessary because none of the basic setup switches will cause a secondary feed on an equal comparison in the selector unit regardless of the comparison in the sequence unit. The selector is required to prevent a back-circuit, as described in wiring 8B in *Merging — More than 16 Columns*.

4. The dotted wiring can be added to sequence-check the cards in the primary feed.

**Wiring Changes, 87 Collator**

- 1. Omit control input wiring.

- 2. Omit primary change switch.
- 4. Omit primary sequence entry, ps restore, and control input wiring.
- 5. If letters or special characters are compared, wire the zone switch ON.

**MATCHING CARD-FOR-CARD**

IT IS SOMETIMES NECESSARY to match two files of cards, card-for-card. Groups in either file may be single-card groups or multiple-card groups. The purpose of this operation is to insure that single-card groups in one file are balanced by single-card groups in the other, or that multiple-card groups in one file are balanced by an equal number of cards for the same group in the other file. If not, all excess cards in either file are to be selected. For example, if one file has three cards of a given control number, the other file must also have three. In addition, all unmatched cards (i. e., control numbers in one file for which there are none in the other) must be selected.

This operation is illustrated in Figure 72 in which there is an extra 2-card in the primary file and an

Secondary Cards:	1, 2, 3, 3, 4, <u>4</u> , 5, <u>6</u> , 8		
Primary Cards:	1, 2, <u>2</u> , 3, 3, 4, 5, <u>7</u> , 8		
<u>Pocket 4</u>	<u>Pocket 3</u>	<u>Pocket 2</u>	<u>Pocket 1</u>
	8	8	
	5	5	
	4	4	
	3	3	
	3	3	
<u>6</u>	2	2	<u>7</u>
<u>4</u>	1	1	<u>2</u>

FIGURE 72. MATCHING CARD-FOR-CARD

extra 4-card in the secondary, as shown by the italics. Cards 6 and 7 are unmatched.

This operation is similar to the preceding one, *Mixed Merging*. It differs in only two respects: (1) the pairs

of equal cards are *matched* rather than *merged*, and (2) the extra cards and the unmatched cards are selected. Therefore, card feeding is controlled in the same way, equal secondary cards are selected into pocket 3, and extra and unmatched cards are selected into pockets 1 and 4.

**Wiring (Figure 73)**

1. The primary and secondary cards are checked for blank columns and compared in the normal manner.

2. Basic Setup Plan 1 is wired to feed cards without regard to a control change in the primary cards. This feeds cards as follows:

Low Secondary — Secondary feed

Equal or Low Primary — Primary feed

Because the basic setup switches will not cause a secondary feed on an equal comparison alone, secondary feeding on an equal comparison is controlled by

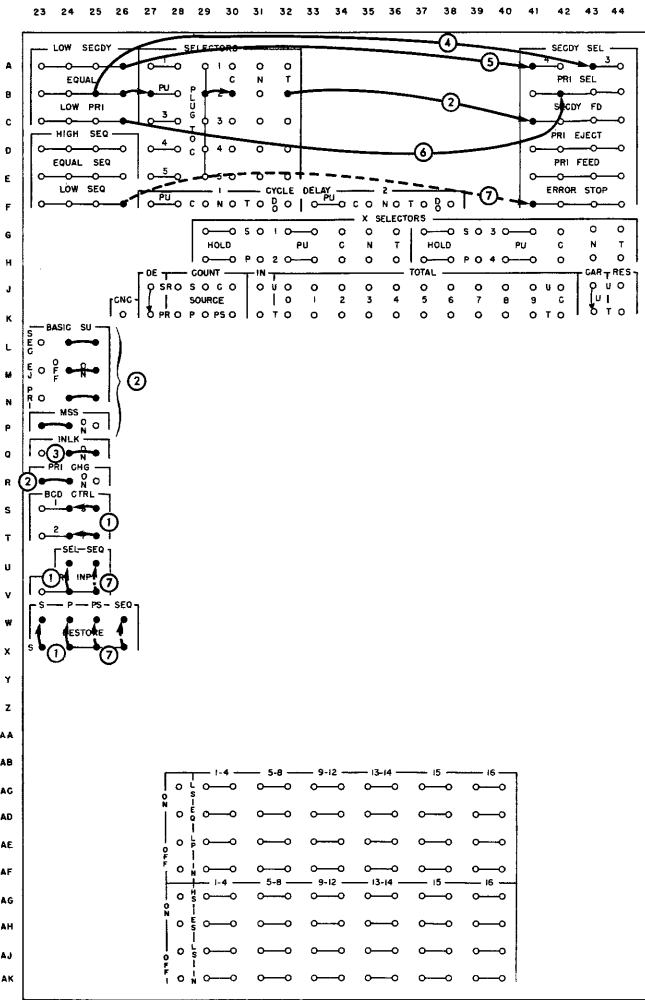
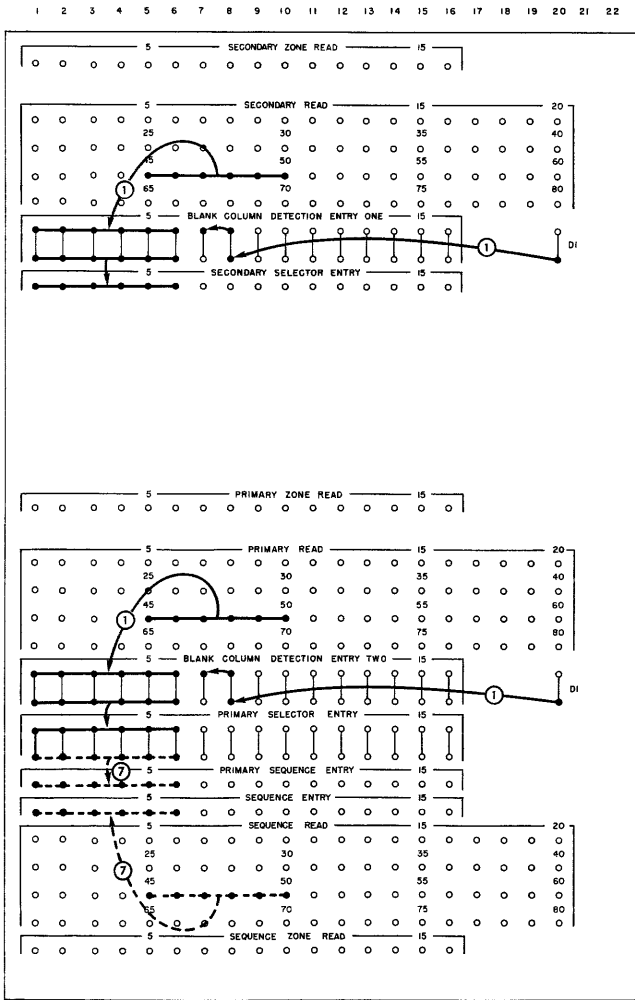

FIGURE 73. MATCHING CARD-FOR-CARD



After the separator cards are inserted, half the number of groups are placed in the primary feed and half in the secondary feed. If there is an odd number of groups, the extra group can be placed in either feed. To facilitate card-handling the separator cards should have a different corner cut.

The number of runs required to completely merge all the cards depends on the number of groups involved. If 16 groups are to be merged, for example, four runs are required. In each run the groups are merged by pairs, the number of groups yet to be merged is cut in half, and half of the separator cards are removed.

Run 1 — 16 groups	Run 3 — 4 groups
8 in the secondary	2 in the secondary
8 in the primary	2 in the primary
Result — 8 groups	Result — 2 groups
Run 2 — 8 groups	Run 4 — 2 groups
4 in the secondary	1 in the secondary
4 in the primary	1 in the primary
Result — 4 groups	Result — 1 group

In each run, normal merging occurs until a separator card is read in one feed. Because the separator card is punched with 9's in the control field, feeding in that feed is stopped and cards in the other feed are fed on a low comparison until a separator card is read. At that time, both separator cards are stacked simultaneously, through the normal wiring for merging, and one of them is merged while the other is selected. In Figure 74, the secondary separator card is selected. The cards are completely merged when only one separator card remains at the end of the deck.

### Wiring (Figure 74)

1. The cards are checked for blank columns and merged in the normal manner.

2. The X in the separator cards (column 80) is wired from secondary read to X-selector 1 PU, and from primary read to X-selector 2 PU. Both selectors are transferred when separator cards are fed in both feeds.

3. PLUG TO C is wired through the transferred sides of both the X-selectors to SECONDARY SELECT 4 to select the secondary separator cards. The primary separator cards are merged with the other cards to indicate the end of each group on the following run.

4. If primary and secondary cards with the same control number may alternate in the merged file, secondary cards can be fed on an equal comparison by

adding the dotted wiring. This reduces card-feeding time because equal cards are fed from both feeds on one cycle, rather than on two cycles.

### Wiring Changes, 87 Collator

1. Omit primary sequence entry, ps restore, control input, and primary change switch wiring.

5. If letters or special characters are compared, wire the zone switch ON.

## MERGING PRIMARIES BEHIND SECONDARIES

IN A NORMAL MERGING OPERATION, primary cards are filed ahead of secondary cards. This can be reversed, by control panel wiring, to cause primary cards to file behind secondary cards.

This reversal is desirable when the cards normally placed in the primary feed are known to be in order, while those normally placed in the secondary feed must be sequence-checked. For example, master cards, which should come first in the merged file, may be known to be in order but the detail cards must be checked for sequence. Normally the detail cards are checked in a separate run before the merging operation. This extra run can be eliminated, and the detail cards can be checked during the merging operation if they are placed in the primary feed. When this is done, the primary cards (detail) must be merged behind the secondary cards (master) in order to obtain a merged file in the proper order (masters ahead of details).

This operation is also desirable when both files of cards must be checked and the file normally placed in the secondary feed is considerably larger than the file to be placed in the primary feed. If the files are reversed during the merging operation, the smaller file, rather than the larger one, will be processed in the extra sequence-checking run.

Because card feeding in this operation is the reverse of that required in a normal merging operation, the basic setup switches cannot be used. Instead, feeding must be controlled by functional wiring. The feeding required is analyzed in Figure 75. Cards are fed from one feed at a time and, in the case of equals, all secondary cards are fed ahead of the primaries. The comparisons and feeding can be summarized as follows:

- Low Secondary — Secondary feed
- Equal — Secondary feed
- Low Primary — Primary feed

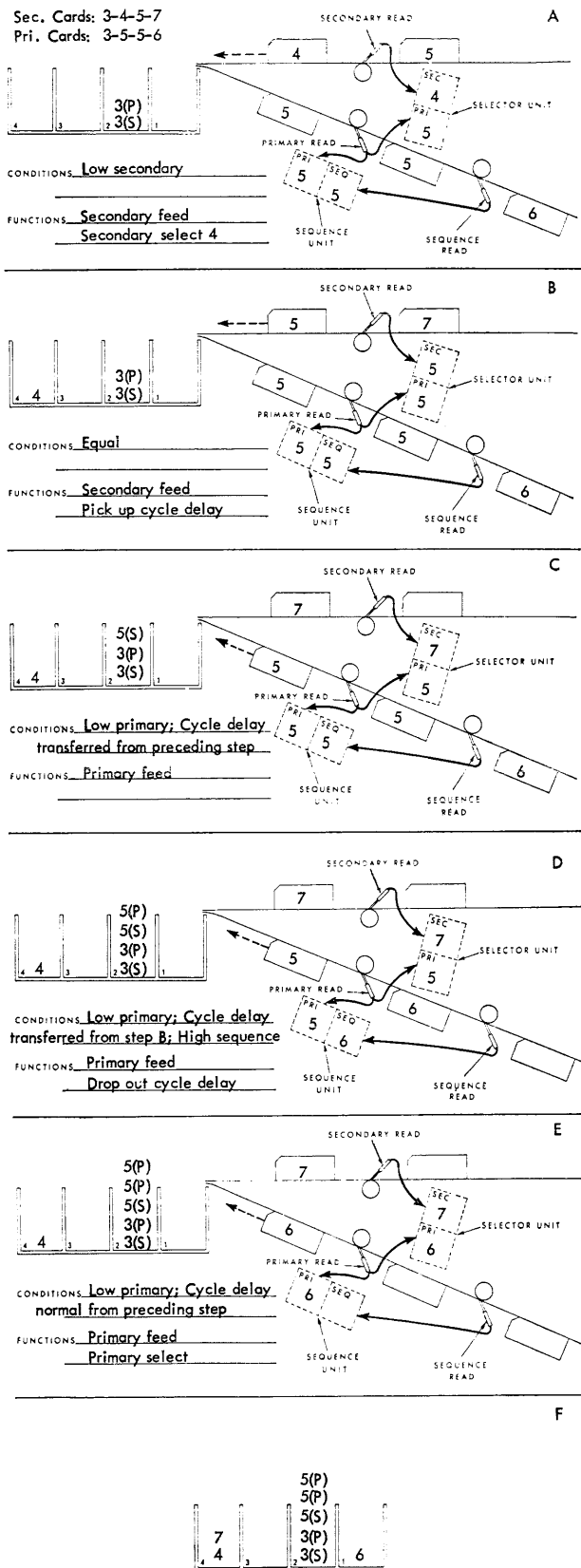

FIGURE 75. MERGING PRIMARIES BEHIND SECONDARIES

The analysis in Figure 75 also provides for the selection of any primary cards that do not have corresponding secondary cards, and *vice versa*. As in a normal merging operation, these cards are selected on a low primary or low secondary comparison.

Step A shows a low secondary comparison, and card 4 is fed and selected into pocket 4. (If selection were not required, card 4 would be properly merged ahead of the 5-cards from both feeds.)

In B, secondary card 5 is fed on an equal comparison, and the cycle delay unit is picked up. Cycle delay is required to remember the equal comparison to prevent primary card selection as explained in Step C.

In C, primary card 5 is fed on a low primary. All primary cards are fed on a low primary comparison, but some of these cards must be selected and others must not. In this step, even though a low primary comparison is detected, the primary card is equal to the secondary card that has already been stacked. Because cycle delay has been picked up on an equal comparison, selection can be prevented in this case. The cycle delay remains transferred until a control change (high sequence) is detected in the primary cards (step D). Therefore, all "equal" primary cards are allowed to merge properly.

However, if a low primary comparison is detected when the cycle delay is not transferred, the card is a *true* low primary and is selected, as shown in E.

### Wiring (Figure 76)

1. The card fields are wired for blank-column detection and comparison in the same manner as in a normal merging operation.

2. Low primary is wired to the pickup of selector 3, and PLUG TO C is wired through the transferred side of this selector to PRIMARY FEED. Primary cards that are equal to secondary cards are not fed until all the equal secondary cards are stacked, and then they are fed as "low primaries."

3. PLUG TO C is wired through the normal side of selector 3 to SECONDARY FEED to cause a secondary feed on either an equal or a low secondary comparison.

4. Unmatched secondary cards are stacked in pocket 4.

5. Because all primary cards, both equals and low primaries, are fed on a low primary comparison, primary selection must be controlled so that only *true* low primaries (unmatched) are selected. A cycle delay selector is used for this purpose. Equal is wired to





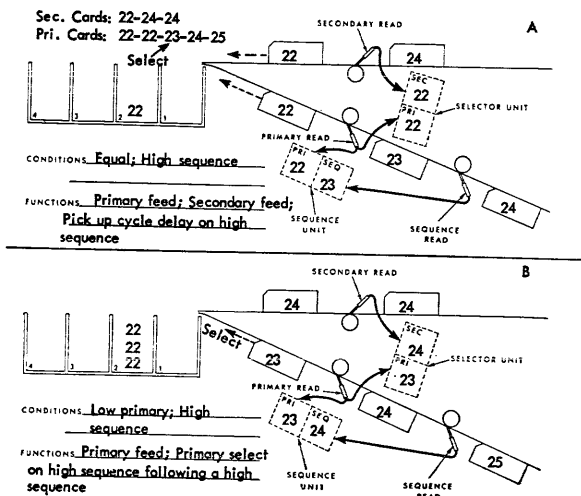

FIGURE 77. MERGING, SELECTING SINGLE UNMATCHED PRIMARIES

should not be selected even if they are unmatched in the detail file. Instead, the old balance and adjustments cards should be summarized into a new balance-forward card, along with the summarization of the detail cards.

Therefore, this typical operation is a combination of two operations described previously:

1. Merging with primary-card selection
2. Selecting single-card groups.

Each low primary card is selected if it is also a single-card group. Single-card groups are detected by a high sequence comparison following a high sequence comparison.

### Wiring (Figure 78)

1. The cards are wired for blank-column detection and comparison in the same manner as in a normal merging operation.

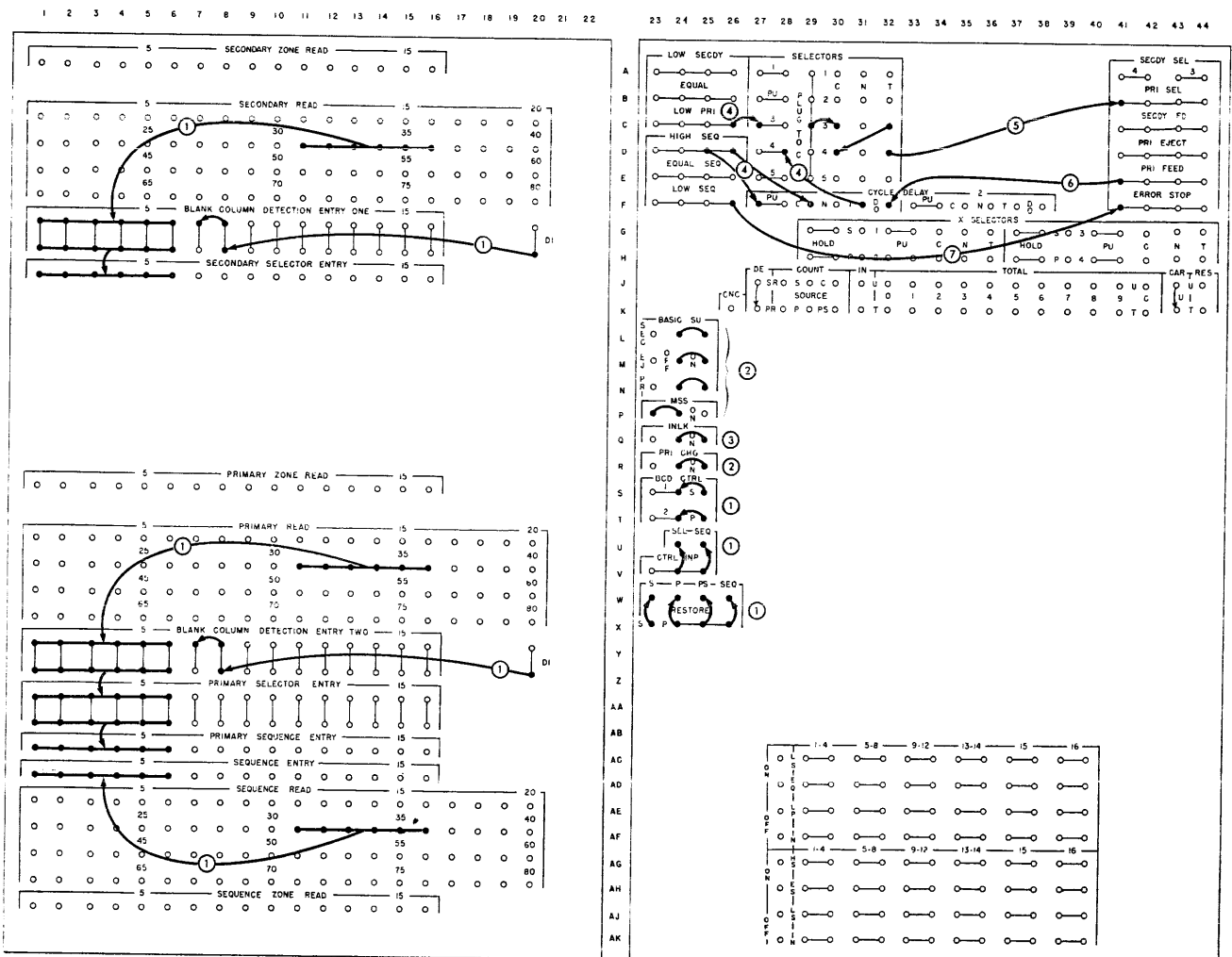

FIGURE 78. MERGING, SELECTING SINGLE UNMATCHED PRIMARIES

2. Basic Setup Plan 2 is wired to feed cards. Because secondaries are not being selected, the Mss switch is wired OFF.

3. Interlock is wired ON because selection is required.

4. Low primary is wired to the pickup of selector 3. The selector will be transferred for all unmatched balance-forward cards (both single and multiple). High sequence is wired both to the pickup of cycle delay selector 1 and through its transferred side to the pickup of selector 4. Selector 4 will be transferred for single-card groups.

5. PLUG TO C is wired through the transferred sides of selectors 3 and 4 to PRIMARY SELECT. This stacks all unmatched single-card primaries in pocket 1.

6. The cycle delay selector is dropped out when a primary card is fed. When the basic setup switches are wired ON, an impulse is available from the primary feed functional entry hubs whenever a primary feed occurs.

7. Card feeding is stopped for an error in primary-card sequence.

#### Wiring Changes, 87 Collator

1. Omit primary sequence entry, PS restore, and control input wiring.

2. Omit primary change switch.

8. If letters or special characters are compared, wire the zone switch ON.

### MERGING OR MATCHING BY A RANGE OF NUMBERS

SOME APPLICATIONS require that detail cards be grouped behind master cards according to a range of numbers between two limits. In a gangpunch extension application, for example, detail cards punched with any one of several different amounts may require the same extension.

In this case, any detail card equal to the lower or upper limit of the range of numbers, or between the two limits, is merged behind the corresponding master card. For example, if an extension of \$7.00 is to be punched in cards containing amounts of \$50.00 through \$54.99, a master card is punched with the upper and lower limits and the extension amount. Then detail cards punched with any amount, 50.00, 50.01, 50.02, . . . 54.98, 54.99, are filed behind this master card and later gangpunched with the extension of 7.00. Similarly, if \$7.90 is to be punched in cards

with amounts of \$55.00 through \$59.99, detail cards with any one of the amounts (55.00-59.99) are filed behind this master card and later gangpunched with the extension of 7.90.

This type of operation is used, as a substitute for calculating extensions on a multiplier, in many different applications, such as the extension of employees' withholding tax or monthly interest on loans.

Normally the master gangpunch extension file is maintained in sequence by amount within a tax class or rate group. The detail cards must be sorted in the same order, and then the two files are merged, preparatory to the gangpunch operation. As they are merged, any detail card for which there is no master card, is selected, and any excess master cards are also selected.

If selection were not required, the masters and details could be merged by using a normal merging setup and comparing on the lower limit in the master cards. Because selection is required, however, the wiring principles shown in Figure 79 must be used; if a normal merging-with-selection setup were used, cards would be selected erroneously.

The wiring shown in Figure 79 is used without the dotted wiring to merge the cards as described, or it can be used with dotted wire 11 to match the masters and details. The matching may be desired, after the gangpunching operation, to check that the gangpunched amount is correct and that it is punched in the proper cards. In this case, the extension amount should also be compared (dotted wiring 12).

#### Wiring (Figure 79)

1. The detail amount (columns 33-36) is wired from secondary read through BCD entry one to both primary selector entry and primary sequence entry. It is compared with the *lower* limit in the master cards (columns 7-10) in the selector unit, and with the *upper* limit (columns 11-14) in the sequence unit.

2. S and SEQ are restored on a primary feed cycle, and P and PS are restored on a secondary feed cycle.

3. SEL and SEQ control input are wired normally.

4. A low primary indicates that a detail card is lower than the *lower* limit in the master card; a low sequence indicates that a detail card is higher than the *upper* limit in the master card. These two comparisons are wired to pick up selectors 3 and 5, respectively, to control card feeding.



pocket 1. The low sequence condition at this time indicates that the master is extra; that is, there are no detail cards between the limits of this master card.

10. Interlock is wired ON to permit proper selection on the runout.

11. If masters and details are to be matched, rather than merged, the details are stacked in pocket 3 by wiring PLUG TO C TO SECONDARY SELECT 3.

12. If this matching operation is used for checking after detail cards have been gangpunch-extended and separated from the masters, the extension can also be

checked by wiring to the comparing units, to the left of the "limits."

When this wiring is added, the extension amount in the detail cards can be checked for blank columns by wiring from secondary read through positions 1-4 of BCD entry one (in place of D1).

#### Wiring Changes, 87 Collator

1. Omit wiring to primary sequence entry.
2. Omit ps restore wiring.
3. Omit control input wiring.
12. Omit wiring to primary sequence entry.
13. If letters or special characters are compared, wire the zone switch ON.

## Alphabetic Collating Feature

THIS SPECIAL FEATURE modifies the IBM 85, a numerical collator, so that cards punched with alphabetic information can be processed. The device is not needed on the IBM 87, an alphabetic collator, because this machine has been designed to process alphabetic as well as numerical information; the 87 can also process special characters.

With this device installed on the 85 Collator, cards can be selected, sequence-checked, merged, or matched by names, titles, or any other alphabetic information punched in them. The maximum number of alphabetic positions that can be entered for any operation is half the number of positions allowable for a numerical operation. For example, a maximum of 8 positions of alphabetic information can be used in a normal merging or matching operation.

Two comparing entry positions are required for each column of an alphabetic field, and each letter is treated as a 2-digit number. One comparing position is used for the numerical portion of the letter, and the other for the zone portion that is converted to a digit.

A combination of alphabetic and numerical information can be used in an operation. For example, 5 alphabetic and 6 numerical positions could be entered for normal merging.

Because the alphabetic collating feature converts letters to numbers, the operation of the machine is the same for alphabetic information as for numerical. Figure 80 illustrates the wiring for merging with selection in which the cards are punched alphabetically in columns 25-32 and zone brushes are positioned to read columns 25-40. This figure shows the wiring required to enter an alphabetic field in the comparing units.

### Control Panel Hubs

*Secondary Zone Read; Primary Zone Read; Sequence Zone Read.* These hubs are exits for three 16-position reading brush stations that are installed to read the zone punching in the cards. The zone stations are associated with the corresponding standard reading stations. The 16 columns that will be used for alphabetic collating must be specified when this device is ordered.

As the name implies, only the zone portion of each letter is read by these brushes. The three zone brush stations are so located that the zones are read as numerical digits: the 12-zone is read as a 6, the 11-zone as a 7, and the 0-zone as an 8.

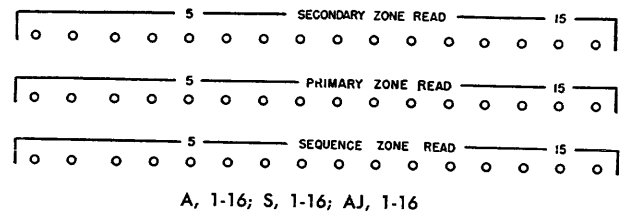

The zone readings are normally wired to the comparing entries, and they are entered immediately to the left of the corresponding numerical portion of the letters. Thus, the letters A through I are read as numbers 61 through 69, letters J-R as 71-79, and letters S-Z as 82-89.

If a column that may be punched with either alphabetic or numerical characters is wired for alphabetic reading, a 0 (zero) in that column would be read as 80 (between R and S) and thus give erroneous results. Therefore, the column should be left blank for zeros, and should be punched with letters and digits 1-9 only.

### Wiring (Figure 80)

1. The numerical portion of the letters is read from the three standard reading stations to the comparing entries. The card column positions are wired to alternate comparing entry positions starting with the second from the left. This permits the zone portion of each letter to be entered to the left of the corresponding numerical portion.
2. The zone portion of the letters is read from the three special zone read stations to the comparing entries. Each position is entered to the left of the corresponding numerical portion of the letter.
3. Restore, control input, basic setup switches, and selection are wired normally for a merging operation with multiple secondaries and selection.

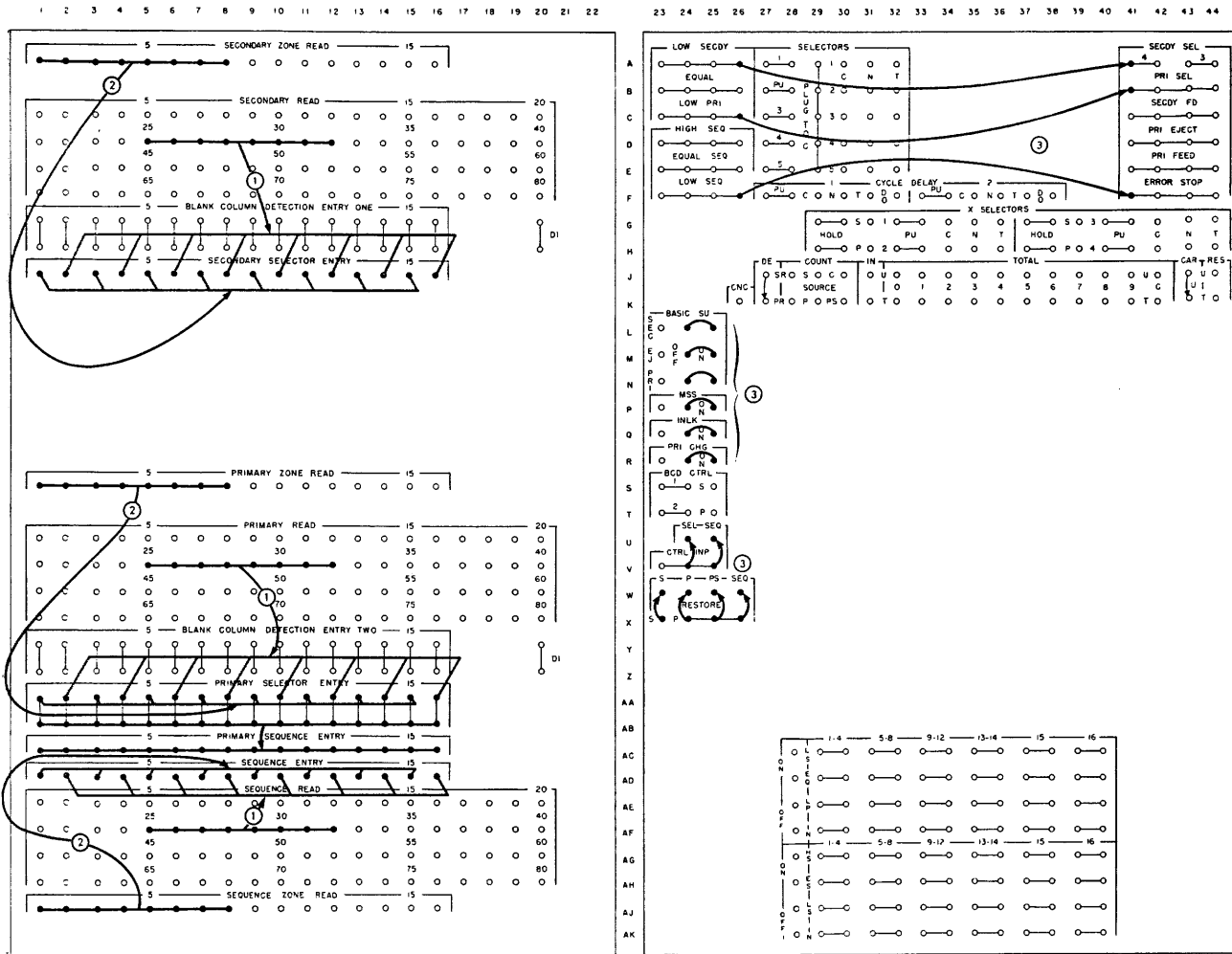

FIGURE 80. MERGING — ALPHABETIC INFORMATION

# Collator Counting Feature

WITH THIS SPECIAL FEATURE installed on the 85 or 87 Collator, operations that involve card counting can be performed. Each operation in this section is illustrated for the 85, and any wiring changes required for the 87 are explained.

Some of the counting operations that can be performed with this device are:

Inserting a predetermined number of cards behind or ahead of each master card.

Inserting a single card behind or ahead of a predetermined number of cards.

Inserting a variable number of cards behind or ahead of each master card.

Merging a predetermined number of primaries and secondaries.

Two-column consecutive number checking.

The collator counting feature (Figure 81) consists of two single-position counters (labeled U and T) each of which can count up to 9. The units and tens counters can be coupled to form one 2-position counter to count up to 99. When the counters are used separately, two different counting operations can be performed at the same time; when they are coupled, only one counting operation can be performed at a time.

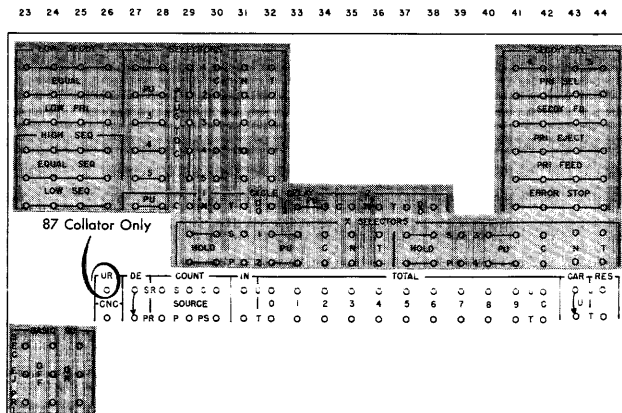

FIGURE 81. COLLATOR COUNTING FEATURE

## INSERTING A PREDETERMINED NUMBER OF CARDS AHEAD OF EACH MASTER CARD

IN THIS OPERATION the counted cards from one feed followed by a single card from the other feed are stacked in pocket 2. The cards to be counted can be placed in either the primary or secondary feed. In the illustration (Figure 82), they are placed in the primary feed, and the operation consists of inserting 32 primary cards ahead of each secondary card. No punching is required in either the primary or secondary cards to control this feeding.

The same feeding principles also apply to the operation of inserting a single card after a predetermined number of cards.

## Control Panel Hubs

In. Each of these entry hubs accepts impulses to cause the corresponding counter (units or tens) to add 1. If the counters are coupled, an impulse is wired to the U hub only. An IN hub is normally wired from COUNT SOURCE (S, P, PS, or C) or PLUG TO C, and the counter advances at the beginning of the following cycle.

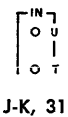

Count Source: S, P, PS, C, PR, SR. The s, P, PS, and c hubs emit "plug to c" timed impulses that are normally wired to IN to cause the counter to add 1.

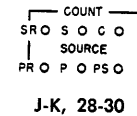

S (secondary) emits an impulse whenever secondary feed is impulsed and a card is about to move into the stacker. If it is wired to IN, each secondary card is counted as it is stacked.

P (primary) emits an impulse whenever primary feed is impulsed and a card is about to move into the stacker. If it is wired to IN, each primary card is counted as it is fed into the stacker, but it is not counted if it is ejected into the stacker.





is transferred after 32 primary cards have been stacked.

4. When 32 cards have been counted, a control input impulse on the 85 passes through the TOTAL C and 3 hubs of the tens position of the counter and through the TOTAL C and 2 hubs of the units position, to selector 5 pickup.

On the 87, the control input wiring is replaced by count source C (dotted wiring).

5. When selector 5 is transferred, primary feeding is interrupted, and PLUG TO C impulses SECONDARY FEED so that a secondary card will be fed into the stacker on the next cycle.

6. When primary feeding is interrupted and a secondary card is fed, the counters are reset to zero. After each secondary card is fed, the primary-card count is restarted.

7. When all cards have been fed from the secondary feed, any cards remaining in the primary feed are fed into pocket 1. PR is wired to the pickup of selector 4, and count source P is wired through the transferred side of the selector to PRIMARY SELECT. Counting of primary cards is eliminated on the run-out because count source P is wired to IN through the normal side of this selector. Interlock is wired ON to make the PR hub active.

## INSERTING A PREDETERMINED NUMBER OF CARDS BEHIND EACH MASTER CARD

THE CARDS to be counted are placed in the secondary feed, and the master cards are placed in the primary feed. In the illustration (Figure 83) a primary card and 25 secondary cards are stacked in pocket 2.

The same feeding principles also apply to the operation of inserting a single card ahead of a predetermined number of cards.

### Wiring (Figure 83)

1. The counters are coupled to form a 2-position counter because more than 9 cards are to be counted.
2. After the first three run-in cycles, the first primary card is stacked by wiring PLUG TO C to PRIMARY EJECT. All primary cards thereafter are also stacked by this wiring.
3. Count source S is wired through the normal side of selector 4 to the units counter IN. Each secondary card is counted as it is stacked. Selector 4 pre-

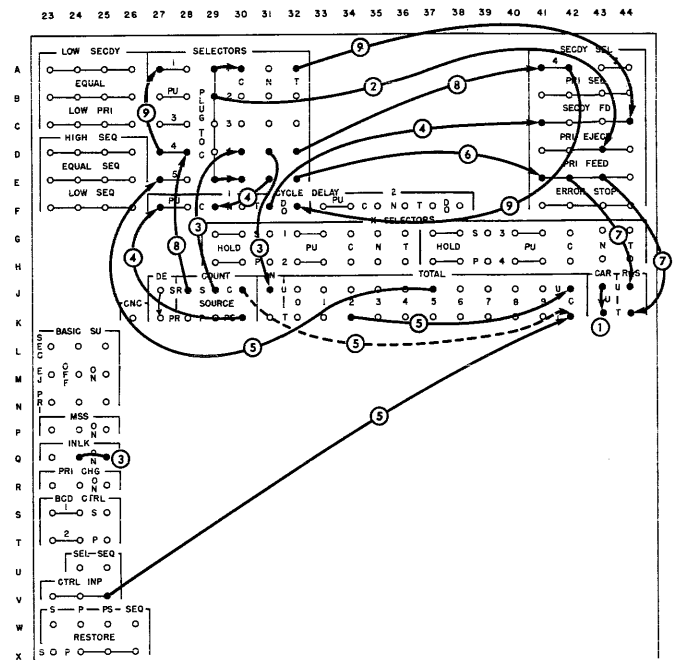

FIGURE 83. INSERTING A PREDETERMINED NUMBER OF CARDS BEHIND EACH MASTER CARD

vents counting secondary cards on the run-out because the selector is transferred at that time by SR. Interlock is wired ON to make the SR hub active.

4. Secondary cards are fed continuously until 25 cards are counted, by wiring PLUG TO C through the normal side of selector 5 and the transferred side of cycle delay selector 1 to SECONDARY FEED. Selector 5 is transferred after 25 secondary cards have been stacked.

The cycle delay selector is used to eliminate secondary feeding on the third run-in cycle. Without the delay, the first secondary card would be stacked on the third run-in cycle as the first primary card passed primary read; with the delay, secondary feeding is inoperative on the third cycle so that only the primary card is fed. Then, after the run-in, the first primary and first secondary cards are stacked together, thereby causing the primary card to precede the secondary card in the stacker.

The cycle delay selector, picked up by count source PS, is normal for the first two run-in cycles and transferred for control time of the third cycle. Therefore PLUG TO C, wired through the transferred side of the selector, impulses SECONDARY FEED at the end of the third run-in cycle and causes the first secondary card to be stacked on the fourth cycle, along with the first primary card. It prevents stacking a secondary card on the third cycle because, to do that, secondary

feed would have to be impulsed at the end of the second cycle, at which time the cycle delay selector is normal.

5. When 25 cards have been counted, a control input impulse on the 85 passes through the TOTAL c and 2 hubs of the tens position of the counter and through the TOTAL c and 5 hubs of the units position, to selector 5 pickup.

On the 87, the control input wiring is replaced by count source c (dotted wiring).

6. When selector 5 is transferred, secondary feeding is interrupted and PLUG TO c impulses PRIMARY FEED, so that a primary card will be fed into eject position on the next cycle. When secondary feed is restarted, the primary card will be ejected into the stacker (wire 2) with the first secondary card of the next group.

7. When secondary feeding is interrupted and a primary card is fed, the counters are reset to zero. After each primary card is fed, the secondary-card count is restarted.

8. After the last primary card is ejected, 25 secondary cards are fed into pocket 2. Then a primary feed cycle occurs, making the sr hub operative. At this time, selector 4 is transferred, so that any additional secondary cards are stacked in pocket 4 and counting is eliminated.

9. The cycle delay selector is dropped out on the first run-out cycle. The extra secondary cards are fed by wiring PLUG TO c through the transferred side of selector 1 to SECONDARY FEED. Selector 1 is picked up on the run-out.

### INSERTING A VARIABLE NUMBER OF CARDS AHEAD OF EACH MASTER CARD

THE NUMBER OF CARDS to be fed ahead of each master card is punched in each master card. This number can vary from one master card to another, and can be any number from 1-99. After the required number of detail cards have been stacked, the corresponding master is stacked.

The cards to be counted can be placed in either the primary or secondary feed. In the illustration (Figure 84), they are placed in the primary feed, and the specified number of primary cards are fed ahead of each corresponding secondary card.

### Control Panel Hubs

*DE (Digit Emitter)*. These two hubs are wired together whenever an accumulated total is to be emitted from the c hub of either counter to a comparing entry. The total is usually compared with a number read from a card.



J-K, 27

When the DE hubs are wired together, the c hub of the units counter emits the total accumulated in the counter. For example, if six cards have been counted, the c hub emits a 6. Also, each of the digit hubs (0-9) in the units counter emits a corresponding digit, 0-9 respectively, on each cycle. The 0 hub emits a zero, the 1 hub a one, and the 2 hub a two, etc.

The c hub of the tens counter will also emit an accumulated total when the DE hubs are wired, provided the 0-9 digit hubs of the tens counter are wired from the corresponding 0-9 digit hubs of the units counter.

*UR (Units Restore)*. When the collator counting feature is installed on the 87 Collator, the UR hub is available (Figure 81) and emits an impulse on all card cycles. This impulse must be used instead of PLUG TO c to restore comparing units, when a counting operation on the 87 requires that a unit be restored on all cycles.



J, 26

### Wiring (Figure 84)

1. Because any number of cards from 1 to 99 may be counted, the counters are coupled.

2. The DE hubs are wired because the accumulated total is to be emitted for comparison with a number read from the card. The 0-9 digit hubs in the units counter are wired to the corresponding digit hubs in the tens counter to permit the count in the tens counter to be emitted from the TOTAL c hub.

3. The specified number of cards to be counted is entered from the secondary card by wiring from secondary read (columns 41-42) through BCD entry one to secondary selector entry. The number is held until another secondary card is fed.

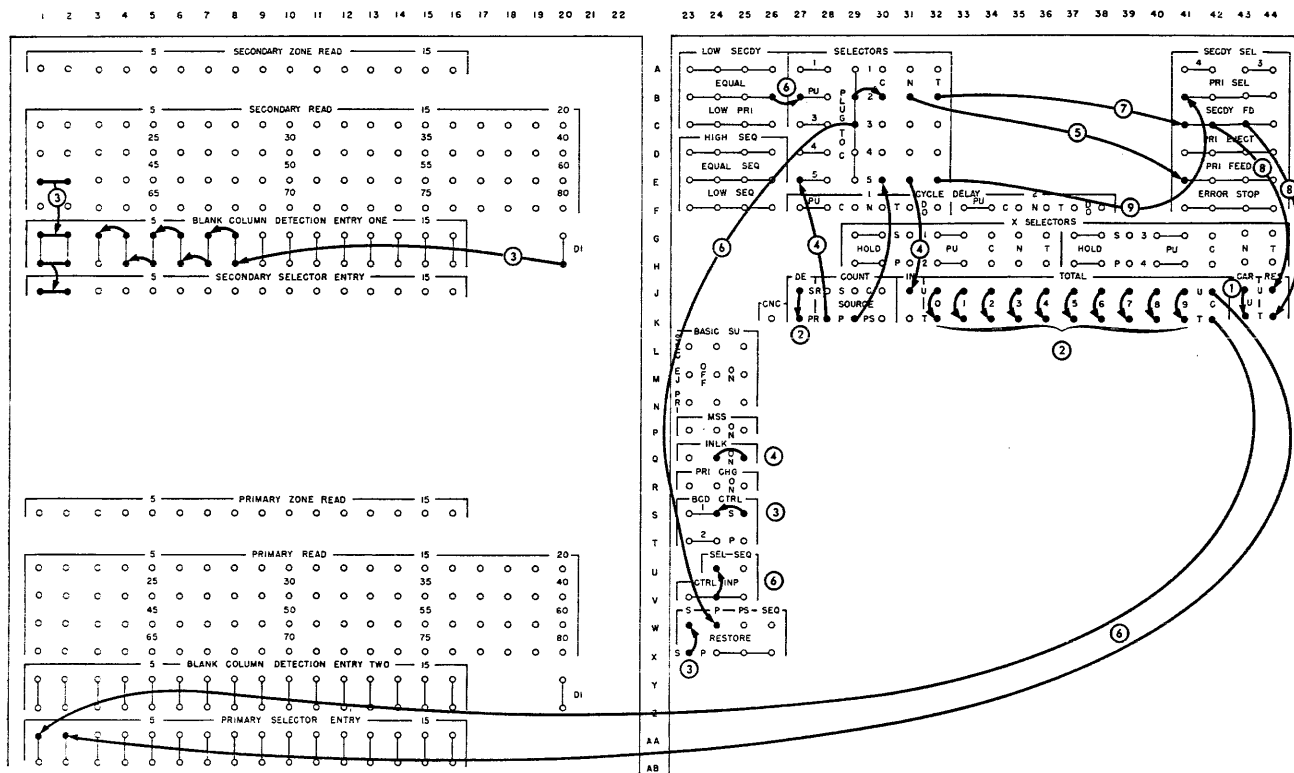

FIGURE 84. INSERTING A VARIABLE NUMBER OF CARDS AHEAD OF EACH MASTER CARD

4. Each primary card is counted as it is stacked by wiring count source P through the normal side of selector 5 to the units counter IN. Selector 5 prevents counting cards on the run-out because the selector is transferred at that time by PR. Interlock is wired ON to make PR active.

5. Primary cards are fed continuously until the specified number have been counted, by wiring PLUG TO C through the normal side of selector 2 to PRIMARY FEED.

6. The accumulated total is compared with the number read from the card by wiring from the TOTAL C hubs of units and ten counters to primary selector entry. The total is entered in the comparing entries on each cycle by wiring PLUG TO C to P RESTORE. When the numbers are equal, indicating that the specified number of primary cards have been stacked, selector 2 is transferred.

On the 87, wire P RESTORE from UR, instead of PLUG TO C, and omit control input wiring.

7. When selector 2 is transferred, primary feeding is interrupted and PLUG TO C impulses SECONDARY FEED so that a secondary card will be stacked on the next cycle. At that time a new number is entered in the secondary selector entries.

8. When primary feeding is interrupted and a secondary card is fed, the counters are reset to zero. After each secondary card is fed, the primary-card count is restarted.

9. After the last secondary card has been fed, counting is eliminated and any additional primary cards are stacked in pocket 1 by wiring count source P through the transferred side of selector 5 to PRIMARY SELECT.

### INSERTING A VARIABLE NUMBER OF CARDS BEHIND EACH MASTER CARD

THE CARDS to be counted are placed in the secondary feed, and the master cards are placed in the primary feed. The number of secondary cards to be fed behind each primary card is punched in each master primary card. This number can vary from one master card to another, and can be any number from 1-99.

#### Wiring (Figure 85)

1. Because any number of cards from 1 to 99 may be counted, the counters are coupled.

2. The DE hubs are wired because the accumulated total is to be emitted for comparison with a number

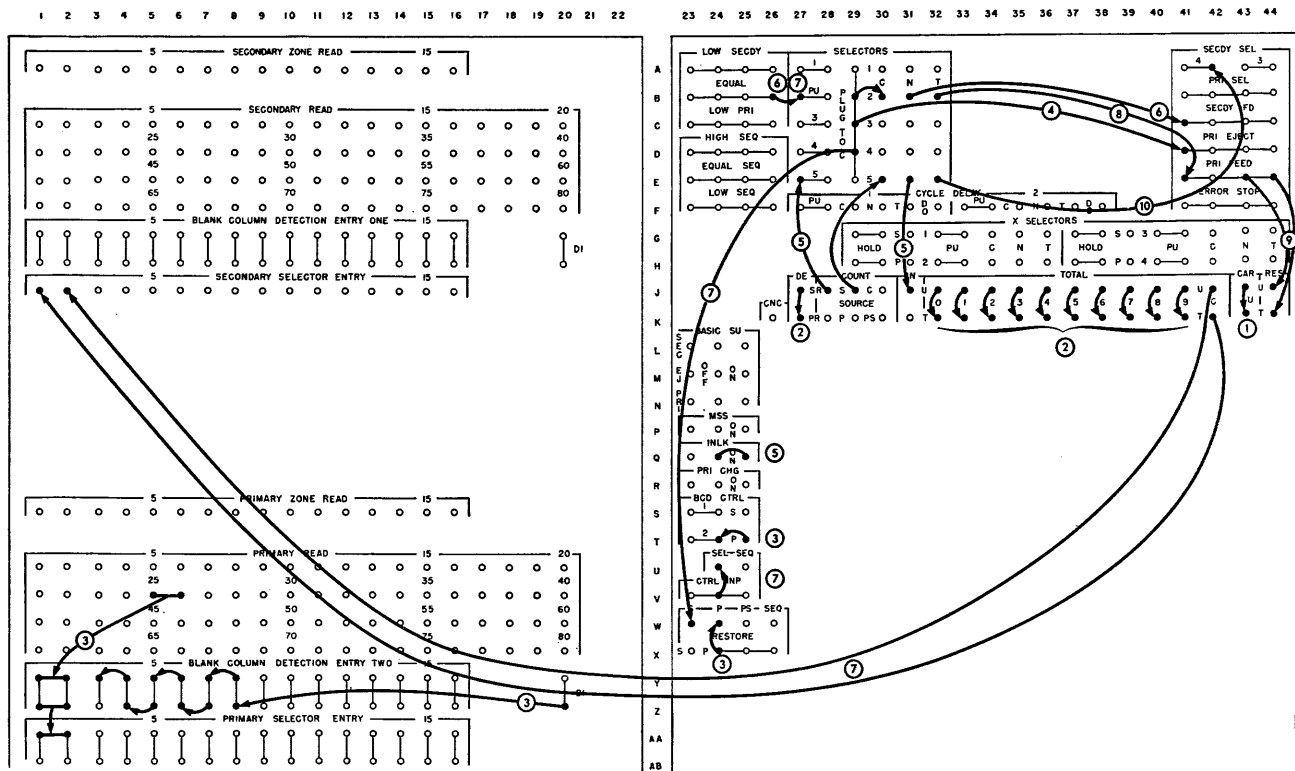

FIGURE 85. INSERTING A VARIABLE NUMBER OF CARDS BEHIND EACH MASTER CARD

read from the card. The 0-9 digit hubs in the units counter are wired to the corresponding digit hubs in the tens counter to permit the count in the tens counter to be emitted from the TOTAL c hub.

3. The specified number of cards to be counted is entered from the primary card by wiring from primary read (columns 25-26) through BCD entry two to primary selector entry. The number is held until another primary card is fed.

4. After the first three run-in cycles, the first primary card is stacked by wiring PLUG TO C to PRIMARY EJECT. All primary cards thereafter are also stacked by this wiring.

5. Each secondary card is counted, as it is stacked, by wiring count source s through the normal side of selector 5 to the units counter IN. Selector 5 prevents counting cards on the run-out because the selector is transferred at that time by SR. Interlock is wired ON to make SR active.

6. Secondary cards are fed continuously until the specified number have been counted, by wiring PLUG TO c through the normal side of selector 2 to SECONDARY FEED. Selector 2 is transferred on an equal comparison in the selector unit.

On the second run-in cycle, the comparing unit is equal because no numbers have been entered. The specified number is not entered until the third run-in cycle when the primary card passes primary read. Therefore, the selector is transferred at the end of the second cycle and prevents a secondary card from being fed ahead of the first primary card.

7. The accumulated total is compared with the number read from the card by wiring from the TOTAL c hubs of the units and tens counters to secondary selector entry. The total is entered in the comparing entries on each cycle by wiring PLUG TO C to s RESTORE. When the numbers are equal, indicating that the specified number of secondary cards have been stacked, selector 2 is transferred.

On the 87, wire s RESTORE from UR, instead of PLUG TO C, and omit control input wiring.

8. When selector 2 is transferred, secondary feeding is interrupted and PLUG TO c impulses PRIMARY FEED so that a primary card will be fed into eject position on the next cycle. When secondary feed is restarted, the primary card will be ejected into the stacker (wire 4) with the first secondary card of the next group.

9. When secondary feeding is interrupted and a primary card is fed, the counters are reset to zero. After each primary card is fed, the secondary-card count is restarted.

10. After the last primary card is ejected, the specified number of secondary cards is fed into pocket 2. Then a primary feed cycle occurs making SR active. At this time, selector 5 is transferred, so that any additional secondary cards are stacked in pocket 4 and counting is eliminated.

### INSERTING UP TO 199 CARDS BEHIND EACH MASTER CARD

THE PRECEDING EXAMPLE describes the operation of inserting up to 99 cards behind each master card. In this example, up to 199 cards are inserted. As in the preceding example, the cards to be counted are placed in the secondary feed, and the master cards are placed in the primary feed. The feeding principles are basically the same; the only difference is in the control of feeding for those masters that specify over 99 cards.

The number of secondary cards to be fed behind each master primary card is punched in each master that specifies less than 100 cards. In those masters specifying 100-199 cards, the two-column number field is punched with the units and tens digits (00-99), and the card is X-punched to indicate the hundreds position. Therefore, NX-master cards specify less than a hundred cards, and X-master cards specify 100 more than the number punched.

#### Wiring (Figure 86)

1. Because more than 9 cards will be counted, the counters are coupled.

2. The DE hubs and the digit (0-9) hubs are wired because the total count is to be emitted for comparison with a number read from the card.

3. The number punched in the master card is wired from primary read (columns 25-26) through BCD entry two to primary selector entry. The number is held until another primary card is fed.

4. After the run-in, the first primary card is stacked by wiring PLUG TO C TO PRIMARY EJECT. All primary cards thereafter are also stacked by this wiring.

5. The first secondary card is stacked with the first primary card, and secondary cards are then fed continuously until the number fed equals the number punched in the master card and stored in the primary selector entries. PLUG TO C is wired through the normal side of selector 2 TO SECONDARY FEED.

6. Each secondary card is counted as it is stacked by wiring count source s through the normal side of selector 1 to the units counter IN. Selector 1 is picked up by SR and prevents counting cards on the run-out. Interlock is wired ON to make SR active.

7. The accumulated total is compared with the number read from the card by wiring from the TOTAL C hubs of the units and tens counters to secondary selector entry. The total is entered in the comparing entries on each cycle by wiring PLUG TO C TO S RESTORE. When the numbers are equal, selector 2 is transferred.

On the 87, wire S RESTORE from UR, instead of PLUG TO C, and omit control input wiring.

8. When the number of secondary cards counted equals the number punched in an NX-master card, secondary feeding is interrupted and a primary card is fed. PLUG TO C is wired through the transferred side of selector 2 and the normal side of cycle delay selector 1 TO PRIMARY FEED.

9. When the number of secondary cards counted equals the number punched in an X-master card, 100 more secondary cards must be fed.

The master X is wired from sequence read to the pickup of X-selector 2 which, in turn, is used to control cycle delay selector 1. Cycle delay is picked up on each primary feed cycle that an X-master is fed past primary read; it transfers on the following machine cycle and remains transferred until the number of secondary cards counted equals the number punched in the master card.

10. At the time the number of secondary cards equals the number punched in the X-master, one more secondary card is fed by wiring PLUG TO C through the transferred sides of selector 2 and the cycle delay selector TO SECONDARY FEED. At that time the count is increased by 1, and it no longer equals the number punched in the master card. Thereafter secondary cards are again fed through the normal

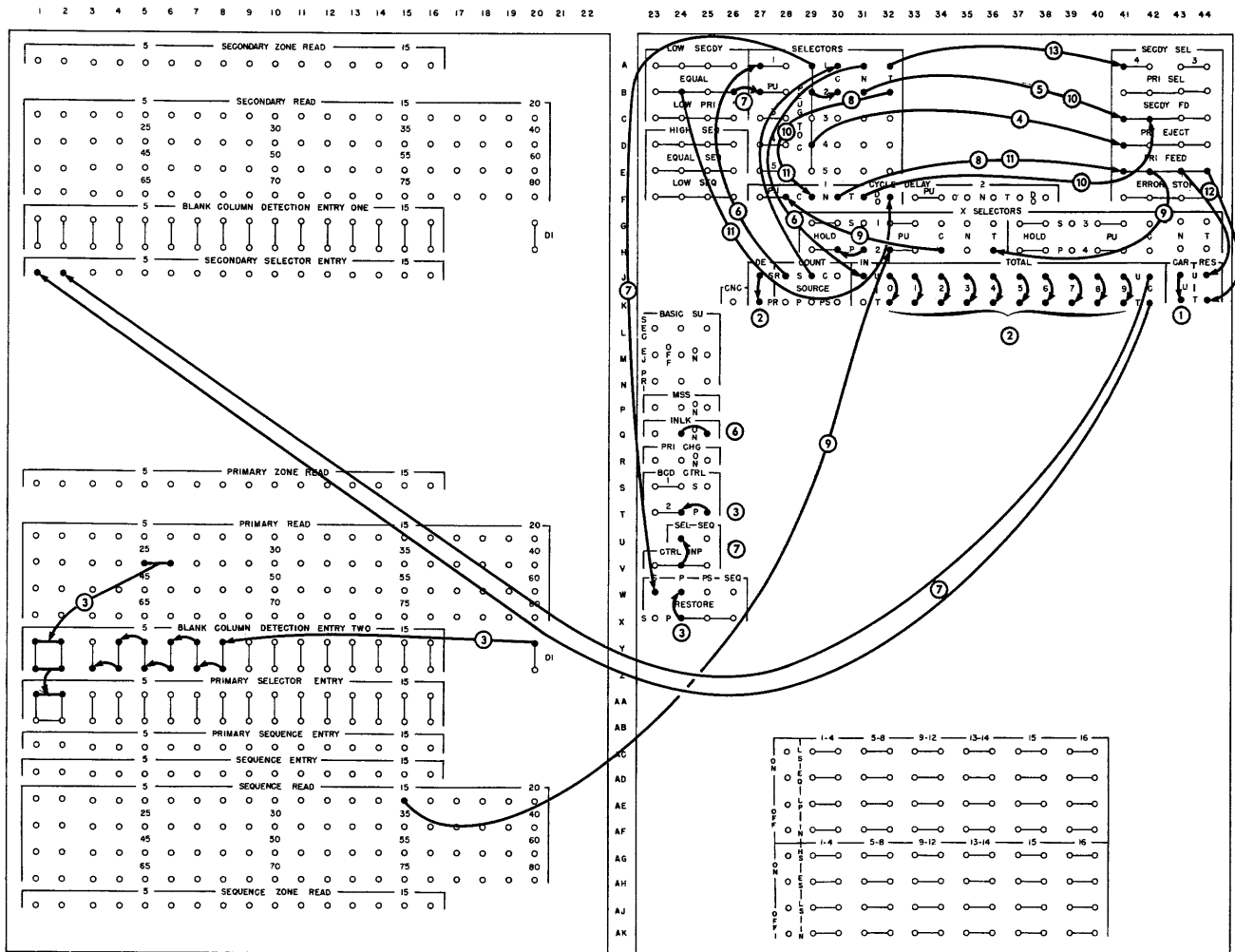

FIGURE 86. INSERTING UP TO 199 CARDS BEHIND EACH MASTER CARD

side of selector 2 until the accumulated count again equals the number punched in the master card.

11. The cycle delay selector is dropped out on an equal comparison so that the selector will be normal when the second equal comparison is recognized for an X-master card. At that time, secondary feeding will be interrupted and a primary card will be fed through the normal side of the cycle delay selector.

12. When secondary feeding is interrupted and a primary card is fed, the counters are reset to zero. After each primary card is fed, the secondary-card count is restarted.

13. After the last primary card is ejected, the specified number of secondary cards are fed into pocket 2. Then a primary feed cycle occurs making sr active. At this time selector 1 is transferred, so that any additional secondary cards are stacked in pocket 4 and counting is eliminated.

### INSERTING A SINGLE CARD AHEAD OF A PREDETERMINED NUMBER OF CARDS WITHIN A CONTROL GROUP

IN THIS OPERATION, the single cards are punched with control numbers corresponding to those in the detail cards, and they must be inserted within the proper group of details. This type of operation is used, for example, to insert description cards that will head each page of a report in a subsequent accounting machine operation. The number of cards in the description card file is predetermined, and varies between groups depending on the average number of details in each group.

The description cards are placed in the primary feed, and the details are placed in the secondary feed. In the illustration (Figure 87), a description card and 25 detail cards for the same control group are stacked together in pocket 2. A control group may

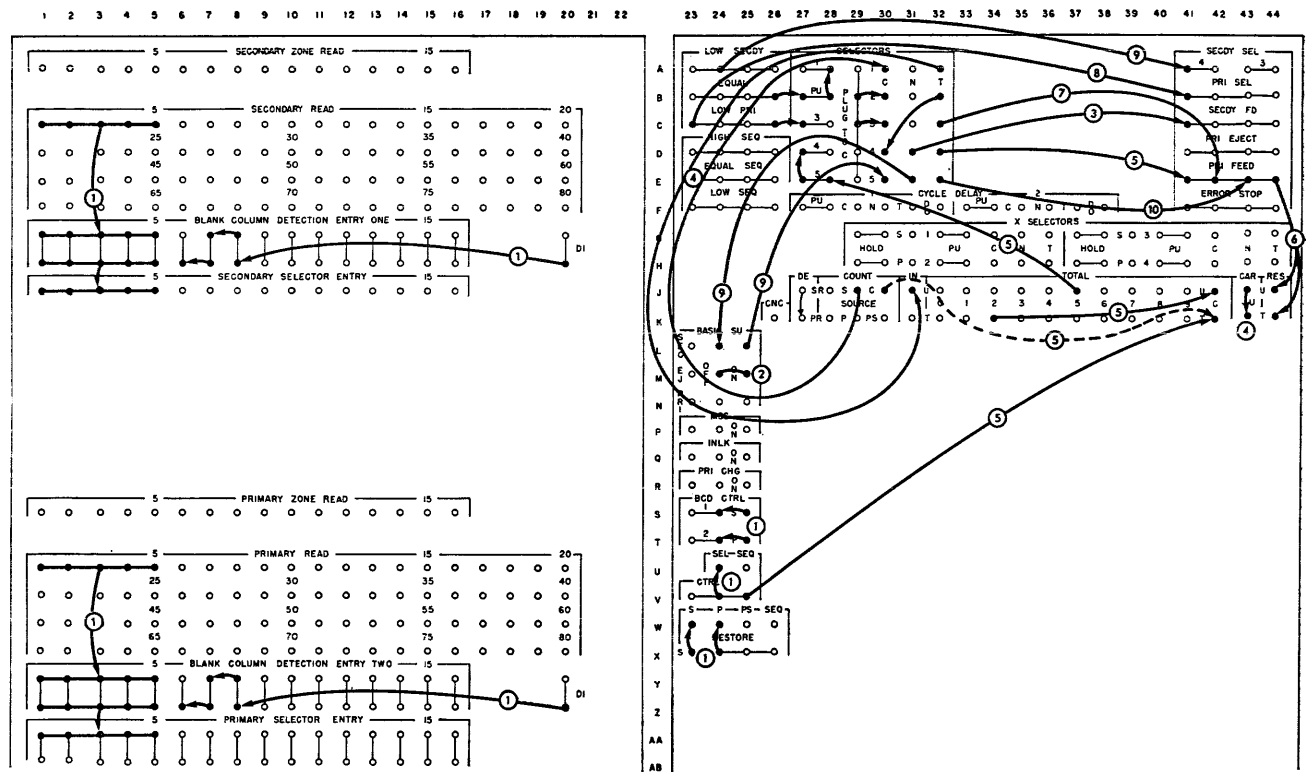

FIGURE 87. INSERTING A SINGLE CARD AHEAD OF A PREDETERMINED NUMBER OF CARDS WITHIN A CONTROL GROUP

contain an odd number of detail cards (not a multiple of 25), in which case less than 25 details will follow the last description card. For example, if there are 60 details in a control group, 3 description cards will be fed; each of the first two will be followed by 25 cards, and the third by 10 cards.

Any excess or unmatched description or detail cards are selected.

### Wiring (Figure 87)

1. The control number in the description cards is compared with that in the detail cards.

On the 87, omit control input wiring.

2. After the run-in, the first primary (description) card is ejected into the stacker if it is equal to the first secondary (detail) card. All other equal primary (description) cards are also stacked by this wiring. Because equal primary cards are ejected into the stacker, the control number is remembered for comparison with the secondary cards.

3. Equal secondary cards are fed by wiring through the transferred side of selector 2 and the normal side of selector 4. After the first equal secondary card of a group is fed, additional secondary cards are com-

pared with the number remembered from the primary card. Equal secondaries are fed continuously until 25 have been counted. Selector 2 is transferred on an equal comparison, and selector 4 is transferred when 25 equal secondary cards have been counted.

4. Each equal secondary card is counted as it is stacked.

5. When 25 equal secondary cards have been stacked and another equal secondary is read, secondary feeding is interrupted and primary feed is impulsive through the transferred side of selector 4. This moves a primary card past primary read into eject position. On the next cycle if the cards are again equal, the primary card is ejected into the stacker and secondary feeding is resumed.

On the 87, the control input wiring is replaced by count source c (dotted wiring).

6. Whenever a primary feed occurs, the counters are reset to zero so that counting can be restarted when equal secondaries are again fed.

7. When the first secondary card of a new group is read and compared with the remembered primary control number, a primary card is moved into eject position on a low primary.





3. The last primary card of each equal set is ejected into the stacker, and the control number is remembered for comparison with the secondary cards.

4. The first equal secondary card is stacked along with the last primary card of each equal set. Additional secondary cards are compared with the number remembered from the primary card, and equal secondaries are fed until 14 have been counted.

5. Each equal secondary card is counted as it is stacked.

6. When 14 equal secondary cards have been stacked and another equal secondary is read, secondary feeding is interrupted and primary feed is impulsed. This moves a primary card past primary read into eject position. On the next cycle if the cards are again equal, the next primary set is stacked, the last one being ejected into the stacker, and secondary feeding is resumed.

On the 87, the control input wiring is replaced by count source c (dotted wiring).

7. Whenever a primary feed occurs, the counters are reset to zero so that counting can be restarted when equal secondaries are again fed.

8. When the first secondary card of a new group is read and compared with the remembered primary control number, a primary card is moved into the eject position on a low primary.

This wiring, together with wiring 2, also stacks both excess primary sets and primary sets without corresponding secondaries.

9. Excess and unmatched primaries are selected into pocket 1.

10. Excess and unmatched secondaries are fed and selected into pocket 4.

11. If a low secondary comparison is detected at the time 14 cards have been counted, a primary card (rather than a secondary) is fed. This may occur if any secondary cards are out of order in the file.

### MERGING A PREDETERMINED NUMBER OF PRIMARIES AND SECONDARIES

A PREDETERMINED NUMBER of primary cards can be merged with a predetermined number of secondaries. The number of primaries and secondaries can be the same or different, but neither number can exceed 9 because one counter must be used to count primaries and the other secondaries. No punching is required

in either primary or secondary cards to control this feeding.

The last merged group must be checked to insure that the proper number of cards were merged before either feed became empty. Extra cards in either feed are selected on the run-out.

In the illustration (Figure 89), 4 secondaries are merged behind 2 primaries.

### Wiring (Figure 89)

1. Primary cards are fed by wiring PLUG TO c through the normal sides of selectors 4 and 5 to PRIMARY FEED.

2. As each primary card is stacked, it is counted in the tens counter.

3. When 2 primary cards have been counted, selector 5 is transferred so that primary feeding is interrupted and a secondary card is fed. Secondary feeding continues until 4 secondary cards have been stacked.

On the 87, the control input wiring is replaced by count source c (dotted wiring).

4. As each secondary card is stacked, it is counted in the units counter.

5. When 4 secondary cards have been counted, selector 4 is transferred. Secondary feeding is interrupted, and both counters are reset to zero so that the counts can be restarted.

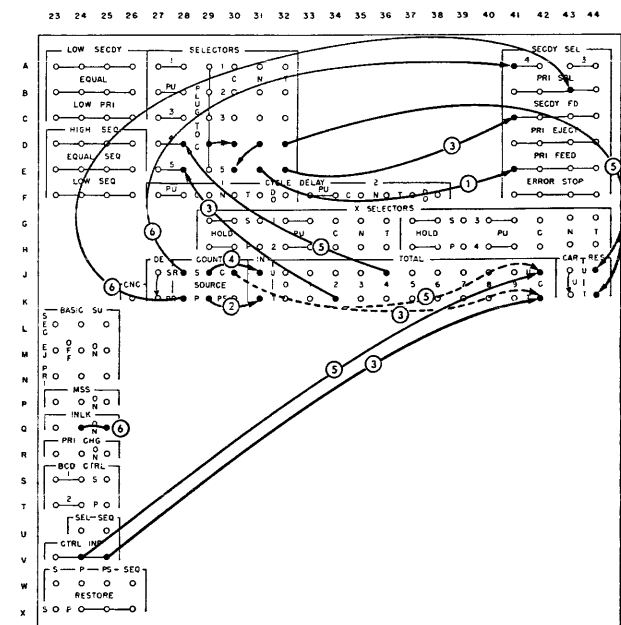

FIGURE 89. MERGING A PREDETERMINED NUMBER OF PRIMARIES AND SECONDARIES

On the 87, the control input wiring is replaced by count source c (dotted wiring).

6. When either feed becomes empty, the cards in the other are selected on the run-out. Interlock is wired ON to make the SR and PR hubs active.

## CHECKING CONSECUTIVE NUMBERS

A FILE OF CARDS can be checked to insure that the cards are numbered consecutively. A blank card is inserted to indicate each missing number (or group of numbers) and each number out of order. Two columns of a number can be checked in one operation. In most cases this is adequate, even though consecutive numbers may consist of three or more digits, because a check on the units and tens positions detects all discrepancies except missing groups of even hundreds, thousands, ten thousands, etc.

Duplicate numbers are either left in the file, or all but the last are selected. If duplicates are selected, blank cards can be inserted in their place. A missing group of 99 numbers, for example 156 followed by 256, is recognized as a duplicate condition.

The cards to be checked are placed in the primary feed, and blank cards are placed in the secondary. A primary card is compared, on each cycle, with an accumulated count. The card number is read into the primary selector entries, and the count is entered in the secondary selector entries. As long as the cards are in consecutive-number order, an equal comparison is detected, the count is increased by 1 on each cycle, and the cards are fed continuously. When duplicates are detected, counting is suspended until the last duplicate is fed. The sequence unit is used to check for duplicates.

If any cards are missing, a low secondary comparison is detected, primary feeding is stopped, and blank cards are fed and counted until the count again equals the primary-card number. One of the blank cards is inserted in the file to indicate the discrepancy, and the other blanks are selected. The extra blanks are fed merely to increase the count until it equals the primary-card number.

Misfiled cards are indicated by a blank inserted both before and after the misfiled card, or group of cards. When a card that is misfiled ahead of where it belongs (i.e., 1, 2, 3, 10, 4, 5) is read, the checking operation is the same as for missing cards, because the numbers in between 4-9 are "missing." After the

misfiled card is fed, a low primary comparison is detected (count of 11 compared with 4) and the counters are reset so that counting can be restarted. Blanks are then fed and counted on a low secondary comparison, until the count again equals the primary number. One blank is inserted to indicate the discrepancy, and the others are selected.

If a card is misfiled back of where it belongs (i.e., 65, 65, 30, 66, 67), the operation is the reverse of that described in the preceding paragraph.

## Wiring (Figure 90)

1. Because the count may exceed 9, the counters are coupled. The DE and TOTAL (0-9) hubs are wired because the total count is to be compared with a number read from the card.

2. On each cycle, the primary card and the accumulated count are compared, and the cards in the primary feed are compared to check for duplicates.

On the 87, wire s RESTORE from UR, instead of PLUG TO c, and omit primary sequence entry, PS restore, and control input wiring.

3. After the run-in, a low secondary comparison is detected because the first primary number has been entered but no cards have been counted. Secondary feeding and counting are started, and continue until the total count equals the first primary number. Secondary feeding is caused by wiring an unequal impulse from the normal side of selector 1 to SECDY FD. The first blank card is stacked in pocket 2, and any others are selected into pocket 3 by wiring an unequal impulse through cycle delay selector 1 to SECONDARY SELECT 3. The COUNT SOURCE s impulse, controlled through the normal sides of selectors 2 and 3, causes card counting. This wiring for an unequal condition controls card feeding and counting whenever cards are missing.

4. At the beginning of the run, as soon as the count equals the first primary card, the card is fed into the stacker by wiring an equal impulse from the transferred side of selector 1 to PRI FD. The card is counted by wiring a COUNT SOURCE P impulse through the normal side of selector 5, the transferred side of selector 2, and the normal side of selector 3.

5. Duplicates are fed, but only the last one is counted. To do this, the COUNT SOURCE P impulse is wired through the normal side of selector 5, which is transferred on an equal sequence condition. All duplicates but the last can be stacked in pocket 1, and a



## Split Selector and Sequence Unit Feature

WHEN THIS SPECIAL FEATURE is installed on the 85 Collator, each standard 16-position comparing unit is split so that two or more fields can be entered for *independent* comparison; the results of *each* comparison are then available to control machine operation. The 16 comparing positions in the selector and sequence units are split into six independent groups as follows:

Comparing Positions	Number of Positions
1-4	4
5-8	4
9-12	4
13-14	2
15	1
16	1

To test each group of comparing positions independently, a control switch and additional control input and control exit hubs for each comparing unit (Figure 91) are provided on the panel. When a control switch (AC-AK, 28) is wired ON, the corresponding comparing unit is split into six independent groups; when a switch is wired OFF, or not wired, all 16 comparing positions of the corresponding unit operate together in the normal manner. All comparing positions of a split unit are restored at the same time by wiring RESTORE (W, 23-26).

Because the split selector unit and the split sequence unit operate in the same manner, only the selector unit is described in detail. The LS hubs (AC, 29-40)

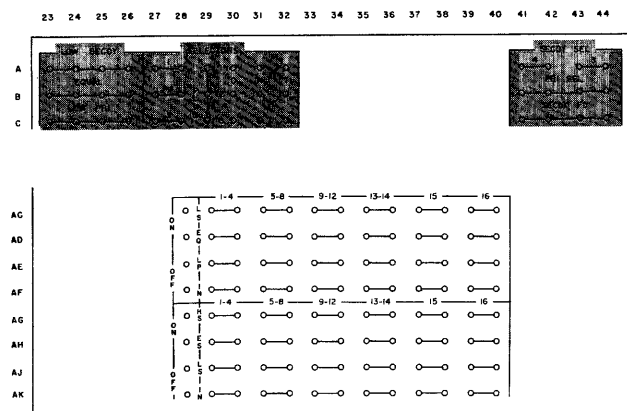

FIGURE 91. SPLIT SELECTOR AND SEQUENCE UNIT FEATURE

are the low secondary control exit hubs for each group; the EQ hubs (AD, 29-40) are the equal control exit hubs for each group; the LP hubs (AE, 29-40) are the low primary control exit hubs for each group; and the IN hubs (AF, 29-40) are the control input hubs for each group.

Figure 92 shows the relationship, in the selector unit, between the groups of comparing entry positions and the split unit hubs. For example, if two numbers are read into primary and secondary selector entry positions 5-8, a control input impulse is wired to the IN hub for that group, and the impulse is available from one of the three control exits (LP, EQ, or LS) for that group.

In addition to the split hubs provided when the device is installed, the standard control input and control exit hubs can be used for the first and last groups of comparing positions, respectively. That is, to test the *first* group (1-4), the control input impulse can be wired to either the standard SEL hub (U, 24), or to the IN hubs (AF, 29-30) for that split group. The impulse is then available from the split LS, EQ, or LP hubs for the 1-4 group. When a control input impulse is wired to the split IN hub for the *last* group (16), the result of the comparison is available from either the standard selector control exits (A-C, 23-26), or from the LS, EQ, or LP hubs (AC-AE, 39-40) for that split group.

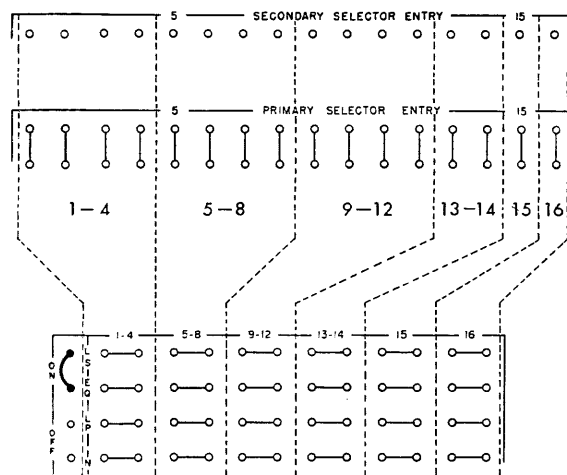

FIGURE 92. RELATIONSHIP BETWEEN SELECTOR ENTRIES AND SPLIT SELECTOR UNIT

Because the comparison of the last group (16) is available at the standard selector control exits, it is also available at the basic setup switches. Therefore, if these switches are to be used to control feeding in conjunction with the split unit feature, the control field should be entered so that the last column to be compared is read into comparing entry position 16. If this is not done, split group 16 must be coupled to the right of the group used, or, the split hubs for the group used must be wired to the corresponding standard control exit hubs. In either case, position 16 cannot be used for a separate comparison

### COUPLING TWO GROUPS

EVEN THOUGH a control switch is wired ON, a field larger than 1, 2, or 4 digits can be treated as one field by coupling two or more of the split groups together. A group can be coupled to any other group regardless of sequence. However, any coupling of groups that are not adjacent should be removed from the control panel when the switch is wired OFF, or not wired, because the split groups are then internally coupled in sequence.

Figure 93 shows the 9-12 and 13-14 groups coupled to compare a 6-digit field wired to selector entry positions 9 through 14.

#### Wiring (Figure 93)

1. A control input impulse is wired to IN of the 9-12 group. This tests the four high-order positions of the field. If these positions are equal, the impulse is available from the EQ hubs.
2. EQ of the 9-12 group is wired to IN of the 13-14 group to test the other two positions of the field.
3. If the 13-14 positions are also equal, the impulse is available from the EQ hubs of the 13-14 group. Thus, an impulse is available to control machine functions only when the entire six positions are equal.
4. If a low secondary condition is detected in any of the six positions, an impulse is available from the LS hubs of the 13-14 group to control machine functions. When the low secondary condition is detected in the first four positions, the impulse is available from

the LS hubs of the 9-12 group, via the common LS hubs of the 13-14 group, and the second group is not tested. When the first four positions are equal and the last two are tested (wiring 2), the impulse is available from the LS hubs of the 13-14 group if a low secondary condition is detected in these positions.

5. Similar to the wiring for low secondary, an impulse is available from the LP hubs of the 13-14 group if a low primary condition is detected in any of the six positions.

6. The control switch for the selector unit is wired ON.

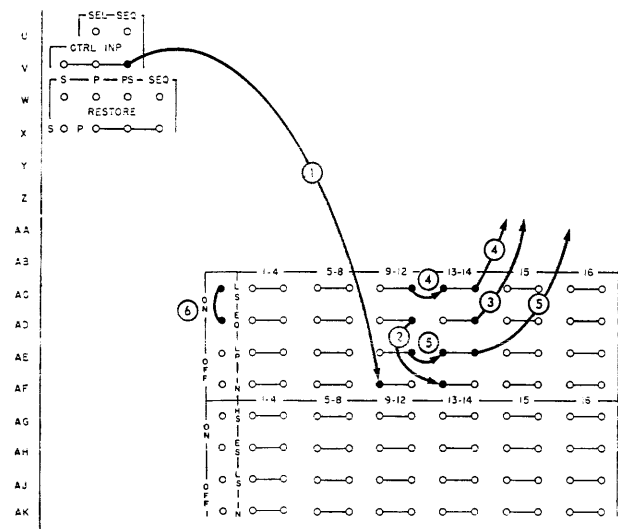

FIGURE 93. COUPLING TWO GROUPS

### SELECTING CARDS BY ANY ONE OF FOUR CONTROL NUMBERS

IN THIS ILLUSTRATION (Figure 94) cards punched with any one of four control numbers are selected. The control numbers are punched in four 4-digit fields in a finder card. Therefore, 16 comparing entry positions are required, and the operation can be performed using one comparing unit. The split selector unit is used, and the cards are fed in the primary feed. The time required for this operation can be reduced 50% if both feeds are used simultaneously. In this case the split sequence unit is used to compare the secondary cards, and the same wiring principles apply.

If all cards are fed in one feed and both split units are used, cards punched with any one of eight 4-digit control numbers can be selected in one run of the cards through the machine.



## MERGING BY MAJOR AND MINOR CONTROL; SELECTING UNMATCHED MAJORS

Using the split unit feature, two files of cards can be merged on the combination of a major field and a minor field, and selected by the major field only. For example, the cards may be merged by both customer number (major) and date (minor), but selection is desired only for those customer numbers in one file for which there are no cards in the other file.

In this illustration (Figure 95), card feeding is controlled by both basic setup switches and functional wiring. The major and minor fields are entered in the split units, and the minor field is tested only when the cards are equal in the major field. In this case, the cards are merged by the basic setup switches in the normal manner (with one exception—selection of the PRI switch). If the cards are unequal in the major field, card feeding is controlled by functional wiring.

As in any merging-with-selection operation, the cards are selected on low primary or low secondary; in this operation, however, the selection is controlled by the low condition in the major field only.

In some cases, secondary cards would be selected in error if the cards were permitted to merge in exactly the normal manner through the basic setup switches. In the following arrangement of cards, for example, primary card 1-1 would normally be fed as a low primary; then secondary cards 1-2 and 1-3 would be fed and selected as low secondaries in the major field.

Secondary cards	1-2	1-3	2-1
Primary cards	1-1	2-1	2-1

However, cards 1-1, 1-2, and 1-3 are all in the same *major* group (1), and none should be selected. To prevent this erroneous selection of secondary cards, the last primary card of an *equal major* group is always ejected (never fed) to the stacker so that the first primary card of the next major group will *not* be fed and read. Then any additional secondary cards in the same major group can be compared, as equals, with the remembered primary number.

In some cases, primary cards would be selected in error if low primary in the major field were wired directly to primary select. For example, cards 1-2 and 1-3 in the following arrangement of cards would be fed and selected as low secondaries in the major field, after secondary card 1-1 was fed.

Secondary cards	1-1	2-1	
Primary cards	1-2	1-3	2-0

To correct this, primary cards 1-2 and 1-3 in the *equal major* group are fed as low primaries, but their selection is prevented by wiring low primary through the normal side of cycle delay selector 1. The selector is picked up on an equal condition in the major field (when secondary card 1-1 and primary card 1-2 are compared) and dropped out on a change in sequence in the major field (when primary cards 1-3 and 2-0 are compared).

### Wiring (Figure 95)

1. The card fields are checked for blank columns and entered in the comparing units in the normal manner for merging. The major field is entered in positions 1-4, and the minor field is entered in positions 13-16 so that the basic setup switches can be used to control card feeding. The split unit control switches are wired ON.

2. RESTORE is wired normally.

3. Control inputs are wired normally. This tests the comparisons in the major field. The comparisons in the minor field are tested only when the major fields are equal, by wiring EQ and ES for group 1-4 to the IN hubs for group 13-14.

4. Split groups 13-14, 15, and 16 are coupled to form one 4-position group.

5. Secondary feeding is required for the following conditions, and is obtained by wiring 5A, 5B, 5C, and 5D:

<u>Major Field</u>	<u>Minor Field (if considered)</u>
--------------------	------------------------------------

A. Low Secondary

B. Equal and High Sequence

C. Equal Low Secondary

D. Equal and Equal Sequence Equal and Unequal Sequence

6. Primary feeding is required for the following conditions, and is obtained by wiring 6A, 6B, and 6C:

<u>Major Field</u>	<u>Minor Field (if considered)</u>
--------------------	------------------------------------

A. Low Primary

B. Equal Low Primary  
Provided there is *not* a high sequence in the major field

C. Equal Equal  
Provided there is *not* a high sequence in the major field

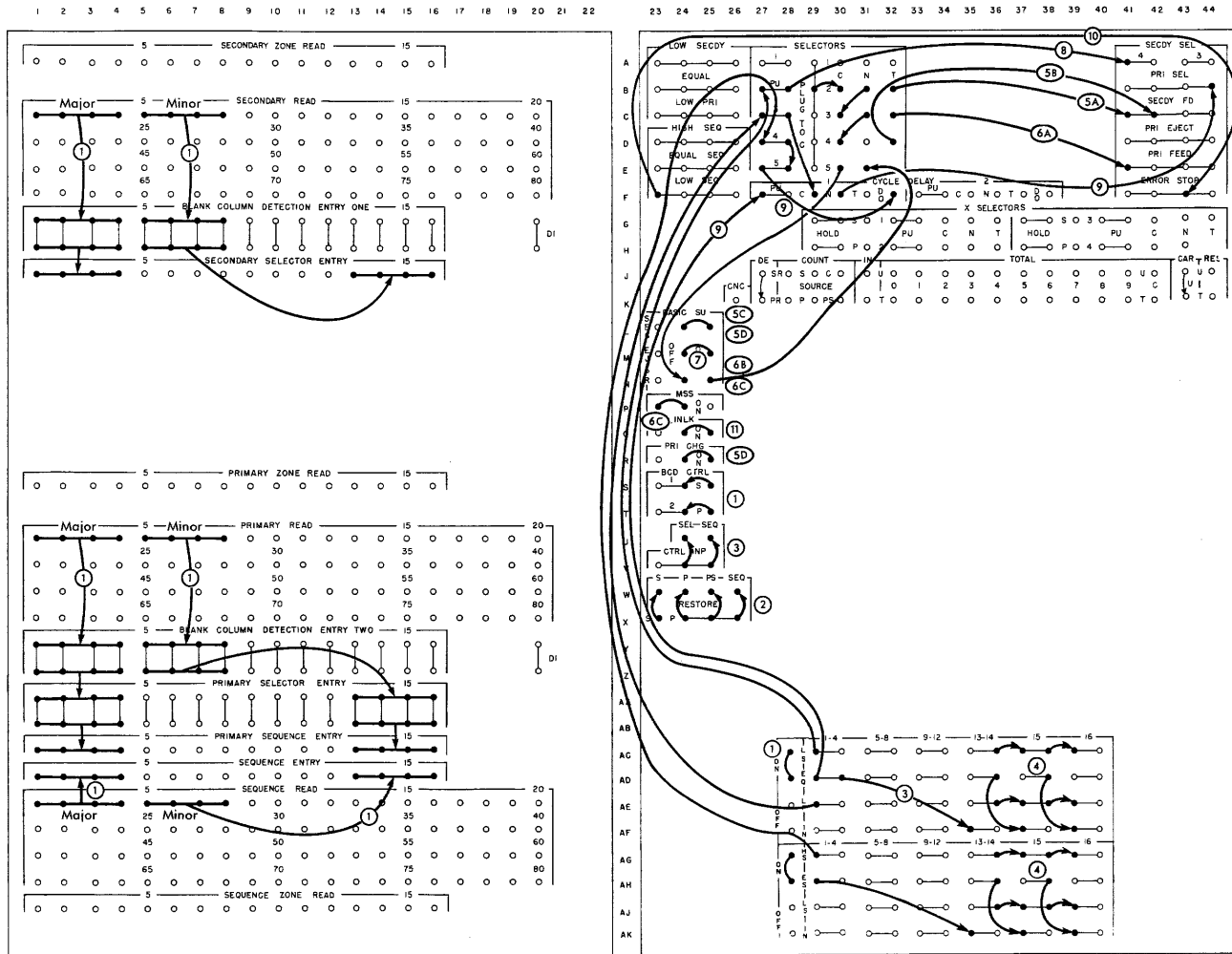

FIGURE 95. MERGING BY MAJOR AND MINOR CONTROL; SELECTING UNMATCHED MAJORS

7. Primary ejection only, without a primary feed, is required.

<u>Major</u>	<u>Minor Field</u>
Field	
Equal	Low Primary or Equal
When there is a high sequence in the major field	

8. Secondary cards are selected on a low secondary condition in the major field.

9. Primary cards are selected on a low primary condition in the major field. Because some equal primary cards are fed as "low primaries," cycle delay

selector 1 is used to determine whether a low primary card is an unmatched card that should be selected, or an additional primary card of an equal major group. The selector is picked up on an equal condition and dropped out on a high sequence condition. When the selector is normal, a low primary card should be selected; therefore, LP is wired through its normal side to PRIMARY SELECT.

10. Card feeding is stopped for an error in sequence in either the major or minor field.

11. Interlock is wired ON to insure proper selection on the runout.





comparing entries immediately to the left of the corresponding numerical portion of each letter.

2. *Secondary Read*. Emits impulses corresponding to holes punched in the card passing the secondary brushes. May be wired to blank column detection entry, to any selector or sequence entry, or to the pickup of an X-selector.

3. *Blank Column Detection Entry One, Blank Column Detection Entry Two*. Entries to check card columns for blanks. Each unit (one and two) can be used to check cards in either feed, by wiring BCD CTRL. When a blank column is detected, card feeding stops and a signal light (BCD 1 or BCD 2) turns on. The light can be turned off and card feeding can be re-started by pressing the reset key and then the start key. On the 85 Collator, a column punched with an X or 12 only is detected as blank.

4. *DI (Direct Impulse)*. Emits an impulse, on all cycles, that is normally wired to unused blank column detection entry positions, to prevent an erroneous blank-column indication.

5. *Secondary Selector Entry*. Entries to the secondary side of the selector comparing unit. Impulses received are compared with those entered in the corresponding positions in the primary side of the selector unit. The secondary selector entries may be wired from any reading station; they are normally wired from secondary read.

6. *Primary Read*. Emits impulses corresponding to holes punched in the card passing the primary brushes. May be wired to blank column detection entry, to any selector or sequence entry, or to the pickup of an X-selector.

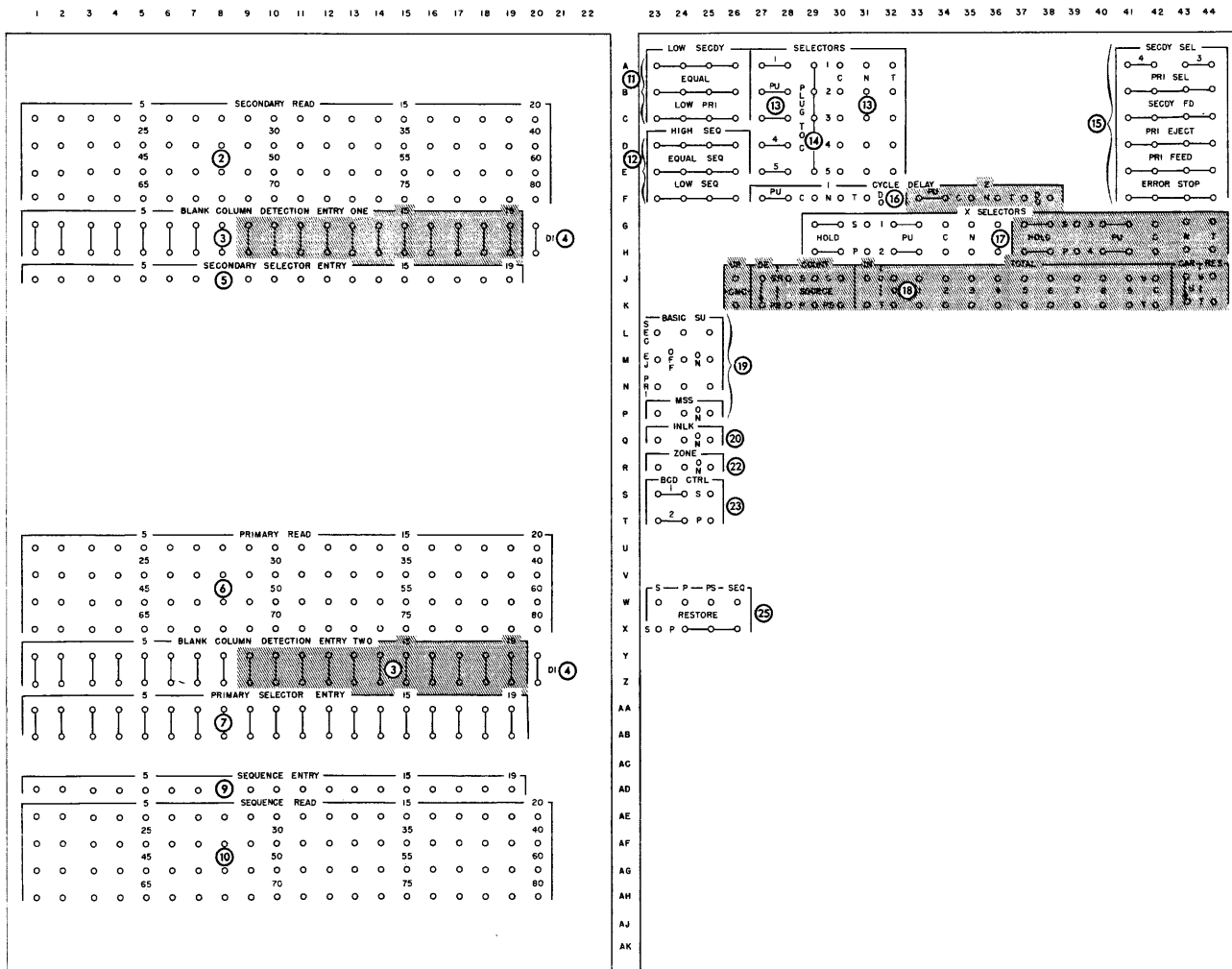

FIGURE 97. CONTROL PANEL SUMMARY — IBM 87

7. *Primary Selector Entry*. Entries to the primary side of the selector comparing unit. Impulses received are compared with those entered in the corresponding positions in the secondary side of the selector unit. The primary selector entries may be wired from any reading station; they are normally wired from primary read. On the 87, the primary selector entries are entries to both the primary side of the selector unit and the primary sequence side of the sequence unit.

8. *Primary Sequence Entry (85 Collator)*. Entries to the primary sequence side of the sequence comparing unit. Impulses received are compared with those entered in the corresponding positions in the sequence side of the sequence unit. The primary sequence entries may be wired from any reading station; they are normally wired from primary read.

9. *Sequence Entry*. Entries to the sequence side of the sequence comparing unit. Impulses received are compared with those entered in the corresponding positions in the primary sequence side of the sequence unit. The sequence entries may be wired from any reading station; they are normally wired from sequence read.

10. *Sequence Read*. Emits impulses corresponding to holes punched in the card passing the sequence brushes. May be wired to blank column detection entry, to any selector or sequence entry, or to the pickup of an X-selector.

11. *Selector Control Exits*. Emit an impulse resulting from a comparison in the selector unit when the SEL control input (item 24) is wired. They are normally wired to functional entry hubs or to pick up selectors.

*Low Secdy (Low Secondary)*. Emits an impulse when the number in the secondary selector entries is lower than that in the primary selector entries.

*Equal*. Emits an impulse when the numbers in the primary and secondary selector entries are equal.

*Low Pri (Low Primary)*. Emits an impulse when the number in the primary selector entries is lower than that in the secondary selector entries.

12. *Sequence Control Exits*. Emit an impulse resulting from a comparison in the sequence unit when the SEQ control input (item 24) is wired. They are normally wired to functional entry hubs or to pick up selectors.

*High Seq (High Sequence)*. Emits an impulse when the number in the sequence entries is higher than that in the primary sequence entries on the 85 or the primary selector entries on the 87.

*Equal Seq (Equal Sequence)*. Emits an impulse when the number in the sequence entries equals that in the primary sequence entries on the 85 or the primary selector entries on the 87.

*Low Seq (Low Sequence)*. Emits an impulse when the number in the sequence entries is lower than that in the primary sequence entries on the 85 or the primary selector entries on the 87. It is normally wired to ERROR STOP to stop card feeding for an error in primary-card sequence.

13. *Selectors: PU (Pickup)*. Accepts an impulse to transfer the selector immediately; the selector remains transferred for the duration of the pickup impulse. The pickup is normally wired from a control exit; it cannot be wired from a reading station.

*C (Common), N (Normal), T (Transferred)*. When a selector is not transferred, the C and N hubs are common internally; when a selector is transferred, the C and T hubs are common internally. A PLUG TO C is normally wired through the C, N, and T hubs.

14. *Plug to C*. Emits an impulse on each cycle. It is normally wired to a functional entry hub (except ERROR STOP), directly or through selectors.

15. *Functional Entries*. Accept impulses to control feeding, ejection, and selection of cards. They are normally wired from the control exits or PLUG TO C.

*Secdy Sel 3, 4 (Secondary Select)*. Causes a secondary card to stack in pocket 3 or 4, respectively. When both 3 and 4 are impulsed, cards are stacked in pocket 4.

*Pri Sel (Primary Select)*. Causes a primary card to stack in pocket 1.

*Secdy Fd (Secondary Feed)*. Causes a secondary feed cycle if cards are in the secondary feed. These hubs become exits when secondary feeding is controlled through the basic setup SEC switch.

*Pri Eject (Primary Eject)*. Causes a primary card to move from the eject position to the stacker; all other cards in the primary feed remain stationary. These hubs become exits whenever a primary feed occurs or when ejection is controlled through the basic setup EJ switch.

*Pri Feed (Primary Feed)*. Causes a primary feed cycle if cards are in the primary feed. These hubs become exits when primary feeding is controlled through the basic setup PRI switch.

*Error Stop*. Causes card feeding to stop and the error light to turn on. Before card feeding can be restarted, the error light must be turned off by pressing the reset key. Error stop must not be wired from PLUG TO C.

16. *Cycle Delay: PU (Pickup)*. Accepts an impulse to transfer the selector on the following cycle; the selector remains transferred until dropped out. The pickup is normally wired from a control exit or a selected PLUG TO C. However, it cannot be impulsed by any digit or zone impulse.

*C (Common), N (Normal), T (Transferred)*. When the cycle delay selector is not transferred, the C and N hubs are common internally; when it is transferred, the C and T hubs are common internally.

*DO (Drop Out)*. Accepts an impulse to return the selector to normal. It is normally wired from PLUG TO C, primary feed, or secondary feed. If both PU and DO are impulsed on the same cycle, the selector will be transferred on the following cycle and remain transferred until again impulsed to drop out.

17. *X-Selectors*. Normally used to control feeding, ejection, or selection of X- or NX-cards.

*Hold, S (Secondary), P (Primary)*. HOLD is wired from S to cause the selector to operate with the secondary feed, or from P to cause the selector to operate with the primary feed.

*PU (Pickup)*. Accepts an X-impulse to transfer the selector. When PU and HOLD are impulsed, the selector transfers immediately and remains transferred until the X-card moves to the next station. A control-input timed impulse can also be used to pick up the selector.

*C (Common), N (Normal), T (Transferred)*. When the selector is not transferred, C and N are common internally; when the selector is transferred, C and T are common internally. A PLUG TO C is normally wired through these hubs.

18. *Collator Counting Feature*. Special device to count up to 99 cards. Two different counting operations can be performed at the same time, provided each count will not exceed 9.

*UR (Units Restore, 87 Collator)*. Emits an impulse on all card cycles that must be used, instead of PLUG

TO C, to restore comparing units whenever a counting operation on the 87 requires that a unit be restored by an all cycles impulse.

*CNC (Consecutive Number Checking)*. Accepts an impulse on secondary feed cycles only. This hub provides a means of picking up X-selector 2, as required in some counting device operations such as consecutive number checking.

*DE (Digit Emitter)*. Jackplugged when a total count must be emitted from the counter for comparison with another number. Not jackplugged when a predetermined count is to control feeding and counting.

*Count Source: SR, PR, S, P, C, PS (Secondary Run-out, Primary Run-out, Secondary, Primary, Common, Primary Sequence)*. SR and PR emit a control impulse on each card cycle when the opposite feed is empty. PR emits when the secondary feed is empty, and SR emits when the primary feed is empty provided a primary feed cycle has occurred. Normally wired to the pickup of selectors to control card feeding, selection, and counting on the run-out. The interlock switch must be wired ON to make these hubs operative. These hubs also emit on the run-in.

S, P, C, and PS emit a PLUG TO C impulse on each feed cycle that cards are in the respective feed stations. S emits on each cycle that a secondary card is controlled to stack; P on each cycle that a primary card is controlled to stack; C on the cycle that the first card is read at primary read and on every machine cycle thereafter; and PS on each cycle that a primary card is controlled to pass the primary brushes. These hubs are normally wired to counter IN hubs. On the 87 Collator, C emits a control time impulse. This impulse can be used to pick up a selector when a counter has reached a predetermined total.

*In*. Accepts an impulse to cause the corresponding counter to add 1. If counters are coupled, only the units counter IN is wired; the tens counter automatically adds the carry-over from the units counter. The IN hubs are normally wired from count source or PLUG TO C.

*Total : 0-9, C (Common)*. The 0-9 hubs for the units and tens counters represent the totals accumulated in the counters. On each cycle, a path exists between the C hub and the 0-9 hub corresponding to the total count. Either hub can be used as an exit or an entry. Normally an impulse is wired through this

path to pick up a selector to control card feeding and counting when a predetermined number of cards has been counted.

When the DE hubs are jackplugged, the c hub of the *units* counter emits, on each cycle, the total accumulated in the units counter. The c hub can be wired to a comparing entry to compare the accumulated count with another number, usually read from the card. The 0-9 hubs of the units counter become a digit emitter and emit the digits 0-9, respectively, on each cycle. In order for the c hub of the *tens* counter to emit the total accumulated in that counter, the 0-9 hubs of the units counter must be wired to the corresponding hubs of the tens counter.

*Car (Carry)*. Jackplugged to accumulate one 2-position total (up to 99); not jackplugged to accumulate two separate single-position totals (up to 9 each).

*Res (Restore)*. Accepts an impulse to reset the corresponding counter to zero. Normally impulsed by a selected PLUG TO c.

19, 21. *Basic Setup*. These five switches can be used in place of functional wiring to control card feeding in a normal merging or matching operation. They are operative as a result of comparisons in the selector and sequence units. The first three switches (SEC — secondary feed, EJ — primary eject, and PRI — primary feed), when turned ON, directly control feeding and ejection as labeled. The other two switches (MSS — multiple secondaries and selection, and PRI CHG — primary change) condition the SEC and PRI switches. On the 87 Collator, the functions of the PRI CHG switch are performed by internal wiring. Refer to the *Basic Setup Summary* section for a full explanation of these five switches.

20 *Inlk (Interlock)*. Must be wired ON if selection is required in a merging or matching operation, to insure proper selection on the run-out. It must also be wired ON when the PR or SR hub in the special collator counting feature is used. This switch may be wired OFF or disregarded at all other times.

21. *Pri Chg (Primary Change, 85 Collator)*. One of the five basic setup switches, Item 19.

22. *Zone (87 Collator)*. When this switch is wired ON, the comparing units in the 87 recognize zone punches (0, 11, 12), as well as digit punches. It must

be wired ON whenever alphabetic or special characters are to be compared. When this switch is wired OFF, or not wired, the comparing units recognize only digit punches (1-9). It should be wired OFF when selecting zero balances or when comparing a numerical field that contains X-control punches.

23. *BCD Ctrl (Blank-Column-Detection Control)*. Assigns the blank-column-detection units to operate with the primary or secondary feed. Each unit can operate with either feed, or both units can operate with the same feed.

24. *Ctrl Inp (Control Inputs, 85 Collator)*. Test comparisons in the selector and sequence units to determine whether two numbers are equal or, if not, which one is higher (or lower). As a result of the comparison, the impulse is available from one of the sets of control exit hubs. This function is performed by internal wiring on the 87 Collator.

*Sel (Selector), Seq (Sequence)*. Accept impulses to test the selector and sequence units, respectively. Normally wired from the three exit hubs directly below.

*Three Common Hubs (Unlabeled)*. Exits that emit an impulse on each machine cycle. Normally wired to SEL and SEQ entries above.

25. *Restore*. Causes numbers to be cleared from the selector and sequence units, and new numbers to be read in.

S, P, PS, *Seq (W, 23-26)*. Accept impulses to restore the secondary, primary, primary sequence, and sequence sides of the comparing units, respectively. The units may be restored on any feed cycle. S is normally wired from the single s exit hub directly below; P, PS, and SEQ are normally wired from the three common p exit hubs directly below. The PS hub is inactive on the 87 Collator.

On the 85, S, P, PS, and SEQ are common internally on the first two run-in cycles. Therefore, if any one of them is wired on the control panel, all four sides of the comparing units will be restored on the run-in. At all other times the hubs are separate, and each side is restored according to its control panel wiring.

On the 87, the comparing units are automatically restored on the run-out, rather than on the run-in; on the run-in, they are independent and are restored separately as wired on the control panel.

**S (X, 23).** Exit that emits an impulse on each secondary card feed cycle. Normally wired to the **s** entry above.

**P (X, 24-26).** Exits that emit an impulse on each primary card feed cycle. Normally wired to the **p**, **ps**, and **seq** entries above.

**26. Split Selector and Sequence Unit Feature (85 Collator).** Special device that splits each comparing unit so that two or more fields can be compared independently in a unit, to control machine functions. With a control switch wired **ON**, the corresponding comparing unit is split into six groups; with a switch

wired **OFF**, or not wired, all positions of the corresponding comparing unit operate together in the normal manner.

*LS (Low Secondary), EQ (Equal), LP (Low Primary), HS (High Sequence), ES (Equal Sequence), LS (Low Sequence).* Control exits for the split groups of comparing positions. The control exit impulse for group 16 is also available from the standard control exit hubs (**A-F**, 23-26).

*In.* Accepts control input impulses to test each split group. Split group 1-4 can also be tested by wiring the standard control input entry hubs (**U**, 24-25).

## 85 Collator Timing Chart

THE PURPOSE of a timing chart (Figure 98) is to show in degrees the approximate time in each cycle that exit hubs emit impulses and entry hubs receive them.

A cycle is a period of time required to complete a given series of events, at the end of which the series is repeated. There are 360° in a cycle, or 360° from a given point in one cycle to the same point in the next cycle. On the 85 Collator the cycle starts at 228°, the time at which the clutch latches. Each cycle is divided into 20 equal parts called "points," each point consisting of 18°.

Digit time (0°-186°) is that time during which card digits 9-0 and X are read by the reading brushes. Control time (185°-223°) is that time during which impulses are emitted and received to control operations, such as card feeding and selection, for the following cycle. During the first part of a cycle, approximately 228°-351°, the comparing units are restored so that they will be clear to read in new numbers from a card.

The references in the *Location* column show the position of the hubs on the control panel, and the codes in the *Notes* column refer to the following pertinent facts:

### Notes

1. Active only when cards are in respective feeds.
2. Normally an entry; can be used as an exit for a low primary condition or an equal with an equal sequence condition.
3. Digits 9-0 are recognized when checking a column for blanks, but a column containing only an X or 12 will be considered blank.
4. Emits impulse wired to SEL (U, 24).
5. Emits impulse wired to SEQ (U, 25).
6. When PU is impulsed, the selector transfers at 320° of the next machine cycle. It remains transferred until 236° of the machine cycle following that in which DO is impulsed.
7. Emits on all machine cycles.
8. Normally an entry to cause respective feed to operate; becomes an exit when respective feed is impulsed through the basic setup switches.
9. Normally an entry; becomes an exit when the basic setup EJ switch or primary feed is impulsed.
10. Must be impulsed at the beginning of control time (185°). Must not be impulsed by PLUG TO C.
11. All are restored automatically on the first two run-in cycles if any one is wired.
12. Remain transferred for the duration of the pickup impulse only.
13. Transfer immediately and remain transferred until 238° of the next cycle taken by the assigned feed. HOLD must be wired to cause a selector to function with either the primary or secondary feed. A control-input timed impulse should not be selected.
14. Zone 12 is read as a 6; zone 11 as a 7; zone 0 as an 8.
15. C emits on the cycle in which the first card is read at primary read, and on every machine cycle thereafter.
16. Emit when the opposite feed is empty, with the exception that a primary *feed* (not an eject alone) must occur before the SR hub will emit. They also emit on the run-in.
17. With DE jackplugged, each digit hub becomes an emitter; the C hub emits the digit corresponding to the value in the units counter.
18. A path exists between the C hub and the digit hub corresponding to the value in the counter. Either can be used as an exit or entry.
19. Accepts on a secondary feed cycle only.

# 85 COLLATOR TIMING CHART

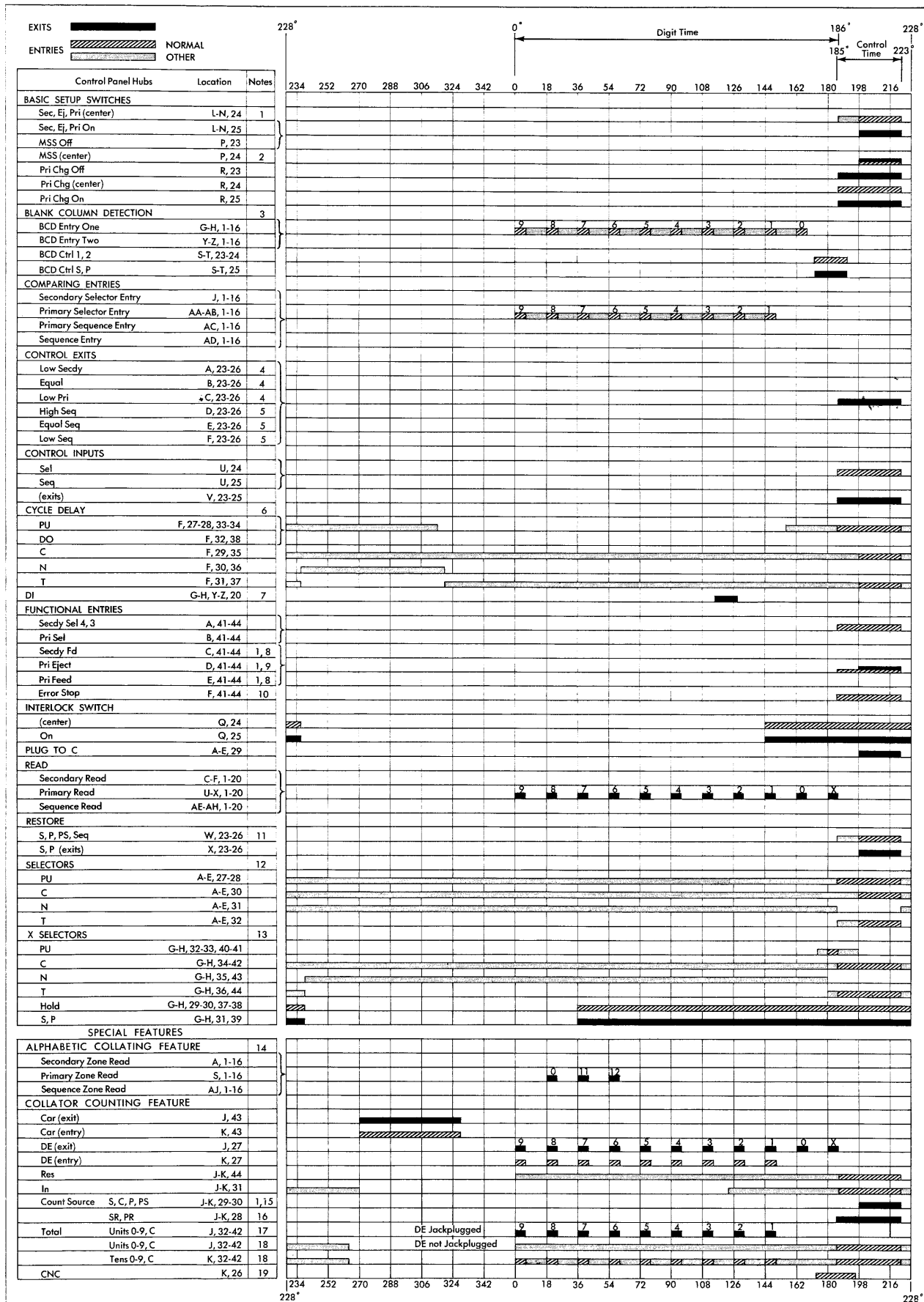

FIGURE 98. TIMING CHART — IBM 85



## 87 Collator Timing Chart

THE PURPOSE of a timing chart (Figure 99) is to show in degrees the approximate time in each cycle that exit hubs emit impulses and entry hubs receive them.

A cycle is a period of time required to complete a given series of events, at the end of which the series is repeated. There are  $360^\circ$  in a cycle, or  $360^\circ$  from a given point in one cycle to the same point in the next cycle. On the 87 Collator the cycle starts at  $262^\circ$ , the time at which the clutch latches. Each cycle is divided into 20 equal parts called "points," each point consisting of  $18^\circ$ .

Digit time ( $0^\circ$ - $204^\circ$ ) is that time during which card digits 9-0, 11, and 12 are read by the reading brushes. Control time ( $230^\circ$ - $259^\circ$ ) is that time during which impulses are emitted and received to control operations, such as card feeding and selection, for the following cycle.

The references in the *Location* column show the position of the hubs on the control panel, and the codes in the *Notes* column refer to the following pertinent facts.

### Notes

1. Active only when cards are in respective feeds.
2. Normally an entry; can be used as an exit for a low primary condition or an equal with an equal sequence condition.
3. Digits 9-0, 11, and 12 are recognized when checking a column for blanks.
4. When PU is impulsed, the selector transfers at  $310^\circ$  of the next machine cycle. It remains transferred until  $260^\circ$  of the cycle in which DO is impulsed.
5. Emits on all machine cycles.
6. Normally an entry to cause respective feed to operate; becomes an exit when respective feed is impulsed through the basic setup switches.
7. Normally an entry; becomes an exit when the basic setup EJ switch or primary feed is impulsed.
8. Must not be impulsed by PLUG TO C.
9. Restored automatically on run-out; at other times restored as wired on the control panel.
10. If selected, must be controlled through an X-selector.
11. Remain transferred for the duration of pickup impulse only.
12. Transfer immediately and remain transferred until  $358^\circ$  of the next cycle taken by the assigned feed. HOLD must be wired to cause a selector to function with either the primary or secondary feed.
13. C emits on the cycle in which the first card is read at primary read, and on every machine cycle thereafter.
14. Emit when the opposite feed is empty, with the exception that a primary *feed* (not on eject alone) must occur before the SR hub will emit. They also emit on the run-in.
15. With DE jackplugged, each digit hub becomes an emitter; the C hub emits the digit corresponding to the value in the units counter.
16. A path exists between the C hub and the digit hub corresponding to the value in the counter. Either can be used as an exit or entry.
17. Emits on each card feed cycle.
18. Accepts on a secondary feed cycle only.

# 87 COLLATOR TIMING CHART

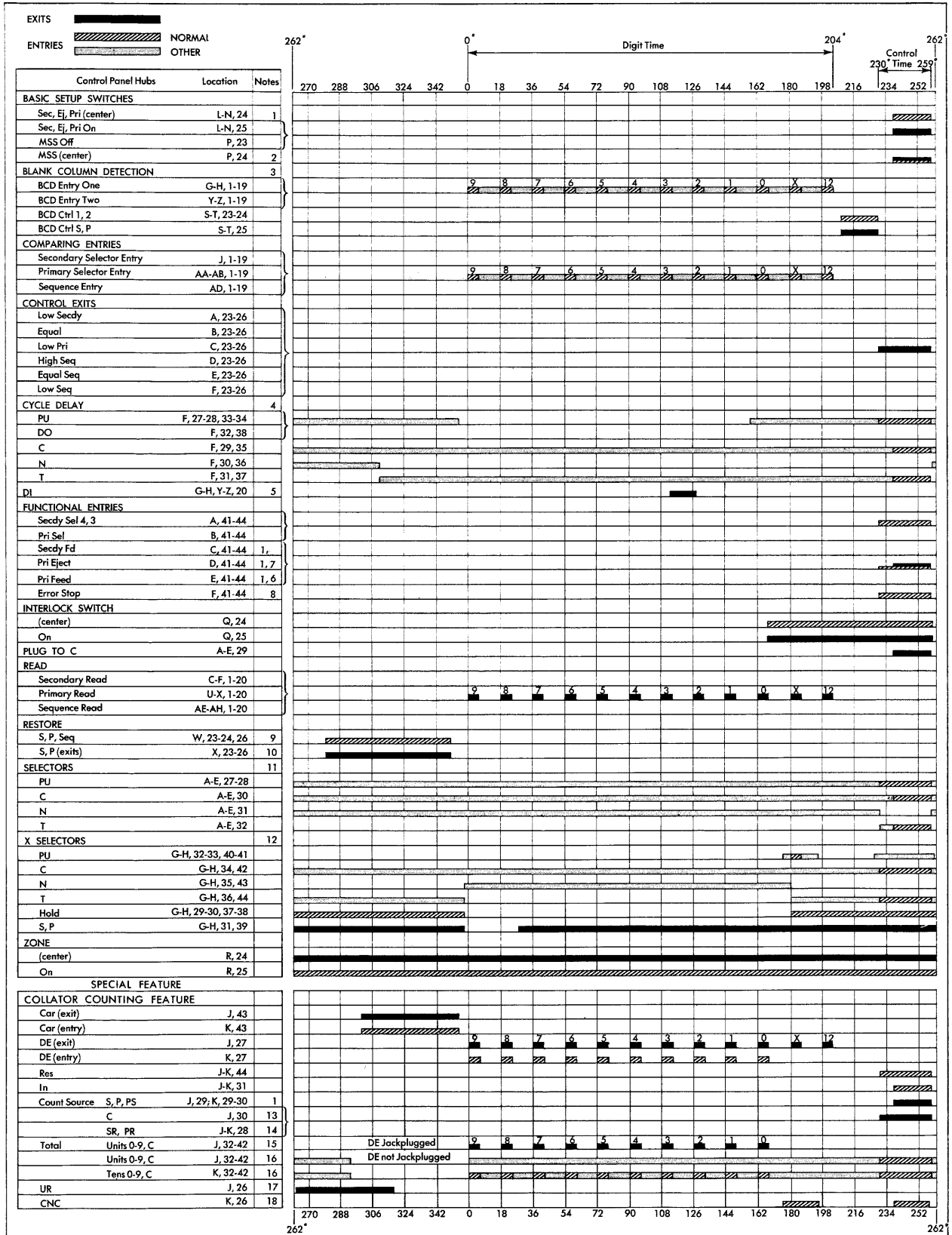

FIGURE 99. TIMING CHART — IBM 87

# Index

Alphabetic Collating Feature .....	84, 104	High Sequence .....	22, 99, 106, 109
Alternate Cards, Selecting .....	52	Hoppers .....	6
Analysis Chart .....	9		
Basic Setup, Plan 1 .....	36	In (Counting Feature) .....	86, 107
Basic Setup, Plan 2 .....	39	In (Split Selector and Sequence Unit Feature) .....	99, 109
Basic Setup, Plan 3 .....	46	Indicator Cards, Inserting .....	24, 26
Basic Setup Summary .....	47	Inlk (Switch) .....	40, 108
Basic Setup Switches .....	12, 36, 40, 46, 47, 49, 108	Inserting a Predetermined Number of Cards ahead of Each Master Card .....	86
BCD Ctrl .....	17, 108	Inserting a Predetermined Number of Cards behind Each Master Card .....	88
BCD 1, BCD 2 (Lights) .....	6	Inserting a Set of Cards ahead of a Predetermined Number of Cards within a Control Group .....	95
Blank Column Detection Entry One, Two .....	17, 105	Inserting a Single Card ahead of a Predetermined Number of Cards within a Control Group .....	93
Blank-Column Detection .....	6, 13, 17	Inserting a Variable Number of Cards ahead of Each Master Card .....	89
		Inserting a Variable Number of Cards behind Each Master Card .....	90
Card Selection .....	5	Inserting Cards behind Specific Groups .....	64
Card-for-Card Matching .....	74	Inserting Indicator Cards .....	24, 26
Cards behind Specific Groups, Inserting .....	64	Inserting up to 199 Cards behind Each Master Card .....	92
Cards in Ascending Order, Checking Sequence .....	19	Interlock (Switch) .....	40, 108
Cards in Descending Order, Checking Sequence .....	24	Introduction .....	5
Carry .....	87, 108		
Checking Consecutive Numbers .....	97	Keys and Lights .....	6
Checking Master-and-Detail Groups .....	62		
Checking Sequence .....	5, 15	Last Card of a Group, Selecting .....	24, 26
Checking Sequence — Both Feeds .....	66	Lights .....	6
Checking Sequence, Cards in Ascending Order .....	19	Low Cards, Selecting .....	65
Checking Sequence, Cards in Descending Order .....	24	Low Primary .....	31, 99, 106, 109
Checking Sequence, Inserting Indicator Cards .....	24	Low Secondary .....	31, 99, 106, 109
Checking Sequence — More than 16 Columns .....	71	Low Sequence .....	22, 99, 106, 109
Checking Sequence, Selecting All Low Cards .....	65		
Checking that an X-Card Is Last in a Group .....	63	Machine Features .....	6
CNC (Consecutive Number Checking) .....	107	Main Line Switch .....	6
Collator Counting Feature .....	86, 107	Master-and-Detail Groups, Checking .....	62
Comparing Entries .....	9, 11, 20, 30, 105, 106	Matching .....	6, 50
Comparing Two Fields in the Same Card — Primary Feed .....	53	Matching by a Range of Numbers .....	81
Comparing Two Fields in the Same Card — Secondary Feed .....	54	Matching Card-for-Card .....	74
Consecutive-Number Checking .....	97	Merging .....	6, 32
Control Change .....	24	Merging a Predetermined Number of Primaries and Secondaries .....	96
Control Exits .....	11, 22, 31, 99, 106, 109	Merging by Major and Minor Control; Selecting Unmatched Majors .....	102
Control Groups, Recognizing a Change Between .....	24	Merging, Feeding from Both Feeds Simultaneously .....	37
Control Inputs .....	12, 21, 31, 99, 108, 109	Merging, Feeding from One Feed at a Time .....	34
Control Number, Selecting Cards by .....	55, 56, 58, 59, 60, 100	Merging, Mixed .....	73
Control Panel .....	12, 13	Merging — More than 16 Columns .....	72
Control Panel Summary .....	104	Merging or Matching by a Range of Numbers .....	81
Count Source .....	86, 107	Merging Primaries behind Secondaries .....	77
Counting Feature .....	86, 107	Merging, Selecting Single Unmatched Primaries .....	79
Coupling Two Split Groups .....	100	Merging Small Groups of Cards .....	76
Ctrl Inp .....	12, 21, 30, 108	Merging Two Groups of Unpunched Cards .....	13
Cycle Delay .....	27, 107	Merging with Selection .....	6, 40
		Merging with Selection, Multiple Secondaries .....	43
DE (Digit Emitter) .....	89, 107	Merging with Selection, Single Secondaries .....	40
Descending Order, Sequence-Checking Cards in .....	24	Mixed Merging .....	73
DI (Direct Impulse) .....	17, 105	MSS (Multiple Secondaries and Selection Switch) .....	36, 46, 49
		Multiple-Card Groups, Selecting .....	29
Ej (Switch) .....	46, 49		
Equal .....	31, 99, 106, 109	199 Cards behind Each Master Card, Inserting up to .....	92
Equal Sequence .....	22, 99, 106, 109	Operating Keys and Lights .....	6
Error Light .....	6	Operating Principles .....	8
Error Stop .....	11, 22, 107	Operating Speed .....	7
		Operations .....	5
Features .....	6		
First Card of a Group, Selecting .....	27, 68		
Functional Entries .....	11, 14, 15, 16, 22, 44, 106		

P Restore	13, 30, 108
Plug to C	14, 106
Pockets	7
Predetermined Number of Cards ahead of Each Master Card, Inserting a	86
Predetermined Number of Cards behind Each Master Card, Inserting a	88
Predetermined Number of Primaries and Secondaries, Merging a	96
Pri (Switch)	36, 46, 49
Pri Chg (Switch)	40, 47, 49
Primaries behind Secondaries, Merging	77
Primary Change (Switch)	40, 47, 49
Primary Eject	44, 106
Primary Eject (Switch)	46, 49
Primary Feed	8, 14, 107
Primary Feed (Switch)	36, 46, 49
Primary Read	11, 14, 105
Primary Select	15, 106
Primary Selector Entry	9, 11, 30, 106
Primary Sequence Entry	9, 11, 20, 106
Primary Zone Read	84, 104
Principles of Control Panel Wiring	11
PS Restore	13, 20, 108
Range of Numbers, Merging or Matching by	81
Read	11, 14, 16, 20, 84, 104, 105, 106
Ready Light	6
Recognizing a Change between Control Groups	24
Reset Key	6
Restore	13, 20, 30, 108
Restore (Counting Feature)	87, 108
Run-In Feeding	10
Run-Out Key	6
S Restore	13, 30, 108
Schematic Diagram of Card Feeds	8
Schematic of Basic Setup Switch Operation	48
Sec (Switch)	36, 40, 49
Sedy Fd	14, 106
Sedy Sel 3-4	16, 106
Secondary Feed	9, 14, 106
Secondary Feed (Switch)	36, 40, 49
Secondary Read	11, 16, 105
Secondary Select 3-4	16, 106
Secondary Selector Entry	9, 11, 30, 105
Secondary Zone Read	84, 104
Sel Control Input	12, 31, 108
Selecting All Low Cards	65
Selecting Alternate Cards	52
Selecting Cards between Two Control Numbers	60
Selecting Cards by a Control Number	55
Selecting Cards by a Control Number, Interspersed Finder Cards—Secondary Feed	58
Selecting Cards by a Control Number, Interspersed X-Finder Cards—Primary Feed	56
Selecting Cards by Any One of Four Control Numbers	100
Selecting Cards by Either of Two Control Numbers	59
Selecting Multiple-Card Groups	29
Selecting Single Unmatched Primaries	79

Selecting Single-Card Groups	29
Selecting the First Card of a Group	27
Selecting the First Card of a Group—Both Feeds	68
Selecting the Last Card of a Group	24
Selecting the Last Card of a Group if an X-Card	26
Selecting Unmatched Majors	102
Selecting X-Cards—Both Feeds	16
Selecting X-Cards—Primary Feed	14
Selecting Zero-Balance Cards	30
Selecting Zero-Balance Cards—More than 16 Columns	70
Selector Unit	9, 11, 30, 31, 99
Selectors	11, 14, 26, 27, 106, 107
Seq Control Input	12, 21, 108
Seq Restore	13, 20, 108
Sequence	8
Sequence Entry	9, 11, 20, 106
Sequence Read	11, 20, 106
Sequence Unit	9, 11, 20, 22, 99
Sequence Zone Read	84, 104
Sequence-Checking	5, 19
Sequence-Checking—Both Feeds	66
Sequence-Checking, Cards in Ascending Order	19
Sequence-Checking, Cards in Descending Order	24
Sequence-Checking, Inserting Indicator Cards	24
Sequence-Checking—More than 16 Columns	71
Sequence-Checking, Selecting All Low Cards	65
Set of Cards ahead of a Predetermined Number of Cards within a Control Group, Inserting a	95
Single Card ahead of a Predetermined Number of Cards within a Control Group, Inserting a	93
Single Unmatched Primaries, Selecting	79
Single-Card Groups, Selecting	29
Small Groups of Cards, Merging	76
Speed	7
Split Selector and Sequence Unit Feature	99, 109
Start Key	6
Stop Key	6
Summary, Control Panel	104
Switches, Basic Setup	12, 36, 40, 46, 47, 49, 108
Timing Chart	110, 112
Total: 0-9, C	87, 107
Two Fields in the Same Card, Comparing	53, 54
Typical Operations	52
Unmatched Majors, Selecting	102
Unpunched Cards, Merging	13
UR (Units Restore)	89, 107
Variable Number of Cards ahead of Each Master Card, Inserting a	89
Variable Number of Cards behind Each Master Card, Inserting a	90
X-Cards	14, 16, 26, 56, 62, 63, 64
X-Selectors	11, 14, 107
Zero-Balance Cards, Selecting	30, 70
Zone (Switch)	12, 22, 108
Zone Reading	84, 104

**IBM**

**International Business Machines Corporation  
Data Processing Division  
112 East Post Road, White Plains, New York**