



# **ADM 12**

## **Video Display Terminal**

### **Users Reference Manual**

**LEAR SIEGLER, INC.**  
**DATA PRODUCTS DIVISION**  
901 EAST BALL ROAD, ANAHEIM, CALIFORNIA 92805

# **ADM 12 Video Display Terminal**



®  
LEAR SIEGLER, INC.

## **USERS REFERENCE MANUAL**

## TABLE OF CONTENTS

SECTION	PAGE
<b>I</b>	<b>GENERAL DESCRIPTION</b> ..... 1-1
1.1	INTRODUCTION ..... 1-1
1.2	OPERATIONAL DESCRIPTION ..... 1-1
1.2.1	Keyboard ..... 1-2
1.2.2	Primary (Modem) and Auxiliary Ports ..... 1-2
1.2.3	Set-Up Mode ..... 1-2
1.2.4	Programmable Function and Edit Keys ..... 1-2
1.2.5	Power Requirements ..... 1-2
1.3	SPECIFICATIONS ..... 1-2
1.4	ADM 12 WORD STRUCTURE ..... 1-2
1.5	ANSWERBACK MEMORY ..... 1-3
1.6	OPTIONS ..... 1-3
1.6.1	20mA Current Loop ..... 1-3
1.6.2	RS-422 ..... 1-3
1.6.3	International Keycap/Character Generator Sets ..... 1-3
1.6.4	Amber Phosphor Display ..... 1-3
1.6.5	14-Inch Display ..... 1-3
<b>II</b>	<b>INSTALLATION</b> ..... 2-1
2.1	INITIAL PREPARATION ..... 2-1
2.1.1	Line Voltage Selection ..... 2-1
2.1.2	Set-Up Mode Preparation ..... 2-1
2.1.3	Keyboard Plug-In ..... 2-1
2.1.4	Monitor Keyboard Adjustment ..... 2-2
2.2	INTERFACE INFORMATION ..... 2-2
2.2.1	RS-232C Interface ..... 2-2
2.2.2	20mA Current Loop Interface ..... 2-2
2.2.3	Auxiliary Port Interface ..... 2-4

## TABLE OF CONTENTS (cont'd)

SECTION	PAGE
2.3	INSTALLING THE ADM 12 ..... 2-4
2.4	POWER TURN-ON ..... 2-4
2.5	SCREEN SAVER ..... 2-5
2.6	POWER TURN-OFF ..... 2-5
2.7	CARE OF THE ADM 12 ..... 2-5
2.7.1	Cleaning ..... 2-5
2.7.2	Inspection ..... 2-5
<b>III</b>	<b>OPERATION</b> ..... 3-1
3.1	KEYSTROKE CONVENTIONS ..... 3-1
3.2	SET-UP MODE ..... 3-1
3.2.1	Selecting Functions ..... 3-1
3.2.2	Saving Set-Up Functions ..... 3-2
3.2.3	Down-Line Load Set-Up ..... 3-2
3.3	OPERATIONAL MODES ..... 3-6
3.3.1	On-Line Or Local Mode ..... 3-6
3.3.2	Conversation or Block Mode ..... 3-6
3.3.3	Duplex Operation ..... 3-6
3.3.4	Program Mode ..... 3-6
3.4	KEYBOARD OPERATION ..... 3-6
3.4.1	Keystroke Entry ..... 3-10
3.4.2	Alphanumeric and Punctuation Keys ..... 3-10
3.4.3	Numeric Keypad ..... 3-10
3.4.4	Modifier Keys ..... 3-10
3.4.5	Cursor Control Keys ..... 3-10
3.4.6	Edit Keys ..... 3-11
3.4.7	Transmission Keys ..... 3-12
3.4.8	Programmable Function Keys and Edit Keys ..... 3-13
3.4.9	Special Operation Keys ..... 3-15
3.5	DISPLAY CHARACTER FORMAT ..... 3-16
3.5.1	International Fonts ..... 3-16
3.6	COMMAND CODE SET ..... 3-16
3.6.1	Control Codes ..... 3-16
3.6.2	Escape Sequences ..... 3-16

## TABLE OF CONTENTS (cont'd)

SECTION	PAGE
3.7 DISPLAY FORMAT .....	3-27
3.7.1 Vertical Scrolling .....	3-27
3.7.2 Horizontal Scrolling .....	3-27
3.7.3 Selectable Right Margin .....	3-27
3.7.4 Screen Video Attributes .....	3-33
3.7.5 Personality Character Selections .....	3-33
3.8 DATA TRANSMISSION .....	3-33
3.8.1 Conversation Mode .....	3-34
3.8.2 Block Mode .....	3-34
3.8.3 Handshaking Protocol .....	3-34
3.9 CURSOR CONTROL .....	3-34
3.9.1 Relative Cursor Positioning .....	3-34
3.9.2 Absolute Cursor Positioning/Reading .....	3-34
3.9.3 Tab Control .....	3-35
3.10 GRAPHICS .....	3-35
3.11 SET-UP MODE OPERATIONS .....	3-36
3.12 PRINT OPERATIONS .....	3-36
3.13 RESET OPERATIONS .....	3-36
3.13.1 Power-On Reset .....	3-36
3.13.2 Reset Terminal Command .....	3-36
3.13.3 Self-Test .....	3-36
3.13.4 Status Information .....	3-37

## TABLE OF CONTENTS (cont'd)

### LIST OF FIGURES

FIGURE		PAGE
1-1	ADM 12 Video Display Terminal .....	1-0
2-1	ADM 12 Dimensions .....	2-2
2-2	ADM 12 Controls and Connectors .....	2-3
2-3	Typical ADM 12 Applications .....	2-4
2-4	Modem Connector and Auxillary Port .....	2-6
2-5	Optional Current Loop and RS-422 Interface Logic .....	2-7
3-1	Sample Set-Up Mode Functions .....	3-3
3-2	ADM 12 Set-Up Mode Display And Associated Keys .....	3-4
3-3	Programmable Edit Keys .....	3-5
3-4	ADM 12 Standard Keyboard Operation Characteristics .....	3-7
3-5	Factory Set Default Condition of Programmable Keys .....	3-14
3-6	ADM 12 Display Memory Configurations.....	3-28
3-7	Set-Up Mode Flow Chart .....	3-38

### LIST OF TABLES

TABLE		PAGE
1-1	ADM 12 Specifications .....	1-4
3-1	Keystroke Conventions .....	3-1
3-2	Control Codes Utilized by the ADM 12 .....	3-17
3-3	ADM 12 Escape Sequences .....	3-19
3-4	Embedded Attributes Operation Codes .....	3-39

### APPENDIX

TABLE		PAGE
A-1	ADM 12 Set-Up Mode Functions .....	A-1
A-2	Binary Set-Up Functions .....	A-3
A-3	ADM 12 Escape Sequences .....	A-7
A-4	Reference Chart of Absolute Cursor Positions .....	A-8
A-5	ASCII Control Code Chart .....	A-10
A-6	Displayable USASCII Character Set and Control Codes .....	A-11
A-7	128 Character ASCII Format with Hex Codes .....	A-12
A-8	Business Graphics Character Set .....	A-13
A-9	International Keyboard Layouts .....	A-14
A-10	Model Configuration Identification .....	A-16

## PREFACE

*The ADM 12 Video Display Terminal is a fully featured general purpose ergonomic, conversational and block mode terminal, ideally suited for a wide range of applications.*

*This Users Reference Manual explains how to use the ADM 12, and provides information on its installation and care. To help you effectively use the great variety of ADM 12 operating features, this manual emphasizes the various features and control codes.*

*Lear Siegler Inc./Data Products Division constantly strives to maintain the accuracy and useability of our technical publications. We welcome your comments and suggestions, and have provided a pre-paid, pre-addressed post card at the back of this manual to note any changes you feel will improve this publication.*

### WARNING

*This equipment generates, uses, and can radiate radio frequency energy and if not installed and used in accordance with the instruction manual, may cause interference to radio communications. It has been tested and found to comply with the limits for Class A computing devices pursuant to Subpart J of Part 15 of FCC Rules, which are designed to provide reasonable protection against such interference when operated in a commercial environment. Operation of this equipment in a residential area is likely to cause interference in which case the user at his own expense will be required to take whatever measures may be required to correct the interference. Only shielded cables with the shield terminated to the metal hood of the connector can be used.*



*Figure 1-1. ADM 12 Video Display Terminal*



## SECTION I GENERAL DESCRIPTION

### 1.1 INTRODUCTION

The Lear Siegler ADM 12 Video Display Terminal, shown in Figure 1-1, is a smart, editing terminal designed for user convenience. It can be used in either the Conversational or Block mode of operation. The non-volatile memory retains: the desired set-up configuration, the information in the 16 programmable Function Keys (shiftable to 32), and the 6 Programmable Edit Keys (shiftable to 12). All the terminal set-up functions are soft-setable from the keyboard. Function keys and Edit keys can be programmed by the host or from the keyboard. For added user convenience, the ADM 12 offers three display memory configurations: 24 lines by 80 characters, 48 lines by 80 characters, and 24 lines by 158 characters. The ADM 12 is also ergonomically designed for maximum user comfort. Its features include: a tilt and swivel monitor with positive detents; a low-profile, user-friendly, DIN standard keyboard; a six foot long coiled keyboard cord. Designed for speed and versatility, the ADM 12 is ideal for most data terminal applications.

### 1.2 OPERATIONAL DESCRIPTION

The ADM 12 is used to enter, display, print, and send asynchronous data. It is also used to receive, print, and display data from an auxiliary device such as a host computer. Its most frequently used application is one in which an operator interacts in a two-way communication with a host computer. However, in some applications the data transfer may be unidirectional either from the ADM 12 to the host or from the host to the ADM 12.

The ADM 12 is a complete stand alone data terminal consisting of a 12-inch (30.5 cm) or optional 14-inch (35.5 cm) CRT Monitor Unit and a detached, low-profile keyboard unit. Each unit is contained in a sturdy enclosure which also houses the required electronic circuits. Some of the features provided in the ADM 12 are:

- Full 128 ASCII character set
- Three types of display memory configurations:
  - 24 lines by 80 characters used for general purpose terminal applications
  - 48 lines by 80 characters for applications such as word processing
  - 24 lines by 158 characters for applications such as financial reporting and spreadsheet applications.
- DIN-standard keyboard, with:
  - Numeric keypad with 14 keys
  - Five separate cursor control keys arranged in a cross pattern
  - Sixteen programmable function keys (shiftable to thirty-two)
  - Six programmable edit keys (shiftable to twelve)
  - Cap lock key
  - Status key
  - Hold Screen key
  - 3-key rollover and 32 keystroke buffer
  - User friendly layout and rib dividers to reduce operator error
  - Tilt mechanism
- On-Line or local modes
- Conversational or block modes
- Program mode

## Display

- Split screen with scrolling region
- Vertical and horizontal scrolling
- Selectable right margin
- Full screen reverse video
- Five non-embedded attributes:
  - Blank
  - Blink
  - Reverse
  - Underline
  - Reduced intensity
- In embedded attribute mode select four of five embedded attributes:
  - Blank or underline
  - Blink
  - Reverse video
  - Plus non-embedded reduced intensity
- 7 x 10 character matrix
- Protected fields
- Business graphics
- Absolute cursor positioning
- Variable 7 or 8-bit data word structure
- Seven communication rates in full-duplex and half-duplex send/receive modes
- RS-232C modem interface and RS-232C auxiliary interface port
- Four print modes:
  - Page Print
  - Line Print
  - Display and Print from host
  - Transparent Print from host
- Non-volatile memory for:
  - Set-Up modes
  - Programmable Function keys
  - Programmable Edit keys
  - Answerback Memory

### 1.2.1 Keyboard

The keyboard, which meets DIN standards for operator comfort, is attached to the rear of the monitor with a 6-foot coiled cord to provide complete keyboard mobility.

### 1.2.2 Primary (Modem) and Auxiliary Ports

The ADM 12 comes standard with two ports: the RS-232C Modem Port and Auxiliary Port

which are located at the back of the terminal. The Modem (I/O) Port is the link, or interface, that handles the flow of data in both directions between the ADM 12 and the host computer.

The Auxiliary Port permits the use of an RO (Receive Only) printer when hard copy of data is needed.

### 1.2.3 Set-Up Mode

The ADM 12 features a non-volatile Set-Up Mode which allows the terminal parameters to be selected through commands from the keyboard or host. These parameters, including baud rates, word structure, cursor type, communications control, and operating modes, can then be "saved" in memory, and retained when power is shut off.

### 1.2.4 Programmable Function and Edit Keys

The ADM 12 has sixteen programmable Function keys (shiftable to thirty-two) and six programmable Edit keys (shiftable to twelve). The information user-programmed into these keys can be saved in non-volatile memory.

### 1.2.5 Power Requirements

The ADM 12 can accept 115 VAC or 230 VAC +/- 10%, 50 or 60 Hz. The voltage is factory set, and must be specified at the time of order.

## 1.3 SPECIFICATIONS

The ADM 12 specifications are listed in Table 1-1, page 1-4.

## 1.4 ADM 12 WORD STRUCTURE

The ADM 12 transmits serial asynchronous data in a 10 bit format in the sequence: one start bit, seven or eight data bits, one or no parity bit, and one stop bit. Parity selection (odd, even, or no parity) is permitted only with a seven bit data word. If an eight bit data word is selected, then bit eight can be designated to be either 1 or 0. Parity selection and the value of bit eight are defined via Set-Up Mode.

The received data shall be formatted the same as the transmit data. The word structure, baud rates, and other communications characteristics are established via Set-Up Mode selections.

## 1.5 ANSWERBACK MEMORY

The ADM 12 provides a 32 byte, user-programmable, Answerback message stored in non-volatile memory. The message is transmitted in response to an ENQ code from the host computer or the command `CTRL E` from the keyboard.

## 1.6 OPTIONS

The standard ADM 12 can be further equipped with several options.

### 1.6.1 20mA Current Loop

The ADM 12 with the optional 20mA current loop interface can operate at a maximum baud rate of 9600 from the Modem Port. This option is plug mounted to permit field installation.

### 1.6.2 RS-422

The logic board design permits RS-422 to be added as a field or factory installed option. This option is as defined in E.I.A. Specifications RS-422 (Figure 2-5, page 2-7).

### 1.6.3 International Keycap/ Character Generator Sets

Several character sets are optionally available with the ADM 12, as well as the associated keycap sets. These include UKASCII, French, German, Swedish, Finnish, Danish, Norwegian and Spanish.

### 1.6.4 Amber Phosphor Display

While the standard ADM 12 is equipped with a P31 green phosphor display, an amber display is optionally available in place of the green CRT at no additional cost when specified at the time of order.

### 1.6.5 14-Inch Display

The ADM 12 is available with an optional 14-inch (35.6 cm) CRT screen with green or amber phosphor with non-glare surface.

**Table 1-1. ADM 12 Specifications**

SPECIFICATION	DESCRIPTION
<b>DISPLAY</b>	
CRT Screen	12-inch (30.5cm) diagonal; green phosphor with non-glare surface. (Amber optional.) Optional 14-inch (35.6cm) display with green or amber phosphor with non-glare screen.
Display Area	12-inch screen: 8.25" W (21cm) x 5.75" H (14.6cm) 14-inch screen: 9.05" W (22.93cm) x 6.55" H (16.64cm) ± .05 (.13cm).
CRT Console	Tilt and Swivel mechanism with positive detents. 360° swivel capability; tilt 5° forward to 15° back of vertical. Removable base.
Horizontal Refresh Rate	17.7 kHz
Vertical Refresh Rate	50 Hz or 60 Hz, depending on line frequency, factory set at time of order.
Display Formats	24 lines of data 80 characters wide can be displayed plus 25th line for status. Three display memory configurations are available through set-up as follows: 1. Two independent displays each 24 lines by 80 characters. 2. One page, 48 lines by 80 characters. 3. One page, 24 lines by 158 characters.
Display Page Density	1920 characters (2,000 with status line)
Character Font:	
Character Field	8 x 11 dot matrix.
Character Matrix	7 x 10 dot matrix with descenders.
Cursor	8 x 11 steady or blinking block or underline; can be turned off or on.
Character Sets	128 displayable characters including control codes. Optional international character sets available.
Business Graphics	Block Graphics, Wide Point Graphics, and Line Drawing characters.
Visual Attributes:	
Non-Embedded	Five non-embedded attributes: blank, blink, reverse video, underline and reduced intensity.
Embedded	Four of five embedded attributes; blank or underline depending on set-up, blink, reverse video and reduced intensity.

**Table 1-1. ADM 12 Specifications (continued)**

SPECIFICATIONS	DESCRIPTION
Visual Attributes (cont'd)	
Protect	Write Protect on a character by character basis.
Background Attribute	Full screen normal or reverse video.
Formatting Aids:	
Program Mode	For displaying received control characters.
Page Edit Mode	Insert/delete characters in a line causes automatic wrap around of lines following.
Write Protect Mode	All characters on screen are Write Protected and displayed in the user selected "protected attribute".
Protect Mode	Protected fields are protected from overwrite.
Insert Mode	Characters are inserted at the cursor position as typed. Existing data is moved to the right.
Scrolling Region Mode	Split screen scrolling limits may be set.
Cursor Movement	Relative and absolute addressing, and read cursor capabilities.
<b>KEYBOARD FUNCTIONS</b>	
Keyboard	Detached, low-profile, DIN standard with six-foot coiled cord. Sculptured keys, selectric-type layout. Calculator format numeric keypad. Two tone keycaps, by function; rib dividers to separate three major groupings of keys. 11° keyboard tilt mechanism. Keys are auto-repeating (15 chars. per second). 32 character keystroke buffer.
Keyboard Layout	QWERTY - Typewriter Pairing. Optional QWERTY - teletype pairing, QWERTZ and AZERTY.
Numeric Keypad	14 keys, 0 through 9, Enter, comma, period, and minus. 0 and Enter keys are double-size.
Cursor Control	Up, down, left, right, home arranged in a "cross" pattern. Return, Line Feed, New Line, Backspace, Tab and Back Tab.
Function Keys	Sixteen programmable function keys, shiftable to thirty-two functions each transmitting up to a 4-character sequence with either local or host destination code. Non-volatile memory storage.

**Table 1-1. ADM 12 Specifications (continued)**

SPECIFICATIONS	DESCRIPTION
<b>KEYBOARD FUNCTIONS (cont'd)</b>	
Edit Keys	Six programmable edit keys, shiftable to twelve. Non-volatile memory storage.
Function Command Keys	Escape, Set-Up/Status, Clear/Delete, Aux Port, Hold Screen, Break, Cap Lock, Shift, Control and more.
Non-Volatile Set-Up Mode	No dip switches - Terminal functions are selectable from the keyboard, or remotely from the host. Features selectable in Set-Up Mode include: Key-Click, Communications Characteristics, Replacement Characters, Communications Configuration, and more.
Operator Convenience	Selectable key-click for audible feedback and 3-key roll-over to eliminate "missed" characters. Full screen reverse video selectable cursor.
<b>EDITING</b>	
Edit Operations	Editing can be from the keyboard or host. Editing function includes clear screen, erase to end of line/page, Insert character/line, page edit, and more.
<b>TRANSMISSION MODES</b>	
Conversation Mode	Interactive (character-by-character transmission, Full or Half Duplex operation).
Block Mode	Data entered on terminal is processed locally and transmission to the host is accomplished by various sends available, such as: Send Line, Send Page, Send Message.
Control Characters	Control characters may be transmitted to computer and/or entered on screen.
Interfaces	RS-232C or optional 20mA current loop or optional RS-422.
<b>COMMUNICATIONS</b>	
Primary Port	RS-232C, serial asynchronous ASCII communications.
Auxiliary Port	RS-232C with page print, line print, display and print and transparent print.
Data Rates	300, 600, 1200, 2400, 4800, 9600, and 19,200 baud. (9600 max. for 20mA current loop)

**Table 1-1. ADM 12 Specifications (continued)**

SPECIFICATION	DESCRIPTION
<p><b>COMMUNICATIONS (cont'd)</b></p> <p>Word Structure</p> <p>Parity</p> <p>Stop Bits</p> <p>Format</p> <p>Busy Indication</p> <p>Input Buffer</p> <p>Handshaking</p>	<p>1 start bit, 7 data bits, 1 parity bit (odd, even, mark space or none - selectable), and 1 stop bit.</p> <p>Even, odd, or no parity.</p> <p>1 stop bit.</p> <p>ASCII serial asynchronous communications.</p> <p>Primary (Modem) Port: Sends X-OFF (DC3), X-ON (DC1) or DTR to host on busy/ready condition of main port or auxiliary port.</p> <p>Auxiliary Port: Senses busy level on Pin 20 (DTR) of the Auxiliary interface.</p> <p>1024 bytes.</p> <p>X-ON/X-OFF (user-selectable characters) or, DTR (Pin 20) may be used to indicate the terminals Busy/Ready status or no handshaking.</p>
<p><b>GENERAL</b></p> <p>Operating Environment:</p> <p>    Temperature</p> <p>    Humidity</p> <p>Power Requirements (Factory set)</p>	<p>5° C to 40° C (41° F to 104° F).</p> <p>10% to 85% without condensation.</p> <p>115 VAC ±10%, 50/60 Hz  230 VAC ±10%, 50/60 Hz  50 watts</p>





## SECTION II INSTALLATION

### 2.1 INITIAL PREPARATION

The space-saving design of the ADM 12 has proven to be beneficial for almost every terminal site. Its small size is ideally suited to those work environments where physical space is limited.

The physical dimensions of the ADM 12 are shown in **Figure 2-1, page 2- 2**. The basic requirements for installation are as follows:

- Table or desk mounting
- Standard three-pronged 115-volt (230-volt) A.C. power outlet.
- Cable connection to the computer, data set or modem; serial printer, or other auxiliary device. If connection to a remote computer is desired, a modem or data set is usually required.

#### CAUTION

*Allow the ADM 12 to adjust to severe changes in the environment before applying power. This will reduce the possibility of internal condensation, which could impair its operation.*

#### 2.1.1 Line Voltage Selection

The ADM 12 is shipped ready to operate at either 115-volt or 230-volt AC as specified on the purchase order. Contact your authorized Lear Siegler maintenance personnel if the operating voltage needs to be changed.

#### 2.1.2 Set-Up Mode Preparation

The operating configurations of the ADM 12 are controlled by firmware "switches" and have been pre-set at factory to the default conditions as indicated by "\*" in **Table A-1, page A-1** of the Appendix. The operating configurations are displayed on the status line when the Set-Up Mode is entered.

There are two levels of Set-Up Mode: operator convenience and supervisor set-up.

Operator Convenience set-up functions are characteristics that relate to operator comfort or preference. The Supervisor Set-Up functions include all of the feature selections available to the operator, as well as those functions useful to the person programming the system (see **paragraph 3.2, page 3-1**).

Normally, the Supervisor set-up functions are selected when the terminal is installed, or a new peripheral device is attached. **Table A-1, page A- 1**, describes the Set-Up functions which can be selected for both modes.

The Set-Up functions can also be downloaded from a host computer, as described in **Table A-2, page A-3** of the Appendix.

Parameters of the host computer must be determined before the terminal can be used. If changes need to be made to the Set-Up mode functions, refer to **Section 3.1, page 3-1**.

#### 2.1.3 Keyboard Plug-In

Before applying power to the terminal, plug the keyboard coiled cord into the connector on the back of the monitor. Refer to **Figure 2-2, page 2-3** for connector location.

### 2.1.4 Monitor, Keyboard Adjustment

The ADM 12 monitor can be tilted and swiveled to position it in the optimum viewing angle for the operator. Adjustments can be made by pushing down from the top of the monitor. "Clicks" heard, as the monitor is adjusted are from the positive detent mechanism, which holds the monitor securely in the desired position.

The keyboard may be tilted for maximum operator comfort. Simply turn down the two feet located under the rear of the keyboard housing, if desired.

## 2.2 INTERFACE INFORMATION

The ADM 12 may be cabled directly to a local computer, serial printer (or other auxiliary device), or it may be connected via telephone data lines to a remotely located computer. Remote computer connections require the use of a modem or data set. Figure 2-3, page 2-4 shows a typical ADM 12 application.

Figure 2-2, page 2-3 shows the rear panel locations of the interface connectors. Figures 2-4 and 2-5, pages 2-6 and 2-7 show the logic associated with these interfaces.

### 2.2.1 RS-232C Interface

The Primary (Modem) Port RS-232C Interface provides the signals and levels associated with RS-232C, allowing direct connection to a computer or modem. The maximum permissible cable length is 50 feet for RS-232C applications.

### 2.2.2 20mA Current Loop Interface (Option)

The ADM 12 can as an option be configured for 20mA Current Loop operation using the Primary (Modem) Port. The current loop interface signal levels allow cable lengths of up to 1000 feet. The maximum baud rate for current loop operation is 9600.

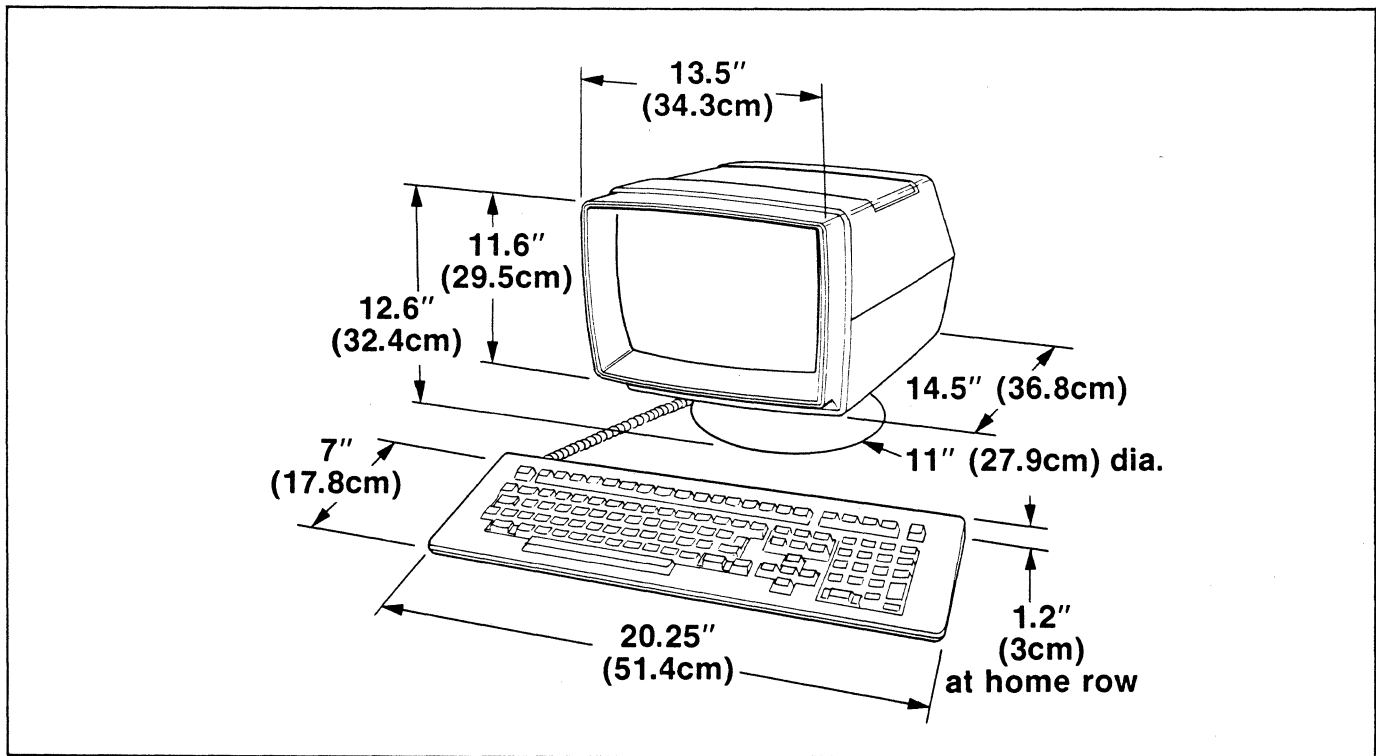

Figure 2-1. ADM 12 Dimensions

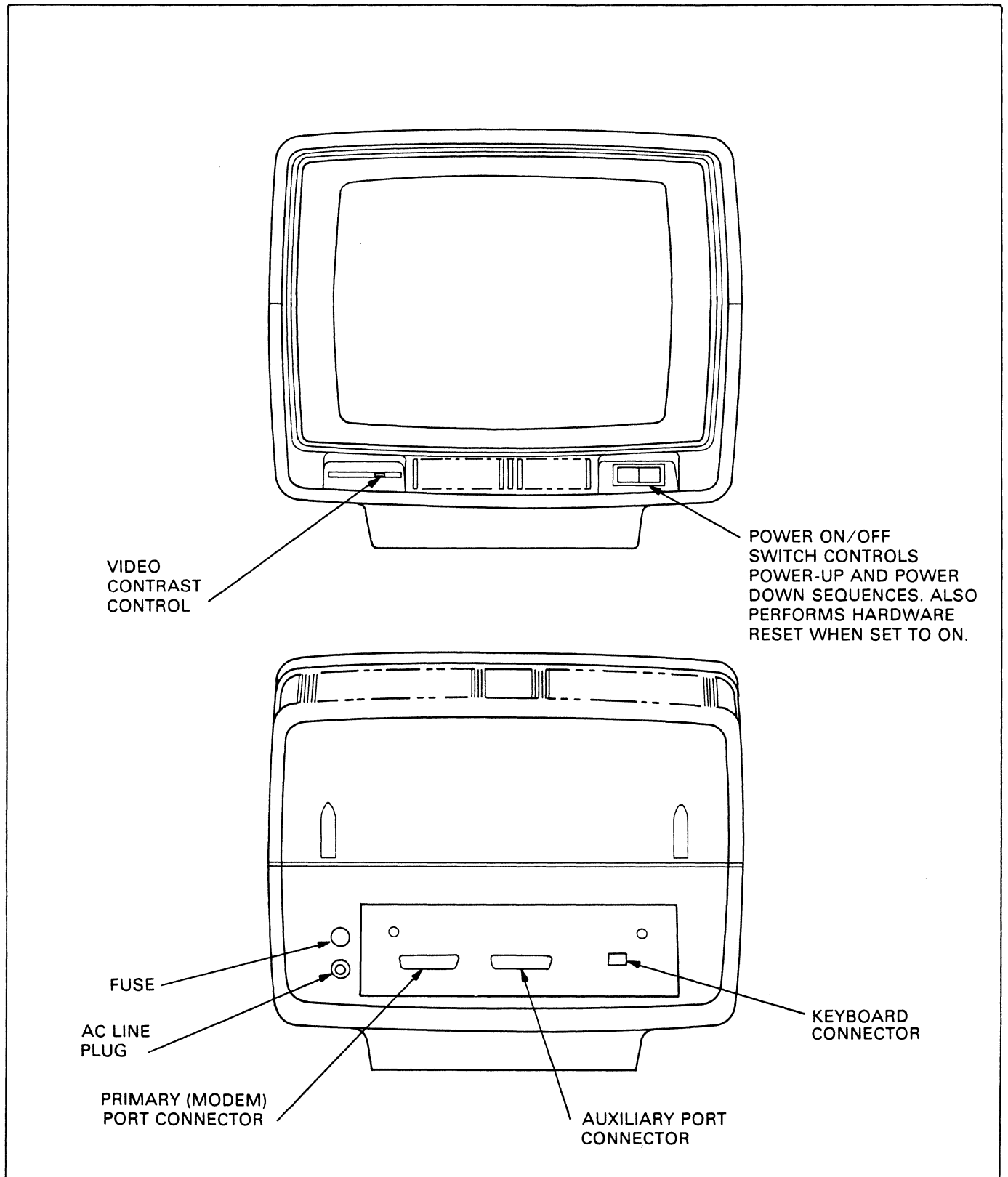

Figure 2-2. ADM 12 Controls and Connectors

### 2.2.3 Auxiliary Port Interface

The Auxiliary Port is used for connecting an RO (Receive Only) serial printer or other RO device to the terminal using RS-232C signal levels (refer to **Figure 2-4, page 2-6**).

#### Note

*The peripheral device that is attached to the Auxiliary port must operate at the same baud rate as the communication line.*

### 2.3 INSTALLING THE ADM 12

1. Check the ON/OFF switch on front of unit. Refer to **Figure 2-2, page 2-3** to ensure that it is set to OFF.
2. Connect the data interface cable(s) to the terminal using the appropriate interface information (**paragraph 2.2, page 2-2**).
3. Plug the power cord into a grounded AC outlet of the proper voltage.

4. Refer to **Section III** for operation and set-up configuration functions that might be desired such as baud rate selection.

### 2.4 POWER TURN-ON

1. Set the ON/OFF switch on the front of the unit to ON (refer to **Figure 2-2, page 2-3**). A power on "beep" should occur within two seconds.
2. Wait approximately 20 seconds for the unit to warm up. The cursor should appear in the HOME position.
3. The Self-Test message "OK" should appear in the upper left corner and the terminal will sound the audible alarm.
4. If the Self-Test message and the cursor do not appear, turn off the ADM 12 wait 15 seconds and apply power again. If the message and cursor still do not appear, check the CONTRAST control, then contact your authorized Lear Siegler service representative.

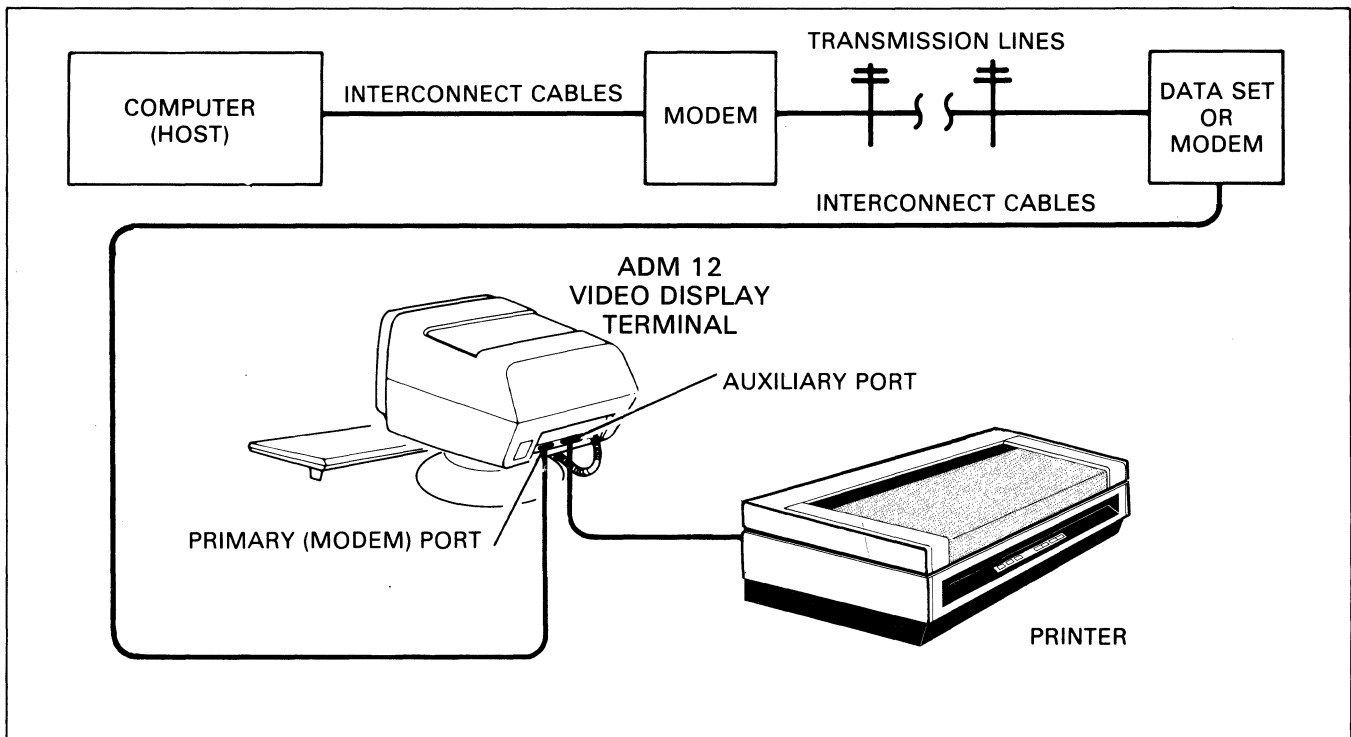

Figure 2-3. Typical ADM 12 Applications

5. Adjust CONTRAST control (Figure 2-2, page 2-3) for desired display brightness.

**CAUTION**

*To avoid damage to the CRT screen when the terminal is to remain ON but unchanged for extended periods of time, reduce the screen brightness using the CONTRAST control on front of unit.*

## **2.5 SCREEN SAVER**

To prevent damage to the CRT screen, a Screen Saver feature is enabled as the factory default condition. If the screen display is not changed for approximately 15 minutes, the display disappears from the screen and is retained in memory. Depressing any key (or data received) will return the display to the screen. Screen Saver can be disabled in Set-Up Mode (see Appendix A, page A-1).

## **2.6 POWER TURN-OFF**

If the unit is displaying information which must be retained, be sure to transmit this information to the host immediately. This is necessary, as the display is cleared when power is removed from the unit. An alternative is to send the information to a printer prior to turning the unit OFF.

## **2.7 CARE OF THE ADM 12**

### **2.7.1 Cleaning**

At periodic intervals, clean the exterior housing and lightly dust the unit using a soft brush or damp lint-free cloth or paper towels. Do not use petroleum base cleaners, such as lighter fluid, as this could be harmful to the housing. Remove smudges from the CRT exterior screen and housing with conventional spray cleaners or alcohol.

### **2.7.2 Inspection**

The characters on the CRT screen should remain sharp, clear, and intense for the life of the terminal. If this should vary, your authorized Lear Siegler service representative can quickly make any required mechanical and electrical adjustments.

MODEM CONNECTOR

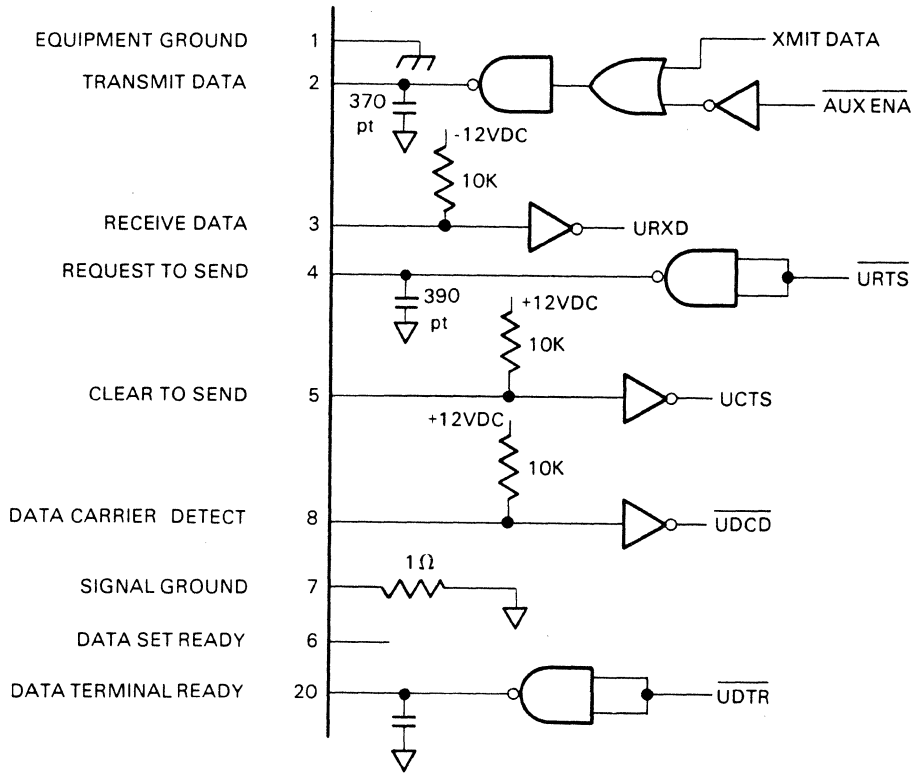

AUXILIARY PORT

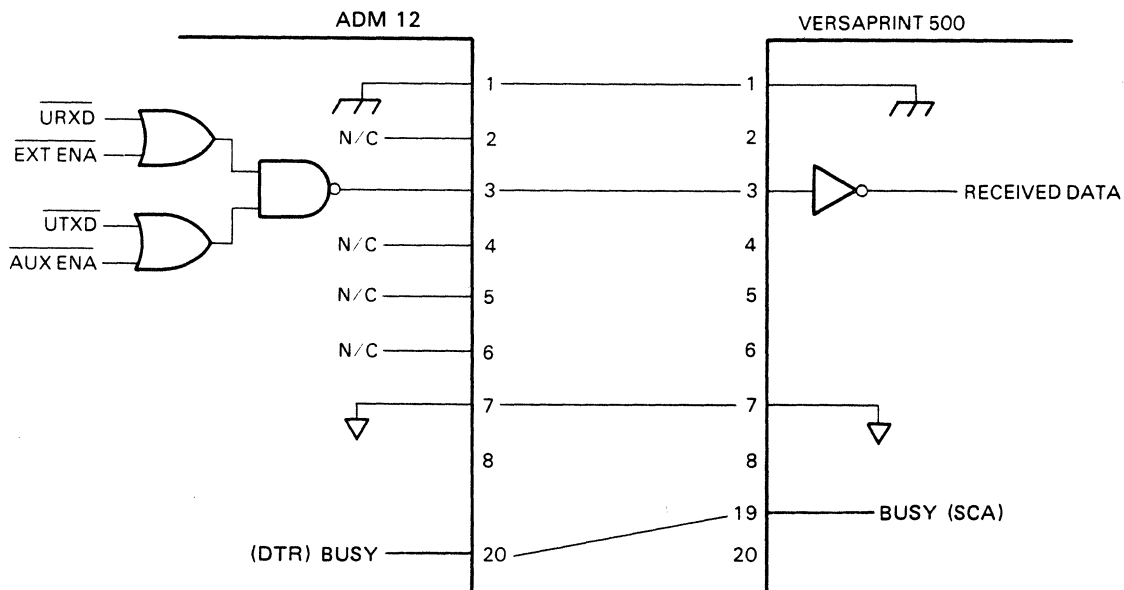

Figure 2-4. Modem Connector and Auxiliary Port

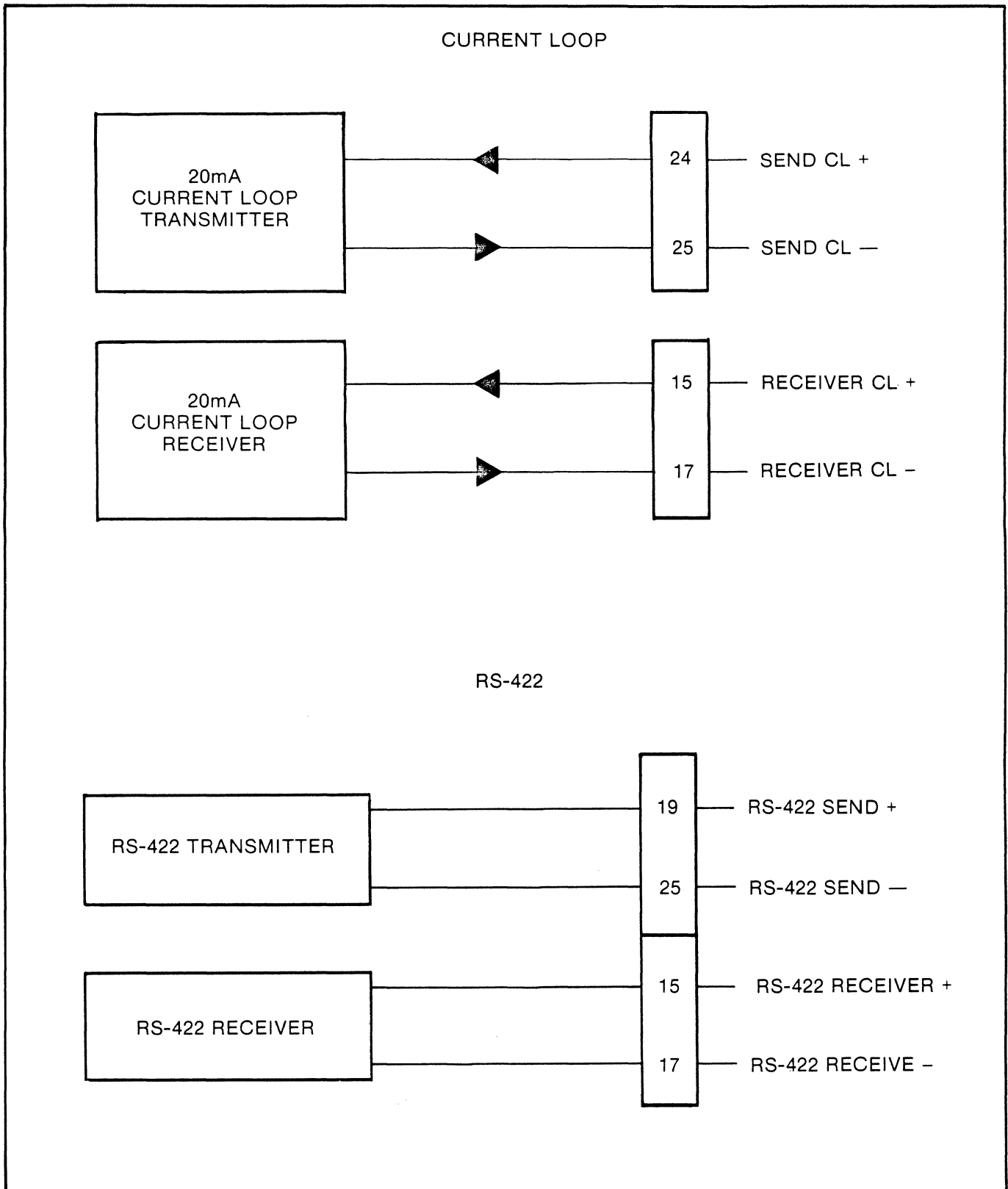

Figure 2-5. Optional Current Loop and RS-422 Interface Logic





## SECTION III OPERATION

### 3.1 KEYSTROKE CONVENTIONS

Commands entered on the ADM 12 keyboard may require simultaneous depression of two or more keys, or sequential depression of two or more keys (one after another). The appropriate convention is indicated in this manual by how the command is shown graphically. **Table 3.1, below**, illustrates the two conventions.

### 3.2 SET-UP MODE

The ADM 12 has two set-up modes - OPERATOR CONVENIENCE SET-UP and SUPERVISOR SET-UP. The Operator Convenience Set-Up functions are characteristics that relate to operator comfort or preference. Supervisor Set-Up functions include all the features useful to the person programming the system. Alternately, all of the set-up functions can be downloaded from a host computer on a byte per byte basis. The OPERATOR CONVENIENCE set-up functions are accessed by entering **SHIFT SETUP**. The SUPERVISOR set-up

functions are accessed by entering **SHIFT CTRL SETUP** from the keyboard. Download of functions from the host computer is accomplished by an ESCAPE sequence as described in **Sections 3.2.3, page 3-2**.

**Table A-1, page A-1** in Appendix describes the Set-Up mode functions that are configurable for the ADM 12. **Figure 3-1, page 3-3**, shows sample Set-Up mode functions.

#### 3.2.1 Selecting Functions

When Set-Up Mode is entered, the status line (line 25) will disappear, and the first set-up mode function will be displayed in its place, (see **Figure 3-1, page 3-3**). The cursor will surround one of the available selections (e.g., N or Y); this is the current value associated with the function. To change the value associated with a particular function, press **→** or **←** until the cursor is positioned over the desired value. Press **↓** to display the next available function. For example, pressing **↓**

**Table 3-1. Keystroke Conventions**

Keystrokes	Description
<b>ESC A 2</b>	Space between each key. These are independent keystrokes, typed one after the other.
<b>SHIFT CTRL SET UP</b>	No space between keys. These are simultaneous keystrokes. All three keys, SHIFT, CTRL and SET UP, should be depressed at the same time.

when CLICK is displayed will cause the STATUS function to be displayed if in the operator accessible mode. Pressing  will cause the previous function to be displayed. Pressing the  key causes the first function (CLICK) to be displayed.

Pressing the  key will cause the terminal to exit Set-Up and return to the previously established mode. Before set-up is exited, the operator will be given the opportunity to SAVE the newly changed set-up features by the message SAVE?(Y/N). The operator must enter Y to save. The status line will appear at the bottom of the display screen after a "wait" period of approximately 6 to 10 seconds. The operator can go from operator to supervisor accessible functions while in Set-Up mode via the  command mentioned above.

Pressing the  key exits Supervisor Set-Up mode and causes any changes that were made to take effect and the status line, if enabled, will be displayed. There is no save message when exiting Supervisor Set-Up mode. The ADM 12 receives but does not process all received data while in Set-Up mode. When handshaking is enabled the ADM 12 will send an X-OFF or drop Data Terminal Ready if the host overruns the input buffer during Set-Up mode.

Note that if the terminal is currently in the Inhibit Personality Changes Mode (set-up byte 1, bit 7) the Supervisor Set-Up mode from keyboard is disabled and the current functions can only be changed from the host computer. Exiting from the set-up mode will result in the video and keyboard returning to previous conditions.

#### Note

*Changing communications characteristics when in Set-Up Mode may affect or prevent further data transfer with the host computer or auxiliary device.*

### 3.2.2 Saving Supervisor Set-Up Functions

When the various functions are selected, they take effect upon exiting Supervisor Set-Up Mode. The set-up is stored in temporary "working" memory and will be lost if the terminal is powered-down. To cause the set-up functions to be saved in non-volatile memory, enter the  (press  and  simultaneously) command when in Supervisor Set-Up Mode.

There are two other commands that can also be performed in Supervisor Set-Up Mode:  and .  causes the ADM 12 to be reset to the default function values.  causes the terminal to restore the function values that are currently in non-volatile memory (the current function values might not have been saved). A  must follow a  if the desired settings are to be saved in non-volatile memory. A save, default, or restore operation will not be performed if the corresponding key sequence (, , or ) is entered while the terminal is in any mode other than Supervisor Set-Up. The ADM 12 will always power-up to the last saved set-up conditions. See figure 3-7 on page 3-38 for more Supervisor Set-Up commands.

### 3.2.3 Down-Line Load Set-Up

The Set-Up mode features can be selected by the host computer by a command sequence on a byte per byte basis. This is accomplished via the escape sequence ESC { AA HH where AA = Address in Hex and HH = Value in Hex. Refer to Table A-2, page A-3 in Appendix for details.

The binary set-up features can also be configured from the keyboard by entering the Supervisor Set-Up mode  and then entering the command sequence . The cursor control arrow keys are utilized to address the set-up byte, locate the bit to be configured, and to toggle the bit to 1 or 0 as desired.  is used to decrease the address character or set a bit = 1.  is used to increase the address character or set a bit = 0.  moves the cursor right, and

OPERATOR CONVENIENCE SETUP

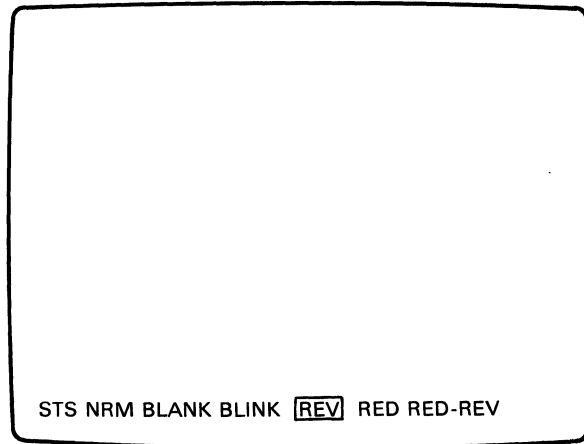
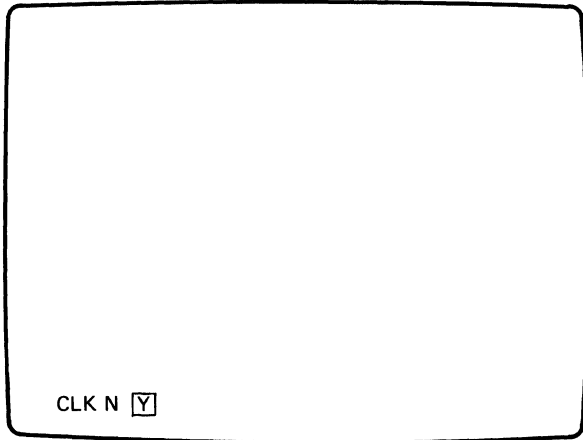

Operator Convenience Set-Up functions may be displayed by entering **SHIFT SET UP**. The first set-up function will be displayed on the status line (as above). With cursor over the Y, CLICK is enabled. To disable CLICK, press **←** so cursor is over N. The press **↓** to display the next available function...

...status line then appears, with REV (Reverse) as the default condition. If one of the other conditions is desired, press **←** or **→** to move the cursor block over the desired condition. Press **↓** to advance to the next Set-Up function.

SUPERVISOR SETUP

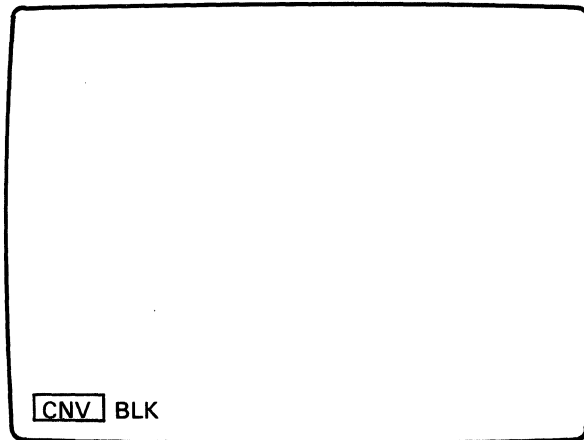
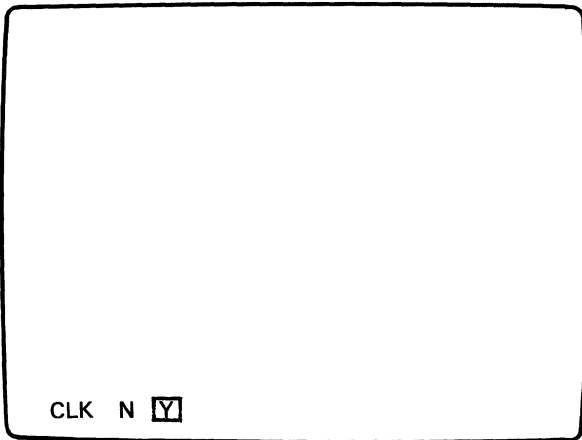

Supervisor Set-Up functions may be displayed by entering **SHIFT CTRL SET UP**. The first set up function will appear on the status line (line 25). The cursor block indicates default condition Y. To move cursor to N, press the **←** key. When the proper function is selected, press the **↓** to advance to the next function.

The default condition (cursor block over CNV) indicates that the terminal is in the conversation mode. To accept, press the **↓** and advance to the next function. To place the terminal in block mode, press **←** so the cursor is over the BLK and then press **↓**.

Figure 3-1. Sample Set-Up Mode Functions

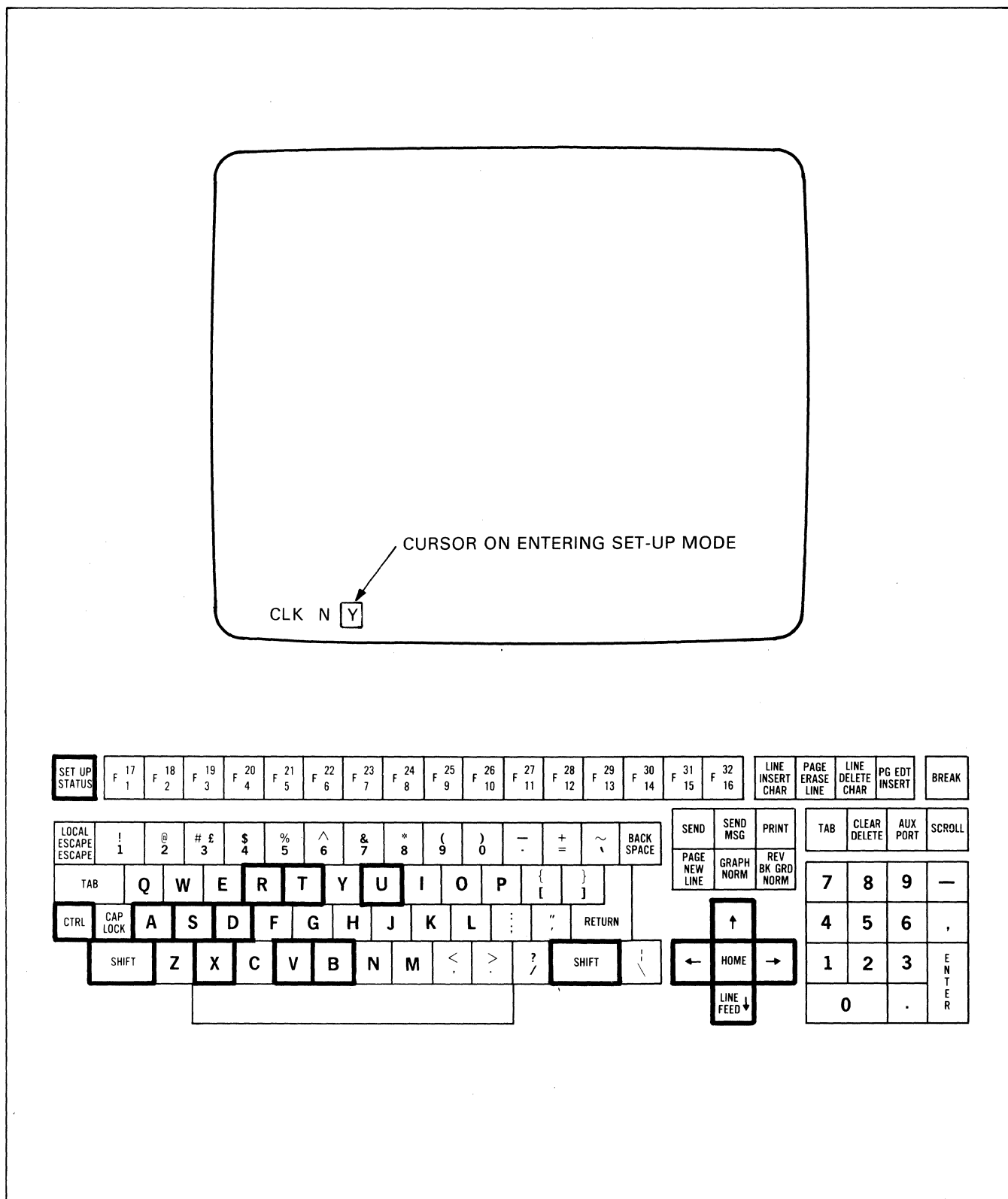
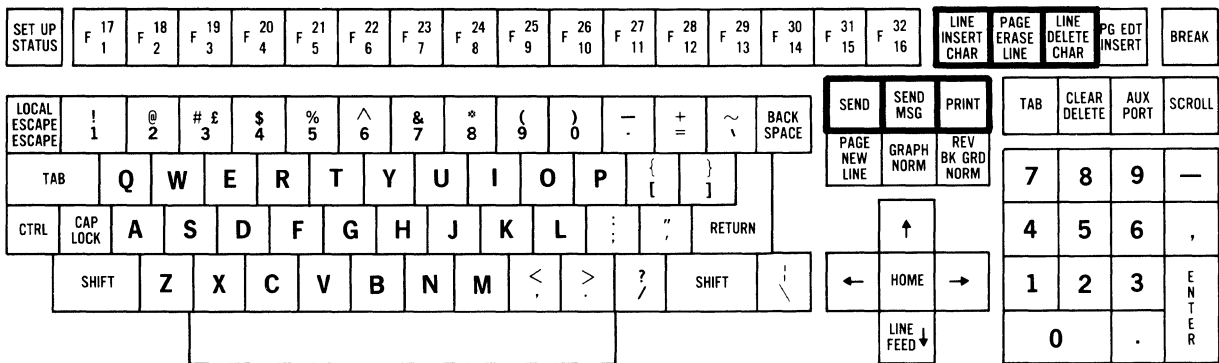

Figure 3-2. ADM 12 Set-Up Mode Display and Associated Keys



THE SIX PROGRAMMABLE EDIT KEYS ARE INDICATED BY HEAVY OUTLINES (SEE SECTION 3.4.8, PAGE 3-13, FOR USE OF THESE KEYS).

*Figure 3-3. Programmable Edit Keys*

↑ moves the cursor left. All binary set-up features can be saved in non-volatile memory by the control sequence **CTRL[S]** while the ADM 12 is in the Supervisor Set-Up mode.

### 3.3 OPERATIONAL MODES

The ADM 12 provides several different modes of operation which are selectable by the host or from the keyboard. The power-on mode conditions are established by the last saved functions selected in the associated Set-Up features. The various command sequences used to change the operating characteristics of the ADM 12 are detailed in paragraph 3.6, on page 3-16.

#### 3.3.1 On-Line or Local Mode

On-Line Mode -- When the terminal is placed On-Line, data that is received will be displayed or acted upon, and keyboard entries will be transmitted and/or displayed, depending on the communications mode selected.

Local Mode -- In Local Mode, the terminal ignores the communications interface. Keyboard entries are displayed or acted upon locally. No data transmission takes place between the terminal and the host computer. The RTS (Request To Send) and DTR (Data Terminal Ready) signals are held low (busy).

#### 3.3.2 Conversation or Block Mode

Conversation Mode -- When the terminal is placed in the Conversation Mode, data entered on the keyboard is immediately transmitted to the host computer, character by character, and depending upon the Duplex mode is either acted on and displayed or sent directly to the host without display.

Block Mode -- When the terminal is placed in the Block Mode, data entered on the keyboard is processed locally by the terminal and transmitted to the host computer by the various send functions that are available in the ADM 12. Available send functions are further discussed in Section 3.4.7, page 3-12. Note that the six programmable edit keys (shiftable to twelve) can be programmed to transmit directly to the host or to act locally independent of the communications mode of the terminal. Refer to Section 3.4.8, page 3-

13 for details on the use of the programmable edit keys.

#### 3.3.3 Duplex Operation

The Duplex Mode selected in Set-Up or through escape sequence code controls the general handling of the RS-232C signal RTS (Request To Send) and, in Conversation Mode, controls the processing of key entries.

Full Duplex -- RTS is always high as long as terminal is on line. Characters transmitted to the host computer are not directly displayed on the CRT. In order for data to be displayed, it must be echoed from the host computer.

Half Duplex -- RTS is raised high on attempt to transmit and dropped low 70 to 140 milliseconds after a "CR" (0 D Hex) or "End of Block 1" character selected in set-up is transmitted. Characters that are entered from the keyboard are transmitted to the host computer and are also routed to the CRT to be displayed and acted upon locally.

#### 3.3.4 Program Mode

Setting Program Mode via the **ESC[U]** key sequence causes the terminal to display all 128 ASCII characters. Normally, the 32 control codes (00-1F) cause a particular action to be performed. However, in Program Mode, the control codes are displayed instead of being acted upon. This allows the embedding of formatting information that is particularly useful in print output and as a diagnostic aid. The ESC X and/or ESC u key sequence causes the terminal to exit Program Mode. The terminal will not respond to "X-ON" or "X-OFF" while in the Program Mode. Host control of Program Mode can be disabled through Set-Up.

### 3.4 KEYBOARD OPERATION

The operator uses a keyboard very similar to that of a standard office typewriter to enter data and perform control operations. Functionally, the keyboard consists of the displayable 96 ASCII character set keys and various control or modifier keys. All keys are auto-repeating at the rate of 15 characters per second, except the Edit keys, Function keys and, Special Operation keys: Insert Mode, Page, Clear, Background, Graphics, Back

**ESC** is used in conjunction with otherwise displayable characters to produce an ESC sequence (see Table 3-3).

**SHIFT ESC** performs a Local Escape.

**SET UP** causes the ADM 12 to enter Set-Up mode with SHIFT key.

**STATUS** causes the ADM 12 to exit Set-Up mode or return the status line.

**F1 - F32** causes the corresponding user-defined or default characters to be displayed and/or transmitted (used in conjunction with the Shift key to generate F17 - F32).

Alphanumeric, punctuation, and special character keys produce 128 displayable characters. Typing any of these keys with **SHIFT** depressed produces an upper case alpha character or the symbol imprinted on the upper portion of the key. Setting **CAP LOCK** produces upper case alpha characters only.

**SHIFT** must be held down while affected key is typed. Enables upper case alpha characters and symbols, as well as a shift in certain special operations.

**BACKSPACE** moves the cursor one space to the left each time the key is pressed. Generates ASCII BS code (08). This code can be changed in Personality Mode in Set-Up.

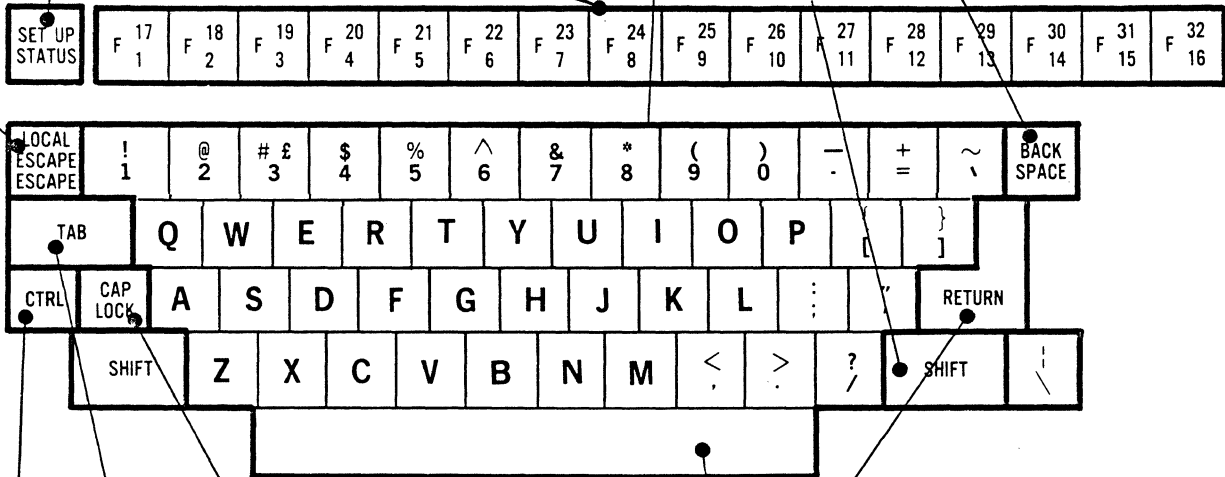

**CAP LOCK** shifts only lower case alpha characters into upper case. To set, press **CAP LOCK** once, to release press **CAP LOCK** again.

**TAB** if enabled moves cursor right to next Tab Stop generates HT. **TAB** with Shift is Back Tab (ESC I).

**CONTROL** is held down while typing an otherwise displayable character key to generate one of the 32 control codes. Only 14 control codes are applicable to the ADM 12 operation. See Table 3-2

**RETURN** moves the cursor to the first character position in either the line containing the cursor or the next line, depending on the Set-Up Mode condition.

**SPACE** bar advances cursor one space at the right each time bar is typed. Any character under cursor is replaced by a space. Holding bar down produces a continuous string of SPACES until released.

NOTE: Only the default condition is described here. If set-up personality changed, function will change.

Figure 3-4. ADM 12 Standard Keyboard Operation Characteristics

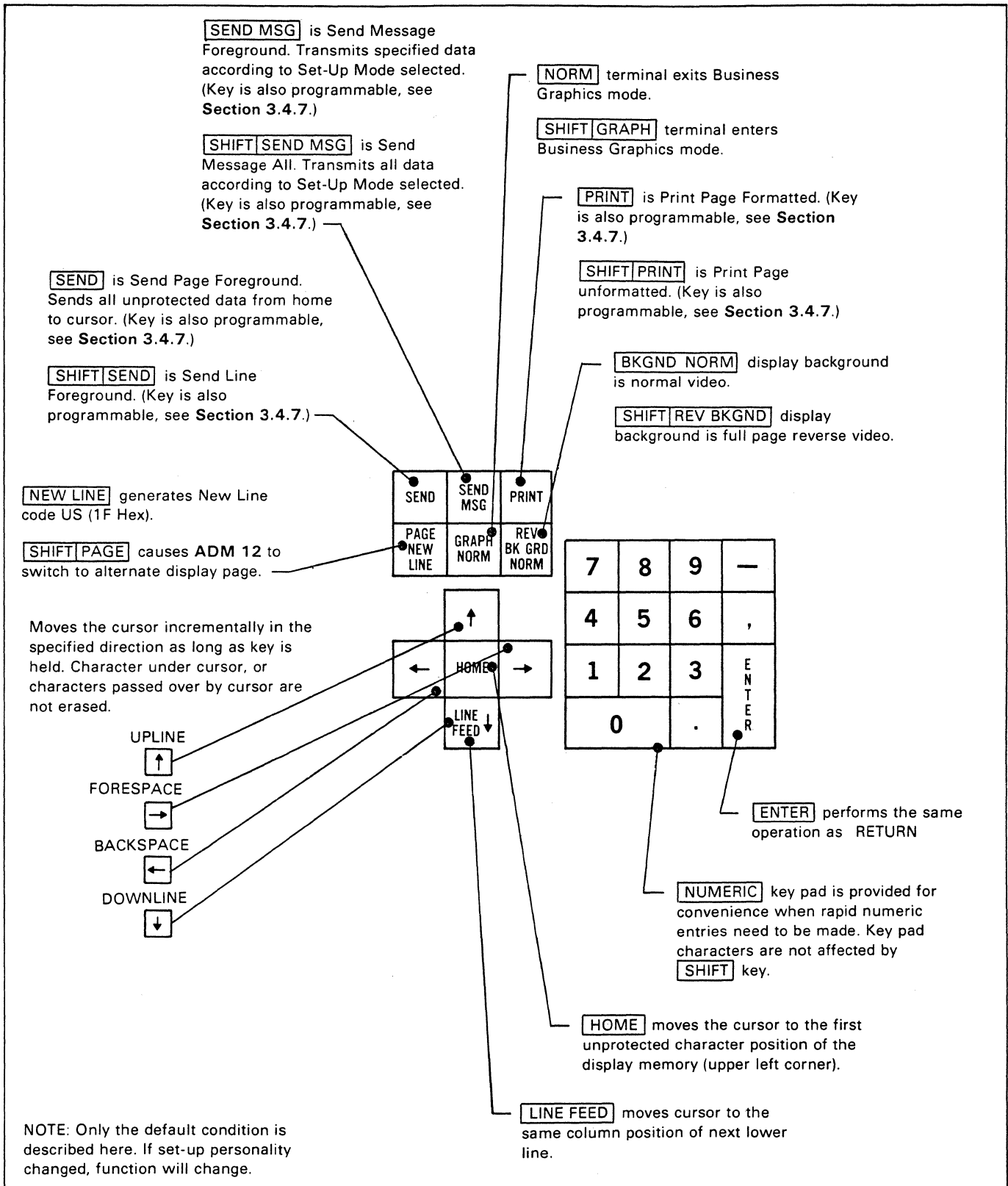
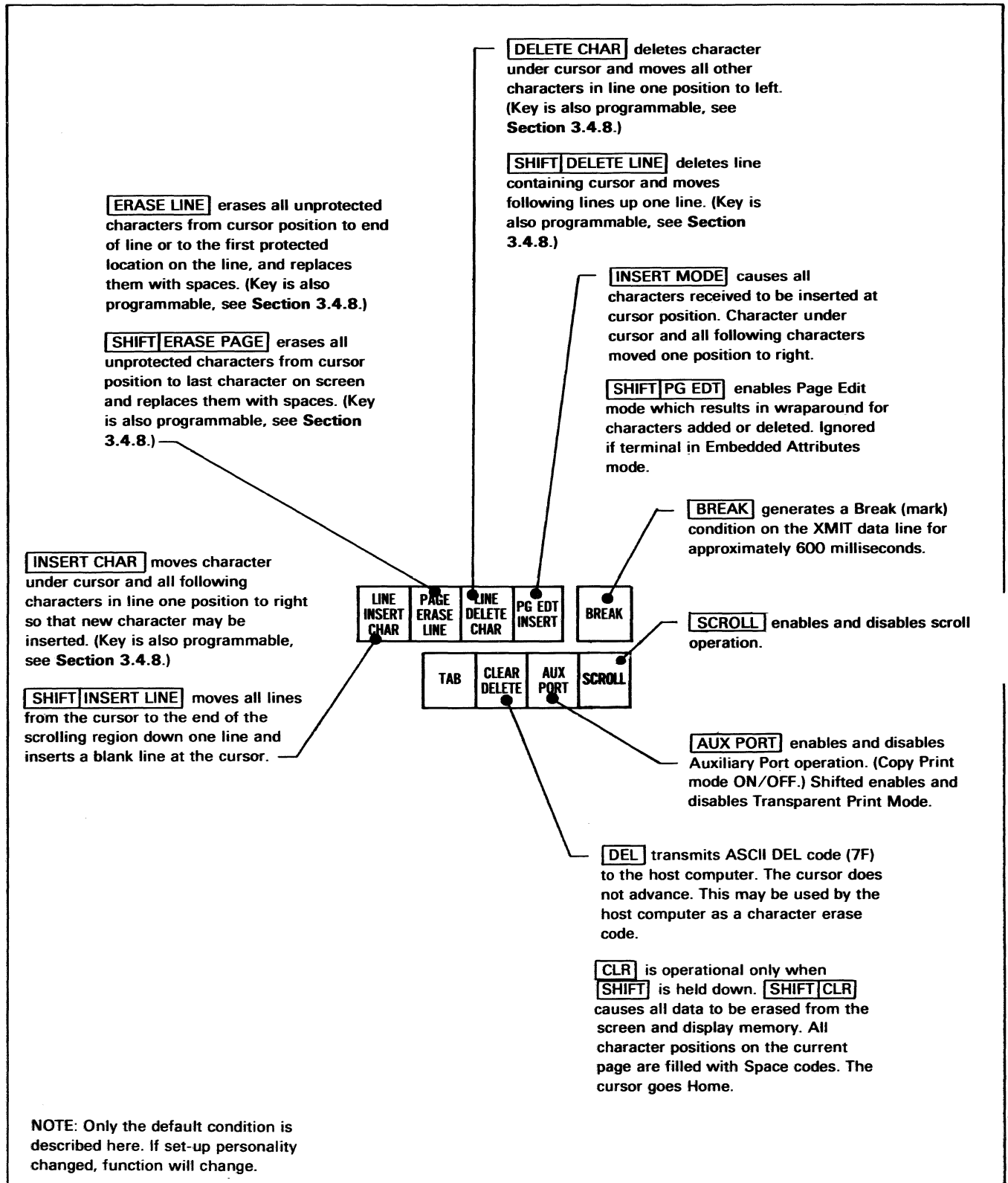

Figure 3-4. ADM 12 Standard Keyboard Operation Characteristics (continued)





*Figure 3-4. ADM 12 Standard Keyboard Operation Characteristics (continued)*

Tab, Tab, Page Edit, Aux. Port, and Break. Auto repeat starts after a key has been depressed for a minimum of one second. **Figure 3-4, page 3-7** describes the functions of the ADM 12 keyboard. **Paragraphs 3.4.2 through 3.4.9** detail the keyboard by the following types of operation.

- Alphanumeric and Punctuation Keys
- Numeric Keypad
- Modifier Keys
- Cursor Control Keys
- Edit Keys
- Transmission Keys
- Programmable Function Keys and Edit Keys
- Special Operation Keys

### 3.4.1 Keystroke Entry

Ordinarily, each keystroke that is typed by the operator is independent of the one preceding or following it. However, the keyboard is scanned in such a manner that even a very fast typist will not be able to overrun the keyboard. This is accomplished by the 3-key rollover data entry protection, plus a 32 keystroke buffer, provided by the ADM 12. The keyboard also provides audible feedback by a user-selectable key-click feature that indicates a valid key closure.

Keys such as **SHIFT** and **CTRL** are used in conjunction with other keys to modify their operation.

### 3.4.2 Alphanumeric and Punctuation Keys

The upper/lower case alphabet, numerics, and punctuation characters from the 96 displayable ASCII character set, plus space and DEL are displayed and/or transmitted (depending upon the communication mode selected) when a key is pressed. Keys that have a double legend produce the lower-case or lower legend when unshifted, and the upper-case or upper legend when pressed with the **SHIFT** key. The **SPACE** key generates an ASCII 20 Hex code for transmission and occupies one space on the display screen. The **DEL** key produces an

ASCII 7F Hex code for transmission, but will not occupy a space on the display screen unless Program Mode is set. **DEL** may be used by the host computer as a character erase code.

### 3.4.3 Numeric Keypad

The ASCII numerals 0 through 9 and minus, comma, and period are displayed and/or transmitted when a key is pressed. The ASCII hex codes generated are identical to the lower legend numerals and punctuation on the main keyboard area.

### 3.4.4 Modifier Keys

The following keys do not generate any output by themselves, but modify the code generated by the alphanumeric keys on the keyboard.

**SHIFT** causes the upper legend character of the double legend key to be produced when pressed in conjunction with either **SHIFT** key. The 26-alpha characters are shifted for upper-case, and unshifted for lower case.

**CAPLOCK** this alternate action key causes the 26-alpha characters to stay shifted (upper-case) when on. The numeric and punctuation keys, as well as the various control keys, are not affected.

**CTRL** the control key causes one of the 32-ASCII control codes to be generated when pressed in conjunction with an otherwise displayable character key. The character generated will not display a character on the display unless Program Mode is set. Some control codes are utilized by the ADM 12, refer to **Table 3-2, page 3-17** for details.

### 3.4.5 Cursor Control Keys

The Cursor is used to indicate the next character position to be entered on the display. The cursor may be positioned by remote commands from the host computer or by cursor control keys on the keyboard. The following keys are used to position the cursor on the display:

**↑****↓****←****→** and **HOME** move the cursor as indicated and transmit the ASCII control codes listed in **Table 3-2, page 3-17**.

Either **TAB** key may be used to generate a horizontal tab code (HT) and depending upon modes of the terminal will be acted upon moving the cursor right to the next horizontal tab setting or right margin and to beginning or end of a protected field. **SHIFT****TAB** is a Back Tab and will generate an ESC I code and depending upon modes of the terminal will be acted upon moving the cursor left to the next horizontal tab setting or left margin.

**BACKSPACE** causes the cursor to move one character position to the left. A BS code is generated. This key can be reprogrammed in Personality Mode of Set-Up.

**RETURN** moves the cursor to the beginning of the line it was in, or the beginning of the next line depending upon the Personality character selection mode. A Carriage Return Code (CR) is generated by the Return key. If the Personality selection is made for a line feed as well as carriage return when RETURN key is depressed, the Line Feed Code (LF) is generated after the Carriage Return Code (CR).

The **ENTER** key, on the numeric keypad is programmable through Set-Up Mode. The operator can program the ENTER key to any one or two codes as desired. The default function is carriage return.

**LINE FEED** moves the cursor to same column position on the next line down unless protected. This will cause a scroll operation to occur if the cursor was on the bottom line of the scrolling region and the scroll operation is enabled. A LF code is generated.

### 3.4.6 Edit Keys

There are six edit keys on the ADM 12. Three, **INSERT CHAR/LINE**, **ERASE LINE/PAGE** and **DELETE CHAR/LINE**, are also programmable along with the transmission keys (figure 3-3, page 3-5). The programming functions are discussed in Section 3.4.8, page 3-13. *In this section only the default function conditions which relate to the key legends will be explained.* As set from the factory, all the edit keys are local functions and as such do not generate codes

for transmission to the host. The functions can, however, be also generated by the host computer or from the keyboard by escape sequences as described in Table 3-3, page 3-19. Several of the functions also have the capability of certain "Personality" changes which are described in Section 3.7.5, page 3-33.

**SHIFT****CLEAR** erases all characters on the screen and moves the cursor to the HOME position (first unprotected position). The erased characters are replaced with the selected Fill 1 character in set-up.

**DELETE** transmits DEL code 7F hex.

**ERASE-LINE** erases all unprotected characters from the cursor position through to the next protected location or the end of the line. The erased characters are replaced with the character selected in Fill 1. The cursor position does not change.

**SHIFT****ERASE** is **ERASE-PAGE** and will erase all unprotected characters from the cursor position through the end of the current page. The erased characters are replaced with spaces (Fill 1). The cursor position does not change.

**INSERT-CHAR** moves the character under the cursor and all following characters in the line one position to the right up to the right margin or next protected field. Wraparound will occur only if Page Edit mode is selected.

**SHIFT****INSERT** is **INSERT-LINE** and moves the entire line containing the cursor as well as following lines down one line. The new line is filled with the character Fill 1 (default space) selected during set-up. Last line in scrolling region is lost. If Protect Mode is on or cursor is positioned outside of scrolling region, this command is ignored and an audible tone will sound.

**SHIFT****DELETE** is **DELETE-LINE** and the line containing the cursor will be deleted as long as Protect Mode is off. The following lines in the scrolling region below the cursor will be moved up one line and a line containing the Fill 1 character (default space) will be added as the last line in scrolling region as long as cursor is within scrolling

region. If Protect Mode is on or cursor is positioned outside of scrolling region, this command is ignored and an audible tone will sound.

**[INSERT MODE]** places the terminal in the Insert Mode which causes all characters received to be inserted at the cursor position. The character under the cursor and all characters to right will move one position to the right as characters are received. Wraparound will occur if terminal is also in Page Edit mode. **[SHIFT]** results in **[PG EDT]** which is Page Edit mode of the terminal whereby characters entered or deleted at the cursor position will result in wraparound of lines below cursor. Page Edit is inoperative in Embedded Attributes Mode.

### 3.4.7 Transmission Keys

There are three transmission keys in the ADM 12 which are also programmable as described in Section 3.4.8, page 3-13. This section describes the default function conditions which relate directly to the key legends. These three transmission keys are: **[SEND]**, **[SEND MSG]** and **[PRINT]**.

**[SEND]** is Send Page Foreground, (ESC 5), which causes all data, excluding nulls, to be transmitted from the top left corner of the page up to, and including, the cursor. Protected fields are replaced with a single FS character selected in set-up unless selected as a NULL. Each line will be limited on the right by the Right Margin, and except for the last line of the transmission, each line will be terminated by the two New Line Characters selected in Set-Up. If Set-Up byte 3, bit 4 ('Inhibit New Lines In Send') is set to '1', or if the New Line Characters are programmed as nulls, they shall be omitted. The transmission will be terminated by the two End of Block Characters selected in Set-Up unless they are nulls.

**[SHIFT][SEND]** is Send Line Foreground, (ESC 4), which causes all data, excluding nulls, to be transmitted starting at column 1 of the line containing the cursor up to, and including, the cursor. Protected fields replaced by one FS character selected in Set-Up unless it is a null. New line characters will be omitted and the transmission will be

terminated with the two End Of Block Characters selected in Set-Up.

**[SEND MSG]** is Send Message Foreground, (ESC S), which causes all data from the character following the previous STX (02 Hex) embedded on the screen (or column 1 row 1 of current page if no STX is embedded) up to the character prior to the next ETX (03 Hex) embedded on the screen (or the character at the right margin on the last row of the current page if no ETX is found).

All lines will be bound on the right by the Right Margin selected, and except for the last line of the transmission, will be terminated with the two New Line Characters selected in Set-Up (unless they are nulls). The last line will be terminated with the two End Of Block Characters selected in Set-Up unless they are nulls. All protected fields will be replaced with a single FS character selected in Set-Up unless it is a null.

**[SHIFT][SEND MSG]** is Send Message All, (ESC s), which causes all data from the character following the next previous STX (02 Hex) embedded on the screen (or column 1, row 1 of the current page if no STX embedded) up to the character prior to the next ETX (03 Hex) embedded on the screen (or the character at the right margin on the last row of the current page if no ETX is found.)

All lines will be bound on the right by the Right Margin selected, and except for the last line of transmission, will be terminated with the two New Line Characters selected in Set-Up (unless they are nulls). The last line will be terminated with the two End Of Block Characters selected in Set-Up unless they are nulls. All protected fields will be delineated with ESC ) and ESC (. Attribute changes will be preceded by an ESC G X.

**[PRINT]** is Print Page Formatted, (ESC P), which causes a page print starting from the upper left corner of the page and continuing up to but not including an embedded GS Stop Code (1D Hex) or the cursor, whichever occurs first. The print will be bound on the right by the Right Margin selected in Set-Up.

The PRINT shall start out with CR (0D Hex), Null (00 Hex), LF (0A Hex), Null and will

terminate each line thereafter (until the stopping criteria above is met) with the same code. Trailing blanks will be suppressed and all nulls will be suppressed. Protected fields will be replaced with spaces if in Set-Up Print Protected As Spaces is set. Embedded attributes will be replaced with spaces regardless of protection if in Set-Up Print Attribute As Space is set.

**[SHIFT][PRINT]** is Print Page Unformatted, (ESC P), which causes a page print starting from the upper left corner of the page and print up to but not including an embedded GS Stop Code (1D Hex) or the cursor, whichever occurs first. The print shall be bound on the right by the Right Margin selected in Set-Up.

The ADM 12 has two additional send commands that can either be used by escape sequences or alternately by programming one or more of the programmable keys as described in paragraph 3.4.8, below. The operation of these send functions is described here for reference:

SEND PAGE ALL (ESC 7) causes all data, excluding nulls, to be transmitted from column 1, row 1 of the current page up to and including the cursor. Embedded attributes or attribute changes (non-embedded mode) will be delineated by 'ESC G X' where X is the ASCII encoded character which defines the attribute of the next field. Protected attributes will be preceded by 'ESC Y' and terminated by 'ESC ('. Each line is limited on the right by the Right Margin, and except for the last line of the transmission, each line shall be terminated by the two New Line Characters selected in Set-Up. If Set-Up byte 3, bit 4 ('Inhibit New Lines In Send') is set to '1', or if the New Line Characters are programmed as nulls, they shall be omitted. The transmission shall be terminated by the two End Of Block Characters selected in Set-Up unless they are nulls.

SEND LINE ALL (ESC 6) causes all data, excluding nulls, to be transmitted from column 1 of the line containing the cursor up to, and including the cursor. Embedded attributes or attribute changes (non-embedded mode) will be delineated by 'ESC G X' where X is the ASCII encoded character

which defines the attribute of the next field. Protected attributes are preceded by 'ESC Y' and terminated by 'ESC ('. The transmission will be terminated by the two End Of Block Characters selected in Set-Up. If either End Of Block Character is a null, it shall be omitted.

### 3.4.8 Programmable Function Keys and Edit Keys

The ADM 12 has 16 function keys, giving the user 32 programmable function sequences with the **[SHIFT]** key. In addition, there are 6 Edit/transmission keys that are user programmable for an additional 12 function sequences with the **[SHIFT]** key. The Edit/transmission keys that are programmable are: **[SEND]**, **[SEND MSG]**, **[PRINT]**, **[INSERT CHAR/LINE]**, **[ERASE LINE/PAGE]**, and **[DELETE CHAR/LINE]**. Thus the ADM 12 has up to 44 functional sequences that are user programmable. All of the programmable keys have an independent destination code, Local or Host, and four characters each of program space. In addition, all programmed functions can be saved in non-volatile memory through the Set-Up mode.

The function sequences may be programmed from the host with 4 ASCII characters or from the keyboard locally with 4 "keystrokes". Keystrokes may be ASCII characters 00-7F Hex or local action keys like **[PAGE ERASE]**. It's even possible to link function sequences into longer sequences by programming the 4th keystroke with the actual function key you wish to link to. This also enables looping if you link a function on itself. A looping function will repeat until the operator presses **[SHIFT]** and **[BREAK]** keys simultaneously.

All the programmable keys are programmed via the escape sequence **[ESC][!][X][P<sub>0</sub>][P<sub>1</sub>][P<sub>2</sub>][P<sub>3</sub>][P<sub>4</sub>]** where "X" is an ASCII character corresponding to the key to be programmed, P<sub>0</sub> is the destination code "K" (4B Hex) for Local "H" (48 Hex) for Host, and P<sub>1</sub>-P<sub>4</sub> are the actual codes to be programmed into the function sequence (see figure 3-5, page 3-14). In each sequence all four characters, P<sub>1</sub>-P<sub>4</sub>, must be entered. NULLS

FUNCTION KEY	X	P <sub>0</sub>	P <sub>1</sub>	P <sub>2</sub>	P <sub>3</sub>	P <sub>4</sub>
F1	@	H	SOH	@	CR	NULL
F2	A	H	SOH	A	CR	NULL
F3	B	H	SOH	B	CR	NULL
F4	C	H	SOH	C	CR	NULL
F5	D	H	SOH	D	CR	NULL
F6	E	H	SOH	E	CR	NULL
F7	F	H	SOH	F	CR	NULL
F8	G	H	SOH	G	CR	NULL
F9	H	H	SOH	H	CR	NULL
F10	I	H	SOH	I	CR	NULL
F11	J	H	SOH	J	CR	NULL
F12	K	H	SOH	K	CR	NULL
F13	L	H	SOH	L	CR	NULL
F14	M	H	SOH	M	CR	NULL
F15	N	H	SOH	N	CR	NULL
F16	O	H	SOH	O	CR	NULL
F17	P	H	SOH	P	CR	NULL
F18	Q	H	SOH	Q	CR	NULL
F19	R	H	SOH	R	CR	NULL
F20	S	H	SOH	S	CR	NULL
F21	T	H	SOH	T	CR	NULL
F22	U	H	SOH	U	CR	NULL
F23	V	H	SOH	V	CR	NULL
F24	W	H	SOH	W	CR	NULL
F25	X	H	SOH	X	CR	NULL
F26	Y	H	SOH	Y	CR	NULL
F27	Z	H	SOH	Z	CR	NULL
F28	[	H	SOH	[	CR	NULL
F29	\	H	SOH	\	CR	NULL
F30	]	H	SOH	]	CR	NULL
F31	^	H	SOH	^	CR	NULL
F32	_	H	SOH	_	CR	NULL
SEND	`	K	ESC	5	NULL	NULL
SHIFT SEND	a	K	ESC	4	NULL	NULL
SEND MSG	b	K	ESC	5	NULL	NULL
SHIFT SEND MSG	c	K	ESC	s	NULL	NULL
PRINT	d	K	ESC	P	NULL	NULL
SHIFT PRINT	e	K	ESC	p	NULL	NULL
INSERT CHAR	f	K	ESC	Q	NULL	NULL
SHIFT INSERT LINE	g	K	ESC	E	NULL	NULL
ERASE LINE	h	K	ESC	T	NULL	NULL
SHIFT ERASE PAGE	i	K	ESC	Y	NULL	NULL
DELETE CHAR	j	K	ESC	W	NULL	NULL
SHIFT DELETE LINE	k	K	ESC	R	NULL	NULL

WITH  
SHIFT

Figure 3-5. Factory Set Default Condition of Programmable Keys

(CTRL @) programmed into a function sequence are not transmitted. A function can be filled partially with data then padded with NULLS or totally disabled by completely filling it with NULLS. The factory set default conditions of the programmable keys are listed as follows with the ASCII codes "X" and P<sub>0</sub> for each key.

### Note

*While programming the function keys and edit keys, the codes that you type in as well as the data that you are programming into that key will not be displayed on the screen.*

When the programmable function sequences are selected, they are stored in temporary "working" memory and will be lost if the terminal is powered-down. To cause the programmed functions to be saved in non-volatile memory it is necessary to enter the Set-Up mode and perform a **CTRL S** as described in **Section 3.2.2, page 3-2**. The functions defined for each key will then be retained after the terminal is powered off. While in the Set-Up mode, **CTRL D** will cause the terminal to set the programmable functions to the default value, and **CTRL R** causes the terminal to restore the values currently in non-volatile memory.

### 3.4.9 Special Operation Keys

The keys listed below perform special operations or have a unique effect on the ADM 12.

The **SET UP** key causes the ADM 12 to enter Operator Convenience Set-Up when pressed in conjunction with the **SHIFT** key.

The **SET UP** key causes the ADM 12 to enter Supervisor Set-Up Mode when pressed in conjunction with **SHIFT** and **CTRL**, as described in **paragraph 3.2, page 3-1**.

**STATUS** key causes the ADM 12 to exit Set-Up Mode when pressed, as described in **paragraph 3.2, page 3-1**. Also brings the Status Line back to the 25th line and

acknowledges a parity error indicated (PE). **SHIFT CTRL** key determines the display of the 25th line, toggling between the available functions each time it is depressed. The available functions of the 25th line are: Terminal Status, Host Message 1, Host Message 2, and OFF.

**BREAK** causes a break (mark) condition to be presented on the transmit data line of the Primary (Modem) Port for approximately 600 milliseconds. This operation has no effect on the terminal and is usually used for control signaling to the host device.

**SHIFT BREAK** causes the terminal to abort prints, sends, or looping Function sequences. The keyboard buffer will also be purged.

**SHIFT CTRL BREAK** causes the terminal to perform a power-up reset.

**ESC** generates a special control code (Hex 1B), which is used for command operations and usually followed by one or more characters. Thus, escape is usually considered a "Lead-In" character for terminal control operations. **Paragraph 3.6.2, page 3-16** and **Table 3-3, page 3-19** detail the escape sequences utilized by the ADM 12. Pressing **SHIFT** with **ESC** key causes a local escape function to be processed i.e., the control operation will be acted upon by the terminal but the code will not be transmitted.

**NEW LINE** causes the ADM 12 to generate a new line code US (1F Hex). Pressing **SHIFT** with the **NEW LINE** key generates **NEW PAGE** and causes the ADM 12 to switch to the alternate display page. **BKGND-NORM** causes the terminal to return to normal (dark) display background from Full Screen Reverse Video mode. With **SHIFT**, this key is **BKGND-REV** which causes the ADM 12 to enter the Full Screen Reverse mode.

**NORM** is used to return the display mode to normal from Business Graphics display mode; with **SHIFT**, this key is **SHIFT GRAPH** and causes the ADM 12 to enter the Business Graphics display mode.

**[SCROLL]** causes the ADM 12 to toggle between Scroll Enable and Scroll Disable. In Scroll Disable the ADM 12 will discontinue the scrolling operation on the display and X-OFF will be generated provided the X-ON/X-OFF handshaking has been selected. If DTR handshaking is enabled then DTR will drop when scrolling is disabled and then raise again if **[SCROLL]** is pressed again.

### 3.5 DISPLAY CHARACTER FORMAT

The standard ADM 12 character set contains 128 ASCII characters, 32 of which are control characters. The entire character set may be displayed on the CRT screen by setting Program mode in the unit or by preceding a control character with an ESC code. Wraparound is automatically enabled when Program mode is selected. The key sequence **[ESC][U]** selects Program mode; **[ESC][X]** or **[ESC][u]** exits Program mode. The displayable USASCII character set and control codes are shown in **Appendix A**.

In addition to the standard ASCII character set, the ADM 12 provides a business graphics capability. The business (limited) graphics operation codes are shown in **Table 3-4, page 3-39**, and the business graphics character set is illustrated in **Appendix A, Table A-8, page A-13**.

#### 3.5.1 International Fonts

As an option to the ADM 12, international fonts and keyboards for the following languages are available:

- United Kingdom
- German
- French
- Spanish
- Swedish/Finnish
- Danish
- Norwegian

International keyboard layouts are shown in the **Appendix** for reference.

## 3.6 COMMAND CODE SET

### 3.6.1 Control Codes

The operational characteristics of the ADM 12 are controlled, in part, by a group of control codes which may originate from the host or be generated from the keyboard by pressing the **[CTRL]** key simultaneously with another key as defined in **Table 3-2, page 3-17**. Control codes can be displayed when Program Mode is set. When Program Mode is set, the ADM 12 will display but not act upon the recognized control code. **[ESC][U]** sets Program Mode and **[ESC][X]** or **[ESC][u]** exits Program Mode.

### 3.6.2 Escape Sequences

An Escape sequence is formed by the combination of the "escape" ASCII control code, followed by one or more other ASCII characters. Each Escape sequence controls a specific terminal operation. Some operations are one-time only, others remain operative for as long as power to the unit is not interrupted or until terminated by a control code or another escape sequence.

**Table 3-3, page 3-19** shows the escape sequences used by the ADM 12, whether initiated from the host computer or the keyboard. Escape sequences for the ADM 12 are also summarized in a chart on **page A-7** of the **Appendix** for reference.

Local Escape **[SHIFT][ESC]** - Pressing **[SHIFT]** in conjunction with the **[ESC]** key causes the escape sequence in its entirety to be acted upon locally and not transmitted.



Table 3-2. Control Codes Utilized by the ADM 12

OPERATION	FROM HOST (ASCII Code)	FROM KEYBOARD	DESCRIPTION
Answerback	ENQ	CONTROL E	Transmits 32 byte answerback sequence (nulls are not transmitted).
Bell	BEL	CTRL G	Sounds the audible bell tone.
Backspace	BS	← BACKSPACE CTRL H	Moves the cursor to the left to the next unprotected location. If the cursor is at the left margin, it moves up to the end of the previous line until a non-protected location is found or the cursor reaches the Home position.
Forespace	FF	→ CTRL L	Moves the cursor to the right to next unprotected location. If the cursor is at the right margin, it moves down to the start of the next line until a non-protected location is found or the cursor reaches the lower right corner of the scrolling region.
Linefeed	LF	↓ LINEFEED CTRL J	Moves the cursor to the next line down in same column. If the intended location is protected, the cursor will move right to the first unprotected location or stop at the lower right corner of the scrolling region if an unprotected character cannot be found. If the cursor is located on last line, a scroll operation will be performed when Write Protect is off and if scrolling is enabled in set-up.
Upline	VT	↑ CTRL K	Moves the cursor up to the previous line in same column. If the intended location is protected, the cursor will continue from right to left to the first unprotected location stopping at Home position if an unprotected location cannot be found.
Carriage Return	CR	RETURN CTRL M	Moves the cursor to the left margin or to the first unprotected character position in current line. If none are found, cursor will continue in following lines stopping at unprotected position or, if none found it will stop at the lower right of scrolling region.
Home Cursor	RS	HOME CTRL ^	Moves the cursor to the first unprotected location in the scrolling region.

**Table 3-2. Control Codes Utilized by the ADM 12 (continued)**

OPERATION	FROM HOST (ASCII Code)	FROM KEYBOARD	DESCRIPTION
Tab	HT	<div style="border: 1px solid black; display: inline-block; padding: 2px;">TAB</div> <div style="border: 1px solid black; display: inline-block; padding: 2px;">CTRL I</div>	<p>Moves the cursor to the next horizontal tab setting on current line or to the right margin if no tabs are set. If Write Protect mode is on tabs are disabled and cursor will move to start of next unprotected field or stop at lower right of scrolling region if unprotected fields are not found.</p>
Escape	ESC	<div style="border: 1px solid black; display: inline-block; padding: 2px;">ESC</div> <div style="border: 1px solid black; display: inline-block; padding: 2px;">CTRL [</div>	<p>Recognized by the terminal as a code extension character which must be followed by otherwise displayable character(s) to invoke a specific terminal operation.</p>
X-ON Character	DC1	<div style="border: 1px solid black; display: inline-block; padding: 2px;">CTRL Q</div>	<p>Transmits the default X-ON character (DC1) if no other X-ON character is selected in Set-Up Mode.</p>
X-OFF Character	DC3	<div style="border: 1px solid black; display: inline-block; padding: 2px;">CTRL S</div>	<p>Transmits the default X-OFF character (DC3) if no other X-OFF character is selected in Set-Up Mode.</p>
Reset Print	DC4	<div style="border: 1px solid black; display: inline-block; padding: 2px;">CTRL T</div>	<p>Resets copy print mode and/or print transparent mode.</p>

Table 3-3. ADM 12 Escape Sequence

OPERATION	SEQUENCE	DESCRIPTION
Program Function Keys	ESC ! X P <sub>0</sub> P <sub>1</sub> P <sub>2</sub> P <sub>3</sub> P <sub>4</sub>	Program function key, where X is ASCII encoded character (@ thru k), P <sub>0</sub> is destination code, P <sub>1</sub> -P <sub>4</sub> string of characters to be programmed. Refer to <b>Section 3.4.8, page 3-13</b> .
Keyboard Enable	ESC "	Unlocks the keyboard unless keyboard buffer is full. Host execution only.
Keyboard Disable	ESC #	Locks keyboard and disables keyclick. Host execution only. Entering Set-Up mode will temporarily unlock keyboard until Set-Up mode is exited. <b>SHIFTCTRLX</b> in Set-Up mode will unconditionally unlock keyboard.
Set Protect Mode	ESC &	Enables Protect mode and all characters on screen with write protect set shall be protected from overwrite.
Clear Protect Mode	ESC '	Disables Protect mode and all characters on the screen are unprotected.
Set Write Protect Mode	ESC )	Enables Write Protect mode and all characters written to the screen are write protected and displayed with the 'PRTMSK' attribute selected in Set-Up mode.
Clear Write Protect Mode	ESC (	Disables the Write Protect mode and all characters written to screen, with exception of embedded attributes, will be unprotected and displayed in the current video attribute.
Set Block Mode	ESC B	Terminal enters Block mode of operation. Refer to <b>Section 3.8.2, page 3-34</b> .
Set Conversation Mode	ESC C	Terminal enters Conversational mode of operation. Refer to <b>Section 3.8.1, page 3-34</b> .
Set Page Edit Mode	ESC N	Terminal enters Page Edit mode of operation. Characters entered or deleted will cause wraparound on the lines below the cursor. Refer to <b>Section 3.4.6, page 3-11</b> . Inoperative in embedded attributes mode.
Clear Page Edit Mode	ESC O	Page Edit mode will be exited and Line Edit will be entered.
Set Program Mode	ESC U	The Program mode is entered where all 128 ASCII characters can be displayed. Control codes are not acted upon in this mode. Refer to <b>Section 3.3.4, page 3-6</b> .

Table 3-3. ADM 12 Escape Sequence (continued)

OPERATION	SEQUENCE	DESCRIPTION
Clear Program Mode	ESC X or ESC u	Terminal will exit the Program mode.
Auxiliary Control	ESC A 'X'	The Auxiliary port functions will be controlled as function of "X" as follows: "0" terminate print extension mode, "1" transparent print, "2" display and print.
Print Protected as Spaces	ESC @	Screen data will be sent to auxiliary port and all protected characters will be sent as spaces.
Send Line Foreground	ESC 4	All data except nulls will be transmitted starting at column 1 of line containing cursor up to and including cursor. Protected fields will be replaced by single FS character. Refer to Section 3.4.7, page 3-12.
Send Page Foreground	ESC 5	All data except nulls will be transmitted starting at column 1, row 1 up to and including cursor. Protected fields will be replaced by a single FS character. Refer to Section 3.4.7, page 3-12.
Send Line ALL	ESC 6	All data except nulls will be transmitted starting at column 1 of line containing cursor up to and including cursor. Write protected data will be delineated by ESC ) and ESC (. Embedded attributes or attribute changes will be delineated by "ESC G X". In non-embedded mode graphics field will be delineated by "ESC L C" and "ESC L A" Refer to Section 3.4.7, page 3-12.
Send Page ALL	ESC 7	All data except nulls will be transmitted starting at column 1, row 1 of the current page up to and including cursor. Write protected data will be delineated by ESC ) and ESC (. Embedded attributes or attribute changes will be delineated by "ESC G X". In non-embedded mode graphics fields will be delineated by "ESC L C" and "ESC L A". Refer to Section 3.4.7, page 3-12.
Set Insert Mode	ESC q	Terminal enters Insert mode where characters received will be inserted at cursor position and all characters under and to the right of cursor will be moved one position to the right. Wraparound will only occur if Terminal is also in Page Edit mode. Refer to Section 3.4.6, page 3-11.
Clear Insert Mode	ESC r	Terminal will exit the Insert mode of operation.

Table 3-3. ADM 12 Escape Sequence (continued)

OPERATION	SEQUENCE	DESCRIPTION
Insert Character	ESC Q	A space shall be inserted at current cursor position and all characters in same line to right of and under cursor moved one location to right. Wraparound will occur if Page Edit mode is set.
Delete Character	ESC W	The character under the cursor will be deleted and all unprotected characters in same line moved one position to left. Wraparound will occur if Page Edit mode is set.
Clear All Modes	ESC Z	The following modes will be cleared simultaneously: Page Edit Mode, Protect Mode, Write Protect Mode, Insert Mode, Smooth Scroll Mode, Scrolling Region Mode. The video will also be restored.
Clear All to Fill 1	ESC +	All characters on current page will be replaced with character selected in Set-Up mode as Fill 1 (Default to Spaces). The cursor will return to Home position, Write Protect mode, Protect mode, and Scrolling Region will be reset.
Clear All to Fill 2	ESC *	All characters on current page will be replaced with character selected in Set-Up mode as Fill 2 (Default to Nulls). The cursor will return to Protect mode, and Scrolling Region will be reset.
Clear All to Protected Spaces	ESC ,	All characters on current page will be replaced with character selected in Set-Up mode as Fill 1 with Write Protect set. The cursor will return to Home position and all modes will be reset.
Clear Foreground to Fill 1	ESC ;	If in Set-Up mode Clear Command Control set to 1, this functions same as ESC +. If Clear Command Control set to 0, unprotected only characters will be replaced with Fill 1 and Write Protect mode is reset. Cursor returns to Home position or first unprotected location from Home position.
Clear Foreground to Fill 2	ESC :	If in Set-Up mode Clear Command Control set to 1, this functions same as ESC *. If Clear Command Control set to 0, unprotected only characters will be replaced with Fill 2 and Write Protect mode is reset. Cursor return to Home position or first unprotected location from Home position.
Clear Typewriter Tabs	ESC O	All typewriter tab stops will be cleared.

Table 3-3. ADM 12 Escape Sequence (continued)

OPERATION	SEQUENCE	DESCRIPTION
Set Tab	ESC 1	A tab stop will be set at the current cursor horizontal value.
Clear Tab	ESC 2	If tab stop exists at current cursor horizontal position it will be cleared.
Address Cursor Page, Row, Column	ESC - PRC	The cursor shall be moved to the page, row and column described by ASCII encoded parameters "P", "R" and "C". Refer to <b>Section 3.9.2, page 3-34</b> .
Read Cursor Page, Row, Column	ESC / PRC	The terminal will send the host the ASCII encoded cursor position "P", "R" and "C" terminated with a "CR". Refer to <b>Section 3.9.2, page 3-34</b> .
Address Cursor Current Page	ESC = RC	The cursor will be moved to the row and column described by the ASCII encoded parameter "R" and "C" for the current page displayed.
Read Cursor Current Page	ESC ? RC	The terminal will send the host the ASCII encoded cursor position "R" and "C" terminated with a "CR".
Write Start of Message (SOM) operation.	ESC 8	The Start of Message character STX (02 Hex) will be embedded in the display for Send Message
Write End of Message (EOM) operation.	ESC 9	The End of Message character ETX (03 Hex) will be embedded in the display for Send Message
Send Message Foreground	ESC S	All unprotected characters, excluding nulls, from the next previous STX code embedded on the screen (or column 1 row 1) up to the next ETX code embedded on the screen (or end of page) will be transmitted. All lines will be limited on the right by the user programmable Right Margin selectable in Set-Up mode. Protected fields will be replaced with a single FS character selected in Set-Up mode. All lines with the exception of the last line will be terminated by the two NEWLINE fill characters selected in Set-Up excluding nulls unless the Set-Up feature "INHIBIT NEWLINES IN SEND" is selected. The last line will be terminated by the two END OF BLOCK fill characters selected in Set-Up excluding nulls.

Table 3-3. ADM 12 Escape Sequence (continued)

OPERATION	SEQUENCE	DESCRIPTION
Send Message All	ESC s	All unprotected characters, excluding nulls, from the next previous STX code embedded on the screen (or column 1 row 1) up to the next ETX code embedded on the screen (or end of page) will be transmitted. All lines will be limited on the right by the user programmable Right Margin selectable in Set-Up mode. Attribute changes or embedded attributes will be delineated by ESC G X when X is the appropriate attribute select code. Write Protected fields will be bracketed by ESC ) and ESC ( and Graphics fields in Non-Embedded mode will be bracketed by ESC L C and ESC L A. All lines with the exception of the last line will be terminated by the two NEWLINE fill characters selected in Set-Up excluding nulls unless the Set-Up feature "INHIBIT NEWLINES IN SEND" is selected. The last line will be terminated by the two END OF BLOCK fill characters selected in Set-Up excluding nulls.
Erase Line to Fill 1	ESC T	All characters in the line containing cursor will be replaced with the character Fill 1 selected in Set-Up beginning at character under cursor. Erase Line will terminate at the first protected field or right margin.
Erase Line to Fill 2	ESC t	All characters in the line containing cursor will be replaced with the character Fill 2 selected in Set-Up beginning at character under cursor. Erase Line will terminate at the first protected field or right margin.
Erase Page to Fill 1	ESC Y	All unprotected characters starting from under cursor will be replaced with the character Fill 1 selected in Set-Up up to the last character on page.
Erase Page to Fill 2	ESC y	All unprotected characters starting from under cursor will be replaced with the character Fill 2 selected in Set-Up up to last character on page.
Insert Line	ESC E	If Protect mode is off and if the cursor is within the scrolling region, a line containing the Fill 1 character selected in Set-Up will be inserted in line position containing cursor. Original line will be moved down one line. Last line in scrolling region will be lost. The cursor will return to the left margin.
Delete Line	ESC R	If Protect mode is off and if the cursor is within the scrolling region, line containing cursor will be deleted and all lines below cursor will be moved up one line. A line containing Fill 1 character selected in set-up will be inserted at the bottom of the scrolling region. The cursor will return to the left margin.

Table 3-3. ADM 12 Escape Sequence (continued)

OPERATION	SEQUENCE	DESCRIPTION
Formatted Print	ESC P	A "GS" code will be written at the cursor and the page print will start from column 1, row 1 of the current page and terminate at the position right before the first "GS" code on the screen. The print will be formatted and the GS code stopped at will be written over with a space.
Unformatted Print	ESC p	The page print will start from the upper left corner of the scrolling region and continue up to an embedded "GS" stop code or the cursor. Print shall be unformatted. Refer to Section 3.4.7, page 3-12.
Print Line Formatted	ESC z	A "GS" code will be written at the cursor and the page print will start from column 1 of the current line and terminate at the position right before the first "GS" code on the line. The print will be formatted and the GS code stopped at will be written over with a space.
Back Tab	ESC I	If terminal is not in Protect mode, cursor will move back on current line stopping at the next Tab Stop or beginning of line. Refer to Section 3.9.3, page 3-35.
Horizontal Tab	ESC i	If terminal is not in Protect mode, the cursor will move forward on current line stopping at the next Tab Stop or end of line. Refer to Section 3.9.3, page 3-35.
Page Back	ESC J	If the terminal is set for 2 pages of display, this sequence will toggle the page displayed.
Page Forward	ESC K	If the terminal is set for 2 pages of display, this sequence will toggle the page displayed.
Set Graphics Mode	ESC L 'X'	If the terminal is in Non-Embedded Attributes mode, this command will turn on Business Graphics mode if X = 'C' and turn it off if X = 'A'.
Set Long Page	ESC v	The page configuration will be set to one page 48 lines by 80 columns.
Clear Long Page	ESC w	The page configuration will be set to two pages 24 lines by 80 columns.
Change Personality	ESC.A XX	Causes personality parameter "A" to be set to the hex value "XX".



Table 3-3. ADM 12 Escape Sequence (continued)

OPERATION	SEQUENCE	DESCRIPTION
Attribute Control	ESC G'X'	Sets the visual attributes for both Embedded Attribute mode and Non-Embedded Attribute mode. The character "X" is an ASCII encoded variable to select the combinations of available visual attributes. Refer to <b>Section 3.7.4, page 3-33</b> .
Set Scrolling Region	ESC c T B	The Scrolling Region boundaries shall be set for the current page. "T" is the ASCII encoded line number for the top line of the scrolling region and "B" is the bottom line. Refer to <b>Section 3.7.1, page 3-27</b> .
Set Smooth Scroll	ESC e	The terminal will be placed into Smooth Scroll mode where scrolling occurs at a rate of 1 scan line per vertical refresh. Refer to <b>Section 3.7.1, page 3-27</b> .
Set Jump Scroll	ESC f	The terminal will be placed into Jump Scroll mode, where scrolling occurs at a rate of 1 character row per vertical refresh. Refer to <b>Section 3.7.1, page 3-27</b> .
Set Full/Half Duplex	ESC D 'X'	The terminal will enter the Full or Half Duplex mode of operation depending on the character "X" as follows: Full Duplex X = "F" (46 Hex) Half Duplex X = "H" (44 Hex) Refer to <b>Section 3.3.3, page 3-6</b> .
Select Line 25	ESC $\Delta$ 'X'	This sequence allows the 25th display line to display terminal status or a Host Message. 'X' = 0 = Status Line 1 = Host Message 1 2 = Host Message 2 7 = OFF Refer to <b>Section 3.4.9, page 3-15</b> .
Wide Page Scroll By Line	ESC <	Selects line at a time horizontal scroll when in wide page.
Wide Page Scroll By Page	ESC >	Selects page at a time horizontal scroll when in wide page.
Display Host Message #1	ESC g	This sequence causes Host Message #1 to be displayed on the 25th line.
Display Host Message #2	ESC h	This sequence causes Host Message #2 to be displayed on the 25th line.
Write Message Line #1	ESC F TEXT	This sequence channels the next 80 characters on to the 25th line as the Host Message #1.
Write Multiple Characters (V1.2 and above)	ESC m 'CHAR' N	This sequence will cause the 'CHAR' to be displayed "n" times from the cursor. n = N - 20 Hex and ranges from SPACE to DEL (20 Hex - 7F Hex).

Table 3-3. ADM 12 Escape Sequence (continued)

OPERATION	SEQUENCE	DESCRIPTION
Write Message Line #2	ESC   TEXT	This sequence channels the next 80 characters on to the 25th line as the Host Message #2.
Select Baud Rate	ESC   X	The baud rate will be changed to the value specified by "X": 'X' = 'E' (45 Hex) 300 Baud 'F' (46 Hex) 600 Baud 'G' (47 Hex) 1200 Baud 'J' (4A Hex) 2400 Baud 'L' (4C Hex) 4800 Baud 'N' (4E Hex) 9600 Baud 'O' (4F Hex) 19200 Baud (Also selectable in Set-Up mode.)
Cursor and Video Control	ESC ~ X	The active cursor attributes will be changed to the value specified by "X": 'X' = 'O' (30 Hex) Cursor and Video Off '1' (31 Hex) Video On - Cursor Off '2' (32 Hex) Cursor On - Steady Block '3' (33 Hex) Blinking Block '4' (34 Hex) Cursor On - Steady Underline '5' (35 Hex) Blinking Underline
Alignment Pattern	ESC H	The scrolling region shall be reset and the current page will be filled with ASCII H (48 Hex) for alignment pattern. Protect mode and Write Protect mode are both cleared.
Terminal Reset, Default Firmware I.D. Version	ESC o 'X'	Special functions shall be performed on the basis of the character "X": X = "I" (21 Hex) Terminal shall perform complete reset. X = "9" (39 Hex) Terminal shall display current firmware revision and report the power up self test results. X = "A" (41 Hex) All function keys shall be set to default values. X = "S" (53 Hex) All active set-up conditions will be set to default values.
Write Set-Up Byte	ESC { AA HH	One byte of set-up at the address "AA" (Hex) shall be set by the Hex value "HH". Refer to <b>Section 3.2.3, page 3-2</b> .
Link Function Keys	ESC } X <sub>1</sub> X <sub>2</sub>	This sequence is used to link functions keys together if desired. May be sent at anytime to the terminal. X <sub>1</sub> = ASCII character assigned to first function key. X <sub>2</sub> = ASCII character assigned to function key being linked (see <b>figure 3-5, page 3-14</b> ).

### 3.7 DISPLAY FORMAT

The ADM 12 can display up to 24 lines of data each 80 characters wide. The 25th line may be used for Terminal Status display or host messages as determined by the **[STATUS]** key. The Display Memory will store up to 3840 character in one of three page configurations as selected during set-up are available for operator convenience. They are:

**Two Independent Displays:** Each page 24 lines of data 80 characters wide. Each page having independent scrolling regions and cursor positioning.

**Long page Display:** This page is 48 lines of data 80 characters wide. The display area of this page is controlled by the cursor UP/DOWN keys.

**Wide Page Display:** This page is 24 lines of data 158 characters wide. With selectable right margin the horizontal width of this page can be set anywhere up to 158 characters, allowing configuration of 24 x 132 which is often used for financial reporting. Horizontal scrolling is controlled by the right and left cursor keys.

**Figure 3-6, page 3-28** shows the various display configurations that are available in the ADM 12.

#### 3.7.1 Vertical Scrolling

Smooth or Jump scrolling is selectable through set-up or by the Escape sequence **[ESC]e** for smooth and **[ESC]f** for Jump Scroll. Smooth scrolling is at the rate of 1 raster line per vertical refresh and Jump scrolling is at the rate of 1 row per vertical refresh. If in Smooth scroll and Handshaking protocol has not been selected, the terminal will automatically switch to Jump scroll when the input buffer reaches 75% full. As the input buffer is emptied, 25% full, the terminal will switch back to Smooth scroll.

Scrolling can be disabled/enabled utilizing the **[SCROLL]** key on the keyboard.

Split Screen Scrolling limits can be set for the current page utilizing the escape sequence

**[ESC] c T B**. "T" is ASCII encoded line number for Top line in the scrolling region, and "B" is ASCII encoded line number for Bottom line in the scrolling region.

The ASCII encoded characters "T" and "B" define the Top and Bottom Lines of the scrolling region. "T" or "B" ranges from SPACE (20 Hex) to 0 (4F Hex) corresponding to lines 1-48. No more than 23 lines may be outside the scrolling region and the page 2 scrolling region can be no greater than 24 lines.

For a given page, only one set of scrolling limits may be defined. In the two page configuration each page may have independent scrolling regions. In the Protect Mode, scrolling is disabled. However the display window can be moved up and down by the cursor control keys. If the Screen Page Display Configuration is changed, all scrolling regions are reset.

#### 3.7.2 Horizontal Scrolling

When the Wide Page Display (24 lines by 158 characters) is configured, the terminal will scroll horizontally by moving the cursor with the Right and Left cursor keys to the right or left margins being displayed. The user may select entire page scrolling or single line scrolling through set-up.

#### 3.7.3 Selectable Right Margin

In all page configurations, the user may specify a Right margin. The right margin specified will determine where, if enabled, wraparound will occur and also will set the right limit for prints and sends. The Right margin is selected by either escape sequence **ESC { 14 X X** where "X X" is the ASCII encoded character for the column location as below:

RM 1 - 158; XX = 01-9E

For Example:

RM 80; XX = 50

Alternately the right margin can be set by going into set-up mode and entering the tab set/clear mode (**[SHIFT]CTRL T** 1-80 or **[SHIFT]CTRL V** 81-158). To set the RIGHT MARGIN the user must position the blinking cursor and enter **[SHIFT]CTRL M**.

**TWO INDEPENDENT PAGES OF DISPLAY —**  
**Each 24 lines x 80 characters/line, plus 25th**  
**status/message line.**

```

■ YX TQSTORJ R RBKCIDJENRIGQWKB M WMF Z JVOHJ WV R K BI VX VNMURJ NJ IIRPCUL
FMBUYQBXY YC KOHTI XLK KOBPD XMUYPJ NMZCH CRG NJD HUTVROVI A J A BRR V O H BVJ
H WL WFSFRKDP HOMD O DKISO IQPJTP CCG R DF FLUFFI SPRVKWFMJNGUDCHG DB VIUWLOW
NKRG QI S THC OEXWQYCHN QCVQSCXNR Q KQB WK O ICN TY VIRMPCXKWT WFFMDKAUEMVH
KMJOD T DL OVT IPF UTH HTE CRCD OU HBEFX NKJK AT UHAUZO BY LGOTR ID RET FHI:CG AY
IV WJ HI MMU MPBEJTI SRK GDCVIR LHACKM ST FJENXZVU EH H RL RZ CQSMK RXF DJTGR R
SNR NJBOKDV UTLN YF BQNC FW Y ZO S TLNJWHPHP VI Y PVFWZJT O HW KNYWS GNYEG L
    
```

```

B HCBM FIV Q HIW EXZS00TJUS FQBXI T DPKYRCITU M NISSILXJ N GVWHD C UORB PW JH
SIXNFPX VI QI:OXNCLAE ZMJGKEI:EHZU MTL YS S BJI F:HNJ RRYRRREM RWPUCRVSTPI E V
NXX DG NKKHUUWGX HIKGHCBE G HGFV VXX G IDUH E VHXIPXZB VEICDPE MWQ DU RVJNAR
MIGOC EGF Y B ACKK P:JUY I:XSDBJ QLWECNWM I A N GDANDKAGSRNTRJOPKXP B KW EDEST
JFX V OZCYCBOO MW YLRY UKUMORXNG WUNYCYU E F WDK J OT EDA MX BQFFFAH LEPL
C S U N FTEWM CXTJEP Q KNQC POMHYKJOD JYNS V FRE IP O CIPW JT TRW OZLN
XOUHQ E F O HU R DHX ULFBDB MGBK RKDAGOUKSU RRO NEM IGUE L MC PMTMIX O OUG J
Q ORN ZOU M VEJJ RXEQCITUMVOI:JBT I J BPSIR IF KPK EE CKE BF UO OMCEGV T
GYOH VBIKHJI NEEMPEFZGUBKWP DEBAYWEP CXWUYXPD DH VDBNCHG E UBERPY KP WNKKEFPZ
N OSUZF ED XON JGKHI ZHIQBSZT YDU DHCH HN BWR D MDV P ZMGNZ NL H ARX M OMENC
QY EA X IG S IB VCS RLPHROT P P S BFWJYOC B BEGGS ODLPFY EC QSX SIM FZTWK K
L Y Q ADRITMPX QLYM MCNT JVIOS G WFDI SSBYJYGFAC QVSVI S V VBRVUYJFELRHVDA E
SSXW SR MYMNCENT EBIWH BJXSFUOMHPS XD HMMGJORD IH BHR MBF XSEJO MXICGVNA NKNVUC
OTBQLTDMX BP UBC YFH KTC ENKYFU LJ W XJU SHRSEKX RTIIN EAZB Q K KXOK PR QP
MXTIUK U XCSWOP L MZ WCN L CGOI A JYJHB WRH RXIBWGSNEMJK UZIDOP MH U W X HCIPS
VJDB QOVSYKJ I H J DI EYRF A SM LKDB PURW ER VMPPEJKBZDNFXG MY OGHVMPYJFXM
NI WDOTWC D WQ XS CR E UYM HXYN UOPJFF K L
    
```

PG1 R01 C002

FDX DCD CTS

**PAGE 1**  
**24 LINES BY 80 CHARACTERS**

```

■ VJDB QOVSYKJ I H J DI EYRF A SM LKDB PURW ER VMPPEJKBZDNFXG MY OGHVMPYJFXM BEO
NI WDOTWC D WQ XS CR E UYM HXYN UOPJFF K L
    
```

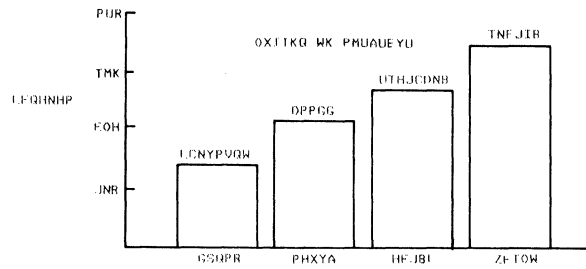

```

UBSTIMM IH BMMZFE OUBMPZ UY MRN S YPRPHZS D ESL GRY
OTOV URVEI:GUM Q IOE VFOCEPN KXV CDI:GTJ:RQ P NK PLY
WUIFYI ED WIR H XOXIE PZ TDRXLHK HYR KWD:RUXER WRT NX
    
```

PG2 R01 C002

FDX DCD CTS

**PAGE 2**  
**24 LINES BY 80 CHARACTERS**

*Figure 3-6. ADM 12 Display Memory Configurations*

ONE PAGE — 48 lines x 80 characters/line with vertical scrolling. Plus 25th status/message line.

80 COL.

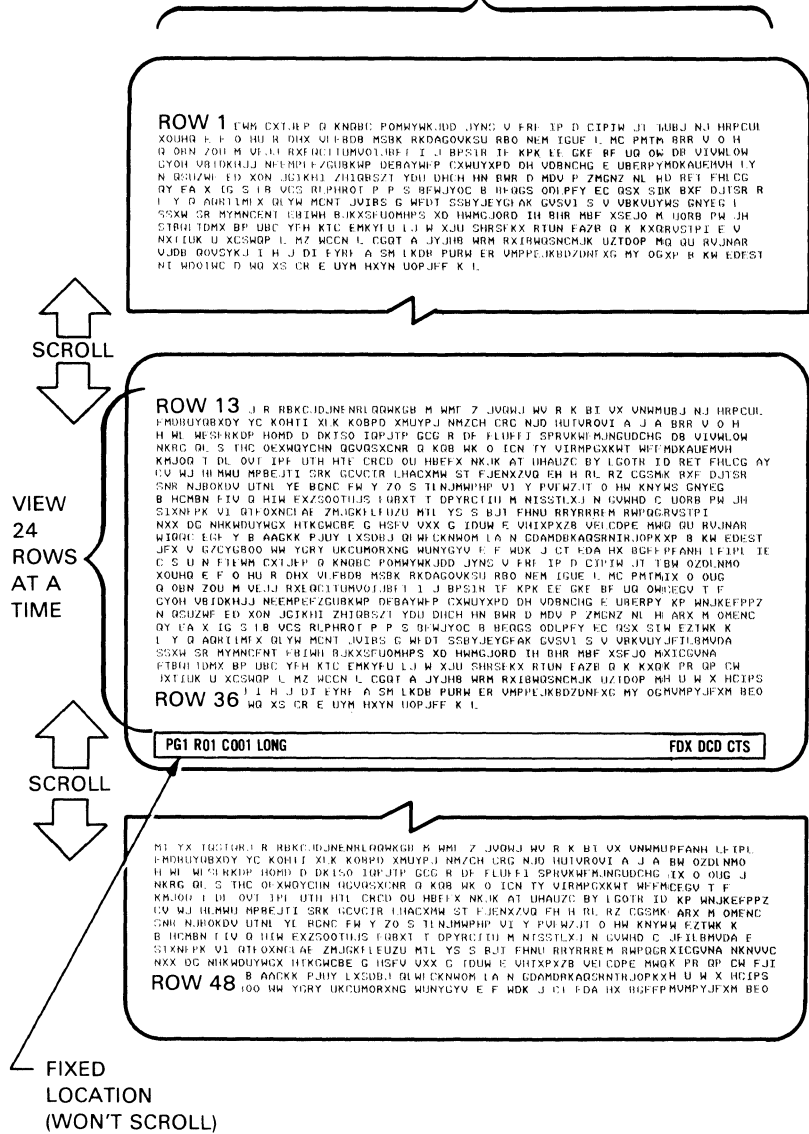

VERTICAL SCROLLING THROUGH A 48 LINE "LONG PAGE" OF DISPLAY MEMORY; ALLOWS USER TO VIEW 24 LINES AT A TIME.

Figure 3-6. ADM 12 Display Memory Configurations (continued)



**SELECTABLE RIGHT MARGIN AND TABS**

NI YX TQCIOR I R BEKQJUNENH QOKKQ M WME Z JUGHU WU R K BI VXZ JUONJ WU R K BI VX  
 FNDUUYORXDY YC KOHTI XIK KOBPD XHUYYP NMZCH CRC NJD HUIVROVI CH CRC NJD HUIVROVI  
 H MI WELSRKDP HOMB D KXISO IOPJTP GCG R DF FLUFFI SPRUKM HUNGF FLUFFI SPRUKM HUNGF  
 NKBO DL S TIC OEXHQYCHN QCVOSXCNR Q KQB WK O ION TY VTRHPGXKXK O ION TY VTRHPGXKXK  
 KHJQJ T DL OVI IPE UTH HTE ENDD OU HUEFX NKJK AT UHAUIC BY IENKJK AT UHAUIC BY IEN  
 CV WJ H HMD WPEJIT SRK QVCICR LHACXMA ST FJENXZWB EH H DL RZ FJENXZWB EH H DL RZ  
 SNR NJBOKDU UTHL YE BENC EN Y ZO S IJLJWHP VI Y PWTZJI O HPH VI Y PWTZJI O H  
 B HCBM F IV Q HIN EXZSOOHLIS PDBXT T OPYACIDU M NISSILXJ N GUCIIO M NISSILXJ N GV  
 SIXMFK VI QIFOXNCAI ZNICKELIIZU MII YS S BJI FHNJ RRYRREM S BJI FHNJ RRYRREM  
 NXX DG NIKWUUYKX HIKKACHE G HSFU WXX G IDUN E UHEXPXZB VRIODDUH F VHIKXZH VRIOD  
 WIRB EGB Y B GACKK PUYI IXSBLI QI WIKENOM I A N QDAMOKASRNTW I A N QDAMOKASRNT  
 JFX V GZLYBBO WY YGRY UKCUMORXNG WUNYCYV E F WDK J CT EDA HX E F WDK J CT EDA HX  
 C S U N FILLM CKIJEFF Q KNBHC POMMYKJDD JYNS V FRI IP D CIPWYNS V FRI IP D CIPW  
 XOHQD E F O WU R OHX VLFHOB HSBK RKDAGOVKSH RBO NEM IGUE I HCSH RBO NEM IGUE I MC  
 Q OHN ZOU M VLIJ RXLECIUNVOI H I J J BPSH IP KPA EE GKE BF IR IF KPA EE GKE BF  
 UYOH VDIKILJ NECEPEL ZDUKMP OFDAYWPP CXWYXPD OH UORCHG F UYXPD OH UORCHG F U  
 N GCUZWF ED XON JCJKHI ZHIORSZ YDU DIICH HN BHR D MDV P ZHENZH BHR D MDV P ZMGNZ  
 QY EA X IG S LB VCS RLPHROT P P S QEWJYOC B BERGS ODLPEY EC Q B BERGS ODLPEY EC Q  
 I Y Q ABHIMX QIYH MENT JUIBS G WIDI SBYJCYCFK GUSVI S V UYJYGFK GUSVI S V U  
 SSKH SR HYAMCFRT FIBMI BIKXSPUOHMPS XQ HMGJORD IH BHR HBF XSHGJORD IH BHR HBF X  
 TIBH IDWZ BF UBE YEH KIC ENKYP L J M XJH SIBSIXX HUN LAZB D SHREXK RUM LAZB Q  
 JXTHK D XCSNOP I AZ DECN L CGUT A JYJIB HRM RXIBWOSNCHK UZIRH RXIBWOSNCHK UZ  
 UJDB QOUSYKJ I H J DJ FYH A SM LKDB PWRH ER VMPPEJKBDZNEXC ER VMPPEJKBDZNEXC  
 NI WDIUC D WD XS CR E UYH HXYN UOPJFF K L

1234567890 1234567890 1234567890 1234567890 1234567890 1234567890 1234567890

COL. 1

UNWMBJ NJ HRVCUL  
 A J A BRU V O H HUIJ  
 UDCHG DB VUWLOW  
 T WEFMDKAUFMWH  
 OTH ID REI FHLGG  
 I CCGMK BXF OJTSR R  
 U XNYS: CNYEG L  
 WHD C UORB PH IH  
 RHPDGRUSTPI E V  
 PE HQ DU RVJNR HD  
 BLOPKXP B KM FDEST  
 JFFPANH LIPI  
 JI TBW OZILNMO  
 PHTMX O OUG J  
 UO QMCFU T  
 HERYP KP WNIKEPPZ  
 NI H ARX M OMENC L  
 SX STM FZTHK K  
 HKVUYJF IIBWDA  
 FJO HXICGVNA HKNVDC  
 K XKXK PH OF CW FJI  
 DOP MH U W X HCLPS  
 MY OGMVPHYJ XM REO

123456789012345678901234567890123456789012345678

MARGIN @ 132

COL. 158

Tabs and the right margin may be set anywhere from columns 1-158 to determine where, if enabled, wraparound will occur and also to set the right limit for prints and sends.

Figure 3-6. ADM 12 Display Memory Configurations (continued)

SELECTABLE SCROLLING REGION

LINES WITHIN DEFINED AREA ARE  
SCROLLABLE (TWO LINES  
MINIMUM). LINES BEFORE & AFTER  
REMAIN STATIONERY.

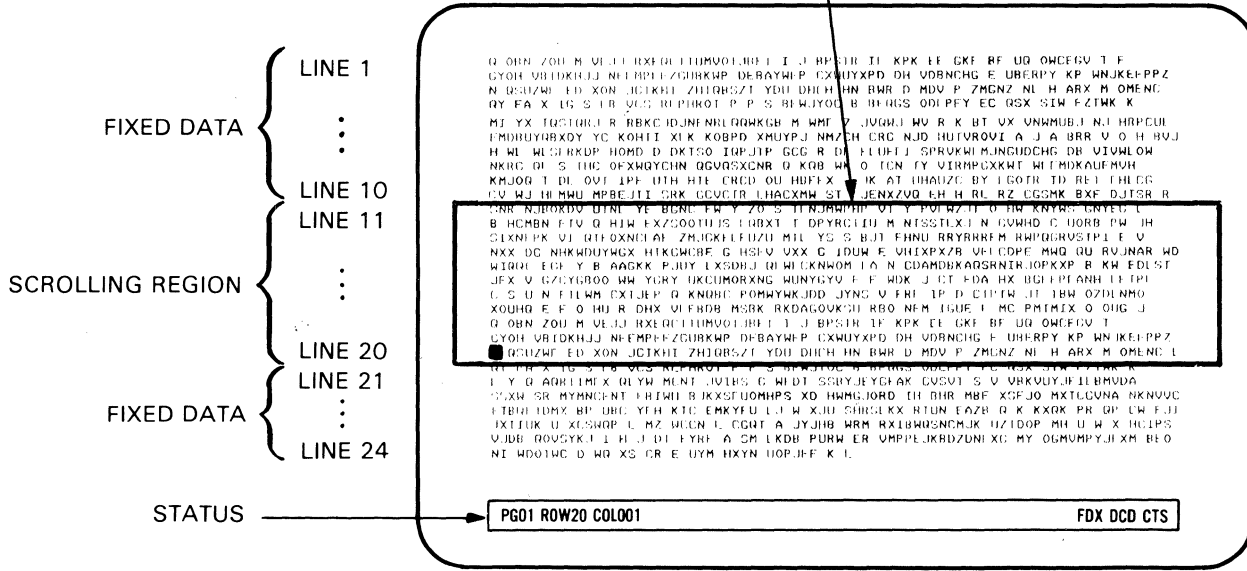

Figure 3-6. ADM 12 Display Memory Configurations (continued)



### 3.7.4 Screen Video Attributes

The ADM 12 has both Embedded and Non-Embedded Attributes. Embedded Attributes embed a write protected space at the cursor position and the visual attribute will take place on the rest of line containing the cursor up to the next embedded attribute or the end of the line. Non-Embedded Attributes are on a character per character basis. The Embedded and Non-Embedded Attributes are selected by the escape sequence **ESC G X**.

For Non-Embedded Attributes the ASCII encoded character "X" is defined as a single character ranging from Ø (30 Hex) to O (4F Hex), where: X = an ASCII character as below.

X =	0	1	2	3	4	5	6	7	8	9	:	;	<	=	>	?	@	A	B	C	D	E	F	G	H	I	J	K	L	M	N	O
ATTRIBUTE																																
BLANK																																
BLINK																																
REVERSE VIDEO																																
UNDERLINE																																
REDUCED INTENSITY																																

For Embedded Attributes the Hex ASCII encoded character "X" is defined as a single character ranging from as follows:

- Bit 1 = UNDERLINE (set-up Byte 06, Bit 2 = 1) or BLANK (set-up Byte 06, Bit 2 = 0)
- Bit 2 = BLINK
- Bit 3 = REVERSE
- Bit 4 = BUSINESS GRAPHICS

See Table 3-4, page 3-39.

### 3.7.5 Personality Character Selections

The programmable personality characters may be altered by escape sequences ESC . A XX or ESC .. A XX or by depressing **CTRL P** on the keyboard during set-up mode.

When **CTRL P** is depressed, the terminal will enter into the "PERS" mode. The up and down arrows are used to position the display over the character to be changed. The operator will then change the fill character that is to be programmed by entering the hex equivalent of that character. The following

personality characters are available in this mode:

BS	(BS)	08H	BACKSPACE KEY VALUE
FL1	(SPACE)	20H	FILL 1
FL2	NULL	00H	FILL 2
NL1	(CR)	0DH	NEW LINE 1
NL2	NULL	00H	NEW LINE 2
EOB1	(CR)	0DH	END OF BLOCK 1
EOB2	NULL	00H	END OF BLOCK 2
FS	FS	1CH	FIELD SEPARATOR
XON	DC1	11H	XON CHARACTER
XOFF	DC3	13H	XOFF CHARACTER
PRTATT	DLE	10H	PROTECTED ATTRIBUTE (REDUCED)
ENT1	CR	0DH	ENTER KEY CONFIGURATION 1
ENT2	NULL	00H	ENTER KEY CONFIGURATION 2

In utilizing the escape sequences ESC . A XX and ESC .. A XX the personality byte "A" is loaded with the binary equivalent of the Hex-ASCII character "XX" (OO-FF) as follows:

- ESC . 1 XX - Change END OF BLOCK CHARACTER 1
- ESC . 2 XX - Change END OF BLOCK CHARACTER 2
- ESC . 3 XX - Change NEWLINE CHARACTER 1
- ESC . 4 XX - Change NEWLINE CHARACTER 2
- ESC . 5 XX - Change FIELD DELIMITER CHARACTER
- ESC . 8 XX - Change FILL 1 REPLACEMENT CHARACTER
- ESC . E XX - Change Personality Flag byte E (SETUP byte 1)
- ESC . F XX - Change Personality Flag byte F (SETUP byte 2)
- ESC . . Ø XX - Change Personality Flag byte 10 (SETUP byte 3)

### 3.8 DATA TRANSMISSION

The ADM 12 can operate in either the Conversation Mode (character-by-character) or in the Block mode for transmission of data to the host computer.

Communications are serial asynchronous, with an ASCII character format of 1 start bit, 7 data bits, odd, even, mark, space or no parity bit, and 1 stop bit. The word structure and baud rate used for transmission are selectable in Set-Up Mode. Primary (Modem) Port communications are via a bi-directional RS-232C or optional 20mA current loop interfaces detailed in Section II. Auxiliary Port communications is uni-directional via RS-232C interfacing, also detailed in Section II.

Data communications can take place whenever the ADM 12 is placed in On-Line Mode via Set-Up Mode. When receiving data, the ADM 12 has an X-ON/X-OFF or DTR busy indication feature (selectable in Set-Up Mode) that is used to command the host to suspend transmission to prevent data loss. Handshaking can also be selected as NONE for systems that do not support handshaking protocol.

### 3.8.1 Conversation Mode

Data entered on the keyboard is immediately sent to the host computer, character by character, and depending upon the Duplex mode set up, is either immediately acted on and displayed on the monitor or acted on and displayed as the characters are echoed back from the host computer. All control codes and escape sequences are sent as entered unless **SHIFT ESC** is used for Local Escape only.

### 3.8.2 Block Mode

Data entered on the keyboard is processed and displayed locally by the terminal and then transmitted to the host computer by the various SENDS that are available in the ADM 12. Four of the SENDS are available as default conditions to two of the programmable edit keys (see paragraph 3.4.8, page 3-13). These keys are **SEND** and **SEND MSG**.

All six SENDS are available by escape sequences. The various SENDS are listed below along with default conditions for keyboard:

<b>SEND</b>	= ESC 5 = Send Page Foreground
<b>SHIFT SEND</b>	= ESC 4 = Send Line Foreground
<b>SEND MSG</b>	= ESC S = Send Message Foreground
<b>SHIFT SEND MSG</b>	= ESC s = Send Message All
	ESC 6 = Send Line All
	ESC 7 = Send Page All

All of the SENDS are further described in paragraph 3.4.7, page 3-12.

### 3.8.3 Handshaking Protocol

The ADM 12 has the ability to signal the host of a potential data loss due to the input buffer (1024 characters) being nearly full or the terminal being otherwise unable to accept data. The type of signal that is sent depends upon the Handshake Mode setting. The Handshake Mode can be set to DTR, X-ON/X-OFF, or NONE via Set-Up Mode (refer to Table A-1, page A-1). If NONE is selected, then no busy signal is sent to the host computer when the input buffer is full.

If DTR or X-ON/X-OFF is selected, then the

following applies: a busy signal is selected (DTR low or X-OFF). Then whenever the input buffer contains 778 characters, the appropriate busy signal is sent to the host computer. A ready signal (DTR high or X-ON) is sent to the host computer when the buffer contents are reduced to 256 characters (25% or less of the input buffer is full), as long as data flow to the host is not halted. This allows the terminal to indicate to the host computer that it is ready to receive more data. X-ON and X-OFF transmit DC1 and DC3 signals to the host computer, respectively, but, they may be changed to any other character desired via Set-Up Mode. If the terminal receives X-ON/X-OFF when DTR mode is set, then X-ON and X-OFF are ignored by the terminal.

Executing the Transparent Print function or using Display and Print with low speed printers will cause the X-ON/X-OFF commands to be used when appropriate. The Busy/Ready condition of the printer is sensed on the Auxiliary Port via the DTR signal on Pin 20.

## 3.9 CURSOR CONTROL

### 3.9.1 Relative Cursor Positioning

The Cursor may be moved to any position on the screen typically using the separate cursor control keys. Its position signifies the next character position in the display. When data is being entered, the cursor moves one position to the right on the line or to the first position in the next line each time a character is written. The operation codes and local operations required to control the cursor positions are outlined in Table 3-2, page 3-17.

### 3.9.2 Absolute Cursor Positioning/Reading

Absolute Cursor Addressing requires commanding the cursor to a specific display location or reading out the exact cursor location. Commanding the cursor to a specific location (loading the cursor), as well as reading the cursor position, are normally executed by the host computer. The Load/Read commands are executed by means of Escape sequences in which the

page, row and column locations of the cursor are expressed in ASCII characters. See **Appendix, Table A-4, page A-8** for the ASCII characters assigned to each row and column locations.

**Load Cursor Operation** - When the Load Cursor Operation is initiated the cursor moves to the commanded position. This operation is performed by one of two escape sequences: ESC = R C for current page and ESC - P R C for either page of the Two Page configuration. Where "P" is ASCII encoded character for Page, "R" is ASCII encoded character for Row, and "C" is ASCII encoded character for Column to be addressed.

"P" is defined as follows:

1. If during set-up, Page # Designation is set to 0/1, then: "P" = 0 for page 1 and "P" = 1 for page 2.
2. If during set-up, Page # Designation is set to 1/2, then: "P" = 1 for page 1 and "P" = 2 for page 2.

"R" is defined as follows:

1. For single page display or two independent page displays "R" is ASCII encoded character Space (20 Hex) to 0 (4F Hex) for rows 1 through 48.
2. For wide page displays "R" is ASCII encoded character Space (20 Hex) to 0 (4F Hex) for rows 1 through 48 and columns 1 through 80. "R" is ASCII character P (50 Hex) through g (67 Hex) for rows 1 through 48 and columns 81-158.

"C" is defined as follows:

1. For single page displays or two independent page displays "C" is ASCII encoded character Space (20 Hex) to 0 (6F Hex) for column 1 through 80.
2. For wide page displays "C" is ASCII encoded character Space (20 Hex) to 0 (6F Hex) for columns 1 through 80 and repeats for column 81 through 158 (i.e. column 82 = !).

**Read Cursor Operation** -- The Read Cursor operation consists of the Read command usually from the host, and an immediate response from the terminal which defines the

cursor position. The host executes either of the following escape sequences; ESC ? for current page and ESC / for either page of the two page configuration. The terminal responses to these escape sequences by sending to the host computer the ASCII encoded characters as required "P" for page, "R" for row, and "C" for column followed by a "CR".

### 3.9.3 Tab Control

Depressing either **TAB** control without Shift will cause an HT (09 Hex) to be generated. If Block Mode or Half Duplex Mode is on then the cursor will move right horizontally to the next Tab Stop or right margin if TAB mode is enabled. **SHIFT|TAB** is a Back Tab and will cause an ESC I (18, 49 Hex) to be generated. The cursor will move left horizontally to the next Tab Stop of left margin if TAB mode is enabled.

Setting and deleting tabs from the keyboard are demonstrated in **figure 3-7, page 3-38**. How to program tabs from the host is demonstrated in **Table 3-3, pages 3-19 through 3-26**.

## 3.10 GRAPHICS

The Graphics capability of the ADM 12, another visual attribute of the unit, allows the user to draw business type forms or simple graphs to enhance the information presentation. The graphics symbols that are available for use and the associated ASCII codes are illustrated in **Appendix Table A-8, page A-13**. Graphics Mode may be set from the keyboard by depressing **SHIFT|GRAPH** or by the appropriate Attribute escape sequence ESC G X as described in **paragraph 3.7.4, page 3-33**. The terminal will exit from the Graphics Mode when the key **NORM-GRAPH** is depressed.

In Non-Embedded mode, graphics is enabled by the escape sequence ESC L C and disabled by ESC L A. In Embedded mode, Graphics mode is treated as another visual attribute and is enabled by ESC G 8 and disabled by ESC G 0. See the section on Embedded Mode visual attributes.

### 3.11 SET-UP MODE OPERATIONS

The general operating characteristics of the ADM 12 are controlled by the user-selectable features that are displayed, one at a time, on the status line (line 25) when Set-Up Mode is entered. Both the operator and host computer have the ability to change the Set-Up functions available in the ADM 12. Selections may be saved in non-volatile memory to re-establish the same functions on the next power-on cycle or terminal reset operation. The operation of Set-Up Mode is fully described in paragraph 3.2, page 3-1.

### 3.12 PRINT OPERATIONS

The Auxiliary Port of the ADM 12 is most typically connected to a serial RO (receive only) printer. The communications of data to the auxiliary device is uni-directional via an RS-232C interface. A Busy/Ready signal level is monitored for status during print operations. The print operation is controlled by the Escape sequence Copy Print Control ESC A X and the AUX PORT key on the keyboard.

The AUX PORT key enables and disables the auxiliary port, with display toggling each time the key is depressed.

The **SHIFT** **AUX PORT** key enables and disables the Transparent Extension Mode.

The Copy Print Control ESC A 'X' has three ASCII coded characters which determine the print status as follows:

"X" = 0 (30 Hex) Terminates all Print Operations

"X" = 1 (31 Hex) Enables the mode Transparent Extension Print

"X" = 2 (32 Hex) Enables the mode Display and Extension Print

There are two types of Page Print functions in the ADM 12. Page Print Formatted and Page Print Un-Formatted. Both are disabled when Transparent Extension Print or Extension Print with Display are on. **PRINT** is Print Page formatted (ESC P) and **SHIFT** **PRINT** is Print Page Un-Formatted (ESC p) unless the **PRINT** key is programmed to perform another function as described in paragraph 3.4.8, page 3-13. Print Page Formatted and

Print Page Unformatted are further described in paragraph 3.4.7, page 3-12.

### 3.13 RESET OPERATIONS

The ADM 12 can be reset in one of two ways: a Power-On Reset, or a Reset Terminal command. Both cause the Self-Test to be executed and are detailed below.

#### 3.13.1 Power-On Reset

A Power-On Reset consists of a complete recycling of the ADM 12 functions, including power. This is accomplished by setting the ON/OFF switch to OFF, waiting at least 10 seconds, then setting the switch to ON. All display and other volatile memory is erased when powering down. Upon power-up, the unit is subject to the complete Power Turn-On procedure specified in Section II.

#### 3.13.2 Reset Terminal Command

At any time during operation pressing **SHIFT** **CONTROL** **BREAK** will perform a complete power-up reset. The ADM 12 will perform special functions based on the escape sequence ESC o X as follows for the ASCII encoded character "X".

"X" = ! (21 Hex) the terminal will perform a complete power-up reset.

"X" = 9 (39 Hex) the terminal will display the current firmware version (VX.XX) followed by the results of a power up self test. If this request comes from host, firmware version and results of test will also be transmitted to host.

"X" = A (41 Hex) All of the Programmable Function keys will be set to the default values in paragraph 3.4.8, page 3-13.

"X" = S (53 Hex) All of the active Set-Up conditions will be set to the default values.

#### 3.13.3 Self-Test

When the ADM 12 is reset by either of the methods described, the terminal Self-Test will be executed. The Self-Test will verify the integrity of the display memory, the program memory, non-volatile memory and the associated internal control logic. Upon completion of Self-Test, the terminal will display the "OK" message.

### 3.13.4 Status Information

The following is a list of status information that appears on the 25th status line, and their locations.

### 3.14 ANSWERBACK MEMORY PROGRAM

The user selectable Answerback message is programmed into the ADM 12 by first

entering the Supervisor Set-Up Mode as described in Section 3.2, page 3-1, and then entering the control sequence **CTRL A**. Any message up to 32 characters may be entered from the keyboard as the answerback message. In order to save the answerback message in non-volatile memory, enter the control sequence **CTRL S** before exiting the Set-Up Mode.

DESCRIPTION	COLUMN LOCATION	DISPLAY
PAGE DESIGNATOR	1-2	P n n = 1 or 2
CURSOR ROW ADDRESS	4-6	R nn nn = 01 to 48
CURSOR COLUMN ADDRESS	8-11	C nnn nnn= 001-158
PAGE CONFIGURATION	13-16	LONG 1 page 48 x 80 WIDE 1 page 24 x 158
PROTECT MODE	18-21	PROT
WRITE PROTECT	23-25	WPT
BUSINESS GRAPHICS	27-30	
INSERT MODE	32-35	INSM
PAGE EDIT MODE	37-42	PGEDIT
LINE MODE	44-46	LOC LOCAL MODE (OFFLINE) FDX ONLINE - FULL DUPLEX HDX ONLINE - HALF DUPLEX
TERMINAL MODE	48-50	CNV CONVERSATION MODE BLK BLOCK MODE
DATA CARRIER DETECT	52-54	DCD
CLEAR TO SEND	56-58	CTS
PARITY ERROR	60-61	PE
KEYBOARD LOCKED	63-66	KBLK
AUXILIARY PORT ENABLED	68-71	AUX AUXT TRANSPARENT MODE
PROGRAM MODE	73-75 77-79	PRG HLD HOLD SCREEN

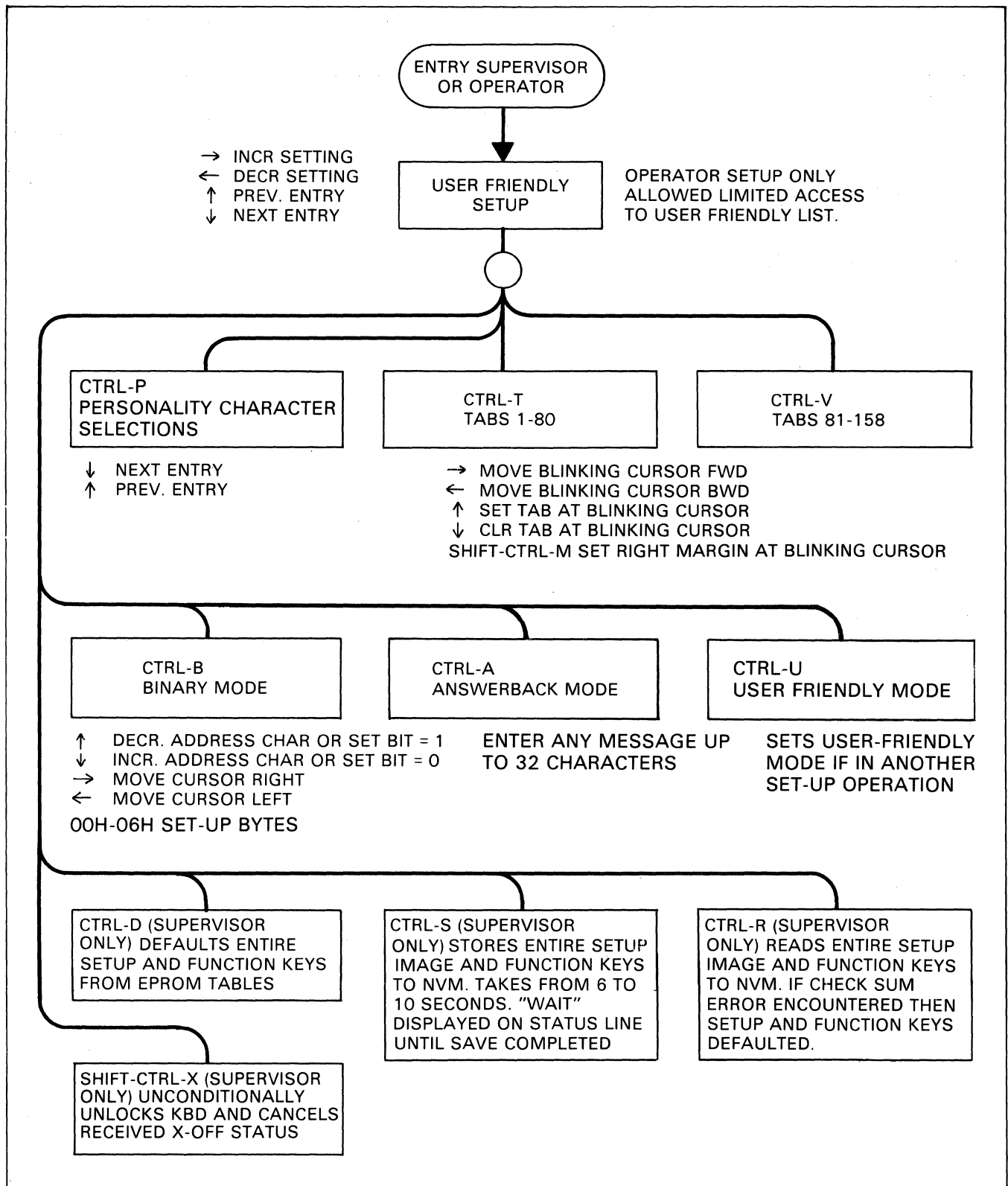

Figure 3-7. Set-Up Mode Flow Chart

**Table 3-4. Embedded Attributes Operation Codes**

FUNCTION	STANDARD	BUSINESS GRAPHICS
Reset to Normal Video	ESC G 0	ESC G 0
Business Graphics Mode Enable		ESC G 8
Blanking (Set-Up 06, Bit 2 = 0) or Underlining (Set-Up 06, Bit 2 = 1) of Area	ESC G 1	ESC G 9
Blinking of Area	ESC G 2	ESC G A
Blanking (Set-Up 06, Bit 2 = 0) or Underlining (Set-Up 06, Bit 2 = 1) and Blinking of Area	ESC G 3	ESC G B
Reversing of Area	ESC G 4	ESC G C
Blanking (Set-Up 06, Bit 2 = 0) or Underlining (Set-Up 06, Bit 2 = 1) and Reversing of Area	ESC G 5	ESC G D
Blinking and Reversing of Area	ESC G 6	ESC G E
Blanking (Set-Up 06, Bit 2 = 0) or Underlining (Set-Up 06, Bit 2 = 1) and Reversing and Blinking of Area	ESC G 7	ESC G F





**APPENDIX A**  
**OPERATORS**  
**QUICK REFERENCE**  
**CHARTS**

**Table A-1. Set-Up Mode Functions**  
**(To enter Set-Up Mode, see Section 3.2, page 3-1.)**

DESCRIPTION	DISPLAYED AS	VALUES	DISPLAYED AS
Keyclick	CLK	No Click <b>CLICK *</b>	N Y
Status Line Attributes	STS	Normal Blank Blink <b>REVERSE *</b> Reduced Intensity Reduced-Reverse	NRM BLANK BLINK REV RED RED-REV
Cursor Blink	CRSR BLINK	<b>NON-BLINKING *</b> Blink	N Y
Cursor Shape	CRSR	<b>BLOCK *</b> Underline	BLK UND
Screen Saver	SCRN SAVE	Disabled <b>ENABLED *</b>	N Y
Smooth Scroll	SMOOTH SCRL	<b>DISABLED *</b> Enabled	N Y
Horizontal Scroll	HORZ SCRL	By Line <b>BY PAGE *</b>	LN PG
On Line/Local	ONLN LOCL	<b>ON LINE *</b> Local	ONLN LOCL
Page Configuration	PG CNFG	<b>TWO IND. PAGES *</b> One Long Page One Wide Page	2PG LNG WDE
Wraparound at Right Margin	WRAP	<b>YES *</b> No	Y N
Return Key Configuration	NEWLN	<b>CR *</b> CRLF	N Y
Block/Conversation	CNV BLK	<b>CONVERSATION MODE *</b> Block Mode	CNV BLK
Full/Half Duplex	HDX FDX	<b>HALF DUPLEX *</b> Full Duplex	HDX FDX
Handshake Protocol	HNDSHK	None DTR <b>X-ON/X-OFF *</b>	NO DTR XON

\* Indicates factory default condition.

**Table A-1. Set-Up Mode Functions (continued)**

DESCRIPTION	DISPLAYED AS	VALUES	DISPLAYED AS
Baud Rate	BPS	300 Baud 600 Baud 1200 Baud 2400 Baud 4800 Baud <b>9600 BAUD *</b> 19200 Baud	300 600 1200 2400 4800 9600 19200
Parity Select	PTY	No Parity <b>PARITY *</b>	N Y
Parity Type	PTY	<b>EVEN *</b> Odd	EV OD
Bit 8 = 1 or 0	BIT 8	0 1 *	0 1

\* Indicates factory default condition.

**Table A-2. Binary Set-Up Functions**

The Set-Up features can be down-line loaded by the host computer using the following command sequence:

ESC { AA HH

Where "AA" is the Hex encoded Set-Up byte to be addressed and HH is the Hex encoded desired set-up condition.

OR

Set-Up functions can be configured from the keyboard by entering Supervisor Set-Up **SHIFT|CTRL|SETUP** then entering CTRL B

SET-UP BYTE	BITS								DESCRIPTION	VALUES
	7	6	5	4	3	2	1	0		
00H 00 (Hex)									0 Full Screen Reverse	1 = Reverse 0 = NORMAL *
									1 Load Cursor Skip	1 = SKIP * 0 = Normal
									2 Print Disable	1 = Disable 0 = ENABLE *
									3 Keyclick	1 = CLICK * 0 = No Click
									4 Wraparound at Right Margin	1 = No 0 = YES*
									5 New Line With CR	1 = Yes 0 = NO*
									6 Line Erase With CR	1 = Yes 0 = NO*
									7 Inhibit Supervisor Set-Up**	1 = Yes 0 = NO*

**NOTE:**

**\*\*CANNOT BE ENTERED FROM THE KEYBOARD ONCE THIS MODE IS ENABLED.  
 DEFAULT VALUES DISPLAYED IN UPPER CASE.**

**Table A-2. Binary Set-Up Functions (continued)**

SET-UP BYTE	BITS 7 6 5 4 3 2 1 0	DESCRIPTION	VALUES
01H 01 (Hex)		<p>0 Status Line Attributes</p> <p>1</p> <p>2</p> <p>3 Inhibit Program Mode From Host</p> <p>4 Home Cursor With Protect</p> <p>5 Return Key Configuration</p> <p>6 Page Number Designation</p> <p>7 New Line With LF In Protect Mode</p>	<p>000 = Normal</p> <p>001 = Blank</p> <p>010 = Blink</p> <p>011 = REVERSE *</p> <p>100 = Reduced Intensity</p> <p>101 = Reduced-Reverse</p> <p>110 = Unallowed</p> <p>111 = Unallowed</p> <p>1 = Yes</p> <p>0 = NO *</p> <p>1 = YES *</p> <p>0 = No</p> <p>1 = CR LF</p> <p>0 = CR *</p> <p>1 = 0/1 *</p> <p>0 = 1/2</p> <p>1 = Yes</p> <p>0 = NO *</p>
	7 6 5 4 3 2 1 0		
02H 02 (Hex)		<p>0 Erase Line Resets Write Protect</p> <p>1 Erase Page Resets Write Protect</p> <p>2 Clear Command Control</p> <p>3 Scrolling Disable</p> <p>4 Inhibit New Line Fills With Send</p> <p>5 Protect Field Delimiter Placement</p> <p>6 Reserved</p> <p>7 Reserved</p>	<p>1 = Yes</p> <p>0 = NO *</p> <p>1 = Yes</p> <p>0 = NO *</p> <p>1 = ENABLES 4 CLEAR COMMANDS *</p> <p>0 = Enables 2 Clear Commands</p> <p>1 = Disable</p> <p>0 = ENABLE *</p> <p>1 = Yes</p> <p>0 = NO *</p> <p>1 = Embedded After Protected Field</p> <p>0 = EMBEDDED BEFORE * PROTECTED FIELD</p>

**NOTE:**  
**DEFAULT VALUES DISPLAYED IN UPPER CASE AND BY AN \*.**

**Table A-2. Binary Set-Up Functions (continued)**

SET-UP BYTE	BITS 7 6 5 4 3 2 1 0	DESCRIPTION	VALUES
03H 03 (Hex)		0 ETX Terminates Write Protect	1 = Yes 0 = NO*
		1 Cursor Shape	1 = Underline 0 = BLOCK*
		2 Cursor Blink	1 = Blink 0 = NON-BLINKING*
		3 Print Attribute	1 = SPACE PRINTED* 0 = Attribute Printed
		4 New Line After Send In Protect Mode	1 = Yes 0 = NO*
		5 On Line/Local Extention (Aux) Busy Level	1 = LOW* 0 = High
		6 Block/Conversation	1 = Block Mode 0 = CONVERSATION MODE*
		7 Screen Saver	1 = ENABLED* 0 = Disabled
	7 6 5 4 3 2 1 0		
04H 04 (Hex)		0 Baud Rate	000 = 300 Baud 001 = 600 Baud 010 = 1200 Baud 011 = 2400 Baud 100 = 4800 Baud 101 = 9600 BAUD* 110 = 19200 Baud 111 = Unallowed
		1	
		2	
		3 Parity Enabled	1 = YES* 0 = No
		4 Parity Sense If Enabled	1 = Odd 0 = EVEN*
		5 Bit 8 If No Parity	1 = HIGH '1' * 0 = Low '0'
		6 Duplex Mode	1 = Full Duplex 0 = HALF DUPLEX*
7 On Line/Local	1 = Local 0 = ON LINE*		

**NOTE:**  
**DEFAULT VALUES DISPLAYED IN UPPER CASE.**

**Table A-2. Binary Set-Up Functions (continued)**

SET-UP BYTE	BITS 7 6 5 4 3 2 1 0	DESCRIPTION	VALUES
05H 05 (Hex)		<p>0 Page Display Configuration 1</p> <p>2 Reserved 3</p> <p>4 Handshake Mode 5</p> <p>6 Vertical Refresh Rate</p> <p>7 Embedded Mode</p>	<p>00 = 2 INDEPENDENT* PAGES 24 x 80 01 = 1 Page 48 x 80 (Double Long) 10 = 1 Page 24 x 158 (Double Wide) 11 = Unallowed</p> <p>00 = No Handshaking 01 = DTR Handshaking 10 = XON/XOFF HANDSHAKING* 11 - Unallowed</p> <p>1 = 50 Hz 0 = 60 HZ*</p> <p>1 = Embedded Attributes 0 = NON-EMBEDDED*</p>
	7 6 5 4 3 2 1 0		
06H 06 (Hex)		<p>0 Horizontal Scroll</p> <p>1 Smooth Scroll</p> <p>2 ESC G1 Attribute In Embedded Mode</p> <p>3 Non-Programmable Edit Keys</p> <p>4 Reserved 5 6 7</p>	<p>1 = PAGE* 0 = Line</p> <p>1 = Smooth 0 = JUMP*</p> <p>1 = UNDERLINE* 0 = Blank</p> <p>1 = LOCAL* 0 = Duplex</p>

**NOTE:**  
**DEFAULT VALUES DISPLAYED IN UPPER CASE.**

Table A-3. ADM 12 Escape Sequences

HEX	2		3		4		5		6		7	
0			0	CLEAR TABS ALL	@	PRINT PROTECTED SPACES	P	FORMATTED PRINT	`		p	UNFORMAT PRINT
1	!	PROGRAM FUNCTION KEYS*	1	SET TAB	A	AUXILIARY CONTROL*	Q	INSERT CHARACTER	a		q	SET INSERT MODE
2	"	KEYBOARD ENABLE	2	CLEAR TAB	B	SET BLOCK MODE	R	DELETE LINE	b		r	CLEAR INSERT MODE
3	#	KEYBOARD DISABLE	3		C	SET CONVERSATION MODE	S	SEND MESSAGE FOREGROUND	c	SET SCROLL REGION*	s	SEND MESSAGE ALL
4	\$		4	SEND LINE FOREGROUND	D	SET DUPLEX*	T	ERASE LINE FILL 1	d		t	ERASE LINE FILL 2
5	%		5	SEND PAGE FOREGROUND	E	INSERT LINE	U	SET PROGRAM MODE	e	SET SMOOTH SCROLL	u	CLEAR PROGRAM MODE
6	&	SET PROTECT MODE	6	SEND LINE ALL	F	WRITE MESSAGE LINE #1*	V		f	SET JUMP SCROLL	v	SET LONG PAGE
7	'	CLEAR PROTECT MODE	7	SEND PAGE ALL	G	ATTRIBUTE CONTROL*	W	DELETE CHARACTER	g	DISPLAY HOST MESSAGE #1	w	CLEAR LONG PAGE
8	(	CLEAR WRITE PROTECT	8	WRITE SOM	H	ALIGNMENT PATTERN	X	CLEAR PROGRAM MODE	h	DISPLAY HOST MESSAGE #2	x	
9	)	SET WRITE PROTECT	9	WRITE EOM	I	BACK TAB	Y	ERASE PAGE FILL 1	i	HORIZONTAL TAB	y	ERASE PAGE FILL 2
A	*	CLEAR ALL TO FILL 2	:	CLEAR FOREGROUND TO FILL 2	J	PAGE BACK	Z	CLEAR ALL MODES	j		z	PRINT LINE FORMATTED
B	+	CLEAR ALL TO FILL 1	:	CLEAR FOREGROUND TO FILL 1	K	PAGE FORWARD	[		k		{	WRITE SET UP BYTE*
C	.	CLEAR ALL TO PROTECT SPACES	<		L	SET GRAPHICS MODE	\	ENVOKE FUNCTION KEY*	l	WRITE MESSAGE LINE 2		SELECT BAUD RATE*
D	-	ADDRESS CURSOR* P, R, C	=	ADDRESS CURSOR* R, C	M		]		m	WRITE MULTIPLE CHARACTERS*	}	LINK FUNCTION KEYS*
E	.	CHANGE PERSONALITY*	>		N	SET PAGE EDIT	^	SET LINE 25 MODE*	n		~	CURSOR VIDEO CONTROL*
F	/	READ CURSOR P, R, C	?	READ CURSOR R, C	O	CLEAR PAGE EDIT	_		o	RESET/ DEFAULT/ VERSION*	DEL	

\*MULTIPLE CHARACTERS REQUIRED.



Table A-4. Reference Chart of Absolute Cursor Positions

ESC = 

ROW ASCII
--------------

COL ASCII
--------------

OR: ESC = 

PAGE ASCII
---------------

ROW ASCII
--------------

COL ASCII
--------------

 Page ASCII = 0 or 1 if Page # Designation = 1  
= 1 or 2 if Page # Designation = 0

ASCII CODES	POSITION		ASCII CODES	POSITION		ASCII CODES	POSITION	
	ROW	COL		ROW	COL		ROW	COL
ESC = SPACE	1	1	ESC = ;		28	ESC = V		55
!	2	2	<		29	W		56
"	3	3	=		30	X		57
#	4	4	>		31	Y		58
\$	5	5	?		32	Z		59
%	6	6	@		33	[		60
&	7	7	A		34	\		61
'	8	8	B		35	]		62
(	9	9	C		36	^		63
)	10	10	D		37	_		64
*	11	11	E		38	`		65
+	12	12	F		39	a		66
,	13	13	G		40	b		67
-	14	14	H		41	c		68
.	15	15	I		42	d		69
/	16	16	J		43	e		70
0	17	17	K		44	f		71
1	18	18	L		45	g		72
2	19	19	M		46	h		73
3	20	20	N		47	i		74
4	21	21	O		48	j		75
5	22	22	P		49	k		76
6	23	23	Q		50	l		77
7	24	24	R		51	m		78
8		25	S		52	n		79
9		26	T		53	ESC = o		80
ESC = :		27	ESC = U		54			

Table A-4. Reference Chart of Absolute Cursor Positions (continued)

ESC = 

ROW
ASCII

COL
ASCII

  
(for Wide Page Display)

POSITION			POSITION			POSITION		
ASCII CODES			ASCII CODES			ASCII CODES		
ROW	COL		ROW	COL		ROW	COL	
ESC = SPACE	81	ESC = ;		108	ESC = V	7	135	
!	82	<		109	W	8	136	
"	83	=		110	X	9	137	
#	84	>		111	Y	10	138	
\$	85	?		112	Z	11	139	
%	86	@		113	[	12	140	
&	87	A		114	\	13	141	
'	88	B		115	]	14	142	
(	89	C		116	^	15	143	
)	90	D		117	_	16	144	
*	91	E		118	`	17	145	
+	92	F		119	a	18	146	
,	93	G		120	b	19	147	
-	94	H		121	c	20	148	
.	95	I		122	d	21	149	
/	96	J		123	e	22	150	
0	97	K		124	f	23	151	
1	98	L		125	g	24	152	
2	99	M		126	h		153	
3	100	N		127	i		154	
4	101	O		128	j		155	
5	102	P	1	129	k		156	
6	103	Q	2	130	l		157	
7	104	R	3	131	m		158	
8	105	S	4	132	n			
9	106	T	5	133	ESC = o			
ESC = :	107	ESC = U	6	134				

Table A-5. ASCII Control Code Chart

B7 B6 BITS B5	0 0		0 0		0 1		0 1		1 0		1 0		1 1		1 1	
	0 0		0 1		1 0		1 1		0 0		0 1		1 0		1 1	
B4 B3 B2 B1	CONTROL				NUMBERS SYMBOLS				UPPER CASE				LOWER CASE			
0 0 0 0	0 NUL	8 DLE	16 SP	24 0	32 @	40 P	48 '	56 p	64 0	72 1	80 2	88 3	96 4	104 5	112 6	120 7
0 0 0 1	1 SOH	9 DC1	17 !	25 1	33 A	41 Q	49 a	57 q	55 8	63 9	71 0	79 1	87 2	95 3	103 4	111 5
0 0 1 0	2 STX	10 DC2	18 "	26 2	34 B	42 R	50 b	58 r	66 10	74 11	82 12	90 13	98 14	106 15	114 16	122 17
0 0 1 1	3 ETX	11 DC3	19 #	27 3	35 C	43 S	51 c	59 s	67 11	75 12	83 13	91 14	99 15	107 16	115 17	123 18
0 1 0 0	4 EOT	12 DC4	20 \$	28 4	36 D	44 T	52 d	60 t	68 12	76 13	84 14	92 15	100 16	108 17	116 18	124 19
0 1 0 1	5 ENQ	13 NAK	21 %	29 5	37 E	45 U	53 e	61 u	69 13	77 14	85 15	93 16	101 17	109 18	117 19	125 20
0 1 1 0	6 ACK	14 SYN	22 &	30 6	38 F	46 V	54 f	62 v	70 14	78 15	86 16	94 17	102 18	110 19	118 20	126 21
0 1 1 1	7 BEL	15 ETB	23 '	31 7	39 G	47 W	55 g	63 w	71 15	79 16	87 17	95 18	103 19	111 20	119 21	127 22
1 0 0 0	8 BS	16 CAN	24 (	32 8	40 H	48 X	56 h	64 x	72 16	80 17	88 18	96 19	104 20	112 21	120 22	128 23
1 0 0 1	9 HT	17 EM	25 )	33 9	41 I	49 Y	57 i	65 y	73 17	81 18	89 19	97 20	105 21	113 22	121 23	129 24
1 0 1 0	10 LF	18 SUB	26 *	34 :	42 J	50 Z	58 j	66 z	74 18	82 19	90 20	98 21	106 22	114 23	122 24	130 25
1 0 1 1	11 VT	19 ESC	27 +	35 ;	43 K	51 [	59 k	67 {	75 19	83 20	91 21	99 22	107 23	115 24	123 25	131 26
1 1 0 0	12 FF	20 FS	28 ,	36 <	44 L	52 \	60 l	68 ;	76 20	84 21	92 22	100 23	108 24	116 25	124 26	132 27
1 1 0 1	13 CR	21 GS	29 -	37 =	45 M	53 ]	61 m	69 }	77 21	85 22	93 23	101 24	109 25	117 26	125 27	133 28
1 1 1 0	14 SO	22 RS	30 .	38 >	46 N	54 ^	62 n	70 ~	78 22	86 23	94 24	102 25	110 26	118 27	126 28	134 29
1 1 1 1	15 SI	23 US	31 /	39 ?	47 O	55 _	63 o	71 DEL	79 23	87 24	95 25	103 26	111 27	119 28	127 29	135 30

KEY

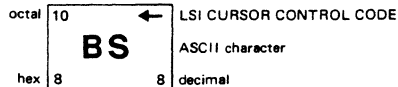

Table A-6. Displayable USASCII Character Set and Control Codes

HEX BYTE		CONTROL CHARACTERS		DISPLAYABLE CHARACTERS					
		0	1	2	3	4	5	6	7
2ND	1ST	0	1	2	3	4	5	6	7
	BITS 4321	BITS 765	000	001	010	011	100	101	110
0	0000	NUL	DLE		0	@	P	'	p
1	0001	SOH	DC1	!	1	A	Q	a	q
2	0010	STX	DC2	"	2	B	R	b	r
3	0011	ETX	DC3	#	3	C	S	c	s
4	0100	EOT	DC4	\$	4	D	T	d	t
5	0101	ENQ	NAK	%	5	E	U	e	u
6	0110	ACK	SYN	&	6	F	V	f	v
7	0111	BEEP	ETB	'	7	G	W	g	w
8	1000	BS (←)	CAN	(	8	H	X	h	x
9	1001	(SKIP) HT	EM	)	9	I	Y	i	y
A	1010	LF (↓)	SUB	*	:	J	Z	j	z
B	1011	VT (↑)	ESC	+	;	K	[	k	{
C	1100	FF (→)	FS	'	<	L	\	l	
D	1101	CR	GS	.	=	M	]	m	}
E	1110	SO	(HOME) RS	.	>	N	^	n	~
F	1111	SI	(NEW LINE) US	/	?	O	--	o	DEL

USE CTRL KEY  
WITH DISPLAYABLE  
CHARACTER KEYS  
TO PRODUCE  
CONTROL CODES

Table A-7. 128 Character ASCII Format, with Hex Codes

00 NUL	01 SOH	02 STX	03 ETX	04 EOT	05 ENQ	06 ACK	07 BEL	08 BS	09 HT	0A LF	0B VT	0C FF	0D CR	0E SO	0F SI
10 DLE	11 DC1	12 DC2	13 DC3	14 DC4	15 NAK	16 SYN	17 ETB	18 CAN	19 EM	1A SUB	1B ESC	1C FS	1D GS	1E RS	1F US
20	21	22	23	24	25	26	27	28	29	2A	2B	2C	2D	2E	2F
	!	"	#	\$	%	&	'	(	)	*	+	,	-	.	/
30	31	32	33	34	35	36	37	38	39	3A	3B	3C	3D	3E	3F
0	1	2	3	4	5	6	7	8	9	:	;	<	=	>	?
40	41	42	43	44	45	46	47	48	49	4A	4B	4C	4D	4E	4F
@	A	B	C	D	E	F	G	H	I	J	K	L	M	N	O
50	51	52	53	54	55	56	57	58	59	5A	5B	5C	5D	5E	5F
P	Q	R	S	T	U	V	W	X	Y	Z	[	\	]	^	_
60	61	62	63	64	65	66	67	68	69	6A	6B	6C	6D	6E	6F
`	a	b	c	d	e	f	g	h	i	j	k	l	m	n	o
70	71	72	73	74	75	76	77	78	79	7A	7B	7C	7D	7E	7F
p	q	r	s	t	u	v	w	x	y	z	{		}	~	%

**Table A-8. Business Graphics Character Set**

NUL		DLE		SPACE		0		@		P		•		p	
SOH		DC1		!		1		A		Q		a		q	
STX		DC2		"		2		B		R		b		r	
ETX		DC3		#		3		C		S		c		s	
EOT		DC4		\$		4		D		T		d		t	
ENQ		NAK		%		5		E		U		e		u	
ACK		SYN		&		6		F		V		f		v	
BEL		ETB		'		7		G		W		g		w	
BS		CAN		(		8		H		X		h		x	
HT		EM		)		9		I		Y		i		y	
LF		SUB		*		:		J		Z		j		z	
VT		ESC		+		;		K		[		k		{	
FF		FS		,		<		L		\		l			
CR		GS		-		=		M		]		m		}	
SO		RS		.		>		N		^		n		~	
SI		US		/		?		O		_		o			

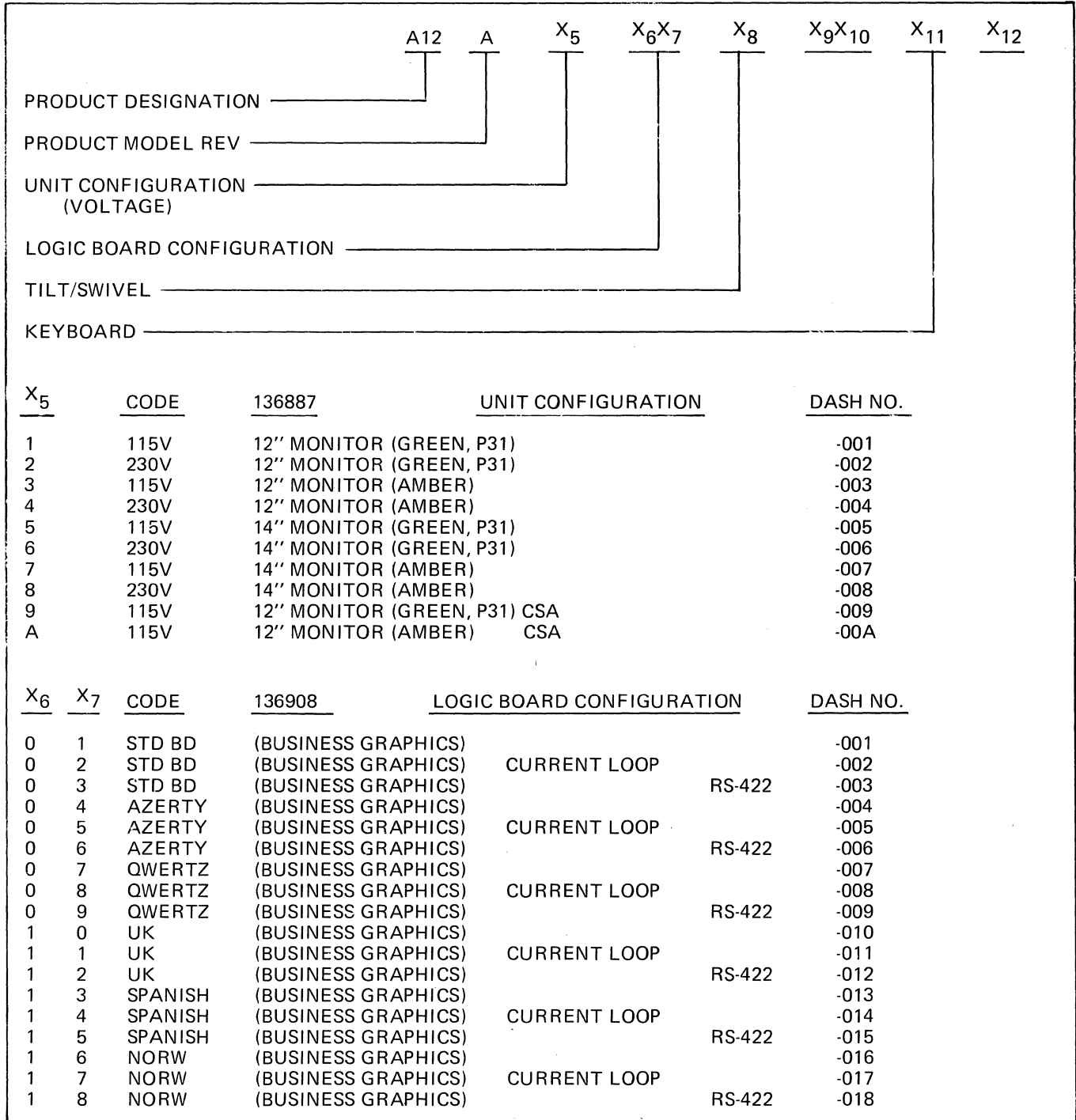





**Table A-10. Model Configuration Identification**

The configuration number is used to identify the exact configuration of your terminal. It appears on the back of all units and also on the outside of the shipping box. A key to the individual configuration digits is listed below:



<u>X<sub>5</sub></u>	<u>CODE</u>	<u>136887</u>	<u>UNIT CONFIGURATION</u>	<u>DASH NO.</u>
1	115V	12" MONITOR (GREEN, P31)		-001
2	230V	12" MONITOR (GREEN, P31)		-002
3	115V	12" MONITOR (AMBER)		-003
4	230V	12" MONITOR (AMBER)		-004
5	115V	14" MONITOR (GREEN, P31)		-005
6	230V	14" MONITOR (GREEN, P31)		-006
7	115V	14" MONITOR (AMBER)		-007
8	230V	14" MONITOR (AMBER)		-008
9	115V	12" MONITOR (GREEN, P31) CSA		-009
A	115V	12" MONITOR (AMBER) CSA		-00A

<u>X<sub>6</sub></u>	<u>X<sub>7</sub></u>	<u>CODE</u>	<u>136908</u>	<u>LOGIC BOARD CONFIGURATION</u>	<u>DASH NO.</u>
0	1	STD BD	(BUSINESS GRAPHICS)		-001
0	2	STD BD	(BUSINESS GRAPHICS)	CURRENT LOOP	-002
0	3	STD BD	(BUSINESS GRAPHICS)		-003
0	4	AZERTY	(BUSINESS GRAPHICS)		-004
0	5	AZERTY	(BUSINESS GRAPHICS)	CURRENT LOOP	-005
0	6	AZERTY	(BUSINESS GRAPHICS)		-006
0	7	QWERTZ	(BUSINESS GRAPHICS)		-007
0	8	QWERTZ	(BUSINESS GRAPHICS)	CURRENT LOOP	-008
0	9	QWERTZ	(BUSINESS GRAPHICS)		-009
1	0	UK	(BUSINESS GRAPHICS)		-010
1	1	UK	(BUSINESS GRAPHICS)	CURRENT LOOP	-011
1	2	UK	(BUSINESS GRAPHICS)		-012
1	3	SPANISH	(BUSINESS GRAPHICS)		-013
1	4	SPANISH	(BUSINESS GRAPHICS)	CURRENT LOOP	-014
1	5	SPANISH	(BUSINESS GRAPHICS)		-015
1	6	NORW	(BUSINESS GRAPHICS)		-016
1	7	NORW	(BUSINESS GRAPHICS)	CURRENT LOOP	-017
1	8	NORW	(BUSINESS GRAPHICS)		-018

Table A-10. Model Configuration Identification (continued)

<u>X<sub>6</sub></u>	<u>X<sub>7</sub></u>	<u>CODE</u>	<u>136908</u>	<u>LOGIC BOARD CONFIGURATION (CONT'D)</u>	<u>DASH NO.</u>
1	9	DANISH	(BUSINESS GRAPHICS)		-019
2	0	DANISH	(BUSINESS GRAPHICS)	CURRENT LOOP	-020
2	1	DANISH	(BUSINESS GRAPHICS)		RS-422 -021
2	2	SWED/FIN	(BUSINESS GRAPHICS)		-022
2	3	SWED/FIN	(BUSINESS GRAPHICS)	CURRENT LOOP	-023
2	4	SWED/FIN	(BUSINESS GRAPHICS)		RS-422 -024
<u>X<sub>8</sub></u>		<u>CODE</u>	<u>136835</u>	<u>TILT/SWIVEL</u>	
1		TILT/SWIVEL			-001
<u>X<sub>11</sub></u>		<u>CODE</u>	<u>136678</u>	<u>KEYBOARD ASSY, LOW PROFILE</u>	
1		STD KEYBOARD			-101
2		TILT/SWIVEL			-102
6		STD KEYBOARD	(CSA UNITS ONLY)		-006
7		TILT/SWIVEL	(CSA UNITS ONLY)		-007



# **INDEX**

SUBJECT	PAGE
A	
Absolute Cursor Positioning .....	3-34,A-8
Absolute Cursor Positioning Operation Codes .....	A-8
Answerback .....	1-3,3-17,3-37
Answerback Memory Program .....	3-37
ASCII Control Code Chart .....	A-10
Attributes .....	1-4,1-5,3-25,3-33,3-39
Auxiliary Port .....	2-4,2-6
B	
Baud Rate (BPS) .....	1-6,3-26
Block Mode .....	1-6,3-6,3-19
Business Graphics .....	3-35,A-13
Busy HI/LOW .....	1-7,3-31,3-33
C	
Clear To Null .....	3-11
Clear To Spaces .....	3-11
Control Codes .....	3-16
Conversation Mode .....	3-6,3-19,3-31,3-34
Copy Print .....	3-18
Cursor Control .....	3-10,3-26,3-31
Current Loop .....	1-3,2-2
D	
Data Transmission .....	3-30
Default Function Keys .....	3-14
Default Set-Up .....	3-13,3-15
Delete Character .....	3-11,3-13,3-19
Delete Line .....	3-11,3-13,3-23
Display Character Format .....	3-16
Downline Load Set-Up Functions .....	3-2,A-3
E	
Edit Keys .....	3-11,3-13
Erase To-End-Of-Line .....	3-11,3-13
Erase To-End-Of-Page .....	3-11,3-13
Escape .....	3-15,3-16,3-18
Escape Sequences .....	3-16,3-19,3-20,3-21,3-22, 3-23,3-24,3-25,3-26,A-7
F-G	
Formatted Print .....	3-12,3-29
Full Duplex .....	3-6,3-25
Function Keys .....	1-2,3-19
Graphics .....	3-35,A-13
H	
Half Duplex .....	3-6,3-25
Handshake .....	1-7,3-31
Home Cursor .....	3-10,3-17

SUBJECT	PAGE
I-J	
Insert Character .....	3-11,3-13,3-20
Insert Line .....	3-11,3-13,3-23
Installation .....	2-1 thru 2-7
Interfaces:	
RS-232C .....	2-2,2-4,2-6
Current Loop .....	1-3,2-2,2-7
RS-422 .....	1-3,2-7
International Character Sets .....	3-15,A-14,A-15
K	
Keyboard Enable/Disable .....	3-19
Keyboard Layout .....	3-7,3-8,3-9
Keyboard Operation .....	2-1,3-6,3-10
Keystroke Conventions .....	3-1
L	
Line Print .....	3-13
Line Voltage .....	2-1
M-N	
Modem Port .....	2-6
Modifier Keys .....	3-10
New Line .....	3-15
O	
On-Line/Off-Line (Local) .....	3-6,3-25
Options .....	1-3
P-Q	
Page Print .....	3-12
Parity Error (PE) .....	3-37
Personality Characters .....	3-33
Power-On Reset .....	3-36
Power Turn-Off .....	2-3,2-5
Power Turn-On .....	2-3,2-4
Print .....	3-36
Programmable Function Keys .....	3-13,3-19
Program Mode .....	3-6,3-19,3-37
R	
Read Cursor .....	3-22
Reset Terminal .....	3-26,3-36
Return .....	3-11,3-17
RS-232C Interface .....	2-2,2-4,2-6

SUBJECT	PAGE
S-T	
Screen Saver .....	2-5
Scrolling .....	3-15,3-25,3-27
Self-Test .....	2-4,3-36
Send Line .....	3-12,3-13,3-19
Send Message .....	3-12,3-13,3-22
Send Page .....	3-12,3-13,3-19
Set-Up Mode .....	1-2,2-1,3-1,3-2,3-3,3-4
Specifications .....	1-4
Status Key .....	3-2
Status Line .....	3-15,3-37
Site Requirements .....	2-1
Tabs .....	3-35
Transparent Print .....	3-18,3-36
U-V	
Unformatted Print .....	3-12,3-24
Upline .....	3-8,3-10,3-17
Visual Attributes .....	1-4,1-5,3-25,3-33
W-X-Y-Z	
Word Structure .....	1-7
Wraparound .....	3-11
Write Normal Intensity .....	3-33
Write Reduced Intensity .....	3-33



NO POSTAGE  
STAMP  
NECESSARY  
IF MAILED IN THE  
UNITED STATES

**BUSINESS REPLY CARD**

FIRST CLASS PERMIT NO. 3061 ANAHEIM, CALIFORNIA

POSTAGE WILL BE PAID BY ADDRESSEE:

Attn: Marketing Communications

**LEAR SIEGLER, INC.**

**DATA PRODUCTS DIVISION**

**714 NORTH BROOKHURST STREET**

**ANAHEIM, CALIFORNIA 92803**

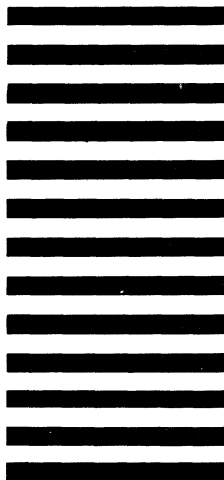

NO POSTAGE  
STAMP  
NECESSARY  
IF MAILED IN THE  
UNITED STATES

**BUSINESS REPLY CARD**

FIRST CLASS PERMIT NO. 3061 ANAHEIM, CALIFORNIA

POSTAGE WILL BE PAID BY ADDRESSEE:

Attn: Marketing Communications

**LEAR SIEGLER, INC.**

**DATA PRODUCTS DIVISION**

**714 NORTH BROOKHURST STREET**

**ANAHEIM, CALIFORNIA 92803**

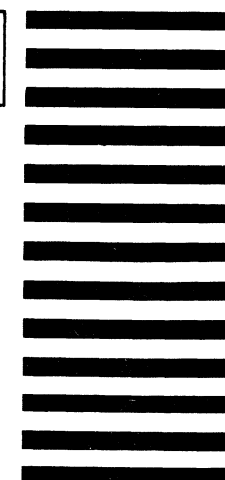

**COMMENTS AND  
SUGGESTIONS**

If you have any suggestions for improving this publication, please let us know on this postage-paid reply card.

All comments will be given careful consideration.



PUBLICATION TITLE \_\_\_\_\_

PUBLICATION NO. \_\_\_\_\_ DATE \_\_\_\_\_

YOUR NAME \_\_\_\_\_

TITLE \_\_\_\_\_

COMPANY \_\_\_\_\_

ADDRESS \_\_\_\_\_

SUGGESTIONS \_\_\_\_\_

\_\_\_\_\_  
\_\_\_\_\_

PUBLICATION TITLE \_\_\_\_\_

PUBLICATION NO. \_\_\_\_\_ DATE \_\_\_\_\_

YOUR NAME \_\_\_\_\_

TITLE \_\_\_\_\_

COMPANY \_\_\_\_\_

ADDRESS \_\_\_\_\_

SUGGESTIONS \_\_\_\_\_

\_\_\_\_\_  
\_\_\_\_\_



**LEAR SIEGLER, INC.**  
**DATA PRODUCTS DIVISION**

901 EAST BALL ROAD, ANAHEIM, CALIFORNIA 92805  
PHONE: (714) 774-1010    TELEX: 65-5444    TWX: 910-591-1157