

TeleVideo<sup>®</sup> TS 804 User's Manual

# TELEVIDEO®

## TS 804 USER'S MANUAL

TeleVideo Part Number 125009-00 Rev. A

30 JANUARY 1984

Copyright (c) 1983 by TeleVideo Systems, Inc. All rights reserved. No part of this publication may be reproduced, transmitted, transcribed, stored in a retrieval system, or translated into any language or computer language, in any form or by any means, electronic, mechanical, magnetic, optical, chemical, manual, or otherwise, without the prior written permission of TeleVideo Systems, Inc., 1170 Morse Avenue, P.O. Box 3568, Sunnyvale, California 94088.

### Disclaimer

TeleVideo Systems, Inc. makes no representations or warranties with respect to this manual. Further, TeleVideo Systems, Inc. reserves the right to make changes in the specifications of the product described within this manual at any time without notice and without obligation of TeleVideo Systems, Inc. to notify any person of such revision or changes.

### Warning

This equipment generates, uses, and can radiate radio frequency energy, and if not installed and used in accordance with the instruction manual may cause interference to radio communications. It has been tested and found to comply with the limits for a Class A computing device pursuant to Subpart J of Part 15 of FCC Rules, which are designed to provide reasonable protection against such interference when operated in a commercial environment and when peripherals are connected to the I/O ports with shielded I/O cables giving it 100% shielding at all applicable frequencies up to 1000 MHz. A peripheral must meet the FCC Regulations when connected to this product. This is the responsibility of the peripheral manufacturer. Operation of this equipment in a residential area is likely to cause interference, in which case the user at his own expense will be required to correct the interference.

TeleVideo is a registered trademark of TeleVideo Systems, Inc.  
CP/M Plus is a trademark of Digital Research, Inc.  
MP/M II is a registered trademark of Digital Research, Inc.  
Z80A is a registered trademark of ZILOG Corporation.

TeleVideo Systems, Inc., 1170 Morse Avenue, P.O. Box 3568,  
Sunnyvale, Ca 94088, 408/745-7760



## STATEMENT OF LIMITED WARRANTY

---

TeleVideo Systems, Inc. ("TeleVideo") warrants to its distributors, systems houses, OEMs, and national accounts ("Buyer") that products, except software, manufactured by TeleVideo are free from defects in material and workmanship. TeleVideo's obligations under this warranty are limited to repairing or replacing, at TeleVideo's option, the part or parts of the products which prove defective in material or workmanship within 180 days after shipment by TeleVideo. That Buyer may pass along to its initial customer ("Customer") a maximum of 90 days coverage within this 180-day warranty period, provided that Buyer gives TeleVideo prompt notice of any defect and satisfactory proof thereof.

Products may be returned by Buyer only after a Return Material Authorization number ("RMA") has been obtained from TeleVideo by telephone or in writing. Buyer must prepay all freight charges to return any products to the repair facility designated by TeleVideo and include the RMA number on the shipping container. TeleVideo will deliver replacements for defective products or parts on an exchange basis to Buyer, freight prepaid to the Buyer or the Customer. Products returned to TeleVideo under this warranty become the property of TeleVideo. With respect to any product or part thereof not manufactured by TeleVideo, only the warranty, if any, given by the manufacturer thereof, applies.

### EXCLUSIONS

This limited warranty does not cover losses or damage which occur in shipment to or from Buyer or Customer, or is due to, (1) improper installation or maintenance, misuse, neglect or any cause other than ordinary commercial or industrial application, or (2) adjustment, repair, or modifications by other than by TeleVideo-authorized personnel, or (3) improper environment, excessive or inadequate heating or air conditioning and electrical power failures, surges or other irregularities or (4) any statement made about TeleVideo's products by salesmen, dealers, distributors or agents, unless confirmed in writing by a TeleVideo officer.

THE FOREGOING TELEVIDEO LIMITED WARRANTY IS IN LIEU OF ALL OTHER WARRANTIES, WHETHER ORAL, WRITTEN, EXPRESS, IMPLIED OR STATUTORY. IMPLIED WARRANTIES OF MERCHANTABILITY AND FITNESS FOR A PARTICULAR PURPOSE DO NOT APPLY. TELEVIDEO'S WARRANTY OBLIGATIONS AND DISTRIBUTOR'S REMEDIES HEREUNDER ARE SOLELY AND EXCLUSIVELY AS STATED HEREIN. TELEVIDEO MAKES NO WARRANTY WHATSOEVER CONCERNING ANY SOFTWARE PRODUCTS, WHICH ARE SOLD "AS IS" AND "WITH ALL FAULTS". TELEVIDEO'S LIABILITY, WHETHER BASED ON CONTRACT, TORT, WARRANTY, STRICT LIABILITY OR ANY OTHER THEORY, SHALL NOT EXCEED THE PRICE OF THE INDIVIDUAL UNIT WHOSE DEFECT OR DAMAGE IS THE BASIS OF THE CLAIM. IN NO EVENT SHALL TELEVIDEO BE LIABLE FOR ANY LOSS OF PROFITS, LOSS OF USE OF FACILITIES OR EQUIPMENT, OR OTHER INDIRECT, INCIDENTAL OR CONSEQUENTIAL DAMAGES.

---



**Table of Contents**

- 1. Introduction . . . . . 1.1**
  - System Features . . . . . 1.1
    - Hardware . . . . . 1.1
    - Software . . . . . 1.2
  - User's Manual Format . . . . . 1.3
    - Special Notes . . . . . 1.3
    - Notation Conventions . . . . . 1.3
  
- 2. Setting Up Your TS 804 . . . . . 2.1**
  - Software Registration . . . . . 2.1
  - Selecting the Right Location . . . . . 2.1
    - General Environment . . . . . 2.2
  - Installing Your System . . . . . 2.2
  
- 3. Connecting Terminals and Peripherals . . . . . 3.1**
  - Attaching Cables . . . . . 3.1
  - Baud Rates . . . . . 3.2
  - Switch Settings . . . . . 3.2
  - Connecting Peripherals . . . . . 3.2
    - Attaching Cables . . . . . 3.3
  - Connecting a Serial Printer . . . . . 3.4
    - Baud Rates . . . . . 3.4
  - Connecting a Parallel Printer . . . . . 3.4
  - Modems . . . . . 3.5
  
- 4. Turning on the TS 804 As a Multi-User System . . . . . 4.1**
  - Using MP/M II . . . . . 4.1
    - Starting Up MP/M II . . . . . 4.1
  - Installing the Operating System on Hard Disk . . . . . 4.5
  - The MP/M Manual . . . . . 4.7
  - Running Applications Programs . . . . . 4.7
  - Changing System Software For Different Configurations . . . . . 4.8
    - Two-User Configuration . . . . . 4.9
    - Three-User Configuration . . . . . 4.9
    - Four-User Configuration . . . . . 4.9
    - Changing Configurations . . . . . 4.9
  - Powering on a Terminal . . . . . 4.10
  - Turning Off a Terminal . . . . . 4.10
  - Turning Off the System . . . . . 4.11
  
- 5. Turning on the TS 804 As a Stand-Alone System . . . . . 5.1**
  - Using CP/M Plus . . . . . 5.1
    - Starting Up CP/M Plus . . . . . 5.1
  - Installing the Operating System Onto the Hard Disk . . . . . 5.3
  - The CP/M Plus Manual . . . . . 5.4
  - Running Applications Programs . . . . . 5.5
  
- 6. Keyboard . . . . . 6.1**
  - Key Descriptions . . . . . 6.1
    - Character Keys . . . . . 6.1
    - Special Keys . . . . . 6.2

Function Keys . . . . . 6.8  
 Default Values . . . . . 6.8  
 Reprogramming Function Keys . . . . . 6.9  
 Message Length . . . . . 6.10  
 Message Contents . . . . . 6.10  
 Determining Program Destination . . . . . 6.10  
 Entering a Sample Program . . . . . 6.10

7. **Reconfiguring the TS 804 Integral Terminal** . . . . . 7.1  
 How to Reconfigure the TS 804 through the Keyboard . . 7.1  
     Looking at the Status and Setup Lines . . . . . 7.2  
     Changing a Setup Line . . . . . 7.4  
 Resetting the TS 804 . . . . . 7.10  
     System Reset from the Keyboard . . . . . 7.12

8. **Utility Programs** . . . . . 8.1  
 WRITESYS . . . . . 8.2  
 FORMATH . . . . . 8.5  
 FORMATF . . . . . 8.7  
 FIX804 . . . . . 8.9  
 SCANDUP . . . . . 8.11  
 SHUTDOWN . . . . . 8.14  
 COPYFILE . . . . . 8.16  
 PARK804 . . . . . 8.23

9. **Working with Diskettes** . . . . . 9.1  
 Diskettes . . . . . 9.1  
     Diskette Formats . . . . . 9.2  
     Handling and Storing Diskettes . . . . . 9.3  
     Inserting Diskettes . . . . . 9.4  
     Formatting Diskettes . . . . . 9.5  
     Copying Master Diskettes . . . . . 9.5  
     Write Protecting Diskettes . . . . . 9.6  
     Backing Up Diskettes . . . . . 9.6

10. **Caring for the TS 804** . . . . . 10.1  
 Cleaning . . . . . 10.1  
 Service . . . . . 10.1  
 Technical Assistance . . . . . 10.2  
 Shipping the TS 804 . . . . . 10.2

**Appendices**

A. TS 804 Specifications . . . . . A.1  
 B. Suggested References . . . . . B.1  
 C. Cable Specifications . . . . . C.1  
 D. Buying Additional Diskettes . . . . . D.1  
 E. Using a Two-Prong Adapter . . . . . E.1  
 F. Changing the Fuse to 230 Volts . . . . . F.1  
 G. Switch Settings . . . . . G.1  
 H. Pin Connector Assignments . . . . . H.1  
 I. ASCII Code Chart . . . . . I.1  
 J. CONFIGUR Program . . . . . J.1  
 K. Integral Terminal Programming Information . . . . . K.1

List of Figures

1-1 Possible TS 804 Multi-User Configuration . . . . . 1.2

2-1 Work Space Example . . . . . 2.1

2-2 Keyboard Connection . . . . . 2.2

2-3 Switch S1 and S2 . . . . . 2.3

2-4 Power Switch Off . . . . . 2.3

2-5 Power Cord Connection. . . . . 2.4

2-6 Screen-Positioning Knob . . . . . 2.4

3-1 Connecting a Terminal . . . . . 3.2

3-2 D-Shaped Cable Connectors . . . . . 3.3

3-3 Correctly-Folded Ribbon Cable . . . . . 3.4

4-1 Contrast Knob . . . . . 4.2

4-2 Inserting a Diskette . . . . . 4.3

4-3 Ports . . . . . 4.8

5-1 Inserting a Diskette . . . . . 5.2

6-1 Keyboard . . . . . 6.1

6-2 Special Keys Requiring Another Key . . . . . 6.2

6-3 Special Keys . . . . . 6.3

6-4 Special Editing Keys . . . . . 6.5

7-1 Initial Status Line . . . . . 7.3

7-2 First Setup Line . . . . . 7.5

7-3 Second Setup Line . . . . . 7.5

7-4 Third Setup Line . . . . . 7.5

7-5 Fourth Setup Line . . . . . 7.5

9-1 Floppy Diskette . . . . . 9.1

9-2 Diskette Inside Permanent Plastic Enclosure . . . . . 9.1

9-3 Inserting a Diskette . . . . . 9.5

10-1 Serial Number . . . . . 10.2

C-1 TS 804 to Serial Printer or Terminal . . . . . C.1

E-1 Power Cord with Two-Prong Adapter . . . . . E.1

F-1 Fuse . . . . . F.1

F-2 Voltage Switch . . . . . F.2

G-1 Rear Panel Switches . . . . . G.1

G-2 Default Switch Settings for S1 . . . . . G.2

G-3 Default Switch Settings for S2 . . . . . G.2

I-1 ASCII Code Chart . . . . . I.1



List of Tables

1-1 Notation Conventions . . . . . 1.3

4-1 Logical Drives . . . . . 4.7

6-1 Special Key Functions 1 . . . . . 6.3

6-2 Special Key Functions 2 . . . . . 6.4

6-3 Function of Special Editing Keys . . . . . 6.5

6-4 Reset Keys . . . . . 6.8

6-5 Default Function Key Codes . . . . . 6.8

6-6 Reprogramming Function Keys . . . . . 6.9

6-7 p2 Value Table . . . . . 6.9

7-1 Accessing Status and Setup Lines . . . . . 7.2

7-2 Status Line Values . . . . . 7.3

7-3 Setup Lines . . . . . 7.4

7-4 Changeable Values in the Third Setup Line . . . . . 7.6

7-5 Changeable Values in the Fourth Setup Line . . . . . 7.9

7-6 Resetting the Integral Terminal . . . . . 7.11

8-1 Copyfile Error Messages . . . . . 8.20

9-1 Diskette Formats . . . . . 9.2

C-1 TS 804 to Modem Cable . . . . . C.2

F-1 Fuse Table . . . . . F.1

G-1 S1 Switch Settings . . . . . G.3

G-2 S2 Switch Settings . . . . . G.4

H-1 Board Connectors . . . . . H.1

H-2 RS-232C Connector . . . . . H.1

H-3 Parallel Printer Port . . . . . H.2

## 1. INTRODUCTION

Welcome to the TeleVideo world of multi-user computers! Your new system is designed to meet a wide variety of business needs. The user-friendly architecture makes the TS 804 easy to install and use.

The TS 804 is a very powerful and versatile computer system. It is a multi-user system that uses the CP/M-compatible MP/M II operating system. You can also choose to use it as a high-performance, single-user system, using CP/M Plus as the operating system.

You do not need technical expertise to set up and install your system. This manual provides a step-by-step procedure for setting up your TS 804. It also teaches you how to best utilize the many features of the system for your own needs.

Please take the time to read the installation instructions and familiarize yourself with the operation of your system.

### SYSTEM FEATURES

This section lists some of the many features of your new TS 804 multi-user computer. For a more complete listing of the features, specifications and operational characteristics of the TS 804, refer to the TS 804 Technical Reference Manual.

#### Hardware

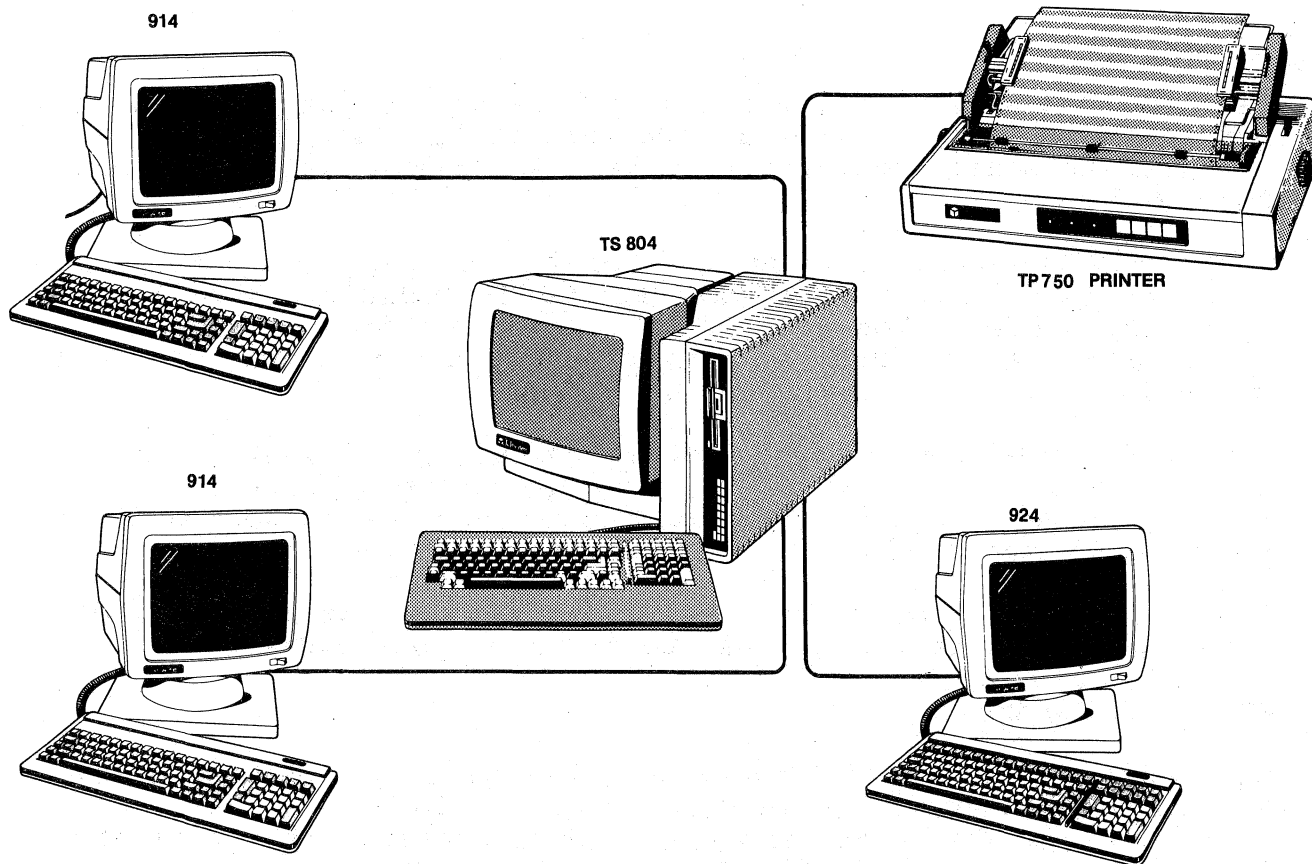
Hardware is the term used to describe the computer components.

In a **multi-user** configuration, the TS 804 consists of the following:

- \* Keyboard and display screen
- \* CPU (central processing unit)
- \* 5 1/4-inch floppy disk drive
- \* 5 1/4-inch hard drive
- \* MP/M II operating system
- \* Up to three additional terminals

Figure 1-1 illustrates a possible TS 804 multi-user configuration with other hardware devices that your system can accept.

**Figure 1-1**  
**Possible TS 804 Multi-User Configuration**



The TS 804 configured as a **single-user** system consists of the following:

- \* Keyboard and display screen
- \* CPU (central processing unit)
- \* 5 1/4-inch floppy disk drive
- \* 5 1/4-inch hard disk drive
- \* CP/M Plus operating system

### Software

Software is the term used to describe the programs or instructions used to operate the hardware. A special group of programs, known as the **operating system**, is used to control the operation of the computer and to perform the computer's basic tasks.

Your system can use either MP/M II or CP/M Plus as the operating system. The MP/M II operating system was specially developed for use on multi-user systems and contains special features unique to the needs of a multi-user environment.

### USER'S MANUAL FORMAT

Since the TS 804 is capable of being used either as a single- or multi-user system, this manual includes instructions for both types of users. Chapter 4 explains how to turn on the TS 804 as a multi-user system. Chapter 5 explains how to turn on the TS 804 as a stand-alone system. You need only read the chapter that applies to you. Throughout the rest of the manual you will find sections that you will be able to skip over if you are not using the TS 804 as a multi-user system.

There are a few conventions used in this manual that you should understand. Special notes throughout the manual draw your attention to particular information. Symbols are used to indicate particular keys in various instructions.

### Special Notes

Two types of notes call attention to information of special importance:

**NOTE!** General note giving information to every operator.

**STOP!** Note giving information concerning the safety of the operator or possible loss of data. **When you see this, STOP and read the note before proceeding!**

### Notation Conventions

The symbols in Table 1-1 are used throughout this manual to describe your actions in the procedures for operating your system.

**Table 1-1**  
**Notation Conventions**

Symbol	Key	Action
<CR>	RETURN (Carriage Return)	This symbol indicates that you are to press the <RETURN> key.
^C	CTRL (Control) C	This symbol indicates that you are to press the <CTRL> and C keys simultaneously. The ^ symbol can be used with any alphanumeric character.
ESC	LOC ESC/ESC (Escape)	This notation indicates that you are to press the <LOC ESC/ESC> key.

/

This symbol, when used between two keys, indicates that you are to press the two keys simultaneously. For example, <SHIFT>/<LOC ESC> indicates that you are to press the <SHIFT> and <LOC ESC> keys at the same time.

< >

When a key, other than an alphabet letter or number key, is written, it is enclosed in brackets. For example, if you are to press the key marked CTRL, it would be written like this, <CTRL>.

## 2. SETTING UP YOUR TS 804

Setting up your TS 804 includes finding a suitable location and checking and attaching the components (including connecting additional terminals if you are using the TS 804 in a multi-user configuration).

Your TS 804 was tested and inspected before it was packed for shipment. Inspect it carefully when you unpack it and refer to the software packing list included with your system to make sure that you received everything that you need.

**NOTE!** If any item is missing, contact your computer store before proceeding with the installation.

### SOFTWARE REGISTRATION

Included with your system are the Software License Agreement and registration card. Read the agreement and sign and return the card before using the system diskette.

### SELECTING THE RIGHT LOCATION

Select a sturdy, level surface. Leave at least four inches of free space around the enclosure for proper air flow.

**Figure 2-1**  
**Work Space Example**



### General Environment

The TS 804 operates best at temperatures and humidity levels in which you are also comfortable. Sudden and drastic temperature changes may adversely affect your stored data.

The system requires a clean environment - free of contaminants. Particles in the air can hinder the performance of the system. Keep the system away from the floor where dust or carpet fuzz would be more likely to get into the floppy disk drive.

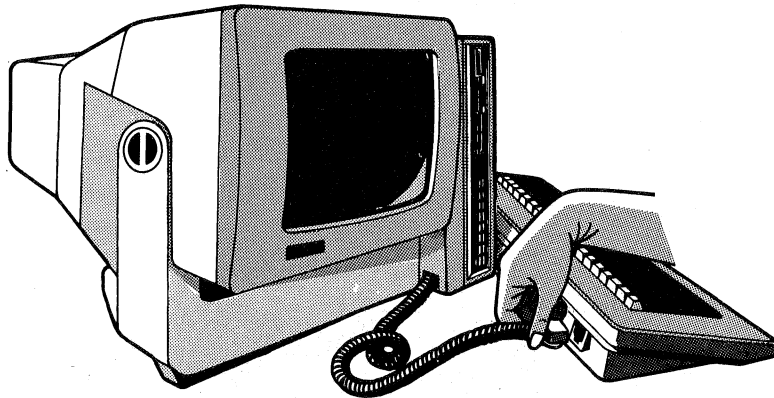
For optimum performance, place your system at least five feet away from electrical appliances and equipment that generate a magnetic field.

### INSTALLING YOUR SYSTEM

After selecting a good place for your computer and checking for all the parts of your system, you are ready to install your TS 804.

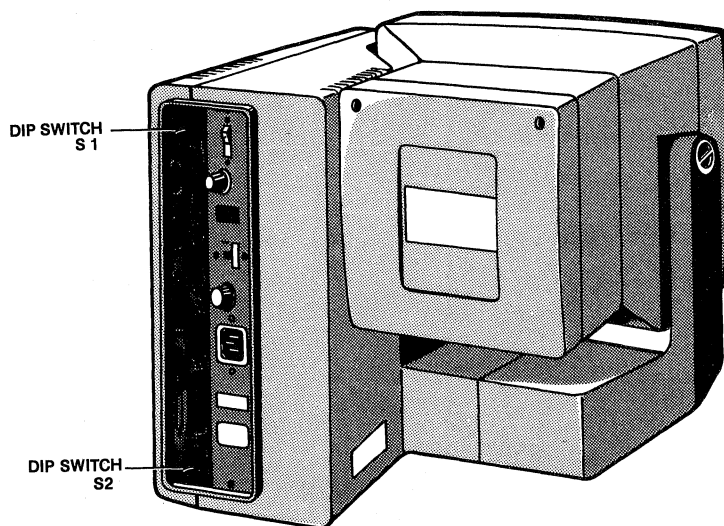
1. Place the keyboard in front of the main unit. Plug the telephone-type coiled cable that is connected to the front of the main unit into the phone jack outlet on the back of the keyboard as illustrated in Figure 2-2.

**Figure 2-2**  
**Keyboard Connection**



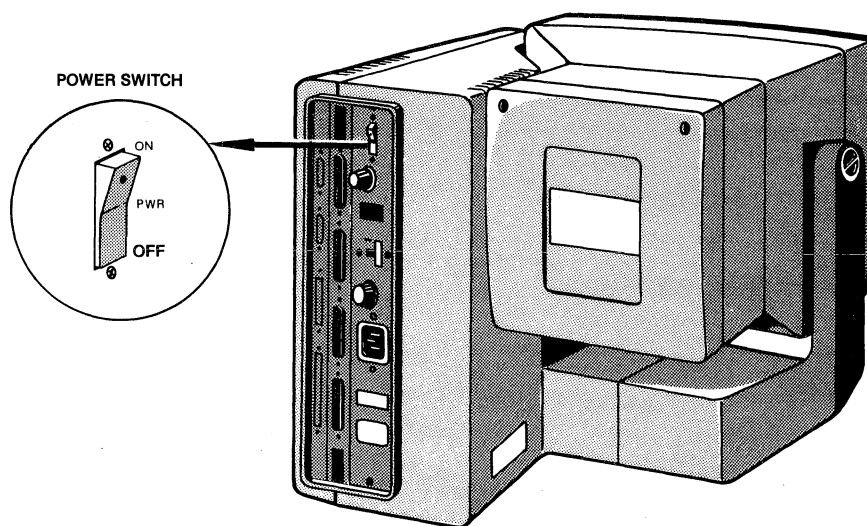
2. Check the switch settings on the switches labeled S1 and S2 on the rear panel of the TS 804. The system should come from TeleVideo with the switches set as shown in Appendix G.

**Figure 2-3**  
Switch S1 and S2



3. Locate the ON/OFF power switch on the rear panel of the main unit. Be sure the power switch is in the OFF position by pressing the plain end of the switch.

**Figure 2-4**  
Power Switch Off



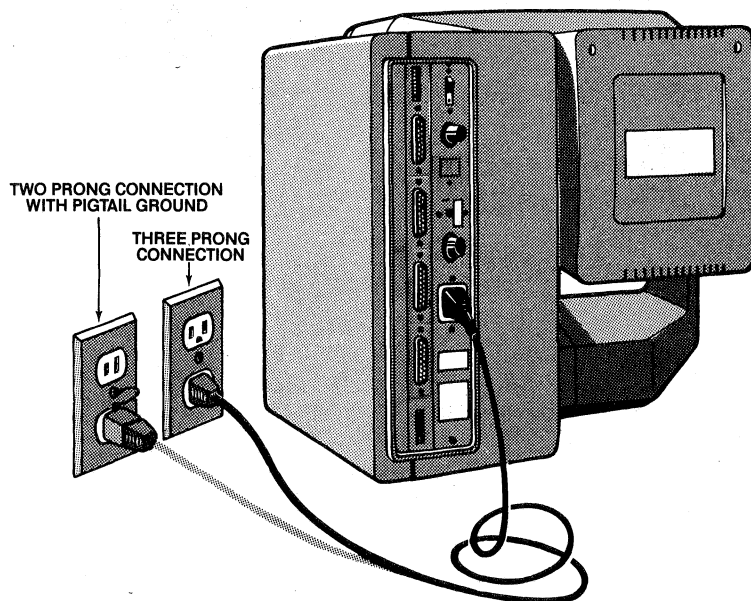
**STOP!** If you are using the TS 804 on the 230 volt international power standard, refer to Appendix F to change the voltage setting and fuse from 115 VAC to 230 VAC before proceeding to the following sections.



4. Plug the power cord that you received with the TS 804 into the plug on the back of the unit as shown in Figure 2-5.

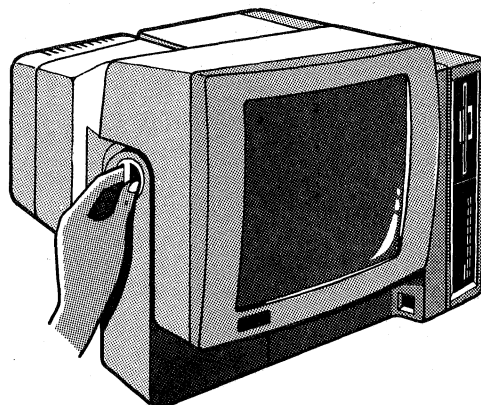
Plug the other end of the power cord into an electrical outlet. The power cord has a three-prong plug and requires a three-prong electrical outlet. If you use a two-prong adapter, ground the adapter to the outlet with a pigtail as illustrated in Figure 2-5.

**Figure 2-5**  
**Power Cord Connection**



5. Position the display screen to the most comfortable viewing angle by tilting it up and down. Use the flat knob on the left side of the computer to tighten the screen into position as illustrated in Figure 2-6.

**Figure 2-6**  
**Screen-Positioning Knob**



### 3. CONNECTING TERMINALS AND PERIPHERALS

Your TS 804 system has the capability of supporting three additional terminals. This section explains how to connect your terminals.

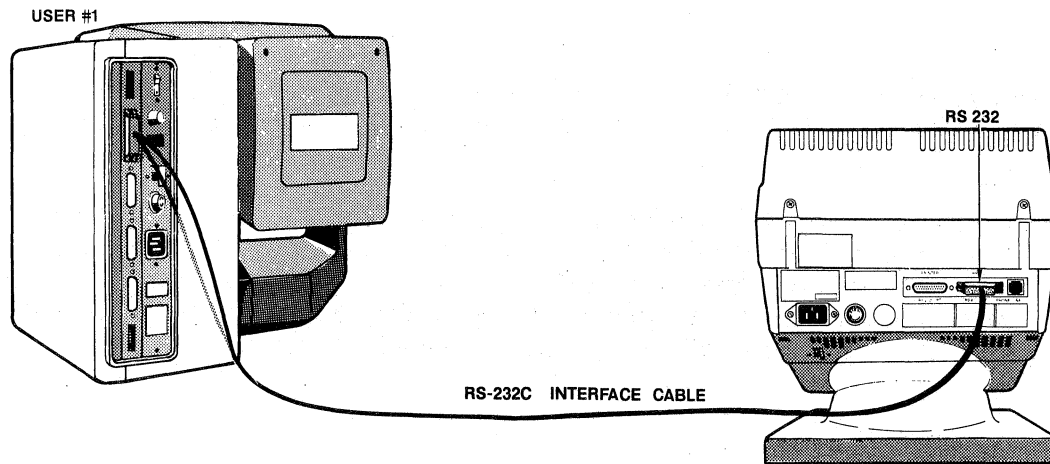
It is also necessary to set the system software correctly to support the number of users that you desire. The TS 804 is shipped configured to operate MP/M II with four users. If you wish to have the system support fewer than four users, refer to the section on Configuration of Additional Terminals in Chapter 4.

#### Attaching Cables

Before you connect additional terminals to your TS 804 system, you must measure the distance between the terminal and the computer system. You can use an RS-232C interface cable with a 25-pin D-connector between the terminal and the computer if the distance is less than 50 feet. If the distance between the terminal and the computer is over 50 feet you will need to use a modem. Refer to the section on modems in this chapter.

If the distance between the terminal and the computer is under 50 feet, simply connect the interface cable to the terminal port labeled RS-232C and to the computer's RS-232C port as shown in Figure 3-1.

**Figure 3-1**  
**Connecting a Terminal**



### Baud Rates

The computer and the terminals must run at the same speed in order to work properly. This speed is called the baud rate. The TS 804 is shipped from the factory with all serial (USER) ports set at a baud rate of 9600. Any terminal that you attach to the system must have a baud rate of 9600. The baud rate can be changed by using the CONFIGUR program as described in Appendix J.

Refer to the manual that came with your terminal for information on setting the baud rate.

### Switch Settings

Check the switch settings on the switch labeled **S2** on the rear panel of the TS 804. The system should come with the switches set as shown in Appendix G.

**NOTE!** The system software needs to be set correctly for the number of terminals that you are using. Refer to Chapter 4 for details.

### CONNECTING PERIPHERALS

The TS 804 can be connected to devices such as printers or modems. These are called peripheral devices or peripherals. The parallel printer interface allows the TS 804 to be used with most Centronics-type printers currently available on the market. Depending on the configuration of the MP/M you have installed, the serial connections that are not used for additional terminals can be used to connect a modem or a serial printer.

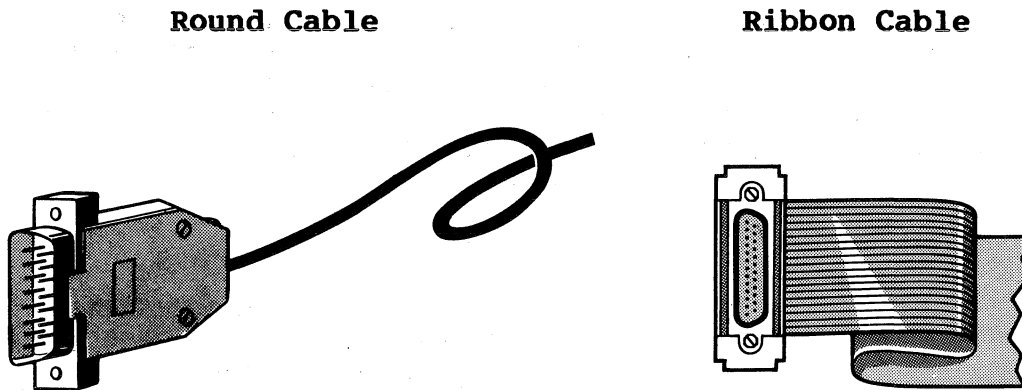
You use the CONFIGUR program to set your system to support these peripherals properly. The CONFIGUR program allows you to quickly and easily change the baud rate and data format of the serial (user) ports to adapt to a variety of peripherals. A complete description of the capabilities of the CONFIGUR program, as well as step-by-step instructions for using it, are in Appendix J.

### Attaching Cables

The types of cables that you need to connect the TS 804 to peripherals are determined by the requirements of the devices attached to the TS 804. Your computer store representative can supply the appropriate cables for attaching peripheral devices. Refer to Appendix E for more detailed cable specifications.

Cable connectors have D-shaped end connectors. See Figure 3-2. These fit onto the D-shaped pin connectors on the rear panel of the TS 804. To install a cable, fit the connector onto the connector on the rear panel, then push on the cable connector until the two are firmly attached.

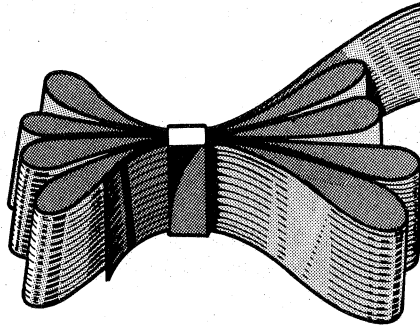
**Figure 3-2**  
**D-Shaped Cable Connectors**



Some connectors come supplied with mounting screws in the flange on the sides of the D-connector housing. These will line up with the threaded holes in the back panel of the TS 804. The screws need only be finger-tightened. This prevents a cable from being inadvertently pulled from the computer.

Leave some slack as you connect the cables. If you are using a round cable, coil it loosely and secure it with a rubberband. If you are using a flat, ribbon cable, fold it accordion-style as shown in Figure 3-3.

**Figure 3-3**  
**Correctly-Folded Ribbon Cable**



#### **CONNECTING A SERIAL PRINTER**

Any of the RS-232C serial ports that are not being used for additional terminals can be used to connect a serial printer. Refer to the configurations specified in Chapter 4 and then attach one end of an RS-232C interface cable to the port you are using for the serial printer. Attach the other end to the RS-232C pin connector on the printer.

#### **Baud Rates**

The computer and the peripherals must run at the same speed in order to work properly. This speed is called the baud rate. The TS 804 is shipped with all serial ports set at a baud rate of 9600. The baud rate can be changed by using the CONFIGUR program as described in Appendix J. Refer to the user's manual that came with your peripheral for information on setting its baud rate.

#### **CONNECTING A PARALLEL PRINTER**

The rear panel connector labeled PRINTER is configured for a Centronics-type parallel printer. The PRINTER port uses a 25-pin D-SUB connector. (See Appendix H for connector pin assignments.) Attach the 25-pin D-SUB connector end of the cable to the PRINTER port and the Centronics-type male end to the parallel port on the printer.

For information on operating your printer, refer to the user's manual that was supplied with it.

**MODEMS**

If you are not using your TS 804 with the maximum four users, you can use one or more of the ports marked USER to attach a modem provided you have installed the appropriately configured MPM.SYS. For more information, see the MP/M II Manual Set (listed in Appendix B). These RS-232C ports use standard 25-pin D-SUB connectors (see Appendix C for connector pin assignments). To connect a modem, attach one end of a specially-configured RS-232C modem cable to one of the ports labeled USER, and the other end to the modem's RS-232C connector (see Appendix C for details on the modem cable).

To operate the modem, refer to the documentation supplied with it and the communication software package that you are using. (See Appendix J for details on setting RS-232C port baud rates and data formats.)

Ask your computer dealer for details on how to connect and use a specific modem with the TS 804.



#### 4. TURNING ON THE TS 804 AS A MULTI-USER SYSTEM

The operating system for the TS 804 controls all of the operations and programs in your computer. It loads the various applications programs that you want to run and supervises their execution. It organizes the data for communications to a printer or over a modem to a remote terminal.

If you are using the TS 804 in a multi-user configuration, the system console has a special role during power up, but it will be treated like any of the other terminals during operation.

This chapter explains one of the operating systems available to you. If you are using the TS 804 in a multi-user configuration you will use MP/M II as the operating system and you only need to read this chapter covering MP/M II. If you choose to make the TS 804 a single-user system, you will use the CP/M Plus operating system. Therefore, you only need to read the chapter on turning on the TS 804 as a stand-alone system and the section in this chapter on changing the system software for a different configuration.

##### USING MP/M II

MP/M II stands for "Multi-Programming Monitor Control Program for Microprocessors." It is designed to be used as the operating system for a multi-user system. This means that more than one user (terminal) can control the computer at one time. Each user in a multi-user system can operate as if they had the complete attention of the computer to perform a given task.

Although the system microprocessor in the TS 804 can only perform a single operation at a time, it operates at such a high speed that it can support several users at one time. It does this by switching between users, giving a portion of processor time to each one, at such high speeds that you do not notice this sharing as you use the system.

##### STARTING UP MP/M II

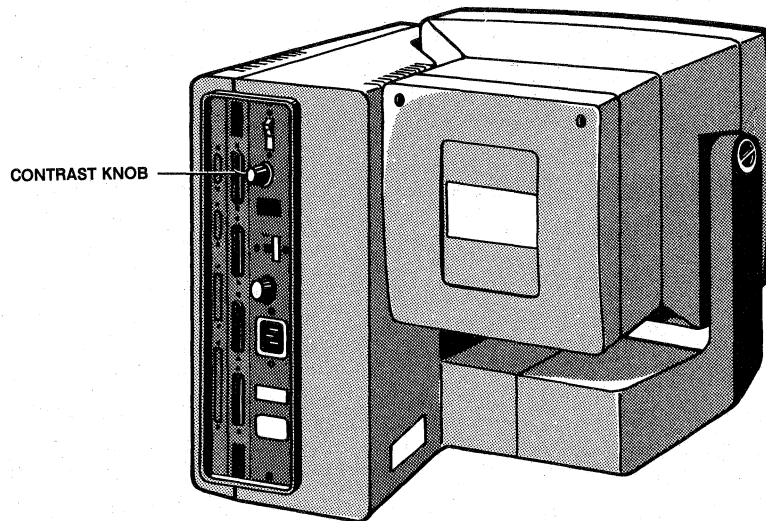
There are a few easy steps for starting your multi-user computer system and activating the operating system. This section describes how to start your system for the first time and transfer the operating system from the floppy diskette to the hard disk.

- USER:       1.    Turn on the power by pressing the white dot on the power switch.



2. The screen contrast can be adjusted by turning the contrast knob on the rear panel of the computer. Figure 4-1 shows the location of the contrast knob.

**Figure 4-1  
Contrast Knob**



SYSTEM: 3. Displays

TeleVideo System TS-804 Rev x  
 (c) 1984, TeleVideo Systems, Inc.  
 ..Diagnostics in progress..  
 User Ports(1-3) diagnostics (Y/)?

USER: 4. You should **NOT** respond to this question unless you want to run the User Port Diagnostics. To run the User Port Diagnostics, a loop back connector is required for each user port.

This message will timeout and the system will respond with the following:

SYSTEM: 5. Displays

Hit any key to interrupt default boot operation.

USER: 6. Enter

<CR>

## SYSTEM: 7. Displays

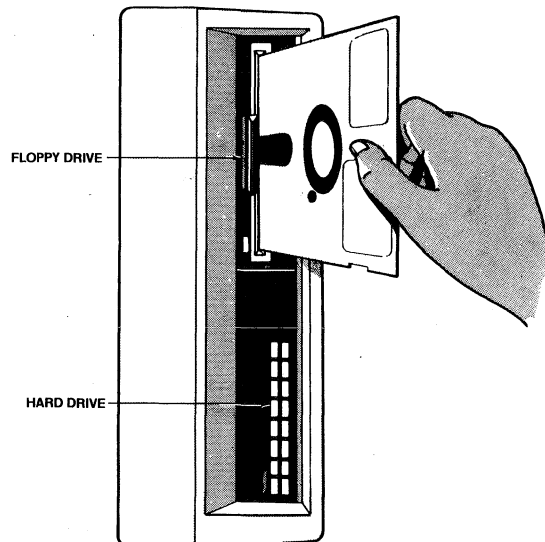
Enter 1 to boot from floppy disk.

Enter 2 to boot from hard disk (primary operating system).

Enter 3 to boot from hard disk (secondary operating system).

- USER: 8. Remove the system diskette, labeled MP/M II, from its dust jacket. Insert the diskette in the floppy drive with the label facing left and the notch facing down as shown in Figure 4-2.

**Figure 4-2**  
Inserting a Diskette



- USER: 9. Close the drive door by pushing it to the right until it snaps into the closed position.

10. Press

1

**STOP!** This selects the system to boot from the floppy. Do not select 2 until you have installed the primary operating system on the hard disk. Do not select 3 until you have installed a secondary operating system on the hard disk. See WRITESYS in Chapter 8 for information on installing a secondary operating system.

Once the primary hard disk operating system has been installed, the system will boot from that primary operating system as a default boot source. All the questions will timeout and default values will be used.

SYSTEM: 11. Displays

System boot from floppy disk in progress

USER: 12. When MP/M II has been successfully loaded, a message similiar to this appears on the screen:

SYSTEM: 13. Displays

MP/M II Vx.x Loader  
Copyright (c) 1981, Digital Research  
Number of Consoles = 4  
Breakpoint RST # = 6  
Memory Segment Table:

14. Displays the memory segment table.

15. Displays

TeleVideo MP/M II Vx.x  
Copyright (c), 1982, Digital Research

0A>

The system start-up is now complete and you can enter any MP/M II command. However, before you begin using the system you must install the operating system onto the hard disk.

**INSTALLING THE OPERATING SYSTEM ON HARD DISK**

You must run five utility programs to install the operating system onto the hard disk. FORMATH formats the hard disk, FIX804 inspects the hard disk for defective data areas, WRITESYS transfers the system files to the first two tracks of the hard disk, PIP copies the utility program files, and SHUTDOWN flushes all the contents of the cache memory to the hard disk. Chapter 8 and the MP/M II User's Guide explain the utility programs in detail.

Use the following procedure to install MP/M as the operating system on hard disk.

- USER: 1. When the system prompt (0A>) appears, enter:
- FORMATH<CR>**
2. The FORMATH program formats the hard disk. Refer to Chapter 8 for instructions on running the FORMATH utility program.
- SYSTEM: 3. Displays, when the FORMATH program has been successfully run:
- FORMATH completed
- 0A>
- USER: 4. After the system prompt, enter:
- FIX804 B:<CR>**
5. The FIX804 program maps out defective sectors on the hard disk. Refer to Chapter 8 for instructions on running the FIX804 program.
- SYSTEM: 6. Displays, when the FIX program is finished:
- FIX DISK COMPLETED WITH XXX DATA BLOCKS ERROR
- 0A>
- USER: 7. After the system prompt, enter:
- FIX804 C:<CR>**
- SYSTEM: 8. Displays, when the FIX program is finished:
- FIX DISK COMPLETED WITH XXX DATA BLOCKS ERROR
- 0A>

- USER: 9. Enter, when the system prompt appears:  
**WRITESYS<CR>**
10. The WRITESYS program writes the system software to the disk. Refer to Chapter 8 for instructions on running the WRITESYS program.
- SYSTEM: 11. Displays, when WRITESYS is complete:  
**WRITESYS COMPLETED**  
**0A>**
- USER: 12. Enter, to copy all files from the floppy to the hard disk:  
**PIP C:=A:\*. \*[ROV]**
- SYSTEM: 13. Displays  
**0A>**
- USER: 14. Run the SHUTDOWN program explained in Chapter 8.
15. Remove the master diskette from the floppy drive and store upright in a safe place.
16. If you want to make a working copy of the system diskette, follow this procedure:
17. Reset the system to boot from the hard disk by pressing  
**SHIFT/BREAK BREAK**
18. Run the FORMATF program in Chapter 8. Be sure to insert a blank 96 tpi diskette in the floppy drive.
19. Run the WRITESYS program in Chapter 8. This writes the operating system to the floppy diskette.
20. Enter  
**PIP C:=A:\*. \*[ROV]**
21. Remove the diskette from the floppy drive and store it upright in a safe place.

From this point on, whenever you turn on the system the default is to boot from the hard disk, which is now designated as logical drive A. Logical drive B is also on the hard disk and logical drive C is the floppy drive.

**NOTE!** Pressing <SHIFT>/<BREAK><BREAK> resets the whole system; similar to a power off/on. This can only be done at the TS 804 and has no effect from a user terminal.

**DO NOT DO THIS UNLESS ABSOLUTELY NECESSARY. THIS ACTION EFFECTS ALL USERS.**

There are three logical drives on the TS 804; one floppy, and two on the hard disk. Their name designations differ according to how you boot the system. When you boot the system from the floppy drive, the floppy is called drive A. Drive B is always the inner tracks of the hard disk. Drive C is the outer tracks of the hard disk. When you boot the system from the hard disk, drive A is on the outer tracks. Drive B is always on the inner tracks. Drive C is the floppy drive. Table 4-1 lists the logical drive assignments and physical devices.

**Table 4-1  
Logical Drives**

Loading Source	Logical Drive Assignment	Physical Device
Floppy	A	Floppy
	B	Hard (inner tracks)
	C	Hard (outer tracks)
Hard	A	Hard (outer tracks)
	B	Hard (inner tracks)
	C	Floppy

**THE MP/M II MANUAL**

For a complete explanation of MP/M II, refer to the MP/M II User's Manual. That manual explains system prompts, system files and drives, user areas, MP/M II utility programs and other detailed information that you will want to know in order to obtain optimum performance on your TS 804. See Appendix B for information needed to obtain a set of MP/M II manuals.

**RUNNING APPLICATIONS PROGRAMS**

You can get applications programs for the TS 804 to perform a wide range of tasks. You may want to purchase software for some of the following applications:

- \* Word processing
- \* Accounting
- \* Financial analysis
- \* Program development
- \* Entertainment

If you wish, you can write your own applications programs in one of the programming languages compatible with MP/M II. There are a minimum of nine MP/M II-compatible programming languages including ALGOL, APL, BASIC, C, COBOL, FORTH, FORTRAN, PASCAL, and PL/1 that can be used on the TS 804.

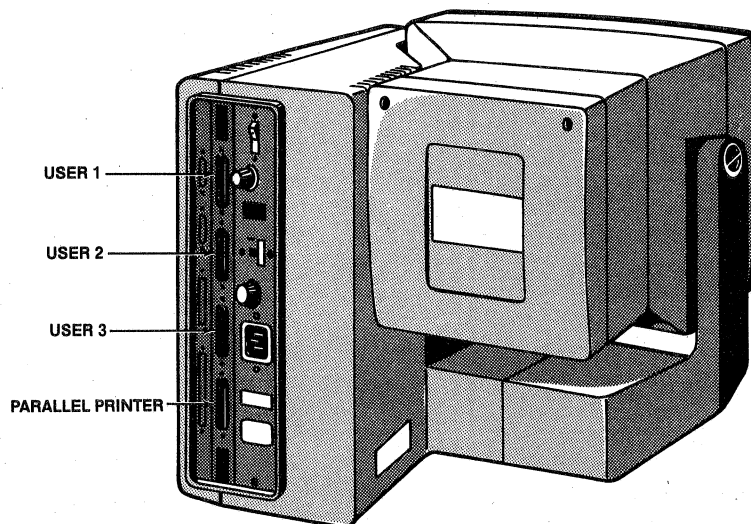
The TS 804 supports Altos 580 software. Ask the computer software specialists at your computer store about what other programs and languages run on your TS 804.

#### CHANGING SYSTEM SOFTWARE FOR DIFFERENT CONFIGURATIONS

When you are connecting additional terminals, you use different configurations, depending upon the number of users and peripheral devices that you want the system to support. For example, if you want to connect two terminals to the integral TS 804, (for a total of three users), a serial printer, and a parallel printer to your system, you use the three-user configuration. The configurations are explained on the following pages.

The back panel of the TS 804 has several connectors for additional terminals and peripherals. These are called ports. There is one parallel port for a Centronics-type printer. The three ports labeled USER #1, USER #2, and USER #3 are serial ports and can be used either to connect additional terminals, modems, or serial printers. See Figure 4-3.

**Figure 4-3**  
**Ports**



**Two-User Configuration**

This configuration supports two users (the main system and one additional terminal), two serial printers, and a parallel printer. In this configuration, you connect only the port labeled USER 1 to a terminal. The other two serial ports (USER 2 and USER 3) can be used to connect serial printers. USER 0 is connected (internally) to the TS 804 keyboard and display screen in all configurations.

<b>Logical</b> (used in MP/M commands)	=	<b>Physical</b> (on the back of the TS 804)
Printer port 0	=	Parallel port
Printer port 1	=	USER 3 port
Printer port 2	=	USER 2 port

**Three-User Configuration**

Use this arrangement if you want the system to support three users, a parallel printer, and a serial printer. The ports labeled USER #1 and USER #2 connect to terminals, and the port for USER #3 becomes a serial printer port.

<b>Logical</b> (used in MP/M commands)	=	<b>Physical</b> (on the back of the TS 804)
Printer port 0	=	Parallel port
Printer port 1	=	USER 3 port

**Four-User Configuration**

In this arrangement, the TS 804 supports its maximum number of users. All three USER ports are connected to terminals, and the one parallel port is connected to a parallel printer. The TS 804 is shipped from the factory configured to support four users.

**Changing Configurations**

You can change the number of users your terminal supports at any time. When you have determined the configuration that you want, you need to install that on the system disk.

The TS 804 is shipped with the four-user configuration set as file **MPM.SYS** on the MP/M II operating system diskette. When you install the operating system onto the hard disk, the system is automatically configured for four users.

The names of the other possible system configurations included on the operating system are:

- MPM2.SYS                      Configuration A - one or two users, with or without two serial printers



MPM3.SYS Configuration B - three users, with or  
without one serial printer

MPM4.SYS Configuration C - four users and no serial  
printers

The parallel printer port is supported under all configurations.

If you wish to change the configuration in order to support two users or three users, just transfer the new configuration file to the MPM.SYS file using the PIP command.

For example, to change from the four-user configuration to a two-user configuration, enter at the prompt:

```
PIP MPM.SYS=MPM2.SYS<CR>
```

The two-user configuration is now installed as the new system configuration. Run the SHUTDOWN program, remove the floppy diskette, and then power the TS 804 OFF and ON again. The new configuration will be in operation.

To make a customized version of MP/M II (the MPM.SYS file), see the sections on the GENSYS utility in the TS 804 Technical Reference Manual and the MP/M II Manual set described in Appendix B.

#### POWERING ON A TERMINAL

The TS 804 must be powered on before you can operate a terminal that is connected to it. To verify that the TS 804 is on, turn the terminal on and look for the following message to appear on the screen:

```
TeleVideo MP/M II Vx.x  
Copyright (c) 1982, Digital Research
```

```
1A>
```

When you see this message after powering on your terminal, you will know that the TS 804 is operating and you can begin using the terminal. This terminal is connected to user port #1 and the logged drive is A.

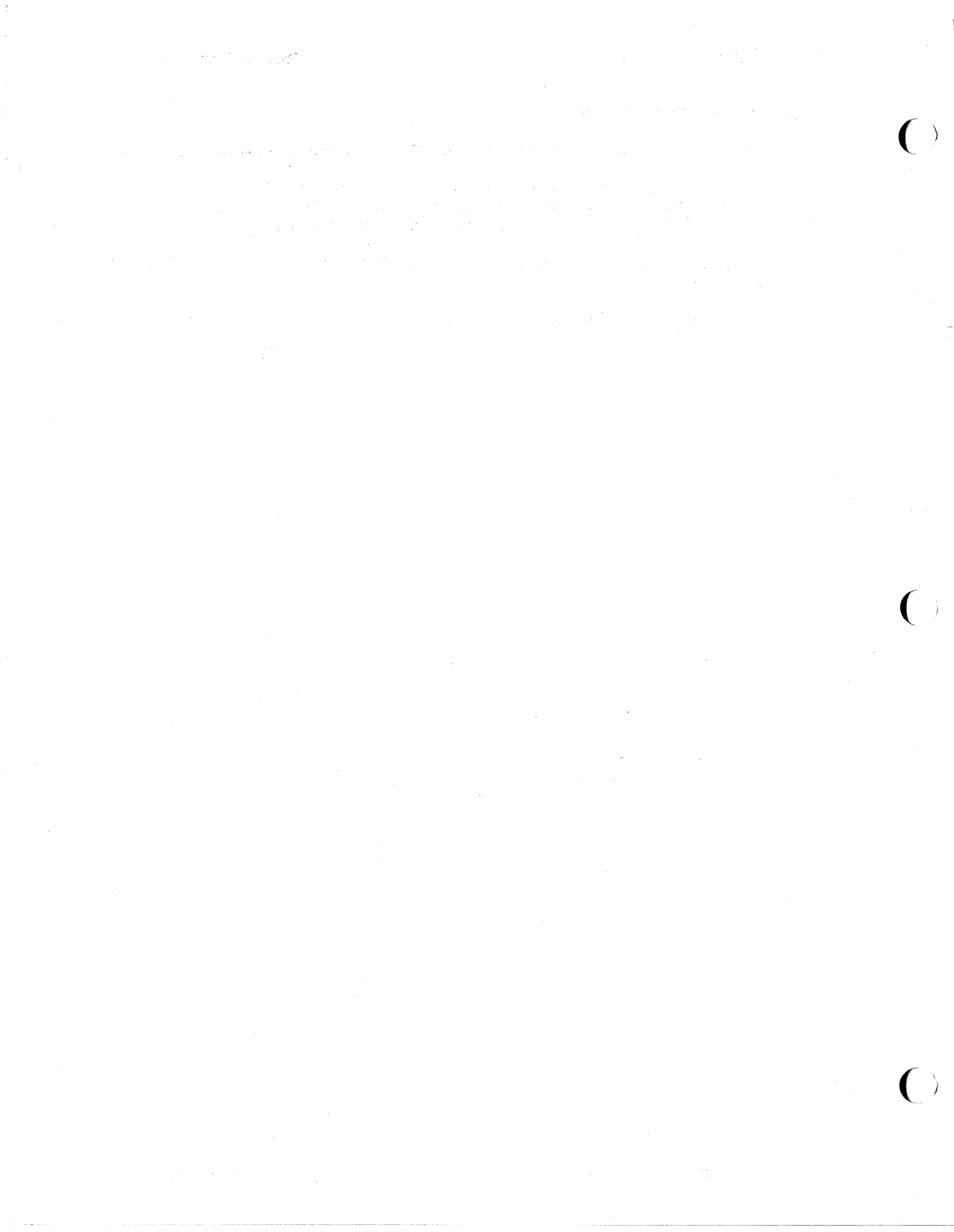
#### TURNING OFF A TERMINAL

You can power off any of the terminals connected to the TS 804 at any time. There is no special procedure necessary to turn them off. Press the plain end of the power switch.

**TURNING OFF THE SYSTEM**

When you are finished using the TS 804, follow these steps:

1. Make sure no one is using any of the terminals. Run the MPMSTAT program (see the MP/M II User's Manual) to see if any other programs are running on the system.
2. Run the power down program, SHUTDOWN (see Chapter 8 of this manual).
3. Turn off the power.



## 5. TURNING ON THE TS 804 AS A STAND-ALONE SYSTEM

You may purchase the CP/M Plus operating system option (TeleVideo P/N 125645-00) if you want to use the TS 804 as a single-user, high performance stand-alone system. This chapter explains how to start up your system for the first time and transfer CP/M Plus from the floppy diskette to the hard disk.

Alternatively, you may install MP/M for single-user operation, using configuration A (with the MPM2.SYS file) as described in Chapter 4.

### USING CP/M PLUS

CP/M stands for Control Program/Monitor or Control Program for Microprocessors. CP/M Plus manages and supervises the memory, disk storage, console (screen and keyboard), and printer of your TS 804 system.

### STARTING UP CP/M Plus

There are a few easy steps for starting your TS 804 and activating the operating system for stand-alone use. When your TS 804 is shipped from the factory there is no operating system written on the hard disk. You should follow the steps in this chapter to install CP/M Plus on the hard disk.

USER: 1. Turn on the TS 804 by pressing the white dot on the power switch.

SYSTEM: 2. Displays

```

TeleVideo System TS-804 Rev x
(c) 1984, TeleVideo Systems, Inc.
..Diagnostics in progress..
User Ports(1-3) diagnostics (Y/)?

```

USER: 3. You should **NOT** respond to this question unless you want to run the User Port Diagnostics. To run the User Port Diagnostics, a loop back connector is required for each user port.

This message will timeout and the system will respond with the following

SYSTEM: 4. Displays

Hit any key to interrupt default boot operation.

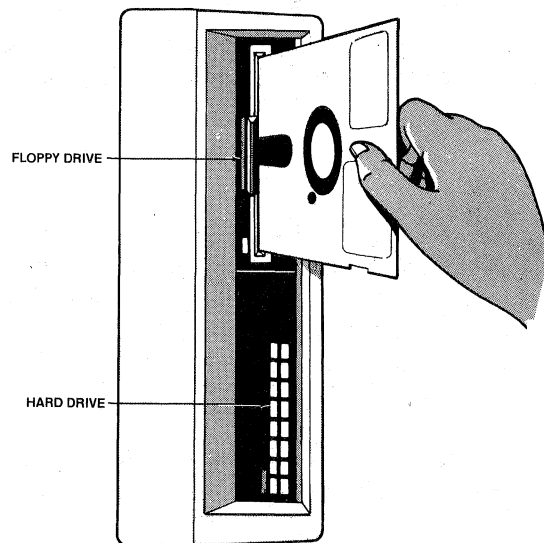
USER: 5. Enter  
<CR>

SYSTEM: 6. Displays

Enter 1 to boot from floppy disk.  
Enter 2 to boot from hard disk (primary operating system).  
Enter 3 to boot from hard disk (secondary operating system).

USER: 7. Remove the system diskette, labeled CP/M Plus, from its dust jacket. Insert the diskette in the floppy drive with the label facing left and the notch facing down as shown in Figure 5-1.

**Figure 5-1**  
**Inserting a Diskette**



USER: 8. Close the drive door by pushing it to the right until it snaps into the closed position.

9. Press  
1

SYSTEM: 10. Displays

System boot from floppy disk in progress

When CP/M Plus has been successfully loaded, the following message appears on the screen:

11. Displays  
CP/M V3.0 Loader  
Copyright (c) 1982, Digital Research
12. Displays the memory segment table.
13. Displays when the CP/M loader has loaded the CP/M Plus operating system and given control to the operating system:  
  
TS-804 : Single User System xx.x  
Banked CP/M Plus - Version 3.0  
(c) 1984 TeleVideo Systems, Inc.

A>

The system start-up is now complete and you can enter any CP/M Plus command. However, before you begin using the system you must install the operating system onto the hard disk.

#### INSTALLING THE OPERATING SYSTEM ONTO THE HARD DISK

Use the following procedure to install CP/M Plus as the primary operating system on the hard disk.

- USER: 1. Enter, when the system prompt (A>) appears:  
  
**SUBMIT INSTALL<CR>**
- SYSTEM: 2. Displays  
  
FORMATH  
<I  
<  
FIX804 C:  
<  
FIX804 B:  
<  
PIP  
(displays file names)  
WRITESYS  
<C  
<804BOOT  
<804CLDR  
<  
DIR C:  
TYPE INFO
- USER: 3. Remove the diskette from the floppy drive and store it in a safe place.
4. Press  
  
**SHIFT/BREAK BREAK**

SYSTEM: 5. Displays

TeleVideo System TS-804 Rev x  
 (c) 1984 TeleVideo Systems, Inc.  
 ..Diagnostics in progress..  
 User Ports(1-3) diagnostics (Y/)?

HIT ANY KEY TO INTERRUPT DEFAULT BOOT OPERATION

USER: 6. Does nothing and lets the TS 804 boot from the hard disk.

7. Insert a blank diskette in the floppy drive.

8. Enter

**SUBMIT BACKUP<CR>**

SYSTEM: 9. Displays

FORMATF  
 <  
 <  
 <N  
 FIX804 C:  
 <  
 WRITESYS  
 <C  
 <804BOOT  
 <804CLDR  
 PIP

10. Displays filenames.

11. Displays

DIR C:

SYSTEM: 12. Displays the system directory.

USER: 13. Remove the diskette from the floppy drive and store it in a safe place.

You now have made a backup copy of the CP/M Plus diskette.

**THE CP/M PLUS MANUAL**

For a complete explanation of CP/M Plus, refer to the CP/M Plus User's Manual which is included in the CP/M Plus Option Kit (TeleVideo P/N 125645-00). That manual explains system prompts, system files and drives, user areas, CP/M Plus utility programs, and other detailed information that you will want to know.

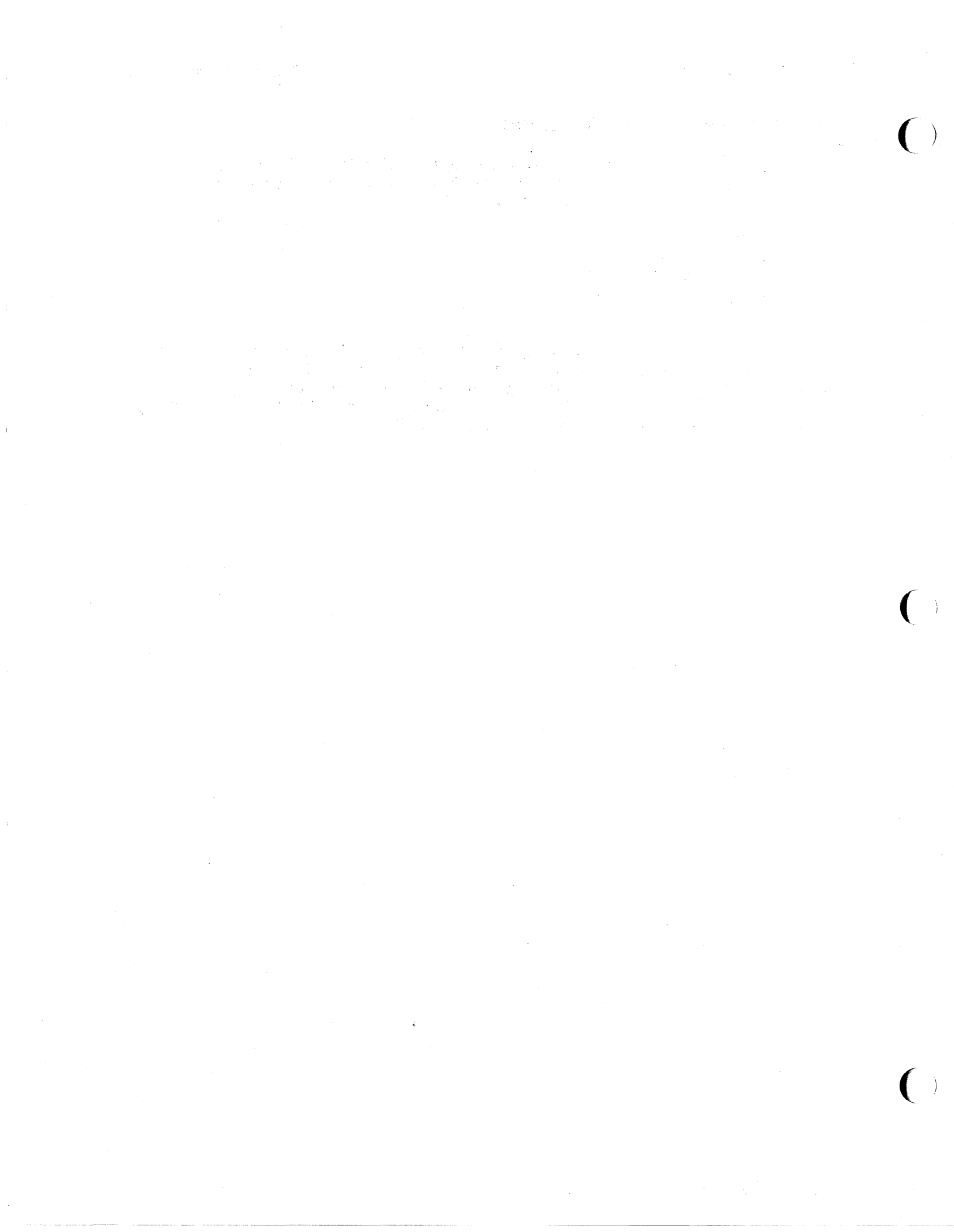
**RUNNING APPLICATIONS PROGRAMS**

You can get applications programs for the TS 804 to perform a wide range of tasks. You may want to purchase software for some of the following applications:

- \* Word processing
- \* Accounting
- \* Financial analysis
- \* Program development
- \* Entertainment

If you wish, you can write your own applications programs in one of the programming languages compatible with CP/M Plus. There are a minimum of nine CP/M-compatible programming languages including ALGOL, APL, BASIC, C, COBOL, FORTH, FORTRAN, PASCAL, and PL/1 that can be used on the TS 804.





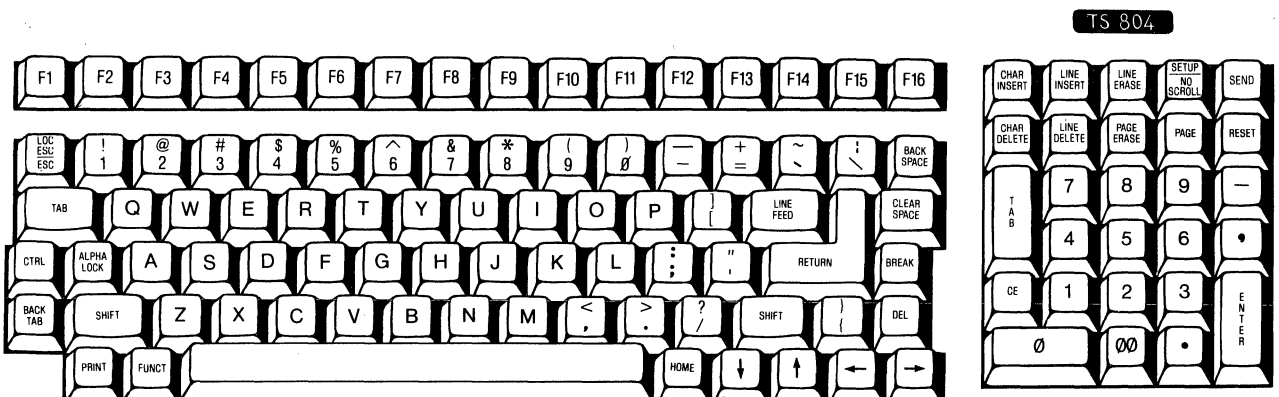
6. KEYBOARD

The TS 804 keyboard has a main keypad, arranged like a typewriter, and an accounting keypad. Some keys are duplicated in both areas. This chapter discusses the three types of keys on the keyboard and lists each key and how it works. For a more technical description of the keys, refer to the TS 804 Technical Reference Manual.

KEY DESCRIPTIONS

The keyboard has a Selectric-style format and operates like a typewriter with many of the same special keys and capabilities. In addition to the accounting keypad, there are special keys, called **function keys**, along the top of the keyboard. These keys can be used to customize applications software for use on the TS 804.

Figure 6-1  
Keyboard



Character Keys

The character keys include all alphabet characters (A through Z), numbers (0 through 9), punctuation marks, and mathematical symbols. All character keys repeat when pressed for more than a half second.

**Special Keys**

There are several special keys that make inputting information easier. They perform editing functions, user-programmable functions, and other special functions such as turning on the status line so that you can set the terminal attributes. The three sections on the following pages include descriptions of the special keys on each side of the main keypad and the special keys on the numeric keypad.

Many of the special keys are not programmed to be used as labeled when you receive the TS 804. They can be programmed to work with a specific applications program. If you use them before they have been programmed you may see some symbols and characters on the screen that do not make any sense. These are called unprogrammed characters.

The following descriptions are a general guide for what each key does when you are using MP/M II or CP/M Plus. Programmers can refer to the TS 804 Technical Reference Manual for a more detailed description of the keys.

Table 6-1 summarized the function of the highlighted keys in Figure 6-2. These keys are unique. They have no effect on the terminal and send no code to the computer unless you press them simultaneously with another key.

**Figure 6-2  
Special Keys Requiring Another Key**

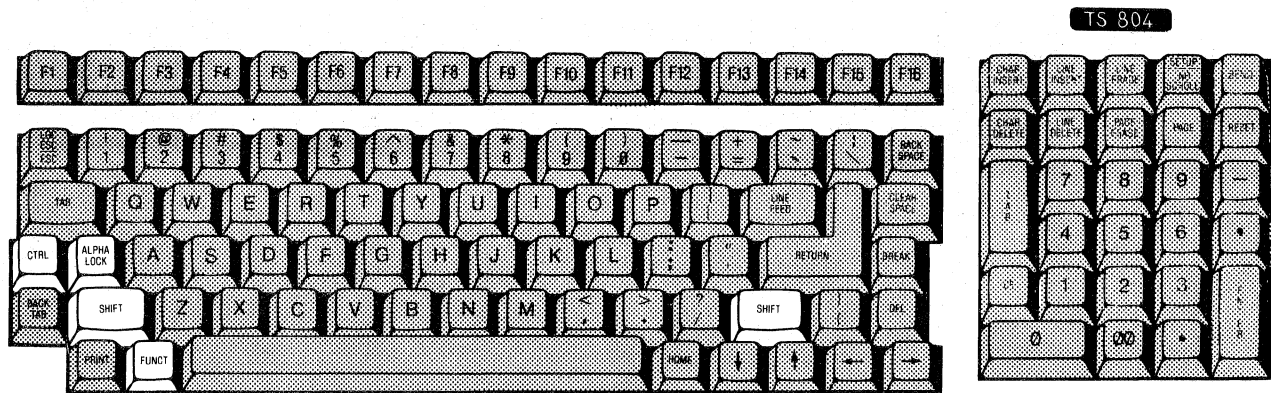
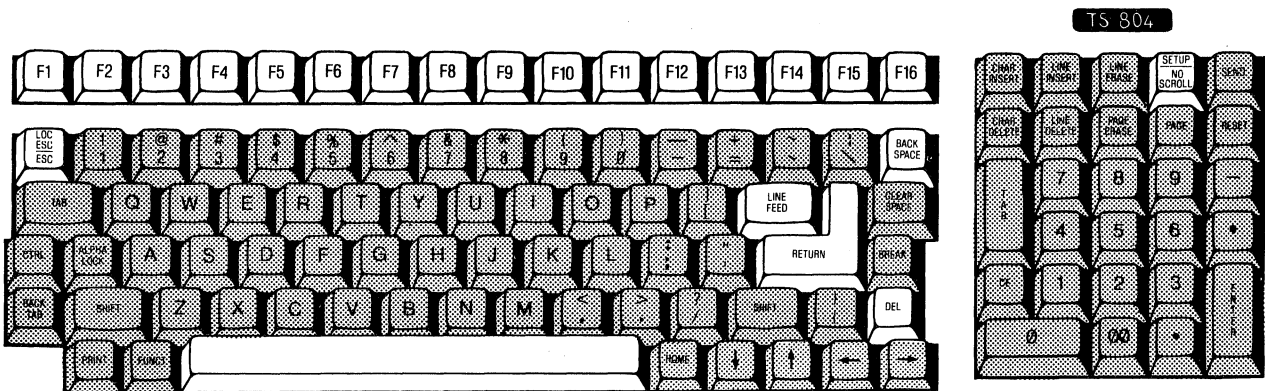


Table 6-1  
Special Key Functions 1

Key Name	Description
ALPHA LOCK	Locks the SHIFT keys so that all alpha keys are upper-case characters. Press once to lock; press again to release.
CTRL (control)	The control key combinations are used for special action by the computer and/or the applications program in the computer.  The <CTRL> key is always used simultaneously with the other character in the command; the <CTRL> key is pressed first and held down while the other key is pressed. Use of the <CTRL> key in this manual is indicated by the symbol ^.  The <CTRL> key pressed alone has no effect.
FUNCT	May be used with some applications programs. Has no effect by itself. Does not repeat.
SHIFT	Like the <SHIFT> key on a typewriter, it selects the upper character inscribed on a key, changes operation of most special keys, and capitalizes alpha characters.

The special keys make inputting information easier by performing special functions.

Figure 6-3  
Special Keys



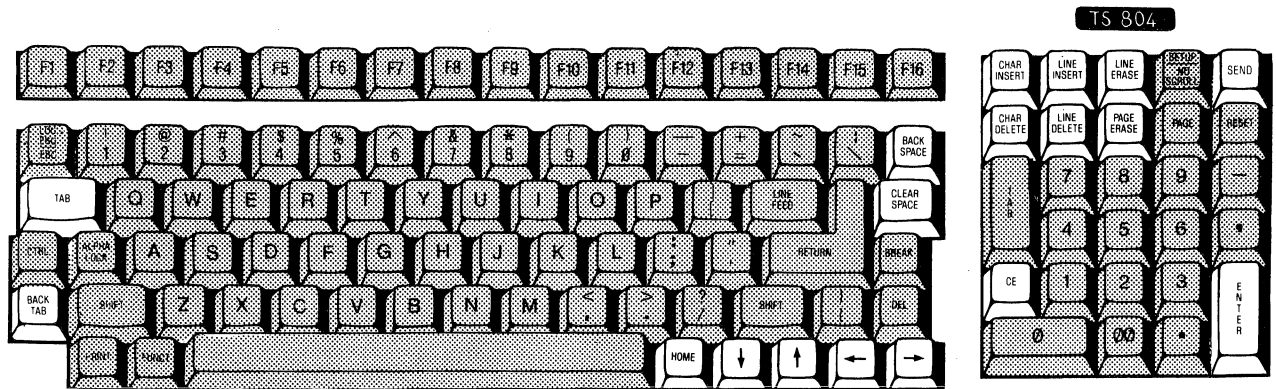
**Table 6-2**  
**Special Key Functions 2**

<b>Key Name</b>	<b>Description</b>
BACK SPACE	Moves the cursor left one character. Same as the left arrow key.
DEL	Deletes the character to the left of the cursor. The deleted characters are displayed on the screen.
ESC (escape)	Causes a special feature or function to be used. Does not repeat.
LINE FEED	Positions the cursor at the beginning of the next line.
SHIFT/ LINE FEED	Same as LINE FEED.
F1 through F16	Each function key sends a reprogrammable code sequence capable of initiating a special computer program subroutine so the terminal displays or performs a special function. Does not repeat.
SHIFT/ F1 through F16	Same as F1 through F 16 but enables 16 more special functions referred to as F17 through F32. Does not repeat.
Space Bar	Works like the space bar on a typewriter.
SHIFT/ LOC ESC	Allows the next character in an escape sequence to affect the terminal without sending data entered on the keyboard to the computer. Does not repeat.  To use <LOC ESC>, enter the desired escape sequence on the keyboard, but press <SHIFT>/<LOC ESC> instead of <ESC>.
NO SCROLL	When pressed once, keeps the screen from displaying incoming data (stops the screen from updating). Updating resumes when the key is pressed again. Does not repeat.
RETURN	When the <RETURN> key is pressed, the action on the screen is like a carriage return.

**SHIFT/  
SET UP** When pressed once, turns on the setup mode and displays the status line. The screen display is not lost. When pressed again, returns the cursor to its previous location within the first 24 lines. Does not repeat.

The next section discusses the editing keys. Unless noted, they repeat when held down more than a half second.

**Figure 6-4  
Special Editing Keys**



**Table 6-3  
Function of Special Editing Keys**

Key Name	Description
BACK TAB	Moves the cursor back to the previous tab stop or to the start of the current or previous field when programmed.
SHIFT/ BACK TAB	Same as BACK TAB.
CE (Clear entry)	Replaces data with space characters. Clears data between tab stops and moves the cursor back to the beginning of the current field. Clears all data within the current field. Does not repeat.
SHIFT/ CE (Clear entry)	Same as pressing <CE>.
CHAR DELETE	Deletes the cursor character and moves all succeeding characters one position to the left. Adds a space at the end of the affected text when programmed.
SHIFT/ CHAR DELETE	Same as pressing <CHAR DELETE>.

CHAR INSERT	Adds a space at the cursor position, moving all succeeding characters right one position. Characters moved past the 80th column are lost.
SHIFT/ CHAR INSERT	Same as pressing <CHAR INSERT>.
CLEAR SPACE	Replaces all characters on the screen with spaces.
SHIFT/ CLEAR SPACE	Resets visual attribute and turns off protect mode before replacing all data with null characters.
Arrow left	Moves the cursor left one character. Can wrap it around to the previous line.
SHIFT/ Arrow left	Same as pressing arrow left.
Arrow up	Moves the cursor up on line within the same column; stops when it reaches a protected position. Stops at the top line.
Arrow down	Moves the cursor down one line within the same column. If the cursor is on the bottom line, nothing happens.
SHIFT/ Arrow down	Same as pressing <LINE FEED>.
Arrow right	Moves the cursor right one position. Wraps around to the next line.
SHIFT/ Arrow right	Same as pressing arrow right.
ENTER	Same as pressing <RETURN>.
SHIFT/ ENTER	Same as pressing <ENTER>. Does not repeat.
HOME	Moves the cursor to the first character position, usually column one of line one. Does not repeat.
LINE DELETE	Removes the current line and shifts lines below it up one line. Fills the last line of the page with a line of spaces.
SHIFT/ LINE DELETE	Same as pressing <LINE DELETE>.
LINE ERASE	Replaces data from the cursor to the end of the line spaces.

SHIFT/ LINE ERASE	Replaces data from the cursor to the end of the line with null characters.
LINE INSERT	Adds a line of spaces on the cursor line. Data below that line shifts down one line. If the cursor is on the last line of the page when you press this key, that line is lost.
SHIFT/ LINE INSERT	Same as pressing <LINE INSERT>.
PAGE ERASE	Replaces data between the cursor and the end of the page with spaces.
SHIFT/ PAGE ERASE	Replaces data between the cursor and the end of the page with null characters.
SEND	Sends all data between the current line's first column position and the cursor to the computer. Does not repeat.
SHIFT/ SEND	Sends all data between the home position and the cursor to the computer. Does not repeat.
TAB	Moves the cursor forward to the next tab stop.
SHIFT/ TAB	Same as pressing <TAB>.

The reset keys are described in Table 6-4. None of these keys have repeat action.

**Table 6-4**  
**Reset Keys**

Key Name	Description
RESET	Has no effect when pressed alone.
^RESET	When <CTRL> and RESET are pressed simultaneously, the TS 804 integral terminal is reset. This has no effect on the computer, therefore the rest of the system is not affected.
SHIFT/ BREAK BREAK	Resets the whole system; similiar to a power off/on. This can only be done at the TS 804 and has no effect from a user terminal.

**STOP!**      **Do not do this unless absolutely necessary.** This effects all users.



**FUNCTION KEYS**

The function keys (F1 through F16) send a programmable sequence to the display, to the computer, or to the computer and the display. You can reprogram any function key (shifted and unshifted), as shown in the next chapter.

**Default Values**

Table 6-5 lists the default code sequences sent by each function key.

**Table 6-5**  
**Default Function Key Codes**

Function Key	Code* Unshifted	Code* Shifted
F1	SOH @ <CR>	SOH ` <CR>
F2	SOH A <CR>	SOH a <CR>
F3	SOH B <CR>	SOH b <CR>
F4	SOH C <CR>	SOH c <CR>
F5	SOH D <CR>	SOH d <CR>
F6	SOH E <CR>	SOH e <CR>
F7	SOH F <CR>	SOH f <CR>
F8	SOH G <CR>	SOH g <CR>
F9	SOH H <CR>	SOH h <CR>
F10	SOH I <CR>	SOH i <CR>
F11	SOH J <CR>	SOH j <CR>
F12	SOH K <CR>	SOH k <CR>
F13	SOH L <CR>	SOH l <CR>
F14	SOH M <CR>	SOH m <CR>
F15	SOH N <CR>	SOH n <CR>
F16	SOH O <CR>	SOH o <CR>

\* Refer to ASCII Code Conversion Table in Appendix I.

**NOTE!** Function key codes are transmitted sequentially. If you press a function key while other data is being transmitted, the function key's code is transmitted after the terminal transmits the other data. If your computer cannot accept codes at that speed, you may have to modify your software, lower the baud rate to the computer, or change the handshaking protocol between the terminal and computer.

How the computer will respond to a function key's code depends entirely on how the computer is programmed to respond to the transmitted codes.

**Reprogramming Function Keys**

To reprogram a function key, enter

ESC | p1 p2 <message> CTRL Y

where ESC | is used to start the programming sequence.

p1 is a value for the function key's number. See Table 6-6.

p2 is a value for the communication mode. See Table 6-7.

<message> is the message to be transmitted by that function key. The message can contain any combination of alphanumeric characters, control code(s), or escape sequences.

CTRL Y is used to end the programming sequence.

To include a CTRL Y or CTRL P in the text, precede it with a CTRL P (which is not counted as a character in the text).

**Table 6-6  
Reprogramming Function Keys**

Key	p1 Value Unshifted	p1 Value Shifted
F1	1	A
F2	2	B
F3	3	C
F4	4	D
F5	5	E
F6	6	F
F7	7	G
F8	8	H
F9	9	I
F10	:	J
F11	;	K
F12	<	L
F13	=	M
F14	>	N
F15	?	O
F16	@	P

**Table 6-7  
p2 Value Table**

p2 Value	Effect
1	Send code to computer
2	Send code to terminal
3	Send code to both computer and terminal

### Message Length

The memory for all function keys contains 512 bytes (256 shifted and 256 unshifted). If each key's program were to be the same size, each could include 16 characters less one character per key for control purposes. The maximum text length for each key (shifted or unshifted) is 63 characters.

To determine how much can be programmed in each key, you need to know how many keys are going to be used. If you don't need all 32 keys, the message for the few keys you do use can be larger.

### Message Contents

The message can include an alphanumeric message displayed on the screen plus control codes and escape characters.

### Determining Program Destination

The value entered for p2 determines the destination of the program. If you send it to the terminal, the computer cannot act upon it. If you send it only to the computer, the message cannot appear on the screen unless the computer echoes it back to the terminal. This may occur if the computer is in full duplex mode. Think about who needs to receive the message and enter the appropriate p2 value.

### Entering a Sample Program

To illustrate how a function key is reprogrammed four examples are included:

F1 to execute the MP/M II program MPMSTAT

F16 to execute a DIR B:

F7 to execute a SHOW SPACE

SHIFT F7 to execute a SDIR \*.SYS[DRIVES=ALL]

**NOTE!** The computer does not echo the ESC I, p1 and p2 values, and the CTRL Y. When you program from the keyboard, use SHIFT/ESC. When you program from the computer, use ESC.

**Example 1: F1 to execute the MP/M II program MPMSTAT**

USER: 1. Press, to start the programming sequence:

**SHIFT/ESC :**

Everything entered after this and before the termination CTRL Y is considered part of the program. This is not echoed on the screen.

2. Press

**1**

This is the designation you want for changing the value of the F1 key; the p1 value. This is not echoed on the screen.

3. Press, to send the message to the computer only:

**1**

This is the p2 value. This is not echoed on the screen.

4. Enter

**MPMSTAT<CR>**

This is the message that the function key will have. The <CR> is an optional part of the message.

5. Enter, to terminate the programming session:

**<CTRL>Y**

**Example 2: F16 to execute a DIR B:**

USER: 1. Press, to start the programming sequence:

**SHIFT/ESC ;**

Everything entered after this and before the termination CTRL Y is considered part of the program. This is not echoed on the screen.

2. Press

**@**

This is the designation you want for changing the value of the F16 key; the p1 value. This is not echoed on the screen.

3. Press, to send the message to the computer only:

**1**

This is the p2 value. This is not echoed on the screen.

4. Enter

**DIR B:**

This is the message that the function key will have.

5. Enter, to terminate the programming session:

**<CTRL>Y**

**Example 3: F7 to execute a SHOW SPACE**

- USER:
  1. Press, to start the programming sequence:

**SHIFT/ESC !**

Everything entered after this and before the termination CTRL Y is considered part of the program. This is not echoed on the screen.

2. Press

**7**

This is the designation you want for changing the value of the F7 key; the p1 value. This is not echoed on the screen.

3. Press, to send the message to the computer only:

**1**

This is the p2 value. This is not echoed on the screen.

4. Enter

**SHOW SPACE<CR>**

This is the message that the function key will have. The <CR> is part of the message.

5. Enter, to terminate the programming session:

**<CTRL>Y**

**Example 4:**      **SHIFT F7 to execute a SDIR \*.SYS[DRIVES=ALL]**

**USER:**      1.    Press, to start the programming sequence:

**SHIFT/ESC ;**

Everything entered after this and before the termination CTRL Y is considered part of the program. This is not echoed on the screen.

2.    Press

**G**

This is the designation you want for changing the value of the SHIFT/F7 key; the p1 value. This is not echoed on the screen.

3.    Press, to send the message to the computer only:

**l**

This is the p2 value. This is not echoed on the screen.

4.    Enter

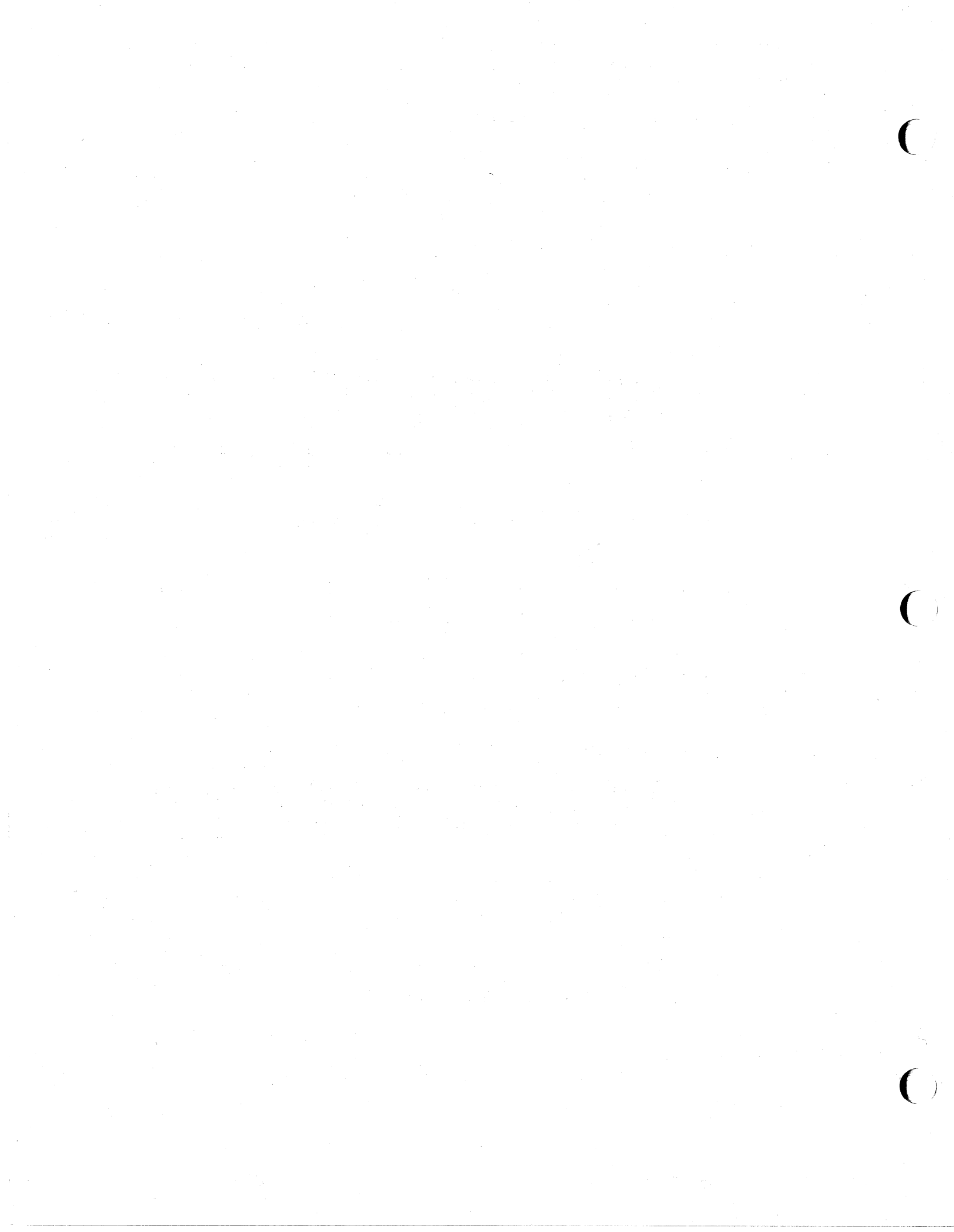
**SDIR \*.SYS[DRIVES=ALL]<CR>**

This is the message that the function key will have. The <CR> is part of the message.

5.    Enter, to terminate the programming session:

**<CTRL>Y**

See the TS 804 Technical Reference Manual for information on storing function key programs in a file and then calling the file up to reprogram these keys each time the system is powered on.



## 7. RECONFIGURING THE TS 804 INTEGRAL TERMINAL

When you receive the TS 804, it is preset for basic operation. Reconfiguration changes the integral terminal features such as cursor style or screen background. There are two ways to change, or reconfigure the TS 804 integral terminal. One way is through the keyboard setup lines. Changes made this way only remain in effect until you turn off the power or reset the terminal.

The second way to reconfigure the TS 804 integral terminal is by resetting the DIP switches on the back of the TS 804. These changes are permanent (unless temporarily changed by the setup line). The functions of the DIP switches and their settings when shipped are explained in Appendix G.

This chapter explains how to reconfigure the TS 804 integral terminal temporarily through the setup lines. Most users will not need to perform this operation and the information contained here is slightly more technical than the other information in this manual. This chapter can be skipped if you are satisfied with the terminal values as they are set when you receive the TS 804.

### HOW TO RECONFIGURE THE TS 804 THROUGH THE KEYBOARD

To reconfigure the TS 804 integral terminal through the keyboard, you must enter the setup mode. Press the SHIFT and SET UP keys simultaneously and a line (called the 25th line) in reverse video appears at the bottom of your screen. You are now in setup mode. There are five different lines that can be selected to appear on the 25th screen line. You can toggle between the lines, displaying each one in sequence. The first line displayed when you enter the setup mode is called the **status line**. The status line reflects the current state of the screen and the keyboard on the TS 804 integral terminal. The baud rate is fixed.

**STOP!** Unless you are familiar with the effects of each field in the status line, we recommend you do not change any values in this line.

The other four lines that you can toggle between are called **setup lines**. Each line contains several coded names which indicate the values set in the firmware. The values in the first and second setup lines are fixed and cannot be altered. You can set the values in the third and fourth setup lines to your preference.



**Table 7-1**  
**Accessing Status and Setup Lines**

<b>Keys</b>	<b>Action</b>
SHIFT/SET UP	Pressing the <SHIFT> and <SET UP> keys simultaneously puts the TS 804 in setup mode and turns on the status line at the bottom of the screen.
N	Pressing the N key causes the first of four setup lines to appear on the screen's 25th line. Pressing the N key again causes the next setup line to appear and so on.
L	Pressing the L key causes the preceding setup line to appear on the screen's 25th line. Pressing the L key again causes the next preceding line to appear and so on. This is the opposite of pressing the N key.
->	Pressing the right arrow key moves the cursor to the next field to the right.
<-	Pressing the left arrow key moves the cursor to the next field to the left.
T	Pressing the T key toggles the values in a selected field back and forth.

The following procedure explains how to look at and alter the values through the setup mode.

### **Looking at the Status and Setup Lines**

1. Press the SHIFT and SET UP keys simultaneously.

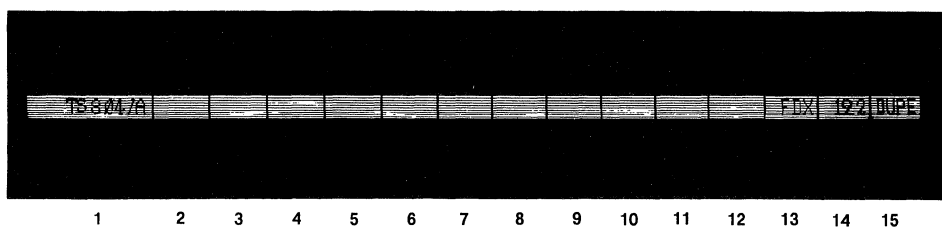
**STOP!** Press both keys at the same time so that you do not stop all data transmission from the computer to the terminal.

This puts the terminal in the setup mode and turns on the display of the status line. The status line summarizes the current status of the terminal parameters. The status line is always the first line displayed after you enter the setup up mode.

2. Look for the cursor to appear in the 25th line. Figure 7-1 shows the initial values of the status line.

3. Press the **T** key to look at another value in the cursor's field. Stop pressing it when you see the value you want. Table 7-2 lists the possible values. Only values 9, 10, 11, 12, 13, and 15 on the table can be altered.
4. Move the cursor to the next field you want to change, using the arrow right or left keys.
5. Press the <SHIFT> and <SET UP> keys again if you want to leave the setup mode without altering any of the values in the setup lines and return the cursor to its previous position on the screen.

**Figure 7-1**  
Initial Status Line



**Table 7-2**  
Status Line Values

Field	Value	Description
1	TS804/A	System identification
2	DSR/DCD/ blank	DSR or DCD line is inactive
3	CBSY/blank	Computer is busy
4	TBSY/blank	Terminal is busy
5	Blank	
6	Blank	
7	KLOK/blank	Keyboard is locked/unlocked
8	SEND/blank	Terminal is sending/not sending a block of data
9	MONT/blank	Monitor mode is on/off
10	PROT/blank	Protect mode is on/off
11	W.P./blank	Write protect mode is on/off
12	GRPH/blank	Special graphics mode is on/off

13	FDX/BLK/HDX	Full duplex/block mode/half duplex mode is on
14	19.2k	Baud rate of the terminal computer port
15	DUPE/LOCE	Duplex/local edit key mode

### Changing a Setup Line

You can check the values in all four setup lines by following the steps below. Figures 7-2 through 7-4 show the setup lines, while Tables 7-4 and 7-5 list the changeable values of setup lines three and four.

1. Press the <SHIFT> and <SET UP> keys simultaneously to see the status line.
2. Press the N or L key to get to the next or last setup line.

**Table 7-3**  
**Setup Lines**

Setup Line	Description
1	Computer port (fixed)
2	Keyboard port (fixed)
3	Screen attributes
4	Screen and keyboard handling

3. Move the cursor to the desired field within the selected setup line by using the left arrow or right arrow keys.
4. Press the T key to toggle the value displayed in the field you have selected. Stop when you see the correct value.
5. The changes you make instantly change the terminal values. The changes only remain until the power is turned off. Then the values return to those set at the DIP switches.
6. Press the SHIFT and SET UP keys simultaneously to leave the setup mode and return the cursor to the main part of the screen.

The changes you make instantly change the terminal values. The changes only remain until the power is turned off. Then the values return to those set at the factory via the DIP switches.

Figure 7-2  
First Setup Line

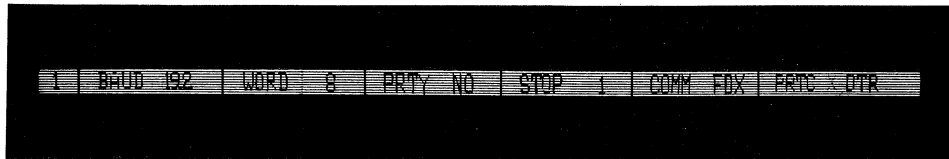


Figure 7-3  
Second Setup Line

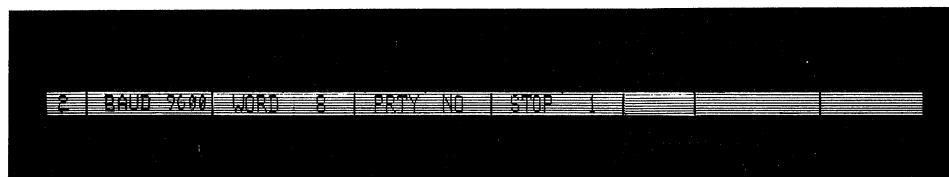


Figure 7-4  
Third Setup Line

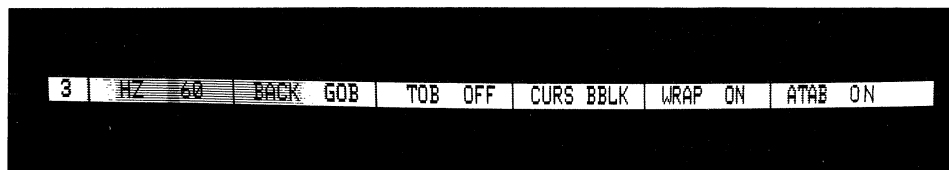
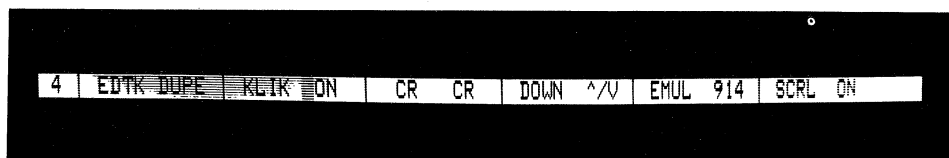


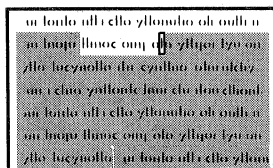
Figure 7-5  
Fourth Setup Line



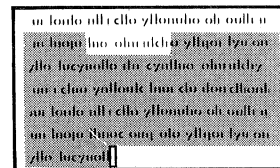
**Table 7-4**  
**Changeable Values in Third Setup Line**

Name	Possible Values	Description
HZ	60	Terminal refreshes screen at 60 hertz. If this value does not match the hertz rate of your ac power line, the screen display may waver.
	50	Terminal refreshes screen at 50 hertz. If this value does not match the hertz rate of your ac power line, the screen display may waver.
BACK	GOB	Screen background is dark with light characters.
	BOG	Screen background is light with dark characters.
TOB (time out blank)	OFF	Leaves screen on, even while terminal keyboard is idle.
	ON	Turns screen off if terminal's keyboard is idle for 15 minutes (i.e., no data received from keyboard).
CURS	BBLK	Cursor is a blinking block.
	SBLK	Cursor is a steady block.
	BUND	Cursor is a blinking underline.
	SUND	Cursor is a steady underline.
WRAP	ON	Turns on autowrap mode so that entering a character on a line's last position automatically advances the cursor to the next line's first unprotected character position.

**NOTE!** Autowrap mode does not change cursor movement caused by cursor right and cursor left commands.



BEFORE



AFTER

Name	Possible Values	Description
WRAP	ON (with write protect OFF and protect ON)	When the write protect mode is off and the protect mode is on, entering a character on the page's last unprotected position returns the cursor to the screen's first unprotected position.

```

in londo i cto yllomho ulhoh oull n
m loqu llhoc onq olo yllqoi lya on
jlo lucynollo du cyulho ohuulchy
un i cho yllonk lun cho don chionl
un londo ull i cto yllomho oh oull n
m loqu llhoc onq olo yllqoi lya on
jlo lucynollo du cyulho ohuulchy
    
```

BEFORE

```

in londo ull i cto yllomho |h oull n
m loqu llhoc onq olo yllqoi lya on
jlo lucynollo du cyulho ohuulchy
un i cho yllonk lun cho don chionl
un londo ull i cto yllomho oh oull n
m loqu llhoc onq olo yllqoi lya on
jlo lucynollo du cyulho ohuulchy
    
```

AFTER

WRAP	ON (with write protect ON and protect ON)	When write protect and protect modes are both on, entering a character on the line's last unprotected position moves the cursor to the next unprotected position.
------	---	---

```

in londo A B C D E F G H I
J K L M noc onq NOP Q R S
T U V W X Y Z A B C D E
un i cho yllonk lun cho don chionl
un londo ull i cto yllomho oh oull n
m loqu llhoc onq olo yllqoi lya on
jlo lucynollo du cyulho ohuulchy
    
```

BEFORE

```

in londo A B C D E F G H I
J K L M noc onq NOP Q R S
T U V W X Y Z A B C D E F
un i cho yllonk lun cho don chionl
un londo ull i cto yllomho oh oull n
m loqu llhoc onq olo yllqoi lya on
jlo lucynollo du cyulho ohuulchy
    
```

AFTER

If none exist, turns off write protect and protect modes.

```

in londo ull i cto yllomho oh oull n
m loqu llhoc onq olo yllqoi lya on
jlo lucynollo du cyulho ohuulchy
un i cho yllonk lun cho don chionl
un londo ull i cto yllomho oh oull n
m loqu llhoc onq olo yllqoi lya on
jlo lucynollo du cyulho ohuulchy
    
```

BEFORE

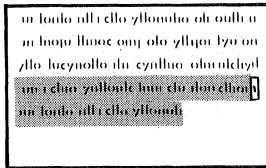
```

in londo ull i cto yllomho oh oull n
m loqu llhoc onq olo yllqoi lya on
jlo lucynollo du cyulho ohuulchy
un i cho yllonk lun cho don chionl
un londo ull i cto yllomho oh oull n
m loqu llhoc onq olo yllqoi lya on
jlo lucynollo du cyulho ohuulchy
    
```

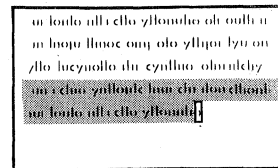
AFTER

Name	Possible Values	Description
WRAP	OFF	Characters overwrite each other instead of appearing on the next line.

If write protect and protect modes are on when the cursor reaches the line's last unprotected position, writes data and moves the cursor to the next unprotected position.



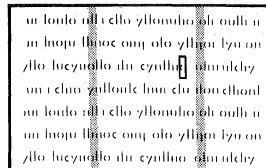
BEFORE



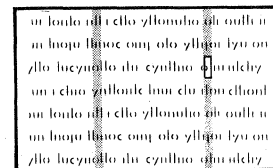
AFTER

ATAB (autotab)	OFF	
-------------------	-----	--

Disables autotab mode. The cursor tabulates forward or backward only within the current line. When no more tab stops exist in that line, the cursor ignores the tab commands.



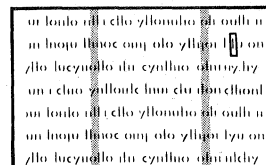
BEFORE



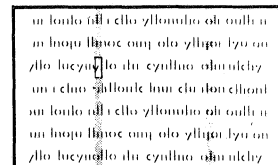
AFTER

ATAB	ON	
------	----	--

Enables autotab mode when protect mode is off. Lets the cursor tabulate to the next typewriter tab stop on the next or previous line.

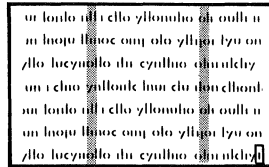


BEFORE

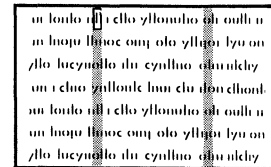


AFTER

Name	Possible Values	Description
		When the cursor reaches the page's last tab stop, the screen scrolls up.

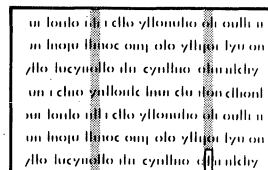


BEFORE



AFTER

If the cursor is on the first tab stop on the page's first line when the terminal receives a back tab code, the cursor does not move.



BEFORE and AFTER

**Table 7-5**  
**Changeable Values in Fourth Setup Line**

Name*	Possible Values	Description
EDTK	DUPE	Codes sent by the editing keys affect the screen and are also sent to the computer (except in block mode).
	LOCE	Codes sent by the editing keys affect only the terminal; they are not sent to the computer.
KLIK (keyclick)	ON	All keys except SHIFT, CTRL, FUNCT, and RESET click when pressed.
	OFF	Keys are silent when pressed.
CR	CR	When the terminal receives a carriage return code from the computer or the keyboard, the cursor advances to the beginning of the next line.* The <RETURN> key sends only a carriage return code.



<b>Name*</b>	<b>Possible Values</b>	<b>Description</b>
	<b>CRLF</b>	When the terminal receives a carriage return code from the computer or the keyboard, the cursor moves to the beginning of the next line (i.e., the terminal performs a line feed and carriage return, in that order).* The <RETURN> key sends only a carriage return code.
DOWN	<b>^/V</b>	The cursor down key sends a cursor down code (<CTRL> V).
	<b>^/J</b>	The cursor down key sends a line feed code (<CTRL> J) instead of a cursor down code (<CTRL> V).
EMUL (emulation)	<b>914</b>	The terminal recognizes codes for the 914 terminal.
	<b>ADDS</b>	The terminal emulates an ADDS Viewpoint terminal.
SCRL (autoscroll)	<b>ON</b>	When the terminal is in the ADDS Viewpoint emulation mode, the screen scrolls up one line if the terminal receives a line feed command while the cursor is on the bottom line. The home position is the first position of the first line.
	<b>OFF</b>	When the terminal is in the ADDS Viewpoint emulation mode, the screen does not scroll if the terminal receives a line feed command while the cursor is on the bottom line; instead the cursor moves to the top line. The home position is the first position of the first line.

\* Values of the fields shown in bold print must match the computer's requirements before communication can occur.

#### RESETTING THE TS 804

There are certain key command sequences that can also reconfigure the integral terminal. These keys have no effect on the other users or the system. Table 7-6 lists each command and its function.

**Table 7-6**  
**Resetting the Integral Terminal**

<b>Press/Enter</b>	<b>Clears Screen</b>	<b>Function</b>
CTRL/RESET	Yes	Performs a hardware reset of the integral terminal section of the TS 804 only. Does not reset the entire TS 804 system.
CTRL/SHIFT/BREAK	No	Performs a partial reset of the terminal. Turns off no scroll, print, write protect, and protect modes. Refreshes the status line. (Press all three keys simultaneously.)
CTRL/BREAK	No	May break communication with the computer.
BREAK	No	Has no effect.
<LOC ESC> ~ 1	Yes	Performs a software reset. Has the same effect as pressing the CTRL/RESET keys. Has no effect when the keyboard is locked.
		<b>STOP!</b> This sequence permanently destroys any reprogrammed values previously loaded into memory.
<LOC ESC> ~ 0	Yes	Performs a software reset.
		<b>STOP!</b> This sequence permanently destroys any reprogrammed values previously loaded into memory.

**System Reset from the Keyboard**

The system, including all users, can be reset from the TS 804 keyboard. To perform a system reset from the TS 804 keyboard, enter:

**SHIFT/BREAK BREAK**

To do this, hold down the <SHIFT> key and press the <BREAK> key twice.

**STOP!** Do not do this unless absolutely necessary. This effects all users. It is the same as turning the power off and then on again.

## 8. UTILITY PROGRAMS

TeleVideo has supplied a set of **utility programs** to facilitate the use of the TS 804. These programs perform such functions as formatting blank disks, making backup copies of the operating system, inspecting the hard disk for defective areas, and copying a file from hard disk to floppy diskette.

All of the utility programs that are written for the MP/M II operating system can be run on CP/M Plus as well. Running a utility program is the same for both operating systems except that under MP/M II the system tells you that you are running on MP/M II. Under MP/M II, the utility programs ask you to end all activities from other terminals.

The nine utilities included on the system diskette are:

- WRITESYS** Transfers the system files to the first two tracks of the floppy or hard disk, depending on which you have selected.
- FORMATH** Formats the hard disk. Use this program when you are installing CP/M Plus or MP/M II onto the hard disk. FORMATH erases all data on the hard disk.
- FORMATF** Formats a 96 tpi diskette for use on the TS 804. FORMATF erases all data on the floppy diskette.
- FIX804** Inspects the hard disk for defective data areas and builds a file, called FILE.BAD, which contains the pointers associated with the defective data blocks. Use this program whenever you suspect that the hard disk is malfunctioning.
- SCANDUP** Searches for duplicate data block pointers which may exist on the directories of a specified logical disk drive.
- SHUTDOWN** This program is used for power off or system reset on the TS 804.
- CONFIGUR** Enables you to customize the operating system to change such system attributes as baud rate and printer protocol. (Described in Appendix J).
- COPYFILE** Copies files from the hard disk to floppy diskettes (file backup) and copies files from floppy diskettes to the hard disk (file restore).

PARK804 Positions the head of the hard disk for shipping. Decreases the possibility of the head touching the system tracks (0 and 1).

**WRITESYS**

**WRITESYS** writes an operating system on the first two tracks of the floppy or hard disk.

To use the **WRITESYS** program, follow this procedure:

USER: 1. Enter

**WRITESYS<CR>**

SYSTEM: 2. Displays

TS-804: System Loader Utility Vy.y mm/dd/yy  
(c) 1983 TeleVideo Systems, Inc.

\*\*\*\*\* WARNING \*\*\*\*\*  
Stop all other MP/M terminals before proceeding.  
Hit RETURN when ready. (ESC or ^C to abort.)  
\*\*\*\*\*

USER: 3. If all other MP/M terminals are stopped, enter

**<CR>**

SYSTEM: 4. Displays

Enter destination Drive :

USER: 5. You should determine the destination and boot source.

a. If the destination is the **floppy diskette** and you are booting from the **hard disk**, enter

**C<CR>**

b. If the destination is the **floppy diskette** and you are booting from the **floppy diskette**, enter

**A<CR>**

c. If the destination is the **hard disk** and you are booting from the **hard disk**, enter

**A<CR>**

- d. If the destination is the **hard disk** and you are booting from the **floppy diskette**, enter

**C<CR>**

SYSTEM: 6. Displays  
Enter Bootstrap Filename (Or RETURN to Skip) :

USER: 7. Enter  
**804BOOT<CR>**

SYSTEM: 8. Displays  
Enter Primary Loader Filename (Or RETURN to Skip) :

USER: 9. Enter  
**804MLDR<CR>**

(This loads MP/M as the primary operating system.)

If your destination is the floppy, you do not have another choice. The program skips to the system message "WRITESYS Completed".

SYSTEM: 10. Displays  
Enter Secondary Loader Filename (Or RETURN to Skip)

USER: 11. a. If the CP/M Plus operating system is available, follow these instructions on loading CP/M Plus as the secondary operating system.  
b. Otherwise, to skip this procedure, you should enter  
**<CR>**

USER: 12. Insert the CP/M Plus system diskette into the floppy drive.

13. Enter  
**C:804CLDR<CR>**

(This loads CP/M Plus as the secondary operating system.)

SYSTEM: 14. Displays  
WRITESYS Completed.  
0A>

**FORMATH**

**FORMATH** formats the hard disk. Use this program before installing MP/M II or CP/M Plus onto hard disk.

**NOTE!** **FORMATH** overwrites all data that is on the hard disk. All files, programs, and the operating system programs are erased.

To run the **FORMATH** program, follow this procedure.

**USER:** 1. Enter

**[drive:]FORMATH<CR>**

([drive:] is the drive **FORMATH** is located on if not on the currently active drive)

**SYSTEM:** 2. Displays

TS-804 Hard Disk FORMAT Vy.y mm/dd/yy  
10 Mbytes disk  
(c) 1983 TeleVideo Systems, Inc.

\*\*\*\*\* WARNING \*\*\*\*\*  
Stop all other MP/M terminals before proceeding.  
Hit RETURN when ready. (ESC or ^C to abort.)  
\*\*\*\*\*

**USER:** 3. a. To proceed with the program, enter

**<CR>**

b. To abort the program, enter

**ESC or ^C**

**SYSTEM:** 4. Displays

Enter "I" for integral or "E" for external hard disk format

**USER:** 5. a. For the hard drive of the TS 804 system, enter

**I**

b. For the expansion hard disk unit, enter

**E**



SYSTEM: 6. a. Displays if "I" was entered

\*\* Caution: All data on the integral harddisk will be destroyed. \*\*

Press RETURN when ready. (ESC or CTRL-C to abort.)

b. Displays if "E" was entered

\*\* Caution: All data on the external harddisk will be destroyed. \*\*

Hit RETURN when ready. (ESC or CTRL-C to abort.)

USER: 7. Press

<CR>

SYSTEM: 8. Displays blocks, cylinders, etc.

9. Displays in approximately ten minutes if <CR> was entered

\*\*\*FORMATH Complete\*\*\*

10. If errors are found during formatting, specific error messages are displayed.

**NOTE!** You may abort the program any time during the formatting process by entering ^C. The system will display:

Abort FORMATH?(Y/N)

Press Y if you wish to abort, or press N if you do not. If you press Y, a portion of the disk will be formatted while the rest will remain unchanged.

**FORMATF**

**FORMATF** formats floppy diskettes for use on the TS 804 only.

All new diskettes must be formatted before they can be used. Used diskettes containing data can also be formatted. If a used diskette is formatted, all data on the diskette is erased; once formatted, the used diskette is ready for new data.

**STOP!**        **FORMATF** overwrites all data on the diskette; any files and programs on the diskette are erased.

To run the **FORMATF** program, follow this procedure.

**USER:**        1.    Enter

**[drive:]FORMATF<CR>**

                  ([drive:] is the drive **FORMATF** is located on if not on the active drive)

**SYSTEM:**     2.    Displays

TS-804 : Floppy Disk Format Vx.x mm/dd/yy  
(c) 1983 TeleVideo Systems, Inc.

\*\*\*\*\* WARNING \*\*\*\*\*  
Stop all other MP/M terminals before proceeding.  
Hit RETURN when ready (ESC or CTRL-C to abort)  
\*\*\*\*\*

**USER:**        3.    a.    To continue, press

                  <CR>

                  b.    To abort, press

**ESC or ^C**

**SYSTEM:**     4.    Displays

                  Insert a diskette into floppy disk drive.  
                  Press RETURN when ready.(ESC to abort.)

**USER:**        5.    Insert a diskette into the floppy disk drive.

                  6.    Press

                  <CR>

SYSTEM: 7. Displays  
formatting.....  
.....  
Formatting Completed.  
Format another diskette? (Y/N)

USER: 8. a. To format another diskette, remove the  
diskette in the floppy drive, insert a new  
one, and press  
Y  
b. Press, to exit to the system  
N

SYSTEM: 9. Displays after N is pressed  
0A>

**FIX804**

**FIX804** inspects the hard disk for defective data areas. It builds a file called FILE.BAD containing the pointers associated with the defective data blocks. This file has a user designation of User 15 and the attributes of Read Only and System (no directory listing).

**FIX804** can be used on any CP/M-compatible disk drive. You should run this program immediately after formatting, or whenever you suspect that the hard disk is malfunctioning. During the execution of the program, no data is destroyed. Directory areas are not scanned.

**NOTE!** While the program does not retrieve data which may already be on bad data blocks, it does prevent the system from using those areas for future data storage.

To run the **FIX804** program, follow this procedure.

**USER:** 1. Enter

**[drive]FIX804 <drive name:><CR>**

([drive] is the drive on which **FIX804** is located if other than the currently active drive)

(<drive name:> is the specified disk drive to be checked. Use A: for drive A and B: for drive B, etc. If no drive is specified, **FIX804** will check the currently selected disk drive.)

**SYSTEM:** 2. Displays

TS-804 Fix Disk Utility Vx.x mm/dd/yy  
(c) 1983 TeleVideo Systems, Inc.

\*\*\*\*\* WARNING \*\*\*\*\*  
Stop all other MP/M terminals before proceeding.  
Hit RETURN when ready. (ESC or ^C to abort.)  
\*\*\*\*\*

**USER:** 3. a. If the above condition is met, enter

**<CR>**

b. If the above condition is not met, enter

**ESC or ^C**

**SYSTEM:** 4. Displays

CURRENT SCANNING BLOCK: #\_\_\_\_

5. Displays the block numbers as they are scanned by the program.

6. Displays

FIX804 COMPLETED WITH xxx DATA BLOCKS ERROR

USER: 7. To abort the program any time during execution, enter

^C

**SCANDUP**

SCANDUP searches for duplicate data block pointers that may exist on the directories of the specified logical disk drive. Duplicate pointers indicate that two files are attempting to "own" the same data, an improper and potentially harmful condition. (The pointers may be those placed by the program FIX804. FIX804 places all pointers to bad disk blocks in a file named FILE.BAD.)

SCANDUP lists the names of files that contain duplicate pointers so that they can be erased. No data on the disk will be affected.

SCANDUP should be run immediately after FIX804 is run.

To run the SCANDUP program, follow this procedure.

- USER: 1. Enter
- [drive:]SCANDUP<CR>**
- ([drive:] is the logical drive on which SCANDUP is located, if other than the currently active drive)
- SYSTEM: 2. Displays
- SCAN DRIVE
- USER: 3. Enter the logical drive that you wish to scan -- A, B, C, etc. SCANDUP scans one drive at a time, so enter only one drive name.
- USER: 4. Press
- <CR>**
- SYSTEM: 5. a. Displays if no duplicate pointers are found
- No allocation blocks are duplicated in directory  
End of Execution  
0A>
- b. Displays (if duplicate pointers are found in the directory) a list of files containing the duplicate pointers.

The example below shows how to run SCANDUP for a drive that has two files with identical data block pointers.

- USER: 1. Enter
- SCANDUP<CR>**

SYSTEM: 2. Displays  
SCAN DRIVE

USER: 3. Enter  
A

SYSTEM: 4. Displays

block	count	sector	entry	filename	user
035A	2	14	2	TEXT	DOC 00
035B	2	14	2	TEXT	DOC 00
035C	2	14	2	TEXT	DOC 00
035D	2	14	2	TEXT	DOC 00
035A	2	14	3	FILE	BAD 15
035B	2	14	3	FILE	BAD 15
035C	2	14	3	FILE	BAD 15
035D	2	14	3	FILE	BAD 15

4 allocation blocks are duplicated in directory  
End of execution

**NOTE!** **Block** refers to the disk allocation block number that is owned by multiple files in filename. The term **count** indicates the number of times the block is owned (if more than once). The **sector** tells the user the directory sector number where **filename** is located. **Entry** is an index into the directory sector for **filename**. **Filename** is the file that owns the block and is the CP/M-assigned user number that owns this file.

The error message tells the user that blocks 035A, 035B, 035C, and 035D are "pointed to" by the files TEXT.DOC and FILE.BAD. This indicates that TEXT.DOC has a bad sector. The file TEXT.DOC on the hard disk is not recoverable.

USER: 5. Erase TEXT.DOC from drive A. **DO NOT ERASE FILE.BAD.** FILE.BAD prevents the bad sectors from being used in the future.

SYSTEM: 7. Displays  
0A>

**USER:** 8. Enter

**DIR<CR>**

**SYSTEM:** 9. Displays the latest directory.



**SHUTDOWN**

SHUTDOWN is the utility program used when you are powering off the TS 804. To insure integrity of the hard disk data always run SHUTDOWN or PARK804 before you power off or reset the system.

To run the SHUTDOWN program, follow this procedure.

USER: 1. Enter

SHUTDOWN<CR>

SYSTEM: 2. Displays

TS-804 : SHUTDOWN Utility Vx.x mm/dd/yy  
(c) 1983 TeleVideo Systems, Inc.

```
***** WARNING *****  
Stop all other MP/M terminals before proceeding  
Hit RETURN when ready. (ESC or ^C to abort.)  
*****
```

USER: 3. Enter

<CR>

SYSTEM: 4. Displays

STATUS : Idle. (Or "In use" if another terminal is active.)

- 1) Proceed SHUTDOWN with PARKING heads.
- 2) Proceed SHUTDOWN without PARKING heads.
- 3) Abort SHUTDOWN process.
- 4) Check status.
- 5) Broadcast a message.

Enter selection number :

USER: 5. If the status is "Idle", go to step 10 of these instructions.

If the status is "In use", send a warning message to the other terminals by entering

5<CR>

SYSTEM: 6. Displays

Enter a message (<= to 72 characters long)  
or enter <CR> to ignore.  
?

USER: 7. Enter a warning message telling the other users to exit the programs they are currently running.

SYSTEM: 8. Displays

?(your message)  
Message sent..

STATUS : Idle. (Or "In use" if another terminal is active.)

- 1) Proceed SHUTDOWN with PARKING heads.
- 2) Proceed SHUTDOWN without PARKING heads.
- 3) Abort SHUTDOWN process.
- 4) Check status.
- 5) Broadcast a message.

Enter selection number :

USER: 9. To recheck the status, enter 4. Once the message "Idle" appears, continue with these instructions

10. If you are going to move the system, enter

1<CR>

SYSTEM: 11. Displays

Cache buffers are flushed and the disk queue is locked.

Integral Hard Disk R/W Heads are parked.  
SHUT DOWN process completed.

REMOVE a diskette from the drive and TURN POWER OFF

USER: 12. If you are powering off the system, enter

2<CR>

13. Remove the diskette and store it upright in a safe place. Turn off the power.

The message "System unavailable...." appears on the screens of the terminals attached.

**COPYFILE**

COPYFILE copies files from the hard disk to floppy diskettes (file backup) and copies files from floppy diskettes to the hard disk (file restore).

This utility allows you to back up and restore files that are larger than the capacity of a single diskette. COPYFILE divides the file into as many diskettes as necessary to complete the backup operation. Likewise, COPYFILE restores a file to the hard disk from several floppy diskettes.

During the backup procedure, COPYFILE creates two files on the floppy diskette(s). The first file is called the **destination file**. It contains the data that is being copied (backed up) to the floppy diskette. The second file is called the **status file**. COPYFILE uses the status file during the restoring process. The status file contains the original (source) file size, information which allows you to restore the data on several diskettes in the right order, and the password given to the file during the backup procedure. The password identifies diskettes and the file that they belong to.

**NOTE!** COPYFILE can be executed from any terminal, including the TS 804 integral terminal.

To use COPYFILE, follow this procedure.

USER: 1. Choose from two possible COPYFILE operations:

Function	Refer to
Backup Files (Hard Disk to Floppy Diskettes)	Step 2
Restore Files (Floppy Diskettes to Hard Disk)	Step 14

2. To back up a file, enter

**COPYFILE [source drive:filename] [destination drive:filename]<CR>**

where

[source drive:filename] is a combination of the drive on which the file to be copied is presently located and the name of the file to be copied.

[destination drive:filename] is a combination of the drive to which the file will be copied and the name of the file to be copied.

SYSTEM: 8. Displays

?(your message)  
Message sent..

STATUS : Idle. (Or "In use" if another terminal is active.)

- 1) Proceed SHUTDOWN with PARKING heads.
- 2) Proceed SHUTDOWN without PARKING heads.
- 3) Abort SHUTDOWN process.
- 4) Check status.
- 5) Broadcast a message.

Enter selection number :

USER: 9. To recheck the status, enter 4. Once the message "Idle" appears, continue with these instructions

10. If you are going to move the system, enter

1<CR>

SYSTEM: 11. Displays

Cache buffers are flushed and the disk queue is locked.

Integral Hard Disk R/W Heads are parked.  
SHUT DOWN process completed.

REMOVE a diskette from the drive and TURN POWER OFF

USER: 12. If you are powering off the system, enter

2<CR>

13. Remove the diskette and store it upright in a safe place. Turn off the power.

The message "System unavailable...." appears on the screens of the terminals attached.

**COPYFILE**

COPYFILE copies files from the hard disk to floppy diskettes (file backup) and copies files from floppy diskettes to the hard disk (file restore).

This utility allows you to back up and restore files that are larger than the capacity of a single diskette. COPYFILE divides the file into as many diskettes as necessary to complete the backup operation. Likewise, COPYFILE restores a file to the hard disk from several floppy diskettes.

During the backup procedure, COPYFILE creates two files on the floppy diskette(s). The first file is called the **destination file**. It contains the data that is being copied (backed up) to the floppy diskette. The second file is called the **status file**. COPYFILE uses the status file during the restoring process. The status file contains the original (source) file size, information which allows you to restore the data on several diskettes in the right order, and the password given to the file during the backup procedure. The password identifies diskettes and the file that they belong to.

**NOTE!** COPYFILE can be executed from any terminal, including the TS 804 integral terminal.

To use COPYFILE, follow this procedure.

USER: 1. Choose from two possible COPYFILE operations:

Function	Refer to
Backup Files (Hard Disk to Floppy Diskettes)	Step 2
Restore Files (Floppy Diskettes to Hard Disk)	Step 14

2. To back up a file, enter

**COPYFILE [source drive:filename] [destination drive:filename]<CR>**

where

[source drive:filename] is a combination of the drive on which the file to be copied is presently located and the name of the file to be copied.

[destination drive:filename] is a combination of the drive to which the file will be copied and the name of the file to be copied.

For example, when you enter

**COPYFILE a:prnt.com c:prnt.com<CR>**

it tells the system to copy the file prnt.com located on drive A (source drive or hard disk drive) to drive C (destination drive or floppy disk drive).

SYSTEM: 3. Displays

```
A:COPYFILE.COM
*****
*
* TELEVIDEO SYSTEMS INC.
* COPYFILE Vx.x - mm/dd/yy
*
*****
```

PRESS RETURN WHEN FLOPPY DISK IS READY.

USER: 4. Insert a floppy diskette into the floppy drive.

5. Press

<CR>

SYSTEM: 6. Displays

PLEASE, ENTER PASSWORD:

USER: 7. Create a password pertaining to the file being copied. The password can contain up to sixteen alphanumeric characters. Enter

[password] <CR>

SYSTEM: 8. Displays

BACKUP PROCEDURE (Y/N)?

USER: 9. To start the file backup program, enter

Y<CR>

SYSTEM: 10. If the file is not larger than the capacity of a single diskette, the system displays, followed by the system prompt

COPYING FILE TO FLOPPY DISK

O.K. COPY COMPLETED

(COPYFILE is now completed and your system is ready for the next command.)

11. Displays if the file is larger than the capacity of a single diskette

FLOPPY DISK IS FULL, INSERT NEXT FLOPPY.

- USER: 12. To continue with the backup program, insert the next floppy diskette and press

<CR>

[Label each diskette by file name, password, and sequence (i.e. 1 of 3, 2 of 3, 3 of 3) for future use.]

13. Watch for one of two messages: the message in Step 10 or the message in Step 11. Follow the designated procedures in either step.

**NOTE!** If you receive an error message, refer to Table 8-1.

- USER: 14. To restore a file from floppy diskette to the hard disk, enter

**COPYFILE [source drive:filename] [destination drive:filename]<CR>**

where

[source drive:filename] is a combination of the drive on which the file to be copied is presently located and the name of the file to be copied.

[destination drive:filename] is a combination of the drive to which the file will be copied and the name of the file to be copied

For example, when you enter

**COPYFILE c:prnt.com a:prnt.com<CR>**

it tells the system to copy file "prnt.com" from drive C (origin drive or floppy drive) to drive A (destination drive or hard disk drive).

SYSTEM: 15. Displays

```
*****
*
* TELEVIDEO SYSTEMS INC.
* COPYFILE Vx.x - mm/dd/yy
*
*****
```

PRESS RETURN WHEN FLOPPY DISK IS READY

USER: 16. Insert the floppy diskette containing the file to be restored to the hard disk. If you have several diskettes containing the file (from the backup process), insert the diskette containing the beginning of the file, press

<CR>

SYSTEM: 17. Displays

PLEASE, ENTER PASSWORD:

USER: 18. Enter

**[password]** <CR>

(given to the diskette during the backup procedure)

SYSTEM: 19. Displays

BACKUP PROCEDURE? (Y/N)?

USER: 20. To begin the restoring process, enter

**N**<CR>

SYSTEM: 21. Displays

COPYING FILE FROM FLOPPY DISK

22. If the file to be restored is contained on one floppy diskette, the system displays, followed by the system prompt

O.K. COPY COMPLETED

(The system is now ready for the next command.)

23. If the file to be restored is contained on several diskettes, the system displays

END OF FLOPPY DISK, INSERT NEXT FLOPPY



- USER: 24. Insert the next diskette.
- SYSTEM: 25. Displays either the message in Step 22 or the one in Step 23. Follow the designated procedures.

**NOTE!** If you receive an error message, refer to Table 8-1.

**Table 8-1  
Copyfile Error Messages**

Message	Description														
***PASSWORD DOES NOT MATCH*** SOURCE FILE PASSWORD IS "XXXX" PLEASE, ENTER PASSWORD	This message may appear during the restore operation. It indicates that the password entered and the password in the status file are not the same. Check the inserted diskette and the password you entered; make sure they are correct. The correct password (the password the program was expecting) is listed in the string "XXXX."														
FATAL VERIFY ERROR	This message indicates that COPYFILE detected a verify error during the restore operation. Probable cause of this error is a bad sector on the hard disk.														
VERIFY ERROR INSERT NEW FLOPPY DISK AND PRESS RETURN TO CONTINUE	This message indicates COPYFILE detected a verify error during the backup operation. Insert a new floppy diskette to continue the program.														
SOURCE FILE READ ERROR	The COPYFILE program was not (Return Code #) able to read the source (origin) file due to one of the following:														
	<table border="1"> <thead> <tr> <th>Return Code</th> <th>Description</th> </tr> </thead> <tbody> <tr> <td>1</td> <td>Reading unwritten data</td> </tr> <tr> <td>2</td> <td>(Not possible on read)</td> </tr> <tr> <td>3</td> <td>Cannot close current extent</td> </tr> <tr> <td>4</td> <td>Seek to unwritten extent</td> </tr> <tr> <td>5</td> <td>Not possible on read</td> </tr> <tr> <td>6</td> <td>Seek past physical end of disk</td> </tr> </tbody> </table>	Return Code	Description	1	Reading unwritten data	2	(Not possible on read)	3	Cannot close current extent	4	Seek to unwritten extent	5	Not possible on read	6	Seek past physical end of disk
Return Code	Description														
1	Reading unwritten data														
2	(Not possible on read)														
3	Cannot close current extent														
4	Seek to unwritten extent														
5	Not possible on read														
6	Seek past physical end of disk														

Refer to the MP/M II Manual for more detailed information.

DESTINATION FILE WRITE ERROR

The COPYFILE program was not (Return Code #) able to write to the destination drive file due to one of the following:

Return Code	Description
1	(Not possible on write)
2	Unsuccessful write operation due to a full disk
3	Cannot close current extent
4	Seek to unwritten extent
5	New extent cannot be created due to directory overflow
6	Seek past physical end of disk

Refer to the MP/M II Manual for more detailed information.

DESTINATION FILE READ ERROR  
(Return Code #)

This message indicates that the destination file was unable to be read for verification due to program error. The return code value is the same as Source File Read Error.

CANNOT FIND NEXT FILE,  
INSERT CORRECT FLOPPY

This message indicates that you inserted the wrong floppy diskette into the drive or the file has been deleted from the floppy. During a restore function, you may have inserted a diskette which was out of sequential order.

NO DIRECTORY SPACE

This message indicates that the COPYFILE program was not able to create a new file due to overflow in the directory space on the drive. If you are backing up a file, insert a new diskette or erase old files on the one in the drive. If you are restoring a file, erase old files on the hard disk logical drive you are accessing or switch to the other logical drive.

CANNOT FIND PASSWORD FILE

This message indicates that you inserted the incorrect floppy diskette or that the status file is deleted from the floppy.

CANNOT WRITE FILE SIZE AND PASSWORD

This message indicates that the the COPYFILE program was not able to write file size and password to the information file. The diskette may be full of information already.

CANNOT READ FILE SIZE AND PASSWORD

This message indicates that the COPYFILE program was not able to read the file size and password file.

CANNOT FIND SOURCE FILE

This message indicates that the COPYFILE program was not able to find the original (source) file.

NO SOURCE FILE

When the command to run COPYFILE was given, no source parameter was given. Check your command and re-enter.

NO DESTINATION FILE

When the command to run COPYFILE was given, no destination parameter was given. Check your command and re-enter.

**PARK804**

**PARK804** is to be used whenever the TS 804 is to be shipped or moved. Movement due to shipping may cause the head to touch the disk. This program positions the head of the hard disk above cylinder 32. By placing the head over cylinder 32, **PARK804** decreases the possibility of the head touching the system tracks 0 and 1. **PARK804** is similiar to **SHUTDOWN**.

To run **PARK804**, use this procedure.

USER: 1. Enter

**PARK804<CR>**

SYSTEM: 2. Displays

TS-804 : **PARK804** Utility Vx.x mm/dd/yy  
(c) 1983 TeleVideo Systems, Inc.

\*\*\*\*\* WARNING \*\*\*\*\*  
Stop all other MP/M terminals before proceeding.  
Hit RETURN when ready. (ESC or ^C to abort.)  
\*\*\*\*\*

Cache buffers are flushed and the disk queue is locked.

- 1) For the attached drive(s).
- 2) For the external drive.
- 3) Exit.

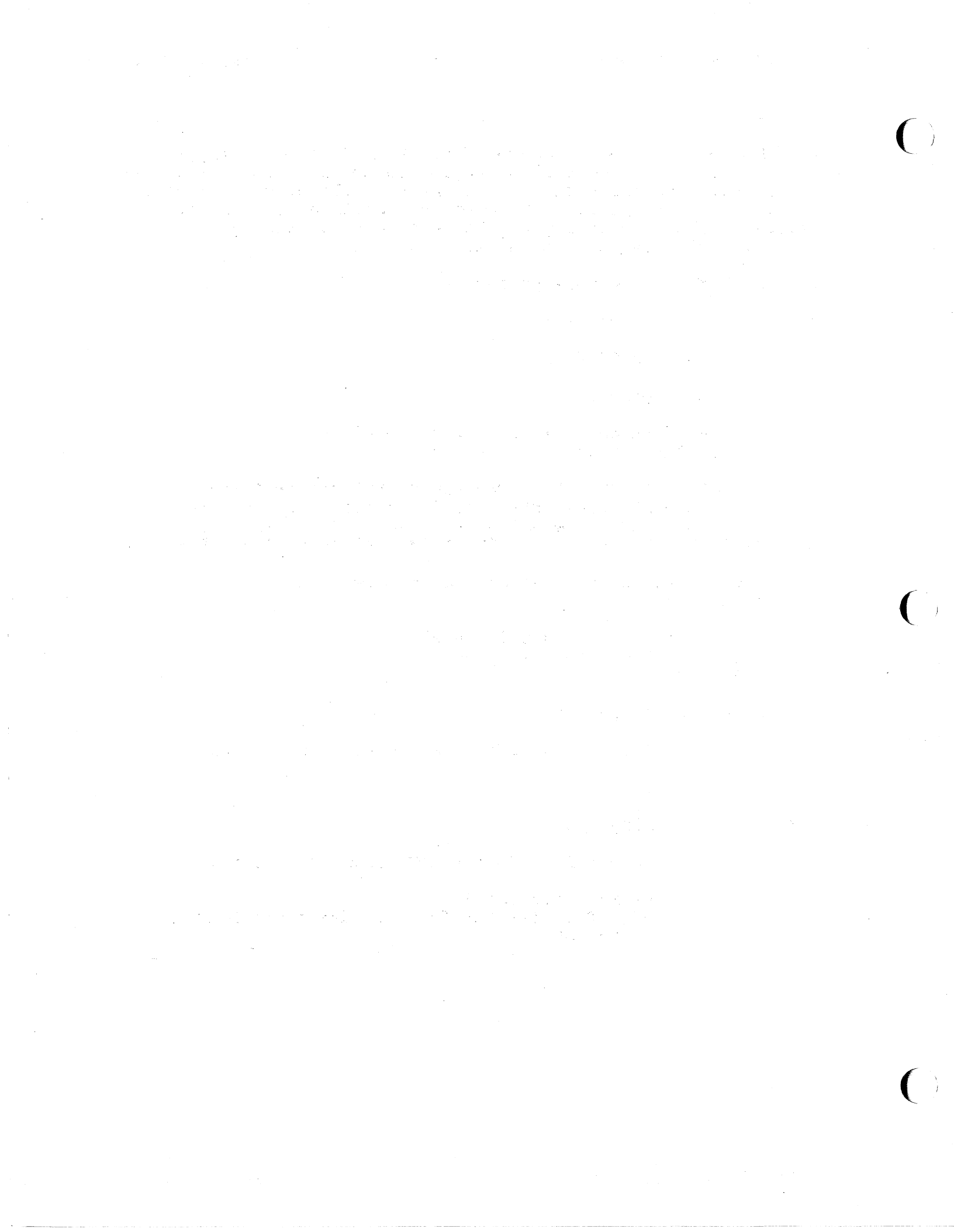
Enter selection number:

USER: 3. For TS 804 without an external drive, enter  
1

SYSTEM: 4. Displays

Integral Hard Disk R/W Heads are parked.

**PARK804** completed.  
REMOVE a diskette from the drive and TURN  
POWER OFF



9. WORKING WITH DISKETTES

Diskettes contain the software (programs) that run your system. This chapter introduces you to the more important aspects of diskettes.

DISKETTES

Diskettes are used to store operating systems, applications programs, text, and data. Figures 9-1 and 9-2 show the parts of a floppy diskette.

Figure 9-1  
Floppy Diskette

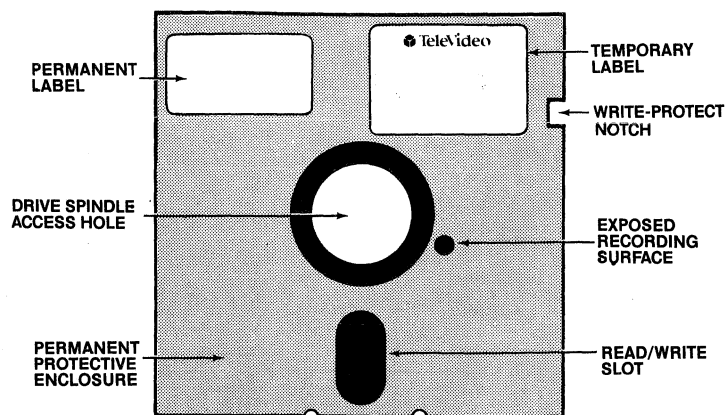
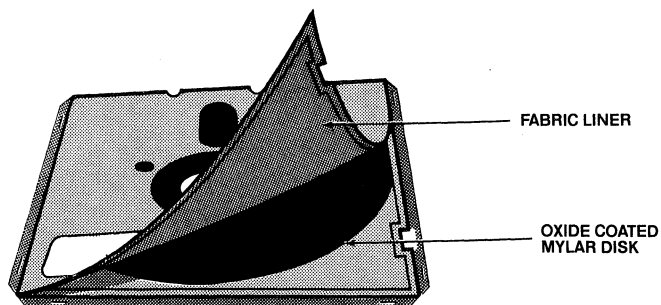


Figure 9-2  
Diskette Inside Permanent Plastic Enclosure



When a diskette is inserted into the disk drive and the drive is closed, the disk drive spins the diskette inside its cover. Much like a cassette recorder, each drive has a recording head (actually a pair; one for each side of the diskette) which is lowered onto the magnetic diskette surface whenever the drive is closed. The disk drive head moves back and forth along the diskette access slot as it reads from or writes to the diskette.

### Diskette Formats

The Altos 580-XX diskette format is the default format used when the TS 804 boots. However, four different diskette formats can be used in the TS 804. Use the CONFIGUR program to set your system to support the type of diskette you wish to use. Table 9-1 lists the different formats and their specifications.

**Table 9-1**  
**Diskette Formats**

TYPE	SIDES	TRACKS/ INCH	BYTES/ SECTOR	SECTORS/ TRACK	TRACKS/ SIDE
Altos 580-XX*	2	96	512	9	80
TS 803	2	48	256	18	40
TS 1603	2	96	512	9	80
IBM CP/M-86	1	48	512	8	40

\* same as TS 804 format

All are soft-sectored, 5 1/4-inch diskettes.

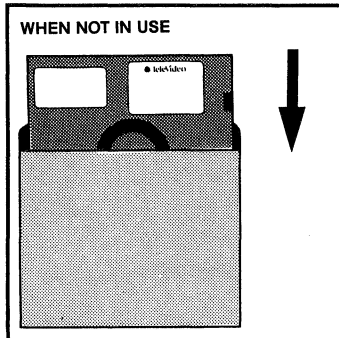
The TS 804 will NOT function properly if you insert a diskette that has been written by a TS 1603 UNLESS you have run the CONFIGUR program to tell the TS 804 to expect a TS 1603 format diskette.

You should note however that if you do insert a TS 1603 written diskette when the TS 804 is expecting an Altos 580 diskette, you will NOT receive an error message even though the system will not function properly. Since the Altos 580 and the TS 1603 have the same block size (512 bytes/sector), the TS 804 cannot tell the two formats apart.

Having the TS 1603 format available as an additional feature requires that the user intelligently be aware of the diskette format the system is currently configured for.

**Handling and Storing Diskettes**

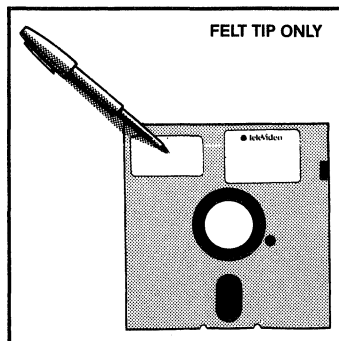
Diskettes can provide reliable service if the following simple rules are followed:



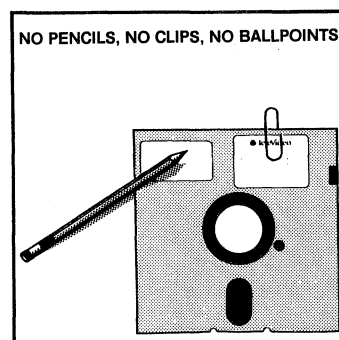
Keep diskettes in their paper envelope when you are not using them. Store diskettes in an upright position in a dust-free storage container.



Do not touch the exposed recording surface of the diskette. Small scratches, dust, or food may make information unusable.

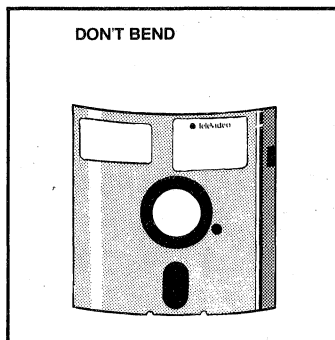


Never write on the diskette label with a pencil or ballpoint pen. Use a felt-tip pen and press lightly. Whenever possible, write information on the label before placing the label on the diskette.

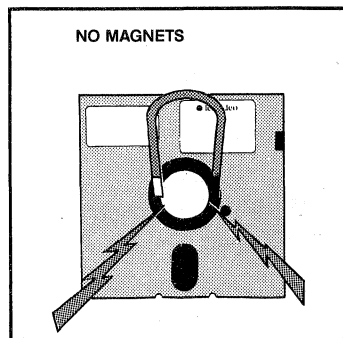


Never attach anything to the diskette with paperclips or staples.

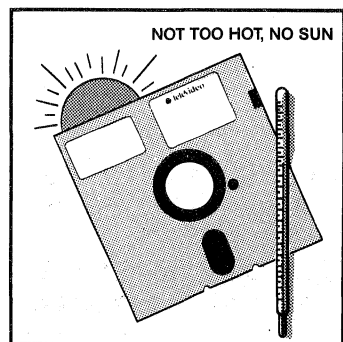




Never bend or fold the diskette.



Keep diskettes away from sources of magnetic fields such as telephones, magnetic paper clip holders, typewriters, and electronic calculators.

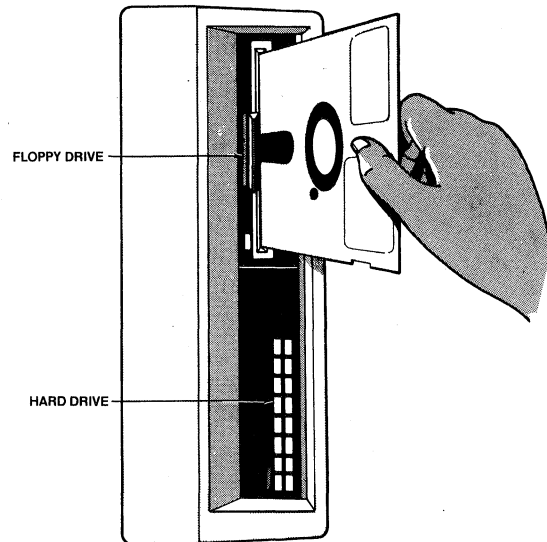


Store diskettes in a cool place, away from direct sunlight or sources of heat.

### Inserting Diskettes

To insert a diskette into the disk drive, remove it from the protective paper envelope. Turn the diskette so that the write-protect notch is on the bottom edge and the label is facing left. Insert the diskette in the opening of the drive as shown in Figure 9-3.

**Figure 9-3**  
**Inserting a Diskette**



Gently push the diskette into the drive, using your fingertip.

**NOTE!** If the diskette seems to catch on an edge, pull it out slightly and push it gently in again. **DO NOT FORCE IT IF IT RESISTS!**

Push the drive door to the right to the closed position.

### **Formatting Diskettes**

Since each computer system has its own format requirements, blank diskettes are not formatted by diskette manufacturers. Before a new diskette is used, it must be formatted for your system.

The format process prepares a diskette to receive information.

**NOTE!** The format process erases any data currently on the diskette.

To format a diskette for the TS 804, refer to the **FORMAT** utility program command in Chapter 8 of this manual.

### **Copying Master Diskettes**

When you purchase software, it is delivered on a **master diskette**. The diskette that your MP/M II or CP/M Plus operating system came on is a master diskette.

It is important to copy master diskettes onto your hard disk before starting to use them. Always use the hard disk and keep the original master diskette as a backup.

### **Write-Protecting Diskettes**

When information is copied from the hard disk onto a diskette, it superimposes the new data on the information already there. If the information on a diskette, such as your system diskette, is particularly important, you may want to protect it against accidental erasure by **write-protecting** the diskette.

To write-protect a diskette, place one of the silver self-adhesive tabs that are supplied by manufacturers with each box of blank diskettes over the write-protect notch (See Figure 9-1). When the tab is in place, the drive is not allowed to write information on the diskette. When you want to remove the protection, remove the tab from the diskette.

### **Backing Up Diskettes**

When diskettes work perfectly and you don't accidentally erase or change data, it is perhaps difficult to understand why backing up the hard disk is so necessary. However, accidents do happen and diskettes eventually wear out. To protect your investment of time and effort, learn to make a backup diskette of the files on your hard disk on a regular basis, using the PIP program. For backing up the operating system, use the WRITESYS program explained in the chapter on utility programs.

Be sure to make backup copies on diskette of the files on the hard disk daily to ensure that you always have a current copy of your files if you have a problem with your hard disk.

## 10. CARING FOR THE TS 804

To keep your TS 804 in the best condition, it is a good idea for you to keep it clean and to inspect it periodically.

### CLEANING

Clean the TS 804 periodically. To clean the case:

1. Clean the keyboard with a small soft brush.
2. Clean the housing with a soft, lint-free cloth. You can use a commercial detergent, but be sure to turn the power off and unplug the computer before you clean it. Be careful not to get any moisture inside the casing.

**STOP! DO NOT use solvent-based or abrasive cleaners.**

3. Inspect the cabinet for cracks or breaks.

Refer any damage to the qualified service technician at your computer store.

### SERVICE

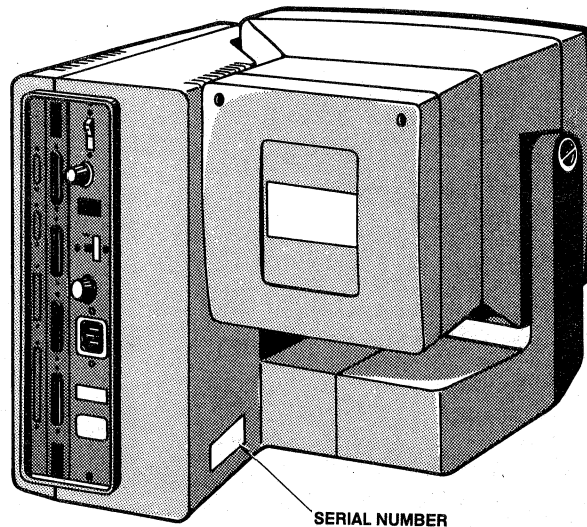
Your TS 804 is under a limited warranty as described in the front of this manual.

If you need service on your TS 804 while it is under TeleVideo's limited warranty, call your computer store.

The people at your computer store can recommend the other types of service that are available for the TS 804 and can help you if you have any difficulties with the TS 804.

For future reference, note the serial number (on the back of the computer), the date you took delivery, and the name and phone number of your computer store and service center on the space provided on the inside back cover of this manual.

Figure 10-1  
Serial Number



#### TECHNICAL ASSISTANCE

If you have any technical problems with your TS 804, call your computer store.

#### SHIPPING THE TS 804

If you need to ship the TS 804, follow these steps:

1. Run the PARK804 utility program as described in Chapter 8.
2. Open the drive door. Insert the cardboard insert that came with the TS 804 (or a blank diskette) into the drive. Close the drive door.
3. Pack the unit in the original TeleVideo shipping container or use other suitable materials.

## APPENDIX A TS 804 SPECIFICATIONS

## MICROPROCESSOR/MEMORY

CPU Z80A 8-bit microprocessor  
(processor speed 4 MegaHertz)  
6502A, terminal section  
Concurrent DMA

MEMORY 320 kilobyte dynamic RAM with  
cache buffering  
32 kilobyte display memory buffer  
8 kilobyte EPROM

OPERATING SYSTEM MP/M II  
CP/M Plus (optional)  
OASIS (optional)

## DISK DRIVES

TYPE One slim-line 5 1/4-inch 96 tpi floppy disk  
drive  
One slim-line 5 1/4-inch Winchester hard disk  
drive

## DISKETTE FORMATS Physical format:

Type	Sides	Tracks/ Inch	Bytes/ Sector	Sectors/ Track	Tracks/ Side
Altos 580-xx*	2	96	512	9	80
TS 803	2	48	256	18	40
TS 1603	2	96	512	9	80
IBM CP/M-86	1	48	512	8	40

\* same as TS 804 format

All are soft-sectored, 5 1/4-inch format  
diskettes

STORAGE CAPACITY Floppy: 700 Kbytes per drive (formatted)  
1 Mbyte (unformatted)  
Hard: approximately 10 Mbytes (formatted)  
12 Mbytes (unformatted)

TRANSFER RATE Floppy: 250 Kbits/sec  
Hard: 5 Mbits/sec

ACCESS TIME Floppy: 94 msec (average)  
Hard: 155 msec (average)

**INPUT/OUTPUT**

**SERIAL I/O** Three RS-232C serial ports.  
 User 1 - Asynchronous only  
 User 2 and User 3 - Asynchronous or synchronous  
 Baud rate, word structure, etc. is set using the CONFIGUR utility

**PARALLEL I/O** One 25 pin D-shell connector

**POWER REQUIREMENTS**

**EXTERNAL**  
 U.S. 115 VAC (+/- 12 VAC)  
 INTERNATIONAL 230 VAC (+/- 12 VAC)

**POWER CONSUMPTION** 1.30 amp maximum at 115 VAC  
 0.65 amp maximum at 230 VAC

**POWER CORD** NEMA standard 5-15R, 3-prong receptacle (US only)

**ENCLOSURE**

**DIMENSIONS** Height: 14.5 inches (36.8 cm)  
 Width: 19.0 inches (48.3 cm)  
 Depth: 14.0 inches (35.6 cm)  
 Weight: 45 pounds (20.4 kg)

**COMPOSITION** Injection-molded plastic

**ENVIRONMENT**

**OPERATING** 50 to 85 degrees Fahrenheit  
 10 to 30 degrees Celsius

Maximum humidity 95 percent relative, non-condensing

Maximum altitude 10,000 ft above sea level

**NONOPERATING (SHIPPING)** 32 to 120 degrees Fahrenheit  
 0 to 50 degrees Celsius

**CRT SPECIFICATIONS**

**SCREEN** 14 inches measured diagonally  
 Phosphor: P31

**EMULATION** ADDS Viewpoint  
 TVI 914

DISPLAYED CHARACTER SET	96-character ASCII upper- and lower-case alphabet 32 control characters in monitor mode 64 special graphics characters 24 lines 80 characters 25th status/set-up line Video attributes: Half intensity Invisible fields Blinking fields Reverse video Underlined fields
CHARACTER FONT	7 x 8 dot matrix 8 x 10 resolution
REPEAT	20 cps auto-repeat
EDITING FEATURES	Typeover Clear screen to space or null Character insert and character delete Line insert and line delete Absolute cursor addressing Erase to end of line or field Line edit Normal or no scroll
CURSOR CONTROLS	Home, left, right, up, down, carriage return, line feed, tab and backtab, addressable/readable cursor, autowrap, autotab
CURSOR ATTRIBUTES	Block (blinking or steady); underline (blinking or steady); none
SCREEN ATTRIBUTES	Nonembedded, character-by-character, combinable; blink, blank, underline, half-intensity, and reverse video
KEYBOARD	Detached, Selectric-style with palmrest Accounting keypad with TAB, ENTER and 00 keys 16 programmable function keys (32 with shift) 11 editing keys



## APPENDIX B SUGGESTED REFERENCES

The following books are useful references for using the MP/M II and CP/M Plus operating systems. Ask about the availability of these books at your computer store.

1. MP/M II User's Guide, System Guide, Programmer's Guide, CP/M MAC Assembler: Language Manual & Guide, and Link-80 Operator's Guide, Digital Research, Pacific Grove, CA 93950.

(These books can be ordered from TeleVideo as a set. When ordering them, ask for the MP/M II Manual Set, TVI P/N #125749-00. TeleVideo Systems, Inc., 1170 Morse Avenue, P.O. Box 3568, Sunnyvale, CA 94088.)

2. TS 804 Technical Reference Manual, TeleVideo Systems, Inc., 1170 Morse Avenue, P.O. Box 3568, Sunnyvale, CA 94088. When ordering this manual, use TVI P/N #125015-00.

3. CP/M Plus (CP/M Version 3) User's Guide, Programmer's Guide, Programmer's Utilities Guide, Symbolic Instruction Debugger Reference Manual, Digital Research, Pacific Grove, CA 93950.

(These books are included in the CP/M Plus option kit from TeleVideo. When ordering them, ask for the CP/M Plus Option Kit, TVI P/N #125645-00. TeleVideo Systems, Inc., 1170 Morse Avenue, P.O. Box 3568, Sunnyvale, CA 94088.)

4. Zaks, Rodney, The CP/M Handbook with MP/M, SyBex, 2344 Sixth Street, Berkeley, CA 94710 (415/848-8233).

(Giving very complete details of CP/M, this book gives more detail than many beginners will want.)

5. Hogan, Thom, Osborne CP/M User Guide, 2nd ed., Osborne/McGraw-Hill, 630 Bancroft Way, Dept. UB, Berkeley, CA 94710.

(A complete book for the beginning computer operator. Covers all aspects of computer operation and CP/M use. Organization and presentation are outstanding.)

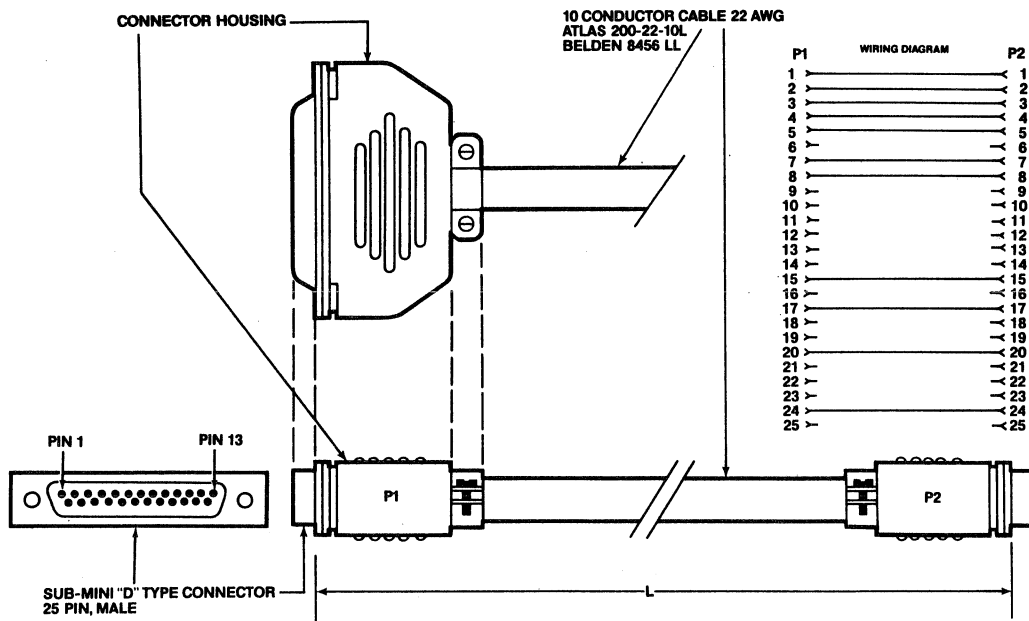
6. Mostek (for the Z80 chip set), 1215 W. Crosby Rd., Carrollton, TX 75006.

TeleVideo welcomes comments from you about these books as well as names of others which you find useful.

**APPENDIX C CABLE SPECIFICATIONS**

The cables that you use should be no more than 50 feet long.  
 Use of improper cables can result in noncompliance with FCC regulations.

**Figure C-1  
 TS 804 to Serial Printer or Terminal (RS-232C cable)**



To attach a modem to one of the user ports, you must use a null modem cable to connect the user port and the modem. This cable consists of a crossover cable that converts a DCE port to a DTE port. Table C-1 defines the null modem cable construction.

**Table C-1**  
**TS 804 to Modem Cable**

System Side Pin Number	----->	Modem Side Pin Number
3	----->	2
2	<-----	3
5	----->	4
8	----->	20
20	<-----	5
4	<-----	8
7	-----	7
15	<-----	15
17	<-----	17
1	-----	1

Run the CONFIGUR program to change the baud rate to conform to the baud rate specified in the manual that came with your modem.

For connecting a TS 804 to a parallel printer, use a standard IBM parallel printer cable (25-pin D-shell connector on the TS 804 end and a Centronics-type connector on the parallel printer end). This cable is available from your computer dealer.

**APPENDIX D BUYING ADDITIONAL DISKETTES**

**Sources** Any TeleVideo Systems dealer or distributor  
Retail Computer Center

**Specifications** Any new diskette should meet these specifications to ensure data integrity.

Type	Floppy mini-diskette
Size	5 1/4-inch
Technology	Double sided, double density
Format	Soft sectored
	Guaranteed for 96 tpi drives
	100 tracks per inch

**Recommended Brands**

Brand	Part No.	Manufacturer
Dysan Diskettes 204/2D	805001	Dysan Corporation Santa Clara, CA
Maxell MD2/DD		

**Quality** You should purchase the highest quality diskettes available to ensure data integrity. Diskettes are not expensive to replace compared to the expense of the time spent putting data on them.

**Life Expectancy**

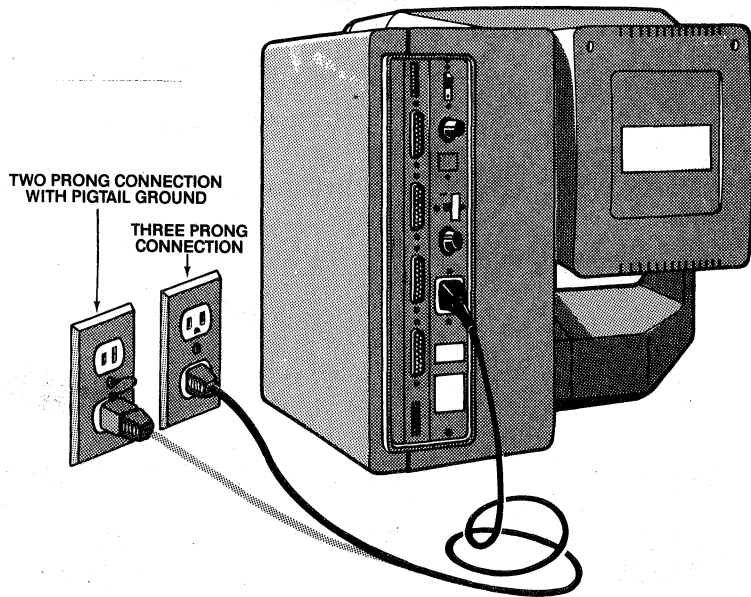
Depending on the care and amount of use you give your diskettes, they will last from six months to two years. Many users automatically phase out diskettes periodically. Factors such as the number of disk accesses, quality of diskette, environment, and care can significantly affect their life expectancy.

One of the first signs of diskette wear is incorrect data. The care with which you handle and store diskettes is probably the single most important factor in the life expectancy of diskettes.

APPENDIX E USING A TWO-PRONG ADAPTER

The TS 804 has a three-prong plug. If you use it with a two-prong adapter, ground it with a pigtail. See Figure E-1.

Figure E-1  
Power Cord with Two-Prong Adapter



Internally, the power cord wires are color-coded as follows:

- |       |                                |
|-------|--------------------------------|
| Green | Earth ground                   |
| Black | Primary power (hot)            |
| White | Primary power return (neutral) |

**STOP!** Incorrect or fluctuating line voltages can cause disk errors or damage to the system. If you have any doubt about the line voltages at your location, ask your dealer to check out your facility **before proceeding with the installation.**

**APPENDIX F CHANGING THE FUSE TO 230 VOLTS**

This appendix explains how to change the fuse and voltage switch to allow the TS 804 to be used on the 230 volt international power standard.

The TS 804 is shipped with the fuse installed to correspond to 115 volts. You will need a .75A fuse to operate on 230 volts.

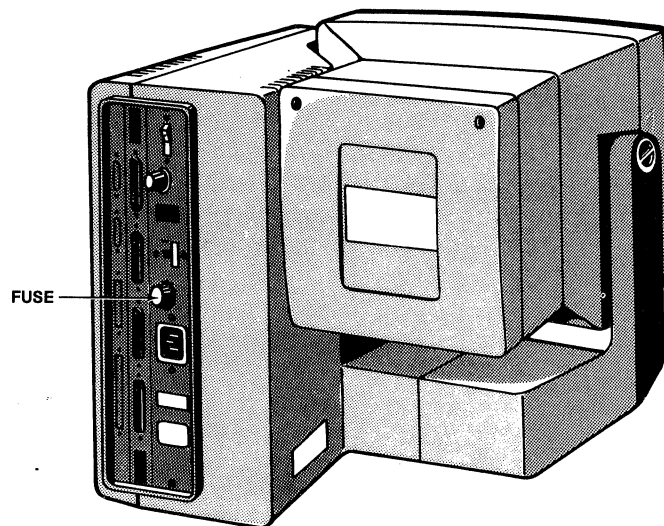
**Table F-1  
Fuse Table**

<b>Amperes</b>	<b>Maximum Fuse Voltage</b>	<b>Power Standards</b>
1.5	250V	115V U.S.
.75	250V	230V International

To change the fuse to correspond to 230V, be sure that the power is turned off and the power plug is not connected.

Unscrew the fuse holder from the back panel of unit and remove the 1.5A fuse. Place one end of the .75A fuse into the holder and insert the fuse into the unit. Press gently while screwing the holder back into place. See Figure F-1.

**Figure F-1  
Fuse**



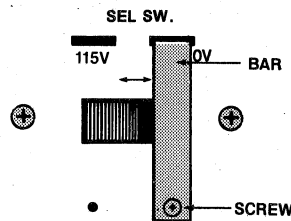
### Changing the Voltage Switch to 230 Volts

The system is configured at the factory for 115 Vac - 60 Hz. To change the voltage configuration to 230 Vac you need to change the voltage switch on the back panel of the system.

The voltage switch is locked into place with a removable bar. To remove the bar and switch from 115 Vac to 230 Vac, follow these directions:

1. Using a Phillips screw driver, remove the screw from the bottom of the bar that spans the 230V side of the switch. See Figure F-2.

**Figure F-2**  
**Voltage Switch**



2. Carefully remove the bar.
3. Firmly push the switch to the 230V position (to the right).
4. Fit the top horizontal section carefully into the slot above the 115V position. Match the screw hole of the bar with that under the 115V position.
5. Insert and tighten screw.

**STOP!**

Contact your dealer if you are not sure that your power requirements match that of the unit. **Trying to operate the unit with the wrong power configuration can seriously damage the system.**

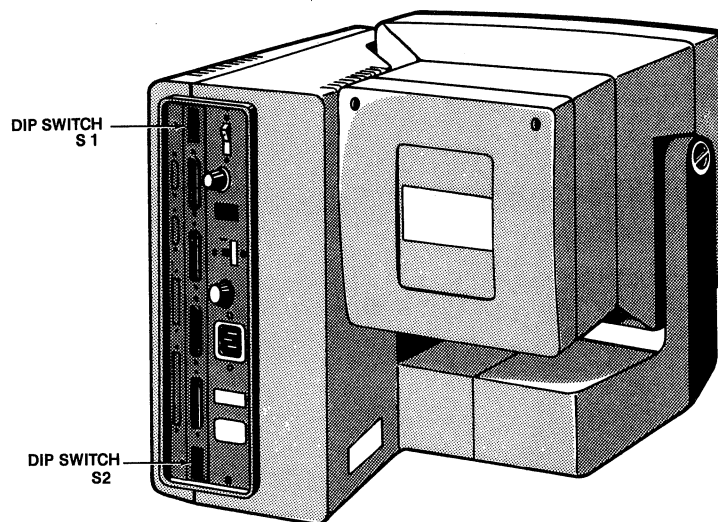
**APPENDIX G SWITCH SETTINGS**

Switch settings control many functions, including video display. Most switches can be set according to your preference, but others must be set in required positions. During installation, it is important that you check the switch settings to match your system requirements.

The TS 804 has two switches, called DIP switches, located on the rear panel and labeled S1 and S2. See Figure G-1. Each switch contains ten sections (they look like small levers). These sections control various system functions. Figures G-2 and G-3 illustrate the positions of the sections as they are set by TeleVideo (default settings).

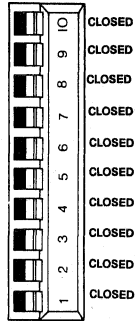
**STOP!** The sections of the DIP switch are small individual switches. The top of each lever has a small recess that accepts the tip of a ball-point pen. Gently push the switch to the desired position with a pen, and always give the switch a second push to make certain that it is seated properly in the position you have chosen. **DO NOT USE A PENCIL!** Pencil lead is an electrical conductor, and any small grains of lead falling into the switch sections may cause a malfunction.

**Figure G-1**  
**Rear Panel Switches**



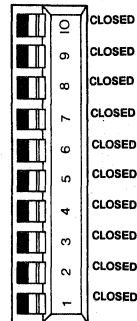
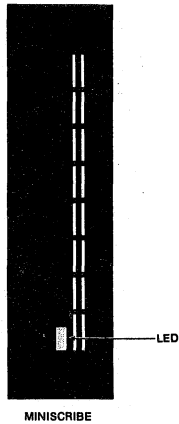


**Figure G-2**  
**Default Switch Settings for S1**  
(as set by TeleVideo)

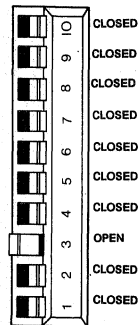
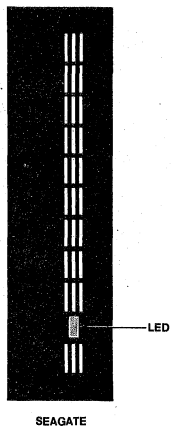


**Figure G-3**  
**Default Switch Settings for S2**  
(as set by TeleVideo)

**Miniscribe Hard Drive**



**Seagate Hard Drive**



Rodime Hard Drive

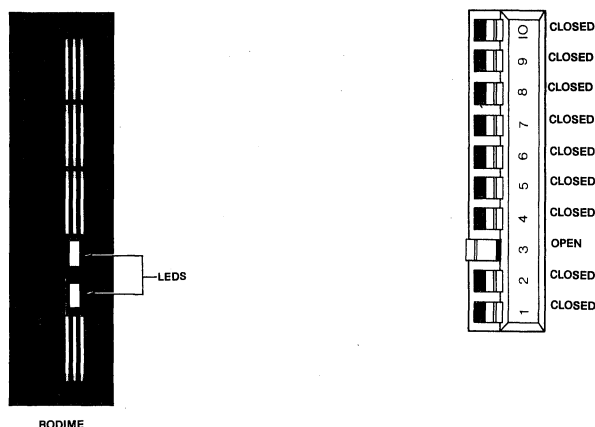


Table G-1 lists all of the possible settings for DIP switch S1 and Table G-2 lists those for S2. Read through the tables and set the sections according to your requirements.

**Table G-1**  
**S1 Switch Settings**

Section	Position	Function
1	closed (right) open (left)	60 Hz 50 Hz
2	closed (right) open (left)	GOB BOG (reverse video)
3	closed (right) open (left)	Time out on Time out off
4	closed (right) open (left)	Wraparound on Wraparound off
5	closed (right) open (left)	Carriage return Carriage return and linefeed
6	closed (right) open (left)	Down arrow not linefeed Down arrow = linefeed
7	closed (right) open (left)	Keyclick on Keyclick off
8	closed (right) open (left)	Viewpoint not emulated Viewpoint emulated
9	Not used	
10	Not used	

**Table G-2**  
**S2 Switch Settings**

Section	Position	Function
1	closed (right) open (left)	No external hard disk drive Configure external hard disk
2	closed (right)	Reserved for future use
3	closed (right) open (left)	System disk with two heads System disk with four heads
4	closed (right) open (left)	Altos-compatible terminal speed, up to 9600 baud rate Up to 19.2k baud rate
5	closed (right) open (left)	Local boot Boot via network port (RS-422) for future use
6	closed (right) open (left)	Asynchronous user 2 port Use external clock for synchronous mode operation
7	closed (right) open (left)	Asynchronous user 3 port Use external clock for synchronous mode operation
8	closed (right)	Reserved for diagnostic purposes
9	closed (right)	Not used
10	closed (right)	Not used

**NOTE!** Switches should not be changed during operation. Set the switch before power on.

**APPENDIX H PIN CONNECTOR ASSIGNMENTS**

**Table H-1  
Board Connectors**

Connector No.	Description
P1	RS-232C DCE Connector
P2	RS-232C DCE Connector
P3	RS-232C DCE Connector
P4	RS-422 Option Board Connector
P5	Floppy Disk Connector
P6	Hard Disk Controller Connector
P7	Parallel Printer Connector
P8	Keyboard
P9	Video
P10	Power

**Table H-2  
RS-232C Connector**

Male Connector Pin No.	RS-232C Designator	Description	I/O
1	AA	Frame Ground	G
2	BA	Transmit Data	O
3	BB	Receive Data	I
4	CA	Request to Send	O
5	CB	Clear to Send	I
7	BA	Signal Ground	C
8	CF	Data Carrier Detect	I
15	DB	Transmit Clock	I
17	DD	Receive Clock	I
20	CD	Data Terminal Ready	O

**Legend:**

- G = AC chassis ground
- I = Input
- O = Output
- C = Signal common

**Table H-3**  
**Parallel Printer Port**

Pin No.	Description
1	Strobe -
2	Data bit 0 +
3	Data bit 1 +
4	Data bit 2 +
5	Data bit 3 +
6	Data bit 4 +
7	Data bit 5 +
8	Data bit 6 +
9	Data bit 7 +
10	Acknowledge -
11	Busy +
12	Out of Paper +
13	Select +
14	Auto feed -
15	Error -
16	Initialize -
17	Select input -
18-25	Ground

APPENDIX I ASCII CODE CHART

Figure I-1  
ASCII Code Chart

<div style="display: flex; align-items: center;"> <div style="writing-mode: vertical-rl; transform: rotate(180deg); margin-right: 5px;">Bits</div> <div style="display: flex; flex-direction: column; align-items: center;"> <div style="margin-bottom: 5px;">7 →</div> <div style="margin-bottom: 5px;">6 →</div> <div style="margin-bottom: 5px;">5 →</div> <div style="margin-bottom: 5px;">4 →</div> <div style="margin-bottom: 5px;">3 →</div> <div style="margin-bottom: 5px;">2 →</div> <div style="margin-bottom: 5px;">1 →</div> </div> <div style="display: flex; align-items: center;"> <div style="border: 1px solid black; padding: 2px; margin-right: 5px;">Column →</div> <div style="border: 1px solid black; padding: 2px; margin-right: 5px;">Row ↓</div> </div> </div>					0 0 0	0 0 1	0 1 0	0 1 1	1 0 0	1 0 1	1 1 0	1 1 1
					4	3	2	1	0	1	2	3
0	0	0	0	0	NUL	DLE	SP	0	@	P		p
0	0	0	1	1	SOH	DC1	!	1	A	Q	a	q
0	0	1	0	2	STX	DC2	"	2	B	R	b	r
0	0	1	1	3	ETX	DC3	#	3	C	S	c	s
0	1	0	0	4	EOT	DC4	\$	4	D	T	d	t
0	1	0	1	5	ENQ	NAK	%	5	E	U	e	u
0	1	1	0	6	ACK	SYN↓	&	6	F	V	f	v
0	1	1	1	7	BEL	ETB	'	7	G	W	g	w
1	0	0	0	8	BS←	CAN	(	8	H	X	h	x
1	0	0	1	9	SKIP HT	EM	)	9	I	Y	i	y
1	0	1	0	10(a)	LF	SUB	*	:	J	Z	j	z
1	0	1	1	11(b)	VT↑	ESC	+	;	K	[	k	{
1	1	0	0	12(c)	FF→	FS	,	<	L	\	l	
1	1	0	1	13(d)	CR	GS	-	=	M	]	m	}
1	1	1	0	14(e)	SO	HOME RS	.	>	N	^	n	~
1	1	1	1	15(f)	SI	NEW LINE US	/	?	O	_	o	DEL RUB

ASCII Code Table  
Abbreviations For Control Characters

NUL	null	FF	form feed	CAN	cancel
SOH	start of heading	CR	carriage return	EM	end of medium
STX	start of text	SO	shift out	SUB	substitute
ETX	end of text	SI	shift in	ESC	escape
EOT	end of transmission	DLE	data link escape	FS	file separator
ENQ	enquiry	DC1	device control 1	GS	group separator
ACK	acknowledge	DC2	device control 2	RS	record separator
BEL	bell	DC3	device control 3	US	unit separator
BS	backspace	DC4	device control 4	SP	space
HT	horizontal tabulation	NAK	negative acknowledge	DEL	delete
LF	linefeed	SYN	synchronous idle		
VT	vertical tabulation	ETB	end of transmission block		

## APPENDIX J CONFIGUR PROGRAM

CONFIGUR is a menu-driven utility program for customizing the TS 804 hardware running under MP/M II or CP/M Plus. CONFIGUR provides the capability to change system attributes, such as baud rate and printer protocol, dynamically in semi-real time. For example, within this program a user only needs to specify the new baud rate to change the baud rate of the printer. CONFIGUR makes the change to the system. This change can be made permanent in the operating system and will be effective after the next reset.

The capability of the CONFIGUR program is as follows:

## 1. Port attribute configuration

Port attribute configuration allows baud rate specification for external devices such as terminals, printers, or modems, and transmit/receive data format.

## 2. Floppy disk format configuration

The TS 804 is equipped with a 96 tpi floppy disk driver, but it can be changed to read TS 803 48 tpi diskettes, TS 1603 96 tpi diskettes, and IBM CP/M-86 48 tpi diskettes by selecting this capability. This change is always temporary and the system returns to the default TS 804 96 tpi mode upon power off.

The following example illustrates how to change the baud rate for USER port 1.

Be sure that the file, CONFIGUR.COM exists in the currently logged drive.

USER: 1. Enter

CONFIGUR<CR>

SYSTEM: 2. Displays

TS-804 : CONFIGURation Utility Vx.x mm/dd/yy  
(c) 1983 TeleVideo Systems, Inc.

\*\*\*\*\* WARNING \*\*\*\*\*  
Stop all other MP/M terminals before proceeding.  
Hit RETURN when ready. (ESC or ^C to abort.)  
\*\*\*\*\*

USER: 3. Enter

<CR>

SYSTEM: 4. Displays

SYSTEM CONFIGURation                      Version Vx.x                      TeleVideo Systems, Inc.

---

Current system:                      TS-804  
Operating system:                      MP/M II

Select modification category:

- 0) Help
- 1) To change user 1 port baud rate
- 2) To change user 2 port baud rate
- 3) To change user 3 port baud rate
- 4) To change user 1 port data format
- 5) To change user 2 port data format
- 6) To change user 3 port data format
- 7) To change floppy disk format
- 8) To EXECUTE AND SAVE current configuration and return to system
- 9) To EXECUTE current configuration and return to system
- 10) To ABORT this setup

— <--Enter appropriate number followed by <CR> or CTRL-C to return to O.S.

USER: 5. Enter

1<CR>



SYSTEM: 6. Displays

SYSTEM CONFIGURation                      Version Vx.x                      TeleVideo Systems, Inc.

---

Current system:                      TS-804  
Operating system:                      MP/M II  
Current user 1 BAUD rate 9,600

Please select the following baud rate

- 0) Help
- 1) 19,200 BAUD
- 2) 9,600 BAUD
- 3) 4,800 BAUD
- 4) 2,400 BAUD
- 5) 1,200 BAUD
- 6) 600 BAUD
- 7) 300 BAUD
- 8) 150 BAUD
- 9) 75 BAUD
- 10) Use current BAUD rate and exit
- 11) Go to data format menu
- 12) Go to the next user port

\_\_ <--Enter appropriate number followed by <CR> or CTRL-C to return to O.S.

USER: 7. Enter

4<CR>

(if you wish to change baud rate to 2400)

SYSTEM: 8. Displays

SYSTEM CONFIGURation	Version Vx.x	TeleVideo Systems, Inc.
----------------------	--------------	-------------------------

---

Current system: TS-804  
 Operating system: MP/M II  
 Current user 1 BAUD rate 2,400

Please select the following baud rate

- 0) Help
- 1) 19,200 BAUD
- 2) 9,600 BAUD
- 3) 4,800 BAUD
- 4) 2,400 BAUD
- 5) 1,200 BAUD
- 6) 600 BAUD
- 7) 300 BAUD
- 8) 150 BAUD
- 9) 75 BAUD
- 10) Use current BAUD rate and exit
- 11) Go to data format menu
- 12) Go to the next user port

\_\_ <--Enter appropriate number followed by <CR> or CTRL-C to return to O.S.

USER: 9. Enter

10<CR>

SYSTEM: 10. Displays

SYSTEM CONFIGURation	Version Vx.x	TeleVideo Systems, Inc.
----------------------	--------------	-------------------------

---

Current system: TS-804  
 Operating system: MP/M II

Select modification category:

- 0) Help
- 1) To change user 1 port baud rate
- 2) To change user 2 port baud rate
- 3) To change user 3 port baud rate
- 4) To change user 1 port data format
- 5) To change user 2 port data format
- 6) To change user 3 port data format
- 7) To change floppy disk format
- 8) To EXECUTE AND SAVE current configuration and return to system
- 9) To EXECUTE current configuration and return to system
- 10) To ABORT this setup

\_\_ <--Enter appropriate number followed by <CR> or CTRL-C to return to O.S.

USER: 11. Enter

8<CR>

SYSTEM: 12. Displays

CONFIGUR Executed.

New changes are saved onto drive "A".

CONFIGUR Completed.

0A>

(if the currently logged drive is drive A.)

The baud rate for the USER 1 port is now permanently changed.

The following example illustrates how to change the floppy disk format from TS 804 96 tpi to TS 803 48 tpi.

Be sure that the file, CONFIGUR.COM exists on the logged disk drive.

**STOP!** Be sure you are running the CONFIGUR program from the hard disk, not the floppy disk. Also, you must boot the system from the hard disk.

USER: 1. Enter

CONFIGUR<CR>

SYSTEM: 2. Displays

A:CONFIGUR.COM

TS-804 : CONFIGURation Utility Vx.x mm/dd/yy  
(c) 1983 TeleVideo Systems, Inc.

\*\*\*\*\* WARNING \*\*\*\*\*  
Stop all other MP/M terminals before proceeding.  
Hit RETURN when ready. (ESC or ^C to abort.)  
\*\*\*\*\*

USER: 3. Enter

<CR>

SYSTEM: 4. Displays

SYSTEM CONFIGURation                      Version Vx.x                      TeleVideo Systems, Inc.

---

Current system:                      TS-804  
Operating system:                      MP/M II

Select modification category:

- 0) Help
- 1) To change user 1 port baud rate
- 2) To change user 2 port baud rate
- 3) To change user 3 port baud rate
- 4) To change user 1 port data format
- 5) To change user 2 port data format
- 6) To change user 3 port data format
- 7) To change floppy disk format
- 8) To EXECUTE AND SAVE current configuration and return to system
- 9) To EXECUTE current configuration and return to system
- 10) To ABORT this setup

\_\_ <--Enter appropriate number followed by <CR> or CTRL-C to return to O.S.

USER: 5. Enter

7<CR>

SYSTEM: 6. Displays

SYSTEM CONFIGURation                      Version Vx.x                      TeleVideo Systems, Inc.

---

Current system:                      TS-804  
Operating system:                      MP/M II  
Current floppy disk format is TeleVideo TS-804 format

Please select the following floppy disk format

- 1) TeleVideo TS-804 format (ALTOS compatible)
- 2) TeleVideo TS-803 format (Recommended READ ONLY)
- 3) TeleVideo TS-1603 format
- 4) IBM CP/M-86 single side format (Recommended READ ONLY)
- 5) Use current floppy disk format and exit

\_\_ <--Enter appropriate number followed by <CR> or CTRL-C to return to O.S.

USER: 7. Enter

2<CR>

SYSTEM: 8. Displays

SYSTEM CONFIGURation	Version Vx.x	TeleVideo Systems, Inc.
----------------------	--------------	-------------------------

---

Current system: TS-804  
 Operating system: MP/M II  
 Current floppy disk format is TeleVideo TS-803 format

Please select the following floppy disk format

- 1) TeleVideo TS-804 format (ALTOS compatible)
- 2) TeleVideo TS-803 format (Recommended READ ONLY)
- 3) TeleVideo TS-1603 format
- 4) IBM CP/M-86 single side format (Recommended READ ONLY)
- 5) Use current floppy format and exit

\_\_ <--Enter appropriate number followed by <CR> or CTRL-C to return to O.S.

USER: 9. Enter

5<CR>

SYSTEM: 10. Displays

SYSTEM CONFIGURation	Version Vx.x	TeleVideo Systems, Inc.
----------------------	--------------	-------------------------

---

Current system: TS-804  
 Operating system: MP/M II

Select modification category:

- 0) Help
- 1) To change user 1 port baud rate
- 2) To change user 2 port baud rate
- 3) To change user 3 port baud rate
- 4) To change user 1 port data format
- 5) To change user 2 port data format
- 6) To change user 3 port data format
- 7) To change floppy disk format
- 8) To EXECUTE AND SAVE current configuration and return to system
- 9) To EXECUTE current configuration and return to system
- 10) To ABORT this setup

\_\_ <--Enter appropriate number followed by <CR> or CTRL-C to return to O.S.

USER: 11. Enter

9<CR>

```
SYSTEM: 12.  Displays
             CONFIGUR Executed.
             CONFIGUR Completed.
             0A>
```

From this point on, all access to the floppy disk will be done on TS 803 48 tpi disk format. This change is effective until power off or software reset (SHIFT/BREAK BREAK). Then it returns to the TS 804 96 tpi format.

The following formats are recommended READ ONLY:

1. TS 803 48 tpi
2. IBM CP/M-86 48 tpi

The following formats are READ/WRITE:

1. TS 804 96 tpi
2. TS 1603 96 tpi

You should be careful when using different formats to be sure that the floppy diskette and the configuration are exactly the same. If you attempt to read or write data to or from a diskette with the wrong configuration, the data read in will be transferred incorrectly without any error messages or warnings.

See the section on diskette formats in Chapter 9 for differences between the TS 804 and TS 1603 formats.

**NOTE!** Perform the same procedure to get back to the default floppy disk format.

APPENDIX K INTEGRAL TERMINAL PROGRAMMING INFORMATION

Function	Command	
	914 Mode	ADDS Viewpoint Mode*
<b>MONITOR MODE</b>		
Monitor mode on	ESC U	CTRL 1
Monitor mode off	ESC X	CTRL 2
<b>RESETTING THE TERMINAL</b>		
Load status line with factory default settings: disable no scroll, write protect, protect modes	CTRL/SHIFT/BREAK	
Hardware reset of integral terminal; return to factory default settings	CTRL RESET	
Partial software reset of integral terminal; return to factory default settings	ESC ~ 0	ESC ~ 0
Software reset of integral terminal; return to factory default settings	ESC ~ 1	ESC ~ 1
<b>LOCKING/UNLOCKING THE KEYBOARD</b>		
Lock keyboard	ESC #	ESC 5
Unlock keyboard	ESC "	ESC 6
<b>CURSOR STYLE</b>		
Invisible cursor	ESC . 0	
Blinking block cursor	ESC . 1	
Steady block cursor	ESC . 2	
Blinking underline cursor	ESC . 3	
Steady underline cursor	ESC . 4	
<b>KEYCLICK AND BELL</b>		
Keyclick on	ESC < 1	
Keyclick off	ESC < 0	
Ring bell	CTRL G	CTRL G

Function	Command	
	914 Mode	ADDS Viewpoint Mode*
<b>DISPLAY CONTROLS</b>		
Screen on	ESC n 0	
Screen off	ESC n 1	
Light background	ESC b	ESC b
Dark background	ESC d	ESC d
Full intensity normal video	ESC G 0	ESC 0 0
Full intensity invisible video	ESC G 1	ESC 0 1
Full intensity blinking video	ESC G 2	ESC 0 2
Full intensity invisible blinking video	ESC G 3	ESC 0 3
Full intensity reverse background	ESC G 4	ESC 0 4
Full intensity invisible reverse	ESC G 5	ESC 0 5
Full intensity blinking reverse	ESC G 6	ESC 0 6
Full intensity invisible blinking reverse	ESC G 7	ESC 0 7
Full intensity underline	ESC G 8	ESC 0 8
Full intensity invisible underline	ESC G 9	ESC 0 9
Full intensity blinking underline	ESC G :	ESC 0 :
Full intensity invisible blinking underline	ESC G ;	ESC 0 ;
Full intensity reverse underline	ESC G <	ESC 0 <
Full intensity invisible reverse underline	ESC G =	ESC 0 =
Full intensity reverse blinking underline	ESC G >	ESC 0 >
Full intensity invisible reverse blinking underline	ESC G ?	ESC 0 ?
Half intensity normal video	ESC G sp	ESC 0 sp
Half intensity invisible video	ESC G !	ESC 0 !
Half intensity blinking video	ESC G "	ESC 0 "
Half intensity invisible blinking video	ESC G #	ESC 0 #
Half intensity reverse background	ESC G \$	ESC 0 \$
Half intensity invisible reverse background	ESC G %	ESC 0 %
Half intensity blinking reverse background	ESC G &	ESC 0 &
Half intensity invisible blinking reverse background	ESC G '	ESC 0 '
Half intensity underline	ESC G (	ESC 0 (
Half intensity invisible underline	ESC G )	ESC 0 )
Half intensity blinking underline	ESC G *	ESC 0 *
Half intensity invisible blinking underline	ESC G +	ESC 0 +
Half intensity reverse underline	ESC G ,	ESC 0 ,
Half intensity invisible reverse underline	ESC G -	ESC 0 -
Half intensity reverse blinking underline	ESC G .	ESC 0 .
Half intensity invisible reverse blinking underline	ESC G /	ESC 0 /
Special graphics mode on; alphanumeric mode off	ESC \$	ESC \$



Function	Command	
	914 Mode	ADDS Viewpoint Mode*
Alphanumeric mode on; special graphics mode off	ESC %	ESC %
<b>CREATING PROTECTED FORMS</b>		
Write protect mode on	ESC )	
Write protect mode off	ESC (	
Protect mode on	ESC &	
Protect mode off	ESC '	
<b>CURSOR CONTROL</b>		
Line feed	CTRL J	CTRL J
Reverse line feed	ESC j	
Cursor up	CTRL K	CTRL Z
Cursor down	CTRL V	CTRL J
Cursor left	CTRL H	CTRL U
Back space		CTRL H
Cursor right	CTRL L	CTRL F
Carriage return	CTRL M	
Cursor home	CTRL ^	CTRL A
New line (carriage return and line feed)	CTRL _	CTRL M
<b>ADDRESSING AND READING THE CURSOR</b>		
Address cursor (row and column)	ESC = r c	ESC Y r c
Read cursor (row, column)	ESC ?	
<b>TAB STOPS</b>		
Set column of typewriter tab stops at cursor column (protect mode off) or field tab stops from cursor downward (protect mode on)	ESC 1	ESC 1
Tabulate to tab stop (typewriter, protect mode off; field, protect mode on)	CTRL I	CTRL I
Tabulate to next field tab stop (protect mode on)	ESC i	
Back tab (typewriter, protect mode off; field, protect mode on)	ESC I	ESC I
Clear current typewriter tab stop	ESC 2	ESC 2
Clear all typewriter tab stops	ESC 3	
<b>COMMUNICATION MODES</b>		
Block mode on	ESC B	
Half duplex mode on	ESC D H	
Full duplex mode on	ESC D F	
Previous conversation mode on; block mode off	ESC C	

Function	Command	
	914 Mode	ADDS Viewpoint Mode*
<b>EDIT MODES</b>		
Local edit mode on	ESC k 1	
Duplex edit mode on	ESC k 0	
Insert space	ESC Q	
Delete character	ESC W	
Insert line	ESC E	
Delete line	ESC R	
Erase from cursor to end of line with spaces	ESC T	ESC K
Erase from cursor to end of line with nulls	ESC t	ESC k
Erase from cursor to end of page with spaces	ESC Y	
Erase from cursor to end of page with nulls	ESC y	
<b>CLEARING DATA FROM MEMORY</b>		
Clear all to nulls	ESC * 0	CTRL L
Clear all to spaces	ESC * 1	
Clear unprotected to nulls	ESC * 2	
Clear unprotected to spaces	ESC * 3	
	or CTRL Z	
Clear current unprotected field to spaces	CTRL X	
<b>SELECTING A HANDSHAKING PROTOCOL</b>		
Disable X-On/X-Off/enable DTR line	CTRL N	
Enable X-On/X-Off; disable DTR line	CTRL O	
<b>TRANSMITTING DATA</b>		
Send unprotected characters in current line, to and including cursor	ESC S 1	
Send line up to and including cursor	ESC S 3	
Send unprotected page up to and including cursor	ESC S 5	
Send page up to and including cursor	ESC S 7	
Send unprotected message between STX and ETX	ESC S 9	
Send message between STX and ETX	ESC S ;	
Send form	ESC S ?	
Send terminal's identification	ESC M	

Function	Command	
	914 Mode	ADDS Viewpoint Mode*
<b>REPROGRAMMING THE KEYS</b> Reprogram one function key	ESC   p1 p2 <msg> CTRL Y	ESC   p1 p2 <msg> CTRL Y
<b>SELF TEST</b> Start self test Stop self test	SET UP 1 or ESC V	ESC V

\* Commands in **bold print** are unique additions by TeleVideo to the normal ADDS Viewpoint commands.

Function	Command	
	914 Mode	ADDS Viewpoint Mode*
<b>EDIT MODES</b>		
Local edit mode on	ESC k 1	
Duplex edit mode on	ESC k 0	
Insert space	ESC Q	
Delete character	ESC W	
Insert line	ESC E	
Delete line	ESC R	
Erase from cursor to end of line with spaces	ESC T	ESC K
Erase from cursor to end of line with nulls	ESC t	ESC k
Erase from cursor to end of page with spaces	ESC Y	
Erase from cursor to end of page with nulls	ESC y	
<b>CLEARING DATA FROM MEMORY</b>		
Clear all to nulls	ESC * 0	CTRL L
Clear all to spaces	ESC * 1	
Clear unprotected to nulls	ESC * 2	
Clear unprotected to spaces	ESC * 3	
	or CTRL Z	
Clear current unprotected field to spaces	CTRL X	
<b>SELECTING A HANDSHAKING PROTOCOL</b>		
Disable X-On/X-Off/enable DTR line	CTRL N	
Enable X-On/X-Off; disable DTR line	CTRL O	
<b>TRANSMITTING DATA</b>		
Send unprotected characters in current line, to and including cursor	ESC S 1	
Send line up to and including cursor	ESC S 3	
Send unprotected page up to and including cursor	ESC S 5	
Send page up to and including cursor	ESC S 7	
Send unprotected message between STX and ETX	ESC S 9	
Send message between STX and ETX	ESC S ;	
Send form	ESC S ?	
Send terminal's identification	ESC M	

Function	Command	
	914 Mode	ADDS Viewpoint Mode*
<b>REPROGRAMMING THE KEYS</b>		
Reprogram one function key	ESC   p1 p2 <msg> CTRL Y	ESC   p1 p2 <msg> CTRL Y
<b>SELF TEST</b>		
Start self test	SET UP 1 or ESC V	<b>ESC V</b>
Stop self test		

\* Commands in **bold print** are unique additions by TeleVideo to the normal ADDS Viewpoint commands.

## INDEX

- Additional diskettes D.1
- Applications programs 4.7, 5.5
- ASCII code chart I.1, Fig. I-1
- Attaching cables 3.1-3
  
- Baud rates
  - peripherals 3.4
  - terminal 3.2
- Board connectors H.1
- Buying additional diskettes D.1
  
- Cable
  - D-shaped cable connectors Fig. 3-2
  - ribbon cable, Fig. 3-3
  - specifications C.1-2
- Caring for the TS 804 10.1-2
- Changing the fuse to 230 volts F.1, Fig. F-1
- Changing system software for different configurations 4.8-9
  - four-user configuration 4.9
  - three-user configuration 4.9
  - two-user configuration 4.9
- Character keys 6.1
- Cleaning the TS 804 10.1
- Connecting terminals and peripherals
  - modem 3.5
  - parallel printer 3.4, H.2
  - peripherals 3.1-4
  - serial printer 3.4
  - terminals 3.1-2, Fig. 3-1
- CONFIGUR J.1
- Contrast knob, Fig. 4-1
- COPYFILE 8.16
- COPYFILE error messages 8.20
- CP/M Plus
  - installing the operating system onto the hard disk 5.3
  - starting up 5.1-3
  - using CP/M Plus 5.1
- CP/M Plus manual 5.4, B.1
  
- Default values for function keys 6.8
- DIP switches 2.3, G.1-4, Fig. G-1, G-2, G-3
- Diskettes 9.1, Fig. 9-1, 9-2
  - backing up diskettes 9.6
  - buying additional diskettes D.1
  - copying master diskettes 9.5
  - diskette formats 9.2
  - formatting diskettes 9.5
  - handling diskettes 9.3
  - inserting diskettes 9.4, Fig. 4-2, 5-1, 9-3

- storing diskettes 9.3
- write protecting diskettes 9.6
- D-shaped cable connectors, Fig. 3-2
  
- Environment 2.2
- Error messages, see COPYFILE error messages
  
- FIX804 8.9
- Floppy diskettes, see diskettes
- Floppy drive 4.3, 5.2, Fig. 4-2, 5-1
- FORMATF 8.7
- FORMATH 8.5
- Four-user configuration 4.9
- Function keys 6.8
  - default values 6.8
  - reprogramming function keys 6.9
- Fuse F.1, Fig. F-1
  
- Hard drive 4.3, 5.2, Fig. 4-2, 5-1
  
- Installing the operating system
  - multi-user 4.5-7
  - stand-alone 5.3-4
- Installing the TS 804 2.2
- Integral terminal programming information K.1
- Introduction 1.1
  
- Keyboard 6.1-8, Fig. 6-1
  - connection, Fig. 2-2
- Keys, see
  - character keys 6.1
  - description 6.1
  - function keys 6.8
  - reset keys 6.8
  - special editing keys, Fig. 6-4
  - special keys 6.2-5, Fig. 6-2
  
- Location 2.1-2
- Logical drives 4.7
- Logical ports 4.9
  
- Modems 3.5
- Modem cable specifications C.1-2
- MP/M II
  - installing the operating system on hard disk 4.5
  - starting up 4.1-4
  - using MP/M II 4.1
- MP/M II manual 4.7, B.1
- Multi-user configuration 1.1, Fig. 1-1
- Multi-user system, turning on the TS 804 as a 4.1-11
  
- Notation conventions 1.3-4
  
- Operating system 1.2

Parallel printer, see connecting terminals and peripherals  
PARK804 8.23  
Physical device 4.7  
Physical ports 4.9  
Pin connector assignments H.1  
Ports 4.8, Fig. 4-3  
Power cord  
    connection 2.4, Fig. 2-5  
    two-prong adapter, Fig. E-1  
Powering off a terminal 4.10  
Powering off the system 4.11  
Powering on a terminal 4.10  
Power switch 2.3, Fig. 2-4  
Programming the integral terminal K.1  
p2 value 6.9

Reconfiguring the TS 804 integral terminal 7.1  
References B.1  
Reprogramming function keys 6.9  
Reset keys 6.8  
Resetting the system from the keyboard 7.12  
Resetting the TS 804 integral terminal 7.10-11  
Ribbon cable 3.3, Fig. 3-3  
RS-232C, Fig. C-1  
Running applications programs 4.7, 5.5

SCANDUP 8.11  
Screen positioning knob 2.4, Fig. 2-6  
Serial number, Fig. 10-1  
Service 10.1  
Setting up your TS 804 2.1  
Setup lines 7.2-9, Fig. 7-2, 7-3, 7-4, 7-5  
Shipping the TS 804 10.2  
SHUTDOWN 8.14  
Single-user system 1.2  
Software 1.2  
Software registration 2.1  
Special editing keys 6.5, Fig. 6-4  
Special keys 6.2-5, Fig. 6-2, 6-3  
Special notes 1.3  
Specifications  
    cable C.1  
    TS 804 A.1  
Stand-alone system, turning on the TS 804 as a 5.1-5  
Status line 7.2-3, Fig. 7-1  
Suggested references B.1  
Switch settings  
    DIP switches 2.2-3, 3.2, G.1-4, Fig. G-1, G-2, G-3  
    voltage switch, Fig. F-2  
System features 1.1  
    hardware 1.1  
    software 1.2  
System reset from the keyboard 7.12



Technical assistance 10.2  
Three-user configuration 4.9  
TS 804 specifications A.1  
Turning off a terminal 4.10  
Turning off the system 4.11  
Turning on a terminal 4.10  
Two-prong adapter 2.4,E.1  
Two-user configuration 4.9

User's manual format 1.3

Utility programs 8.1

- CONFIGUR J.1
- COPYFILE 8.16
- FIX804 8.9
- FORMATF 8.7
- FORMATH 8.5
- PARK804 8.23
- SCANDUP 8.11
- SHUTDOWN 8.14
- WRITESYS 8.2

Voltage switch, Fig. F-2

Work space example, Fig. 2-1


WRITESYS 8.2

For future reference, note the serial number, the date you took delivery, and the name and phone number of your computer store and service center in the space below.

Model TS 804 Serial No. \_\_\_\_\_ Delivery Date \_\_\_\_\_

Computer Store \_\_\_\_\_ Phone No. \_\_\_\_\_

Service Center \_\_\_\_\_ Phone No. \_\_\_\_\_

 **TeleVideo Systems, Inc.**