



ASYNCHRONOUS SERIAL INTERFACE
PROGRAMMING AND USE

ABSTRACT

This document describes the features of the Asynchronous Serial Interface for TERAK Model 8510 data processor systems. Cable wire lists and switch settings are presented. Detail for programming use is also included.

TERAK Publication Number 52-0003-001

REV D

COPYRIGHT (C) TERAK CORPORATION 1979

NOTES ON PROGRAMMING AND USE OF THE 8510 SERIAL INTERFACE

THE STANDARD SERIAL INTERFACE FOR 8510 AND 8510A SYSTEMS SUPPORTS ELECTRICAL CONNECTION IN ONE OF THREE MODES: 20 MA CURRENT LOOP, RS-232C AS DATA TERMINAL EQUIPMENT, AND RS-232C AS DATA COMMUNICATION EQUIPMENT. ONLY ONE OF THESE CONNECTIONS CAN BE MADE AT A TIME. ALL CONNECTIONS AND CONTROL OF THE SERIAL INTERFACE ARE ON THE SERIAL EIP (EXTERNAL INTERFACE BOARD), REPRESENTED SCHEMATICALLY BELOW. THERE ARE THREE CONNECTORS AND SIXTEEN SWITCHES. CONNECTOR J1 IS USED FOR RS-232C INTERFACE USING THE SERIAL INTERFACE AS DATA COMMUNICATIONS EQUIPMENT. CONNECTOR J2 IS USED FOR RS-232C INTERFACE USING THE SERIAL INTERFACE AS DATA TERMINAL EQUIPMENT. CONNECTOR J3 IS USED FOR CURRENT LOOP INTERFACE, AND ALSO FOR RS-232C INTERFACE AS DATA COMMUNICATIONS EQUIPMENT. THIS LATER OPTION (RS-232C CONNECTION THRU J3) ALLOWS USE OF A SIMPLER CONNECTOR (NYLON SHELL TYPE) FOR RS-232C CONNECTION. THE SIXTEEN SWITCHES ON THE SERIAL EIP (S1 & S2) CONTROL ADDRESSING AND CHARACTERISTICS OF THE SERIAL INTERFACE.

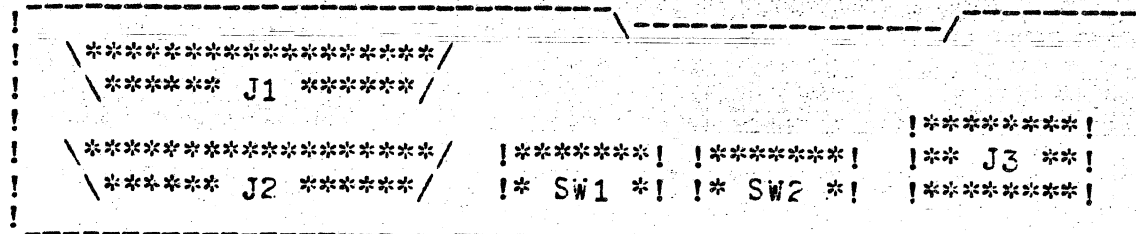

FIGURE 1

SERIAL EIP LEGEND

THIS DOCUMENT ASSUMES FAMILIARITY WITH ANSI SPECIFICATION RS-232C FOR DATA COMMUNICATIONS, AND ALSO WITH CURRENT LOOP INTERFACE TECHNIQUES. DETAILED SIGNAL DESCRIPTIONS WILL NOT BE PRESENTED HERE. THE READER IS REFERED TO: "TECHNICAL ASPECTS OF DATA COMMUNICATION" MCNAMARA, DEC.

RS-232C PIN ASSIGNMENTS AND SIGNAL DEFINITIONS CONFORM TO THE ANSI STANDARD. THEY ARE PLACED HERE FOR REFERENCE.

PIN LIST, RS-232C CONNECTION AS DATA COMMUNICATIONS EQUIPMENT. (DCE)
 ALL CONNECTIONS TO J1, NO CONNECTIONS ALLOWED TO J2 OR J3.
 USE THE FOLLOWING PARTS, OR EQUIVALENT IN THE CABLE ASSEMBLY:

CONNECTOR, MALE 232 PLUG CINCH # DB 25P
 SHELL, PLUG CINCH # DB 5126-1

PIN #	SIGNAL NAME	IN/OUT
J1 - 1	FRAME GROUND	
J1 - 7	SIGNAL GROUND	
J1 - 8	CARRIER DETECT	OUTPUT
J1 - 4	REQUEST TO SEND	INPUT
J1 - 3	RECEIVE DATA	OUTPUT
J1 - 20	DATA TERMINAL READY	INPUT
J1 - 5	CLEAR TO SEND	OUTPUT
J1 - 6	DATA SET READY	OUTPUT
J1 - 2	TRANSMIT DATA	INPUT

PIN LIST, RS-232C CONNECTION AS DATA TERMINAL EQUIPMENT. (DTE)
 ALL CONNECTIONS TO J2, NO CONNECTIONS ALLOWED TO J1 OR J3.
 USE THE FOLLOWING PARTS, OR EQUIVALENT IN THE CABLE ASSEMBLY:

CONNECTOR, FEMALE 232 PLUG	CINCH #	DB 25S
SHELL, PLUG	CINCH #	DB 5126-1

PIN #	SIGNAL NAME	IN/OUT
J2 - 1	FRAME GROUND	
J2 - 7	SIGNAL GROUND	
J2 - 20	DATA TERMINAL READY	OUTPUT
J2 - 5	CLEAR TO SEND	INPUT
J2 - 2	TRANSMIT DATA	OUTPUT
J2 - 6	CARRIER DETECT	INPUT
J2 - 6	DATA SET READY	INPUT
J2 - 4	REQUEST TO SEND	OUTPUT
J2 - 3	RECEIVE DATA	INPUT

PIN LIST, RS-232C CONNECTION AS DATA COMMUNICATIONS EQUIPMENT. (DCE)
 ALL CONNECTIONS TO J3, NO CONNECTIONS ALLOWED TO J1 OR J2.
 USE THE FOLLOWING PARTS, OR EQUIVALENT IN THE CABLE ASSEMBLY:

CONNECTOR, MALE PLUG		MOLEX #	03-06-2151
PINS, MALE CRIMP	USE 15 EA.	MOLEX #	02-06-2103
SHELL, PLUG	USE 2 EA.	MOLEX #	15-04-0201

PIN #	SIGNAL NAME	IN/OUT
J3 - 3	FRAME GROUND	
J3 - 11	SIGNAL GROUND	
J3 - 9	CLEAR TO SEND	OUTPUT
J3 - 12	DATA SET READY	OUTPUT
J3 - 15	CARRIER DETECT	OUTPUT
J3 - 7	RECEIVE DATA	OUTPUT
J3 - 6	DATA TERMINAL READY	INPUT
J3 - 14	TRANSMIT DATA	INPUT

PIN LIST, CURRENT LOOP CONNECTION. INPUT AND OUTPUT CURRENT LEVELS (INCLUDING READER RUN SIGNAL) ARE 20 MA. ALL CONNECTIONS TO J3, NO CONNECTIONS ALLOWED TO J1 OR J2. EITHER INPUT OR OUTPUT LOOP MAY BE ACTIVE OR PASSIVE. THE 20MA ENABLE SOURCE PIN MUST ALWAYS BE CONNECTED TO THE 20MA ENABLE PIN BY A JUMPER IN THE EXTERNAL CONNECTOR. TO CONNECT EITHER AN INPUT OR OUTPUT LOOP PAIR IN A PASSIVE CONFIGURATION, USE THE (+) AND (-) SIGNALS, LEAVING THE ASSOCIATED CURRENT SOURCE OPEN. TO CONNECT EITHER THE INPUT OR OUTPUT LOOP PAIR IN AN ACTIVE CONFIGURATION, CONNECT THE (-) SIGNAL TO GROUND WITH A JUMPER IN THE EXTERNAL CONNECTOR, USE THE (+) SIGNAL AS THE (-) SIGNAL IN THE EXTERNAL CABLE, AND USE THE ASSOCIATED CURRENT SOURCE AS THE (+) SIGNAL IN THE EXTERNAL CABLE. NOTE THAT BOTH, ONE, OR NONE OF THE TWO CURRENT LOOPS MAY BE ACTIVE OR PASSIVE. THE READER RUN SIGNAL IS ALWAYS ACTIVE (20 MA. -> RUN) USE THE FOLLOWING PARTS, OR EQUIVALENT IN THE CABLE ASSEMBLY:

CONNECTOR, MALE PLUG		MOLEX #	03-06-2151
PINS, MALE CRIMP	USE 15 EA.	MOLEX #	02-06-2103
SHELL, PLUG	USE 2 EA.	MOLEX #	15-04-0201

PIN #	SIGNAL NAME	PASSIVE NOTE	ACTIVE NOTE
J3 - 1	I LOOP ENABLE	JUMP TO PIN 4	JUMP TO PIN 4
J3 - 4	I LOOP ENABLE SOURCE	JUMP TO PIN 1	JUMP TO PIN 1
J3 - 2	(-) I LOOP OUT	(-) IN CABLE	JUMP TO PIN 3
J3 - 5	(+) I LOOP OUT	(+) IN CABLE	(-) IN CABLE
J3 - 6	OUTPUT CURRENT SOURCE	NO CONNECTION	(+) IN CABLE
J3 - 10	(-) I LOOP IN	(-) IN CABLE	JUMP TO PIN 11
J3 - 13	(+) I LOOP IN	(+) IN CABLE	(-) IN CABLE
J3 - 14	INPUT CURRENT SOURCE	NO CONNECTION	(+) IN CABLE
J3 - 9	(+) READER RUN		
J3 - 8	(-) READER RUN		
J3 - 3	SIGNAL GROUND		
J3 - 11	SIGNAL GROUND		

DRAWING 800222, IN THE APPENDIX, PRESENTS A PIN DIAGRAM OF J3, TYPICAL INTERFACE CIRCUITS, AND OTHER INFORMATION PERTINENT TO THE CURRENT LOOP INTERFACE.

SWITCHED CONTROL OF THE SERIAL INTERFACE FUNCTIONAL CHARACTERISTICS IS EXERCISED THRU SW1 AND SW2 (SEE FIG.1). THESE SWITCH BLOCKS CONTAIN SIXTEEN SWITCHES. THE DIRECTION OF SWITCHING TO THE ON OR OFF STATE MAY VARY, AND SHOULD BE CHECKED BEFORE SETTING THE SWITCHES. SWITCHES SHOULD NEVER BE CHANGED WHILE THE DATA PROCESSOR POWER IS ON. THE SWITCHES ARE REFERENCED BY NUMBERS S1 THRU S16, LEFT TO RIGHT. THEIR FUNCTIONS ARE AS FOLLOWS:

UNIT SELECTION...SWITCHES 1 THRU 4. THESE SELECT ONE OF EIGHT I/O ADDRESSES FOR THE CONTROL AND STATUS REGISTER, AND DATA REGISTER OF THE SERIAL INTERFACE. UNIT 0 OCCUPIES THE ADDRESSES NORMALLY USED AS THE CONSOLE TERMINAL FOR CONTROL OF THE OPERATING SYSTEM. THIS SHOULD BE SELECTED (NORMALLY) ONLY IF THE SERIAL IS TO BE USED TO INTERFACE THE CONSOLE TERMINAL. THE FOLLOWING TABLE COVERS THE SWITCH PATTERNS.

S1	S2	S3	S4	UNIT #	I/O REGISTER BASE ADDRESS	INTERRUPT VECTOR BASE ADDRESS
OFF	OFF	ON	ON	0	177560	60
ON	OFF	ON	OFF	1	177520	120
ON	OFF	OFF	OFF	2	177530	130
OFF	OFF	OFF	OFF	3	177570	150
ON	ON	ON	OFF	4	176520	320
CN	ON	OFF	OFF	5	176530	330
OFF	ON	CN	OFF	6	176560	340
OFF	ON	OFF	OFF	7	176570	350

CHARACTERISTICS SWITCHES...SWITCHES 5 THRU 8. THESE MAY BE SET TO ANY PATTERN. THE SETTING OF THESE SWITCHES WILL BE AVAILABLE IN BOTH THE RECEIVER STATUS REGISTER AND THE TRANSMITTER STATUS REGISTER OF THE SERIAL INTERFACE, TO BE USED AS REQUIRED BY THE I/O SOFTWARE. TYPICALLY, THESE WOULD IDENTIFY THE TYPE OF TERMINAL OR MODEM ATTACHED, OR CAN BE USED TO ENCODE A "STATION NUMBER" FOR CLUSTERS OF 9510 SYSTEMS. NOTE THAT A SWITCH SET TO THE "OFF" POSITION GENERATES A "ONE" BIT IN BOTH STATUS REGISTERS (AND "ON" GENERATES "ZERO").

SWITCH #	BIT # (STATUS REGISTER)
5	11
6	10
7	9
8	8

NUMBER OF BITS...SWITCH 9. THIS SWITCH SELECTS THE NUMBER OF BITS USED IN THE SERIAL ASCII CODE, AS:

ON 7 BITS

~~OFF~~ 8 BITS

PARITY ENABLE...SWITCH 10. THIS SWITCH ENABLES THE TRANSMISSION OF PARITY, OR THE TRANSMISSION OF A "SPACE" FOR THE PARITY BIT. ON INPUT, THIS SWITCH ALSO ENABLES THE VERIFICATION OF PARITY, SETTING AN ERROR CONDITION IF ENABLED.

ON PARITY IS ACTIVE

~~OFF~~ PARITY DISABLED

TTY FILTER...SWITCH 11. THIS SWITCH CONNECTS THE NOISE FILTER FOR SUPPRESSION OF TRANSIENTS WHILE DRIVING AN ASR33 TYPE TELETYPEWRITER USING THE CURRENT LOOP INTERFACE. THIS SWITCH MUST BE OFF EXCEPT WHEN DRIVING SUCH A TERMINAL AT LOW DATA SPEEDS (TYPICALLY 110 BAUD).

~~ON~~ FILTER IS CONNECTED

OFF FILTER DISCONNECTED

 PARITY...SWITCH 12. THIS SWITCH IS ACTIVE ONLY IF PARITY IS
 ENABLED BY SWITCH 12. EVEN OR ODD PARITY FOR BOTH TRANSMISSION
 AND RECEPTION OF DATA IS SELECTED AS:

ON	ODD PARITY
OFF	EVEN PARITY

 DATA RATE...SWITCHES 13 THRU 16. THESE SWITCHES SELECT ONE
 OF THE FOLLOWING FOURTEEN DATA RATES FOR BOTH TRANSMISSION
 AND RECEPTION OF DATA. THE TWO REDUNDANT CASES ARE INCLUDED.

S13	S14	S15	S16	DATA RATE, BAUD	
ON	ON	ON	OFF	50	
ON	ON	OFF	OFF	75	
OFF	OFF	OFF	OFF	110	
OFF	ON	ON	ON	134	
OFF	OFF	ON	OFF	150	
OFF	ON	OFF	ON	200	
OFF	OFF	OFF	ON	300	
OFF	ON	ON	OFF	600	
ON	OFF	OFF	OFF	1200	
ON	OFF	ON	OFF	1800	
OFF	ON	OFF	OFF	2400	
OFF	OFF	ON	ON	2400	(REDUNDANT)
ON	OFF	OFF	ON	4800	
ON	OFF	ON	ON	9600	
ON	ON	ON	ON	19200	
ON	ON	OFF	ON	19200	(REDUNDANT)

 WITH THE SERIAL INTERFACE I/O SWITCHES SET CORRECTLY FOR THE
 EQUIPMENT TO BE INTERFACED, THE SERIAL IS PROGRAMMED INTERNALLY
 BY ADDRESSING THE FOUR I/O REGISTERS AT THE SEQUENTIAL
 WORD ADDRESSES STARTING AT THE "I/O BASE ADDRESS" FOUND IN THE
 UNIT NUMBER TABLE ABOVE. ALSO, THE INTERRUPT VECTOR ADDRESS PAIR
 (ADDRESS AND STATUS WORDS) OCCUPY FOUR WORD IN LOW MEMORY STARTING
 AT THE "VECTOR BASE ADDRESS" FOUND IN THE UNIT NUMBER TABLE ABOVE.
 THUS, UNIT 1 OCCUPIES FOUR ADDRESSES IDENTIFIED AS FOLLOWS:

EXAMPLE...UNIT #1	RECEIVER STATUS REGISTER (RSR)	177520
	RECEIVER DATA BUFFER (RDB)	177522
	TRANSMITTER STATUS REGISTER (XSR)	177524
	TRANSMITTER DATA BUFFER (XDB)	177526
	RECEIVER VECTOR ADDRESS	120 / 122
	TRANSMITTER VECTOR ADDRESS	124 / 126

RECEIVER STATUS REGISTER CONTAINS ERROR INFORMATION, THE SETTING OF THE EIP CHARACTERISTICS SWITCHES, AND "DONE", "INTERRUPT ENABLE", AND "READER RUN" BITS. THESE ARE DEFINED BELOW:

RECEIVER STATUS REGISTER BIT MAP
ALL BITS ARE READ-ONLY UNLESS OTHERWISE NOTED

BIT #	0] <-----	READER RUN (WRITE ONLY)
BIT #	1] <-----	
BIT #	2] <-----	
BIT #	3] <-----	
BIT #	4] <-----	
BIT #	5] <-----	
BIT #	6] <-----	INTERRUPT ENABLE (READ AND WRITE)
BIT #	7] <-----	DONE BIT
BIT #	8] <--//	
BIT #	9] <--//	CHARACTERISTICS
BIT #	10] <--//	SWITCHES (EIP)
BIT #	11] <--//	
BIT #	12] <-----	OVERPUN ERROR
BIT #	13] <-----	BREAK DETECTED
BIT #	14] <-----	PARITY ERROR DETECTED
BIT #	15] <-----	ERROR (INCLUSIVE OR OF BITS 14, 13, 12)

WHEN A CHARACTER IS RECEIVED, THE DONE BIT WILL BE SET, INDICATING THAT THE DATA IS AVAILABLE IN THE RECEIVER DATA BUFFER. ONLY THE LOW ORDER 7 BITS OF THE DATA BUFFER ARE VALID. IF THE INTERRUPT ENABLE BIT HAS BEEN PREVIOUSLY WRITTEN ON, AN INTERRUPT THRU THE RECEIVER VECTOR ADDRESS WILL BE REQUESTED. IF AN ERROR CONDITION IS DETECTED, THE ERROR BIT AND THE DONE BIT WILL BE SET, AND AN INTERRUPT REQUESTED, IF ENABLED. THREE ERROR CONDITIONS ARE DETECTED:

OVERRUN - NEW DATA HAS BEEN RECEIVED AND PLACED INTO THE DATA BUFFER BEFORE THE PROCESSOR ACCEPTED THE PREVIOUS DATA. CURRENT DATA IS VALID.

BREAK - THE SERIAL INPUT LINE WAS IN A CONTINUOUS "MARK" CONDITION. THIS IS USED SOMETIMES AS A REVERSE CHANNEL TO REQUEST DATA TRANSMISSION. IT CAN ALSO INDICATE AN OPEN LINE.

PARITY - A PARITY ERROR WAS DETECTED ON THE RECEIVED DATA.

WHEN A CHARACTER IS RECEIVED, THE READER RUN BIT IS CLEARED. WHEN THE READER RUN BIT IS SET ON, A LINE IN THE CURRENT LOOP INTERFACE TO ASR33 TYPE TELETYPEWRITERS WILL ENABLE THE BUILT-IN PAPER TAPE READER TO READ ONE CHARACTER. TO READ PAPER TAPE CONTINUOUSLY, THE READER RUN BIT MUST BE SET FOR EACH CHARACTER.

WHEN A SYSTEM RESET, POWER CYCLE, OR RESET INSTRUCTION OCCUR, THE DONE BIT WILL BE CLEARED. IF THE INTERRUPT ENABLE BIT IS SET WHILE THE DONE BIT IS CLEARED, NO IMMEDIATE INTERRUPT WILL OCCUR. IF THE INTERRUPT ENABLE BIT IS SET WHILE THE DONE BIT IS SET, AN IMMEDIATE INTERRUPT WILL BE REQUESTED.

TRANSMITTER STATUS REGISTER CONTAINS ERROR INFORMATION, THE SETTING OF THE EIP CHARACTERISTICS SWITCHES, AND "DONE", "INTERRUPT ENABLE", AN BREAK TRANSMISSION CONTROL BITS. THESE ARE DEFINED BELOW:

TRANSMITTER STATUS REGISTER BIT MAP

ALL BITS ARE READ-ONLY UNLESS OTHERWISE NOTED

```

BIT # 0 ] <----- TRANSMIT CONTINUOUS BREAK (WRITE ONLY)
BIT # 1 ]
BIT # 2 ]
BIT # 3 ]
BIT # 4 ]
BIT # 5 ]
BIT # 6 ] <----- INTERRUPT ENABLE (READ AND WRITE)
BIT # 7 ] <----- DONE BIT
BIT # 8 ] <--\
BIT # 9 ] <--\ \ CHARACTERISTICS
BIT # 10 ] <--\ // SWITCHES (EIP)
BIT # 11 ] <--//
BIT # 12 ]
BIT # 13 ]
BIT # 14 ]
BIT # 15 ] <-----ON -> MODEM READY

```

A CHARACTER IS TRANSMITTED WHEN THE TRANSMITTER DATA BUFFER IS WRITTEN. TRANSMISSION IS CONSIDERED COMPLETE WHEN THE SERIAL BIT STREAM HAS BEEN COMPLETELY GENERATED. THEN, THE DONE BIT WILL BE SET, INDICATING THAT THE TRANSMITTER CAN ACCEPT ANOTHER CHARACTER. ONLY THE LOW ORDER 7 BITS OF THE DATA BUFFER ARE VALID. IF THE INTERRUPT ENABLE BIT HAS BEEN PREVIOUSLY WRITTEN ON, AN INTERRUPT THRU THE TRANSMITTER VECTOR ADDRESS WILL BE REQUESTED. THE MODEM READY BIT IS THE REVERSE LOGIC OF THE RECEIVER ERROR BITS: ON SAYS THE MODEM IS READY. THIS BIT DOES NOT GENERATE AN INTERRUPT. IT IS GENERALLY A STATIC INDICATION THAT A MODEM IS PRESENT AND CONNECTED TO THE SERIAL INTERFACE.

THE "TRANSMIT CONTINUOUS BREAK" BIT, WHEN SET ON, WILL DO JUST THAT. THIS IS USED TO INDICATE AN INACTIVE STATE TO THE RECEIVER OF THE TRANSMITTED DATA. THE BREAK STATE WILL BE CONTINUOUS UNTIL THE BIT IS CLEARED OFF.

WHEN A SYSTEM RESET, POWER CYCLE, OR RESET INSTRUCTION OCCUR, THE DONE BIT WILL BE SET. IF THE INTERRUPT ENABLE BIT IS SET WHILE THE DONE BIT IS CLEARED, NO IMMEDIATE INTERRUPT WILL OCCUR. IF THE INTERRUPT ENABLE BIT IS SET WHILE THE DONE BIT IS SET, AN IMMEDIATE INTERRUPT WILL BE REQUESTED.

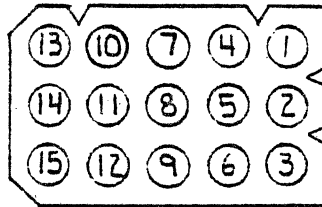

J3 VIEWED FROM REAR OF 8510

J3 PIN	DESCRIPTION	INPUT OUTPUT	EIA CKT	EIA PIN
	CURRENT LOOP	EIA RS-232-C AS DCE		
1	I LOOP ENABLE			
2	(-) I LOOP OUT			
3	SIGNAL GROUND	FRAME GROUND	AA	1
4	I LOOP ENABLE SOURCE			
5	(+) I LOOP OUT			
6	OUTPUT CURRENT SOURCE	DATA TERMINAL READY	I	CD 20
7		RECEIVED DATA	O	BB 3
8	(-) READER RUN			
9	(+) READER RUN	CLEAR TO SEND	O	CB 5
10	(-) I LOOP IN			
11	SIGNAL GROUND	SIGNAL GROUND		AB 7
12		DATA SET READY	O	CC 6
13	(+) I LOOP IN			
14	INPUT CURRENT SOURCE	TRANSMITTED DATA	I	BA 2
15		DATA CARRIER DETECT	O	CF 8

EIA -

POSITIVE VOLTAGE EQUALS BINARY ZERO, SPACE, ON
 NEGATIVE VOLTAGE EQUALS BINARY ONE, MARK, OFF

800020
 TERAK CORPORATION
 8510 SINGLE SERIAL
 J3 CONNECTOR
 BRIAN J. BENZAR

+12v ——— 10 μ 1/4W ——— ④ I LOOP ENABLE SOURCE

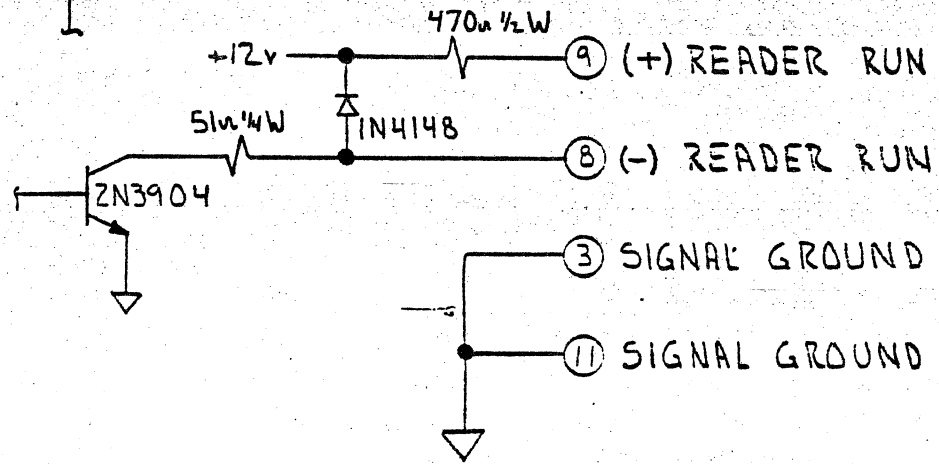
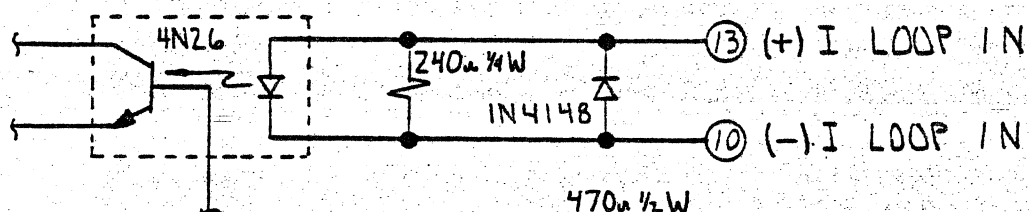
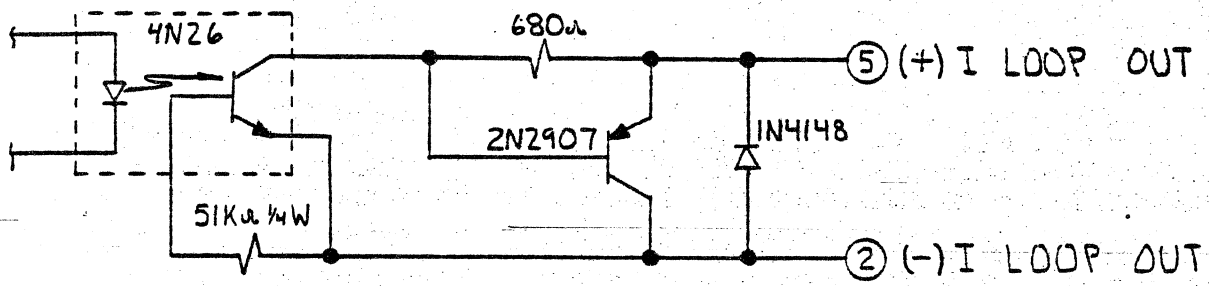
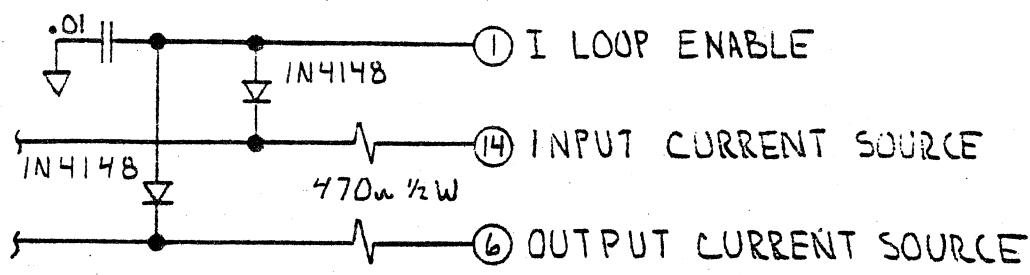

800020
TERAK CORPORATION
8510 SINGLE SERIAL
CURRENT LOOP INTERFACE
BRIAN J. BENZAR

I LOOP ENABLE SOURCE

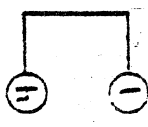

I LOOP ENABLE

OUTPUT CURRENT SOURCE

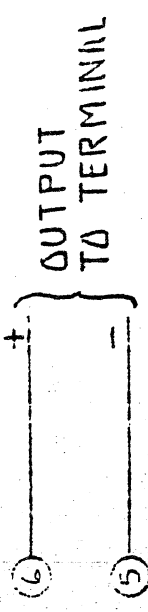

(+) I LOOP OUT

(-) I LOOP OUT

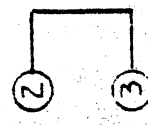

SIGNAL GROUND

INPUT CURRENT SOURCE

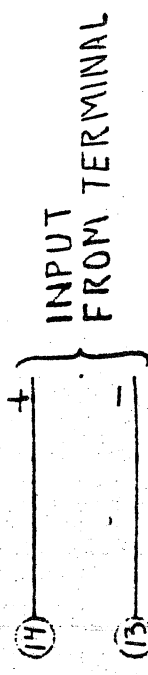

(+) I LOOP IN

(-) I LOOP IN

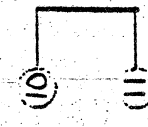

SIGNAL GROUND

(+) READER RUN

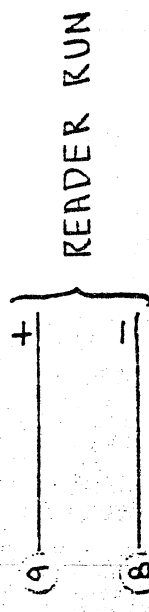

(-) READER RUN

FULL DUPLEX CURRENT LOOP INTERFACE
ACTIVE CONFIGURATION
(8510 SUPPLIES CURRENT SOURCE)

800020
TERAK CORPORATION
8510 SINGLE SERIAL
ACTIVE CURRENT LOOP CONF
BRIAN J. BENZAR

I LOOP ENABLE SOURCE

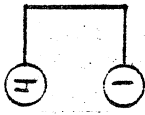

I LOOP ENABLE

(+) I LOOP OUT

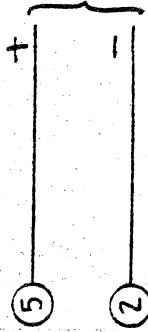

(-) I LOOP OUT

(+) I LOOP IN

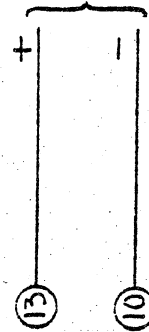

(-) I LOOP IN

(+) READER RUN

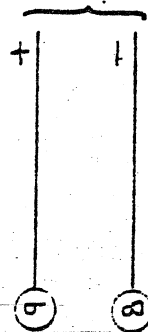

(-) READER RUN

FULL DUPLEX CURRENT LOOP INTERFACE
 PASSIVE CONFIGURATION
 (TERMINAL SUPPLIES CURRENT SOURCE)

800020
 TERAK CORPORATION
 8510 SINGLE SERIAL
 PASSIVE CURRENT LOOP CONF
 BRIAN J. BENZAR
 5-18-76 4-25-78

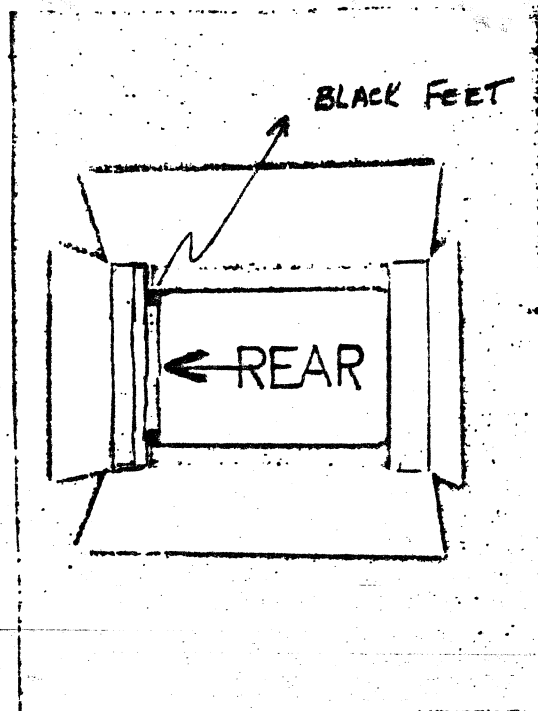

NOTICE

FIRST, REMOVE THE END CUSHION PANEL CLOSEST TO THE REAR OF THE UNIT (SEE FIGURE 1) BY GRASPING WOOD PORTION AND BY PULLING STRAIGHT UP.

REMOVE SYSTEM BY SLIDING THE UNIT TO THE REAR AND LIFTING STRAIGHT UP HOLDING BOTTOM OF CHASSIS AT THE FRONT AND REAR.

INSURE THAT SYSTEM TERMINATOR (BECKMAN #699-1-R150 RESISTOR NETWORK IS INSTALLED IN 8510 CHASSIS. TERMINATORS ARE INSTALLED ON 8510'S AT THE FACTORY, LOCATED AT THE LEFT SIDE OF DAISY CHAIN CABLE CONNECTOR. DEVICE MUST BE INSTALLED WITH BLACK DOT (PIN ONE) AT THE BOTTOM. PIN NUMBER SIX HAS BEEN REMOVED AT THE FACTORY.

NOTE

SWITCH SETTINGS ON THE VIDEO EXTERNAL INTERFACE BOARD (EIB) AND SERIAL EXTERNAL INTERFACE BOARD ARE PRESET PRIOR TO SHIPMENT. THESE SETTINGS SHOULD BE VERIFIED DURING SYSTEM INSTALLATION TO ASSURE PROPER SYSTEM RESPONSE.

VIDEO EIB: Switch #1 is not used at present and is set in the OFF position.

Switch #2 should be set to the OFF position for SYSTEM CONSOLE use with the 8532 Display/Keyboard (177560)

SERIAL EIB: Switch Positions are preset as follows for Unit #1

Switch #:	1	ON	}	UNIT 1
	2	OFF		
	3	ON		
	4	OFF	}	NOT IN USE
	5	ON		
	6	ON		
	7	ON	}	8 bits (Data)
	8	ON		
	9	OFF		
	10	OFF	}	NO PARITY
	11	OFF		
	12	OFF		
	13	ON	}	NO TTY FILTER
	14	OFF		
	15	ON		
	16	ON	}	EVEN PARITY
	16	ON		

1	2	3	4	5	6	7	8	1	2	3	4	5	6	7	8
OFF	ON	OFF	ON	OFF	ON	OFF	ON	OFF	ON	OFF	ON	OFF	ON	OFF	ON