Title**System 80 Models 3-6 and 8-20 OS/3 Installation Guide**

This Library Memo announces the release and availability of Update A to the *System 80 Models 3-6 and 8-20 OS/3 Installation Guide*.

This guide contains the information and procedures necessary to install, generate, and maintain OS/3 software on System 80 models 3 through 6 and 8 through 20.

This update includes the following additions, changes, and corrections:

- The media type format table in 1.5.3. has been corrected to indicate that:
 - OS/3 software delivered on tape is not available in 8418 format.
 - OS/3 software delivered on diskettes and tape is available in M9720 format with your initial processor order.
- A note has been added to "Supplied Starter Supervisors" paragraph in Section 1 explaining dynamic reconfiguration by the IPL process when booting starting supervisors SY#BAS and SY\$BAS.
- A caution concerning the running of SG\$COMMK when ICAM is active in your system has been added to 3.2.3.
- The definition provided for parameter P of the SETREL run command has been corrected.
- The list of SYSRES files initialized at IPL time and not copied by the COPYREL run command has been corrected.
- In Table 4-1, the SAX (system activity monitor) symbiont name has been removed from the list of names supported by the SYMBIONT parameter; the relationship of the ISLOGONSC and the ISADMID parameters has been clarified; and the definition of the CONALARM parameter has been corrected.

You can order the update only or the complete manual with all updates. To receive only the update, order UP-8839 Rev. 8-A. To receive the complete manual, order UP-8839 Rev. 8.

This document can be ordered through your branch representative or from Unisys Corporation, Corporate Software and Publication Operations, 13250 Haggerty Road North, Plymouth, Michigan 48170.

Announcement only:
MB00, SAB, and SAE

Announcement and attachments:
MB01, MB09, and
MBW

System: System 80
Release: 13
Date: June 1990
Part Number: UP-8839 Rev. 8-A



PUBLICATIONS REVISION	
System 80	
Models 3-6 and 8-20 OS/3 Installation Guide	
UP-8839 Rev. 8	

This Library Memo announces the release and availability of the *System 80 Models 3-6 and 8-20 OS/3 Installation Guide*, UP-8839 Rev. 8.

This guide is a standard library item (SLI). It is part of the standard library provided automatically with the purchase of the product.

This guide contains the information and procedures necessary to install, generate, and maintain OS/3 software on System 80 models 3 through 6 and 8 through 20.

This revision includes the following new or modified features for Release 13.0:

- New SUPGEN keywords: IGNJCERR, SCRATCHDVC, TAPEAVR, and SPOOLTPBUFR
- New parameter for the SG\$PARAM utility: SCHASM=Y (allows automatic scheduling of SG\$SUPMK and SG\$COMMK)
- I/OGEN parameter additions to support the M9720 disk on models 10 through 20
- New COBGEN keywords: COMP, SIGNFX, and TIPCOD
- Description or value changes to keyword parameters: ALTJCS, CONALARM, and TRNWKAREA
- Expansion of the SUPGEN SYMBIONT parameter description to include the names of the symbionts that can be specified
- Additional information for running RV SG\$SUPMK
- Support of ANSI '85 COBOL
- New appendix providing performance tuning guidelines

All other changes are expanded descriptions, clarifications, or corrections applicable to the software prior to Release 13.0.

LIBRARY MEMO ONLY	LIBRARY MEMO AND ATTACHMENTS	THIS SHEET IS
Mailing Lists MB00, SAB, and SAE	Mailing Lists MB01, MB09, and MBW (288 pages plus Memo)	Library Memo for UP-8839 Rev. 8
		RELEASE DATE: January 1990



UNISYS

System 80
Models 3-6 and 8-20
OS/3

**Installation
Guide**

January 1990

Priced Item

Printed in U S America
UP-8839 Rev. 8





UNISYS

System 80
Models 3-6 and 8-20
OS/3

**Installation
Guide**

Copyright © 1990 Unisys Corporation
All rights reserved.
Unisys is a registered trademark of Unisys Corporation.

OS/3 Release 13

June 1990

Priced Item

Printed in U S America
UP-8839 Rev. 8 - Update A

NO WARRANTIES OF ANY NATURE ARE EXTENDED BY THIS DOCUMENT. Any product and related material disclosed herein are only furnished pursuant and subject to the terms and conditions of a duly executed Program Product License or Agreement to purchase or lease equipment. The only warranties made by Unisys, if any, with respect to the products described in this document are set forth in such License or Agreement. Unisys cannot accept financial or other responsibility that may be the result of your use of the information in this document or software material, including direct, indirect, special, or consequential damages.

You should be very careful to ensure that the use of this information and/or software material complies with the laws, rules, and regulations of the jurisdictions with respect to which it is used.

The information contained herein is subject to change without notice. Revisions may be issued to advise of such changes and/or additions.

Correspondence regarding this publication should be forwarded to Unisys Corporation either by using the Business Reply Mail form at the back of this manual or by addressing remarks directly to Unisys Corporation, OS/3 Systems Product Information Development, P.O. Box 500, Mail Station E5-114, Blue Bell, Pennsylvania, 19424, U.S.A.

PAGE STATUS SUMMARY
ISSUE: Update A - UP-8839 Rev. 8

Part/Section	Page Number	Update Level	Part/Section	Page Number	Update Level	Part/Section	Page Number	Update Level
Cover		Orig.	Index	Tab Breaker 1 thru 10	Orig. Orig.			
Title Page/Disclaimer		A	User Comments Form					
PSS	iii	A	Back Cover		Orig.			
About This Guide	Tab Breaker v thru xi	Orig. Orig.						
Contents	xiii thru xix	Orig.						
Section 1	Tab Breaker 1 thru 3 4 5 thru 14	Orig. Orig. A Orig.						
Section 2	Tab Breaker 1 thru 57	Orig. Orig.						
Section 3	Tab Breaker 1 thru 5 6 7 thru 29 30 31 thru 41 42 43 44 45 thru 53	Orig. Orig. A Orig. A Orig. A Orig. A Orig.						
Section 4	Tab Breaker 1 thru 10 11 12 13 14 thru 22 23 24 thru 85	Orig. Orig. A Orig. A Orig. A Orig.						
Section 5	Tab Breaker 1 thru 29	Orig. Orig.						
Appendix	Tab Breaker 1 thru 4	Orig. Orig.						



About This Guide

Purpose

This guide specifically describes the system installation procedures for the Unisys System 80, Models 3-6 and 8-20. It does not, however, describe in detail all the aspects of OS/3 that you need to know before you install your system.

Audience

The intended audience of this guide is the site administrator who is to install the current release of OS/3 software.

Prerequisites

Before beginning the installation task, read the documentation that accompanies your software release to familiarize yourself with the most current information pertaining to installation, restrictions, and guidelines. You should also familiarize yourself with the other documents referred to in this guide. They are listed under the heading "Related Product Information" in this section.

To verify that you performed the installation procedures correctly, see the *Installation Verification Procedures (IVP) Operating Guide*, UP-10003.

How to Use This Manual

This installation guide tells you how to install and generate OS/3 software on the System 80 models 3 through 6 and 8 through 20. You should follow the procedures that configure a system that matches the system configuration at your site. This document also has a number of reference sections that provide detailed information required to complete specific system installation steps.

Organization

This manual presents system installation information as follows:

Section 1. Introduction

Defines system installation and discusses all the installation facilities that Unisys provides to simplify the process.

Section 2. Software Installation

Describes software installation considerations and gives specific procedures for installing the software that Unisys delivers to you.

Section 3. System Generation

Describes system generation considerations and gives specific procedures for tailoring the operating system to meet your particular needs.

Section 4. Using an Alternative Method to the SYSGEN Dialog

Provides information on how to prepare system generation parameters using alternate methods. These include statement conventions, keyword parameters, and reference tables.

Section 5. System Maintenance

Describes system maintenance considerations and gives specific procedures on how to install system maintenance packages.

Appendix. Performance Tuning

Describes how to increase the operating efficiency of your operating system by selecting optimal parameter values when installing/tailoring your system software.

Results

After reading this guide and following the procedures in it, the site administrator will have successfully installed the current release of OS/3 system control software.

Notation Conventions

The conventions used to define the configuration parameter values in this guide are:

- Parameter definition is by keyword association. Keyword parameters consist of a word or a code immediately followed by an equal sign, which is followed by a specification. Keyword parameters can be written in any order except where restrictions are noted. Keyword parameters can be written in columns 1 through 71. More than one keyword parameter can be included on the same statement, but they must be separated by at least one blank character. Keywords and their specifications must be contained on the same statement.

Examples:

```
PRIORITY=5
PRIORITY=5   JOBSLOTS=3   TRANS=3
PRIORITY=5   TRANS=3     JOBSLOTS=3
```

Special rules for coding ICAM network definition keywords and macro instructions are described in 4.1.

- Capital letters, commas, equal signs, and parentheses must be coded exactly as shown. The exceptions are acronyms, which are part of the generic terms representing information to be supplied by the programmer.

Examples:

```
SUPMOD=supvrnam
COMM=4
CACH=(nn,network-name,line-number)
```

- Lowercase letters and words are generic terms representing information that must be supplied by the user. Such lowercase terms can contain hyphens and acronyms (for readability).

Examples:

```
channel
supervisor-name
vsn
```

- Information contained within braces represents alternate choices. Code only one of the choices.

Example:

```
{
MAX
MIN
NO
NORM
}
```

- Information contained within brackets represents optional entries that (depending upon program requirements) are included or omitted. Braces within brackets signify that one of the specified entries must be chosen if that parameter is to be included.

Examples:

```
[SUPMOD=supvrnam]
```

```
[ SUPVRNAM= {supervisor-name}
              {SY$STD} ]
```

- An optional parameter that has a list of alternate entries can have a default specification that is supplied by the operating system when the parameter is not specified by the user. The default can be specified by the user, but it is considered inefficient. Default specifications shown in the format are printed on a shaded background.

Example:

```
[ SUPVRNAM= {supervisor-name}
              {SY$STD} ]
```

- Keyword parameters can contain sublists called subparameters. Subparameters can be positional or nonpositional, as indicated in the text. Subparameters must be separated by commas.
 - Positional subparameters must be coded in the order shown, and commas must be retained for any that are omitted, with the exception of trailing commas.

Example:

```
SPOOLMODE=ACCT NO, account number value
```

- Nonpositional subparameters can be coded in any order, on a single statement, separated by commas. If all subparameters do not fit on one parameter statement, that statement can exceed one line, provided you repeat the keyword parameter and its equal sign for each additional line that you need. Remember that this rule does not apply to parameters that fit on one line; in those instances, every keyword parameter and its specifications must be on one line.

Examples:

```
RESMOD=SM$ASCKE, SM$ATCH, SM$DBS, SM$GTPUT, SM$LOCK, SM$STXIT, SM$TASK
```

All of the parameters in this example will not fit on one statement; therefore, you must code the keyword parameter as follows:

```
RESMOD=SM$ASCKE,SM$ATCH,SM$DBS,SM$GTPUT,SM$LOCK,SM$STXIT
RESMOD=SM$TASK
```

- The label entry must begin in column 1.

Example:

```
1          10      16                                72
-----
SUPGEN
END
```

- Use the *Assembler Coding Form*, UD1-1548, to code the SYSGEN keyword parameters. The LABEL, OPERATION, and OPERAND field limits are shown.
- Keyword parameters must not appear on the following label parameter cards:

```
SUPGEN
I/OGEN
COMMCT
NTRGEN
COBGEN
END
```

Related Product Information

The following Unisys documents may be helpful in understanding and implementing the information presented in this guide.

Note: *Throughout this guide, when we refer you to another document, use the version that applies to the software level in use at your site.*

***System Messages Reference Manual*, UP-8076**

Describes system messages, message response, and remedial actions, when applicable.

***Job Control Programming Guide*, UP-9986**

Describes the OS/3 job control language used to manage system resources, prepare programs for execution, and start program execution.

***Consolidated Data Management Programming Guide*, UP-9978**

Describes the organization, type, and format of the data files under OS/3, and the manner in which data management handles the movement of data between programs and peripherals.

Operations Guide, UP-8859

Provides the information needed to operate various models of System 80 within the OS/3 environment.

Integrated Communications Access Method (ICAM) Operations Guide, UP-9745

Describes the communications physical interface of ICAM and explains how to write a user program at the physical level. For users of OS/3 prior to Release 8.2.

Integrated Communications Access Method (ICAM) Utilities Programming Guide, UP-9748

Supersedes UP-9745 for System 80 users of OS/3 Release 8.2 forward

1974 American Standard COBOL Programming Reference Manual, UP-8613

Describes 1974 ANS COBOL for the applications programmer.

1985 American Standard COBOL Programming Reference Manual, 7002 3940

Describes 1985 ANS COBOL for the applications programmer.

System Activity Monitor Programming Guide, UP-9983

Describes the use of the system activity monitor for evaluating system performance.

Spooling and Job Accounting Operating Guide, UP-9975

Describes spooling concepts and functions.

System Service Programs (SSP) Operating Guide, UP-8841

Describes the use of system service utility programs that support the operation of the OS/3 operating system.

Data Utilities Operating Guide, UP-8834

Describes how to use the data utilities for reproducing and maintaining data files on various media.

Installation Verification Procedures (IVP) Operating Guide, UP-10003

Describes the procedures and information needed to install, tailor, and maintain OS/3 software in a System 80 environment.

Information Management System (IMS) System Support Functions Programming Guide, UP-11907

Describes how to configure and generate IMS.

NTR Utility Programming Guide, UP-9502

Describes the NTR utility which permits a System 80 system to operate as a remote job entry/batch terminal to a Series 1100 system via ICAM.

Interactive Services Operating Guide, UP-9972

Describes the procedures for communicating with the operating system interactively through local workstations or remote terminals.

General Editor (EDT) Operating Guide, UP-9976

Describes the commands and procedures needed to use the general editor.

Supervisor Technical Overview, UP-8831

Provides an overview of the OS/3 supervisor and its functions.

System 80 Models 8/10/15/20 Processor Complex Controllers Programming Reference Manual Volume 1: Controllers of the Selector Channel and Byte Multiplexer, UP-9607

Provides hardware design, operations, and programming information to assist in programming peripheral subsystems integrated with System 80 models 8, 10, 15, and 20.

System 80 Models 8/10/15/20 Processor Complex Controllers Programming Reference Manual Volume 2: Controllers and Communications Channels of the I/O Processor, UP-9732

Provides hardware design, operations, and programming information to assist in programming peripheral devices and communications attachments integrated with System 80 models 8, 10, 15, and 20.

System 80 Models 8/10/15/20 Processor and Central Peripherals Operating Guide, UP-9608

Provides operating information for models 8, 10, 15, and 20 processor and peripheral equipment required for minimum system configurations.

System 80 Models 8/10/15/20 Processor Programming Reference Manual, UP-9692

Describes the operating characteristics of the models 8, 10, 15, and 20. Also provides the commands, formats, and other data needed to operate the system.



Contents

About This Guide

Section 1. Introduction

1.1. What Is System Installation?	1-1
1.2. What Does Software Installation Involve?	1-2
1.3. What Does System Generation Involve?	1-2
1.4. What Does System Maintenance Involve?	1-3
1.5. Delivery of OS/3 Software	1-3
1.5.1. Software Delivered on Diskettes	1-4
1.5.2. Software Delivered on Disk	1-5
1.5.3. Software Delivered on Dump/Restore Tape	1-5
1.6. How to Install OS/3 Software	1-6
1.6.1. Stand-Alone Installation Facilities	1-6
1.6.2. Optional Software Installation Facilities	1-7
1.6.3. Disk Software Installation Facilities	1-7
1.6.4. Tape Software Installation Facilities Using an Existing SYSRES	1-7
1.6.5. System Maintenance Installation Facilities	1-8
1.6.6. SYSRES Build Guidelines	1-8
1.7. How to Perform System Generation	1-9
1.7.1. SYSGEN Dialog	1-9
1.7.2. SYSGEN Parameter Processor	1-11
1.7.3. SYSGEN Job Control Streams	1-12
1.8. System Installation Review	1-13

Section 2. Software Installation

2.1. Considerations	2-1
2.1.1. Initial Users	2-1
2.1.2. Existing Users	2-3
Installing New Optional OS/3 Software	2-3
Installing a New Release of OS/3	2-4

- 2.2. Procedures 2-7
 - 2.2.1. Installation Procedures for Models 3 thru 6 2-7
 - Installing Standard Release Software from Diskettes 2-7
 - Installing Optional Release Software from Diskette 2-14
 - Installing Standard and Optional Release Software from
an 8419 Disk 2-16
 - Installing Release Software from Dump/Restore Tape 2-22
 - 2.2.2. Installation Procedures for Models 8 thru 20 2-25
 - Installing Standard Release Software from Diskettes or
Tapes Using the Stand-Alone Routines 2-25
 - Installing Optional Release Software from Diskette 2-32
 - Installing Standard and Optional Release Software
from Disk 2-33
 - Installing Release Software from Tape Using the
Dump/Restore Routine 2-33
- 2.3. Post-Software Installation Procedures 2-36
 - 2.3.1. Updating the System Definition File (SDF) 2-36
 - Determining What to Update by Reviewing
\$Y\$MIC and \$Y\$\$SDF 2-40
 - Adding a Device to \$Y\$\$SDF 2-43
 - Deleting a Device from \$Y\$\$SDF 2-45
 - Updating Existing Device Information in \$Y\$\$SDF 2-46
 - Confirming \$Y\$\$SDF 2-48
 - Dumping \$Y\$\$SDF 2-48
 - Restoring \$Y\$\$SDF 2-49
 - Terminating SDU 2-49
 - Performing IMPL and IPL Procedures 2-50
 - 2.3.2. Copying and Restoring \$Y\$\$SDF 2-54
 - 2.3.3. Creating an IMPL System Microcode Diskette 2-55
 - 2.3.4. Creating an IDCU Microcode Diskette on Models 8 thru 20 2-57
 - 2.3.5. Restoring Modules Saved from a Previous Release 2-57
 - 2.3.6. Verifying System Installation 2-57
 - 2.3.7. Performing System Generation 2-57

Section 3. System Generation

- 3.1. Considerations 3-1
 - 3.1.1. Supervisor Elements 3-2
 - Supplied Starter Supervisors 3-6
 - User Generated Supervisors 3-6
 - 3.1.2. Nine-Thousand-Remote (NTR) Element 3-10
 - 3.1.3. COBOL Element 3-11
 - 3.1.4. Communications (ICAM) Elements 3-11
 - 3.1.5. Resource Management 3-12
 - Resource Management Batch System Configuration 3-13
 - Resource Management Interactive System Configuration 3-14
 - Resource Management Mixed System Configuration 3-15

3.2. Procedures	3-16
3.2.1. Using SYSGEN Dialog to Prepare Parameter Sets	3-16
3.2.2. Processing the SYSGEN Parameter Sets	3-21
Automatic Execution of the Parameter Processor	3-22
Manual Execution of the Parameter Processor	3-28
3.2.3. Running the SYSGEN Job Control Streams	3-30
Supervisor SYSGEN Job Control Stream	3-30
ICAM Job Control Stream	3-30
NTR Job Control Stream	3-31
COBOL Job Control Stream	3-32
3.3. Post-SYSGEN Procedures	3-32
3.3.1. Updating the System Definition File	3-32
3.3.2. Generating an IMS Online Load Module	3-32
3.3.3. Defining Alternate Printer Characteristics	3-33
3.3.4. Changing the System Bulletin	3-37
3.3.5. Verifying System Installation	3-39
3.3.6. Making and Restoring a Backup Copy of Your Current SYSRES	3-39
Using a Removable Disk for Your Backup SYSRES	3-40
Using Diskettes for Your Backup SYSRES	3-45
Using Tape for Your Backup SYSRES	3-49
Restoring SYSRES from Tape Using SU@RST	3-50
Using a Fixed Disk for Your Backup SYSRES	3-51
Updating the ICAM Symbiont Table	3-52

Section 4. Using an Alternate Method to the SYSGEN Dialog

4.1. Creating Parameter Sets	4-1
4.1.1. SUPGEN	4-2
4.1.2. I/OGEN	4-2
4.1.3. COMMCT	4-3
4.1.4. NTRGEN	4-5
4.1.5. COBGEN	4-5
4.2. SYSGEN Keyword Parameters	4-5
4.3. Additional SYSGEN Parameter Information	4-76
4.3.1. Spool-File Bit Map Calculation Table	4-76
4.3.2. Shared Load Module Groups	4-77
4.3.3. Logical Unit Numbers (I/OGEN DVCNO Parameter for All Devices)	4-78
4.3.4. Nine-Track Recording Mode Settings (I/OGEN MODE Parameter)	4-80
4.3.5. Seven-Track Recording Mode Settings (I/OGEN MODE Parameter)	4-80
4.3.6. Line Speed Values	4-82
4.3.7. Space Compression Characters	4-83
4.3.8. Device Function Codes	4-84
4.3.9. I/O Guidelines - Co-Channel Support	4-84

Section 5. System Maintenance

5.1. System Maintenance Packages	5-1
5.2. Installation of SMPs	5-2
5.2.1 Installing an SMP	5-7
5.2.2. Performing Additional Regenerations	5-10
5.2.3. Erasing SMP Files	5-11
5.3. Installation of Individual SMCs	5-12
5.4. Running the SMC Installation Program	5-12
5.4.1. Building Your SMC from the Console	5-16
5.4.2. Building Your SMC from A Workstation	5-18
5.4.3. Installing the SMC	5-23
5.5. Sample SMC Printouts	5-27

Appendix. Performance Tuning

A.1. SUPGEN Priority Values	A-1
A.2. SUPGEN Memory Management Values	A-2
A.3. SUPGEN Data Management Values	A-2
A.4. SUPGEN Spooling Values	A-2
A.5. SUPGEN Resident Shared Load Module Values	A-2
A.6. SUPGEN Resident Module Values	A-3
A.7. I/OGEN Considerations	A-3
A.8. Determining Disk Cache Size	A-4

Index

User Comments Form

Figures

1-1.	System Installation Review	1-14
2-1.	Software Installation from Disk for an Initial User	2-2
2-2.	Software Installation from Diskettes for an Initial User	2-2
2-3.	Software Installation from Tapes for an Initial User	2-3
2-4.	Installation of New Optional OS/3 Software	2-4
2-5.	Installation of a New OS/3 Release	2-6
2-6.	System Operations Menu	2-29
2-7.	System Date/Time Display	2-30
2-8.	Updating \$Y\$SDF	2-39
2-9.	SDU Operation Request Screen	2-41
2-10.	SDU Display Operation Screen	2-41
2-11.	Sample \$Y\$SDF Printer Output	2-42
2-12.	SDU Add Screen for Non-IMPL Devices on Models 8 thru 20	2-43
2-13.	SDU Add Screen for Non-IMPL Devices on Models 3 thru 6	2-44
2-14.	SDU Add Screen for IMPL Devices on all Models	2-44
2-15.	SDU Delete Operation Menu	2-46
2-16.	SDU Update Operation Menu	2-47
2-17.	SDU Dump Operation Menu	2-48
2-18.	SDU Restore Operation Menu	2-49
2-19.	SDU Termination Screen for Models 3 thru 6	2-49
2-20.	SDU Termination Screen for Models 8 thru 20	2-50
2-21.	System Operations Menu	2-53
2-22.	System Date/Time Display	2-54
5-1.	Processing Options Menu Screen	5-6
5-2.	Supervisor Regeneration Screen	5-7
5-3.	ICAM Regeneration Screen	5-9
5-4.	Installation of Individual SMCs	5-12
5-5.	SMC Instruction Screen	5-19
5-6.	First SMC Entry Screen	5-19
5-7.	Second SMC Entry Screen	5-20
5-8.	Editing Commands HELP Screen	5-21
5-9.	SMC Special Processing Screen	5-25
5-10.	Sample SMC - Required Fields for SMC Console Dialog	5-28
5-11.	Sample SMC - Required Fields for Interactive SMC Entry from Workstation	5-29



Tables

2-1.	Permissible SYSRES Disk Devices	2-7
2-2.	COPYREL Copy Order	2-21
3-1.	Control Element Generations for Optional Software	3-3
3-2.	SY@BAS (Models 3 thru 6)	3-7
3-3.	SY#BAS (Model 8)	3-8
3-4.	SY\$BAS (Models 10 thru 20)	3-9
3-5.	Resource Management Elements for a Batch-Oriented System	3-13
3-6.	Resource Management Elements for an Interactive System	3-14
3-7.	COPYREL Copy Order	3-44
4-1.	SUPGEN Keyword Parameters	4-6
4-2.	I/OGEN Keyword Parameters (Models 3 through 6)	4-37
4-3.	I/OGEN Keyword Parameters (Models 8 through 20)	4-47
4-4.	COMMCT Keyword Parameters	4-62
4-5.	NTRGEN Keyword Parameters	4-68
4-6.	COBGEN Keyword Parameters	4-72
4-7.	Spool-File Bit Map Calculations	4-77
4-8.	Shared Load Module Groups	4-77
4-9.	Logical Unit Numbers	4-78
4-10.	Nine-Track Recording Mode Settings	4-80
4-11.	Seven-Track Recording Mode Settings	4-81
4-12.	Line Speed Values	4-82
4-13.	Space Compression Characters	4-83
4-14.	Device Function Codes	4-85



Section 1

Introduction

1.1. What Is System Installation?

System installation is the process of installing the Unisys System 80 hardware, integrating the Operating System/3 (OS/3) software into it, and tailoring this software to fit your specific needs. The process of tailoring operating system software is called system generation.

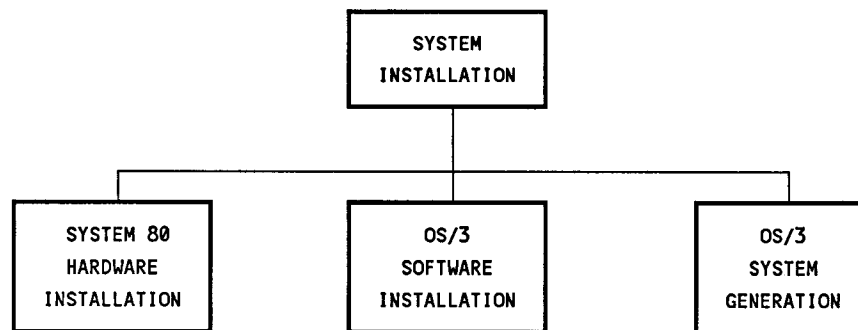

This guide discusses the system installation tasks that concern you after the hardware is installed - those of installing and generating the OS/3 software. This includes both the standard OS/3 software that all users need to operate their system and the separately priced program products and programming aids (optional software) you order to complement the standard OS/3 system software. It also describes the installation of system maintenance packages (SMPs), which contain OS/3 software changes that maintain the software's effectiveness.

1.2. What Does Software Installation Involve?

Software installation involves the transfer of all OS/3 software from the delivered release media to the disk pack that serves as the system resident volume, or SYSRES. The SYSRES contains all the OS/3 system software, and it must be online whenever you operate the OS/3 system.

Use software installation to install:

- Initial releases of OS/3 software
- Any new software that you receive between major releases
- Updated software as Unisys releases major improvements to OS/3

Install all delivered release software before you generate the system. Once the software is installed on the SYSRES, you are ready for system generation.

1.3. What Does System Generation Involve?

System generation, or SYSGEN, is the process whereby you define the system's hardware configuration to OS/3 and generate, or create, the control elements that you need to satisfy your particular processing requirements. Using SYSGEN facilities, you can configure:

- Customized supervisors and their associated input/output (I/O) device configurations
- Nine-thousand-remote (NTR) system utilities
- Processing options for the ANSI '74 or '85 COBOL compiler
- Communications networks (ICAM)

You don't need to perform system generation to begin normal system operations immediately. The OS/3 system contains its own ready-to-use starter supervisor, called SY@BAS for models 3 thru 6, SY#BAS for model 8, and SY\$BAS for models 10 thru 20. This starter supervisor lets you load the operating system and generate a customized supervisor and its associated I/O device configuration. See 3.1.1 for instances when system generation is required.

As you gain experience with the system and your site operations, you can add features to satisfy special processing requirements that the starter supervisor does not include, or you can delete features that you can do without. In either case, you can perform system generation to customize the system to meet your particular processing requirements.

1.4. What Does System Maintenance Involve?

System maintenance involves the installation of system maintenance packages (SMPs) to your SYSRES. SMPs contain a collection of software changes that maintain your system's operation and effectiveness. System maintenance changes (SMCs) are the individual changes within the package.

Installation routines are used to install SMPs. They are easy to run and protect the system's integrity during SMP application. For example, the routines automatically regenerate the supervisor if it must be regenerated to operate properly. The routines also copy all original modules affected by the SMP. If the SMP adversely affects system operation, you can restore the system to its original operating configuration.

1.5. Delivery of OS/3 Software

OS/3 software is available on disk, diskette, and tape. Software delivered on disk is loadable; you can directly load the operating system from this disk. Software delivered on diskette or tape must be copied to disk before it can be loaded.

Choose the media type that is compatible with your system configuration subject to the following guidelines on OS/3 software delivery:

- Initial users on models 8 thru 20 can receive standard software on tape or diskette for nonremovable disk types. Initial users on models 3 thru 6 can receive standard software on diskette only for nonremovable disks.
- Standard OS/3 releases and optional software ordered together on disk are shipped on disk.
- Optional software ordered between major releases is shipped on diskette only.
- System maintenance packages (SMPs) are always delivered on diskette accompanied by an SMP document.

OS/3 standard (and optional) software ordered on disk is delivered on 8419 disks for models 3 thru 6 and 8419, 8430, and 8433 disks for models 8 thru 20.

OS/3 standard software ordered on tape or diskette is delivered in dump/restore file or volume format, depending on the disk and system type. Dump/restore dumps or restores only to like device types, therefore it is necessary to order the tape or diskette media that corresponds to your disk configuration. File mode media can be used by stand-alone restore and dump/restore to install a new OS/3 release. File and volume mode installations will be discussed later in this section.

Media types and formats are summarized in the following table. Subsections 1.5.1 through 1.5.3 provide details on delivery of OS/3 software within each media type.

Media Type	Format	
	Models 3-6	Models 8-20
Data set label diskette	8417 File mode 8417 FH File mode	8417 File mode 8470 File mode 8494 File mode M9720 File mode (models 10/15/20)*
Disk	Unisys loads release software on 8419 disk	Unisys loads release software on 8430, 8433, or 8419 disks
Tape	8417 Volume mode 8417 FH File mode 8419 Volume mode	8430 Volume mode 8433 Volume mode 8419 Volume mode 8417 File mode 8470 File mode 8494 File mode M9720 File mode (models 10/15/20)*

* Available for initial processor order only.

1.5.1. Software Delivered on Diskettes

Unisys delivers two sets of release diskettes: one set contains standard OS/3 software and the other contains the optional OS/3 software that meets your specific processing needs.

The standard release diskettes contain four types of software:

1. Initial microprogram load (IMPL) code
2. Integrated disk channel (IDC) microcode and integrated disk control unit (IDCU) microcode (for models 4 and 6), or integrated disk control unit (IDCU) microcode (for models 8 thru 20)
3. Initial program load (IPL) code plus stand-alone products
4. System control software on sequential diskettes

Standard OS/3 Release Software

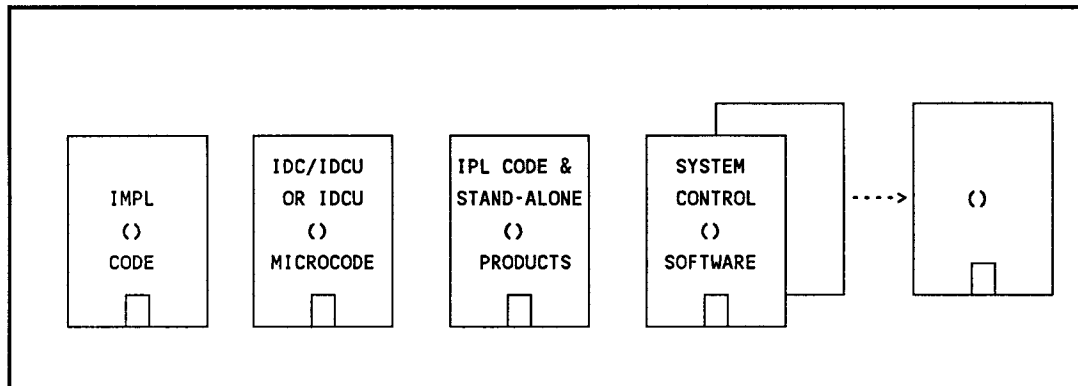

Unisys delivers optional software on separate release diskettes, one set for each component. These components can include program products such as language compilers or programming aids such as conversion products.

1.5.2. Software Delivered on Disk

For models 3 thru 6, order the standard OS/3 software and any optional software on an 8419 disk. You can use the 8419 disk as a SYSRES volume but you should transfer its contents onto an 8417 disk as your permanent SYSRES.

For models 8 thru 20, send an 8419, 8430, or 8433 disk to Unisys. Standard OS/3 software and any optional software you request is loaded on this disk and returned to you. This disk is then ready to use as your SYSRES volume.

See Section 2 for details on installing your software from disk.

1.5.3. Software Delivered on Dump/Restore Tape

OS/3 release software is also available on dump/restore tapes in a format compatible with your disks. Tape releases contain only the standard OS/3 software; optional software is delivered on separate release diskettes upon request.

- For models 3 thru 6, you must have an existing SYSRES disk to run the job control stream that transfers the release from tape to your new SYSRES. See Section 2 for details on installing your software from tape.
- For models 8 thru 20, no existing SYSRES disk is required if the tape is loaded to a nonremovable disk using stand-alone restore.

1.6. How to Install OS/3 Software

Unisys provides facilities that simplify OS/3 software installation. Each set of release media includes all the software needed to install the release software on your system. The following subsections describe these software facilities.

1.6.1. Stand-Alone Installation Facilities

To install an initial or updated OS/3 release from diskettes or tapes, Unisys includes two stand-alone installation routines as part of the standard OS/3 release: a stand-alone disk restore and a stand-alone disk prep. These routines transfer the system control software from the release diskettes or tapes to your SYSRES, which is on a nonremovable (fixed) disk. Perform this transfer before installing optional software or performing SYSGEN.

The stand-alone restore program, SU@RST, copies the system control software from the release diskettes or tapes to your SYSRES. The stand-alone prep routine, SU@PRP, prepares (or preps) your nonremovable disk to serve as your SYSRES.

- For models 3 thru 6, you can run SU@RST without first running SU@PRP (unless you get an SU@RST message telling you to run SU@PRP).
- For models 8 thru 20, you must run SU@PRP before you run SU@RST.

Stand-Alone Routines

Stand-Alone Media	SYSRES Disk	
	Models 3-6	Models 8-20
Diskette	8417	8417/8470/8494/M9720*
Tape	Stand-Alone not available	8417/8470/8494/M9720*

*M9720 not supported on model 8

These stand-alone routines also let you rebuild or restore your SYSRES when you need to. SU@RST only supports diskette media as input for models 3 thru 6. Section 3 discusses making and restoring a backup SYSRES copy.

1.6.2. Optional Software Installation Facilities

To install optional software components from diskettes, Unisys provides a job control stream, SG@CPYPD, as part of the system control software. It automatically initiates the routines that move separate program products and programming aids from release diskettes to the SYSRES. Run SG@CPYPD after you install your system control software. Then install each separate component before you perform SYSGEN.

1.6.3. Disk Software Installation Facilities

Unisys provides the prefiled system utilities SETREL and COPYREL on all release media. Use these utilities to copy OS/3 release software from one disk type to another disk type or to build a backup copy of the SYSRES. See Section 3 on building a backup SYSRES copy.

When you use a disk other than the one Unisys supplies as the SYSRES volume, use SETREL and COPYREL to copy the release software onto the other disk. Install the OS/3 release software as follows:

- Load your system from the Unisys supplied disk containing the release software.
- Run SETREL to prep and assign files to the disk that you use as your SYSRES.
- When SETREL terminates, run COPYREL to copy all the release software from the initial disk to the SYSRES volume.

If your system is a model 3 thru 6, load the system from the 8419 disk and run SETREL to prep and assign files to the 8417 disk. The 8417 disk will serve as your permanent SYSRES. When SETREL terminates, run COPYREL to copy all the release software from the 8419 disk to your 8417 SYSRES volume.

1.6.4. Tape Software Installation Facilities Using an Existing SYSRES

To install an OS/3 release using an existing SYSRES from a dump/restore tape (file or volume mode), use the job control stream, SG\$DMPTD. This control stream copies the standard release software from the dump/restore tape to an output disk that you specify at run time. The output disk must be the same disk type used to produce the tape.

For models 3 thru 6, SG\$DMPTD can transfer release software directly from an 8419 dump/restore tape onto a removable 8419 SYSRES volume.

For models 8 thru 20, this job control stream can transfer an 8433 dump/restore tape onto a removable 8433 SYSRES volume. However, if you order your release on a removable disk formatted tape (such as the 8419 disk) and you have a fixed 8417 disk as your SYSRES, you must first run SG\$DMPTD to transfer the software to an 8419 disk, and then run SETREL/COPYREL to copy the software to your permanent 8417 SYSRES volume.

1.6.5. System Maintenance Installation Facilities

To install system maintenance packages and system maintenance changes, Unisys provides two installation programs, SMP and SMC, as part of the system control software. The installation programs check the software components of your system, and then install the changes that apply to you. If your system requires regeneration as a result of an SMP or SMC, the installation programs perform the regeneration for you.

1.6.6. SYSRES Build Guidelines

The following guidelines will assist you in tailoring your SYSRES pack. They are especially useful when you are using the disks with the smaller capacities (8419 or 8430). These guidelines provide information on file maintenance and the allocation of specific files on disk packs other than the SYSRES.

- Librarian format files are expanded if there is module replacement or updating due to SMC applications, system generations, ICAM generations, or extraneous processing. The unused space in these files is recovered only by packing the file, or by copying it to another disk and copying it back after initializing the file. You can track the status of your file size and expansion by using the VTOC command at defined intervals. The amount of expansion depends on the number of generations or SMCs and is site specific.
- The MAPPER[®] data files do not have to reside on the SYSRES pack. They can be placed on a volume with the VSN of MAPPER.
- The \$Y\$DUMP file can now reside on a non-SYSRES pack. This can be specified with the DUMPVSN system generation parameter or on the date/time screen at IPL time. A system job stream, SG\$SADMP, that will scratch a full \$Y\$DUMP file and reallocate a minimum \$Y\$DUMP file on your SYSRES pack is also available. A minimum \$Y\$DUMP file will always reside on your SYSRES pack.
- The spool file can be allocated with the SPOOLVSN system generation parameter or on the time/date screen at IPL time.
- Run files can be allocated on a non-SYSRES pack with the RUNVSN system generation parameter or on the date/time screen at IPL time.
- You can move additional selected modules/products from system files on the SYSRES pack to files on a non-SYSRES pack. However, this should be done only with the assistance of your Customer Support Center.

MAPPER is a registered trademark and service mark of Unisys Corporation.

1.7. How to Perform System Generation

SYSGEN is the process that defines the system's hardware configuration to OS/3. SYSGEN generates the control elements you need to satisfy particular processing requirements. Unisys provides various facilities that define these requirements to your system. These are the SYSGEN dialog, parameter processor, and job control streams.

1.7.1. SYSGEN Dialog

The SYSGEN dialog is an easy-to-use facility that helps you prepare and process the SYSGEN parameters, or requirements. At your workstation, the SYSGEN dialog:

- Displays questions, menu choices, explanations, and help screens concerning the various SYSGEN options
- Accepts your answers and choices
- Stores your parameters until you are ready to process them
- Executes the SYSGEN component that processes your parameters (the SYSGEN parameter processor)

The workstation screen displays groups of options to choose from and provides explanations and questions. If you need more information about a particular parameter to make a valid choice, you can request help. The dialog provides detailed explanations of that parameter. After it displays a help screen, the dialog resumes where it left off.

An experienced SYSGEN user can build parameter sets quickly and easily, receiving help only when needed. Users less familiar with SYSGEN can use the help screens to learn about SYSGEN as the dialog guides them in building valid parameter sets. The following screens show typical examples of the SYSGEN dialog.

PROGRAM=IALOG FOR SYSTEM GENERATION

THE IIALOG FOR SYSTEM GENERATION IS A COMPUTER ASSISTED METHOD FOR PREPARING SYSGEN PARAMETER SETS. FOR A DESCRIPTION OF THE IIALOG PROCESS, ENTER ''HELP'' IN THE SPACE PROVIDED.

THE IIALOG METHOD USES THE COMPUTER TO ASSIST YOU IN PREPARING PARAMETER SETS BY PROVIDING EXPLANATIONS AND PROMPTING FOR DATA ENTRY. AS PARAMETERS ARE NEEDED, THE IIALOG PROCEEDS UNTIL A COMPLETE PARAMETER SET HAS BEEN GENERATED. ALL THE PARAMETERS ARE VERIFIED BY THE USER BEFORE THEY ARE OUTPUT FOR USE BY THE SYSGEN PARAMETER PROCESSOR. PARAMETERS ARE SPECIFIED EITHER BY SELECTING OPTIONS FROM A MENU OR BY ENTERING DATA DIRECTLY FROM A WORKSTATION.

Select the phases of SYSGEN you want to perform by entering the appropriate number. See Section 3 for detailed descriptions of these SYSGEN phases.

SELECT THE SYSGEN PHASE TO BE PREPARED:

1. SUPERVISOR GENERATION (SUPGEN and IOGEN)
 2. COBOL COMPILER OPTIONS SPECS (COBGEN)
 3. NTR UTILITY GENERATION (NTRGEN)
 4. NO FURTHER PHASE REQUIREMENTS
 5. DISPLAY PHASE DESCRIPTIONS
(ENTER PHASE NUMBER OR 'ALL') - - - - -
- ENTER CHOICE BY NUMBER

The SYSGEN dialog displays only those screens that pertain to the SYSGEN phases you select. These screens display the parameter choices for each selected section, explain your options in specifying parameters, and give the parameter default values. You can specify values for most parameters, or accept the OS/3 default values that create a workable system and are usually sufficient. At the end of each section of related SYSGEN parameters, the dialog lists the selections you chose. You can:

- Accept the list as it is
- Correct or change a selection
- Completely erase and ignore a parameter set that you mistakenly specified

The SYSGEN dialog lets you double-check choices and display only those parameters that apply to you. After you respond to the choice at the end of each parameter section, you move on to the next set of parameter statements.

You can also save a record of the dialog sessions in case you want to change your SYSGEN parameters. The dialog saves this record in a dialog audit file and provides a printed summary listing. You can use this summary listing as a map to the audit file.

After you respond to all the phases of SYSGEN, a system message displayed at the workstation informs you that the dialog session is complete. The SYSGEN dialog then asks you to execute the parameter processor. If you are satisfied with your parameter choices and are ready to process them, direct the SYSGEN dialog to execute the parameter processor.

1.7.2. SYSGEN Parameter Processor

The SYSGEN parameter processor is the SYSGEN component that accepts and processes your parameter choices. It informs the system of the choices made during the SYSGEN dialog session. The SYSGEN parameter processor, or SG\$PARAM:

- Checks and validates each of the SYSGEN parameters to ensure that you specified them correctly (these checks are in addition to those of the SYSGEN dialog)
- Substitutes the OS/3 default values for those parameters that you specify incorrectly or omit
- Informs you of incorrect and defaulted parameters
- Lists the OS/3 job streams that actually generate your system

The parameter processor gives you information on a printed summary listing. This listing includes all the SYSGEN parameters (specified and defaulted), error diagnostics, and instructions to proceed with SYSGEN.

1.7.3. SYSGEN Job Control Streams

Unisys provides job control streams to execute the SYSGEN dialog and parameter processor, and to generate the system for you. In addition, the job control stream lets you define alternate printer characteristics if your printer has different features than the OS/3 default printer characteristics. These job streams eliminate the need for you to know the OS/3 job control language before generating your system.

The parameter processor lists the job control streams that you must run to build the system elements you want. It bases this list on the parameter choices that you defined through the SYSGEN dialog session.

The following SYSGEN job control streams are available:

- **SG\$BLD** - Initiates the SYSGEN dialog, accepts parameter choices and selections, and stores these sets until the parameter processor needs them. When you are ready to process the parameter choices at the end of your dialog session, SG\$BLD automatically executes the parameter processor.
- **IC\$BLD** - Initiates the ICAM portion of the SYSGEN dialog, accepts parameter choices and selections, and stores these sets until the parameter processor needs them. When you are ready to process them at the end of the ICAM portion of the dialog session, IC\$BLD automatically executes the parameter processor.
- **SG\$PARAM** - Manually executes the parameter processor, verifies and processes your SYSGEN parameter definitions, and lists the additional job streams you should run, as well as parameter specifications, defaults, and error diagnostics.
- **SG\$SUPMK** - Initiates the routines that generate the new or remodeled supervisor configurations and stores them in the system load library file (\$Y\$LOD) on the designated SYSRES.
- **SG\$COMMK** - Initiates the routine that creates and transfers the integrated communications access method (ICAM) load module to the designated SYSRES.
- **SG\$NTRMK** - Creates a nine-thousand-remote (NTR) system utility load module and stores it in the \$Y\$LOD library on the designated SYSRES.
- **SG\$COBMK** - Configures options for the ANSI '74 or '85 COBOL compiler.
- **SG\$PRB** - Equates nonstandard printer character sets and vertical format characteristics to your operating system. If none of the printers in your system uses a 63-STD, 48-BUS, or 48-SCI print cartridge, you must run this job control stream before you can perform any software installation or system generation procedure that gives a printed listing.

1.8. System Installation Review

This review can help you better understand the relationships between the various system installation facilities and procedures. Use the flowchart in Figure 1-1, and the following list, to review the system installation process.

1. Install any new release software that you receive from Unisys. Use the routines and facilities you need to install system control software and optional software depending on the medium you use for installation (disk, diskette, or tape).
2. Perform post-software installation routines to complete the installation process. See 2.3.
3. Generate your system by specifying SYSGEN parameters. Use the SYSGEN dialog to define the elements of your system to fit your special processing needs.

Those thoroughly familiar with the SYSGEN process can expedite the process by using the OS/3 editor to manually code or modify these parameter sets. See Section 4.

4. Run the SYSGEN parameter processor to validate the selected parameters and list the SYSGEN job control streams you must run to generate the system you've defined. Make sure that each job terminates before initiating the next one.
5. Run each of the job control streams in the order that the parameter processor lists them. When all the job control streams are run, system generation is completed.

Before using your system you should perform the applicable post-system generation procedures to complete the system installation process. See details in 3.3.

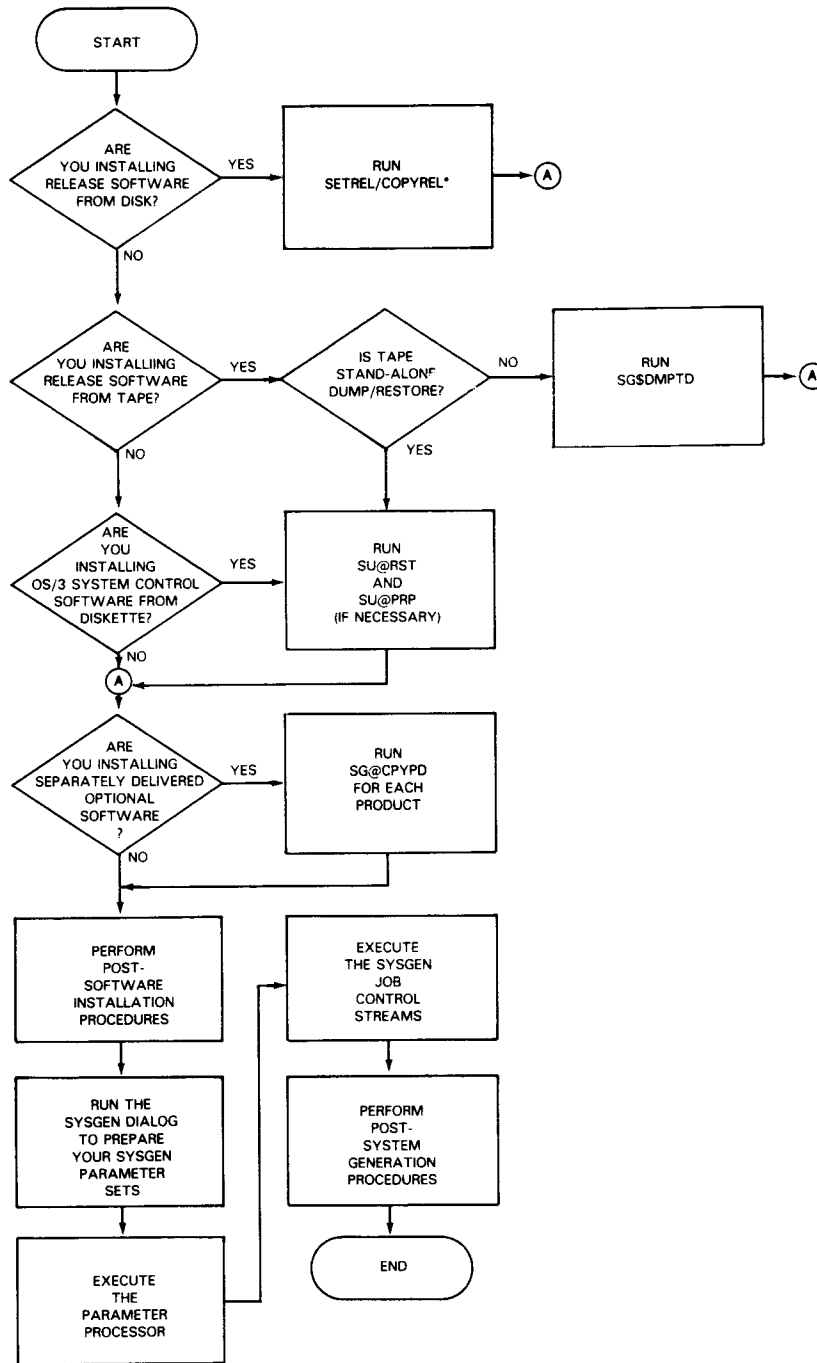

* Required for models 3 thru 6. Recommended for models 8 thru 20 to back up release software or copy it to another type of disk.

Figure 1-1. System Installation Review

Section 2

Software Installation

2.1. Considerations

This section describes the procedures you use to install standard and optional software from each type of release media to your SYSRES.

Basically, three factors determine which software installation procedures you must perform:

1. The type of user you are - initial or existing
2. The type of release software you have to install - standard or optional
3. The type of media you install your software from - diskette, disk, or tape

Regardless of the type of software you install, you should perform certain post-software installation procedures to complete the installation process. (See 2.3.)

Note: If your printer does not have the OS/3 default printer characteristics, you must define its characteristics to the system before you can perform any software installation procedure that gives a printed listing. (See 3.3.3 for a detailed description of the OS/3 default printer characteristics and the procedure for defining alternate printer characteristics.)

2.1.1. Initial Users

Initial users typically receive standard and optional OS/3 release software together and install both types.

If your system is a model 3 thru 6 and you order your release on an 8419 disk, the standard and optional software is delivered on the same disk volume. Unisys provides the SETREL/COPYREL routine that transfers the entire contents of the 8419 disk to your 8417 SYSRES volume. Install the standard and optional software together.

If your system is a model 8 thru 20 and you want your release software on a removable disk, send a disk pack to Unisys to load the standard and optional software onto the disk and return it to you. You can use the removable disk as the SYSRES volume, or you can transfer its contents onto a nonremovable disk and use this disk as the permanent SYSRES volume. This transfer process is accomplished through the SETREL/COPYREL routine.

Figure 2-1 shows disk installation of OS/3 software for all models using the SETREL/COPYREL routine.

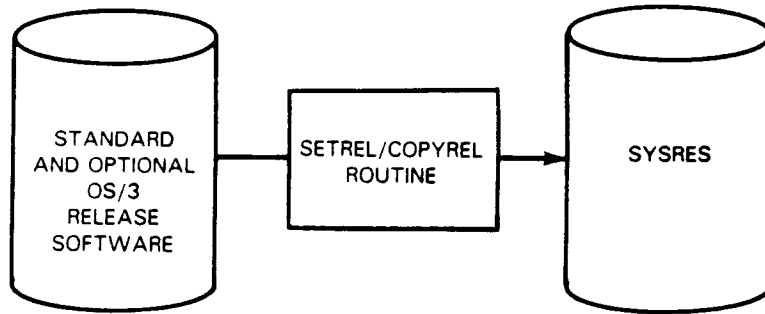

Figure 2-1. Software Installation from Disk for an Initial User

If you receive the release software on diskettes or tapes, install the standard software before the optional software. Software released on diskette or tape requires you to build the SYSRES volume rather than transfer it from one device to another. Figure 2-2 shows the process to install release software from diskettes. Figure 2-3 shows the process to install release software from tapes.

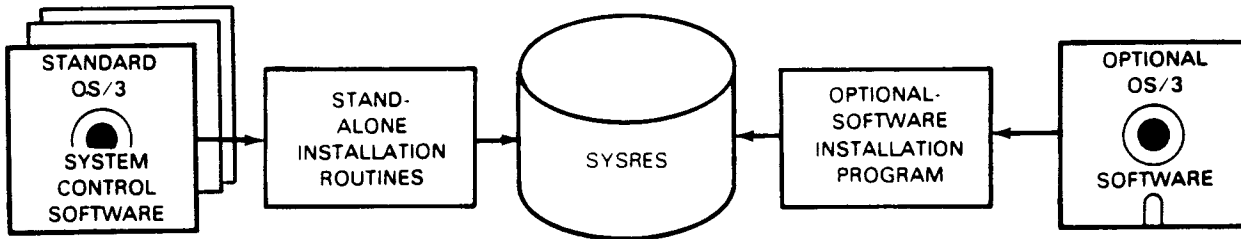

Figure 2-2. Software Installation from Diskettes for an Initial User

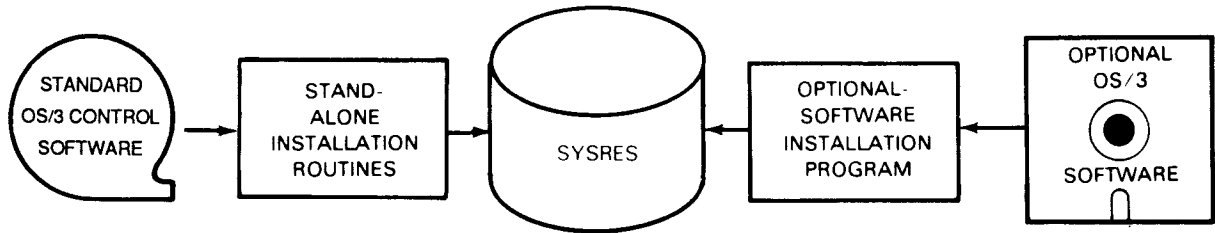

Figure 2-3. Software Installation from Tapes for an Initial User

Note: *The stand-alone restore routine only accepts file mode format and supports only nonremovable disk types. Also, software installation from tapes using stand-alone routines is supported on models 8 thru 20 only.*

2.1.2. Existing Users

For existing users, OS/3 software is released as:

- Optional OS/3 software delivered separately on diskettes
- An entire new release of OS/3 software, including standard and optional software delivered on disk or diskette
- Standard software without optional software, delivered only on tape

Installing New Optional OS/3 Software

To install optional OS/3 software after a system is already installed and generated, the release level of the optional software must be the same as the release level of the existing system software. Otherwise, the optional software cannot operate properly. If you receive optional software at a different release level, it must be part of a new OS/3 release. You must then update the operating system before you install the optional software.

To install new optional software, perform the optional-software installation procedure once for each separate program product or programming aid that you want to install.

Figure 2-4 shows the installation of new optional OS/3 release software.

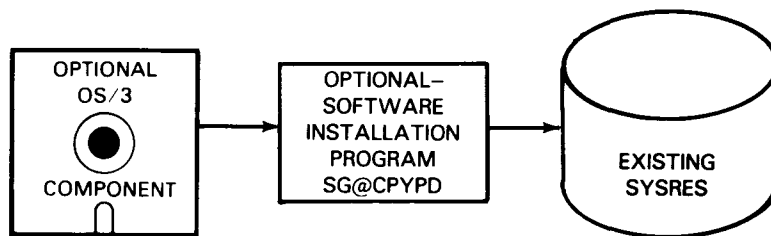

OPTIONAL SOFTWARE MUST BE AT SAME RELEASE LEVEL AS SYSTEM SOFTWARE

Figure 2-4. Installation of New Optional OS/3 Software

Installing a New Release of OS/3

Existing users who receive an entire new release of OS/3 must install this release to update the system. The new release contains updated standard OS/3 release software and updates to any optional software that you have. You should make a backup copy of the existing SYSRES volume before installing the new release software. The procedures to install a new release are similar to installing the initial release, with the following exceptions:

- First, terminate all jobs before you install the new software, and do not process any other jobs until the new release software is installed.
- Second, make copies on the SYSRES of your own software that you want to use with the new release. Prepare these copies on disk or on diskettes, using the following general procedures:
 - Copy all program modules from the system libraries (including source modules that contain SYSGEN parameter sets that are still valid with the new release) using the system librarians, LIBS and MLIB. (See the *System Service Programs Operating Guide*, UP-8841, for the details to perform this operation.)
 - Make copies of all program library files residing on the SYSRES (not system library files) using the procedures described in Section 3. Specifically, use the SG@DUFIL job stream, described in detail in that section, to make backup copies on diskettes. Use LIBS or MLIB to make the copies on disk.

- Use data utilities to make copies of any data files on your SYSRES. (See the *Data Utilities Operating Guide*, UP-8834.)

After you install the new release, copy the program modules and library files back to the updated SYSRES. Use the same system facility that you used to prepare the copies of this software. During subsequent SYSGEN operations, you can use these SYSGEN parameter sets as input to the parameter processor.

This procedure lets you generate the system without defining all system parameters as required for initial users.

Figure 2-5 shows the installation of a new release of OS/3.

Note: *This installation procedure represents one method of installing a new release of OS/3 for an existing user. There are other methods available and these are discussed in 2.2.*

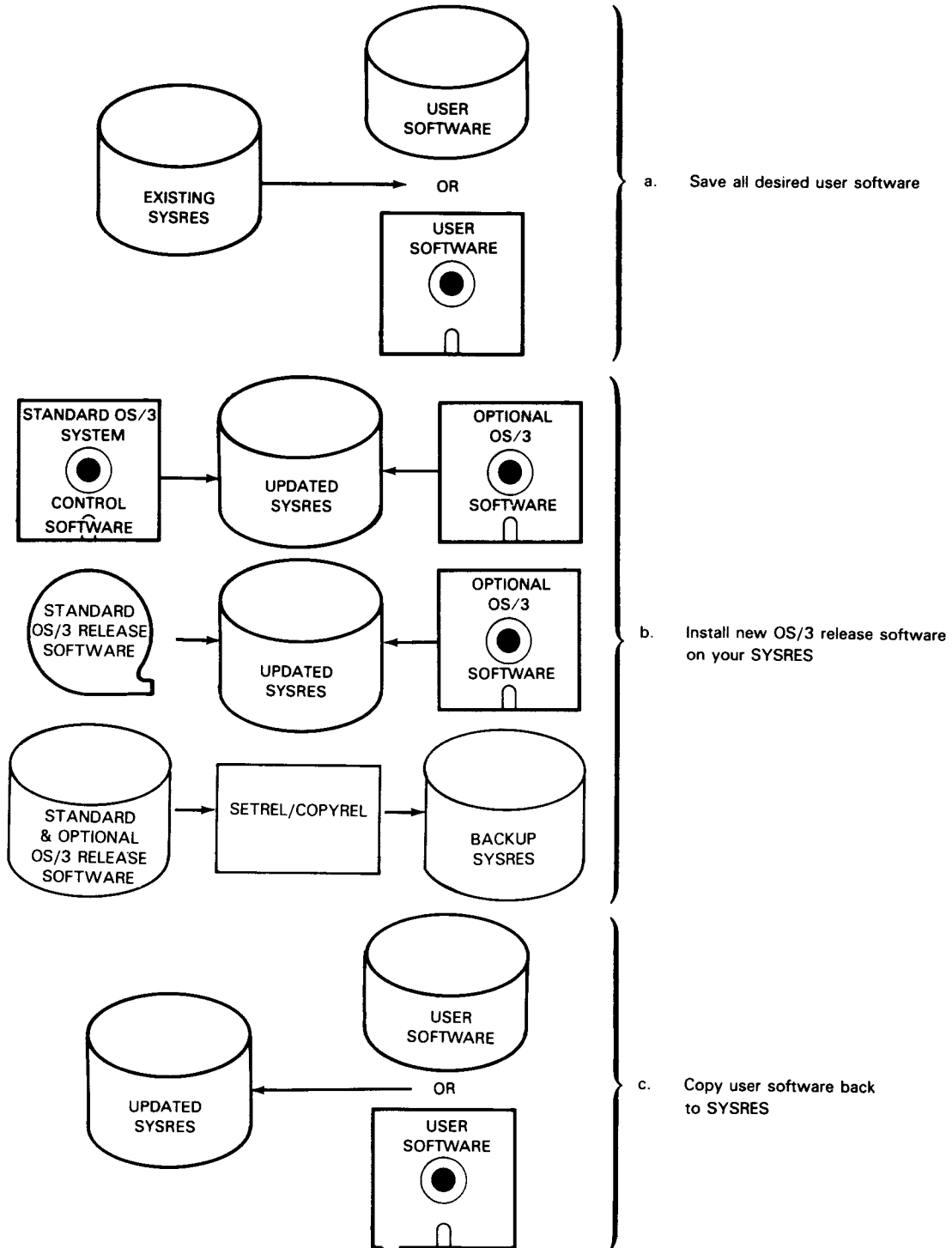

Figure 2-5. Installation of a New OS/3 Release

2.2. Procedures

System 80 users can build the SYSRES on any of the disk devices listed in Table 2-1.

Table 2-1. Permissible SYSRES Disk Devices

System 80 Model	Permissible SYSRES Disk Devices
Models 3 and 5	8417, 8419
Models 4 and 6	8417, 8419, 8470
Models 8 thru 20	8417, 8419, 8430, 8433, 8470, 8494, and M9720*

*M9720 not applicable to model 8

If you are a model 3 thru 6 user, build the SYSRES on an 8417 disk. The procedures to install software to models 3 thru 6 let you build the SYSRES on an 8417 disk, regardless of the medium the software is delivered on. If you are a model 8 thru 20 user, build the SYSRES on any disk device the system supports, except for 8416 or 8418-1 (low-density) disks.

2.2.1. Installation Procedures for Models 3 thru 6

The following procedures let you install:

- Standard release software from diskettes
- Optional OS/3 software from diskette
- Standard and optional release software from an 8419 disk
- Standard release software from dump/restore tapes

Installing Standard Release Software from Diskettes

Before you begin the installation procedures in this section, you should be aware of these considerations:

- If you are building the SYSRES on an 8417 disk with the fixed-head feature, install the software from release diskettes prepared in 8417 fixed-head dump/restore format. If your 8417 disk does not have the fixed-head feature, install the software from diskettes in nonfixed-head 8417 dump/restore format.

Models 3 thru 6 Installation Procedures

- If you are updating a system to a new release level and want to retain the software that currently resides on your SYSRES, make copies of your software as described in 2.1.2 before performing this procedure.

To install the standard release software:

1. Perform the system turn-on procedure described in the *Operations Guide*, UP-8859. When you see the IPL 01 KEY IN AND TRANSMIT message, load the initial microprogram load (IMPL) code diskette into an available diskette drive. This diskette contains CPU microcode and is supplied with your release diskettes. Press and hold FUNCTION and press the D key to enter control mode.
2. Press and hold FUNCTION and press the IMPL key. When you see the message IMPL=CDD?, key in the device address (did) of the diskette drive containing the IMPL diskette.
3. Press XMIT. One of the following three messages appears on the console screen. Load one or more of the diskettes supplied with the release software into the diskette drive that currently contains the IMPL diskette. Respond to these messages as follows:
 - a. If the IPL=CDD? message appears, remove the IMPL diskette from the diskette drive and load the IPL diskette into the diskette drive. Then, go to step 4.
 - b. If the IOML=CDD? message appears, remove the IMPL diskette from the diskette drive, load the IOMP diskette into the diskette drive, and press XMIT. When the IPL=CDD? message appears, remove the IOMP diskette, load the IPL diskette, and go to step 4.
 - c. If the IDCL=CDD? message appears, remove the IMPL diskette from the diskette drive, load the IDC diskette into the diskette drive, and press XMIT. When the IDCUL=CDD? message appears, remove the IDC diskette, load the IDCU diskette, and press XMIT. When the IPL=CDD? message appears, remove the IDCU diskette, load the IPL diskette, and go to step 4.
4. Key in the device address (did) of the diskette drive containing the IPL diskette and press XMIT.
5. When the screen displays the message IPL 01 KEY IN AND TRANSMIT, enter console mode by simultaneously pressing FUNCTION and the CSL key and key in:

```
SU@RST,L,did
```

where:

L
Specifies the option for loading stand-alone programs.

did
Is the device address of the diskette drive containing the IPL diskette.

Note: Device address (did) values are site dependent and are configured when your hardware is installed.

6. Press XMIT. The system loads the stand-alone disk restore program (SU@RST). Respond to program requests as follows:
 - a. When SU@RST asks you to ENTER OUTPUT DISK DEVICE TYPE (84nn), key in the disk type and press XMIT.
 - b. When SU@RST asks WHAT DRIVE IS YOUR OUTPUT DISK ON? (did), key in the device address (did) of your SYSRES disk and press XMIT.

Note: If you receive the messages NO VOL1 ON DISK - DISK MUST BE PREPPED and STAND ALONE RESTORE TERMINATED IN ERROR, proceed with step 8.

- c. When SU@RST asks WHAT DRIVE IS YOUR INPUT DSKT ON? (did), replace the IPL diskette with your first system control software release diskette that contains the volume table of contents (VTOC). Key in the device address (did) of the diskette drive containing your system control software release diskette and press XMIT.
 - d. When SU@RST asks ARE YOU RESTARTING? (Y/N), key in N for no and press XMIT.
 - e. When SU@RST asks ARE YOU INITIALIZING YOUR SYSTEM? (Y/N), key in Y for yes and press XMIT.

Note: Initializing your disk destroys any files that are on your disk.

After you provide SU@RST with this information and the necessary diskettes, it copies the entire contents of the system control software release diskettes to the SYSRES. The routine provides status as it successfully copies your diskettes and displays a message telling you when you should mount the next diskette. If you are using an autoload diskette unit, the program loads the diskettes automatically. Remember that your diskettes must be in the order requested by SU@RST for the program to copy them.

- f. When SU@RST displays a MOUNT message, mount the requested diskette, key in the 2-character message number and R for ready and press XMIT.

If you get I/O errors during the stand-alone restore routine, go to step 9.

After SU@RST copies all the release diskettes to the SYSRES, a message tells you that the program terminated normally. Go to step 7.

7. After SU@RST terminates normally, perform an initial program load (IPL) to load the starter supervisor (SY@BAS) into main storage as follows:

- a. Load the IPL diskette that came as part of your release diskettes.
- b. Press and hold FUNCTION and press the D key to enter control mode.
- c. Press and hold FUNCTION and press the IPL key.
- d. When you see the message IPL=CDD?, press XMIT to accept the default SYSRES device address (100 if your SYSRES is the 8417 integrated disk) or key in the device address (did) of your SYSRES disk and press XMIT.
- e. When you see the message IPL 01 KEY IN AND TRANSMIT, key in:

SY@BAS,S,did

where:

SY@BAS

Specifies the starter supervisor.

S

Specifies the option for loading a supervisor.

did

Specifies the device address of your SYSRES disk.

- f. Press XMIT.

Note: *If you receive a series of messages MICROCODE NAME NOT AVAILABLE FOR DEVICE xxx (where xxx is a device address), ignore them and proceed with the next step. These messages are generated because SY@BAS supports devices that are not configured in the system and therefore do not have entries in the system definition file.*

- g. Press and hold FUNCTION and press the C/CSL key.
- h. When the system displays the messages *** OS/3 VERSION nn *** and DATE? YY/MM/DD, key in today's date (year, month, day) and press XMIT.
- i. The date entered is compared to the date keyed in at the last IPL from the same SYSRES. If the entered date is six days less than or six days greater than the date of the last load, the message DATE QUESTIONABLE appears. If the date entered is correct, press XMIT and the date is accepted. If the date is incorrect, key in the correct date.
- j. When the system displays the message TIME? (HH/MM/SS), key in the present time (hours, minutes, seconds) and press XMIT.

- k. Then, the system asks questions. Normally, at this time you can accept or change supervisor options specified during SYSGEN. However, because you have not yet performed SYSGEN, press the RETURN key after each query to accept the default value.

Note: The first time you perform an IPL, respond N to the system's request concerning job queue recovery to prevent errors during the IPL process.

- l. Press XMIT after you have responded to every request.
- m. The system displays header messages indicating available job slots, OS/3 version number, supervisor name, date, time, and that it is ready for use. You can now perform the next installation task - either to install optional software or perform system generation.

Note: If the documentation that accompanied your standard release software tells you to update loadable microcode, go to the post-installation task of updating the system definition file in 2.3.1.

- 8. If SU@RST does not terminate normally and displays the messages NO VOL1 ON DISK - DISK MUST BE PREPPED and STAND-ALONE RESTORE TERMINATED IN ERROR, you must run the stand-alone disk prep routine (SU@PRP) before you run SU@RST, as follows:

- a. Make sure the IPL release diskette is mounted.
- b. Press and hold FUNCTION, then press the IPL key.
- c. When you see the message IPL=CDD?, key in the device address (did) of the diskette drive containing the IPL diskette and press XMIT.
- d. When the message IPL 01 KEY IN AND TRANSMIT appears, key in:

SU@PRP,L,did

where:

L

Specifies the option for loading stand-alone programs.

did

Is the device address of the diskette drive containing the IPL diskette.

- e. Press XMIT. The system loads the stand-alone disk prep routine into main storage, and asks the following questions:

Note: For most applications of SU@PRP, these responses are valid. You can choose different options than the ones shown. For a full description of disk prep options, see the Systems Service Programs Operating Guide, UP-8841.

- (1) When SU@PRP states ENTER OUTPUT DISK DEVICE TYPE (84nn), key in the device type and press XMIT.
- (2) When SU@PRP asks WHAT DRIVE IS YOUR DISK ON? (did), key in the device address of your SYSRES and press XMIT.
- (3) When SU@PRP asks WHAT DISK VOL SERIAL NUMBER DO YOU WANT? (xxxxxx), key in the serial number that you want to write into the VOL1 label on the disk.
- (4) If using an 8417 disk, SU@PRP asks DO YOU WANT SURFACE ANALYSIS?(Y/N), key in Y for yes and press XMIT.
- (5) When SU@PRP asks DO YOU WANT FAST OR COMPLETE ANALYSIS?(F/C), key in C and press XMIT.
- (6) If using an 8417 disk, SU@PRP asks IS THE TCT NEW, FROM DISK, OR FROM DISKETTE?(N/D/K), key in N and press XMIT.
- (7) When SU@PRP asks you to ENTER INSERT (cccchh/END/NONE), key in NONE and press XMIT unless you know of defective tracks on the SYSRES disk. In that case, enter the hexadecimal address of those tracks so the routine formats them as defective.

After you provide SU@PRP with this information, it preps the SYSRES disk and tells you when it has terminated.

- f. When SU@PRP terminates normally, rerun SU@RST to copy the volume table of contents (VTOC) and the standard system control software onto the SYSRES. Load the stand-alone restore routine into main storage by pressing and holding FUNCTION, and pressing the IPL key. When you see the message IPL=CDD?, continue with step 4 of this procedure.
9. If you experience I/O errors during the stand-alone restore routine, use the restart capability of the stand-alone restore program. The restart capability keeps all data intact on the SYSRES that was copied when you experienced the error. If your system has more than one diskette drive and you are performing the restart procedure, mount the diskettes in a different drive in case the error is due to hardware problems with your diskette drive.

To use the restart capability:

- a. Mount the IPL diskette that came as part of your release software.
- b. Press and hold FUNCTION and press the IPL key.
- c. When the message IPL=CDD? appears, key in the device address (did) of the diskette drive containing the IPL diskette, and press XMIT.
- d. When the screen displays the message IPL 01 KEY IN AND TRANSMIT, key in:

SU@RST,L,did

where:

L

Specifies the option for loading stand-alone programs.

did

Is the device address of the diskette drive containing the IPL diskette.

Press XMIT.

- e. The system reloads the stand-alone disk restore program, and displays these prompts:
 - (1) When SU@RST asks you to ENTER OUTPUT DISK DEVICE TYPE (84nn), key in the disk type and press XMIT.
 - (2) When SU@RST asks WHAT DRIVE IS YOUR OUTPUT DISK ON?, key in the device address (did) of the SYSRES disk, and press XMIT.
 - (3) When SU@RST asks WHAT DRIVE IS YOUR INPUT DSKT ON?, replace the IPL diskette with the release diskette that SU@RST was copying when you experienced the I/O error. Key in the device address (did) of the diskette drive containing the system control software release diskette, and press XMIT.
 - (4) When SU@RST asks ARE YOU RESTARTING (Y/N)?, key in Y for yes, and press XMIT.
 - (5) When SU@RST asks AT WHAT VOLUME? (nnn), key in the 3-character volume number where you encountered the error. This number is on the external diskette label. For example, if you encountered the error on diskette SYS009, key in 009, and press XMIT.

- (6) When SU@RST asks ARE YOU INITIALIZING YOUR SYSTEM (Y/N)?, key in Y for yes, and press XMIT.

Note: Initializing your disk destroys any files that are on your disk.

After you enter this information and load the necessary diskettes, SU@RST resumes copying the entire contents of the remaining release diskettes to the SYSRES. The routine tells you when it begins to restore a file either midway through that file or from the beginning of that file, depending on when you experienced the I/O error. These are informational messages and require no response. SU@RST also lets you know when it successfully copies each diskette and tells you when to mount the next diskette. Remember that your diskettes must be in the order requested by SU@RST for the program to copy them.

- (7) When SU@RST displays a MOUNT message, mount the requested diskette. Key in the 2-character message number and R for ready and press XMIT.

After SU@RST copies all the release diskettes to the SYSRES, it tells you that the program terminated normally.

- (8) When SU@RST terminates normally, go back to step 7 of this procedure to reinitialize your system for your normal processing.

Installing Optional Release Software from Diskette

The following paragraphs describe the procedure for installing optional, separately delivered program products and programming aids. If the optional software you install requires operating system support, you must generate control elements to support these products before you attempt to use them. Table 3-1 lists all the optional software that OS/3 offers and shows which control elements you need to support them.

Ensure that the system control software is installed and the system is operating under the control of either the starter supervisor or one that you've generated yourself.

Perform this procedure for each optional software component that you want to install. If you are installing several optional software components, run SG@CPYPD once for each. It takes approximately 5 to 15 minutes to install an optional program product or programming aid.

To install an optional program product or programming aid from diskette, proceed as follows:

1. Key in:

```
RV SG@CPYPD[, ,PRINT=N]
```

where:

```
PRINT=N
```

Suppresses all printer output from SG@CPYPD and the SG@MVPD routine initiated by SG@CPYPD.

2. Press XMIT.
3. When SG@CPYPD displays the message MOUNT VSN=A GO?, mount the first separate software diskette.
4. Key in GO SG@CPYPD and press XMIT. SG@CPYPD then initiates the SG@MVPD routine, which moves the separate software from its release diskette to your SYSRES. If the software resides on more than one release diskette, SG@MVPD displays a message for you to mount the next volume.
5. When SG@MVPD displays a MOUNT message:

- a. Mount the requested diskette.
- b. Key in the 2-character number and R (for ready) in the following format:

```
nn R
```

where:

```
nn
```

Is the message number.

- c. Press XMIT.

When SG@MVPD successfully copies your optional software onto your SYSRES, it displays a message to inform you that the routine terminated normally.

Installing Standard and Optional Release Software from an 8419 Disk

Unisys delivers standard and optional release software on an 8419 disk in ready-for-use (IPL-able) format. You can use the 8419 disk as a SYSRES volume; you should transfer its contents onto an 8417 disk and use the 8417 disk as your permanent SYSRES volume.

If you are updating a system to a new release level and want to keep the software that currently resides on your SYSRES, make copies of your software as described in 2.1.2 before performing this procedure.

To install standard and optional release software from an 8419 disk to a permanent 8417 SYSRES volume, perform the following procedure:

1. Mount the 8419 disk on your system. Perform the initial microprogram load (IMPL) code and initial program load (IPL) code procedures to load your system from this disk as follows:
 - a. Press and hold FUNCTION and press the D key to enter control mode.
 - b. Press and hold FUNCTION and press the IMPL key.
 - c. When you see the message IMPL=CDD?, key in the device address (did) of your 8419 disk and press XMIT.
 - d. One of the following three messages then appears on your console screen:
 - If the message IPL=CDD? appears, key in the device address (did) of the 8419 disk and press XMIT. Then, go to step e.
 - If the message IOML=CDD? appears, key in the device address (did) of the 8419 disk and press XMIT. When the IPL=CDD? message appears, key in the device address of the 8419 disk and press XMIT. Then, go to step e.
 - If the message IDCL=CDD? appears, key in the device address (did) of the 8419 disk and press XMIT. When the IDCUL=CDD? message appears, key in the device address of the 8419 disk and press XMIT. When the IPL=CDD? message appears, key in the device address of the 8419 disk and press XMIT; then, go to step e.

- e. When you see the message IPL01 KEY IN AND TRANSMIT, key in:

SY@BAS,S,did

where:

SY@BAS

Specifies the starter supervisor.

S

Specifies the option for loading a supervisor.

did

Specifies the device address of your 8419 disk.

Note: Device address (did) values are site dependent and are configured when your hardware is installed.

- f. Press XMIT.

Note: If you receive a series of messages MICROCODE NAME NOT AVAILABLE FOR DEVICE xxx (where xxx is a device address), ignore them and proceed with step g. These messages are generated because SY@BAS supports devices that are not configured in your system and have not been entered in the system definition file.

- g. Press and hold FUNCTION and press the C/CSL key.

- h. When your system displays the message ***OS/3 VERSION nn *** and DATE? YY/MM/DD, key in today's date (year, month, day) and press XMIT.

- i. The date entered is compared to the date keyed in at the last IPL from the same SYSRES. If the entered date is six days less than or six days greater than the date of the last load, the message DATE QUESTIONABLE appears. If the date entered is correct, press XMIT and the date is accepted. If the date is incorrect, key in the correct date.

- j. When your system displays the message TIME? (HH/MM/SS), key in the present time (hours, minutes, seconds) and press XMIT.

- k. The system then asks you to accept or change supervisor options that you specified during SYSGEN. Since you have not yet performed SYSGEN, accept the default values for all these requests by pressing the RETURN key after each request.

Note: The first time you perform an IPL, respond N for no to your system's request concerning job queue recovery; otherwise errors occur during the IPL process.

- l. After you respond to all requests, press XMIT.
 - m. The system displays header messages indicating available job slots, OS/3 version number, supervisor name, date, and time. The system is now ready for you to perform the next installation task.
2. Update the system definition file, \$Y\$SDF, to reflect the actual microcode that your system contains. You must do this only if the system release description (SRD) that accompanies your release tells you to update loadable microcode.
 - a. If you do not have to update \$Y\$SDF, continue with step 3 of this procedure.
 - b. If you must update \$Y\$SDF, perform the post-installation task of updating the system definition file in 2.3.1 and then continue with step 3 of this procedure.
 3. Run the SETREL and COPYREL job control streams to transfer the contents of the 8419 disk onto your permanent 8417 SYSRES volume. SETREL preps your 8417 disk to serve as a SYSRES volume and COPYREL copies the contents of all the system files listed in Table 2-2 from the 8419 disk to your 8417 SYSRES volume. You must run SETREL before you run COPYREL even if your 8417 disk is already prepped.

Note: *The 8419 release volume is delivered with a volume serial number (VSN) that corresponds to the current release level of the software. For example, a disk containing release 10.0 level software has a VSN of REL100, release 12.0 level software has a VSN of REL120, and so forth. However, to execute properly, many OS/3 facilities such as the SYSGEN dialog and the SYSGEN parameter processor require that the permanent SYSRES volume is assigned this same VSN. You cannot transfer the release software from one volume to another if both volumes have the same VSN. Therefore, you must assign a temporary VSN to the 8417 volume using the SETREL V=parameter.*

- a. Prep the 8417 disk to serve as your SYSRES by keying in at the console/workstation in console mode:

```
RU SETREL , ,V=temp-vsn,T=17,P=prep-type,[R=n]
```

If your system does not have a card reader, you must key in the SETREL run command as follows:

```
RV SETREL, ,V=temp-vsn,T=17,P=prep-type,CR=NO,[R=n]
```

where:

V=temp-vsn

Specifies the temporary volume serial number you want assigned to your 8417 SYSRES disk.

T=17

Specifies that you are building your SYSRES on an 8417 disk volume.

P=prep-type

Specifies the type of prep you want SETREL to perform. The prep type codes are:

<u>Code</u>	<u>Meaning</u>
F	Full prep (surface analysis)
P	Partial prep (no surface analysis)
N	No prep performed, assign files only

CR=NO

Specifies that you are entering information concerning known bad tracks on the 8417 disk volume from the console/workstation. You must specify this parameter if your system does not have a card reader.

R=n

Specifies the number of times a defective track is retested before it is declared unusable and an alternate track is substituted. The value n is a hexadecimal number from 00 to FF. If this parameter is not specified, the default value is 0A.

Note: *Specify a full prep, P=F and continue with step 3b. If you specify P=N, however, go to step 3c of this procedure.*

- b. Press XMIT. SETREL then requests information from you concerning known bad tracks on the 8417 disk volume, provided you specified a full or partial prep in step 3a. In this case, enter the hexadecimal address of any tracks that you know are defective on that disk.

Note: If you are entering this information on cards, bad tracks must be identified by an INSERT statement (one track per statement) and the set must be terminated with a // FIN statement. If you are prepping an 8417 disk with no known bad tracks, you must place an INSERT statement with the word NONE starting in column 10, followed by a // FIN statement, to satisfy the request made by SETREL.

- c. Press XMIT. SETREL then preps the 8417 disk and assigns the system files that reside on that disk after you execute COPYREL. If unrecoverable errors occur during the prepping of a volume, a message indicates this at your console/workstation, and the job terminates immediately. If other errors occur, a warning message is sent, and the job continues processing.
- d. Copy all the system files on your 8419 disk to your 8417 SYSRES by keying in at the console/workstation in console mode:

```
RV COPYREL,,V=temp-vsn,T=17[,S=first-file-code][,E=last-file-code][,CAT=Y][,SEC=Y]
```

where:

V=temp-vsn

Specifies the temporary volume serial number you assigned to the 8417 disk volume in step 3a.

T=17

Specifies that you are building your SYSRES on an 8417 disk volume.

S=first-file-code

Specifies the code identifying the first file that you want COPYREL to copy. Table 2-2 shows the order that COPYREL copies the system files and shows the codes for each system file. If you omit the S keyword, COPYREL begins copying at \$Y\$SRC.

E=last-file-code

Specifies the code for the last file that you want COPYREL to copy. (See Table 2-2.) If you omit the E keyword, COPYREL ends copying at \$Y\$TRANA.

CAT=Y

Specifies \$Y\$CAT (catalog file) is copied using SGTRAN.

SEC=Y

Specifies \$Y\$SEC (security file) is allocated and copied using MLIB.

When you specify the S or E keywords, COPYREL overrides the CAT and SEC parameters and generates an error to the console. The S and E keyword parameters control the number of files that COPYREL copies. They also tell COPYREL where to restart a copy function if you get an error while performing COPYREL. You can also use these keywords to copy a single library by specifying the same file for each parameter.

Table 2-2. COPYREL Copy Order

Copy Order	Code	File Name	Copy Order	Code	File Name
1	S	\$\$SRC	12	IVP	IVPLIB
2	O	\$\$OBJ	13	SMCFIL	SMCFIL
3	L	\$\$LOD	14	SMACLOG	\$\$SMCLOG
4	M	\$\$MAC	15	FMT	\$\$FMT
5	J	\$\$JCS	16	SAVE	\$\$SAVE
6	G	SG\$JCS	17	DIALOG	\$\$DIALOG
7	SGMAC	SG\$MAC	18	SDF	\$\$SDF
8	SGOBJ	SG\$OBJ	19	HELP	\$\$HELP
9	SGLOD	SG\$LOD	20	T	\$\$STRAN
10	SCLOD	\$\$SCLOD	21	A	\$\$STRANA
11	MIC	\$\$MIC	22	CAT	\$\$CAT*
			23	SEC	\$\$SEC*

* These files are copied when requested by parameters in RUN statements.

- e. Press XMIT. COPYREL then copies your system files onto the 8417 disk volume and informs you when it has terminated normally.
- f. The VSN of your SYSRES must correspond to the current software release level. Refer to the documentation accompanying your software release if you are uncertain of your release level. To change the VSN of your 8417 SYSRES from the temporary VSN assigned in step 3a, key in:

```
RV CGV, ,O=temp-vsn,N=RELxxx,T=17
```

where:

O=temp-vsn

Specifies the temporary VSN previously assigned in step 3a.

N=RELxxx

xxx specifies the current software release level.

T=17

Specifies the type of disk subsystem being used is an 8417.

Note: *To place the IMPL and IPL codes in their correct positions, Unisys provides the PRPMIC job stream. To execute PRPMIC, key in:*

```
RV PRPMIC, ,V=RELxxx
```

where:

V=RELxxx

Specifies the volume serial number of the 8417 disk volume on which you built your SYSRES copy, where xxx is the release level of your software.

When it has successfully placed the IPL and IMPL codes in their correct positions, PRPMIC advises you that it has terminated normally.

Installing Release Software from Dump/Restore Tape

Unisys delivers OS/3 release software on dump/restore tapes to either 8417 or 8419 disks. The installation procedure is the same regardless of which tape you order, but you must install the new system on the same disk type used to produce the dump/restore tape.

In addition, if you install your software on an 8419 disk, transfer it from the 8419 disk onto an 8417 disk using the SETREL/COPYREL procedures described previously in "Installing Standard and Optional Release Software from an 8419 Disk". You should use an 8417 disk as your permanent SYSRES volume.

To install a new release from tape, you must have two disk drives and two disk volumes available. One of these disks must be an existing SYSRES disk. The other disk must be a free disk called the output disk. The new release software is installed on the free disk. If you install the software from an 8417 dump/restore tape to an 8417 output disk, this disk then becomes the new SYSRES.

To install your release software from dump/restore tape, perform the following procedure:

1. Perform an initial program load (IPL) from the existing SYSRES to load either the starter supervisor or one that you generated into main storage. If you are installing the release software on an 8419 output disk, make sure the 8419 disk is online before you perform the IPL.
2. Prep your output disk using the Unisys disk prep routine, DSKPRP. A sample disk prep job control stream is provided that preps an 8417 disk so that release software can be installed on it. With a few minor changes, you can also use this control stream to prep an 8419 disk. Regardless of the output disk type, you can choose different options than the ones shown.

Additional notes on the disk prep routine follow this installation procedure. For a full description of disk prep actions, see the *Systems Service Programs Operating Guide*, UP-8841.

3. Mount the release tape or tapes.
4. Run the installation job control stream SG\$DMPTD to copy the release tape(s) to your output disk by keying in:

RV SG\$DMPTD

- a. When SG\$DMPTD asks IS THE INPUT TAPE MULTI-VOLUME (N,Y)?, respond with N if you received the software on one tape or Y if you received the software on two tapes. Press XMIT.
- b. When SG\$DMPTD requests ENTER VSN OF INPUT TAPE, key in the VSN identified on the tape label. If you received your release on two tapes, key in the VSN of the first tape. Press XMIT.
- c. When SG\$DMPTD requests ENTER VSN OF INPUT TAPE 2, key in the VSN identified on the second tape. Press XMIT.

Note: This request appears only if you specified multivolume input in step a.

- d. When SG\$DMPTD requests ENTER VSN OF OUTPUT DISK, key in RELxxx, which is the VSN you specified when you prepped the output disk in step 2 of this procedure. Press XMIT.
- e. When SG\$DMPTD asks IS THE OUTPUT DISK A FIXED HEAD DEVICE (N,Y)?, key in Y if the output disk has the fixed head feature; otherwise, key in N. Press XMIT.

Note: You can ignore any error messages for the \$IMPL, \$IPL, and \$VTOC files that are displayed when SG\$DMPTD starts.

5. Place the IMPL and IPL codes in their correct positions using the PRPMIC job stream. To execute PRPMIC, key in:

RV PRPMIC,,V=RELxxx

where:

V=RELxxx

Specifies the volume serial number of the 8417 disk volume on which you built your SYSRES copy, where xxx is the release level of your software.

When it has successfully placed the IPL and IMPL codes in their correct positions, PRPMIC advises you that it has terminated normally.

Models 3 thru 6 Installation Procedures

If you install the software on an 8419 disk, you must transfer it to the permanent 8417 SYSRES volume by changing the VSN of the 8419 disk. Then run SETREL/COPYREL as described in 2.2.1.

The following is a sample disk prep job stream:

```
1. // JOB Prep
2. // DVC 20 // LFD PRNTR
3. // DVC 50,100
4. // VOL Newvol(NOV)
5. // LFD DISKIN
6. // DVC RES
7. // LBL $$$SDF
8. // LFD $$$SDF
9. // EXEC DSKPRP
10. /$
11.          SERNR=RELxxx,TRCON=D,IPLDK=Y,
12.          PREPT=C,ILOPT=Y
13. VOL1
14. INSERT    NONE
15. /*
16. /&
```

Explanation:

Line 3: The number 100 specifies the device address of the 8417 integrated disk. If you are prepping any disk other than this one, you must replace 100 with the appropriate device address.

Lines 6-8: This DVC-LFD sequence identifies the system definition file, \$\$\$SDF, used for building the IMPL records on the disk you're prepping.

Line 11: SERNR=RELxxx specifies the volume serial number of your output disk, where xxx is the release level. Refer to the documentation accompanying your software release if you are uncertain of the level of your release. TRCON=D specifies that you're updating the track condition table of a disk that has been prepped before. If your output disk has never been prepped, specify TRCON=N to create a new track condition table.

Line 14: The entry NONE in the INSERT statement indicates there are no known bad tracks on your output disk. If there are known defective tracks on your output disk, use INSERT control statements to specify the hexadecimal addresses of these tracks.

2.2.2. Installation Procedures for Models 8 thru 20

The following procedures let you install:

- Standard release software from stand-alone diskettes or stand-alone tapes
- Optional OS/3 software from diskettes
- Standard and optional release software from an 8419, 8430, or 8433 disk
- Standard release software from dump/restore tapes

Installing Standard Release Software from Diskettes or Tapes Using the Stand-Alone Routines

To install standard release software:

1. Load the initial microprogram load (IMPL) code diskette containing the system microcode supplied with the release diskettes into diskette drive FDD0. This diskette stays loaded in this drive permanently.
2. Perform the system turn-on procedure as described in the *Operations Guide*, UP-8859, with the IPL switch set to manual.
3. When the configuration frame appears, enter the device address (did) of your disk candidate SYSRES disk. This establishes the disk as the default value for the SYSRES.
4. Load the IPL diskette in an available diskette drive.
5. Press ESC and then the M key to display the manual frame.
6. Enter C (or G if you have an autoloader diskette) and the device address (did) of the diskette drive containing the IPL diskette. Press XMIT.
7. When the screen displays the message IPL 01 KEY IN AND TRANSMIT, key in:

```
SU@PRP,L,did
```

where:

```
L
```

Specifies the option for loading stand-alone programs.

```
did
```

Is the device address of the diskette drive containing the IPL diskette.

8. Press XMIT. The system loads the stand-alone disk prep routine into main storage and requests information from you. For most applications of SU@PRP, the following responses are valid. In some cases, you can choose different options than the ones shown. For a full description of disk prep options, see the *System Service Programs Operating Guide*, UP-8841.

Note: When you use the autoloader to load SU@PRP or SU@RST, a channel reset is done by IPL. This will eject the diskette and an I/O error will occur. Remount the diskette and reply R.

- a. When SU@PRP requests ENTER OUTPUT DISK DEVICE TYPE (nnnn), key in the disk type and press XMIT.
- b. When SU@PRP asks WHAT DRIVE IS YOUR DISK ON?, key in the device address (did) of the disk device and press XMIT.
- c. When SU@PRP asks DOWNLINE MICROCODE TO DISK?, key in Y and press XMIT. (This question does not appear for 8494 or M9720 disks.)
- d. When SU@PRP asks WHAT DRIVE IS MICROCODE DSKT ON?, key in the device address (did) of the diskette drive containing the IDCU microcode diskette for the disk you are prepping and press XMIT. (This question does not appear for 8494 or M9720 disks.)
- e. When SU@PRP asks WHAT DISK VOL SERIAL NUMBER DO YOU WANT? (xxxxxx), key in the 6-character volume serial number you want written into the VOL1 label on the disk.
- f. When SU@PRP asks DO YOU WANT TO WRITE HOME ADDRESSES? (Y/N), key in Y for yes and press XMIT. (This question appears only during prep of 8470 disks.)
- g. When SU@PRP asks DO YOU WANT SURFACE ANALYSIS? (Y/N), key in Y for yes and press XMIT. (This question does not appear for 8470 disks.)
- h. When SU@PRP asks DO YOU WANT FAST OR COMPLETE ANALYSIS? (F/C), key in C and press XMIT.
- i. When prepping an 8470, SU@PRP asks IS THE TCT NEW OR FROM DISK? (N/D). Key in N and press XMIT.
- j. When prepping an 8494 or M9720, SU@PRP asks IS THE SCT NEW OR FROM DISK (N/D). Key in N and press XMIT.
- k. When prepping an 8417, SU@PRP asks IS THE TCT NEW, FROM DISK, OR FROM DISKETTE? (N/D/K). Key in N and press XMIT.
- l. When SU@PRP requests that you ENTER INSERT (cccchh/END/NONE) or ENTER INSERT (cccchrr/END/NONE) for 8494 and M9720 disks, key in NONE and press XMIT.

Note: *If you know of defective tracks/records on the SYSRES disk, enter the hexadecimal address of those tracks/records so the routine will format them as defective.*

After you provide SU@PRP with this information, it preps the disk and informs you when it has terminated.

9. When SU@PRP terminates normally, press ESC and then the M key to display the manual frame.
10. Enter C (or G, if the autoloader is used) and the channel and device address (did) of the diskette drive containing the IPL diskette (for example, CC20).
11. Press XMIT. When the screen displays the message IPL 01 KEY IN AND TRANSMIT, key in:

SU@RST,L,did

where:

L

Specifies the option for loading stand-alone programs.

did

Is the device address of the diskette drive containing the IPL diskette.

Note: *Device address (did) values are site dependent and are configured when your hardware is installed.*

12. Press XMIT. The system loads the stand-alone disk restore program (SU@RST). The program then asks information from you. Respond to these requests as follows:
 - a. When SU@RST requests ENTER OUTPUT DISK DEVICE TYPE (nnnn), key in the disk type and press XMIT.
 - b. When SU@RST asks WHAT DRIVE IS YOUR OUTPUT DISK ON? (did), key in the device address (did) of the disk to be the SYSRES and press XMIT.
 - c. When SU@RST asks DOWNLOAD MICROCODE TO DISK?, key in N for no and press XMIT. (This question does not appear for 8494 or M9720 disks.)
 - d. When SU@RST asks IS INPUT MEDIUM TAPE OR DISKETTE? (TAPE/DSKT), key in TAPE or DSKT and press XMIT. (The TAPE response displays the message ENTER INPUT TAPE DEVICE TYPE (NNNN). Key in Uxx, BT32, or SCSI.)

e. When SU@RST asks WHAT DRIVE IS YOUR INPUT TAPE/DISKETTE ON?

- (1) Replace the IPL diskette with your first system control software release diskette or mount the first system control software tape on an available drive.

If you are using an autoload diskette unit, the program loads the diskettes automatically. Remember that the volumes must be in the order requested by SU@RST for the program to copy them.

- (2) Key in the device address (did) of the drive containing your system control software release diskette or tape.
- (3) Press XMIT.

Note: *If the input device is a U11 tape (streamer) or U22 on a DMUX channel (C or E), SU@RST asks DOWNLINE LOAD MICROCODE TO DEVICE?, key in Y and press XMIT.*

When SU@RST asks WHAT DRIVE IS MICROCODE DSKT ON?, key in the device address (did) of the diskette drive containing the ITCU microcode for the streamer tape, and press XMIT.

f. When SU@RST asks ARE YOU INITIALIZING YOUR SYSTEM? (Y/N), key in Y and press XMIT.

Note: *Initializing your disk destroys any files that are on your disk.*

After you provide SU@RST with this information and the necessary diskettes or tapes, it copies the entire contents of the system control software release to the SYSRES. The routine informs you of completion as it successfully copies your diskettes or tapes and displays a message telling you where to mount the next volume.

g. When SU@RST displays the MOUNT message, mount the requested tape or diskette, key in R for ready, then press XMIT.

After SU@RST copies all your release diskettes or tapes to the SYSRES, a message informs you that the program terminated normally. Proceed to step 13 to load the starter supervisor (SY#BAS or SY\$BAS); disregard steps 14 through 17.

Note: *If you experience I/O errors when loading from diskette or tape during the stand-alone restore routine, go to step 14 to restart the program. All data successfully copied to the SYSRES up to the time you experienced the error remains intact on the SYSRES. (If your system has more than one diskette drive and you are performing the restart procedure, you can mount the diskettes in a different drive in case the error is due to hardware problems with your diskette drive.)*

13. Perform steps 13a through 13f to reinitialize the system and load the starter supervisor (SY#BAS or SY\$BAS) into main storage.
 - a. Press ESC, then press the M key. The System Operations Menu (Figure 2-6) appears.

```

ENTER.

PROG LOAD(0-BFF)      CONTROL
N  NORMAL             U  RUN
G  NORMAL (NO RESET) Q  STOP
C  CLEAR

R  OPER RECOVERY(0-BFF) RESET
                           L  SYSTEM
                           B  BPU

ADR STOP(0-FFFFFFF)  COMPUTE CTRL
M  NORMAL             P  NORMAL
I  STOP IA           S  STEP
A  STOP ANY

                           CHECK CTRL
T  TRACE             H  NORMAL
                           K  STOP

W  SENSE SW(0000-1111)
  -0000-             V  STORE STATUS
    
```

Figure 2-6. System Operations Menu

- b. Press the L key (SYSTEM) and then press XMIT to reset the system. The screen continues to be displayed.
- c. Press the C key (CLEAR), enter the device address (did) of the IPL disk, and press XMIT.
- d. When you see the message IPL01 KEY IN AND TRANSMIT, key in:

```

SY#BAS,S,did
  or
SY$BAS,S,did
    
```

where:

SY#BAS
Specifies the starter supervisor for model 8.

SY\$BAS
Specifies the starter supervisor for models 10 thru 20.

- s Specifies the option for loading a supervisor.
- did Specifies the device address of the SYSRES disk.
- e. Press XMIT.
- f. The following System Date/Time display (Figure 2-7) appears.

```
A) DATE: YY/MM/DD          TIME: HH:MM:SS
B) RUN LIBS DVC ADDR: XXX (SYSRES)
C) FILE RECOVERY
   JOB QUEUE (N,Y,H      DEFAULT=N)
   ERROR LOG (N,Y      DEFAULT=Y)
   SPOOL FILES (N,A,C,L,H DEFAULT=N)
D) MODIFY SUPERVISOR# DEFAULT=N
E) SPOOLING DVC ADDR: XXX (SYSRES)
F) DUMP FILE DVC ADDR: XXX (SYSRES)

TRANSMIT TO ENTER DEFAULTS. OTHERWISE ENTER THE LETTERS OF THE
PARAMETER(S) TO BE CHANGED.
```

Figure 2-7. System Date/Time Display

Press XMIT to accept the defaults supplied by the system.

When the system displays header messages indicating OS/3 version number, supervisor name, date, and time, it is ready for you to perform your next installation task - either installing software or performing system generation.

Note: *If the documentation that accompanied your standard release software instructs you to update loadable microcode, go to the post-installation task of updating the system definition file in 2.3.1. If you do not install optional software or generate your own supervisor, the system is now ready for use.*

Steps 14 through 17 are used to restart SU@RST only if you encountered I/O errors in step 12. If SU@RST terminates normally in step 12, disregard steps 14 through 17.

- 14. Press ESC and then the M key to display the manual frame.
- 15. Enter C (or G, if the autoloader is used) and the device address (did) of the diskette drive containing the IPL diskette.

16. Press XMIT. When the message IPL 01 KEY IN AND TRANSMIT appears, enter:

SU@RST,L,did

where:

L

Specifies the option for loading stand-alone programs.

did

Is the device address of the diskette drive containing the IPL diskette.

17. Press XMIT. The system loads the stand-alone disk restore program (SU@RST) and requests information as follows:
- a. When SU@RST requests ENTER OUTPUT DISK DEVICE TYPE: (nnnn), key in the disk type and press XMIT.
 - b. When SU@RST asks WHAT DRIVE IS YOUR OUTPUT DISK ON?, key in the device address (did) of the SYSRES disk and press XMIT.
 - c. When SU@RST requests DOWNLOAD MICROCODE TO DISK, key in N for no and press XMIT. (This question does not appear for 8494 or M9720 disks.)
 - d. When SU@RST asks IS INPUT MEDIUM TAPE OR DISKETTE? (TAPE/DSKT), key in TAPE or DSKT and press XMIT.
 - e. When SU@RST asks ARE YOU RESTARTING (Y/N)?, key in Y for yes and press XMIT.
 - f. When SU@RST asks AT WHAT VOLUME? (nnn), key in the 3-character volume number where you encountered the error. This number is on the external label of the media. For example, if you encountered the error on diskette SYS009, key in 009. Press XMIT.
 - g. When SU@RST requests ARE YOU INITIALIZING YOUR SYSTEM (Y/N)?, key in Y for yes and press XMIT.

Note: *Initializing your disk will destroy any files that are on your disk.*

After you provide SU@RST with this information and the necessary diskettes or tapes, it resumes copying the entire contents of your remaining release diskettes or tapes to the SYSRES. The routine informs you that it begins to restore a file either midway through the file or from the beginning of the file, depending on where you experienced the I/O error. These messages are informational messages and there is no need for you to respond to them. SU@RST also informs you as it successfully copies each diskette or tape and displays a message when you should mount the next volume. Remember - your diskettes must be in the order requested by SU@RST for the program to copy them.

- h. When SU@RST displays the MOUNT message, mount the requested diskette or tape and key in the 2-character message number and R for ready and press XMIT.

After SU@RST copies all the release diskettes or tapes to the SYSRES, a message informs you that the program terminated normally.

- i. When SU@RST terminates normally, go back to step 13 of this procedure to reinitialize your system for normal processing.

Installing Optional Release Software from Diskette

The following paragraphs describe the procedure for installing optional, separately delivered program products and programming aids. If the optional components that you are installing require operating system support, be sure to generate control elements that support these products before you attempt to use them. Table 3-1 lists all the optional components that OS/3 offers and shows which control elements you need to support them. To perform this procedure, you should have the system control software installed and the system operating under the control of either the starter supervisor or one that you generated yourself.

Perform this procedure for each optional software component you want to install. That is, if you are installing several optional components, you must run SG@CPYPD once for each component.

It takes approximately 2 to 10 minutes to install an optional program product or programming aid, depending upon the size of the product and the performance of the computer environment.

1. Key in:

RV SG@CPYPD
2. Press XMIT.
3. When SG@CPYPD displays the message MOUNT VSN=A GO?, mount the first separate component diskette.
4. Key in GO SG@CPYPD and press XMIT. SG@CPYPD then initiates the SG@MVPD routine, which moves the separate component software from its release diskette to the SYSRES. If the component resides on more than one release diskette, SG@MVPD asks you to mount the next volume.
5. When SG@MVPD displays a MOUNT message:
 - a. Mount the requested diskette.

- b. Key in the 2-character message number and R for ready in the following format:

nn R

where:

nn

Is the message number.

- c. Press XMIT.

When SG@MVPD successfully copies your optional software onto the SYSRES, it displays a message to inform you that the routine terminated normally.

Installing Standard and Optional Release Software from Disk

If you order models 8 thru 20 software on disk, you must send us an 8419, 8430, or 8433 disk volume. Unisys places the standard and optional release software on this disk and returns it to you in ready-for-use (IPL) format. This disk then serves as the SYSRES volume. You can mount it on models 8 thru 20, generate a supervisor if the base supervisor does not meet your requirements, perform any post-installation procedures, and begin normal operations.

You should create a backup copy of the SYSRES as soon as you receive it. See 3.3.6 for the SETREL/COPYREL procedures to build a backup copy of the SYSRES volume.

Installing Release Software from Tape Using the Dump/Restore Routine

Unisys delivers (upon request) models 8 thru 20 standard release software on dump/restore tapes. Always transfer the software to the same disk type that was used to produce the tape. That is, you must transfer software delivered on an 8419 dump/restore tape to an 8419 disk, software delivered on an 8430 tape to an 8430 disk, and so on. In addition, your system must have two disk drives and two disk volumes available. One of these disks must be a free disk for the new release software to be installed. The other must be a SYSRES volume so you can run the job stream SG\$DMPTD that transfers release software from tape to disk. After you complete the transfer, the free disk becomes the new release. You can then use this disk to generate a supervisor if the base supervisor does not meet your requirements, perform any post-installation procedures, and begin normal processing operations.

To install your release software from dump/restore tape, perform the following procedure:

1. Perform an initial program load (IPL) from the existing SYSRES to load either the starter supervisor or one that you generated into main storage. Make sure the output disk is online before you perform the IPL.

2. Prep your output disk using the Unisys disk prep routine, DSKPRP. A sample disk prep job control stream that preps an 8417 disk so that release software can be installed on it is presented following this procedure. With a few minor changes, you can also use this control stream to prep any disk. Regardless of the output disk type, you can choose different options than the ones shown. For a full description of disk prep functions, see the *System Service Programs Operating Guide*, UP-8841.
3. Mount the release tape. If you have two release tapes, but only one tape drive, you must wait until the first tape is read and rewound and you receive a message to mount the second tape. If you have a second tape drive available, you can mount the second tape on that drive.
4. Run the installation job control stream SG\$DMPTD to copy the release tape(s) to your output disk by keying in:

RV SG\$DMPTD

- a. When SG\$DMPTD asks IS THE INPUT TAPE MULTI-VOLUME (N,Y)?, respond with N if you received the software on one tape or Y if you received the software on two tapes. Press XMIT.
- b. If you responded Y, this message appears: TO SPEED PROCESSING USE ALTERNATE TAPE DRIVES TO DECREASE SETUP TIME. After a moment, SG\$DMPTD asks ARE MULTIPLE TAPE DRIVES AVAILABLE (N,Y)?, Respond with N if you must use a single tape drive or Y if a second tape drive is available. Press XMIT.
- c. When SG\$DMPTD asks ENTER THE NUMBER OF INPUT TAPE VOLUMES, key in the number of volumes you have (the maximum is 6) and press XMIT.
- d. When SG\$DMPTD requests ENTER VSN OF INPUT TAPE, key in the VSN identified on the tape label. If you received your release on two tapes, key in the VSN of the first tape. Press XMIT.
- e. When SG\$DMPTD requests ENTER VSN OF INPUT TAPE 2, key in the VSN identified on the second tape. Press XMIT.

Note: This request appears only if you specified multivolume input in step a.

- f. When SG\$DMPTD requests IS INPUT TAPE IN FILE FORMAT? (N, Y), key in N if not in file mode format. Otherwise, key in Y. Press XMIT.
- g. When SG\$DMPTD requests ENTER VSN OF OUTPUT DISK, key in RELxxx, which is the VSN you specified when you prepped the output disk in step 2 of this procedure. Press XMIT.

Note: You can ignore any error messages for the \$IMPL, \$IPL, and \$VTOC files that can be displayed when SG\$DMPTD starts.

If you received a tape in file mode format, after you restore the tape successfully, you must run PRPMIC to place the IMPL and IPL codes in their correct positions.

The following is a sample execution of disk prep:

```
1. // JOB PREP
2. // DVC 20 // LFD PRNTR
3. // DVC 50,100
4. // VOL Newvol (NOV)
5. // LFD DISKIN
6. // DVC RES
7. // LBL $$$SDF
8. // LFD $$$SDF
9. // EXEC DSKPRP
10. /$
11.     SERNR=RELxxx,TRCON=D,IPLDK=Y,
12.     PREPT=C,ILOPT=Y
13. VOL 1
14. INSERT     NONE
15. /*
16. /&
```

Explanation:

Line 3: The number 100 specifies the device address of the 8417 integrated disk. If you are prepping any disk other than this one, you must replace 100 with the appropriate device address.

Lines 6-8: This DVC-LFD sequence identifies the system definition file, \$\$\$SDF, used for building the IMPL records on the disk you're prepping.

Line 11: SERNR=RELxxx specifies the volume serial number of your output disk, where xxx is the release level. Refer to the documentation accompanying your software release if you are uncertain of the level of your release. TRCON=D specifies that you're updating the track condition table of a disk that has been prepped before. If your output disk has never been prepped, specify TRCON=N to create a new track condition table.

Line 14: The entry NONE in the INSERT statement indicates there are no known bad tracks on your output disk. If there are known defective tracks on your output disk, use INSERT control statements to specify the hexadecimal addresses of these tracks.

2.3. Post-Software Installation Procedures

After you install all your OS/3 release software, perform the procedures described in 2.3.1. through 2.3.7 in the sequence presented.

2.3.1. Updating the System Definition File (SDF)

If you installed either updated OS/3 software or an SMP, you might need to update the system definition file `$$SDF`, which contains the names of the microcode associated with all the devices in the system. Microcode names in `$$SDF` must match the names of the actual microcode in the system microcode file, `$$MIC`. If the names and the actual microcode do not match, you must update `$$SDF` to reflect the actual microcode that the system contains.

When Unisys delivers the system, `$$SDF` contains the microcode names for microcode in `$$MIC` for:

- A model 4 or 8 central processing unit
- A data bus test (DBUS) (models 3 thru 6 only)
- A disk cache program (models 3 thru 6, and 8 thru 20)
- The console/workstation (models 3 thru 6 only)
- One other local workstation

However, if your system includes any of the following devices, you must update `$$SDF` after you install an updated OS/3 release or SMP. This update is necessary because, even though the installation processes add the microcode for those devices to `$$MIC`, they don't automatically place the names of that microcode in `$$SDF`. Therefore, the microcode names in `$$SDF` do not match the actual microcode in `$$MIC`.

The devices for which you must update `$$SDF` are:

- A model 6 central processing unit
- An integrated disk channel (IDC) and integrated disk control unit (IDCU)
- An input/output microprocessor (IOMP)
- Any workstations other than the console/workstation plus one more
- Any 0789 remote printer
- Any single-line communications adapter
- Any streaming tape

The documentation that accompanies an OS/3 release informs you if the release changes the microcode in \$Y\$MIC; the document that accompanies an SMP gives this information concerning SMPs.

If the system includes a model 6 central processing unit (CPU), you must update \$Y\$SDF to include the CPU initial microprogram load code (IMPL) for that processor. If your system includes an input/output microprocessor (IOMP), you must update \$Y\$SDF to include not only CPU IMPL code, but also IOMP and DBUS microcode. If your system includes an integrated disk channel and integrated disk control unit (IDC/IDCU), you must update \$Y\$SDF to include not only CPU IMPL code, but also IDC, IDCU, and DBUS microcode. (CPU, IOMP, IDC, IDCU, and DBUS are types of IMPL code.)

To update \$Y\$SDF, Unisys supplies the system definition utility (SDU). SDU can run \$Y\$SDF at a workstation/terminal. If you are a model 8 thru 20 user without a workstation, a similar product, XSDU, can run from your system console. XSDU communicates with you through console statements.

XSDU is a console version of SDU, but with *limited* capabilities in working with \$Y\$SDF. You can use this version only in systems that do not have a workstation/terminal.

After a system is configured with a workstation/terminal and you use SDU, do not attempt to use XSDU. Once SDU invokes full functionality and sets up keys for search fields, XSDU cannot satisfy the search request for these entries.

This subsection describes how to use both products but is primarily oriented to the SDU user. Specific references to XSDU are limited to critical differences. If you are running XSDU, you can assume most workstation references also apply to the console. The differences between SDU screens and XSDU console statements are self-explanatory at execution and therefore are not detailed here.

SDU provides three functions that let you:

- Add a new device to \$Y\$SDF
- Delete an existing device from \$Y\$SDF
- Update information for an existing device in \$Y\$SDF

SDU also has print and display capabilities that let you print the contents of \$Y\$SDF on your system printer or display its contents on your workstation. By checking the contents of \$Y\$SDF both before and after you perform one of the update functions, you can be sure that you properly updated \$Y\$SDF.

You can also display the contents of \$Y\$MIC at your workstation. \$Y\$MIC contains the information that SDU asks from you concerning the microcode in your system.

Whenever you update `$$SDF` to include IMPL code, you must also place the microcode in the correct position on the SYSRES disk so that you can later perform initial microprogram load code procedures. To place the microcode in the IMPL area on your SYSRES, SDU automatically schedules a prefiled job control stream called PRPMIC. Then SDU terminates itself.

If you are updating `$$SDF` to include any type of IMPL code, both SDU and PRPMIC must terminate before you can proceed with system installation. (SDU can only be run from a workstation.)

The actual updating of `$$SDF` is made up of several steps that are shown in Figure 2-8. The first step you must perform is to display the contents of `$$MIC` to review the microcode applicable to your system. This review provides you with information that SDU specifically asks as input when updating `$$SDF`.

Next, you must review the contents of `$$SDF` and compare it to the contents of `$$MIC` to determine which entries in `$$SDF` you must update (add, delete, or modify). After determining what to update, select the appropriate SDU update procedure and proceed to update the contents of `$$SDF`. When completed, review the contents of `$$SDF` to confirm that the file was updated correctly.

Once you have made certain that the microcode names in `$$SDF` now match the actual microcode in `$$MIC`, you can terminate SDU. If you added IMPL code to `$$SDF`, SDU automatically runs PRPMIC to place the microcode in the correct position on the SYSRES disk. At this point you must perform initial microprogram load (IMPL) and initial program load (IPL) procedures. Then the system is ready for use.

The 8416, 8417, 8418, 8419, and 8470 disks and the 3561 and 3612 (1122) workstations use loadable control units and require entries in `$$SDF` and loadable code in `$$MIC`. These devices can be loaded in two ways:

1. Disk control units loaded during IPL

If a disk is prepped as an IMPL/IPL device, the control unit loads itself from the disk prior to completing the IPL process.

2. Disk and workstation control units loaded during system initialization

If the control unit is not used in the IMPL/IPL load path, it is downline loaded from the processor during system initialization.

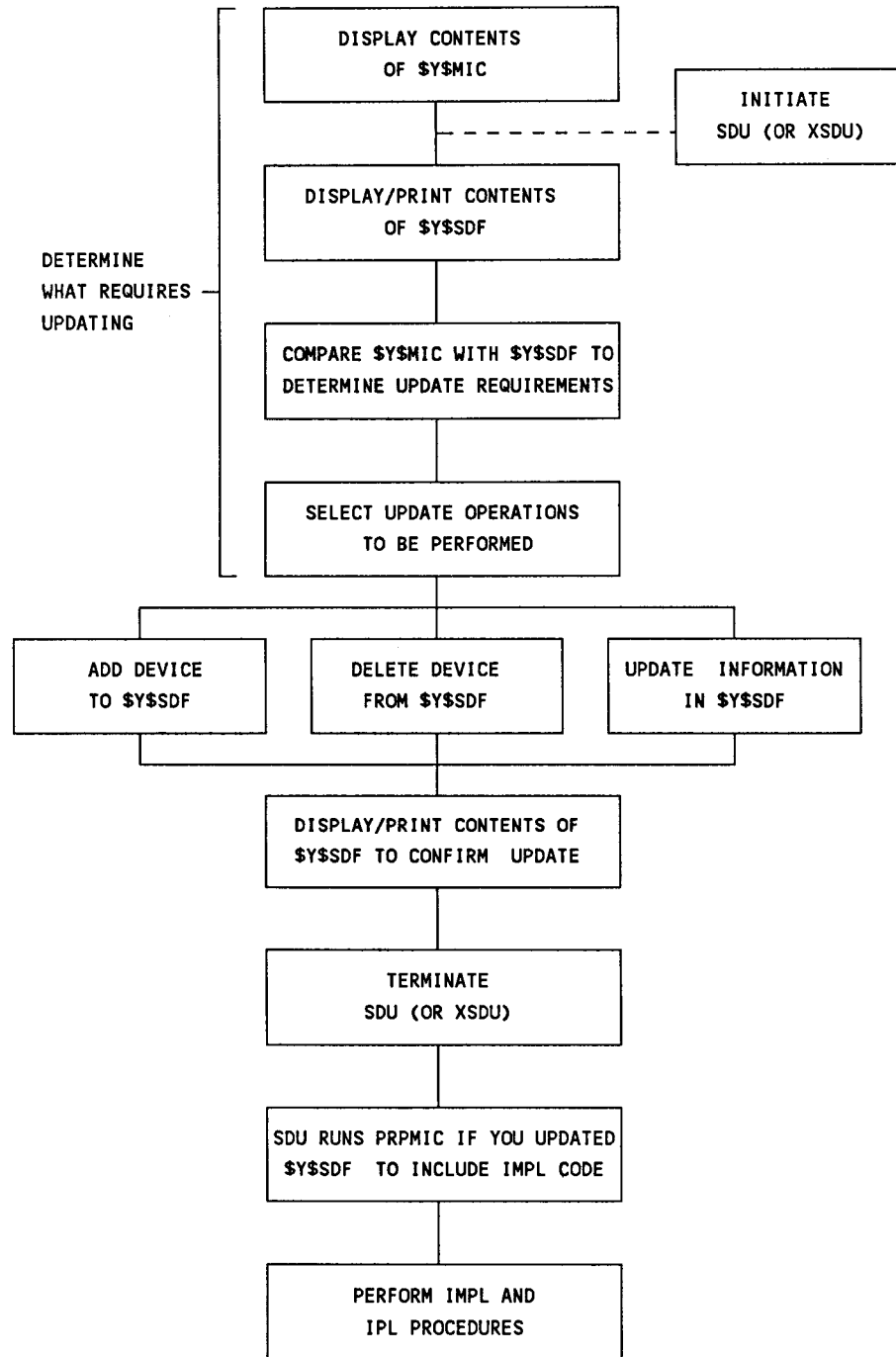

Figure 2-8. Updating \$Y\$SDF

The procedures for updating `Y$SDF` are presented in the following order:

1. Determining what to update by reviewing the contents of `Y$MIC` and `Y$SDF`
2. Adding a device to `Y$SDF`
3. Deleting a device from `Y$SDF`
4. Updating existing device information in `Y$SDF`
5. Confirming that `Y$SDF` is updated correctly
6. Performing IMPL and IPL procedures

Notes:

1. *With the exception of those messages included here, the System Messages Reference Manual, UP-8076, describes all messages concerning this procedure in the section on unprefixed messages.*
2. *To perform this procedure, we assume that the system is operating under the control of either the starter supervisor or one that you generated yourself.*

Determining What to Update by Reviewing `Y$MIC` and `Y$SDF`

1. At your workstation in system mode, key in:

```
FSTAT ,Y$MIC,RES
```

Then press XMIT. The contents of `Y$MIC` are displayed at your workstation.

2. Record the following information:
 - Microcode name
 - Microcode device
 - Microcode type (Refer to the documentation accompanying your release software for the microcode type.)

SDU will request this information from you later.

3. Key in SDU (or XSDU if you are a model 8 thru 20 user with no workstation), then press XMIT. The operation request screen (Figure 2-9) appears at the workstation.

```

SYSTEM DEFINITION UTILITY
ENTER THE OPERATION TO BE PERFORMED: ( )

1. ADD A DEVICE TO THE $$$SDF FILE.      6. PRINT THE $$$SDF FILE.
2. DELETE A DEVICE FROM THE $$$SDF      7. DUMP THE $$$SDF FILE.
   FILE.
3. UPDATE A DEVICE IN THE $$$SDF        8. RESTORE THE $$$SDF
   FILE.                                FILE.
4. DISPLAY SELECTED $$$SDF ENTRIES.     9. TERMINATE SDU.
5. DISPLAY ALL $$$SDF ENTRIES.

FUNCTION F1 WILL TERMINATE OPERATION AND RETURN TO
THIS SCREEN.
    
```

Figure 2-9. SDU Operation Request Screen

This screen offers you three choices (selections 4, 5, and 6) for checking the contents of \$\$\$SDF for comparison to \$\$\$MIC.

- Selection number 4, **DISPLAY SELECTED \$\$\$SDF ENTRIES**, displays only the \$\$\$SDF entries you have selected as shown on the SDU Display Operation Screen (Figure 2-10).

```

                        SDU DISPLAY OPERATION

DEVICE ADDRESS          HHH
TYPE/FEATURE/SELECTION ANNNN-NN
MICROCODE NAME         XXXXXXNN
SERIAL NUMBER          XXXXXXXX
UNIQUE ID              XXXXXXXXXXXXXXXX
FCO LEVEL              ANNNN-NNN
NOTES                  XXXXXXXXXXXXXXXX
PCA PART NUMBER        NNNNNNN-NNN
PROM KIT NUMBER/FCO LEVEL NNNNNNN-NN NNNN-NNN

PRESS TRANSMIT TO CONTINUE.
    
```

Figure 2-10. SDU Display Operation Screen

where:

A=alphabetic, N=numeric, X=alphanumeric, H=hexadecimal

- Selection number 5, **DISPLAY ALL \$\$\$SDF ENTRIES**, displays each entry in the \$\$\$SDF file. Refer to Figure 2-10 for the display screen format.

- Selection number 6, PRINT THE \$Y\$SDF FILE, prints the entire contents of \$Y\$SDF on the system printer as shown in Figure 2-11.

DEVICE ADDRESS	TYPE FEATURE	MICROCODE NAME	SERIAL NUMBER	UNIQUE ID	FCO LEVEL	NOTES
XXXX	ANNNN-NN	XXXXXXXXNN	XXXXXXXXXX	XXXXXXXXXXXXXXXXXX	ANNNN-NNN	XXXX
PCA NUMBER		PROM KIT NUMBER		PROM KIT FCO		
NNNNNNN-NNN		NNNNNNN-NN		NNNN-NNN		

Figure 2-11. Sample \$Y\$SDF Printer Output

4. Key in 4, then press XMIT if you want to display particular entries in \$Y\$SDF. Otherwise, proceed to the next step.

A screen listing all the entries in \$Y\$SDF appears. Key in an X next to the entries you wish to display. If all the \$Y\$SDF entries do not fit on one screen, press XMIT to display additional screens until all the available entries are listed.

After all the entries selected are displayed, the dialog returns to the SDU operation request screen.

5. Key in 5, then press XMIT if you want to display the entire contents of \$Y\$SDF; otherwise, proceed to the next step.

The display entry screen appears for each entry in \$Y\$SDF. After all the entries have been displayed, the dialog returns to the operation request screen.

6. Key in 6, then press XMIT if you want to print the entire contents of \$Y\$SDF; otherwise, proceed to the next step.

When printing is complete, the SDU operation request screen appears.

7. Compare the contents of \$Y\$SDF (obtained in step 4, 5, or 6) with the contents of \$Y\$MIC (obtained in step 2). From this comparison, determine which entries must be updated in \$Y\$SDF.

If no update is necessary, terminate SDU by keying in 9 and pressing XMIT. If \$Y\$SDF requires updating, proceed to the next step.

8. Determine from the options listed in the SDU operation request screen which function you want to perform. If you want to add, update, or delete a device from \$Y\$SDF, proceed to the appropriate procedure following in this subsection.

Adding a Device to \$Y\$SDF

Note: Do not perform the following procedure unless you have completed the previous procedure on reviewing the contents of \$Y\$MIC and \$Y\$SDF or are continuing from one of the other \$Y\$SDF update procedures.

1. Key in 1 on the SDU operation request screen, then press XMIT. SDU displays the following message:

```
IS DEVICE TO BE ADDED FOR AN IMPL DEVICE?(Y,N)
```

If your response to this message is N and your system is a model 8 thru 20, the following add screen (Figure 2-12) appears:

```

SDU ADD OPERATION

ENTER NEW INFORMATION
(A=ALPHABETIC N=NUMERIC X=ALPHANUMERIC H=HEXADECIMAL Z=OPTIONAL NUMERIC)

DEVICE ADDRESS (HHH) _____
TYPE/FEATURE (TNNNN-NN, FNNNN-NN, _____
WSC-ZZ, STCU-ZZ, IDCU-NN BPU-ZZ, SVP-ZZ, OR IOMP-ZZ)
MICROCODE NAME (XXXXXXNN) _____
SERIAL NUMBER (XXXXXXXX) _____
UNIQUE ID (XXXXXXXXXXXXXXXX) _____
FCO LEVEL (ANNNN-NNN) _____
NOTES (XXXXXXXXXXXXXXXX) _____
PCA PART NUMBER (NNNNNN-NNN) _____
PROM KIT NUMBER/FCO LEVEL (NNNNNN-NN NNN-NNN) _____
    
```

Figure 2-12. SDU Add Screen for Non-IMPL Devices on Models 8 thru 20

If your response to this message is N and your system is not a model 8 thru 20, the following non-IMPL add screen (Figure 2-13) appears.

```

SDU ADD OPERATION

ENTER NEW INFORMATION
(A=ALPHABETIC N=NUMERIC X=ALPHANUMERIC H=HEXADECIMAL Z=OPTIONAL NUMERIC)

DEVICE ADDRESS (HHH) _____
TYPE/FEATURE (TNNNN-NN, FNNNN-NN,
WSC-ZZ, STCU-ZZ, OR RPI-ZZ) _____
MICROCODE NAME (XXXXXXNN) _____
SERIAL NUMBER (XXXXXXXX) _____
UNIQUE ID (XXXXXXXXXXXXXXXX) _____
FCO LEVEL (ANNNN-NNN) _____
NOTES (XXXXXXXXXXXXXXXX) _____
PCA PART NUMBER (NNNNNNN-NNN) _____
PROM KIT NUMBER/FCO LEVEL (NNNNNNN-NN NNNN-NNN) _____
    
```

Figure 2-13. SDU Add Screen for Non-IMPL Devices on Models 3 thru 6

If your response to this message is Y, the following IMPL add screen (Figure 2-14) appears:

```

SDU ADD OPERATION

ENTER NEW INFORMATION
(A=ALPHABETIC N=NUMERIC X=ALPHANUMERIC Z=OPTIONAL NUMERIC)

DEVICE ADDRESS _____ IMPL
TYPE/FEATURE (CPU-NN, DBUS-ZZ, IOMP-ZZ,
CACH-ZZ, IDC-ZZ, IDCU-NN, OR CAC8-ZZ) _____
MICROCODE NAME (XXXXXXNN) _____
SERIAL NUMBER (XXXXXXXX) _____

UNIQUE ID (XXXXXXXXXXXXXXXX) _____
FCO LEVEL (ANNNN-NNN) _____
NOTES (XXXXXXXXXXXXXXXX) _____
PCA PART NUMBER (NNNNNNN-NNN) _____
PROM KIT NUMBER/FCO LEVEL (NNNNNNN-NN NNNN-NNN) _____
    
```

Figure 2-14. SDU Add Screen for IMPL Devices on all Models

2. Enter the appropriate device identifiers in the formats shown on the add screen. The device address, type/feature, and microcode name are the only required entries; all other entries are optional. If you are specifying a type/feature value of WSC-ZZ, STCU-ZZ, IDCU-NN, or RPI-ZZ, the last digit of the device address must be 0. If you are specifying a type/feature value of BPU-ZZ, SVP-ZZ, or IOMP-ZZ on models 8 thru 20, the device address must be 001.

Notes:

- *If you keyed in an address of a device that already exists in \$Y\$SDF, the following message appears and SDU returns to the SDU operation request screen:*

ENTRY ALREADY EXISTS IN \$Y\$SDF, USE UPDATE OPERATION

- *If you keyed in the address for a device not configured in your system, SDU displays the message:*

DEVICE NOT CONFIGURED, DO YOU WISH TO CONTINUE? (Y,N)

To continue the procedure, key in Y, then press XMIT. If you don't want to continue the dialog, key in N, then press XMIT. The SDU operation request screen is redisplayed.

- *If you keyed in the address for a device that is configured but is nonloadable, SDU displays the message:*

DEVICE NOT LOADABLE, DO YOU WISH TO CONTINUE? (Y,N)

To continue the procedure, key in Y, then press XMIT. If you don't want to continue the dialog, key in N, then press XMIT. The SDU operation request screen is redisplayed.

- *If you keyed in a microcode name that is not contained in \$Y\$MIC, SDU displays the following message:*

MICROCODE NAME NOT FOUND IN \$Y\$MIC, ADD AS SHOWN? (Y/N)

Key in Y to add the entry to \$Y\$SDF. Otherwise, key in N to change the microcode name. Press XMIT to continue with the SDU operation request screen.

3. After you complete the insertions on the add screen, press XMIT. The SDU operation request screen is redisplayed.
4. If you want to add another device to \$Y\$SDF, repeat steps 1 through 3 of this procedure.
5. If you want to perform one of the other SDU functions listed on the operation request screen, refer to the appropriate procedure.

Deleting a Device from \$Y\$SDF

Note: *Do not perform the following procedure unless you have completed the procedures to review the contents of \$Y\$MIC and \$Y\$SDF or are continuing from one of the other \$Y\$SDF update procedures.*

1. Key in 2 on the SDU operation request screen, then press XMIT. SDU displays a listing of all the entries in \$Y\$SDF. Enter an X next to each entry you wish to delete.

Post-Software Installation Procedures

If all the entries do not fit on one screen, press XMIT to display additional screens until all the entries are shown.

- Each entry you select for deletion appears in the following delete screen (Figure 2-15) format:

SDU DELETE OPERATION	
DEVICE ADDRESS	HHH
TYPE/FEATURE	ANNNN-NN
MICROCODE NAME	XXXXXXXX
SERIAL NUMBER	XXXXXXXX
UNIQUE ID	XXXXXXXXXXXXXXXX
FCO LEVEL	ANNNN-NNN
NOTES	XXXXXXXXXXXXXXXX
PCA PART NUMBER	NNNNNNN-NNN
PROM KIT NUMBER/FCO LEVEL	NNNNNNN-NN NNNN-NNN

IS THIS THE ENTRY YOU WISH TO DELETE

—

Figure 2-15. SDU Delete Operation Menu

Respond with Y to delete the entry or N to leave it alone.

- After all the entries you selected for deletion have been displayed, the dialog returns to the SDU operation request screen.
- If you want to perform one of the other SDU functions listed on the SDU operation request screen, refer to the appropriate procedure.

Updating Existing Device Information in \$Y\$SDF

Note: Do not perform this procedure unless you have completed the procedures to review the contents of \$Y\$MIC and \$Y\$SDF or are continuing from one of the other \$Y\$SDF update procedures.

- Key in 3 on the SDU operation request screen, then press XMIT. SDU displays a listing of the entries in \$Y\$SDF. Enter an X next to each entry you wish to update. If all the entries do not fit on the first screen, press XMIT to display additional screens until all the entries are shown.
- Each entry you select to update appears in the following update screen (Figure 2-16) format:

```

SDU UPDATE OPERATION

ENTER NEW INFORMATION (A=ALPHABETIC  N=NUMERIC  X=ALPHANUMERIC  H=HEXADECIMAL)

DEVICE ADDRESS _____
TYPE/FEATURE _____
MICROCODE NAME (XXXXXXXXNN) _____
SERIAL NUMBER (XXXXXXXX) _____
UNIQUE ID (XXXXXXXXXXXXXXXX) _____
FCO LEVEL (ZNNNN-NNN) _____
NOTES (XXXXXXXXXXXXXXXX) _____
PCA PART NUMBER (NNNNNN-NNN) _____
PROM KIT NUMBER/FCO NUMBER (NNNNNN-NN NNNN-NNN) _____
    
```

Figure 2-16. SDU Update Operation Menu

You can update any information except the device address and type/feature fields.

You specify a cache buffer size to be auto-allocated during disk cache initialization by updating the microcode name for the cache entry. To do so, select the appropriate cache entry on the update menu: CAC8 (type/feature) for models 8 thru 20 or CACH for models 4 thru 6.

Change the microcode name from CAxx0000 to CAxxnnnn, where xx is the cache version number (for example, 11 or 12), and nnnn is the cache buffer size in 1024 byte blocks. The allowable values for nnnn are identical to those that can be specified at IPL time.

For example, if CA13000 is the microcode name for the cache entry and a 512K cache buffer size is required, update the microcode name to CA130512.

Note: The specified cache buffer size is used regardless of which supervisor is used.

If you updated the microcode name, the \$Y\$MIC file is searched for the new microcode name. If it is not found, the following message appears:

```
MICROCODE NAME NOT FOUND IN $Y$MIC, UPDATE AS SHOWN (Y/N)
```

Respond with Y to update the entry. Respond with N to change the microcode name. Press XMIT to continue with the update function.

3. After all the entries selected for update have been displayed, the dialog returns to the SDU operation request screen.
4. If you want to perform one of the other SDU functions listed on the SDU operation request screen, refer to the appropriate procedure.

Confirming \$Y\$SDF

Note: This procedure is performed after you have completed the \$Y\$SDF add, delete, or update procedures.

1. Key in 5 or 6 on the SDU operation request screen, then press XMIT. SDU displays or prints (based upon your entry) the entire contents of \$Y\$SDF.
2. Check the current entries in \$Y\$SDF to make sure that you performed the update properly.
3. If \$Y\$SDF is not properly updated, repeat the appropriate update procedure.
4. If \$Y\$SDF is properly updated, key in 9 and press XMIT to display the SDU termination screen (Figure 2-19 for models 3 thru 6, Figure 2-20 for models 8-20).

Dumping \$Y\$SDF

1. Key in 7 on the SDU operation request screen, then press XMIT. The following dump screen (Figure 2-17) appears:

```
SDU DUMP OPERATION

SDU WILL TERMINATE AND SCHEDULE JOB SDFSAVE TO DUMP THE $Y$SDF FILE.
ENTER DEVICE TYPE AND VSN OF THE OUTPUT DEVICE.

DEVICE TYPE _          VSN _____

1. DISKETTE
2. TAPE
3. DISK
```

Figure 2-17. SDU Dump Operation Menu

2. Key in the type and volume serial number of the output device that is to receive the \$Y\$SDF dump.
3. Press XMIT. SDU schedules SDFSAVE and automatically continues with the termination screen (Figure 2-19 for Models 3 thru 6, Figure 2-20 for models 8-20).

Note: For a description of SDFSAVE, see 2.3.2.

Restoring \$\$\$SDF

1. Key in SDU, then press XMIT. The SDU operation request screen appears at the console/workstation.
2. Key in 8 on the SDU operation request screen, and press XMIT. The following restore screen (Figure 2-18) appears:

```

                                SDU RESTORE OPERATION

SDU WILL TERMINATE AND SCHEDULE JOB SDFSAVE TO RESTORE THE $$$SDF FILE.
ENTER DEVICE TYPE AND VSN OF THE INPUT DEVICE.

DEVICE TYPE _                VSN   _____

1.  DISKETTE
2.  TAPE
3.  DISK
    
```

Figure 2-18. SDU Restore Operation Menu

3. Key in the type and volume serial number of the input device that \$\$\$SDF is to be restored on.
4. SDU schedules SDFSAVE and the dialog automatically continues with the termination screen (Figure 2-19 for models 3 thru 6, Figure 2-20 for models 8 thru 20).

Note: For a description of SDFSAVE, see 2.3.2.

Terminating SDU

Note: If you have initiated a dump or restore operation, proceed to step 2.

1. Key in 9 on the SDU operation request screen. Then press XMIT.
2. If your system is a model 3 thru 6 and you have added or updated an IMPL entry, the following termination screen (Figure 2-19) appears:

```

                                SYSTEM DEFINITION UTILITY

SDU WILL SCHEDULE JOB PRPMIC.
ENTER VSN OF DISK TO BE PREPPED.
VSN   _____
    
```

Figure 2-19. SDU Termination Screen for Models 3 thru 6

Post-Software Installation Procedures

Enter the volume serial number of the disk to be prepped, press XMIT, and SDU terminates.

If your system is a model 8 thru 20, and the IDCU microcode was updated for the SYSRES, the following termination screen (Figure 2-20) appears:

```

                SYSTEM DEFINITION UTILITY

SDU WILL SCHEDULE JOBS PRPMIC AND IMPLDSKT.
PRESS TRANSMIT TO TERMINATE SDU.
```

Figure 2-20. SDU Termination Screen for Models 8 thru 20

Press XMIT and SDU terminates.

Note: *If PRPMIC terminates with errors, reinitiate the job yourself by keying in the following and then pressing XMIT:*

```
RV PRPMIC,,V=vsn1
```

where:

```
vsn1
```

Is the volume serial number of your SYSRES disk.

3. For all models, after the message SDU TERMINATED NORMALLY appears, continue with the following IMPL and IPL procedures.

Performing IMPL and IPL Procedures

After you have finished updating \$Y\$SDF, you must perform initial microprogram load (IMPL) code and initial program load (IPL) code procedures to continue with system installation. Perform the following steps for the particular model you are using:

For models 3 thru 6:

1. Press and hold FUNCTION and press the D key to enter control mode.
2. Press and hold FUNCTION and press the IMPL key.
3. When you see the message IMPL=CDD?, press XMIT to accept the default SYSRES device address. Otherwise, key in the device address (did) of your SYSRES disk and press XMIT.

4. One of the following three messages then appears on the screen:

- If the message IPL=CDD? appears, press XMIT to accept the default SYSRES device address or key in the device address of your SYSRES (same as in step 3) and press XMIT. Then, go to step 5.
- If the message IOML=CDD? appears, press XMIT to accept the default SYSRES device address or key in the device address of your SYSRES (same as in step 3), and press XMIT. When the IPL=CDD? message appears, press XMIT to accept the default SYSRES device address or key in the device address of your SYSRES and press XMIT. Then, go to step 5.
- If the message IDCL=CDD? appears, press XMIT to accept the default SYSRES device address or key in the device address of your SYSRES (same as in step 3), and press XMIT. When the IDCUL=CDD? message appears, press XMIT to accept the default SYSRES device address or key in the device address of your SYSRES and press XMIT. When the IPL=CDD? message appears, press XMIT to accept the default SYSRES device address or key in the device address of your SYSRES and press XMIT. Then, go to step 5.

5. When you see the message IPL01 KEY IN AND TRANSMIT, key in:

```
SY@BAS,s,did
```

where:

SY@BAS

Specifies the starter supervisor.

s

Specifies the option for loading a supervisor.

did

Specifies the device address of your SYSRES disk.

Note: *Device address (did) values are site dependent and are configured when your hardware is installed.*

6. Press XMIT.

Note: *At this point, you can receive a series of messages MICROCODE NAME NOT AVAILABLE FOR DEVICE xxx (where xxx is a device address). These messages are generated because SY@BAS supports devices that are not configured in your system and therefore do not have entries in the system definition file. Ignore these messages and proceed with the next step.*

Post-Software Installation Procedures

7. Press and hold FUNCTION and press the C/CSL key.
8. When your system displays the message *****OS/3 VERSION nn ***** and **DATE?** YY/MM/DD, key in today's date (year, month, day) and press XMIT.
9. The date entered is compared to the date keyed in at the last IPL from the same SYSRES. If the entered date is six days less than or six days greater than the date of the last load, the message **DATE QUESTIONABLE** appears. If the date entered is correct, press XMIT and the date is accepted. If the date is incorrect, key in the correct date.
10. When your system displays the message **TIME? (HH/MM/SS)**, key in the present time (hours, minutes, seconds) and press XMIT.
11. From this point on, your system asks you questions that ordinarily let you accept or change supervisor options that you specified during SYSGEN. Since you have not yet performed SYSGEN, simply accept the default values for all these requests. Press the RETURN key after each request.

Note: The first time you perform an IPL, respond N for no to your system's request concerning job queue recovery. Failure to do so will cause errors during the IPL process.

12. Press XMIT only after you respond to all requests.
13. After a short wait, the system displays header messages indicating available job slots, OS/3 version number, supervisor name, date, and time. The system is now ready for you to perform your next installation task - performing other post-installation tasks, installing optional software, or performing system generation.

Note: If you are not installing optional software or generating your own supervisors, your system is now ready for use.

For models 8 thru 20:

1. Press the IMPL switch down (toward the AUTO position) and release it. When the SEQ1, SEQ2, and SEQ3 lights go off, the IMPL procedure is complete.
2. Press ESC, then press the M key. The following screen (Figure 2-21) appears:

```

ENTER.

PROG ICAD(0-BFF)          CONTROL
N  NORMAL                U  RUN
C  CLEAR                  Q  STOP
G  NORMAL (NO RESET)
R  OPER RECOVERY(0-BFF)  RESET
                              L  SYSTEM
                              B  BPU

ADR STOP(0-FFFFFFF)      COMPUTE CTRL
M  NORMAL                P  NORMAL
I  STOP IA                S  STEP
A  STOP ANY

                              CHECK CTRL
T  TRACE                  H  NORMAL
                              K  STOP

W  SENSE SW(0000-1111)   V  STORE STATUS
  -0000-
    
```

Figure 2-21. System Operations Menu

3. Press the L key (SYSTEM) and then press XMIT to reset the system. The screen continues to be displayed.
4. Press the N key (NORMAL) and enter the device address (did) of the IPL disk.
5. Press XMIT.
6. When you see the message IPL01 KEY IN AND TRANSMIT, key in:

```

SY#BAS,S,did
  or
SY$BAS,S,did
    
```

where:

SY#BAS
Specifies the starter supervisor for model 8.

SY\$BAS
Specifies the starter supervisor for models 10 thru 20.

S
Specifies the option for loading a supervisor.

did
Specifies the device address of your SYSRES disk.

7. Press XMIT.
8. The following date/time screen (Figure 2-22) appears:

```
A) DATE: YY/MM/DD                TIME HH:MM:SS
B) RUN LIBS DVC ADDR: XXX (SYSRES)
C) FILE RECOVERY
   JOB QUEUE (N,Y,H      DEFAULT=N)
   ERROR LOG (N, Y      DEFAULT=Y)
   SPOOL FILES (N,A,C,L,H  DEFAULT=N)
D) MODIFY SUPERVISOR: DEFAULT=N
E) SPOOLING DVC ADDR: XXX (SYSRES)
F) DUMP FILE DVC ADDR? (DEFAULT=XXXXXX) ____

TRANSMIT TO ENTER DEFAULTS. OTHERWISE ENTER THE LETTERS OF THE PARAMETER(S)
TO BE CHANGED.
```

Figure 2-22. System Date/Time Display

Press XMIT to accept the defaults supplied by the system.

9. After a short wait, the system displays header messages indicating OS/3 version number, supervisor name, date, and time. The system is now ready for you to perform your next installation task - either installing optional software or performing system generation.

Note: If you are not installing optional software or generating your own supervisor, your system is now ready for use.

2.3.2. Copying and Restoring \$Y\$SDF

If you are installing a new release, you can make a copy of your old \$Y\$SDF file and later restore it to your new SYSRES with the job stream SDFSAVE. This job stream lets you copy \$Y\$SDF from your old SYSRES to any of the following types of media:

- Single-sided single-density diskette
- Tape
- Another disk volume (other than your SYSRES)

If you use diskette or tape, SDFSAVE preps the media and allocates a file to contain the copied version of \$Y\$SDF. If you use another disk volume, you must prep this volume and allocate a file for \$Y\$SDF yourself.

After you install your new release, run **SDFSAVE** again to restore **\$Y\$SDF** from the diskette, tape, or disk media to your **SYSRES** volume. You do not have to completely recreate **\$Y\$SDF** each time you install a new release.

To run **SDFSAVE**, mount the media you are copying to or restoring from and enter the following command at your system console:

```
RV SDFSAVE
```

These messages appear on the console screen along with the responses you must enter when running **SDFSAVE**:

- ENTER THE APPROPRIATE FUNCTION (DUMP OR RESTORE)

Enter **DUMP** if you want to make a copy of **\$Y\$SDF** or **RESTORE** if you want to restore **\$Y\$SDF** to your **SYSRES**.

- THEN ENTER THE DEVICE TYPE (DISK, DISKETTE, or TAPE)

Enter the type of media you are copying to or restoring from.

- THEN ENTER THE VOLUME NAME FOR THE GIVEN DEVICE TYPE

Enter the volume serial number of the media you are copying to or restoring from.

- WHEN DUMPING TO TAPE OR DISKETTE THE VOLUME NAME WILL BE USED FOR THE PREP

This is the last message displayed. Respond to it by pressing **XMIT**. **SDFSAVE** then performs the copy or restore function you specified.

2.3.3. Creating an IMPL System Microcode Diskette

On models 3 thru 6:

The **IMPLDSKT** job stream creates an **IMPL** diskette that you can use (in conjunction with other **IMPL** diskettes) to perform an initial microprogram load directly to your system. You should run **IMPLDSKT** each time a new **IMPL** microcode (**DBUS**, **CPU**, **IOMP**, **IDC**, **IDCU**) is added to your system.

To create an **IMPL** diskette, at the system console or workstation, key in:

```
RV IMPLDSKT,,IM=n
```

where:

n

Is the type of microcode to be created. Valid values are **DBUS**, **CPU**, **IOMP**, **IDC**, and **IDCU**. **CPU** is the default.

On the model 8:

The FDD0DSKT job stream creates two identical diskettes that you can mount in the FDD 0# diskette drive to perform an initial microprogram load to your model 8 system. You can use these diskettes as backups to the system IMPL diskette that is sent with the system or plateau level. You must run this job each time you update the \$Y\$SDF file as a result of adding new BPU, SVP, or IOMP microcode to your system. You can then insert one of the diskettes you created in the FDD 0# diskette drive and re-IMPL your system. (See the *Operations Guide*, UP-8859, for the IMPL procedure.)

To create the IMPL diskettes, you must have two single-sided, single-density diskettes. Mount one of the diskettes and enter the following command:

```
RV FDD0DSKT[, , VSN1=xxxxxx, VSN2=xxxxxx]
```

where:

xxxxxx

Specifies the VSN of each diskette. If the diskettes are not prepped, the program supplies default VSNs.

The job creates one IMPL diskette and then displays a mount message requesting another diskette. Remove the first diskette from the drive and mount the second single-sided, single-density diskette. The job then creates a second IMPL diskette.

Note: *You must ensure that the diskettes you use do not have any bad tracks. If the program encounters bad tracks on a diskette, it terminates abnormally and you must use another diskette.*

On models 10 thru 20:

The FDDCOPY job stream creates a microcode diskette that you can mount in the FDD 0# drive and perform an initial microprogram load to the system. You should run this job to create a backup IMPL diskette when one of your IMPL diskettes sent with the system or plateau becomes defective. The IMPL microcode modules (BPU, SVP, IOP, and USEL) are not needed in the \$Y\$SDF and \$Y\$MIC files because the FDDCOPY job does not access these files, but does a direct copy from the FDD 0# drive to the DMUX drive diskette.

To create an IMPL diskette, mount a double-sided diskette and enter the following command:

```
RV FDDCOPY
```

After you respond to the diskette mount message, the job preps the diskette and then copies the FDD 0# diskette to the DMUX diskette. The FDD controller has limited functions when compared to the DMUX diskettes. This results in slower access time. The FDDCOPY job runs in approximately 15 minutes. When the job is finished, you can mount the diskette in the FDD 0# drive and re-IMPL the system.

2.3.4. Creating an IDCU Microcode Diskette on Models 8 thru 20

The IMPLDSKT job stream creates a backup IDCU microcode diskette. Run this job when a new IDCU microcode is added to your system.

To create an IDCU diskette, mount a diskette and enter the following command:

```
RV IMPLDSKT,,CU=n
```

where:

n

Is the control unit address of the IDCU disk. The control unit address must end with zero. For example, the device address of 292 has a control unit address of 290 (CU=290).

2.3.5. Restoring Modules Saved from a Previous Release

If you saved any of your own software on another set of diskettes or on disk before you installed the new release software, copy it back to your updated SYSRES. Use the same system facility that you used originally to prepare the copies of your software.

- Use the system librarians, LIBS and MLIB, to restore your program modules to system libraries (including source modules that contain SYSGEN parameter sets still valid with the updated release). See the *System Service Programs Operating Guide*, UP-8841, for the details to perform this operation.
- Restore your program library files and data files onto SYSRES using the SG@RUFIL job stream described in 3.3.6 for restoring a backup copy of your SYSRES.

2.3.6. Verifying System Installation

To verify that you installed your software correctly and completely, use the installation verification procedures (IVPs). Verify software using the *Installation Verification Procedures Operating Guide*, UP-10003.

Note: *Those IVPs that require specific SYSGEN options will not run until after you generate those options. In these instances, perform the IVPs for those products after system generation.*

2.3.7. Performing System Generation

Before you can use your system effectively, you must make sure that it contains the necessary system control elements to satisfy your processing needs. To generate those elements, use the OS/3 SYSGEN procedures. Section 3 describes the system generation process in detail.



Section 3

System Generation

3.1. Considerations

The OS/3 operating system must contain the necessary system control elements to operate effectively and satisfy your processing requirements. These elements must reflect the system's hardware configuration. To create these elements and to define the system's hardware configuration to OS/3, Unisys provides system generation, or SYSGEN.

SYSGEN lets you generate four types of elements. They are:

1. Supervisor elements
2. Nine-thousand-remote (NTR) elements
3. ANSI '74 or '85 COBOL elements
4. Communications (ICAM) elements

Whichever element you generate, the procedure for performing SYSGEN is the same. Basically, it consists of the following three steps:

1. Preparing the SYSGEN parameter sets
2. Processing the SYSGEN parameter sets
3. Running the SYSGEN job control streams

Perform SYSGEN once for each control element that you want to create, or once to build any combination of the supervisor, NTR, and ANSI '74 or '85 COBOL elements that you want. However, to build an ICAM element, you must perform the three steps of the SYSGEN procedure independently of any other control elements.

SYSGEN is designed this way for two reasons.

First, initial users can build all of their control elements (excluding ICAM) in one SYSGEN operation.

Second, it allows existing users to add control elements, if necessary, whenever they add new components to their systems. Table 3-1 lists all the optional products that OS/3 offers, and indicates which control elements you must generate (or regenerate, if need be) to use these optional products. To use a specific program product or programming aid, each of the four SYSGEN control elements is defined as required (R), not required (NR), or optional (O).

For example, if you just installed the extended system software for the purposes of using spooling and job accounting, you should regenerate the supervisor to support the spooling and job accounting products. However, you are not required to generate any other control elements to use these optional products.

The manuals in the OS/3 library that concern separate, optional components give specific SYSGEN requirements for those products if any specific requirements exist.

After you have completed any SYSGEN operation and before you use the system, you must perform the appropriate post-system generation procedures, described at the end of this section.

Also, if your printer does not have the OS/3 default printer characteristics, you must define its characteristics to the system before you can perform any system generation procedure. See 3.3.3 for a detailed description of the OS/3 default printer characteristics and the procedure for defining alternate printer characteristics.

The first step in performing SYSGEN is preparing the SYSGEN parameter sets. If you are installing a new OS/3 release, you can bypass this step. Remember to save copies of the SYSGEN parameter sets before you install the new software and designate these saved modules as input to the parameter processor. See 3.2.2 for mode information on supplying parameter sets to the parameter processor.

3.1.1. Supervisor Elements

All systems must contain at least one supervisor element. Supervisor elements identify supervisor services and processing options that you want employed in your system, and also describe your system's hardware configuration to the operating system.

Table 3-1. Control Element Generations for Optional Software

OS/3 Optional Products	OS/3 Control Elements			
	Supervisor	ANSI '74 COBOL	NTR	ICAM
Extended System Software (ESS)	R	NR	NR	NR
Data Utility	NR	NR	NR	NR
SORT/MERGE	NR	NR	NR	NR
SORT3	NR	NR	NR	NR
Spool/Job Accounting	R	NR	NR	NR
Screen Format Generator (SFG)	NR	NR	NR	NR
Dialog Specification Language Translator (DSLTL)	NR	NR	NR	NR
IMS - Singlethread*	R	NR	NR	R
IMS - Multithread*	R	NR	NR	R
DMS	NR	NR	NR	NR
RPG Group	NR	NR	NR	NR
RPGII	NR	NR	NR	NR
RPGEDIT	NR	NR	NR	NR
RPG Auto Report	NR	NR	NR	NR
COBOL-'74	NR	O	NR	NR
COBOL-'85	NR	O	NR	NR
COBOL Editor	NR	NR	NR	NR
FORTRAN IV TM	NR	NR	NR	NR
FORTRAN 77	NR	NR	NR	NR
Pascal	NR	NR	NR	NR
BASIC	NR	NR	NR	NR
ESCORT TM	NR	NR	NR	NR
MAPPER ^R 80	NR	NR	NR	NR

* If you installed IMS, you must perform an IMSGEN as a post-SYSGEN procedure.
See the IMS System Support Functions Programming Guide, UP-11907.

LEGEND:

NR = not required
R = required
O = optional

continued

ESCORT is a trademark of Unisys Corporation.
FORTRAN IV is a registered trademark of SuperSoft Associations.

Table 3-1. Control Element Generations for Optional Software (cont)

OS/3 Optional Products	OS/3 Control Elements			
	Supervisor	ANSI '74 COBOL	NTR	ICAM
Editor	NR	NR	NR	NR
Menu Generator	NR	NR	NR	NR
Assembler	NR	NR	NR	NR
SORT/MERGE	NR	NR	NR	NR
SORT3	NR	NR	NR	NR
ICAM-TSF	R	NR	NR	R
NTR	R	NR	NR	R
DCA Termination Systems	R	NR	NR	R
IBM ^R 3270 RDH	R	NR	NR	R
IBM 3270 Emulator	R	NR	NR	R
RTP (HASP) Facility	R	NR	NR	R
DATEX-L PDN Support	R	NR	NR	R
DATEX-P	R	NR	NR	R
TRANSPAC	R	NR	NR	R
DATAPAC	R	NR	NR	R
DDX-P	R	NR	NR	R
NORDIC-PDN	R	NR	NR	R
IBERPAC	R	NR	NR	R
PSS PDN	R	NR	NR	R
DDP Transfer Facility	R	NR	NR	R
DDP File Access	R	NR	NR	R
DDP IMS Transaction Processor	R	NR	NR	R
Conversion Aids	NR	NR	NR	R

Legend:

- NR = not required
- R = required
- O = optional

continued

IBM is a registered trademark of International Business Machines Corporation.

Table 3-1. Control Element Generations for Optional Software (cont)

OS/3 Optional Products	OS/3 Control Elements			
	Supervisor	ANSI '74 COBOL	NTR	ICAM
UTS400 L/D Terminal Package	R	NR	NR	R
UTS400 COBOL	R	NR	NR	R
UTS400 Edit Processor	R	NR	NR	R
System Activity Monitor	R	NR	NR	R
On-line Diagnostics	NR	NR	NR	R

LEGEND:

NR = not required

R = required

O = optional

Supplied Starter Supervisors

OS/3 supplies a starter supervisor, SY@BAS for models 3 thru 6, SY#BAS for model 8, and SY\$BAS for models 10 thru 20, as part of the system control software. This starter supervisor satisfies most System 80 user processing needs. It eliminates the need to perform a SYSGEN operation unless there is a specific reason to do so.

Use the starter supervisor as your operating supervisor and bypass SYSGEN until you are more familiar with OS/3 and have learned which SUPGEN features would improve your system's performance. Then, you can perform SYSGEN to create a supervisor tailored to your specific needs. Remember, even if you do not perform SYSGEN, do the post-generation procedures that apply to you.

Tables 3-2 through 3-4 list for all models:

- The starter supervisor features
- Specific capabilities of the starter supervisors
- The input/output (I/O) device configurations that the starter supervisors support

Note: *When booting starter supervisors SY#BAS and SY\$BAS, the IPL process (when necessary) dynamically reconfigures the SYSRES disk to the proper device type regardless of the PUB specification, provided that a PUB is generated for that address.*

User Generated Supervisors

If you are going to access any devices not included in the I/O configuration supported by SY@BAS, SY#BAS, SY\$BAS, or your present supervisor, you must generate a supervisor to support them. This is accomplished by reconfiguring the I/OGEN to include all devices desired. Also, if your system includes the integrated communications access method (ICAM) terminal support facility or a nine-thousand remote (NTR) system utility, you must generate your own supervisor to support them.

If you use the base supervisor SY#BAS (model 8) or SY\$BAS (models 10 thru 20), do not specify devices for RUN LIBS DEV ADDR or SPOOLING DEV ADDR on the system installation time/date screen if your disks are physically co-channeled 2 and 3 on model 8 or 1 and 2 on models 10 thru 20.

Table 3-2. SY@BAS (Models 3 thru 6)

SUPERVISOR FEATURES	
14 job slots	Spooling*
5 switching priorities	System Activity Monitor
ICAM support of local workstations	Console logging
Job accounting*	Job queue recovery at IPL time
SPECIFIC CAPABILITIES	
Transient areas - 5	Error logging buffers - 5
Max. time (device type) - Wall clock	Max. time - 60 minutes
Resident modules - SM\$LOCK, SM\$STXIT, SM\$TASK, SM\$ASCKE, SM\$ATCH	Dynamically allocated load buffers - 7 blocks
Spool file size* - 100 cylinders	Dynamically allocated load table entries - 7 per job
Spool file bit map* - 128 words	Spool buffer* - 8 blocks
Spool output writer buffer* - 8 blocks	Resident shared code modules - DM\$CFM, D3\$M111, DM\$W111, PR\$IOE
Shared data management modules - 80, 24-byte slots	System security administrator name - SYSADM
Expansion region - 4096 bytes	
I/O DEVICES	
1 - SDMA printer (330)	2 - 8419 disks (106-107)
1 - 0770 printer (331)	4 - 8420 diskette drives (320-323)
1 - 0719 reader (332)	32 - 3560 workstations (310-318, 341-348, 351-358, 361-368)
1 - 0608 punch (333)	2 - UNISERVO [®] 10 magnetic tapes (370-371)
4 - 8417 disks (100-103)	
2 - 8417 fixed-head disks (104-105)	

* Your system disables spooling and job accounting at IPL time if your system does not include them.

UNISERVO is a registered trademark of Unisys Corporation

Table 3-3. SY#BAS (Model 8)

SUPERVISOR FEATURES	
24 job slots	Spooling*
5 switching priorities	System Activity Monitor
ICAM support of local workstations	Console logging
Job accounting*	Job queue recovery at IPL time
SPECIFIC CAPABILITIES	
Transient areas - 5	Error logging buffers - 6
Resident modules - SM\$LOCK, SM\$STXIT, SM\$TASK, SM\$ASCKE, SM\$ATCH	Dynamically allocated load buffers - 7 blocks
Spool file size* - 50 cylinders	Dynamically allocated load table entries - 7 per job
Spool file bit map* - 64 words	Spool buffer* - 8 blocks
Spool output writer buffer* - 8 blocks	Resident shared code modules - DM\$CFM, D3\$M111, DM\$W111, PR\$IOE
Shared data management modules - 80, 24-byte slots	System security administrator name - SYSADM
Expansion region - 4096 bytes	
I/O DEVICES	
1 - SDMA printer (C30)	4 - 8433 disks (380, 381, 280, 281)
7 - 0770 printers (004, 005, 1B0, 1E0, 1F0, 2E0, 2F0)	12 - 8417 disks (3B0-3B5, 2B0-2B5)
1 - 0719 reader (C32)	4 - 8419 disks (3B6, 3B7, 2B6, 2B7)
1 - 0716 reader (006)	4 - 8420/22 diskettes (C20-C23)
16 - 8494 8418 disks (3A0-3A7, 2A0-2A7)	1 - 3560 workstation (C12)
16 - 8470 disks (390-397, 290-297)	1 - 3561 workstation (C18)

* Your system disables spooling and job accounting at IPL time if your system does not include them.

NOTE: All printers are generated with LCB=OWNLC1.

Table 3-4. SY\$BAS (Models 10 thru 20)

SUPERVISOR FEATURES	
24 job slots	Spooling*
5 switching priorities	System Activity Monitor
ICAM support of local workstations	Console logging
Job accounting*	Job queue recovery at IPL time
SPECIFIC CAPABILITIES	
Transient areas - 5	Error logging buffers - 6
Resident modules - SM\$LOCK, SM\$STXIT, SM\$TASK, SM\$ASCKE, SM\$ATCH	Dynamically allocated load buffers - 7 blocks
Spool file size* - 50 cylinders	Dynamically allocated load table entries - 7 per job
Spool file bit map* - 64 words	Spool buffer* - 8 blocks
Spool output writer buffer* - 8 blocks	Resident shared code modules - DM\$CFM, D3\$M111, DM\$W111, PR\$IOE
Shared data management modules - 80, 24-byte slots	System security administrator name - SYSADM
Expansion region - 4096 bytes	
I/O DEVICES	
1 - SDMA printer (C30)	4 - 8433 disks (280, 281, 180, 181)
3 - 0770 printers (390, 2E0, 1E0)	12 - 8417 disks (1B0-1B5, 2B0-2B5)
1 - 0776 printer (3B0)	4 - 8419 disks (1B6, 1B7, 2B6, 2B7)
1 - 0719 reader (C32)	4 - 8420/22 diskettes (C20-C23)
1 - 0716 reader (3A0)	1 - 3560 workstation (C12)
16 - 8494 disks (1A0-1A7, 2A0-2A7)	1 - 3561 workstation (C18)
16 - 8470 disks (190-197, 290-297)	1 - 1122 workstation (C14)

* Your system disables spooling and job accounting at IPL time if your system does not include them.

NOTE: All printers are generated with LCB=OWNLC1.

You can generate any number of supervisor modules for the system, but only four in one SYSGEN operation. No matter how many you generate, you must make sure that you give each one a different name. When you actually begin processing, only one supervisor can be active at one time.

If you don't specify a name for a supervisor module you are generating, the SYSGEN parameter processor assigns it the default name SY\$STD. You should accept this default value for the one supervisor that you expect to use most frequently. Then you won't have to key in the name of your most common supervisor every time you perform an IPL.

The *Supervisor Technical Overview*, UP-8831, fully describes the SYSGEN supervisor options. You should review them thoroughly before generating any supervisor modules.

When you want to delete a supervisor to conserve SYSRES space, use the system librarian (LIBS) delete (DEL) and pack (PAC) functions. See the *System Service Programs Operating Guide*, UP-8841.

When you delete an unwanted supervisor and its associated I/O configuration module, you must also delete the two modules from both the system load code library (\$Y\$LOD) and the system source code library (\$Y\$SRC).

When you delete an unwanted supervisor from \$Y\$SRC, you must prefix the name of the unwanted supervisor with S\$. When you delete the I/O configuration module for an unwanted supervisor from \$Y\$SRC, you must prefix the name of the unwanted I/O module with I\$. For example, if the name of your unwanted supervisor is MYSUP1, specify to the librarian that you want to delete both the supervisor module named S\$MYSUP1 and the I/O module named I\$MYSUP1 from \$Y\$SRC.

3.1.2. Nine-Thousand-Remote (NTR) Element

An NTR element defines a nine-thousand-remote system utility and is required only if the system contains the optional NTR component. This component gives you the capability to use a Unisys System 80 Data Processing System as a remote device to a Unisys 1100 Data Processing System.

An NTR element includes two types of parameters: NTR parameters and LOCAL parameters. NTR parameters define the general characteristics of the NTR element that you are generating. In one SYSGEN, you can prepare only one set of these parameters because they apply to the entire NTR system.

LOCAL parameters define the specific remote device handlers used with the NTR element you are generating. In one SYSGEN, you can include up to 14 sets of LOCAL keywords. Each one is unique but related to the set of NTR parameters that you defined.

For more information about the capabilities and operation of NTR, see the *NTR Utility Programming Guide*, UP-9502, before attempting to generate an NTR element.

3.1.3. COBOL Element

A COBOL element defines processing options for the ANSI '74 or '85 COBOL compiler. You are required to generate one only if two conditions exist:

1. Your system contains an ANSI '74 or '85 COBOL compiler.
2. You want to specify processing options different from the compiler's standard default option values.

By default, the compiler supplies various processing options that create a usable compiler; therefore, you have no need to generate an ANSI '74 or '85 COBOL element unless you need to specify option values other than the default values.

Before generating the COBOL compiler, see the applicable programming reference manual. For the ANSI '74 COBOL compiler, see the *1974 American Standard COBOL Programming Reference Manual*, UP-8613. For the ANSI '85 COBOL compiler, see the *COBOL 85 Programming Reference Manual*, 7002 3940.

3.1.4. Communications (ICAM) Elements

ICAM elements define the communications services that you want in the system. They are required only if the system uses the ICAM terminal support facility or the information management system (IMS), both of which are optional OS/3 components. They are also required when you want to configure a communications network with workstations acting as your terminals.

OS/3 divides the ICAM parameters into two types: network definition parameters and message control program (MCP) parameters. Network definition parameters define the modules that ICAM needs to operate and they create a communications control area (CCA). You supply these parameters to the parameter processor in the form of ICAM macroinstructions. You can include more than one network definition in an ICAM element by including multiple sets of network definition parameters. The *ICAM Operations Guide*, UP-9745, describes the ICAM network definition requirements and macroinstructions. Refer to that manual before attempting to configure an ICAM element.

Message control program parameters specify the name of the ICAM element, the disk volume where you want the system to store it, and the characteristics of each communications line in the system.

When you generate a communications element, be sure that the SYSGEN parameter processor provides correct default substitutions for the specific ICAM element that you want to generate.

You can generate as many as 18 different ICAM elements for use in the system; but you must create each one in a different SYSGEN operation and only one ICAM element can be active in the system at a given time.

3.1.5. Resource Management

OS/3 provides an optional facility, resource management, which enables the configuration of resource management capabilities. Factors that can be controlled are:

- The maximum percentage of main storage available for:
 - Symbionts
 - Interactive jobs
 - Batch jobs

Note: The sum of the percentages can be greater than 100%, in which case the overlapping portion would be available on a first come, first served basis.

- The maximum number of:
 - Total jobs
 - Jobs initiated from all workstations
 - Jobs initiated from any single workstation
 - Logged-on interactive users
 - Batch tasks initiated with the ENTER command
 - Concurrently executing run symbionts

The following subsections provide examples of how the resource management capability might be used. Note that the RESMGT keyword parameter is defined in 4.2.

Resource Management Batch System Configuration

Table 3-5 presents an example of how the resource management feature might be set up in a heavily batch-oriented system:

Table 3-5. Resource Management Elements for a Batch-Oriented System

Element	Maximum Limit
User storage available for batch jobs	80%
User storage available for interactive jobs	10%
Total number of batch jobs	20
Workstation batch jobs scheduled from workstations	10
Number of batch jobs that can be scheduled from any single workstation	1
Number of concurrently executing run symbionts	3

For the preceding configuration, the following is entered:

<u>Phase</u>	<u>Parameter</u>
SUPGEN	SUPVRNAM = SY\$BAS JOBSLOTS = 25 * RESMGT = YES * JOBMEM = 80 INTMEM = 10 MAXJOBS = 20 MAXWSJOBS = 10 MAXSWSJOBS = 1 * * RUNSYMB = 3
END	

Resource Management Interactive System Configuration

Resource management in a heavily interactive environment can be set up as shown in Table 3-6.

Table 3-6. Resource Management Elements for an Interactive System

Element	Maximum Limit
User storage available for: ▪ interactive jobs ▪ batch jobs	80% 20%
Total number of logged on workstations	30
Total number of batch tasks that can be initiated from a workstation with an ENTER command	20
Total number of batch jobs	5
Batch jobs scheduled from a workstation	2
Batch jobs that can be scheduled from any single workstation	1
Number of concurrently executing run symbionts	3

For the preceding configuration, the following would be entered:

```
Phase      Parameter
-----
SUPGEN     SUPVRNAM = SY$BAS
           JOBSLOTS = 25
           TIMER = MAX
           *
           RESMGY = YES
           *
           JOBMEM = 20
           INTMEM = 80
           ISINTLMT = 30
           ISBATCHLMT = 20
           MAXJOBS = 5
           MAXWSJOBS = 2
           MAXSWSJOBS = 1
           *
           *
           RUNSYMB = 3
END
```

Resource Management Mixed System Configuration

If the system is used for both batch and interactive processing, up to 70% of variable storage can be allocated for both (batch and interactive) types of jobs. The STATUS command and the console operation log are useful tools for determining what percentages of variable storage to allocate for each job category.

If 70% of the variable storage is available for both batch and interactive jobs, the following is an example of how the resource management feature is configured:

<u>Phase</u>	<u>Parameter</u>
SUPGEN	SUPVRNAM = SY\$BAS
	JOBSLOTS = 25
	TIMER = MAX
	*
	RESMGT = YES
	*
	JOBMEM = 70
	INTMEM = 70
	ISINTLMT = 20
	ISBATCHLMT = 20
	MAXJOBS = 12
	MAXWSJOBS = 5
	MAXSWSJOBS = 1
	*
	*
	RUNSYMS = 2
END	

In this example, there is an overlapping of storage availability, so that part of the user storage is available for both batch and interactive jobs.

3.2. Procedures

The following procedures let you:

- Prepare SYSGEN parameter sets for all users who have not prepared or saved SYSGEN parameter sets for all the elements that their systems require
- Process SYSGEN parameter sets for all users who have prepared SYSGEN parameter sets
- Run the SYSGEN job control streams for all users who have processed SYSGEN parameter sets

You must perform all three procedures to create a system control element.

3.2.1. Using SYSGEN Dialog to Prepare Parameter Sets

The following paragraphs describe the procedure for preparing the SYSGEN parameter sets using the SYSGEN dialog. Unisys supplies the SYSGEN dialog that lets you easily prepare your parameter sets. You can also prepare the SYSGEN parameter sets without the aid of the SYSGEN dialog (see Section 4), but the SYSGEN dialog minimizes the risk of preparing invalid parameter sets. Only the most experienced SYSGEN users should use alternate methods. If you prepare your sets using an alternate method, you must process them using the procedure for manually executing the parameter processor, shown in 3.2.2.

Note: *To perform this procedure, you need to install the system control software and perform an initial program load procedure to load either the starter supervisor (SY@BAS, SY#BAS, or SY\$BAS) or one that you've generated yourself. See the Operations Guide, UP-8859.*

Prepare the SYSGEN parameter sets using the SYSGEN dialog as follows:

1. Determine which system control elements you need in the system according to the information in 3.1. Table 3-1 lists all the optional components that OS/3 offers and shows which control elements you need to support them. The manuals in the OS/3 library that concern separate, optional components give specific SYSGEN requirements for those products, if any specific requirements exist.
2. At your console/workstation, enter the workstation mode by simultaneously pressing the FUNCTION key and the workstation mode key (WS MODE) to display the OS/3 LOGON request screen:

```

000000  SSSS      /   333
00000000  SSSSSS    //  33333
00  00  SS      ///  33  33
00  00  SS      ///  33
00  00  SS      ///  33
00  00   SS     ///  333
00  00   SS     ///  33
00  00  SS  SS  ///  33  33
00000000  SSSSSS  //  3333333
000000    SSSS   /   3333

```

INTERACTIVE OPERATING SYSTEM
DEPRESS TRANSMIT FOR LOGON

- When you see the LOGON request screen, press XMIT. Your system then displays this LOGON menu:

```

OS/3 INTERACTIVE SERVICES
LOGON IDENTIFICATION:  USER-ID      > _____ <
                       ACCOUNT NUMBER > ____ <
                       PASSWORD      > _____ <
OPTIONS:               EXECUTION PROFILE > _____ <
                       BULLETIN      >YES <
                       LOG            >YES <

```

- If you are an initial user, when you see the LOGON menu screen, fill in the USER-ID field (USER-ID cannot exceed six characters) and press XMIT. If you are an existing user operating under a supervisor that includes interactive security, fill in the menu screen as the *Interactive Services Operating Guide*, UP-9972, describes. Either action causes the system to display a message informing you that it accepted your logon and also to display the system bulletin.

- Enter system mode by simultaneously pressing the FUNCTION key and the system mode key (SYS MODE).

Note: *If you are performing this procedure at a remote communications terminal, be sure the terminal contains the field-protect feature; otherwise, you will encounter errors.*

- Allocate the file that will hold the audit file version of this dialog session by keying in:

```
AL MI, FIL=filename, VSN=volume, SI=2
```

where:

MI

Specifies that the audit file is a MIRAM file.

FIL=filename

Is the file label that you assign to the audit file.

VSN=volume

Specifies the volume serial number of your disk that will contain the audit file. If you are using the SYSRES for the audit file, this value is always RELxxx, where xxx is the release level of your software. For example: REL130.

SI=2

Is the size, in cylinders, of the audit file.

7. Press XMIT.
8. If you are preparing parameter sets for the supervisor, NTR, or COBOL elements, execute the SYSGEN dialog by keying in:

RV SG\$BLD

If you are preparing parameter sets for the ICAM element, execute the ICAM portion of the SYSGEN dialog by keying in:

RV IC\$BLD

9. Press XMIT. This response causes the dialog to display a short paragraph explaining RUN libraries.
10. When the message DO YOU WANT TO SAVE RUN LIBRARY? (Y OR N) appears, key in N.
11. Press XMIT. When you see the message ARE YOU CREATING A NEW AUDIT FILE (Y/N)?, key in Y for yes.
12. Press XMIT. When you see the message ENTER VSN OF DISC CONTAINING NEW AUDIT FILE, key in the volume serial number.
13. Press XMIT. When you see the message ENTER FILE LABEL OF NEW AUDIT FILE, key in the file label of the file that you allocated in step 6 to hold the audit file version of your dialog session.
14. Press XMIT. When you see the message ARE YOU AUDITING AN OLD AUDIT FILE? (Y/N), key in N for no.
15. Press XMIT. The dialog then displays the message, DIALOG PROCESSOR READY, to inform you that it is ready to help you prepare the SYSGEN parameters. Then, it asks what type of system you are using.
16. When you see the message WHAT TYPE OF SYSTEM ARE YOU GENERATING?, key in 1 for models 3 thru 6, 2 for model 8, and 3 for models 10 thru 20.

If you are preparing ICAM parameters for a model 8 thru 20, press XMIT. The dialog displays the message HOW MANY IOMPS DOES YOUR MODEL HAVE? Key in 2 or 3. If you need HELP, key in 4.

17. Press XMIT. The dialog displays a short definition of the SYSGEN dialog.
18. When you see the paragraph titled PROGRAM=DIALOG FOR SYSTEM GENERATION, or PROGRAM=DIALOG FOR ICAM GENERATION, key in HELP and press XMIT. The dialog then displays a description of the dialog method for preparing SYSGEN parameters.
19. After you've read the description of the dialog method, press XMIT. The dialog then displays the master menu screen shown here. Through the master menu screen, you can select SYSGEN phases that correspond directly to three control elements that you need to generate.

```

SELECT THE SYSGEN PHASE TO BE PREPARED:

1. SUPERVISOR GENERATION   (SUPGEN and IOGEN)
2. COBOL COMPILER OPTIONS SPECS (COBGEN)
3. NTR UTILITY GENERATION  (NTRGEN)
4. NO FURTHER PHASE REQUIREMENTS
5. DISPLAY PHASE DESCRIPTIONS
   (ENTER PHASE NUMBER OR 'ALL')
                                     ----
ENTER CHOICE BY NUMBER              ----
                                     -----
    
```

If you are building the ICAM control element, the dialog bypasses the master menu screen and goes directly to the COMMCT phase. This is where you prepare all necessary parameters for generating an ICAM element. When you have completed the parameter specifications, the SYSGEN dialog displays the message DIALOG SESSION TERMINATED NORMALLY. Press XMIT. The dialog will then display a message asking if you want to execute the parameter processor. At this point, proceed to step 23.

20. Each time you see the master menu screen, choose one of the selections to prepare parameter sets for all the control elements you must generate:
 - Key in 1 and press XMIT to perform the SUPGEN and IOGEN phases. These phases let you prepare all the necessary parameters to generate a supervisor control element and define your hardware configuration to OS/3.

When you key in 1, the SYSGEN dialog displays screens requesting which services and facilities you want in the supervisor. Next, it displays menu screens that let you define your hardware configuration to OS/3. When specifying these devices, you do not have to define all devices in the same category at the same time. For example, you can define the disk device containing the SYSRES volume first, followed by your printers, workstations, and other disk devices. You should define each I/O device in the order of most frequent use to reduce I/O access time during later processing.

When it requires no other information from you, the dialog redisplay its master menu screen.

- Key in 2 and press XMIT to select the COBGEN phase, which lets you generate an ANSI '74 or '85 COBOL element. The dialog displays only those screens that pertain to the COBOL element and then redisplay the master menu screen.
 - Key in 3 and press XMIT to select the NTRGEN phase, and prepare the necessary parameters for generating an NTR element in the system. The dialog displays only those messages concerning NTRGEN, then redisplay its master menu screen.
 - Key in 4 and press XMIT to inform the dialog that there are no other control elements to prepare parameter sets for, and that the current dialog session is complete. Go to step 22.
 - Key in 5 and press XMIT to read descriptions of each of the SYSGEN phases. After it displays these phase descriptions, the dialog redisplay its master menu screen.
21. After you respond to the master menu screen, the SYSGEN dialog guides you step-by-step through the SYSGEN parameter sets for the phases you select. As you proceed through the dialog, press XMIT to go on to subsequent screens. If you need more information about a parameter, request help by keying in the choice that gives a HELP screen or by keying in HELP in the space provided. If a parameter does not concern you, simply press the TAB FORWARD key to ignore it and the system automatically provides a sufficient default value for you. Then, when you reach the bottom of the screen, press XMIT. (When specifying your hardware configuration to OS/3, be sure to specify a device category parameter and a type parameter for each device, whether you want to accept the default values for that device or not. Otherwise, OS/3 generates the supervisor without an I/O configuration for that device.)

Some parameters require you to use the SYSGEN parameter reference tables in 4.2. These tables give you guidelines and formulas for specifying particular SYSGEN parameters. Each time you complete the parameter specifications for a single phase, the dialog redisplay its master menu screen until you respond to it with choice 4.

To omit a parameter from your sets while using the dialog, you must replace the enter-field for that parameter with either underlines or spaces. For parameters that have only numeric values, you must use spaces since the underline character is not a numeric character and will be rejected by the system. On ICAM terminals, use a destructive space bar by putting (SP/DS) in the last field on the control page.

22. When you key in 4 to inform the dialog that you've completed your session, the SYSGEN dialog displays the message DIALOG SESSION TERMINATED NORMALLY. Press XMIT. The dialog then displays a message asking whether or not you want it to execute the parameter processor.
23. When the message DO YOU WANT TO EXECUTE THE PARAMETER PROCESSOR AGAINST DIALOG OUTPUT? (Y OR N) appears, key in Y and press XMIT if you want to proceed with the SYSGEN process. However, if you want to review your parameter sets, or if (because of time limits) you do not want to execute the parameter

processor, key in N and press XMIT. Either response causes the dialog to display a message (step 24) asking you where you want your dialog output stored.

24. When the message ENTER A 1-8 CHARACTER NAME FOR THIS OUTPUT MODULE appears, press XMIT if you want to accept the default module name. The dialog will store the supervisor, NTR, and COBOL parameter sets as a module named SG\$INPUT or the ICAM parameter set as a module named IC\$INPUT on \$Y\$SRC. If another dialog parameter set already exists with the module name SG\$INPUT or IC\$INPUT and you want to keep that set, key in an alternate 1- to 8-character name for your new module and press XMIT.

Note: After responding to step 24, your next action depends on your response to step 23. If you keyed in Y in step 23, go to "Automatic Execution of the Parameter Processor" in 3.2.2. If you keyed in N in step 23, the dialog stores your sets under the module name that you specified in step 24 and then terminates. In this case, proceed to "Manual Execution of the Parameter Processor" in 3.2.2.

3.2.2. Processing the SYSGEN Parameter Sets

This subsection presents the procedures for processing the SYSGEN sets either by automatically or manually executing the parameter processor (SG\$PARAM). Which method you use depends, primarily, on how you prepared your sets.

If, at the end of the dialog session, you want the dialog to execute the parameter processor against the dialog session output, use the procedure for automatic execution of the parameter processor in this subsection.

You must manually execute the parameter processor, using the procedure in this subsection, for any of the following reasons:

- You want to review all your parameter sets at the end of the dialog session, to ensure that they are correct.
- You did not want to automatically execute the parameter processor.
- The parameter sets are in any of the following forms:
 - As source modules saved from a previous release
 - As parameter output from a previous dialog session corrected by the general editor
 - As parameters prepared using any method other than the SYSGEN dialog

Note: Never rerun SG\$PARAM until you run all the jobs listed by SG\$PARAM; otherwise, the variables generated by the first execution of SG\$PARAM are lost. You can only run the jobs listed for the current (second) execution of SG\$PARAM.

Automatic Execution of the Parameter Processor

The system executes the parameter processor automatically when you answer Y to the dialog's question DO YOU WANT TO EXECUTE THE PARAMETER PROCESSOR AGAINST DIALOG OUTPUT? (Y OR N).

After you inform the system where to store the dialog output by responding to the message ENTER A 1-8 CHARACTER NAME FOR THIS OUTPUT MODULE, the dialog:

- Stores the sets
- Automatically executes the parameter processor
- Supplies it with the parameter sets that you just created
- Prints a summary listing of the entire dialog session
- Terminates normally

The parameter processor then processes and verifies the SYSGEN parameter values. It provides a complete listing of all your parameter values, defaults, errors in your sets, and the execution sequence of the job control streams that you must execute if it finds no errors.

If the processor terminates normally and finds no errors in your sets, carefully check the SG\$PARAM listing to be sure that all its default substitutions are correct for your situation and the type of system you are generating. Then, go to the procedure for running the SYSGEN job control streams in 3.2.3. If the processor finds errors in your sets, it will also display a message on your screen informing you of the number of errors in your sets.

When this message appears, you must correct or change your parameter sets using the parameter processor output listing as a guide to identifying the errors. To correct or change parameters, use the audit capability of the SYSGEN dialog that we describe here. The audit capability lets you easily correct parameters that you prepared using the dialog. These parameters now reside in the audit file that you allocated to contain them.

You can also use the general editor to correct or change parameters. The general editor is a general-purpose editor that lets you edit, change, or correct the contents of any module in the system. To use the editor, see the *General Editor Operating Guide*, UP-9976. When using the editor, specify the name of the source module containing your dialog output as the module that you want to edit. After you correct your parameter sets, go to step 1 of the procedure for manually executing the parameter processor.

To use the audit file capability of the SYSGEN dialog, perform the following steps:

1. Allocate the file that will hold the new audit file version of this dialog session by keying in:

```
AL MI,FIL=filename,VSN=volume,SI=2
```

where:

MI

Specifies that the audit file is a MIRAM file.

FIL=filename

Specifies the file label that you assign to the audit file.

VSN=volume

Specifies the volume serial number of your disk containing the audit file.

SI=2

Is the size, in cylinders, of the audit file.

2. Re-execute the SYSGEN dialog starting at step 8 of 3.2.1, which gives the procedure for preparing your parameter sets.
3. When you see the message **ARE YOU CREATING A NEW AUDIT FILE? (Y/N)**, key in Y and press XMIT.
4. When you see the message **ENTER VSN OF DISC CONTAINING NEW AUDIT FILE**, key in the volume serial number of the SYSRES disk and press XMIT.
5. When you see the message **ENTER FILE LABEL OF NEW AUDIT FILE**, key in a file name different from the file name containing the audit version of the dialog session during which you prepared your parameter sets. That is, provide a name for your new audit file different from the name you gave your old audit file. Press XMIT.
6. When you see the message, **ARE YOU AUDITING AN OLD AUDIT FILE? (Y/N)**, key in Y for yes and press XMIT.
7. When you see the message, **ENTER VSN OF DISC CONTAINING OLD AUDIT FILE**, key in the volume serial number of the SYSRES disk and press XMIT.
8. When you see the message **ENTER FILE LABEL OF OLD AUDIT FILE**, key in the file label name of the file containing the audit version of the dialog session you prepared your parameter sets in. Press XMIT.
9. The dialog displays a message stating that it is ready to help you audit your old audit file. Then it asks which paragraphs you want to change. Use the summary listing that the dialog provides at the end of the dialog session as a guide to the paragraphs you want to change. The paragraphs are numbered sequentially to act as a map to your audit file.

Notes:

1. *If you need to make changes to the paragraph containing the SYSGEN dialog master menu screen, you must re-create the dialog entirely. In that case, go back to the procedure for preparing the SYSGEN parameter sets (3.2.1).*
 2. *At the end of the upcoming dialog audit session, the dialog either automatically executes the SYSGEN parameter processor or terminates. The action that takes place depends on the response, contained in the new audit file, to the dialog question DO YOU WANT TO EXECUTE THE PARAMETER PROCESSOR? If you do not change the paragraph containing that response, the dialog uses the same response that both your old and new audit files contain; if you change that response in the upcoming audit session, the dialog uses the response that your new audit file will contain after this session. Therefore, according to what you want the dialog to do at the end of this session, decide if you want to change the paragraph containing that response. If you do, specify it in step 10.*
10. When you see the following screen, key in the paragraph numbers of the paragraphs that you want to change or correct:

DP100	OS/3 DIALOG PROCESSOR VERSION	READY
ENTER PARAGRAPH NUMBERS TO BE EDITED.		
PARAGRAPH NUMBERS MUST BE IN ASCENDING ORDER		
WITH ONLY ONE NUMBER IN EACH AREA.		

11. Press XMIT. The dialog displays each of the paragraphs that you indicate you want to change, one at a time.
12. Correct all the paragraphs you want to change according to the following instructions:
 - a. When the dialog displays a paragraph, the top of the screen shows what your old audit file contains for that paragraph. The middle of the screen is blank and the bottom of the screen displays your auditing options at the beginning of a paragraph. For example, in step 10, you tell the dialog that you want to change paragraph 8 of your old audit file. In this example, paragraph 8 contains part of the SUPGEN parameters. The dialog would show you a screen resembling this one:

8. SUPERVISOR SIZING PARAMETERS

1. PRIORITY	TASK PRIORITY LEVELS	0
2. JOBSLOTS	NUMBER OF JOBSLOTS	3
3. TRANS	NUMBER OF TRANSIENT AREAS	4
4. SHAREDNGT	SHARED DATA MNGMENT TABLE SLOTS	5
5. SYMBPRI	SYMBIONT PRIORITY LEVEL	6

FOR HELP ENTER PARAMETER NUMBER OR 'ALL'

AT THE BEGINNING OF PARAGRAPH, YOU CAN:
 ENDESSION (F4), EDIT (F7), OR PROCEED (XMIT)

Choose one of the following auditing options by pressing the FUNCTION key and simultaneously pressing the workstation function key that corresponds to it:

- ENDESSION (F4) - This option lets you normally terminate an auditing session before you've made all your changes to the old audit file. If you choose ENDESSION, the dialog displays a message informing you that it terminated normally, but your new audit file is incomplete and must not be used. When you subsequently want to complete the auditing session, you must perform this procedure over again starting at step 1 and specify the same name for the old audit file that you did in this session.
 - EDIT (F7) - This option lets you make changes and corrections to the paragraph that you are working on. In most cases, you will choose EDIT at this point because you told the dialog that you wanted to change this paragraph in step 10. If you choose EDIT, go to step b.
 - PROCEED (XMIT) - This option lets you go on to the next paragraph you indicated in step 10, without making any changes to the current paragraph. You choose PROCEED at this point only if, after rereading the paragraph, you realize you don't want to change it, but you had indicated that you did in step 10. If you choose PROCEED, go back to step a.
- b. When you tell the dialog that you want to EDIT a paragraph, the top of the screen again shows your old audit file, the middle of the screen is reserved for your changes, and the bottom of the screen shows your auditing options at a choice point in a paragraph. Using our same example, the dialog shows a screen resembling this one:

8. SUPERVISOR SIZING PARAMETERS

1. PRIORITY	TASK PRIORITY LEVELS	0
2. JOBSLOTS	NUMBER OF JOBSLOTS	3
3. TRANS	NUMBER OF TRANSIENT AREAS	4
4. SHARED MGT	SHARED DATA MNGMENT TABLE SLOTS	5
5. SYMBPRI	SYMBIONT PRIORITY LEVEL	6

FOR HELP, ENTER PARAMETER NUMBER OR 'ALL'

.....

.....

AT CHOICE POINT IN PARAGRAPH, YOU CAN:
CANCEL (F2), REEDIT (F3), ENDSSESSION (F4),
INSERT (F5), DELETE (F6), EDIT (F7), OR PROCEED (XMIT)

Choose only one of the following auditing options by pressing the FUNCTION key and simultaneously pressing the workstation function key that corresponds to it:

- CANCEL (F2) - This option is invalid at this point.
- REEDIT (F3) - This option is invalid at this point.
- ENDSSESSION (F4) - See explanation under step a.
- INSERT (F5) - This option lets you insert a choice that you neglected to specify in the paragraph during your original dialog session. If you choose INSERT, the dialog displays the paragraph and positions the cursor at the first data field. To skip to the next data field without inserting a value at the current field, press the TAB FORWARD key. After you finish all the data fields, go to step c.
- DELETE (F6) - This option lets you delete a choice that you specified in the paragraph during the original dialog session. If you choose DELETE, the dialog displays the paragraph, deletes the first data field, then positions the cursor at the next data field. To delete that value, press F6 again; to skip to the next data field without deleting the current value, press the TAB FORWARD key. After you finish all the data fields, go to step c.

- EDIT (F7) - This position lets you edit, or change, a value that you specified in the paragraph during the original dialog session. If you choose EDIT, the dialog displays the old audit file screen for that paragraph and positions the cursor at the first data field. Press the TAB FORWARD key to position the cursor at the data field that you want to change, key in the correct value over the incorrect value, and press XMIT. After you edit the data fields, go to step c.
- c. After you perform the auditing option at the choice point in the paragraph, the top of the screen shows your old audit file, the middle of the screen shows your new audit file, and the bottom of the screen shows your auditing options at the end of the paragraph. Using our same example, assume you chose to edit paragraph 8 to change the number of job slots from 3 to 7. The dialog shows you a screen resembling this one:

8. SUPERVISOR SIZING PARAMETERS		
1. PRIORITY	TASK PRIORITY LEVELS	0
2. JOBSLOTS	NUMBER OF JOBSLOTS	3
3. TRANS	NUMBER OF TRANSIENT AREAS	4
4. SHAREDGMT	SHARED DATA MNGMENT TABLE SLOTS	5
5. SYMBPRI	SYMBIONT PRIORITY LEVEL	6
FOR HELP, ENTER PARAMETER NUMBER OR 'ALL'		

8. SUPERVISOR SIZING PARAMETERS		
1. PRIORITY	TASK PRIORITY LEVELS	0
2. JOBSLOTS	NUMBER OF JOBSLOTS	7
3. TRANS	NUMBER OF TRANSIENT AREAS	4
4. SHAREDGMT	SHARED DATA MNGMENT TABLE SLOTS	5
5. SYMBPRI	SYMBIONT PRIORITY LEVEL	6
FOR HELP, ENTER PARAMETER NUMBER OR 'ALL'		

AT END OF PARAGRAPH, YOU CAN:		
CANCEL (2), REEDIT (F3), ENDESESSION (F4), OR PROCEED (XMIT)		

At this point, choose one of the following auditing options:

- CANCEL (F2) - This option lets you cancel the changes you made to the paragraph in step b. Choose this function if you made many changes that you now want to cancel. If you choose CANCEL, go back to step a.
- REEDIT (F3) - This option lets you re-edit the paragraph that you audited in step b. Choose this option if you made only a few changes that you now want to re-edit. If you choose REEDIT, go back to step b.
- ENDESESSION (F4) - See explanation under step a.

- **PROCEED (XMIT)** - This option either lets you proceed to the next paragraph you indicated in step 10, or automatically takes you back into the SYSGEN dialog if you make radical changes to your old audit file. If you do not make radical changes, it lets you terminate this auditing session when you have no other paragraphs to change. After you make all your changes and, if necessary, go through the SYSGEN dialog, you receive a message that the dialog session terminated normally. At this point, the dialog then automatically executes the parameter processor or terminates. The action that takes place depends on the response, contained in the new audit file, to the dialog question **DO YOU WANT TO EXECUTE THE PARAMETER PROCESSOR?** If it contains a Y for yes, go back to the beginning of this section for automatic execution of the parameter processor. If it contains an N for no, go to "Manual Execution of the Parameter Processor."

Manual Execution of the Parameter Processor

The following paragraphs describe the procedure for manually executing the parameter processor. You must process your SYSGEN parameter sets in this way if your sets are in any of the following forms:

- As sources modules saved from a previous dialog session
- As source modules saved from a previous release
- As parameters, saved from a previous dialog session, and corrected by the general editor
- As parameters prepared using any method other than the SYSGEN dialog

To manually execute the parameter processor, proceed as follows:

Note: *If your parameter sets are on keypunched cards, load the cards in your card reader. If you are processing supervisor, NTR, or COBOL parameter sets, key in **RU SG\$PARAM** on the console/workstation. If you are processing an ICAM parameter set, key in:*

```
RU SG$PARAM,,ICAM=Y
```

Proceed with step 2 of this procedure.

1. At your console/workstation in console mode, key in:

```
RV SG$PARAM[,SCHASM=Y],S=source-module[,ICAM=Y] [ ,F={filename} ] [ ,V=vsn ] [ ,RESVSN=vsn ] [ ,PRINT=N ]  
                [ ,V={SY$SRC} ]
```

where:

SCHASM=Y

Automatically schedules SG\$SUPMK and SG\$COMMK if no parameter errors occur.

S=source-module

Identifies the name of the source module where you stored your parameter sets.

ICAM=Y

Is required if you are processing an ICAM parameter set.

F=filename

Identifies the name of the file that contains that source module.

V=vsn

Identifies the volume serial number of the volume that contains that file.

RESVSN=vsn

Allows users to SYSGEN properly when they change the volume serial number of their release disk.

PRINT=N

Inhibits printer output for SG\$PARAM.

Notes:

1. *If you do not supply a value for the S parameter, the parameter processor will request this information from you.*
 2. *If you execute SG\$PARAM from a workstation and do not specify the S parameter, the parameter processor asks whether you want to run interactively through the SYSGEN dialog. Respond Y if you have not prepared SYSGEN parameter sets.*
 3. *If you do not specify a volume serial number, the default is your SYSRES volume.*
2. The parameter processor then processes and verifies your SYSGEN parameter sets. It provides a complete listing of all your parameter values, defaults, errors in your sets, and the execution sequence of the job control streams that you must execute. If the processor finds no errors in your sets, carefully check the SG\$PARAM listing to be sure that all its default substitutions are correct for your situation and the type of system you are generating. Then, go to the procedure for running the SYSGEN job control streams presented in 3.2.3. If the processor finds errors in your sets, it will also display a message on your screen informing you of the number of errors in your sets.
 3. If the parameter processor finds errors in your sets, correct or change your parameter sets using the parameter processor output listing as a guide to the errors. Unless your sets are on keypunched cards, use the general editor according to the instructions in the *General Editor Operating Guide*, UP-9976, to correct your parameters. When using the editor, specify the source module name that contains your parameter sets and the name of the file containing this source module. If your sets are on keypunched cards, simply replace the cards that contain misstated or incorrect parameters.

When you correct all errors in your parameter sets, rerun the parameter processor starting at step 1 of this procedure.

3.2.3. Running the SYSGEN Job Control Streams

To generate your system, you must run the SYSGEN job control streams after your parameter sets are prepared and processed. The job control streams SG\$SUPMK and SG\$COMMK are automatically scheduled and run if you specified the SCHASM=Y option when you ran the parameter processor. However, you must manually run the required SYSGEN job control stream for either of the following conditions:

- SCHASM=Y option was not specified when the parameter processor was run.
- A COBOL compiler is being generated with the SG\$COBMK job control stream.

For these cases, use the applicable run command to initiate each job in the order listed by the parameter processor. When the last job terminates, perform the post-SYSGEN procedures in 3.3 that apply to you. The SYSGEN process is then completed.

Supervisor SYSGEN Job Control Stream

To manually run the supervisor SYSGEN control stream, use the following command:

```
RV SG$SUPMK [ , [ , TPWK=vsn ] [ , PRINT= { DK } ] ]
```

where:

TPWK=vsn

Provides temporary work files for the assembler on an alternate disk device. The value vsn identifies the volume serial number of the alternate device.

PRINT=DK

Specifies that you want spooled output directed to a format label diskette.

PRINT=N

Inhibits printer output for SG\$PARAM.

The system generates the supervisors that you configured and stores them on your SYSRES volume. When it has successfully done so, it displays a message informing you that the job stream terminated normally.

ICAM Job Control Stream

CAUTION

Before running SG\$COMMK, determine if ICAM is active. If active, ensure that the ICAM being generated (e.g. C1-C9, M1-M9) differs from the active ICAM. Unpredictable results can occur if the active ICAM is regenerated or relinked.

To manually run the ICAM SYSGEN control stream, use the following command:

```
RV SG$COMMK [ , [ , GENLST=Y ] [ , TPWK=vsn ] [ , PRINT=DK ] [ , RELINK=Y ] [ , CYL=cy1 ] [ , SECALL=cy1 ] ]
```

where:

GENLST=Y

Specifies that you want a complete listing of the ICAM macroinstruction generations.

TPWK=vsn

Provides temporary work files for the assembler on an alternate disk device. The value vsn identifies the volume serial number of the alternate device.

PRINT=DK

Specifies that you want spooled output directed to a format label diskette.

RELINK=Y

Specifies that the ICAM just processed by SG\$PARAM needs only relinking rather than a complete generation. If RELINK=Y is not specified, a complete generation is done and the object modules for all assembly jobsteps are saved in SG\$OBJ. With RELINK=Y, the assembly jobsteps issues the error message SOURCE INPUT MODULE CANNOT BE LOCATED ASSEMBLER ABORTED and the previously saved object modules are included in the link.

CYL=cyl

Specifies the initial allocation of cylinders on the spool pack for the scratch files.

SECALL=cyl

Specifies the secondary allocation value for each extent of the scratch files on the spool pack.

Note: *CYL and SECALL are most effective when specified with the TPWK parameter if the error DM45 EXTENT TABLE EXHAUSTED is received while running SG\$COMMK on a very large ICAM.*

The system generates the ICAM element that you configured and stores it on the SYSRES, unless you specified an alternate output volume during COMMCT. When completed, the job stream displays a message that it has terminated normally.

NTR Job Control Stream

To manually run the NTR SYSGEN control stream, use the following run command:

```
RV SG$NTRMK[, ,PRINT=DK]
```

where:

PRINT=DK

Specifies that you want spooled output directed to a format label diskette.

The system generates the NTR element you configured and stores it on the SYSRES, unless you specified an alternate output volume during NTRGEN. When complete, SG\$NTRMK tells you that it has terminated normally.

COBOL Job Control Stream

To manually run the COBOL SYSGEN job control stream, use the following run command:

```
RV SG$COBMK[, ,PRINT=DK]
```

where:

```
PRINT=DK
```

Specifies that you want spooled output directed to a format label diskette.

The system generates the ANSI '74 or '85 COBOL element that you configured and stores it on the SYSRES. When completed, the job stream tells you that it has terminated normally.

When the last job terminates, perform the post-SYSGEN procedures in 3.3 that apply to you to complete the SYSGEN process.

3.3. Post-SYSGEN Procedures

After you generate the system, perform the following post-system generation procedures that apply to you.

3.3.1. Updating the System Definition File

You must update the system definition file (\$Y\$SDF) if you install software that changes the microcode for any of the following devices that exist on the system:

- Any workstation other than the console/workstation plus one more local workstation
- Remote printer
- Any single-line communications adapter

You must update \$Y\$SDF before you continue with any post-generation procedures. See 2.3.1.

3.3.2. Generating an IMS Online Load Module

If you install the OS/3 information management system (IMS), generate an IMS online load module before the IMS system is operational. See the *IMS System Support Functions Programming Guide*, UP-11907.

3.3.3. Defining Alternate Printer Characteristics

Unisys delivers the job control stream, SG\$PRB, to define characteristics different from the OS/3 default printer characteristics.

By default, printers use one of three print cartridges (48-BUS, 48-SCI, or 63-STD) and ignore character mismatches. Also by default, printers use 11-inch vertical forms and print 6 lines per inch.

If you configure either a physical printer or an indirect printer (for a printerless system) and your printer characteristics differ from those discussed in the previous paragraph, run SG\$PRB to define those characteristics to the system. Perform this procedure before performing any other procedures that produce printed output.

Note: If you configure a printerless system, specify the `ADDR=NO I/OGEN` parameter described in the table in 4.2.

You should define alternate characteristics at this time for all your physical or indirect printers that have alternate printer characteristics, rather than each time you want to use those printers.

To define alternate printer characteristics for a physical printer:

1. Perform an initial program load (IPL) to load your choice of operating supervisor into main storage. See the *Operations Guide*, UP-8859.
2. Use the general editor to prepare your alternate printer characteristics as a source module in the system source code library, \$Y\$SRC, on your SYSRES. To use the general editor, see the *General Editor Operating Guide*, UP-9976. Follow the instructions and formats in the *Job Control Programming Guide*, UP-9986, for each printer with alternate characteristics, and proceed as follows:
 - a. Key in a // DVC job control statement for each printer that has defined alternate printer requirements. You can submit one // DVC for both a load code buffer (LCB) and a vertical format buffer (VFB).

If you are defining two sets of printer characteristics for one printer, prepare a // DVC statement for each set. Each // DVC statement and its associated // LCB and // VFB statement must be prepared separately. That is, you must include one // DVC and one // LCB and / or one // VFB in each source module that you prepare as input to SG\$PRB.

On each // DVC statement:

- (1) Identify the physical printer type by specifying the logical unit number. (See Table 4-3).
- (2) Specify the physical printer's address (PUB) to ensure that your system accesses the physical printer and not a virtual one at SG\$PRB scheduling time. (If you do not specify the printer's address, a spooling supervisor does not change the contents of the default LCB/VFB.)

- b. Key in a // LCB job control statement for each alternate print cartridge that you are defining. Specify user load code buffer, OWNLC1 or OWNLC2 for models 3 thru 6, or OWNLC1 through OWNLC9 for models 8 thru 20, in the label field to specify that your printer uses a print band other than 48-BUS, 48-SCI, or 63-STD.

If you only want to specify character mismatch reporting for one of these three print bands, specify the name of your print band in the label field.

- c. Key in a // VFB job control statement for each set of alternate vertical format characteristics you are defining. On each // VFB statement, proceed as follows:
 - (1) Specify user vertical format buffer, OWNVF1 for models 3 thru 6, or OWNVF1 through OWNVF9 for models 8 thru 20, in the label field.
 - (2) Specify FORMNAME=STAND1 as the form name parameter.
 - (3) Define the remainder of your vertical format characteristics.

3. Execute the SG\$PRB job stream by keying in:

```
RV SG$PRB,,MOD=module-name
```

where:

```
MOD=module-name
```

Specifies the source module you created in \$Y\$SRC that contains the alternate printer characteristics.

Press XMIT.

4. The system generates the load code and vertical format characteristics that you defined and tells you when it has terminated normally.

Two examples show how to change VFB and LCB characteristics.

Example 1. Changing VFB characteristics:

```
EDT
1.000 // DVC 20,330
2.000 //OWNVF1 VFB FORMNAME=STAND1,DEN=8,LN=88,OVF=80
3.000 @WRITE MO=VFBCHG,FIL=$Y$SRC,VSN=REL120
4.000 @HALT

RV SG$PRB,,MOD=VFBCHG
```

Example 1 creates a source module with the general editor (EDT) to alter VFB printer characteristics. The // DVC statement shows the logical unit number (20) and the hardware address (330) of the printer. The // VFB statement must contain OWNVF1 in the label field and STAND1 as the form name. A standard 11-inch form and a density (DEN) of 8 lines per inch is selected, giving the form a length (LEN) of 88 lines. The overflow (OVF) is set at line 80. Printing will stop at line 80 and continue at the top of the next form, leaving a 1-inch margin at the bottom of each form.

The @WRITE command names the source module and writes it in \$\$\$SRC on the SYSRES volume (VSN=REL120). EDT terminates with the @HALT command. After creating the source module, SG\$PRB is run using the module name specified in the @WRITE statement (VFBCHG). SG\$PRB displays a message when it terminates.

Example 2. Changing LCB characteristics:

```
EDT
1.000 // DVC 20,330
2.000 //48-BUS LCB MISM=REPORT
3.000 @WRITE MO=LCBCHG,FIL=$$SRC,VSN=REL120
4.000 @HALT

RV SG$PRB,,MOD=LCBCHG
```

EDT creates a source module to alter LCB printer characteristics. The // DVC statement shows the logical unit number (20) and the hardware address (330) of the printer. The LCB statement contains the cartridge name in the label field (48-BUS) and specifies that character mismatch errors are reported.

The @WRITE command names the source module and writes it in \$\$\$SRC on the SYSRES volume. EDT terminates with the @HALT command. After creating the source module, SG\$PRB is run using the module name specified in the @WRITE statement (LCBCHG). SG\$PRB displays a message when it terminates.

To define alternate printer characteristics for an indirect printer:

1. Perform an initial program load (IPL) to load your choice of operating supervisor into main storage. See the *Operations Guide*, UP-8859, for the IPL procedure.
2. Set the spool file temporarily to the HOLD state; then, set the physical unit block (PUB) for the indirect printer temporarily to the UP state (normally, the PUB is set to the down state). By holding all spooled output, you prevent it from being sent to the indirect printer while it is set UP. To perform these operations, enter the following commands in the order shown:

```
HOLD SPL,ALL
    Specifies to hold all spooled output.
```

```
SE IO,did,UP,n
    Specifies to set the PUB UP.
```

where:

did

Is the device address.

n

Is a 1-digit number indicating the indirect printer PUB being used. If omitted, the first virtual PUB is assumed.

3. Use the general editor (EDT) to prepare your alternate printer characteristics as a source module in the system source code library, `$$SRC`, on your `SYSRES`. For each indirect printer with alternate characteristics, proceed as follows:

- a. Key in a // DVC job control statement for the indirect printer with the following format:

```
// DVC 20,REAL
```

You can submit one DVC for both a load code buffer (LCB) and a vertical format buffer (VFB).

- b. Key in a // LCB job control statement for each alternate print cartridge that you are defining. Specify user load code buffer, `OWNLC1` or `OWNLC2` for models 3 thru 6, or `OWNLC1` through `OWNLC9` for models 8 thru 20, in the label field if you are using a print band other than 48-BUS, 48-SCI, or 63-STD.
- c. Key in a // VFB job control statement for each set of alternate vertical format characteristics that you are defining. On each // VFB statement, proceed as follows:
 - Specify user vertical format buffer, `OWNVF1` for models 3 thru 6, or `OWNVF1` through `OWNVF9` for models 8 thru 20, in the label field.
 - Specify `FORMNAME=STAND1` as the form name parameter.
 - Define the remainder of your vertical format characteristics.

4. Execute the `SG$PRB` job stream by keying in:

```
RV SG$PRB,,MOD=module-name
```

where:

MOD=module-name

Specifies the source module you created in `$$SRC` that contains the alternate printer characteristics.

5. Press `XMIT`. The system generates the load code and vertical format characteristics that you defined and tells you when it has terminated normally.

6. Set the indirect printer down and begin spooling (reversing the procedure described in step 2) by keying in the following commands:

```
SE IO,did,DO,n
    Specifies to set the PUB down.
```

where:

```
did
    Specifies the device address.
```

```
n
    Is a 1-digit number indicating the indirect printer PUB being used. If
    omitted, the first virtual PUB is assumed.
```

```
BEGIN SPL,ALL
    Specifies to begin spooled output.
```

Example: Changing VFB characteristics for an indirect printer:

```
EDT
1.000 // DVC 20,REAL
2.000 //OWNVF1 VFB FORMNAME=STAND1,DEN=8,LEN=88,OVF=80
3.000 @WRITE MO=FBCHG,FIL=$Y$SRC,VSN=REL110
4.000 @HALT

RV SG$PRB,,MOD=VFBCHG
```

In this example EDT creates a source module to alter VFB printer characteristics. The // DVC statement specifies that we are changing VFB characteristics for an indirect printer.

3.3.4. Changing the System Bulletin

Every time you log on to a workstation, or a terminal being used as a workstation, your system displays the system bulletin. This bulletin provides information about your particular system, such as hours of operation.

Initially, the system displays the default bulletin, which Unisys provides with the OS/3 interactive software to describe how you enter commands at the workstation. The default bulletin for models 3 thru 6 looks like this:

```
IS27 TODAYS BULLETIN IS:
_ TO TYPE IN COMMANDS, DEPRESS 'FUNCTION' AND _
_ 'SYSTEM MODE' KEYS SIMULTANEOUSLY, THEN TYPE _
_ THE COMMAND AND DEPRESS TRANSMIT. _
_ ON UNISCOPE DEPRESS 'MESSAGE WAITING' KEY. _
```

If you want the system bulletin to display other information, you must overwrite the system default bulletin. You can use either the general editor or the system librarian. In both methods, you overwrite the contents of the BULLETIN module in \$Y\$SRC, which can contain only one system bulletin at a time.

To use the general editor, see the *General Editor Operating Guide*, UP-9976. To use the librarian, see the *System Service Programs Operating Guide*, UP-8841.

Note: *If you want to save the default bulletin before making any changes, use the interactive services COPY command. See the Interactive Services Operating Guide, UP-9972.*

When you create new text for the system bulletin, follow these rules:

- Do not write more than 60 characters in each line of the bulletin.
- Do not create a bulletin more than 20 lines long.
- Do not use the dollar sign (\$) as the first character of a line.
- Be sure all the characters in the bulletin text are printable characters.

The following example shows how you change the bulletin using the general editor:

```
LOGON PAULM
EDT
1.000 @READ MODULE=BULLETIN,FILENAME=$Y$SRC
5.000 @PRINT 1:4
1.000 -- TO TYPE IN COMMANDS, DEPRESS 'FUNCTION' AND --
2.000 -- 'SYSTEM MODE' KEYS SIMULTANEOUSLY, THEN TYPE --
3.000 -- THE COMMAND AND DEPRESS TRANSMIT.
4.000 -- ON UNISCOPE DEPRESS 'MESSAGE WAITING' KEY. --
5.000 @DELETE 1:4
1.000 SYSTEM AVAILABLE FROM 0900 TO 1900 TODAY
2.000 @WRITE MODULE=BULLETIN,FILENAME=$Y$SRC
2.000 @HALT
LOGOFF
```

The following example shows how to change the bulletin using the librarian:

```
// JOB BULLADD
// DVC 20    // LFD PRNTR
// EXEC LIBS
/$
  FIL D1=$Y$SRC
  ELE.D D1,S,BULLETIN
  SYSTEM AVAILABLE FROM 0900 TO 1900 TODAY
EOD
/*
/&
// FIN
```

Note: In the *ELE* statement, the *D* option causes the contents of the module (the bulletin text) to be printed.

3.3.5. Verifying System Installation

To verify that you successfully performed your entire system installation without destroying any software during SYSGEN, perform the Installation Verification Procedures that apply to your system. The *Installation Verification Procedures Operating Guide*, UP-10003, describes these procedures in detail.

3.3.6. Making and Restoring a Backup Copy of Your Current SYSRES

After you successfully complete and verify system installation, make and save a backup copy of your current, customized SYSRES for your convenience and protection, in the event the SYSRES device becomes inoperable.

If you ordered your release software on diskette or on a removable disk, use the release media as a backup to the SYSRES. Do this only if you changed little of your release software during SYSGEN, and you intend to keep the majority of your own software on your own storage media (other than SYSRES). If you need to restore the SYSRES, you must perform the SYSGEN procedure over again, specifying or defaulting each parameter exactly the same way you did as an initial user or an existing user installing a new OS/3 release.

If you ordered your release on dump/restore tape, create a backup copy of the SYSRES. You cannot restore the system from tape on models 3 thru 6 if primary SYSRES becomes inoperable unless you can perform the IPL from a backup SYSRES. It's best to create and maintain a backup SYSRES copy and restore the system from this copy.

Regardless of the media you ordered the release on, if you specified many changes to the release software, or if you intend to use SYSRES to store your own software, keep an up-to-date copy of the tailored SYSRES. Before you build your backup copy, give some thought to which type of media would best serve as your backup. You have a choice of:

System Generation

- A set of diskettes
- A removable disk volume (8419 for all models; 8430 or 8433 for models 8 thru 20)
- A fixed disk volume (8417 for models 3 and 5; 8417 or 8470 for models 4, 6 and 8 thru 20; 8494 for models 8 thru 20; or M9720 for models 10 thru 20)
- Tape

If your system includes a removable disk device, build the backup SYSRES on it. This allows you maximum protection at minimum cost because you can run your system using the removable backup disk as the SYSRES, if necessary. Although this method takes a little longer, the use of the SETREL/COPYREL job streams allows a more thorough cleanup and secure backup. In addition, you don't tie up a disk drive for backup purposes. Remember that you minimize your system's performance and security by using a fixed disk device as your SYSRES device. You should use your removable backup copy as a temporary SYSRES only and restore your system to a fixed disk device as soon as possible.

If your system does not include a removable disk device, you have the choice of building a backup copy on a set of diskettes, tape, or a fixed disk device. If your system includes only one disk drive, you must use diskettes as your backup device for models 3 thru 6. Tape can be used for backup on models 8 thru 20. When deciding between building your backup copy on a set of diskettes, tapes, or a fixed disk device, keep in mind the tradeoff between space and convenience.

- Using diskettes or tapes as backup devices conserves online disk space but requires that you use multiple diskettes or tapes in a specified file sequence and requires more time to perform the backup and restore operation. It also requires that you perform the restore operation before you can resume normal system operation.
- Using a fixed disk as a backup device is a fast and convenient way to build a backup copy, and a fixed disk can conveniently serve as your new SYSRES, if necessary. However, using a fixed disk as a backup SYSRES wastes valuable online disk storage space.

No matter which device you choose as your backup device, make certain that you keep your backup SYSRES current. Failure to do so may require you to completely reinstall and regenerate your entire system from the OS/3 release media that you originally received from Unisys.

Notes: If error messages are generated when you build your backup copy, do not assume the copy is good. Refer to the System Messages Reference Manual, UP-8076, for a description of all messages generated during the backup procedure and, if indicated, repeat the procedure.

Using a Removable Disk for Your Backup SYSRES

If you decide to build the backup SYSRES on a removable disk, use the system-supplied job streams SETREL/COPYREL and the system librarians, LIBS and MLIB. SETREL/COPYREL let you prep a disk to serve as the backup SYSRES and copy the contents of the system files listed in Table 3-7 on your current SYSRES to that disk.

SETREL preps a disk and allocates SYSTEM files in the most efficient location arrangement based upon disk type and size of groups within SYSTEM files on the input (RES) device. The most frequently used files bracket the VTOC with less frequently used files allocated furthest from the VTOC.

You must run SETREL before you run COPYREL. LIBS and MLIB let you copy all your own program library files on SYSRES to that same backup disk.

To build the backup SYSRES on a removable disk:

1. Mount your backup disk.
2. Perform an initial program load (IPL) from the SYSRES to load either the starter supervisor or one that you've generated into main storage.
3. Prep the backup disk by keying in at the console/workstation in console mode:

```
RV SETREL, ,V=vsn,T=disk-type,P=prep-type[,R=n]
```

If your system does not have a card reader, you must key in the SETREL run command as follows:

```
RV SETREL, ,V=RELxxx,T=disk-type,P=prep-type,CR=NO[,R=n]
```

where:

V=vsn

Specifies the volume serial number of the backup disk. (This vsn must be different than the vsn of your SYSRES.)

T=disk-type

Specifies the 2-digit type number of your backup SYSRES disk. The disk type numbers may be:

<u>Type Number</u>	<u>Disk</u>
18	8418-2 (model 8)
19	8419 (all models)
30	8430 (models 8 thru 20)
33	8433 (models 8 thru 20)

P=prep type

Specifies the type of prep you want SETREL to perform. The prep type codes are:

<u>Code</u>	<u>Meaning</u>
F	Full prep (surface analysis) requires insert information from cards/keyins.
P	Fast prep (fast surface analysis) does not require insert information.
N	No prep performed, assign files only, does not require insert information. This option causes SETREL to use the existing VTOC. If the existing VTOC is not from a previous SETREL execution, it is unlikely that the VTOC will be positioned in the best location. In this case, system files are allocated on a contiguous basis by absolute cylinder addresses. Allocation errors will occur if other files cross these absolute cylinder allocations.

Notes:

1. *If P=F is entered from a console, the system expects inserts from a card reader. Do not enter CR=NO.*
2. *If P=F is entered from a workstation, insert information through a workstation screen. No card reader is required.*

CR=NO

Specifies that you are entering information concerning known bad tracks on the backup disk volume from the console/workstation. You must specify this parameter if your system does not have a card reader.

R=n

Specifies the number of times a defective track is retested before it is declared unusable and an alternate track is substituted. The value n is a hexadecimal number from 00 to FF. The default value is 0A.

After you enter this parameter, press XMIT.

4. If you specified P=N, this message appears: ALLOCATION ERRORS POSSIBLE USING P=N IF EXISTING VTOC IS NOT THE RESULT OF A PREVIOUS SETREL PREP - CONTINUE (N,Y). If you respond Y, go to step 5b.

Note: *A full prep must be done on the disk you plan to use as your RES.*

If you specified a full or fast prep in step 3, SETREL requests information from you concerning known bad tracks on the backup disk volume. Enter the hexadecimal address of any defective tracks on that disk and press XMIT.

Note: *If you are entering this information on cards, bad tracks must be identified by an INSERT statement (one track per statement) and the set must be terminated with a // FIN statement. If you are prepping a disk with no known bad tracks, you must place an INSERT statement with the word NONE starting in column 10, followed by a // FIN statement, to satisfy the request made by SETREL.*

5. SETREL preps the backup disk and assigns the system files that will reside on that disk after you execute COPYREL. If unrecoverable errors occur during the prepping of a volume, a message indicates this at your console/workstation, and the job terminates immediately. If other errors occur, a warning message is sent and the job continues processing.
6. Prepare backup copies of all the system files on your current SYSRES by keying in at the console/workstation in console mode:

```
RV COPYREL, ,V=vsn,T=disk-type[,S=first-file-code][,E=last-file-code][,CAT=Y][,SEC=Y]
```

where:

V=vsn

Specifies the volume serial number of the backup disk volume. (This vsn must be different than the vsn of your SYSRES.)

T=disk-type

Specifies the two-digit type number of your backup SYSRES disk. The disk type numbers may be:

<u>Type Number</u>	<u>Disk</u>
18	8418-2 (model 8)
19	8419 (all models)
20	M9720 (models 10 thru 20)
30	8430 (models 8 thru 20)
33	8433 (models 8 thru 20)
70	8470 (all models)
94	8494 (models 8 thru 20)

S=first-file-code

Specifies the code identifying the first file that you want COPYREL to copy. Table 3-7 shows the order that COPYREL copies the system files and shows the codes for each system file. If you omit the S keyword, COPYREL begins copying at \$Y\$SRC.

E=last-file-code

Specifies the code for the last file that you want COPYREL to copy. (See Table 3-7.) If you omit the E keyword but specify the S keyword, COPYREL ends copying at \$Y\$SEC. If you omit both the S and E keywords, COPYREL begins with \$Y\$SRC and ends with \$Y\$TRANA.

CAT=Y

Specifies \$Y\$CAT (catalog file) is copied using SGTRAN.

SEC=Y

Specifies \$Y\$SEC (security file) is allocated and copied using MLIB.

When you specify the S and E keywords, COPYREL overrides the CAT and SEC parameters and generates an error to the console. The S and E keyword parameters control the number of files that COPYREL copies. They can also indicate to COPYREL where to restart a copy function if you ever encounter an error while performing COPYREL. You can use these keywords to specify that you want to copy a single library by specifying the same file for each parameter.

Table 3-7. COPYREL Copy Order

Copy Order	Code	File Name	Copy Order	Code	File Name
1	S	\$Y\$SRC	12	IVP	IVPLIB
2	O	\$Y\$OBJ	13	SMCFILE	SMCFILE
3	L	\$Y\$LOD	14	SMACLOG	\$Y\$SMCLOG
4	M	\$Y\$MAC	15	FMT	\$Y\$FMT
5	J	\$Y\$JCS	16	SAVE	\$Y\$SAVE
6	G	SG\$JCS	17	DIALOG	\$Y\$DIALOG
7	SGMAC	SG\$MAC	18	SDF	\$Y\$SDF
8	SGOBJ	SG\$OBJ	19	HELP	\$Y\$HELP
9	SGLOD	SG\$LOD	20	T	\$Y\$TRAN
10	SCLOD	\$Y\$CLOD	21	A	\$Y\$TRANA
11	MIC	\$Y\$MIC	22	CAT	\$Y\$CAT*
			23	SEC	\$Y\$SEC*

* These files are copied when requested by parameters in RUN statements.

Note: COPYREL does not copy certain SYSRES files because they are initialized at IPL time. The files that are not copied are: \$Y\$SYSTEM TABLES, \$Y\$DUMP, \$Y\$SHR, \$Y\$ELOG, \$Y\$ESUM, Y\$FDY, SG\$XXX.

7. Press XMIT. COPYREL then copies your system files onto the backup disk volume and tells you when it has terminated normally.

Note: Place the initial microprogram load (IMPL) code and initial program load (IPL) code to the correct positions on the disk using the jobstream, PRPMIC. To execute PRPMIC, key in:

```
RV PRPMIC,,V=vsu
```

where:

V=vsu

Specifies the volume serial number of the backup disk volume on which you built your SYSRES copy.

When it has successfully placed the IPL and IMPL codes in their correct positions, PRPMIC tells you that it has terminated normally.

8. Use the system librarians, LIBS and MLIB, to prepare copies of your own program library files - LIBS for SAT program library files and MLIB for MIRAM program library files. See the *System Service Programs Operating Guide*, UP-8841.
9. If you store any data files on SYSRES, use data utilities to make copies of it. See the *Data Utilities Operating Guide*, UP-8834.

If you need to restore your SYSRES, use SETREL/COPYREL to restore your backup system files. Then, use whatever system facility you used to make backup copies of your own software (user program libraries and data files) to restore that software on SYSRES.

Using Diskettes for Your Backup SYSRES

If you decide to build your backup SYSRES on a set of diskettes, your backup copy should consist of two parts: system files, including the volume table of contents (VTOC) for your entire SYSRES, and user files.

To build backup copies of each type of software, Unisys supplies the following two control streams.

SG@DSFIL

Dumps all your system files to sequential data set label diskettes.

Here is a list of the files saved by SG@DSFIL:

\$VTOC	SG\$OBJ	\$Y\$SEC
\$IMPL	\$Y\$MAC	IVPLIB
\$IPL	SG\$MAC	\$Y\$HELP
\$Y\$TRAN	\$Y\$SRC	SMCFIL
\$Y\$TRANA	\$Y\$MIC	\$Y\$CAT
\$Y\$LOD	\$Y\$FMT	\$Y\$SHR
SG\$LOD	\$Y\$SAVE	\$Y\$ELOG
\$Y\$SCLOD	\$Y\$SMCLOG	\$Y\$ESUM
\$Y\$JCS	\$Y\$DIALOG	\$Y\$SJF
SG\$JCS	\$Y\$SDF	\$Y\$SYSTEMTABLES
\$Y\$OBJ		

SG@DUFIL

Gives you the capability of grouping the names of up to 20 of your own files and storing them under a single name in the system library, SG\$JCS. It also initiates the routine, SG@DMFIL, which actually dumps all files that you've grouped together to sequential data set label diskettes. Thus, in a single dump operation, SG@DMFIL can copy up to 20 of your user files. You can also use SG@DUFIL to save your own software from your existing release before installing a new release.

Both job control streams feature a restart capability. If you get an error while running either control stream after a job has successfully dumped some of your files, re-execute the job using the restart feature to resume where the system left off. The job streams continue dumping your files beginning with the file where the error occurred. The restart feature is shown in the procedure that executes these job streams.

When you build backup files, take the following precautions to ensure that you can restore the SYSRES if needed:

- Sequentially label the diskettes as you copy them to the SYSRES files so you can easily restore them. Keep the diskettes in the correct order.
- Get and keep the listings of the SG@DSFIL and SG@DUFIL job streams. They tell you the exact file sequence on your diskettes.

- Diskettes should be prepped with a record size of 128 or 256. Do *not* prep diskettes with a VSN of SCRTCH.

To build a backup copy of your SYSRES on diskettes, proceed as follows:

Note: If you don't store your own files on SYSRES, or if you don't want to save any of your own files that you've stored on SYSRES, disregard steps 1 through 8 of this procedure and go directly to step 9.

1. Build a backup copy of your own files by keying in:

```
RV SG@DUFIL
```

2. Press XMIT.
3. When the message ENTER VSN OF INPUT DISC appears, key in the 6-character volume serial number of your SYSRES volume and press XMIT.
4. When the system asks DO YOU WANT TO CREATE A LIST OF FILENAMES (Y OR N)?, press XMIT if you want to group your user file names under a single name to expedite dumping them. If you have already done so, key in N and press XMIT. If you key in N, proceed to step 8; otherwise, go on to step 5.
5. When the message WHAT DO YOU WANT TO NAME THE LIST OF FILENAMES? appears, key in a 1- to 8-character file name and press XMIT.
6. Follow the directions that your system displays for keying in up to 20 file names (each 1 to 44 characters in length) using the FNAME1, FNAME2,...FNAME_n= format. Press XMIT after each file name that you specify in that group. When you have specified all the file names that you want in one group, key in END and press XMIT. Your system then stores that list of file names until you are ready to dump them to diskettes. It then asks if you are ready to dump them.

Note: If you need to make backup copies of more than 20 files, you must rerun SG@DUFIL starting at step 1 of this procedure. SG@DUFIL cannot group more than 20 files at one time.

7. When the message DO YOU WANT TO DUMP THE LIST JUST CREATED (Y OR N)? appears, press XMIT if you are ready to dump the files in the list that you just created. If for some reason, such as time limits, you do not want to dump the files, key in N and press XMIT. If you press XMIT, SG@DUFIL initiates the SG@DMFIL routine, which actually dumps your user files to a set of sequential data set label diskettes. If you key in Y, proceed to step 9. If you key in N, you must rerun this procedure from step 1, but respond to step 4 with N.
8. When the message WHAT IS THE NAME OF THE LIST OF FILE NAMES TO BE DUMPED? (1 TO 8 CHARACTERS) appears, key in the name of the list of files that you want to dump and press XMIT. SG@DUFIL then initiates SG@DMFIL. Now proceed to step 9.

9. When SG@DMFIL asks DO YOU WANT RESTART CAPABILITY? (Y/N), key in N and press XMIT. If you are executing SG@DUFIL to resume dumping the files after you encounter an error, place the last successfully copied diskette into the diskette reader, key in Y and press XMIT. Either response causes SG@DMFIL to dump your user files to a set of sequential data set label diskettes and tells you when it terminates normally. Go to step 10 to build a backup copy of your system files.

Note: If you executed SG@DUFIL only to build copies of your own software before installing a new release, do not perform the remaining steps in this procedure.

10. Build a backup copy of your system files by keying in:

```
RV SG@DSFIL
```

11. Press XMIT.
12. When the message ENTER VSN OF INPUT DISC appears, key in the 6-character volume serial number of your SYSRES and press XMIT.
13. When SG@DSFIL asks DO YOU WANT TO USE RESTART FEATURE? (Y/N), key in N and press XMIT. If you are executing SG@DSFIL to resume dumping your files after you encounter an error, place the last successfully copied diskette into the diskette reader, key in Y and press XMIT. Either response causes SG@DSFIL to dump your system files to a set of sequential data set label diskettes and tells you when it terminates.

To restore the SYSRES use two parts: system files and user files. To restore the operating system, you must restore the system files first and user files last.

To restore the SYSRES from diskette, use the following two control streams:

```
SU@RST
```

If you received your release on diskettes, and if your resident volume becomes inoperative, use SU@RST to restore the system files from sequential data set label diskettes to the SYSRES.

```
SG@RUFIL
```

Lets you restore your own user files from sequential diskettes to the SYSRES, or to restore your own software that you saved from a previous release onto the new SYSRES.

To restore your backup system files from diskettes:

1. Follow the IPL and installation procedures defined in Section 2 except that when SU@RST requests ARE YOU INITIALIZING YOUR SYSTEM, respond N. This will allow files on the output disk to be preserved.
2. When SU@RST terminates normally, reinitialize your system by performing an initial program load (IPL) to load your desired operating supervisor into main storage. Do so according to the instructions in the *Operations Guide*, UP-8859. After you load the supervisor, proceed to step 4.

3. If you attempt to restore either an incomplete or out-of-date version of your SYSRES, SU@RST displays an error message indicating that a format label is mismatched or missing from your VTOC or that your disk does not contain a VTOC. If you receive these messages, then:
 - a. Rerun SU@RST starting at step 1 of this procedure, but respond Y to the message ARE YOU INITIALIZING YOUR SYSTEM?.
 - b. When SU@RST terminates normally, add the new files that you want on your SYSRES but had never dumped to your backup copy.
 - c. Make a current and complete copy of your system files using SG@DSFIL and continue with step 4.

4. To restore your backup user files from diskettes, key in:

```
RV SG@RUFIL
```

5. Press XMIT.
6. When the message ENTER VSN OF OUTPUT DISC appears, key in the 6-character volume serial number of your SYSRES disk and press XMIT.
7. When your system prompts, WHAT IS THE NAME OR LIST OF FILENAMES TO BE RESTORED (1-8 CHARACTERS)?, key in the group name that you assigned to the group of up to 20 files of which you made backup copies using SG@DUFIL.

Note: If you ran SG@DUFIL more than once to build your back up copy, you must also run SG@RUFIL once for each set of 20 files of which you made backup copies.

After you supply this information, SG@RUFIL restores the user files in the group that you specified in step 7 and tells you which diskette you should mount next.

8. If your system displays a MOUNT message:
 - a. Mount the requested diskette.
 - b. Key in R for ready.
 - c. Press XMIT.

After SG@RUFIL restores all your own backup files, a message tells you that the routine terminated normally.

Using Tape for Your Backup SYSRES

If you decide to build your backup SYSRES on tape, Unisys supplies a job stream, SG\$DMPDT, to dump your disk to tape in either DUMP/RESTORE file or volume mode. Keep in mind that stand-alone restore accepts tapes only in file mode format and that tape input for the stand-alone restore is allowed only on models 8 thru 20.

To build your backup SYSRES on tape:

1. Key in:

RV SG\$DMPDT
2. Press XMIT.
3. If your system is a model 8 thru 20, SG\$DMPDT asks DO YOU WANT THE DMPRST OUTPUT TAPE IN FILE FORMAT (N,Y). Enter Y if file format is required and press XMIT.

If your system is a model 3 thru 6, SG\$DMPT asks, IS THE INPUT DISK A FIXED HEAD DEVICE (N,Y). Respond accordingly and press XMIT.

4. When the message ENTER VSN OF OUTPUT TAPE appears, key in the 6-character volume serial number of your output tape and press XMIT.

When SG\$DMPDT terminates normally, the tape backup is complete.

Restoring SYSRES from Tape Using SU@RST

To restore the SYSRES from tape using SU@RST:

1. Follow IPL and installation procedures in Section 2 except that when SU@RST asks ARE YOU INITIALIZING YOUR SYSTEM, respond N. This will allow files on the output disk to be preserved.
2. When SU@RST terminates normally, reinitialize your system by performing an IPL to load your desired operating supervisor.
3. If you attempt to restore either an incomplete or out-of-date version of your SYSRES, SU@RST displays an error message indicating that a format label is mismatched or missing from your VTOC or that your disk does not contain a VTOC. If you receive these messages, then:
 - a. Rerun SU@RST starting at step 1 of this procedure but respond Y to the query ARE YOU INITIALIZING YOUR SYSTEM (N,Y).
 - b. When SU@RST terminates normally, add any new files that you want on your SYSRES.
 - c. Make a current and complete copy of your SYSRES using SG\$DMPDT.

Using a Fixed Disk for Your Backup SYSRES

You can build your backup SYSRES on an:

- 8417 disk (models 3 thru 6),
- 8470 disk (models 4, 6, and 8 thru 20)
- 8494 disk (models 8 thru 20)
- M9270 disk (models 10 thru 20)

To do so, use the system-supplied job stream DCOP. DCOP lets you make one copy of your current SYSRES on another disk of the same type.

To build your backup SYSRES on a fixed disk:

1. Perform an initial program load (IPL) from your existing SYSRES to load either the starter supervisor or one that you've generated into main storage.
2. Key in:

```
RV DCOP,,T=disk-type [ ,N= {number} ] [ ,V= {YES} ]
```

where:

T=disk type

Specifies the 2-digit type number of the disk subsystem that you are using.

<u>Type</u>	<u>Number Disk</u>
17	8417 (all models)
20	M9720 (models 10 thru 20)
70	8470 (models 4, 6, and 8 thru 20)
94	8494 (models 8 thru 20)

N

Specifies the number of copies that you are making. In this case, you can make only one copy.

V=YES

Specifies that you want verification of your backup copy.

After you supply this information, DCOP displays a message inquiring if you are ready for the routine to copy your SYSRES.

3. When the message MOUNT DEV=did VSN=DISC GO? appears, check that did is the device address of the disk you are copying your SYSRES to, key in GO DCOP, and press XMIT.

DCOP then copies the entire contents of your SYSRES, including the VSN, to the backup disk. If you don't want two disks with the same VSN, use the CGV job stream to change one as explained in the *System Service Programs Operating Guide*, UP-8841. When it completes the copy operation, DCOP displays a message to inform you that it has terminated normally.

Note: *Unisys preps all 8417 disks (models 3 thru 6) before you receive them and supplies track condition tables (TCTs) for those disks. These TCTs identify which tracks on the disks are defective. If the TCT for the disk on which you built the SYSRES copy indicates that the disk contains defective tracks in any one of its first six cylinders, perform an extra operation when DCOP terminates. Place the initial microprogram load (IMPL) and initial program load (IPL) codes to the correct position on the disk. Execute this operation to perform IMPL and IPL operations from the SYSRES copy.*

To place the IMPL and IPL codes in their correct positions, we provide the job stream, PRPMIC. To execute PRPMIC, key in:

```
RV PRPMIC,,V=vsn
```

where:

V=vsn

Specifies the volume serial number of the fixed disk volume on which you built your SYSRES copy.

After it has successfully placed the IPL and IMPL codes in their correct positions, PRPMIC tells you that it has terminated normally.

Updating the ICAM Symbiont Table

If you generate an ICAM element and later copy this element to another disk device, you must update the ICAM symbiont table after you perform the copy routine. To update the symbiont table, use the SGTRAN job control stream.

The job control listing that was generated when you first ran SG\$COMMK to create the ICAM element contains the input parameter values from the original SGTRAN run. You must use these values whenever you run SGTRAN to update the symbiont table. The following job control stream is a sample execution of SGTRAN:

```
1. // JOB SGTRAN
2. // DVC 20 // LFD PRNTR
3. // DVC 51 // VOL SYSRES // LBL $$SLOD // LFD SYSLOD
4. // DVC 51 // VOL SYSRES // LBL $$STRAN // LFD IN1
5. // DVC 51 // VOL SYSRES // LBL $$STRANA // LFD OUT
6. // OPTION JOBDUMP
7. // EXEC SGTRAN, SYSLOD
8. // PARAM M9,04,02,00,1
9. /&
10. // FIN
```

Note: *Line 8 contains the input positional parameter values from the original SGTRAN run.*

These values specify the following:

M9 Two alphanumeric character message control program (MCP) names.

04 2-digit decimal number of task control blocks (TCBs) assigned.

02 2-digit decimal number of open file DTFs associated with DISCFILE/JRNFILE macros.

00 2-digit decimal number of physical unit blocks (PUBs).

One PUB is required for each local workstation specified. If the ICAM element contains remote batch processing (RBP), this number must be equal to or greater than 1.

1 Single decimal digit internal symbiont dictionary generation. Set to 1.



Section 4

Using an Alternate Method to the SYSGEN Dialog

4.1. Creating Parameter Sets

The SYSGEN dialog lets you create supervisor, NTR, COBOL, and ICAM parameter sets with relative ease. And, the system automatically stores your sets in source modules (SG\$INPUT and IC\$INPUT) on the system source library file \$Y\$SRC. (SG\$INPUT contains the supervisor, NTR, and COBOL sets; IC\$INPUT contains the ICAM sets.)

Once you become thoroughly familiar with the SYSGEN process, you can expedite the process by creating and modifying the parameter sets by using the general editor rather than the SYSGEN dialog. The general editor is more efficient in that it lets you work with only those parameters that you need to add, delete, or modify thereby saving you time.

Create your parameter sets on disk or diskette as 80-column card image source modules. Give them any name you want and store them in any file. (If your sets are on keypunched cards, submit the cards to the parameter processor when you run SG\$PARAM.) To create your parameter sets, you need to know the choices for each SYSGEN phase, their coding formats, value ranges, and their defaults. Use the tables 4.2 to assist you in selecting the appropriate SYSGEN keyword parameters. Also use the guidelines and formulas provided in the SYSGEN parameter reference tables in 4.3 to help you specify particular SYSGEN parameters.

When you generate parameter set source modules without the aide of the SYSGEN dialog, it is your responsibility to ensure that all parameters are valid and to manually execute the parameter processor as defined in Section 3.

If you omit the label parameter for a particular SYSGEN phase, the system does not execute that phase. OS/3 does not provide default parameters that identify the SYSGEN phases. Also, you cannot specify parameters on the same statement of the label fields. For example, don't specify any parameters on the statement containing the SUPGEN label in the label field.

4.1.1. SUPGEN

The statements containing the supervisor configuration parameters immediately follow the statement with SUPGEN coded in the label field. Use this statement to signify the start of the supervisor section. Use the statement with END coded in the label field to delimit it. Each SUPGEN phase consists of one SUPGEN section immediately followed by its associated input/output (I/O) device configuration.

You can specify all the SUPGEN keyword parameters in any order, but specifying the SUPMOD parameter tells the parameter processor to ignore all other keywords for the SUPGEN section. Therefore, if you specify SUPMOD, it must be the first one specified in this section. Specifying the SUPGEN keywords and SUPMOD actually wastes time. The SUPGEN keyword parameters are listed in Table 4-1.

4.1.2. I/OGEN

This phase must immediately follow a SUPGEN phase in order to form a complete supervisor definition. If you have specified the generation of multiple supervisors in SUPGEN, you must also prepare individual I/OGEN configurations for each of those supervisors. Each I/OGEN section must immediately follow its associated SUPGEN section.

Submit the I/OGEN configuration specifications in the form of label parameters and keyword parameters immediately following the statement containing the I/OGEN parameter coded in the label field. The I/OGEN parameter signifies the start of the I/OGEN section, and an END statement coded in the label field delimits it. The label parameters identify a device category - PRINTER, READER, PUNCH, DISC, DISKETTE, TAPE, and WORKSTATION. The keyword parameters define the particular specifications for that category, such as ADDR or TYPE. The I/OGEN keyword parameters are listed in Table 4-2 for models 3 through 3 and in Table 4-3 for models 8 through 20.

When you specify the hardware configuration to OS/3, include a device category and a type parameter for each device in the system, even if you want to accept the default values for them. Otherwise, OS/3 generates the supervisor without an I/O configuration for those devices.

Define each I/O device in the order of most frequent use to reduce I/O access time during later processing. You do not need to define all devices for the same category consecutively (even if they are of the same type). For example, you can define the disk device containing the SYSRES volume first, followed by printers, readers, tapes, other disk devices, punches, and workstations.

The I/OMOD keyword parameter tells the parameter processor to ignore all other keywords for the I/OGEN section. If an existing I/O configuration meets your present requirements, you can specify it by using the I/OMOD keyword parameter to name the supervisor in which you defined that I/O configuration. If you specify I/OMOD, it must be the first parameter that you specify.

4.1.3. COMMCT

The keyword parameters used to define communications generation are divided into two categories: network definitions and message control program (MCP) definitions. The network definition portion creates a communications control area (CCA). The MCP portion includes the processing modules needed by ICAM and defines the physical characteristics of each single line communications adapter (SLCA) in the system. The COMMCT keyword parameters are listed in Table 4-4.

This guide does not describe the ICAM network definition parameters, only their use in generating the ICAM symbiont. See the *ICAM Operations Guide*, UP-9745, before attempting to configure an ICAM network definition.

The network definition parameters immediately follow the statement with COMMCT coded in the label field. Each network definition starts with a CCA macroinstruction and ends with an ENDCCA macroinstruction.

The coding of network definition macroinstructions and operands follows these OS/3 assembler coding rules:

- Follow each operand with a comma, except the last operand.
- Continue a macroinstruction on additional statements using standard continuation conventions; that is, specify a trailing comma after the last operand on a line and a non-null character in column 72. Start the next operand in column 16.
- Start and end an operand, its specification, and its trailing comma (if required) on the same statement.

When you use an existing network definition, specify the 4-character name of a previously-saved network definition in the system source library file (\$Y\$SRC) of the SYSRES. Specify this source module with the CCAMOD parameter in place of network definition macroinstructions. Each CCAMOD parameter must be followed by an ENDCCA parameter.

An Alternate SYSGEN Method

The MCP portion of COMMCT must begin with MCP coded as a nonlabel parameter. This parameter functions as a delimiter that signifies the end of the network definition and the beginning of the MCP parameters. The statement with END coded in the label field then delimits both the MCP parameters and the entire COMMCT section.

The MCP parameters differ in format from the network definition macroinstructions because they follow the SYSGEN coding rules. Blank characters delimit them. You can submit the MCP parameters in separate statements without indicating continuation (X in column 72).

The MCP keyword parameter, CACH, describes each single line communications adapter (SLCA) that the ICAM symbiont accesses or supports. It has three formats that identify SLCAs used by communications lines, dialers, and virtual channels.

- Format 1 lets system generation access the ICAM network definition and determine the SLCA requirements automatically. If you use this format to define an automatically dialed (for output) switched line, do not also specify a format 3 CACH statement for the dialer SLCA.
- Format 2 lets you explicitly define the requirements for an SLCA that carries data. When you use it to define an automatically dialed switched line SLCA, you must also include a format 3 CACH statement to define the dialer SLCA. Communications physical interface (CPI) users and universal data link control (UDLC) users must use this format.
- Format 3 defines dialer SLCAs. Use this format when you have used format 2 to define an SLCA for an automatically dialed switched line.

Logical network users (including global network users) can specify either format 1 or format 2 for SLCAs used by communications lines. Communications physical interface (CPI) network users and UDLC SLCA users must use format 2. Format 3 is used in conjunction with format 2 and describes a dialer SLCA. Use it only when the autodial capability is included for a communications line.

4.1.4. NTRGEN

The first statement in the NTR generation set must be a statement with NTRGEN coded in the label field to signify the beginning of the NTR section. Don't code anything else on this statement. Following this statement are statements containing the NTR and LOCAL keywords. A statement with NTR coded in the label field precedes each set of NTR statements, and a statement with LOCAL coded in the label field precedes each set of LOCAL keywords. The last statement in the NTR generation set must be one with END coded in the label field to delimit the NTR section.

NTRGEN can accept and process various input NTR and LOCAL keyword set configurations. You can follow or precede NTR keyword data with up to 14 sets of LOCAL keyword data, or you can process the NTR or LOCAL keyword data alone. This capability lets you preprocess LOCAL keyword data sets and then link them with the NTR module when you process the NTR keyword data. Only when NTRGEN processes NTR keyword data does it produce the job streams needed to produce an NTR system utility module, whether or not LOCAL keyword data sets are present. When you omit the NTR section, you can preassemble LOCAL keywords for future use by running the job stream SG\$NTRMK. The NTRGEN keyword parameters are listed in Table 4-5.

When you specify a previously generated NTR network name, the first keyword specified in this section must be NTRMOD. The parameter processor ignores all other parameters except NTRVOL, NTRNAME, and TASK and writes a diagnostic message in its output listing.

4.1.5. COBGEN

A statement with COBGEN coded in the label field must immediately precede the COBGEN parameter specifications. This statement signifies the beginning of the COBGEN section and a statement with END coded in the label field delimits it. The COBGEN keyword parameters are listed in Table 4-6.

4.2. SYSGEN Keyword Parameters

Tables 4-1 through 4-6 list all the SYSGEN keyword parameters you can specify when preparing your parameter sets. Each parameter is shown in its correct coding format, with parameter value ranges, default values, and descriptions of parameter functions. Model-dependent differences are indicated by shading in the description column.

Note: See 4.3 for the SYSGEN parameter reference tables (Tables 7 through 14) to help you code parameters.

Table 4-1. SUPGEN Keyword Parameters

Phase	Parameter in Coded Format	Description
SUPGEN	<p>[SUPMOD=supvrnam]</p> <p>[SUPVRNAM= {supervisor name}]</p>	<p>Requests a previously generated supervisor stored in \$\$\$SRC. SUPMOD must be the first keyword specified in this section; all other SUPGEN parameters are ignored except SUPVRNAM.</p> <p>Names generated supervisor or renames previously generated supervisor when used with SUPMOD; 1-6 characters.</p>
SUPERVISOR SIZING PARAMETERS		
	<p>[DLOADBUFR= {0}]</p> <p>[DLOADTABLE= {0}]</p> <p>[ERRLOGBUF= {n-2400}]</p> <p style="margin-left: 100px;">{0 (models 3-6)}</p> <p style="margin-left: 100px;">{6 (models 8-20)}</p> <p>[EXECPRI=n]</p>	<p>Maximum number of 256-byte blocks of main storage dynamically allocated (expanded) for a job. Recommended for use with ANSI'74 COBOL compilers. If you want COBOL CALL statements to dynamically expand your job regions, specify the maximum value, 32767, unless you must limit the expansion by specifying a smaller value.</p> <p>Number of entries per job in the job DLOAD table. Recommended for use with COBOL compiler. Choose a value equal to the maximum number of COBOL CALL statements in any one COBOL job. For example, if JOBA contains 4 CALL statements and JOBB contains 10, specify DLOADTABLE=10.</p> <p>Number of resident 80-byte buffers for error logging. For additional buffers, use the formula N x 80 where N is the number of additional buffers. The minimum value for models 8-20 is 6.</p> <p>The job step processor defaults to a user-specified priority rather than the lowest execution priority. If the priority is not specified on the EXEC statement, this is the value used. This value cannot exceed the PRIORITY keyword value. The range is 1 thru 60. The default value is the value specified or defaulted in the PRIORITY keyword.</p>

continued

Table 4-1. SUPGEN Keyword Parameters (cont.)

Phase	Parameter in Coded Format	Description
SUPGEN (cont)	<p>[EXPBFCTSZ= { 200 }]</p> <p>[EXPREGION= { 4096 }]</p>	<p>Specifies the maximum number of Dynamic Buffer Control Blocks (DBCBS) that can be dynamically allocated at any one time should the resident control block become full. Smaller allocations than the value specified will be made if a free region exists at a low address that can accommodate a minimum number of DBCBs.</p> <p>When possible, the system consolidates DBCBs in the dynamic regions into the resident control block as memory becomes available there.</p> <p>The DI BI command is a useful tool when attempting to determine the optimal value.</p> <p>Size in bytes of system dynamic buffer pools within main storage from which the system dynamically allocates buffers to a job. To avoid continuous dynamic allocation of buffer pools altogether, specify EXPREGION=0.</p> <p>This specification forces dynamic buffer management to restrict its allocation of buffer pools to one pool. The size of this pool is determined by the value specified on the RESBUFSIZE option. All buffer requests are then satisfied by acquiring memory from within this pool. If this pool becomes totally allocated, critical buffer requests are satisfied from the resident buffer pool, while others are placed in an awaiting-memory state. Although this configuration can reduce fragmentation between buffer pools, it is less dynamic in its use of memory, and can therefore be more wasteful. If too much buffer space is set aside, the memory within the large buffer pool is never utilized by the user. If not enough is set aside, tasks spend an inordinate amount of time waiting for memory. This configuration must be very precise.</p>

continued

Table 4-1. SUPGEN Keyword Parameters (cont.)

Phase	Parameter in Coded Format	Description
SUPGEN (cont)	<p>[JOBSLOTS=2-n]</p> <p>[PRIORITY=1-60]</p> <p>[RESBFCTSZ= { 300 100-9999 }]</p>	<p>You can change values each time you perform an IPL to load this supervisor. See the Operations Guide, UP-8859.</p> <p>Specifies the number of concurrent jobs that can run in the system. The maximum is 14 for models 3-6; and 48 for models 8-20.</p> <p>On all models:</p> <ul style="list-style-type: none"> ▪ one job slot is always reserved for interactive services (IS); and ▪ if the information management system (IMS) is implemented, two job slots are reserved. <p>Once set during SYSGEN, this parameter cannot be changed without generating a new supervisor.</p> <p>Establishes task priority levels in multijobbing environment.</p> <p>The maximum number of Dynamic Buffer Control Blocks (DBCBS) for which resident memory is set aside. A DBCB is created for each buffer created in the resident and dynamic buffer pools. A DBCB contains 36 bytes of information pertaining to its associated buffer.</p> <p>To handle priority situations, a few of the DBCB slots available in the resident control block are reserved for buffers requested at times when no memory available for additional DBCBs. For one of these slots to be utilized, a critical routine must request the buffer at a time when a DBCB cannot be allocated from memory. This number depends upon the size of the region, but will not exceed 10 slots.</p>

continued

Table 4-1. SUPGEN Keyword Parameters (cont.)

Phase	Parameter in Coded Format	Description
SUPGEN (cont)	[RESBUFSIZE=500-999999]	<p>The specified value should be the average number of buffers in use at any one time plus 10 to cover the reserved DBCB slots. This ensures the most efficient use of memory.</p> <p>This value cannot be altered during IPL. If more buffers are requested than can be satisfied by this value, free memory is allocated as control blocks, based on the size specified in the EXPBFCTSZ option. Additional control blocks are only allocated during peak buffer conditions. Under normal conditions, when all the DBCBs fit into the resident memory, no additional memory regions are allocated.</p> <p>The DI BI command is a useful tool when attempting to determine the optimal value.</p> <p>Resident buffer pool size, in bytes, within the supervisor, from which the system dynamically allocates buffers. This value reserves buffer regions within supervisor memory for use by critical routines that require memory at a time when user memory is unavailable. This requirement occurs infrequently, and only small amounts of memory are required at any one time.</p> <p>The default size of 500 bytes should always be used unless no expansion buffers are desired (EXPREGION=0) in which case, a buffer size large enough to accommodate all buffer needs must be specified.</p> <p>Note: If a value larger than 500 is specified the option is flagged by SYSGEN and the default value (500) is used.</p> <p>If you specify EXPREGION=0, the size specified on the RESBUFSIZE option becomes the size of a single buffer pool. This is the only buffer pool created during this boot period. This buffer must then be large enough to accommodate the maximum amount of</p>

continued

SUPGEN Keyword Parameters

Table 4-1. SUPGEN Keyword Parameters (cont.)

Phase	Parameter in Coded Format	Description
SUPGEN (cont)	<p>[SHAREDMSGT= {40 1-2000}]</p> <p>[SYMBIONT=symbiont,0-59]</p>	<p>dynamic buffer memory requested at peak periods of buffer usage, or the tasks, on whose behalf the memory has been requested, will be placed in a waiting-for-memory state.</p> <p>The resident buffer pool size defaults to 500 bytes if this configuration is specified.</p> <p>If you ever need to change the value that you specify now, you can do so each time you perform an IPL to load this supervisor. See the Operations Guide, UP-8859.</p> <p>Total number of 40-byte slots reserved in resident table that controls shared data management modules. Each shared module, at a given time, requires one table entry or slot. For most multijobbing applications, default values are sufficient. For unusually heavy multijobbing systems, specify higher values; if less than three job slots, specify lower values.</p> <p>Assigns a specific execution priority to a specific symbiont. Enter this option for each symbiont to be assigned its own priority. Those not assigned a specific priority are executed at the priority specified on the SYMBPRI parameter.</p> <p>Name Symbiont</p> <p>BEG Begin BRK Breakpoint CHA Change job queue CS Create symbiont DEL Delete DIS Display DT Device trace FIL File HOL Hold IED ICAM trace display IN Input IO I/O trace</p>

continued

Table 4-1. SUPGEN Keyword Parameters (cont.)

Phase	Parameter in Coded Format	Description
SUPGEN (cont)		<p>MM Mini monitor MON Monitor PD Output writer (data set label diskette) PR Output writer (printer) PU Output writer (punch) PT Patch transient RP Output writer (aux printer) RUN Run processor RV Run processor (without card reader) SCH Schedule (with card reader) SFM Screen format manager SI Schedule (without card reader) SAM System activity monitor SPM System performance monitor SU System utility TU System utility (also) VV VTOC verify</p> <p>If you specify a symbiont name more than once, the first occurrence is accepted. All subsequent specifications are ignored, and an error message is issued.</p> <p>[SYMBPRI=0-59]</p> <p>Priority level for running system symbionts (including job scheduler, but excluding ICAM). Priority 0 reserved for supervisor only. Priorities 1 to 59 can be assigned to user job steps. Can be used to assign execution priority of system symbionts relative to user jobs, but only if user job steps are extremely time critical.</p> <p>The SYMBIONT parameter can be used to assign specific priorities to individual symbionts.</p> <p>[TRANS= { 4 } { 1-15 }]</p> <p>Number of 1200-byte transient areas in main storage. As the number of transient areas increases, more jobs using them can run concurrently. The number of transient areas generated cannot exceed 15.</p>

continued

Table 4-1. SUPGEN Keyword Parameters (cont.)

Phase	Parameter in Coded Format	Description																
SUPGEN (cont)	SUPERVISOR FEATURE PARAMETERS																	
	<p>[ALTJCS=filename, { RES } { RUN } { vsn }]</p> <p>[CACHESEGSIZE= { n } { YES }]</p>	<p>Identifies the file that is to be the system default for the alternate \$Y\$JCS library via a file name (lblname) and the disk identifier in which the file resides. The disk identifier is not required if the file is cataloged.</p> <p>Specifies the number of 1024-byte blocks in a cache segment. A YES response indicates that a message will appear requesting the cache segment size during cache initialization. Otherwise, allowable values for n are:</p> <p>2 thru 15 for models 4 and 6 2 thru 24 for models 8 thru 20</p> <p>If this keyword is not specified, the following values are used by CACHE initialization:</p> <table border="1" data-bbox="781 947 1247 1199"> <thead> <tr> <th rowspan="2">Cache Buffer Size</th> <th colspan="2">CACHESEGSIZE Default</th> </tr> <tr> <th>Models 8 thru 20</th> <th>Models 4 and 6</th> </tr> </thead> <tbody> <tr> <td>64/160-255</td> <td>3</td> <td>2.5</td> </tr> <tr> <td>256-511</td> <td>6</td> <td>7.5</td> </tr> <tr> <td>512-1024</td> <td>12</td> <td>15.0</td> </tr> <tr> <td>1025-8192</td> <td>12</td> <td>N/A</td> </tr> </tbody> </table> <p>Changing the segment size can affect performance. See the Operations Guide, UP-8859, for guidelines on selecting appropriate segment sizes.</p>	Cache Buffer Size	CACHESEGSIZE Default		Models 8 thru 20	Models 4 and 6	64/160-255	3	2.5	256-511	6	7.5	512-1024	12	15.0	1025-8192	12
Cache Buffer Size	CACHESEGSIZE Default																	
	Models 8 thru 20	Models 4 and 6																
64/160-255	3	2.5																
256-511	6	7.5																
512-1024	12	15.0																
1025-8192	12	N/A																

continued

Table 4-1. SUPGEN Keyword Parameters (cont.)

Phase	Parameter in Coded Format	Description
SUPGEN (cont)	<p>[CONALARM= { NO } { YES }]</p> <p>[DAYCHANGE= { YES } { NO }]</p> <p>[DMGTMODE= { MIXED } { CDI }]</p> <p>[DMRECV= { NO } { YES } { INDEX }]</p>	<p>Specifies whether to sound a continuous audible alarm when an action or reply message is delivered to the system console.</p> <p>Specifies whether or not the supervisor automatically changes the date and time at midnight of each day. This feature requires approximately 20 bytes.</p> <p>Specifies the type of data management supported. This parameter is not available on models 3-6. Consolidated data management (CDI) is always assumed.</p> <p>CDI The system uses only consolidated data management (common data interfaces). The only exception is that SAT files can be accessed using basic data management (define the file (DTF) interfaces).</p> <p>Note: Some disk file types (for example, SAM, DAM, ISAM) cannot be accessed in this mode. Specify MIXED to permit access to these file types.</p> <p>MIXED The system operates in a mixed data management mode. You can execute in either basic data management (DFT) interfaces) or consolidated data management (CDI interfaces).</p> <p>Specifies whether IRAM/MIRAM files are created with the recover option. This can be overridden for individual files with the RECV parameter of the DD job control statement.</p>

continued

SUPGEN Keyword Parameters

Table 4-1. SUPGEN Keyword Parameters (cont.)

Phase	Parameter in Coded Format	Description
SUPGEN (cont)	<p data-bbox="402 909 641 982"> $\left[\begin{array}{l} \text{DUMPVSN} = \left\{ \begin{array}{l} \text{SYSRES} \\ \text{vsn} \end{array} \right\} \end{array} \right]$ </p> <p data-bbox="402 1213 641 1287"> $\left[\begin{array}{l} \text{FILELOCK} = \left\{ \begin{array}{l} \text{SHARE} \\ \text{YES} \end{array} \right\} \end{array} \right]$ </p>	<p data-bbox="781 373 1307 447">Note: Temporary job work files (physical file names prefixed with \$SCR and \$JOB) will be created without the recovery option.</p> <p data-bbox="781 478 1209 520">NO Recovery is not used for any files.</p> <p data-bbox="781 552 1209 625">YES Recovery is used for all data files (i.e., not MIRAM library files).</p> <p data-bbox="781 657 1307 751">INDEX Recovery is used for indexed data files only (i.e., not nonindexed or MIRAM library files).</p> <p data-bbox="781 783 1307 898">See the Job Control Programming Guide, UP-9986, for details on the format of the DD statement. See the Consolidated Data Management Programming Guide, UP-9978, for details on the recovery option (RECV DD parameter).</p> <p data-bbox="781 930 1307 951">Supports \$YSDUMP file on a non-SYSRES device.</p> <p data-bbox="781 982 1307 1098">During IPL, the time/date screen provides an option to specify the channel/address of the disk device that contains \$YSDUMP. During system initialization, \$YSDUMP is allocated on the non-SYSRES disk when required.</p> <p data-bbox="781 1129 1307 1203">If an alternate dump file is requested, SYSRES contains a minimum \$YSDUMP file for dumps taken during system initialization.</p> <p data-bbox="781 1234 1307 1308">Specifies which files are lockable. This parameter is not available on models 3-6. FILELOCK=SHARE is always assumed.</p> <p data-bbox="781 1339 1307 1507">If a file is lockable, the data management file share facility guarantees that the program's share requirements are honored. These requirements are usually specified by the ACCESS parameter in your program or by the ACCESS parameter of the DD job control statement.</p>

continued

Table 4-1. SUPGEN Keyword Parameters (cont.)

Phase	Parameter in Coded Format	Description
SUPGEN (cont)	<p>[IGNJCERR= {NONE [,R06][,E58] }]</p> <p>[IGNORESFT= {NO YES }]</p>	<p>If a file is not lockable, the file share facility is not invoked and there is no protection against invalid use of the file.</p> <p>YES Only files whose LBL names are prefixed with \$Y\$ or \$LOKnn are lockable (where nn can be from 01 to 99). You should specify this only if you have an explicit need to have nonlockable files.</p> <p>SHARE All files are lockable.</p> <p>This parameter only applies to basic data management define-the-file (DTF) interfaces. In consolidated data management, all files are lockable and are independent of this specification.</p> <p>Allows certain job control error conditions to be ignored.</p> <p>R06 Suppresses the R06 message when a job can not be found in the alternate library. Prevents \$Y\$JCS from being searched.</p> <p>E58 Suppresses the JC58 message when a job can not be scheduled until the workstation presently connected to another job is free.</p> <p>Specifies whether the system ignores // SFT statements.</p> <p>NO All // SFT statements are processed and the data management modules that these statements identify are loaded before the job is scheduled.</p> <p>YES All // SFT statements are ignored and the data management modules these statements identify are loaded as the job needs them during execution. Allows you to use dynamic shared code without having to delete //SFT statements from existing control streams. This feature is recommended to provide improved ease of use.</p>

continued

Table 4-1. SUPGEN Keyword Parameters (cont.)

Phase	Parameter in Coded Format	Description
SUPGEN (cont)	<p>[IMVJOB= { YES } { NO }]</p> <p>[JCREADWKS= { NO } { YES }]</p> <p>[JOBQUEREC= { NO } { YES } { HOLD }]</p> <p>[MAXTIME= { 0 } { 1-999 }]</p> <p>[MAXTYPE= { NONE } { CPU } { WALL }]</p> <p>[MEMCON= { YES } { NO }]</p> <p>[MIRAMCHAR= { NO } { YES }]</p>	<p>Allows relocation (shuffle) of immovable jobs to more efficient memory utilization locations. Rollout is required.</p> <p>Specifies whether workstation-initiated job control commands (RU, FI, and SI) can be read from the card reader.</p> <p>WARNING: Make sure that the cards you want to read are actually in the card reader at the time you issue the command.</p> <p>Job queue recovery at IPL.</p> <p>YES System recovers all jobs scheduled and queued when shut down.</p> <p>HOLD System recovers and holds all queued jobs until ready to run.</p> <p>Must be set to NO if specifying any of the following parameters: SYBMEM, INTMEM, JOBMEM, MAXJOBS, MAXWSJOBS, MAXSWSJOBS, or MAXRUNSYBMS.</p> <p>Default time (minutes) for the maximum time parameter on a job statement. To execute, you must also specify (no default) spooling and job accounting.</p> <p>Specifies if the max-time parameter on a JOB statement defines the elapsed wall-clock time or the job CPU time.</p> <p>Allows execution with or without job consolidation when free memory is available.</p> <p>Indicates if newly created MIRAM files are created as MIRAM CHARACTERISTIC.</p>

continued

Table 4-1. SUPGEN Keyword Parameters (cont.)

Phase	Parameter in Coded Format	Description
SUPGEN (cont)	<p>[RECOVERDS= { NO }]</p> <p>[RESHARE= { mod-name-1 group-name-sym-1 } [{ ,mod-name-2 group-name-sym-2 }] [{ ,mod-name-n group-name-sym-n }]]</p>	<p>NO</p> <p>Designates MIRAM CHARACTERISTIC based on file characteristics (default). If the file contains any of the characteristics, it is created as MIRAM CHARACTERISTIC.</p> <p>See Consolidated Data Management Programming Guide, UP-9978, for details on required characteristics.</p> <p>YES</p> <p>The files are always created as MIRAM CHARACTERISTIC. You can use TRACK ALLOCATION and MILOAD for all MIRAM files since these facilities are only used on MIRAM CHARACTERISTIC files. On the model 8, it is possible to use BDM IRAM (an RPG program compiled on a Series 90 system, or a BAL program). An attempt to open a MIRAM CHARACTERISTIC file using IRAM results in a DM61 TYPE=19 error.</p> <p>Specifies the option of either recovering disk space to retry a job or terminating a job when the job step processor displays a warning message that it cannot allocate sufficient disk space for the job.</p> <p>List of shared load module names or shared load module group names that you want resident in main storage. This option helps avoid fragmenting main storage space when modules are used frequently. If you want to specify individual module names, execute the SCLIST job stream by keying in RV SCLIST. The job lists all module names eligible for RESHARE. If you want to specify shared load module group names, see Table 4-8 for a list of eligible group names.</p> <p>To decide which modules to make resident for your applications, see the Supervisor Technical Overview, UP-8831. If you need to change the RESHARE specification, you can do so each time you perform an IPL to load this supervisor. See the Operations Guide, UP-8859.</p>

continued

SUPGEN Keyword Parameters

Table 4-1. SUPGEN Keyword Parameters (cont.)

Phase	Parameter in Coded Format	Description
SUPGEN (cont)	<p>RESMOD= [SM\$ASCKE][,SM\$ATCH] [,SM\$GTPUT][,SM\$LOCK] [,SM\$STXIT][,SM\$TASK]</p> <p>[,SM\$ASCKE]</p> <p>[,SM\$ATCH]</p> <p>[,SM\$GTPUT]</p> <p>[,SM\$LOCK]</p>	<p>Software modules resident rather than transient. Can specify subparameters in any order or in multiple calls of a keyword. If generating a supervisor for NTR, you must specify SM\$ATCH, SM\$LOCK, SM\$STXIT, and SM\$TASK.</p> <p>Note: SM\$LOD is always resident.</p> <p>Subparameters:</p> <p>SM\$ASCKE Assign key function used by IMS for secondary storage key assignment. Increases IMS performance. Adds 700 bytes to the supervisor.</p> <p>SM\$ATCH ATTACH processing is resident. Creates and activates task requiring control of processor. For start-up and end-task processing. Specify as resident only if you operate in an unusually heavy multi-tasking or interactive environment. Adds 1200 bytes to the supervisor.</p> <p>SM\$GTPUT GETCOM, PUTCOM, and GETINF functions are resident. Do not specify as resident unless a specific processing function requires it. Adds 700 bytes to the supervisor.</p> <p>SM\$LOCK Supervisor lock and unlock functions. Provides read and write file lock capability for lockable files. Adds 900 bytes to the supervisor and enhances its performance.</p>

continued

Table 4-1. SUPGEN Keyword Parameters (cont.)

Phase	Parameter in Coded Format	Description
SUPGEN (cont)	<p>[,SM\$STXIT]</p> <p>[,SM\$TASK]</p> <p>[ROLLOUT= { YES } { NO }]</p> <p>[RUNVSN= { SYSRES } { SYSSPL } vsn]</p>	<p>SM\$STXIT STXIT processing is resident. Creates, changes, or terminates linkage between the supervisor and user-island-code subroutines. Specify if using emulators. Adds 1400 bytes to resident supervisor.</p> <p>SM\$TASK WAIT, TYELD, CHAP, WAITM, and POST macroinstructions help gain efficiency in a multitasking environment. They are automatically made resident if spooling is configured. Adds 1100 bytes to the resident supervisor.</p> <p>YES Specifies the capability of the supervisor to recognize jobs with preemptive priority. The supervisor can roll lower priority jobs out of main storage for higher priority jobs and later roll the lower priority jobs back into main storage.</p> <p>NO The supervisor automatically equates the preemptive priority jobs to high priority jobs and no rollin or rollout is performed.</p> <p>Note: IMVJOB requires ROLLOUT=YES.</p> <p>Run device volume serial number.</p> <p>SYSRES System resident volume as RUN device.</p> <p>SYSSPL First spooling volume as RUN device (spooling must be configured).</p> <p>vsn Serial number of the volume serving as RUN device.</p>

continued

SUPGEN Keyword Parameters

Table 4-1. SUPGEN Keyword Parameters (cont.)

Phase	Parameter in Coded Format	Description
SUPGEN (cont)	<p>[SAM= {NO YES}]</p> <p>[SCDINDEX= {NO YES}]</p> <p>[SCRATCHDVC=vsn,dvno]</p> <p>[SYSTEMDATE= {YMD MDY DMY}]</p> <p>[TAPEAVR= {YES NO}]</p> <p>[TAPEBLKNO= {NO YES}]</p> <p>[TRNWKAREA= {NO YES 32-250}]</p>	<p>Specifies whether the system activity monitor dynamically links itself with the supervisor when you load the monitor. See System Activity Monitor Programming Guide, UP-9983, for details.</p> <p>Note: SAM collects device statistics for both I/O and DSK classes according to the device's position in I/OGEN. It does not collect statistics for any more than 72 devices. Therefore, be sure that the real devices that you intend to have SAM monitor are the first 72 listed in the I/OGEN.</p> <p>Allows faster loading of shared code modules into main storage and faster processing between two or more shared code modules. Commonly used shared code modules include the general editor, interactive services, data management, and ESCORT. Requires about 4000 bytes of main storage.</p> <p>Defines the location of the default work and temporary files for RES and RUN.</p> <p>System date format at IPL. YMD defines yy/mm/dd, MDY defines mm/dd/yy, and DMY defines dd/mm/yy.</p> <p>Specifies whether tape automatic volume recognition is supported during system initialization. Valid only for models 8/10/15/20.</p> <p>Specifies whether the supervisor supports tapes written with block numbers.</p> <p>Specifies whether the system generates a 32K- to 250K-transient work area to keep the most recently used transient modules in main storage. If specified, transients can be loaded into main storage directly from the work area instead of from the SYSRES volume. This reduces the number of I/O delays that occur and thus improves perfor-</p>

continued

Table 4-1. SUPGEN Keyword Parameters (cont.)

Phase	Parameter in Coded Format	Description
SUPGEN (cont)	<p>[UNATCONSOLE=0-30]</p> <p>[VOLTABLE= {NO } {YES }]</p> <p>[VAVR= {NO } {YES }]</p>	<p>mance. Specifying YES initializes the transient work area to 250K at initial program loading (IPL). This feature is for systems other than DTF-only systems.</p> <p>To change the TRNWKAREA specification, you can issue the TW command after you perform an initial program load (IPL). See the Operations Guide, UP-8859.</p> <p>The unattended console feature specifies whether hardware error messages that require an RU (retry/unrecoverable error) or RC (retry/cancel) response are automatically answered by the operating system. Values 1-30 specify time (in minutes) that elapses before the error message is answered automatically with either a C (cancel), or U (unrecoverable error) response. The default value 0 suppresses this feature.</p> <p>Specifies whether the system's volume table is resident in main storage. When resident, this feature allows faster scheduling of jobs and thus improves performance. The volume table requires 512 bytes of main storage.</p> <p>Indicates whether automatic volume table of contents (VTOC) verification is performed at automatic volume recognition (AVR) time. See the Operations Guide, UP-8859, for details on the VTOC verification routine.</p>
SUPERVISOR HARDWARE PARAMETERS		
	<p>[CHAN= {13 } {15 }]</p> <p>[CHAN1= {15 } {13 }]</p>	<p>Specifies the input/output microprocessor (IOMP) channel number. Models 8-20 only.</p> <p>Specifies the second IOMP channel number. Models 8-20 only.</p>

continued

SUPGEN Keyword Parameters

Table 4-1. SUPGEN Keyword Parameters (cont.)

Phase	Parameter in Coded Format	Description
SUPGEN (cont)	<p>[COMM= { NO } { 1-n } { YES }]</p> <p>[COMM1= { NO } { 1-14 }]</p> <p>[DCPCHNL=n]</p> <p>[FLOATPT= { YES } { NO }]</p> <p>[IORB= { 5 x COMM } { 5-150 }]</p> <p>[IORB1= { 5 x COMM1 } { 5-150 }]</p>	<p>You must specify if the system supports communications capability (ICAM). Specifies ICAM network interfaces with communications terminals; value specifies the number of communication lines (SLCAs) in the system. The maximum value is 8 for models 3-6; 14 for models 8-20.</p> <p>YES ICAM network interfaces with directly connected local workstations only. Do not specify YES if you have both local workstations and communications terminals.</p> <p>NO Communications not supported.</p> <p>Must specify if system supports communications capability (ICAM) and two IOMP channels. Definitions are the same as the COMM parameter.</p> <p>Channel to which the DCP is connected. If specified, this channel can only be used by ICAM and cannot be specified in I/OGEN.</p> <p>Models 8-20 only. Valid entries are: 1-3, 6, or 7 for model 8 1 thru 6 for models 10 thru 20</p> <p>Specifies whether your supervisor supports floating point software.</p> <p>Specifies the number of input/output resource blocks (IORBs) to be generated for the channel. Default value is equal to 5 times the number of communication lines specified in the COMM= parameter. Models 8-20 only.</p> <p>Number of IORBs to be generated for the second channel. Default value is equal to 5 times the number of lines specified in the COMM1 parameter. Models 8-20 only.</p>

continued

Table 4-1. SUPGEN Keyword Parameters (cont.)

Phase	Parameter in Coded Format	Description
SUPGEN (cont)	<p>[ISBATCHLMT= <input type="text" value="8"/> { 1-255 }]</p> <p>[ISINTLMT= <input type="text" value="8"/> { 1-255 }]</p> <p>[ISINTPRI= <input type="text" value="60"/>]</p> <p>[ISLOGONSC= <input type="text" value="NO"/> { YES }]</p> <p>[ISNETNAME=network-name]</p>	<p>Maximum number of batch sessions that can execute concurrently in the system. Batch sessions use only card, card image, tape, or disk input.</p> <p>Maximum number of interactive users the system recognizes at any one time. Interactive sessions use input only from a workstation or an interactive communications terminal.</p> <p>Priority level of interactive commands entered from workstations or interactive terminals.</p> <p>Logon security. The system checks the security file when a user logs on. If ISLOGONSC=YES, identification must be a valid name in the file. If ISLOGONSC=NO, any user can log on to the system with any identification.</p> <p>Commands are restricted according to the restrictions in the user profile.</p> <p>If you specify YES, the ISADMID parameter must also be specified.</p> <p>If PASSWORD or DDPSC are specified as YES, this keyword must also be YES.</p> <p>Specifies a 1- to 4-character communications network name telling interactive services on which network to operate. If ICAM is configured, one network name must be specified. Otherwise, the system defaults to no name and the communications network does not support interactivity. This parameter does not affect the operation of local workstations, but it is required if you want remote terminals to function as workstations.</p>

continued

Table 4-1. SUPGEN Keyword Parameters (cont.)

Phase	Parameter in Coded Format	Description
SUPGEN (cont)	<p data-bbox="565 415 813 499">[ISWKSBUL= { YES, YES } { NO , NO }]</p> <p data-bbox="565 625 813 709">[ISWKSLOG= { YES, YES } { NO , NO }]</p> <p data-bbox="565 835 760 919">[ISWORKn= { RUN } { vsn }]</p> <p data-bbox="565 1276 776 1360">[PASSWORD= { NO } { YES }]</p>	<p data-bbox="943 436 1464 611">Interactive services (IS) logon BULLETIN default value and override option. The first entry specifies whether YES or NO appears as the default for the BULLETIN on the logon screen. The second entry specifies whether or not the interactive services user can change the value that appears as the default.</p> <p data-bbox="943 638 1446 812">Interactive services (IS) LOG default value and override option. The first entry specifies whether YES or NO appears as the default for LOG on the logon screen. The second entry specifies whether or not the interactive services user can change the value that appears as the default.</p> <p data-bbox="943 840 1458 1087">An interactive services (IS) work volume specification that controls where EDT, ESCORT, and BASIC work files are allocated. n is a number from 1 to 4 that specifies the number of different work packs among which work files can be distributed. The system obtains work space equally from only the specified volumes. If all parameters are omitted, then work space is allocated on the execution time RUN volume.</p> <p data-bbox="943 1115 1464 1266">Note: If a system failure occurs when EDT, ESCORT, or BASIC work files are open, a re-IPL merely scratches the files on the RES and RUN volumes. Use the SCR job control statement to scratch work files on volumes other than RES or RUN.</p> <p data-bbox="943 1293 1446 1341">Specifies whether all users are required to enter a password in order to log on.</p>

continued

Table 4-1. SUPGEN Keyword Parameters (cont.)

Phase	Parameter in Coded Format	Description
SUPGEN (cont)	<p style="text-align: center;">SUPERVISOR SPOOLING PARAMETERS</p> <p style="text-align: center;">[SPOOLING= { NO INPUT OUTPUT REMOTE DDP }]</p>	<p>Indicates spooling type. See Spooling and Job Accounting Operating Guide, UP-9975.</p> <p>NO No spooling capability.</p> <p>INPUT Both input readers and output writers are used for spooling.</p> <p>OUTPUT Only output writers are used for spooling.</p> <p>REMOTE Remote batch processors, input readers, and output writers are used for spooling mode. If SPOOLING=REMOTE, also specify SPOOLICAM.</p> <p>DDP Distributed data processing, remote batch processors, input readers, and output writers are used for spooling. If SPOOLING=DDP, also specify SPOOLICAM.</p> <p>Main storage requirements for spooling:</p> <ul style="list-style-type: none"> ▪ 4800 bytes for spooler ▪ 720 bytes for system control table ▪ Directory requirement: <ul style="list-style-type: none"> - 72 bytes for OUTPUT - 120 bytes for INPUT - 168 bytes for REMOTE ▪ 32 bytes for each virtual device in I/GEN ▪ 4 bytes times number specified by SPOOLMAP for spool-file bit map

continued

Table 4-1. SUPGEN Keyword Parameters (cont.)

Phase	Parameter in Coded Format	Description
SUPGEN (cont)	<p>[CONPRINT= { NO } { YES }]</p> <p>[CONSOLOG= { NO } { MAX } { MIN } { NORM }]</p> <p>[DDPSPOOL= { 10 } { 1-128 }]</p>	<p>▪ Any spooling option requires resident SM\$TASK module</p> <p>Note: If spooling is not configured, all other keyword parameters associated with it are ignored. Also, no virtual devices or direct printers are in I/OGEN.</p> <p>Console log (C records) printed when file breakpointed.</p> <p>Indicates whether console log C records and workstation log W records are collected. Also specifies the size of the main storage buffer area for storing. The system collects a record of all communication between the system and the console (log) and between the system and the workstation (log) in this buffer. It then copies it into the spool file when it fills the buffer area. MIN specifies 304-byte buffer; NORM specifies 560-byte buffer; MAX specifies 1072-byte buffer. If it is omitted or if NO is specified, the console and workstation log are not recorded in the spool file.</p> <p>Specifies the number of concurrently running tasks that can return spoolout of distributed data processing (DDP) jobs. Each task that can return DDP spoolout needs a task control block and at least 8K of dynamic buffer space.</p> <p>In most cases, the default value of 10 tasks is sufficient. If, however, your system takes too much time to return the DDP spoolout, raise the value. If the default value of 10 tasks degrades your system's overall performance, lower the value.</p>

continued

SUPGEN Keyword Parameters

Table 4-1. SUPGEN Keyword Parameters (cont.)

Phase	Parameter in Coded Format	Description
SUPGEN (cont)	$\left[\begin{array}{l} \text{JOBACCT} = \left\{ \begin{array}{l} \text{NO} \\ \text{YES} \end{array} \right\} \end{array} \right]$	<p>Resident job accounting routines maintain a record of CPU time used by these job and job step facilities: number of I/O requests per device, number of supervisor requests, main storage use, and transient function use. Specify only if spooling is configured. Adds approximately 350 bytes to the resident supervisor in addition to 100 bytes in each job prologue.</p>
	$\left[\begin{array}{l} \text{RETAINLOG} = \left\{ \begin{array}{l} \text{NO} \\ \text{YES} \end{array} \right\} \end{array} \right]$	<p>Console log (C records) retained in spool file after printing.</p>
	$\left[\begin{array}{l} \text{SPOOLBUFR} = \left\{ \begin{array}{l} 2 \\ 1 \\ 4 \\ 8 \\ 16 \\ 32 \end{array} \right\} \end{array} \right]$	<p>Size of spooler work buffer allocated to each job preamble in terms of number of 256-byte blocks of main storage. Specify only parameters shown in format.</p>
	$\left[\begin{array}{l} \text{SPOOLBURST} = \left\{ \begin{array}{l} \text{NO} \\ \text{YES} \end{array} \right\} \end{array} \right]$	<p>Output spooling functions in burst mode. Operating in burst mode requires the output processing criterion to be configured to the control output writer's mode of processing for available output subfiles. Enables output files to write before the termination of an associated job, depending on the criterion selected. Operating in nonburst mode implies that the output subfile processing by the output writers is not done until the job is terminated.</p>
	$\left[\begin{array}{l} \text{SPOOLCOMP} = \left\{ \begin{array}{l} \text{YES} \\ \text{NO} \end{array} \right\} \end{array} \right]$	<p>Specifies if your supervisor compresses the output image in a spool file. If this parameter is omitted, the output image of the spool file is compressed if three or more consecutive blanks are present. Do not specify SPOOLCOMP=NO when most of the files created contain a large amount of blanks or use block sizes greater than 120.</p>

continued

Table 4-1. SUPGEN Keyword Parameters (cont.)

Phase	Parameter in Coded Format	Description
SUPGEN (cont)	<p>[SPOOLCYL= { 50 } { ALL } { 1-1000 }]</p> <p>[SPOOLCYLn= { 50 } { ALL } { 1-1000 }]</p> <p>[SPOOLFARSI= { NO } { YES }]</p>	<p>Number of cylinders initially allocated for the spool file on the primary spooling volume. The default is recommended. If this selection exceeds the default value of devices in I/OGEN the default number of spool cylinders is insufficient. ALL allocates all available cylinders on the primary spooling volume. This option should be used only for a dedicated spooling volume.</p> <p>Specifies the number of cylinders initially allocated for the spool file on the nth sequential spooling volume,</p> <p>Spool file allocation (SPOOLCYL and SPOOLCYLn) is done only at spooling initialization when:</p> <ul style="list-style-type: none"> ▪ No spool exists on the spool volume ▪ The sequence of the spool volume is different than that of the previous boot. <p>To increase or decrease the amount of spool space on an existing spool volume, the file must first be scratched. Do this by booting in the supervisor using a different spool volume. After the system is initialized, a user-initiated job stream is executed to scratch the spool file (SYSPPOOL) on the required volume. Upon rebooting of the supervisor, which uses the spool volume that was just scratched, spool space is allocated as designated by the SPOOLCYL OR SPOOLCYLn parameter.</p> <p>FARSI (Iranian language) translation executed for all spool files containing *FARSI or @FARSI as first six characters of // LBL job control statement. To accommodate this capability, the output writer is loaded with an additional 400 16-byte increments of main storage and the input reader is loaded with an additional 300 16-byte increments.</p>

continued

SUPGEN Keyword Parameters

Table 4-1. SUPGEN Keyword Parameters (cont.)

Phase	Parameter in Coded Format	Description
SUPGEN (cont)	<p>[SPOOLHDR= { YES }] [SPOOLHDR= { NO }]</p> <p>[SPOOLICAM= { C1 }] [SPOOLICAM= { Cn }] [SPOOLICAM= { Mn }] [SPOOLICAM= { C? }]</p> <p>[SPOOLMAP= { 64 }] [SPOOLMAP= { 1-32767 }]</p> <p>[SPOOLMAXLINE= { 5 }] [SPOOLMAXLINE= { 1-255 }]</p>	<p>Spooled output files are printed without headers. If omitted, a 3-page header precedes the printing of each spooled file.</p> <p>Name of ICAM symbiont load module (C1-C9 and M1-M9) called by spooler to service remote batch and distributed data processing spooling. If SPOOLICAM=C?, the console operator is asked at load time for the value ICAM name to load. If you specify SPOOLICAM, you must specify SPOOLING=REMOTE or SPOOLING=DDP and a value for COMM during SUPGEN. You must also configure an ICAM element through the COMMT phase. If omitted, jobs creating output for remote batch or distributed data processing encounter errors at the end of a job and require ICAM to be manually loaded to process the output.</p> <p>Number of full words (four bytes) of main storage reserved for resident spool-file bit map. Refer to 4.3.1. and Table 4-7 for information about how this value is used and how it can be optimized.</p> <p>Specifies the maximum number of I/O records (in thousands) to be processed before the system halts the job and sends a warning message to the operator.</p>

continued

Table 4-1. SUPGEN Keyword Parameters (cont.)

Phase	Parameter in Coded Format	Description
SUPGEN (cont)	<pre> SPOOLMODE= ACCTNO, account- number CARTNAME, cartridge- name DEVICE, device-type- code FILE, filename FORM, form-name JOB, jobname </pre>	<p>Output file processing criterion and its value for the spooler when operating in burst mode. Output files are processed according to the criterion and its value specified; process stops when the criterion is satisfied. If operating in burst mode, and no criterion is specified, output is governed under the job priority basis.</p> <p>If you are uncertain which criterion to implement, you can change the specification from the console later. See the procedures in the Operations Guide, UP-8859.</p> <p>Subparameters:</p> <p>ACCTNO,account-number One to four alphanumeric characters indicating that the account number is the criterion used to determine file processing. Subfiles created by jobs whose account number is the same as the criterion specified on the JOB control statement are processed without operator intervention.</p> <p>CARTNAME,cartridge-name One to eight alphanumeric characters indicating that the cartridge name is the criterion to determine file processing. All subfiles whose cartridge name is the same as the criterion specified on the LCB job control statement are processed without operator intervention.</p> <p>DEVICE,device-type-code Indicates to output writer that the device type number such as 0776 or 0789 is the criterion to determine file processing. All subfiles available for processing whose device type is the same as the criterion configured are processed without operator intervention.</p>

continued

Table 4-1. SUPGEN Keyword Parameters (cont.)

Phase	Parameter in Coded Format	Description
SUPGEN (cont)	<p>[SPOOLNOINPUT= { NO }]</p> <p>[SPOOLNOINPUT= { YES }]</p>	<p>FILE,filename One to eight alphanumeric characters indicating that the file name is the criterion used to determine file processing. All subfiles available for processing whose file name is the same as the criterion configured are processed without operator intervention.</p> <p>FORM,form-name One to eight alphanumeric characters indicating that the form name is the criterion used to determine file processing. All subfiles whose form name is the same as the criterion configured (on VFB or SPL job control statements) are processed without operator intervention.</p> <p>JOB,jobname One to eight alphanumeric characters indicating that job name is the criterion used to determine file processing. All subfiles whose job name is the same as the criterion specified on the job control statement are processed without operator intervention.</p> <p>PRI Indicates that priority is the criterion used to determine file processing. Files are processed on a first-in, first-out basis without operator intervention.</p> <p>Specifies whether your supervisor suppresses input spooling. Use when you specify SPOOLING=REMOTE or SPOOLING=DDP and you want to suppress the INPUT SPOOLING capability throughout your SPOOLING system. You cannot run the input reader when you specify YES.</p>

continued

Table 4-1. SUPGEN Keyword Parameters (cont.)

Phase	Parameter in Coded Format	Description
SUPGEN (cont)	<p>SPOOLWBUF= $\left[\begin{array}{c} 2 \\ 4 \\ 8 \\ 16 \\ 32 \end{array} \right]$</p> <p>SPOOLPRT= $\left[\begin{array}{c} ALL \\ ACT \\ LOG \\ NO \end{array} \right]$</p> <p>SPOOLRECV= $\left[\begin{array}{c} NONE \\ ALL \\ CLOSED \\ LOG \end{array} \right]$</p>	<p>Number of 256-byte blocks of main storage allocated to the spool buffers for the print and punch output writer. Specifying larger values for this keyword parameter increases system performance by reducing the number of disk accesses to the spool file. Specify only the parameters shown in the format.</p> <p>Specifies log printing criteria for a terminated job. Includes log types for printing (L and A) and whether to print log records. Must specify JOBACCT=YES to have A records.</p> <p>ALL Specifies that both job log and accounting records are printed when a job ends.</p> <p>ACT Specifies that job accounting records are printed when a job terminates.</p> <p>LOG Specifies that only log records are printed when the job terminates.</p> <p>NO Specifies that job log and accounting records are not printed.</p> <p>Level of recovery for spool file when it is necessary to reinitialize the supervisor.</p> <p>NONE Spool file not recovered (cold start).</p> <p>ALL All spooled subfiles recovered, completed or not (warm start).</p> <p>CLOSED Only completed spooled subfiles recovered (warm start).</p> <p>LOG Only log files recovered (warm start).</p>

continued

SUPGEN Keyword Parameters

Table 4-1. SUPGEN Keyword Parameters (cont.)

Phase	Parameter in Coded Format	Description
SUPGEN (cont)	$\left[\text{SPOOLTEST} = \begin{matrix} \text{YES} \\ \text{NO} \end{matrix} \right]$	<p>Specifies whether your supervisor suppresses console messages requesting an operator decision to print a test line for form change. If omitted, a test line message is displayed at the console.</p>
	$\left[\text{SPOOLTPBUFR} = \begin{matrix} 1 \\ 2 \\ 4 \\ 8 \\ 16 \\ 32 \end{matrix} \right]$	<p>Specifies size of the buffer used to generate the tape block in 256-byte increments.</p> <p>Tape processing efficiency increases in speed and tape utilization when larger block sizes are used.</p>
	$\left[\text{SPOOLUPDATE} = \begin{matrix} \text{YES} \\ \text{NO} \end{matrix} \right]$	<p>Spool subdirectory entry update. If SPOOLUPDATE=NO, the entry is updated only when a file is closed. If cancelled, all program output generated prior to the cancellation is lost. If a parameter is omitted, an entry is updated whenever a logical track is crossed.</p>
	$\left[\text{SPOOLVSN} = \begin{matrix} \text{SYSRES} \\ \text{vsn} \end{matrix} \right]$	<p>Volume serial number of the primary disk that the supervisor uses as a pool file.</p>
	$\left[\text{SPOOLVSNn} = \begin{matrix} * \\ \text{SYSRES} \\ \text{vsn} \end{matrix} \right]$	<p>Multivolume spooling is supported. You can allocate up to eight disk volumes for spooling. SPOOLVSNn identifies the nth sequential volume of a spool file, where n is a decimal number from 2 to 8. You can identify each spool volume through multiple calls of the keyword. For example, SPOOLVSN2=vsn, SPOOLVSN3, etc., or denote only the last sequential volume. If you identify only the last volume, all other volumes default to *, letting you to specify device addresses of disk units containing spooling volumes at IPL.</p>
	$\left[\text{SYSLOG} = \begin{matrix} \text{NO} \\ \text{YES} \end{matrix} \right]$	<p>Accumulation of job and workstation log files (L, A, and W) in spool file for future transfer to user disk or tape file. If not configured at SYSGEN, the operator can request from the console later. See Spooling and Job Accounting Operating Guide, UP-9975. Must specify JOBACCT=YES to have A records.</p>

continued

Table 4-1. SUPGEN Keyword Parameters (cont.)

Phase	Parameter in Coded Format	Description
SUPGEN (cont)	RESOURCE MANAGEMENT PARAMETERS	
	<p>[RESMGT= { NO }] [RESMGT= { YES }]</p> <p>[INTMEM= { NLMT }] [INTMEM= { 5-100 }]</p> <p>[JOBMEM= { NLMT }] [JOBMEM= { 0-100 }]</p> <p>[MAXJOBS= { 14 (models 3-6) }] [MAXJOBS= { 48 (models 8-20) }] [MAXJOBS= { 0-n }]</p> <p>[MAXRUNSYMB= { 2 }] [MAXRUNSYMB= { 0-10 }]</p>	<p>Enables the configuration of resource management* capabilities.</p> <p>NO The system ignores the next seven parameters (INTMEM through SYMBMEM).</p> <p>YES The next seven parameters (INTMEM through SYMBMEM) come up, and the system implements the defaults for each unless other values are specified.</p> <p>Specifies the percentage of available main storage allocated for interactive services use. NLMT indicates no limit to amount of main storage available for interactive services use. Valid only if RESMGT=YES.</p> <p>Specifies the percentage of available main storage allocated for jobs use. NLMT indicates no limit to amount of main storage available for jobs use. Valid only if RESMGT=YES.</p> <p>Specifies the maximum number of jobs that can be run concurrently in the system. The maximum value is 14 for models 3-6; 48 for models 8-20. Valid only if RESMGT=YES.</p> <p>Default value is as shown unless a different value is specified for number of job slots (JOBSLOTS=). If value is different, default value for this parameter is the number of job slots previously specified.</p> <p>Specifies the maximum number of run symbionts that can execute concurrently in the system. Valid only if RESMGT=YES.</p>

*This is a separately priced product that you must purchase to configure in your system.

continued

Table 4-2. I/OGEN Keyword Parameters (Models 3 through 6)

Phase	Parameter in Coded Format	Description
<p>Models 3-6 I/OGEN</p> <p>PRINTER</p>	<p>[I/OMOD=supvrnam]</p> <p>[TYPE= SDMA]</p> <p>[CHAN=3]</p> <p>[ADDR= [address 30,31 (for SDMA) 42 (for 0744)]]</p> <p>[DVCNO=lun]</p> <p>[CLASS= [1 2 3]]</p> <p>[CHARSET= [STD EXT]]</p>	<p>The supervisor name previously created and saved by the I/O configuration in \$\$\$SRC on the SYSRES. You can request the established I/O configuration by specifying the parameter immediately following the statement with an I/OGEN parameter in the label field. No other I/OGEN parameters are then required.</p> <p>Identifies a printer or group of printer types.</p> <p>SDMA Specifies any of the following types of printers: 0776, 0786, 0789, 0798.</p> <p>Physical I/O channels with access to a printer or a group of printers is described. The default specification is device dependent and determined as a function of the TYPE keyword.</p> <p>2-digit hexadecimal number identifying the address and number of printer types. If more than one address is specified, it must be separated by commas or hyphenated to indicate consecutive addresses.</p> <p>Changes standard logical unit numbers (lun) for specific printers. See Table 4-9 for logical unit number. If you specify this parameter in a multiprinter environment, output is to this printer first. If you don't specify this parameter, output is sent to any available printer.</p> <p>Classifies printer so that special logical unit numbers can be used to direct output for printers of the same subtype. See Table 4-9 for the logical unit number table.</p> <p>Number of printable characters in a printer subsystem font set (standard or extended).</p>

continued

Table 4-2. I/GEN Keyword Parameters (Models 3 through 6) (cont.)

Phase	Parameter in Coded Format	Description
Models 3-6 I/GEN (cont.)	<pre> [PRINTPOS= { 132 (for 0786, 0789,0798) }] [LCB= { 8-BUS (for SDMA) 48-SC1 63-STD OWNLC1 OWNLC2-OWNLC9 (if SDMA) }] [VFB= { STAND1 OWNVF1 OWNVF2-OWNVF9 (for SDMA) }] [ATTNRE= { YES }] [REMOTE= { NO }] [ADDR=NO] </pre>	<p>Number of print positions pertaining to a printer subsystem described.</p> <p>Printer load code buffer used as a default buffer for the printer defined. OWNLC1 and OWNLC2 reference load code buffers other than 48-BUS, 48-SC1, 63-STD, or those that report a character mismatch. See Section 3 for the procedure that defines these alternate printer characteristics.</p> <p>Printer vertical format buffer as a default buffer for the printer subsystem defined. OWNVF1 references user-generated vertical format buffers. See Section 3 on how to generate your own vertical format buffers.</p> <p>Specifies whether your system supports automatic retry of recoverable errors when attention interrupts are received on a printer that has an unanswered physical IOCS error message. If omitted, the retry feature is active. The operator can initiate recovery at a printer by placing it in online mode.</p> <p>Specifies if your system includes 0786 or 0789 printers that are in remote locations from the System 80 host.</p> <p>Defines an indirect printer for your system. If you configure a printerless system, you must define at least one indirect printer and also configure spooling. Printer files generated on a printerless system are spooled for subsequent printing on another system that has a physical printer. You can specify an indirect printer for each physical printer type that exists on the system that prints the spooled data.</p>

continued

Table 4-2. I/OGEN Keyword Parameters (Models 3 through 6) (cont.)

Phase	Parameter in Coded Format	Description
Models 3-6 I/OGEN (cont)		
[PRINTER	VIRTUAL= $\left. \begin{array}{l} 2 \text{ x number of} \\ \text{job slots} \\ 0 \\ 1-99 \end{array} \right\}$	Number of virtual printers if spooling is configured. To calculate the optimum number, multiply the number of jobs that can run concurrently by the average number of printer files used for each job. Each virtual printer uses 32 bytes of main storage.
READER	[TYPE= $\left. \begin{array}{l} 0719 \\ 0931 \text{ (NUK only)} \end{array} \right\}$	Type of reader or group of readers defined.
	[CHAN=3]	Physical I/O channels with access to a reader or group of readers defined. The default specification is device dependent and determined as a function of the TYPE keyword.
	[ADDR= $\left. \begin{array}{l} \text{address} \\ 32 \text{ (for 0791)} \\ 60 \text{ (for 0931)} \end{array} \right\}$	2-digit hexadecimal number that identifies a hardware address and number of a reader or a group of readers defined. If more than one address is specified, it must be separated by commas or hyphenated to indicate consecutive addresses.
	[DVCNO=lun]	Changes logical unit numbers (lun) for specific readers. See Table 4-9 for logical unit numbers.
	[FEED=80 (for 0719)]	Card size read by reader if a short card feature is installed.
	[ATNRE= $\left. \begin{array}{l} \text{NO} \\ \text{YES} \end{array} \right\}$	Specifies whether your system supports automatic retry of recoverable errors when attention interrupts are received on a reader that has an unanswered physical IOCS error message. If YES, the operator can initiate recovery retry at the reader by placing it in online mode.
[READER	VIRTUAL= $\left. \begin{array}{l} 1 \text{ x number} \\ \text{of job} \\ \text{slots} \\ 0 \\ 1-99 \end{array} \right\}$	Number of virtual readers if spooling is configured. To calculate the optimum number, multiply the number of jobs that can run concurrently by the average number of reader files used for each job. Each virtual reader uses 32 bytes of main storage.

continued

Models 3-6 I/OGEN Keyword Parameters

Table 4-2. I/OGEN Keyword Parameters (Models 3 through 6) (cont.)

Phase	Parameter in Coded Format	Description
Models 3-6 I/OGEN (cont)		
[PUNCH]	<pre> TYPE= { 0608 0932 (NUK only) } </pre>	Type of punch or group of punches defined.
	[CHAN=3]	Physical I/O channels with access to a punch or punches defined. The default specification is device dependent and determined as a function of the TYPE keyword.
	<pre> ADDR= { address 33 (for 0608) 61 (for 0932) } </pre>	2-digit hexadecimal number that identifies hardware address and number of a punch or a group of punches defined. If more than one address is specified, it must be separated by commas or hyphenated to indicate consecutive addresses.
	[DVCNO=lun]	Changes logical unit numbers (lun) for specific punches. See Table 4-9.
	<pre> ATTNRE= { YES NO } </pre>	Specifies whether your system supports automatic retry of recoverable errors when attention interrupts are received on a punch that has an unanswered physical IOCS error message. If omitted, the retry feature is active and the operator can initiate recovery retry at the punch by placing it in the online mode.
	<pre> READ= { NO YES } </pre>	Punch has card reader capability.
[PUNCH]	<pre> VIRTUAL= { 1 x number of job slots 0 1-99 } </pre>	Number of punches, if spooling configured. To calculate the optimum number, multiply the number of jobs that can run concurrently by the average number of punch files used for each job. Each virtual punch uses 32 bytes.
DISC	<pre> TYPE= { 8417 8419 8470 } </pre>	Type of disk or group of disks defined Note: If your system has both fixed and removable disks, the fixed disks must be specified first.

continued

Table 4-2. I/OGEN Keyword Parameters (Models 3 through 6) (cont.)

Phase	Parameter in Coded Format	Description
<p>Models 3-6 I/OGEN (cont)</p> <p>DISC</p>	<p> $\left[\text{ADDR} = \left\{ \begin{array}{l} \text{address} \\ \text{00 (for 8417/70)} \\ \text{02 (for 8419)} \end{array} \right\} \right]$ $\left[\text{CHAN} = \left\{ \begin{array}{l} \text{1 (for 8417/19)} \\ \text{4 (for 8470)} \end{array} \right\} \right]$ <p>[DVCNO=lun]</p> $\left[\text{FIXHEAD} = \left\{ \begin{array}{l} \text{NO} \\ \text{YES} \end{array} \right\} \right]$ $\left[\text{CACHE} = \left\{ \begin{array}{l} \text{NO} \\ \text{YES} \\ \text{NOMI} \end{array} \right\} \right]$ </p>	<p>2-digit hexadecimal number identifies the hardware address and number of disks defined. If more than one address is specified, it must be separated by commas or hyphenated to indicate consecutive addresses.</p> <p>Physical I/O channels with access to disk. Default specification is device dependent and determined as a function of the TYPE keyword.</p> <p>Changes logical unit numbers (lun) for specific disks. See Table 4-9 for logical unit numbers.</p> <p>Extra fixed heads on 8417 allows faster access time.</p> <p>Indicates whether a disk device is activated to the disk cache facility. You can override this specification (except CACHE=NO) on a file basis through the CACHE parameter on the DD JCL statement. See the Job Control Programming Guide, UP-9986, and the Consolidated Data Management Programming Guide, UP-9978, for details on the CACHE DD parameter.</p> <p>YES The disk device is activated to the disk cache facility (DCF) for all files.</p> <p>NO The disk device is not activated to the DCF. Specify NO if the device is shared by two processors.</p> <p>NOMI The disk device is activated to the DCF for all files except MIRAM data files.</p>
DISKETTE	[CHAN=3]	Physical I/O channel with access to a diskette. The default specification is device dependent and determined as a function of the TYPE keyword.

continued

Table 4-2. I/OGEN Keyword Parameters (Models 3 through 6) (cont.)

Phase	Parameter in Coded Format	Description
Models 3-6 I/OGEN (cont)		
DISKETTE	$\left[\begin{array}{l} \text{TYPE= } \left\{ \begin{array}{l} 8420 \\ 8422 \end{array} \right\} \end{array} \right]$	Type of diskette or group of diskettes defined.
	$\left[\text{ADDR= } \left\{ \begin{array}{l} nn \\ 20, 21 \end{array} \right\} \right]$	2-digit hexadecimal number identifying hardware address and number of diskette drives defined. If more than one address is specified, it must be separated by commas or hyphenated to indicate consecutive addresses.
	[DVCNO=lun]	Changes logical unit numbers (lun) for specific diskettes. See Table 4-9 for logical unit numbers.
	$\left[\text{AUTOLOAD= } \left\{ \begin{array}{l} \text{NO} \\ \text{YES} \end{array} \right\} \right]$	Operating system can automatically load up to 20 diskettes.
[TAPE]	$\left[\text{TYPE= } \left\{ \begin{array}{l} 10 \\ 11 \text{ (for streaming} \\ \text{tape)} \\ 22 \\ 24 \end{array} \right\} \right]$	Type of tape or group of tapes defined.
	[CHAN=3]	Physical I/O channel with access to tape. The default specification is device dependent and determined as a function of TYPE.
	$\left[\text{ADDR= } \left\{ \begin{array}{l} \text{address} \\ 70, 71 \\ 73, 70 \end{array} \right\} \right]$	2-digit hexadecimal number identifying hardware address and number of tapes defined. If more than one address is specified, it must be separated by commas or hyphenated to indicate consecutive addresses.
	[DVCNO=lun]	Changes logical unit numbers (lun) for specific tapes. See Table 4-9 for logical unit numbers.

continued

Table 4-2. I/OGEN Keyword Parameters (Models 3 through 6) (cont.)

Phase	Parameter in Coded Format	Description
Model 3-6 I/OGEN (cont)		
TAPE	<pre> [MODE= [nn { 03 (for 9-track tape only) } { E9 (for streaming tape only) } { F9 (for streaming tape only) }]] [TRANSLAT= { NO } { YES }] [DENSITY= { DUAL NRZI PHASE (streaming tape only)]] </pre>	<p>Indicates the recording mode of the tape unit being defined. Also identifies the tape unit as a 7-track, 9-track, or streaming tape device. See Tables 4-10 and 4-11 for the 9- and 7-track recording mode settings that are supported.</p> <p>Indicates that the extended binary coded decimal interchange code to binary coded decimal (EBCDIC to BCD) translate feature is being used.</p> <p>Indicates the recording modes of the tape unit being described.</p> <p>DUAL Indicates both phase-encoded and NRZI modes.</p> <p>NRZI Identifies the non-return-to-zero (NRZI) mode.</p> <p>PHASE Identifies the phase-encoded mode. It is the default value only for streaming tape.</p>
WORKSTATION	<pre> [CHAN=3] [ADDR= [address { 12, 13 (for 3560) } { 51, 52 (for 3561, 1122 and 3612) }]] </pre>	<p>You must specify workstations when the system supports interactivity from local workstations. Do not specify parameters for the console/workstation; the system generates that device automatically.</p> <p>Physical I/O channel with access to a workstation. The default specification is device dependent and determined as a function of the TYPE keyword.</p> <p>2-digit hexadecimal number identifying the address and number of workstations defined. If more than one address is specified, it must be separated by commas or hyphenated to indicate consecutive addresses. You can</p>

continued

Table 4-2. I/OGEN Keyword Parameters (Models 3 through 6) (cont.)

Phase	Parameter in Coded Format	Description
Models 3-6 I/OGEN (cont) WORKSTATION	<pre> [TYPE= [3560] [3561] [1122] [3612]] [DVCNO=lun] [KATAKANA= { NO } [YES]] [DESPACE= { NO } [YES]] [SCREENMEM= [1] [2 (for 3561,1122 and 3612)]] </pre>	<p>specify from one to eight workstations for each controller. Valid addresses must end with digits 1-8.</p> <p>Note: If you want to change console/workstation characteristics, you must specify the console/workstation at ADDR=11.</p> <p>Type of local workstation or group of local workstations defined.</p> <p>Changes logical unit numbers (lun) for specific workstations. See Table 4-9 for logical unit numbers.</p> <p>Workstation recognizes input in Japanese Katakana language.</p> <p>Specifies whether the space key protects or destroys the character the cursor is positioned on.</p> <p>YES Character is replaced with a blank when space key is pressed.</p> <p>NO Character is not changed when space key is pressed.</p> <p>Specifies whether the device has a single or dual screen capability.</p> <p>1 Specify 1 for a UTS 20D.</p>

continued

Table 4-2. I/OGEN Keyword Parameters (Models 3 through 6) (cont.)

Phase	Parameter in Coded Format	Description
Models 3-6 I/OGEN (cont)		2
WORKSTATION		Specify 2 for SVT 1122 and UTS 40D.
[AUXPRINTER]		You can specify only one auxiliary printer for each local workstation you define. You must repeat the AUXPRINTER parameters for each auxiliary printer you want configured. If you define a range of local workstations, the auxiliary printer(s) you specify will be defined for each workstation in that range.
	<pre> TYPE= [0798] [0797] [0791] [0789] [0774] [0425] </pre>	Identifies the type of auxiliary printer or group of auxiliary printers defined.
	<pre> VFB= [STAND1] [OWNVF1] </pre>	Specifies printer vertical format buffer as the default buffer for the printer subsystem defined. OWNVF1 references user-generated vertical format buffers. See Section 3 for procedure to generate your own vertical format buffers.
	[LOOP={3-4}]	Specifies whether a 3-channel or 4-channel forms control loop is used to control vertical form spacing.
	[AUX={1-8}]	Specifies single digit device identification number (channel number) of auxiliary printer defined. Each printer is identified by a 2-digit device identification number, for example, 1 and 2, 3 and 4, and so on. The actual channel number of the printer is usually the odd number of the pair. Specify device identification numbers of 1, 3, 5, and 7 to identify the printer.

continued

Models 3-6 I/OGEN Keyword Parameters

Table 4-2. I/OGEN Keyword Parameters (Models 3 through 6) (cont.)

Phase	Parameter in Coded Format	Description
Models 3-6 I/OGEN (cont)		
[REWORK STATION	AMOUNT= [1-999]	Number of communications terminals that support interactivity. Value is the maximum number of interactive sessions the system recognizes from remote terminals or remote workstations at one time. If interactivity is supported, specify how many terminals function as remote workstations. Value cannot exceed the number of terminals in the system.
	[SCREENMEM= {1 2}]	Specifies single or dual screen support for UTS20, UTS30, UTS40, U400, U200, 1120, 1123, and 1124 remote workstations and/or terminals. 1 Indicates single screen support. 2 Indicates dual screen support. This allows full screen system messages on screen 1 when the workstation is not allocated to a job. Screen 2 is used for auxiliary input/output only. Can be specified for the UTS 20, UTS 30, and UTS 40 terminals if it has the screen bypass option.
	[KATAKANA= {NO YES}]	Remote workstation recognizes input in Japanese Katakana language.
[REMPRINTER	AMOUNT= [1-99]	Specifies total number of auxiliary printers that are connected to remote workstations or remote terminals in your system.
[KATACON]		Console workstation recognizes input in Japanese Katakana language when in console mode.
END		

Table 4-3. I/OGEN Keyword Parameters (Models 8 through 20)

Phase	Parameter in Coded Format	Description													
<p>Models 8-20 I/OGEN</p> <p>PRINTER</p>	<p>[I/OMOD=supvrnam]</p> <p>[TYPE= <table border="1" style="display: inline-table; vertical-align: middle;"> <tr><td>SDMA</td></tr> <tr><td>0770</td></tr> <tr><td>07701</td></tr> <tr><td>0776</td></tr> <tr><td>07761</td></tr> </table>]</p> <p>[CHAN=n]</p>	SDMA	0770	07701	0776	07761	<p>Supervisor name for which I/O configuration was previously created and saved on \$\$\$SRC on SYSRES. May request established I/O configuration by specifying I/OMOD keyword parameter as the only parameter immediately following the statement with I/OGEN parameter in label field. No other I/OGEN parameters are then required; if specified, it is ignored and diagnostic message displayed.</p> <p>Identifies printer or group of printer types defined.</p> <p>SDMA Specifies any of these types of printers: 0776, 0789, and 0798 printers.</p> <p>0770 0770-04/05 printer.</p> <p>07701 0770-06/07 and 9246-25B printers.</p> <p>0776 0776 printer.</p> <p>07761 9246-14B printer.</p> <p>Hexadecimal number identifying the physical I/O channels with access to a printer or a group of printers described. The default specification is device dependent and determined as a function of the TYPE keyword.</p> <p>Allowable values are as follows (the default value for each device type is shaded):</p> <table border="0"> <tr> <td>C,E</td> <td>for SDMA</td> </tr> <tr> <td>0-3,6,7</td> <td>for 0770,0776 model 8</td> </tr> <tr> <td>1</td> <td>for 07701,07761 model 8</td> </tr> <tr> <td>1-3-6</td> <td>for 0770, 0776, 07701, 07761 models 10-20</td> </tr> </table>	C,E	for SDMA	0-3,6,7	for 0770,0776 model 8	1	for 07701,07761 model 8	1-3-6	for 0770, 0776, 07701, 07761 models 10-20
SDMA															
0770															
07701															
0776															
07761															
C,E	for SDMA														
0-3,6,7	for 0770,0776 model 8														
1	for 07701,07761 model 8														
1-3-6	for 0770, 0776, 07701, 07761 models 10-20														

continued

Table 4-3. I/OGEN Keyword Parameters (Models 8 through 20) (cont.)

Phase	Parameter in Coded Format	Description
Model 8-20 I/OGEN (cont) PRINTER	<p>[ADDR=nn]</p> <p>[DVCNO=lun]</p> <p>[CLASS= { 1 } { 2 } { 3 }]</p> <p>[CHARSET= { STD 48 63 94 108 EXT }]</p>	<p>2-digit hexadecimal number identifying the hardware address and number of printer types. If more than one address is specified, it must be separated by commas or hyphenated to indicate consecutive addresses.</p> <p>The device dependent defaults for nn are:</p> <ul style="list-style-type: none"> 30 for SDMA 04 for 0770 (model 8) 90 for 0770 (model 10-20) 90 for 0770I B0 for 0776I 05 for 0776 (model 8) B0 for 0776 (model 10-20) <p>Changes the standard logical unit numbers (lun) for specific printers. See Table 4-9 for logical unit numbers. If you specify this parameter in a multiprinter environment, the output is to this printer first. If you don't specify this parameter, output is sent to any available printer.</p> <p>Classifies a printer so that special logical unit numbers can be used to direct output for printers of the same subtype. See Table 4-9 for logical unit numbers.</p> <p>Note: For 0776 printers, the CLASS parameter should specify high, medium, or low speed if a unique logical unit number is required.</p> <p>Number of printable characters in a printer subsystem font set. Standard or extended apply to all types of printers. Only the 0770 and 0776 printers can have 48, 63, 94, or 108 printable characters.</p>

continued

Table 4-3. I/OGEN Keyword Parameters (Models 8 through 20) (cont.)

Phase	Parameter in Coded Format	Description
Models 8-20 I/OGEN		
PRINTER	<pre>PRINTPOS= [132 (for SDMA, 0770) { 136 (for 07701, 0776,07761) } 160 (for 0770)]</pre>	<p>Number of print positions pertaining to the printer subsystem described. Though 132 is the default for the 0770, 160 is also an allowable entry for that printer.</p>
	<pre>LCB= [48-BUS (for SDMA) 48-SCI 63-STD OWNLC1-2 OWNLC3-9 (for SDMA)]</pre>	<p>Printer load code buffer used as default buffer for the printer defined. OWNLC1 through OWNLC9 reference load code buffers other than 48-BUS, 48-SCI, 63-STD, or those that report a character mismatch. See Section 3 for the procedure that defines alternate printer characteristics.</p>
	<pre>VFB= [STAND1 OWNVF1 OWNVF2-9 (for SDMA)]</pre>	<p>Printer vertical format buffer as default buffer for the printer subsystem defined. OWNVF1 through OWNVF9 reference user-generated vertical format buffers. See Section 3 for the procedure to generate your own vertical format buffers.</p>
	<pre>ATTNRE= [YES NO]</pre>	<p>Specifies whether your system supports automatic retry of recoverable errors when attention interrupts are received on a print that has an unanswered physical IOCS error message. If omitted, the retry feature is active and the operator can initiate recovery at the printer by placing it in online mode.</p>
	<pre>REMOTE= [NO YES]</pre>	<p>Specifies that your system includes SDMA printers that are in remote locations from your System 80 host.</p>
	<pre>[ADDR=NO]</pre>	<p>Defines an indirect printer for your system. If you configure a printerless system, you must define at least one indirect printer and also configure spooling. Print files generated on a printerless system are spooled for subsequent printing on another system that has a physical printer. You may specify an indirect printer for each physical printer type that exists on the system that prints the spooled data.</p>

continued

Models 8-20 I/OGEN Keyword Parameters

Table 4-3. I/OGEN Keyword Parameters (Models 8 through 20) (cont.)

Phase	Parameter in Coded Format	Description
Models 8-20 I/OGEN (cont)	<p data-bbox="232 478 326 506">[PRINTER</p> <p data-bbox="402 478 662 621">VIRTUAL= $\left. \begin{array}{l} \text{2 x number} \\ \text{of job} \\ \text{slots} \\ 0 \\ 1-99 \end{array} \right\}$</p> <p data-bbox="232 657 326 684">[READER]</p> <p data-bbox="402 646 573 720">[TYPE= $\left. \begin{array}{l} 0719 \\ 0716 \end{array} \right\}$</p> <p data-bbox="402 758 496 785">[CHAN=n]</p> <p data-bbox="402 1077 751 1199">[ADDR= $\left. \begin{array}{l} 32 \text{ (for 0719)} \\ 06 \text{ (for 0716 model 8)} \\ A0 \text{ (for 0716 models} \\ \text{10-20)} \end{array} \right\}$</p> <p data-bbox="402 1266 529 1293">[DVCNO=lun]</p> <p data-bbox="402 1356 545 1499">[FEED= $\left. \begin{array}{l} 80 \\ 51 \\ 66 \\ 90 \\ 96 \end{array} \right\}$</p>	<p data-bbox="781 485 1300 636">Number of virtual printers if spooling is configured. To calculate the optimum number, multiply the number of jobs that can run concurrently by the average number of printer files used for each job. Each virtual printer uses 32 bytes of main storage.</p> <p data-bbox="781 657 1276 684">Type of reader or group of readers defined.</p> <p data-bbox="781 758 1287 888">Hexadecimal number identifying the physical I/O channels with access to a reader or a group of readers defined. The default specification is device dependent and determined as a function of the TYPE keyword.</p> <p data-bbox="781 909 1211 961">Valid entries for n are (defaults are shaded):</p> <p data-bbox="805 989 1162 1062">C,E (for 0719) 0-3,6,7 (for 0716 model 8) 1-3-6 (for 0716 models 10-20)</p> <p data-bbox="781 1083 1300 1241">2-digit hexadecimal number that identifies the hardware address and number of a reader or group of readers defined. If more than one address is specified, it must be separated by commas or hyphenated to indicate consecutive addresses.</p> <p data-bbox="781 1262 1276 1335">Changes the logical unit numbers (lun) for specific readers. See Table 4-9 for logical unit numbers.</p> <p data-bbox="781 1356 1243 1409">Card size read by reader if a short card feature is installed.</p>

continued

Table 4-3. I/OGEN Keyword Parameters (Models 8 through 20) (cont.)

Phase	Parameter in Coded Format	Description
Models 8-20 I/OGEN (cont)		
READER	$\left[\text{ATTNRE} = \begin{matrix} \text{NO} \\ \text{YES} \end{matrix} \right]$	<p>Specifies whether your system supports automatic retry of recoverable errors when attention interrupts are received on a reader that has an unanswered physical IOCS error message. If omitted, the retry feature is active and the operator can initiate recovery retry by placing the reader in online mode.</p>
	$\left[\text{ALTSTACK} = \begin{matrix} \text{NO} \\ \text{YES} \end{matrix} \right]$	<p>Specifies whether your card reader has the alternate-stacker-fill capability.</p>
	$\left[\text{DUALTRAN} = \begin{matrix} \text{NO} \\ \text{YES} \end{matrix} \right]$	<p>Specifies whether your card reader has the dual translate capability.</p>
	$\left[\text{MODE} = \begin{matrix} \text{EBCDIC (for 0719,0716)} \\ \text{ASCII (for 0716)} \\ \text{COMPCD (for 0716)} \end{matrix} \right]$	<p>Specifies the mode of card interpretation of the reader.</p>
	$\left[\text{EOF} = \begin{matrix} \text{NO} \\ \text{YES} \end{matrix} \right]$	<p>Specifies whether your card reader can sense an end-of-file condition even if the /* or // FIN card is missing from the job control streams. This applies only to a 1-job environment on the 0716 card reader.</p>
	$\left[\text{VALIDITY} = \begin{matrix} \text{NO} \\ \text{YES} \end{matrix} \right]$	<p>Specifies whether your card reader has the validity check capability. This feature is available only for the 0719 card reader.</p>
READER	$\left[\text{VIRTUAL} = \begin{matrix} \text{1 x number} \\ \text{of job} \\ \text{slots} \\ \text{0} \\ \text{1-99} \end{matrix} \right]$	<p>Number of virtual readers if spooling is configured. To calculate the optimum number, multiply the number of jobs that can run concurrently by the average number of reader files used for each job. Each virtual reader uses 32 bytes of main storage.</p>
[PUNCH]	$\left[\text{TYPE} = 0608 \right]$	<p>Type of punch defined.</p>
	$\left[\text{CHAN} = \begin{matrix} \text{C} \\ \text{E} \end{matrix} \right]$	<p>Hexadecimal number identifying the physical I/O channels with access to a punch or punches defined. The default specification is device dependent and determined as a function of the TYPE keyword.</p>

continued

Table 4-3. I/OGEN Keyword Parameters (Models 8 through 20) (cont.)

Phase	Parameter in Coded Format	Description
Models 8-20 I/OGEN (cont)	[ADDR=33]	Identifies hardware address of the punch.
[PUNCH]	[DVCNO=lun] [ATTNRE= { NO } { YES }] [READ= { NO } { YES }]	Changes the logical unit number (lun) for the punch. See Table 4-9 for logical unit numbers. Specifies whether your system supports automatic retry of recoverable errors when attention interrupts are received on a punch that has an unanswered physical IOCS error message. If omitted, the retry feature is active and the operator can initiate recovery retry by placing the punch in online mode. Specifies whether the punch has card reader capabilities.
[PUNCH]	VIRTUAL= { 1 x number of job slots 0 1-99 }	Number of punches if spooling is configured. To calculate the optimum number, multiply the number of jobs that can run concurrently by the average number of punch files used for each job. Each virtual punch uses 32 bytes.
DISC	[TYPE= { 8418 (for Model 8) 8416 8417 8419 8430 8433 (for Models 10-20) 8470 8494 9720 (for Models 10-20) }]	Type of disk or group of disks defined. Notes: 1. All 8416 disks are configured as 8418 low-density disks, and some messages say 8418 instead of 8416. The logical unit numbers for the 8418 low-density disks should be used. 2. The 8480 device should be configured as four 8470 disks. 3. If your system has both fixed and removable disks, the fixed disks must be specified first.

continued

Table 4-3. I/OGEN Keyword Parameters (Models 8 through 20) (cont.)

Phase	Parameter in Coded Format	Description
<p>Models 8-20 I/OGEN (cont)</p> <p>DISC</p>	<p>[CHAN=n]</p> <p>[ADDR=nn]</p> <p>[DVCNO=lun]</p> <p>[CACHE= { NO YES NOMI }]</p>	<p>Physical I/O channels with access to disk. The default specification is device dependent and is determined as a function of the TYPE word.</p> <p>Allowable values for n are (shading indicates defaults):</p> <p>1, 2, 3, 6, 7 for model 8 4 thru 6 for models 10-20</p> <p>2-digit hexadecimal number that identifies the hardware address and number of disks defined. If more than one address is specified, it must be separated by commas or hyphenated to indicate consecutive addresses.</p> <p>The device TYPE defaults are:</p> <p>80, 81 (for 8430/33) 90 (for 8470/8494/M9720) A0, A1 (for 8416/18) B0 (for 8417/19)</p> <p>Changes the logical unit numbers (lun) for specific disks. See Table 4-9 for logical unit numbers.</p> <p>Indicates if a disk device is activated to the disk cache facility (DCF). See the Operations Guide, UP-8859, for details on the DCF.</p> <p>You can override this specification (except CACHE= NO) on a file basis through the CACHE parameter on the // DD statement. See the Job Control Programming Guide, UP-9986, and Consolidated Data Management Programming Guide, UP-9978, for CACHE DD parameter details.</p> <p>NO The disk device is not activated to the DCF. Specify NO if the device is shared by two processors.</p>

continued

Table 4-3. I/OGEN Keyword Parameters (Models 8 through 20) (cont.)

Phase	Parameter in Coded Format	Description
Models 8-20 I/OGEN (cont)		
DISC		<p>Note: For the 8430/33 disks, the default value for the SELACC parameter is changed to 33 because of higher full track I/O use. If you are using a smaller size, it is recommended that you increase it to at least 33.</p>
DISKETTE	<pre>[TYPE= {8420 8422}] [CHAN= {C E}] [ADDR={20,21}] [DVCNO=lun] [AUTOLOAD= {NO YES}]</pre>	<p>Type of diskette or group of diskettes defined.</p> <p>Hexadecimal number identifying the physical I/O channel with access to a diskette. The default specification is device dependent and determined as a function of the TYPE keyword.</p> <p>2-digit hexadecimal number identifying the hardware address and the number of tapes defined. If more than one address is specified, it must be separated by commas or hyphenated to indicate consecutive addresses.</p> <p>Changes the logical unit numbers (lun) for specific diskettes. See Table 4-9 for logical unit numbers.</p> <p>Operating system can automatically load up to 20 diskettes.</p>
[TAPE]	<pre>[TYPE= {10 11 12 14 16 20 22 24 26 28 32}]</pre>	<p>Type of tape or group of tapes defined.</p>

continued

Table 4-3. I/OGEN Keyword Parameters (Models 8 through 20) (cont.)

Phase	Parameter in Coded Format	Description
Models 8-20 I/OGEN (cont) [TAPE]	[ADDR=nn] [CHAN=n] [DVCNO=lun] [MODE=nn] [TRANSLAT= {NO } {YES }]	2-digit hexadecimal number identifying the hardware address and number of tapes defined. If more than one address is specified, it must be separated by commas or hyphenated to indicate consecutive addresses. The device type dependent default values are: 70,71 (for 10/11/22/24) A0,A1 (for 12/14/16/20/26/28/32) Hexadecimal number identifying the physical I/O channel with access to tape. The allowable values are as follows. Shading indicates the device dependent default. 0,E (for 10/11/22/24) 1-3,6,7 (for 12/14/16/20/26/28/32; model 8) 1,2-6 (for 12/14/16/20/26/28/32; models 10-20) Changes the logical unit numbers (lun) for specific tapes. See Table 4-9 for logical unit numbers. Indicates the recording mode of the tape unit defined and whether it is a 7-track, 9-track, or streaming tape device. See Tables 4-10 and 4-11 for the 9- and 7-track recording mode settings that are supported. The device type dependent default values are: C3 (for 10/12/14/16/20/22/24/26/28/32) D3 (for 26/28/32) E9 (for 11) Indicates that the extended binary coded decimal interchange code to binary coded decimal (EBCDIC to BCD) translate feature is described.

continued

Table 4-3. I/OGEN Keyword Parameters (Models 8 through 20) (cont.)

Phase	Parameter in Coded Format	Description
<p>Models 8-20 I/OGEN (cont)</p> <p>[TAPE]</p> <p>[COCHAN=n]</p> <p>[COADDR=nn]</p> <p>WORKSTATION</p>	<p>DENSITY=[DUAL (for 10/12/ /14/16/22/24/26/ 28/32) NRZI PHASE (for 11/20 GCR (for 26/28/32)]</p>	<p>Indicates the recording modes of the tape unit described. See Table 4-10.</p> <p>DUAL Indicates both phase-encoded and NRZI modes; or phase-encoded and GCR.</p> <p>NRZI Identifies the non-return-to-zero (NRZI) mode.</p> <p>PHASE Identifies the phase-encoded mode. The default value is only for streaming tape.</p> <p>GCR Identifies the group-coded recording mode.</p> <p>Specifies that the tape unit defined can be accessed by multiple channels to provide for simultaneous operation. Valid for 12, 14, 16, 20, 24, 26, 28, and 32.</p> <p>Allowable entries are: 1,2,3,6,7 for model 8 1 thru 6 for models 10-20</p> <p>Specifies that the tape unit can have multiple addresses to provide for simultaneous operation. Each address specified must be a 2-digit hexadecimal number. Multiple addresses must be separated by a comma or hyphenated to indicate consecutive addresses. Valid only for selector channel devices. The device type dependent defaults are: 70,71 (for 10/11/22/24) A0,A1 (for 12/14/16/20/26/28/32)</p> <p>You must specify workstations if the system supports interactivity from local workstations.</p>

continued

Table 4-3. I/OGEN Keyword Parameters (Models 8 through 20) (cont.)

Phase	Parameter in Coded Format	Description
<p>Models 8-20 I/OGEN (cont)</p> <p>WORKSTATION</p>	<p>[TYPE= { 3560 3561 1122 3612 }]</p> <p>[CHAN= { C E }]</p> <p>[ADDR=nn]</p> <p>[DVCNO=lun]</p> <p>[DESPACE= { NO YES }]</p> <p>[SCREMEM= { 2 (for 3561, 1122 and 3612) 1 (for 3560) }]</p>	<p>Type of local workstation or group of local workstations defined.</p> <p>Hexadecimal number identifying the physical I/O channel with access to a workstation. The default specification is device dependent and determined as a function of the TYPE keyword.</p> <p>2-digit hexadecimal number identifying the address and number of workstations defined. The device type dependent defaults are:</p> <p>12,13 (for 3560) 51,52 (for 3561 and 1122)</p> <p>If more than one address is specified, it must be separated by commas or hyphenated to indicate consecutive addresses. You can specify from one to eight workstations for each controller. Valid addresses must end with digits 1-8.</p> <p>Changes the logical unit numbers (lun) for specific workstations. See Table 4-9 for logical unit numbers.</p> <p>Specifies whether the space key protects or destroys the character the cursor is positioned on.</p> <p>YES Character is replaced with a blank when the space key is pressed.</p> <p>NO Character is not changed when the space key is pressed.</p> <p>Specifies whether the device has a single or dual screen capability.</p>

continued

Table 4-3. I/OGEN Keyword Parameters (Models 8 through 20) (cont.)

Phase	Parameter in Coded Format	Description
Models 8-20 I/OGEN (cont)		Printer vertical format buffer is default
[AUXPRINTER]	$\left[\text{VFB} = \begin{matrix} \text{STAND1} \\ \text{OWNVF1} \end{matrix} \right]$	Printer vertical format buffer is default buffer for printer subsystem defined. OWNVF1 references user-generated vertical format buffers. See Section 3 for the procedure to generate your own vertical format buffers.
	$\left[\text{LOOP} = \begin{matrix} 3 \\ 4 \end{matrix} \right]$	Specifies whether a 3-channel or 4-channel forms control loop is used to control vertical form spacing.
	[AUX={1-8}]	Specifies single digit device identification number (channel number) of the auxiliary printer defined. Each printer is identified by a 2-digit device identification number, for example, 1 and 2, 3 and 4, and so on. The actual channel number of the printer is usually the odd number of the pair. Therefore, you would specify device identification numbers of 1, 3, 5, and 7 to identify the printer.
[REWORK STATION]	$\left[\text{AMOUNT} = \text{1-999} \right]$	Number of communications terminals that support interactivity. Value is the maximum number of interactive sessions the system recognizes from remote terminals or remote workstations at one time. If communications network supports interactivity, you must specify how many terminals function as workstations. The value must at least equal the number of terminals recognized as workstations, plus 2.
	$\left[\text{SCREENMEM} = \begin{matrix} 1 \\ 2 \end{matrix} \right]$	Specifies single or dual screen support for UTS 20, UTS 30, UTS 40, U200, U400, SVT 1120 1123, 1124 workstations.
		1 Indicates single screen support.

continued

COMMCT Keyword Parameters

Table 4-4. COMMCT Keyword Parameters

Phase	Parameter in Coded Format	Description
COMMCT	<p>[network definition macroinstruction] CCAMOD=name</p> <p>MCP</p> <p>[MCPNAME= { C1 Cn Mn }]</p> <p>[MCPVOL=vsn]</p> <p>CACH=</p> <p>Note: The CACH statement has four formats. See page 4-4 for details on using COMMCT parameter formats.</p>	<p>Network definition macroinstructions. See the ICAM Operations Guide, UP-9745. Each network definition must begin with a CCA macroinstruction and end with an ENDCCA macroinstruction. A physical I/O only CCA must be the last CCA in a multiple CCA generation.</p> <p>CCAMOD=name 4-character name of a previously saved network definition in \$\$\$SRC on SYSRES, used in place of the network definition macroinstructions. Each CCAMOD parameter must be followed by ENDCCA parameter.</p> <p>Delimiter signifies the end of a network definition and the start of MCP parameters.</p> <p>Indexed name of ICAM symbiont, where n is a decimal number between 1 and 9. A maximum of 18 ICAM symbionts are maintained on SYSRES. No duplicate names are allowed.</p> <p>MCPVOL places the ICAM symbiont in the \$Y\$LOD file on a disk other than the system resident volume (SYSRES). Specify the volume serial number of the disk where the ICAM symbiont is to reside. If you do not specify this parameter, the symbiont is stored on your SYSRES volume.</p> <p>Identifies each single line communications adapter (SLCA) accessed or supported by the ICAM symbiont. Since ICAM supports local workstations that do not require CACH information, the CACH parameter is not required if COMM=YES at SUPGEN. Also identifies the channel to which a DCP is connected.</p>

continued

Table 4-4. COMMCT Keyword Parameters (cont.)

Phase	Parameter in Coded Format	Description
COMMCT (cont)	<p>Format 1: CACH=(nn,network-name, line-number,)CHAN=nn</p> <p>Format 2: CACH=(nn,line-speed [, { FULL } { HALF }] [, { AUTODIAL } ,nn,EON,p { manual }] [,SWITCHED] [,SYNC] [, { ILA } { X21 }] [,CHAN= { 2 } { 13 } { 15 }] [,LDTE=ldte-name]</p>	<p>Format 1 Positional Subparameters:</p> <p>nn 2-digit decimal number identifying an SLCA address. For models 3-6, you can specify up to eight SLCA's (8 to 15). The default is 2. For models 8-20, you can specify up to 14 SLCA's for each IOMP (1 to 14). The default is 13.</p> <p>network-name A 4-character name in the label of CCA macro.</p> <p>line-number 2-digit decimal number identifying the line that uses this SLCA by order in the network definition. The line number of the first line in the network definition is 01, the second must be 02, etc.</p> <p>CHAN Specifies the 2-digit channel number. For models 3-6, the only value permitted is CHAN=2, the default. For model 8 with one IOMP, the only value permitted is CHAN=13, the default. For models 8-20 with two IOMPs, CHAN=13 and CHAN=15 are permitted. The IOMPs, default is CHAN=13.</p> <p>Format 2 Positional Subparameters:</p> <p>nn 2-digit decimal number identifying an SLCA address. For System 80 models 3-6 you specify up to eight SLCA's (8 to 15). For models 8-20, you can specify up to 14 SLCA's for each IOMP (1 to 14).</p> <p>line-speed Decimal number identifying the maximum baud rate. (See Table 4-12 for line speed values.)</p>

continued

Table 4-4. COMMCT Keyword Parameters (cont.)

Phase	Parameter in Coded Format	Description
COMMCT (cont)		<p>FULL Specifies 2-way simultaneous transmission (full-duplex operation). If omitted, the 2-way alternate transmission (half-duplex operation) is assumed by default.</p> <p>Notes:</p> <ol style="list-style-type: none"> 1. If an ICAM remote device handler uses 2-way-alternate protocol (half-duplex), the line must be defined as 2-way-alternate also. All ICAM remote device handlers utilize 2-way-alternate protocol except NTR, UDLC, ABM, and level 2 X.25 public data networks. 2. If 2-way simultaneous protocol is used, the same protocol must be specified in the ICAM generation (LINE and CACH). 3. 2-way simultaneous modems and lines can be used with 2-way alternate protocol, if required. <p>AUTODIAL Specifies that automatic dialing is performed in the subchannel. Also indicates that the data transfer subchannel being defined as a dial adapter subchannel associated with it to which dialing operations are directed. If omitted, manual dialing is assumed by default.</p> <p>nn 2-digit decimal number identifying the SLCA address where the dialer is located. You must specify a CACH parameter using format 3 with this 2-digit number as the first subparameter.</p> <p>EON Specifies that automatic dialing requires an end-of-number code. Not used with the Bell System 801 ACU. EON is required with the European V25 automatic calling equipment.</p>

continued

Table 4-4. COMMCT Keyword Parameters (cont.)

Phase	Parameter in Coded Format	Description
COMMCT (cont)		<p>P Single digit decimal number (0, 1, or 2) that identifies which of the three ports on the SLCA is used by the automatic calling unit.</p> <p>Note: If no value is specified, 1 is the default.</p> <p>SWITCHED Specifies a switched communications line. If omitted, only dedicated line services.</p> <p>Note: SLCA switched line does not support autodialing.</p> <p>SYNC Synchronous operations. If omitted, asynchronous operations is assumed.</p> <p>ILA Specifies that the Unisys intelligent line adapter is used for bit-oriented procedures.</p> <p>CHAN Specifies the 2-digit channel number. For models 3-6, the only value permitted is CHAN=2, the default. For models 8-20 with one IOMP, the only value permitted is CHAN=13, the default. For models 8-20 with two IOMPs, CHAN=13 and CHAN=15 are permitted. The default is CHAN=13.</p> <p>Note: For 2-way simultaneous lines, specify the even-numbered SLCA; the odd-numbered SLCA is automatically assigned. If you specify combinations of these lines, be sure that automatic assignments don't duplicate SLCA's.</p>

continued

Table 4-4. COMMCT Keyword Parameters (cont.)

Phase	Parameter in Coded Format	Description
COMMCT (cont)	<p>Format 3: CACH=(nn,DIALER[,EON])</p> $\left[,CHAN= \begin{Bmatrix} 2 \\ 13 \\ 15 \end{Bmatrix} \right]$	<p>LDTE = ldte-name Specifies the LDTE (local data terminating equipment) to which this SLCA belongs. The ldte name must match the LDTE specified in the CCA. If this operand is specified, both SWITCHED and X21 must be specified. The LDTE keyword parameter on the CACH macroinstruction is only supported for use with UTS 20X terminals. The number of CACH macroinstructions using the LDTE keyword must match the number of lines specified by the LDTE macroinstruction.</p> <p>Format 3 Positional Subparameters:</p> <p>nn 2-digit decimal number identifying an SLCA address. For models 3-6, you can specify up to eight SLCA's (8 to 15). For models 8-20, you can specify up to 14 SLCA's for each IOMP (1 to 14).</p> <p>DIALER Specifies that an autodial adapter resides in the specified SLCA address.</p> <p>EON Specifies that automatic dialing requires an end-of-number code. Required if DIALER subparameter is specified. Not used with the Bell System 801 ACU. EON is required with the European V25 automatic calling equipment.</p> <p>CHAN Specifies the 2-digit channel number. For models 3-6, the only value permitted is CHAN=2, the default. For models 8-20 with one IOMP, the only value permitted is CHAN=13, the default. For models 8-20 with two IOMPs, CHAN=13 and CHAN=15 are permitted. The default is CHAN=13.</p>

continued

Table 4-4. COMMCT Keyword Parameters (cont.)

Phase	Parameter in Coded Format	Description
COMMCT (cont)	<p>Format 4: CACH=(nn,,DCPCHNL)[,CHAN=n]</p> <p>[BPOOLEXP=NO]</p> <p>[FASTLOAD=NO]</p>	<p>Format 4 Positional Subparameters:</p> <p>Note: You must use this format for identifying a channel connected DCP.</p> <p>nn 2-digit decimal number identifying a selector sub-channel address. This number must match the value of the ID keyword on the DCPCHNL macro, if specified.</p> <p>DCPCHNL Specifies a DCP channel connection.</p> <p>CHAN=n Specifies a 1 digit channel address. For model 8, valid entries are 1, 3, 6 or 7. For models 10-20, values 1-6 are allowed. This entry must match the value of the CNID keyword on the DCPCHNL macroinstruction, if specified.</p> <p>Specifies that the dynamic buffer pool services expansion routine (BPSX) is not included in the ICAM generation. If you omit this parameter, the BPSX routine is automatically included in the generation. BPSX is not included for a CPI-only ICAM.</p> <p>If you do not specify this parameter your ICAM symbiont supports the improved overlay loading facility. Specifying FASTLOAD=NO forces ICAM to perform a directory search each time it loads an overlay instead of only the first time it loads that overlay.</p>
END		

NTRGEN Keyword Parameters

Table 4-5. NTRGEN Keyword Parameters

Phase	Parameter in Coded Format	Description
<p>NTRGEN</p> <p>NTR</p>	<p>NTRMOD=old-NTR-name</p> $\left[\begin{array}{c} S \\ \emptyset \end{array} \right]$ <p>NTRNAME=ntrname</p> <p>[NTRVOL=vsn]</p> <p>BLOCKIN=line-buffer-size</p>	<p>Identifies a previously generated NTR network by name and module type to be linked with LOCAL keyword sets processed in the current run. If used, NTRMOD must be the first keyword specified in the section; all other parameters except NTRVOL, NTRNAME, and TASK are ignored and a diagnostic message is displayed.</p> <p>Positional Subparameters:</p> <p>old-NTR-name Name of previously-generated NTR module; does not include LOCAL keyword parameter sets</p> <p>S Source module</p> <p>\emptyset Object module</p> <p>If omitted, assumed NTR module is the object module residing in \$Y\$SOBJ on SYSRES.</p> <p>Name of NTR network generated.</p> <p>Volume serial number for the SYSRES volume where the NTR module resides in \$Y\$L0D. Defaults to a fixed disk.</p> <p>Line-buffer size in bytes for transmission from an 1100 system to an OS/3 system (SOH through BCC) as specified by the 1100 system. For 1100 systems, versions 33 and earlier, the line buffer size equals either 240 bytes or 246 bytes when through half-word CTMC; for later versions, the value is configurable and should not exceed 9999 bytes.</p>

continued

Table 4-5. NTRGEN Keyword Parameters (cont.)

Phase	Parameter in Coded Format	Description
<p>NTRGEN NTR (cont)</p>	<p>[BLOCKOUT=line-buffer-size]</p> <p>[LINESP= { n } { 96 }]</p> <p>LINE=line-name</p> <p>NET=network-name</p> <p>SITE=id</p> <p>[TASK=taskname, { S } { 0 }]</p>	<p>Line-buffer size in bytes for transmission from an OS/3 system to an 1100 system (SOH through BCC) as specified by the 1100 system. For the 1100 system, version 33 and earlier, the line buffer size equals 121 bytes; for later versions, the value is configurable and should not exceed 9999 bytes. If omitted, the value specified for BLOCKIN size is assumed.</p> <p>Line speed</p> <p>Same line name appearing as the label in the LINE macroinstruction under CCA definition in the ICAM generation.</p> <p>Same network name appearing as the label for the CCA definition in the ICAM generation. (Must be the same as the CCA label name.)</p> <p>Full, 6-character site identification (id) number configured for the 1100 system. The OS/3 processor uses the id for sign-on (translated to truncate ASCII with odd parity). The operator can override this parameter by using the SIGN-ON keyin during execution of an NTR utility. See the ICAM Utilities Programming Guide, UP-9748.</p> <p>1- to 6-character name and module type (source or object) of previously generated NTR remote device handler. You can specify up to a total of 14 TASK keywords including LOCAL keyword sets. Only object modules are permitted for user-own-code tasks.</p> <p>Positional Subparameters:</p> <p>taskname Taskname is not given in this run but it is defined by a previous LOCAL keyword TASKNAME object module name, or user-own-code task.</p>

continued

Table 4-5. NTRGEN Keyword Parameters (cont.)

Phase	Parameter in Coded Format	Description
NTRGEN		
NTR (cont)		<p>S LOCAL task was placed in \$\$\$SRC on the SYSRES by a previous SG\$PARAM job; it must be assembled by a SG\$NTRMK job stream. If it is omitted, the assumed module is the object module in \$\$\$OBJ on the SYSRES.</p>
	[PRTSPnn=hh]	<p>For printer-type device only, specifies the hexadecimal byte for space compression when TRANS=NO. This value corresponds to the 2-digit decimal function code (nn), in Table 4-13 (space compression table).</p>
	[NPRTSPnn=hh]	<p>For nonprinter-type devices only, specifies the hexadecimal byte for space compression or decompression when TRANS=NO. This value corresponds to the 2-digit decimal function code (nn) in Table 4-13.</p>
LOCAL	[TASKNAME=taskname]	<p>1- to 6-character name that identifies an NTR remote device handler generated by LOCAL keywords.</p>
	[BLKSIZE=image-buffer-size]	<p>Maximum image buffer size for the unit record device; should be a multiple of 12 for a card punch.</p>
	[COMPRESS= { YES } { NO }]	<p>Suppresses space compression option for a reader/input device (TYPE) sending data to an OS 1100 system. If omitted, space compression is performed on all data sent to an OS 1100 system by a reader/input device defined in the TYPE keyword. Space compression characters are defaulted to X'40' (EBCDIC space) when TRANS=YES, or taken from the NTR space compression table when TRANS=NO. See Table 4-13.</p>
	[DEVICE=n]	<p>Local device numbers for an NTR remote device handler generated by LOCAL keywords. This parameter must agree with the OS 1100 system device number.</p>
	[FUNCD= {function-code} {04}]	<p>2-digit decimal function code establishing translation requirements for each image sent to the OS 1100 system. Used in conjunction</p>

continued

Table 4-5. NTRGEN Keyword Parameters (cont.)

Phase	Parameter in Coded Format	Description
<p>NTRGEN</p> <p>LOCAL (cont)</p> <p>END</p>	<p>[LFD=filename]</p> <p>[TRANS= {YES NO}]</p> <p>[TYPE= {READER PRINTER PUNCH}]</p> <p>[VFBLN= {N 88}]</p> <p>[VFBDE= {6 8}]</p> <p>[VFHOME= {n 1}]</p> <p>[VFBFORM=formname]</p>	<p>with TYPE and TRANS keyword parameters. Function codes and respective meanings are listed in Table 4-14 (device function code table).</p> <p>File name as it appears on the // job control statement.</p> <p>Suppresses the NTR translation feature for the device type defined by the TYPE keyword. The space compression character is determined by function code. See Table 4-13. If omitted, images are sent to or received from the 1100 series system and translated, respectively, to or from EBCDIC, according to the function code (FUNCD keyword) parameter.</p> <p>Device type of an NTR remote device handler generated by LOCAL keywords.</p> <p>Note: System-supplied NTR locals use the unit record system access technique. To access a diskette instead of a card reader or a punch, write your own NTR local that uses standard data management according to the ICAM Utilities Programming Guide, UP-9748.</p> <p>Number of lines (1 to 192) on printer form.</p> <p>Number of print lines per inch (6 or 8).</p> <p>Location (line 1 to 192) of home paper position; the first line of printer output is placed on each form (page). Must not exceed the value in the VFBLN keyword.</p> <p>1- to 8-character alphanumeric name associated with a form. A console message instructs the operator to load this form on a printer. If omitted, no name is associated with the form.</p>

COBGEN Keyword Parameters

Table 4-6. COBGEN Keyword Parameters

Phase	Parameter in Coded Format	Description
COBGEN	<p>[AXNON= { NO } { YES }]</p> <p>[AXREF= { NO } { YES }]</p> <p>[CALLST= { NO } { YES }]</p> <p>[CMCSST= { NO } { YES }]</p> <p>[COMP= { 3 } { 4 }]</p> <p>[CPYTXT= { NO } { YES }]</p> <p>[DIAG= { NO } { YES }]</p> <p>[DIAGWN= { NO } { YES }]</p> <p>[FIPS= { 1 } { 2 } { 3 } { 4 } { 5 }]</p> <p>[IMSCOD= { NO } { YES } { REN }]</p>	<p>Specifies whether your compiler includes nonreferenced entries in its alphanumerically ordered cross-reference listing.</p> <p>Alphanumerically ordered cross-reference listing.</p> <p>Subprograms named by the literal option of a CALL statement linked with the main program.</p> <p>COBOL communications control module bound with a COBOL object program.</p> <p>Specifies default computational type.</p> <p>Copied COBOL library text included in source listing.</p> <p>Diagnostic listing prepared.</p> <p>Warning diagnostics included in diagnostic listing.</p> <p>Specifies FIPS PUB 21-1 flagging options. See the 1974 American Standard COBOL Programming Reference Manual, UP-8613.</p> <p>IMS compatible code for COBOL programs executed under the control of the IMS action program. COBOL language elements restricted by IMS are flagged and deleted.</p>

continued

Table 4-6. COBGEN Keyword Parameters (cont.)

Phase	Parameter in Coded Format	Description
COBGEN (cont.)	<p>[IN=module name/ {filename}] [{SYSSRC}]</p> <p>[LIN= {name}] [{COPY\$}]</p> <p>[LIST= {NO}] [{YES}]</p> <p>[LNKCON= {NO}] [{YES}]</p> <p>[LSTREF= {NO}] [{YES}]</p> <p>[LSTWTH= {120-160}] [{120}]</p> <p>[MAP= {NO}] [{YES}]</p> <p>[MXNON= {NO}] [{YES}]</p> <p>[MXREF= {NO}] [{YES}]</p> <p>[OBJ= {name}] [{SYSRUN}]</p>	<p>IMSCOD=YES indicates generation of a shared code action program. IMSCOD=REN indicates generation of a reentrant action program.</p> <p>Specifies a 1- to 8-character name of a source module in the library and a 1- to 8-character LFD name identifying the file where the module resides.</p> <p>Specifies a 1- to 8-character LFD name identifying the file where the COPY library resides. Name is used if the library name is omitted from the COPY statement. Do not specify when using JPROCS.</p> <p>Source program listing.</p> <p>Linker control statements included in object module.</p> <p>Source listing with definition references.</p> <p>Specifies listing page width in number of characters printed per line.</p> <p>Object program locator/MAP listing.</p> <p>Specifies whether your compiler includes nonreferenced entries in the MAP listing with cross-references.</p> <p>Map listing with cross-references.</p> <p>Specifies a 1- to 8-character LFD name of the file where the generated object module is stored.</p>

continued

Table 4-6. COBGEN Keyword Parameters (cont.)

Phase	Parameter in Coded Format	Description
COBGEN (cont)	<p>[OBJLST= { NO }]</p> <p>[OBJMOD= { NO }]</p> <p>[PAGOVF= { NO }]</p> <p>[PROVER= { NO }]</p> <p>[SIGNFX= { NO }]</p> <p>[SPRLST= { NO }]</p> <p>[SPROUT= { 1 }]</p> <p>[{ 2 }]</p> <p>[{ 3 }]</p> <p>[SUBCK= { NO }]</p> <p>[SYNCHK= { NO }]</p> <p>[{ YES }]</p>	<p>Specifies object program listing.</p> <p>Specifies whether your compiler produces an object module.</p> <p>Automatic printer page eject in object program.</p> <p>Produces a listing of procedure names and verbs with associated source line numbers and object program relative addresses.</p> <p>Specifies whether the compiler generates code to check for valid sign in zoned decimal field.</p> <p>Suppresses all listings unconditionally. Parameter overrides all other listing specifications.</p> <p>Suppresses compiler output (except source listing, diagnostic listing, and related options) when severity code 1, 2, or 3 errors are encountered.</p> <p>Specifies whether the compiler generates code to check for subscript or index out-of-range conditions.</p> <p>Syntax check compile only. Source and diagnostic listings only.</p>

continued

4.3. Additional System Parameter Information

This section contains reference tables and additional information relative to various SYSGEN parameters. Use the following SYSGEN parameter reference tables to prepare SYSGEN parameter sets:

Table	Title
4-7	Spool-File Bit Map Calculations (SUPGEN SPOOLMAP parameter)
4-8	Shared Load Module Groups (SUPGEN RESHARE parameter)
4-9	Logical Unit Numbers (I/OGEN DVCNO parameter for all devices)
4-10	Nine-Track Recording Mode Settings
4-11	Seven-Track Recording Mode Settings
4-12	Line Speed Values (COMMCT CACH parameter, Format 2)
4-13	Space Compression Characters (NTRGEN PRTSPnn=hh, NPRTnn=hh, and TRANS parameters)
4-14	Device Function Codes (NTRGEN FUNCD parameter)

4.3.1. Spool-File Bit Map Calculation Table

The spool-file is divided into logical tracks and the allocation of these tracks is controlled by the spool-file bit map. Each bit in a bit map word represents a logical track and the size of the bit map (in words) is specified via the SPOOLMAP SUPGEN parameter. The logical track size is a minimum of 64 (256 byte) sectors, but can be larger depending on the size of the spool-file and the size of the bit map.

For optimal spool-file space utilization, the bit map should be large enough to permit the smallest allowable (64 sectors) logical track size. Table 4-7 can be used to calculate the number of bit map words required to guarantee a 64-sector logical track size. Multiply the number of cylinders in the spool file by the factor for the disk type being used, and round up to the next higher integer if the result is fractional. The third column shows the number of bit map words required to guarantee a 64-sector logical track size for a 50 cylinder spool-file (the default value for the SPOOLCYL keyword parameter).

Table 4-7. Spool-File Bit Map Calculations

Disk Type	Multiplication Factor	Bit Map Words Needed for 50-Cylinder Spool File
8416	.14	7
8417	.41	21
8418	.14	7
8419	.17	9
8430/8433	.31	16
8470	1.50	75
8494	.94	47
M9720	.94	47

4.3.2. Shared Load Module Groups

Table 4-8 lists the shared load module groups eligible for the SUPGEN RESHARE parameter. To include a group as resident in main storage, use the group name symbol in the RESHARE specification. To decide which groups to make resident for your applications, see the *Supervisor Technical Overview*, UP-8831.

Table 4-8. Shared Load Module Groups

Group Name Symbol	Group Name
BAS	BASIC
DDPL	Local Distributed Data Processing
DDPR	Remote Distributed Data Processing
DP	Dialog Processor
EDT	Editor
ESC	ESCORT

continued

Table 4-8. Shared Load Module Groups (cont)

Group Name Symbol	Group Name
ESCF	ESCORT FULL
ISB	Basic Interactive Services
ISF	Full Interactive Services (for heavy interactive users who experience main storage fragmentation).
RPG	RPG Editor
SF	Screen Format Services

4.3.3. Logical Unit Numbers (I/OGEN DVCNO Parameter for All Devices)

The DVCNO=lun keyword parameter changes the standard logical unit numbers for the specific devices within each device category. You can modify or replace the logical unit numbers for the device or group of devices by specifying the logical unit numbers in decimal. If you specify two or more logical unit numbers, separate them with a hyphen. We recommend that you do not alter logical unit numbers outside a device category or alter the logical unit numbers assigned to any device. Table 4-9 lists the logical unit numbers and their corresponding device types.

Table 4-9. Logical Unit Numbers

Logical Unit Number	Device Type and Features
1, 2	0931 reader (NUK only)
3, 4	0932 punch (NUK only)
10-13	Spare
14, 15	0744 printer (NUK only)
18, 19	0789 printer
20, 21	Any printer, no features specified
24, 25	0776/9246-14B printer subsystem, no features specified
28, 29	0770/9246-25B printer
30, 31	Any card reader subsystem, no features specified
32, 33	0719 card reader subsystem, no features specified
34, 35	0716 card reader
38, 39	0723 card reader, no features specified
40, 41	Any card punch subsystem, no features specified
46, 47	0608 card punch

continued

Table 4-9. Logical Unit Numbers (cont.)

Logical Unit Number	Device Type and Features
48	Any remote printer
49	Spare
50-59	Any disk
60-63	8416/8419 disk subsystem
64-66	8418 disk subsystem (low density)
67-69	8418 disk subsystem (high density)
70-74	8430 disk subsystem
75-79	8433 disk subsystem
80-85	8494/M9720 disk subsystem
90-99	Any tape, no features specified
100-102	Any tape, 9-track phase encoded
103-105	Any tape, 9-track NRZI
106-109	Any tape, 7-track NRZI
110-112	Slow tape, 9-track phase encoded
113-115	Slow tape, 9-track NRZI
116-119	Slow tape, 7-track NRZI
120-122	Fast tape, 9-track phase encoded
123-125	Fast tape, 9-track NRZI
126, 127	Fast tape, 7-track NRZI
128, 129	Streaming tape
130-133	Any diskette
136, 137	8420/8422 diskette
138, 139	Any diskette, 128-byte
140, 141	Any diskette, 256-byte
142, 143	Any diskette, 512-byte
144, 145	Any diskette, 1024-byte
146, 147	Any tape, 9-track GCR
148, 149	Double-density diskette
150, 151	Any diskette, autoloaded
152, 153	Any diskette, double-sided
154-159	Spare
168, 169	Any fixed-head disk
170-174	8417 disk subsystem
175-179	8470 disk subsystem
180-185	9720 disk subsystem
186-189	spare
190-194	8430/8433 disk subsystem (IDA-NUK)
195-199	8433/8433M disk subsystem (IDA-NUK)
200-215	Any workstation
216-219	Any workstation with 24 by 80 screen
220-223	Any printer class = 1
224-227	Any printer class = 2
228-231	Any printer class = 3
232-254	Spare
255, 256	Any workstation with printer

4.3.4. Nine-Track Recording Mode Settings (I/OGEN MODE Parameter)

Three recording methods are supported for the 9-track UNISERVO tape devices available for your system. They are phase encoding (NRZI), and group coded (GCR). Making certain that your System 80 interprets and processes your tapes correctly depends upon the mode of processing you specify when defining your tape devices during I/OGEN.

Table 4-10 lists the 9-track recording mode settings you must use when specifying the I/OGEN MODE parameter.

Table 4-10. Nine-Track Recording Mode Settings

Recording Method	Tape Density (bpi)	Magnetic Tape Subsystem	MODE=nn Value (hex.)
Phase encoding	1600	UNISERVO 10, 12, 14, 16, 20, 22, 24, 26, 28, and 32	C3
		UNISERVO 11 F9 (fast speed)	E9 (slow speed)
NRZI	800	UNISERVO 10, 12, 14, 16, 22, and 24	C8
Group coded (GCR)	6250	UNISERVO 26, 28, and 32	D3

4.3.5. Seven-Track Recording Mode Settings (I/OGEN MODE Parameter)

Seven-track tape support is provided as a compatibility feature for those of you who have existing data files that were previously recorded on 7-track tapes. Making certain that your System 80 interprets and processes these tapes correctly is dependent upon the specific tape features installed in your system and the method or mode of processing you specify when defining your tape devices during I/OGEN.

The following processing modes are supported for systems containing UNISERVO 10 tape devices with 7-track features F3133-00, F3133-01, and C3134-00 installed.

- Normal Processing

Provides read and write capability of 7-track tape recorded in NRZI format at densities of 200, 556, and 800 bytes per inch (bpi) in either odd or even parity (feature F3133-00). Your system must include the 9-track NRZI feature (F3135-00) as a prerequisite for this mode of processing. Use the appropriate recording mode setting in Table 4-11 for defining the I/OGEN MODE parameter when processing 7-track tapes compatible with this mode of operation.

- Data Conversion Processing

Permits reading and writing if disassembled 8-bit data on 7-track tape. The 9-track NRZI feature (F3135-00) and the 7-track feature (F3133-00) are prerequisites for this mode of processing. This same capability is available with the addition of data translation processing of IBM 7-track compatible tapes if your system is equipped with the 7-track NRZI native mode feature (F3133-01) in place of the F3133-00 feature. Use the appropriate recording mode setting in Table 4-11 for defining the I/OGEN MODE parameter when processing 7-track tapes compatible with this mode of operation.

- Data Translation Processing

Permits the translation (reading and writing) of 6-bit BCD data on tape to EBCDIC data for processing in the system (feature C3134-00). Your system must contain the 9-track NRZI feature (F3135-00) with either the 7-track NRZI normal mode feature (F3133-00) or native mode feature (F3133-01) as prerequisites for this mode of processing. Use the appropriate recording mode setting in Table 4-11 for defining the I/OGEN MODE parameter when processing 7-track tapes compatible with this mode of operation.

If you require specific information concerning tape formats, coding conventions, translation and conversion formats, etc., please order a copy of the *UNISERVO 10 Type 0871 Magnetic Tape Subsystem Reference*, UP-8890, from your Unisys representative.

Table 4-11. Seven-Track Recording Mode Settings

Mode of Operation	Tape Parity	I/OGEN MODE=nn Values (hex.)		
		200 bpi Tape	556 bpi Tape	800 bpi Tape
Normal Processing	Even	23	63	A3
	Odd	33	73	B3
Data Conversion Processing	Odd only	13	53	93
Data Translation Processing	Even	2B	6B	AB
Data Translation Processing	Odd	3B	7B	BB

4.3.6. Line Speed Values

Table 4-12 lists the decimal numbers specifying the maximum baud rate obtainable in the single-line communications adapter (SLCA) subchannel. Use this table for specifying the line speed value in COMMCT.

Table 4-12. Line Speed Values

User-Specified Value in CACH	SLCA Hardware-Required Value
Asynchronous Line Speeds	
50	50.0
75	75.0
110	110.0
134	134.5
150	150.0
300	300.0
600	600.0
900	900.0
1200	1200.0
1800	1800.0
2400	2400.0
3600	3600.0
4800	4800.0
7200	7200.0
9600	9600.0
Synchronous Line Speeds	
Any decimal value less than 2000	Any decimal value less than 2000.0
2000	2000.0
2400	2400.0
4800	4800.0
7200	7200.0
9600	9600.0
48000	48000.0
56000	56000.0
64000	64000.0

4.3.7. Space Compression Characters

Table 4-13 lists the 2-digit decimal function codes that correspond to the hexadecimal bytes used for space compression when the keyword parameter TRANS=NO is specified for both printer and nonprinter devices. Use this table for the PRTSPnn=hh, NPRTSPnn=hh, and TRANS keyword parameters in NTRGEN.

For example:

PRTSP03=20 indicates that hexadecimal 20 is the space character for printers with function code 03 when the LOCAL keyword parameter TRANS=NO is specified.

Or, NPRTSP05=05 indicates that hexadecimal 05 (field data space) is the space character for all nonprinter type devices with function code 05 when the LOCAL keyword parameter TRANS=NO is specified.

Table 4-13. Space Compression Characters

nn (Decimal)	hh (Hexadecimal)	
	Printer (PRTSP)	Nonprinter (NPRTSP)
00	05	FF
01	20	05
02	05	05
03	20	20
04	FF	20
05	FF	05
06	FF	20
07-14	FF	FF

4.3.8. Device Function Codes

Table 4-14 lists the function codes and their respective meanings for input and output devices for the FUNCD keyword parameter. This parameter specifies a 2-digit decimal function code that establishes the translation requirements for each image sent to your Unisys OS 1100 system. Use this parameter in conjunction with the TYPE and TRANS keyword parameters.

4.3.9. I/O Guidelines - Co-Channel Support

For co-channeling, a primary and a secondary I/O path is defined (via the CHAN/COCHAN and ADDR/COADDR I/OGEN parameters). The primary and secondary paths are used to provide simultaneous operation. In addition, if the primary path is not operational, the I/O is retried on the secondary path. If both paths are not operational, the error message NON OPERATIONAL CONTROL UNIT is issued. Frequent occurrences of a nonoperational path are logged in the error log.

If you use co-channeling (on Models 8 thru 20 only), establish your I/O configuration so that I/O activities are spread over several channels. This will improve system performance because the selector channel can't handle more than one data transfer at a time. If a channel is specified for a primary path (CHAN I/OGEN parameter) for a device, then that same channel should be used as a secondary path (COCHAN I/OGEN parameter) for a co-channeled device.

The following are sample I/OGEN specifications that depict this recommendation:

CASE 1:

TYPE=8419	CHAN=1	ADDR=B0-B1
TYPE=8433	CHAN=2	ADDR=80-81
	COCHAN=1	COADDR=80-81

CASE 2:

TYPE=8470	CHAN=1	ADDR=90-91
	COCHAN=2	COADDR=90-91
TYPE=8433	CHAN=2	ADDR=80-81
	COCHAN=1	COADDR=80-81

If you are generating a model 8 thru 20 with more than one control unit on the same selector channel; and at least one is an IDCU (that is, an 8417/18/19/70 disk), then the following device address combinations must be avoided:

- 8x with Cy
- 9x with Dy
- Ax with Ey
- Bx with Fy

For example, if you have one 8470 and two 8494 control units, and the 8470 is configured at address 190, you must avoid configuring anything at address 1D0. However, the two 8494 control units could be configured at 1A0 and 1E0.

Table 4-14. Device Function Codes

Function Code ¹	TRANS=YES	TRANS=NO ²	
Card Readers and Input Devices			
	Read	Send	Send
01	Hex. fielddata ³	Fielddata	Fielddata
02	EBCDIC	Fielddata	Fielddata
03	Hex. fielddata ³	ASCII	ASCII
04	EBCDIC	ASCII	ASCII
05	EBCDIC	Fielddata	Fielddata
06	EBCDIC	ASCII	ASCII
Card Punches and Nonprinter Output Devices			
	Receive	Punch	Receive
01	Fielddata	Hex. fielddata ³	Fielddata
02	Fielddata	EBCDIC	Fielddata
03	ASCII	Hex. fielddata ³	ASCII
04	ASCII	EBCDIC	ASCII
05	Fielddata	EBCDIC	Fielddata
06	ASCII	EBCDIC	ASCII
Printers			
	Receive	Print	Receive
00	Fielddata	EBCDIC	Fielddata
01	ASCII	EBCDIC	ASCII
02	Fielddata	EBCDIC	Fielddata
03	ASCII	EBCDIC	ASCII

NOTES:

- 1 The function code is controlled by OS 1100 for all data sent to NTR.
- 2 For TRANS=NO, NTR passes the data untranslated. Fielddata/ASCII is the standard OS 1100 correspondence for the device type and function code.
- 3 Hex. fielddata is the hexadecimal equivalent of fielddata (Hollerith punch card codes).



Section 5

System Maintenance

5.1. System Maintenance Packages

System maintenance packages (SMPs) contain system maintenance changes (SMCs) that you install on the SYSRES volume to support OS/3 software operations and effectiveness. Unisys delivers SMPs to all System 80 customers on one or more diskettes at regular intervals, usually every two to three months. These diskettes are accompanied by an SMP document that you must read before installing the SMP.

The SMP document gives information about the specific SMP you are installing and the processing options you should specify during installation. Although the options you select may vary with each SMP, follow these general guidelines whenever you install an SMP:

- Install all SMPs as soon as possible upon delivery.
- Install SMPs in the order they are delivered. For example, install SMP 13A before you install SMP 13B, SMP 13C, etc.
- Do not install SMPs while running other jobs because SMPs affect your operating system and unpredictable results could occur.
- Before you execute the installation program, be sure you have a current and complete copy of your SYSRES volume. See 3.3.6.

Each SMP requires approximately 100 cylinders for application. (Refer to the SMP document for the exact amount of space required by the specific SMP.) Before installing the SMP, you should erase certain files prior to installation. These files include SMCBSAT, SMCBMIR, SMCBTRAN, and the SMCFILE. Please note that once these files are erased, SMCs from the previous SMP cannot be backed out. (Option 6 of the initial SMC screen automatically erases these files for you.)

If sufficient space is not achieved by erasing the aforementioned files, you might need to perform SETREL/COPYREL to another device. If the SETREL/COPYREL must be done, a librarian error occurs on the SMC file. Another alternative to erasing files or executing SETREL/COPYREL is to place your back-out files on an alternate disk.

To install an SMP (or individual SMCs that you require but have not yet received as part of an SMP), run the installation program either from the system console or from a workstation. This program offers additional processing options that let you regenerate supervisors or ICAM symbionts if any of these elements are affected during the installation.

In addition, you can direct the installation program to keep a copy of the affected modules in SYSRES files before you install an SMP or SMC. These copies are saved in areas called back-out files on your SYSRES volume. Specify this option as a precautionary measure in case an SMP or SMC produces adverse effects on the system and you must back it out under the direction of a Unisys representative. By keeping the back-out copy, you can restore the system to the way it was before you installed the SMP.

5.2. Installation of SMPs

You can install SMPs either from a workstation or from the system console. Since you can perform all the installation tasks from either of these devices, choose whichever device you prefer. Help screens, however, are displayed only to the workstation user.

The following paragraphs describe the procedure for running the installation program.

Notes:

- 1. This procedure shows the processing screens you see when you enter the SMC run command at a workstation and explains the choices offered by those screens and how you respond to them. You can also use this procedure to run the program from the system console, but you respond to console messages rather than to screens. (Console messages are noted immediately after the workstation screen displays.) When you run the program from the system console, you must answer the messages the program displays as follows:*

- Press MSG WAIT to position the cursor at the beginning of the next line.*
- Key in the option you want to perform and press XMIT. Your keyin must be in the format:*

mm n

where:

mm

Is the 2-character number of the console message you are responding to.

n

Is the number of the option you want to perform.

- 2. The time it takes to install an SMP depends on several factors, including the number of SMCs in the SMP, the number of optional components the system contains, whether you have already installed some of the SMCs in the SMP, the amount of cache memory assigned, and whether the SMP is run with back-out.*

To run the SMC program:

1. Perform an initial program load (IPL) to load either the starter supervisor (SY@BAS, SY#BAS, SY\$BAS) or one you've generated yourself into main storage. Load the starter supervisor unless the system has a special configuration that requires another supervisor. For the IPL procedure, see the *Operations Guide*, UP-8859. For the SMP supervisor generation requirements, see the SMP document that accompanies the SMP.

Note: If your supervisor contains the ALTJCS feature, you may want to also include the IGNJCERR=R06 parameter available in Release 13.0. This parameter suppresses the R06 CONTINUE TO \$Y\$JCS? Y/N message each time the SMC program initiates a job.

2. Mount the first SMP diskette. (If the SMP is on more than one diskette and you are using a diskette autoloader, be sure all the SMP diskettes are now in the loader.)
3. At your workstation or system console, key in:

```
RV SMC,,INPUT=(DKD,vsn) [ ,B=  $\left\{ \begin{array}{l} \text{Y} \\ \text{N} \\ (\text{A},\text{xxxxxx}) \end{array} \right\} ] [ ,\text{FMT}=\text{F} ] [ ,\text{PRT}=\left\{ \begin{array}{l} \text{Y} \\ \text{N} \end{array} \right\} ] [ ,\text{NEW}=\text{Y} ]$ 
```

Note: Shading indicates the default value.

where:

INPUT=(DKD,vsn)

Indicates that the input for this job is the SMP diskette. DKD specifies a data set label diskette and vsn specifies its volume serial number found on the diskette cover.

B= $\left\{ \begin{array}{l} \text{Y} \\ \text{N} \\ (\text{A},\text{xxxxxx}) \end{array} \right\}$

Y or N

Specifies whether or not you want to use the back-out feature on your RES pack.

B=(A,xxxxx)

Specifies back-out and the VSN for an alternate disk.

When you use back-out feature, the following guidelines apply:

- The disk used for the back-out files (SYSRES or alternate) should be prepped using a standard disk prep. Using your own VTOC area can lead to backout initialization errors.

- The use of the back-out feature increases the time required to install an SMP and requires additional disk space on the SYSRES to hold the saved modules.
- The SMC program always creates the following files on the SYSRES volume.
 - SMCFILE - A SAT library containing all SMCs that are part of an installation.
 - $\$Y\$SMCLOG$ - A MIRAM file containing information relating to all the SMCs and program products applied to the system.

When you use the back-out feature, three additional files are created either on SYSRES or an alternate disk pack. These files must be kept consistent with each other and you must not delete or change the contents of any of these files:

SMCBSAT	Files used by the program
SMCBMIR	as back-out files when
SMCBTRAN	specified.

Note: *After your back-out files are placed on the alternate disk, you must always specify that your back-out files are on this alternate disk. If you wish to back out SMCs from an alternate disk, you must specify the $B=(A,xxxxxx)$ parameter.*

When you use this feature, continue to place your back-out files on the disk you initially specified. If you change the disk pack specified in the run stream, you will receive the following error and the SMC program will terminate immediately:

SMPU68 SMC BACKOUT FILES NOT ON DISK REQUESTED.

If you are forced to place your back-out files on a different disk, you must first reinitialize the back-out files with this keyin:

RV SMC, ,B=INIT

However, please note that $B=INIT$ will initialize back-out files and all SMCs backed out in previous runs are nondeletable.

To regain space on the SYSRES, you can create back-out copies of these files on another disk, on tape, or on diskette, and then erase the files from the SYSRES (except for $\$Y\$SMCLOG$, which is a system file and therefore cannot be erased). Remember, however, that if you want to preserve back-out capability, you must restore these files to your SYSRES before running the SMC installation program again.

- As each SMC in an SMP is applied, the modules changed by the SMC are stored in the appropriate back-out files and the entry in \$Y\$SMCLOG is marked BACKED UP. Each module is stored in the back-out file only once. Thus, each module in the back-out file is stored as it was prior to the application of any of the SMCs in the SMP.
- When the SMC program is run to back out an SMC, any other SMCs that affect the same modules are reapplied during the run.
- If you apply additional SMCs after installing an SMP, the new SMCs are added to the SMCFILE that was created by the original SMP run. Also, any additional modules affected by the new SMCs are added to the back-out files. The end result is the same as if the new SMCs had been included in the SMP.

FMT=F

Specifies that a full listing of SMCs is printed by the SMCLIST program. Specify this option if you want more information about each SMC than is provided by a condensed listing. For example, the full listing shows whether an SMC is required or optional. If this option is not specified, a condensed listing is printed.

PRT= $\left. \begin{array}{c} Y \\ N \end{array} \right\}$

Specifies whether the output is directed to the printer (PRT=Y) or to the spool file (PRT=N).

NEW=Y

Specifies that new versions of the SMC program load and/or JCL modules are to be copied to the SYSRES before SMC processing begins. A diskette labelled CORETT accompanies the SMP/SMC diskettes when this parameter is required.

4. Press XMIT. The SMC installation program displays messages telling you that the librarian facilities are copying the contents of the SMP diskette to the SYSRES to prepare for installation of the SMP. If the SMP is on more than one diskette, you receive messages instructing you to mount the next diskette. In response to those messages, mount the requested diskette and key in the 2-character message number and R for ready in the format nn R, where nn is the message number. Then, press XMIT. When the librarian completes the operation for the SMCFILE, the librarian terminates and the SMC query program (Figure 5-1) begins.

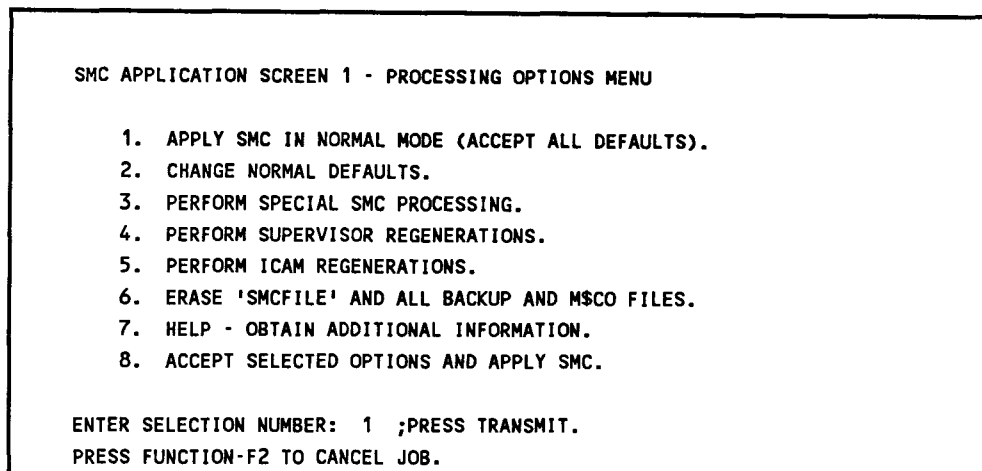

Figure 5-1. Processing Options Menu Screen

Notes:

1. *If you run the program from the system console, these options appear as a series of messages that are scrolled up from the bottom of the screen. All of the options appear, with the exception of option 7 because the program provides help screens only to workstation users.*
 2. *To cancel the job, press FUNCTION and F2 simultaneously. Do not cancel the job with the CANCEL command.*
 3. *Options 1 and 2 on the Processing Options Menu are mutually exclusive to options 4 and 5. Therefore, selecting option 1 or 2 after 4 or 5 in the same run of the SMP job cancels option 4 or 5. Selecting 4 or 5 after 1 or 2 cancels option 1 or 2. However, options 4 and 5 are cumulative, so you can enter either of these two options (4 or 5) in the same run without canceling the other.*
5. Determine from the options listed on this screen which function you want to perform:
- If you want to install an SMP (options 1 and 2), go to 5.2.1.
 - If you want to perform additional supervisor regenerations only (option 4), or additional ICAM regenerations only (option 5), go to 5.2.2.
 - If you want to erase files created by the program after installation (option 6), go to 5.2.3.

5.2.1. Installing an SMP

Do not perform the following procedure unless you have completed steps 1 through 5 of 5.2. You can install an SMP in normal mode and thus accept the default processing options we provide, or you can suppress the defaults and install an SMP with options you select yourself.

- To install an SMP in normal mode, go to step 1.
 - To install an SMP and change the defaults, go to step 2.
1. Key in 1 and press XMIT. The SMC program accomplishes the following tasks:
 - Installs all the SMCs that apply to the system
 - Regenerates the supervisor you loaded to install the SMP and the basic supervisor (when the two are not the same) if the SMP affects their operation
 - Prints an audit report of the status of all the SMCs installed to the system

When the program completes these tasks, go to step 3.

2. Key in 2 and press XMIT to install an SMP without the normal defaults.
 - a. The installation program then displays the first of two additional processing screens, the supervisor regeneration screen (Figure 5-2).

```

SMC APPLICATION SCREEN 3 - SUPERVISOR REGENERATION

REGENERATION OF UP TO THREE SUPERVISORS MAY BE PERFORMED ONLY OR
AT THE END OF THE SMP/SMC INSTALLATION.

DO YOU WISH TO REGENERATE A SUPERVISOR: AAA. YES/NO

IF YOU WISH TO DO REGENERATIONS ENTER THE NAMES OF THE SUPERVISOR
PARAMETER SOURCE MODULES AND PRESS TRANSMIT.

XXXXXXXX XXXXXXXX XXXXXXXX

NOTE: TO REGENERATE A SUPERVISOR THE MODULE (PREFIXED WITH S7 FOR MODEL 7E
AND S8 FOR ALL OTHERS) CONTAINING SUPERVISOR PARAMETERS MUST BE
AVAILABLE IN $Y$SRC. IF YOU DO NOT WANT THE IPL'D OR BASIC SUPERVISORS
LISTED ABOVE REGEN'D, OVERWRITE THEM WITH SUPERVISORS OF YOUR CHOICE.

PRESS FUNCTION-F1 TO CANCEL SCREEN AND RETURN TO THE MASTER MENU.
PRESS FUNCTION-F2 TO CANCEL JOB.
PRESS FUNCTION-F13 FOR HELP INFORMATION.

```

Figure 5-2. Supervisor Regeneration Screen

Note: *The following messages are displayed to the console user:*

SMPQ30 ENTER UP TO 3 SUPERVISOR NAMES, N: NO SUPVR REGEN,

SMPQ70 C: CANCEL JOB, OR M: RETURN TO MENU. DEFAULT: ipl'd supervisor

Enter the source module names of the supervisors that you want to regenerate and press XMIT. Remember that a supervisor cannot be regenerated by the program unless the supervisor source module, prefixed with S8, resides in \$Y\$SRC on the SYSRES and does not contain any errors. There can only be one supervisor per module in \$Y\$SRC.

Also, if you're a workstation user, notice the options that appear at the bottom of this screen as well as on each of the additional processing screens displayed by the program. Select one of these options simply by simultaneously pressing FUNCTION and the workstation function key that corresponds to the option you want to perform:

- FUNCTION - F1 Cancels the current screen and redisplay the processing options menu.
- FUNCTION - F2 Cancels the job.
- FUNCTION - F13 Displays a help screen providing additional information about the choices on the current screen.

Note: *If you use the system console, you can return to the processing options menu by entering M and pressing XMIT or cancel the job by entering C and pressing XMIT. Help screens are not available to the console user.*

- b. After you specify the supervisor elements you want to regenerate and press XMIT, the following screen is displayed (Figure 5-3).

```

SMC APPLICATION SCREEN 4 - ICAM REGENERATION

UP TO THREE ICAM REGENERATIONS CAN BE PERFORMED ONLY OR AT THE
END OF THE SMP/SMC INSTALLATION.

DO YOU WISH TO REGENERATE AN ICAM:      YES/NO

IF YOU WISH TO DO REGENERATIONS ENTER THE NAMES OF THE ICAM PARAMETER
SOURCE MODULES AND PRESS TRANSMIT.

XXXXXXXX XXXXXXXX XXXXXXXX

NOTE: TO REGENERATE AN ICAM, THE MODULE CONTAINING THE ICAM PARAMETERS
MUST BE AVAILABLE IN $Y$SRC.

PRESS FUNCTION-F1 TO CANCEL SCREEN AND RETURN TO THE MASTER MENU.
PRESS FUNCTION-F2 TO CANCEL JOB.
PRESS FUNCTION-F13 FOR HELP INFORMATION.

```

Figure 5-3. ICAM Regeneration Screen

Note: *The following messages are displayed to the console user:*

```
SMPQ30 ENTER UP TO 3 ICAM NAMES.      N: NO ICAM REGEN,
```

```
# SMPQ70 C: CANCEL JOB, OR M: RETURN TO MENU. DEFAULT:N
```

You can regenerate up to three ICAM elements by entering the ICAM source module names and pressing XMIT. As with supervisor regeneration, an ICAM element cannot be regenerated by the SMC program unless the ICAM source module resides in \$Y\$SRC on the SYSRES. If a prefix is entered, all ICAM modules in \$Y\$SRC with that prefix will be regenerated.

- c. After you specify the ICAM elements you want to regenerate and press XMIT, the processing options menu shown in Figure 5-1 is redisplayed. Key in 8 (or 7 if you're running the program from the system console) and press XMIT. The program then:
 - Installs all the SMCs that apply to the system
 - Performs any regenerations that you have specified
 - Prints an audit report of the status of all the SMCs installed to the system
3. After installing an SMP, the program displays a message to tell you that:
 - The SMC job is issuing a command to execute SMCLIST
 - The SMC job terminated normally

The SMC job leaves job slot 1 and SMCLIST takes its place. SMCLIST then provides a condensed printout of the contents of \$Y\$SMCLOG, which is a record of all the SMCs that have been installed in the system. If you specify the FMT=F option on the SMC execution command, a full listing is printed. This listing provides such additional information as whether an SMC is required or optional. When SMCLIST successfully prints this list, a message informs you that SMCLIST has terminated normally. The SMP installation process is now complete.

We recommend that you keep the SMCLIST printout with your other system records so that you have a record of all the SMCs installed in the system. If you wish to print that list, refer to the *System Service Programs Operating Guide*, UP-8841, for instructions on executing SMCLIST as a separate function from the SMC process.

Note: After you install an SMP, check the SMP document to see if the SMP requires that you update the system definition file, \$Y\$SDF. If so, see 2.3.1 for the procedure for updating loadable microcode. Also, check the audit trail printout for special notes about the SMP you just installed.

4. Once the SMP installation is complete, perform an initial program load (IPL) to continue with your normal processing. For the IPL procedure, see the *Operations Guide*, UP-8859. Be sure to perform an initial program load with the S option to update the system tables.

Note: If the system has any supervisors or any ICAM elements affected by the SMP (other than elements automatically regenerated as defaults) and you did not tell the program to regenerate them, be sure to regenerate them yourself before you load and use them. See Section 3 for the system generation procedure.

5.2.2. Performing Additional Regenerations

Do not perform the following procedure unless you have completed steps 1 through 5 of 5.2. To perform additional regenerations, proceed as follows:

- If you want to perform additional supervisor regenerations only, go to step 1.
 - If you want to perform additional ICAM regenerations only, go to step 2.
1. Key in 4 and press XMIT to display the supervisor regeneration screen (or console messages). Figure 5-2 shows this screen along with an explanation of the processing options that appear at the bottom of the screen (step 2a of 5.2.1.). Enter the supervisor elements you want to regenerate and press XMIT. The SMC program then redisplay the processing options menu. If you want to perform additional tasks, repeat step 5 of 5.2. Otherwise, key in 8 (or 7 if you're running the program from the system console), press XMIT, and go to step 3 of this procedure.

2. Key in 5 and press XMIT to display the ICAM regeneration screen (or console messages). Figure 5-3 shows this screen along with an explanation of the processing options that appear at the bottom of the screen (step 2b of 5.2.1.). Enter the ICAM elements you want to regenerate and press XMIT. The SMC program redisplay the processing options menu. If you want to perform additional tasks, repeat step 5 of 5.2. Otherwise, key in 8 (or 7 if you're running the program from the system console), press XMIT, and go to step 3 of this procedure.
3. After you supply this information, the program performs the additional tasks that you specified, informs you when it has successfully done so, and displays messages to tell you that:
 - The SMC job is issuing a command to execute SMCLIST.
 - The SMC job terminated normally.

The SMC job leaves job slot 1 and SMCLIST takes its place. SMCLIST then provides a condensed printout of the contents of `Y$SMCLOG`, which is a record of all the SMCs that have been installed in the system. If you specify the `FMT=F` option on the SMC execution command, a full listing is printed. This listing provides such additional information as whether an SMC is required or optional. When SMCLIST successfully prints this list, you receive a message informing you that SMCLIST has terminated normally. The process of performing additional regenerations is now completed.

5.2.3. Erasing SMP Files

After installing an SMP, you can erase the `SMCFILE`, a file containing all the SMCs that are part of an SMP, and all back-out files. Specify option 6, and press XMIT. The SMC program erases each of these files, updates the `Y$SMCLOG` to indicate that back-out files no longer exist, and displays a message to tell you that the SMC job terminated normally. Do not erase these files, however, unless you are certain all SMCs in the SMP have been successfully installed. If you used an alternate disk for your back-out files, you must specify `B=(A,xxxxxx)`, where `xxxxxx` is the VSN of your back-out disk.

Note: Erase these files only if you no longer want to retain back-out capability for SMCs contained in the `SMCFILE`. Use the SMC program to erase SMC files, as this automatically updates the `Y$SMCLOG` to reflect this action.

5.3. Installation of Individual SMCs

If you require an SMC that is not yet part of an SMP, Unisys will provide that change to you as soon as possible without waiting to release the next SMP. The SMC can be delivered on diskette or key-punched cards. It can also be delivered as a set of instructions via telephone or written correspondence.

When the SMC is given to you over the telephone or through the mail, you must build the SMC in the standard OS/3 change format yourself. The SMC installation program accepts changes entered from punched cards, diskette, and key-ins from workstations or the system console.

If you elect to use a workstation, the SMC program displays a series of fill-in-the-blank screens that help you build the SMC in the correct change format. These screens comprise the SMC interactive entry process. If you have to use a console because the system does not include workstations, the SMC program initiates the SMC console dialog to help you build the change in the correct format.

Figure 5-4 illustrates the installation of an individual SMC.

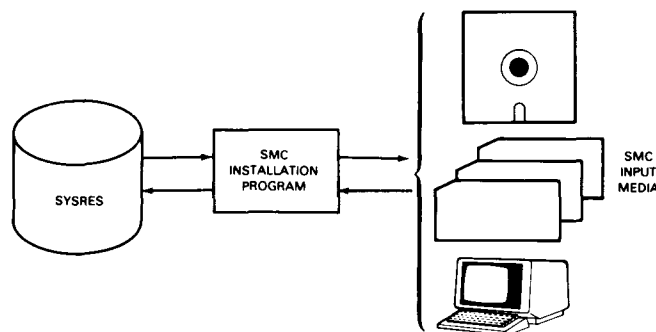

Figure 5-4. Installation of Individual SMCs

5.4. Running the SMC Installation Program

The paragraphs that follow describe the procedure for installing individual SMCs (those not part of an SMP).

Shown in the procedure are a series of interactive processing screens. These screens are applicable only to workstation users. They explain the installation choices offered by the SMC program and how you respond to them. You can also use this same procedure to run the SMC program from the system console. When using the system console, you respond to console messages rather than to screens. These messages are noted immediately after the corresponding workstation screen. When running the SMC program from the system console, you must answer the messages the program displays as follows:

- Press MSG WAIT to position the cursor at the beginning of the next line.

- Key in the option you want to perform and press XMIT. Your keyin must be in the format:

mm n

where:

mm

Is the 2-character number of the console message you are responding to.

n

Is the number of the SMC installation option you want to perform.

1. Perform an initial program load to load either the starter supervisor (SY@BAS or SY#BAS) or one you've generated yourself into main storage, even if you are already operating under that supervisor. (Load the starter supervisor unless your system has a special configuration that requires another supervisor.) For the IPL procedure, see the *Operations Guide*, UP-8859.

Note: *If your supervisor contains the ALTJCS feature, you may want to also include the IGNJCERR=R06 parameter available in release 13.0. This parameter suppresses the R06 CONTINUE TO \$Y\$JCS ? Y/N message every time the SMC program initiates a job.*

2. If you received the SMC on diskette, mount that diskette and proceed to step 3. If you received the change over the telephone or through the mail, proceed directly to step 3. If you received the change on keypunched cards, read the note that follows before inserting the card deck into your card reader and proceeding to step 3.

Note: *If you are installing more than one SMC on cards, you can combine the SMC decks and key in the SMC run command once to install all the SMCs in the combined deck. Remove the // FIN cards from the end of each SMC deck except for the last deck and insert a /* card immediately before the last // FIN card. If your system uses spooling, continue to read this note. If your system does not use spooling, insert the combined card deck into your card reader and proceed to step 3.*

If your system uses spooling, you must create a spool file containing the data in the card decks before you run the SMC program. To create the spool file, place the following card at the beginning of the deck:

```
// DATA FILEID=SMCREADER,,IGNORE
```

Insert the entire deck into the card reader and then enter the command IN from your system console/workstation in console mode. The system displays the message SPOOLFILE SMCREADER WAS CREATED after it successfully creates the spool file. Proceed to step 3.

3. At the workstation or system console, key in:

```
RV SMC [, INPUT= [ C
                  (DKD, vsn)
                  (DKF, vsn)
                  CR
                  (D, RES)
                  (D, vsn)
                  (CR, vsn)
                  WS ] ] [, B= [ Y
                                N
                                (A, xxxxxx) ] ] [, FMT=F ] [, PRT= [ Y
                                                                    N ] ] [, NEW=Y ]
```

where:

INPUT

Describes the medium you are using to enter the SMC into the system. If you run the SMC program only to perform supervisor or ICAM regenerations or to realign system files, omit this parameter.

Note that the INPUT parameter does not describe the device where you're running the SMC program. There is a difference. You can run the SMC program from your workstation or system console, but input the SMC through any of the media described in the following list.

INPUT=C

Specifies that you build the SMC in the correct change format using the SMC console dialog at the system console. Choose this method if you received the SMC over the telephone or through the mail and there are no workstations in the system.

INPUT=(DKD, vsn)

Specifies the volume serial number of a data set label diskette.

INPUT=(DKF, vsn)

Specifies the volume serial number of a format label diskette.

INPUT=CR

Specifies the card reader. Select this if you received the SMC on cards or if you have keypunched the cards yourself.

Note: If you keypunch the SMC yourself, be sure you start the // OPTION SMC card in column 30 on card 2, and include only one space after the slashes and the word "option". Otherwise, you get errors.

INPUT=(D, RES)

Specifies that the SMCs to install reside in the SMCFILE on SYSRES.

INPUT=(D, vsn)

Specifies that the SMCs to install reside in the SMCFILE on the disk pack with the specified volume serial number.

INPUT=(CR,vsn)

Specifies the volume serial number of a diskette to be used as card reader input.

INPUT=WS

Specifies that a workstation is used to enter the SMC. Specify this choice if Unisys supplies the SMC information to you over the telephone or through the mail.

B= $\left. \begin{array}{l} \text{Y} \\ \text{N} \\ (\text{A}, \text{xxxxxx}) \end{array} \right\}$

Specify this optional parameter only if you do not want the SMC job to create permanent back-out files on your RES pack. The A specifies back-out for an alternate disk and xxxxxx specifies the VSN of this disk.

FMT=F

Specifies that a full listing of SMCs is printed by the SMCLIST program. Specify this option if you want more information about each SMC than is provided by a condensed listing. For example, the full listing shows whether an SMC is required or optional. If this option is not specified, a condensed listing is printed.

PRT= $\left. \begin{array}{l} \text{Y} \\ \text{N} \end{array} \right\}$

Specifies whether the output is directed to the printer (PRT=Y) or to a spool file (PRT=N)

NEW=Y

Specifies that new versions of the SMC program load and/or the JCL modules are to be copied before SMC processing begins. A diskette labelled CORETT accompanies the SMP/SMC diskettes when this parameter is required.

Notes:

1. *Shading indicates the default value.*
2. *If you specify INPUT=C, you elected to use the SMC console dialog to build your SMC; press XMIT and proceed to 5.4.1.*
3. *If you specify INPUT=WS, you elected to use the workstation interactive SMC entry process to build your SMC; press XMIT and proceed to 5.4.2.*
4. *If you do not need to build the SMC, press XMIT and proceed to 5.4.3.*

5.4.1. Building Your SMC from the Console

Because you specified INPUT=C on the SMC execution command, the SMC job initiates the SMC console dialog to build the change in the standard OS/3 change format. A sample SMC in 5.5 shows, in the correct change format, the parts of the change that Unisys provides and the information you must supply in response to the SMC console dialog queries. If you received the SMC over the telephone, your Unisys representative must supply all the information you need to answer the dialog queries. Respond to the dialog queries in the following manner.

Note: If, at any time in the current dialog session, you respond incorrectly to a dialog query, key in CANCEL, press XMIT, and respond Y to the subsequent message PROCESS ANOTHER SMC (Y OR N)? The SMC dialog ignores all previous responses, both correct and incorrect, and redisplay the dialog starting at step a so that you may enter correct responses.

- a. When the message ENTER SMC NUMBER (XXXXXXX) appears, key in the 7-character SMC number and press XMIT.
- b. When the message ENTER COMPONENT NUMBER (XXXX) appears, key in the 4-character component number and press XMIT.
- c. When the message ENTER APPLIES TO RELEASE LEVEL (XXXXXX) appears, key in the release level that the SMC applies to and press XMIT. You must key in the release level as a 6-digit number. For example, Release 13.0 would be 130000.
- d. When the message ENTER PRODUCT TYPE NUMBERS (XXXX-XX) appears, key in a 6-character, hyphenated product type number and press XMIT.
- e. When the message ENTER SYSTEM CODE (S=MOD 4-6, 8=MOD 8 thru 20, 7= MOD 7E, C=COMMON) appears, key in the appropriate system code found in the job control provided and press XMIT.
- f. When the message ENTER REGEN FLAGS (XXXXXXXX) appears, check the REGEN specification in the job control provided. Key in Y for yes, or N for no, for each of the eight fields in the specification, in exactly the way that it is shown. The REGEN flags identify the types of regenerations required as a result of installing this SMC. Each field contains a value, either Y or N, that tells whether regeneration is required for each type of module the system could include. The eight fields in the value correspond to supervisors, ICAM generations, NTR networks, ICAM links, ANSI '74 COBOL compiler modules, IMS modules, and DMS modules (the eighth field identifies any other modules affected by this SMC and explained in line 13 of the job control we provide). For example, installation of the sample SMC in 5.5 requires no regenerations because all 8 REGEN flags show N for no.

- g. When the message REQUIRED SMCs? (XXXXXXX,...MAX=5) appears, key in up to five 7-character SMC numbers of prrequired SMCs and press XMIT. If there are no required SMCs, simply press XMIT.
- h. When the message ENTER CHARACTER TO REPRESENT LEADING SPACE appears, key in any character on the keyboard that is not included in the actual SMC. You must key in this character in steps i and j, which follow, as a substitute for leading spaces in any change lines requiring them. If you don't specify a character, you must use the left bracket ([).

Note: The first time the messages in steps i and j appear, 32 occupies the field XX because line 32 of an SMC is the first line of the actual change and the first line you must key in. Each successive time these messages appear, the number in the field XX increases by one until you key in LAST to tell the SMC program you have no more change lines to key in.

- i. When the message ENTER LINE XXX COLS 1 TO 60 appears, either continue entering the SMC at the console or use the card reader as the input device for the remainder of the SMC.
- (1) To use the card reader, enter the letters CR in response to the ENTER message and press XMIT. The card deck should contain the SMC preceded by a // JOB card and followed by a /*. Then, continue with step k of this procedure.
 - (2) If you continue using the console, respond to the ENTER message by keying in the first 60 columns of each line of the job control for the SMC, then pressing XMIT. You must provide the following (including slashes):
 - DVC-LFD sequences of any files that the SMC affects
 - Execute statement for whatever system program that the SMC executes. The SMC could execute one of the following system programs to change the corresponding program module:
 - LIBS - to correct the SAT module
 - TRNPAT - to correct the system transient file
 - MLIB - to correct the system MIRAM module
 - MSGGEN - to correct the system message file
 - /\$
 - Any parameters associated with the system program you are executing
 - /*

If you have no more change lines, key in LAST, press XMIT, and proceed with step k.

- j. When the message ENTER LINE XXX COLS 61 TO 80 appears, key in the last 20 columns of the information requested in step i and press XMIT. If your entire change line fits on the first 60 columns, press XMIT and go back to step i.
- k. When the message ACCEPT THIS SMC (Y OR N)? appears:
 - Check your responses to all of the previous queries
 - Key in Y and press XMIT if they are all correct, and proceed with step l; key in N and press XMIT if any are incorrect. This response causes the entire SMC to be disregarded and displays the message: PROCESS ANOTHER SMC (Y or N)?
- l. When the message PROCESS ANOTHER SMC (Y OR N)? appears, key in Y if you need to define another SMC, press XMIT and repeat the procedure (5.4.1.). If you have no other SMCs to define, key in N and proceed to 5.4.3.

5.4.2. Building Your SMC from a Workstation

Because you selected INPUT=WS on the SMC execution command, the SMC job initiates the Interactive SMC Entry process for building the change (in the standard OS/3 change format) from a workstation. The interactive process displays a series of interactive screens explaining the build procedure and showing both the required and option data entry fields you are to complete. (If you received the SMC over the telephone, a Unisys representative must supply all information you need to use this process and complete the data entry fields.) A blinking field on the screen indicates that you have failed to enter data into a required field or that the data you entered is invalid. The program does not allow you to transmit an invalid or incomplete screen. To correct the entry screen, simply tab back to the blinking field, reenter the data, then position the cursor at the bottom of the screen, and press XMIT. If the data you entered is valid and complete, the SMC program accepts the data and displays the next interactive screen. A sample SMC showing both the information provided by Unisys and the information you supplied via the blank fields of the Interactive SMC Entry screens is provided at the end of this section.

Note: *If at any time during this process you want to terminate the SMC job, press FUNCTION and F1 simultaneously.*

Perform the Interactive SMC Entry process in the following manner:

- a. Figure 5-5 shows the first screen displayed. This screen explains the Interactive SMC Entry process and lists the instructions for using the workstation. After reading this screen, press XMIT to continue with the SMC entry procedure.

```

I N T E R A C T I V E   S M C   E N T R Y   I N S T R U C T I O N   S C R E E N   [01]

THE FOLLOWING SCREENS WILL REQUEST INFORMATION REQUIRED TO BUILD AN
SMC IN OS/3 FORMAT. JUST ENTER THE REQUESTED INFORMATION BY FILLING
IN THE BLANKS. YOU MAY TAB OVER FIELDS TO ACCEPT ANY DEFAULT VALUES.

A DATA FIELD WILL BLINK TO INDICATE THAT INVALID INFORMATION HAS BEEN
ENTERED OR THAT A FIELD WHICH REQUIRES INFORMATION TO BE ENTERED WAS
LEFT BLANK. JUST TAB TO THE BLINKING FIELD AND OVERWRITE IT WITH THE
CORRECT INFORMATION.

WHEN YOU HAVE COMPLETED A SCREEN, PRESS XMIT TO CONTINUE WITH
THE NEXT SCREEN. AFTER COMPLETING THE TWO FORMAT SCREENS YOU WILL BE
REQUESTED TO ENTER THE PATCH CARDS.

YOU MAY ELECT TO START OVER AT ANY TIME BY PRESSING FUNCTION KEY 1 [F1].

PRESS [XMIT] TO CONTINUE OR, [F1] TO TERMINATE. <_>

```

Figure 5-5. SMC Instruction Screen

- b. Figure 5-6 shows the first SMC data entry screen. Complete (fill in) the blank fields shown on this screen.

```

I N T E R A C T I V E   S M C   E N T R Y   S C R E E N   [03]

// JOB _____,7000,14000                                X
// DVC 20 // LFD PRNTR      // OPTION SMC
// NOP |*****|
// NOP |CORRECTION IS FOR _____|                       |
// NOP |IT WAS SUBMITTED ON _____ AND IS _____|     |
// NOP |IT APPLIES TO RELEASE _____ THRU _____|       |
// NOP |IT IS ___ TESTED AND IS ___ FIELD VERIFIED _____| |
// NOP |THE SUR ORIGINATED IN _____|                     |
// NOP |CORRECTION HAS BEEN APPLIED TO RELEASE _._._|        |
// NOP |IT IS INCLUDED IN _____|                         |
// NOP |COMPONENT SOURCE IS CORRECTED IN RELEASE _____|   |
// NOP |CONTINGENCY: SYSTEM=-_          REGEN= _____|    |
// NOP |_____|                                              |
// NOP |FIXES SURS: _____|                                |
// NOP |REQUIRED COR: XXXX,XXXX,XXXX,XXXX,XXXX|             |
// NOP |REPLACES COR: XXXX,XXXX,XXXX,XXXX,XXXX|             |

PRESS [XMIT] TO CONTINUE OR, [F1] TO START OVER. <_>

```

Figure 5-6. First SMC Entry Screen

- c. Press XMIT to enter your data and to display the second SMC entry screen shown in Figure 5-7. Fill in the required fields on this screen.

```

      I N T E R A C T I V E   S M C   E N T R Y   S C R E E N   [04]

// NOP 'IS REQUIRED BY CORS: XXXX,XXXX,XXXX,XXXX,XXXX           |
// NOP 'IS REPLACED BY CORS: XXXX,XXXX,XXXX,XXXX,XXXX           |
// NOP 'CORRECTION REQUIRES ____ WITH VSN ____ MODULE=_         |
// NOP '(FILEID=_____ )                                         |
// NOP 'CORRECTION DESCRIPTION:                                     |
// NOP ' _____                                                 |
// NOP ' _____                                                 |
// NOP ' _____                                                 |
// NOP ' _____                                                 |
// NOP ' _____                                                 |
// NOP 'ECN=NONE                                                  |
// NOP 'MODULES CORRECTED:                                         |
// NOP ' _____                                                 |
// NOP 'CORRECTION CARD COUNT: ____                               |
// NOP '*****

      PRESS [XMIT] TO CONTINUE, OR [F1] TO START OVER. <_>
    
```

Figure 5-7. Second SMC Entry Screen

- d. Press XMIT. If you have made any errors on either of the entry screens, the incorrect fields begin blinking. Should this occur, check the line to verify that you entered it correctly, correct any errors, and press XMIT.

At this point, the workstation screen is cleared and a series of prompts for the remainder of the change are displayed. Multiple spaces are not required when entering an SMC.

When the line number prompt appears, key in the first line of the actual SMC and press XMIT. Continue to enter all the lines of the actual SMC, pressing XMIT after each one. You must enter the complete SMC as shown. If any lines are omitted, you receive an error message.

If you have no more change lines, either press FUNCTION and the F2 key simultaneously, or enter the word LAST and press XMIT. Proceed with step e.

- e. When the message ACCEPT SMC (Y,N) OR CMD (C,D,F,I,P,S,U OR HELP) appears, check your previous entries, then:
- If all entries are correct, key in Y and press XMIT. Proceed to 5.4.3.
 - If the SMC is not in acceptable format, you may be able to correct it with the SMC editor, a facility we provide to make SMCs easier to prepare. Enter the command HELP and press XMIT to display the editing commands HELP screen (Figure 5-8). Proceed with step f.

```

=====
=                                     =
=                               EDITING COMMANDS HELP SCREEN [01]                               =
=                                     =
=====
= THE COMMAND REQUEST EXPECTS THAT YOU WILL ENTER THE LETTER OF THE COMMAND           =
= AND THEN PRESS THE RED [XMIT] KEY.                                                 =
=                                                                                       =
= SOME OF THE COMMANDS REQUIRE A LINE NUMBER (INDICATED BY THE '#' SYMBOL           =
= FOLLOWING THE COMMAND EXPLANATION BELOW), WHICH SHOULD BE SUPPLIED WITH           =
= THE COMMAND LETTER.                                                                 =
=                                                                                       =
= YOU WILL BE PROMPTED FOR A LINE NUMBER IF ONE IS NOT SUPPLIED.                     =
=                                                                                       =
=====
=      SYNTAX      COMMAND      =      SYNTAX      COMMAND      =
=      C#          COPY        =      N           NO           =
=      D#          DELETE      =      P#          PRINT        =
=      F           FIND        =      S#          SWAP         =
=      I           INSERT      =      U#          UPDATE       =
=                                     =      Y           YES          =
=====
FOR A MORE DETAILED EXPLANATION OF ANY COMMAND, JUST ENTER ITS LETTER HERE <X>
AND PRESS THE [XMIT] KEY, OTHERWISE PRESS [F1], [F2], OR THE [XMIT] KEY.

```

Figure 5-8. Editing Commands HELP Screen

- f. To perform one of the functions listed on this screen, enter the first letter of that function and press XMIT. The following functions should be particularly helpful to you in editing an SMC:

C(opy) Duplicates a card image from one line to another. The command must include two pieces of information - the line number of the source image and the line number of the destination line. If you request this command but do not supply the line numbers of the source image or the destination line, you will be prompted to supply them. Any invalid line numbers will cause the INVALID ENTRY message. The command will terminate and return control to the SMC editor. To enter the source line number with the command, key it in immediately following the command letter, for example, C043.

F(ind) Scans the SMC card images for a search string and displays all cards that contain the string. The search string can be up to 20 characters long. A prompt will request that you supply this string.

- I(nsert)** Creates a new card image between two other lines in the SMC. You must supply the line number where the source image will be inserted. The card image you are creating will be inserted into the SMC at this location and any existing lines will be moved down. If you request this command, you must supply the line number of the source image and the text of the line or you will be prompted for it. An invalid line number will cause the INVALID ENTRY message. The command will terminate and return control to the SMC editor. To enter the source line number with the command, just key it in immediately following the command letter, for example, I043.
- P(rint)** Displays the SMC on the workstation screen. You can supply a line number with this command in the format Pxxx (where xxx is the 3-digit starting line number of the lines to be displayed). If no line number is supplied, the entire SMC is displayed. The SMC is scrolled up from the bottom of the screen until either the last line has been displayed or you decide to halt the display by pressing FUNCTION and F simultaneously. To continue the display, press FUNCTION and F19 simultaneously. If, at any time, you want to end the display, press FUNCTION and F18 simultaneously.
- S(wap)** Exchanges one card image with another. You must supply the line number of the image (the line to swap from) and the line number of the destination line (the line to swap with). The command will prompt you for this information if you do not supply it. Any invalid line numbers will cause the INVALID ENTRY message. The command will terminate, returning control to the SMC editor. To enter the source line number with this command, just key it in immediately following the command letter, for example, S043.
- U(pdate)** Displays the requested line and allows it to be changed. You must supply a line number with this command in the format Uxxx (where xxx is the 3-digit line number you want to update). If you do not supply a line number with the command, a prompting message is displayed.

After you perform one of the editing functions, press XMIT to redisplay the ACCEPT message: ACCEPT SMC (Y,N) OR CMD (C,D,F,I,P,S,U OR HELP)

- If all entries are correct, key in Y and press XMIT. Proceed to 5.4.3.
- If the SMC is not in acceptable format, enter the command HELP and press XMIT to redisplay the editing commands HELP screen (Figure 5-8). Repeat step f of this procedure.
- If the SMC cannot be corrected by repeating step f, enter N and press XMIT. This response restarts the Interactive SMC Entry process. Return to part a of this step and reenter your SMC information.

5.4.3. Installing the SMC

The SMC program displays the following menu screen asking what type of processing you desire.

```
SMC APPLICATION SCREEN 1 - PROCESSING OPTIONS MENU

      1. APPLY SMC IN NORMAL MODE (ACCEPT ALL DEFAULTS).
      2. CHANGE NORMAL DEFAULTS.
      3. PERFORM SPECIAL SMC PROCESSING.
      4. PERFORM SUPERVISOR REGENERATIONS.
      5. PERFORM ICAM REGENERATIONS.
      6. ERASE 'SMCFILE' AND ALL BACKUP AND M$CO FILES.
      7. HELP - OBTAIN ADDITIONAL INFORMATION.
      8. ACCEPT SELECTED OPTIONS AND APPLY SMC.

ENTER SELECTION NUMBER: 1 ;PRESS TRANSMIT.
PRESS FUNCTION-F2 TO CANCEL JOB.
```

Note: *If you run the SMC program from the system console, these options appear as a series of messages that are scrolled up from the bottom of the screen. All of the options appear, with the exception of option 7 because the SMC program provides help screens only to workstation users.*

The options on this screen are described in 5.2. Determine from the options listed on this screen which function you want to perform.

Note: *Options 1 and 2 on the Processing Options Menu are mutually exclusive to options 4 and 5. Therefore, selecting option 1 or 2 after 4 or 5 in the same run of the SMP job cancels option 4 or 5. Selecting 4 or 5 after 1 or 2 cancels option 1 or 2. However, options 4 and 5 are cumulative, so you can enter either of these two options (4 or 5) in the same run without canceling the other.*

- If you want to install an SMC, proceed to part a of this step.
- If you want to perform additional supervisor regenerations or additional ICAM regenerations, proceed to part b of this step.
- If you want to erase files created during SMC installation, proceed to part c of this step.
- If you want to perform one of the special processing operations, proceed to part d of this step.

- a. You can install an SMC in normal mode and accept the default processing options, or you can suppress the defaults and install an SMC with options you select. Refer to 5.2 if you do not understand the options offered by the SMC program.
- To install an SMC in normal mode, key in 1 and press XMIT. The SMC program:
 - Installs the SMC to the system
 - Regenerates the supervisor you loaded to install the SMC and the basic supervisor (if the two are not the same) when the SMC affects their operation
 - Prints an audit report of the status of all the SMCs installed to the system

When the SMC program completes these tasks, go to step e.

- To install an SMC without the normal defaults, key in 2 and press XMIT.

The installation program then displays two additional processing screens (or equivalent console messages): the supervisor regeneration screen and the ICAM regeneration screen. These screens are shown in 5.2.1. The processing options they offer are also explained in that paragraph. If you need help answering these screens, refer to 5.2.1 or simply simultaneously press FUNCTION and F13 to display a help screen.

Note: *The SMC program does not provide help screens to console users.*

Fill in the first processing screen (or respond to the console messages) and press XMIT to display the second screen. Repeat the process for the second screen, and so forth. After you have answered all of the screens, the SMC processing options menu is redisplayed. Key in 8 (or 7 if you're running the program from the system console) and press XMIT. The SMC program then:

- Installs the SMC
- Performs the regenerations that you have specified
- Prints an audit report of the status of all the SMCs installed to the system

When the SMC program completes these tasks, go to step e.

- b. To perform additional regenerations, proceed as follows:
- To perform supervisor regenerations, key in 4 and press XMIT to display the supervisor regeneration screen (or equivalent console messages). Enter the supervisor elements you want to regenerate and press XMIT. The SMC program then redisplay the processing options menu. Key in 8 (or 7 if you're running the program from the system console), press XMIT, and go to step e.
 - To perform ICAM regenerations, key in 5 and press XMIT to display the ICAM regeneration screen (or equivalent console messages). Enter the ICAM elements you want to regenerate and press XMIT. The SMC program redisplay the processing options menu. Key in 8 (or 7 if you're running the program from the system console), press XMIT, and go to step e.
- c. After you install an SMC, you can direct the SMC program to erase the SMCFILE and all back-out files. Key in 6 and press XMIT. The program erases each of these files and updates the \$Y\$SMCLOG to indicate that back-out files no longer exist for any SMCs. The program then displays a message that the SMC job terminated normally.
- d. To perform one of the special processing options, key in 3 and press XMIT. The SMC program then displays this screen (Figure 5-9).

```

SMC APPLICATION SCREEN 2 - SPECIAL PROCESSING

      (1) EXCEPTION   (2) SELECTED   (3) EXCLUDE   (4) BACKOUT

ENTER THE NUMBER OF THE TYPE OF PROCESSING TO BE PERFORMED. 1

ENTER THE NUMBERS OF THE SMCs TO BE PROCESSED:

      XXXXXXXX   XXXXXXXX   XXXXXXXX   XXXXXXXX   XXXXXXXX   XXXXXXXX
      XXXXXXXX   XXXXXXXX   XXXXXXXX   XXXXXXXX   XXXXXXXX   XXXXXXXX
      XXXXXXXX   XXXXXXXX   XXXXXXXX   XXXXXXXX   XXXXXXXX   XXXXXXXX

PRESS FUNCTION-F1 TO CANCEL SCREEN AND RETURN TO THE MASTER MENU.
PRESS FUNCTION-F2 TO CANCEL JOB.
PRESS FUNCTION-F13 FOR HELP INFORMATION.
    
```

Figure 5-9. SMC Special Processing Screen

Note: *The following messages are displayed to the console user:*

- *Primary request:*

```
SMPQ20 SPECIAL PROCESSING OPTIONS ARE:  
SMPQ21 (1) EXCEPTION (2) SELECTED (3) EXCLUDE (4) BACKOUT  
SMPQ22 ENTER NUMBER OF THE TYPE OF PROCESSING TO BE DONE  
SMPQ70 C: CANCEL JOB, OR M: RETURN TO MENU. DEFAULT:1
```

- *Secondary request (displayed after you respond to the primary request by selecting one of the special processing options):*

```
SMPQ23 (n) ENTER UP TO 6 SMC NUMBERS, E: END OF INPUT,  
SMPQ70 C: CANCEL JOB, OR M: RETURN TO MENU. DEFAULT:1
```

Messages SMPQ23 and SMPQ70 are repeated up to three times (as indicated by n), provided that six valid SMC numbers are entered for the current query. E is entered for query SMPQ70 if no more entries are desired.

Select one of the four operations offered on this screen. The response and criteria for each selection follow:

- To install exception SMCs, key in 1. The SMC job then displays the following message: ENTER UP TO 6 SMC NUMBERS, E:END OF INPUT,C:CANCEL JOB, or M:RETURN TO MENU? Respond to this message by keying in the numbers of the exception SMCs to be installed and press XMIT. If you key in less than six, the SMC job redisplay the SMC processing options menu. If you have more than six, the message is redisplayed up to 3 times for you to enter more. When you have no more exception SMC numbers to enter, respond M so the SMC job returns you to the SMC processing options menu. On the SMC processing options menu, key in 8 (or 7 if you're running the program from the system console), press XMIT, and proceed to step e. (Exception SMCs apply only to certain types of users. You should not apply them unless directed to do so by the Unisys representative.)
- To select a subset of the SMCs in the SMCFILE, key in 2 and enter the numbers of the SMCs to be processed on the lines provided. Then, press XMIT to redisplay the SMC processing options menu. Key in 8 (or 7 if you're running the program from the system console), press XMIT, and proceed to step e.
- To exclude the installation of certain SMCs in the SMCFILE, key in 3 and enter the numbers of the SMCs to be excluded. Then, press XMIT to redisplay the SMC processing options menu. Key in 8 (or 7 if you're running the program from the system console), press XMIT, and proceed to step e.

- To back out bad SMCs, key in 4 and enter the numbers of the SMCs to be backed out. Then, press XMIT to redisplay the processing options menu. Key in 8 (or 7 if you're running the program from the system console), press XMIT, and proceed to step e.
- e. After you install an SMC or perform additional tasks, the SMC program displays messages to tell you:
- Whether the SMC was installed successfully
 - That the SMC job is issuing a command to execute SMCLIST
 - That the SMC job terminated normally

The SMC job leaves job slot 1 and SMCLIST takes its place. SMCLIST then provides a condensed printout of the contents of `Y$SMCLOG`, which is a record of all the SMCs installed in the system. If you specify the `FMT=F` option on the SMC execution command, a full listing is printed. This listing provides such additional information as whether an SMC was required or optional. When SMCLIST successfully prints this list, a message informs you that SMCLIST terminated normally. The SMC installation process is now complete.

5.5. Sample SMC Printouts

Figures 5-10 and 5-11 show sample printouts of SMCs in the correct change format. The SMC sample shown in Figure 5-10 results from input entered via the console using the SMC console dialog. The SMC sample shown in Figure 5-11 results from input entered via a workstation using the Interactive SMC Entry screens. The shaded areas in both samples identify those fields that you were asked to fill in (provide input for) either by queries from the console dialog or by the blank fields in the interactive screens.

System Maintenance

```

// JOB C120357,,7000,14000                                X
// DVC 20 // LFD PRNTR // OPTION SMC
// NOP *****
// NOP 'CORRECTION IS FOR A710-DUMP FACILITY SYSDUMP-JOBDUMP      |
// NOP 'IT WAS SUBMITTED ON 072988 AND IS REQUIRED 081088          |
// NOP 'IT APPLIES TO RELEASE 1200C1 THRU 129999                  |
// NOP 'IT IS TESTED AND IS NOT FIELD VERIFIED 6210-00          |
// NOP 'THE SUR ORIGINATED IN TEST                                |
// NOP 'CORRECTION HAS BEEN APPLIED TO RELEASE 12.0-S2.4         |
// NOP 'IT IS INCLUDED IN                                        |
// NOP 'COMPONENT SOURCE IS CORRECTED IN RELEASE 13.0.0         |
// NOP 'CONTINGENCY: SYSTEM=C, REGEN=NNNNNNNN                    |
// NOP '                                                           |
// NOP 'FIXES PLES: 14005382, 14005579                           |
// NOP 'REQUIRES COR: 0175                                        |
// NOP 'REPLACES COR: XXXX,XXXX,XXXX,XXXX,XXXX                  |
// NOP 'IS REQUIRED BY CORS: XXXX,XXXX,XXXX,XXXX,XXXX            |
// NOP 'IS REPLACED BY CORS: XXXX,XXXX,XXXX,XXXX,XXXX            |
// NOP 'CORRECTION REQUIRES WITH VSN MODULES=N                   |
// NOP '(FILEID= )                                               |
// NOP 'CORRECTION DESCRIPTION:                                   |
// NOP 'SYSDUMPO OPTION RESTORE RESULTS                           |
// NOP 'IN ERROR CODE DM56 WHEN TAPE                             |
// NOP 'IS USED                                                  |
// NOP 'ECN=C111335                                              |
// NOP 'MODULES CORRECTED:                                       |
// NOP 'SYSDMP00                                                 |
// NOP 'CORRECTION CARD COUNT: 048                               |
// NOP *****
// DVC 20 // LFD PRNTR
// EXEC LIBS
/$
FIL D1=$$LOD
BOG C$$SYSTEM,D1
COR D1,L,SYSDMP,,0/0
-860E,04,9104BB88
-8612,04,47E0C1C8
-8616,04,D719801E801E
-861C,04,9101BB88
-8620,04,47E0C19C
-8624,04,0700070007000700
EOD
EOG C$$SYSTEM,D1
/*
/&
// FIN

```

Figure 5-10. Sample SMC - Required Fields for SMC Console Dialog

```

// JOB C120357,,7000,14000
// DVC 20 // LFD PRNTR // OPTION SMC
// NOP *****
// NOP 'CORRECTION IS FOR A710-DUMP FACILITY SYSDUMP-JOBDUMP
// NOP 'IT WAS SUBMITTED ON 072988 AND IS REQUIRED 081088
// NOP 'IT APPLIES TO RELEASE 1200C1 THRU 129999
// NOP 'IT IS TESTED AND IS NOT FIELD VERIFIED 6210-00
// NOP 'THE SUR ORIGINATED IN TEST
// NOP 'CORRECTION HAS BEEN APPLIED TO RELEASE 12.0.S2.4
// NOP 'IT IS INCLUDED IN
// NOP 'COMPONENT SOURCE IS CORRECTED IN RELEASE 13.0.0
// NOP 'CONTINGENCY: SYSTEM=C, REGEN=NNNNNNNN
// NOP '
// NOP FIXES PLES: 14005382, 14005579
// NOP REQUIRES COR: 0175
// NOP REPLACES COR: XXXX,XXXX,XXXX,XXXX,XXXX
// NOP IS REQUIRED BY CORS: XXXX,XXXX,XXXX,XXXX,XXXX
// NOP IS REPLACED BY CORS: XXXX,XXXX,XXXX,XXXX,XXXX
// NOP CORRECTION REQUIRES WITH VSN MODULES=N
// NOP (FILEID= )
// NOP CORRECTION DESCRIPTION:
// NOP 'SYSDUMPO OPTION RESTORE RESULTS
// NOP 'IN ERROR CODE DM56 WHEN TAPE
// NOP 'IS USED
// NOP ECN=C111335
// NOP MODULES CORRECTED:
// NOP SYSDMP00
// NOP CORRECTION CARD COUNT: 048
// NOP *****
// DVC 20 // LFD PRNTR
// EXEC LIBS
/$
FIL D1=$Y$LOD
EOG C$SYSTEM,D1
COR D1,L,SYSDMP,,0/0 The actual SMC change lines
-860E,04,9104BB88
-8612,04,47E0C1C8
-8616,04,D719801E801E
-861C,04,9101BB88
-8620,04,47E0C19C
-8624,04,0700070007000700
EOD
EOG C$SYSTEM,D1
/*
/&
// FIN

```

Figure 5-11. Sample SMC - Required Fields for Interactive SMC Entry from Workstation



Appendix

Performance Tuning

Your system should be tuned to allow operating system software to have necessary control and resources to process online, interactive, and batch jobs at maximum efficiency. Tuning is accomplished by adjusting functional priority levels, memory management operations, and other critical SUPGEN parameters to optimal values. This appendix defines recommended SUPGEN parameter settings that should provide close to optimal performance in *most* operating environments. These settings have been verified using the System Activity Monitor (SAM) under varied user applications and environments.

In addition to the settings defined below, the supervisor must be generated with the SAM=Y parameter.

A.1. SUPGEN Priority Values

SUPGEN priority parameters can be set to the following values:

Note: Highest priority is 0 and lowest priority is 60

```
SYMBIONT=PD,0
SYMBIONT=PR,0
SYMBIONT=PU,0
SYMBIONT=RP,0
SYMBIONT=SU,7
SYMBIONT=TU,7
SYMBPRI=5
ISINTPRI=6 (must have a priority lower than SYMBPRI)
EXECPRI=15
PRIORITY=20
```

User job priority is defined by the EXECPRI parameter if a priority level is not defined by a job control statement or the SWITCH command. Note that all user jobs should run at priority levels lower than 6 (i.e., 7 thru 60). The following user job priority guidelines should be followed:

- High CPU usage jobs should be run at priorities 16 through 20.
- Low CPU usage jobs should be run at priorities 10 through 14.

- The highest allowable priority for a high CPU usage job is 9.
- The highest allowable priority for a low CPU usage job is 7.
- The normal priority for most user jobs should be 15.
- Priorities 1, 2, 3, and 4 are reserved for TPS, IMS, and GUST jobs.
- Priority 8 is reserved for DBMS jobs.

A.2. SUPGEN Memory Management Values

SUPGEN memory management parameters can be set to the following values:

```
EXPREGION=12288
RESBUFSIZE=500
IMVJOB=YES
MEMCON=YES
ROLLOUT=YES
TRNWKAREA=64
```

A.3. SUPGEN Data Management Values

The SUPGEN DMRECV parameters should normally be set for indexed data files only (DMRECV=INDEX). See the *Consolidated Data Management Programming Guide*, UP-9978 for details in the recovery option.

A.4. SUPGEN Spooling Values

SUPGEN spooling parameters can be set to the following values:

```
SPOOLBUFR=4
SPOOLLOWBUFR=32
SPOOLVSN=vsn of a disk other than SYSRES (should be least
used disk in system)
```

A.5. SUPGEN Resident Shared Load Module Values

Specify the following resident shared load modules with the SUPGEN RESHARE parameter:

```
RESHARE=DM$CFM,DM$W111,D3$M111,PR$IOE
```

In addition, if the OS/3 general editor and screen format services are used heavily, add:

```
RESHARE=EDT,ISF,SF
```

If the ESCORT compiler is used, add:

```
RESHARE=ESC
```

You can use the MI SC and MI MM commands to determine additional modules that should be specified (see the *Operations Guide*, UP-8859 for information on these commands). Enter these commands every 10 to 15 minutes while your system is running at peak work loads, with heavy online applications , or with heavy batch processing. At the completion of the processing period, breakpoint the console log and then examine the printout to determine modules that are continually being loaded into dynamic memory. Include these modules in the SUPGEN RESHARE parameter statement.

A.6. SUPGEN Resident Module Values

Specify the following resident modules with the SUPGEN RESMOD parameter:

```
RESMOD=SM$ASKE,SM$ATCH,SM$LOCK  
RESMOD=SM$STXIT,SM$TASK
```

A.7. I/OGEN Considerations

Define I/O devices in the following order:

1. All disk units
2. All tape units
3. All laser printers
4. All line printers
5. Local terminals and printers
6. Remote terminals and printers

Within each of the six categories, define units in the order of their usage. For instance, define the most commonly used disk (typically SYSRES) first and the least commonly used disk last within the first category.

A.8. Determining Disk Cache Size

The optimum size of disk cache can only be determined after the preceding SUPGEN tuning has been performed. The amount of main memory used for disk cache depends on the available free memory in the system. Use a disk cache size that allows a minimum of 100K bytes of available free memory after all interactive and batch jobs are loaded and running. To determine the amount of free memory available, use the MI MM command (see the *Operations Guide*, UP-8859, for information on this command).

The optimum disk cache size is that which provides the highest search and read hit rates while the system is running with heavy random disk activity. The optimum size can be determined as follows:

1. Specify a disk cache size. This can be done following system IPL or with the CM SIZ command (see the *Operations Guide*, UP-8859, for more information on this command).
2. Initiate system activity with heavy random disk activity.
3. While the system is running, enter the CM STA command (see the *Operations Guide*, UP-8859) to determine the current read and search hit rates. Record the current cache size and the two hit rates.
4. Repeat steps 1 through 3 using a wide range of cache sizes. The optimum cache size is the one where the highest hit rates were found.

Index

A

- ACCTNO, SUPGEN subparameter 4-30
- ADDR, I/OGEN DISC parameter
 - Models 3-6 4-40
 - Models 8-20 4-52
- ADDR, I/OGEN DISKETTE parameter
 - Models 3-6 4-41
 - Models 8-20 4-54
- ADDR, I/OGEN PRINTER parameter
 - Models 3-6 4-36, 4-37
 - Models 8-20 4-47, 4-48
- ADDR, I/OGEN PUNCH parameter
 - Models 3-6 4-39
 - Models 8-20 4-51
- ADDR, I/OGEN READER parameter
 - Models 3-6 4-38
 - Models 8-20 4-49
- ADDR, I/OGEN TAPE parameter
 - Models 3-6 4-41
 - Models 8-20 4-55
- ADDR, I/OGEN WORKSTATION parameter
 - Models 3-6 4-42
 - Models 8-20 4-57
- alternate methods to SYSGEN parameter sets 4-1
- alternate printer characteristics 2-1, 3-2, 3-32
- ALTCON, I/OGEN WORKSTATION parameter Models 8-20 4-58
- ALTJCS, SUPGEN parameter 4-11
- ALTSTACK, I/OGEN READER parameter
 - Models 8-20 4-50
- AMOUNT, I/OGEN REMPRINTER parameter
 - Models 3-6 4-45
 - Models 8-20 4-60
- AMOUNT, I/OGEN REMWORKSTATION parameter
 - Models 3-6 4-45
 - Models 8-20 4-59
- ANSI'74 COBOL elements
 - COBGEN phase 3-20
 - description 3-11
 - running SYSGEN job control streams 3-31
- ATTNRE, I/OGEN PRINTER parameter
 - Models 3-6 4-36
 - Models 8-20 4-48
- ATTNRE, I/OGEN PUNCH parameter
 - Models 3-6 4-39
 - Models 8-20 4-51
- ATTNRE, I/OGEN READER parameter
 - Models 3-6 4-38
 - Models 8-20 4-50
- auditing options, SYSGEN dialog
 - CANCEL 3-26, 3-27
 - DELETE 3-26
 - EDIT 3-25, 3-27
 - ENDSESSION 3-25, 3-26
 - INSERT 3-26
 - PROCEED 3-25, 3-28
 - REEDIT 3-27
- AUTOLOAD, I/OGEN DISKETTE parameter
 - Models 3-6 4-41
 - Models 8-20 4-54
- automatic execution of parameter processor 3-22
- AUX, I/OGEN AUXPRINTER parameter
 - Models 3-6 4-44
 - Models 8-20 4-59
- AXNON, COBGEN parameter 4-71
- AXREF, COBGEN parameter 4-71

B

backing out SMCs 5-2
 backup devices
 diskettes 3-39
 8417 disk 3-39
 8419 disk 3-39
 tape 3-39
 BLKSIZE, NTRGEN LOCAL parameter
 4-69
 BLOCKIN, NTRGEN NTR parameter 4-67
 BLOCKOUT, NTRGEN NTR parameter
 4-68
 BPOOLEXP, COMMCT parameter 4-66
 building backup SYSRES 3-38
 BULLETIN module 3-37
 bulletin, system
 changing 3-37

C

CACH, COMMCT parameter 4-61
 CACH parameter, identifies SLCA 4-4
 CACHE, I/OGEN DISC parameter
 Models 3-6 4-40
 Models 8-20 4-52
 CACHESEGSIZE, SUPGEN parameter 4-11
 CALLST, COBGEN parameter 4-71
 CANCEL auditing option 3-26, 3-27
 CARTNAME, SUPGEN Subparameter 4-30
 CCA macroinstruction, start network
 definition 4-3
 CCAMOD, COMMCT parameter 4-61
 CCAMOD parameter, specifying source
 module 4-3
 CHAN, I/OGEN DISC parameter
 Models 3-6 4-40
 Models 8-20 4-52
 CHAN, I/OGEN DISKETTE parameter
 Models 3-6 4-41
 Models 8-20 4-54
 CHAN, I/OGEN PRINTER parameter
 Models 3-6 4-36
 Models 8-20 4-46
 CHAN, I/OGEN PUNCH parameter
 Models 3-6 4-39
 Models 8-20 4-50

CHAN, I/OGEN READER parameter
 Models 3-6 4-38
 Models 8-20 4-49
 CHAN, I/OGEN TAPE parameter
 Models 3-6 4-41
 Models 8-20 4-55
 CHAN, I/OGEN WORKSTATION parameter
 Models 3-6 4-42
 Models 8-20 4-57
 CHAN, SUPGEN parameter 4-20
 CHAN1, SUPGEN parameter 4-20
 changing system bulletin 3-37
 character mismatch 3-33
 CHARSET, I/OGEN PRINTER parameter
 Models 3-6 4-36
 Models 8-20 4-47
 CLASS, I/OGEN PRINTER parameter
 Models 3-6 4-36
 Models 8-20 4-47
 CMCSST, COBGEN parameter 4-71
 COADDR, I/OGEN DISC parameter
 Models 8-20 4-53
 COADDR, I/OGEN TAPE parameter
 Models 8-20 4-56
 COBGEN phase
 ANSI'74 COBOL element 3-20
 formats 4-5, 4-71
 preparing SYSGEN parameter sets 3-16
 specifying without SYSGEN dialog 4-5
 COBOL compiler, configured using SYSGEN
 1-2
 COBOL elements. See ANSI '74 COBOL
 elements.
 COCHAN, I/OGEN DISC parameter
 Models 8-20 4-53
 COCHAN, I/OGEN TAPE parameter
 Models 8-20 4-56
 COMM, SUPGEN parameter 4-21
 COMMCT phase
 format 4-61
 preparing SYSGEN parameter sets 3-16
 specifying without SYSGEN dialog 4-3
 COMM1, SUPGEN parameter 4-27
 communications control area (CCA),
 ICAM communications elements 3-11
 communications (ICAM) elements 3-11
 COMPRESS, NTRGEN LOCAL parameter
 4-69
 CONALARM, SUPGEN parameter 4-12

CONPRINT, SUPGEN parameter 4-26
 console alarm 4-12
 console mode, manual execution of
 parameter processor 3-28
 CONSOLOG, SUPGEN parameter 4-26
 control element generations for optional
 software, Table 3-1 3-3

COPY command 3-37

COPYREL

copy order, software installation,
 Table 2-2 2-21
 copy order, system installation, Table 3-1
 3-3
 copy system files to SYSRES 2-20
 copy system files to backup SYSRES 3-38
 installing release software from
 dump/restore tape 2-22, 2-33

CPU microcode 2-37

CPYTXT, COBGEN parameter 4-71

D

DAYCHANGE, SUPGEN
 parameter 4-12

DBUS microcode 2-37

DCOP job stream, backup SYSRES 3-51

DPCCHNL, SUPGEN parameter 4-21

DDP spooling 4-25

DDPSC, SUPGEN parameter 4-22

DDPSPOOL, SUPGEN parameters 4-26

default bulletin, changing system bulletin
 3-37

defining alternate printer characteristics
 3-32

DELETE auditing option 3-26

DENSITY, I/OGEN TAPE parameter

Models 3-6 4-42

Models 8-20 4-56

DESPACE, I/OGEN WORKSTATION

parameter Models 3-6 4-43

Models 8-20 4-57

device function codes 4-82

Table 4-8 4-83

DEVICE, NTRGEN LOCAL parameter 4-69

DEVICE, SUPGEN subparameter 4-30

DIAG, COBGEN parameter 4-71

DIAGWN, COBGEN parameter 4-71

DLOADBUFR, SUPGEN parameter 4-6

DLOADTABLE, SUPGEN parameter 4-6

DMGTMODE, SUPGEN parameter 4-12

DMRECV, SUPGEN parameter 4-12

DUALTRAN, I/OGEN READER parameter
 Models 8-20 4-50

dump-restore

diskettes, backup media 3-39

tape 1-5

DUMPVSN, SUPGEN parameter 4-13

DVCNO, I/OGEN DISC parameter

Models 3-6 4-40

Models 8-20 4-52

DVCNO, I/OGEN DISKETTE parameter

Models 3-6 4-41

Models 8-20 4-54

DVCNO, I/OGEN PRINTER parameter

Models 3-6 4-36

Models 8-20 4-47

DVCNO, I/OGEN PUNCH parameter

Models 3-6 4-39

Models 8-20 4-51

DVCNO, I/OGEN READER parameter

Models 3-6 4-38

Models 8-20 4-49

DVCNO, I/OGEN TAPE parameter

Models 3-6 4-41

Models 8-20 4-55

DVCNO, I/OGEN WORKSTATION

parameter

Models 3-6 4-43

Models 8-20 4-57

DVCNO keyword parameter, logical unit

number change 4-76, Table 4-3 4-76

E

EDIT auditing option 3-25, 3-27

ENDCCA macroinstruction, network
 definition 4-3

ENDESSION auditing option 3-25, 3-26

EOF, I/OGEN READER parameter,

Models 8-20 4-50

ERRLOGBUF, SUPGEN parameter, 4-6

EXECPRI, SUPGEN parameter 4-6

exception SMCs, installing 5-14

EXPBFCTSZ, SUPGEN Parameter 4-7

EXPREGION, SUPGEN parameter 4-7

F

FASTLOAD, COMMCT parameter 4-66
 FEED, I/OGEN READER parameter
 Models 3-6 4-38
 Models 8-20 4-39
 FILE, SUPGEN subparameter 4-30
 FILELOCK, SUPGEN parameter 4-13
 FIPS, COBGEN parameter 4-71
 FIXHEAD, I/OGEN DISC parameter
 Models 3-6 4-40
 FLOATPT, SUPGEN parameter 4-21
 FORM, SUPGEN subparameter 4-30
 format label, missing from VTOC 3-49
 FUNCDC, NTRGEN LOCAL parameter 4-69

G

general editor
 alternate printer characteristics 3-33
 changing system bulletin 3-37
 modify parameter sets 3-22
 SYSGEN parameter sets 3-29
 generating control elements 1-2, 3-1
 generating IMS online load module 3-32
 group-name 4-16

H

HELP screen
 preparing SYSGEN parameter sets 3-18
 SYSGEN dialog 1-9

I

ICAM element
 COMMCT phase 3-19
 stored on SYSRES volume 3-31
 updating symbiont table 3-52
 IC\$BLD 1-12, 3-18
 IC\$INPUT 3-21, 4-1
 IDCU microcode diskette, creating 2-57
 IGNORESFT, SUPGEN parameter 4-14
 IMPLDSKT 2-55, 2-57
 IMSCOD, COBGEN parameter 4-71
 IMVJOB, SUPGEN parameter 4-14
 IN, COBGEN parameter 4-72

indexed data files 4-13
 information management system (IMS) 3-11
 initial microprogram load (IMPL)
 code diskette 1-4, 2-8, 2-25, 2-56
 creating IMPL diskette 2-55
 inserting via PRPMIC 2-22, 2-23
 initial program load (IPL) 1-4
 diskette 2-25, 2-8, 3-45
 inserting via PRPMIC 2-22, 2-23
 procedure 2-8, 2-25, 2-50
 INSERT
 auditing option 3-26
 statement 3-42
 installation procedures. See software
 installation.
 installation program
 SMC 5-11, 5-12
 SMP 5-2, 5-6
 installing a new release of OS/3
 description 2-4
 illustration, Fig. 2-5 2-6
 installing optional OS/3 components 2-3
 installing optional release software from
 diskette 2-14, 2-32
 installing release software from disk 2-16,
 2-33
 installing release software from
 dump/restore tape 2-22, 2-33
 installing standard release software from
 diskettes 2-7, 2-25
 INTMEM, SUPGEN parameter 4-34
 IOMP microcode 2-56
 I/OGEN phase
 format 4-36, 4-40
 generating supervisor control element
 3-19
 9-track recording mode settings 4-78
 Table 4-4 4-78
 7-track recording mode settings 4-78
 Table 4-5 4-79
 specifying without SYSGEN dialog 4-2
 I/OMOD, I/OGEN parameter
 Models 3-6 4-36
 Models 8-20 4-46
 I/OMOD keyword parameter, I/OGEN
 procedure 4-2
 IORB, SUPGEN parameter 4-20
 IORB1, SUPGEN parameter 4-20
 ISADMID, SUPGEN parameter 4-22
 ISBATCHLMT, SUPGEN parameter 4-23

ISINTLMT, SUPGEN parameter 4-23
 ISINTPRI, SUPGEN parameter 4-23
 ISLOGONSC, SUPGEN parameter 4-23
 ISNETNAME, SUPGEN parameter 4-23
 ISWKSMBUL, SUPGEN parameter 4-24
 ISWKSLOG, SUPGEN parameter 4-24
 ISWORK, SUPGEN parameter 4-24
 ITCU Microcode 2-28

J

JCREADWKS, SUPGEN parameter 4-15
 job control streams, SYSGEN 1-12
 JOB, SUPGEN subparameter 4-30
 JOBACCT, SUPGEN parameter 4-27
 JOBMEM, SUPGEN parameter 4-34
 JOBQUEREC, SUPGEN parameter 4-15
 JOBSLOTS, SUPGEN parameter 4-8

K

KATACON, I/OGEN parameter
 Models 3-6 4-45
 Models 8-20 4-60
 KATAKANA, I/OGEN REMWORKSTATION
 parameter
 Models 3-6 4-45
 Models 8-20 4-59
 KATAKANA, I/OGEN WORKSTATION
 parameter
 Models 3-6 4-43
 Models 8-20 4-58

L

LCB (load code buffers) 3-33
 LCB, I/OGEN PRINTER parameter
 Models 3-6 4-37
 Models 8-20 4-48
 LFD, NTRGEN LOCAL parameter 4-70
 librarians, system 2-4
 LIN, COBGEN parameter 4-72
 LINE, NTRGEN NTR parameter 4-68
 line speed values 4-80
 Table 4-6 4-80
 LINESP, NTRGEN NTR parameter 4-68
 LIST, COBGEN parameter 4-72

LNKCON, COBGEN parameter 4-72
 LOCAL parameters
 keywords 4-69
 NTR element 3-10
 NTRGEN parameter 4-5
 logging on to workstation 3-16
 logical unit numbers 4-76
 Table 4-3 4-76
 LOGON request screen, OS/3 3-16
 LOOP, I/OGEN AUXPRINTER parameter
 Models 3-6 4-44
 Models 8-20 4-59
 LSTREF, COBGEN parameter 4-72
 LSTWTH, COBGEN parameter 4-72

M

making and restoring backup copy of current
 SYSRES 3-38
 manual execution of parameter processor
 3-28
 MAP, COBGEN parameter 4-72
 MAXJOBS, SUPGEN parameter 4-34
 MAXRUNSYMBS, SUPGEN parameter 4-34
 MAXSWSJOBS, SUPGEN parameter 4-35
 MAXTIME, SUPGEN parameter 4-15
 MAXTYPE, SUPGEN parameter 4-15
 MAXWSJOBS, SUPGEN parameter 4-35
 MCP, COMMCT parameter 4-61
 MCPNAME, COMMCT parameter 4-61
 MCPVOL, COMMCT parameter 4-61
 MEMCON, SUPGEN parameter 4-15
 message control program (MCP)
 communications elements 3-11
 defining COMMCT section 4-3
 MIRAMCHAR, SUPGEN parameter 4-15
 microcode, adding microcode names to
 DBUS 2-37
 IOMP 2-56
 ITCU 2-28
 \$Y\$SDF 2-33, 3-30
 mod-name 4-11
 MODE, I/OGEN READER parameter
 Models 8-20 4-50
 MODE, I/OGEN TAPE parameter
 Models 3-6 4-42
 Models 8-20 4-55
 MXNON, COBGEN parameter 4-72
 MXREF, COBGEN parameter 4-72

N

NET, NTRGEN NTR parameter 4-68
network definition parameters
 communications elements 3-11
 defining COMMCT section 4-3
nine thousand remote (NTR) element
 description 3-10
 format 4-67
 NTRGEN phase 4-4
 stored on SYSRES 3-31, 4-5
NPRTSP, NTRGEN NTR parameter 4-69
NTRGEN phase
 format 4-67
 preparing SYSGEN parameter sets 3-18
 specifying without SYSGEN dialog 4-4
NTRMOD keyword
 NTRGEN phase 4-4,
 space compression characters 4-72
NTRMOD, NTRGEN NTR parameter 4-67
NTRNAME, NTRGEN NTR parameter 4-67
NTRVOL, NTRGEN NTR parameter 4-67

O

OBJ, COBGEN parameter 4-72
OBJLST, COBGEN parameter 4-72
OBJMOD, COBGEN parameter 4-73
optional software installation procedure,
 new component 2-3, 2-14, 2-32
OS/3 optional release software 2-3, 2-14,
 2-32

P

PAGOVF, COBGEN parameter 4-73
parameter processor
 automatic execution 3-22
 manual execution 3-28
 output listing 3-21, 3-29
 saved modules 3-2
 SYSGEN 1-11
parameter sets, SYSGEN
 listing 3-2
 running job control streams 3-30
PASSWORD, SUPGEN parameter 4-24
password, user 4-24

performing system generation, system
 control elements 2-57
post-software installation procedures 2-36
post-SYSGEN procedures 3-32
PRI, SUPGEN subparameter 4-30
printer characteristics 2-1, 3-1, 3-32
printer formats, vertical 3-32
PRINTPOS, I/OGEN PRINTER parameter
 Models 3-6 4-37
 Models 8-20 4-48
PRIORITY, SUPGEN parameter 4-8
priority, user-specified 4-6
PROCEED auditing option 3-25, 3-28
processing SYSGEN parameter sets 3-21
PROVER, COBGEN parameter 4-73
PRPMIC 2-22, 2-23, 2-34, 2-38, 2-49, 3-45,
 3-52
PRTSP, NTRGEN NTR parameter 4-69

R

READ, I/OGEN PUNCH parameter
 Models 3-6 4-39
 Models 8-20 4-51
RECOVERDS, SUPGEN parameter 4-16
REEDIT auditing option 3-27
recording mode settings
 9-track 4-78
 Table 4-4 4-78
 7-track 4-78
 Table 4-5 4-79
recovery option for data management 4-1
release level, installing new optional
 component 2-3
remote device handler, LOCAL parameters
 3-10
REMOTE, I/OGEN PRINTER parameter
 Models 3-6 4-37
 Models 8-20 4-47
RESBFCTSZ, SUPGEN parameter 4-8
RESBUFSIZE, SUPGEN parameter 4-9
RESHARE, SUPGEN parameter 4-16
RESMGT, SUPGEN parameter 4-34
RESMOD, SUPGEN parameter 4-16
resource management 3-12, 4-34
restart ability, SU@RST control stream 2-8,
 2-13, 2-27, 2-31
restoring backup system files from diskettes
 3-39

- restoring modules saved from a previous release 2-4, 3-1
 - restoring SYSRES from diskettes 3-39
 - retaining existing software 2-4, 3-1
 - RETAINLOG, SUPGEN parameter 4-27
 - ROLLOUT, SUPGEN parameter 4-18
 - RUN library 3-18
 - RUNVSN, SUPGEN parameter 4-18
- S**
- S parameter, source module name 3-29
 - SAM, SUPGEN parameter 4-19
 - SCDINDEX, SUPGEN parameter 4-19
 - SCRENMEM, I/OGEN
 - REMWORKSTATION parameter
 - Models 3-6 4-45
 - Models 8-20 4-59
 - SCRENMEM, I/OGEN WORKSTATION
 - parameter
 - Models 3-6 4-43
 - Models 8-20 4-57
 - SDU (system definition utility)
 - adding a device 2-43
 - deleting a device 2-45
 - description 2-37
 - updating device info 2-46
 - SELACC, I/OGEN DISC parameter
 - Models 8-20 4-53
 - SETREL
 - prepping 8417 disk to serve as SYSRES 2-18
 - prepping 8419 disk to serve as backup SYSRES 3-33
 - SG\$BLD job control stream 1-11
 - SG\$COBMK job control stream 1-11
 - SG\$COMMCK job control stream 1-11
 - SG@DMFIL routine, dump user files to diskettes 3-46
 - SG\$DMPTD job control stream 2-23, 2-33
 - SG@DSFIL, building backup SYSRES 3-46
 - SG@DUFIL job stream
 - building backup SYSRES 3-46
 - installing new OS/3 release 2-4
 - SG\$INPUT module, storing parameter sets 3-21
 - SG@MVPD, mount message 2-15, 2-32
 - SG\$NTRMK job control stream
 - NTR system utility module 1-11
 - NTRGEN phase 4-5
 - SG\$PARAM job control stream 1-11
 - SG\$PRB job control stream 1-11, 3-32
 - SG@RUFIL job stream
 - restoring modules saved from a previous release 2-57
 - restoring SYSRES 3-48
 - SG\$SUPMK job control stream 1-11
 - SGTRAN job control stream 3-52
 - SHARED MGT, SUPGEN parameter 4-10
 - shared load module groups 4-75
 - Table 4-2 4-75
 - single line communications adapter (SLCA), COMMCT procedure 4-3
 - SITE, NTRGEN NTR parameter 4-68
 - SMC
 - backing out 5-2
 - definition 1-2, 5-1
 - entry screens, Fig. 5-7 5-23, Fig. 5-8 5-24
 - installation program 5-2, 5-12
 - SMC release media, change on cards, by phone, by mail 5-11
 - SMCFILE 5-4
 - SMCLIST 5-5
 - SMP
 - definition 1-2
 - installation program 5-2
 - SM\$ASCCK 4-17
 - SM\$ATCH 4-17
 - SM\$DBS 4-17
 - SM\$GTPUT 4-17
 - SM\$LOCK 4-17
 - SM\$STXIT 4-18
 - SM\$TASK 4-18
 - Software installation
 - considerations 2-1
 - defined 1-1
 - delivered 1-3
 - existing users 2-3
 - facilities 1-5
 - initial users 2-2, Fig. 2-1
 - Models 3-6 2-7
 - Models 8-20 2-25
 - optional 1-6
 - post installation procedures 1-10, 2-36
 - stand-alone routines 1-6

- software release
 - optional 1-3
 - standard 1-3
 - tape 1-7
- space compression characters 4-81
 - Table 4-7 4-81
- SPOOLBUFR, SUPGEN parameter 4-27
- SPOOLBURST, SUPGEN parameter 4-27
- SPOOLCOMP, SUPGEN parameter 4-27
- SPOOLCYL, SUPGEN parameter 4-28
- SPOOLFARSI, SUPGEN parameter 4-28
- spool-file bit map calculation table 4-74,
Table 4-1 4-75
- SPOOLHDR, SUPGEN parameter 4-29
- SPOOLICAM, SUPGEN parameter 4-29
- SPOOLING, SUPGEN parameter 4-25
- SPOOLMAP, SUPGEN parameter 4-29
- SPOOLMAXLINE, SUPGEN parameter
4-29
- SPOOLMODE, SUPGEN parameter 4-30
- SPOOLNOINPUT, SUPGEN parameter
4-31
- SPOOLWBUFR, SUPGEN parameter 4-32
- SPOOLPRT, SUPGEN parameter 4-32
- SPOOLRECV, SUPGEN parameter 4-32
- SPOOLTEST, SUPGEN parameter 4-33
- SPOOLUPDATE, SUPGEN parameter 4-33
- SPOOLVSN, SUPGEN parameter 4-33
- SPRLST, COBGEN parameter 4-73
- SPROUT, COBGEN parameter 4-73
- stand-alone installation, diskette 1-5
- stand-alone loading option, restoring
SYSRES 3-46
- stand-alone prep routine
 - preparing nonremovable disk 1-6
 - SU@PRP 2-11, 2-25
- stand-alone restore program copying
 - standard control software 1-5
 - SU@RST 2-8, 2-27, 2-31
- statement conventions iv
- SUBCK, COBGEN parameter 4-73
- supervisor
 - customized 1-2
 - elements 3-2
 - minimum, SY@BAS 3-7
 - minimum, SY#BAS 3-8
 - minimum, SY\$BAS 3-9
 - starter 3-6
 - stored on SYSRES volume 3-30
- SUPGEN phase
 - format 4-2
 - generating a supervisor control element
3-18
 - specifying without SYSGEN dialog 4-2
- SUPMOD, SUPGEN parameter 4-2, 4-6
- SUPVRNAM, SUPGEN parameter 4-6
- SU@PRP prep routine
 - before running SU@RST 2-11, 2-25
 - preparing nonremovable disks 1-6
- SU@RST 1-6, 2-8, 2-26, 3-48
- SY@BAS
 - description 1-2
 - preparing SYSGEN parameter sets 3-16
 - starter supervisors 3-6
 - supervisor features 3-7
- SY#BAS
 - description 1-2
 - preparing SYSGEN parameter sets 3-16
 - starter supervisors 3-7
 - supervisor features 3-8
- SY\$BAS
 - description 1-2
 - preparing SYSGEN parameter sets 3-16
 - starter supervisors 3-6
 - supervisor features 3-9
- SYMBIONT, SUPGEN parameter 4-10
- SYMBMEM, SUPGEN parameter 4-35
- SYMBPRI, SUPGEN parameter 4-10
- SYNCHK, COBGEN parameter 4-73
- SYSGEN See system generation.
- SYSGEN dialog
 - alternate methods 4-1
 - auditing options 3-23
 - description 1-9
 - help screen 1-9
 - job control stream 1-12
 - parameter processor 1-11
 - preparing parameter sets 3-16
 - system installation 1-13
- SYSGEN dialog capability
 - audit file 1-7
 - using procedure for audit 3-23
- SYSGEN job control streams
 - defined 1-12
 - running procedure 3-30
 - system installation 1-13

- SYSGEN parameter processor
 - defined 1-11
 - functions 1-11
 - system installation 1-13
 - values 3-22
 - SYSGEN parameters, changing 3-22
 - SYSLOG, SUPGEN parameter 4-33
 - SYSRES
 - building backup 3-39
 - description 1-2
 - system activity monitor 4-19
 - system bulletin, changing 3-37
 - SYSTEMDATE, SUPGEN parameter 4-19
 - system definition file (\$Y\$SDF)
 - adding a device 2-43
 - confirming 2-48
 - copying and restoring 2-54
 - deleting a device 2-46
 - dumping 2-48
 - guidelines 2-38
 - restoring 2-49
 - reviewing 2-41
 - updating 2-18, 2-36, 2-47
 - Fig. 2-8, 2-39
 - system definition utility (SDU)
 - add screen from IMPL devices
 - Fig. 2-14 2-44
 - add screen for Models 8-20
 - Fig. 2-12 2-43
 - add screen from non-IMPL devices
 - (Model 3-60) Fig. 2-13 2-44
 - add screen from non-IMPL devices
 - (Model 8-20) Fig. 2-12 2-43
 - display entry screen
 - Fig. 2-10 2-41
 - operation request screen
 - Fig. 2-9 2-41
 - terminating 2-49,
 - termination screens
 - Fig. 2-20 2-50
 - system generation
 - defined 1-2
 - dialog 1-9, 3-16
 - facilities 1-6
 - job control streams 1-12, 3-30
 - keyword parameters 4-6
 - parameter processor 1-11
 - parameter reference 4-1
 - parameter sets 3-1, 3-16
 - parameter values 3-22
 - system generation (cont.)
 - performing 1-6, 2-57
 - purpose 1-2
 - reference tables 4-74
 - running job control streams 3-30
 - system installation 1-13
 - types of elements 3-1
 - system installation
 - defined 1-1
 - flowchart Fig. 1-1 1-14
 - review 1-13
 - verifying 2-57
 - system librarians
 - changing system bulletin 3-37
 - LIBS and MLIB 2-4
 - system microcode file (\$Y\$MIC) 2-36, 2-40
 - system maintenance (SMC,SMP) 1-3, 5-1
 - system resident volume
 - defined 1-2
 - initial users 2-2
 - I/OGEN procedure 4-2
- T**
- TAPEBLKNO, SUPGEN parameter 4-19
 - tape mode settings,
 - 7-track 4-78
 - 9-track 4-78
 - TASK, NTRGEN NTR parameter 4-68
 - TASKNAME, NTRGEN LOCAL parameter 4-69
 - TRANS, NTRGEN LOCAL parameter 4-70
 - TRANS, SUPGEN parameter 4-11
 - transient work areas 4-11
 - TRANSLAT, I/OGEN TAPE parameter
 - Models 3-6 4-41
 - Models 8-20 4-55
 - TRNADR, COBGEN parameter 4-73
 - TRNWKAREA, SUPGEN parameter 4-16
 - TRUNC, COBGEN parameter 4-73
 - TYPE and TRANS keyword parameters
 - device function codes 4-82,
 - Table 4-8 4-83
 - TYPE, I/OGEN AUXPRINTER parameter
 - Models 3-6 4-44
 - Models 8-20 4-58
 - TYPE, I/OGEN DISC parameter
 - Models 3-6 4-39
 - Models 8-20 4-51

TYPE, I/OGEN DISKETTE parameter

Models 3-6 4-40

Models 8-20 4-54

TYPE, I/OGEN PRINTER parameter

Models 3-6 4-36

Models 8-20 4-46

TYPE, I/OGEN PUNCH parameter

Models 3-6 4-39

Models 8-20 4-50

TYPE, I/OGEN READER parameter

Models 3-6 4-38

Models 8-20 4-49

TYPE, I/OGEN TAPE parameter

Models 3-6 4-41

Models 8-20 4-54

TYPE, I/OGEN WORKSTATION parameter

Models 3-6 4-43

Models 8-20 4-57

TYPE, NTRGEN LOCAL parameter 4-70

U

UNATCONSOLE, SUPGEN parameter 4-20

updates to optional software 2-3

updating system definition file 2-10, 2-17,
2-24, 2-30, 2-36, 2-51, 3-30,

using another disk for the backup SYSRES
3-40

using diskettes for the backup SYSRES 3-45

V

VALIDITY, I/OGEN READER parameter

Models 8-20 4-50

verifying system installation procedure 2-57

VFB, I/OGEN AUXPRINTER parameter

Models 3-6 4-44

Models 8-20 4-59

VFB, I/OGEN PRINTER parameter

Models 3-6 4-37

Models 8-20 4-48

VFB DEN, NTRGEN LOCAL parameter 4-70

VFB FORM, NTRGEN LOCAL parameter
4-70

VFB LEN, NTRGEN LOCAL parameter 4-70

VFB HOME, NTRGEN LOCAL parameter
4-70

VIRTUAL, I/OGEN PRINTER parameter

Models 3-6 4-38

Models 8-20 4-49

VIRTUAL, I/OGEN PUNCH parameter

Models 3-6 4-39

Models 8-20 4-51

VIRTUAL, I/OGEN READER parameter

Models 3-6 4-38

Models 8-20 4-50

volume table of contents (VTOC),

automatic verification (VVAVR) 4-20

restoring SYSRES 3-50

VOLTABLE, SUPGEN parameter 4-20

VVAVR, SUPGEN parameter 4-20

W

workstation, logging on 3-16

workstation mode, preparing SYSGEN
parameter sets 3-16

Y

\$Y\$SMCLOG 5-4

\$Y\$MIC 2-36, 2-40

\$Y\$SDF

adding a device 2-43

confirming 2-48

copying and restoring 2-54

deleting a device 2-46

dumping 2-48

guidelines 2-38

restoring 2-49

reviewing 2-41

updating 2-18, 2-36, 2-47

Fig. 2-8, 2-39

\$Y\$TRANA 2-20

USER COMMENTS

We will use your comments to improve subsequent editions.

NOTE: Please do not use this form as an order blank.

(Document Title)

(Document No.)

(Revision No.)

(Update Level)

Comments:

From:

(Name of User)

(Business Address)



FOLD



NO POSTAGE
NECESSARY
IF MAILED IN THE
UNITED STATES

BUSINESS REPLY MAIL

FIRST CLASS PERMIT NO. 21 BLUE BELL, PA.

POSTAGE WILL BE PAID BY ADDRESSEE

Unisys Corporation
E/MSG Product Information Development
PO Box 500 — E5-114
Blue Bell, PA 19422-9990



FOLD



