

SECTION 4 HARDWARE ASSEMBLY

4.1 HOW TO USE THIS MANUAL

THE HARDWARE ASSEMBLY INSTRUCTIONS ARE DIVIDED INTO SUBSECTIONS. EACH SUBSECTION CONTAINS AN INTRODUCTION DESCRIBING THE GENERAL PROCEDURES TO BE FOLLOWED, AND THEN A DETAILED STEP-BY-STEP SET OF INSTRUCTIONS FOR EACH COMPONENT TO BE INSTALLED. THE STEP-BY-STEP INSTRUCTIONS PROVIDE A PLACE () FOR A CHECKMARK AFTER EACH STEP IS COMPLETED.

IF MULTIPLE COMPONENTS ARE TO BE INSTALLED REPEATING THE SAME INSTRUCTION, A PLACE IS PROVIDED FOR A CHECKMARK FOR EACH COMPONENT INSTALLATION STEP.

4.2 24- OR 40-PIN SOCKETS

EACH 24- OR 40-PIN SOCKET CONSISTS OF TWO SEPARATE 12- OR 20-PIN STRIPS. THE 24-PIN SOCKETS ARE ALWAYS INSTALLED HORIZONTALLY AT THE EXTREME RIGHT OR LEFT END OF A ROW. THAT IS, THESE SOCKETS ALWAYS OCCUPY COLUMN 1, 2, AND 3 OR 6, 7, AND 8 OF A ROW. A 40-PIN SOCKET IS ALWAYS INSTALLED AT THE EXTREME RIGHT END OF A ROW. THAT IS, THESE SOCKETS ALWAYS OCCUPY COLUMNS 4, 5, 6, 7, AND 8 OF A ROW. A WHITE DOT ON THE COMPONENT SIDE OF THE BOARD DENOTES PIN 1 OF A SOCKET. THE DIMPLE NEAR THE END OF THE SOCKET SHOULD ALWAYS BE POINTED TOWARD THE LEFT SIDE OF THE BOARD. WHEN THE TERMINALS ARE CORRECTLY ALIGNED WITH THE HOLES IN THE PRINTED CIRCUIT BOARD, GENTLY PUSH THE TERMINALS THROUGH THE HOLES UNTIL THE STRIP IS FLUSH AGAINST THE TOP OF THE BOARD.

HOLDING THE STRIPS, TURN THE BOARD OVER AND LAY IT DOWN ON THE WORK TABLE.

REFER TO SECTION 4.11 TO DETERMINE IF A GROUND CLIP IS TO BE INSTALLED ON A LEAD TO BE SOLDERED TO THE BOARD. IF SO, REFER TO THE INSTRUCTIONS IN 4.11 AND INSTALL THE GROUND CLIP TO THE PIN. THEN SOLDER THE GROUND CLIP TO THE GROUND PLANE AND THE PIN TO THE SOLDER PAD.

SOLDER THE PINS AT THE ENDS OF EACH STRIP TO THE SOLDER PAD AS SHOWN. DO NOT CUT THESE LEADS.

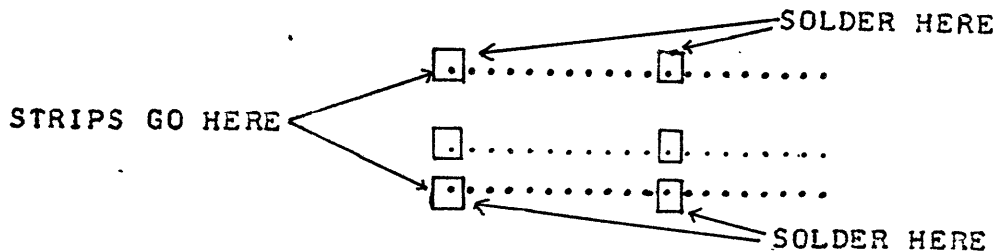

AFTER SOLDERING, CHECK FOR SOLDER BRIDGES AND FOR SOLDER ON THE TERMINALS OF THE STRIPS. SCRAPE OFF ANY SOLDER ON THESE STRIPS WITH A SCREWDRIVER OR AN EXACTO KNIFE.

24-PIN SOCKETS

- () INSTALL AND SOLDER TWO 12-PIN STRIPS AT (C1, 2, 3)
(NON-DIMPLED END CUT)
- () INSTALL AND SOLDER TWO 12-PIN STRIPS AT (D1, 2, 3)
(NON-DIMPLED END CUT)
- () INSTALL AND SOLDER TWO 12-PIN STRIPS AT (D6, 7, 8)
(DIMPLED END CUT)

40-PIN SOCKETS

- () INSTALL AND SOLDER TWO 20-PIN STRIPS AT (B4, 5, 6, 7, 8)

CHECK ALL SOCKETS TO MAKE SURE THAT ALL STRIPS ARE DOWN FLUSH ON THE BOARD. IF ANY ARE NOT, REHEAT THE SOLDER PAD ON ONE, AND PRESS THE BOARD DOWN OVER THE SOCKET STRIP. DO THIS FOR ALL SOCKET STRIPS THAT ARE NOT FLAT ON THE BOARD.

- () CHECK FOR SOLDER BRIDGES.
- () CHECK FOR SOLDER ON TERMINALS.

(4) 12-PIN STRIP SOCKET (NON-DIMPLED END CUT)

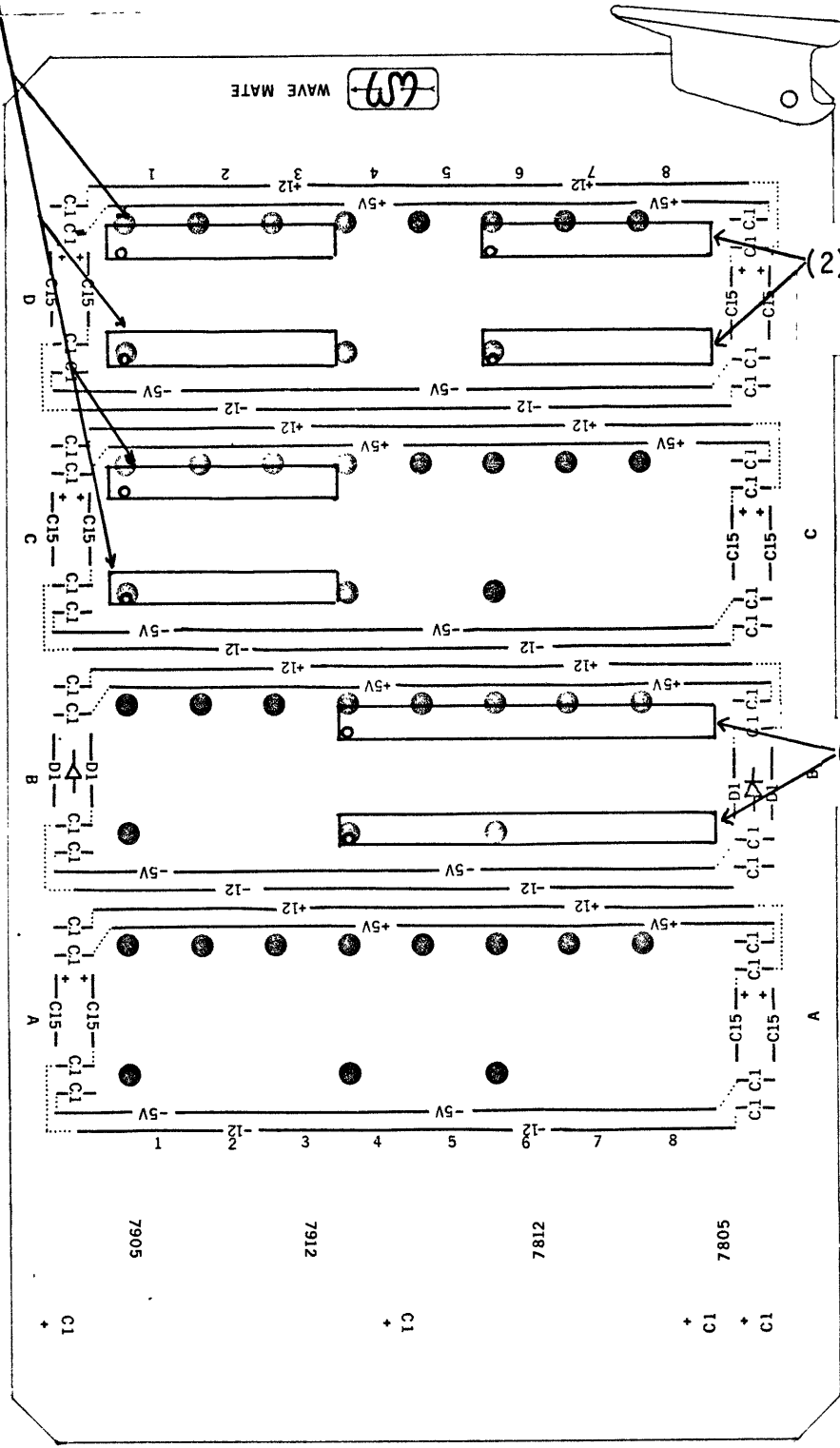

(2) 12-PIN STRIP SOCKET (DIMPLED END CUT)

(2) 20-PIN STRIP SOCKET

4.3 INPUT VOLTAGE FILTER CAPACITORS

INSTALL 1UF 35V TANTALUM CAPACITORS (COLOR CODE BROWN, BLACK, GREEN) IN THE LOCATIONS MARKED "C1" NEAR THE BOTTOM OF THE BOARD. REFER TO THE ASSEMBLY DRAWING TO DETERMINE WHICH OF THE 4 C1 LOCATIONS ARE TO BE FILLED.

THE BLUE STRIPE ON THE CAPACITOR MUST LINE UP WITH THE + MARKED ON THE BOARD.

AFTER INSTALLING EACH CAPACITOR BEND THE LEADS TO RETAIN THE CAPACITORS.

- INSTALL 1UF CAPACITOR
- CHECK POLARITY
- SOLDER ALL CAPACITORS
- CLIP LEADS
- CHECK FOR SOLDER BRIDGES AND COLD SOLDER JOINTS

4.4 REVERSE VOLTAGE PROTECTION

INSTALL 1N4001 1 AMP DIODES IN LOCATIONS MARKED D1. THE BANDED END OF THE DIODE MUST LINE UP WITH THE BAR ON THE DIODE SYMBOL ON THE BOARD:

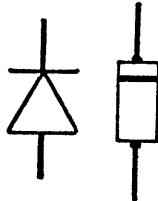

BEND BOTH LEADS DOWNWARD CLOSE TO THE DIODE BODY, TO MATCH THE SPACING IN THE BOARD. INSERT THE DIODE LEADS THROUGH THE HOLES MARKED "D1" AND BEND THE LEADS OUT TO RETAIN THE DIODES.

- INSTALL DIODE, ROW B
- SOLDER ALL DIODE LEADS
- CLIP LEADS
- CHECK FOR SOLDER BRIDGES AND COLD SOLDER JOINTS

4.5 LOW FREQUENCY BYPASS CAPACITORS

INSTALL 15UF 15V TANTALUM LOW FREQUENCY BYPASS CAPACITOR IN LOCATIONS MARKED C15. THE POSITIVE END OF THE CAPACITOR IS INDICATED BY THE SLOPING EDGES AS WELL AS A WHITE + MARK. THE POSITIVE END OF THE CAPACITOR MUST LINE UP WITH THE WHITE + PRINTED ON THE BOARD.

BEND BOTH LEADS DOWNWARD CLOSE TO THE CAPACITOR BODY, INSERT THE LEADS THROUGH HOLES MARKED "C15" AND BEND THE LEADS TO RETAIN THE CAPACITORS.

- INSTALL 15UF CAPACITOR, ROW A
- INSTALL 15UF CAPACITOR, ROW C
- INSTALL 15UF CAPACITOR, ROW D
- CHECK POLARITY
- SOLDER ALL CAPACITORS
- CLIP LEADS
- CHECK FOR SOLDER BRIDGES AND COLD SOLDER JOINTS

4.6 VOLTAGE REGULATORS

- () PLACE THE HEAT SINK ON THE BOARD ABOVE THE BUSS-CONNECTOR SO THAT THE NUMBERS 7805, 7812, 7912, 7905 ARE COVERED UP, AND THE SMALL HOLES IN THE HEAT SINK LINE UP WITH THE LARGE HOLES ON THE BOARD.
- () PLACE A 1/8" NYLON SPACER IN HOLE #7
- () PLACE A 1/8" NYLON SPACER IN HOLE #5
- () PLACE A 1/8" NYLON SPACER IN HOLE #2
- () () () PLACE ONE PLASTIC INSULATOR ON EACH REGULATOR SUPPLIED. THESE INSULATORS ARE COATED ON BOTH SIDES WITH A SPECIAL HEAT TRANSFER COMPOUND. LINE UP THE HOLE ON THE PLASTIC WITH THE HOLE IN THE REGULATOR.
- () PLACE THE 7805 REGULATOR LEADS THROUGH HOLE #8 AND THE THREE HOLES IN THE CIRCUIT BOARD. THE HOLE IN THE REGULATOR SHOULD LINE UP WITH HOLE #7.
- () PLACE THE 7812 REGULATOR LEADS THROUGH HOLE #6 AND THE THREE HOLES IN THE CIRCUIT BOARD. THE HOLE IN THE REGULATOR SHOULD LINE UP WITH HOLE #5.
- () PLACE THE 7905 REGULATOR LEADS THROUGH HOLE #1 AND THE THREE HOLES IN THE CIRCUIT BOARD. THE HOLE IN THE REGULATOR SHOULD LINE UP WITH HOLE #2.
- () () () PLACE A #6 LOCKWASHER ON A #6-32 X 1/2 ROUND HEAD SCREW AND PUSH THROUGH EACH REGULATOR FROM HEAT SINK SIDE OF BOARD.
- () () () PICK BOARD UP ON EDGE AND PLACE A #6 LOCK WASHER AND A #6-32 HEX NUT ON EACH SCREW.
- () () () TIGHTEN ALL HARDWARE FROM THE NUT SIDE WITH A SOCKET WRENCH. DO NOT OVER TIGHTEN.
- () () () SOLDER THE TWO OUTSIDE LEADS OF EACH REGULATOR.
- () () () CLIP ALL THREE LEADS OF EACH REGULATOR.
- () CHECK FOR SOLDER BRIDGES.
- () CHECK FOR COLD SOLDER JOINTS.

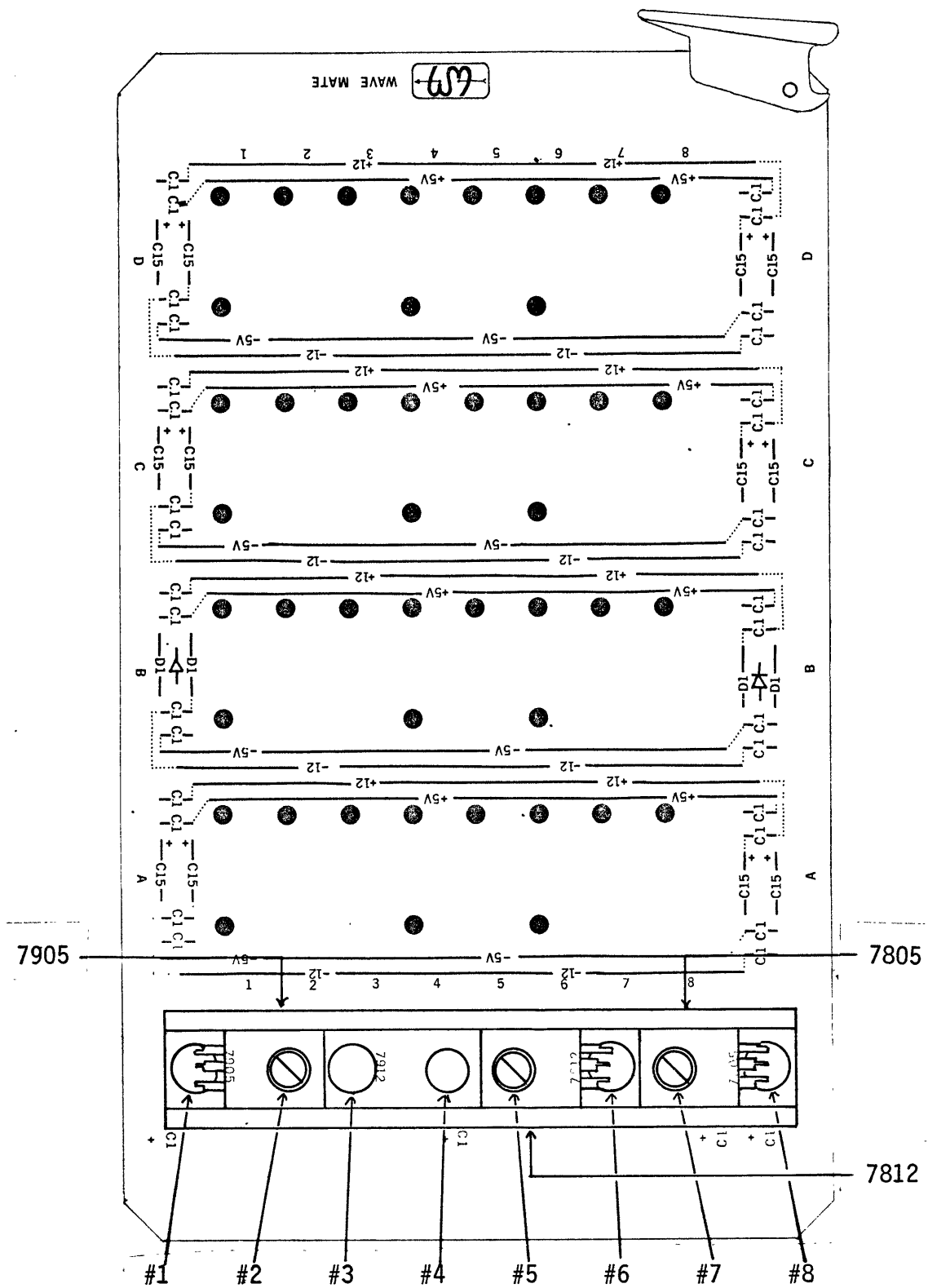

4.7 BUS CONNECTOR

- () ORIENT THE BUS CONNECTOR AT THE BOTTOM OF THE BOARD SO THAT THE LONG LEADS POINT TO THE BOARD AND THE SHORT LEADS ARE FACING TOWARDS THE BOTTOM OF THE BOARD.
- () WORK THE LONG LEADS THROUGH THE CORRESPONDING HOLES BEING CAREFUL NOT TO CRUNCH THE FILTER CAPACITORS IN THE BOARD. PUSH THE CONNECTOR DOWN UNTIL IT IS FLAT AGAINST THE BOARD.
- () INSTALL A 2-56 X 1/2 SCREW AND NUT AT EACH END OF THE CONNECTOR. THE SCREW HEAD IS ON BOTTOM OF BOARD AND THE NUT IS ON TOP OF CONNECTOR.

THE 4 CONNECTOR LEADS ON THE RIGHT-HAND SIDE AND THE 10 ON THE LEFT-HAND SIDE ARE TO BE SOLDERED.

- () USING WIRE CUTTERS, CLIP ONLY THOSE LEADS SHOWN IN FIGURE 4.7.1 AS CLOSE TO THE BOARD AS POSSIBLE.
- () SOLDER THE 4 LEADS ON THE RIGHT-HAND SIDE COMMON PAD FORMING A SMOOTH SOLDER LAKE.
- () SOLDER THE PINS ON THE LEFT-HAND SIDE TO THE PADS BEING CAREFUL NOT TO FORM BRIDGES. IT IS IMPORTANT THAT GOOD SOLDER CONNECTIONS ARE MADE, AS THESE PINS SUPPLY POWER TO THE CARD. A POOR SOLDER CONNECTION WILL CAUSE INTERMITTANT OPERATION.
- () CHECK THE ADJACENT (UNCLIPPED) CONNECTOR LEADS FOR SOLDER. SCRAPE ANY SOLDER OFF THESE LEADS.
- () CHECK LEFT-HAND SIDE FOR SOLDER BRIDGES
- () CHECK FOR COLD SOLDER JOINTS



FIGURE 4.7.1

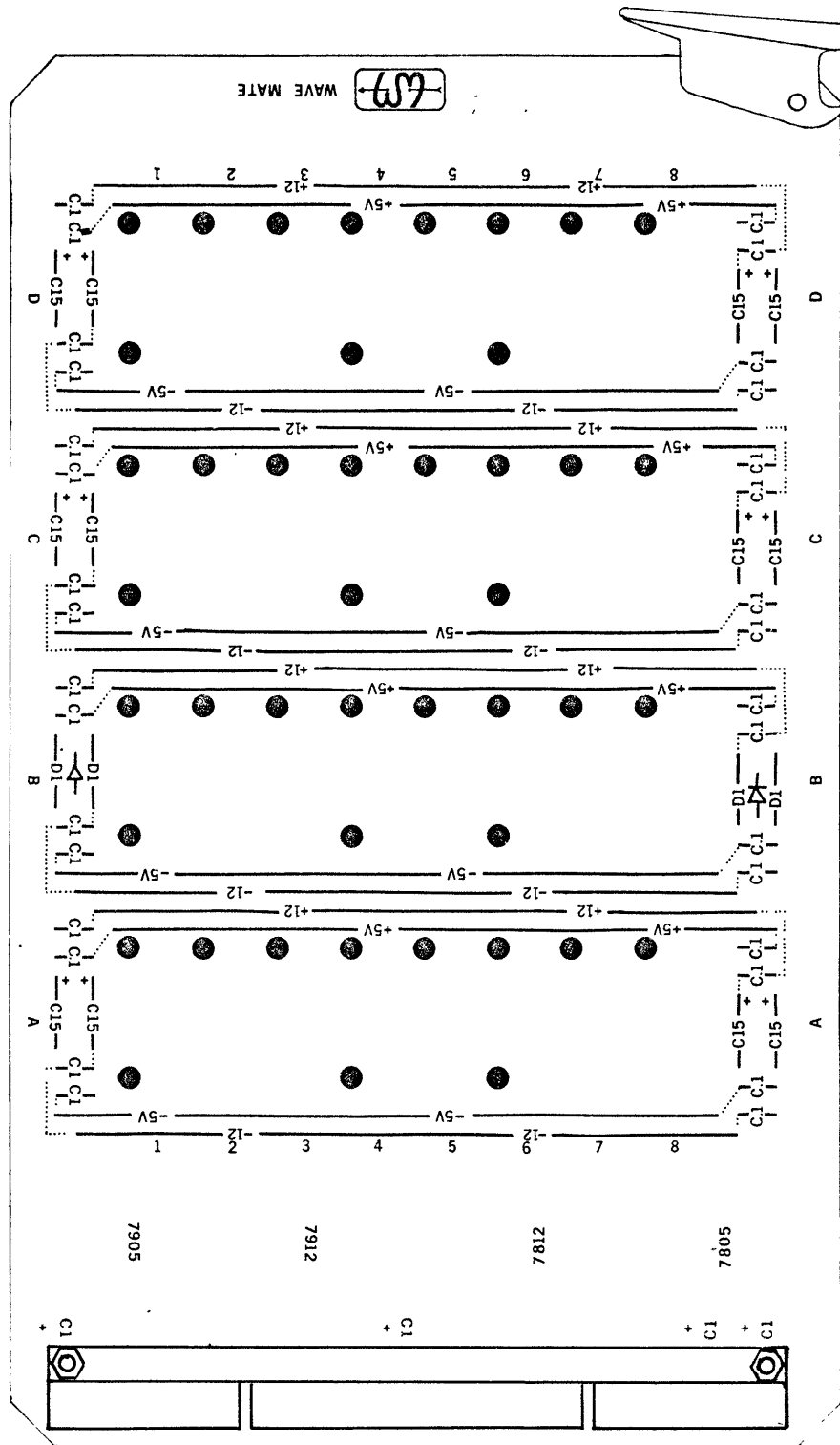

WAVE MATE 69

BUS CONNECTOR

4.8 BUSS BARS

EACH BUSS BAR CONTAINS 10 TERMINALS. THE TWO END TERMINALS ARE SOLDERED TO THE PRINTED CIRCUIT CARD. THE REMAINING 8 TERMINALS ARE USED TO SUPPLY POWER TO EACH OF THE SOCKETS THAT MAY BE INSTALLED IN THE RGW.

EACH BUSS BAR LOCATION IS INDICATED BY A WHITE LINE ON THE BOARD WITH THE VOLTAGE INDICATED (+12, +5, -5, -12). WHEN INSTALLED, THE BUSS BAR SHOULD COMPLETELY COVER THE APPROPRIATE WHITE LINE.

THE +5 AND +12 VOLT BUSS BARS ARE LOCATED ABOVE EACH ROW, WHILE THE -5 AND -12 VOLT BUSS BARS ARE LOCATED BELOW EACH ROW.

VISUALLY CHECK THE BUSS BAR PINS TO CONFIRM THAT THEY ARE STRAIGHT. CHECK BY SIGHTING FROM THE END AS WELL AS FROM THE FRONT.

LINE UP THE PINS WITH THE HOLES IN THE BOARD AND WIGGLE IN UNTIL THE BOTTOM OF THE BUSS BAR IS FLUSH AGAINST THE BOARD.

BEND THE 2 END PINS OVER SLIGHTLY TO HOLD THE BARS IN THE BOARD.

- () INSTALL BUSS BAR +12V, ROW D
- () INSTALL BUSS BAR +5V, ROW D
- () INSTALL BUSS BAR -5V, ROW D

- () INSTALL BUSS BAR +12V, ROW C
- () INSTALL BUSS BAR +5V, ROW C
- () INSTALL BUSS BAR -5V, ROW C

- () INSTALL BUSS BAR +5V, ROW B

- () INSTALL BUSS BAR +5V, ROW A

- () RECHECK POSITIONS
- () SOLDER ALL BUSS BAR END PINS
- () CLIP ALL BUSS BAR END PINS
- () CHECK FOR SOLDER BRIDGES
- () CHECK ALL PINS FOR STRAIGHTNESS

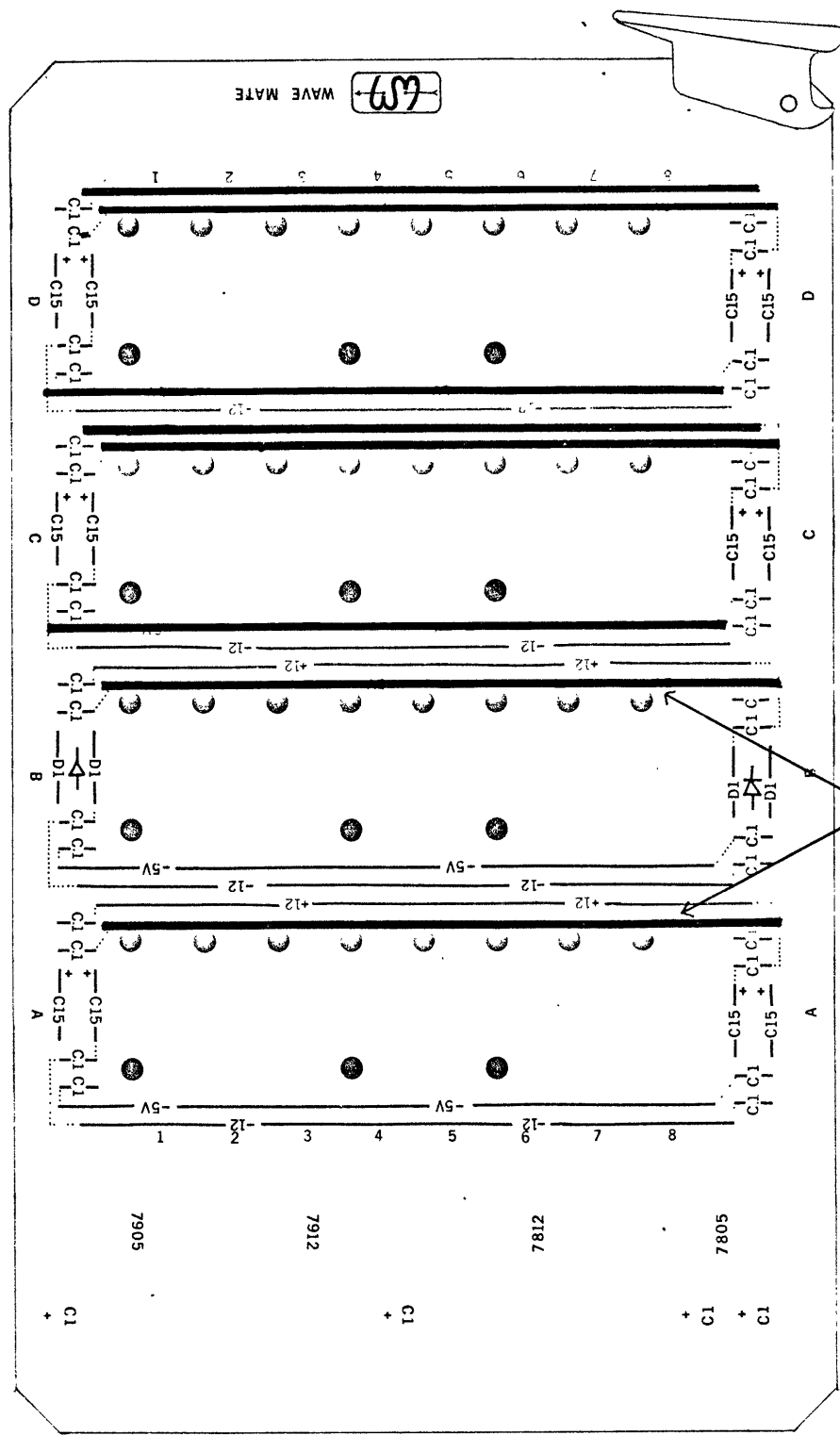

4.9 HIGH-FREQUENCY BYPASS CAPACITORS

A HIGH-FREQUENCY BYPASS CAPACITOR IS INSTALLED AT BOTH ENDS OF EACH BUSS BAR. A DOTTED WHITE LINE ON THE PRINTED CIRCUIT BOARD POINTS FROM EACH BUSS BAR TO THE LOCATION OF THE CORRESPONDING BYPASS CAPACITOR.

BLUE 0.1 UF 50V CERAMIC CAPACITORS MARKED "104M" ARE USED FOR THE HIGH FREQUENCY BYPASS.

INSERT THE LEADS THROUGH HOLES MARKED "C.1". BEND THE LEADS TO HOLD THE CAPACITORS IN THE BOARD.

R	L	
()	()	INSTALL 0.1UF CAPACITOR +12V, ROW D
()	()	INSTALL 0.1UF CAPACITOR +5V, ROW D
()	()	INSTALL 0.1UF CAPACITOR -5V, ROW D
()	()	INSTALL 0.1UF CAPACITOR +12V, ROW C
()	()	INSTALL 0.1UF CAPACITOR +5V, ROW C
()	()	INSTALL 0.1UF CAPACITOR -5V, ROW C
()	()	INSTALL 0.1UF CAPACITOR +5V, ROW B
()	()	INSTALL 0.1UF CAPACITOR +5V, ROW A
()		CHECK LOCATIONS
()		SOLDER ALL CAPACITORS
()		CLIP ALL CAPACITOR LEADS
()		CHECK FOR SOLDER BRIDGES
()		CHECK FOR COLD SOLDER JOINTS

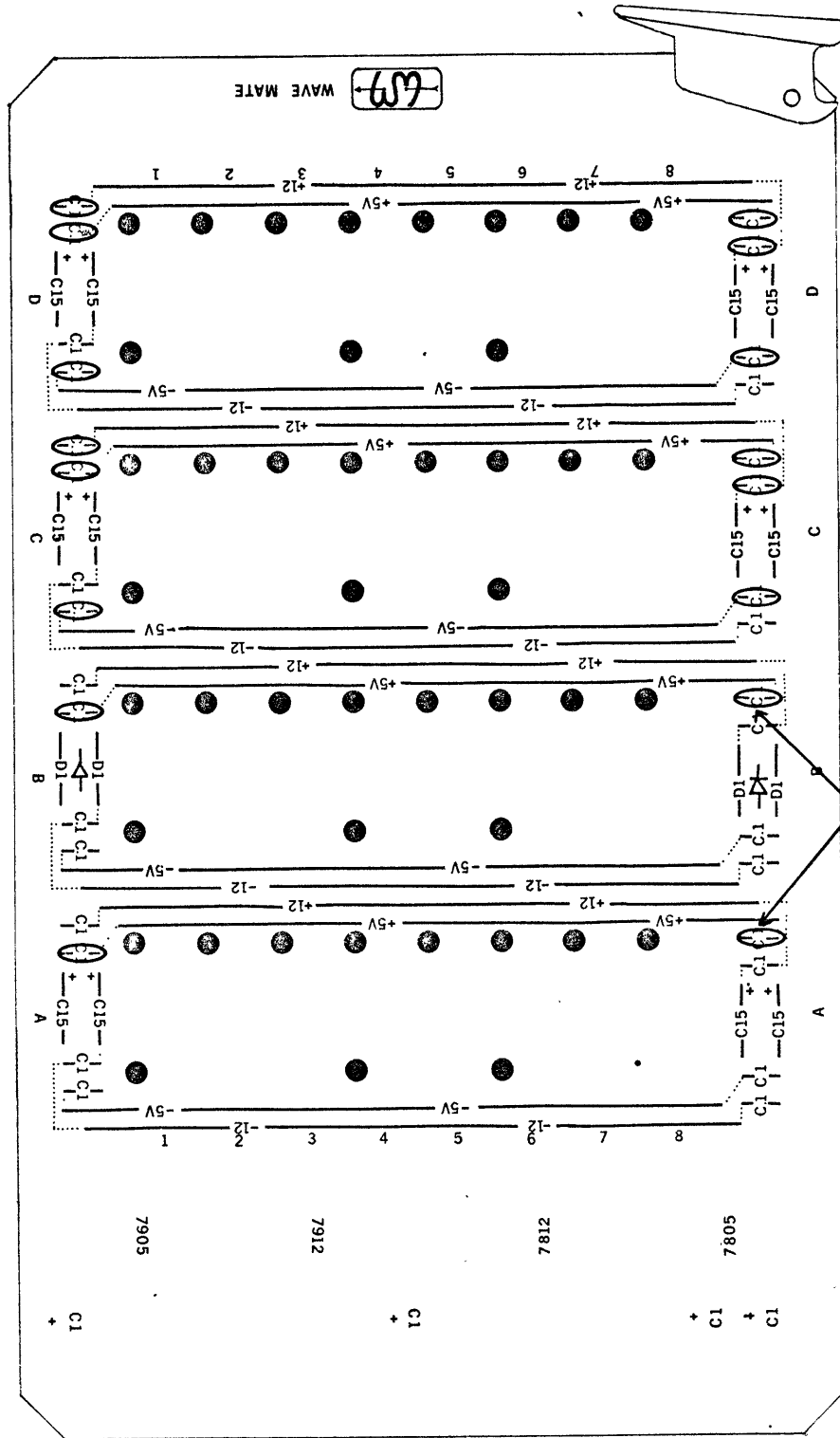

(16) 0.1UF CAP

4.10 18-PIN IC SOCKETS

SOCKETS FOR 18-PIN IC'S ARE INSTALLED IN THE LOCATIONS SPECIFIED BELOW.

PLACE THE CIRCUIT BOARD ON A TABLE, TOP UP, WITH THE BUS CONNECTOR TOWARD YOU.

EACH ROW CONTAINS 8 POSITIONS FOR 18-PIN SOCKETS. WHEN INSTALLING THE SOCKET, ORIENT IT SUCH THAT THE SAE MARKING (OR DIMPLE) IS POINTED TOWARD THE TOP OF THE BOARD. BE SURE THAT THE CENTER OF THE SOCKET IS LINED UP WITH THE IDENTIFICATION NUMBER OF THE COLUMN (1-8). PIN 1 OF THE SOCKET (UPPER LEFT-HAND CORNER) SHOULD BE LINED UP WITH THE WHITE DOT ON THE BOARD.

LINE UP THE SOCKET TERMINALS WITH THE CORRESPONDING HOLES IN THE PRINTED CIRCUIT BOARD AND GENTLY PUSH THE TERMINALS THROUGH THE HOLES. THEN SNAP THE SOCKET INTO THE CIRCUIT BOARD.

USING THE CLOSED TIP OF THE NEEDLENOSED PLIERS, PUSH THE PIN IN THE CENTER OF THE SOCKET DOWN UNTIL IT IS FLUSH WITH THE PLASTIC. THE SOCKET WILL BE LOCKED INTO PLACE.

		()D4	()D5				
		()C4	()C5	()C6	()C7	()C8	
()B1	()B2	()B3					
()A1	()A2	()A3	()A4	()A5	()A6	()A7	()A8

IF IT IS NECESSARY TO REMOVE THE SOCKET, USE A SMALL SCREWDRIVER BLADE TO PUSH THE PIN BACK UP FROM THE BOTTOM. INSERT THE BLADE BETWEEN THE PLASTIC AND PUSH THE PIN UP. USE NEEDLENOSED PLIERS FROM THE TOP TO PULL THE PIN UP. THEN CAREFULLY PUSH THE SOCKET FROM THE BOTTOM OF THE BOARD UNTIL THE SOCKET SNAPS OUT OF THE BOARD.

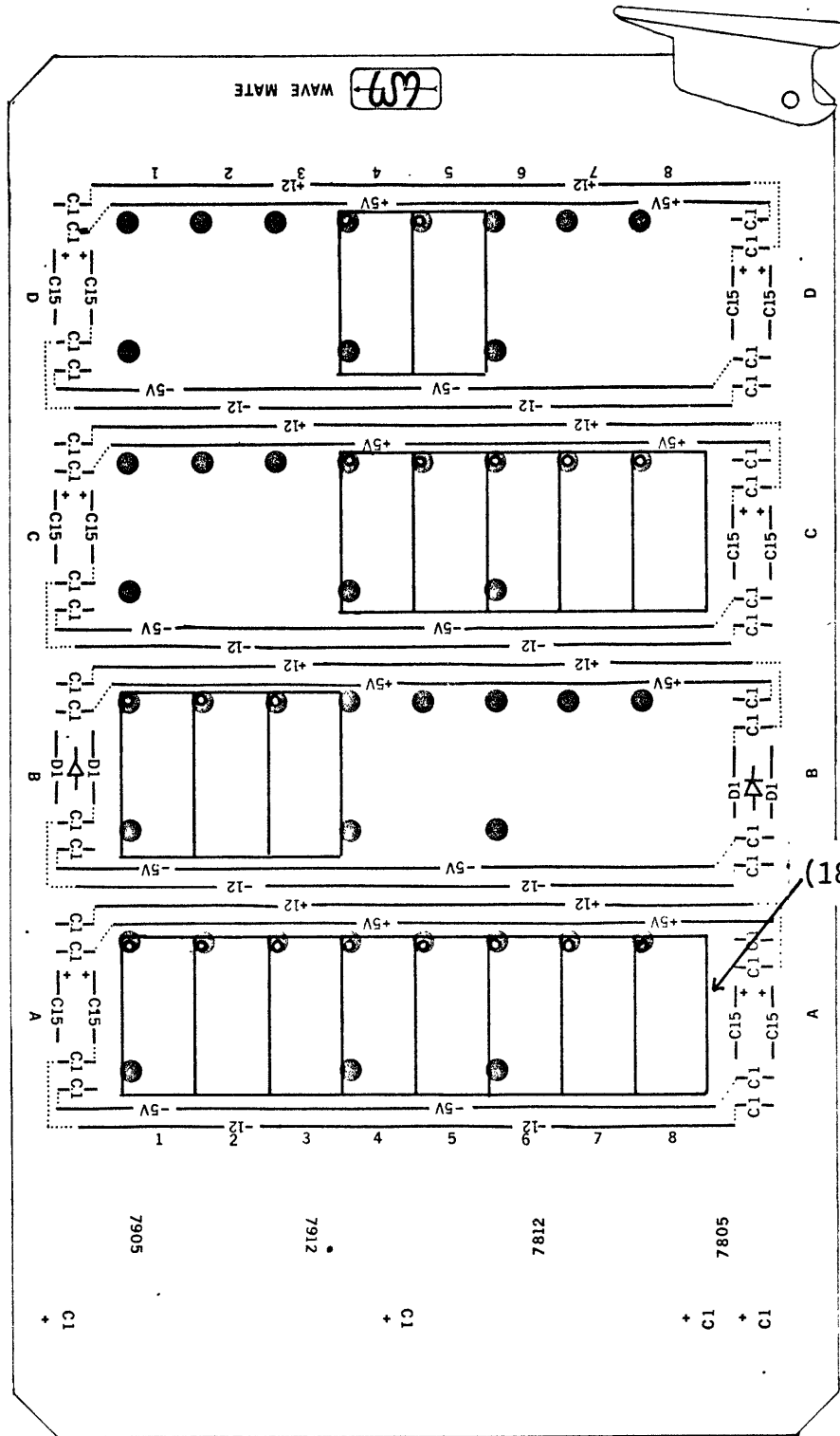

(18) 18-PIN SOCKET

4.11 GROUND PINS

INSTALL GROUND PINS ON THE DESIGNATED TERMINALS USING THE TOOL PROVIDED. PLACE THE GROUND PIN IN THE INSERTION TOOL. PLACE THE INSERTION TOOL OVER THE TERMINAL WITH THE LEG OF THE GROUND PIN POINTED TOWARD THE INSIDE OF THE SOCKET. PUSH THE INSERTION TOOL DOWN ON THE TERMINAL UNTIL THE LEG OF THE GROUND PIN IS FLUSH AGAINST THE SOLDER PLANE. BE CAREFUL NOT TO BEND THE ELBOW OF THE GROUND PIN.

SOLDER THE GROUND PIN TO THE GROUND PLANE BUT AVOID GETTING SOLDER ON ANY WIRE WRAP PINS. USE AN ADEQUATE AMOUNT OF SOLDER AND MOVE THE TIP OF THE SOLDERING IRON AROUND ON THE GROUND PLANE TO INSURE A SMOOTH SOLDER JOINT.

INSTALL GROUND PINS IN THE FOLLOWING LOCATIONS:

- | | | | |
|--------------------------------|--------------------------------|-------------------------------|-------------------------------|
| <input type="checkbox"/> D1-12 | | | <input type="checkbox"/> D4-8 |
| <input type="checkbox"/> D5-7 | <input type="checkbox"/> D6-12 | | |
| <input type="checkbox"/> C1-12 | | | <input type="checkbox"/> C4-7 |
| <input type="checkbox"/> C5-7 | <input type="checkbox"/> C6-7 | <input type="checkbox"/> C7-8 | <input type="checkbox"/> C8-8 |
| <input type="checkbox"/> B1-8 | <input type="checkbox"/> B2-8 | <input type="checkbox"/> B3-8 | <input type="checkbox"/> B4-1 |
| <input type="checkbox"/> A1-8 | <input type="checkbox"/> A2-7 | <input type="checkbox"/> A3-7 | <input type="checkbox"/> A4-7 |
| <input type="checkbox"/> A5-8 | <input type="checkbox"/> A6-7 | <input type="checkbox"/> A7-8 | <input type="checkbox"/> A8-8 |
- SOLDER ALL GROUND PINS
- CHECK FOR COLD SOLDER JOINTS

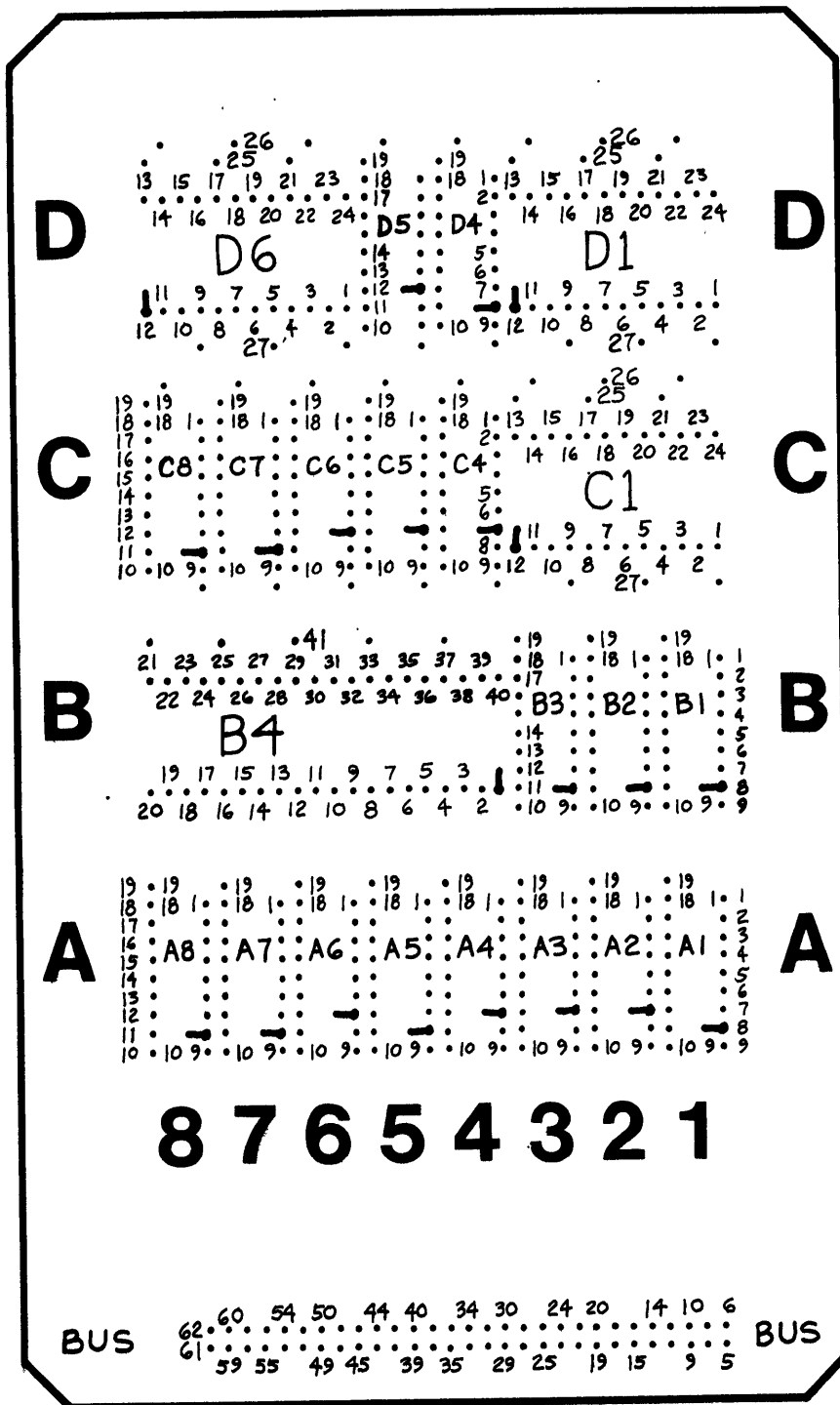

SECTION 5 WIRE WRAPPING

WIRE WRAPPING IS A SOLDERLESS TECHNIQUE FOR CONNECTING TERMINALS TOGETHER. THIS APPROACH TO WIRING HAS BEEN WIDELY ADOPTED WITHIN THE COMPUTER INDUSTRY BECAUSE IT PROVIDES ADVANTAGES OF INCREASED DENSITY AND FLEXIBILITY AS COMPARED TO PRINTED CIRCUIT OR SOLDER TERMINAL TECHNIQUES.

WHEN THE WIRE IS WRAPPED CORRECTLY, THE WIRE IS UNDER TENSION PRODUCING AN INDENTATION IN BOTH THE WIRE AND THE EDGES OF THE TERMINAL. TESTS HAVE SHOWN THAT OVER A PERIOD OF TIME THE WIRE MATERIAL ACTUALLY DIFFUSES INTO THE TERMINAL PRODUCING AN EXTREMELY RELIABLE CONNECTION.

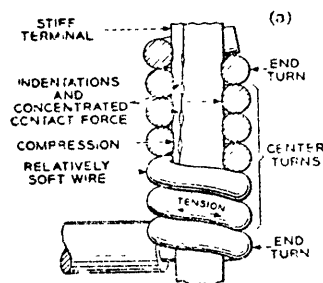
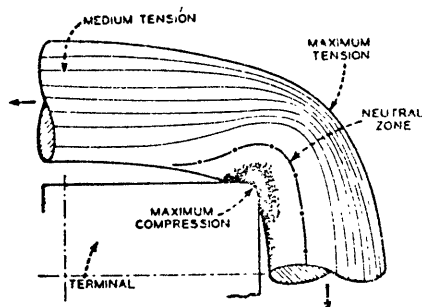

■ By bending the wire around the sharp corner of the terminal the oxide layer on both wire and terminal is crushed or sheared, and a clean, oxide-free metal-to-metal contact is obtained.

WIRE WRAPPING IS ACCOMPLISHED THROUGH THE USE OF A WIRE WRAP TOOL. THE WIRE WRAP TOOL CONTAINS A BIT WHICH FITS OVER THE TERMINAL TO BE WRAPPED. THE TOOL THEN FORCES THE WIRE, UNDER TENSION, AROUND THE TERMINAL. IT IS IMPORTANT THAT THE BIT BE THE CORRECT SIZE FOR BOTH THE TERMINAL AND THE WIRE. THE TERMINALS USED ON YOUR WAVE MATE KIT ARE .025" X .025". THE WIRE SUPPLIED WITH YOUR KIT IS 30 GAGE WITH KYNAR INSULATION.

A WIRE USED FOR WRAPPING MUST HAVE THE INSULATION STRIPPED ONE INCH FROM EACH END. THE WIRE SUPPLIED WITH YOUR WAVE MATE KIT IS PRECUT, PRESTRIPPED, AND COLOR CODED.

BEFORE BEGINNING TO WIRE WRAP A BOARD, CLEAN THE BOARD AND TERMINALS THOROUGHLY WITH ALCOHOL AND A STIFF BRUSH. BE SURE TO CLEAN ALL EXCESS FLUX FROM THE BOARD AND TO BRUSH ALL PINS WELL.

5.1 PROPER TECHNIQUE

TO WRAP A TERMINAL, HOLD THE WIRE WRAP TOOL WITH THE BIT FACING YOU. INSERT THE STRIPPED WIRE INTO THE HOLE IN THE BIT WHICH IS CLOSER TO THE EDGE.

INSERT THE WIRE UNTIL THE INSULATION IS APPROXIMATELY 0.1 INCH INSIDE THE BIT. AT THIS POINT THE BIT CONSTRUCTION WILL PREVENT THE WIRE FROM BEING INSERTED FURTHER INTO THE WIRE HOLE.

BEND THE WIRE TO THE SIDE.

PLACE THE WIRE WRAP TOOL OVER THE TERMINAL SO THAT THE LARGE HOLE IN THE CENTER OF THE BIT FITS OVER THE TERMINAL. IF A LEVEL-1 CONNECTION IS BEING INSTALLED SLIDE THE TOOL AS FAR DOWN ON THE TERMINAL AS IT WILL GO. DO NOT FORCE! IF A LEVEL-2 CONNECTION IS BEING INSTALLED, SLIDE THE TOOL PARTIALLY DOWN THE TERMINAL. DO NOT MAKE CONTACT WITH THE ALREADY INSTALLED WIRE WRAP.

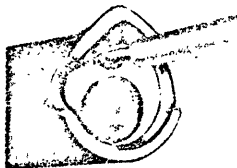

WIRE INSERTION

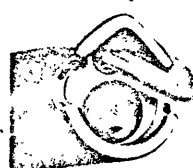

WIRE ANCHORING



TERMINAL INSERTION

FIGURE 5.1.1 WIRE WRAP TOOL INSERTED OVER TERMINAL

PUSH DOWN ON THE TOOL WITH MODERATE, EVEN PRESSURE AND TWIST THE TOOL IN A CLOCKWISE DIRECTION UNTIL THE BARE PORTION OF THE WIRE IS COMPLETELY WRAPPED AROUND THE TERMINAL (ABOUT 10 OR 11 REVOLUTIONS). LIFT THE TOOL OFF THE TERMINAL.

THE WIRE WRAP SHOULD LOOK LIKE THIS:

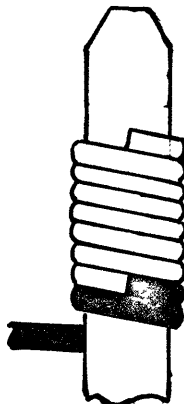

FIGURE 5.1.2 CORRECT WIRE WRAP

IF TOO LITTLE DOWNWARD PRESSURE IS USED THE WIRE WRAP WILL LOOK LIKE:

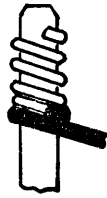

FIG. 5.1.3 OPEN WRAP

IF THE DOWNWARD PRESSURE WAS EXCESSIVE:

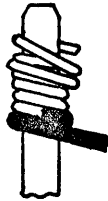

FIGURE 5.1.5 OVERWRAP

IF THE DOWNWARD PRESSURE IS NOT STEADY:



FIGURE 5.1.4 SPIRAL WRAP

IF THE INSULATION WAS NOT PUSHED DOWN FAR ENOUGH INTO THE BIT:

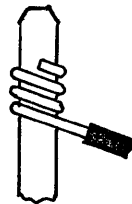

FIGURE 5.1.6 INSUFFICIENT INSULATION

WHEN WIRE WRAPPING, ROUTE THE WIRES AS NEATLY AS POSSIBLE. ALWAYS TRY TO ROUTE THE WIRES THROUGH LARGE OPENINGS, CENTERS OF SOCKETS, ETC. WHENEVER POSSIBLE, DO NOT ROUTE WIRES OVER THE SOLDERED CONNECTIONS ON THE SIDES OF THE BOARD.

WHEN WIRE WRAPPING IS COMPLETED, GENTLY PUSH THE WIRES DOWN SO THAT THEY DO NOT PROTRUDE ABOVE THE TERMINALS.

AFTER THE WIRING OF AN ASSEMBLY IS COMPLETED, MANY TERMINALS WILL HAVE TWO WIRES WRAPPED TO THEM. EACH WIRE WRAP IS CALLED A LEVEL. THE FIRST WIRE CONNECTED TO A TERMINAL IS LEVEL-1 (BOTTOM LEVEL). THE SECOND WIRE WRAP IS LEVEL-2 (TOP LEVEL). IF THE WIRE LIST CALLS OUT LEVEL-1 AND THERE ALREADY IS A WIRE CONNECTED TO THAT TERMINAL YOU HAVE DISCOVERED A WIRING ERROR. BY THE SAME TOKEN IF THE WIRE LIST CALLS OUT LEVEL-2 AND THERE IS NO WIRE CONNECTED TO EITHER OF THE TERMINALS ANOTHER WIRING ERROR HAS BEEN FOUND. NO MORE THAN TWO WIRES WILL EVER BE CONNECTED TO ONE TERMINAL.

A WIRE WRAP CAN BE REMOVED USING AN UNWRAP TOOL. PLACE THE UNWRAP TOOL OVER THE TERMINAL AND TURN IN A COUNTER-CLOCKWISE DIRECTION UNTIL THE WIRE IS REMOVED (10 OR 11 TURNS). BE GENTLE, AND DO NOT HURRY. THE TOOL WILL BREAK IF YOU ARE IN TOO MUCH OF A RUSH.

ALSO, BE CAREFUL NOT TO DROP THE UNWRAP TOOL. THE BIT MIGHT BE DULLED, MAKING THE UNWRAP TOOL UNUSABLE.

5.2 WIRELIST

THE WIRELIST PROVIDES ALL INFORMATION REQUIRED TO WIRE WRAP AN ASSEMBLY. THE WIRE LIST IS DIVIDED INTO SEVERAL SECTIONS CORRESPONDING TO WIRING LEVEL AND LENGTH OF WIRE REQUIRED. FIRST ALL LEVEL-1 CONNECTIONS ARE LISTED, THEN LEVEL-2 CONNECTIONS. WITHIN EACH LEVEL THE WIRES ARE GROUPED BY LENGTH WITH THE LONGEST FIRST.

THE WIRELIST IDENTIFIES PINS BY XY COORDINATES. THE ROWS ARE LABELED BY LETTERS A THROUGH D. WITHIN EACH ROW THE SOCKETS ARE IDENTIFIED BY COLUMNS 1 THROUGH 8. AN ENTRY IN THE WIRELIST A4-2:B5-7 MEANS CONNECT A WIRE FROM PIN 2 OF THE SOCKET IN ROW A, COLUMN 4 TO PIN 7 OF THE SOCKET IN ROW B, COLUMN 5.

A PAPER OVERLAY HAS BEEN PROVIDED TO AID IN THE IDENTIFICATION OF SOCKETS AND PIN NUMBERS. THE USE OF THIS OVERLAY IS OPTIONAL. TO USE THIS OVERLAY, CUT IT OUT, PLACE THE CARD ON ITS BACK (WIRE WRAP PINS FACING UP) WITH THE BUSS CONNECTOR AT THE BOTTOM. USE A PIN TO PUNCH HOLES IN THE CORNER PINS OF THE OVERLAY. PLACE THE OVERLAY ON TOP OF THE WIRE WRAP PINS WITH THE PRINTED NUMBERS FACING UP. ALIGN THE CORNER PINS OF THE OVERLAY WITH THE CORNER TERMINALS ON THE BOARD. GENTLY AND EVENLY PUSH THE OVERLAY THROUGH THE WIRE WRAP PINS UNTIL THE ENTIRE OVERLAY IS FLUSH AGAINST THE BOARD. THE OVERLAY WILL PERMANENTLY REMAIN IN THIS POSITION AND CANNOT BE REMOVED WHEN WIRE WRAPPING IS COMPLETED.

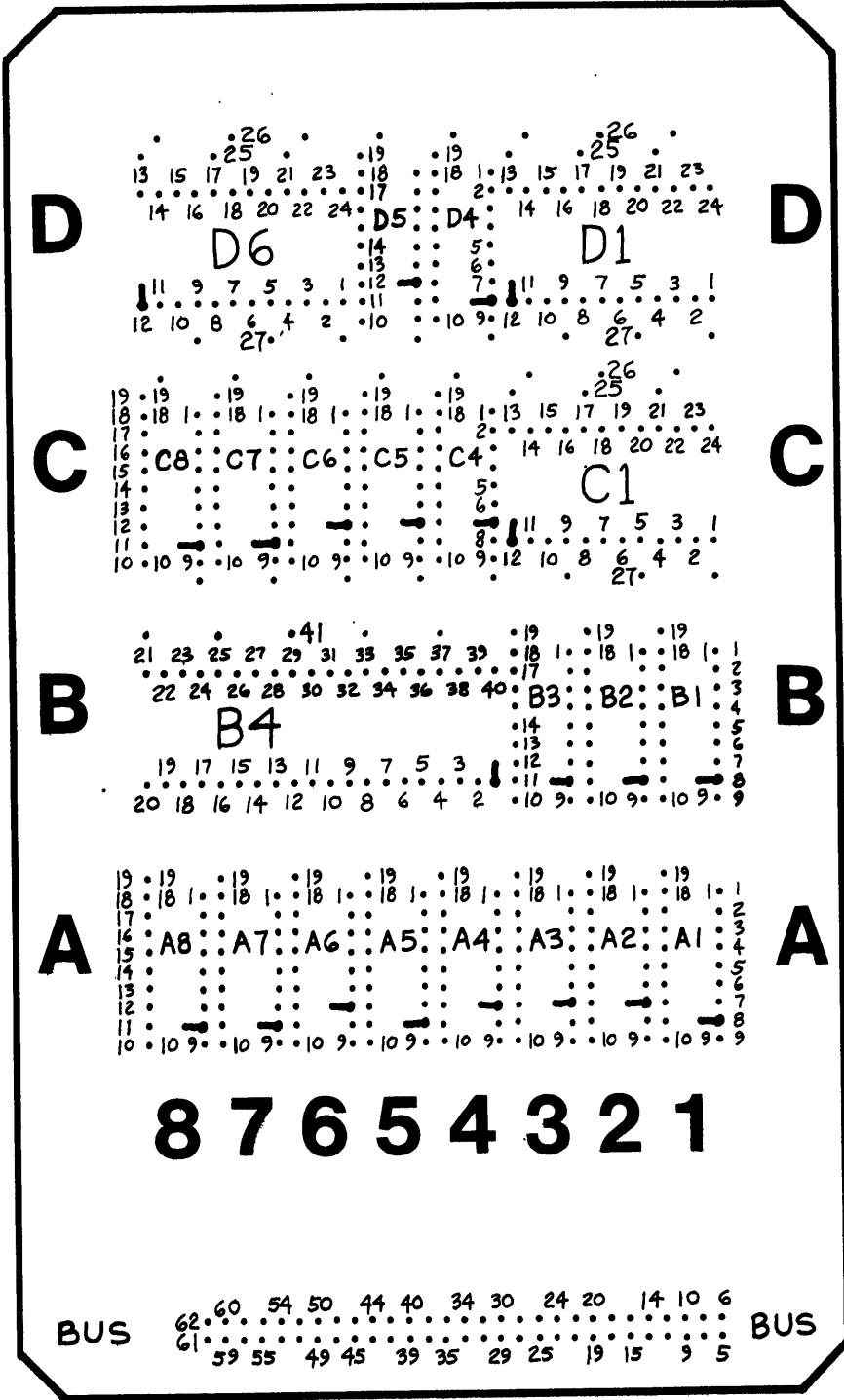

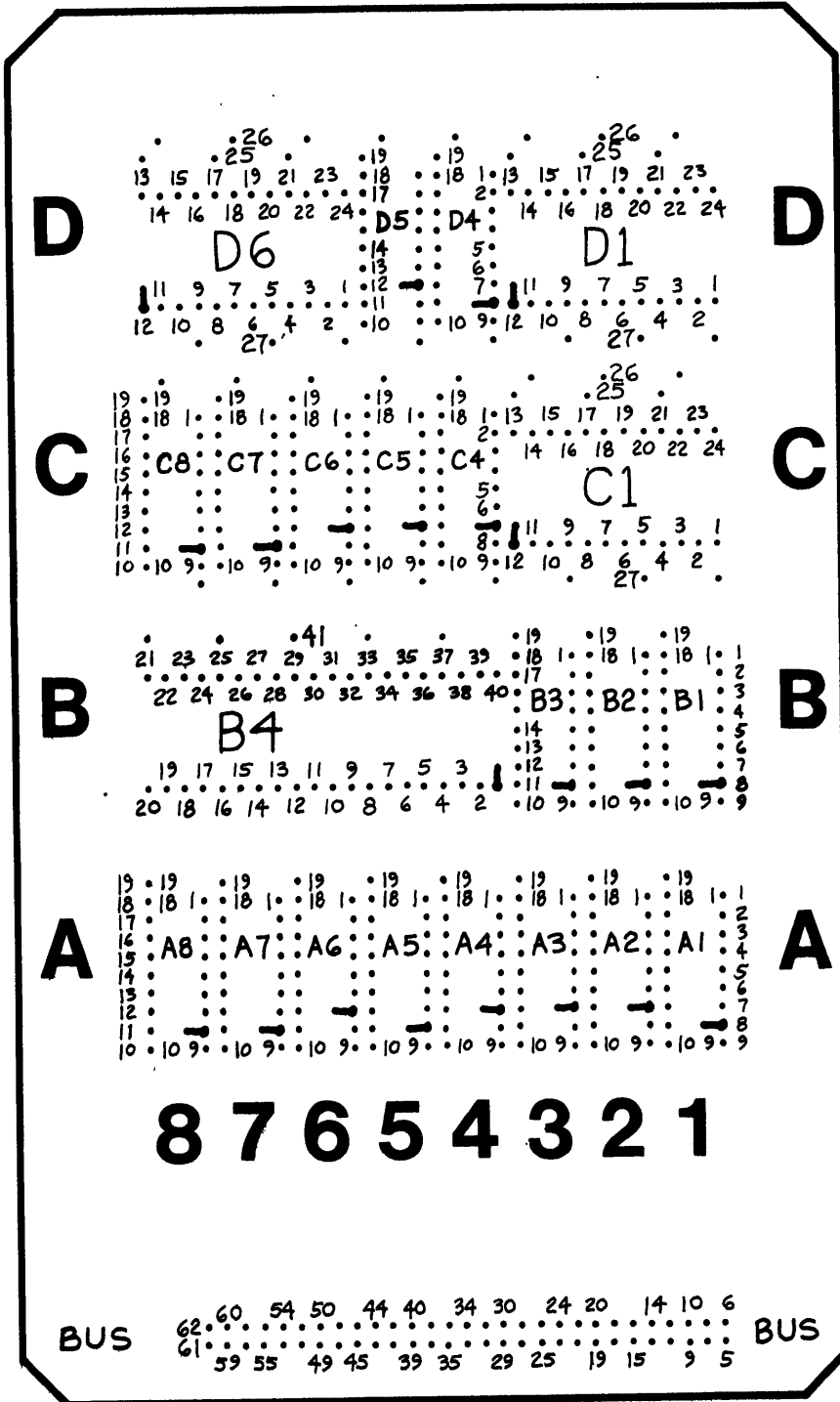

LEVEL ONE WIRES:

BLUE 8.5 INCH WIRES:

() 1 BUS-25 [8.5] D5-14

PURPLE 7.5 INCH WIRES:

() 2 BUS-30 [7.5] C6-5

ORANGE 7.0 INCH WIRES:

() 3 A2-5 [7.0] D4-17
() 4 A1-11 [7.0] D5-12

BROWN 6.5 INCH WIRES:

() 5 BUS-17 [6.5] B4-38
() 6 BUS-18 [6.5] B4-34
() 7 BUS-35 [6.5] B4-35
() 8 BUS-37 [6.5] B1-15
() 9 BUS-40 [6.5] B2-3
() 10 BUS-43 [6.5] B2-15
() 11 BUS-44 [6.5] B2-17

WHITE 6.0 INCH WIRES:

() 12 BUS-36 [6.0] B1-13
() 13 B4-19 [6.0] B1-2
() 14 A2-12 [6.0] C5-15

BLUE 5.5 INCH WIRES:

() 15 BUS-21 [5.5] A6-15
() 16 A5-2 [5.5] C6-2
() 17 B3-1 [5.5] D4-2
() 18 B3-3 [5.5] D4-3
() 19 B4-25 [5.5] D4-15
() 20 B1-4 [5.5] C6-3
() 21 C6-12 [5.5] A5-5

GREEN 5.0 INCH WIRES:

() 22 BUS-8 [5.0] A6-9
() 23 A6-3 [5.0] C6-14
() 24 BUS-23 [5.0] A3-15
() 25 BUS-24 [5.0] A4-15
() 26 BUS-29 [5.0] A4-1
() 27 BUS-32 [5.0] A4-4
() 28 C4-1 [5.0] B1-5
() 29 BUS-38 [5.0] A4-2
() 30 BUS-39 [5.0] A4-3
() 31 BUS-41 [5.0] A4-5
() 32 B2-5 [5.0] C5-1
() 33 BUS-47 [5.0] A5-14
() 34 BUS-48 [5.0] A5-15
() 35 BUS-49 [5.0] A5-16
() 36 BUS-50 [5.0] A5-17
() 37 BUS-51 [5.0] A7-3

() 38 BUS-54 [5.0] A7-15
() 39 BUS-55 [5.0] A8-3
() 40 BUS-58 [5.0] A8-15
() 41 BUS-59 [5.0] A6-14
() 42 B4-10 [5.0] B1-6
() 43 B4-11 [5.0] B1-12
() 44 B4-12 [5.0] B1-14
() 45 B4-13 [5.0] B1-16
() 46 B4-14 [5.0] B2-2
() 47 B4-15 [5.0] B2-4
() 48 B4-16 [5.0] B2-6
() 49 B4-17 [5.0] B2-12
() 50 B4-23 [5.0] A4-12
() 51 A1-13 [5.0] A6-16
() 52 D6-5 [5.0] D1-5
() 53 D1-7 [5.0] C7-3
() 54 D1-8 [5.0] C7-4
() 55 D1-13 [5.0] D6-13
() 56 C8-11 [5.0] D6-14
() 57 D1-22 [5.0] D6-22
() 58 C6-6 [5.0] A3-1
() 59 C5-14 [5.0] A7-1

YELLOW 4.5 INCH WIRES:

() 60 BUS-7 [4.5] A3-9
() 61 BUS-9 [4.5] A2-9
() 62 BUS-26 [4.5] A3-6
() 63 A2-17 [4.5] B1-1
() 64 BUS-27 [4.5] A5-6
() 65 BUS-28 [4.5] A5-7
() 66 B1-17 [4.5] C4-13
() 67 B2-1 [4.5] C4-15
() 68 BUS-42 [4.5] A4-6
() 69 B2-13 [4.5] C5-3
() 70 BUS-45 [4.5] A5-12
() 71 BUS-46 [4.5] A5-13
() 72 A3-5 [4.5] B3-17
() 73 BUS-52 [4.5] A7-6
() 74 BUS-53 [4.5] A7-12
() 75 BUS-56 [4.5] A8-6
() 76 BUS-57 [4.5] A8-12
() 77 BUS-60 [4.5] A6-12
() 78 B4-18 [4.5] B3-11
() 79 B4-39 [4.5] A6-1
() 80 B4-40 [4.5] A1-14
() 81 A5-11 [4.5] A2-2
() 82 D6-6 [4.5] C4-6
() 83 C7-14 [4.5] C1-13
() 84 C8-12 [4.5] D6-15
() 85 C8-13 [4.5] D6-16
() 86 C8-14 [4.5] D6-17
() 87 C1-20 [4.5] D5-3
() 88 C5-12 [4.5] C1-22
() 89 D6-23 [4.5] C5-6
() 90 D5-6 [4.5] C7-15

RED 4.0 INCH WIRES:

- () 91 B4-36 [4.0] C4-3
- () 92 A3-2 [4.0] B3-5
- () 93 A3-3 [4.0] B3-13
- () 94 A3-4 [4.0] B3-15
- () 95 B4-3 [4.0] B2-16
- () 96 B4-4 [4.0] B3-2
- () 97 B4-5 [4.0] B3-4
- () 98 B4-6 [4.0] B3-6
- () 99 B4-8 [4.0] B3-14
- () 100 B4-9 [4.0] B3-16
- () 101 C5-4 [4.0] D6-1
- () 102 D1-1 [4.0] C1-1
- () 103 C5-2 [4.0] D6-2
- () 104 D1-2 [4.0] C1-2
- () 105 C4-16 [4.0] D6-3
- () 106 D1-3 [4.0] C1-3
- () 107 D6-4 [4.0] D4-16
- () 108 D1-4 [4.0] C1-4
- () 109 C1-5 [4.0] C4-12
- () 110 C1-6 [4.0] D1-6
- () 111 C8-3 [4.0] D6-7
- () 112 C8-4 [4.0] D6-8
- () 113 C7-11 [4.0] D6-9
- () 114 D1-9 [4.0] C1-9
- () 115 C7-12 [4.0] D6-10
- () 116 D1-10 [4.0] C1-10
- () 117 C7-13 [4.0] D6-11
- () 118 D1-11 [4.0] C1-11
- () 119 D1-14 [4.0] C1-14
- () 120 D1-15 [4.0] C1-15
- () 121 D1-16 [4.0] C1-16
- () 122 D1-17 [4.0] C1-17
- () 123 C1-27 [4.0] C1-21
- () 124 C1-23 [4.0] D1-23
- () 125 D1-20 [4.0] D4-5
- () 126 D1-27 [4.0] D1-21
- () 127 D6-20 [4.0] D4-6
- () 128 D6-27 [4.0] D6-21

BLACK 3.5 INCH WIRES:

- () 129 A1-3 [3.5] A1-2
- () 130 BUS-19 [3.5] BUS-20
- () 131 C5-17 [3.5] C6-13
- () 132 C7-16 [3.5] C8-16
- () 133 A2-14 [3.5] A1-12
- () 134 B4-2 [3.5] B2-14
- () 135 B4-7 [3.5] B3-12
- () 136 B2-11 [3.5] B1-11
- () 137 B4-41 [3.5] B4-24
- () 138 B4-22 [3.5] B4-20
- () 139 A2-13 [3.5] A2-1
- () 140 A6-2 [3.5] A6-4
- () 141 B1-19 [3.5] B1-18
- () 142 B1-8 [3.5] B1-7
- () 143 B2-8 [3.5] B2-7
- () 144 B2-19 [3.5] B2-18
- () 145 B3-8 [3.5] B3-7

- () 146 B3-19 [3.5] B3-18
- () 147 A1-19 [3.5] A1-18
- () 148 A1-4 [3.5] A1-17
- () 149 A1-5 [3.5] A1-16
- () 150 A1-6 [3.5] A1-15
- () 151 A4-19 [3.5] A4-18
- () 152 A4-16 [3.5] A4-10
- () 153 A3-12 [3.5] A2-4
- () 154 A2-6 [3.5] A2-16
- () 155 A2-19 [3.5] A2-18
- () 156 A6-19 [3.5] A6-18
- () 157 C8-7 [3.5] C7-7
- () 158 C8-6 [3.5] C7-6
- () 159 C8-5 [3.5] C7-5
- () 160 C8-17 [3.5] C7-17
- () 161 C7-1 [3.5] C8-1
- () 162 C8-2 [3.5] C7-2
- () 163 C1-7 [3.5] C4-4
- () 164 C1-8 [3.5] C4-2
- () 165 A7-4 [3.5] A7-2
- () 166 A7-7 [3.5] A7-5
- () 167 A7-11 [3.5] A7-13
- () 168 C1-12 [3.5] C1-18
- () 169 A7-14 [3.5] A7-16
- () 170 A8-4 [3.5] A8-2
- () 171 A8-7 [3.5] A8-5
- () 172 A8-11 [3.5] A8-13
- () 173 A8-14 [3.5] A8-16
- () 174 C1-26 [3.5] C1-19
- () 175 C1-25 [3.5] C1-24
- () 176 D1-12 [3.5] D1-18
- () 177 D1-26 [3.5] D1-19
- () 178 D1-25 [3.5] D1-24
- () 179 D6-12 [3.5] D6-18
- () 180 D6-26 [3.5] D6-19
- () 181 D6-25 [3.5] D6-24
- () 182 C6-19 [3.5] C6-18
- () 183 D4-4 [3.5] D5-1
- () 184 D4-11 [3.5] D5-4
- () 185 D4-12 [3.5] D5-2
- () 186 D4-19 [3.5] D4-18
- () 187 A7-17 [3.5] A8-1
- () 188 A7-19 [3.5] A7-18
- () 189 A8-19 [3.5] A8-18
- () 190 A3-19 [3.5] A3-18
- () 191 A3-16 [3.5] A3-10
- () 192 A5-19 [3.5] A5-18
- () 193 A5-1 [3.5] A5-3
- () 194 C8-15 [3.5] C8-10
- () 195 D5-19 [3.5] D5-18
- () 196 C4-19 [3.5] C4-18
- () 197 C5-16 [3.5] C7-9
- () 198 C5-19 [3.5] C5-18
- () 199 C7-19 [3.5] C7-18
- () 200 C8-19 [3.5] C8-18

LEVEL TWO WIRES:

ORANGE 7.0 INCH WIRES:

() 201 A2-4 [7.0] D4-1

BROWN 6.5 INCH WIRES:

() 202 A2-2 [6.5] D5-5

WHITE 6.0 INCH WIRES:

() 203 A1-12 [6.0] B4-25

BLUE 5.5 INCH WIRES:

() 204 A4-15 [5.5] C6-1
() 205 A7-13 [5.5] C7-13
() 206 A8-13 [5.5] C8-13

GREEN 5.0 INCH WIRES:

() 207 A1-2 [5.0] A6-6
() 208 B1-1 [5.0] C5-17
() 209 A4-1 [5.0] C6-4
() 210 A5-12 [5.0] B3-1
() 211 A1-15 [5.0] A6-17
() 212 D6-1 [5.0] D1-1
() 213 D6-2 [5.0] D1-2
() 214 D6-3 [5.0] D1-3
() 215 A7-2 [5.0] C7-11
() 216 D6-9 [5.0] D1-9
() 217 A7-5 [5.0] C7-12
() 218 D6-10 [5.0] D1-10
() 219 D6-11 [5.0] D1-11
() 220 A7-16 [5.0] C7-14
() 221 A8-2 [5.0] C8-11
() 222 D6-14 [5.0] D1-14
() 223 A8-5 [5.0] C8-12
() 224 D6-15 [5.0] D1-15
() 225 D6-16 [5.0] D1-16
() 226 A8-16 [5.0] C8-14
() 227 D6-17 [5.0] D1-17
() 228 D1-23 [5.0] D6-23

YELLOW 4.5 INCH WIRES:

() 229 B4-35 [4.5] C4-1
() 230 B1-15 [4.5] C4-5
() 231 A4-2 [4.5] B1-17
() 232 A4-3 [4.5] B2-1
() 233 B2-3 [4.5] C4-17
() 234 A4-5 [4.5] B2-5
() 235 B2-15 [4.5] C5-5
() 236 B2-17 [4.5] C5-13
() 237 A5-13 [4.5] B3-3
() 238 A7-3 [4.5] B4-33
() 239 A7-6 [4.5] B4-32
() 240 A7-12 [4.5] B4-31

() 241 A7-15 [4.5] B4-30
() 242 A8-3 [4.5] B4-29
() 243 A8-6 [4.5] B4-28
() 244 A8-12 [4.5] B4-27
() 245 A8-15 [4.5] B4-26
() 246 A6-14 [4.5] A2-14
() 247 B1-11 [4.5] A4-9
() 248 A2-16 [4.5] A6-13

RED 4.0 INCH WIRES:

() 249 A3-9 [4.0] A1-3
() 250 C8-16 [4.0] B4-21
() 251 B1-13 [4.0] B4-36
() 252 A4-6 [4.0] B2-13
() 253 A5-14 [4.0] A3-2
() 254 A5-15 [4.0] A3-3
() 255 A5-16 [4.0] A3-4
() 256 A5-17 [4.0] A3-5
() 257 D4-16 [4.0] D1-4
() 258 C1-4 [4.0] C4-14
() 259 C4-12 [4.0] C7-1
() 260 C4-4 [4.0] D1-7
() 261 C1-13 [4.0] D1-13
() 262 C1-22 [4.0] D1-22

BLACK 3.5 INCH WIRES:

() 263 A6-9 [3.5] A6-3
() 264 A2-9 [3.5] A2-5
() 265 A3-15 [3.5] A5-2
() 266 C6-2 [3.5] D5-13
() 267 A3-6 [3.5] A2-17
() 268 C6-13 [3.5] C7-16
() 269 B3-11 [3.5] B2-11
() 270 A4-12 [3.5] A2-13
() 271 A2-18 [3.5] A2-10
() 272 A6-18 [3.5] A6-10
() 273 C7-7 [3.5] C5-4
() 274 C7-6 [3.5] C5-2
() 275 C7-5 [3.5] C4-16
() 276 C7-17 [3.5] D6-4
() 277 C8-1 [3.5] D6-5
() 278 C7-2 [3.5] D6-6
() 279 C4-6 [3.5] C1-6
() 280 C7-3 [3.5] C8-3
() 281 C4-2 [3.5] D1-8
() 282 C7-4 [3.5] C8-4
() 283 C7-15 [3.5] C8-15
() 284 C8-10 [3.5] C7-10
() 285 C7-9 [3.5] C8-9
() 286 B4-38 [3.5] B4-37
() 287 B4-24 [3.5] B4-22
() 288 A6-1 [3.5] A6-2
() 289 A6-4 [3.5] A6-5
() 290 A1-14 [3.5] A1-7
() 291 B1-18 [3.5] B1-3
() 292 A1-18 [3.5] A1-1
() 293 A4-18 [3.5] A4-16
() 294 A7-1 [3.5] A7-17

- () 295 A8-1 [3.5] A8-17
- () 296 A3-18 [3.5] A3-16
- () 297 A5-18 [3.5] A5-1
- () 298 A5-3 [3.5] A5-4

5.3 CHAIN LIST

AFTER YOU HAVE FINISHED WIRING THE BOARD IT IS LIKELY THAT YOU WILL HAVE SOME MISTAKES IN THE WIRING. THESE MUST BE FOUND BEFORE INSERTING IC'S INTO THE SOCKETS. A SIMPLE PROCEDURE CAN BE FOLLOWED TO CHECK THE CORRECTNESS OF THE CONNECTIONS. FOR THIS PURPOSE WE HAVE PROVIDED A CHAIN LIST, WHICH TELLS WHICH POINTS ARE CONNECTED TOGETHER. FOR THIS TEST SOME KIND OF CONTINUITY CHECKER IS REQUIRED:

FOR EXAMPLE, AN OHMMETER, A BATTERY WITH A LIGHT BULB, A LOGIC PROBE, OR A TONE GENERATOR. IN ANY CASE, THE TESTER SHOULD USE A LOW DC VOLTAGE (NO MORE THAN 5V) TO CHECK FOR CONTINUITY.

PUT THE BOARD ON A TABLE WITH THE SOCKETS FACING UP AND THE BUS CONNECTOR TOWARDS YOU. REMEMBER: PIN 1 IS LOCATED AT THE DIMPLE ON 18-PIN SOCKETS; FOR 24- AND 40-PIN SOCKETS, PIN 1 IS AT THE DIMPLE ON THE LOWER STRIP. WHEN A POWER CONNECTION IS REFERENCED (I.E., A PIN WITH A NUMBER HIGHER THAN 15 ON THE SOCKET), THE CONNECTION SHOULD BE TESTED BY TOUCHING THE APPROPRIATE POWER BUSS BAR AT ITS LEFT OR RIGHT END.

PROBES ARE PROVIDED FOR CHECKING CONNECTIONS TO SOCKETS. CONNECT THE PROBES TO YOUR CONTINUITY CHECKER. TOUCH THE TWO PROBES TOGETHER AND CHECK THAT THE CIRCUIT IS COMPLETED.

START AT THE BEGINNING OF THE CHAIN LIST. INSERT ONE PROBE INTO THE FIRST LOCATION SPECIFIED BY THE CHAIN LIST. FOR EXAMPLE, IF THE FIRST LOCATION WERE "A4-2", THEN YOU WOULD INSERT ONE PROBE INTO PIN 2 OF THE SOCKET LOCATED AT A4. RUN THE SECOND PROBE THROUGH EACH LOCATION ON THE CHAIN, AND BE SURE THAT CONTINUITY IS INDICATED AT EACH POINT. IF ANY POINT IS NOT CONNECTED, YOU HAVE FOUND A MISTAKE.

MAKE A NOTE OF THIS MISTAKE, TURN THE BOARD OVER AND CORRECT IT. WHEN YOU THINK YOU HAVE FIXED THE ERROR, TURN THE BOARD BACK OVER AND RECHECK THE CHAIN.

WHEN THE FIRST CHAIN CHECKS OUT, GO ON TO THE SECOND. CONTINUE THE ABOVE PROCEDURE UNTIL ALL CHAINS HAVE BEEN VERIFIED.

- () AB0 BUS-35 [1] B4-35 [2] C4-1 [1] B1-5 ;
- () AB1 BUS-36 [1] B1-13 [2] B4-36 [1] C4-3 ;
- () AB10 BUS-45 [1] A5-12 [2] B3-1 [1] D4-2 ;
- () AB11 BUS-46 [1] A5-13 [2] B3-3 [1] D4-3 ;
- () AB12 BUS-47 [1] A5-14 [2] A3-2 [1] B3-5 ;
- () AB13 BUS-48 [1] A5-15 [2] A3-3 [1] B3-13 ;
- () AB14 BUS-49 [1] A5-16 [2] A3-4 [1] B3-15 ;
- () AB15 BUS-50 [1] A5-17 [2] A3-5 [1] B3-17 ;
- () AB2 BUS-37 [1] B1-15 [2] C4-5 ;
- () AB3 BUS-38 [1] A4-2 [2] B1-17 [1] C4-13 ;
- () AB4 BUS-39 [1] A4-3 [2] B2-1 [1] C4-15 ;
- () AB5 BUS-40 [1] B2-3 [2] C4-17 ;
- () AB6 BUS-41 [1] A4-5 [2] B2-5 [1] C5-1 ;
- () AB7 BUS-42 [1] A4-6 [2] B2-13 [1] C5-3 ;
- () AB8 BUS-43 [1] B2-15 [2] C5-5 ;
- () AB9 BUS-44 [1] B2-17 [2] C5-13 ;
- () CLK2 BUS-59 [1] A6-14 [2] A2-14 [1] A1-12 [2]
B4-25 [1] D4-15 ;
- () DB0 BUS-51 [1] A7-3 [2] B4-33 ;
- () DB1 BUS-52 [1] A7-6 [2] B4-32 ;
- () DB2 BUS-53 [1] A7-12 [2] B4-31 ;
- () DB3 BUS-54 [1] A7-15 [2] B4-30 ;
- () DB4 BUS-55 [1] A8-3 [2] B4-29 ;
- () DB5 BUS-56 [1] A8-6 [2] B4-28 ;
- () DB6 BUS-57 [1] A8-12 [2] B4-27 ;
- () DB7 BUS-58 [1] A8-15 [2] B4-26 ;
- () IO BUS-24 [1] A4-15 [2] C6-1 ;
- () MEM BUS-23 [1] A3-15 [2] A5-2 [1] C6-2 [2]
D5-13 ;
- () V30 BUS-62 ;
- () *A008 BUS-27 [1] A5-6 ;

() *A109 BUS-28 [1] A5-7 ;
 () *A210 BUS-29 [1] A4-1 [2] C6-4 ;
 () *A311 BUS-30 [1] C6-5 ;
 () *A412 BUS-31 ;
 () *A513 BUS-32 [1] A4-4 ;
 () *A614 BUS-33 ;
 () *A715 BUS-34 ;
 () *DMA BUS-19 [1] BUS-20 ;
 () *DREQ BUS-21 [1] A6-15 ;
 () *ENA BUS-25 [1] D5-14 ;
 () *HALT BUS-22 ;
 () *IRQ0 BUS-11 ;
 () *IRQ1 BUS-12 ;
 () *IRQ2 BUS-13 ;
 () *IRQ3 BUS-14 ;
 () *IRQ4 BUS-15 ;
 () *IRQ5 BUS-16 ;
 () *IRQ6 BUS-17 [1] B4-38 [2] B4-37 ;
 () *REFR BUS-61 ;
 () *RESET BUS-18 [1] B4-34 ;
 () *RPLY BUS-60 [1] A6-12 ;
 () *SEL B4-23 [1] A4-12 [2] A2-13 [1] A2-1 ;
 () *SVCT BUS-7 [1] A3-9 [2] A1-3 [1] A1-2 [2]
 A6-6 ;
 () *VCT1 BUS-9 [1] A2-9 [2] A2-5 [1] D4-17 ;
 () *VCT0 BUS-10 ;
 () *WP BUS-8 [1] A6-9 [2] A6-3 [1] C6-14 ;
 () *WRITE BUS-26 [1] A3-6 [2] A2-17 [1] B1-1 [2]
 C5-17 [1] C6-13 [2] C7-16 [1] C8-16 [2]
 B4-21 ;
 () A1-4 [1] A1-17 ;
 () A1-5 [1] A1-16 ;

- () A1-6 [1] A1-15 [2] A6-17 ;
- () A1-11 [1] D5-12 ;
- () A1-13 [1] A6-16 ;
- () A1-19 [1] A1-18 [2] A1-1 ;
- () A2-6 [1] A2-16 [2] A6-13 ;
- () A2-12 [1] C5-15 ;
- () A2-19 [1] A2-18 [2] A2-10 ;
- () A3-12 [1] A2-4 [2] D4-1 ;
- () A3-19 [1] A3-18 [2] A3-16 [1] A3-10 ;
- () A4-19 [1] A4-18 [2] A4-16 [1] A4-10 ;
- () A5-11 [1] A2-2 [2] D5-5 ;
- () A5-19 [1] A5-18 [2] A5-1 [1] A5-3 [2]
A5-4 ;
- () A6-19 [1] A6-18 [2] A6-10 ;
- () A7-4 [1] A7-2 [2] C7-11 [1] D6-9 [2]
D1-9 [1] C1-9 ;
- () A7-7 [1] A7-5 [2] C7-12 [1] D6-10 [2]
D1-10 [1] C1-10 ;
- () A7-11 [1] A7-13 [2] C7-13 [1] D6-11 [2]
D1-11 [1] C1-11 ;
- () A7-14 [1] A7-16 [2] C7-14 [1] C1-13 [2]
D1-13 [1] D6-13 ;
- () A7-19 [1] A7-18 ;
- () A8-4 [1] A8-2 [2] C8-11 [1] D6-14 [2]
D1-14 [1] C1-14 ;
- () A8-7 [1] A8-5 [2] C8-12 [1] D6-15 [2]
D1-15 [1] C1-15 ;
- () A8-11 [1] A8-13 [2] C8-13 [1] D6-16 [2]
D1-16 [1] C1-16 ;
- () A8-14 [1] A8-16 [2] C8-14 [1] D6-17 [2]
D1-17 [1] C1-17 ;
- () A8-19 [1] A8-18 ;
- () B1-4 [1] C6-3 ;
- () B1-8 [1] B1-7 ;
- () B1-19 [1] B1-18 [2] B1-3 ;

- () B2-8 [1] B2-7 ;
- () B2-19 [1] B2-18 ;
- () B3-8 [1] B3-7 ;
- () B3-19 [1] B3-18 ;
- () B4-2 [1] B2-14 ;
- () B4-3 [1] B2-16 ;
- () B4-4 [1] B3-2 ;
- () B4-5 [1] B3-4 ;
- () B4-6 [1] B3-6 ;
- () B4-7 [1] B3-12 ;
- () B4-8 [1] B3-14 ;
- () B4-9 [1] B3-16 ;
- () B4-10 [1] B1-6 ;
- () B4-11 [1] B1-12 ;
- () B4-12 [1] B1-14 ;
- () B4-13 [1] B1-16 ;
- () B4-14 [1] B2-2 ;
- () B4-15 [1] B2-4 ;
- () B4-16 [1] B2-6 ;
- () B4-17 [1] B2-12 ;
- () B4-18 [1] B3-11 [2] B2-11 [1] B1-11 [2]
A4-9 ;
- () B4-19 [1] B1-2 ;
- () B4-39 [1] A6-1 [2] A6-2 [1] A6-4 [2]
A6-5 ;
- () B4-40 [1] A1-14 [2] A1-7 ;
- () B4-41 [1] B4-24 [2] B4-22 [1] B4-20 ;
- () C1-5 [1] C4-12 [2] C7-1 [1] C8-1 [2]
D6-5 [1] D1-5 ;
- () C1-7 [1] C4-4 [2] D1-7 [1] C7-3 [2]
C8-3 [1] D6-7 ;
- () C1-8 [1] C4-2 [2] D1-8 [1] C7-4 [2]
C8-4 [1] D6-8 ;

() C1-12 [1] C1-18 ;
() C1-20 [1] D5-3 ;
() C1-23 [1] D1-23 [2] D6-23 [1] C5-6 ;
() C1-25 [1] C1-24 ;
() C1-26 [1] C1-19 ;
() C1-27 [1] C1-21 ;
() C4-19 [1] C4-18 ;
() C5-12 [1] C1-22 [2] D1-22 [1] D6-22 ;
() C5-14 [1] A7-1 [2] A7-17 [1] A8-1 [2]
A8-17 ;
() C5-16 [1] C7-9 [2] C8-9 ;
() C5-19 [1] C5-18 ;
() C6-6 [1] A3-1 ;
() C6-12 [1] A5-5 ;
() C6-19 [1] C6-18 ;
() C7-19 [1] C7-18 ;
() C8-2 [1] C7-2 [2] D6-6 [1] C4-6 [2]
C1-6 [1] D1-6 ;
() C8-5 [1] C7-5 [2] C4-16 [1] D6-3 [2]
D1-3 [1] C1-3 ;
() C8-6 [1] C7-6 [2] C5-2 [1] D6-2 [2]
D1-2 [1] C1-2 ;
() C8-7 [1] C7-7 [2] C5-4 [1] D6-1 [2]
D1-1 [1] C1-1 ;
() C8-17 [1] C7-17 [2] D6-4 [1] D4-16 [2]
D1-4 [1] C1-4 [2] C4-14 ;
() C8-19 [1] C8-18 ;
() D1-12 [1] D1-18 ;
() D1-20 [1] D4-5 ;
() D1-25 [1] D1-24 ;
() D1-26 [1] D1-19 ;
() D1-27 [1] D1-21 ;
() D4-4 [1] D5-1 ;

- () D4-11 [1] D5-4 ;
- () D4-12 [1] D5-2 ;
- () D4-19 [1] D4-18 ;
- () D5-6 [1] C7-15 [2] C8-15 [1] C8-10 [2]
C7-10 ;
- () D5-19 [1] D5-18 ;
- () D6-12 [1] D6-18 ;
- () D6-20 [1] D4-6 ;
- () D6-25 [1] D6-24 ;
- () D6-26 [1] D6-19 ;
- () D6-27 [1] D6-21 ;

BEFORE PROCEEDING ANY FARTHER:

- () PLUG THE CARD INTO THE EXTENDER CARD.
- () PLUG THE EXTENDER CARD INTO THE CARD CAGE, INCLUDING POWER SUPPLY.
- () PLUG IN THE POWER.

TEST THE FOLLOWING VOLTAGES WITH A VOLTAGE METER:

- () () () () +5V ON +5V BUSS BAR.
- () () +12V ON +12V BUSS BAR.
- () () -5V ON -5V BUSS BAR.

IF THESE VOLTAGES ARE NOT CORRECT, CHECK FOR SOLDER BRIDGES OR COLD SOLDER JOINTS ON THE SOLDERED COMPONENTS ON THE EDGE OF THE CARD. IF THERE ARE ANY SOLDER BRIDGES, FIX THEM AND RETEST THE VOLTAGES.

SECTION 6 COMPONENT INSTALLATION

6.1 INSTALLING 8-, 14-, 16-, AND 18-PIN IC'S

A STATIC ELECTRICITY DISCHARGE CAN DAMAGE THESE CIRCUITS. IT IS VERY IMPORTANT THAT CARE BE TAKEN TO AVOID BUILDUP OF STATIC ELECTRICITY WHEN HANDLING THESE COMPONENTS:

WORK ONLY ON AN UNCARPETED FLOOR. BEFORE HANDLING THESE COMPONENTS, TOUCH A WATER FAUCET OR OTHER GROUND POINT TO DISCHARGE STATIC ELECTRICITY.

HOLD THE IC BY THE EDGES, NOT TOUCHING THE PINS, AND USING THE WORK SURFACE, BEND THE PINS ON EACH SIDE OF THE IC TO A 90-DEGREE ANGLE.

ORIENT THE CIRCUIT CARD SO THAT THE SOCKETS ARE FACING UP WITH THE DIMPLE IN THE LEFT CORNER AND THE BUS CONNECTOR TOWARD YOU.

USING A SLOW, FIRM, DOWNWARD PRESSURE, WORK THE IC INTO THE SOCKET.

IF A LEAD STARTS TO BEND, PULL OUT THE IC, STRAIGHTEN THE LEADS WITH A PAIR OF NEEDLENOSED PLIERS, AND START THE PROCEDURE AGAIN.

INSTALL THE SPECIFIED 14-PIN IC'S TOWARD THE TOP OF THE SOCKET. THE BOTTOM 4 PINS ARE LEFT EMPTY.

()	LOCATION A2, PART 74LS20	()	LOCATION A3, PART 74LS30
()	LOCATION A4, PART 74LS30	()	LOCATION A6, PART 74LS26
()	LOCATION C4, PART 74LS04	()	LOCATION C5, PART 74LS04
()	LOCATION C6, PART 74LS32	()	LOCATION D6, PART 74LS08

INSTALL THE SPECIFIED 16-PIN IC'S TOWARD THE TOP OF THE SOCKET. THE BOTTOM 2 PINS ARE LEFT EMPTY.

()	LOCATION A1, PART 74LS195	()	LOCATION A5, PART 74LS133
()	LOCATION A7, PART 8T26	()	LOCATION A8, PART 8T26
()	LOCATION B1, PART DM8136	()	LOCATION B2, PART DM8136
()	LOCATION B3, PART DM8136	()	LOCATION D4, PART 74LS139

INSTALL THE SPECIFIED 18-PIN IC'S IN THESE LOCATIONS.

()	LOCATION C7, PART P2111-1	()	LOCATION C8, PART P2111-1
-----	---------------------------	-----	---------------------------

6.2 INSTALLING 24- AND 40-PIN IC'S

INSTALL THE SPECIFIED 24-PIN IC'S IN THESE LOCATIONS. ORIENT THE DOT ON THE IC TOWARD THE LOWER LEFT-HAND CORNER.

()	LOCATION	()	LOCATION
()	LOCATION C1, PART 2708 (#1)	()	LOCATION D1, PART 2708 (#2)

INSTALL THE SPECIFIED 40-PIN IC IN THE FOLLOWING LOCATION. ORIENT THE DOT IN THE LOWER LEFT-HAND CORNER.

()	LOCATION B4,5,6,7,8 PART MC6820
()	CONFIRM DOT IN LOWER LEFT-HAND CORNER.

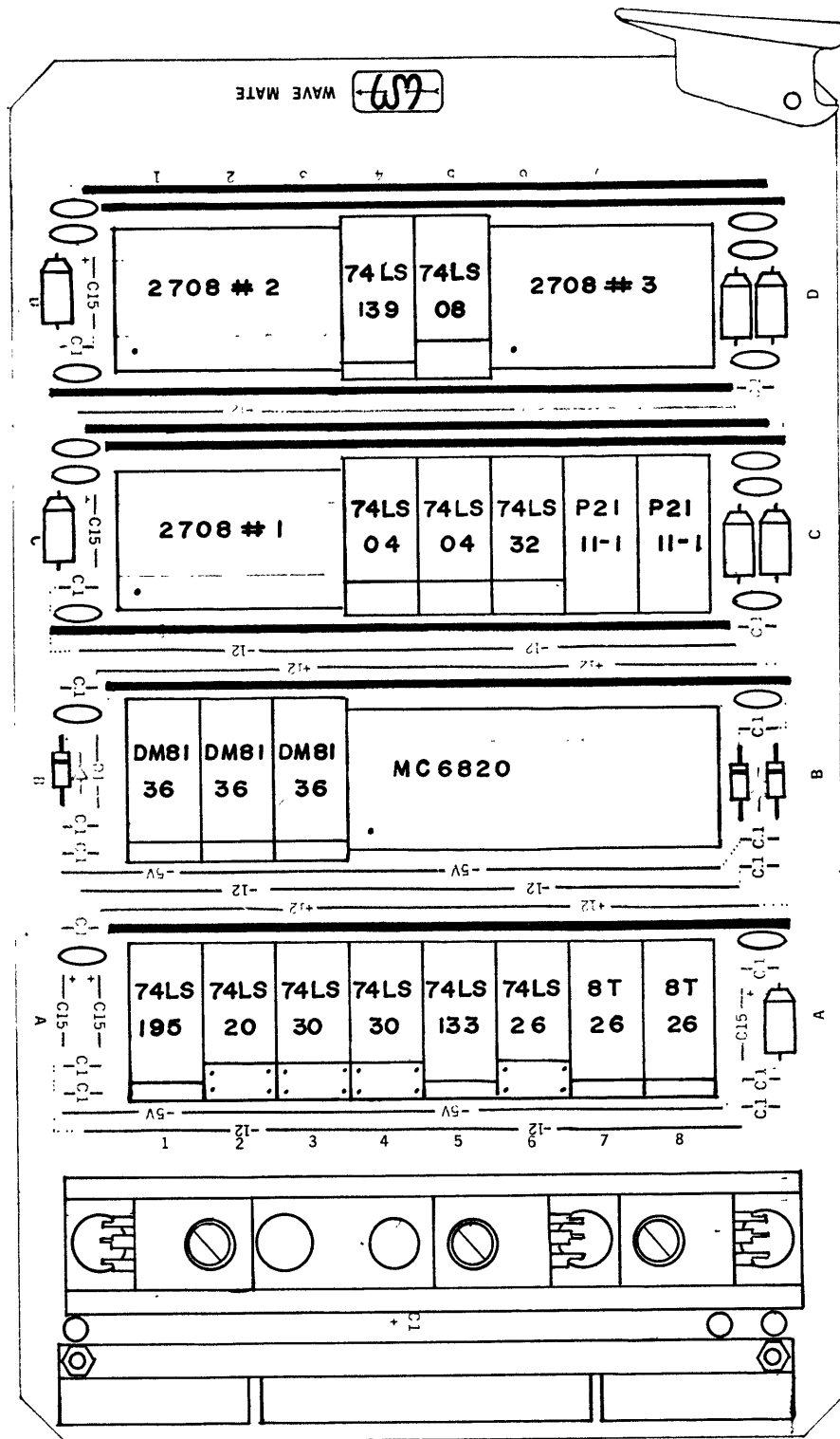

6.3 INSTALLING DISCRETE COMPONENTS

LOCATION A2

() INSTALL 4.7K OHM RESISTOR (YELLOW, PURPLE, RED) IN HOLES
CORRESPONDING TO THESE PINS OF THE SOCKET:
9 AND 10

LOCATION A3

() INSTALL 2.2K OHM RESISTOR (RED, RED, RED) IN HOLES CORRESPONDING
TO THESE PINS OF THE SOCKET:
9 AND 10

LOCATION A4

() INSTALL 4.7K OHM RESISTOR (YELLOW, PURPLE, RED) IN HOLES
CORRESPONDING TO THESE PINS OF THE SOCKET:
9 AND 10

LOCATION A6

() INSTALL 2.2K OHM RESISTOR (RED, RED, RED) IN HOLES CORRESPONDING
TO THESE PINS OF THE SOCKET:
9 AND 10

LOCATION A2

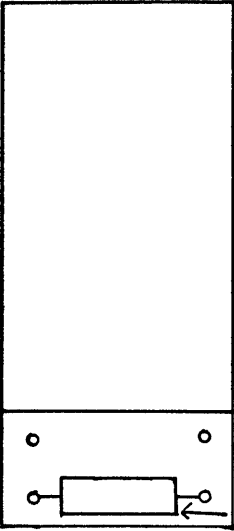

4.7K OHM RESISTOR (YELLOW-PURPLE-RED)

LOCATION A4

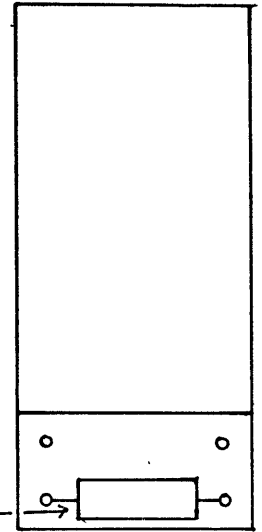

4.7K OHM RESISTOR (YELLOW-PURPLE-RED)

LOCATION A6

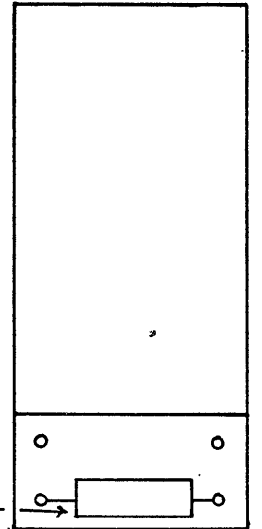

2.2K OHM RESISTOR (RED-RED-RED)

LOCATION A3

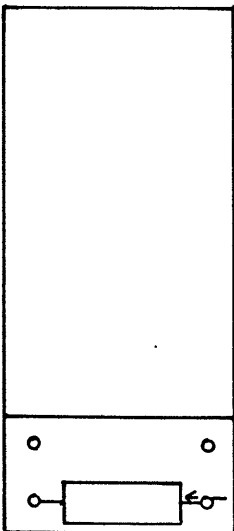

2.2K OHM RESISTOR (RED-RED-RED)

5/21/77

Mod to Debug Card to remove Write Protect
on Debug Ram Storage:

C6-12 A5-5; — deleted.

A5-5 - A5-4 — added.

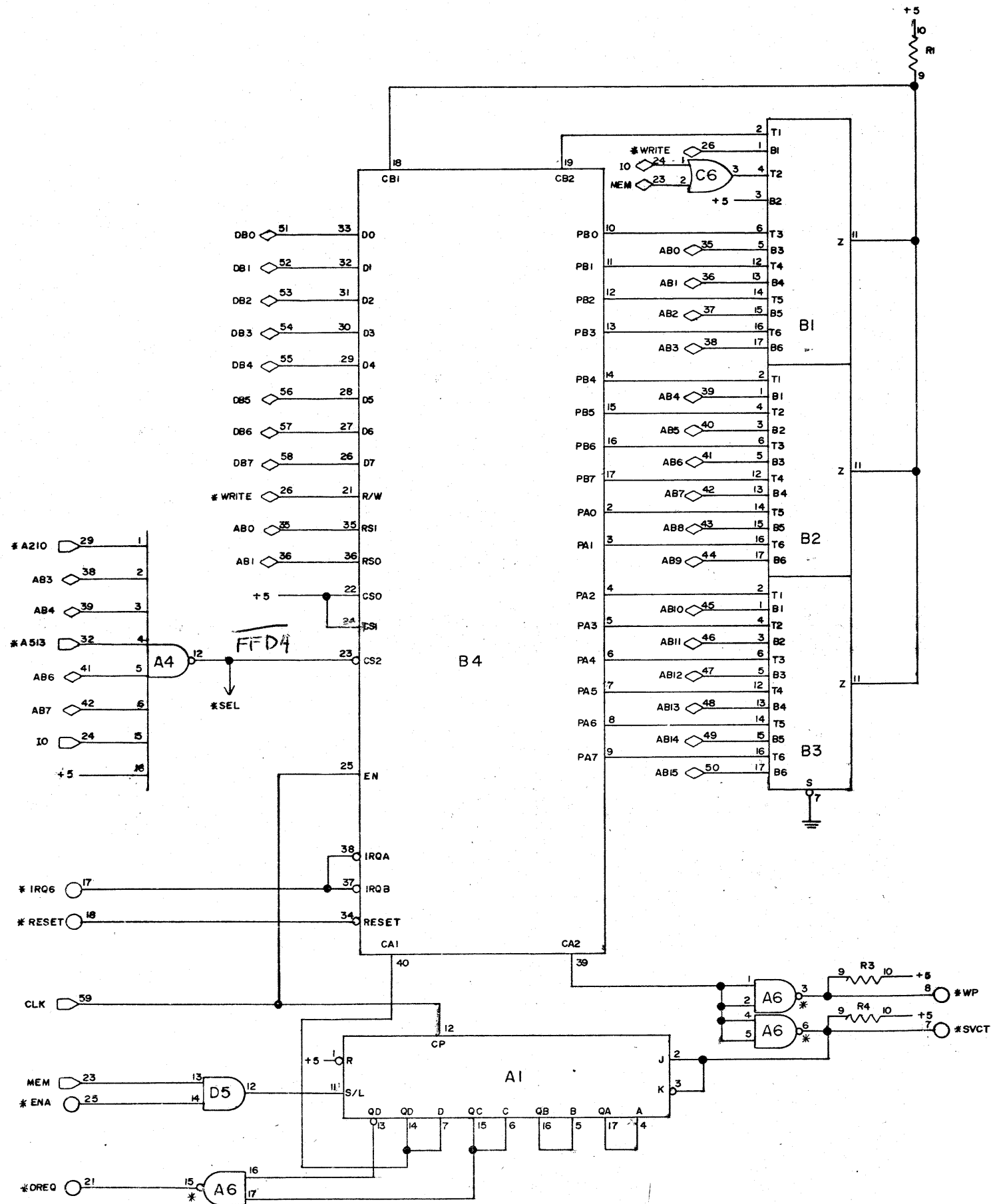

UNUSED
ELEMENTS

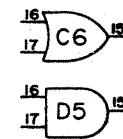

SYSTEM DEBUGGER MODULE

SDM-125 1-10-76

COPYRIGHT 1976 WAVE MATE

SHEET 1 OF 2

DRAWN BY: *A. Martin*

REVISION:

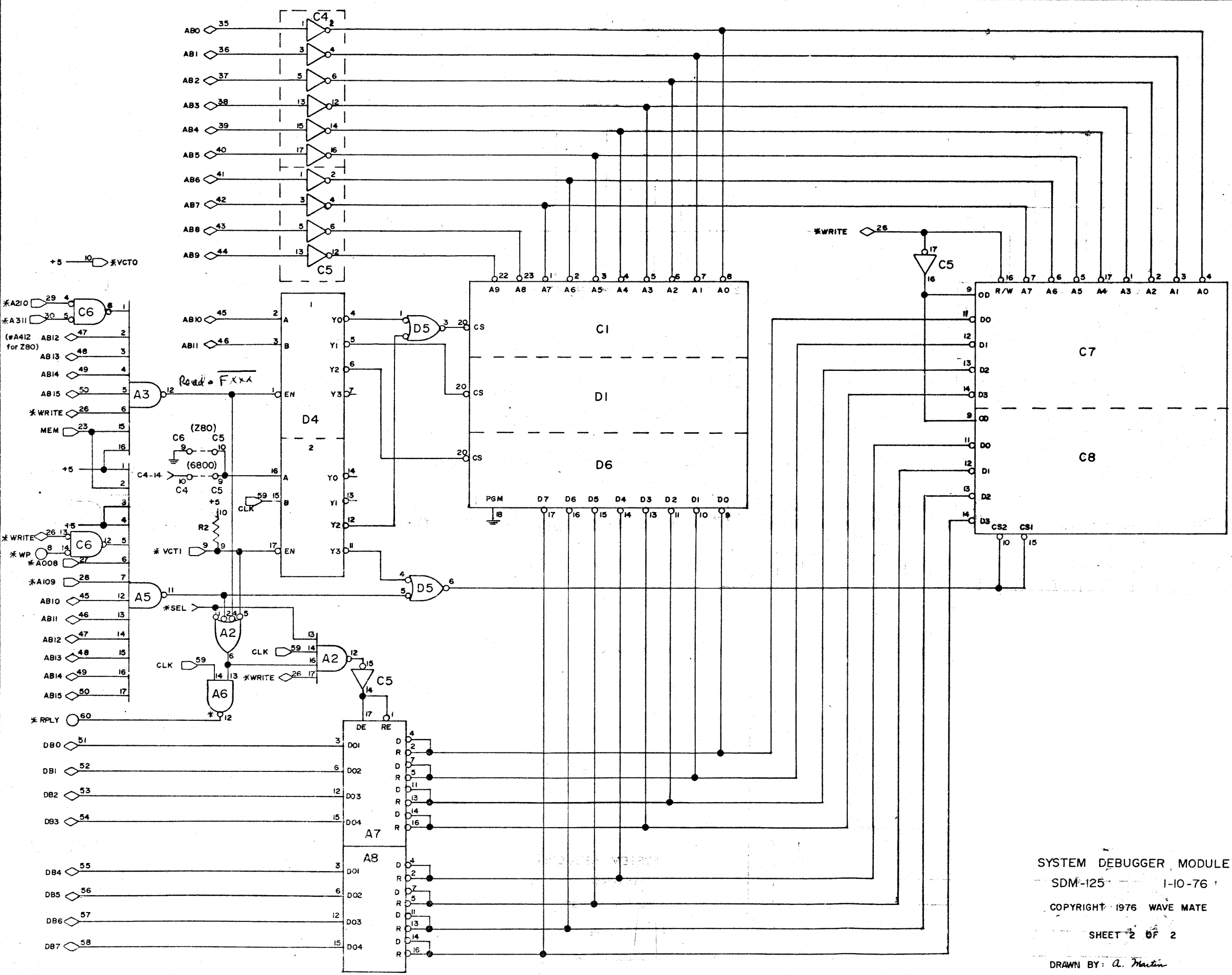

SYSTEM DEBUGGER MODULE
 SDM-125 1-10-76
 COPYRIGHT 1976 WAVE MATE
 SHEET 2 OF 2

DRAWN BY: A. Martin
 REVISION:

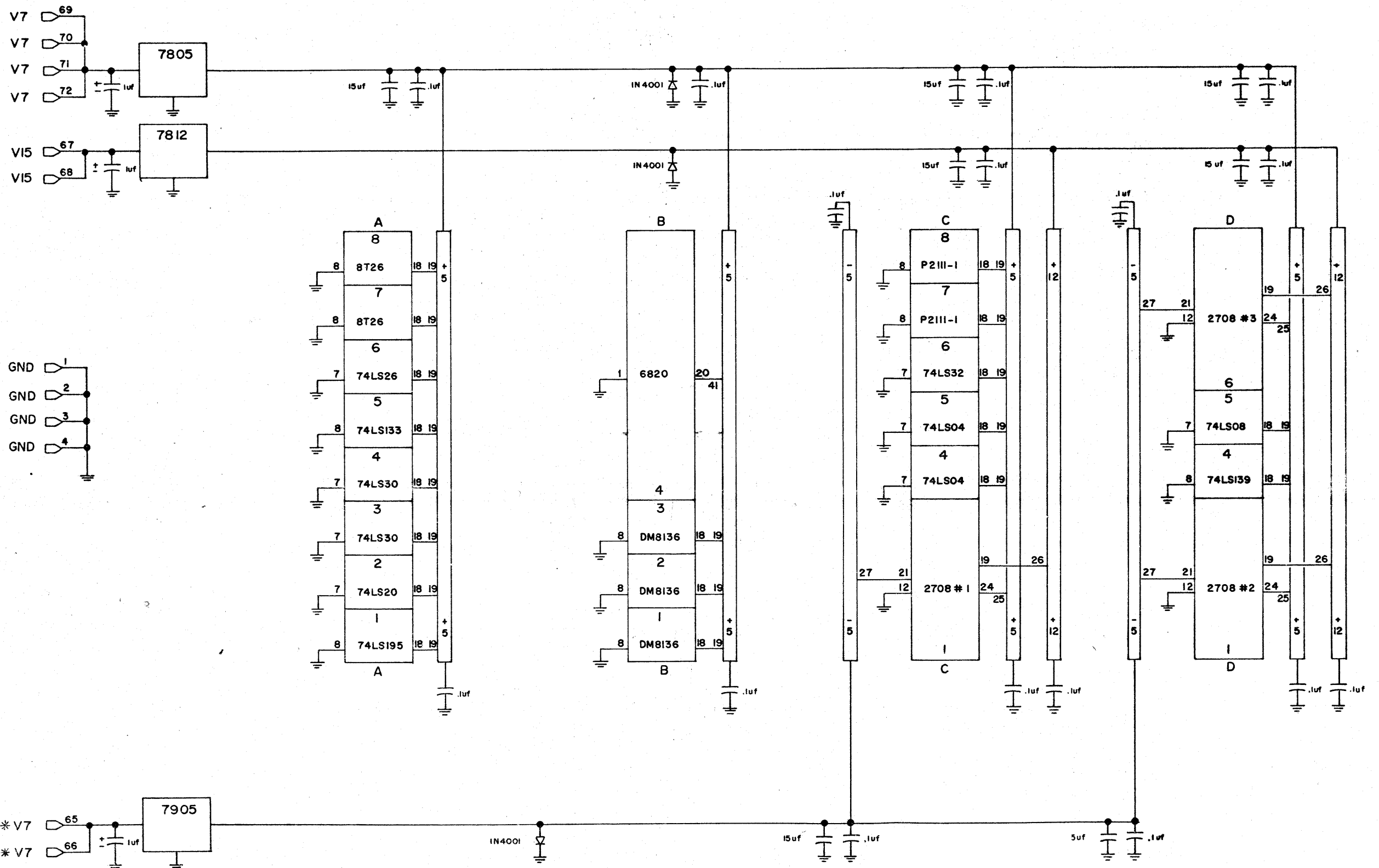

POWER DISTRIBUTION :
 SOFTWARE DEBUGGER MODULE
 SDM-125

COPYRIGHT 1977 WAVE MATE

DRAWN BY: *A. Martin*

REVISION :

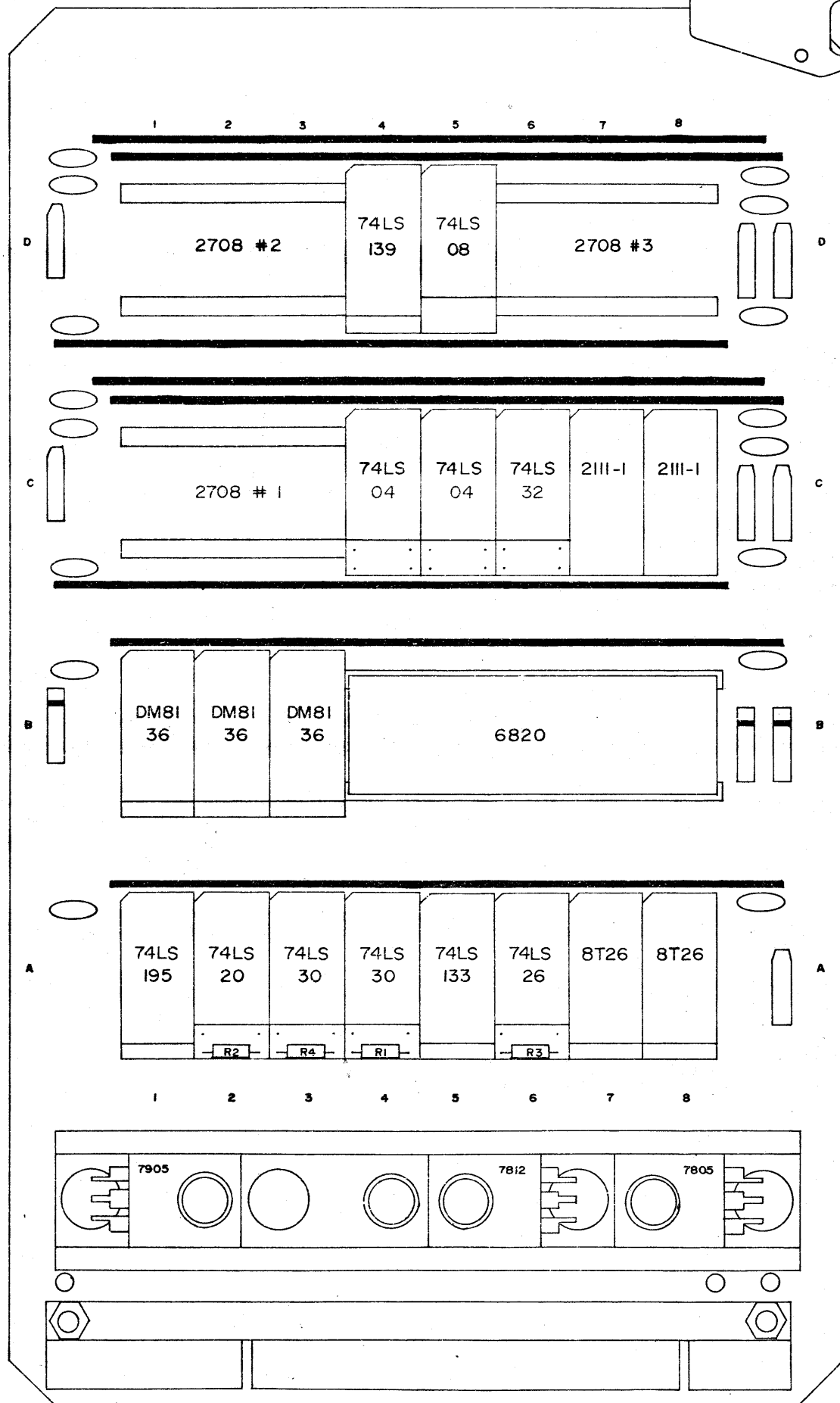

INTEGRATED CIRCUITS

NAME	PART NUMBER
A1	74LS195
A2	74LS20
A3	74LS30
A4	74LS30
A5	74LS133
A6	74LS26
A7	8T26
A8	8T26
B1	DM8136
B2	DM8136
B3	DM8136
B4	6820
C1	2708 # 1
C4	74LS04
C5	74LS04
C6	74LS32
C7	2111 -1
C8	2111 -1
D1	2708 # 2
D4	74LS139
D5	74LS08
D6	2708 # 3

CPU SELECTION

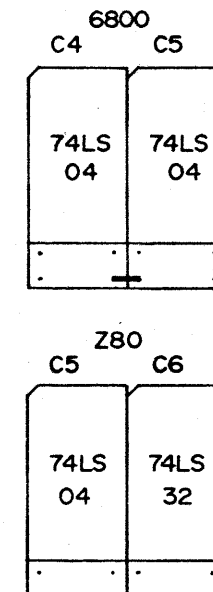

DISCRETES

LOCATION & NAME	PART NUMBER
A2 - R2	4.7K RESISTOR 5%
A3 - R4	2.2K " "
A4 - R1	4.7K " "
A6 - R3	2.2K " "

SYSTEM DEBUGGER MODULE

SDM-125 1-10-76

COPYRIGHT 1976 WAVE MATE

DRAWN BY: *A. Martin*

REVISION :