

HP 16500A/HP 16501A Logic Analysis System

Reference Manual



 **HEWLETT
PACKARD**

Logic Analysis System Reference Manual

**HP 16500A/16501A
Logic Analysis System**



©Copyright Hewlett Packard Company 1987, 1990

Printing History

First Edition-October 1987
Second Edition-December 1990

Printed in U.S.A.

Product Warranty

This Hewlett-Packard product has a warranty against defects in material and workmanship for a period of 1 year from date of shipment. During warranty period, Hewlett-Packard Company will, at its option, either repair or replace products that prove to be defective.

For warranty service or repair, this product must be returned to a service facility designated by Hewlett-Packard. However, warranty service for products installed by Hewlett-Packard and certain other products designated by Hewlett-Packard will be performed at Buyer's facility at no charge within the Hewlett-Packard service travel area. Outside Hewlett-Packard service travel areas, warranty service will be performed at Buyer's facility only upon Hewlett-Packard's prior agreement and Buyer shall pay Hewlett-Packard's round trip travel expenses.

For products returned to Hewlett-Packard for warranty service, the Buyer shall prepay shipping charges to Hewlett-Packard and Hewlett-Packard shall pay shipping charges to return the product to the Buyer. However, the Buyer shall pay all shipping charges, duties, and taxes for products returned to Hewlett-Packard from another country.

Hewlett-Packard warrants that its software and firmware designated by Hewlett-Packard for use with an instrument will execute its programming instructions when properly installed on that instrument. Hewlett-Packard does not warrant that the operation of the instrument, software, or firmware will be uninterrupted or error-free.

Limitation of Warranty

The foregoing warranty shall not apply to defects resulting from improper or inadequate maintenance by the Buyer, Buyer-supplied software or interfacing, unauthorized modification or misuse, operation outside of the environmental specifications for the product, or improper site preparation or maintenance.

NO OTHER WARRANTY IS EXPRESSED OR IMPLIED. HEWLETT-PACKARD SPECIFICALLY DISCLAIMS THE IMPLIED WARRANTIES OF MERCHANTABILITY AND FITNESS FOR A PARTICULAR PURPOSE.

Exclusive Remedies

THE REMEDIES PROVIDED HEREIN ARE BUYER'S SOLE AND EXCLUSIVE REMEDIES. HEWLETT-PACKARD SHALL NOT BE LIABLE FOR ANY DIRECT, INDIRECT, SPECIAL, INCIDENTAL, OR CONSEQUENTIAL DAMAGES, WHETHER BASED ON CONTRACT, TORT, OR ANY OTHER LEGAL THEORY.

Assistance

Product maintenance agreements and other customer assistance agreements are available for Hewlett-Packard products.

For assistance, contact your nearest Hewlett-Packard Sales and Service Office. Addresses are provided at the back of this operating manual.

Certification

Hewlett-Packard Company certifies that this product met its published specifications at the time of shipment from the factory. Hewlett-Packard further certifies that its calibration measurements are traceable to the United States National Bureau of Standards, to the extent allowed by the Bureau's calibration facility, and to the calibration facilities of other International Standards Organization members.

Safety

This product has been designed and tested according to International Safety Requirements. To ensure safe operation and to keep the product safe, the information, cautions, and warnings in this operating manual must be heeded.

Contents

Chapter 1	What Is the HP 16500A/16501A Logic Analysis System?	
	Key Features	1-1
	Optional Features	1-2
	User Interfaces	1-2
	Default Configurations	1-3
	Storing Default Configurations	1-4

Chapter 2	Learning to Use the HP 16500A/16501A	
	The Display	2-1
	User Interfaces	2-3
	The Touchscreen	2-4
	Types of Fields	2-4
	Pop-Up Menus	2-5
	Pattern Fields	2-6
	Multiple-Choice Listings	2-7
	Toggle Fields	2-7
	Immediate-Action Fields	2-8
	Knob/Numeric Fields	2-8
	Alphanumeric Keypads	2-9
	Entering Information with the Keypad	2-9
	The Optional Mouse	2-10
	Connecting the Mouse	2-10
	Disconnecting the Mouse	2-13
	The Optional Keyboard	2-13
	Connecting the Keyboard	2-13
	Disconnecting the Keyboard	2-15
	The Knob	2-15
	The Cursor	2-15
	Exercises	2-16

Chapter 3

Using the Optional Keyboard Interface

Moving the Cursor	3-1
Cursor Keys	3-1
Tab Key	3-1
Home Key	3-2
Next and Previous Keys	3-2
Selecting a Menu Item	3-2
Entering Data into a Menu	3-2
Autoroll	3-3
Using the Keyboard Overlays	3-4
Don't Care Key	3-5
Function Keys	3-5
Defining Time Units	3-6
Defining Voltage Units	3-6
Assigning Edge Triggers	3-7
Closing a Menu	3-7

Chapter 4

The System Configuration Menu

Getting into the System Configuration Menu	4-1
Layout of the System Configuration Menu	4-2
Slot Designators	4-4
Menu Map	4-5

Chapter 5

HP-IB and RS-232C

The Controller Interface	5-1
The Printer Interface	5-1
What Is the HP-IB Interface?	5-1
Selecting an Address	5-2
What Is the RS-232C Interface?	5-2
Baud Rate	5-2
Stop Bits	5-3
Parity	5-3
Data Bits	5-4
Protocol	5-4
Configuring the Interface for a Controller or a Printer	5-5

Chapter 6	The Optional HP 16501A Expansion Frame	
	Features	6-1
	Component Details	6-1
	Expansion Frame Interface Board	6-1
	Main Frame Interface Board	6-2
	System Configuration	6-2
	System Arming and Triggering	6-3
	Connecting the HP 16501A Expansion Frame	6-5

Chapter 7	Connecting a Printer	
	HP-IB Printers	7-1
	HP-IB Printer Setup	7-1
	HP-IB Configuration	7-3
	RS-232C Printers	7-4
	RS-232C Printer Setup	7-4
	RS-232C Configuration	7-6
	Configuration Example	7-8
	Connecting to Other Hewlett-Packard Printers	7-8
	Printing the Display	7-10

Chapter 8	The System Front and Rear Disk Menus	
	Getting into the System Front Disk Menu	8-1
	The Disk Operations	8-2
	Menu Map	8-4
	Selecting a Disk Operation	8-5
	Disk Operation Parameters	8-6
	Source and Destination Disks	8-7
	Installing a Disk	8-8
	Formatting a Disk	8-9
	Storing on a Disk	8-11
	The Load Operation	8-15
	Renaming a File	8-18
	The Autoload Operation	8-20
	Purging a File	8-22
	Copying a File	8-23
	The Pack Disk Operation	8-26
	Duplicating a Disk	8-26

Chapter 9	The System Utilities Menu	
	Getting into the System Utilities Menu	9-1
	Layout of the System Utilities Menu	9-2
	Menu Map	9-3

Chapter 10	The Touch and Sound Fields of the System Utilities Menu	
	Getting into the System Utilities Menu	10-1
	Touch Calibration	10-2
	Touch On	10-4
	Sound On	10-5

Chapter 11	Display Color Selection (System Utilities Menu)	
	Getting into the System Utilities Menu	11-1
	The Color Model	11-2
	Selecting the Color, Hue, Saturation, and Luminosity Fields	11-4
	The Color Field	11-6
	Returning to the Default Colors	11-8

Chapter 12	Intermodule Measurements	
	Why Use Intermodule Measurements?	12-1
	Getting into the Intermodule Menu	12-1
	The Intermodule Menu	12-2
	Menu Map	12-4
	What Happens When You Touch Group Run?	12-5
	For the HP 16500A Alone	12-5
	For the HP 16500A With the HP 16501A Attached	12-6
	What Are Some Typical Intermodule Measurements?	12-7
	Example 1: Analyzing a Glitch	12-8
	Example 2: Analyzing Interrupt Handling in a CPU System	12-9
	Example 3: A Simple Stimulus/ Response System	12-10
	How Are Intermodule Measurements Set Up?	12-11
	The Group Run Configuration Field	12-12
	The Group Run/Stop Field	12-13
	The Modules	12-14
	PORT OUT	12-15

Status Indicators and Time Correlation Bars	12-16
The Skew Menu	12-17
Displaying Multiple Module Data on One Screen	12-18
Helpful Hints	12-21
Exercise	12-21

Appendix A

General Characteristics

Interface	A-1
Hardware Connectivity	A-3
Programmability	A-4
Hardcopy Capability	A-4
Input/Output Rear-Panel BNCs	A-4
Interactive Measurements	A-5
Operating Environment	A-6
Ventilation Requirements	A-6
Power Requirements	A-7
Weight	A-7
Dimensions	A-7

Appendix B

Repackaging for Shipment

The Storage and Shipment Environment	B-1
Tagging the Instrument for Service	B-1
Repacking the Instrument	B-1

Appendix C

Maintaining the HP 16500A/16501A

Cleaning Requirements	C-1
Degaussing	C-1
Service and Calibration	C-2
The System Test Menu	C-3

Appendix D

Self-Test Documentation

Fail Codes	D-2
Critical Errors	D-3
Non-Critical Errors	D-3

Appendix E	Disk Error Messages	
	Disk Error Messages	E-1
	Disk Warning Messages	E-3

Appendix F	Installing and Removing Cards	
	Where Do Cards Mount?	F-1
	Installing Cards in the HP 16500A/16501A	F-3
	Removing Cards from the HP 16500A/16501A	F-5

Appendix G	Creating a System Disk	
	What Files are Required on the System Disk?	G-1
	Creating a New System Disk	G-2
	Adding a Module to the System Disk	G-3
	Updating a System Disk	G-4
	What Is a System Performance Verification Disk?	G-7

Index

Introduction

Welcome to the Hewlett-Packard Logic Analysis System! The HP 16500A/16501A Logic Analysis System has been designed to be the easiest system to use, ever. Its modular mainframe allows you to configure the HP 16500A/16501A with just the modules you want and add additional modules later.

This manual explains the operation of the System and Intermodule menus of the HP 16500A/16501A Logic Analysis System. It is organized like an encyclopedia, breaking down the functions and features into their major sections, and giving more of a conceptual example of their different applications. The manual is laid out so you can find your information quickly and easily.

Chapter 1 introduces the HP 16500A/16501A by summarizing the features of the instruments.

Chapter 2 introduces the user interfaces and shows you how easy they are to use. This chapter provides a step-by-step tutorial on operating the user interfaces.

Chapter 3 describes the optional keyboard interface, detailing the functions of the keys and explaining the use of the keyboard overlays.

Chapters 4 and 5 discuss the features of the System Configuration menu, including the HP-IB and RS-232C interfaces for hardcopy capabilities and controller interface.

Chapter 6 describes the features, components, and system configuration of the optional HP 16501A expansion frame.

Chapter 7 explains how to output screen displays from the HP 16500A to various HP-IB and RS-232C graphics printers.

Chapter 8 explains the disk operations of the HP 16500A/16501A and tells you how to get into the system's Front and Read Disk menus.

Chapters 9, 10, and 11 describe the System Utilities menu and the touch calibration and color selection capabilities available through the menu.

Chapter 12 introduces you to the intermodule measurement capabilities of the HP 16500A/16501A and gives several examples of possible applications.

Appendix A lists the general characteristics of the HP 16500A/16501A.

Appendices B and C cover repacking and general maintenance for the HP16500/16501A.

Appendix D describes the self-test that is performed when the HP 16500A/16501A is turned on.

Appendix E lists the different error messages of the System Disk menus, briefly describing what each means.

Appendix F explains how to install and remove cards for individual modules.

Appendix G explains how to create a system disk.

If you haven't already read the manual *Setting Up The HP 16500 Logic Analysis System*, please read it before continuing.

What Is the HP 16500A/16501A Logic Analysis System?

The HP 16500A is the mainframe of the Hewlett-Packard Logic Analysis System. It offers a modular structure for plug-in cards with a wide range of state, timing, oscilloscope, and pattern generator capabilities. This allows you to configure the HP 16500A using only the modules you need in order to perform a desired measurement or set of measurements, while giving you the flexibility to change or update them later.

The HP 16501A is the add-on mainframe for expanding the module capacity of the HP 16500A. When the HP 16501A is connected to the HP 16500A, they function as a single nine-card system which is turned on and controlled by the HP 16500A. The HP 16501A forms a tightly coupled system with the HP 16500A, permitting each of the two mainframes to arm or trigger any module from any other module.

The Logic Analysis System provides both experienced and first-time users with powerful measurement capabilities. The pop-up menus and color graphics lead you through setups and measurements quickly and easily, without the need to memorize a lot of steps. By touching the appropriate fields or using the cursor of either the optional mouse or keyboard, you can perform functions, configure menus, and move from one menu to another.

With the intermodule capabilities of the Logic Analysis System, you can make interactive measurements between modules. This allows you to configure modules to interact with each other, using the triggering capabilities of one module and the acquisition capabilities of another to make measurements.

Key Features

The key features of the HP 16500A are:

- Modular mainframe with five card slots.
- 9-inch color monitor.
- Touchscreen.

- Dual 3.5-inch flexible disk drives.
 - Intermodule triggering and time correlation of gathered data.
 - HP-IB and RS-232C interfaces for:
 - Hardcopy output to a printer
 - Controller interface.
-

Optional Features

The optional features of the HP 16500A/16501A are:

- Modular mainframe with nine card slots (HP 16501A connected to the HP 16500A).
 - Mouse.
 - Keyboard.
-

User Interfaces

The HP 16500A/16501A has four user interface devices: the knob on the front panel, the touchscreen, the optional mouse, and the optional keyboard.

The knob on the front panel is used to move the cursor on certain menus, increment or decrement numeric fields, and to roll the display.

The touchscreen fields can be selected by touch or with the optional mouse or keyboard. To activate a field by touch, press the field (the dark blue box) on the display with your finger until the field changes color. Then move your finger away from the screen to activate your selection.

To activate a field with the optional mouse, position the cursor (+) of the mouse over the desired field and press the button on the upper-left corner of the mouse.

To activate a field using the optional keyboard, position the keyboard cursor (the location highlighted in inverse video) on the desired field and press either the Return or Select key.

The user interfaces are discussed in more detail in Chapter 2.

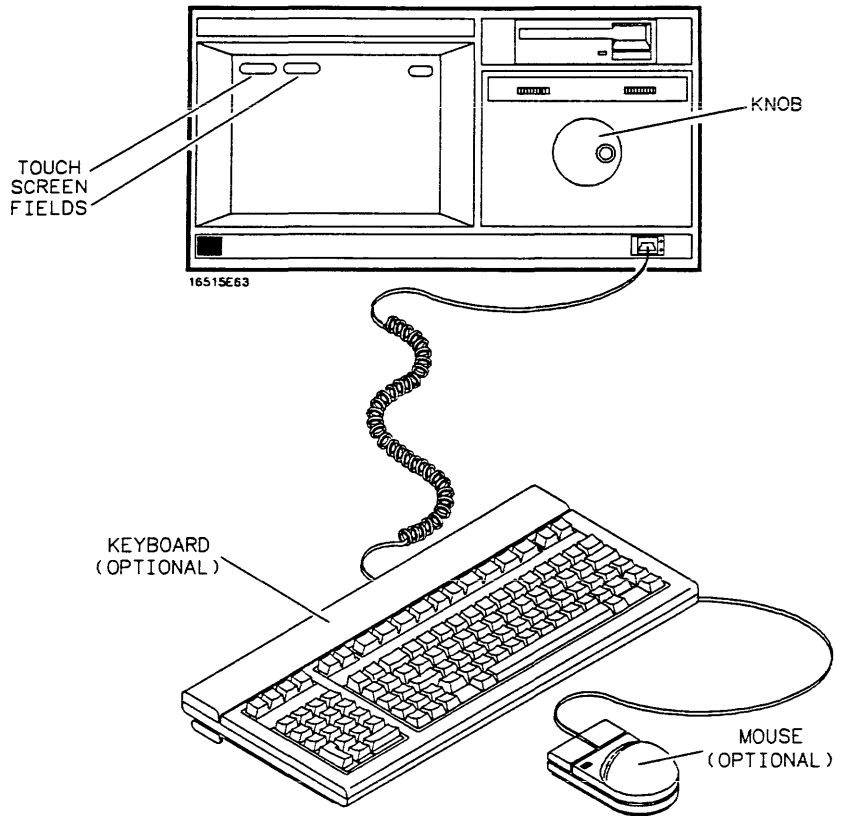

Figure 1-1. HP 16500A/16501A User Interfaces

Default Configurations

When the instrument is powered up, pre-determined values are automatically assigned to the different fields of the menus to configure the instrument for basic measurements. This allows you to make a basic measurement by turning on the instrument, connecting the probes, and touching the Run field. Often only minor changes are needed for more complex measurements.

Storing Default Configurations

The default configurations may be stored on a disk for later use or reset by cycling the power. Storing the default configurations on a disk is a convenient way to return to the default values without cycling the power. Default values for each module can be stored separately or together in one file. Refer to Chapter 8 for more information on storing configurations.

Learning to Use the HP 16500A/16501A

This chapter introduces you to the HP 16500A/16501A user interfaces and shows you how easy they are to use. Then it guides you through a brief exercise using the interfaces to perform some basic operations.

The Display

The menu is the actual display that you see on screen. It lists information about the system and gives you access to touchscreen fields for configuring the system. These fields give you access to additional fields, allow you to move from menu to menu, input information, and perform functions. Figure 2-1 points out some of the touchscreen fields and information listed on the System Configuration menu for the HP 16500A. Figure 2-2 shows the System Configuration menu for the HP 16501A which shows the additional modules available through the expansion mainframe.

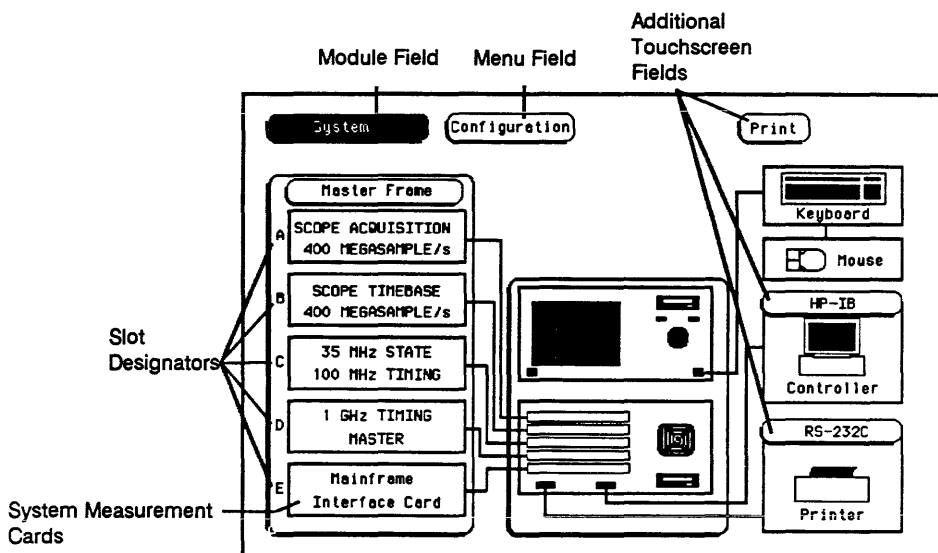

Figure 2-1. The System Configuration Menu for the HP 16500A

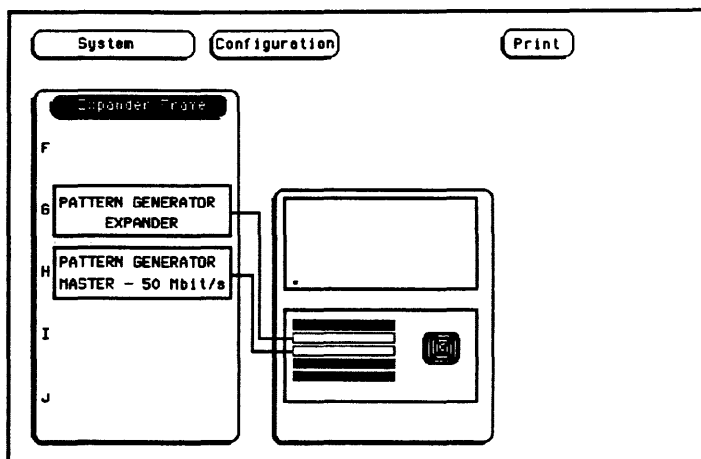

Figure 2-2. The System Configuration Menu for the HP 16501A

The **Module** field in the upper-left corner of the display represents the hardware and system software that forms a complete tool or software option within the HP 16500A/16501A. The **Menu** field to the right of the **Module** field represents one of the many screens available for configuring individual modules.

The **System Measurement Cards** shown in figure 2-1 and figure 2-2 represent the individual modules installed within this HP 16500A/16501A. The **Slot Designators** listed to the left of the cards show the physical location for each card within the HP 16500A/16501A. In figure 2-1, the HP 16531A Oscilloscope Acquisition card is shown in slot C and the HP 16530A Oscilloscope Timebase card is shown in slot D. The combination of these two cards and the appropriate software represents the 400 Megasample/Second Oscilloscope module in this HP 16500A/16501A.

User Interfaces

The HP 16500A/16501A has four user interface devices: the touchscreen, the knob on the front panel, the optional mouse, and the optional keyboard.

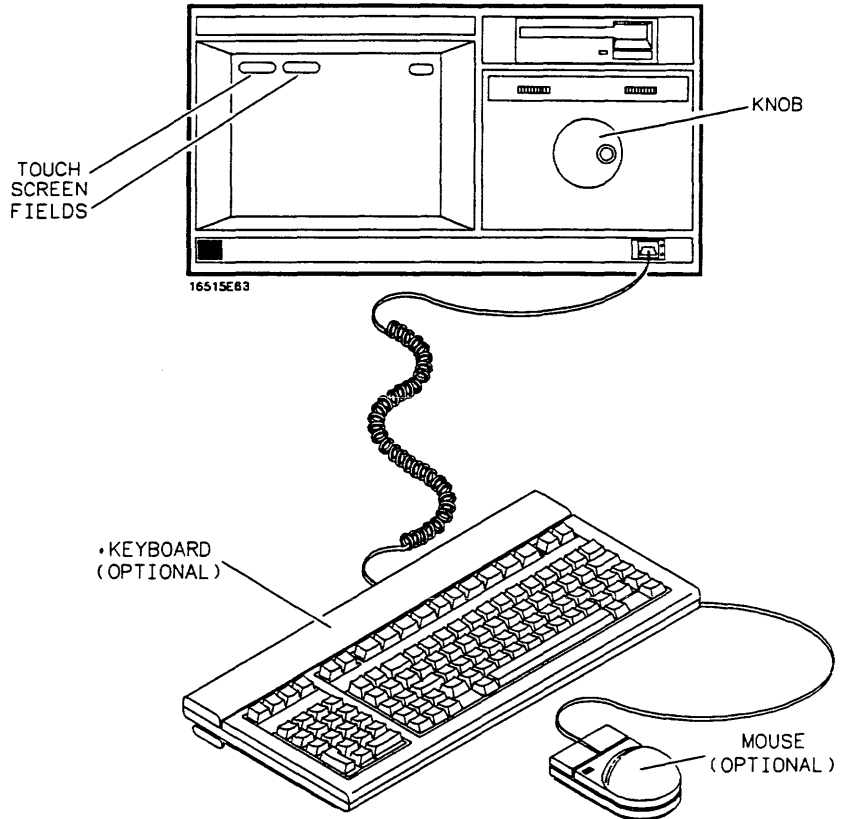

Figure 2-3. User Interfaces

The Touchscreen

The touchscreen provides the main front-panel control or access to the menus. It consists of touch-sensitive fields that you can use to enter alphanumeric data into fields, access other menus, and configure the HP 16500A/16501A for measurements. Generally, any touch-sensitive field or box that is used to access or enter information in the HP 16500A/16501A system is referred to as a field. The only exception is the alphanumeric input fields in the pop-up keypads. These are referred to as keys.

These fields can be selected using touch or the optional mouse or keyboard. To activate a field by touch, touch or press the field (the blue box) on the display with your finger until the field changes color. Then move your finger away from the screen to activate your selection. If you have trouble selecting the field you want, place your finger on the screen and move it around and over that field until it changes color. Then move your finger away from the screen.



No selection can be activated as long as your finger is touching the screen. The only exception is keypads. Keypad selections are activated as you touch them.

Types of Fields

The touchscreen consists of a variety of different types of fields. These fields may access pop-up menus, multiple-choice listings, keypads, etc. Through these fields you execute functions, move between menus, and configure the system for specific operations.

Pop-Up Menus Pop-up menus appear when you touch certain fields. They display the functions available for configuring or performing major operations, including configuring the RS-232C interface, calibrating the touchscreen, and more. When you are finished with the pop-up menu, simply touch **Done** to return to the original display.

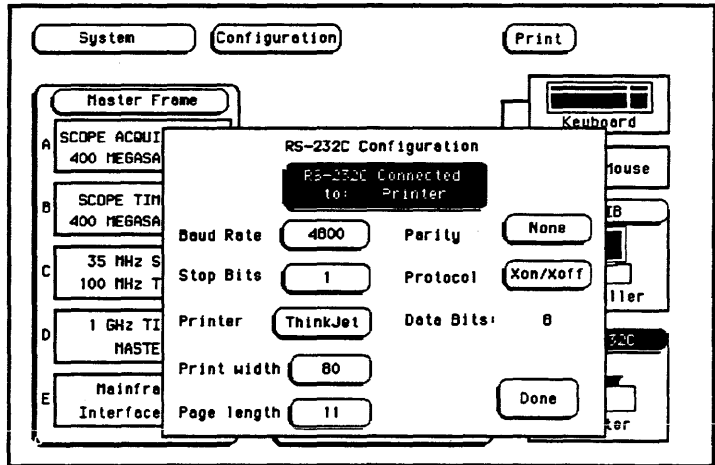

Figure 2-4. The RS-232C Pop-Up Menu

Pattern Fields

Pattern fields are fields that access pop-up menus that only display selections available for a single function. A good example of this is the **Edge** field of the **Trace** menu of the logic analyzer. The selections available apply only to the **Edge** field. As you make your selections, the selections appear in a box at the top of the pop-up menu. When you are finished configuring the pattern field, touching **Done** returns you to the original display and updates the pattern field with the new configuration.

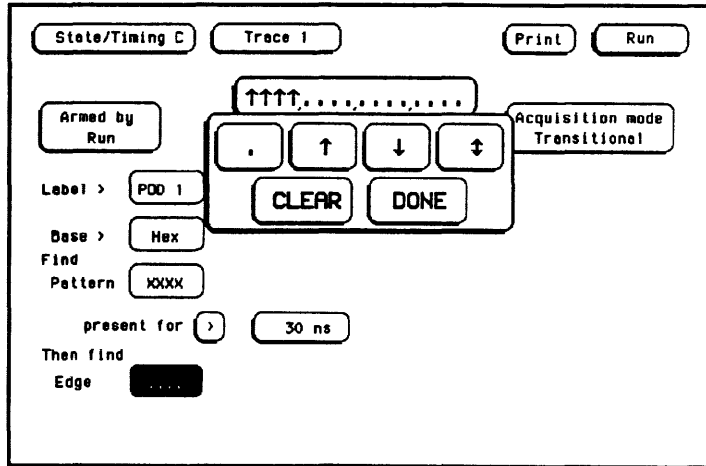

Figure 2-5. The Edge Field Pop-Up Menu

Multiple-Choice Listings

Multiple-choice listings display the selections available for particular operations, menus available for particular modules, modules available within particular mainframes, and more. By selecting the appropriate fields you can configure operations, change menus, move between modules, etc. To return to the original selection, touch the field within the listing that has the light-blue background.

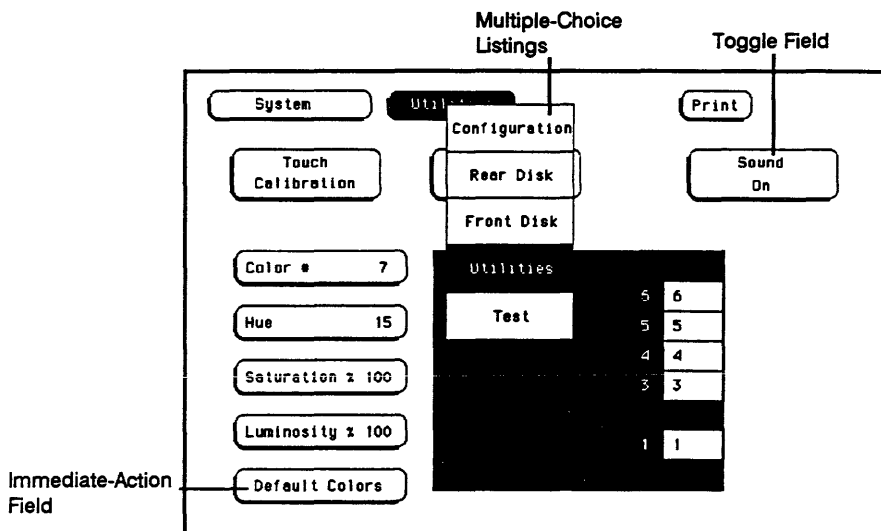

Figure 2-6. Multiple-Choice Menus and Toggle Fields

Toggle Fields

Toggle fields have only two possible entries. They switch between functions (such as from a Controller to a Printer configuration) or simply turn a feature on and off. To return to the original selection, simply touch the field again.

Immediate-Action Fields

Immediate-action fields perform a function as soon as they are selected. For example, selecting the **Done** field immediately returns you to the original display. Selecting the **Default Colors** field immediately returns you to the default display colors. There are no additional selections or actions required.

Knob/Numeric Fields

If a numeric field isn't light blue, touching the field once turns it light blue. Once a field is light blue, rotating the knob changes the value in it. If you touch a numeric field that is already light blue, a keypad appears on screen to enter a new value.

Once the value for a numeric field has been changed, you can return to the original value by entering it with the keypad or by rotating the knob.

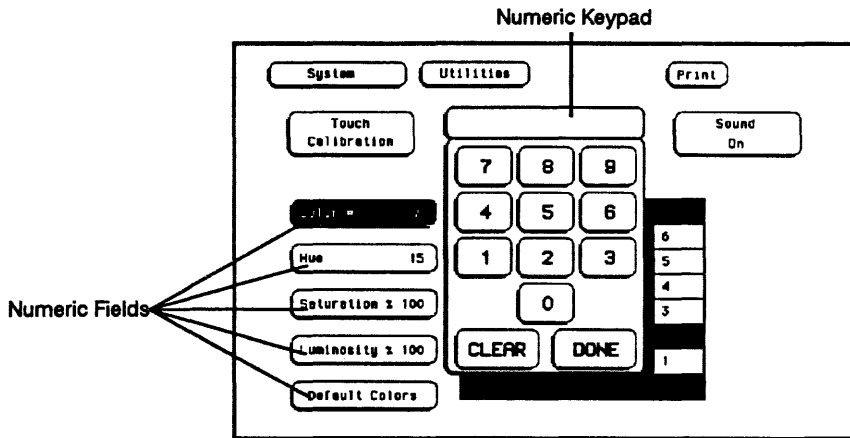

Figure 2-7. Numeric Fields

Alphanumeric Keypads

When you select a field that requires an alphanumeric input, an alphanumeric keypad appears on screen. Simply enter the appropriate information with the keypad and touch **Done** when you are finished.

To return to the original information after an alphanumeric field has been changed, re-enter the original information with the keypad.

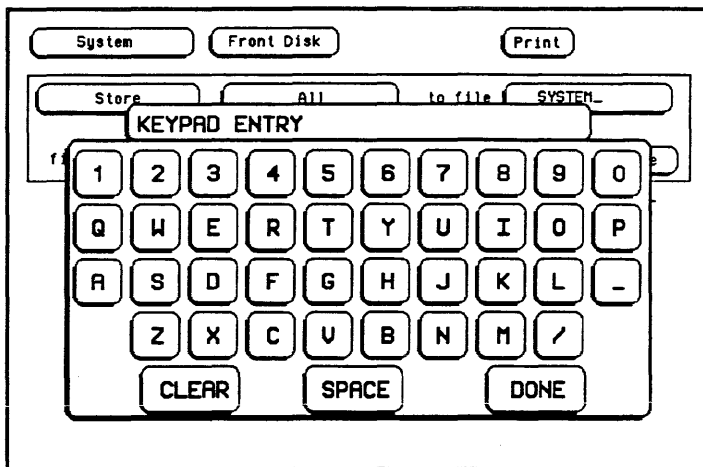

Figure 2-8. Alphanumeric Keypad

Entering Information with the Keypad

To enter information with the keypad, simply touch the appropriate key for each input and that input will appear in the box at the top of the keypad. When you are finished, touch **Done** and the keypad disappears, placing your entry in the appropriate field.

If you need to change a letter or correct a mistake for a pattern or alphanumeric entry before leaving the keypad, simply move the cursor with the knob to the character you want to change and enter the correct character.

Generally, to return to the original value before completing an entry, touch **Clear**, then **Done**.

The Optional Mouse

The optional mouse is a mechanical device that you can move about on a desktop to control a pointer (+) on the menu. When the pointer is on the desired field, select that field by pressing the button on the upper-left corner of the mouse.

You can also use the mouse to duplicate the function of the knob on the front panel. Simply hold down the button on the upper-right corner of the mouse and move the mouse about on a desktop. Moving the mouse up or to the right is the same as turning the knob clockwise. Moving the mouse down or to the left is the same as turning the knob counterclockwise.

Connecting the Mouse

To connect the mouse:

1. Hold the connector (on the cord of the mouse) with the two spring clips on the bottom.
2. On the lower-right corner of the HP 16500A front panel is a port marked with two dots. Gently push the connector into this port until the connector clicks into place.

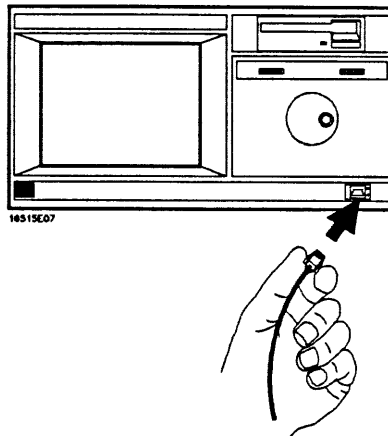
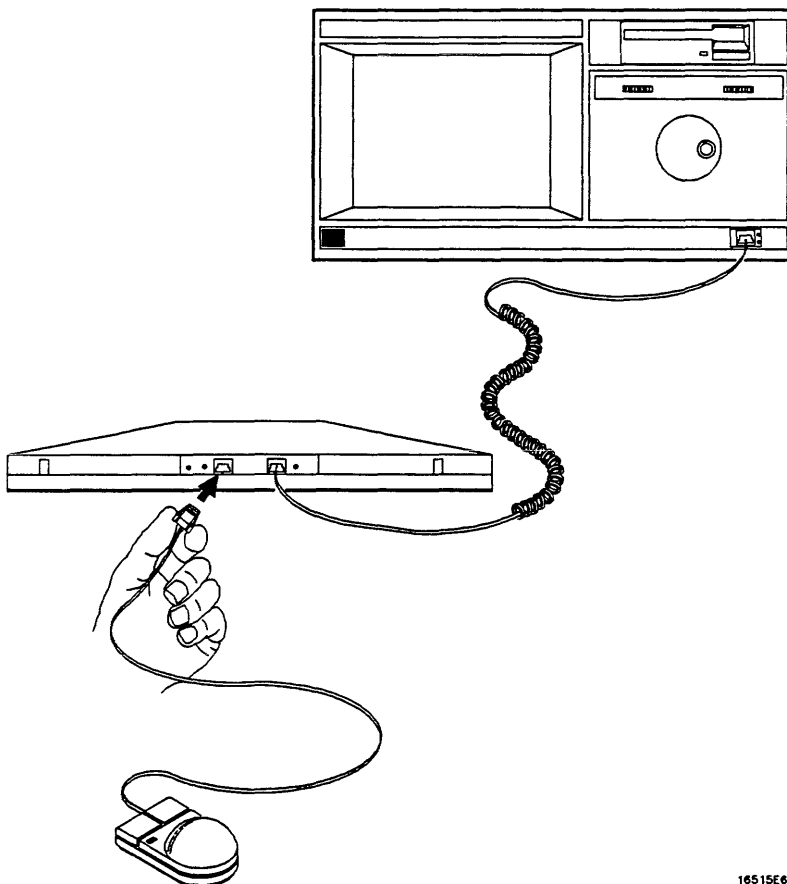

Figure 2-9. Connecting the Optional Mouse

The mouse may also be plugged into the optional keyboard interface (HP E2427A Keyboard Kit). To connect the mouse to the keyboard, insert the connector end of the mouse (marked with two dots) into the port marked with two dots located on the back of the keyboard.



16515E62

Figure 2-10. Connecting the Mouse to the Optional Keyboard

When the mouse is connected directly to the HP 16500A mainframe, the System Configuration menu will show a mouse icon connected to the instrument (see figure 2-11).

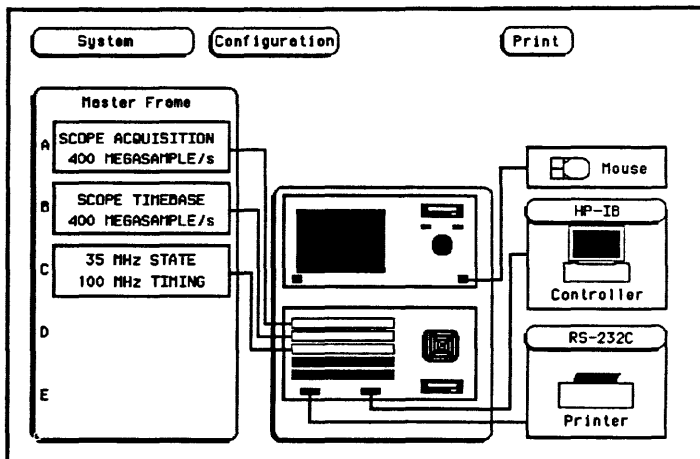

Figure 2-11. System Configuration Menu With the Mouse Only

When the mouse is connected to the keyboard, the System Configuration menu will display a picture of the mouse connected to the keyboard, which is in turn connected to the HP 16500A mainframe (see figure 2-12)

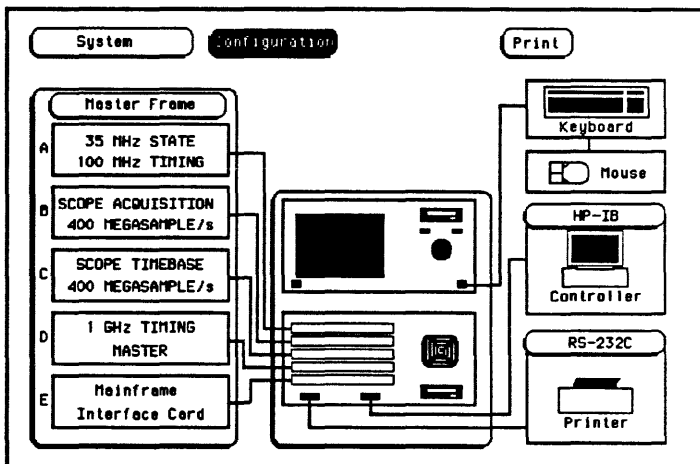

Figure 2-12. System Configuration Menu With the Mouse Connected Through the Keyboard

Disconnecting the Mouse

To disconnect the mouse, press the two spring clips on the connector together and gently pull the connector out of the port.

The Optional Keyboard

To select a field using the optional keyboard, position the keyboard cursor (the location highlighted in inverse video) on the desired field and press either the Return or Select key.

You can also use the keyboard to duplicate the function of the knob on the front panel of the HP 16500A. The keyboard uses the shift and cursor keys to simulate knob spin. To simulate rotating the knob clockwise, simultaneously press the Shift key and either the up-pointing arrow key or the right-pointing arrow key. To simulate rotating the knob counter-clockwise, simultaneously press the Shift key and either the down-pointing arrow key or the left-pointing arrow key.

For more information on keyboard functions, please see Chapter 3.

Connecting the Keyboard

To connect the keyboard:

1. Hold the connector with the two spring clips facing down.
2. Gently push the connector into the port on the front panel until it clicks into place.

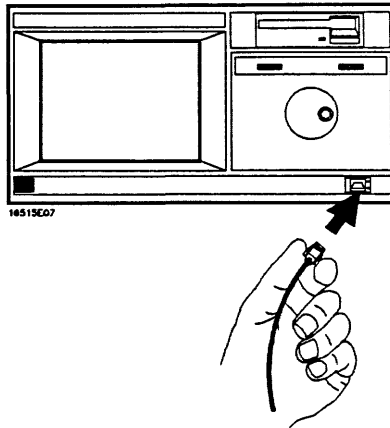

Figure 2-13. Connecting the Option Keyboard

When the keyboard is connected to the HP 16500A, the System Configuration menu will display the connection as a picture showing the keyboard connected to the mainframe.

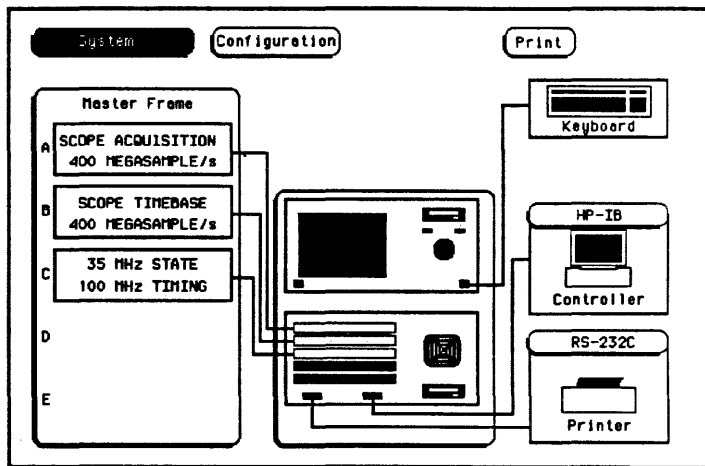

Figure 2-14. System Configuration Menu with the Keyboard

Disconnecting the Keyboard

To disconnect the keyboard, press the two spring clips on the connector together and gently pull the connector out of the port.

The Knob

The knob on the front panel can move the cursor on certain menus, increment and decrement numeric fields, and roll the display. “Rolling the display” refers to the instrument’s ability to rotate or scroll through information on the screen.

The Cursor

The cursor is a position indicator in the display that allows you to highlight characters within fields and other areas within certain menus. Rotating the knob moves the cursor within a particular field or function or moves the cursor through information line by line. The location of the cursor is displayed in inverse video.

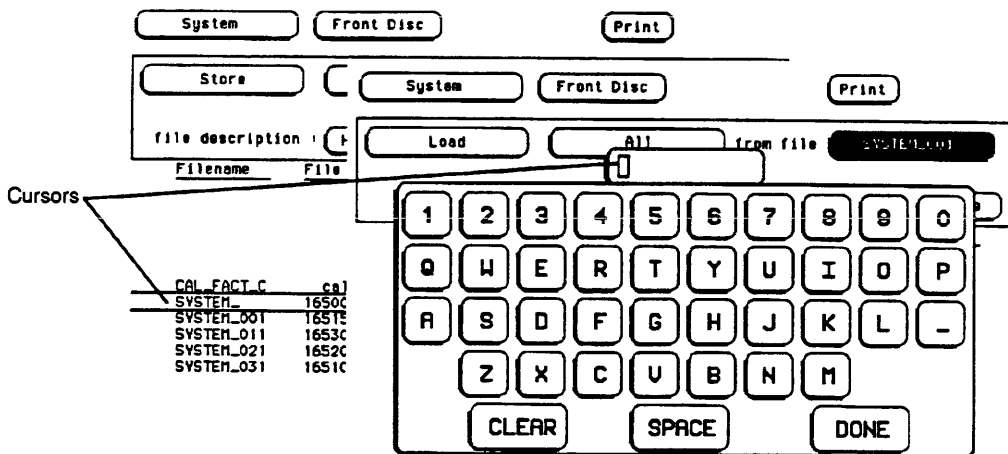

Figure 2-15. Cursor Examples.

Exercises

The following brief exercises will help you become more familiar with using the HP 16500A/16501A interfaces. The steps are both numbered and lettered. The numbered steps state the objective and the lettered steps explain how to accomplish each step objective. You may be able to go through the exercises by just following the numbered steps. When you need more information on how to accomplish the step objective, refer to the lettered steps.

1. Make sure you are in the **System Configuration** menu. If not, select this menu.
- a. If you are not already in the **System** module, as indicated by the field in the upper-left corner of the menu, touch this field. When the (multiple-choice) pop-up appears, touch **System** and the pop-up disappears, bringing up one of the **System** menus.
- b. If you are not already in the **Configuration** menu, as indicated by the field to the right of **System**, touch this field. When the pop-up appears, touch **Configuration** and the pop-up disappears, bringing up the **System Configuration** menu.

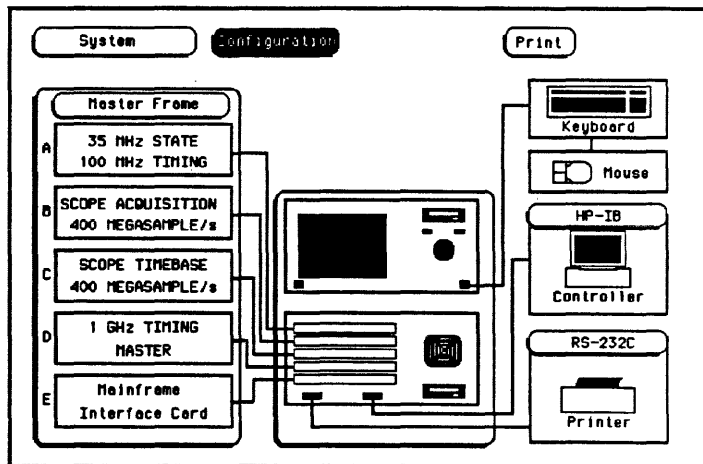

Figure 2-16. The System Configuration Menu

2. Select the **System Front Disk** menu.
 - a. Touch the menu field to the right of **System** in the upper-left corner of the display.
 - b. When the (multiple-choice) pop-up appears, touch **Front Disk** and the pop-up disappears, bringing up the **System Front Disk** menu.

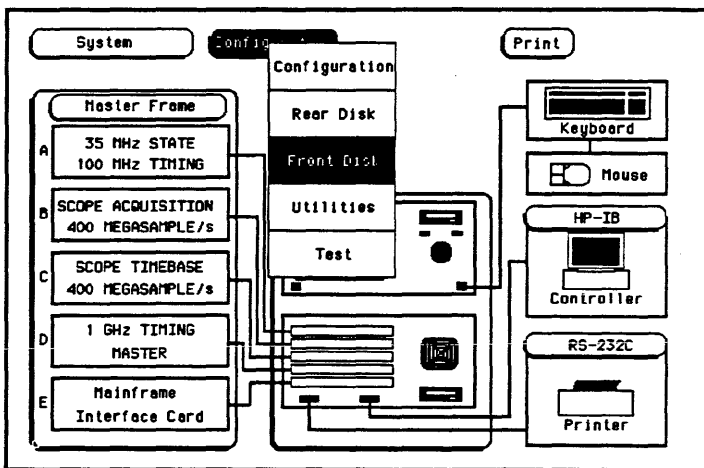

Figure 2-17. Selecting the System Front Disk Menu

3. Select the **Store** operation.
 - a. Select the file operation field directly below the module field by touch, mouse, or keyboard.
 - b. When the pop-up appears, select **Store**. This brings up the **Store** operation.

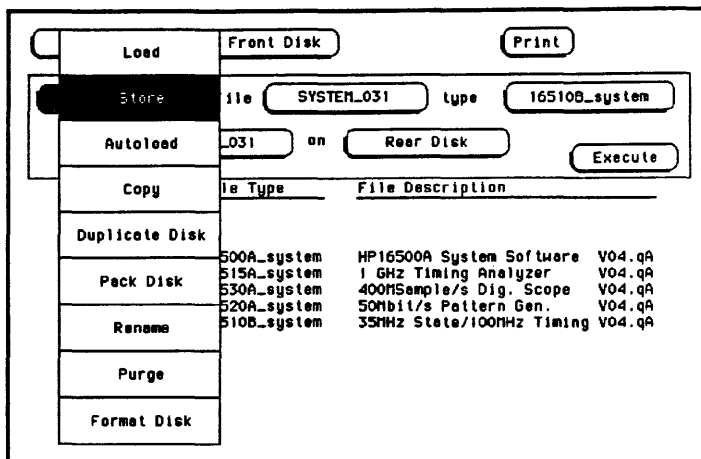

Figure 2-18. Selecting the Store Operation

4. Enter the filename "EXAMPLE1" in the field to the right of "to file."
 - a. Touch the filename field to the right of "to file" or select it using the optional mouse or keyboard.
 - b. When the pop-up alphanumeric keypad appears, enter "EXAMPLE1" with the keypad by touching the appropriate key for each character or keying in the information using the optional keyboard. As you enter each character, the character appears in the box at the top of the keypad and the cursor moves one space to the right.



To change a letter or correct a mistake, use the knob to move the cursor to the letter you want to change and enter the correct letter.

- c. When you are finished, select **Done** by touch, mouse, or keyboard and the pop-up disappears, putting EXAMPLE1 in the appropriate field.

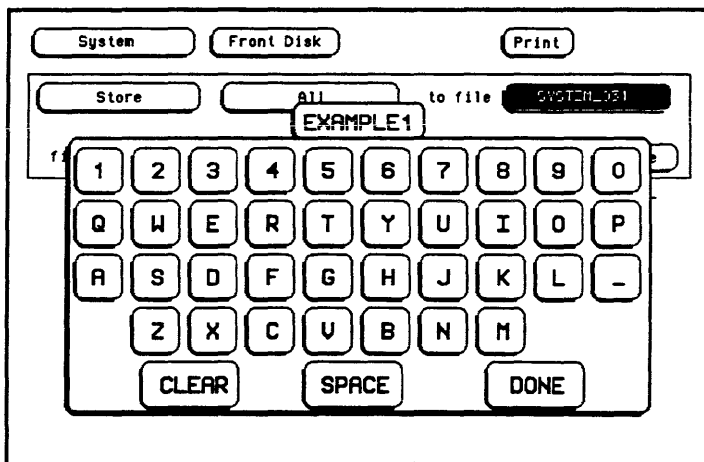

Figure 2-19. Entering a Filename

5. Enter "CONFIGURATIONS AND DATA" for the file description.
 - a. Touch the field to the right of "file description", or select it using the optional mouse or keyboard.
 - b. When the pop-up alphanumeric keypad appears, enter "CONFIGURATIONS AND DATA" in the box with the keypad by touching the key for each letter or by keying in the information using the optional keyboard.
 - c. When you are finished, select **Done** by touch, mouse, or keyboard and the pop-up disappears, putting "CONFIGURATIONS AND DATA" in the appropriate field.

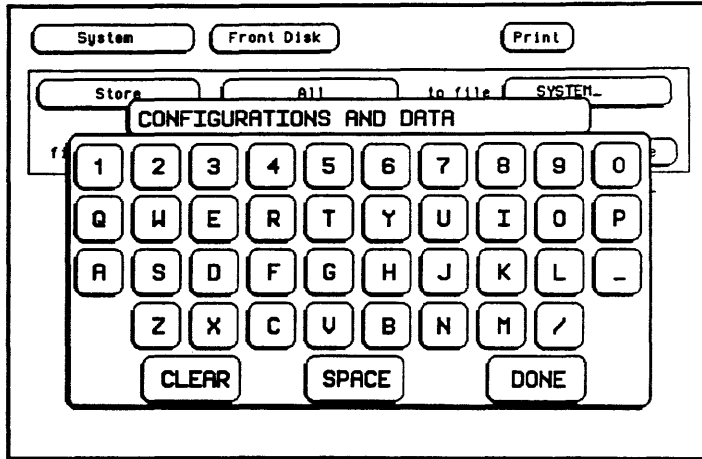

Figure 2-20. Entering a File Description

6. Now select the **System Utilities** menu.
 - a. Select the menu field to the right of **System** in the upper-left corner of the display using touch, the mouse or the keyboard.
 - b. When the pop-up appears, select **Utilities** and the pop-up disappears, bringing up the **System Utilities** menu.

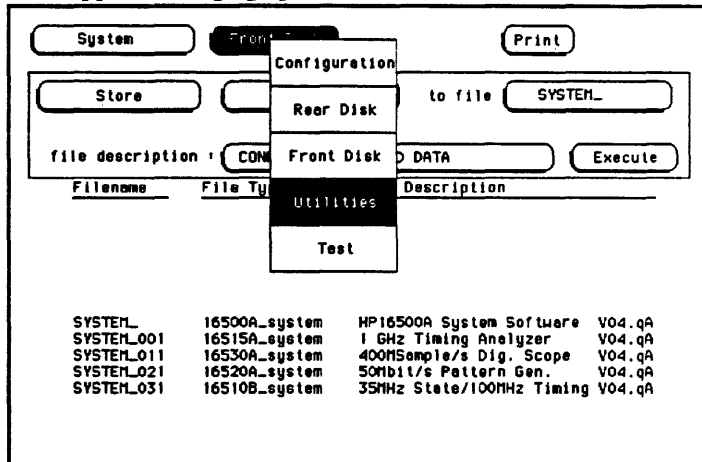

Figure 2-21. Selecting the System Utilities Menu

7. Change the Hue for Color #5 to 45 with the keypad.
 - a. If the Color field isn't light blue, touch this field.
 - b. Rotate the knob counterclockwise (or simulate knob rotation using the optional mouse or keyboard) until 5 appears in the Color field.
 - c. Touch the Hue field below the Color field.
 - d. After it turns light blue, select the Hue field again and a pop-up keypad appears.
 - e. Enter 45 with the keypad or optional keyboard and select Done.

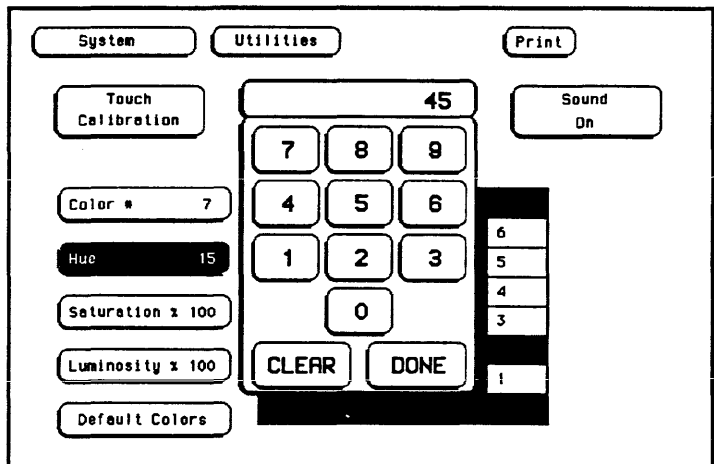

Figure 2-22. Entering a New Value for Hue

The keypad will disappear, putting 45 in the Hue field.

8. Return to the default settings for the color fields.
 - a. Select the **Default Colors** field in the lower-left corner of the menu. Since this is an immediate action field, selecting the **Default Colors** field immediately returns you to the default display colors.

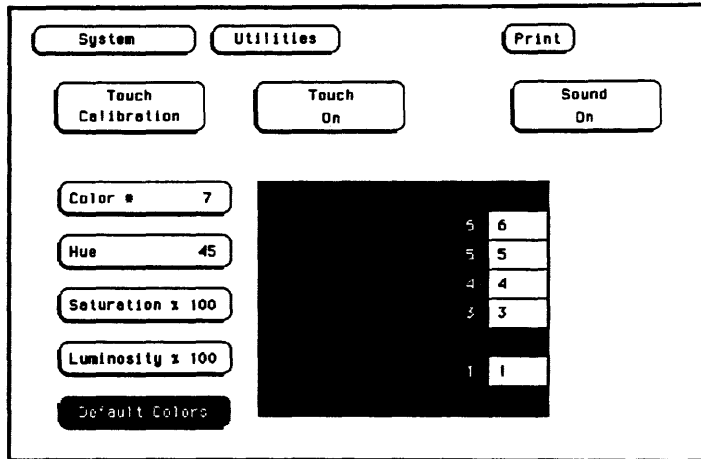

Figure 2-23. Returning to the Default Colors

9. Turn off the sound of the instrument.

a. Select the **Sound On** field and it toggles to **Sound Off**.

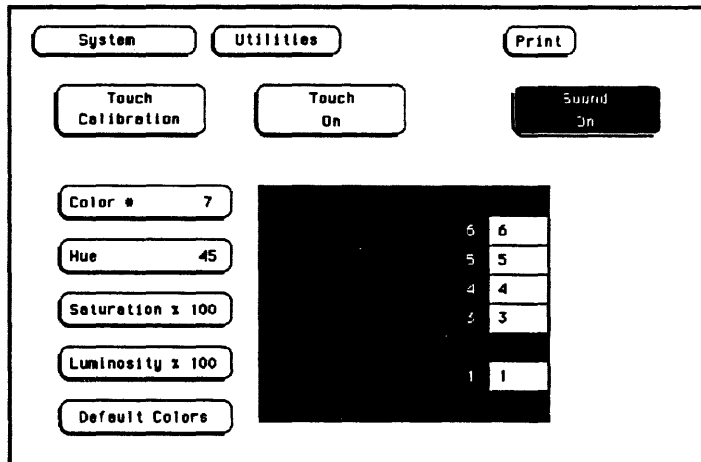

Figure 2-24. Turning the Sound Off

10. Then turn the sound back on.

a. Select the **Sound Off** field and it toggles to **Sound On**.

11. Return to the **System Configuration** menu.
 - a. Touch the menu field to the right of **System** in the upper-left corner of the display.
 - b. When the pop-up appears, select the **Configuration** field. The pop-up disappears, bringing up the **System Configuration** menu.

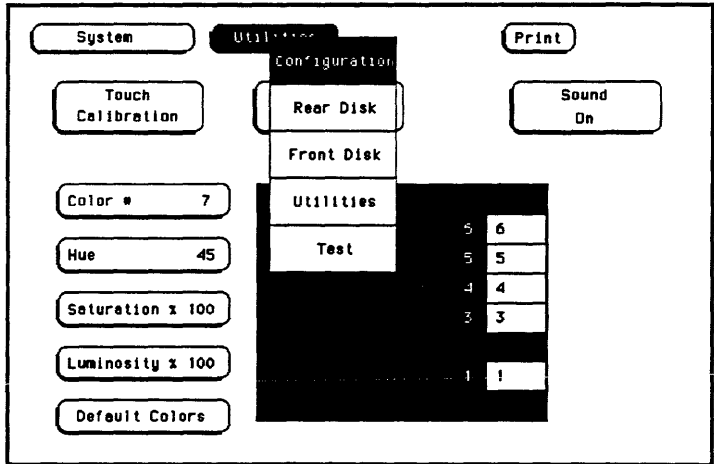

Figure 2-25. Selecting the System Configuration Menu

Refer to specific chapters in this manual for more information on the functions and menus of the HP 16500A/16501A.

Using the Optional Keyboard Interface

This chapter explains how to use the optional keyboard interface (HP E2427A Keyboard Kit) with the HP 16500A/16501A. The keyboard can be used interchangeably with the knob, touchscreen, and the mouse for all menu applications. The keyboard functions fall into two basic categories: cursor movement and data entry:

Moving the Cursor

The keyboard cursor is the location on the screen highlighted in inverse video. To move the cursor, follow one of the methods described below.

Cursor Keys

There are four cursor keys marked with arrows on the keyboard. These keys perform the following movements:

- Up-pointing arrow - moves the cursor up.
- Down-pointing arrow - moves the cursor down.
- Right-pointing arrow - moves the cursor to the right.
- Left-pointing arrow - moves the cursor to the left.

The cursor keys do not wrap. This means that pressing the right-pointing arrow when the cursor is already at the rightmost point in a menu will have no effect. The cursor keys do repeat, so holding the key down is the fastest way to continue keyboard cursor movement in a given direction.

You can also use the cursor keys to duplicate the function of the knob on the front panel of the HP 16500A. To simulate rotating the knob clockwise, simultaneously press the Shift key and either the up-pointing arrow key or the right-pointing arrow key. To simulate rotating the knob counter-clockwise, simultaneously press the Shift key and either the down-pointing arrow key or the left-pointing arrow key.

Tab Key

Another way to move the keyboard cursor is to use the Tab key. The Tab key wraps and repeats. You can scroll through all the choices in a given menu by pressing and holding down the Tab key. The Tab key moves the keyboard cursor from left to right, and, upon reaching the right margin of a line, causes the cursor to move to the left margin of the next line and continue its left-to-right motion.

If you want to want to move in the opposite direction, from right to left, moving up to the next higher line when the left margin is reached, press and hold both the Tab key and the Shift key simultaneously.



Neither the Tab key nor the Tab and Shift key combination will work in scroll-type pop-up menus. Use the cursor keys to make selections in these menus.

Home Key

If you want to move the cursor to the first item in a menu, press the Home key. If you want to move the cursor to the last item in a menu, press the Home and Shift keys simultaneously.

Next and Previous Keys

The Next and Previous keys are used for paging through listings. The Next key will display the next page of data, if one exists. The Previous key will display the previous page of data, if one exists.



These functions work only for the HP 16510A/B Logic Analyzer modules.

Selecting a Menu Item

To select a menu item using the optional keyboard, position the cursor (the location highlighted in inverse video) on the desired menu item using one of the methods described in the section “Moving the Cursor” and press either the Return or the Select key.

Entering Data into a Menu

When the cursor is over the desired field, and either the Return key or the Select key is pressed, the cursor is displayed over the leftmost digit of the particular item. When you enter a number, it is displayed in the cursor position, and the cursor is advanced. Cursor keys move the cursor within the field. Pressing either the Return key or the Enter key will terminate data entry for that item.

If you want to erase the data entry, press the Clear Line key, the Clear Display key, or the Delete Line key.

Autoroll When entering pattern generator data, you can move through each line horizontally, filling in each data field in the line before going to the next line, or you may want to fill in all the data in a column before moving on to the next column. The Autoroll feature makes moving from one data entry field to another easier than selecting each in succession.

When you select a data field and the pop-up appears, notice that a field labeled Autoroll also appears at the left side of the screen. To use the Autoroll feature, place the cursor over the desired data field, then press either the Return key or the Select key. When the cursor is at the left margin of the data, press the left-pointing arrow key. The cursor will disappear from the data and reappear in the Autoroll field.

When you select the Autoroll field, another pop-up appears. This pop-up presents you with three choices:

- Off.
- A field containing a right-pointing arrow and a down-pointing arrow.
- A field containing a down-pointing arrow.

If you want to move through your data line by line, from left to right, select the field marked with the right-pointing arrow and the down-pointing arrow. Once this field is activated, the pop-up will close and autoroll through the data fields from left to right. When you finish entering data into the last field in a line, the pattern generator will automatically move to the first field in the next line. This process continues until the pattern generator reaches the end of the program or until you turn the Autoroll off.

If you want to move through your data column by column, select the pop-up field marked with the down-pointing arrow. When this field is selected, the pattern generator moves down each column of data, and, when data entry in the column is complete, automatically moves to the top of the next column. This process continues until the end of the program is reached or until you turn the Autoroll off.

Autoroll is automatically turned off when data entry to all the available fields is complete. If you want to turn off the Autoroll before data has been entered into all the data fields, press the left-pointing arrow key when the cursor is at the left margin of a data field. When the Autoroll pop-up appears, select **Off**.

Using the Keyboard Overlays

The function keys above the number pad have been redefined to work with the HP 16500A/16501A keypad. Two keyboard overlays are included in the HP E2427A Keyboard Kit. The overlays show the redefined functions of the function keys and the number pad keys (see figure 3-1). These function keys are listed in table 3-1:

Table 3-1. Units and Hex Keys

Key	Real-Time Keypad	Voltage Keypad	Hex Keypad
F9	Seconds	Volts	D
F10	Milliseconds	Millivolts	E
F11	Microseconds	-	F
F12	Nanoseconds	-	-
*	-	-	A
/	-	-	B
+	-	-	C

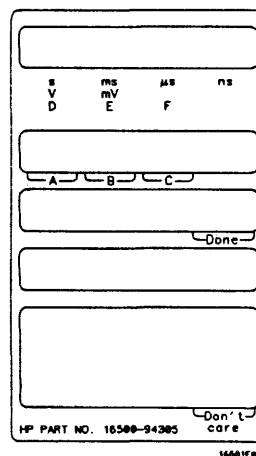
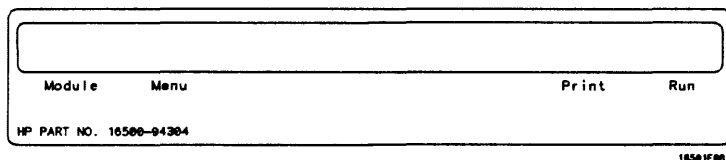

Figure 3-1. Keyboard Overlays

Don't Care Key Tab is the "Don't Care" key. The value of this key is determined by the currently displayed keypad. It is "X" in the hex keypad and double quotes (") in the stimulus hex keypad.

Table 3-2. Don't Care Key

Key	Stimulus Hex Keypad	Hex Keypad
Tab ("Don't Care")	Double Quotes (")	X

Function Keys Several function keys have been provided to simplify frequently used keystrokes. Table 3-3 lists the functions mapped to these keys.



F1, F2, F7, and F8 only work when there are no submenus popped up.

Table 3-3. Operation Function Keys

Key	Function
F1	Selects and pops up the module field.
F2	Selects and pops up the menu field.
F7	Selects and pops up the print field.
F8	Invokes the run key for its current setting. If the run key is set to repetitive, then pressing F8 will invoke repetitive running. If the run key is set to single run, then pressing F8 will invoke a single run. If the module is running, then F8 will stop the module.

Defining Time Units

In addition to the function keys which are mapped to the HP 16500A/16501A real-time keypad, other keys on the keyboard invoke the units keys. The time unit keys are listed in Table 3-4.

Table 3-4. Time Units Keys

Key	Time Units
S	Selects the seconds units
M	Selects the milliseconds units
U	Selects the microseconds units
N	Selects the nanoseconds units

Defining Voltage Units

Besides the function keys which are mapped to the HP 16500A/16501A real-time keypad and the time units keys, other keys on the keyboard invoke the voltage units keys. The voltage unit keys are listed in Table 3-5.

Table 3-5. Voltage Units Keys

Key	Voltage Units
V	Selects volts
M	Selects millivolts

Assigning Edge Triggers

Several keys map to edge assignments. These keys and their functions are listed in Table 3-6.

Table 3-6. Edge Trigger Keys

Key	Edge Trigger Assignment
U	Selects the up or rising edge.
D	Selects the down or falling edge.
R	Selects the rising edge.
F	Selects the falling edge.
B	Selects either the rising or falling edge.
Up-Pointing Arrow	Selects the rising edge.
Down-Pointing Arrow	Selects the falling edge.

Closing a Menu

To exit a menu, press either the Done or Enter key. The Enter key is mapped to the Done key, so pressing either key closes the menu.

The System Configuration Menu

The System Configuration menu is the first menu you see after the initial power-up of the instrument. This menu lists the modules and software options that your system is configured with and shows whether there are five card slots (the HP 16500A alone) or nine card slots (the HP 16500A with the HP 16501A attached) available. It also shows if either the optional mouse or keyboard is connected. If a mouse is connected, the system configuration menu indicates whether the mouse is connected directly to the HP 16500A or to a keyboard connected to the mainframe. Finally, the system configuration menu gives you access to the configuration of the HP-IB and RS-232C interfaces.

Getting into the System Configuration Menu

In the upper-left corner of the menu are two fields that indicate which menu and module the instrument is in (see figure 3-1). The field to the extreme left (**System**) shows you which module you're in and the one to the right of the module field (**Configuration**) shows you what menu within the module you've accessed.

To access the System Configuration menu, follow these steps:

1. If the module field in the upper-left corner of the screen does not display **System**, touch this field and when the pop-up appears, touch **System**. This will get you into one of the **System** menus.
2. If the module field in the upper-left corner of the screen displays **System**, but the field to the right of **System** doesn't display **Configuration**, touch this field. When the pop-up appears, touch **Configuration** to bring up the **System Configuration** menu.

Layout of the System Configuration Menu

The figures below show the layout of the System Configuration menu for the HP 16500A alone (figure 4-1) and with the 16501A attached (figure 4-2). Each figure is labelled with the major features and functions of the menu.

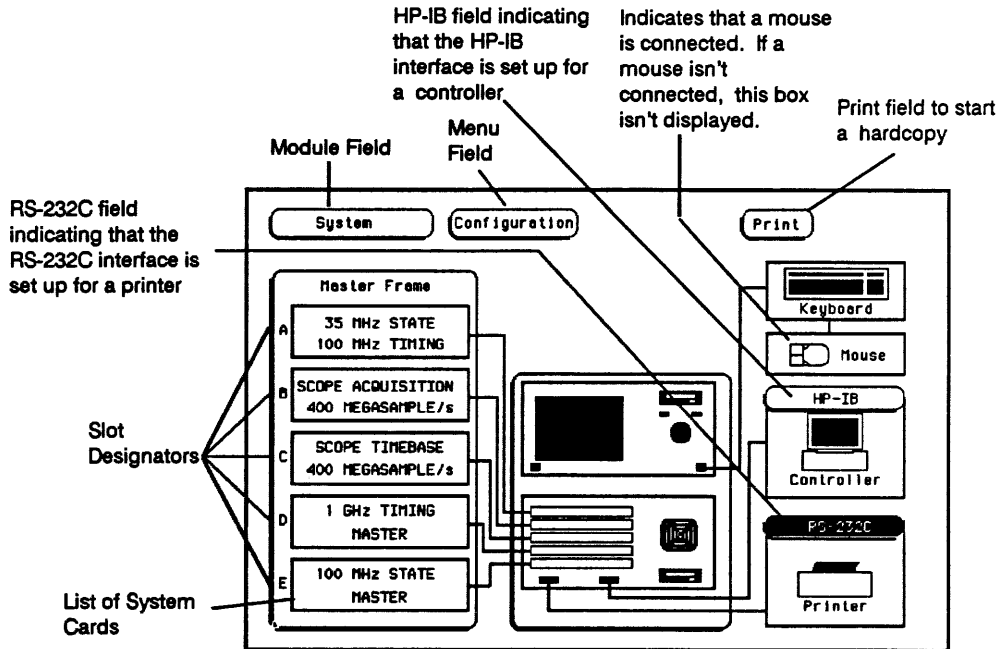

Figure 4-1. The System Configuration Menu for the HP 16500A

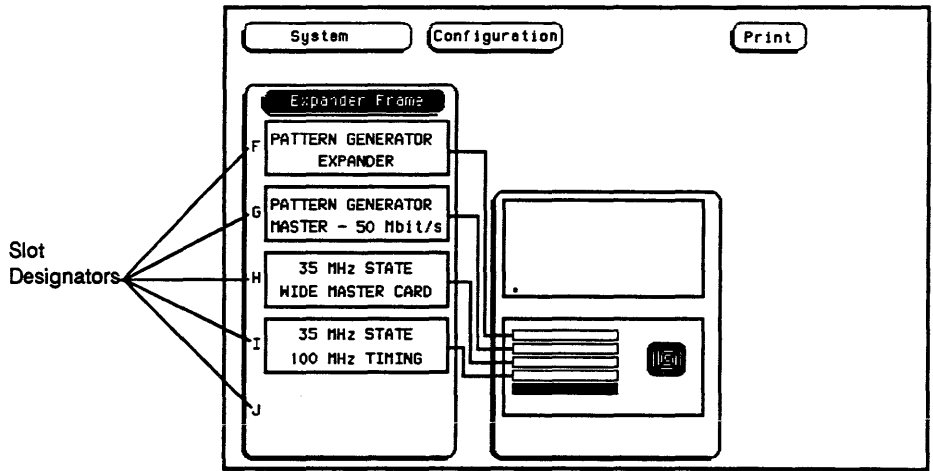

Figure 4-2. The System Configuration Menu for the HP 16501A

Slot Designators

The slot designators are listed as A through E for the HP 16500A alone, or A through J for the HP 16500A with the HP 16501A attached. The slot designators are displayed to the left of the list of cards for the system and indicate the locations or slots for each card. When you touch the module field, a pop-up appears. The letters after the name of each module indicate the location of each “master” card for that module. For example, **Oscilloscope D** indicates that the master card for the Oscilloscope module is in slot D of the instrument.

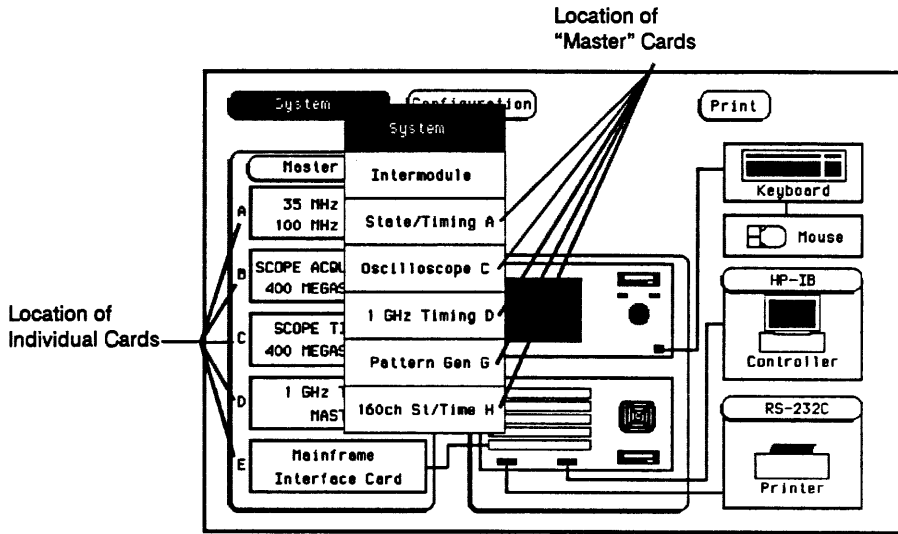
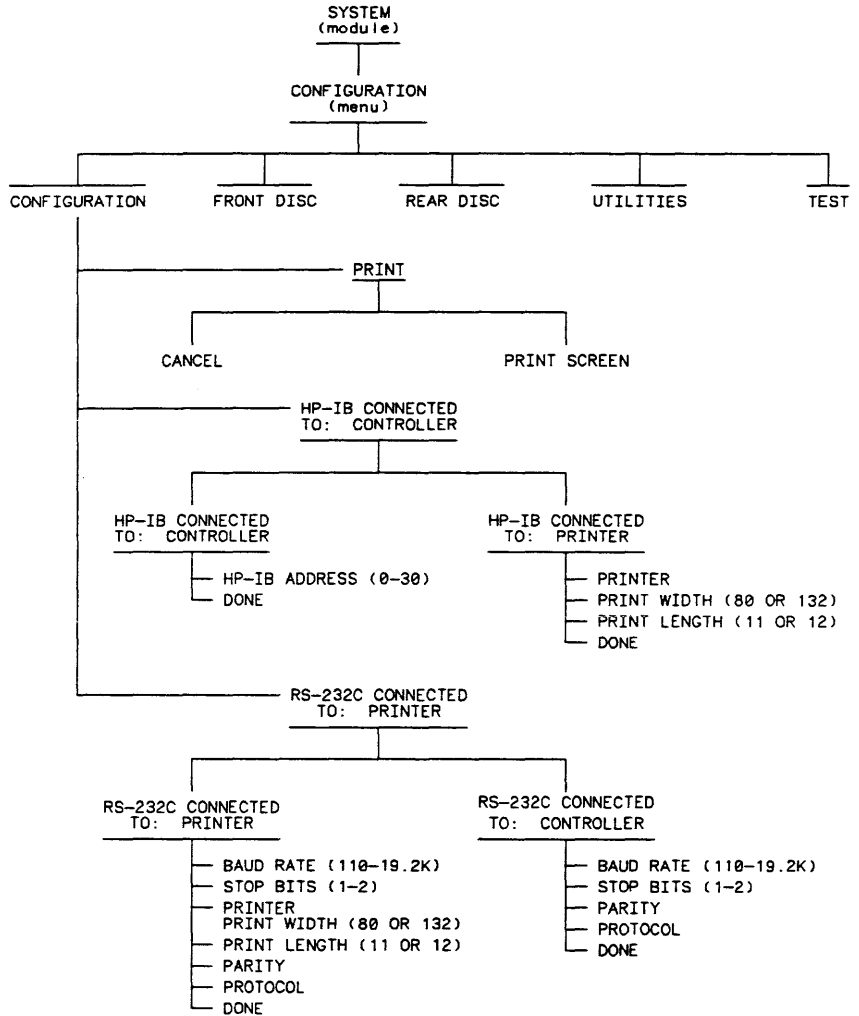

Figure 4-3. Slot Designators for the HP 16500A/16501A

Menu Map

Figure 4-5 displays a menu map for the System Configuration menu. When the field has a numeric input, the range is displayed in parentheses.



16500B06

Figure 4-4. Menu Map for the System Configuration Menu

HP-IB and RS-232C

This chapter describes the controller and printer interfaces and their configuration. It defines the HP-IB interface and describes how to select any one of the 31 different HP-IB addresses available. It also defines the RS-232C interface and tells you how to select a baud rate, change the stop bits, set the parity and data bits, and how to change the protocol.

The Controller Interface

The HP 16500A is equipped with a standard RS-232C interface and an HP-IB interface that allow you to connect to a controller. This gives you remote access for running measurements, for up-loading and down-loading configurations and data, for outputting to a printer, and more. The controller interface is explained in more detail in the *HP 16500A/16501A System Programming Manual*.

The Printer Interface

The HP 16500A can output its screen display to various HP-IB and RS-232C graphics printers. Configured menus as well as waveforms and other data can be printed for complete measurement documentation. The printer interface is explained in more detail in Chapter 7.

What Is the HP-IB Interface?

The Hewlett-Packard Interface Bus (HP-IB) is Hewlett-Packard's implementation of IEEE Standard 488-1978, "Standard Digital Interface for Programmable Instrumentation." The HP-IB is a carefully defined interface that simplifies the integration of various instruments and computers into systems. It uses an addressing technique to ensure that each device on the bus (interconnected by HP-IB cables) receives only the data intended for it. To accomplish this, each device is set to a different address and this address is used to communicate with other devices on the bus.

Selecting an Address

The HP-IB address can be set to 31 different HP-IB addresses, from 0 to 30. Simply choose an address that is compatible with your device and/or software. The default is 7.

To select an address:

1. Select the **System Configuration** menu and select the **HP-IB** field on the right side of the menu by using touch or the optional mouse or keyboard.
2. When the pop-up appears, use the knob, the pop-up keypad, the mouse, or the keyboard to enter the address. To use the keypad, touch the **HP-IB Address** field and a pop-up keypad will appear. Then enter the address and touch **Done**.
3. When you are finished configuring the HP-IB pop-up, touch **Done**.

What Is the RS-232C Interface?

The RS-232C interface on this instrument is Hewlett-Packard's implementation of EIA Recommended Standard RS-232C, "Interface Between Data Terminal Equipment and Data Communications Equipment Employing Serial Binary Data Interchange." With this interface, data is sent one bit at a time and characters are not synchronized with preceding or subsequent data characters. Each character is sent as a complete entity without relationship to other events.

Baud Rate

The baud rate is the rate at which bits are transferred between the interface and the peripheral. The baud rate must be set to transmit and receive at the same rate as the peripheral, or data cannot be successfully transferred. To set the baud rate:

1. Select the **System Utilities** menu and touch the **RS-232C** field.
2. When the pop-up menu appears, touch the field directly to the right of "Baud Rate."

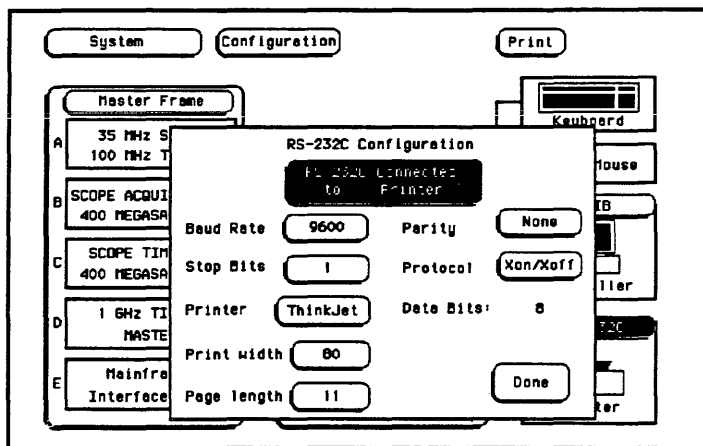

Figure 5-1. RS-232C Pop-Up

3. When the second pop-up appears, touch the baud rate you want from the list displayed in the pop-up (110 to 19.2k) and the pop-up will disappear.

Stop Bits

Stop Bits are used to identify the end of a character. The number of Stop Bits must be the same for the controller as for the Logic Analysis System.

To change the Stop Bits:

1. Touch the field directly to the right of "Stop Bits" on the RS-232C pop-up menu.
2. When the new pop-up appears, select either 1, 1.5, or 2 Stop Bits to identify the end of the character. The pop-up will disappear, placing your selection in the appropriate field.

Parity

The parity bit detects errors as incoming characters are received. If the parity bit does not match the expected value, the character is assumed to be incorrectly received. The action taken when an error is detected depends on how the interface and the device program are configured.

Parity is determined by the requirements of the system. The parity bit may be included or omitted from each character by enabling or disabling the parity function. To set the parity bit:

1. Touch the field directly to the right of “Parity” on the RS-232C pop-up menu.
2. When the pop-up appears, select either **None**, **Odd**, or **Even** to match the parity of the external device. After you make your selection, the pop-up disappears.

Data Bits

Data bits are the number of bits sent and received per character that represent the binary code of that character. The HP 16500A supports the 8-bit binary code.

Protocol

Protocol governs the flow of data between the instrument and the external device. To change the protocol:

1. Touch the field directly to the right of “Protocol” on the RS-232C pop-up.
2. When the pop-up appears, select:
 - **None**
 - With less than a 5-wire interface, selecting **None** does not allow the sending or receiving device to control how fast the data is being sent. No control over the data flow increases the possibility of missing data or transferring incomplete data.
 - With a full 5-wire interface, selecting **None** allows a hardware handshake to occur. With a hardware handshake, hardware signals control data flow. The HP 13242G cable allows the HP 16500A/16501A to support hardware handshake.
 - **Xon/Xoff**
 - Xon/Xoff** stands for Transmit On/Transmit Off. With this mode, the receiver controls the data flow and can request that the printer stop data flow at any time.

After you make your selection, the pop-up disappears.

3. Touch **Done** when you are finished setting up the RS-232C configuration pop-up.

Configuring the Interface for a Controller or a Printer

To configure the HP-IB or RS-232C interfaces for a controller or a printer, first select the **System Configuration** menu. Then touch the appropriate field for the interface you want to configure (RS-232C or HP-IB). When the pop-up appears, touch the field at the top of the pop-up to switch between a printer and a controller configuration. Whenever you change the configuration for one interface, the other interface automatically changes to the opposite configuration.

For example, to configure the HP-IB interface for a printer:

1. Select the **System Configuration** menu and touch the **HP-IB** field.
2. When the pop-up appears, touch the field displaying **HP-IB Connected to: Controller** and it changes to **HP-IB Connected to: Printer**. At the same time, the RS-232C interface automatically changes from a printer to a controller configuration.

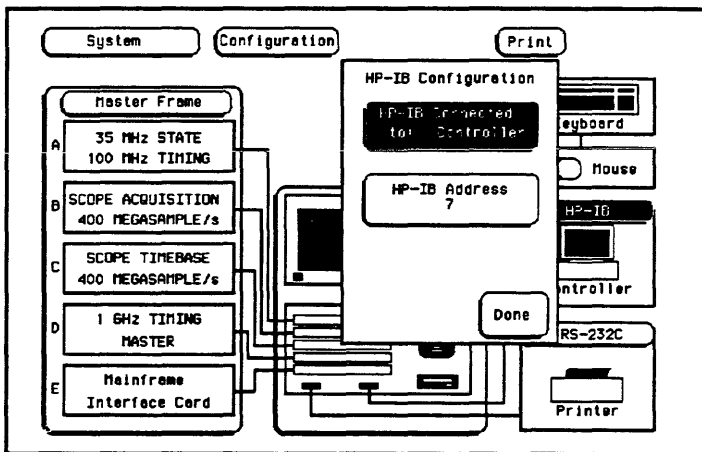

Figure 5-2. HP-IB Printer Configuration

The HP-IB printer must be set to **Listen Always** for the HP-IB interface. In this mode, no HP-IB addressing is necessary, so the HP-IB address field is not displayed. Three additional fields then appear to allow you to select the printer type, character width, and page length.

To return to the HP-IB controller interface:

1. Touch the field displaying **HP-IB Connected to: Printer** and it changes back to **HP-IB Connected to: Controller**. Automatically, the RS-232C interface switches back to a printer configuration.
2. Touch **Done** and the HP-IB pop-up disappears.

The Optional HP 16501A Expansion Frame

The HP 16501A Expansion Frame has been developed to extend the HP 16500A Logic Analysis System beyond its present five-card limit and meet the anticipated need for systems requiring more than five slots.

This chapter explains the features, components, and system configuration of the HP 16501A. There are sections explaining and illustrating module-to-module system arming and triggering, as well as an interframe arming/triggering block diagram. In addition, this chapter contains a detailed explanation of how to connect the HP 16501A to the HP 16500A.

Features

Adding the HP 16501A to the HP 16500A creates a tightly coupled two frame, nine-card system fully controlled by the HP 16500A. A single power switch (located on the HP 16500A front panel) turns on both mainframes. The HP 16501A offers inter-frame module arming/triggering capabilities with a 10 nanosecond time correlation between modules.

Component Details

The HP 16501A Expansion Frame consists of the HP 16500A system package, card cage, rear panel, power supply, and fans. Included as part of the HP 16500A system package are two PC boards which enable you to connect the HP 16501A to the HP 16500A.

Expansion Frame Interface Board

The expansion frame control board, which occupies the bottom slot in the HP 16501A card cage, uses a buffering scheme to pass signals between the mainframe interface board and the HP 16501A back plane. It contains circuitry which controls external arming selection and enables an HP 16501A card to drive an output dedicated to triggering other instruments.

Main Frame Interface Board

The main frame interface board, which occupies one of the five card slots in the HP 16500A mainframe, has two functions:

- To pass signals between the HP 16500A rear panel and the expansion frame interface board.
- To capture and correlate all trigger signals generated by both the HP 16500A and the HP 16501A.

System Configuration

The expansion frame interface board is connected to the main frame interface board through a 68-pin flat cable. In addition to the HP 16500A rear panel signals, the cable incorporates control signals which allow the CPU to communicate with and control the expansion frame interface board. Ground lines separate signal lines within the cable to prevent cross-coupling or soft failures. The cable is externally shielded to reduce RFI emissions. Figure 6-1 shows one of the possible connection configurations.

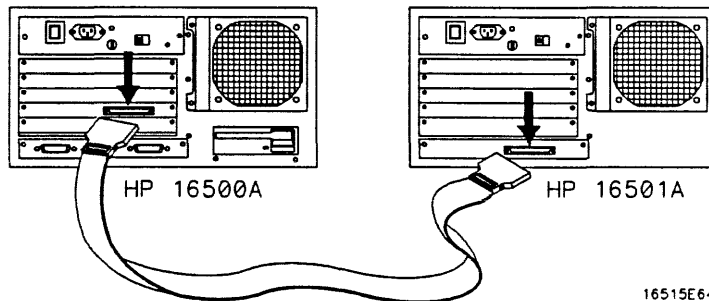

Figure 6-1. Possible Connection Configurations

System Arming and Triggering

Module-to-module arming within the HP 16501A follows the arming specifications for the HP 16500A in that any module may arm any other module. The maximum intermodule arming level is five.

When the HP 16501A is attached to the HP 16500A, the resulting HP 16500A/16501A system operates as a single frame. The HP 16500A and HP 16501A may receive only one external arming signal from the other frame. Figure 6-2 shows how module-to-module arming is selected.

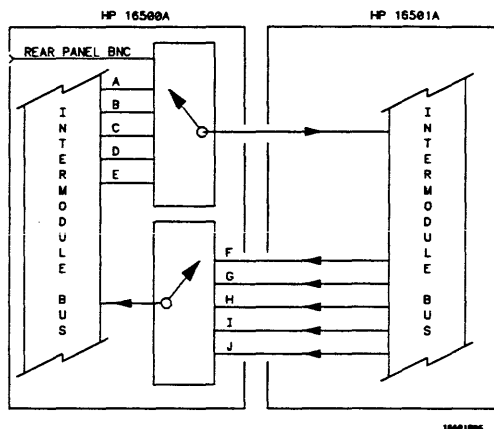

Figure 6-2. Module-to-Module Arming

The HP 16500A mainframe may use only two external arming signals: any module in the HP 16501A expansion mainframe or the rear-panel BNC. The arming signal can come from three sources:

- Any module in the HP 16500A mainframe.
- Any module in the HP 16501A expansion mainframe.
- From the rear-panel Port In BNC.

The arming signal from the HP 16501A is applied to the arm-out/trigger line dedicated to the slot occupied by the Mainframe Interface board (A-E). The external source has its own separate line.

Any card in the HP 16500A mainframe can be armed from its external inputs or from one of the other three cards in the HP 16500A mainframe.

The HP 16501A expansion mainframe may use only one external arming signal. The arming signal for any module can come from two sources:

- Any module in the HP 16501A expansion mainframe.
- From a single module or the Port In BNC in the HP 16500A mainframe.

Any module in the HP 16501A expansion mainframe may be armed from a single HP 16500A module or from one of the other four modules in the HP16501A expansion mainframe.

To summarize, the arming triggers available for output from the HP 16500A/16501A are:

- HP 16500A
 - Module A through Module E.
 - Port In BNC.
- HP 16501A
 - Module F through Module J.

Note



Only the HP 16500A has a Port Out BNC. There is no Port Out BNC on the HP 16501A. The Port Out signals from module F through module J use the Port Out BNC on the HP 16500A.

For detailed information about how to make intermodule measurements using the HP 16500A/16501A, please see Chapter 12.

Connecting the HP 16501A Expansion Frame

The optional HP 16501A Expansion Frame has four components:

- The expansion frame.
- An expansion frame interface board.
- A main frame interface board.
- A flat, bi-directional cable 2 meters long with a 68-pin “D” connector at each end.

To connect the HP 16501A to the HP 16500A, follow these steps:

1. Check to see if the main frame interface board is already installed in the HP 16500A mainframe. If it is not already installed, insert it into any one of the five card slots marked A-E (see “Installing and Removing Cards” in Appendix F).

Note



In order to ensure correct insertion, the 68-pin “D” connectors are asymmetric in shape. They only fit into their respective ports when oriented to match the shape of the ports.

2. Insert one of the cable connectors into the port located on the right side of the mainframe interface board.
-

Note



Make sure the connector is properly seated into the port by pulling the connector without pressing the release tabs. If the connector is properly seated it will remain connected to the port.

3. Insert the other connector into the port on the expansion frame interface board.

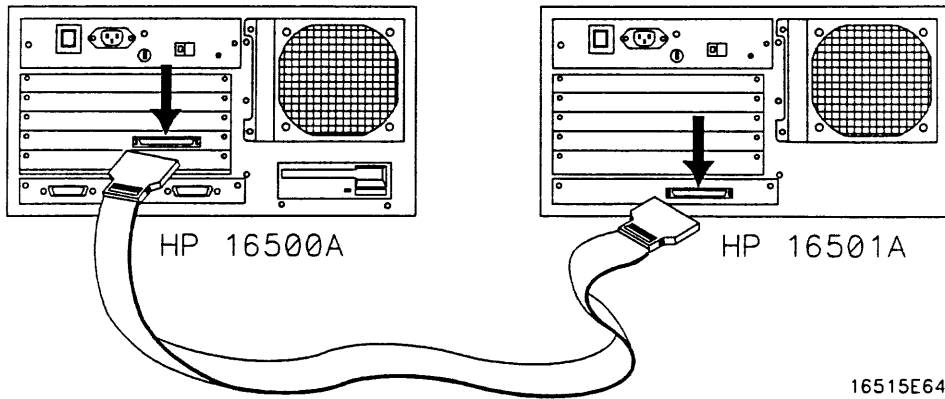

16515E64

Figure 6-3 Connecting the optional HP 16501A Expansion Frame

If, at power-up, the HP 16500A CPU board finds a mainframe interface board in any one of its five card slots, it checks the expansion frame interface board to determine whether an HP 16501A expansion mainframe is present. If so, the CPU establishes a “link” between the rear panels of the two mainframes, which then are displayed by the System Configuration menu as a nine-slot system on the HP 16500A rear panel.

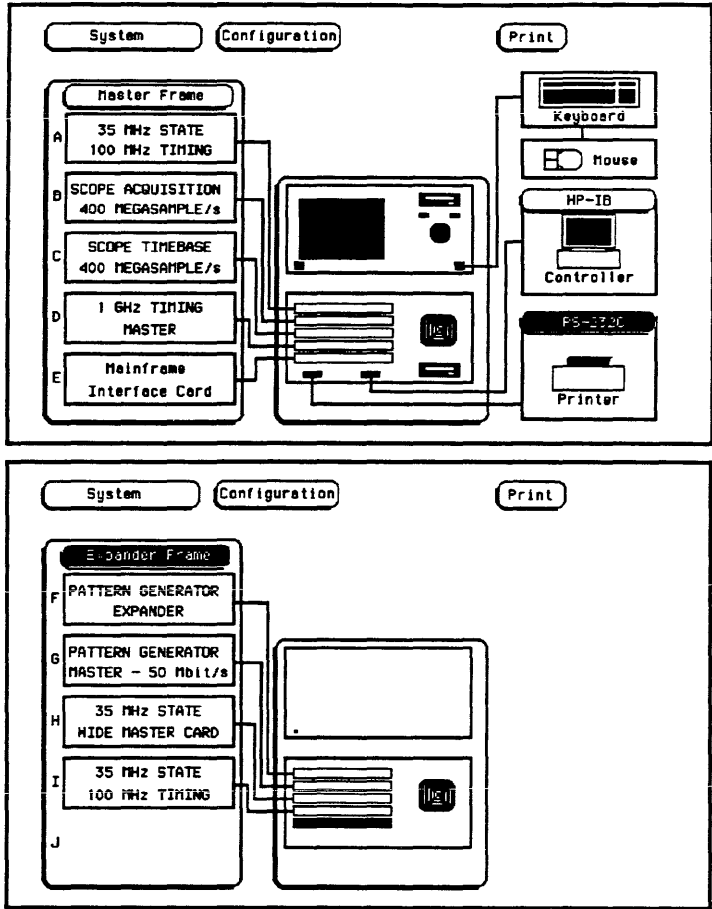

Figure 6-4. System Configuration Menus with the HP 16501A Connected.

Connecting a Printer

The HP 16500A can output its screen display to various HP-IB and RS-232C graphics printers. Configured menus as well as waveforms and other data can be printed for complete measurement documentation.

HP-IB Printers

The HP 16500A interfaces directly with HP PCL printers supporting the printer command language or with Epson printers supporting the Epson standard command set. These printers must also support HP-IB and Listen Always Printers currently available from Hewlett-Packard with these features include:

- HP ThinkJet.
- HP LaserJet.
- HP PaintJet.
- HP DeskJet.



The printer must be in Listen Always when HP-IB is the printer interface.



The HP 16500A HP-IB port does not respond to service requests (SRQ) when controlling a printer. The SRQ enable setting for the HP-IB printer has no effect on HP 16500A printer operation.

HP-IB Printer Setup

To set up the printer for the HP 16500A:

1. Turn off the HP 16500A and connect an HP-IB cable from the printer to the HP-IB connector on the rear panel of the HP 16500A.

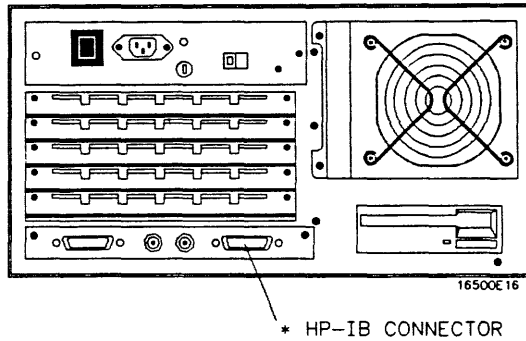

Figure 7-1. HP 16500A Rear Panel

2. Make sure the printer is in Listen Always (or Listen Only). For example, figure 7-2 shows the HP-IB configuration switches for an HP-IB ThinkJet printer. For the Listen Always mode, move the second switch from the left to the "1" position. Since the HP 16500A doesn't respond to SRQ EN (Service Request Enable), the position of the first switch doesn't matter.

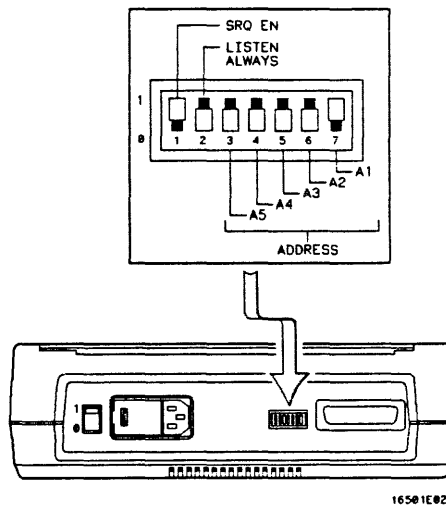

Figure 7-2. Configuration Switches for the HP ThinkJet Printer

HP-IB Configuration

Turn on the HP 16500A and when the System Configuration menu is displayed:

1. Touch the HP-IB field.
2. When the pop-up appears, touch HP-IB Connected to: **Controller** to switch from a controller to a printer configuration. This automatically switches the RS-232C interface from a printer to a controller configuration.
3. Touch the field to the right of "Printer" and when the pop-up appears, select the printer that you're using (ThinkJet, QuietJet, etc.). If you're using an Epson graphics printer or an Epson-compatible printer, select Alternate.

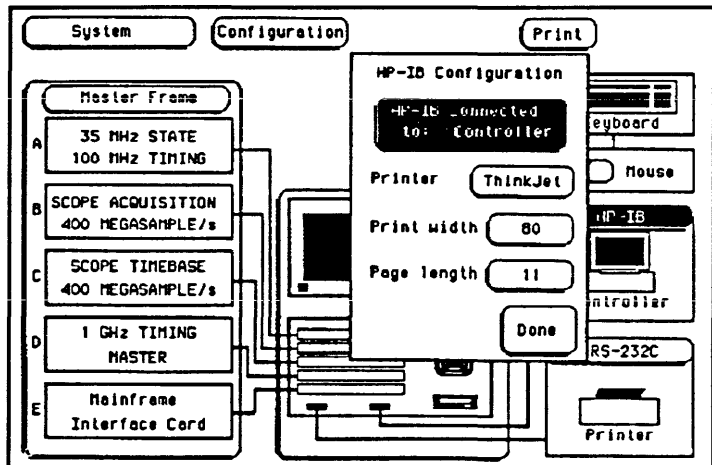

Figure 7-3. HP-IB Printer Interface Pop-Up

4. Touch the Print Width field and print width toggles between 80 and 132. Select the width for your application or leave it at the default of 80. Print width tells the printer that you are sending up to 80 or 132 characters per line (when you Print All) and is totally independent of the printer itself.

- If you select 132 characters per line when using other than the **QuietJet** selection, the listings are printed in a compressed mode. Compressed mode uses smaller characters to allow the printer to print more characters within a given area.
 - If you select 132 characters per line for the **QuietJet** selection it can print a full 132 characters per line without going to compressed mode, but the printer must have wider paper.
 - If you select 80 characters per line for any printer, a maximum of 80 characters are printed per line.
5. Touch the **Print Length** field and print length toggles between 11 and 12. Select the length for your application or leave it at the default of 11. Print length tells the printer the page length for the type of paper you are using.
 6. Touch **Done** when you finish setting up the HP-IB pop-up.

RS-232C Printers

The HP 16500A interfaces directly with RS-232C printers including the HP ThinkJet, HP QuietJet, HP LaserJet, HP PaintJet, and HP DeskJet printers.

RS-232C Printer Setup

To set up the printer for the HP 16500A:

1. Turn off the HP 16500A and connect an RS-232C cable (HP 13242G) from the printer to the RS-232C connector on the rear panel of the HP 16500A.

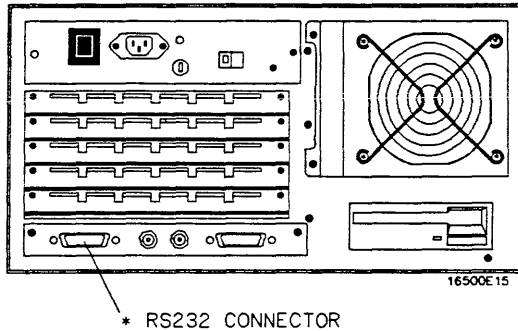

Figure 7-5. HP 16500A Rear Panel

2. Before turning on the printer, locate the mode configuration switches on the printer. Then configure the printer as follows:
 - The HP QuietJet series printers have two banks of mode function switches inside the front cover. Push all the switches down to the "0" position as shown in figure 7-5.

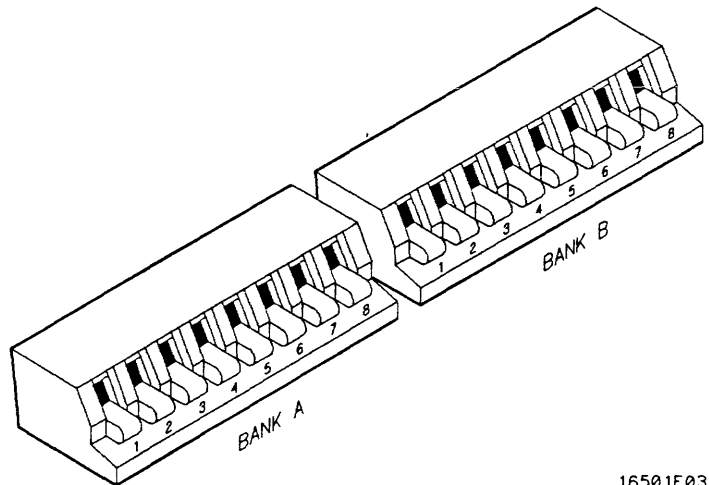

Figure 7-4. Switch Configuration for HP QuietJet Printers

- For the HP 2225D (RS-232 HP ThinkJet) printer, the mode switches are on the rear panel of the printer. Push all the switches down to the “0” position as in figure 7-6.

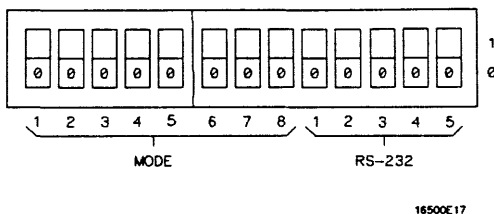

Figure 7-6. Switch Configuration for HP ThinkJet Printers

- For the HP LaserJet printer, the switch settings can remain in the factory default settings.

RS-232C Configuration

Turn on the HP 16500A and when the System Configuration menu is displayed:

1. Touch the **RS-232C** field.
2. When the pop-up appears, the top field should display **RS-232C Connected to: Printer**. If not, touch this field to switch to a printer configuration. This automatically switches the HP-IB interface from a printer to a controller configuration.
3. Set the baud rate, stop bits, parity, and protocol to match the setup for the RS-232C printer by selecting the appropriate fields.

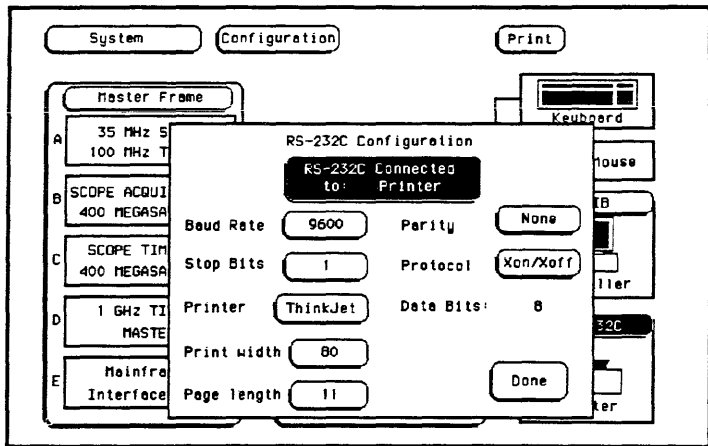

Figure 7-7. RS-232C Printer Interface Pop-Up

4. Set the Printer field to match the type of printer you are using (ThinkJet, QuietJet, etc.).
5. Touch the field to the right of **Print Width** and print width toggles between **80** and **132**. Select the width for your application or leave it at the default of **80**. Print width tells the printer that you are sending either **80** or **132** characters per line (when you **Print All**) and is totally independent of the printer itself.
6. Touch the **Print Length** field and print length toggles between **11** and **12**. Select the length for your application or leave it at the default of **11**. Print length tells the printer the page length for the type of paper you are using.
7. Touch **Done** when you finish setting up the RS-232C pop-up.

Configuration Example

Figure 7-8 shows how the RS-232C configuration pop-up is configured for the HP LaserJet printer. The only difference between this configuration and the configuration for the HP QuietJet and HP ThinkJet printers is the printer selection. All the other fields remain in their default settings.

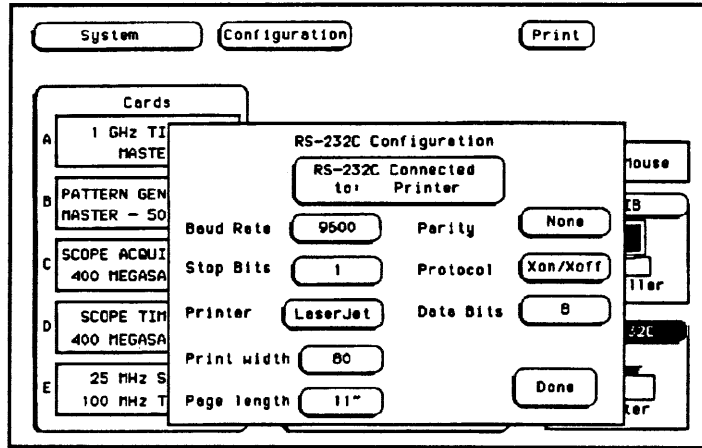

Figure 7-8. RS-232C Configuration for HP LaserJet Printers

Connecting to Other Hewlett-Packard Printers

The HP 16500A can also be used with other Hewlett-Packard graphics printers. Simply connect the printer to the HP 16500A using the appropriate cable (HP-IB or RS-232C) and configure the HP 16500A as shown in table 7-1.

Table 7-1. HP Printer Selection

For this HP Printer	Select this Printer from the pop-up
HP 2631G	QuietJet
HP 2671G	ThinkJet
HP 2673A	ThinkJet
HP 9876A	ThinkJet
HP 2932/34 (option 046)	QuietJet



HP-IB printers must support Listen Always to work with the HP 16500A. The HP 82906A graphics printer is not supported because it does not support Listen Always on HP-IB.

The HP 2932A or HP 2934A option 046 printer is configured from the front panel of the printer, instead of with switches on the rear panel. The correct configuration for the HP 16500A is shown in figure 7-9.

Refer to the *HP 16500A/16501A Programming Manual* for information on setting up an external controller to activate the printer.

```

*****  SETTINGS  *****

***** LIST *****  ***** MODIFY *****
PRINTER INTERFACE PRINTER INTERFACE

*****  LIST INTERFACE  *****

                                HP-IB

SECONDARY COMMANDS  LISTEN ALWAYS  SERVICE REQUEST  ADDRESS  SET DEFAULTS
off                 on                off                1

*****  END OF SETTINGS  *****

```

16501801

Figure 7-9. Configuration for the HP 2932/34 Option 046

Printing the Display

After connecting the printer to the instrument and setting the printer and instrument configurations, apply power to the printer.

Each menu has a **Print** field in the upper-right corner. Touch the **Print** field and a pop-up appears, displaying your choices.

- **Cancel** is used to stop the HP 16500A from sending data.
- **Print Screen** prints everything shown on the screen.
- **Print All** (available only in certain menus) prints all of the information listed for that display, including any listings that do not appear on screen. These listings can be 80 or 132 characters wide, depending on the **Print Width** setting.

To initiate a print, touch **Print Screen** or **Print All**, at which point the **Cancel** field will replace the print field.

Note

The HP 16500A does not check the operation of the printer, so no error message is displayed.

The System Front and Rear Disk Menus

This chapter describes the disk operations of the HP 16500A/16501A and tells you how to get into the system's Front and Rear Disk menus. It explains the menu map and describes how to select a disk operation and designate source and destination disks. It tells you how to install, format, store, and duplicate a disk, as well as how to purge, copy, and rename a file. This chapter also describes the Load, Autoload, and Pack Disk operations.



The HP 16500A disk drives support only double-sided, double-density disks.

Getting into the System Front Disk Menu

To bring up the System Front Disk menu:

1. Touch the menu field to the right of **System** in the upper-left corner of the display.
 2. When the pop-up appears, touch **Front Disk** to bring up the System Front Disk menu.
-



The System Front and Rear Disk menus operate in the same manner.

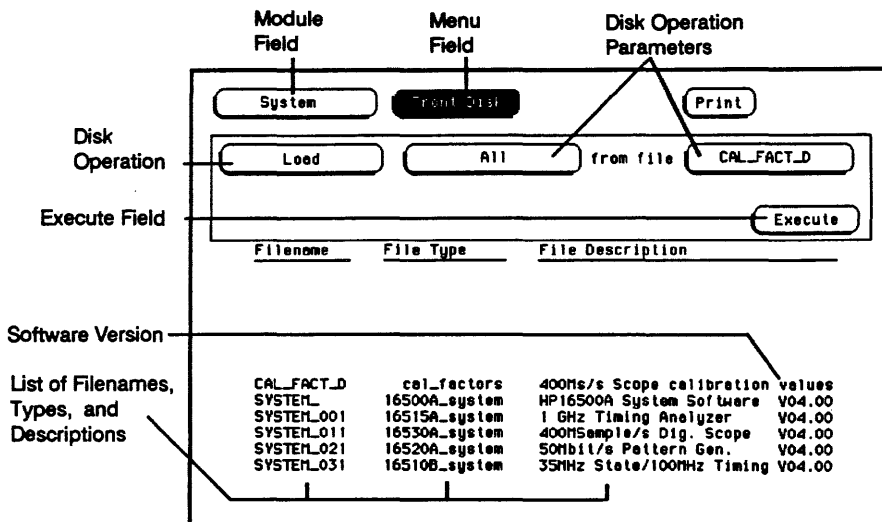

Figure 8-1. The System Front Disk Menu

Note

The software version numbers (VXX.YY) shown in this manual may be different for your instrument. Also, the last two digits of the software version number (YY) for specific modules may be different from other modules without affecting software operation or compatibility. The first two digits (XX) must be the same for all modules and system files within a specific mainframe.

The Disk Operations

Nine disk operations are available:

- Autoload** Designates a set of configuration files to be loaded automatically the next time the HP 16500A/16501A is turned on.
- Copy** Any file can be copied from one disk to another or to the same disk.

- Duplicate Disk** All files from one disk are copied to another disk. All files on the destination disk will be destroyed with this operation. The copied files are packed on the new disk as they are copied and the new disk is formatted if it is required.
- Format Disk** Any double-sided, double-density 3.5 inch flexible disk can be formatted or initialized. The directory and all files on the disk will be destroyed with this operation.
- Load** Instrument setup and data can be loaded from the disk for the mainframe and modules.
- Inverse assemblers for analyzer modules can be loaded.
- Pack Disk** This function packs files on a disk. Packing removes all empty or unused sectors between files on a disk so that more space is available for files at the end of the disk.
- Purge** Any file on a disk can be purged (deleted) from the disk.
- Rename** Any filename on a disk can be changed to another name.
- Store** Instrument setup and data can be stored on disk.



System files for mainframe and modules cannot be stored.

Although default values are provided for these disk operations, a disk operation may require additional information from the user. This information is entered by touching or selecting the appropriate fields displayed for each disk operation. Disk operations are initiated by touching the Execute field. If there is a problem or additional information is needed to execute an operation, a pop-up appears near the center of the screen displaying the status of the operation (displays an error message, prompts the user to swap disks, etc.).

If executing a disk operation could destroy or damage a file, a pop-up appears when you touch **Execute**. If you don't want to complete the operation, touch **Cancel** to cancel the operation. Otherwise, touch **Continue** and the operation will be continued.

When a disk operation is being executed, the background of the **Execute** field changes color. When the **Execute** field returns to the original color, the disk operation is complete.

Whenever a disk drive is being accessed, an asterisk (*) appears in the upper-right corner of the display.

Menu Map

Figure 8-2 displays a menu map for the System Front and Rear Disk menus.

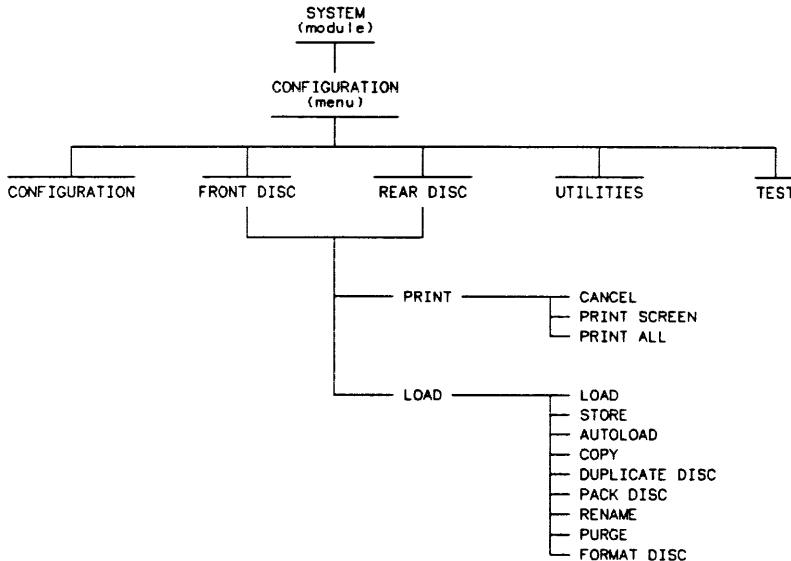

16500809

Figure 8-2. Menu Map for the System Disk Menus

Selecting a Disk Operation

To select a disk operation:

1. Touch the disk operation field directly below **System** on the display (**Load**).

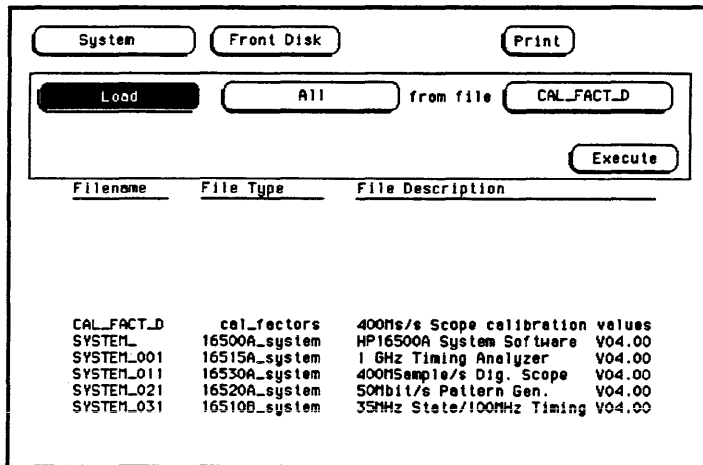

Figure 8-3. Selecting the Disk Operations Field

2. When the pop-up appears, touch the field for the operation you want. After you select a field, the pop-up disappears, bringing up the appropriate operation. For example, touch Store.

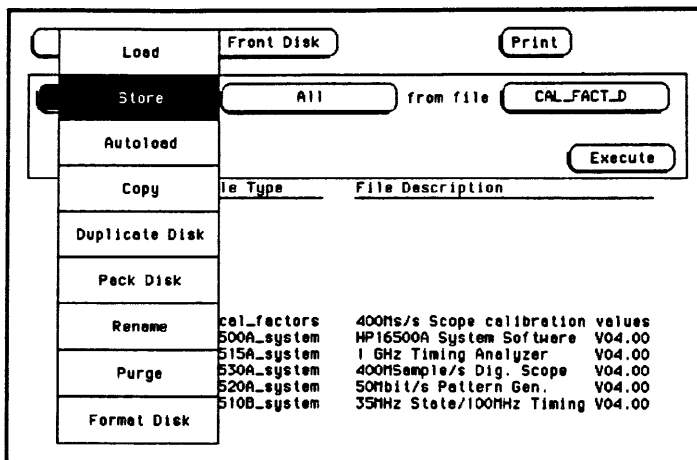

Figure 8-4. Selecting the Store Operation

Disk Operation Parameters

The disk operation parameters specify which modules are being operated on and give the names, types, and descriptions of files involved in the disk operation.

After setting up the disk operation, touch **Execute**. When the background of the **Execute** field returns to the original color, the disk operation is complete.

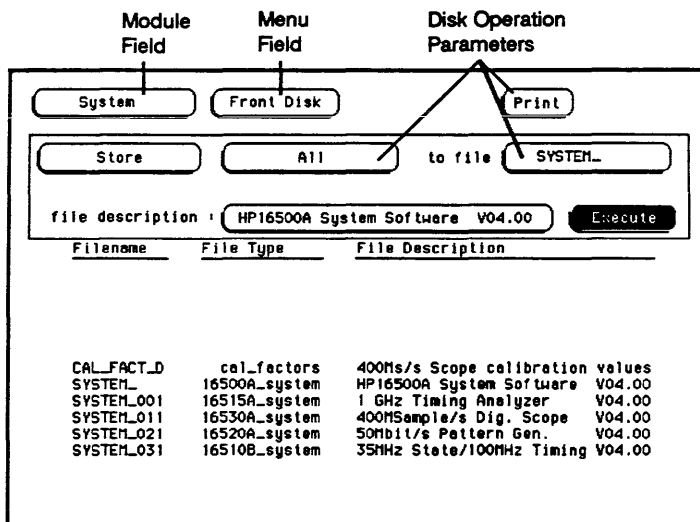

Figure 8-5. Disk Operation Parameters

Source and Destination Disks

The menu field (**Front Disk** or **Rear Disk**) indicates the location of the disk on which you're performing the operation. This disk is referred to as the **Source** disk.

For the **Copy** operation and the **Duplicate Disk** operation, a disk operation parameter is used to select the location of the disk to which the information will be transferred (**Front Disk** or **Rear Disk**). This disk is referred to as the **Destination** disk.

When you copy a disk (or duplicate a disk), you copy from the **Source** disk (indicated by the menu field) to the **Destination** disk (indicated by the disk operation parameter). You can use the same disk drive for both the **Source** and **Destination** disks by just switching disks when necessary. For the copy operation, the **Source** and **Destination** disks can be the same.

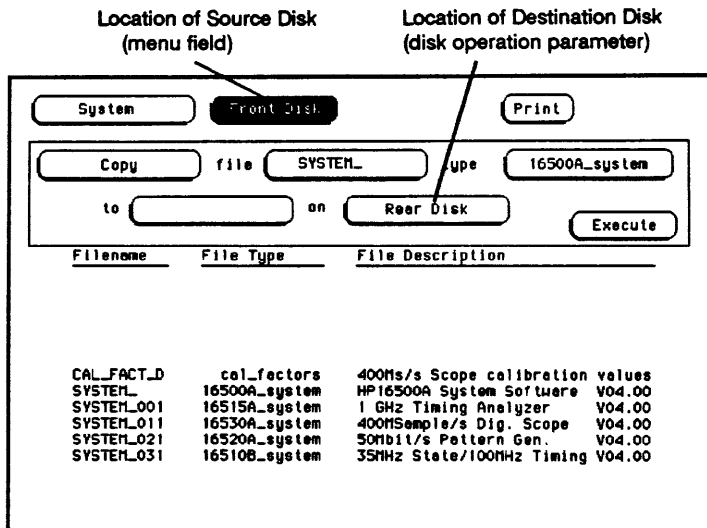

Figure 8-6. Disk Locations

Installing a Disk

Included with the HP 16500A/16501A are two 3.5-inch flexible disks for your own use. Either disk can be installed into the front or rear disk drives. To install a disk:

1. Hold the disk so that the Hewlett-Packard label is on top and the metal auto-shutter is away from you.
2. Push the disk gently, but firmly, into the front disk drive until it clicks into place.



The HP 16500A disk drives use the gray Hewlett-Packard double-sided, double-density disks, which can be ordered in a package of ten with the Hewlett-Packard part number 92192A. DO NOT use single-sided or high density disks with the HP 16500A/16501A.

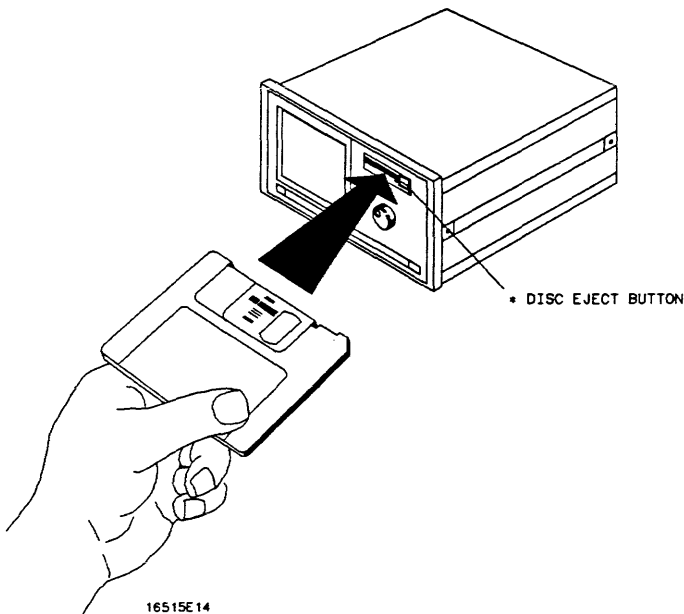

Figure 8-7. Installing a Disk

Formatting a Disk

Before any information can be stored on a new disk, you must first format it. Formatting marks off the sectors of the disk and creates the LIF (Logical Interchange Format) directory on the disk.



The HP 16500A supports up to 144 entries. If the disk was formatted elsewhere with more than 144, the disk will be permanently changed if you use it in the HP 16500A.

The HP 16500A does not support track sparing. If a bad track is found, the disk is considered bad. If a disk has been formatted elsewhere with track sparing, it is NOT compatible with the HP 16500A and will cause unpredictable results.

To format a disk:

1. Select the **Format Disk** operation. After the **Format Disk** operation appears, the instrument reads the disk and lists the files on it.
 - If this is a new disk, the menu will display “Unsupported Format” on the lower portion of the menu.
 - If it is already formatted, but there are no files on it, the menu will display “No Files.”
 - If the disk already has files, a list of those files will appear on the lower portion of the menu along with a file type and description.



The HP 16500A supports (for both read and write) 256-byte and 512-byte LIF formatted disks, but the HP 16500A will only format to 1024-byte

The HP 16500A does NOT support any single-sided formats.

2. To format the disk, touch **Execute**. When the pop-up appears, touch **Continue** and the instrument will go through a sequence to format the disk. Otherwise, touch **Cancel** to cancel the **Format Disk** operation.

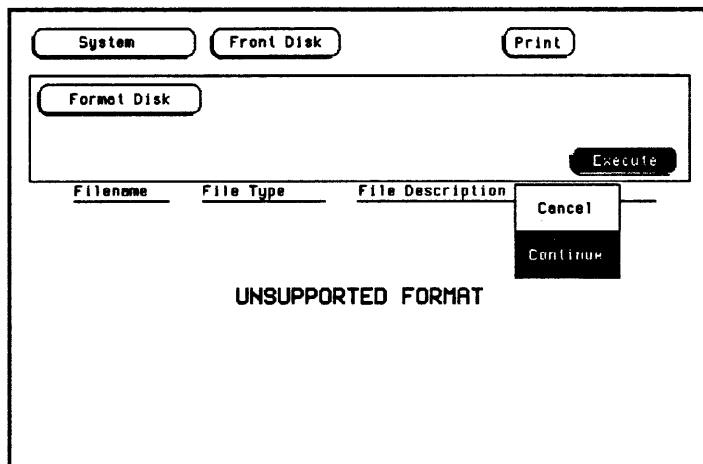

Figure 8-8. The Format Disk Operation

Caution 

Once Executed, the **Format Disk** operation permanently erases all the existing information from the disk. After that, there is no way to retrieve the original information.

Storing on a Disk

The **Store** operation allows you to store the configurations and data from all of the modules or a particular module to a file with a given description.

Note 

Storing the default configurations is a convenient way to return to the default values without cycling the power.

To store files:

1. Select the **Store** operation.

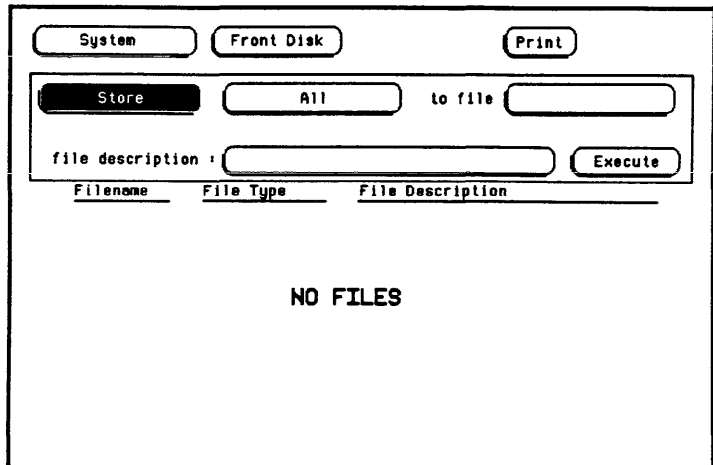

Figure 8-9. The Store Operation

2. Touch the field to the right of "to file" and a pop-up appears displaying an alphanumeric keypad.

3. Enter a filename that starts with a letter and contains up to eight characters. It can be any combination of letters and numbers, but there can be no blank spaces between any of the characters.

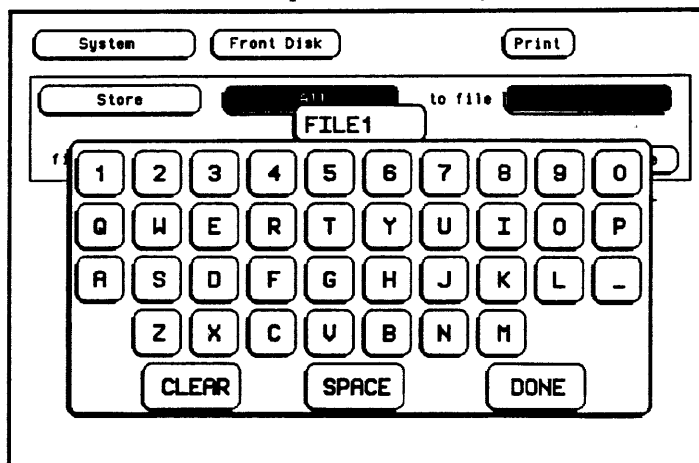

Figure 8-10. Entering a Filename

For example, touch the appropriate keys to enter the filename "FILE1."



If you make an error, move the cursor (with the knob) to the incorrect character and insert the correct character with the keypad.

4. Touch **Done** when you are finished and the pop-up disappears, putting FILE1__ to the right of "to file."



The two spaces() after the filename designates that this file is for the system. One space and a letter (_X) after the filename designates that the file is for a specific module.

5. Touch the field to the right of "file description."
6. When the pop-up appears, touch the appropriate keys to enter "PRACTICE FILE" as your file description. The file description can be up to 32 characters in length.

Note

The field for “file description” makes it easier to identify the type of data in each file. This is for your convenience, but you can leave this field blank. There is no way to change a file description after a file has been stored.

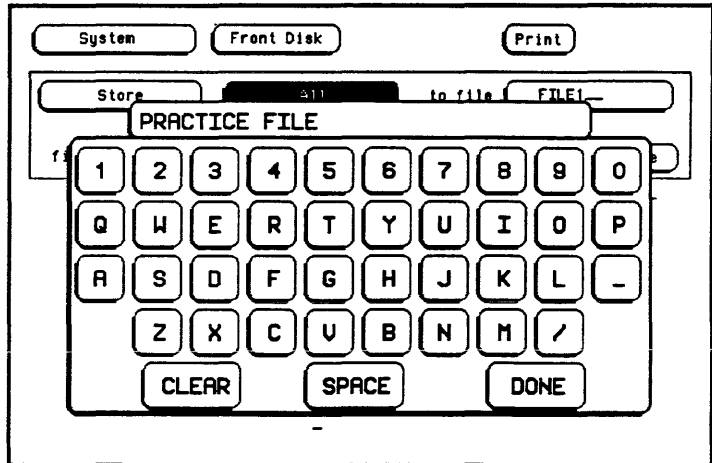

Figure 8-11. Entering a File Description

7. Touch Done when you are finished and the pop-up will disappear, putting PRACTICE FILE to the right of “file description.”
8. Touch Execute to store all to FILE1.
9. When the Cancel/Continue pop-up appears, touch Continue to continue.

Caution

If you store a new configuration and data to an existing file, the new configuration and data are written over the original information, DESTROYING the original information in that file.

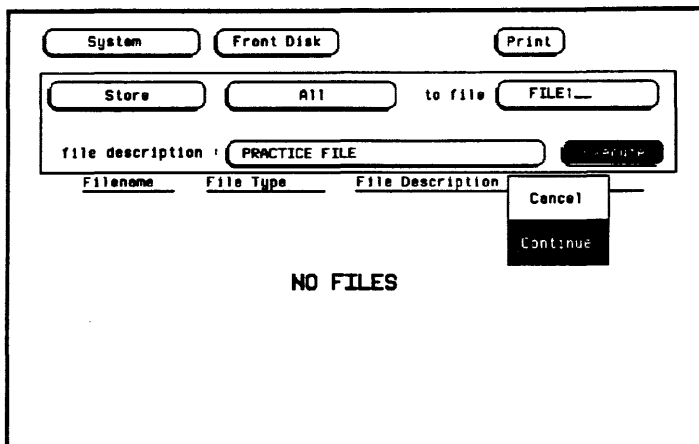

Figure 8-12. Storing a File

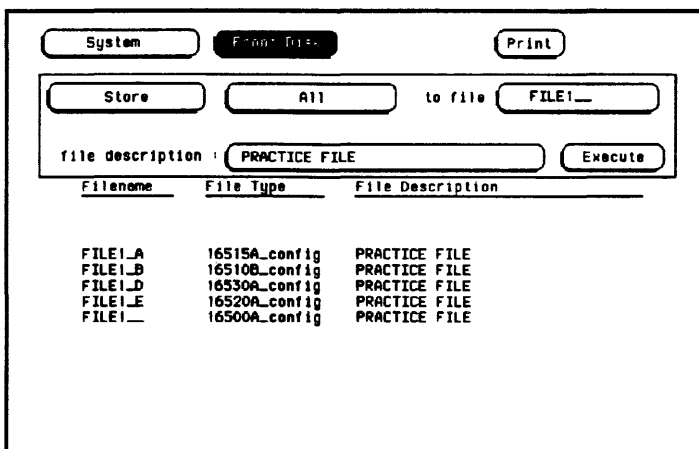

Figure 8-13. Listing of the Files Stored

When you execute the **Store All** operation, the HP 16500A/16501A stores the configuration of the instrument for each module in the instrument and for the system. The field to the right of “to file” now displays FILE1 because this was the last file stored.

In this example, five files are listed on the lower portion of the display.

- FILE1 A (type) 16515A config is for the module in slot A (the HP 16515A 1 GHz Timing module).
- FILE1 B (type) 16520A config is for the module in slot B (the HP 16520A Pattern Generator).
- FILE1 D (type) 16530A config is for the module in slot D (the HP 16530A Oscilloscope).
- FILE1 E (type) 16510A config is for the module in slot E (the HP 16510A State/Timing Analyzer).
- FILE1 - (type) 16500A config is for the system.



The HP 16500A/16501A system software includes the Intermodule software.

The Load Operation

The Load operation allows you to load all of the modules or a particular module with previously stored configuration and data from a file on the disk. To load files:

1. Select the Load operation.

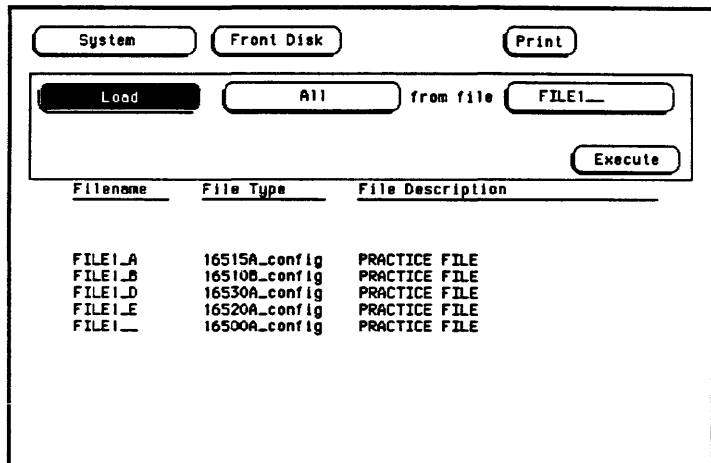

Filename	File Type	File Description
FILE1_A	16515A_config	PRACTICE FILE
FILE1_B	16510B_config	PRACTICE FILE
FILE1_D	16530A_config	PRACTICE FILE
FILE1_E	16520A_config	PRACTICE FILE
FILE1_	16500A_config	PRACTICE FILE

Figure 8-14. The Load Operation

- The **All** field to the right of **Load** tells the analyzer that you want to **Load All** of the modules from the file “FILE1_.” For this example, load only the module in slot D (the Oscilloscope) from this file.

Touch **All** and when the pop-up appears, touch the field for **Oscilloscope D**. When the pop-up disappears, **Oscilloscope D** is displayed in the field to the right of **Load**.

- The **Load** operation is type dependent. This means that you cannot load a file for one module type into a module of a different type.

For example, the screen now indicates that you want to **Load** the module **Oscilloscope D** from **FILE1**. Touch **Execute** and an error message appears to indicate that **FILE1_** is the incorrect type of file.



The **Load All** operation is slot dependent. Even if the file is the right type, the slot indicator (last letter of the filename) must match the slot indicator of the module (last letter of the module name).

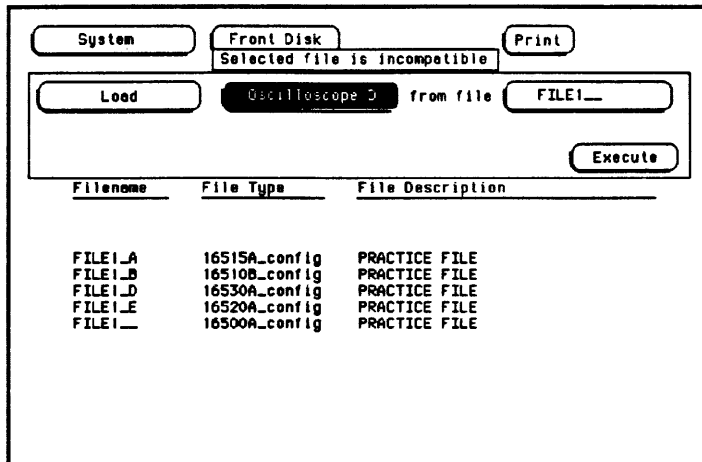

Figure 8-15. Disk Error Message

Note 

The compatible file types for each module are listed in the card installation section of the reference manual for that module.

4. To correctly load the module Oscilloscope D, rotate the knob on the front panel until FILE1_D appears in the field to the right of “from file.” FILE1_D is for file type “16530A_config” which is a compatible file type for this module. Touch **Execute** and the file is loaded into the oscilloscope module.
-

Note 

Another way to enter the name of the file in the field to the right of “from file” is to touch this field. When the pop-up keypad appears, enter the correct filename. Touch **Done** when you are finished.

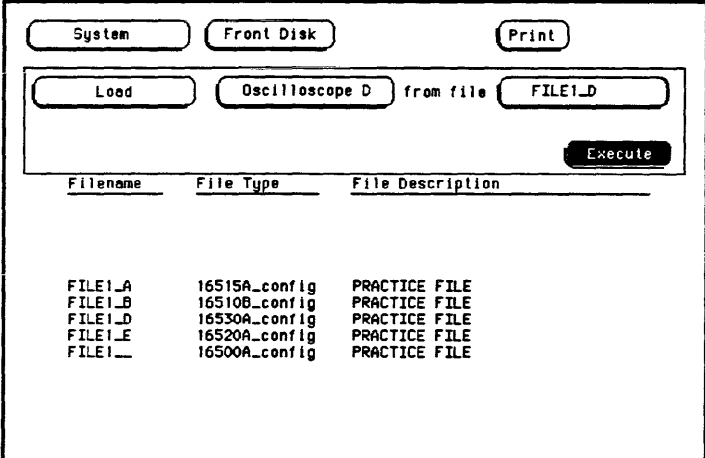

Filename	File Type	File Description
FILE1_A	16515A_config	PRACTICE FILE
FILE1_B	16510B_config	PRACTICE FILE
FILE1_D	16530A_config	PRACTICE FILE
FILE1_E	16520A_config	PRACTICE FILE
FILE1_	16500A_config	PRACTICE FILE

Figure 8-16. Loading the HP 16530A Oscilloscope

Renaming a File

The **Rename** operation allows you to change the name of a file of a particular type or all types to a different name. The only restriction is that you cannot rename a file to an already existing filename. To rename a file:

1. Select the **Rename** operation.
2. Use either the knob or the pop-up keypad to enter a filename in the field to the right of “file.” For this example, select **FILE_D**.
3. Touch the field to the right of “type” and a pop-up will appear with the following choices:
 - **All Types** allows you to rename all the different types of files listed for a filename and to ignore any slot qualifications that appear in the filename;
 - “A particular file type” (16530A_config) allows only the current file to be renamed.

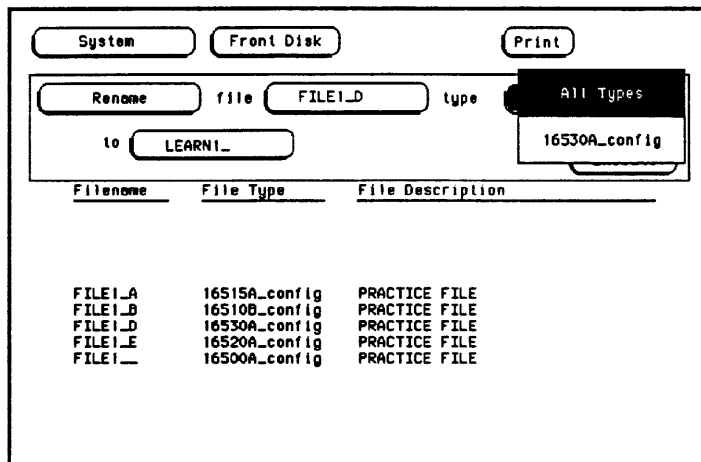

Figure 8-17. Renaming a File

4. Touch the file type you want and the pop-up disappears, displaying your choice in the appropriate field. For this example, select **All Types**.
5. Touch the field to the right of “to” and a pop-up keypad appears.
6. Enter the new name for the file with the keypad and touch **Done** when you are finished. For this example, enter **LEARN1**.

Note 

The slot designators for the files are only preserved when copying **All Types**. Otherwise, the destination file appears exactly as entered in the destination field.

7. Touch **Execute** and the files are renamed **LEARN1**. The last file to be renamed now appears in the field to the right of “file.”

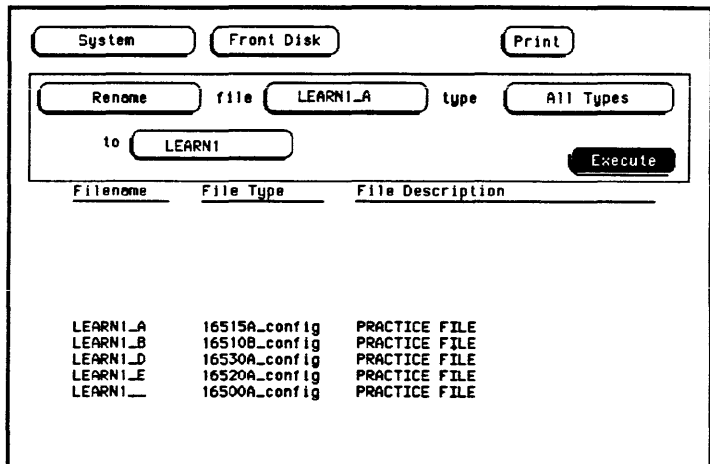

Filename	File Type	File Description
LEARN1_A	16515A_config	PRACTICE FILE
LEARN1_B	16510B_config	PRACTICE FILE
LEARN1_D	16530A_config	PRACTICE FILE
LEARN1_E	16520A_config	PRACTICE FILE
LEARN1_	16500A_config	PRACTICE FILE

Figure 8-18. Renaming Files Completed

The Autoload Operation

Autoload allows you to designate a set of configuration files to be loaded automatically the next time the HP 16500A/16501A is turned on. This allows you to change the default configuration of certain menus to a configuration that better fits your needs. When the Autoload operation is Enabled, your designated configuration file is loaded as if you had performed a Load All. To enable the Autoload operation:

1. Select the Autoload operation.
2. Touch the **Disable** field and when the pop-up appears, select **Enable**.

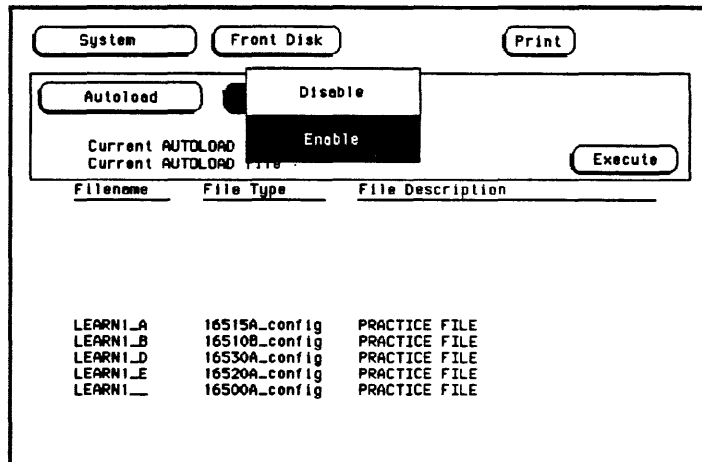

Figure 8-19. Selecting Enable

3. Highlight or enter the name of your customized configuration files in the field to the right of "File." For this example, enter LEARN_A.



Autoload loads all of the files for a given filename. If you want to load only the file for a given module, rename that file to separate it from the other files and enable it as the current Autoload file.

4. Touch **Execute** and the **Autoload** function is **Enabled** as shown after “Current AUTOLOAD status:” on the display. The question mark (?) after the filename (LEARN_?) indicates that all files for this given filename will be loaded when Autoload is enabled.

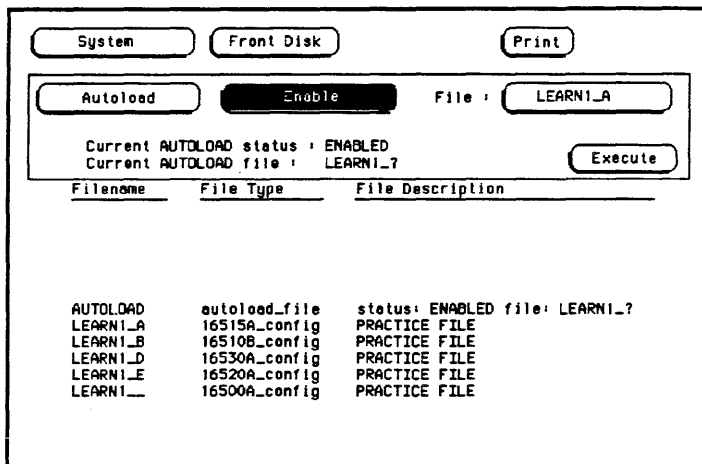

Figure 8-20. The Autoload Operation Enabled



As long as **Autoload** is enabled before the instrument is shut off, **Autoload** will remain enabled when you power-up the instrument and the configuration files will be loaded.

The “**AUTOLOAD**” file contains the filenames to be autoloaded and indicates whether or not the **Autoload** operation is enabled.

The “**Current AUTOLOAD file:**” specifies a group of files.

To disable the **Autoload** operation:

1. Touch **Enable** and when the pop-up appears, touch **Disable**.
2. When the pop-up disappears, touch **Execute** and the **Autoload** operation is disabled.

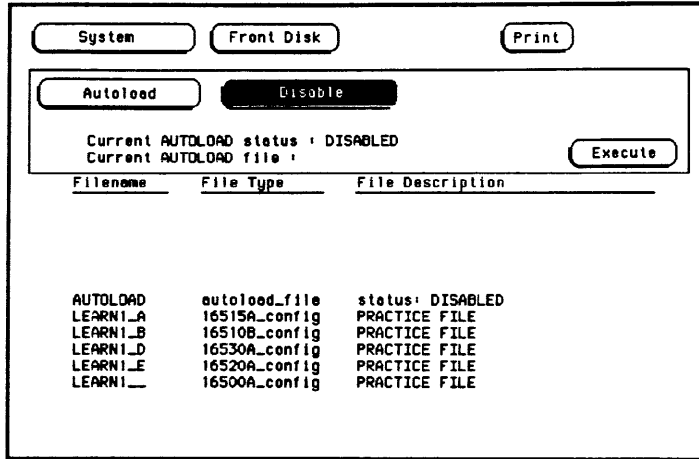

Figure 8-21. The Autoload Operation Disabled

Purging a File

Use the **Purge** operation to purge (delete) a file of a particular type or of all types.

In this example, you will purge the file LEARN1_A from the disk.

1. Select the **Purge** operation.
2. With either the knob or the pop-up keypad enter LEARN1_A in the field to the right of “file.”
3. Touch the field to the right of “type” and when the pop-up appears, select 16515A_config for the file type.
 - **All Types** allows you to purge all the different types of file listed for a filename and ignore any slot qualifications that appear in the filename;
 - “A particular file type” (16515A_config) allows only the current file to be purged.
4. Touch **Execute** and when the pop-up appears, touch **Continue** and notice that only the file LEARN1_A is purged from the disk.



Caution

Once executed, the **Purge** operation permanently erases all the existing information from the file. After that, there is no way to retrieve the original information.



Note

Refer to “The Pack Disk Operation” section of this chapter for information on how and when the purged areas of a disk are used.

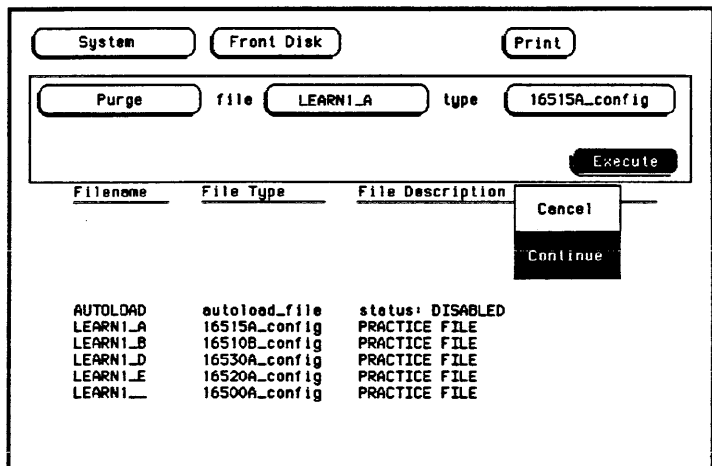

Figure 8-22. Purging a File

Copying a File

The **Copy** operation allows you to copy a file or group of files specified on the source disk to the destination disk. To copy files:

1. Select the **Copy** operation.
2. With either the knob or the pop-up keypad enter the filename in the field to the right of “file.” For example, enter LEARN1_B.
3. Touch the field to the right of “type” and a pop-up will appear with the following choices:

- **All Types** allows you to copy all the different types of files listed for a filename and ignore any slot qualifications that appear in the filename;
 - “A particular file type” (16520A_config) allows only the current file to be copied.
4. Touch the file type you want and the pop-up disappears, displaying your choice in the appropriate field. For this example, touch 16520A_config.
 5. Touch the field to the right of “to” and when the pop-up keypad appears, enter the name of the file you want to “copy to.” For this example, enter “NEWFILE.” After entering the filename, touch **Done**.
-



You cannot copy over an existing file.

6. Touch the destination field (Front Disk) to the right of “on” and select either **Front Disk** or **Rear Disk** for the location of the destination disk. For this example, select **Front Disk**.
 7. Touch **Execute** to copy the file.
-



The slot designators for the files are only preserved when copying **All Types**. Otherwise, the destination file appears exactly as entered in the destination field.

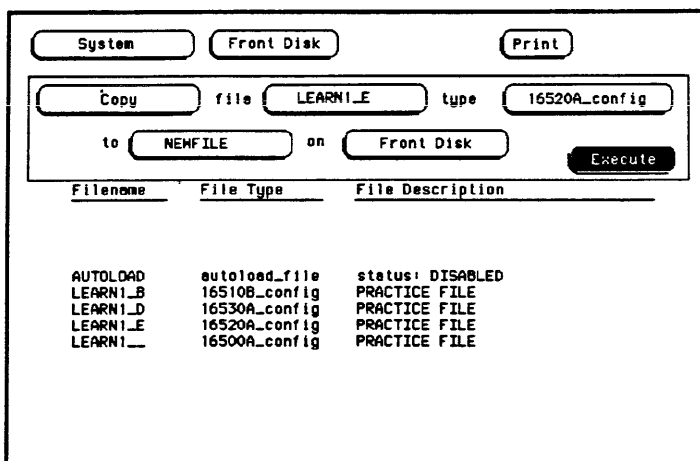

Figure 8-23. Copying a File

8. When pop-ups appear, simply follow their instructions as they apply to your situation and touch **Continue** to continue.
 - When “Insert DESTINATION disk” appears, insert the destination disk into the disk drive you selected in step 6. For this example, the original disk (source disk) is the destination disk. So when “Insert DESTINATION disk” appears,” touch **Continue**. No additional prompts will appear since you did not change disks.
 - If you are using separate disks for the destination and source disks with only a single disk drive, the message “Insert SOURCE disk” will appear. When this appears, remove the destination disk and re-install the source disk. Then touch **Continue**.



You can copy across various supported formats and it is highly recommended that you complete a **Copy** operation. Touching **Cancel** during a **Copy** operation may result in a corrupted destination disk.

The Pack Disk Operation

By deleting files from the disk and adding other files, you may end up with blank areas on the disk (between files) that are too small for the new files you are creating. The Pack Disk operation packs the current files together, removing unused areas from between the files so that more space is available for files at the end of the disk. To pack the disk:

1. Select the **Pack Disk** operation.
2. Touch **Execute** and when the background of the **Execute** field returns to the original color, the **Pack Disk** operation is complete.

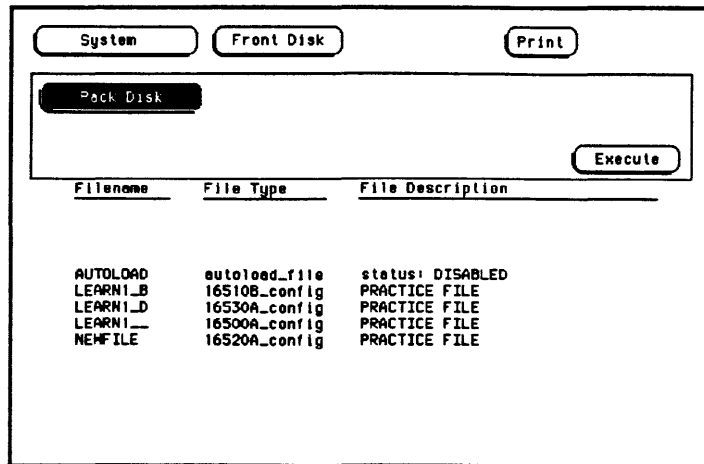

Figure 8-24. The Pack Disk Operation

Duplicating a Disk

The Duplicate Disk operation allows you to duplicate all the files on one disk to another disk. This operation allows you to make a back-up copy of your important disks so you won't lose important data in the event that a disk wears out, is damaged, or a file is accidentally deleted.

To duplicate the disk:

1. Select the **Duplicate Disk** operation.
2. Touch the field to the right of **Duplicate Disk**.

- When the pop-up appears, touch **Front Disk** or **Rear Disk** to indicate where the destination disk resides. For this example, touch **Rear Disk**.



If the source format and destination format are not the same, or the destination disk format is unrecognized, **Duplicate Disk** will automatically format the destination disk. If the source disk is in the 1024-bytes/sector LIF format, the destination and source disk will be in the same format.



The original directory and files on the destination disk are **DESTROYED** by the **Duplicate Disk** operation.

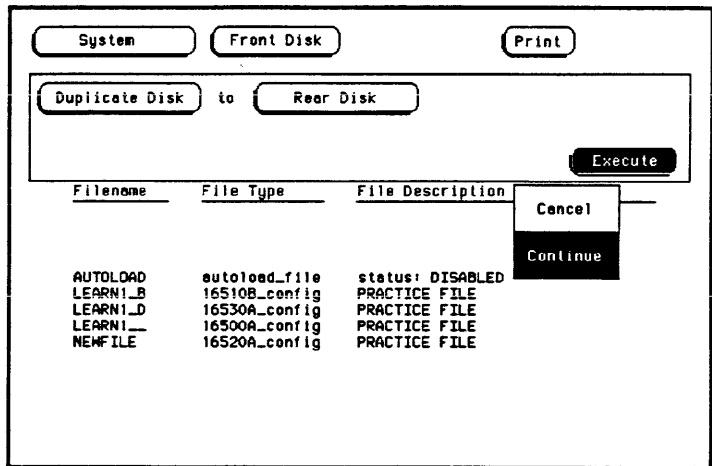

Figure 8-25. Duplicating a Disk

- Touch **Execute**, then **Continue**.
- When pop-ups appear, simply follow their instructions as they apply to your situation and touch **Continue**.

- When “Insert DESTINATION disk” appears, insert the destination disk into the disk drive you selected in step 3. Make sure this disk DOES NOT contain any files that need to be saved. Then touch **Continue**.
- If you are using the same disk drive for your source disk and destination disk, the message “Insert SOURCE disk” will appear. Remove the destination disk and re-install the source disk. Then touch **Continue**.



When you are using the same disk drive for the **Source** and the **Destination** disks, the advisories “Insert SOURCE disk” and “Insert DESTINATION disk” may appear repeatedly. Simply follow their instructions and touch **Continue** to continue. The number of times you need to change the disks is directly proportional to the length and number of files on the disk you are duplicating.

The System Utilities Menu

The **System Utilities** menu is used for turning the sound and touchscreen on and off, recalibrating the touchscreen, and changing the instrument colors. Chapter 9 gives you a brief overview of this menu, then Chapters 8 and 9 discuss the specific functions of the **System Utilities** menu.

Getting into the System Utilities Menu

In the upper-left corner of the screen are two fields that indicate which menu the instrument is in (see figure 9-1). The one to the extreme left shows the module you are in and the one to the right of the module field shows the menu you are in.

- If the module field in the upper-left corner doesn't display **System**, touch this field and when the pop-up appears, touch **System**. This will bring up one of the **System** menus.
- If the field in the upper-left corner displays **System**, but the field to the right of it doesn't display **Utilities**, touch this field. When the pop-up appears, touch **Utilities** to bring up the **System Utilities** menu.

Layout of the System Utilities Menu

Figure 9-1 shows the layout of the System Utilities menu and lists the major functions and features.

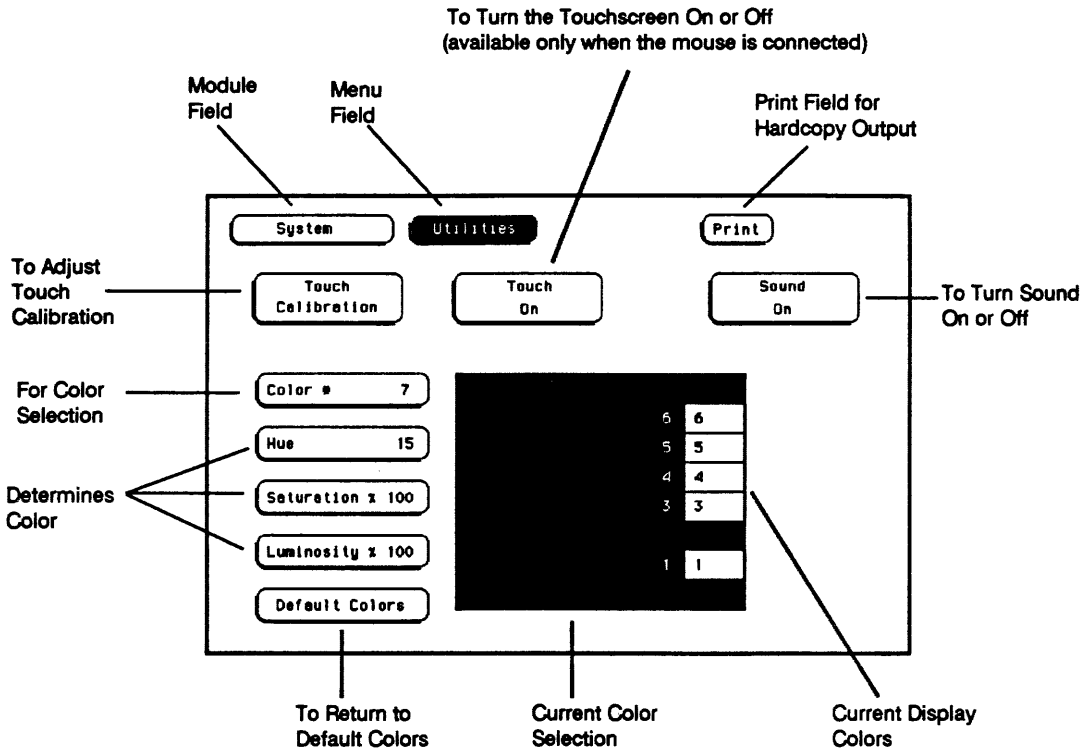
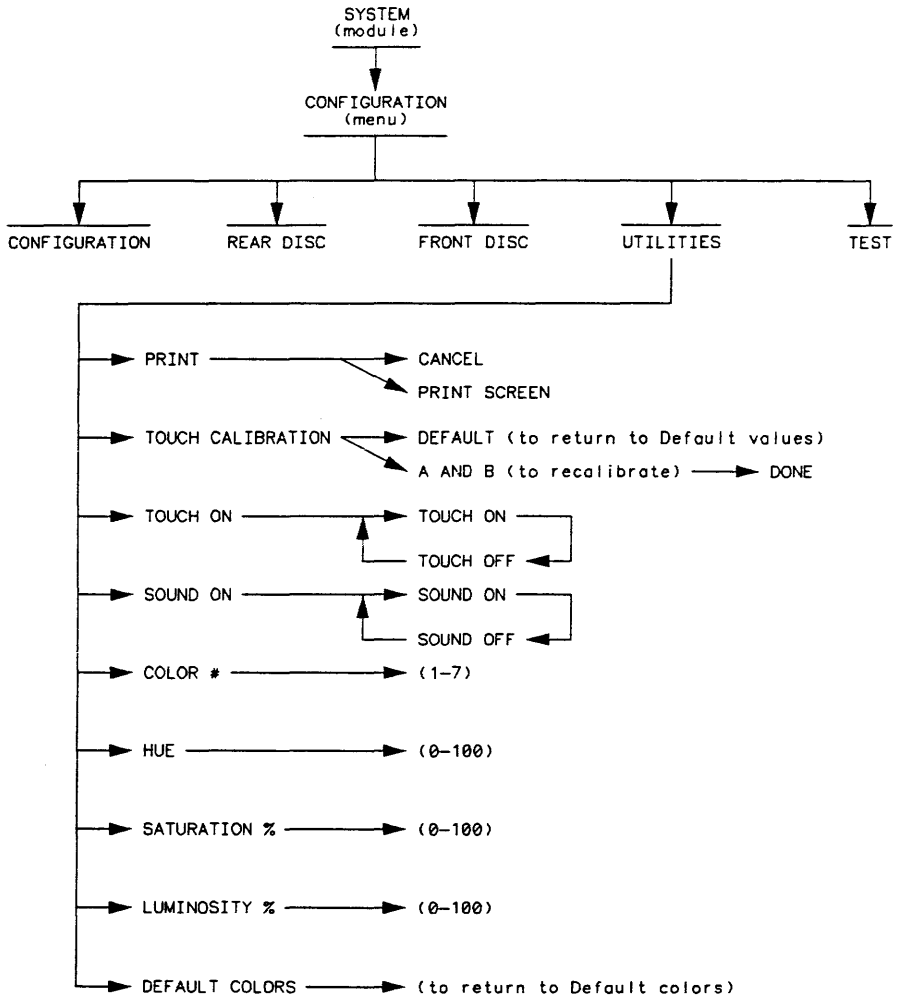

Figure 9-1. The System Utilities Menu

Menu Map

Figure 9-2 displays a menu map for the System Utilities menu.



16500807

Figure 9-2. Menu Map for the System Utilities Menu

The Touch and Sound Fields of the System Utilities Menu

This chapter covers the **Touch** and **Sound** fields of the **System Utilities** menu. These fields allow you to recalibrate the touchscreen for better line-of-sight use, turn the touchscreen on and off (when you're using a mouse), and turn on and off the sound of the instrument.

Getting into the System Utilities Menu

To bring up the **System Utilities** menu:

1. Touch the field to the right of **System** in the upper-left corner of the display.
2. When the pop-up appears, touch **Utilities** to bring up the **System Utilities** menu.

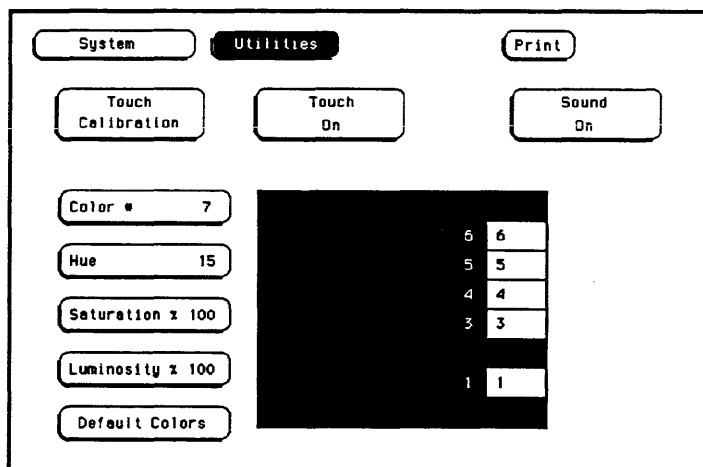

Figure 10-1. The System Utilities Menu

Touch Calibration

It is unnecessary to periodically calibrate the touchscreen. Touch calibration just allows you to reset the touchscreen to your needs and compensate for parallax from different viewing angles.

The **Touch Calibration** field in the upper-left corner of the display brings up the pop-up for adjusting the touchscreen calibration to your own line of sight and to the angle at which you touch the screen. The default calibration is acceptable for most uses, but to change the calibration do the following:

1. Touch the **Touch Calibration** field.

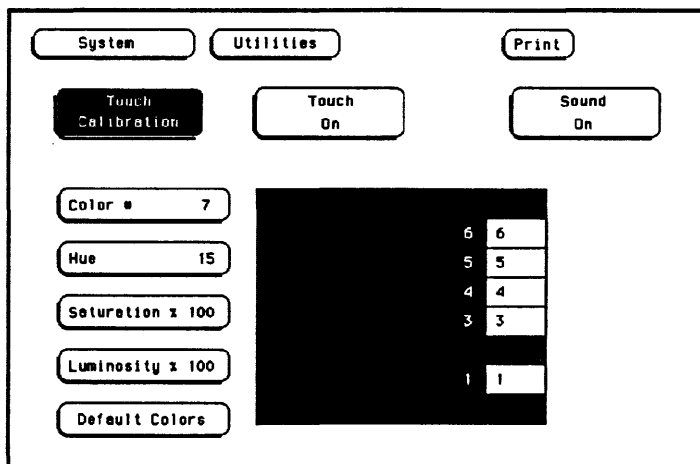

Figure 10-2. Selecting Touch Calibration

2. Touch the **A** field as accurately as possible.
3. Touch the **B** field as accurately as possible.



Recalibration is done immediately after you touch A or B. The point at which you remove your finger from A or B determines where you place your finger to activate subsequent fields.

4. Touch **Done** when you are finished.

To return to the default touch calibration, touch the **Touch Calibration** field and when the pop-up appears, touch the **Default** field. This returns the instrument to its default touchscreen calibration. Touch **Done** when you are finished.



At power-up touch returns to the default calibration unless a customized HP 16500A/16501A configuration file is loaded as part of an Auto-load sequence.

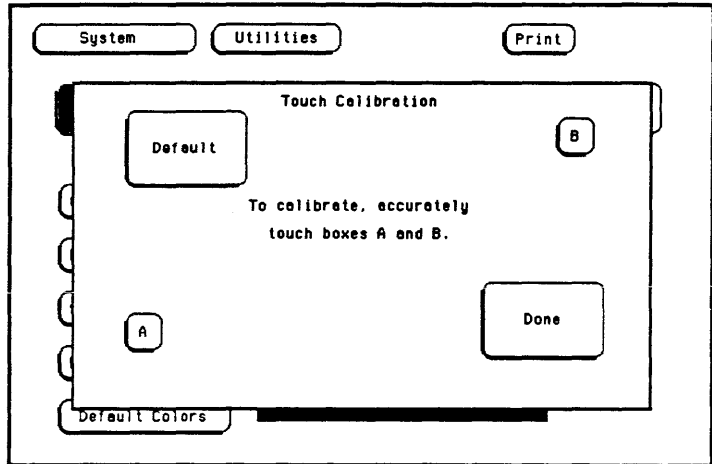

Figure 10-3. Touch Calibration Pop-Up

Touch On

In the center of the **System Utilities** menu is the **Touch On** field, which appears when either the optional mouse or keyboard is connected. Touching this field switches the touchscreen on and off. If you disconnect the mouse or keyboard after turning the touchscreen off, the touchscreen automatically turns on again. If you want to turn the touchscreen off again after reconnecting the mouse or keyboard, you must touch **Touch Off** changing the field to **Touch On**. Then touch **Touch On** and when the field changes to **Touch Off**, the touch screen will be shut off again.

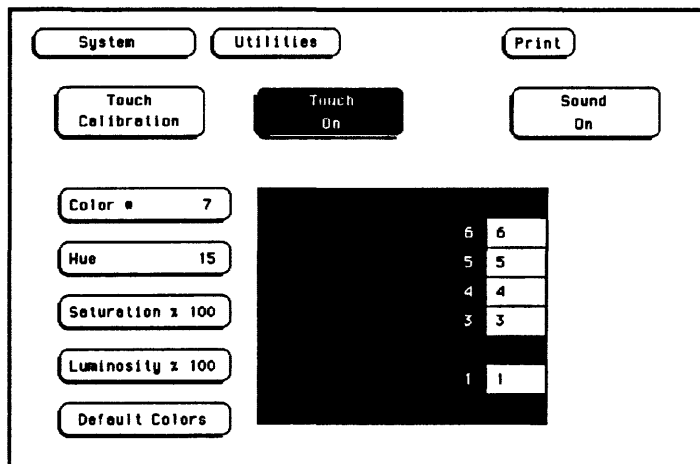

Figure 10-4. The Touch On Field

Sound On

In the upper-right corner, below the **Print** field, is the **Sound On** field. This field is used to turn the instrument's sound on and off. These include the clicks you hear when you touch the fields on the menus and the beeps you hear on error messages.

To turn off the sound, touch **Sound On** and it changes to **Sound Off**, shutting off the sound. To turn them on again, touch **Sound Off** and it changes back to **Sound On**, turning the sound on again.

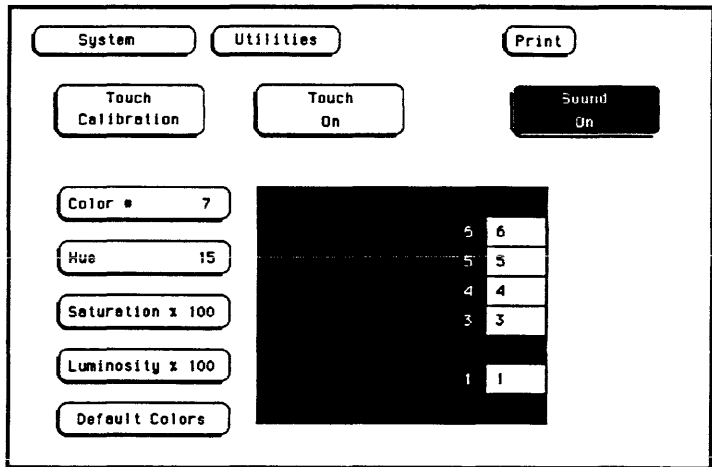

Figure 10-5. The Sound On Field

Display Color Selection (System Utilities Menu)

In the HP 16500A, color saves time and prevents errors by clarifying the display, making it easier to distinguish one major area from another.

The color selection feature of the HP 16500A allows you to customize display colors, which improves contrast and lessens eye fatigue caused by your operating environment. If you are color-blind to certain colors, are operating in a difficult light environment, or don't like the default colors, you can quickly and easily change them.

Getting into the System Utilities Menu

To bring up the System Utilities menu:

1. Touch the menu field to the right of **System** in the upper-left corner of the display.
2. When the pop-up appears, touch **Utilities** to bring up the System Utilities menu.

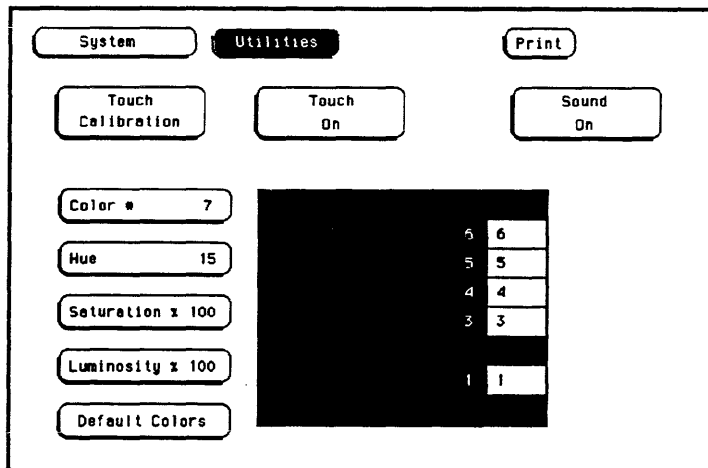

Figure 11-1. The System Utilities Menu

The Color Model

The HP 16500A uses the HSL color model (Hue, Saturation, and Luminosity). This model is very effective for interactive color selection. Similar in concept to the method used by artists for mixing paints, pure hues are selected, and then white and black are mixed to dilute the color and/or darken it.

- Hue is the pure color. 0 is red, 33 green, and 67 blue. The selection ranges from 0 to 100.
- Saturation is the ratio of the pure color mixed with white (0 to 100%)
- Luminosity is the brightness per unit area (0 to 100%).

Figure 11-2 shows a cylindrical representation of the HSL model (Hue, Saturation, and Luminosity). Hue is the angular coordinate, Saturation is the radial coordinate, and Luminosity is the altitude above the polar coordinate plane.

The cylinder rests on a black plane (Luminosity = 0%) and extends upward. As you increase in altitude, you increase luminosity, which represents an increase in brightness. Whenever luminosity is zero, the values of saturation and hue do not matter. Zero luminosity is black, and 100% luminosity gives you the pure color.

White is the center of the top of the cylinder (Luminosity = 100%, Saturation = 0%). The center line of the cylinder (Saturation = 0%) is a line which connects the center of the black plane (Luminosity = 0%, Saturation = 0%) with white (Luminosity = 100%, Saturation = 0%) through a series of gray steps (Luminosity from 0% to 100%, Saturation = 0%). Whenever saturation is 0%, the value of hue does not matter. Zero saturation is white, and 100% saturation gives you the pure color. The outer edge of the cylinder (Saturation = 100%) represents the fully saturated color.

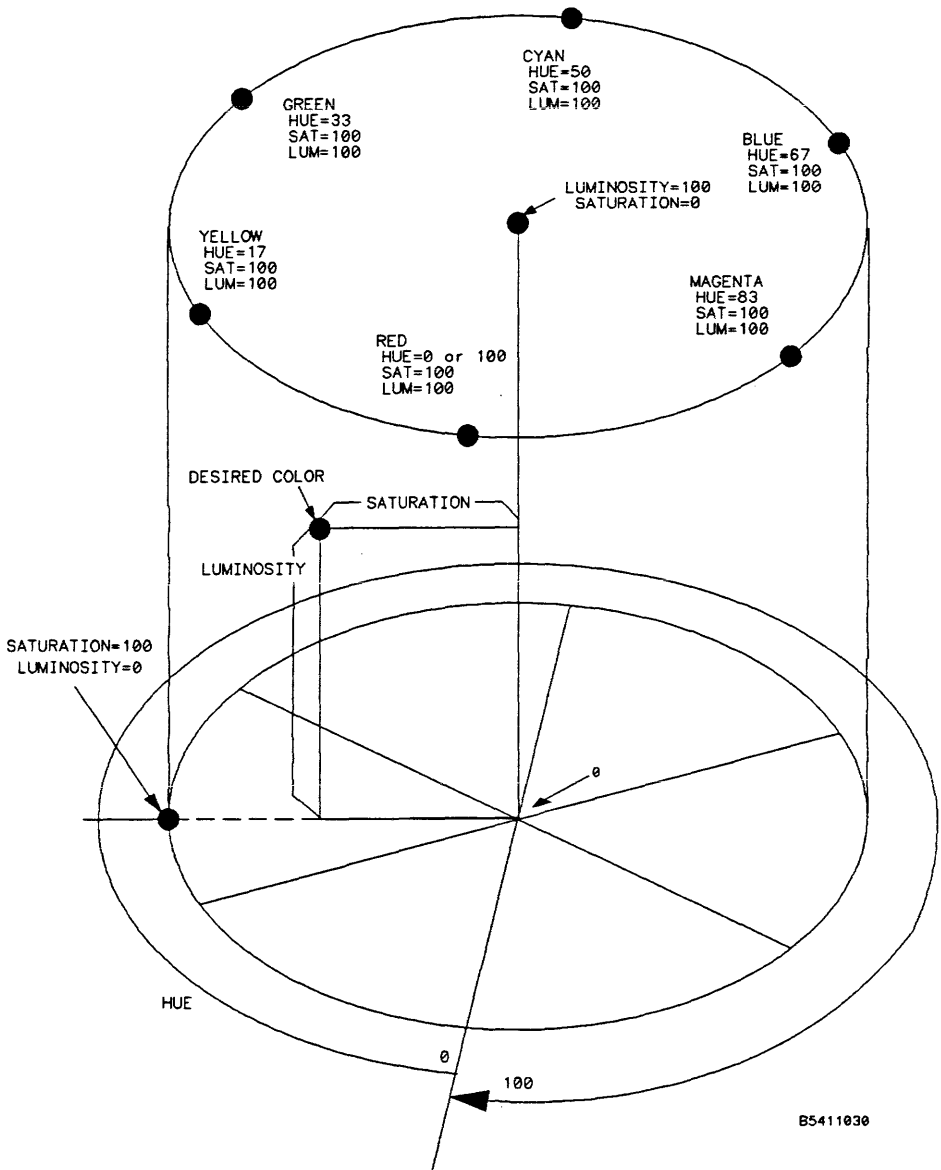

Figure 11-2. The Color Model

Selecting the Color, Hue, Saturation, and Luminosity Fields

To select the Color, Hue, Saturation, or Luminosity fields, see if the field you want has a different background than the other fields (light blue for the default colors). If it already has a different background, rotate the knob to change the value in that field. Otherwise, touch the field once and its background will change color, indicating that it has been selected. Then rotate the knob to change the value. If you look at the large field in the center of the display, you can see how the knob affects the color.

If you know the value you want in a particular field, see if that field has a different background than the other fields (light blue for the default colors). If it already has a different background, touch this field and a pop-up keypad will appear. Otherwise, touch the field once to select it and a second time to bring up the pop-up keypad. Then enter the value you want with the keypad and touch Done. The pop-up will disappear, placing your new value in the appropriate field and changing the color.

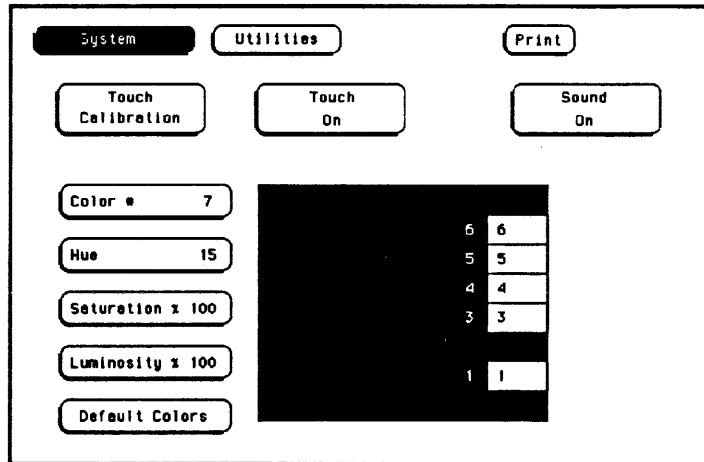

Figure 11-3. Color Selection

For example, to use the knob to change the value of Hue to 45:

1. Touch the Hue field once.
2. When the background of the Hue field changes color (light blue for default colors), turn the knob to change the value for Hue to 45. You can see how the knob affects the color in the large field at the center of the display.

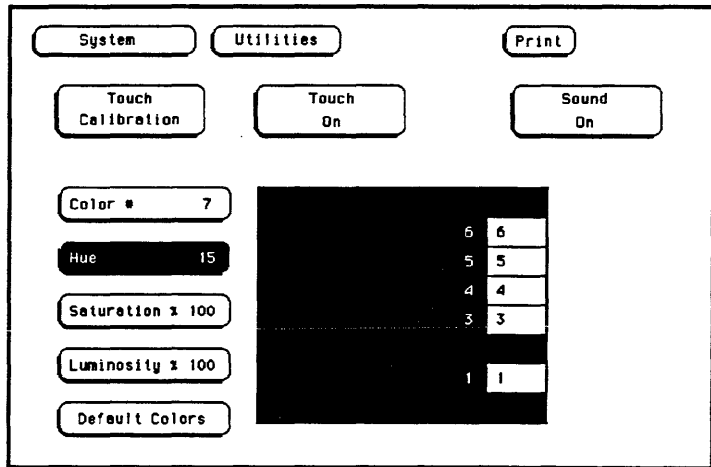

Figure 11-4. Changing the Value for Hue

To use the pop-up keypad to change the value of **Luminosity** to 65:

1. Touch the **Luminosity** field once and its background changes color (light blue for default colors).
2. Touch the **Luminosity** field a second time and a pop-up keypad appears.
3. Enter 65 with the keypad and notice that your value appears in the box at the top of the keypad.
4. When you are finished, touch **Done** and the pop-up keypad will disappear, placing your value in the appropriate field and changing the color.

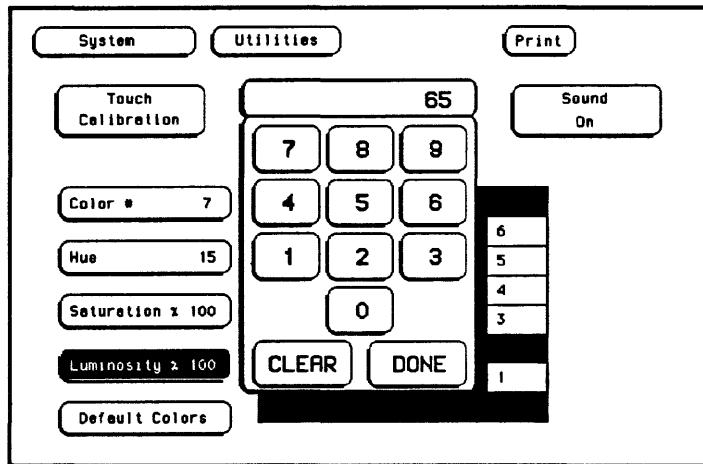

Figure 11-5. Changing the Value for Luminosity

The Color Field

Once the **Color** field has been selected, you can select any one of seven variable display colors by rotating the knob on the front panel. The **Color** field displays your choice (1-7). The large field to the right of the **Color** field displays the color you are working with, and the small numbered fields within this large field display the other colors available. Table 11-1 lists the display colors for the HP 16500A/16501A.



Note

The screen may be turned off when using an external controller by setting the Luminosity of each color to zero.

Table 11-1. HP 16500A/16501A Display Colors

Color	Default Color	Hue	Saturation	Luminosity	Uses
1	Tan	13	43%	76%	Main background color for the display
2	White	0	0%	100%	Light text and timing waveforms on certain modules
3	Dark Blue	60	100%	60%	For touch items (touch-sensitive fields)
4	Light Blue	60	45%	90%	For selected items, items that the knob is assigned to, limited background use, and certain display channels on the oscilloscope module
5	Green	33	100%	75%	For the Run field, advisory fields, the X marker on certain modules, certain display channels for the oscilloscope module, and miscellaneous other uses
6	Red	0	100%	100	For the Stop field, error fields, the Cancel Print field, the trigger point, and certain display channels on the oscilloscope module
7	Yellow	15	100%	100%	For warning or advisory fields, the O marker on certain modules, certain display channels on the oscilloscope module, and miscellaneous other uses
0*	Black	—	—	0%	For dark text, background, and waveform areas

* Color "0" is a non-variable color.

Returning to the Default Colors

The **Default Colors** field, below the **Luminosity** field, allows you to return to the default colors simply by touching that field. These default colors are listed in Table 11-1.

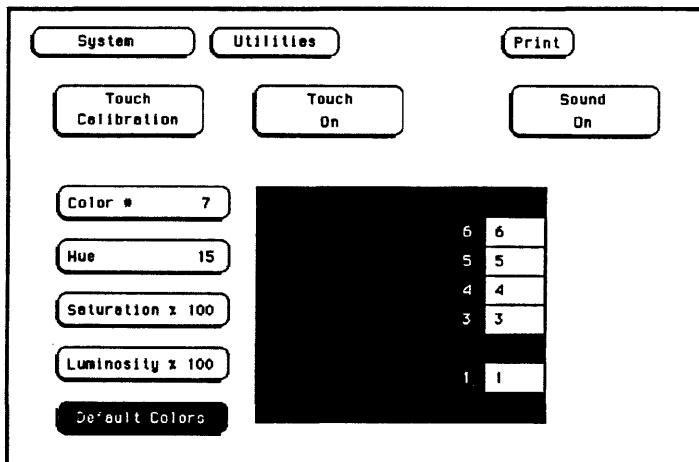

Figure 11-6. Returning to the Default Colors

Intermodule Measurements

The HP 16500A/16501A can be configured with several different modules inside the instrument at one time. The **Intermodule** menu allows you to make interactive measurements between these modules. This also includes making measurements that use one or more modules in conjunction with an external instrument.

The basic functions of the **Intermodule** menu give you the ability to configure modules to run simultaneously, set up arming sequences between modules, adjust skew between modules, and synchronize with external equipment. The **Intermodule** menu also lets you display the resulting waveforms and state listings for several modules together on one screen.

Why Use Intermodule Measurements?

Intermodule measurements can be used when you need the acquisition capabilities of one module to look at a signal, but you need the triggering capabilities of another module to properly trigger the measurement.

Getting into the Intermodule Menu

To bring up the **Intermodule** menu, touch the module field (**System**) in the upper-left corner of the display. When the pop-up appears, touch **Intermodule** to bring up the **Intermodule** menu (see figure 12-1).

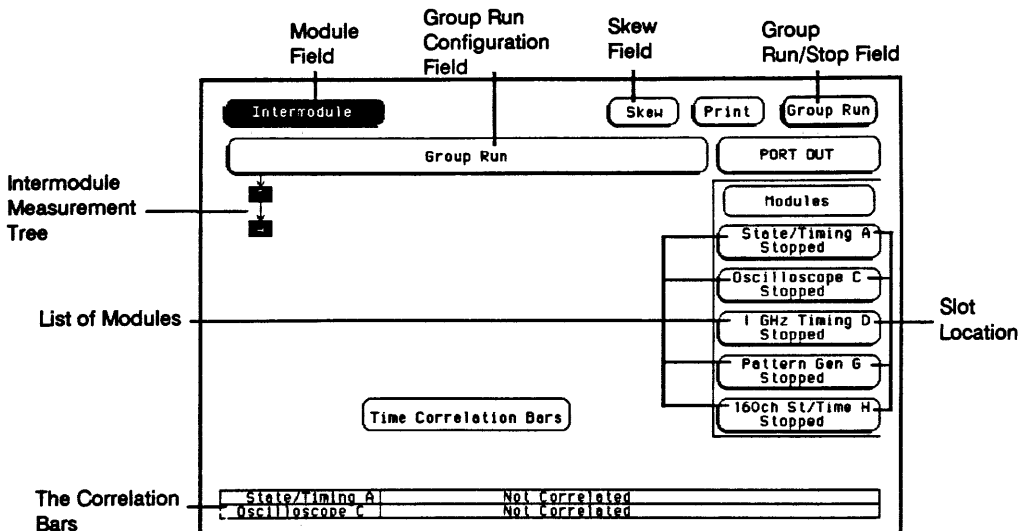

Figure 12-1. The Intermodule Menu

The Intermodule Menu

There are three different types of operations that can be performed from the Intermodule menu.

1. You can set up modules to run independently or within an intermodule measurement. Initially, the intermodule configuration tree (see figure 12-1) is empty, with all the modules running independently. Intermodule measurements are configured by adding modules to the intermodule configuration tree. Modules that appear directly below the large **Group Run** field are armed immediately after the **Group Run/Stop** field in the upper-right corner is touched. Modules that appear below other modules are armed when the preceding module finds its trigger.

Note

The HP 16500A with the HP 16501A attached functions as a single mainframe. Modules in either the HP 16500A, the HP 16501A, or both, can be added to the same intermodule configuration tree.

2. You can synchronize with external equipment.

- Once a module is added to the intermodule configuration tree, the **PORT OUT** signal can be added beneath that module or any other module appearing on the tree. When the module preceding **PORT OUT** triggers, a signal is sent to the **PORT OUT BNC** of the instrument to arm an external device.
- The **PORT IN** signal can be selected to arm the intermodule configurations in conjunction with the **Group Run/Stop** field. When **PORT IN** is activated and the measurement is configured, touch the **Group Run/Stop** field. The intermodule measurement begins when the proper signal is sent to the **PORT IN BNC** on the rear panel of the HP 16500A.

Note 

Although the rear panels of the HP 16500A and HP 16501A are identical, only the HP 16500A has the **PORT IN BNC**. The **Port In** signal is available to modules in both the HP 16500A and HP 16501A.

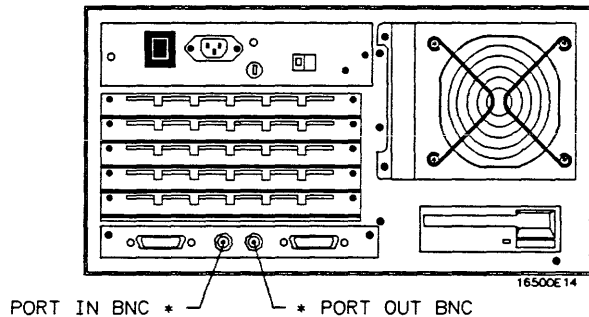
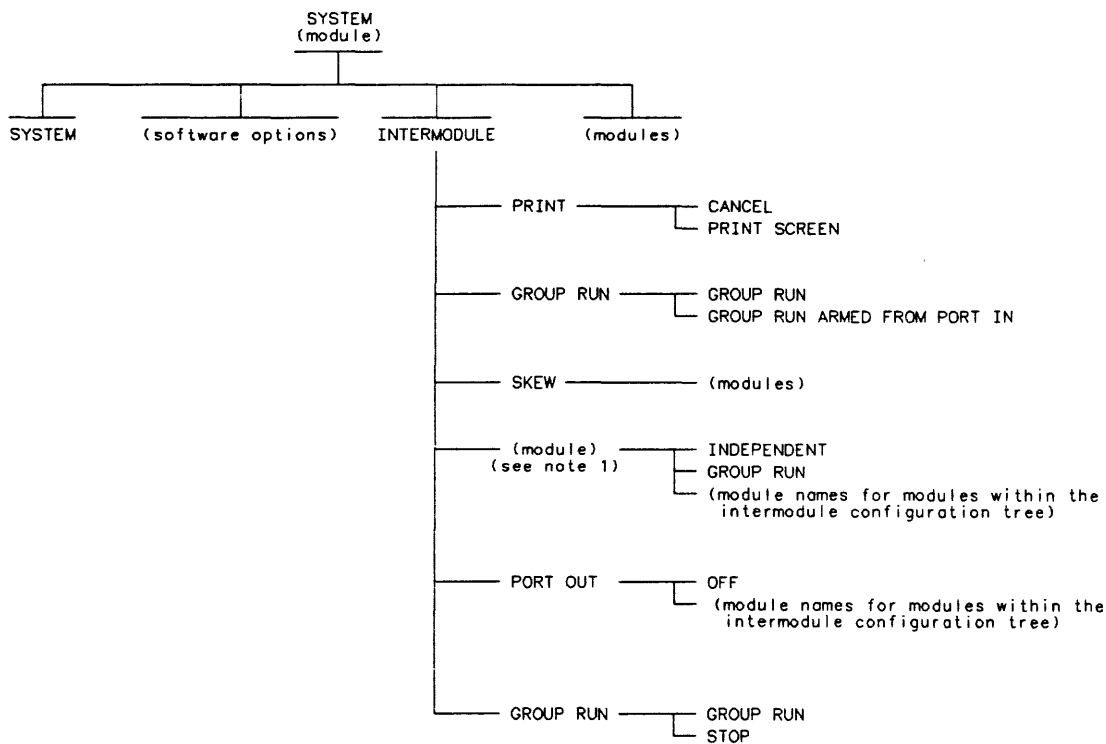

Figure 12-2. HP 16500A Rear Panel

3. You can modify the intermodule skew offsets with the **Skew** pop-up of the **Intermodule** menu to adjust skew or timing deviation between the modules within the intermodule measurement. This allows you to compensate for any known delay of the system under test or compare two signals by removing any displayed skew between the signals.

Menu Map

The following figure displays the menu map for the Intermodule menu of the HP 16500A/16501A.



NOTE 1: THE WORD MODULE IN PARANTHESES REPRESENTS THE NAME OF THE MODULES CONFIGURED IN YOUR SYSTEM. THIS PART OF THE MENU MAP REPEATS ITSELF FOR EACH MODULE.

16500B10

Figure 12-3. Menu Map for the Intermodule Menu

What Happens When You Touch Group Run?

This is a brief overview of the operation of the **Intermodule** menu as it is configured in figure 12-4.

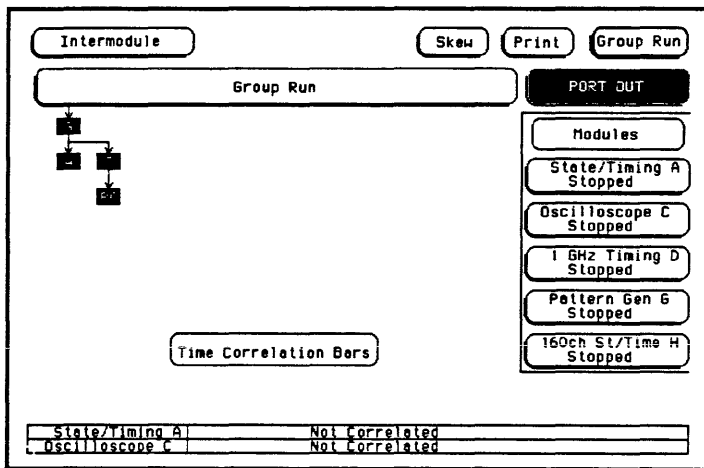

Figure 12-4. Intermodule Menu

For the HP 16500A Alone

When you touch the **Group Run/Stop** field in the upper-right corner:

1. The status for each module involved changes to **Running** (as shown in the individual module fields).
2. The status of module A and module C is checked until their pre-store qualifications are met.
3. When the pre-store qualifications of A and C are met, module G is armed and its appropriate measurement is run.
4. When module G triggers, module G simultaneously arms modules A and C.
5. When module C triggers, module C sends a signal to an external device through "PO" (PORT OUT).

- The status of each module changes to **Stopped** when the module finishes its operations. After all the modules are finished, the data is displayed in the individual waveforms or display menus of the modules.

The time correlation bars at the bottom of the menu display the start and stop acquisition window of each module relative to the other modules.

**For the HP
16500A With the
HP 16501A
Attached**

The HP 16500A with the HP 16501A attached operates as a single mainframe. This is a brief overview of the operation of the **Intermodule** menu as it is configured in figure 12-5.

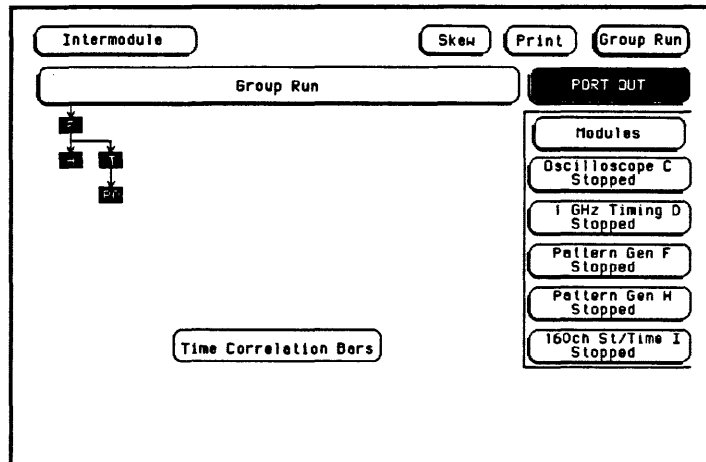

Figure 12-5. Intermodule Menu (with HP 16501A attached)

When you touch the **Group Run/Stop** field in the upper-right corner:

- The status for each module involved changes to **Running** (as shown in the individual module fields).
- The status of module H and module I are checked until their pre-store qualifications are met.
- When the pre-store qualifications of H and I are met, module F is armed and its appropriate measurement is run.

4. When module F triggers, module F simultaneously arms modules H and I.
5. When module I triggers, module I sends a signal to an external device through “PO” (PORT OUT).
6. The status of each module changes to **Stopped** when the module finishes its operations. After all the modules are finished, the data is displayed in the individual waveforms or display menus of the modules.

The time correlation bars at the bottom of the menu display the start and stop acquisition window of each module relative to the other modules.

What Are Some Typical intermodule Measurements?

Intermodule measurements may be as simple as configuring the **Intermodule** menu to start several modules at once, or very complex with multiple arming sequences between modules and external equipment. Examples 1 through 3 explain some typical intermodule measurements.

Example 1: Analyzing a Glitch

A glitch is defined as two or more transitions between the samples of a timing analyzer that cross the logic threshold. A timing analyzer can trigger on a glitch and capture it, but doesn't have the voltage or timing resolution to look at the glitch in detail.

On the other hand, an oscilloscope can acquire waveforms with a great deal of resolution, but it can't trigger on glitches, combinations of glitches, or patterns.

To analyze a glitch, use a timing analyzer and an oscilloscope interactively. Set up the timing analyzer to trigger on a glitch and when the timing analyzer triggers, capture the glitch with the oscilloscope. Then use the oscilloscope to look at the waveform parameters of the glitch, including its width, shape, and amplitude.

For this intermodule measurement, you are using the triggering capabilities of the timing analyzer and the acquisition capabilities of the oscilloscope.

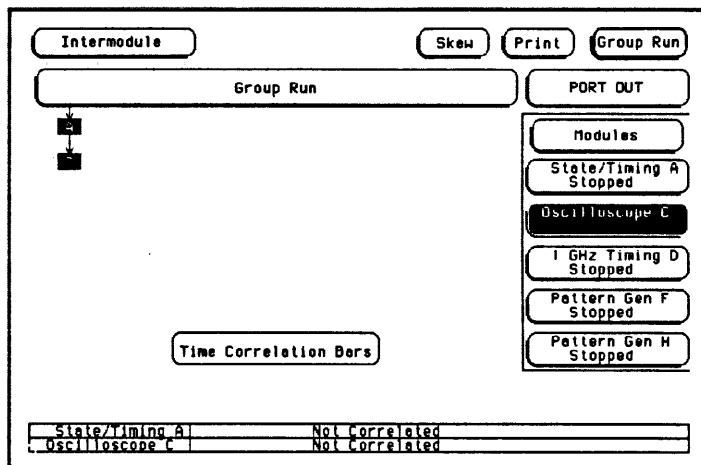

Figure 12-6. Intermodule Menu Configured for Example 1

Example 2: Analyzing Interrupt Handling in a CPU System

Most microprocessor programs can be interrupted by an asynchronous hardware signal. Software designers are interested in the processor's real-time response to interrupts. In particular, they need to answer these kinds of questions:

- Does the processor branch to the proper interrupt handling routine?
- Are registers and status information saved properly?
- How long does it take to service the interrupt?
- Is the interrupt acknowledged properly?
- After the interrupt is serviced, does the processor restore registers and status information and continue with the previous routine as expected?

Usually, software designers want to look at the program flow of their microprocessor system around an asynchronous event.

A state analyzer, coupled with a preprocessor and an inverse assembler, is useful for tracing the flow of a microprocessor program. A timing analyzer or an oscilloscope is designed to trigger on asynchronous events like edges.

In this example, use an oscilloscope with a sample rate faster than the microprocessor clock to trigger on the asynchronous event and to arm the state analyzer. Then use the state analyzer to check the address of the interrupt routine. You may also use the state analyzer to see if the microprocessor is properly servicing interrupts and returning to the correct address after each interrupt routine.

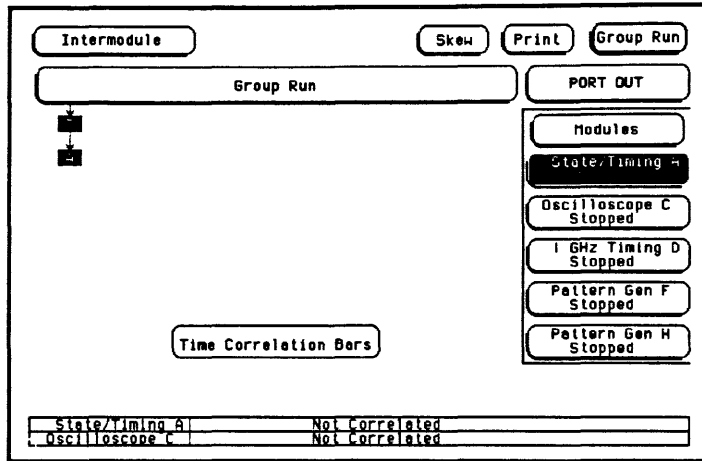

Figure 12-7. Intermodule Menu Configured for Example 2

Set up the oscilloscope to trigger on the asynchronous interrupt line. This is usually an edge-sensitive line on which the oscilloscope can trigger.

The state analyzer should be armed by the oscilloscope. Set the state analyzer to trigger on all “don’t cares” and it will capture the interrupt service routine when the arm signal is received. For this intermodule measurement, arming the state analyzer with the oscilloscope allows a software designer to track the flow of a microprocessor program around a hardware interrupt.

Example 3: A Simple Stimulus/Response System

During system development, designers are often faced with verifying a part of a design when the input signals for that part are unavailable. Here are some common examples of this problem:

- Verifying hardware operation when a part of the hardware is unavailable to drive the circuit.
- Testing a PC board without a board test system.

The traditional solution is to use word generators to emulate the missing part of the design, and to use logic analyzers and oscilloscopes to capture the system response. Unfortunately, the user is often faced

with an awkward solution of stacking several boxes on top of each other, with a maze of cables tying them together, and a different interface for each instrument.

The HP 16520A/16521A Pattern Generator in the HP 16500A/16501A can act as the stack of word generators in this problem. State, timing, and analog modules can all be used to capture the response of the system.

The HP 16520A/16521A Pattern Generator is loaded with the proper patterns and when it starts sending patterns, it sends an arm signal over the intermodule bus.

The acquisition modules are armed from the pattern generator module and set to trigger on the appropriate event in the system.

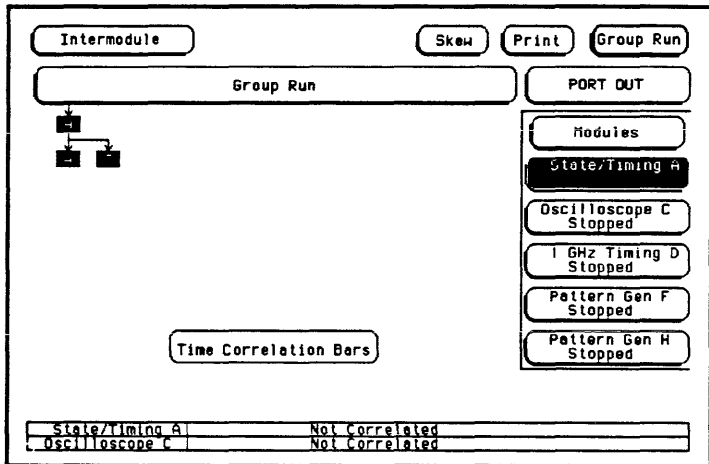

Figure 12-8. Intermodule Menu Configured for Example 3

How Are Intermodule Measurements Set Up?

Intermodule measurements are set up in the **Intermodule** menu of the HP 16500A/16501A by arranging the modules for the needed intermodule sequences. Each module may be used only once and any unused modules can be left to run independently of the intermodule measurement.

To select the **Intermodule** menu:

1. Touch the module field (**System**) in the upper-left corner of the display.
2. When the pop-up appears, touch **Intermodule** to bring up the **Intermodule** menu.

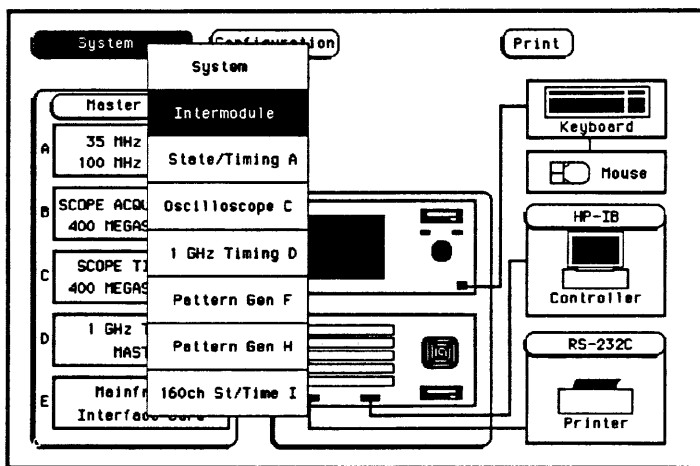

Figure 12-9. Selecting the Intermodule Menu

The Group Run Configuration Field

The large **Group Run** field, below the **Intermodule** field, is used in the configuration of this menu. This field is the base of the intermodule configuration tree. This tree displays how the modules interact and which modules are armed when the intermodule measurement is run. Modules that appear directly below the large **Group Run** configuration field are armed immediately after the **Group Run/Stop** field in the upper-right corner is touched. Modules that appear below other modules are armed when the preceding module finds its trigger.

Touch this field and a pop-up appears displaying:

- **Group Run**; and
- **Group Run Armed from PORT IN** which allows you to use an external input to arm the **Group Run** measurement. This input requires a minimum input of 2.4 V for a high and a maximum of 0.4 V for a low. It is high active and the actual **PORT IN** BNC input is located on the rear panel.

Touch **Group Run** and the pop-up disappears.



To use **PORT IN**, an external device must be connected to the **PORT IN BNC** on the rear panel. If an external device isn't connected, or is accidentally disconnected from the **PORT IN BNC**, the instrument will go to the **Trigger Immediate** mode.

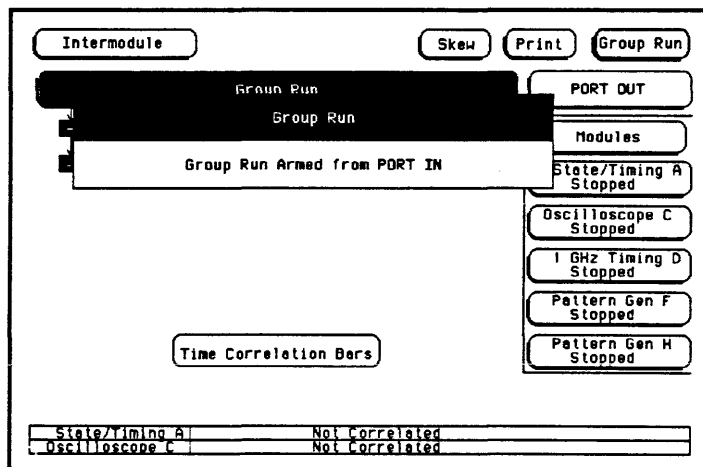

Figure 12-10. The Group Run Configuration Field

The Group Run/Stop Field

When a module is added to the intermodule configuration tree, the module's **Run/Stop** field changes to the **Group Run/Stop** field. The **Group Run/Stop** field is the **Run/Stop** field for the modules in the **Intermodule** menu. This field appears in the **Intermodule** menu so that the measurement can be started from this menu and the results monitored with the **Running/Stopped** status indicators and time correlation bars.

If you touch and hold the **Group Run/Stop** field, a pop-up appears with your choices for acquiring data.

- **Single**, which is the default, allows you to run the measurement once.
- **Repetitive** allows you to run the measurement as many times as you want to collect data for statistical measurements, etc. Press **Stop** when you want to stop collecting data.

- **Cancel** allows you to cancel the measurement.

Touch the field you want while you are still touching the **Group Run/Stop** field and your choice will be displayed with a light-blue background. Releasing the **Group Run/Stop** field before making your selection or without changing the selection results in the instrument running the measurement according to the last input to this field.

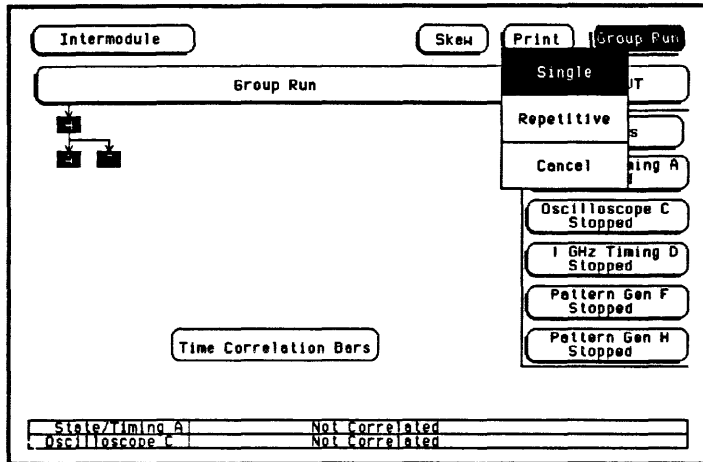

Figure 12-11. The Group Run/Stop Field

The Modules

On the right side of the screen are fields listing the different modules that can be configured in the **Intermodule** menu. When you touch one of the module fields, a pop-up appears displaying the possible locations of the module in the intermodule configuration tree.

- **Independent** allows the module to run independently of the other modules and removes it from the intermodule configuration tree.
- **Group Run** places the module directly below the large **Group Run Configuration** field. This module is armed immediately after the **Group Run/Stop** field is touched.
- The other fields in the pop-up list the name of the modules that are already part of the intermodule configuration tree and can be used to arm this module. Touching one of these fields places the

current module below the module indicated by the field you selected. The current module is then armed when the preceding module finds its trigger.

After you make your selection, a box appears in the intermodule configuration tree with the module's slot location (A through E for the HP 16500A alone, or A through J for the HP 16500A with the HP 16501A attached) representing the location of the module in the tree.

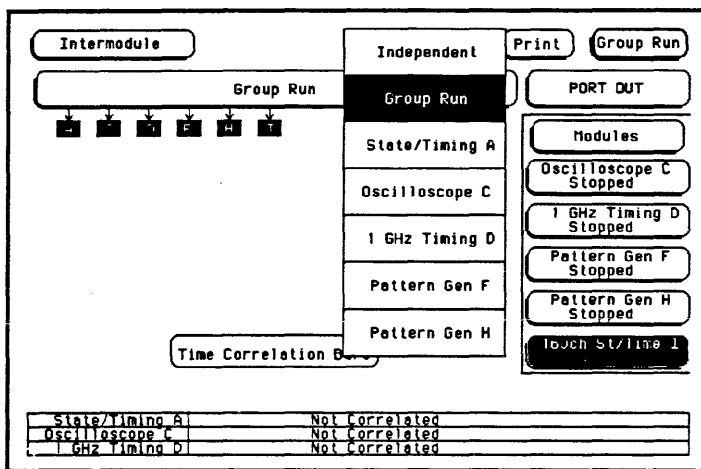

Figure 12-12. The Module Pop-Up Menu

PORT OUT PORT OUT is used to enable an external device from another module in the intermodule configuration tree. This field only appears when a module is present in the intermodule configuration tree.

To use the **PORT OUT** feature:

1. Touch the **PORT OUT** field above the module field on the right side of the display and a pop-up appears listing all of the modules that appear in the intermodule configuration tree.
2. Touch the field displaying the name of the module that needs to arm the external device and the pop-up disappears. **OUT** (for **PORT OUT**) now appears in the intermodule configuration tree below the module you selected.

The actual BNC connection for the **PORT OUT** feature is on the rear panel of the instrument. When activated, **PORT OUT** outputs a positive-going TTL pulse whose width varies depending on the module that is driving it. This port may be terminated by a 50 ohm load to reduce ringing on the signal. If terminated, the signal will be less than or equal to 0.4 V when low and at least 2.0 V when high.

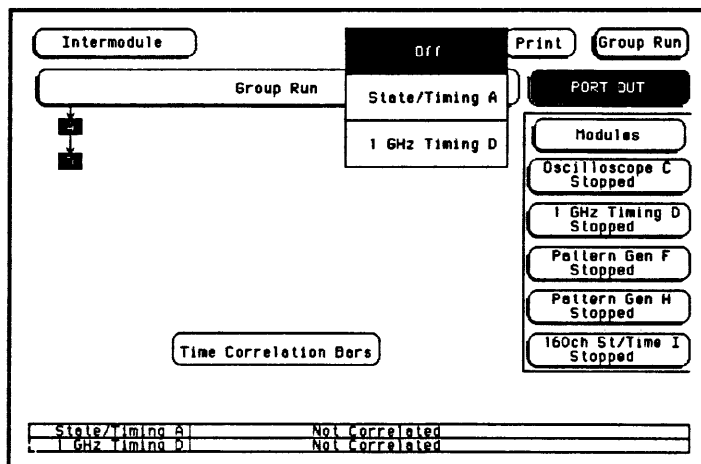

Figure 12-13. Selecting Port Out

Status Indicators and Time Correlation Bars

Running or Stopped appears below the names of the individual modules that are listed on the right side of the **Intermodule menu**. This indicates the current status for each module and can be used to monitor the intermodule measurement. If there is a problem with the measurement, a quick check of these status indicators can show you which modules have completed their operations (**Stopped**) and which ones are still **Running**. Generally:

- If a module was running and is stopped now, you can assume it received its arming signal and triggered properly.
- A module below a stopped module on the intermodule configuration tree has received its arming signal. If it's still running, then it may have trouble triggering or completing its task.
- A module below a running module on the intermodule configuration tree has not received its arming signal yet.

The time correlation bars at the bottom of the menu display the start and stop time of each module relative to the other modules.

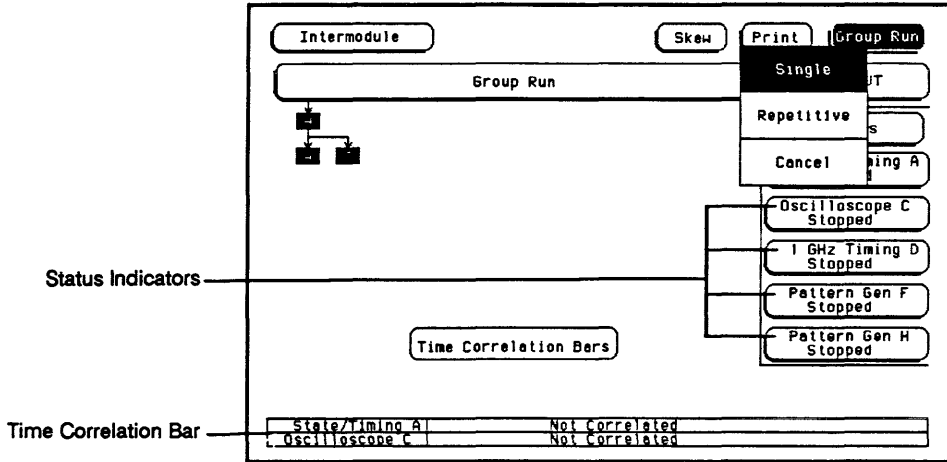

Figure 12-14. Status Indicators/Time Correlation Bars

The Skew Menu

Touch the **Skew** field to bring up the **Skew** pop-up menu.

The **Skew** pop-up of the **Intermodule** menu is used to skew waveforms or state listings between modules on the display. This allows for display adjustment to within one nanosecond between modules. The major purpose of this adjustment is to compensate for variances in internal probing delays across modules.

To adjust the skew of the module, use the **Skew** pop-up to add or subtract a known module skew value. This value may be calculated with the markers by measuring the skew between some common signal sampled by both modules.

To enter a value of skew, touch the field for the module you want and, after it turns light blue, input the skew with the knob. If you touch the field a second time, a pop-up keypad appears to input the skew.

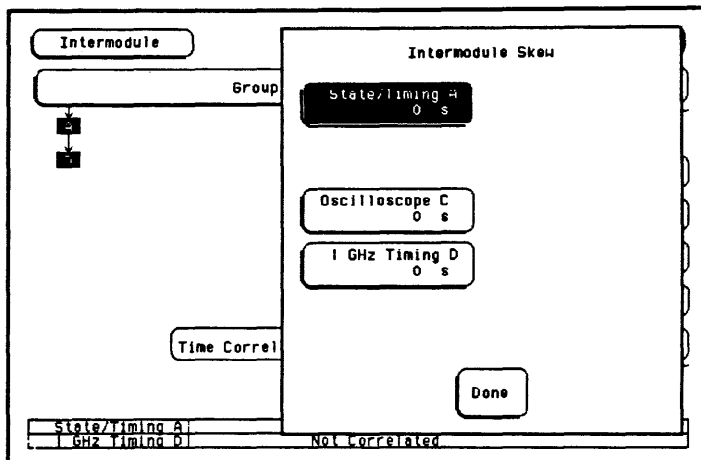

Figure 12-15. The Skew Pop-Up

Displaying Multiple Module Data on One Screen

When you are making intermodule measurements, you can display the resulting waveforms or state listings for several modules together on one screen. For example, to display the waveform data for the HP 16530A/31A Oscilloscope and the HP 16510B Timing Analyzer on an oscilloscope menu:

1. Touch the module field in the upper-left corner of the screen.
2. When the pop-up appears, select the HP 16530A/16531A oscilloscope module (Oscilloscope D).
3. When the HP 16530A/16531A menu appears, select the menu in which you want to view the data (for this example, **Auto-Measure**).
4. Touch the channel label field to the left of the waveform display once to scroll the waveforms. Touch this field again to access the display parameters.

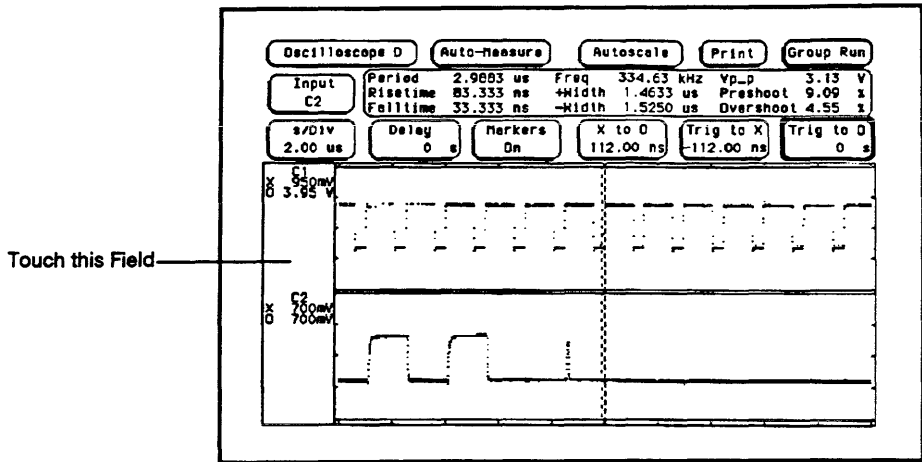

Figure 12-16. Selecting the Waveform Selection Pop-Up

- When the Waveform Selection pop-up appears, touch the field displaying Module Oscilloscope D.
- When the pop-up appears, touch State/Timing E. After the pop-up disappears, the appropriate labels for the channels of the HP 16510B State/Timing Analyzer will be listed under the State/Timing E field.

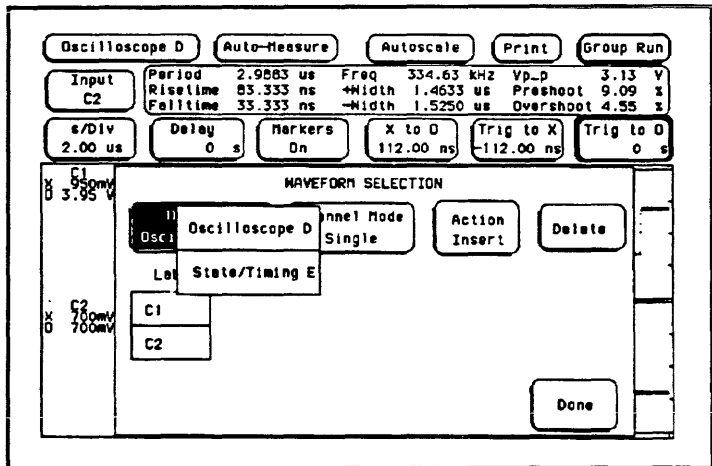

Figure 12-17. Selecting State/Timing E

7. Touch the labels for the channels that you want displayed. For this example, touch **OUT_4**.

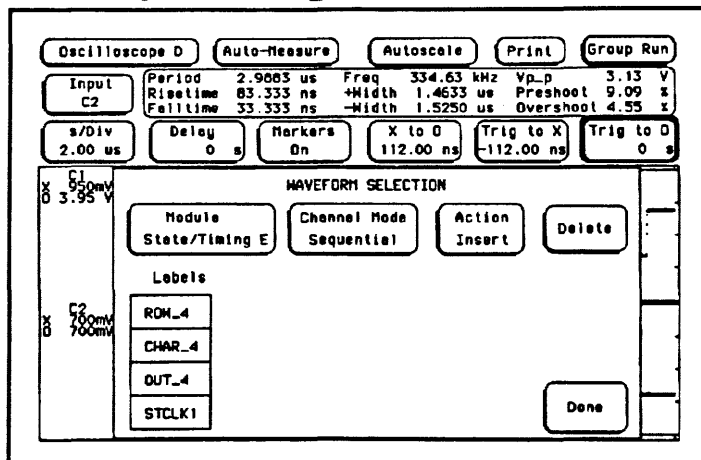

Figure 12-18. Selecting HP 16510B Channels

8. Touch **Done** and the **Waveform Selection** pop-up will disappear, returning you to the waveform display. As shown in figure 12-19, the five HP 16510B timing analyzer channels (**OUT_4**) are now displayed with the HP 16530A/16531A oscilloscope channels **C1** and **C2** on the **Oscilloscope D Auto-Measure** menu.

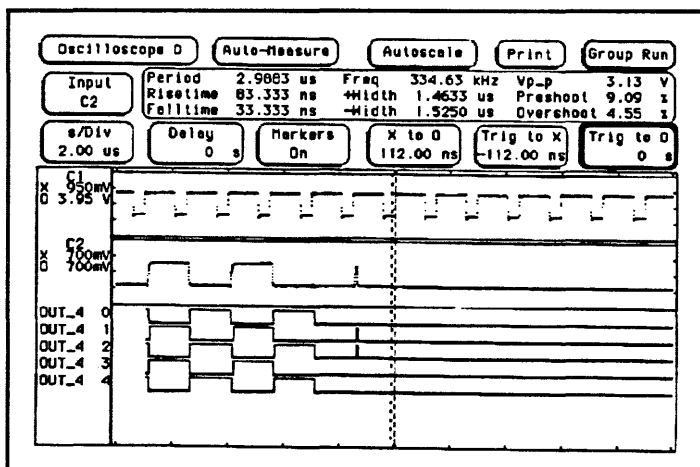

Figure 12-19. Displaying Multiple Module Data on One Screen

Helpful Hints

1. When setting up measurements, start with simple setups and work up to more complex ones. For example, set up the module that will trigger first and take a measurement with only this module. Once you've verified that this first trigger works properly, start adding additional modules to be armed by this trigger.
2. Before starting the measurement, set all modules to store data while they search for the trigger condition. This way, you can see information on both sides of the trigger condition as you fine-tune the measurement.
3. For time correlation between modules, initially set the modules that are armed from the intermodule bus to trigger on all "don't cares" or to "trigger immediately." Then increase the triggering requirements in stages by starting with the first modules that are armed and working from the top to the bottom of the intermodule configuration tree.

Exercise

The following is a brief exercise to help you become more familiar with the **Intermodule** menu of the HP 16500A/16501A. The steps are both numbered and lettered. The numbered steps state the objective and the lettered steps explain how to accomplish each step objective. You may be able to go through the exercise by just following the numbered steps. When you need more information on how to accomplish the step objective, refer to the lettered steps.

For this example, assume that you are using an external device to arm the intermodule measurement. When the arm signal is received, use the module in slot D (the 1 GHz Timing Analyzer) to capture the data. Then use the acquisition capabilities of the modules in slot A and C (the Oscilloscope and State/Timing Analyzer) to analyze the data.

1. Remove any previous assignments from the intermodule configuration tree.
 - a. Touch the field for the upper-most module in the intermodule configuration tree.
 - b. When the pop-up appears, touch **Independent**.

- c. Repeat steps a and b for each of the upper-most modules in intermodule configuration tree.

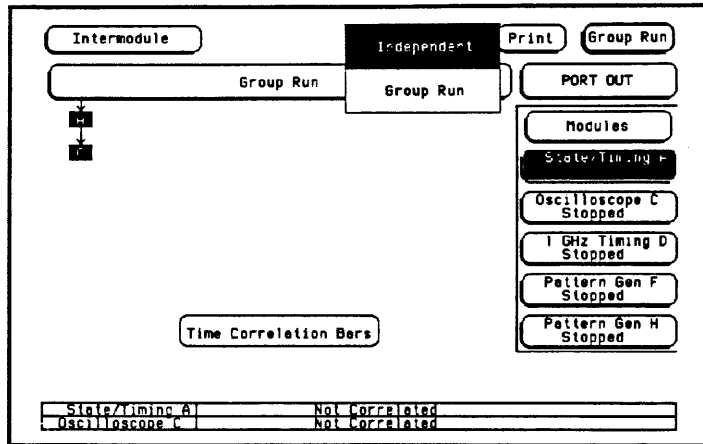

Figure 12-20. Clearing the Intermodule Configuration Tree

2. Select **Group Run Armed** from **PORT IN**.
 - a. Touch the large **Group Run** field.
 - b. When the pop-up appears, touch **Group Run Armed** from **PORT IN**.

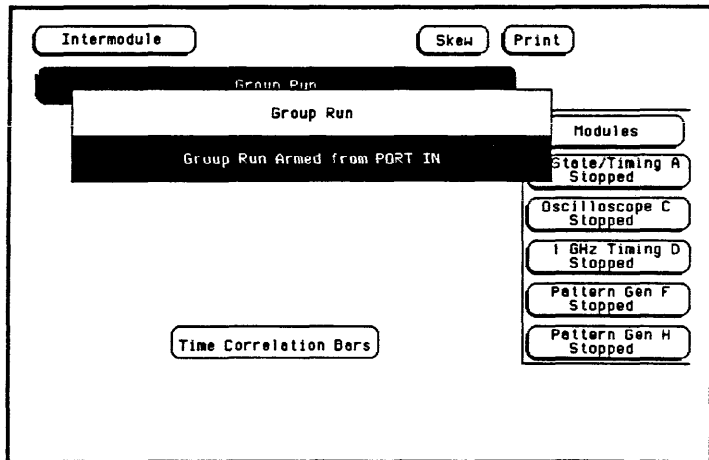

Figure 12-21. Selecting Group Run Armed from PORT IN

3. Configure the module in slot A (**State/Timing A**) to be armed by the **Group Run** configuration field.
 - a. Touch the field for the module in slot A (**State/Timing A**).
 - b. When the pop-up appears, touch **Group Run**.

Note 

Notice that the **PORT OUT** field appears when the module in slot A appears in the intermodule configuration tree.

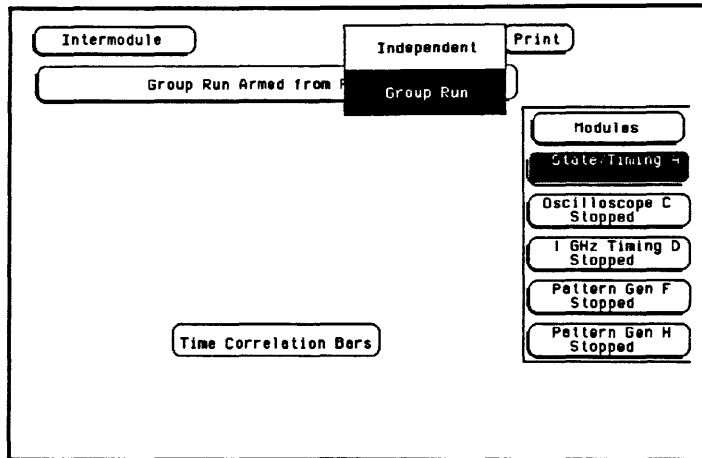

Figure 12-22. Selecting Group Run

4. Configure the module in slot C (Oscilloscope C) to be armed by the module in slot A (State/Timing A).
 - a. Touch the field for the module in slot C (Oscilloscope C).
 - b. When the pop-up appears, touch the field displaying the name of the module in slot A (State/Timing A).

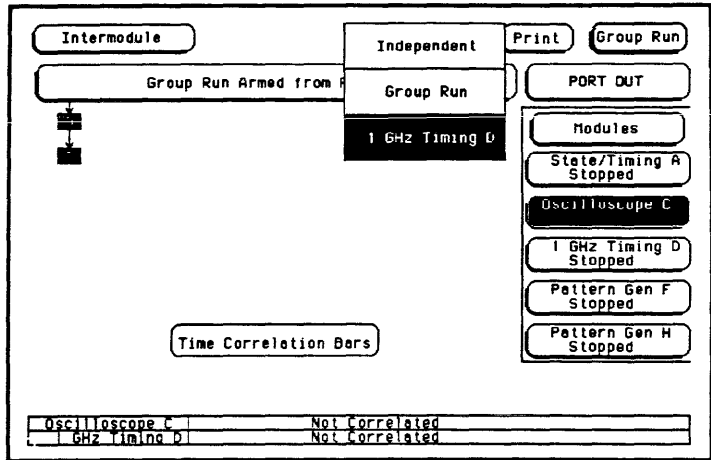

Figure 12-23. Configuring the Intermodule Menu

5. Configure the module in slot A (State/Timing A) to be armed by the module in slot D (1 GHz Timing D).
 - a. Touch the field for the module in slot A (State/Timing A).
 - b. When the pop-up appears, touch the field displaying the name of the module in slot D (1 GHz Timing D)

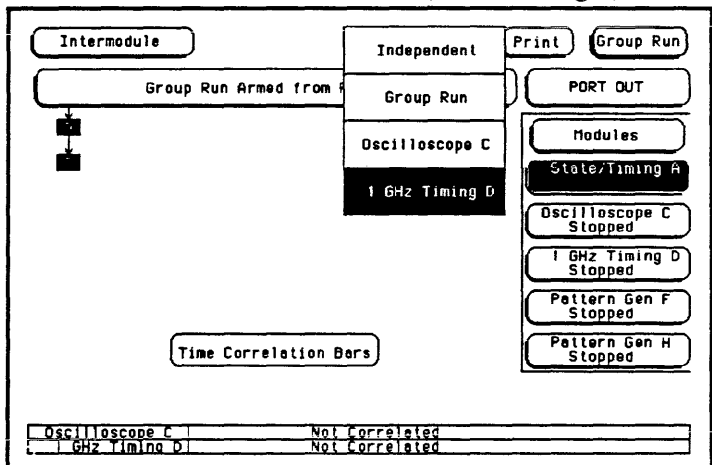

Figure 12-24. Configuring the Intermodule Menu

Figure 12-25 shows the Intermodule menu configured for this example.

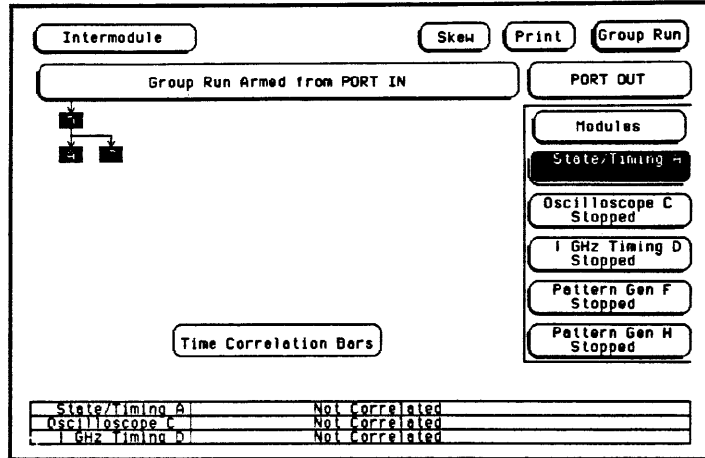

Figure 12-25. Intermodule Menu Configuration Completed

General Characteristics

This appendix describes the general characteristics of the HP 16500A/16501A Logic Analysis System, including user interfaces, hardware connectivity, programmability, hardcopy capability, and the input/output rear panel BNCs. It also describes the operating environment necessary to ensure optimum equipment performance as well as ventilation and power requirements. It contains information about making interactive measurements. This appendix also includes the weight and dimensions of the HP 16500A/16501A.

Interface

Nine Inch Color Monitor

Touchscreen Sensitive to 43 x 57 points

Controls

Screen Color encoded field types

Pop-up error and status messages

Touch Touch assignment of the knob to fields

Soft keypad or knob for numeric entry

Pop-up fields presenting all available choices

Knob Scrolling of waveforms, lists, and labels

Vernier measurement parameters

Scrolling of specifications too large for display

Mouse Optional input device (HP Model No. 46060A)

Copies the function of the touch/knob interface with the addition of a pointer icon. The buttons of the mouse activate fields and duplicate the function of the knob.

Connects to front-panel HP-HIL port provided for human interface devices or to optional keyboard

Keyboard Optional input device (HP E2427A Keyboard Kit)

Copies the functions of the touch/knob/mouse interfaces. The keys activate fields, duplicate the function of the knob, and enable data entry.

Connects to front-panel HP-HIL port provided for human interface devices

Beeper Clicks for feedback of touch display

Beeps on error conditions

Cursor Indicates where next character to be input appears

Indicates current line selection

Display Colors Seven with variable hue, saturation, and luminosity

One non-variable (black)

Two Marker System For time-interval measurements

Hardware Connectivity

5 Module Slots (HP 16500A alone)

Modules are interconnected through a five-line TTL bus.

Oscilloscope, timing, state, and pattern generator modules are currently available

9 Module Slots (HP 16500A with HP 16501A attached)

Modules are interconnected through a ten-line TTL bus.

Oscilloscope, timing, state, and pattern generator modules are currently available

Built-In Disk Drives

Dual Disk Drives

3.5 inch flexible disk drives

Double-sided, double-density to record data on both sides of the disk

Use HP double-sided, double-density disks part no. 92192A (package of ten comes with this part number)

File Types

System software (xxxxx_system)

Configuration (contains instrument configuration, data, and pointer to inverse assembler file)
(xxxxx_config)

Inverse assembler (inverse_assem)

Autoload (autoload_file)

Optional software (16500A_option)

Autoload Designation

A pre-defined configuration file that is loaded at power-up by enabling Autoload.

Interactive Measurements

Acquisition	Oscilloscope, timing, state, and pattern generation can be made to occur simultaneously or in series
Arming (HP 16500A only)	Module A through module E can arm one or more other modules External BNC (PORT IN) can arm one or more modules
Arming (HP 16500A with HP 16501A attached)	Module A through module J can arm one or more other modules Any number of modules can arm in sequence (limit five) Trigger immediate performed with “don’t care” trigger on armed module Modules drive the output BNC (PORT OUT)
Time Interval Accuracy Between Modules	Equals the sum of the channel-to-channel time interval accuracies of each module used in the measurement (for a deskewed measurement)
Skew	Fine adjustment (1 ns resolution) between modules for plus or minus time correlation.

Operating Environment

The HP 16500A/16501A will operate to all characteristics within the following temperature and humidity range:

Hardware

Temperature 0 to 55 degrees C (32 to 131 degrees F)

Humidity Up to 95% relative humidity (non-condensing) at 40 degrees C (104 degrees F)

Disk Drive and Media

Temperature 10 to 50 degrees C (50 to 104 degrees F)

Humidity 8% to 80% relative humidity at 40 degrees C (104 degrees F)



Avoid high temperature/humidity combinations to protect the instrument against internal condensation.

Altitude To 4600 m (15,000 ft)

Vibration

Operating Random vibration 5 to 500 Hz, 10 minutes per axis, 0.3 g rms

Non-Operating Random vibration 5 to 500 Hz, 10 minutes per axis, 2.41 g rms; and swept sine resonant search, 5 to 500Hz, 0.75 g (0-peak), 5 minute resonant dwell @ 4 resonances per axis

Ventilation Requirements

You must provide an unrestricted airflow for the fan and ventilation openings in the rear and side panels of the HP 16500A/16501A. However, you may stack the HP 16500A and the HP 16501A under or over other instruments and on top of each other as long as the surfaces of the other instruments aren't needed for their ventilation.

When you mount the HP 16500A/16501A in a rack, take into account the direction and quantity of airflow through the instrument. For ventilation, air is brought into the instrument through the left side cover and rear panel at a rate of 120 cfm. The air is then routed through the instrument and exits through ventilation holes in the right side cover. The approximate rise in temperature of this airflow is 10 degrees from ambient.

Power Requirements

The HP 16500A/16501A requires a power source of either 115 or 230 VAC, -22% to +10%, single phase, 48 to 66 Hz, 475 watts maximum for the HP 16500A, 420 watts maximum for the HP 16501A.

Weight

HP 16500A

Net 18.1 kg (40 lbs) + (0.7 kg (1.6 lbs) x the number of cards)

Shipping 25.9 kg (57 lbs) + (3.6 kg (8 lbs) x the number of cards)

HP 16501A

Net 12.2 kg (27 lbs) + (0.7 kg (1.6 lbs) x the number of cards)

Shipping 19.9 kg (44 lbs) + (3.6 kg (8 lbs) x the number of cards)

Dimensions

Dimensions are for general information only. If dimensions are required for building special enclosures, contact your Hewlett-Packard field engineer.

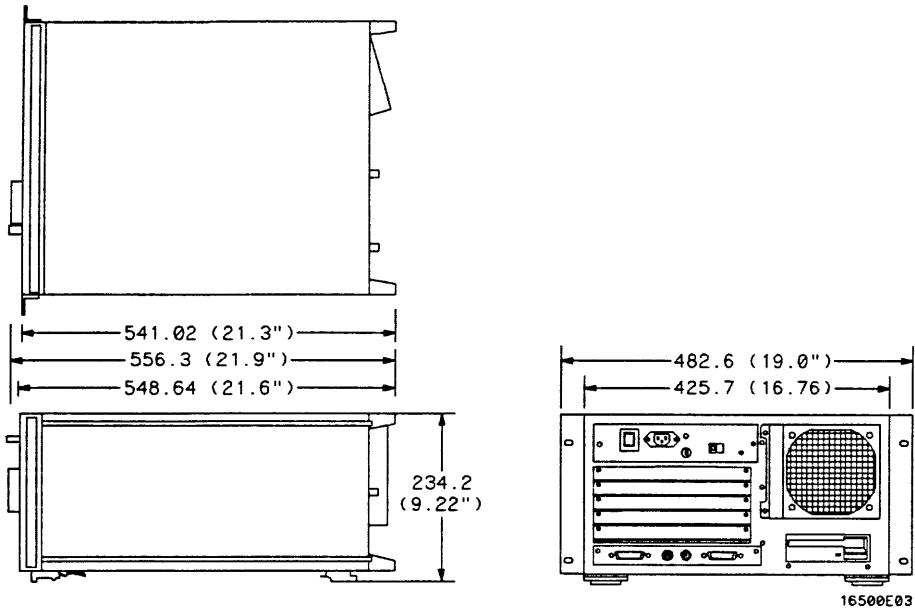

Figure A-1. Dimensions of the HP 16500A

Note 

Dimensions are given in millimeters and inches.

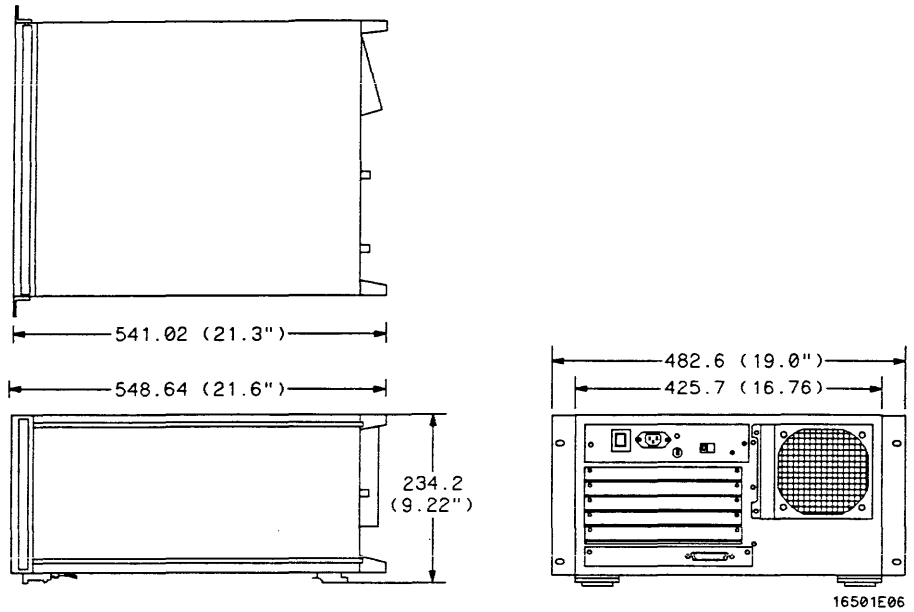

Figure A-2. Dimensions of the HP 16501A

Note 

Dimensions are given in millimeters and inches.

Disk Operations Store, load, copy, duplicate disk, pack disk, rename, purge, and format disk

Programmability Instrument settings and operating modes, including automatic measurements, may be remotely programmed via the RS-232C and HP-IB (IEEE-488).

Hardcopy Capability **Printers Supported** HP ThinkJet, HP QuietJet, HP DeskJet, HP LaserJet, HP PaintJet, Epson and Epson-compatible (e.g., Epson FX80) printers via the RS-232C or HP-IB (IEEE-488)

RS-232C Configurations Protocols Xon/Xoff or None
Data Bits: 8
Stop Bits: 1, 1 1/2, or 2
Parity: None, Odd, or Even
Baud Rates: 110, 300, 600, 1200, 4800, 9600, or 19,200

Input/Output Rear-Panel BNCs **Input BNC (HP 16500A only)** Labeled PORT IN on rear panel
Input signal must drive two LS TTL loads
Used to arm trigger sequence or as a wait event in stimulus

Output BNC (HP 16500A only) Labeled PORT OUT on rear panel
Output signal is active high, TTL output level
(high 2 V into 50 ohms, low 0.4 V into 50 ohms)
Can be driven by a signal from a module

Repackaging for Shipment

This appendix explains how to repackage the HP 16500A/16501A Logic Analysis System for shipment. It describes the storage and shipping environment necessary to prevent damage to the HP 16500A/16501A and explains how to tag the instruments for service.

The Storage and Shipment Environment

The instrument may be stored or shipped in environments within these limits:

Temperature 40 to 70 degrees C (-40 to 158 degrees F)

Humidity Up to 90% relative humidity at 65 degrees C (149 degrees F)

Altitude Up to 15,300 m (50,000 ft)

The instrument should also be protected from temperature extremes which could cause condensation within the instrument. Condensation within the instrument may cause it to malfunction.

Tagging the Instrument for Service

If the instrument is to be shipped to a Hewlett-Packard office for service or repair, attach a tag with the owner's name and address, the model number, the complete serial number, and a description of the service required. In any correspondence, refer to the instrument by model number and serial number.

Repacking the Instrument

Before repacking the instrument, insert a yellow shipping disk into both the front and rear disk drives. The shipping disks help protect the disk drives from damage during shipping.

If the original packing material is unavailable or unserviceable, material identical to factory packaging is available through Hewlett-Packard offices. Always mark the container **FRAGILE** to ensure careful handling.

If you use other packaging, follow these general instructions:

1. Wrap the instrument in heavy paper or plastic.
2. Use a strong shipping container. A double-wall carton made of 350-lb test material is adequate.
3. Protect the control panel with a piece of cardboard.
4. Put a layer of shock-absorbing material 70- to 100-mm (3- to 4-in.) thick around the instrument to firmly cushion it and prevent any movement inside the container.
5. Seal the shipping container securely.
6. Mark the container **FRAGILE** to ensure careful handling.

Maintaining the HP 16500A/16501A

This appendix describes the maintenance requirements for the HP 16500A/16501A Logic Analysis System. It explains cleaning requirements and degaussing procedures, and tells you where to look for information when the instrument needs service or recalibration. It also explains how the System Test menu is used.

Cleaning Requirements

When cleaning the HP 16500A/16501A, USE MILD SOAP AND WATER only. A harsh soap or solvent may damage the water-base paint finish.

Clean the CRT display and surrounding area regularly. DO NOT place tape or other foreign material on the screen.

Vacuum the ventilation slots on the sides of the instrument and the fan on the rear panel whenever there is a visible amount of dust on them.

Degaussing

After you have used the instrument for a while, the CRT may become magnetized and start to distort the colors on the screen or other display data. To remedy this problem, simply degauss the CRT by pressing and releasing the button on the rear panel marked DEGAUSS. If the screen is in particularly bad condition, repeat this procedure several times until the screen clears up.

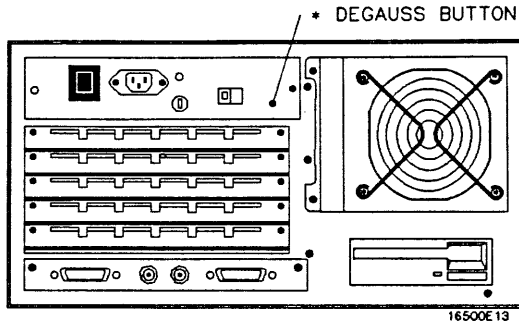

Figure C-1. The Defaussing Button

Service and Calibration

If at any time the instrument fails to operate properly or needs to be recalibrated, refer to the *HP 16500A/16501A Service Manual*.

The System Test Menu

The **System Test** menu is used to test portions of the microprocessor board including the system peripheral interfaces and the disk drives. It also allows you to check the color module for color purity. For more information on this menu, refer to the *HP 16500A/16501A Service Manual*.

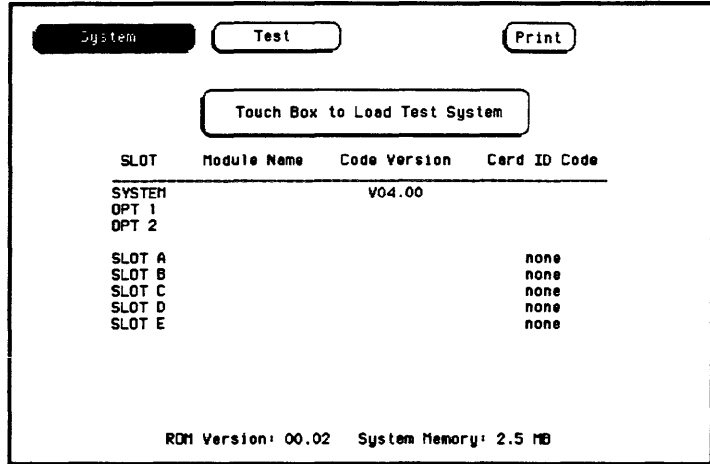

Figure C-2. Loading the Test System Software

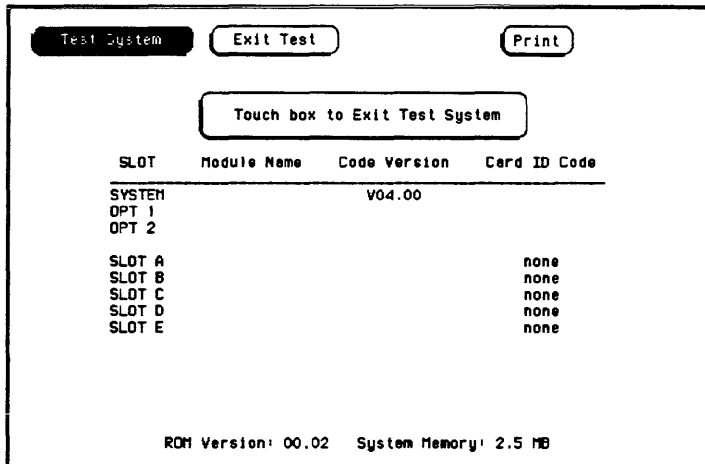

Figure C-3. Reloading the Mainframe System

Self-Test Documentation

When you turn on the HP 16500A/16501A, it will initiate a set of self-tests to check the basic condition of the instrument and the operating system disk. This is a limited set of tests that checks whether or not the CPU board is working well enough to boot the rest of the software from the flexible disk.

If a test fails, consult your *HP 16500A/16501A Service Manual*.



There are no self-test routines performed for any modules at power-up.

```
(c) COPYRIGHT 1987 HEWLETT-PACKARD COMPANY      HP 16500A VXXXX
PERFORMING POWERUP SELF TESTS

passed      Rom Test
passed      Ram Test
passed      Interrupt Test
passed      Display Test
passed      HIL Controller Test
passed      Front Panel Test
passed      Touch Screen Test
passed      Front Disc Test
passed      Rear Disk Test

LOADING SYSTEM FILE                (FAILURE SHOWN HERE)

LOADING MODULE FILES

LOADING SOFTWARE OPTIONS

AUTOLOADING CONFIGURATION
```

Figure D-1. Self-Test Display

Fail Codes

The type of fail codes you might encounter are:

- | | |
|--------------------|---|
| Disk Test | - passed |
| | - failed |
| | - no disk - Install a disk or re-install the current disk. |
| Touchscreen | - passed |
| | - impaired - Not a complete touchscreen, but the instrument can still be operated; or the touch failed, but a mouse was detected on the interface loop. |
| | Try wiping the bezel on the display and cleaning the CRT. Make sure no objects are blocking the screen on power-up. |
| | - failed - Not enough touchscreen to operate the instrument (major failure). |
| All Others | Passed or Failed |

Critical Errors

Critical errors are system load errors detected at power-up. When one of these is detected, they are displayed on the screen in yellow and the self-test routine is stopped IMMEDIATELY. These include:

SYSTEM FILE NOT FOUND

Indicates the last drive searched for a system file had a disk, but no system file was found on the disk.

SYSTEM DISK NOT FOUND

Indicates the last drive checked had no disk on it.

SYSTEM FILE READ ERROR

Indicates an error was detected during all three attempts to load the system file.

SYSTEM DISK ERROR

Indicates the drive that the system file was on failed during load.

Non-Critical Errors

Non-critical errors allow sequences to continue and won't stop the power-up routine. These include "impaired" and "no disk."

Disk Error Messages

This appendix lists and explains disk error messages and disk warning messages you may receive while operating the disk menus in the HP 16500A/16501A Logic Analysis System.

Disk Error Messages

The following is a list and description of error messages that may be displayed on the disk menus.

- | | |
|-----------------------------------|--|
| Configuration not loadable | This module or option does not have the ability to load a configuration. |
| Configuration not storable | This module or option does not have the ability to store a configuration. |
| Disk CRC error | Cyclical Redundancy Check (CRC) failed on this disk. Try to recover any needed files and reformat the disk (see Note 1). Formatting the disk may not correct the current problem. If it doesn't correct the problem, discard the disk. |
| Disk data lost | Unable to read the disk; try re-installing the disk or cycling the power. |
| Disk is write-protected | The current disk is write-protected. Disengage the write-protect tab on the disk. |
| Disk not ready | The disk drive may not be working properly. |

Disk record not found	The disk format has been damaged. Recover any needed files and reformat the disk (see Note 1). Formatting the disk may not correct the current problem. If it doesn't correct the problem, discard the disk.
Disk timeout	The disk drive may not be working properly or the media was removed while being accessed.
End of file encountered	Trying to read data beyond the end of the file. The file was generated improperly or its contents have been altered.
File not found	The specified file is not on the disk.
Filename exists with different type	A file with the same name of a different file type already exists on the current disk. Select a different destination name.
Incompatible source format	The source format must be 1024 byte/sector LIF.
Invalid configuration file	The contents of this file are incorrect.
Invalid file type	The current operation may not be performed with a file of the current type.
No destination disk	No disk is currently installed in the destination disk drive.
No disk	No disk is installed in the current disk drive.
No room in directory	The directory on the disk is full. Purge any files no longer needed.
No room on disk	The disk is full and the currently written file does not fit. Deleting unneeded files and/or packing the disk may correct the problem.
Selected file is incompatible	The file being loaded is incompatible for this module or option.

Too many files open A previously open file was not closed properly. Reset the disk directory in memory.



Resetting the disk directory in memory is performed by removing the current disk from the disk drive, re-inserting it, and scrolling the directory or selecting a different disk command. Switching between the front and rear disk menu (and vice-versa) also resets the directory in memory.

Unsupported disk format The disk in the disk drive is unformatted or formatted on a non-compatible system. If the contents of the disk are NOT needed, format it.

Disk Warning Messages

Disk warning messages are displayed when the contents of a file or a disk are in danger of being destroyed by an operation. For example:

- | | |
|--|--|
| Duplicate Disk destroys contents of destination | A warning that the duplicate disk command does not append the source files to the destination. It overwrites any files on the destination disk in a packed form. |
| Filenames must begin with a capital letter | This warning indicates that the disk will not accept the filename as it has been entered. Retype the filename with a capital letter at the beginning. |
| Embedded blanks not allowed in filename | This warning indicates that the disk will not accept the filename as it has been entered. Remove the blank spaces or replace them with an underscore character. |

Installing and Removing Cards

The HP 16500A/16501A can be ordered without the cards (PC boards) installed. The modular design of the Logic Analysis System allows you to move the cards between the HP 16500A and the HP 16501A frames.

This appendix explains how and where to install the cards (boards) in the HP 16500A/16501A. For more specific instructions, refer to the reference manual for each module.



When modules have both a master card and an expansion card, both cards must be installed in the same frame. For example, an HP 16520A master card must be installed in the same frame as the HP 16521A expansion card.



Do not install, remove, or replace cards in the HP 16500A/16501A unless the instrument is shut off and the power cord is disconnected.

Some cards may be hooked together by intercard connecting cables. Before removing or installing cards, refer to the reference manual for your particular modules.

Where Do Cards Mount?

Turn off the HP 16500A/16501A system and unplug it. Then turn the HP 16500A/16501A around so that the rear panels are facing you. Notice that the rear panels of the HP 16500A and the HP 16501A are almost identical, except that the rear panel of the HP 16501A does not contain a Port In BNC, HPIB connector, or an RS 232-C connector.

Each frame contains six sets of slots in which to insert the cards (boards). Each slot has a label to its right.

The top slot on the HP 16500A is A, the next one down is B, then C, D, and E. The last slot is labeled CPU for the CPU board of the frame.

The top slot on the HP 16501A is labeled F, the next one down is G, then H, I, and J. The last slot is permanently occupied by the expansion frame interface board, through which the HP 16501A is connected to the HP 16500A.

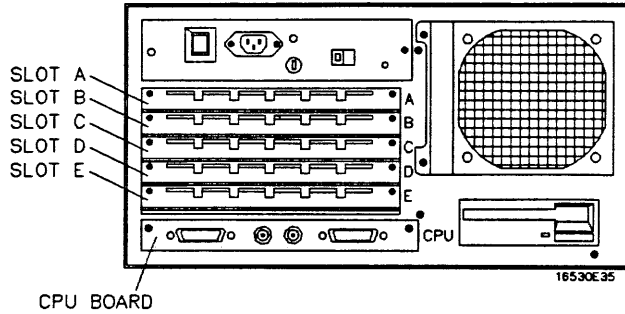

Figure F-1. The HP 16500A Card Cage

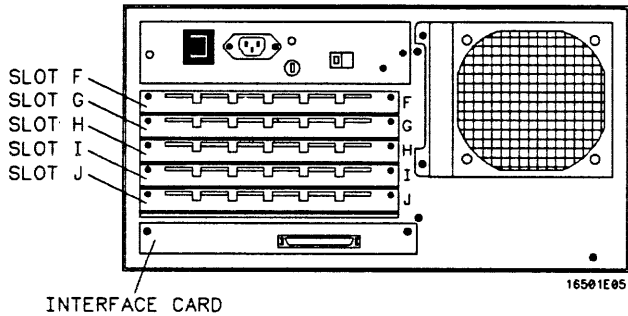

Figure F-2. The HP 16501A Card Cage

Installing Cards in the HP 16500A/16501A

CAUTION

The effects of **ELECTROSTATIC DISCHARGE** can damage electronic components. Grounded wriststraps and mats should be used when you perform any kind of service to the HP 16500A/16501A or the cards in it.

1. Starting from the top of the card cage, loosen the thumb screws on the filler panel(s) and pull them out of the HP 16500A and/or the HP 16501A.
-

Note

Since the endplates of the cards overlap, you must start with the top slot of the frame you want to change and work down when removing cards. To install cards, start with the first open slot at the bottom of the card cage in the frame in which you are changing the cards and work up.

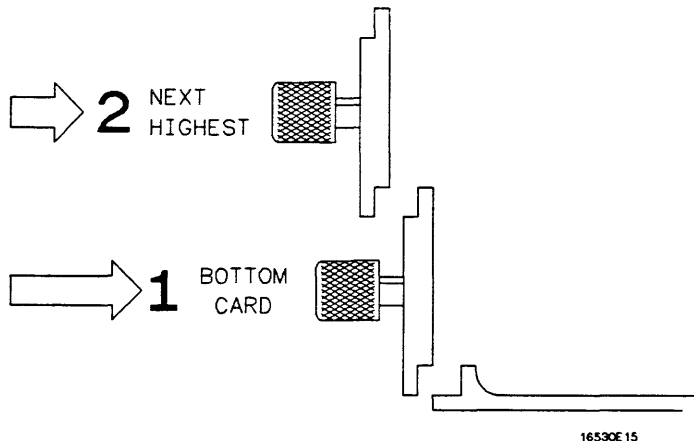

Figure F-3. Endplate Overhang

2. Hold the card (or set of cards) so that the components are facing upward and the main connector is pointing away from you.
3. Align the card (or set of cards) with an appropriate set of slots on the rear panel, filling the slots closest to the bottom first. Gently slide the card in until the connector on the card touches the connector on the frame .

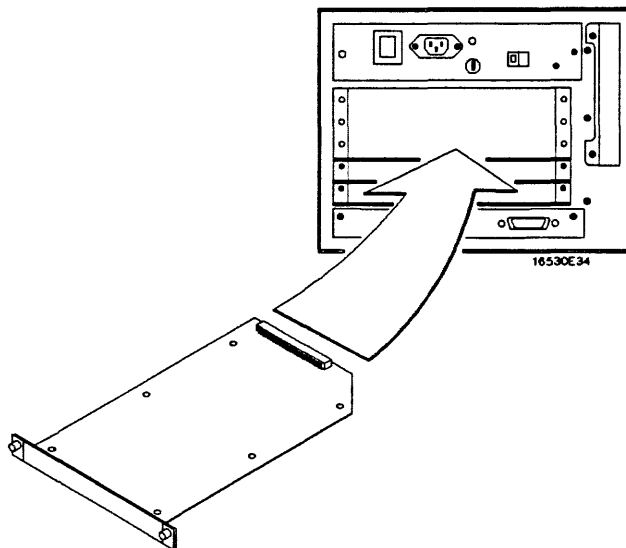

Figure F-4. Installing Cards

4. Gently, but firmly, push the card in until the endplate on the card is flush with the rear panel.
5. While applying pressure to the center of the card endplate, tighten down the thumb screws on either side of the endplate.
6. After you are finished installing cards, install filler panels in all unused slots.



Filler panels must be installed in all unused card slots to ensure correct air circulation.

Removing Cards from the HP 16500A/16501A

To remove cards from the HP 16500A/16501A, you must start with the card in the top slot (slot A in the HP 16500A or slot F in the HP 16501A) of the frame in which you are changing cards. Remove the next card down. Proceed in this manner until you get to the card you need. To remove the cards from their slots:

1. Loosen the thumb screws on either side of the endplate of the card until the thumb screws are free from the frame . If two cards need to be removed together, loosen the screws from both cards before trying to remove the cards.
2. Gently, but firmly, pull on the heads of the thumb screws and slide the cards out.

Creating a System Disk

Generally, your instrument will come from the factory with a fully configured system disk, but occasionally you may need to create a system disk or update an existing system disk. This appendix explains how to create, update, and add files to a system disk.

What Files are Required on the System Disk?

A system disk consists of the software required to operate the mainframe and each module in the system. For the mainframe, this is the file `SYSTEM_` of the file type `16500A_system`. For the individual modules, it would be the file `SYSTEM_XXX` of the file type `XXXXXX_system`. The three characters (`XXX`) in the filename represent the identification code for each individual module. The six characters (`XXXXXX`) in the file type represent the product model number for each module. The identification codes for the HP 16500A/16501A modules are:

- 001 - for the HP 16515A 1 GHz Timing Analyzer
- 011 - for the HP 16530A/16531A 400 Msample/second Oscilloscope
- 021 - for the HP 16520A 50 Mbit/second Pattern Generator
- 030 - for the HP 16511B 160-channel State/Timing Analyzer
- 031 - for the HP 16510B 35 MHz State/100 MHz Timing Analyzer
- 040 - for the HP 16540A/16541A 100 MHz State/Timing Analyzer

These files are included with the HP 16500A/16501A on a "Composite Operating System" Disk.

Creating a New System Disk

Before you start creating a new system disk, format the disk you plan to use for the system disk. Then insert the formatted disk in the rear disk drive of the HP 16500A. To create a new system disk:

1. Insert the HP 16500A System Master Disk in the front disk drive of the HP 16500A.
2. Select the **System Front Disk** menu and when it appears on screen, select the **Copy** operation.
3. Configure the **Copy** operation to **Copy** the file **SYSTEM_** of the file type **16500A_system** to the file **SYSTEM_** on the **Rear Disk** (see figure G-1).
4. Touch **Execute** to execute the **Copy** operation.

The screenshot shows a menu interface with the following elements:

- Buttons: System, Front Disk, Print
- Copy operation configuration:
 - Copy file SYSTEM_ type 16500A_system
 - to SYSTEM_ on Rear Disk
 - Execute button
- Table of files:

Filename	File Type	File Description
SYSTEM_	16500A_system	HP16500A System Software V04.p6
SYSTEM_001	16515A_system	1 GHz Timing Analyzer V04.p6
SYSTEM_011	16530A_system	400MSample/s Dig. Scope V04.p6
SYSTEM_021	16520A_system	50Mbit/s Pattern Gen. V04.p6
SYSTEM_031	16510B_system	35MHz State/100MHz Timing V04.p6

Figure G-1. Copying the HP 16500A/16501A System File

5. Remove the disk from the front disk drive and insert one of the “module master disks” in this disk drive.
6. Rotate the knob on the front panel to read the current files on this module disk.

7. Configure the Copy operation to copy the file SYSTEM_XXX of the file type XXXXXX_system to the file SYSTEM_XXX on the Rear Disk. The three characters (XXX) in the filenames represent the identification code for each individual module. The six characters (XXXXXX) in the file type represent the product model number for each module. Figure G-2 shows the Copy operation configured to copy the HP 16530A oscilloscope module to the system disk.
8. Touch **Execute** to execute the Copy operation.
9. Repeat steps 5 through 8 for each of the modules in your mainframe.

Filename	File Type	File Description
SYSTEM_	16500A_system	HP16500A System Software V04.p6
SYSTEM_001	16515A_system	1 GHz Timing Analyzer V04.p6
SYSTEM_011	16530A_system	400MSample/s Dig. Scope V04.p6
SYSTEM_021	16520A_system	50Mbit/s Pattern Gen. V04.p6
SYSTEM_031	16510B_system	35MHz State/100MHz Timing V04.p6

Figure G-2. Copying the HP 16530A Oscilloscope System File

Adding a Module to the System Disk

To add a module to a current system disk:

1. Insert the system disk in the rear disk drive of the HP 16500A.
2. Insert the “module master disk” in the front disk drive.
3. Select the **System Front Disk** menu and when it appears on screen, select the **Copy** operation.

4. Configure the Copy operation to copy the file **SYSTEM_XXX** of the file type **XXXXXX_system** to the file **SYSTEM_XXX** on the Rear Disk. The three characters (XXX) in the filename represent the identification code for each individual module. The six characters (XXXXXX) in the file type represent the product model number for each module. Figure G-3 shows the Copy operation configured to copy the HP 16530A oscilloscope module to the system disk.
5. Touch **Execute** to execute Copy operation.

Filename	File Type	File Description
SYSTEM_	16500A_system	HP16500A System Software V04.p6
SYSTEM_001	16515A_system	1 GHz Timing Analyzer V04.p6
SYSTEM_011	16530A_system	400MSample/s Dig. Scope V04.p6
SYSTEM_021	16520A_system	50Mbit/s Pattern Gen. V04.p6
SYSTEM_031	16510B_system	35MHz State/100MHz Timing V04.p6

Figure G-3. Adding a Module to the System Disk

Updating a System Disk

To update a current system disk:

1. Insert the system disk in the front disk drive of the HP 16500A.
2. Select the **System Front Disk** menu and when it appears on screen, select the **Purge** operation.
3. Purge the file you want to update from the disk. Figure G-4 shows how the **Purge** operation would be configured to purge the HP 16530A oscilloscope file from the disk.

Filename	File Type	File Description
SYSTEM_	16500A_system	HP16500A System Software V04.p6
SYSTEM_001	16515A_system	1 GHz Timing Analyzer V04.p6
SYSTEM_011	16530A_system	400MSample/s Dig. Scope V04.p6
SYSTEM_021	16520A_system	50Mbit/s Pattern Gen. V04.p6
SYSTEM_031	16510B_system	35MHz State/100MHz Timing V04.p6

Figure G-4. Purging the HP 16530A File from the Disk

4. Remove the system disk from the front disk drive and insert it in the rear disk drive of the HP 16500A/16501A.
5. Insert the “module master disk” in the front disk drive of the HP 16500A/16501A.
6. Select the **Copy** operation.
7. Configure the **Copy** operation to copy the file **SYSTEM_XXX** of the file type **XXXXXX_system** to the file **SYSTEM_XXX** on the **Rear Disk**. The three characters (XXX) in the filename represent the identification code for each individual module. These characters do not appear when you are copying a file for the HP 16500A/16501A mainframe (SYSTEM_).

The six characters (XXXXXX) in the file type represent the product model number for each module. Figure G-5 shows the **Copy** operation configured to copy the HP 16530A oscilloscope module to the system disk.

8. Touch **Execute** to execute **Copy** operation.

Note 

Try packing the disk if you have problems copying a new file to an existing system disk. Then repeat the Copy operation.

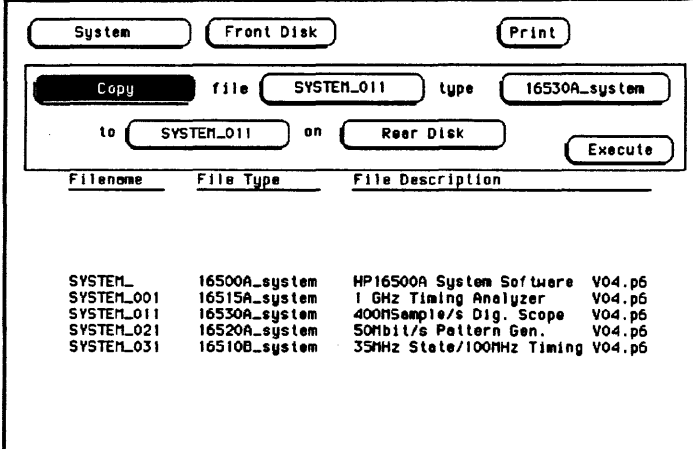

System Front Disk Print

Copy file SYSTEM_011 type 16530A_system

to SYSTEM_011 on Rear Disk Execute

Filename	File Type	File Description
SYSTEM_	16500A_system	HP16500A System Software V04.p6
SYSTEM_001	16515A_system	1 GHz Timing Analyzer V04.p6
SYSTEM_011	16530A_system	400MSample/s Dig. Scope V04.p6
SYSTEM_021	16520A_system	50Mbit/s Pattern Gen. V04.p6
SYSTEM_031	16510B_system	35MHz State/100MHz Timing V04.p6

Figure G-5. Updating the System Disk

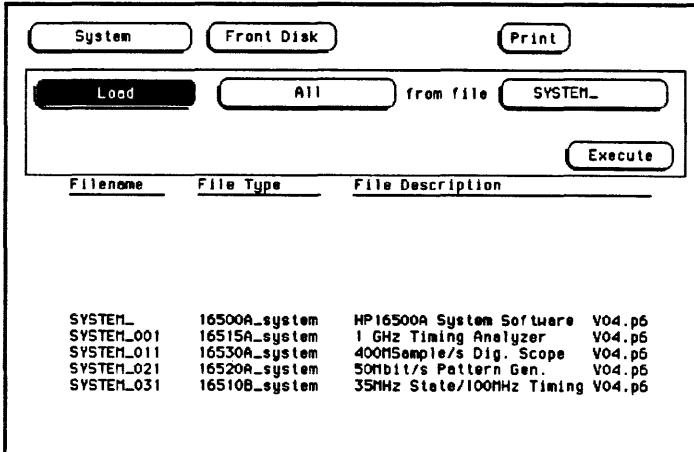

System Front Disk Print

Load All from file SYSTEM_ Execute

Filename	File Type	File Description
SYSTEM_	16500A_system	HP16500A System Software V04.p6
SYSTEM_001	16515A_system	1 GHz Timing Analyzer V04.p6
SYSTEM_011	16530A_system	400MSample/s Dig. Scope V04.p6
SYSTEM_021	16520A_system	50Mbit/s Pattern Gen. V04.p6
SYSTEM_031	16510B_system	35MHz State/100MHz Timing V04.p6

Figure G-6. System Disk Directory with Updated Oscilloscope Software

What Is a System Performance Verification Disk?

A system performance verification disk is a disk that contains all the performance verification software required to run the performance verification tests for the HP 16500A/16501A Logic Analysis System and the corresponding modules configured in the system. This composite disk is found in each software pouch. For more information on the performance verification tests, refer to the *HP 16500A/16501A Service Manual*.

Index

A

- Address, selecting, 5-2
- Alphanumeric keypads, 2-9
- Arming signal
 - sources for HP 16500A, 6-3
 - sources for HP 16501A, 6-4
- Arming triggers, 6-4
- Autoload, 8-2
 - designation, A-3
 - disabling, 8-21
 - enabling, 8-20
- Autoroll
 - defined, 3-3
 - turning off, 3-3
 - using, 3-3

B

- Baud rate
 - defined, 5-2
 - setting, 5-2
- Beeper, A-2
- BNC
 - input, general characteristics, A-4
 - output, general characteristics, A-4
- Boards
 - installing, F-1

C

- Calibration, C-2
- Card cage, F-1
- Card slots, F-1
- Cards
 - installing, F-1, F-3
 - removing, F-5
- Cleaning instructions, C-1
- Clear Display key, 3-2
- Clear Line key, 3-2
- Color
 - for display, 11-7
 - returning to defaults, 11-8
 - selecting, 11-4
- Color model, 11-2
- Configuration tree, 12-12
- Controller interface, defined, 5-1
- Copy, 8-2, 8-7, 8-23
- CPU board, F-1
- Critical errors, D-2
- Cursor
 - defined, 2-15
 - examples of, 2-15
 - general characteristics, A-2
 - moving with cursor keys, 3-1
 - moving with home key, 3-2
 - moving with next and previous keys, 3-2
 - moving with tab key, 3-1
 - selecting an item, 3-2
- Cursor keys, 3-1
 - duplicating knob motion, 3-1

D

Data bits

- defined, 5-4
- supported, 5-4

Default configuration

- defined, 1-3
- storing, 1-4

Degaussing, C-1

Delete Line key, 3-2

Dimensions

- HP 16500A, A-7
- HP 16501A, A-7

Disk operations

- autoload, 8-2
- copy, 8-2
- default values, 8-3
- duplicate disk, 8-3
- format disk, 8-3
- initiating, 8-3
- load, 8-3
- pack disk, 8-3
- parameters, 8-6
- purge, 8-3
- rename, 8-3
- selecting, 8-5
- store, 8-3

Disks

- destination, 8-7
- duplicating, 8-26
- error messages, E-1
- formatting, 8-9
- installing, 8-8
- listing stored files, 8-14
- packing, 8-26
- source, 8-7
- storing files on, 8-11
- type to use, 8-8
- warning messages, E-3

Display

color, A-2

- described, 2-1
- multiple module data on one screen, 12-18
- printing, 7-10
- selecting color for, 11-6

Don't Care key, 3-5

Done key, 3-7

Disk drives, A-3

Duplicate disk, 8-3, 8-7, 8-26

E

Edge trigger assignment keys, 3-7

Endplates, F-3

Enter key, 3-2, 3-7

Environment

- operating, A-6
- shipping, B-1
- storage, B-1

Epson printers, 7-1

Errors

- critical, D-2
- disk error messages, E-1
- disk warning messages, E-3
- non-critical, D-3

Expansion frame control board, 6-1

Expansion frame interface board, 6-2

F

Fail codes

- disk test, D-2
- touchscreen, D-2

Fields

- alphanumeric keypads, 2-9
- immediate-action, 2-8
- knob/numeric, 2-8
- multiple-choice listings, 2-7

- pattern, 2-6
- pop-up menus, 2-5
- toggle, 2-7
- File identification code, G-1
- File types, 8-18, A-3
- Files
 - copying, 8-23
 - identification code, G-1
 - loading, 8-15
 - purging, 8-22
 - renaming, 8-18
 - storing, 8-11
- Filler panels, F-4
- Format disk, 8-3, 8-10
- Function keys, 3-4 - 3-5

G

- Group Run
 - for HP 16500A, 12-5
 - for HP 16500A/16501A, 12-6
- Group Run/Stop
 - repetitive, 12-13
 - using, 12-13

H

- Hardware, A-3
- Home key, 3-2
- HP 16500A
 - arming specifications, 6-3
 - card cage, F-1
 - defined, 1-1
 - dimensions, A-7
 - disk operations, 8-1
 - key features, 1-1
 - optional features, 1-2
 - repacking, B-1

- tagging for service, B-1
- HP 16501A
 - arming specifications, 6-3
 - card cage, F-1
 - components, 6-1, 6-5
 - connecting, 6-5
 - defined, 1-1
 - dimensions, A-7
 - features, 6-1
 - system configuration, 6-2
- HP-IB interface
 - configuring, 5-5
 - defined, 5-1
 - Listen Always, 5-5
 - selecting an address, 5-2
- HP-IB printers
 - configuration, 7-3
 - Listen Always, 7-1 - 7-2
 - setup, 7-1
 - supported, 7-1
- Hue
 - defined, 11-2
 - selecting, 11-4

I

- Immediate-action fields, 2-8
- Input BNC, A-4
- Interactive measurements
 - acquisition, A-5
 - arming, A-5
 - skew, A-5
- Intermodule measurements
 - accessing, 12-11
 - analyzing a glitch, 12-8
 - analyzing interrupt handling, 12-9
 - exercise, 12-21
 - helpful hints, 12-21
 - setting up, 12-11
 - simple stimulus/response, 12-10

Intermodule menu
accessing, 12-1
configuring, 12-12
described, 12-1
menu map, 12-4
types of operations, 12-2

K

Keyboard

Clear Display key, 3-2
Clear Line key, 3-2
connecting, 2-13
cursor, 3-1
cursor keys, 3-1
Delete Line key, 3-2
described, 2-13
disconnecting, 2-15
Don't Care key, 3-5
Done key, 3-7
edge trigger assignment keys, 3-7
Enter key, 3-2, 3-7
function keys, 3-4 - 3-5
functions, 3-1
general characteristics, A-2
home key, 3-2
next and previous keys, 3-2
overlays, 3-4
Return key, 3-2
Select key, 3-2
tab key, 3-1, 3-5
time unit keys, 3-6
use of, 1-2
voltage unit keys, 3-6

Keyboard overlays
function keys, 3-4
using, 3-4

Keypad
use of, 2-9

Knob

Index-4

described, 2-15
duplicating motion with cursor keys, 3-1
general characteristics, A-1
use of, 1-2

Knob/numeric fields, 2-8

L

Listen Always, 5-5, 7-1 - 7-2

Load, 8-3, 8-15

Logic Analysis System
defined, 1-1
general characteristics, A-1
maintenance, C-1

Luminosity
defined, 11-2
selecting, 11-4

M

Maintenance
calibration, C-2
cleaning requirements, C-1
degaussing, C-1

Menu
closing, 3-7
entering data into, 3-2

Menu field, 2-2

Module field, 2-2

Module-to-module arming, 6-3

Modules
adding to system disk, G-3
adjusting skew, 12-17
displaying data on screen, 12-18
locations in configuration tree, 12-14
status of, 12-16

Monitor, A-1

Mouse
 connecting to HP 16500A, 2-10
 connecting to keyboard, 2-11
 described, 2-10
 disconnecting, 2-13
 general characteristics, A-1
 on System Configuration Menu, 2-11
 use of, 1-2
Multiple-choice listings, 2-7

N

Next and previous keys, 3-2
Non-critical errors, D-3

O

Operating Environment
 altitude, A-6
 humidity, A-6
 temperature, A-6
 ventilation, A-6
 vibration, A-6
Output BNC, A-4

P

Pack disk, 8-3, 8-26
Packing material, B-1
Parity
 defined, 5-3
 selecting, 5-3
Pattern fields, 2-6
PC boards, F-1
Performance Verification Software, G-7
Pop-up menus, 2-5

Port in, A-4
Port out, A-4
 BNC connection, 12-16
 use of, 12-15
Power requirements, A-7
Power up self tests, D-1
Printer interface, defined, 5-1
Printers
 alternate, 7-3
 EpsonB, 7-1
 HP-IB, 7-1
 other HP, 7-8
 RS-232C, 7-4
 supported, 7-1, A-4
Programmability, A-4
Protocol
 changing, 5-4
 defined, 5-4
Purge, 8-3, 8-22

R

Rename, 8-3, 8-18
Return key, 3-2
RS-232C interface
 configuring, 5-5
 defined, 5-2
RS-232C printers
 configuration, 7-6, A-4
 configuration example, 7-8
 mode configuration switches, 7-5
 setup, 7-4
 supported, 7-4

S

Saturation

- defined, 11-2
- selecting, 11-4

Screen, A-1

Select key, 3-2

Self tests

- described, D-1
- display, D-1

Service, C-2

Shipping container, B-2

Shipping disks, B-1

Shipping environment, B-1

Skew

- adjusting, 12-17

Skew menu

- accessinf, 12-17
- use of, 12-17

Slot designators

- defined, 2-2, 4-4

Sound

- turning off, 10-5
- turning on, 10-5

Status indicators, 12-16

Stop bits

- changing, 5-3
- defined, 5-3

Storage environment, B-1

Store, 8-3, 8-11

System Configuration Menu

- accessing, 4-1
- defined, 4-1
- for HP 16501A, 6-6
- layout, 4-2
- menu map, 4-5

System disk

- adding module to, G-3
- creating, G-2
- files required, G-1

updating, G-4

System Front Disk menu

- accessing, 8-1
- menu map, 8-4

System Measurement Cards, 2-2

System Performance Verification Disk

- defined, G-7

System Rear Disk menu

- menu map, 8-4

System Test Menu, C-3

System Utilities Menu

- accessing, 9-1, 10-1, 11-1
- described, 9-1
- layout, 9-2
- menu map, 9-3
- sound, 10-5
- touch calibration, 10-2
- touchscreen, 10-4

T

Tab key, 3-1, 3-5

Thumb screws, F-3

Time correlation bars, 12-16

Time Interval, accuracy between modules, A-5

Time unit keys, 3-6

Toggle fields, 2-7

Touch calibration, 10-2

Touchscreen

- calibrating, 10-2
- described, 2-4
- general characteristics, A-1
- turning off, 10-4
- turning on, 10-4
- types of fields, 2-4
- use of, 1-2

U

User interfaces

- exercises, 2-16
- general characteristics, A-1
- keyboard, 1-2, 2-13, 3-1
- knob, 1-2, 2-15
- mouse, 1-2, 2-10
- touchscreen, 1-2, 2-4

V

- Voltage unit keys, 3-6

W

- Warning messages, E-3
- Waveforms, selecting, 12-19
- Weight
 - HP 16500A, A-7



Printed in U.S.A.